

The electronics specialist

maplin

ONLY £1

CATALOGUE 2015



CONTENTS



CABLES



COMPONENTS



POWER



TOOLS



maplin.co.uk

0333 400 9500

The electronics specialist
maplin



/maplin



@maplintweet



/+maplin



/maplintv



/maplinonline

Find what you are looking for easily with the colour coded sections and direct links to our extended range online.

Easy to shop



IN-STORE

over 200 stores nationwide



ONLINE

over 20,000 lines at maplin.co.uk



CLICK + COLLECT

order online and collect instore



PHONE

order on 0333 400 9500



DELIVERY

to your home or office



Contents



CABLES

04 - 21	AV Cables
22 - 27	AV Switches
28 - 29	Stage Cables
30 - 39	Computer Cables
40 - 43	Network Cables
44 - 49	Telephone Cables
50 - 69	Cut Cable
70 - 75	Cable Management
76 - 84	Audio Connectors
84 - 85	Loudspeaker Connectors
86 - 87	XLR Audio
88 - 89	DIN & Multiway Connectors
90 - 91	Computer Connectors
92 - 95	TV & Satellite Connectors
96 - 99	Video & RF Connectors
100 - 107	Power Connectors
108 - 109	Crimp Connectors
110 - 113	PCB Connectors



COMPONENTS

114 - 121	Resistors
122 - 129	Capacitors
130 - 143	Optoelectronics
144 - 159	Semiconductors
160 - 169	Switches
170 - 171	Relays
172 - 179	Transformers, Ferrites & EMC
180 - 187	PCB Development
188 - 191	Fuses
192 - 195	Motors & Servos
196 - 203	Enclosures
204 - 205	Component Loudspeakers



POWER

206 - 213	Electrical Cables
214 - 215	Surge Protection & RCD
216 - 229	Renewable Energy
230 - 253	Batteries
254 - 259	Household Wiring
260 - 285	Power Supplies
286 - 295	Bulbs
296 - 297	Security Lighting



TOOLS

298 - 327	Hand Tools
328 - 333	Power Tools
334 - 341	Soldering
342 - 359	Test & Measurement
360 - 365	Fixings
366 - 375	Tape & Glues
376 - 381	Cleaning & Aerosols
382 - 387	Tool Storage

**our guarantees
to you**

365 DAY

product quality **no quibble guarantee**

PRICE MATCH*

we will **never be beaten on price**

ITEM NOT IN STOCK?

we will order and send it with **free delivery****

* see maplin.co.uk for full terms and conditions

** See in-store for details

CLICK + COLLECT

maplin.co.uk

Check out maplin.co.uk to browse our full range of 30,000 products with more lines added every day! Shopping online from the comfort of your own home has never been easier with our huge range of services and products.

If you can't find what you need in the catalogue, head over to **maplin.co.uk** to browse our full range.

Our speedy Click + Collect service lets you conveniently select where and when you want to pick up your product. If we have it in stock in one of our stores you can click and collect 30 minutes later! Simply pay online and collect your order at a time that suits you.



DELIVERY We can deliver to your home or office on the day of your choice. See online for further details.

Online Exclusives

Online at maplin.co.uk there are tens of thousands more products to choose from. By signing up to our newsletter you will receive the latest news and best offers. It is packed full of the best deals available and information on the newest innovations Maplin have to offer.



Social Media



We want to share our passion for technology with you! Our Facebook, Twitter and YouTube accounts are buzzing with activity on the latest tech, competitions and deals so make sure you Like and Follow our pages to keep up to date!

Follow us [@maplintweet](https://twitter.com/maplintweet) Find us on facebook.com/Maplin



MaplinTV is where we share our exciting tech finds with you. We show you how to make the most of your tech with installation guides and handy tips but also showcase our latest ranges. If your tech know-how has run dry, head to our YouTube channel for help and inspiration.



Need answers?

If you need the answer to your tech problem then our Maplineers are ready to help.

Give us a call on **0333 400 9500** or contact us online.

You can also read and submit reviews/questions online; we would love to hear from you!

CABLES



CONTENTS

04 - 21	AV Cables
22 - 27	AV Switches
28 - 29	Stage Cables
30 - 39	Computer Cables
40 - 43	Network Cables
44 - 49	Telephone Cables
50 - 69	Cut Cable
70 - 75	Cable Management
76 - 84	Audio Connectors
84 - 85	Loudspeaker Connectors
86 - 87	XLR Audio
88 - 89	DIN & Multiway Connectors
90 - 91	Computer Connectors
92 - 95	TV & Satellite Connectors
96 - 99	Video & RF Connectors
100 - 107	Power Connectors
108 - 109	Crimp Connectors
110 - 113	PCB Connectors





Trust our cables. Quality guaranteed.

Essentials

1 year warranty

Value conscious cable
Basic shielding to reduce interference
Nickel plated connectors with copper clad aluminium conductors
Quality cable with 1-year warranty



Maplin

5 year warranty

Improved shielding
Gold plated connectors and pure copper conductors
Thick jacket for durability
Premium quality cable with 5-year warranty

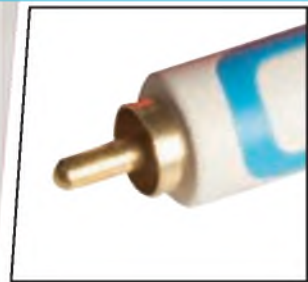

Pro

lifetime warranty

Enhanced shielding
Gold plated connectors and pure copper conductors
Nylon braid jacket for extra strength
Metal connectors on most Pro cables
Highest specification and lifetime warranty



The Maplin branded cable range includes a wide choice of types and lengths, with professional grade options available.

Comprehensive choice of audio visual and computer cables in-store and hugely extended range of varieties available online at maplin.co.uk

The electronics specialist
maplin

AV Cables

HDMI

Maplin Essentials HDMI Cables



- Ideal for use with Sky HD, PS3/4, Xbox One, Blu-Ray, HDTV and any other HDMI devices
- Male to Male
- Suitable for resolutions including 720p and 1080p
- Version 1.4 specification compliant
- Moulded connectors with strain relief
- 1 Year Warranty
- Available in 1.5 and 3 metre lengths

HDMI is a highly versatile cable that combines high definition video and multi-channel audio into one cable. They are commonly used for connecting TVs to set satellite/cables boxes, Blu-ray/DVD players and games consoles. It's also used in PC connectivity and mobile devices, such as tablets and smartphones.

Order Code	Mod: 1031120	Price each exc. VAT 1+	inc. VAT each 1+
A00NT	E HDMI 1.5m	£16.65	£19.99
A01NT	E HDMI 3m	£24.99	£29.99

Maplin Essentials Mini HDMI Cables



- Ideal for use with smartphones, tablets, digital cameras and camcorders, enabling HDTV streaming or playback.
- Suitable for resolutions including 720p and 1080p
- Version 1.4 specification compliant
- Moulded connectors with strain relief
- 1 Year Warranty
- Available in 1.5 and 3 metre lengths

HDMI is a highly versatile cable that combines high definition video and multi-channel audio into one cable. They are commonly used for connecting TVs to set satellite/cables boxes, Blu-ray/DVD players and games consoles. It's also used in PC connectivity and mobile devices, such as tablets and smartphones.

Order Code	Mod: 1031121	Price each exc. VAT 1+	inc. VAT each 1+
A03NT	E miniHDMI 1.5m	£16.65	£19.99
A04NT	E miniHDMI 3m	£24.99	£29.99

Maplin TV

Home of innovation, handy tips and How To videos
youtube.com/maplintv



Maplin Essentials Micro HDMI Cables



- Ideal for use with smartphones, tablets, digital cameras and camcorders, enabling HDTV streaming or playback
- Suitable for resolutions including 720p and 1080p
- Version 1.4 specification compliant
- Moulded connectors with strain relief
- 1 Year Warranty
- Available in 1.5 and 3 metre lengths

HDMI is a highly versatile cable that combines high definition video and multi-channel audio into one cable. They are commonly used for connecting TVs to set satellite/cables boxes, Blu-ray/DVD players and games consoles. It's also used in PC connectivity and mobile devices, such as tablets and smartphones.

Order Code	Mod: 1031122	Price each exc. VAT 1+	inc. VAT each 1+
A06NT	E microHDMI 1.5m	£16.65	£19.99
A07NT	E microHDMI 3m	£24.99	£29.99

Maplin HDMI Cables



- Ideal for use with HDTV, Freeview, Freesat/Sky HD, PS3, PS4, Xbox One, Blu-Ray and any other HDMI device.
- Suitable for resolutions up to and including 1080p and 4K
- Version 2.0 compatible and works with all previous specifications
- 3D TV compatible
- Gold-plated connectors
- Durable and highly flexible outer jacket
- 5 Year Warranty
- Available in 0.75, 1.5, 3, 5, 10 and 20 metre lengths

HDMI is a highly versatile cable that combines high definition video and multi-channel audio into one cable. They are commonly used for connecting TVs to set satellite/cables boxes, Blu-ray/DVD players and games consoles. It's also used in PC connectivity and mobile devices.

Order Code	Mod: 1031123	Price each exc. VAT 1+	inc. VAT each 1+
A09NT	M HDMI 0.75m	£20.82	£24.99
A10NT	M HDMI 1.5m	£24.99	£29.99
A11NT	M HDMI 3m	£33.32	£39.99
A12NT	M HDMI 5m	£45.82	£54.99
A13NT	M HDMI 10m	£66.65	£79.99
A14NT	M HDMI 20m	£91.65	£109.99

Maplin White HDMI Cables



- Ideal for use with HDTV, Freeview, Freesat/Sky HD, PS3, PS4, Xbox One, Blu-Ray and any other HDMI device.
- Suitable for resolutions up to and including 1080p and 4K
- Version 2.0 compatible and works with all previous specifications
- 3D TV compatible
- Gold-plated connectors
- Durable and highly flexible outer jacket
- 5 Year Warranty
- Available in 0.75, 1.5, 3, 5, 10 and 20 metre lengths

HDMI is a highly versatile cable that combines high definition video and multi-channel audio into one cable. They are commonly used for connecting TVs to set satellite/cables boxes, Blu-ray/DVD players and games consoles. It's also used in PC connectivity and mobile devices.

Order Code	Mod: 1031124	Price each exc. VAT 1+	inc. VAT each 1+
A30NT	M HDMI White 0.75m	£20.82	£24.99
A31NT	M HDMI White 1.5m	£24.99	£29.99
A32NT	M HDMI White 3m	£33.32	£39.99
A33NT	M HDMI White 5m	£45.82	£54.99
A34NT	M HDMI White 10m	£66.65	£79.99
A35NT	M HDMI White 20m	£91.65	£109.99

Maplin Mini HDMI Cables



- Ideal for use with smartphones, tablets, digital cameras and camcorders, enabling HDTV streaming or playback.
- Suitable for resolutions up to and including 1080p and 4K
- Version 2.0 compatible and works with all previous specifications
- 3D TV compatible
- Gold-plated connectors
- Durable and highly flexible outer jacket
- 5 Year Warranty
- Available in 0.75, 1.5, 3, 5, 10 and 20 metre lengths

HDMI is a highly versatile cable that combines high definition video and multi-channel audio into one cable. They are commonly used for connecting TVs to set satellite/cables boxes, Blu-ray/DVD players and games consoles. It's also used in PC connectivity and mobile devices. The HDMI Type C connector, or Mini HDMI is featured on many smartphones, tablets and laptop devices, enabling HD video and multi-channel audio output to a TV or monitor.

Order Code	Mod: 1031125	Price each exc. VAT 1+	inc. VAT each 1+
A42NT	M miniHDMI 0.75m	£20.82	£24.99
A43NT	M miniHDMI 1.5m	£24.99	£29.99
A44NT	M miniHDMI 3m	£33.32	£39.99
A45NT	M miniHDMI 5m	£45.82	£54.99
A46NT	M miniHDMI 10m	£66.65	£79.99
A47NT	M miniHDMI 20m	£91.65	£109.99

Maplin Micro HDMI Cables



- Ideal for use with smartphones, tablets, digital cameras and camcorders, enabling HDTV streaming or playback.
- Suitable for resolutions up to and including 1080p and 4K
- Version 2.0 compatible and works with all previous specifications
- 3D TV compatible
- Gold-plated connectors
- Durable and highly flexible outer jacket
- 5 Year Warranty

HDMI is a highly versatile cable that combines high definition video and multi-channel audio into one cable. They are commonly used for connecting TVs to set satellite/cable boxes, Blu-ray/DVD players and games consoles. It's also used in PC connectivity and mobile devices. The HDMI Type D connector, or Micro HDMI is featured on many smartphones, tablets and laptop devices, enabling HD video and multi-channel audio output to a TV or monitor.

Order Code	Mod: 1031126	Price each exc. VAT 1+	inc. VAT each 1+
A49NT	M. microHDMI 0.75m	£20.82	£24.99
A50NT	M. microHDMI 1.5m	£24.99	£29.99
A51NT	M. microHDMI 3m	£33.32	£39.99
A52NT	M. microHDMI 5m	£45.82	£54.99
A53NT	M. microHDMI 10m	£66.65	£79.99
A54NT	M. microHDMI 20m	£91.65	£109.99

Maplin HDMI to DVI-D Cables



- Ideal for use with HDTV, PC and laptop computers
- Suitable for resolutions up to and including 1080p
- Compatible with female DVI-D and DVI-I sockets
- Gold-plated connectors
- Durable and highly flexible outer jacket
- 5 Year Warranty

HDMI is a highly versatile cable that combines high definition video and multi-channel audio into one cable. DVI-D is a digital interface that supports up to 1080p resolution, and is video only, without audio support. DVI-D does not support analogue output, and is incompatible with DVI-A and VGA. Variants of this interface can support analogue output [DVI-A], and both analogue and digital [DVI-I] formats.

Order Code	Mod: 1031127	Price each exc. VAT 1+	inc. VAT each 1+
A56NT	M HDMI to DVI 0.75m	£20.82	£24.99
A57NT	M HDMI to DVI 1.5m	£24.99	£29.99
A58NT	M HDMI to DVI 3m	£33.32	£39.99
A59NT	M HDMI to DVI 5m	£45.82	£54.99
A60NT	M HDMI to DVI 10m	£66.65	£79.99
A61NT	M HDMI to DVI 20m	£91.65	£109.99

Maplin Flat HDMI Cables



- Ideal for use with HDTV, Freeview, Freesat/Sky HD, PS3, PS4, Xbox One, Blu-Ray and any other HDMI

device.

- Flat, flexible cable ideal for custom fitting and installation.
- Suitable for resolutions up to and including 1080p and 4K
- Version 2.0 compatible and works with all previous specifications
- 3D TV compatible
- Gold-plated connectors
- Durable and highly flexible outer jacket
- 5 Year Warranty

HDMI is a highly versatile cable that combines high definition video and multi-channel audio into one cable. They are commonly used for connecting TVs to set satellite/cable boxes, Blu-ray/DVD players and games consoles. It's also used in PC connectivity and mobile devices.

Order Code	Mod: 1031128	Price each exc. VAT 1+	inc. VAT each 1+
A63NT	M Flat HDMI 0.75m	£24.99	£29.99
A64NT	M Flat HDMI 1.5m	£29.15	£34.99
A65NT	M Flat HDMI 3m	£37.49	£44.99
A66NT	M Flat HDMI 5m	£49.99	£59.99
A67NT	M Flat HDMI 10m	£70.82	£84.99
A68NT	M Flat HDMI 20m	£95.82	£114.99

Maplin Flat White HDMI Cables



- Ideal for use with HDTV, Freeview, Freesat/Sky HD, PS3, PS4, Xbox One, Blu-Ray and any other HDMI device.
- Flat, flexible cable ideal for custom fitting and installation.
- Suitable for resolutions up to and including 1080p and 4K
- Version 2.0 compatible and works with all previous specifications
- 3D TV compatible
- Gold-plated connectors
- Durable and highly flexible outer jacket
- 5 Year Warranty

HDMI is a highly versatile cable that combines high definition video and multi-channel audio into one cable. They are commonly used for connecting TVs to set satellite/cable boxes, Blu-ray/DVD players and games consoles. It's also used in PC connectivity and mobile devices.

Order Code	Mod: 1031129	Price each exc. VAT 1+	inc. VAT each 1+
A70NT	M Flat HDMI Wht 1.5m	£29.15	£34.99
A71NT	M Flat HDMI Wht 3m	£37.49	£44.99
A72NT	M Flat HDMI Wht 5m	£49.99	£59.99
A73NT	M Flat HDMI Wht 10m	£70.82	£84.99
A74NT	M Flat HDMI Wht 20m	£95.82	£114.99

Trust our cables. Quality guaranteed.

- Essentials - 1 year warranty
- Maplin - 5 year warranty
- Pro - lifetime warranty

Our Maplin branded cables offer an expansive range of types and lengths with professional grade options available.

see page 5 for full details

KNOW YOUR CABLES

HDMI – High definition multimedia interface, a composite connection for audio, video and data, the most commonly used interconnect between AV equipment and commonly seen on computers and games consoles.

3.5mm Jack – The most common audio connection, most headphones now come with this connection and it is found on most smartphones and portable media players.

1/4 Inch Jack – Now more commonly found on professional audio equipment, a large audio interconnect, found on some bigger headphones and also used in musical instrument connections.

Phono / RCA – Phono leads are usually used for single channel audio or video, often used in pairs of left and right audio or with another cable for video, also used for RGB connections.

DIN – Circular connection with composite pins, used for a variety of equipment, not as commonly used as they used to be. Available in a variety of formats.

Optical Cables – Sometimes referred to as TOS or Toslink, an optic fibre connection usually used for digital audio, used in high specification systems and not susceptible to RF interference.

Coax – Coaxial cables are 2 phase shielded cables, used for TV aerial connections and analogue AV interconnects.

SCART – Used to be the main AV interconnect before HDMI, SCART cables can carry multiple AV and data signals between audio and video equipment.

S-Video – A video only mini-DIN style connection, usually used in tandem with phono L and R for audio.

BNC – A locking analogue connection for coaxial leads, good for robust connection of cables and equipment that is frequently disconnected.

F-Type – Sometimes called F-connector, commonly used on satellite and cable systems, it's a screw thread connector for coaxial cables.

Speakon – A trademarked cable plug type originally made by Neutrik, commonly used for professional connections to loudspeakers and amplifiers – features a spring catch for fast and secure connection.

XLR – Another connection primarily found on professional audio equipment, available with a number of different pin formats but almost always used for balanced audio connections.

Maplin Thin HDMI Cables



- Ideal for use with HDTV, Freeview, Freesat/Sky HD, PS3, PS4, Xbox One, Blu-Ray and any other HDMI device
- Suitable for resolutions up to and including 1080p and 4K
- Version 2.0 compatible and works with all previous specifications
- 3D TV compatible
- Gold-plated connectors
- Durable and highly flexible outer jacket
- 5 Year Warranty
- Available in 0.75, 1.5, 3, 5, 10 and 20 metre lengths

HDMI is a highly versatile cable that combines high definition video and multi-channel audio into one cable. They are commonly used for connecting TVs to set satellite/cable boxes, Blu-ray/DVD players and games consoles. It's also used in PC connectivity and mobile devices.

Order Code	Mod: 1031130	Price each exc. VAT 1+	inc. VAT each 1+
A76NT	M Thin HDMI 0.75m	£24.99	£29.99
A77NT	M Thin HDMI 1.5m	£29.15	£34.99
A78NT	M Thin HDMI 3m	£37.49	£44.99
A79NT	M Thin HDMI 5m	£49.99	£59.99
A80NT	M Thin HDMI 10m	£70.82	£84.99
A81NT	M Thin HDMI 20m	£95.82	£114.99

Maplin Screw HDMI Cables



- Ideal for use with HDTV, Freeview, Freesat/Sky HD, PS3, PS4, Xbox One, Blu-Ray and any other HDMI device
- Suitable for resolutions up to and including 1080p and 4K
- Version 2.0 compatible and works with all previous specifications
- 3D TV compatible
- Gold-plated connectors
- Durable and highly flexible outer jacket
- 5 Year Warranty
- Available in 0.75, 1.5, 3, 5, 10 and 20 metre lengths

HDMI is a highly versatile cable that combines high definition video and multi-channel audio into one cable. They are commonly used for connecting TVs to set satellite/cable boxes, Blu-ray/DVD players and games consoles. It's also used in PC connectivity and mobile devices.

Order Code	Mod: 1031131	Price each exc. VAT 1+	inc. VAT each 1+
A83NT	M HDMI Screw 0.75m	£24.99	£29.99
A84NT	M HDMI Screw 1.5m	£29.15	£34.99
A85NT	M HDMI Screw 3m	£37.49	£44.99
A86NT	M HDMI Screw 5m	£49.99	£59.99
A87NT	M HDMI Screw 10m	£70.82	£84.99
A88NT	M HDMI Screw 20m	£95.82	£114.99

Maplin Swivel HDMI Cables



- Ideal for use with HDTV, Freeview, Freesat/Sky HD, PS3, PS4, Xbox One, Blu-Ray and any other HDMI device
- Suitable for resolutions up to and including 1080p and 4K
- Version 2.0 compatible and works with all previous specifications
- 3D TV compatible
- Gold-plated connectors
- Durable and highly flexible outer jacket
- 5 Year Warranty
- Available in 0.75, 1.5, 3, 5, 10 and 20 metre lengths

HDMI is a highly versatile cable that combines high definition video and multi-channel audio into one cable. They are commonly used for connecting TVs to set satellite/cable boxes, Blu-ray/DVD players and games consoles. It's also used in PC connectivity and mobile devices.

Order Code	Mod: 1031132	Price each exc. VAT 1+	inc. VAT each 1+
A90NT	M HDMI Swivel 0.75m	£29.15	£34.99
A91NT	M HDMI Swivel 1.5m	£33.32	£39.99
A92NT	M HDMI Swivel 3m	£41.65	£49.99
A93NT	M HDMI Swivel 5m	£54.15	£64.99
A94NT	M HDMI Swivel 10m	£74.99	£89.99
A95NT	M HDMI Swivel 20m	£99.99	£119.99

Maplin HDMI Extension Cables



- Ideal for use with HDTV, Freeview, Freesat/Sky HD, PS3, PS4, Xbox One, Blu-Ray and any other HDMI device
- Suitable for resolutions up to and including 1080p and 4K
- Version 2.0 compatible and works with all previous specifications
- 3D TV compatible
- Gold-plated connectors
- Durable and highly flexible outer jacket
- 5 Year Warranty
- Available in 0.75, 1.5, 3, 5, 10 and 20 metre lengths

HDMI is a highly versatile cable that combines high definition video and multi-channel audio into one cable. They are commonly used for connecting TVs to set satellite/cable boxes, Blu-ray/DVD players and games consoles. It's also used in PC connectivity and mobile devices.

Order Code	Mod: 1031133	Price each exc. VAT 1+	inc. VAT each 1+
A97NT	M HDMI Ext 0.75m	£20.82	£24.99
A98NT	M HDMI Ext 1.5m	£24.99	£29.99
A99NT	M HDMI Ext 3m	£33.32	£39.99
A00NU	M HDMI Ext 5m	£45.82	£54.99
A01NU	M HDMI Ext 10m	£66.65	£79.99
A02NU	M HDMI Ext 20m	£91.65	£109.99

Maplin HDMI Adapters



A04NU



A07NU



A08NU



A09NU



A10NU



A11NU



A12NU



A13NU



A14NU

- Fully wired terminals
- Gold-plated connectors
- Durable plastic housing
- 5 Year Warranty

Order Code	Mod: 1031134	Price each exc. VAT 1+	inc. VAT each 1+
A04NU	M HDMI A to C Adp	£10.82	£12.99
A05NU	M HDMI A to D Adp	£10.82	£12.99
A07NU	HDMI Coupler	£10.82	£12.99
A08NU	HDMI to DVI Adaptor	£10.82	£12.99
A09NU	DVI to HDMI Adaptor	£10.82	£12.99
A10NU	HDMI Swivel Adpt M-F	£12.49	£14.99
A11NU	Rightangled 270 HDMI	£10.82	£12.99
A12NU	Rightangled 90 HDMI	£10.82	£12.99
A13NU	Side angled 270 HDMI	£10.82	£12.99
A14NU	Side angled 90 HDMI	£10.82	£12.99

 Browse our entire range at maplin.co.uk

 Friendly expert advice on **0333 400 9500**

Maplin Pro HDMI Cables



- Ideal for use with HDTV, Freeview, Freesat/Sky HD, PS3, PS4, Xbox One, Blu-Ray and any other HDMI device
- Pure copper conductors for optimal signal quality
- Suitable for resolutions up to and including 1080p and 4K
- Version 2.0 compatible and works with all previous specifications
- 3D TV compatible
- Gold-plated connectors
- Nylon braided cable protection for a lifetime of use
- Lifetime Warranty
- Available in 1.5 and 3 metre lengths

Order Code	Mod: 1031135	Price each exc. VAT 1+	inc. VAT each 1+
A16NU	P.HDMI Net 0.75m	£29.15	£34.99
A17NU	P.HDMI Net 1.5m	£33.32	£39.99
A18NU	P.HDMI Net 3m	£41.65	£49.99
A19NU	P.HDMI Net 5m	£58.32	£69.99
A20NU	P.HDMI Net 10m	£83.32	£99.99
A21NU	P.HDMI Net 20m	£116.65	£139.99

Maplin Pro miniHDMI Cables



- Ideal for use with smartphones, tablets, digital cameras and camcorders, enabling HDTV streaming or playback
- Pure copper conductors for optimal signal quality
- Suitable for resolutions up to and including 1080p and 4K
- Version 2.0 compatible and works with all previous specifications
- 3D TV compatible
- Gold-plated connectors
- Nylon braided cable protection for a lifetime of use
- Lifetime Warranty
- Available in 1.5 and 3 metre lengths

Order Code	Mod: 1031136	Price each exc. VAT 1+	inc. VAT each 1+
A24NU	P.miniHDMI 1.5m	£33.32	£39.99
A25NU	P.miniHDMI 3m	£41.65	£49.99

Maplin Pro microHDMI Cables



- Ideal for use with smartphones, tablets, digital cameras and camcorders, enabling HDTV streaming or playback
- Pure copper conductors for optimal signal quality
- Suitable for resolutions up to and including 1080p and 4K
- Version 2.0 compatible and works with all previous specifications
- 3D TV compatible
- Gold-plated connectors
- Nylon braided cable protection for a lifetime of use
- Lifetime Warranty
- Available in 1.5 and 3 metre lengths

Order Code	Mod: 1031137	Price each exc. VAT 1+	inc. VAT each 1+
A31NU	P.microHDMI 1.5m	£33.32	£39.99
A32NU	P.microHDMI 3m	£41.65	£49.99

Maplin Pro Flat HDMI Cables



- Ideal for use with HDTV, Freeview, Freesat/Sky HD, PS3, PS4, Xbox One, Blu-Ray and any other HDMI device
- Flat, flexible cable ideal for custom fitting and installation
- Pure copper conductors for optimal signal quality
- Suitable for resolutions up to and including 1080p and 4K
- Version 2.0 compatible and works with all previous specifications
- 3D TV compatible
- Gold-plated connectors
- Nylon braided cable protection for a lifetime of use
- Lifetime Warranty
- Available in 0.75, 1.5, 3 and 5 metre lengths

Order Code	Mod: 1031138	Price each exc. VAT 1+	inc. VAT each 1+
A44NU	P.Flat HDMI 0.75m	£33.32	£39.99
A45NU	P.Flat HDMI 1.5m	£37.49	£44.99
A46NU	P.Flat HDMI 3m	£45.82	£54.99
A47NU	P.Flat HDMI 5m	£62.49	£74.99

Analogue Audio

Maplin Essentials 3.5mm Stereo Jack Aux Cables



- Ideal for use with CD, MP3, In Car, headphones and other analogue audio devices
- 3 pole Jack terminals with left, right and ground contacts
- Moulded connectors with strain relief
- 1 Year Warranty
- Available in 1.5 and 3 metre lengths

This 3.5mm Jack cable carries stereo sound across a variety of audio devices. It is a highly versatile cable and commonly used when connecting audio equipment to smartphones and MP3 players, tablets, computers, TV's

and gaming consoles. It is also used in many in-car audio and DJ audio systems

Order Code	Mod: 1031165	Price each exc. VAT 1+	inc. VAT each 1+
A71NU	E 3.5mm Lead 1.5m	£6.65	£7.99
A72NU	E 3.5mm Lead 3m	£8.32	£9.99

Maplin Essentials 3.5mm Stereo Jack Aux Extension Cables



- Ideal for use with CD, MP3, In Car, headphones and other analogue audio devices.
- 3 pole Jack terminals with left, right and ground contacts
- Moulded connectors with strain relief
- 1 Year Warranty
- Available in 3 and 5 metre lengths

This 3.5mm Jack cable carries stereo sound across a variety of audio devices. It is a highly versatile cable and commonly used when connecting audio equipment to smartphones and MP3 players, tablets, computers, TV's and gaming consoles. It is also used in many in-car audio and DJ audio systems

Order Code	Mod: 1031166	Price each exc. VAT 1+	inc. VAT each 1+
A74NU	E 3.5mm Ext 3m	£8.32	£9.99
A75NU	E 3.5mm Ext 5m	£10.82	£12.99

Maplin Essentials 3.5mm Stereo Jack Aux to Twin Phono RCA Cables



- Ideal for use with CD, MP3, HDTV surround sound systems and other analogue audio devices
- 3 pole Jack terminals with left, right and ground contacts
- 2 pole Phono terminals with positive and ground contacts
- Moulded connectors with strain relief
- 1 Year Warranty
- Available in 1.5 and 3 metre lengths

This 3.5mm Jack to Twin Phono cable carries stereo sound across a variety of audio devices. It is a highly versatile cable and commonly used when connecting equipment in DJ audio systems, PC audio, and speaker systems for TV's and games consoles. Twin Phono is also known as an RCA connection and carries two mono signals across each Phono connector, which are combined in audio equipment for stereo sound

Order Code	Mod: 1031167	Price each exc. VAT 1+	inc. VAT each 1+
A77NU	E 3.5-2x Phono 1.5m	£6.65	£7.99
A78NU	E 3.5-2x Phono 3m	£8.32	£9.99

Reserve online, collect in-store in 30 minutes



Maplin Essentials Twin Phono RCA Cables



- Ideal for use with CD, MP3, HDTV surround sound systems and other analogue audio devices
- 2 pole Phono terminals with positive and ground contacts
- Moulded connectors with strain relief
- 1 Year Warranty
- Available in 1.5 and 3 metre lengths

Twin Phono is also known as an RCA connection and carries two mono signals across each Phono connector, which are combined in audio equipment for stereo sound. It is an audio cable commonly used when connecting equipment in home and DJ audio systems, PC audio, and in speaker systems for TVs and games consoles.

Order Code	Mod: 1031168	Price each exc. VAT 1+	inc. VAT each
A80NU	E 2x Phono 1.5m	£6.65	£7.99
A81NU	E 2x Phono 3m	£8.32	£9.99

Maplin Essentials Twin Phono RCA Extension Cables



- Ideal for use with CD, MP3, HDTV surround sound systems and other analogue audio devices
- 2 pole Phono terminals with positive and ground contacts
- Moulded connectors with strain relief
- 1 Year Warranty
- Available in 3 and 5 metre lengths

Twin Phono is also known as an RCA connection and carries two mono signals across each Phono connector, which are combined in audio equipment for stereo sound. It is an audio cable commonly used when connecting equipment in home and DJ audio systems, PC audio, and in speaker systems for TVs and games consoles.

Order Code	Mod: 1031169	Price each exc. VAT 1+	inc. VAT each
A83NU	E 2x Phono Ext 3m	£8.32	£9.99
A84NU	E 2x Phono Ext 5m	£10.82	£12.99

Maplin 3.5mm Stereo Jack Cables



- Ideal for use with CD, MP3, In Car, headphones and other analogue audio devices
- 3 pole Jack terminals with left, right and ground contacts
- Gold-plated connectors
- Durable and highly flexible outer jacket
- 5 Year Warranty
- Available in 0.25, 0.5, 0.75, 1.5, 3, 5, 10, 20 and 30 metre lengths

This 3.5mm Jack cable carries stereo sound across a variety of audio devices. It is a highly versatile cable and commonly used when connecting audio equipment to smartphones and MP3 players, tablets, computers, TV's and gaming consoles. It is also used in many in-car audio and DJ audio systems

Order Code	Mod: 1031170	Price each exc. VAT 1+	inc. VAT each
A86NU	M 3.5mm Lead 0.25m	£7.49	£8.99
A87NU	M 3.5mm Lead 0.5m	£8.32	£9.99
A88NU	M 3.5mm Lead 0.75m	£9.15	£10.99
A89NU	M 3.5mm Lead 1.5m	£10.82	£12.99
A90NU	M 3.5mm Lead 3m	£12.49	£14.99
A91NU	M 3.5mm Lead 5m	£14.99	£17.99
A92NU	M 3.5mm Lead 10m	£19.15	£22.99
A93NU	M 3.5mm Lead 20m	£24.99	£29.99
A94NU	M 3.5mm Lead 30m	£33.32	£39.99

Maplin Coiled 3.5mm Stereo Jack Cables



- Ideal for use with CD, MP3, In Car, headphones and other analogue audio devices
- Coiled lead stays compact and avoids tangles
- 3 pole Jack terminals with left, right and ground contacts
- Gold-plated connectors
- Durable and highly flexible outer jacket
- 5 Year Warranty
- Available in 1.5 and 3 metre lengths

This 3.5mm Jack cable carries stereo sound across a variety of audio devices. It is a highly versatile cable and commonly used when connecting audio equipment to smartphones and MP3 players, tablets, computers, TV's and gaming consoles. It is also used in many in-car audio and DJ audio systems

Order Code	Mod: 1031171	Price each exc. VAT 1+	inc. VAT each
A96NU	M 3.5mm C Lead 1.5m	£11.65	£13.99
A97NU	M 3.5mm C Lead 3m	£13.32	£15.99

Maplin Right Angle 3.5mm Stereo Jack Cables



- Ideal for use with CD, MP3, In Car, headphones and other analogue audio devices
- Right angle connector for compact fitting to mobile devices
- 3 pole Jack terminals with left, right and ground contacts
- Gold-plated connectors
- Durable and highly flexible outer jacket
- 5 Year Warranty
- Available in 0.5, 0.75, 1.5, 3, 5, 10, 20 and 30 metre

lengths

This 3.5mm Jack cable carries stereo sound across a variety of audio devices. It is a highly versatile cable and commonly used when connecting audio equipment to smartphones and MP3 players, tablets, computers, TV's and gaming consoles. It is also used in many in-car audio and DJ audio systems

Order Code	Mod: 1031172	Price each exc. VAT 1+	inc. VAT each
A99NU	M 3.5mm RA 1 0.5m	£8.32	£9.99
A00NW	M 3.5mm RA 1 0.75m	£9.15	£10.99
A01NW	M 3.5mm RA 1 1.5m	£10.82	£12.99
A02NW	M 3.5mm RA 1 3m	£12.49	£14.99
A03NW	M 3.5mm RA 1 5m	£14.99	£17.99
A04NW	M 3.5mm RA 1 10m	£19.15	£22.99
A05NW	M 3.5mm RA 1 20m	£24.99	£29.99
A06NW	M 3.5mm RA 1 30m	£33.32	£39.99

Maplin Dual Right Angle 3.5mm Stereo Jack Cables



- Ideal for use with CD, MP3, In Car, headphones and other analogue audio devices
- Two right angle connectors for compact fitting to mobile devices
- 3 pole Jack terminals with left, right and ground contacts
- Gold-plated connectors
- Durable and highly flexible outer jacket
- 5 Year Warranty
- Available in 0.5, 0.75, 1.5, 3 and 5 metre lengths

This 3.5mm Jack cable carries stereo sound across a variety of audio devices. It is a highly versatile cable and commonly used when connecting audio equipment to smartphones and MP3 players, tablets, computers, TV's and gaming consoles. It is also used in many in-car audio and DJ audio systems

Order Code	Mod: 1031173	Price each exc. VAT 1+	inc. VAT each
A08NW	M 3.5mm RA 2 0.5m	£8.32	£9.99
A09NW	M 3.5mm RA 2 0.75m	£9.15	£10.99
A10NW	M 3.5mm RA 2 1.5m	£10.82	£12.99
A11NW	M 3.5mm RA 2 3m	£12.49	£14.99
A12NW	M 3.5mm RA 2 5m	£14.99	£17.99

Maplin 3.5mm Stereo Jack Extension Cables



- Ideal for use with CD, MP3, In Car, headphones and other analogue audio devices
- 3 pole Jack terminals with left, right and ground contacts
- Gold-plated connectors
- Durable and highly flexible outer jacket
- 5 Year Warranty
- Available in 0.75, 1.5, 3, 5, 10, 20 and 30 metre lengths

This 3.5mm Jack cable carries stereo sound across a variety of audio devices. It is a highly versatile cable and commonly used when connecting audio equipment to smartphones and MP3 players, tablets, computers, TV's

and gaming consoles. It is also used in many in-car audio and DJ audio systems.

Order Code	Mod: 1031174	Price each exc. VAT 1+	inc. VAT each
A14NW	M 3.5mm Ext 0.75m	£9.15	£10.99
A15NW	M 3.5mm Ext 1.5m	£10.82	£12.99
A16NW	M 3.5mm Ext 3m	£12.49	£14.99
A17NW	M 3.5mm Ext 5m	£14.99	£17.99
A18NW	M 3.5mm Ext 10m	£19.15	£22.99
A19NW	M 3.5mm Ext 20m	£24.99	£29.99
A20NW	M 3.5mm Ext 30m	£33.32	£39.99

Maplin 3.5mm Mono Jack Cables



- Ideal for use with CD, MP3, In Car, headphones and other analogue audio devices
- 2 pole Jack terminals with positive and ground contacts
- Gold-plated connectors
- Durable and highly flexible outer jacket
- 5 Year Warranty
- Available in 1.5, 3, 5 and 10 metre lengths

This 3.5mm Jack cable carries mono sound across a variety of audio devices. It is commonly used in DJ equipment as well as home entertainment and PC audio systems. Note this is a single channel mono lead, and will not carry stereo sound.

Order Code	Mod: 1031177	Price each exc. VAT 1+	inc. VAT each
A22NW	M 3.5mm M Lead 1.5m	£10.82	£12.99
A23NW	M 3.5mm M Lead 3m	£12.49	£14.99
A24NW	M 3.5mm M Lead 5m	£14.99	£17.99
A25NW	M 3.5mm M Lead 10m	£19.15	£22.99

Maplin Flat Black 3.5mm Stereo Jack Cables



- Ideal for use with CD, MP3, In Car, headphones and other analogue audio devices
- Flat cable is tangle-resistant, ideal for mobile use
- 3 pole Jack terminals with left, right and ground contacts
- Gold-plated connectors
- Durable and highly flexible outer jacket
- 5 Year Warranty
- Available in 0.75, 1.5, 3, 5, 10 and 20 metre lengths

This 3.5mm Jack cable carries stereo sound across a variety of audio devices. It is a highly versatile cable and commonly used when connecting audio equipment to smartphones and MP3 players, tablets, computers, TV's and gaming consoles. It is also used in many in-car audio and DJ audio systems.

Order Code	Mod: 1031178	Price each exc. VAT 1+	inc. VAT each
A27NW	M 3.5mm Flat Bk .75m	£9.99	£11.99
A28NW	M 3.5mm Flat Bk 1.5m	£11.65	£13.99
A29NW	M 3.5mm Flat Bk 3m	£13.32	£15.99
A30NW	M 3.5mm Flat Bk 5m	£15.82	£18.99
A31NW	M 3.5mm Flat Bk 10m	£19.99	£23.99
A32NW	M 3.5mm Flat Bk 20m	£25.82	£30.99



Friendly expert advice on
0333 400 9500

Maplin Flat Red 3.5mm Stereo Jack Cables



- Ideal for use with CD, MP3, In Car, headphones and other analogue audio devices
- Flat cable is tangle-resistant, ideal for mobile use
- 3 pole Jack terminals with left, right and ground contacts
- Gold-plated connectors
- Durable and highly flexible outer jacket
- 5 Year Warranty
- Available in 0.75, 1.5, 3, 5, 10 and 20 metre lengths

This 3.5mm Jack cable carries stereo sound across a variety of audio devices. It is a highly versatile cable and commonly used when connecting audio equipment to smartphones and MP3 players, tablets, computers, TV's and gaming consoles. It is also used in many in-car audio and DJ audio systems.

Order Code	Mod: 1031179	Price each exc. VAT 1+	inc. VAT each
A34NW	M 3.5mm Flat Rd .75m	£9.99	£11.99
A35NW	M 3.5mm Flat Rd 1.5m	£11.65	£13.99
A36NW	M 3.5mm Flat Rd 3m	£13.32	£15.99
A37NW	M 3.5mm Flat Rd 5m	£15.82	£18.99
A38NW	M 3.5mm Flat Rd 10m	£19.99	£23.99
A39NW	M 3.5mm Flat Rd 20m	£25.82	£30.99

Trust our cables. Quality guaranteed.

Our Maplin branded cables offer an expansive range of types and lengths with professional grade options available. [see page 5 for full details](#)

Maplin Flat White 3.5mm Stereo Jack Cables



- Ideal for use with CD, MP3, In Car, headphones and other analogue audio devices
- Flat cable is tangle-resistant, ideal for mobile use
- 3 pole Jack terminals with left, right and ground contacts
- Gold-plated connectors
- Durable and highly flexible outer jacket
- 5 Year Warranty
- Available in 0.75, 1.5, 3, 5, 10 and 20 metre lengths

This 3.5mm Jack cable carries stereo sound across a variety of audio devices. It is a highly versatile cable and commonly used when connecting audio equipment to smartphones and MP3 players, tablets, computers, TV's and gaming consoles. It is also used in many in-car audio and DJ audio systems.

Order Code	Mod: 1031180	Price each exc. VAT 1+	inc. VAT each
A41NW	M 3.5mm Flat Wt .75m	£9.99	£11.99
A42NW	M 3.5mm Flat Wt 1.5m	£11.65	£13.99
A43NW	M 3.5mm Flat Wt 3m	£13.32	£15.99
A44NW	M 3.5mm Flat Wt 5m	£15.82	£18.99
A45NW	M 3.5mm Flat Wt 10m	£19.99	£23.99
A46NW	M 3.5mm Flat Wt 20m	£25.82	£30.99

Maplin 3.5mm Adapters



A48NW

A49NW

A50NW

A51NW

- Fully wired terminals
- Gold-plated connectors
- Durable and highly flexible outer jacket
- 25cm length
- 5 Year Warranty

Order Code	Mod: 1031183	Price each exc. VAT 1+	inc. VAT each
A48NW	M 3.5-2x Phono Skt	£6.65	£7.99
A49NW	M 3.5mm Split Stereo	£6.65	£7.99
A50NW	M 3.5mm Split Mono	£6.65	£7.99
A51NW	M 3.5mm LR Splitter	£6.65	£7.99

Maplin 3.5mm Stereo Jack to Twin Phono RCA Cables



- Ideal for use with CD, MP3, In Car, headphones and other analogue audio devices
- 3 pole Jack terminals with left, right and ground contacts
- 2 pole Phono terminals with positive and ground contacts
- Gold-plated connectors
- Durable and highly flexible outer jacket
- 5 Year Warranty
- Available in 0.5, 0.75, 1.5, 3, 5, 10 and 20 metre lengths

Order Code	Mod: 1031184	Price each exc. VAT 1+	inc. VAT each
A53NW	M 3.5-2x Phono 0.5m	£7.49	£8.99
A54NW	M 3.5-2x Phono 0.75m	£8.32	£9.99
A55NW	M 3.5-2x Phono 1.5m	£9.99	£11.99
A56NW	M 3.5-2x Phono 3m	£11.65	£13.99
A57NW	M 3.5-2x Phono 5m	£14.15	£16.99
A58NW	M 3.5-2x Phono 10m	£21.65	£25.99
A59NW	M 3.5-2x Phono 20m	£33.32	£39.99

Maplin 4 Pole 3.5mm Stereo Jack Cables



- Ideal for specialised devices requiring 4 contacts, such as smartphones and tablets
- 4 pole Jack terminals wired straight-through
- Gold-plated connectors
- Durable and highly flexible outer jacket
- 5 Year Warranty
- Available in 0.75, 1.5, 3, 5 and 10 metre lengths

This 3.5mm Jack cable carries three signals between specialised devices. Smartphones may use the extra contact for stereo audio and microphone functions, while many camera and tablet devices will transmit colour video alongside stereo audio through this cable. It is also used in multi-channel PC audio systems, and handheld radio transceivers.

Order Code	Mod: 1031191	Price each exc. VAT 1+	inc. VAT each
A61NW	M 3.5mm 4P 0.75m	£9.99	£11.99
A62NW	M 3.5mm 4P 1.5m	£11.65	£13.99
A63NW	M 3.5mm 4P 3m	£13.32	£15.99
A64NW	M 3.5mm 4P 5m	£15.82	£18.99
A65NW	M 3.5mm 4P 10m	£19.99	£23.99

Maplin 4 Pole 3.5mm Stereo Jack Extension Cables



- Ideal for specialised devices requiring 4 contacts, such as smartphones and tablets
- 4 pole Jack terminals wired straight-through
- Gold-plated connectors
- Durable and highly flexible outer jacket
- 5 Year Warranty
- Available in 0.75, 1.5, 3, 5 and 10 metre lengths

This 3.5mm Jack cable carries three signals between specialised devices. Smartphones may use the extra contact for stereo audio and microphone functions, while many camera and tablet devices will transmit colour video alongside stereo audio through this cable. It is also used in multi-channel PC audio systems, and handheld radio transceivers.

Order Code	Mod: 1031192	Price each exc. VAT 1+	inc. VAT each
A67NW	M 3.5mm 4P Ex 0.75m	£9.99	£11.99
A68NW	M 3.5mm 4P Ex 1.5m	£11.65	£13.99
A69NW	M 3.5mm 4P Ex 3m	£13.32	£15.99
A70NW	M 3.5mm 4P Ex 5m	£15.82	£18.99
A71NW	M 3.5mm 4P Ex 10m	£19.99	£23.99

Maplin Twin Phono RCA Cables



- Ideal for use with CD, MP3, HDTV surround sound systems and other analogue audio devices
- 2 pole Phono terminals with positive and ground contacts
- Gold-plated connectors
- Durable and highly flexible outer jacket
- 5 Year Warranty

Available in 0.5, 0.75, 1.5, 3, 5, 10 and 20 metre lengths. Twin Phono is also known as an RCA connection and carries two mono signals across each Phono connector, which are combined in audio equipment for stereo sound. It is an audio cable commonly used when connecting equipment in home and DJ audio systems, PC audio, and in speaker systems for TVs and games consoles.

Order Code	Mod: 1031193	Price each exc. VAT 1+	inc. VAT each
A73NW	M 2x Phono 0.5m	£9.15	£10.99
A74NW	M 2x Phono 0.75m	£9.99	£11.99
A75NW	M 2x Phono 1.5m	£10.82	£12.99
A76NW	M 2x Phono 3m	£11.65	£13.99
A77NW	M 2x Phono 5m	£14.15	£16.99
A78NW	M 2x Phono 10m	£21.65	£25.99
A79NW	M 2x Phono 20m	£33.32	£39.99

Maplin Twin Phono RCA Extension Cables



- Ideal for use with CD, MP3, HDTV surround sound systems and other analogue audio devices
- 2 pole Phono terminals with positive and ground contacts
- Gold-plated connectors
- Durable and highly flexible outer jacket
- 5 Year Warranty
- Available in 0.75, 1.5, 3, 5, 10 and 20 metre lengths

Twin Phono is also known as an RCA connection and carries two mono signals across each Phono connector, which are combined in audio equipment for stereo sound. It is an audio cable commonly used when connecting equipment in home and DJ audio systems, PC audio, and in speaker systems for TVs and games consoles.

Order Code	Mod: 1031194	Price each exc. VAT 1+	inc. VAT each
A81NW	M 2x Phono Ext 0.75m	£9.99	£11.99
A82NW	M 2x Phono Ext 1.5m	£10.82	£12.99
A83NW	M 2x Phono Ext 3m	£11.65	£13.99
A84NW	M 2x Phono Ext 5m	£14.15	£16.99
A85NW	M 2x Phono Ext 10m	£21.65	£25.99
A86NW	M 2x Phono Ext 20m	£33.32	£39.99

Maplin Flat Twin Phono RCA Cables



- Ideal for use with CD, MP3, HDTV surround sound systems and other analogue audio devices
- Flat, flexible cable ideal for custom fitting and installation
- 2 pole Phono terminals with positive and ground contacts
- Gold-plated connectors
- Durable and highly flexible outer jacket
- 5 Year Warranty
- Available in 0.5, 0.75, 1.5, 3, 5, 10 and 20 metre lengths

Twin Phono is also known as an RCA connection and carries two mono signals across each Phono connector, which are combined in audio equipment for stereo sound. It is an audio cable commonly used when connecting equipment in home and DJ audio systems, PC audio, and in speaker systems for TVs and games consoles.

carries two mono signals across each Phono connector, which are combined in audio equipment for stereo sound. It is an audio cable commonly used when connecting equipment in home and DJ audio systems, PC audio, and in speaker systems for TVs and games consoles.

Order Code	Mod: 1031195	Price each exc. VAT 1+	inc. VAT each
A88NW	M 2x Phono Flat 0.5m	£9.99	£11.99
A89NW	M 2x Phono Flat 0.75m	£10.82	£12.99
A90NW	M 2x Phono Flat 1.5m	£11.65	£13.99
A91NW	M 2x Phono Flat 3m	£12.49	£14.99
A92NW	M 2x Phono Flat 5m	£14.99	£17.99
A93NW	M 2x Phono Flat 10m	£22.49	£26.99
A94NW	M 2x Phono Flat 20m	£34.15	£40.99

Maplin Single Phono RCA Cables



- Ideal for use with CD, MP3, HDTV surround sound systems and other analogue audio devices
- 2 pole Phono terminal with positive and ground contact
- Suitable for mono audio signal
- Gold-plated connectors
- Durable and highly flexible outer jacket
- 5 Year Warranty
- Available in 0.75, 1.5, 3, 5, 10 and 20 metre lengths

Single Phono is also known as an RCA connection and carries a mono audio signal. Mono audio input/output is relatively rare, and found on specialist recording and audio equipment.

Order Code	Mod: 1031197	Price each exc. VAT 1+	inc. VAT each
A96NW	M Phono 0.75m	£7.49	£8.99
A97NW	M Phono 1.5m	£8.32	£9.99
A98NW	M Phono 3m	£9.15	£10.99
A99NW	M Phono 5m	£10.82	£12.99
A00NX	M Phono 10m	£20.82	£24.99
A01NX	M Phono 20m	£31.65	£37.99

Maplin Single Phono RCA Extension Cables



- Ideal for use with CD, MP3, HDTV surround sound systems and other analogue audio devices
- 2 pole Phono terminal with positive and ground contact
- Suitable for mono audio signal
- Gold-plated connectors
- Durable and highly flexible outer jacket
- 5 Year Warranty
- Available in 0.75, 1.5, 3, 5, 10 and 20 metre lengths

Single Phono is also known as an RCA connection and carries a mono audio signal. Mono audio input/output is relatively rare, and found on specialist recording and audio equipment.

Order Code	Mod: 1031198	Price each exc. VAT 1+	inc. VAT each
A03NX	M Phono Ext 0.75m	£7.49	£8.99
A04NX	M Phono Ext 1.5m	£8.32	£9.99
A05NX	M Phono Ext 3m	£9.15	£10.99
A06NX	M Phono Ext 5m	£10.82	£12.99
A07NX	M Phono Ext 10m	£20.82	£24.99
A08NX	M Phono Ext 20m	£31.65	£37.99

Maplin Twin Stacking Phono RCA Cables



- Ideal for use with CD, MP3, HDTV surround sound systems and other analogue audio devices
- Stacking terminals to attach an additional twin Phono cable in-line
- 2 pole Phono terminals with positive and ground contacts
- Gold-plated connectors
- Durable and highly flexible outer jacket
- 5 Year Warranty
- Available in 1.5 and 3 metre lengths

Twin Phono is also known as an RCA connection and carries two mono signals across each Phono connector, which are combined in audio equipment for stereo sound. This stacking cable can be used to connect a pair of twin Phono cables to a single twin Phono output. A common use is when connecting multiple pairs of speakers to an audio player.

Order Code	Mod: 1031199	Price each exc. VAT 1+	inc. VAT each
A10NX	M Phono Stack 1.5m	£11.65	£13.99
A11NX	M Phono Stack 3m	£13.32	£15.99

Maplin Four Phono RCA Cables



- Ideal for use with Televisions, HDTV surround sound systems, PC audio and DJ music systems
- Two twin Phono pairs for connecting multiple audio devices
- 2 pole Phono terminals with positive and ground contacts
- Gold-plated connectors
- Durable and highly flexible outer jacket
- 5 Year Warranty
- Available in 1.5, 3, 5 and 10 metre lengths

Twin Phono is also known as an RCA connection and carries two mono signals across each Phono connector, which are combined in audio equipment for stereo sound. It is an audio cable commonly used when connecting equipment in home and DJ audio systems, PC audio, and in speaker systems for TV's and games consoles.

Order Code	Mod: 1031200	Price each exc. VAT 1+	inc. VAT each
A13NX	M 4x Phono 1.5m	£13.32	£15.99
A14NX	M 4x Phono 3m	£14.99	£17.99
A15NX	M 4x Phono 5m	£16.65	£19.99
A16NX	M 4x Phono 10m	£24.99	£29.99

Look out for our monthly promotions at your local Maplin store now!

Pop in and pick up a copy of our monthly promotional publication, with special offers on dozens of exciting products. See the end of this catalogue for store listings

Maplin Twin Phono RCA to Twin 1/4" Jack Cables



- Ideal for use in home audio systems and DJ equipment
- 2 pole 1/4" Jack terminals with positive and ground contacts
- 2 pole Phono terminals with positive and ground contacts
- Gold-plated connectors
- Durable and highly flexible outer jacket
- 5 Year Warranty
- Available in 0.75, 1.5, 3, 5, 10 and 20 metre lengths

This 1/4" Jack to Twin Phono cable carries stereo sound across a variety of audio devices. It is a highly versatile cable and commonly used when connecting equipment in home and DJ audio systems, music al instruments, and passive/active speaker systems. The Twin Phono and 1/4" Jack terminals on this cable carry two mono signals across each connector, which are combined in audio

Order Code	Mod: 1031201	Price each exc. VAT 1+	inc. VAT each
A18NX	M 2xPh-2xQt Jk 0.75m	£9.99	£11.99
A19NX	M 2xPh-2xQt Jk 1.5m	£10.82	£12.99
A20NX	M 2xPh-2xQt Jk 3m	£12.49	£14.99
A21NX	M 2xPh-2xQt Jk 5m	£14.99	£17.99
A22NX	M 2xPh-2xQt Jk 10m	£20.82	£24.99
A23NX	M 2xPh-2xQt Jk 20m	£29.15	£34.99

Send direct

If any product is not in stock, we will order it for you and send it with free delivery

Terms and conditions apply



Maplin Twin Phono RCA to Stereo 1/4" Jack Cables



- Ideal for use in home audio systems and DJ equipment
- 3 pole 1/4" Jack terminals with left, right and ground contacts
- 2 pole Phono terminals with positive and ground contacts
- Gold-plated connectors
- Durable and highly flexible outer jacket
- 5 Year Warranty
- Available in 0.75, 1.5, 3, 5, 10 and 20 metre lengths

This 1/4" Jack to Twin Phono cable carries stereo sound across a variety of audio devices. It is a highly versatile cable and commonly used when connecting equipment in home and DJ audio systems, music al instruments, and passive/active speaker systems. Twin Phono is also known as an RCA connection and carries two mono signals across each Phono connector, which are combined in audio equipment for stereo sound.

Order Code	Mod: 1031202	Price each exc. VAT 1+	inc. VAT each
A25NX	M 2xPh-Qt Jk 0.75m	£9.99	£11.99
A26NX	M 2xPh-Qt Jk 1.5m	£10.82	£12.99
A27NX	M 2xPh-Qt Jk 3m	£12.49	£14.99
A28NX	M 2xPh-Qt Jk 5m	£14.99	£17.99
A29NX	M 2xPh-Qt Jk 10m	£20.82	£24.99
A30NX	M 2xPh-Qt Jk 20m	£29.15	£34.99

Maplin Single Phono RCA to Mono 1/4" Jack Cables



- Ideal for use in home audio systems and DJ equipment
- 2 pole 1/4" Jack terminals with positive and ground contacts
- 2 pole Phono terminals with positive and ground contacts
- Gold-plated connectors
- Durable and highly flexible outer jacket
- 5 Year Warranty
- Available in 0.75, 1.5, 3, 5, 10 and 20 metre lengths

This 1/4" Jack cable to Single Phono cable carries mono sound across a variety of audio devices. It is commonly used in home and DJ audio systems, music al instruments, and passive/active speaker systems. Note this is a single channel mono lead, and will not carry stereo sound.

Order Code	Mod: 1031203	Price each exc. VAT 1+	inc. VAT each
A32NX	M Phono-Qt Jk 0.75m	£7.49	£8.99
A33NX	M Phono-Qt Jk 1.5m	£8.32	£9.99
A34NX	M Phono-Qt Jk 3m	£10.82	£12.99
A35NX	M Phono-Qt Jk 5m	£12.49	£14.99
A36NX	M Phono-Qt Jk 10m	£16.65	£19.99
A37NX	M Phono-Qt Jk 20m	£24.99	£29.99

Maplin Twin Phono to Single Phono RCA Cables



- Ideal for use with CD, MP3, HDTV surround sound systems and other analogue audio devices
 - 2 pole Phono terminals with positive and ground contacts
 - Stereo audio signal will be combined into a single mono audio signal
 - Gold-plated connectors
 - Durable and highly flexible outer jacket
 - 5 Year Warranty
 - Available in 0.75, 1.5, 3, 5, 10 and 20 metre lengths
- Twin Phono is also known as an RCA connection and carries two mono signals across each Phono connector, which are combined in audio equipment for stereo sound. This cable combines a Twin Phono stereo audio signal into a Single Phono mono audio signal. Mono audio input/output is relatively rare, and found on specialist recording and audio equipment.

Order Code	Mod: 1031204	Price each exc. VAT 1+	inc. VAT each
A39NX	M 2xPho-Pho 0.75m	£9.99	£11.99
A40NX	M 2xPho-Pho 1.5m	£10.82	£12.99
A41NX	M 2xPho-Pho 3m	£12.49	£14.99
A42NX	M 2xPho-Pho 5m	£14.99	£17.99
A43NX	M 2xPho-Pho 10m	£20.82	£24.99
A44NX	M 2xPho-Pho 20m	£29.15	£34.99

Free Delivery
on all UK orders over **£10**

IT&GS Apply

Maplin Phono Adapters



- Fully wired terminals
- Gold-plated connectors
- Durable plastic housing
- 5 Year Warranty

Order Code	Mod: 1031206	Price each exc. VAT 1+	inc. VAT each
A46NX	M 3.5mm - 2x Phono	£8.32	£9.99
A47NX	M 2x Phono Coupler	£7.49	£8.99
A48NX	M 3x Phono Coupler	£8.32	£9.99

- Ideal as a loudspeaker cable
- 2 pin DIN terminal to 2 core wire
- Gold-plated connectors
- Durable and highly flexible outer cable jacket
- 5 Year Warranty

DIN is a highly versatile terminal used to connect analogue speaker systems, digital MIDI interfaces for computers to musical instruments, and sees application as a data and power cable. This 2 pin DIN to 2 core wire is used to connect passive loudspeakers to power amplifiers.

Order Code	Mod: 1031210	Price each exc. VAT 1+	inc. VAT each
A53NX	M 2pin DIN -Wire 10m	£6.65	£7.99

Maplin Twin 3.5mm Mono Jack to 5 pin DIN Cable 1.5m



- Ideal as an audio or video cable
- 5 pin DIN terminal
- 2 pole Jack terminals with positive and ground contacts
- Gold-plated connectors
- Durable and highly flexible outer jacket
- 5 Year Warranty

DIN is a highly versatile terminal used to connect analogue speaker systems, digital MIDI interfaces for computers to musical instruments, and sees application as a data and power cable. This is a specialised cable, allowing 3.5mm Jack output audio devices to connect to legacy music equipment that uses a DIN connector

Order Code	Mod: 1031211	Price each exc. VAT 1+	inc. VAT each
A55NX	M 5pinDIN-2x3.5 1.5m	£9.99	£11.99

Maplin 3.5mm Jack to 5 pin DIN Cables



- Ideal as an audio or video cable
- 5 pin DIN terminal
- 3 pole Jack terminal with left, right and ground contacts
- Gold-plated connectors
- Durable and highly flexible outer jacket
- 5 Year Warranty
- Available in 1.5 and 3 metre lengths

DIN is a highly versatile terminal used to connect analogue speaker systems, digital MIDI interfaces for computers to musical instruments, and sees application as a data and power cable. This is a specialised cable, allowing 3.5mm Jack output audio devices to connect to legacy music equipment that uses a DIN connector.

Order Code	Mod: 1031209	Price each exc. VAT 1+	inc. VAT each
A50NX	M 3.5mm DIN 1.5m	£8.32	£9.99
A51NX	M 3.5mm DIN 3m	£10.82	£12.99

Maplin 2 pin DIN to 2 core Wire 10m



- Ideal as an audio or video cable
- 5 pin DIN terminals, fully wired through
- 2 pole Quad Phono terminals
- Gold-plated connectors
- Durable and highly flexible outer jacket
- 5 Year Warranty

DIN is a highly versatile terminal used to connect analogue speaker systems, digital MIDI interfaces for computers to musical instruments, and sees application as a data and power cable. This cable has Quad Phono terminals found in analogue HiFi and AV equipment.

Order Code	Mod: 1031212	Price each exc. VAT 1+	inc. VAT each
A57NX	M 5pin DIN-4xPh 1.5m	£11.65	£13.99

Browse our entire range at maplin.co.uk

Maplin 5 pin DIN Cables



- Ideal as a data, audio or video cable
- 5 pin DIN terminals, fully wired through
- Gold-plated connectors
- Durable and highly flexible outer jacket
- 5 Year Warranty
- Available in 1.5, 3, 5 and 10 metre lengths

DIN is a highly versatile terminal used to connect analogue speaker systems, digital MIDI interfaces for computers to musical instruments, and sees application as a data and power cable

Order Code	Mod: 1031215	Price each exc. VAT 1+	inc. VAT each
A59NX	M 5pin DIN Lead 1.5m	£9.99	£11.99
A60NX	M 5pin DIN Lead 3m	£11.65	£13.99
A61NX	M 5pin DIN Lead 5m	£14.15	£16.99
A62NX	M 5pin DIN Lead 10m	£16.65	£19.99

Maplin 5 pin DIN Extension Cables



- Ideal as a data, audio or video cable
- 5 pin DIN terminals, fully wired through
- Gold-plated connectors
- Durable and highly flexible outer jacket
- 5 Year Warranty
- Available in 3 and 5 metre lengths

DIN is a highly versatile terminal used to connect analogue speaker systems, digital MIDI interfaces for computers to musical instruments, and sees application as a data and power cable

Order Code	Mod: 1031221	Price each exc. VAT 1+	inc. VAT each
A64NX	M 5pin DIN Ext Ld 3m	£9.99	£11.99
A65NX	M 5pin DIN Ext Ld 5m	£12.49	£14.99

Maplin Pro 3.5mm Stereo Jack Cables



- Ideal for use with CD, MP3, In Car, headphones and other analogue audio devices
- Pure copper conductors for optimal signal quality
- 3 pole Jack terminals with left, right and ground contacts
- Gold-plated connectors
- Nylon braided cable protection for a lifetime of use
- Lifetime Warranty
- Available in 0.75, 1.5, 3 and 5 metre lengths

Order Code	Mod: 1031223	Price each exc. VAT 1+	inc. VAT each
A69NX	P 3.5mm Lead 0.75m	£12.49	£14.99
A70NX	P 3.5mm Lead 1.5m	£14.15	£16.99
A71NX	P 3.5mm Lead 3m	£16.65	£19.99
A72NX	P 3.5mm Lead 5m	£19.99	£23.99

Maplin Pro 3.5mm Stereo Jack Extension Cables



- Ideal for use with CD, MP3, In Car, headphones and other analogue audio devices
- Pure copper conductors for optimal signal quality
- 3 pole Jack terminals with left, right and ground contacts
- Gold-plated connectors
- Nylon braided cable protection for a lifetime of use
- Lifetime Warranty
- Available in 1.5 and 3 metre lengths

Order Code	Mod: 1031224	Price each exc. VAT 1+	inc. VAT each
A78NX	P 3.5mm Ext 1.5m	£14.15	£16.99
A79NX	P 3.5mm Ext 3m	£16.65	£19.99

Maplin Pro 3.5mm Stereo Jack to Twin Phono Cables



- Ideal for use with CD, MP3, In Car, headphones and other analogue audio devices
- Pure copper conductors for optimal signal quality
- 3 pole Jack terminals with left, right and ground contacts
- 2 pole Phono terminals with positive and ground contacts
- Gold-plated connectors
- Nylon braided cable protection for a lifetime of use
- Lifetime Warranty
- Available in 1.5, 3 and 5 metre lengths

Order Code	Mod: 1031225	Price each exc. VAT 1+	inc. VAT each
A87NX	P 3.5-2x Phono 1.5m	£14.99	£17.99
A88NX	P 3.5-2x Phono 3m	£16.65	£19.99
A89NX	P 3.5-2x Phono 5m	£20.82	£24.99

Maplin Pro Twin Phono Cables



- Ideal for use with CD, MP3, HDTV surround sound systems and other analogue audio devices
- Pure copper conductors for optimal signal quality
- 2 pole Phono terminals with positive and ground contacts
- Gold-plated connectors
- Nylon braided cable protection for a lifetime of use
- Lifetime Warranty
- Available in 0.75, 1.5 and 3 metre lengths

Order Code	Mod: 1031226	Price each exc. VAT 1+	inc. VAT each
A94NX	P 2x Phono 0.75m	£12.49	£14.99
A95NX	P 2x Phono 1.5m	£14.99	£17.99
A96NX	P 2x Phono 3m	£16.65	£19.99

Digital Audio

Maplin Essentials Digital Audio Optical Cables



- Ideal for use PC, Laptop, Xbox, PS3/PS4 and HDTV surround sound systems
- Includes mini-plug TosLink™ adapters
- Moulded connectors with strain relief
- 1 Year Warranty
- Available in 1.5 and 3 metre lengths

Digital Optical cable is also known as a TosLink™ connector. It carries the digital S/PDIF audio standard, which can transmit stereo audio or compressed 5.1/7.1 channel surround sound, all in one cable. It is an audio cable commonly used when connecting digital-grade equipment in home and DJ audio systems, PC audio, and in speaker systems for TVs and games consoles.

Order Code	Mod: 1031241	Price each exc. VAT 1+	inc. VAT each
A00NY	E TOS Lead 1.5m	£8.32	£9.99
A01NY	E TOS Lead 3m	£10.82	£12.99

Maplin Essentials Digital Audio Coax Cables



- Ideal for use with Satellite and Freeview set top boxes and HDTV surround sound systems.
- 2 pole Phono terminals with positive and ground contacts
- Moulded connectors with strain relief
- 1 Year Warranty
- Available in 1.5 and 3 metre lengths

Digital Phono carries a S/PDIF digital audio signal to digital AV equipment. The S/PDIF standard can carry stereo audio or compressed 5.1/7.1 channel surround sound, all in one cable. It is an audio cable commonly used when connecting digital-grade equipment in home and DJ audio systems, PC audio, and in speaker systems for TVs and games consoles.

Order Code	Mod: 1031242	Price each exc. VAT 1+	inc. VAT each
A03NY	E Digital Pho 1.5m	£9.99	£11.99
A04NY	E Digital Pho 3m	£12.49	£14.99

Maplin Digital Audio Optical Cables



- Ideal for use with HDTV and PC surround sound systems, HD Freeview and Freesat boxes, and the PS3, PS4 and Xbox One games consoles.
 - Includes mini-plug TosLink™ adapters
 - Pure plastic optical fibre (POF)
 - Gold-plated connectors
 - Durable and highly flexible outer jacket
 - 5 Year Warranty
 - Available in 0.75, 1.5, 3, 5 and 10 metre lengths
- Digital Optical cable is also known as a TosLink™

connector. It carries the digital S/PDIF audio standard, which can transmit stereo audio or compressed 5.1/7.1 channel surround sound, all in one cable. It is an audio cable commonly used when connecting high quality digital-grade equipment in home and DJ audio systems, PC audio, and in speaker systems for TVs and games consoles.

Order Code	Mod: 1031243	Price each exc. VAT 1+	inc. VAT each
A06NY	M TOS Lead 0.75m	£13.32	£15.99
A07NY	M TOS Lead 1.5m	£14.99	£17.99
A08NY	M TOS Lead 3m	£19.15	£22.99
A09NY	M TOS Lead 5m	£23.32	£27.99
A10NY	M TOS Lead 10m	£29.15	£34.99

Maplin Digital Optical Adapters



A12NY



A13NY



A14NY



A15NY



A16NY



A17NY

- Gold-plated connectors
- Durable plastic housing
- 5 Year Warranty

Order Code	Mod: 1031244	Price each exc. VAT 1+	inc. VAT each
A12NY	M TOS Splitter	£8.32	£9.99
A13NY	M TOS Coupler	£8.32	£9.99
A14NY	M TOS to miniTOS	£8.32	£9.99
A15NY	M MiniTOS to TOS	£8.32	£9.99
A16NY	M Coax-TOS Converter	£12.49	£14.99
A17NY	M TOS-Coax Converter	£12.49	£14.99

Trust our cables. Quality guaranteed.

Our Maplin branded cables offer an expansive range of types and lengths with professional grade options available. **see page 5 for full details**

Maplin Digital Audio Coax Cables



- Ideal for use with Televisions, HDTV surround sound systems, PC audio and DJ music systems.
- 2 pole Phono terminals with positive and ground contacts
- Dual-layer aluminium shielding to preserve digital signal
- Gold-plated connectors
- Durable and highly flexible outer jacket
- 5 Year Warranty
- Available in 0.75, 1.5, 3, 5 and 10 metre lengths

Digital Twin Phono carries a S/PDIF digital audio signal to digital AV equipment. The S/PDIF standard can carry stereo audio or compressed 5.1/7.1 channel surround sound, all in one cable. It is an audio cable commonly used when connecting digital-grade equipment in home and DJ audio systems, PC audio, and in speaker systems for TV's and games consoles.

Order Code	Mod: 1031245	Price each exc. VAT 1+	inc. VAT each
A19NY	M Digital Pho 0.75m	£13.32	£15.99
A20NY	M Digital Pho 1.5m	£14.99	£17.99
A21NY	M Digital Pho 3m	£19.15	£22.99
A22NY	M Digital Pho 5m	£23.32	£27.99
A23NY	M Digital Pho 10m	£29.15	£34.99

Maplin Pro Digital Audio Optical Cables



- Ideal for use with HDTV and PC surround sound systems, HD Freeview and Freesat boxes, and the PS3, PS4 and Xbox One games consoles
- Includes mini-plug TosLink™ adapters
- Pure plastic optical fibre (POF)
- Gold-plated connectors
- Nylon braided cable protection for a lifetime of use
- Lifetime Warranty
- Available in 1.5 and 3 metre lengths

Order Code	Mod: 1031246	Price each exc. VAT 1+	inc. VAT each
A26NY	P TOS Lead 1.5m	£24.99	£29.99
A27NY	P TOS Lead 3m	£33.32	£39.99

Maplin Pro Digital Audio Coax Cables



- Ideal for use with Televisions, HDTV surround sound systems, PC audio and DJ music systems.
- 2 pole Phono terminals with positive and ground

contacts

- Dual-layer aluminium shielding to preserve digital signal
- Gold-plated connectors
- Nylon braided cable protection for a lifetime of use
- Lifetime Warranty
- Available in 1.5 and 3 metre lengths

Order Code	Mod: 1031248	Price each exc. VAT 1+	inc. VAT each
A32NY	P Digital Pho 1.5m	£24.99	£29.99
A33NY	P Digital Pho 3m	£33.32	£39.99

SCART & AV Leads

Maplin Essentials SCART Cables



- Ideal for use with Satellite and Freeview set top boxes and DVD/VHS players
- Fully-wired SCART terminals
- Moulded connectors with strain relief
- 1 Year Warranty
- Available in 1.5 and 3 metre lengths

SCART is a 21 pin connector that can support RGB video or composite video, alongside a stereo audio signal. RGB video output offers a superior-quality colour image compared to composite video, and is the default output on most modern AV equipment. SCART is commonly used when connecting standard definition TVs to satellite/cable boxes, Blu-ray/DVD players and games consoles.

Order Code	Mod: 1031249	Price each exc. VAT 1+	inc. VAT each
A46NY	E SCART Lead 1.5m	£8.32	£9.99
A47NY	E SCART Lead 3m	£10.82	£12.99

Maplin SCART Cables



- Ideal for use with Televisions, HDTV surround sound systems, freeview/freesat boxes and DVD players
- Fully-wired SCART terminals
- Individually screened cable cores
- Gold-plated connectors
- Durable and highly flexible outer jacket
- 5 Year Warranty

• Available in 0.75, 1.5, 3, 5, 10 and 20 metre lengths
 SCART is a 21 pin connector that carries component video, RGB video or composite video alongside a stereo audio signal. Component and RGB video outputs both offer superior colour reproduction compared to composite video on modern AV equipment. SCART is commonly used when connecting standard definition TVs to satellite/cable boxes, Blu-ray/DVD players and games consoles.

Order Code	Mod: 1031250	Price each exc. VAT 1+	inc. VAT each
A69NY	M SCART Lead 0.75m	£12.49	£14.99
A70NY	M SCART Lead 1.5m	£14.15	£16.99
A71NY	M SCART Lead 3m	£16.65	£19.99
A72NY	M SCART Lead 5m	£23.32	£27.99
A73NY	M SCART Lead 10m	£31.65	£37.99
A74NY	M SCART Lead 20m	£41.65	£49.99

Maplin Flat SCART Cables



- Ideal for use with Televisions, HDTV surround sound systems, freeview/freesat boxes and DVD players
- Flat, flexible cable ideal for custom fitting and installation
- Fully-wired SCART terminals
- Individually screened cable cores
- Gold-plated connectors
- Durable and highly flexible outer jacket
- 5 Year Warranty
- Available in 0.75, 1.5 and 3 metre lengths

SCART is a 21 pin connector that carries component video, RGB video or composite video alongside a stereo audio signal. Component and RGB video outputs both offer superior colour reproduction compared to composite video on modern AV equipment. SCART is commonly used when connecting standard definition TVs to satellite/cable

Order Code	Mod: 1031251	Price each exc. VAT 1+	inc. VAT each
A76NY	M Flat SCART 0.75m	£16.65	£19.99
A77NY	M Flat SCART 1.5m	£18.32	£21.99
A78NY	M Flat SCART 3m	£22.47	£26.99

Maplin SCART to Triple Phono Composite Cables



- Ideal for use with Televisions, HDTV surround sound systems, freeview/freesat boxes and DVD players
- Fully-wired SCART terminals
- 2 pole Phono terminals with positive and ground contacts
- Gold-plated connectors
- Durable and highly flexible outer jacket
- 5 Year Warranty

• Available in 0.75, 1.5, 3, 5, 10 and 20 metre lengths
 SCART is a 21 pin connector that carries a video signal alongside a stereo audio signal. Triple Phono is also known as an RCA connection and carries a composite video signal alongside two mono audio signals, which are combined in AV equipment for video with stereo sound. Both SCART and Triple Phono are commonly used when connecting standard definition TVs to satellite/cable boxes, Blu-ray/DVD players and games consoles.

Order Code	Mod: 1031252	Price each exc. VAT 1+	inc. VAT each
A80NY	M SCART-3x Pho 0.75m	£10.82	£12.99
A81NY	M SCART-3x Pho 1.5m	£12.49	£14.99
A82NY	M SCART-3x Pho 3m	£16.65	£19.99
A83NY	M SCART-3x Pho 5m	£20.82	£24.99
A84NY	M SCART-3x Pho 10m	£29.15	£34.99
A85NY	M SCART-3x Pho 20m	£41.65	£49.99

Technical Helpline
0333 400 9500

For technical information and assistance relating to any Maplin purchase, contact our expert team



Maplin SCART to Twin SCART Cables



- Ideal for use with Televisions, HDTV surround sound systems, freeview/freesat boxes and DVD players
- Switchable splitter cable to output two SCART devices to one TV, or split a single SCART signal to two TVs
- Gold-plated connectors
- Durable and highly flexible outer jacket
- 5 Year Warranty
- Available in 0.75, 1.5 and 3 metre lengths

SCART is a 21 pin connector that carries a video signal alongside a stereo audio signal. An input/output switch on the Single Scart terminal allows either splitting of one Scart device to two TVs, or to connect two Scart devices to just one Scart TV socket.

Order Code	Mod: 1031253	Price each exc. VAT 1+	inc. VAT each
A87NY	M SCART-2xSCART0.75m	£14.99	£17.99
A88NY	M SCART-2xSCART 1.5m	£16.65	£19.99
A89NY	M SCART-2xSCART 3m	£20.82	£24.99



We can deliver to your home or office

(UK only)

Maplin SCART to S-Video and Twin Phono RCA Cables



- Connect your PC or Laptop with S-Video output to your TV
- Supplied with a 3.5mm to Twin Phono adapter, ideal for PC soundcards
- Gold-plated connectors
- Durable and highly flexible outer jacket
- 5 Year Warranty
- Available in 0.75, 1.5, 3 and 5 metre lengths

SCART is a 21 pin connector that carries a video signal alongside a stereo audio signal. This cable connects a switchable Input/Output Scart to an S-Video connector, and features the option of a Twin Phono or 3.5mm Jack connector for audio. This cable is useful when connecting a PC or Laptop with an S-Video output to a TV.

Order Code	Mod: 1031254	Price each exc. VAT 1+	inc. VAT each
A91NY	M SCART-SV+2Ph 0.75m	£14.99	£17.99
A92NY	M SCART-SV+2Ph 1.5m	£16.65	£19.99
A93NY	M SCART-SV+2Ph 3m	£20.82	£24.99
A94NY	M SCART-SV+2Ph 5m	£24.99	£29.99



Reserve online and collect at the store of your choice

Maplin SCART to BNC and Four Phono RCA Cable 1.5m



- Connect your DVD player or CCTV DVR to a monitor/TV with BNC input.
- Gold-plated connectors
- Durable and highly flexible outer jacket
- 5 Year Warranty

This cable connects a SCART to two BNC composite video connectors, with two sets of Twin Phono outputs for stereo audio. This cable is useful when connecting a DVD player or CCTV DVR with to a monitor with BNC input.

Order Code	Mod: 1031255	Price each exc. VAT 1+	inc. VAT each
A96NY	M SCART-BNC+4Ph 1.5m	£16.65	£19.99

Maplin SCART to Six Phono Twin Composite Cables



- Ideal for use with Televisions, HDTV surround sound systems, freeview/freesat boxes and DVD players
- Fully-wired SCART terminals
- Individually screened cable cores
- 2 pole Phono terminals with positive and ground contacts
- Gold-plated connectors
- Durable and highly flexible outer jacket
- 5 Year Warranty
- Available in 1.5 and 5 metre lengths

This cable connects a SCART to two composite Phono video connectors, with two sets of Twin Phono outputs for stereo audio. This cable is useful when splitting an AV output to two devices.

Order Code	Mod: 1031256	Price each exc. VAT 1+	inc. VAT each
A98NY	M SCART-6xPhono 1.5m	£16.65	£19.99
A99NY	M SCART-6xPhono 5m	£24.99	£29.99

Maplin SCART Adapters



A01NZ



A02NZ



A03NZ

- Fully wired terminals
- Gold-plated connectors
- Durable plastic housing
- 5 Year Warranty

Order Code	Mod: 1031257	Price each exc. VAT 1+	inc. VAT each
A01NZ	M SCART Coupler	£8.32	£9.99
A02NZ	M SCART-3 Phono+Svd	£10.82	£12.99
A03NZ	M SCART Thru Adaptor	£16.65	£19.99

Maplin Triple Phono Composite Video Cables



- Ideal for use with Televisions, HDTV surround sound systems, freeview/freesat boxes and DVD players.
- 2 pole Phono terminals with positive and ground contacts
- Gold-plated connectors
- Durable and highly flexible outer jacket
- 5 Year Warranty

Triple Phono is also known as an RCA connection and carries a composite video signal alongside two mono audio signals, which are combined in AV equipment for video with stereo sound. Most consumer equipment colour codes yellow as video, red as right audio and white as the left audio channel. It is an AV cable commonly used when connecting standard definition TVs to satellite/cable boxes, Blu-ray/DVD players and games consoles.

Order Code	Mod: 1031258	Price each exc. VAT 1+	inc. VAT each
A05NZ	M 3x Phono Ld 0.75m	£9.99	£11.99
A06NZ	M 3x Phono Ld 1.5m	£10.82	£12.99
A07NZ	M 3x Phono Ld 3m	£12.49	£14.99
A08NZ	M 3x Phono Ld 5m	£14.99	£17.99
A09NZ	M 3x Phono Ld 10m	£20.82	£24.99
A10NZ	M 3x Phono Ld 20m	£29.15	£34.99

Maplin Triple Phono Composite Video Extension Cables



- Ideal for use with Televisions, HDTV surround sound systems, freeview/freesat boxes and DVD players
- 2 pole Phono terminals with positive and ground contacts
- Gold-plated connectors
- Durable and highly flexible outer jacket
- 5 Year Warranty
- Available in 1.5, 3, 5, 10 and 20 metre lengths

Triple Phono is also known as an RCA connection and carries a composite video signal alongside two mono audio signals, which are combined in AV equipment for video with stereo sound. Most consumer equipment colour codes yellow as video, red as right audio and white as the left audio channel. It is an AV cable commonly used when connecting standard definition TVs to satellite/cable boxes, Blu-ray/DVD players and games consoles.

Order Code	Mod: 1031259	Price each exc. VAT 1+	inc. VAT each
A12NZ	M 3x Phono Ex 1.5m	£10.82	£12.99
A13NZ	M 3x Phono Ex 3m	£12.49	£14.99
A14NZ	M 3x Phono Ex 5m	£14.99	£17.99
A15NZ	M 3x Phono Ex 10m	£20.82	£24.99
A16NZ	M 3x Phono Ex 20m	£29.15	£34.99

Maplin 4 Pole Jack to Triple Phono Composite - Sony Camcorder Cables



- Wired for specific use on Sony Camcorders
- 4 pole Jack terminal to 2 pole Phono terminals
- Gold-plated connectors
- Durable and highly flexible outer jacket
- 5 Year Warranty
- Available in 1.5 and 3 metre lengths

This 4 Pole Jack to Triple Phono cable is wired specifically to work with certain Sony Camcorders. Please check with the supplied documentation for your device for compatibility with this product.

Order Code	Mod: 1031260	Price each exc. VAT 1+	inc. VAT each
A18NZ	M.Sony Lead 1.5m	£10.82	£12.99
A19NZ	M.Sony Lead 3m	£12.49	£14.99

Maplin 4 Pole Jack to Triple Phono Composite - Panasonic Camcorder Cables



- Wired for specific use on Panasonic Camcorders
- 4 pole Jack terminal to 2 pole Phono terminals
- Gold-plated connectors
- Durable and highly flexible outer jacket
- 5 Year Warranty
- Available in 1.5 and 3 metre lengths

This 4 Pole Jack to Triple Phono cable is wired specifically to work with certain Panasonic Camcorders. Please check with the supplied documentation for your device for compatibility with this product.

Order Code	Mod: 1031261	Price each exc. VAT 1+	inc. VAT each
A21NZ	M.Panasonic Ld 1.5m	£10.82	£12.99
A22NZ	M.Panasonic Ld 3m	£12.49	£14.99

Maplin TV

Home of innovation,
handy tips and
How To videos

Visit our
channel...

youtube.com/maplintv



Maplin Pro SCART Cables



- Ideal for use with Televisions, HDTV surround sound systems, freeview/freesat boxes and DVD players
- Pure copper conductors for optimal signal quality
- Fully-wired SCART terminals
- Individually screened cable cores
- Gold-plated connectors
- Nylon braided cable protection for a lifetime of use
- Lifetime Warranty
- Available in 1.5 and 3 metre lengths

Order Code	Mod: 1031262	Price each exc. VAT 1+	inc. VAT each
A25NZ	P.SCART Lead 1.5m	£20.82	£24.99
A26NZ	P.SCART Lead 3m	£29.15	£34.99

Video Leads

Maplin S-Video Cables



- Ideal for use with Televisions, HDTV surround sound systems, freeview/freesat boxes and DVD players
- 4 pin DIN terminals
- Individually screened cable cores
- Gold-plated connectors
- Durable and highly flexible outer jacket
- 5 Year Warranty
- Available in 0.75, 1.5, 3, 5, 10 and 20 metre lengths

This S-Video cable supports up to 576i video resolution, a superior alternative to Single Phono composite video output. This cables does not support audio output. It is a video cable used when connecting TVs to satellite/cable boxes, Blu-ray/DVD players and games consoles.

Order Code	Mod: 1031265	Price each exc. VAT 1+	inc. VAT each
A30NZ	M.S-Video Lead 0.75m	£9.99	£11.99
A31NZ	M.S-Video Lead 1.5m	£10.82	£12.99
A32NZ	M.S-Video Lead 3m	£12.49	£14.99
A33NZ	M.S-Video Lead 5m	£16.65	£19.99
A34NZ	M.S-Video Lead 10m	£24.99	£29.99
A35NZ	M.S-Video Lead 20m	£33.32	£39.99

Maplin Triple Phono Component Cables



- Ideal for use with HDTV, Freeview, Freesat/Sky HD, Nintendo Wii, Wii U, Blu-Ray and any other component-output device
- Component video offers enhanced colour reproduction
- 2 pole Phono terminals with positive and ground contacts
- Gold-plated connectors
- Durable and highly flexible outer jacket
- 5 Year Warranty
- Available in 0.75, 1.5, 3, 5, 10 and 20 metre lengths

This Triple Phono Component Cable is also known as a YPbPr cable. Colour information is split over three Phono terminals, offering much richer colour reproduction than a Single Phono composite video signal. It is an AV cable commonly used when connecting TVs to satellite/cable boxes, Blu-ray/DVD players and games consoles.

Order Code	Mod: 1031266	Price each exc. VAT 1+	inc. VAT each
A37NZ	M.RGB Lead 0.75m	£14.99	£17.99
A38NZ	M.RGB Lead 1.5m	£16.65	£19.99
A39NZ	M.RGB Lead 3m	£20.82	£24.99
A40NZ	M.RGB Lead 5m	£24.99	£29.99
A41NZ	M.RGB Lead 10m	£29.15	£34.99
A42NZ	M.RGB Lead 20m	£41.65	£49.99

Subscribe to our newsletter
For deals and information
maplin.co.uk



Maplin Triple Phono Component Extension Cables



- Ideal for use with HDTV, Freeview, Freesat/Sky HD, Nintendo Wii, Wii U, Blu-Ray and any other component-output device
- Component video offers enhanced colour reproduction
- 2 pole Phono terminals with positive and ground contacts
- Gold-plated connectors
- Durable and highly flexible outer jacket
- 5 Year Warranty
- Available in 1.5, 3, 5, 10 and 20 metre lengths

This Triple Phono Component Cable is also known as a YPbPr cable. Colour information is split over three Phono terminals, offering much richer colour reproduction than a Single Phono composite video signal. It is an AV cable commonly used when connecting TVs to satellite/cable boxes, Blu-ray/DVD players and games consoles.

Order Code	Mod: 1031267	Price each exc. VAT 1+	inc. VAT each
A44NZ	M.RGB Ext 1.5m	£16.65	£19.99
A45NZ	M.RGB Ext 3m	£20.82	£24.99
A46NZ	M.RGB Ext 5m	£24.99	£29.99
A47NZ	M.RGB Ext 10m	£29.15	£34.99
A48NZ	M.RGB Ext 20m	£41.65	£49.99

Maplin Single Phono Composite Cables



- Ideal for use with Televisions, Freeview and Freesat boxes, and CCTV systems.
- 2 pole Phono terminal with positive and ground contact
- 75Ω coaxial cable for analogue composite video signal
- Gold-plated connectors
- Durable and highly flexible outer jacket
- 5 Year Warranty
- Available in 1.5, 3, 5, 10 and 20 metre lengths

Single Video Phono is also known as an RCA connection and carries a full colour analogue composite video signal. Composite video is found on standard definition TVs and their AV equipment, such as VHS/DVD recorders and Satellite/cable boxes.

Order Code	Mod: 1031268	Price each exc. VAT 1+	inc. VAT each
A50NZ	M Composite Ld 1.5m	£7.49	£8.99
A51NZ	M Composite Ld 3m	£9.15	£10.99
A52NZ	M Composite Ld 5m	£10.82	£12.99
A53NZ	M Composite Ld 10m	£14.99	£17.99
A54NZ	M Composite Ld 20m	£24.99	£29.99

Maplin Single Phono Composite Extension Cables



- Ideal for use with Televisions, Freeview and Freesat boxes, and CCTV systems.
- 2 pole Phono terminal with positive and ground contact
- 750 coaxial cable for analogue composite video signal
- Gold-plated connectors
- Durable and highly flexible outer jacket
- 5 Year Warranty
- Available in 1.5, 3, 5, 10 and 20 metre lengths

Single Video Phono is also known as an RCA connection and carries a full colour analogue composite video signal. Composite video is found on standard definition TV's and their AV equipment, such as VHS/DVD recorders and Satellite/cable boxes.

Order Code	Mod: 1031269	Price each exc. VAT 1+	inc. VAT each
A56NZ	M Composite Ex 1.5m	£7.49	£8.99
A57NZ	M Composite Ex 3m	£9.15	£10.99
A58NZ	M Composite Ex 5m	£10.82	£12.99
A59NZ	M Composite Ex 10m	£14.99	£17.99
A60NZ	M Composite Ex 20m	£24.99	£29.99

Maplin S-Video Coupler

- Fully wired terminals
- Gold-plated connectors
- Durable plastic housing
- 5 Year Warranty



This S-Video Coupler will connect two S-Video plugs to extend a connection using existing cables. This will allow use of your existing cabling to run a video signal over greater distances.

Order Code	Mod: 1031270	Price each exc. VAT 1+	inc. VAT each
A62NZ	M S-Video Coupler	£8.32	£9.99

BNC Leads

Maplin Phono RCA to BNC Cables



- Ideal for use with CCTV equipment
 - 2 pole Phono terminal with positive and ground contact
 - 75 Ohm Coaxial BNC terminal with positive and ground contact
 - Suitable for a composite video signal
 - Gold-plated connectors
 - Durable and highly flexible outer jacket
 - 5 Year Warranty
 - Available in 0.75, 1.5, 3, 5, 10 and 20 metre lengths
- The single Phono to BNC cable commonly carries a full colour analogue composite video signal, or can alternatively carry a mono audio signal. Single Phono to BNC cables are used with CCTV recorders, CCTV monitors, and specialist commercial video equipment.

Order Code	Mod: 1031271	Price each exc. VAT 1+	inc. VAT each
A63NZ	M Phono - BNC 0.75m	£5.82	£6.99
A64NZ	M Phono - BNC 1.5m	£6.65	£7.99
A65NZ	M Phono - BNC 3m	£8.32	£9.99
A66NZ	M Phono - BNC 5m	£9.99	£11.99
A67NZ	M Phono - BNC 10m	£12.49	£14.99
A68NZ	M Phono - BNC 20m	£20.82	£24.99

Maplin BNC Cables



- Ideal for use with CCTV and radio equipment
- 75 Ohm Coaxial BNC terminals with positive and ground contact
- Suitable for a composite video signal
- Gold-plated connectors
- Durable and highly flexible outer jacket
- 5 Year Warranty
- Available in 0.75, 1.5, 3, 5, 10, 20, 30, 40 and 50 metre lengths

This BNC cable commonly carries a full colour analogue composite video signal or a mono audio signal. BNC terminals commonly transmit composite video to CCTV recorders, CCTV monitors, and specialist test equipment.

Order Code	Mod: 1031272	Price each exc. VAT 1+	inc. VAT each
A69NZ	M BNC Video Ld 0.75m	£5.82	£6.99
A70NZ	M BNC Video Ld 1.5m	£6.65	£7.99
A71NZ	M BNC Video Ld 3m	£8.32	£9.99
A72NZ	M BNC Video Ld 5m	£9.99	£11.99
A73NZ	M BNC Video Ld 10m	£12.49	£14.99
A74NZ	M BNC Video Ld 20m	£20.82	£24.99
A75NZ	M BNC Video Ld 30m	£29.15	£34.99
A76NZ	M BNC Video Ld 40m	£37.49	£44.99
A77NZ	M BNC Video Ld 50m	£45.82	£54.99

Find out more in-store

Our staff can offer friendly and expert advice; we're here to help



Aerial Cables

TV/FM Extension Kit



- 25m kit includes:
- 25m coaxial cable
 - Coax coupler

- Surface coax socket
 - 2 x coax plugs
 - 2-way 'Y' splitter
 - 25 x cable clips
- 15m kit includes:
- 15m coaxial cable
 - Coax coupler
 - Surface coax socket
 - 2 x coax plugs
 - 2-way 'Y' splitter
 - 15 x cable clips

Order Code	Mod: 025917	Price each exc. VAT 1+	inc. VAT each
TB76H	TV/FM Kit 15m	£16.65	£19.99
TB77J	TV/FM Kit 25m	£20.82	£24.99

Trust our cables. Quality guaranteed.

Our Maplin branded cables offer an expansive range of types and lengths with professional grade options available. see page 5 for full details

TV Aerial Flyleads



- Coax plug (male) to Coax plug (male)

Coaxial cable with coax plugs (male) connected at both ends.

Available in 1m, 2m, 5m and 10m lengths.

Order Code	Mod: 000968	Price each exc. VAT 1+	inc. VAT each
N51HT	Flylead 1m	£4.57	£5.49
RW36P	Flylead 2m	£4.99	£5.99
JW39N	Flylead 5m	£6.65	£7.99
JW40T	Flylead 10m	£9.99	£11.99

VCR/TV Aerial Lead



- Coax plug (male) to coax socket (female) lead

Coaxial extension lead manufactured from 750 coaxial cable. Terminated at one end in a coaxial plug and at the other end in a coaxial socket. The terminations are protected with a plastic strain relieving sheath. Typically used to connect the 'RF Out' socket on a VCR to the aerial socket on a TV. Can also be used to extend existing aerial leads. Available in both 2m and 5m lengths.

Order Code	Mod: 000970	Price each exc. VAT 1+	inc. VAT each
GW61R	VCR/TV Aerial Ld 2m	£4.99	£5.99
QY20W	VCR/TV Aerial Ld 5m	£6.65	£7.99

Buy it on the web at maplin.co.uk

Shop for all Maplin products online at our website and check out our latest products and special offers!



F Plug to F Plug Leads



- Ideal for modern TV aerial installations
- Widely used for digital TV: terrestrial, cable and satellite

Quality 100% screened RG59/U 750 cable available in four lengths: 1.5m, 3m, 5m and 10m, with moulded connectors.

Order Code	Mod: 029536	Price each exc. VAT		inc. VAT each
		1+	5+	
BM89W	F Plug to Plug 1.5m	£4.99	£4.58	£5.99
N52HT	F Plug to Plug 3m	£7.07	£6.50	£8.49
Q277J	F Plug to Plug 5m	£9.15	£8.41	£10.99
N53HT	F Plug to Plug 10m	£14.15		£16.99

Order Code	Mod: 029532	Price each exc. VAT		inc. VAT each
		1+	5+	
Q273Q	F Plg to Coax Skt 2m	£4.99	£3.82	£5.99

Maplin F Plug to Coax Plug Cable 2m White



- Ideal for modern TV aerial installations
- Widely used for digital TV: terrestrial, cable and satellite

- 75 Ohm cable
- 2 meter long cable

Quality 100% screened RG59/U 750 cable, 2m long, with moulded connectors.

Order Code	Mod: 029533	Price each exc. VAT		inc. VAT each
		1+	5+	
Q274R	F Plg to Coax Plg 2m	£4.99	£3.82	£5.99

Stage/Instrument

F Plug to F Socket Leads



- Ideal for modern TV aerial installations
- Widely used for digital TV: terrestrial, cable and satellite

Quality 100% screened RG59/U 750 cable available in three lengths: 1.5m, 3m or 5m, with moulded connectors.

Order Code	Mod: 029537	Price each exc. VAT		inc. VAT each
		1+	5+	
Q278K	F Plug to Skt 1.5m	£4.99	£4.58	£5.99
N54HT	F Plug to Skt 3m	£7.07	£6.50	£8.49
Q279L	F Plug to Skt 5m	£9.15	£8.41	£10.99

Maplin F Plug to Coax Socket Cable 2m White



- Ideal for modern TV aerial installations
- Widely used for digital TV: terrestrial, cable and satellite

- 75 Ohm aerial cable
- 2 Meter cable length

Quality 100% screened RG59/U 750 cable, 2m long, with moulded connectors.

Van Damme Black Instrument Cable NP2X - NP2RX Right Angle Jack



- Guitar cables
- Keyboard and sound module cables
- Hi-Fi interconnects
- Low noise and high flexibility for on stage use
- Dual thermoplastic/lapped copper screens for excellent noise rejection
- Ultra pure oxygen free copper for outstanding sonic integrity
- Terminated using 2% Silver solder - lead free RoHS compliant
- Neutrik mono jack NP2X to Right Angle mono jack NP2RX

All products are fully test and quality assured
Van Damme Pro Grade Classic XKE Instrument Cable is a relatively low capacitance unbalanced audio cable for use with guitars, keyboards and other unbalanced output devices. Its tight construction and dual screens of conductive thermoplastic and close lapped copper ensure noise free handling and excellent noise rejection making this cable ideal for on stage use. Each cable is terminated at each end with a Neutrik mono jack NP2X to Right Angle mono jack NP2RX.

Order Code	Mod: 511389	Price each exc. VAT		inc. VAT each
		1+	5+	
N27JT	VD Instrument RA 5m	£16.65		£19.99

Van Damme Black Instrument Cable NP2X-Au-Silent Jack



- Guitar cables
- Keyboard and sound module cables
- Hi-Fi interconnects
- Low noise and high flexibility for on stage use
- Dual thermoplastic/lapped copper screens for excellent noise rejection
- Ultra pure oxygen free copper for outstanding sonic integrity
- Terminated using 2% Silver solder - lead free RoHS compliant
- Neutrik mono jack NP2X to silent mono jack NP2X-Au-Silent

All products are fully test and quality assured
Van Damme Pro Grade Classic XKE Instrument Cable is a relatively low capacitance unbalanced audio cable for use with guitars, keyboards and other unbalanced output devices. Its tight construction and dual screens of conductive thermoplastic and close lapped copper ensure noise free handling and excellent noise rejection making this cable ideal for on stage use. Each cable is terminated at each end with a Neutrik mono jack NP2X to silent mono jack NP2X-Au-Silent.

Order Code	Mod: 511387	Price each exc. VAT		inc. VAT each
		1+	5+	
N25JT	VD Instrmnt slnt 5m	£20.82	£19.99	£24.99

Van Damme Black Microphone Cable NC3MX - NC3FX



- For mic and line level analogue balanced audio
- Ideal for on stage use
- Further improved outer jacket ensures cable remains flexible in sub zero temperatures
- Tightly packed cotton fillers ensure no static build up and even capacitance
- Close lapped copper screen for the best compromise between effective shielding and flexibility
- Combination of silver plated and plain ultra pure oxygen free copper conductors for unsurpassed sound quality
- Standard mic cables Neutrik male XLR NC3MXX to female XLR NC3FXX

Van Damme Tour Grade Classic XKE Microphone cable combines flexibility, durability, noiseless operation and excellent handling characteristics. Now upgraded with more advanced PVC jacketing materials. Van Damme microphone cables can be found in film and recording studios, and are used in professional touring applications. Each cable is terminated with a Neutrik male XLR NC3MXX to female XLR NC3FXX.

Order Code	Mod: 511393	Price each exc. VAT		inc. VAT each
		1+	5+	
N28JT	VD Mic cable XLR 3m	£10.82		£12.99
N29JT	VD Mic cable XLR 5m	£12.49		£14.99
N30JT	VD Mic cable XLR 10m	£16.65		£19.99

Subscribe to our newsletter
For deals and information
maplin.co.uk



Van Damme 1.5mm Black Tour Grade Speaker Cable NL4 Neutrik Speakons



- Matt Blue jacket for on stage use
- Multicore construction optimised for dynamic use
- Ultra pure oxygen free copper for outstanding sonic integrity
- Screw termination wired 1+/1-
- Neutrik Speakon NL4FX to NL4FX 2 core 2x1.5mm

Van Damme Blue Studio Grade Speaker Cable offers a comprehensive conductor size and core count to accommodate almost all potential speaker signals. From 2 core 1.5mm through 8 core 4mm to 18 core 2.5mm the ultra pure copper conductors, cutting edge PVC compounds and dynamic use focused construction provide accurate signal transmission, toughness and flexibility. The products in this range are 2 core 1.5mm cable with Neutrik Speakon NL4 connections at each end.

Order Code	Mod: 511401	Price each exc. VAT 1+	inc. VAT each 5+
N33JT	VD Spkr NL4 1.5 5m	£21.65	£20.82
N34JT	VD Spkr NL4 1.5 10m	£27.49	£26.65
N35JT	VD Spkr NL4 1.5 15m	£33.32	£31.65
N36JT	VD Spkr NL4 1.5 20m	£39.15	£37.49

Buy it on the web at maplin.co.uk

Shop for all Maplin products online at our website and check out our latest products and special offers!



Van Damme 2.5mm Black Tour Grade Speaker Cable NL4 Neutrik Speakons



- Matt blue jacket for on stage use
- Multicore construction optimised for dynamic use
- Ultra pure oxygen free copper for outstanding sonic integrity
- Screw termination wired 1+/1-
- Neutrik Speakon NL4FX to NL4FX 2 core 2x2.5mm

Van Damme Blue Series Studio Grade Speaker Cable offers a comprehensive conductor size and core count to accommodate almost all potential speaker signals. From 2 core 1.5mm through 8 core 4mm to 18 core 2.5mm the ultra pure copper conductors, cutting edge PVC compounds and dynamic use focused construction provide accurate signal transmission, toughness and flexibility. The products in this range are 2 core 2.5mm cable with Neutrik Speakon NL4 connections at each end.

Order Code	Mod: 511408	Price each exc. VAT 1+	inc. VAT each 5+
N37JT	VD Spkr NL4 2.5 5m	£24.99	£24.15
N38JT	VD Spkr NL4 2.5 10m	£32.49	£30.82
N39JT	VD Spkr NL4 2.5 15m	£35.82	£42.99
N40JT	VD Spkr NL4 2.5 20m	£33.32	£39.99

Technical Helpline



0333 400 9500

For technical information and assistance relating to any Maplin purchase, contact our team of experts

AV Switches

HDMI Switches

Nikkai Connect 3 Way Automatic HDMI Switch



- Add 3 devices to one HDMI input
- Automatic switching to the last device switched on
- Manual override button
- LED Indicators
- Full HD 1080p compatible
- Also suitable for 480p, 720p and 1080i signals

An ideal solution for a lack of HDMI inputs on your TV or monitor. This simple to use switch allows two additional devices to be attached to a single HDMI port. The switch is automatic, meaning that it will instantly change to the device you want to use as soon as you switch it on. It also has an override switch allowing manual switching if required. LED indicators clearly show which channel is active. A 50cm flylead attached allows for flexible positioning depending on your wiring arrangement. No additional power is required, as this is supplied from the devices you connect to it, simply plug in and it works.

Order Code	Mod: 265062	Price each exc. VAT 1+	inc. VAT each
N60GY	3w HDMI Switch	£20.82	£24.99

Maplin TV

Home of innovation, handy tips and How To videos

Visit our channel...

youtube.com/maplintv



Nikkai Connect 2 Way Automatic Compact HDMI Switch



- 30cm fly lead
- High quality nickel-plated connectors
- Connect 2 HDMI signal sources to 1 HDMI input
- Ideal where only one HDMI input is available
- For use with HD-TV, HD-SAT, HD-DVD and PS3
- HDTV : 480i, 576i, 480p, 576p, 720p, 1080i and 1080p

An ideal solution for a lack of HDMI inputs on your TV or monitor. This simple to use switch allows two additional devices to be attached to a single HDMI port. The switch is automatic, meaning that it will instantly change to the device you want to use as soon as you switch it on. It also has an override switch allowing manual switching if required. A 30cm flylead attached allows for flexible positioning depending on your wiring arrangement. No additional power is required, as this is supplied from the devices you connect to it, simply plug in and it works.

Order Code	Mod: 220674	Price each exc. VAT 1+	inc. VAT each
N87FQ	2w HDMI Switch	£19.15	£22.99

Shopping with us is easy...

In-store



7 days a week, check store listings at the back of the catalogue for address details

Online



maplin.co.uk

24hrs a day, 7 days a week, 365 days a year

Phone



0333 400 9500

Phone lines open 7 days a week

Buying for business?

0333 400 9740

Want to browse the full range?

Head into store or visit maplin.co.uk



TECH FOR TUNES

LOVE MUSIC?

DJ, STUDIO & AUDIO

Everything you need to get the most out of your music

Visit maplin.co.uk for the very latest in DJ equipment, digital audio, media archiving, microphones and speakers



<http://goo.gl/eF7vDw>

Nikkai Connect 3 Way Automatic HDMI Switch with IR Remote Control



- Add 3 devices to one HDMI input
- Automatic switching to the last device switched on
- IR remote control with remote eye
- LED indicators
- Full HD 1080p support
- Also suitable for 480p, 720p and 1080i

An ideal solution for a lack of HDMI inputs on your TV or monitor, this simple to use switch allows up to 3 additional devices to be attached to a single HDMI port. The switch is automatic, meaning that it will instantly change to the device you want to use as soon as you switch it on. It also has an IR remote control and push button allowing manual switching if required. The IR receiver is attached via a flylead and comes with an adhesive pad so the switch box can be hidden, leaving only the compact IR eye visible. LED indicators clearly show which channel is active. A 50cm flylead attached allows for flexible positioning depending on your wiring arrangement. No additional power is required, as this is supplied from the devices you connect to it, simply plug in and it works.

Order Code	Mod:	Price each exc. VAT	inc. VAT each
N61GY	3w HDMI Swt & Rem	£23.32	£27.99

3 Way 4K HDMI Switch



- Switches between three HDMI device outputs to one HDMI input
- One front mounted input, easy access for mobile devices
- Supports 4K resolution at 10.2 Gbps
- Supports 12 bit per channel (36 bit all channels) deep colour
- HDCP Compliant
- Supports for LPCM and DTS Digital audio formats

This 3 way 4K HDMI Switch offers the flexibility to stream HDMI video and audio in 4K resolution from one of three inputs to one output. It eliminates the need to switch HDMI cables between devices.

Order Code	Mod:	Price each exc. VAT	inc. VAT each
N68DV	3x1 4K HDMI switch	£69.99	£59.99

4K 4x2 Way HDMI Matrix Switch with Audio and Remote



- Connects multiple HD sources (HD set-top box, HDMI DVD player, HD games console etc.) to two HDTVs

- Multiple HDMI input to 2 HDMI and 1 Audio output
- Video Output resolutions: 480p, 576p, 720p, 1080i, 1080p and 4K (2160p)
- Audio Outputs supported: Optical, Digital Coax, 3.5mm Stereo Jack
- Supports DTS Digital
- Compatible with early HDMI devices and SKY HD boxes
- Remote control for output adjustment
- 3D compatible

Most high-definition audio/video components utilise the HDMI interface to provide crystal clear, digital sound and picture. With the wealth of devices now using HDMI, it's easy to run out of free HDMI inputs on your TV set or receiver.

Our 4K 4x2 Way HDMI Matrix Switch solves this problem. It achieves this by providing 4 additional high-definition digital inputs for sources including DVD player, Blu-ray, Disc and HD-DVD players, gaming systems, and high-definition cable/satellite boxes.

A key feature of this device is that it can output to 2 HDTV's via two HDMI outputs. Additionally it offers audio output via Optical, Digital Coax or 3.5M Stereo Jack, to enable connection to your audio systems.

This device is 4K compatible at a resolution of 2160p and will work with most HDMI 3D devices, allowing you to switch between 3D devices on your 3D display. It is also fully compatible with HDCP-enabled sources.

The device has a front panel with LEDs to display the HDMI source currently selected. It also comes with a remote control for port selection.

Order Code	Mod:	Price each exc. VAT	inc. VAT each
N70DV	4x2 HDMI 4K2K HDMI M	£70.82	£84.99

HDMI 5 Way Switch



- Input port on the front for easy access
- Multi-switching methods: intelligent, IR remote or by push button
- Supports resolutions up to 1080p
- Supports 250MHz/2.5Gbps per channel (7.5Gbps all channel) bandwidth
- Supports 12bit per channel (36bit all channel) deep colour
- HDCP pass-through
- Supports uncompressed audio such as LPCM
- Supports compressed audio such as DTS Digital, Dolby Digital (including DTS-HD and Dolby True HD)
- Supports 3D all formats, including 1080p@23.98/24Hz, 720p@59.94/60Hz/50Hz, bandwidth up to 250MHz

A HDMI three way switch, operated by IR remote, press switch, or automatic detection of attached devices.

Order Code	Mod:	Price each exc. VAT	inc. VAT each
N500K	HDMI switch 5x1 HDMI	£29.15	£34.99

HDMI 3 Way Switch



- Input ports on the front for easy access
- Multi-switching methods: intelligent automatic, IR remote or by push button

- Supports resolutions up to 1080p
- Supports 250 MHz/2.5 Gbps per channel (7.5 Gbps all channel) bandwidth
- Supports 12-bit per channel (36-bit all channel) deep colour
- HDCP pass-through
- Supports uncompressed audio such as LPCM
- Supports compressed audio such as DTS Digital, Dolby Digital (including DTS-HD and Dolby True HD)
- Supports 3D all formats, including 1080p@23.98/24 Hz, 720p@59.94/60 Hz/50 Hz, bandwidth up to 250 MHz

A HDMI three way switch, operated by IR remote, press switch, or automatic detection of attached devices.

Order Code	Mod:	Price each exc. VAT	inc. VAT each
N490K	HDMI switch 3x1 HDMI	£20.82	£24.99

Trust our cables. Quality guaranteed.

Our Maplin branded cables offer an expansive range of types and lengths with professional grade options available. [see page 5 for full details](#)

5 Way HDMI Switch with Remote



- Connects multiple HD sources (HD set-top box, HDMI DVD player, HD games console etc) to your HDTV
- Automatic detection and switching to the input source that is on
- Compatible with early HDMI devices and SKY HD boxes
- Self-powering so no AC power adapter is required for most devices
- Signal enhancement to stop signal degradation over cable distances up to 15m
- Multiple HDMI input to 1 output
- Remote control for manual override of the auto function
- Supports output resolutions: 480p, 720p, 1080i and 1080p
- Power supply included so older non-powered HDMI devices will still work
- Compliant to HDMI v1.3b and HDCP1.2

Data transfer speed:	10.2 Gbps
Input Video Signal:	0.5-1.0 vclts p-p
Input DDC Signal:	5 volts p-p (TTL)
Max working current:	200mA
Maximum Single Link Range:	UXGA, 1080P
Output Video:	HDMI1.3+HDCP1.0/1.2
Support resolution:	1080P/1080i/720P/576P/480P/576i/480i

Support video color format:	deep color 24bit/36bit
Support audio format:	LPCM, Dclby-AC3, DTS7.1, C&D/Dclby TrueHD/ DTS-HD Master Audio

HDMI output cable distance:	15mif need longer, amplifier is needed
HDMI version:	HDMI 1.3

Order Code	Mod:	Price each exc. VAT	inc. VAT each
N076F	HDMI 5w Auto&Rem	£33.32	£39.99

Newsletter

Subscribe to our newsletter for information about the latest innovation and the best deals.



3 Way HDMI Switch with Remote



- Connects multiple HD sources (HD set-top box, HDMI DVD player, HD games console etc) to your HDTV
- Automatic detection and switching to the input source that is on
- Compatible with early HDMI devices and SKY HD boxes
- Self-powering so no AC power adapter is required for most devices
- Signal enhancement to stop signal degradation over cable distances up to 15m
- 3 HDMI inputs to 1 output
- Remote control for manual override of the auto function
- Supports output resolutions: 480p, 720p, 1080i and 1080p
- Power supply included so older non-powered HDMI devices will still work
- Compliant to HDMI v1.3b and HDCP1.2

Data transfer speed:	10.2 Gbps
Input Video Signal:	0.5-1.0 volts p-p
Input DDC Signal:	5 volts p-p (TTL)
Max working current:	200mA
Maximum Single Link Range:	UXGA, 1080P
Output Video:	HDMI1.3+HDCP1.0/1.2
Support resolution:	1080P/1080i/720P/576P/480P/576i/480i
Support video color format:	deep color 24bit/36bit
Support audio format:	LPCM, Dolby-AC3, DTS7.1, DSD/Dolby TrueHD/ DTS-HD Master Audio
HDMI output cable distance:	15m if need longer, amplifier is needed
HDMI version:	HDMI 1.3

Order Code	Mod: 808925	Price each exc. VAT 1+	inc. VAT each
N06GF	HDMI 3w Auto&Rem	£24.99	£29.99

HDMI Splitters

2 Way 4K HDMI Splitter



- Splits one HDMI device to two outputs simultaneously
 - Supports 4K resolution at 10.2 Gbps
 - Supports 12 bit per channel (36 bit all channels) deep colour
 - HDCP Compliant
 - Supports for LPCM and DTS Digital audio formats
- This 4K HDMI Splitter offers the flexibility to stream HDMI video and audio in 4K resolution from one input to two outputs simultaneously. It eliminates the need to switch HDMI cables between devices.

Order Code	Mod: 1032548	Price each exc. VAT 1+	inc. VAT each
N66DV	HDMI 1x2 Splitter 4K	£41.65	£49.99

Send direct

If any product is not in stock, we will order it for you and send it with free delivery



Terms and conditions apply.

4 Way 4K HDMI Splitter



- Splits one HDMI device to four outputs simultaneously
- Supports 4K resolution at 10.2 Gbps
- Supports 12 bit per channel (36 bit all channels) deep colour
- HDCP Compliant
- Support for LPCM and DTS Digital audio formats

This 4K HDMI Splitter offers the flexibility to stream HDMI video and audio in 4K resolution from one input to four outputs simultaneously. It eliminates the need to switch HDMI cables between devices.

Order Code	Mod: 1032531	Price each exc. VAT 1+	inc. VAT each
N67DV	HDMI 1x4 Splitter 4K	£74.99	£89.99

HDMI 2 Way Splitter



- Allows one input to be displayed on two displays
- Plug and play, no setup required
- HDMI 1.3b compliant
- Integrated HDCP decryption/encryption engines which are compliant with HDCP Rev 1.3
- Supports 12-bit Deep Full HD, and Full 3D
- Supports Standard Audio, DSD Audio and HD (HBR) Audio

The HDMI Amplifier Splitter is an HDMI splitter with two outputs. It splits the input of a HDMI signal into two outputs simultaneously. The product amplifies the signal output, allowing long distance transmission of the HDMI signal in excess of 15 metres

Input Video Signal	0.5-1.0 volts p-p
Input DDC Signal	5 volts p-p (TTL)
Maximum Single:	Link Range 4K2K
Output Video	HDMI 1.3b+ HDCP1.3
Video format supported:	DTV/HDTV 480i/576i/480p/576p/720p/1080i/1080P

Digital Signal	I/O
HDMI Compliance	HDMI 1.3b
Operating Frequency	Up to 340MHz
Resolutions(HDTV)	Interlaced(50&60Hz) 480i,576i,1080i Progressive(50&60Hz) 480p,576p,720p,1080p

Mechanical Size	88*51.5*25mm
Environmental Operating Temperature:	0°C to +70°C
Operating Humidity:	10% to 85% RH [no condensation]

Storage Temperature:	-10°C to +80°C
Storage Humidity:	5% to 90% RH [no condensation]

Power Requirement External Power Supply 5V DC

Order Code	Mod: 984259	Price each exc. VAT 1+	inc. VAT each
N48QK	HDMI Splitter 1x2 Su	£33.32	£39.99

HDMI 4 Way Splitter



- Plug and play, no setup required
- HDMI Specification 1.3b Compliant
- Integrated HDCP decryption/encryption engines which are compliant with HDCP Rev 1.3
- Supports 12-bit Deep Full HD and Full 3D
- Supports Standard Audio, DSD Audio and HD (HBR) Audio

The HDMI Amplifier Splitter is an HDMI splitter with four outputs. It splits the input of a HDMI signal into four outputs simultaneously. The product amplifies the signal output, allowing long distance transmission of the HDMI signal in excess of 15 metres

Signal Inputs/Output	Input Video Signal 0.5-1.0 volts p-p
	Input DDC Signal 5 volts p-p (TTL)
Maximum Single Output Video	Link Range 4K2K
Video format supported	HDMI 1.4a+ HDCP1.3 DTV/HDTV 480i/576i/480p/576p/720p/1080i/1080P

Digital Signal	I/O
HDMI Compliance:	HDMI 1.3b
Operating Frequency	Up to 340MHz
Resolutions(HDTV)	Interlaced(50&60Hz) 480i,576i,1080i Progressive(50&60Hz) 480p,576p,720p,1080p

Mechanical Size	88*51.5*25mm
Environmental Operating Temperature	0°C to +70°C
Operating Humidity	10% to 85% RH [no condensation]

Storage Temperature:	-10°C to +80°C
Storage Humidity:	5% to 90% RH [no condensation]

Power Requirement External Power Supply 5V DC

Order Code	Mod: 984261	Price each exc. VAT 1+	inc. VAT each
N53QK	HDMI splitter 1x4	£58.32	£69.99



Browse our entire range at maplin.co.uk

2 Way HDMI Splitter



- Splits a HDMI source into two HDMI outputs without signal loss
- HDMI 1.3 HDCP 1.2 DVI compliant
- Supports a wide range of PC and HDTV resolutions from VGA to UXGA and 480i to 1080p
- Built-in EDID simulator and HDCP key-set allows each output to work independently when connecting to a HDMI display
- Immediate picture pop-up upon connection
- Each of the buffered output can run up to 15 metres of cable without signal loss
- Compact size - 11.5 x 6.3 x 2.5 cm

Order Code	Mod: 224915	Price each exc. VAT 1+	inc. VAT each
N08GF	HDMI 2w Splitter	£33.32	£39.99

Buying for business?

0333 400 9740



TruLink 4 Way HDMI Splitter



- Up to 4K resolution and HDCP™-compliant
- Split 1 HDMI audio/video signal to 4 high-definition displays
- HDMI Standard Speed with Deep Colour, x.v. colour, high speed refresh rates and lossless multi-channel surround sound
- Supports 480i, 480p, 720p, 1080i, 1080p and 4k (2160p)
- HDCP-compliant for full playback of high definition content
- Supports up to 12 bit colour
- HDMI 3D capability

The TruLink® 4-port HDMI splitter connects an HDTV receiver, DVD player or other audio/video device to up to four HDTV displays equipped with HDMI inputs. This splitter supports HDMI Standard Speed features of Deep Colour, x.v. colour™, high speed refresh rates and lossless multichannel surround sound. It is HDCP-compliant for full playback of high definition content. This splitter is designed to support 480i, 480p, 720p, 1080i, 1080p and 4K resolutions. This splitter supports 3D, allowing you to split a signal from a 3D device to multiple 3D displays. Cascadable up to 3 layers, one output may be used to distribute the source signal to as many as 64 displays. The built-in equalizer boosts the signal to allow cascading up to 45 metres away.

Order Code	Mod:	Price each exc. VAT 1+	inc. VAT each
NO0NB	CTG 4P HDMI Splitter	£7.77	£7.77

Optical / Audio Switches

Optical and Coax Digital to Analogue Audio Converter



- Converts an optical or digital coaxial input to a stereo 3.5mm or twin phono output
- Supports 192KHz/24bit audio signal
- Requires a Micro B USB input to power the converter
- Supports PCM audio format

This optical to digital converter can allow a digital audio output on a TV, computer or Blu-ray player to connect to an analogue speaker or surround sound system. PCM output is supported for audio, but not Dolby and DTS audio formats.

Order Code	Mod:	Price each exc. VAT 1+	inc. VAT each
A44QX	DA audio converter	£33.32	£39.99

HDMI Audio Extractor



- Extract audio signals from your HDMI device
- Compliant with HDMI HDCP 1.2 and DVI 1.0
- Supports Dolby, DTS and PCM audio standards
- Surround sound ready with EDID switch for LPCM, 5.1/7.1 and Bitstream
- Supports 3D HDMI signal

The HDMI Audio extractor allows you to extract a digital or analogue audio signal from any HDMI source. Ideal for splitting the audio out of a HDMI device to a digital surround sound system, or to analogue speaker system. Another use is to extract audio when connecting to a display monitor without built-in speakers.

Order Code	Mod:	Price each exc. VAT 1+	inc. VAT each
A48QX	HDMI Audio Extractor	£41.65	£49.99

3 Way Optical Digital Audio Switcher



- Prevents wear on cables and connectors caused by repeated plugging and unplugging
- Standard TosLink™ type sockets
- Three optical inputs to one optical output

As more and more items of home entertainment equipment are supplied with optical digital audio connections (TosLinks™) it is increasingly frustrating that amplifiers and surround sound processors have only one input. This simple to use switch solves the problem of having to repeatedly plug and unplug equipment leads. This switcher will allow you to select an input from up to three sources with a positive locking action to ensure optimum signal transfer.

Order Code	Mod:	Price each exc. VAT 1+	inc. VAT each
L34AK	3-Way TosLink Switch	£12.49	£14.99

4 Way Stereo Speaker Switch Box



- Run up to 4 Pairs of speakers from an AV Receiver with only 1 speaker L/R input
- Listen to Speaker Set 1, Set 2, Set 3 or Set 4 individually or all simultaneously, Or even a mixture
- Stylish design - integrates perfectly with new Flat screen TVs and Receivers.

This state of the art switching box allows you to select between or control speakers in 4 different rooms or locations. The spring loaded terminals on the switch box allow secure and easy access for cable of up to 2.5mm diameter, while the unit provides full amplifier circuitry protection maintaining the load at the amplifier at 8 Ohms, regardless of how many speakers are attached. Max 75 Watt output.

Order Code	Mod:	Price each exc. VAT 1+	inc. VAT each
N99KT	4Way Speaker Switch	£20.82	£24.99



Reserve online and collect at the store of your choice

Free Delivery
on all UK orders over **£10**

(T&Cs Apply)

2 Way Stereo Speaker Switch Box



- Run up to 2 Pairs of speakers from an AV Receiver with only 1 speaker L/R input
- Listen to Speaker Set 1 or Set 2 individually or both simultaneously
- Stylish design - integrates perfectly with new Flat screen TVs and Receivers.

This state of the art switching box allows you to select between or control speakers in 2 different rooms or locations. The spring loaded terminals on the switch box allow secure and easy access for cable of up to 2.5mm diameter, while the unit provides full amplifier circuitry protection maintaining the load at the amplifier at 4 to 16 Ohms, regardless of how many speakers are attached. Max 75 Watt output.

Order Code	Mod:	Price each exc. VAT 1+	inc. VAT each
N98KT	2Way Speaker Switch	£16.65	£19.99

Shopping with us is easy...

In-store



7 days a week, check store listings at the back of the catalogue for address details

Online



maplin.co.uk

24hrs a day, 7 days a week, 365 days a year

Phone



0333 400 9500

Phone lines open 7 days a week

Buying for business?

0333 400 9740



/maplin



@maplintweet



/+maplin



/maplinonline



/maplintv

Video Switches

Programmable Universal Modulator



- Allows equipment with SCART or phono outputs to plug in to a TV or aerial socket
- Direct channel selection
- Wideband - TV channels 21 to 69
- Aerial loop-through
- SCART and phono inputs
- No loss in quality!
- Ideal for DVDs, digital TV boxes and CCTV cameras without RF/aerial sockets and for TVs without a SCART socket
- Mains powered
- Tough metal housing

If your TV does not have a SCART socket then this is for you. Connect any composite video device, such as a CCTV camera or camcorder to the aerial socket of a TV. This versatile modulator allows you to select the RF channel with simple DIP switches. Composite video and stereo audio inputs are via phono (RCA) sockets or the SCART socket. An RF input is provided as well as an output, allowing loop-through connection, so that the output of this modulator can be added into an existing aerial distribution network. The full range of available channels means that multiple modulators can be 'daisy-chained' and also avoids conflict with existing broadcast channels (including Channel 5) and other domestic equipment (VCR, Sky, DVD etc). An additional 'brightness' control allows the video input level to be adjusted. This modulator is mains-powered and housed in a sturdy metal case.

Specifications:

System: PAL-I
 RF channels: CH21 - CH69
 RF output: 471.25MHz - 855.25MHz (UHF)
 RF output level: 70dBµV
 Audio sub-carrier: 6.0MHz
 Video input level: 1Vp-p, adjustable
 Power supply: 230Vac, 50Hz
 Dimensions: 140(w)x40(h)x110(d)mm

Order Code	Mod: 033050	Price each exc. VAT 1+	inc. VAT each 5+
VH89W	Universal Modulator	£29.15	£34.99

SCART Switches

SCART Multiway Box with Switch



L09BB

- Allows the use of multiple devices through one SCART connector
- Fully wired (all 21 connectors)
- 50 cm cable

SCART box designed to allow up to 3 devices to be connected to one SCART plug. The cable used is fully screened, 50 cm in length and wired as an extension (i.e. pin 1 to 1, 2 to 2, 3 to 3 etc.). Please note: Contention from 2 or more audio/video outputs sharing 1 conductor input must be avoided, but 1 output to 2 or more inputs is allowable.

Order Code	Mod: 808932	Price each exc. VAT 1+	inc. VAT each 5+
L07BB	SCART - 3 SCART Box	£12.49	£9.99



L10BB



L11BB

- Allows the use of multiple devices through one SCART connector
- Composite video and RGB compatible
- 50cm cable
- Each SCART connector has an on/off switch
- Available in 2, 3 and 5 way

A range of 3 SCART boxes designed to allow up to 5 devices to be connected to one SCART plug. The cable used is fully screened, 50cm in length and wired as an extension (i.e. pin 1 to 1, 2 to 2, 3 to 3 etc.). The 5 way switch box has the addition of AV phono taps for both input and output.

Order Code	Mod: 043158	Price each exc. VAT 1+	inc. VAT each 5+
L09BB	SCART-2 SCART Swt Box	£13.32	£10.65
L10BB	SCART-3 SCART Swt Box	£14.99	£11.99
L11BB	SCART-5 SCART Swt Box	£20.82	£16.65

Nikkai Connect SCART to 3 SCART Box



Nikkai Connect SCART to 2 SCART Box



- Allows the use of two devices through one SCART connector
- Fully wired (all 21 connectors)
- 50 cm cable

SCART box designed to allow two devices to be connected to one SCART plug. The cable used is fully screened, 50 cm in length and wired as an extension (i.e. pin 1 to 1, 2 to 2, 3 to 3 etc.).

Please note: This product is only suitable for allowing two devices to share one SCART input on your TV. Whichever device is powered will be displayed on screen. This device is not suitable for trying to show one audio/video device on two screens.

Order Code	Mod: 808931	Price each exc. VAT 1+	inc. VAT each 5+
L06BB	SCART - 2 SCART Box	£9.99	£7.99

HDMI Converters

VGA to HDMI Converter with Audio Support



- Convert a VGA input into HDMI
- Allows a PC image to be displayed on a HDMI enabled TV with no VGA input
- Also converts stereo audio into the HDMI output
- Up to 1080p resolution support

This simple to use converter box allows any PC with a VGA output to connect to any HDMI enabled display device, such as a flat screen TV or projector. Ideal for TVs or projectors with no VGA input, or where those inputs are being used by other devices. It also converts stereo sound from the PC in the HDMI signal.

Order Code	Mod: 388962	Price each exc. VAT 1+	inc. VAT each 5+
N47HH	VGA to HDMI Conv	£41.65	£49.99

Trust our cables. Quality guaranteed.

Our Maplin branded cables offer an expansive range of types and lengths with professional grade options available. see page 5 for full details



Browse our entire range at maplin.co.uk

RCA S-Video to HDMI Converter with Audio Support



- Convert a RCA or S-Video input into HDMI
- Allows video to be displayed on a HDMI enabled TV with no S-Video or RCA input
- Also converts stereo audio into the HDMI output
- Up to 720p resolution support

This simple to use converter box allows any device with a S-Video or RCA output to connect to any HDMI enabled display device, such as a flat screen TV or projector. Ideal for TVs or projectors with no S-Video or RCA input, or where those inputs are being used by other devices. It also converts stereo sound from the device in the HDMI signal.

Order Code	Mod: 1022062	Price each exc. VAT 1+	inc. VAT each 5+
N38DU	RCA Svid to HDMI Con	£41.65	£49.99

RGB and Stereo Phono Audio to HDMI Converter



- Easy to use - install in seconds, no setup required
- Converts YPbPr video and left/right audio inputs into a complete HDMI output signal
- Supports highest video resolution up to 1080p
- Supports 165 MHz/1.65 Gbps per channel (6.75 Gbps all channel) bandwidth
- Supports 8-bit per channel (24-bit all channel) deep colour

This converter allows older analogue devices to be integrated into modern home HD systems. It features YPbPr/RGB video inputs plus left and right audio inputs enabling you to connect an Xbox 360, PS3, Wii, NTL, DVD player or satellite TV the HDMI socket of your TV

Order Code	Mod: 984272	Price each exc. VAT 1+	inc. VAT each 5+
N51QK	YPbPr+R/L to HDMI	£49.99	£59.99

AV Converters

3 Way Audio/Video Selector



- Three phono (RCA) and one S-VHS input and output
- Manually selectable - control the AV equipment of your choice
- Headphone socket

Each of the three inputs and the output feature a yellow phono socket for video, a red phono socket for right audio and a white phono socket for left audio plus a 4-pin S-video socket. A simple 3-position switch on the top selects which of the three inputs is passed to the output. The AV selector also features a headphone socket output

Order Code	Mod: 032114	Price each exc. VAT 1+	inc. VAT each 5+
L05AA	3 Way AV Selector	£12.49	£14.99

4 Way Video Splitter/Amplifier



- Drive 4 outputs from one input
- Composite video and stereo audio
- Send signals through cables up to 50m length
- Plug-in mains adapter included

A very simple to use audio/video distribution amplifier. All connections are via colour-coded phono (RCA) sockets. The standard colour code is used - yellow for video, white for left audio and red for right audio. The front panel features the AV inputs, an on/off switch and power-on indicator and the DC power socket. The rear panel has the four sets of output sockets. A 12Vdc 500mA plug-in mains adapter and an AV connection lead

Specifications:

Signal Type	Composite Video, Stereo Audio
Video Boost	about 100m distance
Video bandwidth	80 MHz, (-3 dB) 2V p-p
Audio bandwidth	30 MHz
Power supply	DC 12 V @ 0.42A
Power supply	12Vdc, 500mA
Dimensions	125 x 97 x 40mm

Order Code	Mod: 808942	Price each exc. VAT 1+	inc. VAT each 5+
L82AH	4 Way AV Dist Amp	£33.32	£39.99

Reserve online, collect in-store in 30 minutes



Stage Cables

VanDamme Instrument Cable Neutrik Stereo Jack-Jack

Van Damme/Neutrik Instrument Cable 6.35mm Stereo Jack to Jack Black



- For line level analogue balanced audio
- Ideal for on stage use
- Tightly packed cotton fillers ensure no static build up and even capacitance
- Close lapped copper screen for the best compromise between effective shielding and flexibility
- Combination of silver plated and plain ultra pure oxygen free copper conductors for unsurpassed sound quality
- Neutrik stereo/balanced jacks NP3X
- Available in 3m and 5m lengths

Van Damme Tour Grade Classic XKE Microphone cable combines flexibility, durability, noiseless operation and excellent handling characteristics. Now upgraded with more advanced PVC jacketing materials. Van Damme microphone cables can be found in film and recording studios, and are used in professional touring applications. Each cable is terminated with 2 Neutrik NP3X stereo/ balanced jacks

Order Code	Mod: 1032584	Price each exc. VAT 1+	inc. VAT each 5+
N96NL	VD NP3X to Stereo 5M	£22.49	£26.99
N95NL	VD NP3X to Stereo 3M	£19.99	£23.99

Jack (6.35mm) Cables

XLR to Jack Leads



- XLR to 1/4-inch mono jack
- Ideal for mic or numerous other stage applications
- High quality fully shielded low noise cable
- Moulded connectors with strain relief for durability
- Available in 3, 6 and 10 metre lengths

Order Code	Mod: 224859	Price each exc. VAT 1+	inc. VAT each 5+
N61FY	XLR-Jack Cable 3m	£10.82	£12.99
N62FY	XLR-Jack Cable 6m	£14.99	£17.99
N63FY	XLR-Jack Cable 10m	£19.15	£22.99

Look out for our monthly promotions at your local Maplin store now!

Pop in and pick up a copy of our monthly promotional publication, with special offers on dozens of exciting products. See the end of this catalogue for store listings

Microphone Cables

Van Damme Black Microphone Cable NC3MX - NC3FX



- For mic and line level analogue balanced audio
- Ideal for on stage use
- Further improved outer jacket ensures cable remains flexible in sub zero temperatures
- Tightly packed cotton fillers ensure no static build up and even capacitance
- Close lapped copper screen for the best compromise between effective shielding and flexibility
- Combination of silver plated and plain ultra pure oxygen free copper conductors for unsurpassed sound quality
- Standard mic cables Neutrik male XLR NC3MXX to female XLR NC3FXX

Van Damme Tour Grade Classic XKE Microphone cable combines flexibility, durability, noiseless operation and excellent handling characteristics. Now upgraded with more advanced PVC jacketing materials. Van Damme microphone cables can be found in film and recording studios, and are used in professional touring applications. Each cable is terminated with a Neutrik male XLR NC3MXX to female XLR NC3FXX

Order Code	Mod: 511393	Price each exc. VAT 1+	inc. VAT each 5+
N28JT	VD Mic cable XLR 3m	£10.82	£12.99
N29JT	VD Mic cable XLR 5m	£12.49	£14.99
N30JT	VD Mic cable XLR 10m	£16.65	£19.99

Buying for education?
0333 400 9740



Speaker Cables

Van Damme 1.5mm Black Tour Grade Speaker Cable NL4 Neutrik Speakons



- Matt Blue jacket for on stage use
- Multicore construction optimised for dynamic use
- Ultra pure oxygen free copper for outstanding sonic integrity
- Screw termination wired 1+/-
- Neutrik Speakon NL4FX to NL4FX 2 core 2x1.5mm

Van Damme Blue Studio Grade Speaker Cable offers a comprehensive conductor size and core count to accommodate almost all potential speaker signals. From 2 core 1.5mm through 8 core 4mm to 18 core 2.5mm the ultra pure copper conductors, cutting edge PVC compounds and dynamic use focused construction provide accurate signal transmission, toughness and flexibility. The products in this range are 2 core 1.5mm cable with Neutrik Speakon NL4 connections at each end

Order Code	Mod: 511401	Price each exc. VAT		inc. VAT each
		1+	5+	
N33JT	VD Spkr NL4 1.5 5m	£21.65	£20.82	£25.99
N34JT	VD Spkr NL4 1.5 10m	£27.49	£26.65	£32.99
N35JT	VD Spkr NL4 1.5 15m	£33.32	£31.65	£39.99
N36JT	VD Spkr NL4 1.5 20m	£39.15	£37.49	£46.99

Van Damme 2.5mm Black Tour Grade Speaker Cable NL4 Neutrik Speakons



- Matt blue jacket for on stage use
- Multicore construction optimised for dynamic use
- Ultra pure oxygen free copper for outstanding sonic integrity
- Screw termination wired 1+/-
- Neutrik Speakon NL4FX to NL4FX 2 core 2x2.5mm

Van Damme Blue Series Studio Grade Speaker Cable offers a comprehensive conductor size and core count to accommodate almost all potential speaker signals. From 2 core 1.5mm through 8 core 4mm to 18 core 2.5mm the ultra pure copper conductors, cutting edge PVC compounds and dynamic use focused construction provide accurate signal transmission, toughness and flexibility. The products in this range are 2 core 2.5mm cable with Neutrik Speakon NL4 connections at each end

Order Code	Mod: 511408	Price each exc. VAT		inc. VAT each
		1+	5+	
N37JT	VD Spkr NL4 2.5 5m	£24.99	£24.15	£29.99
N38JT	VD Spkr NL4 2.5 10m	£32.49	£30.82	£38.99
N39JT	VD Spkr NL4 2.5 15m	£35.82	£34.15	£42.99
N40JT	VD Spkr NL4 2.5 20m	£33.32	£31.65	£39.99

Van Damme Instrument Cable Neutrik Mono Jack-XLR F

Van Damme/Neutrik Instrument Cable 6.35mm Mono Jack to XLR Socket



- For balanced audio outputs to unbalanced jack inputs
- Low noise and high flexibility for on stage use
- Dual thermoplastic/lapped copper screens for excellent noise rejection
- Combination of silver plated and plain ultra pure oxygen free copper conductors for unsurpassed sound quality
- Terminated using 2% Silver solder - lead free RoHS compliant
- Neutrik mono jack NP2X to XLR female NC3FXX
- Available in 3m and 5m lengths

Van Damme Pro Grade Classic XKE Instrument Cable is a relatively low capacitance unbalanced audio cable for use with guitars, keyboards and other unbalanced input or output devices. Its tight construction and dual screens of conductive thermoplastic and close lapped copper ensure noise free handling and excellent noise rejection making this cable ideal for on stage use. Each cable is terminated with a Neutrik mono jack NP2X and 3 pin female XLR NC3FXX

Order Code	Mod: 1032592	Price each exc. VAT		inc. VAT each
		1+	5+	
N94NL	VD NP2X to XLR F 5M	£16.65		£19.99
N93NL	VD NP2X to XLR F 3M	£14.15		£16.99

Van Damme SC DMX Cable, Neutrik 3 Pin XLR M-F

Van Damme/Neutrik Smart Control DMX Cable 3 Pin XLR Male to Female



- Van Damme Smart Control is specifically designed for DMX512 lighting control
- 22AWG conductors and precision impedance cable for accurate data transfer
- Robust PVC jacketed cable for tour and on stage use
- Terminated with Neutrik 3 pin XLR connectors
- Ideal for use with Maplin's range of DMX lighting products
- Available in 1,3,5,10,20 & 30m lengths
- Available in Grey and Black

Van Damme Smart Control DMX cables offer a stable and reliable connection between DMX controllers and lighting equipment. Proven in the professional market place, these cables are the DMX cable of choice for multiple lighting companies, theatres and performance spaces.

Order Code	Mod: 1032591	Price each exc. VAT		inc. VAT each
		1+	5+	
N97NL	VD 3PXL R to DMX 1MBK	£12.49		£14.99
N98NL	VD 3PXL R to DMX 3MBK	£14.15		£16.99
N99NL	VD 3PXL R to DMX 5MBK	£14.15		£16.99
N01NN	VD 3PXL R 2 DMX 20MBK	£29.15		£34.99
N02NN	VD 3PXL R 2 DMX 30MBK	£41.65		£49.99
N08NN	VD 3PXL R 2 DMX 30MGR	£41.65		£49.99
N07NN	VD 3PXL R 2 DMX 20MGR	£29.15		£34.99
N06NN	VD 3PXL R 2 DMX 10MGR	£20.82		£24.99
N05NN	VD 3PXL R to DMX 5MGR	£16.65		£19.99
N04NN	VD 3PXL R to DMX 3MGR	£14.15		£16.99
N03NN	VD 3PXL R to DMX 1MGR	£12.49		£14.99

Van Damme Mono 6.35mm Cables

Van Damme Black Instrument Cable Neutrik Jacks



- Guitar cables
- Keyboard and sound module cables
- Hi-Fi interconnects
- Low noise and high flexibility for on stage use
- Dual thermoplastic/lapped copper screens for excellent noise rejection
- Ultra pure oxygen free copper for outstanding sonic integrity
- Terminated using 2% Silver solder - lead free RoHS compliant
- All products are fully test and quality assured
- Available in 5m & 10m lengths

Van Damme Pro Grade Classic XKE Instrument Cables are a relatively low capacitance unbalanced audio cables for use with guitars, keyboards and other unbalanced output devices. Its tight construction and dual screens of conductive thermoplastic and close lapped copper ensure noise free handling and excellent noise rejection making this cable ideal for on stage use. Each cable is terminated at each end with a Neutrik mono jack NP2X

Order Code	Mod: 1032590	Price each exc. VAT		inc. VAT each
		1+	5+	
N23JT	VD Instrmnt cbl 10m	£15.82		£18.99
N22JT	VD Instrument cbl 5m	£12.49	£11.75	£14.99

Van Damme XLR to Mono 6.35mm Cables

Van Damme/Neutrik Microphone Cables XLR Male to 6.35mm Jack Black



- For mic and line level analogue balanced audio
- Ideal for on stage use
- Further improved outer jacket ensures cable remains flexible in sub zero temperatures
- Tightly packed cotton fillers ensure no static build up and even capacitance
- Close lapped copper screen for the best compromise between effective shielding and flexibility
- Combination of silver plated and plain ultra pure oxygen free copper conductors for unsurpassed sound quality
- Standard mic cables Neutrik male XLR NC3MX to Jack NP3X
- Available in 3m and 5m lengths

Van Damme Tour Grade Classic XKE Microphone cables combine flexibility, durability, noiseless operation and excellent handling characteristics. Now upgraded with more advanced PVC jacketing materials, Van Damme microphone cables can be found in film and recording studios, and are used in professional touring applications. Each cable is terminated with a Neutrik male XLR NC3MX to Jack NP3X

Order Code	Mod: 1032575	Price each exc. VAT		inc. VAT each
		1+	5+	
N32JT	VD Mic XLR - Jack 5m	£13.32		£15.99
N31JT	VD Mic XLR - Jack 3m	£12.49		£14.99

Computer Cables

USB 2.0 Cables

Maplin USB 2.0 A to B Cables



- Ideal for use with PC printers and hard drives
- Up to 480Mbps transfer speed
- USB A Male to USB B Male
- USB version 2.0 compatible and works with all previous specifications
- USB 3.0 compatible but limited to USB 2.0 transfer speed
- Durable and highly flexible outer jacket
- 5 Year Warranty
- Available in 0.25, 0.5, 0.75, 1.5, 3 and 5 metre lengths

USB (Universal Serial Bus) is a highly versatile cable used to transfer digital data between computer devices. It is commonly used to connect a wide range of peripherals to Laptops, PC tower units and mobile devices, such as tablets and smartphones. The USB B connector is often used to transfer data between PC and printer. It is also used on hard drives and optical disc drives.

Order Code	Mod: 1029403	Price each exc. VAT 1+	inc. VAT each
A00QC	USB2 A(M)-B(M) 0.25m	£6.65	£7.99
A01QC	USB2 A(M)-B(M) 0.5m	£7.49	£8.99
A02QC	USB2 A(M)-B(M) 0.75m	£8.32	£9.99
A03QC	USB2 A(M)-B(M) 1.5m	£9.15	£10.99
A04QC	USB2 A(M)-B(M) 3m	£10.82	£12.99
A05QC	USB2 A(M)-B(M) 5m	£13.32	£15.99

Maplin USB 2.0 A to A Cables



- Ideal for use with PC hard drives and disc drives that use a USB A connector
- Up to 480Mbps transfer speed
- USB A Male to USB A Male
- USB version 2.0 compatible and works with all previous specifications
- USB 3.0 compatible but limited to USB 2.0 transfer speed
- Durable and highly flexible outer jacket
- 5 Year Warranty
- Available in 0.25, 0.5, 0.75, 1.5, 3 and 5 metre lengths

USB (Universal Serial Bus) is a highly versatile cable used to transfer digital data between computer devices. It is commonly used to connect a wide range of peripherals to Laptops, PC tower units and mobile devices, such as tablets and smartphones. The USB A connector is often used on a USB host device, such as a computer. It finds use on some hard drives and optical disc drives, but this is quite rare.

Order Code	Mod: 1030439	Price each exc. VAT 1+	inc. VAT each
A07QC	USB2 A(M)-A(M) 0.25m	£6.65	£7.99
A08QC	USB2 A(M)-A(M) 0.5m	£7.49	£8.99
A09QC	USB2 A(M)-A(M) 0.75m	£8.32	£9.99
A10QC	USB2 A(M)-A(M) 1.5m	£9.15	£10.99
A11QC	USB2 A(M)-A(M) 3m	£10.82	£12.99
A12QC	USB2 A(M)-A(M) 5m	£13.32	£15.99

Maplin USB 2.0 A to A Extension Cables



- Ideal for use with PC hard drives and disc drives that use a USB A connector
- Up to 480Mbps transfer speed
- USB A Male to USB A Female
- USB version 2.0 compatible and works with all previous specifications
- USB 3.0 compatible but limited to USB 2.0 transfer speed

- Durable and highly flexible outer jacket
 - 5 Year Warranty
 - Available in 0.25, 0.5, 0.75, 1.5 and 3 metre lengths
- USB (Universal Serial Bus) is a highly versatile cable used to transfer digital data between computer devices. It is commonly used to connect a wide range of peripherals to Laptops, PC tower units and mobile devices, such as tablets and smartphones. The USB A connector is often used on a USB host device, such as a computer. It finds use on some hard drives and optical disc drives, but this is quite rare.

Order Code	Mod: 1030504	Price each exc. VAT 1+	inc. VAT each
A14QC	USB2 A(M)-A(F) 0.25m	£6.65	£7.99
A15QC	USB2 A(M)-A(F) 0.5m	£7.49	£8.99
A16QC	USB2 A(M)-A(F) 0.75m	£8.32	£9.99
A17QC	USB2 A(M)-A(F) 1.5m	£9.15	£10.99
A18QC	USB2 A(M)-A(F) 3m	£10.82	£12.99

Maplin USB 2.0 A to A Active Extension Cables



- Ideal for use with PC hard drives and disc drives that use a USB A connector
- Powered over USB bus
- Up to 480Mbps transfer speed
- USB A Male to USB A Female
- USB version 2.0 compatible and works with all previous specifications
- USB 3.0 compatible but limited to USB 2.0 transfer speed
- Durable and highly flexible outer jacket
- 5 Year Warranty
- Available in 5 and 12 metre lengths

USB (Universal Serial Bus) is a highly versatile cable used to transfer digital data between computer devices. It is commonly used to connect a wide range of peripherals to Laptops, PC tower units and mobile devices, such as tablets and smartphones. This USB A extension cable is an active repeater, drawing power from an active USB port on a computer or laptop.

Order Code	Mod: 1030544	Price each exc. VAT 1+	inc. VAT each
A20QC	5m USB2 Repeater	£16.65	£19.99
A21QC	12m USB2 Repeater	£24.99	£29.99

Maplin USB 2.0 A to Mini B Cables



- Ideal for use with digital cameras, DV camcorders, MP3 players and mobile hard drives.
 - Up to 480Mbps transfer speed
 - USB A Male to USB Mini B Male
 - USB version 2.0 compatible and works with all previous specifications
 - USB 3.0 compatible but limited to USB 2.0 transfer speed
 - Durable and highly flexible outer jacket
 - 5 Year Warranty
 - Available in 0.25, 0.5, 0.75, 1.5, 3 and 5 metre lengths
- USB (Universal Serial Bus) is a highly versatile cable used to transfer digital data between computer devices. The compact USB Mini B connector is found on many mobile devices. It is most common on digital cameras and mobile

hard drives, and is used for data transfer and battery charging over USB.

Order Code	Mod: 1030545	Price each exc. VAT 1+	inc. VAT each
A23QC	USB2 Mini 5pin 0.25m	£6.65	£7.99
A24QC	USB2 Mini 5pin 0.5m	£7.49	£8.99
A25QC	USB2 Mini 5pin 0.75m	£8.32	£9.99
A26QC	USB2 Mini 5pin 1.5m	£9.15	£10.99
A27QC	USB2 Mini 5pin 3m	£10.82	£12.99
A28QC	USB2 Mini 5pin 5m	£13.32	£15.99

Maplin USB 2.0 A to Mini 4 pin Cable 3m



- Ideal for use with Sony, Olympus and Nikon digital cameras that use the 4 pin micro connector
- Up to 480Mbps transfer speed
- USB A Male to USB Mini 4 pin Male
- Specialised Mini 4 Pin connector
- USB version 2.0 compatible and works with all previous specifications
- USB 3.0 compatible but limited to USB 2.0 transfer speed
- Durable and highly flexible outer jacket
- 5 Year Warranty

USB (Universal Serial Bus) is a highly versatile cable used to transfer digital data between computer devices. The compact USB Mini 4 pin connector is specific to certain digital camera models. Most devices will require a USB miniB connector rather than mini 4 pin, so be sure to check the type of USB socket on your device.

Order Code	Mod: 1030546	Price each exc. VAT 1+	inc. VAT each
A30QC	USB2 Mini 4pin 3m	£12.49	£14.99

Maplin USB 2.0 A to Mini 8 pin Cable 3m



- Ideal for use with Kodak and Nikon digital cameras that use the 4 pin micro connector
- Up to 480Mbps transfer speed
- USB A Male to USB Mini 8 pin Male
- Specialised Mini 8 Pin connector
- USB version 2.0 compatible and works with all previous specifications
- USB 3.0 compatible but limited to USB 2.0 transfer speed
- Durable and highly flexible outer jacket
- 5 Year Warranty

USB (Universal Serial Bus) is a highly versatile cable used to transfer digital data between computer devices. The compact USB Mini 8 pin connector is specific to certain digital camera models. Most devices will require a USB miniB connector rather than mini 8 pin, so be sure to check the type of USB socket on your device.

Order Code	Mod: 1030547	Price each exc. VAT 1+	inc. VAT each
A32QC	USB2 Camera Lead 3m	£12.49	£14.99

Trust our cables. Quality guaranteed.

Our Maplin branded cables offer an expansive range of types and lengths with professional grade options available. [see page 5 for full details](#)

Maplin Black USB 2.0 A to Micro B Cables



- Ideal for use with smartphones and tablets, including Android and Windows-based devices.
- Up to 480Mbps transfer speed
- USB A Male to USB Micro B Male
- USB version 2.0 compatible and works with all previous specifications
- USB 3.0 compatible but limited to USB 2.0 transfer speed
- Durable and highly flexible outer jacket
- 5 Year Warranty
- Available in 0.25, 0.5, 0.75, 1.5, 3 and 5 metre lengths

USB (Universal Serial Bus) is a highly versatile cable used to transfer digital data between computer devices. The compact USB Micro B connector is found on many mobile devices. It is most common on smartphones and tablets, and is used for data transfer and battery charging over USB.

Order Code	Mod: 1030548	Price each exc. VAT 1+	inc. VAT each
A340C	USB2 Micro Blk 0.25m	£6.65	£7.99
A350C	USB2 Micro Blk 0.5m	£7.49	£8.99
A360C	USB2 Micro Blk 0.75m	£8.32	£9.99
A370C	USB2 Micro Blk 1.5m	£9.15	£10.99
A380C	USB2 Micro Blk 3m	£10.82	£12.99
A390C	USB2 Micro Blk 5m	£13.32	£15.99

Maplin White USB 2.0 A to Micro B Cables



- Ideal for use with smartphones and tablets, including Android and Windows-based devices.
- Up to 480Mbps transfer speed
- USB A Male to USB Micro B Male
- USB version 2.0 compatible and works with all previous specifications
- USB 3.0 compatible but limited to USB 2.0 transfer speed
- Durable and highly flexible outer jacket
- 5 Year Warranty
- Available in 0.25, 0.5, 0.75, 1.5, 3 and 5 metre lengths

USB (Universal Serial Bus) is a highly versatile cable used to transfer digital data between computer devices. The compact USB Micro B connector is found on many mobile devices. It is most common on smartphones and tablets, and is used for data transfer and battery charging over USB.

Order Code	Mod: 1030549	Price each exc. VAT 1+	inc. VAT each
A410C	USB2 Micro Wht 0.25m	£6.65	£7.99
A420C	USB2 Micro Wht 0.5m	£7.49	£8.99
A430C	USB2 Micro Wht 0.75m	£8.32	£9.99
A440C	USB2 Micro Wht 1.5m	£9.15	£10.99
A450C	USB2 Micro Wht 3m	£10.82	£12.99
A460C	USB2 Micro Wht 5m	£13.32	£15.99

Maplin Flat Black USB 2.0 A to Micro B Cables



- Ideal for use with smartphones and tablets, including Android and Windows-based devices
- Flat cable is tangle-resistant, ideal for mobile use
- Up to 480Mbps transfer speed
- USB A Male to USB Micro B Male
- USB version 2.0 compatible and works with all previous specifications
- USB 3.0 compatible but limited to USB 2.0 transfer speed
- Durable and highly flexible outer jacket
- 5 Year Warranty
- Available in 0.25, 0.5, 0.75, 1.5, 3 and 5 metre lengths

USB (Universal Serial Bus) is a highly versatile cable used to transfer digital data between computer devices. The compact USB Micro B connector is found on many mobile devices. It is most common on smartphones and tablets, and is used for data transfer and battery charging over USB.

Order Code	Mod: 1030550	Price each exc. VAT 1+	inc. VAT each
A480C	USB2 Mic Fl Blk .25m	£7.49	£8.99
A490C	USB2 Mic Fl Blk 0.5m	£8.32	£9.99
A500C	USB2 Mic Fl Blk .75m	£9.15	£10.99
A510C	USB2 Mic Fl Blk 1.5m	£9.99	£11.99
A520C	USB2 Mic Fl Blk 3m	£12.49	£14.99
A530C	USB2 Mic Fl Blk 5m	£14.99	£17.99

Maplin Flat White USB 2.0 A to Micro B Cables



- Ideal for use with smartphones and tablets, including Android and Windows-based devices
- Flat cable is tangle-resistant, ideal for mobile use
- Up to 480Mbps transfer speed
- USB A Male to USB Micro B Male
- USB version 2.0 compatible and works with all previous specifications
- USB 3.0 compatible but limited to USB 2.0 transfer speed
- Durable and highly flexible outer jacket
- 5 Year Warranty
- Available in 0.25, 0.5, 0.75, 1.5, 3 and 5 metre lengths

USB (Universal Serial Bus) is a highly versatile cable used to transfer digital data between computer devices. The compact USB Micro B connector is found on many mobile devices. It is most common on smartphones and tablets, and is used for data transfer and battery charging over USB.

Order Code	Mod: 1030551	Price each exc. VAT 1+	inc. VAT each
A550C	USB2 Mic Fl Wht .25m	£7.49	£8.99
A560C	USB2 Mic Fl Wht 0.5m	£8.32	£9.99
A570C	USB2 Mic Fl Wht .75m	£9.15	£10.99
A580C	USB2 Mic Fl Wht 1.5m	£9.99	£11.99
A590C	USB2 Mic Fl Wht 3m	£12.49	£14.99
A600C	USB2 Mic Fl Wht 5m	£14.99	£17.99

Maplin Coiled USB Cables



- Ideal for use with PC printers and hard drives
- Coiled lead stays compact and avoids tangles
- Up to 480Mbps transfer speed
- USB version 2.0 compatible and works with all previous specifications
- USB 3.0 compatible but limited to USB 2.0 transfer speed
- Durable and highly flexible outer jacket
- 5 Year Warranty

USB (Universal Serial Bus) is a highly versatile cable used to transfer digital data between computer devices. It is

commonly used to connect a wide range of peripherals to Laptops, PC tower units and mobile devices, such as tablets and smartphones. The USB B connector is often used to transfer data between PC and printer. It is also used on hard drives and optical disc drives.

Order Code	Mod: 1030552	Price each exc. VAT 1+	inc. VAT each
A680C	USB2 B Coil Blk 2m	£10.82	£12.99
A690C	USB2 B Coil Wh 2m	£10.82	£12.99
A700C	USB2 minB Coil Bl 2m	£10.82	£12.99
A710C	USB2 minB Coil Wh 2m	£10.82	£12.99
A720C	USB2 micB Coil Bl 2m	£10.82	£12.99
A730C	USB2 micB Coil Wh 2m	£10.82	£12.99
A740C	USB3 B Coil Bl 2m	£12.49	£14.99
A750C	USB3 B Coil Wh 2m	£12.49	£14.99
A760C	USB3 micB Coil Bl 2m	£12.49	£14.99
A770C	USB3 micB Coil Wh 2m	£12.49	£14.99

Maplin Triple Mobile Cables



- Charge and sync your Apple lightning, Apple 30 pin or Micro-B USB device
- Licensed by Apple for use with iPhones, iPads and iPods with a Lightning or 30 pin connector
- USB version 2.0 compatible and works with all previous specifications
- Durable and highly flexible outer jacket
- 5 Year Warranty

This versatile Triple Cable enables charging and data transfer from your Apple Lightning, Apple 30 pin or Micro-B USB device. Connect to your PC for charging and data transfer, or to a USB power adapter for charging only.

Order Code	Mod: 1031102	Price each exc. VAT 1+	inc. VAT each
A020J	MultiPlug Cbl Black	£20.82	£24.99
A030J	MultiPlug Cbl White	£20.82	£24.99

Maplin Dual Mobile Cables



- Charge and sync your Apple lightning, or Micro-B USB device
- Licensed by Apple for use with iPhones, iPads and iPods with a Lightning connector
- USB version 2.0 compatible and works with all previous specifications
- Durable and highly flexible outer jacket
- 5 Year Warranty

This versatile Dual Cable enables charging and data transfer from your Apple Lightning or Micro-B USB device. Connect to your PC for charging and data transfer, or to a USB power adapter for charging only.

Order Code	Mod: 1031103	Price each exc. VAT 1+	inc. VAT each
A990H	Dual Plug Cbl Black	£16.65	£19.99
A000J	Dual Plug Cbl White	£16.65	£19.99

Maplin USB 2.0 Adapters





A800C



L12BT



A680F



A690F



A700F



A710F



A720F

• A USB gender changer to solve cabling problems

Order Code	Mod: 1031106	Price each exc. VAT 1+	inc. VAT each
A790C	USB2 A(M)-PS/2(F)Adp	£8.32	£9.99
A800C	USB2 A(F)-PS/2(M)Adp	£8.32	£9.99
L12BT	USB A(F)-B(F) Adp	£1.15	£1.39
A680F	USB2 A(F)-Spiral(M)Adp	£6.65	£7.99
A690F	USB2 A(M)-A(M) Adp	£6.65	£7.99
A700F	USB2 A(F)-A(F) Adp	£6.65	£7.99
A710F	USB2 B (F)-microB	£6.65	£7.99
A720F	USB2 Mini USB Micro	£6.65	£7.99

USB 3.0 Cables

Maplin USB 3.0 A to B Cables



- Ideal for use with PC printers and hard drives
- Full Duplex USB 3.0 compliant
- Up to 5Gbps transfer speed
- USB A Male to USB B Male
- USB version 3.0 compatible and works with all previous specifications
- Durable and highly flexible outer jacket
- 5 Year Warranty
- Available in 0.5, 0.75, 1.5, 3 and 5 metre lengths

USB (Universal Serial Bus) is a highly versatile cable used

to transfer digital data between computer devices. It is commonly used to connect a wide range of peripherals to Laptops, PC tower units and mobile devices, such as tablets and smartphones. The USB 3.0 B connector is often used to transfer data between PC and printer. It is also used on hard drives and optical disc drives

Order Code	Mod: 1030554	Price each exc. VAT 1+	inc. VAT each
A830F	USB3 A(M)-B(M) 0.5m	£8.32	£9.99
A840F	USB3 A(M)-B(M) 0.75m	£9.15	£10.99
A850F	USB3 A(M)-B(M) 1.5m	£9.99	£11.99
A860F	USB3 A(M)-B(M) 3m	£12.49	£14.99
A870F	USB3 A(M)-B(M) 5m	£14.99	£17.99

Maplin USB 3.0 A to A Cables



- Ideal for use with PC hard drives and disc drives that use a USB A connector
- Full Duplex USB 3.0 compliant
- Up to 5Gbps transfer speed
- USB A Male to USB A Male
- USB version 3.0 compatible and works with all previous specifications
- Durable and highly flexible outer jacket
- 5 Year Warranty
- Available in 0.5, 0.75, 1.5, 3 and 5 metre lengths

USB (Universal Serial Bus) is a highly versatile cable used to transfer digital data between computer devices. It is commonly used to connect a wide range of peripherals to Laptops, PC tower units and mobile devices, such as tablets and smartphones. The USB 3.0 A connector is often used on a USB host device, such as a computer. It finds use on some hard drives and optical disc drives, but this is quite rare.

Order Code	Mod: 1030556	Price each exc. VAT 1+	inc. VAT each
A890F	USB3 A(M)-A(M) 0.5m	£8.32	£9.99
A900F	USB3 A(M)-A(M) 0.75m	£9.15	£10.99
A910F	USB3 A(M)-A(M) 1.5m	£9.99	£11.99
A920F	USB3 A(M)-A(M) 3m	£12.49	£14.99
A930F	USB3 A(M)-A(M) 5m	£14.99	£17.99

Maplin Black USB 3.0 A to Micro B Cables



- Ideal for use with smartphones and tablets, including Android and Windows-based devices
- Full Duplex USB 3.0 compliant
- Up to 5Gbps transfer speed
- USB A Male to USB Micro B Male
- USB version 3.0 compatible and works with all previous specifications
- Durable and highly flexible outer jacket
- 5 Year Warranty
- Available in 0.5, 0.75, 1.5, 3 and 5 metre lengths

USB (Universal Serial Bus) is a highly versatile cable used to transfer digital data between computer devices. The compact USB 3.0 Micro B connector is found on many mobile devices. It is most common on smartphones and tablets, and is used for data transfer and battery charging over USB.

Order Code	Mod: 1030557	Price each exc. VAT 1+	inc. VAT each
A950F	USB3 A-microB 0.5m	£8.32	£9.99
A960F	USB3 A-microB 0.75m	£9.15	£10.99
A970F	USB3 A-microB 1.5m	£9.99	£11.99
A980F	USB3 A-microB 3m	£12.49	£14.99
A990F	USB3 A-microB 5m	£14.99	£17.99

KNOW YOUR CABLES

USB A – The standard USB format, now found on a huge variety of equipment, designed to standardise connections for computer equipment. Combines data and power connections.

USB B – A square format USB connection, commonly found on printers, almost always found in cables with USB A to USB B.

USB Mini – A compact version of the standard USB lead, used to be prevalent in small media devices and phones.

USB Micro – The most common small format USB connection. Used on smartphones, media devices, often as a power only connection but also for data.

USB 3.0 – A high speed version of the USB, usually in a USB A shape but also available in other variants. Ideal for large data transfer operations.

Firewire – Also referred to as IEEE 1394, developed by Apple as a shaped connector with similar characteristics as USB, now superseded by Thunderbolt connection.

VGA – Video graphics adapter, the VGA connection is usually a thumb screw fitted plug, most commonly found on computer monitors.

DVI – Digital video interface, a composite connection found on some monitors available in a variety of pin formats. Does not carry audio.

DisplayPort – Designed to replace VGA and DVI, DisplayPort is usually found on monitors for video connection but it can also carry audio, USB and other data. Can carry very high definition signal.

Slimport – Usually used as an interconnect between mobile devices and displays capable of very high definition signal transmission.

Thunderbolt – Using the same connector as MiniDisplayPort, combines PCI express and DisplayPort into a single interface. Characterised by chainable and high speed connections. Developed by Apple.

Lightning – A replacement for Apple's 30-Pin connector, Lightning can be inserted either way round and uses only 8 pins for data and bi-directional power.

Maplin White USB 3.0 A to Micro B Cables



- Ideal for use with smartphones and tablets, including Android and Windows-based devices
- Full Duplex USB 3.0 compliant
- Up to 5Gbps transfer speed
- USB A Male to USB Micro B Male
- USB version 3.0 compatible and works with all previous specifications
- Durable and highly flexible outer jacket
- 5 Year Warranty
- Available in 0.5, 0.75, 1.5, 3 and 5 metre lengths

USB (Universal Serial Bus) is a highly versatile cable used to transfer digital data between computer devices. The compact USB 3.0 Micro B connector is found on many mobile devices. It is most common on smartphones and tablets, and is used for data transfer and battery charging over USB.

Order Code	Mod: 1030558	Price each exc. VAT 1+	inc. VAT each
A01QG	USB3 A-microB W 0.5m	£8.32	£9.99
A02QG	USB3 A-microB W 0.75m	£9.15	£10.99
A03QG	USB3 A-microB W 1.5m	£9.99	£11.99
A04QG	USB3 A-microB W 3m	£12.49	£14.99
A05QG	USB3 A-microB W 5m	£14.99	£17.99

Maplin Flat USB 3.0 A to Micro B Cables



- Ideal for use with smartphones and tablets, including Android and Windows-based devices
- Flat cable is tangle-resistant, ideal for mobile use
- Full Duplex USB 3.0 compliant
- Up to 5Gbps transfer speed
- USB A Male to USB Micro B Male
- USB version 3.0 compatible and works with all previous specifications
- Durable and highly flexible outer jacket
- 5 Year Warranty
- Available in 0.5, 0.75, 1.5, 3 and 5 metre lengths

USB (Universal Serial Bus) is a highly versatile cable used to transfer digital data between computer devices. The compact USB 3.0 Micro B connector is found on many mobile devices. It is most common on smartphones and tablets, and is used for data transfer and battery charging over USB.

Order Code	Mod: 1030559	Price each exc. VAT 1+	inc. VAT each
A07QG	USB3 A-micB Flt 0.5m	£9.15	£10.99
A08QG	USB3 A-micB Flt 0.75m	£9.99	£11.99
A09QG	USB3 A-micB Flt 1.5m	£10.82	£12.99
A10QG	USB3 A-micB Flt 3m	£13.32	£15.99
A11QG	USB3 A-micB Flt 5m	£16.65	£19.99

Maplin USB 3.0 A to A Active Extension Cable 3m



- Ideal for use with PC hard drives and disc drives that use a USB A connector

- Powered over USB bus
- Optional power supply input for unpowered USB connections
- Up to 5Gbps transfer speed
- USB A Male to USB A Female
- USB version 3.0 compatible and works with all previous specifications
- Durable and highly flexible outer jacket
- 5 Year Warranty

USB (Universal Serial Bus) is a highly versatile cable used to transfer digital data between computer devices. This USB 3.0 A extension cable is an active repeater, drawing power from an active USB port on a computer or laptop. In a case where a USB port is unpowered such as on a USB hub, an optional 5v power supply can be attached.

Order Code	Mod: 1030560	Price each exc. VAT 1+	inc. VAT each
A13QG	3m USB3 Repeater	£16.65	£19.99

Maplin USB 3.0 Adapter



- Full Duplex USB 3.0 compliant
- Up to 5Gbps transfer speed
- Fully wired terminals
- USB version 3.0 compatible and works with all previous specifications
- Durable plastic housing
- 5 Year Warranty

This adapter will connect a USB 3.0 A connector to a Micro B socket. USB 3.0 Micro B is found on Smartphones, tablets and mobile hard drives.

Order Code	Mod: 1031107	Price each exc. VAT 1+	inc. VAT each
A730F	USB3 A(F)-A(F) Adp	£8.32	£9.99
A740F	USB3 A(M)-B(F) Adp	£8.32	£9.99
A750F	USB3 B(M)-B(F) Adp	£8.32	£9.99
A760F	USB3 A(F)-B(F) Adp	£8.32	£9.99
A770F	USB3 A(M)-A(M) Adp	£8.32	£9.99
A780F	USB3 A(F)-B(M) Adp	£8.32	£9.99
A790F	USB3 A(M)-micB(M) Ad	£8.32	£9.99
A800F	USB3 A(F)-micB(M) Ad	£8.32	£9.99
A810F	USB3 B(F)-micB(M) Ad	£8.32	£9.99

FireWire Cables

Maplin Firewire 1394a 6 Pin Male Cables



- Up to 400 Mbps transfer speed
- Firewire 400 1394a compliant
- Full cable shielding
- Durable and highly flexible outer jacket
- 5 Year Warranty
- Available in 1.5 and 3 metre lengths

Firewire, also known as IEEE1394, is a high speed data cable used to transfer digital data between computer devices. It is commonly used to connect hard disc drives and DV digital video cameras to Laptops and PC tower units.

Order Code	Mod: 1031086	Price each exc. VAT 1+	inc. VAT each
A04QJ	1394a 6(M)-6(M) 1.5m	£16.65	£19.99
A05QJ	1394a 6(M)-6(M) 3m	£20.82	£24.99

Maplin Firewire 1394a 6 Pin Male to 4 Pin Male Cables



- Up to 400 Mbps transfer speed
- Firewire 400 1394a compliant
- Full cable shielding
- Durable and highly flexible outer jacket
- 5 Year Warranty
- Available in 1.5 and 3 metre lengths

Firewire, also known as IEEE1394, is a high speed data cable used to transfer digital data between computer devices. It is commonly used to connect hard disc drives and DV digital video cameras to Laptops and PC tower units.

Order Code	Mod: 1031087	Price each exc. VAT 1+	inc. VAT each
A07QJ	1394a 6(M)-4(M) 1.5m	£16.65	£19.99
A08QJ	1394a 6(M)-4(M) 3m	£20.82	£24.99

Maplin Firewire 1394a 4 Pin Male Cables



- Up to 400 Mbps transfer speed
- Firewire 400 1394a compliant
- Full cable shielding
- Durable and highly flexible outer jacket
- 5 Year Warranty
- Available in 1.5 and 3 metre lengths

Firewire, also known as IEEE1394, is a high speed data cable used to transfer digital data between computer devices. It is commonly used to connect hard disc drives and DV digital video cameras to Laptops and PC tower units.

Order Code	Mod: 1031088	Price each exc. VAT 1+	inc. VAT each 5+
L26BT	1394a 4[M]-4[M] 1.5m	£14.15	£12.74
A09QJ	1394a 4[M]-4[M] 3m	£20.82	£16.99

Maplin Firewire 1394a 9 Pin Male to 4 Pin Male Cables



- Up to 400 Mbps transfer speed
- Firewire 1394a and 1394b compliant
- Full cable shielding
- Durable and highly flexible outer jacket
- 5 Year Warranty
- Available in 1.5 and 3 metre lengths

Firewire, also known as IEEE1394, is a high speed data cable used to transfer digital data between computer devices. It is commonly used to connect hard disc drives and DV digital video cameras to Laptops and PC tower units. This cable adapts 9 pin Firewire 800 to a 4 pin Firewire 400 connection, and will support a maximum transfer rate of 400Mbps.

Order Code	Mod: 1031089	Price each exc. VAT 1+	inc. VAT each 5+
A110J	1394b 9[M]-4[M] 1.5m	£24.99	£29.99
A120J	1394b 9[M]-4[M] 3m	£29.15	£34.99

Maplin Firewire 1394b 9 Pin Male to 6 Pin Male Cables



- Firewire 800 leads, also known as 1394b
- 9-pin male to 6-pin male connection
- Suitable for speeds up to 800Mbps (for Firewire 800 enabled PCs)
- Fully shielded for error-free connections
- Gold plated connections
- Available in 1.5 and 3 metre lengths

Please note that this lead only allows connections of up to 400Mbps. For full speed 800Mbps connections, your PC and equipment must be Firewire 800 enabled and connected using a 9-pin to 9-pin lead (such as Order Code L33BT or L34BT). This lead is designed to allow Firewire 400 equipment to be used with Firewire 800 enabled PCs.

Order Code	Mod: 1031090	Price each exc. VAT 1+	inc. VAT each 5+
L31BT	1394b 9[M]-6[M] 1.5m	£23.32	£27.99
A130J	1394b 9[M]-6[M] 3m	£29.15	£34.99

Maplin Firewire 1394a 9 Pin Male Cables



- Up to 800 Mbps transfer speed
- Firewire 800 1394b compliant
- Full cable shielding
- Durable and highly flexible outer jacket
- 5 Year Warranty
- Available in 1.5 and 3 metre lengths

Firewire, also known as IEEE1394, is a high speed data cable used to transfer digital data between computer devices. It is commonly used to connect hard disc drives and DV digital video cameras to Laptops and PC tower units.

Order Code	Mod: 1031091	Price each exc. VAT 1+	inc. VAT each 5+
L33BT	1394b 9[M]-9[M] 1.5m	£23.32	£27.99
A140J	1394b 9[M]-9[M] 3m	£29.15	£34.99

Maplin Firewire 1394a Adapters



- Up to 400 Mbps transfer speed
- Firewire 1394a and 1394b compliant
- Full cable shielding
- Durable and highly flexible outer jacket
- 5 Year Warranty

Firewire, also known as IEEE1394, is a cable commonly used for high speed video and data transfer. This adapter will connect a 6 pin male Firewire connector to a 4 pin Firewire socket.

Order Code	Mod: 1031092	Price each exc. VAT 1+	inc. VAT each 5+
A160J	1394a 6[F]-4[M] Adp	£8.32	£9.99
A170J	1394a 4[F]-6[M] Adp	£8.32	£9.99

VGA Cables

Maplin VGA Extension Cables



- Ideal for use with VGA input computer monitors and televisions
- Suitable for high definition resolutions including 1080p
- Double cable shielding
- Durable and highly flexible outer jacket
- 5 Year Warranty
- Available in 0.75, 1.5, 3, 5, 10, 20, 30, 40 and 50 metre lengths

VGA is an analogue computer monitor cable that can carry high definition video. It does not carry audio however. It is commonly found on computer monitors, and is a standard video connector on PC tower units and laptops. Many HD televisions also feature this video connector to allow a PC display output.

Order Code	Mod: 1030563	Price each exc. VAT 1+	inc. VAT each 5+
A220G	VGA 15[M]-15[F] 75m	£14.99	£17.99
A230G	VGA 15[M]-15[F] 1.5m	£16.65	£19.99
A240G	VGA 15[M]-15[F] 3m	£20.82	£24.99
A250G	VGA 15[M]-15[F] 5m	£33.32	£39.99
A260G	VGA 15[M]-15[F] 10m	£41.65	£49.99
A270G	VGA 15[M]-15[F] 20m	£58.32	£69.99
A280G	VGA 15[M]-15[F] 30m	£74.99	£89.99
A290G	VGA 15[M]-15[F] 40m	£91.65	£109.99
A300G	VGA 15[M]-15[F] 50m	£108.32	£129.99

Maplin VGA Cables



- Ideal for use with VGA input computer monitors and televisions
- Suitable for high definition resolutions including 1080p
- Double cable shielding
- Durable and highly flexible outer jacket
- 5 Year Warranty
- Available in 0.75, 1.5, 3, 5, 10, 20, 30, 40 and 50 metre lengths

VGA is an analogue computer monitor cable that can carry high definition video. It does not carry audio however. It is commonly found on computer monitors, and is a standard video connector on PC tower units and laptops. Many HD televisions also feature this video connector to allow a PC display output.

Order Code	Mod: 1030564	Price each exc. VAT 1+	inc. VAT each 5+
A320G	VGA 15[M]-15[M] 75m	£14.99	£17.99
A330G	VGA 15[M]-15[M] 1.5m	£16.65	£19.99
A340G	VGA 15[M]-15[M] 3m	£20.82	£24.99
A350G	VGA 15[M]-15[M] 5m	£33.32	£39.99
A360G	VGA 15[M]-15[M] 10m	£41.65	£49.99
A370G	VGA 15[M]-15[M] 20m	£58.32	£69.99
A380G	VGA 15[M]-15[M] 30m	£74.99	£89.99
A390G	VGA 15[M]-15[M] 40m	£91.65	£109.99
A400G	VGA 15[M]-15[M] 50m	£108.32	£129.99

Maplin VGA to BNC Cable 1.5m



- Ideal for use with VGA input computer monitors and televisions
- Suitable for high definition resolutions including 1080p
- Double cable shielding
- Durable and highly flexible outer jacket
- 5 Year Warranty

VGA is an analogue computer monitor cable that can carry high definition video. BNC VGA is a high quality fully shielded connection, found on specialised computer monitors and PC video cards.

Order Code	Mod: 1030565	Price each exc. VAT 1+	inc. VAT each 5+
A420G	VGA 15[M]-BNC 1.5m	£20.82	£24.99

Maplin VGA Adapters



- Fully wired terminals
- Durable plastic housing
- 5 Year Warranty

Order Code	Mod: 1031115	Price each exc. VAT 1+	inc. VAT each 5+
A630G	VGA 15[M]-15[M] Adp	£10.82	£12.99
A640G	VGA 15[F]-15[F] Adp	£10.82	£12.99
A650G	VGA 9[M]-15[F] Adp	£10.82	£12.99
A660G	VGA 9[F]-15[M] Adp	£10.82	£12.99

DVI Cables

Maplin DVI-I Single Link Cables



- Ideal for use with analogue or digital DVI input computer monitors and televisions
- Suitable for high definition resolutions including 1080p
- Double cable shielding
- Durable and highly flexible outer jacket
- 5 Year Warranty
- Available in 1.5, 3 and 5 metre lengths

DVI-I single link is an analogue or digital-capable computer monitor cable that can carry high definition video. DVI-I single link can support 1080p resolutions and is commonly used to connect PC video cards and laptops to monitors

Order Code	Mod: 1030566	Price each exc. VAT 1+	inc. VAT each
A440G	DVI-I Single 1.5m	£16.65	£19.99
A450G	DVI-I Single 3m	£20.82	£24.99
A460G	DVI-I Single 5m	£29.15	£34.99

Maplin DVI-D Single Link Cables



- Ideal for use with DVI-D input computer monitors and televisions
- Suitable for high definition resolutions including 1080p
- Double cable shielding
- Durable and highly flexible outer jacket
- 5 Year Warranty
- Available in 1.5, 3 and 5 metre lengths

DVI-D single link is a digital computer monitor cable that can carry high definition video. DVI-D single link can support 1080p resolution at 60 Hz, and is commonly used to connect PC video cards and laptops to monitors

Order Code	Mod: 1030567	Price each exc. VAT 1+	inc. VAT each
A480G	DVI-D Single 1.5m	£16.65	£19.99
A490G	DVI-D Single 3m	£20.82	£24.99
A500G	DVI-D Single 5m	£29.15	£34.99

Maplin DVI-D Dual Link Cables



- Ideal for use with DVI-D input computer monitors and televisions
- Suitable for high definition resolutions including 1080P
- Double cable shielding
- Durable and highly flexible outer jacket
- 5 Year Warranty

DVI-D dual link is a digital computer monitor cable that can carry high definition video. DVI-D dual link can support 1080P resolution at 60 Hz, and supports greater bandwidth than DVI-D Single for even higher resolutions.

Order Code	Mod: 1030568	Price each exc. VAT 1+	inc. VAT each
A520G	DVI-D Dual 1.5m	£20.82	£24.99
A530G	DVI-D Dual 3m	£24.99	£29.99
A540G	DVI-D Dual 5m	£33.32	£39.99

Maplin DVI-A to VGA Cables



- Ideal for use with VGA input computer monitors and televisions
- Suitable for high definition resolutions including 1080p
- Double cable shielding
- Durable and highly flexible outer jacket
- 5 Year Warranty
- Available in 1.5 and 3 metre lengths

DVI-A to VGA is an analogue computer monitor cable that can carry high definition video. The DVI-A connection is commonly found on PC video cards and laptops, and allows connection to a VGA monitor.

Order Code	Mod: 1030569	Price each exc. VAT 1+	inc. VAT each
A560G	DVI-A(M)-15(M) 1.5m	£29.15	£34.99
A570G	DVI-A(M)-15(M) 3m	£33.32	£39.99

Maplin DVI-D to HDMI Adapters



- Fully wired terminals
- Durable plastic housing
- 5 Year Warranty

This adapter will convert a DVI-D socket on a PC video card or laptop to a HDMI socket, allowing use of a HDMI cable to connect a TV or monitor.

Order Code	Mod: 1031116	Price each exc. VAT 1+	inc. VAT each
A610G	DVI-D(M)-HDMI(F) Adp	£14.99	£17.99
A620G	DVI-D(F)-HDMI(M) Adp	£14.99	£17.99

Maplin DVI-A to VGA Adapters



- Fully wired terminals
- Durable plastic housing
- 5 Year Warranty

This adapter will convert a DVI-A socket on a PC video card or laptop to a VGA socket, allowing use of a VGA cable to connect a monitor

Order Code	Mod: 1031117	Price each exc. VAT 1+	inc. VAT each
A590G	DVI-A(M)-15(F) Adp	£12.49	£14.99
A600G	DVI-A(F)-15(M) Adp	£12.49	£14.99

DisplayPort Cables

Maplin Black DisplayPort Cables



- Fully digital video and data cable for the latest generation of monitors and TV displays
 - Suitable for 1080P and 4K resolutions
 - Locking connectors
 - Durable and highly flexible outer jacket
 - 5 Year Warranty
 - Available in 0.75, 1.5, 3, 5, 10 and 20 metre lengths
- DisplayPort is a digital display interface that can carry video and audio. DisplayPort can output ultra high definition 4K resolutions, and transmit bi-directional USB data alongside a video and audio signal. It is increasingly common on new PC tower units and laptops, and on HD televisions to enable PC display output.

Order Code	Mod: 1030570	Price each exc. VAT 1+	inc. VAT each
A700G	DisplayPort 0.75m	£14.99	£17.99
A710G	DisplayPort 1.5m	£16.65	£19.99
A720G	DisplayPort 3m	£20.82	£24.99
A730G	DisplayPort 5m	£29.15	£34.99
A740G	DisplayPort 10m	£41.65	£49.99
A750G	DisplayPort 20m	£58.32	£69.99

Maplin White DisplayPort Cables



- Fully digital video and data cable for the latest generation of monitors and TV displays
 - Suitable for 1080P and 4K resolutions
 - Locking connectors
 - Durable and highly flexible outer jacket
 - 5 Year Warranty
 - Available in 0.75, 1.5, 3, 5, 10 and 20 metre lengths
- DisplayPort is a digital display interface that can carry video and audio. DisplayPort can output ultra high definition 4K resolutions, and transmit bi-directional USB data alongside a video and audio signal. It is increasingly common on new PC tower units and laptops, and on HD televisions to enable PC display output

Order Code	Mod: 1031043	Price each exc. VAT 1+	inc. VAT each
A770G	DisplayPort Wht. 75m	£14.99	£17.99
A780G	DisplayPort Wht. 1.5m	£12.49	£14.99
A790G	DisplayPort Wht. 3m	£16.65	£19.99
A800G	DisplayPort Wht. 5m	£29.15	£34.99
A810G	DisplayPort Wht. 10m	£41.65	£49.99
A820G	DisplayPort Wht. 20m	£58.32	£69.99

Maplin Black DisplayPort to Mini DisplayPort Cables



- Fully digital video and data cable for the latest generation of monitors and TV displays
 - Suitable for high definition resolutions, including up to 2560x1600
 - Durable and highly flexible outer jacket
 - 5 Year Warranty
 - Available in 0.75, 1.5, 3, 5, 10 and 20 metre lengths
- DisplayPort is a digital display interface that can carry video and audio. DisplayPort can output HD display resolutions, and transmit bi-directional USB data alongside a video and audio signal. The Mini DisplayPort connector is most commonly found on Apple computers, and many laptops and motherboards now accept this display standard

Order Code	Mod: 1031423	Price each exc. VAT 1+	inc. VAT each
A840G	DP - miniDP Blk. 75m	£14.99	£17.99
A850G	DP - miniDP Blk. 1.5m	£16.65	£19.99
A860G	DP - miniDP Blk. 3m	£20.82	£24.99
A870G	DP - miniDP Blk. 5m	£29.15	£34.99
A880G	DP - miniDP Blk. 10m	£41.65	£49.99
A890G	DP - miniDP Blk. 20m	£58.32	£69.99

Maplin White DisplayPort to Mini DisplayPort Cables



- Fully digital video and data cable for the latest generation of monitors and TV displays
- Suitable for high definition resolutions, including up to 2560x1600
- Durable and highly flexible outer jacket
- 5 Year Warranty
- Available in 0.75, 1.5, 3, 5, 10 and 20 metre lengths

DisplayPort is a digital display interface that can carry video and audio. DisplayPort can output HD display resolutions, and transmit bi-directional USB data alongside a video and audio signal. The Mini DisplayPort connector is most commonly found on Apple computers, and many laptops and motherboards now accept this display standard.

Order Code	Mod: 1031044	Price each exc. VAT 1+	inc. VAT each
A910G	DP - miniDP Wht. 75m	£14.99	£17.99
A920G	DP - miniDP Wht. 1.5m	£16.65	£19.99
A930G	DP - miniDP Wht. 3m	£20.82	£24.99
A940G	DP - miniDP Wht. 5m	£29.15	£34.99
A950G	DP - miniDP Wht. 10m	£41.65	£49.99
A960G	DP - miniDP Wht. 20m	£58.32	£69.99

Maplin SlimPort to HDMI Adapters



- Suitable for 1080p HD resolution, up to 1920x1200
- 2 channel stereo audio support
- Durable and highly flexible outer jacket
- 5 Year Warranty

SlimPort is a video output standard for mobile devices. It uses a USB Micro B connector and requires no external power.

Order Code	Mod: 1031113	Price each exc. VAT 1+	inc. VAT each
A34QH	Slimport to HDMI	£16.65	£19.99

Maplin DisplayPort Adapters



- Fully wired terminals
- Durable plastic housing
- 5 Year Warranty

These adapter will allow the connection of Mini DisplayPort to a full size DisplayPort. DisplayPort is a high resolution display interface that can carry video and audio.

Order Code	Mod: 1031114	Price each exc. VAT 1+	inc. VAT each
A670G	DPI(M) to miniDP(F)	£16.65	£19.99
A680G	DPI(F) to miniDP(M)	£16.65	£19.99

Maplin Black Mini DisplayPort Cables



- Fully digital video and data cable for the latest generation of monitors and TV displays
- Suitable for high definition resolutions, including up to 2560x1600
- Durable and highly flexible outer jacket
- 5 Year Warranty
- Available in 0.75, 1.5, 3, 5, 10 and 20 metre lengths

DisplayPort is a digital display interface that can carry video and audio. The Mini DisplayPort connector is most commonly found on Apple computers, and many laptops and motherboards now accept this display standard.

Order Code	Mod: 1031230	Price each exc. VAT 1+	inc. VAT each
A980G	miniDP Blk 0.75m	£14.99	£17.99
A990G	miniDP Blk 1.5m	£16.65	£19.99
A000H	miniDP Blk 3m	£20.82	£24.99
A010H	miniDP Blk 5m	£29.15	£34.99
A020H	miniDP Blk 10m	£41.65	£49.99
A030H	miniDP Blk 20m	£58.32	£69.99

Maplin White Mini DisplayPort Cables



- Fully digital video and data cable for the latest generation of monitors and TV displays
- Suitable for high definition resolutions, including up to 2560x1600
- Durable and highly flexible outer jacket
- 5 Year Warranty
- Available in 0.75, 1.5, 3, 5, 10 and 20 metre lengths

DisplayPort is a digital display interface that can carry video and audio. The Mini DisplayPort connector is most commonly found on Apple computers, and many laptops and motherboards now accept this display standard.

Order Code	Mod: 1031231	Price each exc. VAT 1+	inc. VAT each
A050H	miniDP Wht 0.75m	£14.99	£17.99
A060H	miniDP Wht 1.5m	£16.65	£19.99
A070H	miniDP Wht 3m	£20.82	£24.99
A080H	miniDP Wht 5m	£29.15	£34.99
A090H	miniDP Wht 10m	£41.65	£49.99
A100H	miniDP Wht 20m	£58.32	£69.99

Maplin Black Mini DisplayPort to HDMI Cables



- Fully digital video cable for the latest generation of monitors and TV displays
- Suitable for 1080p HD resolution, including up to 2560x1600
- Durable and highly flexible outer jacket
- 5 Year Warranty
- Available in 0.75, 1.5, 3, 5, 10 and 20 metre lengths

This Mini DisplayPort to HDMI cable enables video and audio output from a PC tower unit or laptop to a HDMI enabled TV or monitor. Mini DisplayPort is most commonly found on Apple computers, and many laptops and motherboards now accept this display standard.

Order Code	Mod: 1031232	Price each exc. VAT 1+	inc. VAT each
A120H	miniDP-HDMI Blk. 75m	£14.99	£17.99
A130H	miniDP-HDMI Blk. 1.5m	£16.65	£19.99
A140H	miniDP-HDMI Blk. 3m	£20.82	£24.99
A150H	miniDP-HDMI Blk. 5m	£29.15	£34.99
A160H	miniDP-HDMI Blk. 10m	£41.65	£49.99
A170H	miniDP-HDMI Blk. 20m	£58.32	£69.99

Maplin White Mini DisplayPort to HDMI Cables



- Fully digital video cable for the latest generation of monitors and TV displays
- Suitable for 1080p HD resolution, including up to 2560x1600
- Durable and highly flexible outer jacket
- 5 Year Warranty
- Available in 0.75, 1.5, 3, 5, 10 and 20 metre lengths

This Mini DisplayPort to HDMI cable enables video and audio output from a PC tower unit or laptop to a HDMI enabled TV or monitor. Mini DisplayPort is most commonly found on Apple computers, and many laptops and motherboards now accept this display standard.

Order Code	Mod: 1031233	Price each exc. VAT 1+	inc. VAT each
A190H	miniDP-HDMI Wht. 75m	£14.99	£17.99
A200H	miniDP-HDMI Wht. 1.5m	£16.65	£19.99
A210H	miniDP-HDMI Wht. 3m	£20.82	£24.99
A220H	miniDP-HDMI Wht. 5m	£29.15	£34.99
A230H	miniDP-HDMI Wht. 10m	£41.65	£49.99
A240H	miniDP-HDMI Wht. 20m	£58.32	£69.99

Maplin Mini DisplayPort Adapters



- Suitable for 1080p HD resolution, up to 1920x1200
- Active digital to analogue conversion
- Durable and highly flexible outer jacket
- 5 Year Warranty

Mini DisplayPort is most commonly found on Apple computers, and many laptops and motherboards now accept this display standard.

Order Code	Mod: 1031234	Price each exc. VAT 1+	inc. VAT each
A260H	miniDP to VGA	£24.99	£29.99
A270H	miniDP to DVI	£16.65	£19.99
A280H	miniDP-HDMI Audio	£16.65	£19.99

Maplin DisplayPort Adapters



- Suitable for 1080p HD resolution, up to 1920x1200
- Active digital to analogue conversion
- Durable and highly flexible outer jacket
- 5 Year Warranty

DisplayPort is increasingly common on new PC tower units and laptops, and on HD televisions to enable PC display output.

Order Code	Mod: 1031235	Price each exc. VAT 1+	inc. VAT each
A290H	Displayport to VGA	£24.99	£29.99
A300H	Displayport to DVI	£16.65	£19.99
A310H	Displayport to HDMI	£16.65	£19.99



Browse our entire range at maplin.co.uk



Over 200 stores nationwide

Thunderbolt Cables

Maplin Black Thunderbolt Cables



- Ideal for use with Apple and Windows-based PC's and Laptops to connect display monitors and hard drives
- Full Duplex Thunderbolt compliant
- Up to 20Gbps transfer speed
- Dual function video and data cable
- Durable and highly flexible outer jacket
- 5 Year Warranty
- Available in 1, 2 and 3 metre lengths

Thunderbolt is a high speed, dual function video and data cable, and is found on the latest Laptops and PC tower units. It is capable of HD video and audio output to a TV or monitor, or high speed data transfer from a Thunderbolt hard drive or peripheral.

Order Code	Mod: 1030561	Price each exc. VAT 1+	inc. VAT each
A150G	Thunderbolt Blk 1m	£24.99	£29.99
A160G	Thunderbolt Blk 2m	£29.15	£34.99
A170G	Thunderbolt Blk 3m	£33.32	£39.99

Maplin White Thunderbolt Cables



- Ideal for use with Apple and Windows-based PC's and Laptops to connect display monitors and hard drives
- Full Duplex Thunderbolt compliant
- Up to 20Gbps transfer speed
- Dual function video and data cable
- Durable and highly flexible outer jacket
- 5 Year Warranty
- Available in 1, 2 and 3 metre lengths

Thunderbolt is a high speed, dual function video and data cable, and is found on the latest Laptops and PC tower units. It is capable of HD video and audio output to a TV or monitor, or high speed data transfer from a Thunderbolt hard drive or peripheral.

Order Code	Mod: 1030562	Price each exc. VAT 1+	inc. VAT each
A190G	Thunderbolt Wht 1m	£24.99	£29.99
A200G	Thunderbolt Wht 2m	£29.15	£34.99
A210G	Thunderbolt Wht 3m	£33.32	£39.99

Lightning Cables

Maplin White Lightning to USB Cables



- Charge and sync your Apple lightning device
- Licensed by Apple for use with iPhones, iPads and iPods with a Lightning connector

- Charge and sync your Apple lightning device
 - Licensed by Apple for use with iPhones, iPads and iPods with a Lightning connector
 - USB version 2.0 compatible and works with all previous specifications
 - Durable and highly flexible outer jacket
 - 5 Year Warranty
 - Available in 0.25, 0.5, 0.75, 1.5 and 3 metre lengths
- The Apple Lightning cable enables charging and data transfer from your Apple Lightning-enabled device. Connect to your PC for charging and data transfer, or to a USB power adapter for charging only

Order Code	Mod: 1031045	Price each exc. VAT 1+	inc. VAT each
A350H	Lightning Wht 0.25m	£13.32	£15.99
A360H	Lightning Wht 0.5m	£14.15	£16.99
A370H	Lightning Wht 0.75m	£14.99	£17.99
A380H	Lightning Wht 1.5m	£16.65	£19.99
A390H	Lightning Wht 3m	£20.82	£24.99

Maplin Black Lightning to USB A Cables



- Charge and sync your Apple lightning device
 - Licensed by Apple for use with iPhones, iPads and iPods with a Lightning connector
 - USB version 2.0 compatible and works with all previous specifications
 - Durable and highly flexible outer jacket
 - 5 Year Warranty
 - Available in 0.25, 0.5, 0.75, 1.5 and 3 metre lengths
- The Apple Lightning cable enables charging and data transfer from your Apple Lightning-enabled device. Connect to your PC for charging and data transfer, or to a USB power adapter for charging only

Order Code	Mod: 1031046	Price each exc. VAT 1+	inc. VAT each
A420H	Lightning Blk 0.25m	£13.32	£15.99
A430H	Lightning Blk 0.5m	£14.15	£16.99
A440H	Lightning Blk 0.75m	£14.99	£17.99
A450H	Lightning Blk 1.5m	£16.65	£19.99
A460H	Lightning Blk 3m	£20.82	£24.99

Maplin Coiled Lightning to USB A Cables



- Charge and sync your Apple lightning device
 - Coiled lead stays compact and avoids tangles
 - Licensed by Apple for use with iPhones, iPads and iPods with a Lightning connector
 - USB version 2.0 compatible and works with all previous specifications
 - Durable and highly flexible outer jacket
 - 5 Year Warranty
 - 2 metres in length
- The Apple Lightning cable enables charging and data transfer from your Apple Lightning-enabled device. Connect to your PC for charging and data transfer, or to a USB power adapter for charging only

Order Code	Mod: 1031047	Price each exc. VAT 1+	inc. VAT each
A490H	Lightning Blk Coil 2m	£19.15	£22.99
A500H	Lightning Wht Coil 2m	£19.15	£22.99

Maplin Lightning to USB A Cables



- Charge and sync your Apple lightning device
- Licensed by Apple for use with iPhones, iPads and iPods with a Lightning connector
- USB version 2.0 compatible and works with all previous specifications
- Durable and highly flexible outer jacket
- 5 Year Warranty
- 0.75 m length
- Available in blue and green

The Apple Lightning cable enables charging and data transfer from your Apple Lightning-enabled device. Connect to your PC for charging and data transfer, or to a USB power adapter for charging only

Order Code	Mod: 1031048	Price each exc. VAT 1+	inc. VAT each
A520H	Lightning Blu 0.75m	£14.99	£17.99
A530H	Lightning Grn 0.75m	£14.99	£17.99

Maplin Lightning to Micro USB Adapter



- Licensed by Apple for use with iPhones, iPads and iPods with a Lightning connector
- Fully wired terminals
- Durable plastic housing
- 5 Year Warranty

This Apple Lightning to Micro B USB adapter enables use of a USB Micro B cable for charging and data transfer from your Apple Lightning-enabled device

Order Code	Mod: 1031108	Price each exc. VAT 1+	inc. VAT each
A920H	Lightning to micUSB	£8.32	£9.99

Apple 30pin Cables

Maplin Black 30 Pin Apple to USB A Cables



- Charge and sync your Apple 30 pin device
- Licensed by Apple for use with iPhones, iPads and iPods with a 30 pin connector
- USB version 2.0 compatible and works with all previous specifications
- Durable and highly flexible outer jacket
- 5 Year Warranty
- Available in 0.5, 0.75, 1.5 and 3 metre lengths

The Apple 30 pin cable enables charging and data transfer from your Apple 30 pin-enabled device. Connect to your PC for charging and data transfer, or to a USB power adapter for charging only

Order Code	Mod: 1031081	Price each exc. VAT 1+	inc. VAT each
A650H	Apple 30pin Blk 5m	£14.15	£16.99
A660H	Apple 30pin Blk 7.5m	£14.99	£17.99
A670H	Apple 30pin Blk 1.5m	£16.65	£19.99
A680H	Apple 30pin Blk 3m	£20.82	£24.99

Maplin White 30 Pin Apple to USB A Cables



- Charge and sync your Apple 30 pin device
- Licensed by Apple for use with iPhones, iPads and iPods with a 30 pin connector
- USB version 2.0 compatible and works with all previous specifications
- Durable and highly flexible outer jacket
- 5 Year Warranty
- Available in 0.25, 0.5, 0.75, 1.5 and 3 metre lengths

The Apple 30 pin cable enables charging and data transfer from your Apple 30 pin-enabled device. Connect to your PC for charging and data transfer, or to a USB power adapter for charging only.

Order Code	Mod: 1031049	Price each exc. VAT 1+	inc. VAT each
A58QH	Apple 30pin Whit. 25m	£13.32	£15.99
A59QH	Apple 30pin Whit. 5m	£14.15	£16.99
A60QH	Apple 30pin Whit. 75m	£14.99	£17.99
A61QH	Apple 30pin Whit. 1.5m	£16.65	£19.99
A62QH	Apple 30pin Whit. 3m	£20.82	£24.99

Samsung 30pin Cables

Maplin Black 30 Pin Samsung to USB A Cables



- Charge and sync your Samsung 30 pin device
- USB version 2.0 compatible and works with all previous specifications
- Durable and highly flexible outer jacket
- 5 Year Warranty
- Available in 0.5, 0.75 and 1.5 metre lengths

The Samsung 30 pin cable enables charging and data transfer from your Samsung 30 pin-enabled device. Connect to your PC for charging and data transfer, or to a USB power adapter for charging only.

Order Code	Mod: 1031104	Price each exc. VAT 1+	inc. VAT each
A77QH	Sam 30pin Blk 5m	£14.15	£16.99
A78QH	Sam 30pin Blk 75m	£14.99	£17.99
A79QH	Sam 30pin Blk 1.5m	£16.65	£19.99

Maplin White 30 Pin Samsung to USB A Cables



- Charge and sync your Samsung 30 pin device
- USB version 2.0 compatible and works with all previous specifications
- Durable and highly flexible outer jacket
- 5 Year Warranty
- Available in 0.5, 0.75 and 1.5 metre lengths

The Samsung 30 pin cable enables charging and data transfer from your Samsung 30 pin-enabled device. Connect to your PC for charging and data transfer, or to a USB power adapter for charging only.

Order Code	Mod: 1031105	Price each exc. VAT 1+	inc. VAT each
A71QH	Sam 30pin Whit 5m	£14.15	£16.99
A72QH	Sam 30pin Whit 75m	£14.99	£17.99
A73QH	Sam 30pin Whit 1.5m	£16.65	£19.99

USB OTG Cables

Maplin USB On The Go Cables



- Connect your phone or tablet to an external USB device
- Works with many USB memory sticks, mice, keyboards, and cameras
- Works with Android phones and tablets
- Available with Micro USB and Samsung 30 pin connectors

This "On The Go" [OTG] cable enables you to connect an external device to your Android mobile phone or tablet if it supports it. Also works on Windows 8 Tablets with a Micro USB 3.0 port. Once the device is connected you can plug in a keyboard, mouse, wireless deskset, USB memory stick, digital camera or games controller. Most phones or tablets with the latest version of Android will detect these devices and allow you to use them accordingly.

For a keyboard and mouse you can use them in apps to enable you to type quickly or be more accurate with a mouse pointer for spreadsheet work. When connected to a USB memory stick or digital camera you can access the files on these devices and transfer the info to your phone or tablet. You can back up your camera so you can keep taking more shots while on holiday. Xbox style controllers can also be added to make playing those games even more fun.

Order Code	Mod: 1031084	Price each exc. VAT 1+	inc. VAT each
A83QH	USB2 microUSB OTG	£9.99	£11.99
A84QH	USB2 microUSB OTG	£9.99	£11.99
A85QH	Samsung 30p OTG	£9.99	£11.99
N43DE	USB3.0 OTG Cable	£12.49	£14.99

MHL Cables

Maplin MHL Adapters



- Fully wired terminals
- Durable plastic housing
- 5 Year Warranty

MHL (Mobile High-Definition Link) allows you to enjoy your music, movies, games and apps on the big screen, with 1080P video and 7.1 channel audio support. This MHL adapter converts a 5 pin Micro-B USB MHL connector to 11 pin, allowing 11 pin MHL devices to use a 5 pin MHL adapter.

Order Code	Mod: 1031110	Price each exc. VAT 1+	inc. VAT each
A89QH	MHL 5pin Adapter	£16.65	£19.99
A90QH	MHL 11pin Adapter	£16.65	£19.99
A91QH	MHL 5-11pin Adp	£8.32	£9.99

Maplin MHL 11 Pin to HDMI Cables



- MHL cable from 11 pin Micro-B USB to HDMI
- HDCP-compliant HD video output up to 1080p
- 7.1 channel digital audio support
- Durable and highly flexible outer jacket
- 5 Year Warranty
- Available in 0.75, 1.5 and 3 metre lengths

MHL (Mobile High-Definition Link) allows you to view your smartphone or tablet on the big screen. Enjoy music, movies, games and apps on your TV or monitor, with 1080P video and 7.1 channel audio support. This MHL cable allows video output from an 11 pin MHL compliant device to a MHL-enabled TV or monitor.

Order Code	Mod: 1031112	Price each exc. VAT 1+	inc. VAT each
A94QH	MHL 11pin-HDMI 0.75m	£16.65	£19.99
A95QH	MHL 11pin-HDMI 1.5m	£20.82	£24.99
A96QH	MHL 11pin-HDMI 3m	£24.99	£29.99

Maplin MHL 11 and 5 Pin Mobile Kit



- MHL cable from 5 pin Micro-B USB to HDMI
- Inline USB terminal for external power
- 5 to 11 pin adapter to allow use of 11 pin output devices
- HDCP-compliant HD video output up to 1080p
- 7.1 channel digital audio support
- 5 Year Warranty

MHL (Mobile High-Definition Link) allows you to view your smartphone or tablet on the big screen. Enjoy music, movies, games and apps on your TV or monitor, with 1080P video and 7.1 channel audio support. This flexible kit allows video output from a 11 pin or 5 pin MHL compliant device to a HDMI-enabled TV or monitor. You will need to connect a 5v USB power supply to power the connection and charge your device.

Order Code	Mod: 1031111	Price each exc. VAT 1+	inc. VAT each
A88QH	MHL 11/5pin Kit	£24.99	£29.99



Over 200 stores nationwide



/maplin



@maplintweet



/+maplin



/maplinonline



/maplintv

Parallel, Serial & PS/2 Cables

Maplin Serial RS232 9 Pin Cables



- Straight wired cable
- Full cable shielding
- Durable and highly flexible outer jacket
- 5 Year Warranty
- Available in 3 metre lengths

Serial RS232 is a standard used to transfer data between computer devices. It is most commonly used to connect legacy printers and networking equipment to Laptops and PC tower units. It also has specialist application in some industrial machinery and scientific equipment.

Order Code	Mod: 1031096	Price each exc. VAT 1+	inc. VAT each
A26QJ	RS232 9(M)-9(M) 3m	£16.65	£19.99
A27QJ	RS232 9(M)-9(F) 3m	£16.65	£19.99
A28QJ	RS232 9(F)-9(F) 3m	£16.65	£19.99
A29QJ	RS232 25(M)-9(F) 3m	£16.65	£19.99
A30QJ	RS232 25(M)-25(F) 3m	£16.65	£19.99

Maplin Serial RS232 Null Modem Cables



- Reverse wired cable
- Full cable shielding
- Durable and highly flexible outer jacket
- 5 Year Warranty
- Available in 3 metre lengths

Serial RS232 Null Modem is a standard used to transfer data between computers and network devices. It is used to connect computers for data transfer and networking, with the cable pins wired in a reverse layout.

Order Code	Mod: 1031097	Price each exc. VAT 1+	inc. VAT each
A32QJ	Null 9(F)-9(F) 3m	£16.65	£19.99
L72BT	Null 25(F)-9(F) 3m	£14.99	£17.99

Maplin Parallel Printer Cables



- Fully-wired printer cable
- 25-pin male to centronics connection
- Suitable for bi-directional printing
- Gold plated connections
- Fully shielded for error-free connections
- Available in 1.5, 3 and 5 metre lengths

A fully wired standard printer cable suitable for all types of printer with a 'centronics' type connection. The cable is also suitable for two-way (bi-directional) printers.

Order Code	Mod: 1031098	Price each exc. VAT 1+	5+	inc. VAT each
L79BT	Par 25(M)-36(M) 1.5m	£10.82	£9.74	£12.99
A33QJ	Par 25(M)-36(M) 3m	£16.65		£19.99
L81BT	Par 25(M)-36(M) 5m	£16.66	£14.99	£19.99

Send direct

If any product is not in stock, we will order it for you and send it with free delivery

Terms and conditions apply.



Maplin PS/2 Cable 3m



- 6 pin terminals
- Full cable shielding
- Durable and highly flexible outer cable jacket
- 5 Year Warranty

PS/2 is a standard used to connect mice and keyboards to Laptops or PC tower units. The PS/2 mouse input is typically coloured green, and keyboard input purple on PC and laptop terminals.

Order Code	Mod: 1031099	Price each exc. VAT 1+	inc. VAT each
A34QJ	PS/2(M)-PS/2(M) 3m	£16.65	£19.99

Maplin PS/2 Extension Cables



- 6 pin terminals
- Full cable shielding
- Durable and highly flexible outer cable jacket
- 5 Year Warranty
- Available in 3 and 5 metre lengths

PS/2 is a standard used to connect mice and keyboards to Laptops or PC tower units. The PS/2 mouse input is typically coloured green, and keyboard input purple on PC and laptop terminals.

Order Code	Mod: 1031101	Price each exc. VAT 1+	inc. VAT each
A35QJ	PS/2(M)-PS/2(F) 3m	£16.65	£19.99
L85BT	PS/2(M)-PS/2(F) 5m	£16.66	£14.99

Maplin PS2 Notebook Splitter Male to 2 Female



- PS/2 splitter lead for notebook use
- Allows a keyboard and mouse to be used via one PS/2 port
- Requires compatible notebook to work
- Gold-plated connections
- Fully shielded for error-free connections
- 50cm cable length

Order Code	Mod: 1031093	Price each exc. VAT 1+	5+	inc. VAT each
L86BT	PS/2(M)-PS/2(F)x2	£12.49	£11.24	£14.99

Maplin Serial RS232 9 Pin to PS2 Adapters



- Converter for use with serial RS232 equipment where a conversion between a 9-pin and PS/2 connection is required

Order Code	Mod: 1031095	Price each exc. VAT 1+	inc. VAT each
L77BT	D 9(F)-PS/2(F) Adp	£10.82	£12.99
L78BT	D 9(M)-PS/2(M) Adp	£10.82	£12.99

Maplin PS/2 DIN Adapters



- Allows PS/2 type cables to be converted to DIN type or vice-versa.
- Simply connect to the end of your existing cable.
- Useful when connecting older DIN type PCs or Keyboards.

Order Code	Mod: 1031094	Price each exc. VAT 1+	inc. VAT each
L89BT	PS/2(M)-DIN(F) Adp	£10.82	£12.99
L90BT	PS/2(F)-DIN(M) Adp	£10.82	£12.99

Maplin D-Type Couplers



- Fully wired terminals
- Durable plastic housing
- 5 Year Warranty

Serial RS232 is a standard used to transfer data between computer devices. It is most commonly used to connect legacy printers and networking equipment to Laptops and PC tower units.

Order Code	Mod: 1031118	Price each exc. VAT 1+	inc. VAT each
A18QJ	L Prtl M/M 25W Gend	£9.99	£11.99
A19QJ	L Prtl F/F 25W Gend	£9.99	£11.99
A20QJ	L Prtl M/M 9W Gend	£8.32	£9.99
A21QJ	L Prtl F/F 9W Gend	£8.32	£9.99

Maplin Serial RS232 Adapters



- Fully wired terminals
- Durable plastic housing
- 5 Year Warranty

Serial RS232 is a standard used to transfer data between computer devices. It is most commonly used to connect legacy printers and networking equipment to Laptops and PC tower units. It also has specialist application in some industrial machinery and scientific equipment.

Order Code	Mod: 1031119	Price each exc. VAT 1+	inc. VAT each
A22QJ	D 9(M)-25(F) Adp	£10.82	£12.99
A23QJ	D 9(M)-25(M) Adp	£10.82	£12.99
A24QJ	D 9(F)-25(F) Adp	£10.82	£12.99
A25QJ	D 9(F)-25(M) Adp	£10.82	£12.99

Trust our cables. Quality guaranteed.

Essentials - 1 year warranty
Maplin - 5 year warranty
Pro - lifetime warranty

Our Maplin branded cables offer an expansive range of types and lengths with professional grade options available.

see page 5 for full details

Want to browse the full range?

Head into store or visit maplin.co.uk



WANT TO MAKE YOUR HOME WORK AROUND YOU?

HOME AUTOMATION

Enhance your home with innovative tech which could even save you money

Visit maplin.co.uk for the very latest in smart heating, app controlled lighting, power management and much more



<http://goo.gl/0C2Zdu>

CONNECTED HOME

Telephone Cables

Telephone Cables & Extension Reels

Telephone Line Jack Extension Cable 3m



A male to female extension cable suitable for use with UK telephone sockets.

Order Code	Mod: 810249	Price each exc. VAT	inc. VAT each
BD08J	Extension Cable 3m	£6.66	£7.99

Telephone Line Jack Extension Cable 5m



A male to female extension cable suitable for use with UK telephone sockets.

Order Code	Mod: 810250	Price each exc. VAT	inc. VAT each
FT45Y	Extension Cable 5m	£7.49	£8.99

Telephone Line Jack Extension Cable



A male to female extension cable suitable for use with UK telephone sockets.

Order Code	Mod: 810251	Price each exc. VAT	inc. VAT each
BD13P	Extension Cable 10m	£9.99	£11.99

Telephone Extension Kit 10m



- Everything you need to provide an outlet for a second telephone extension
- Plug into an existing socket
- Pack of suitable cable clips provided
- Kits are approved for private DIY installation and full instructions are supplied

A kit containing everything you need to provide an outlet for a second (or subsequent) telephone extension. The kit simply plug into an existing socket and provide a new double socket at that point for the existing telephone etc. to plug back into.

Order Code	Mod: 810254	Price each exc. VAT	inc. VAT each
BD05F	Extension Kit 10m	£12.49	£14.99

Telephone Extension Kit 15m



- Everything you need to provide an outlet for a second telephone extension
- Plug into an existing socket
- Pack of suitable cable clips provided
- Kits are approved for private DIY installation and full instructions are supplied

A kit containing everything you need to provide an outlet for a second (or subsequent) telephone extension. The kit simply plugs into an existing socket and provide a new double socket at that point for the existing telephone etc. to plug back into.

Order Code	Mod: 810255	Price each exc. VAT	inc. VAT each
YTS4J	Extension Kit 15m	£13.32	£15.99

Telephone Extension Kit 20m



- Everything you need to provide an outlet for a second telephone extension
- Plug into an existing socket
- Pack of suitable cable clips provided
- Kits are approved for private DIY installation and full instructions are supplied

A kit containing everything you need to provide an outlet for a second (or subsequent) telephone extension. The kit simply plugs into an existing socket and provide a new double socket at that point for the existing telephone etc. to plug back into.

Order Code	Mod: 810256	Price each exc. VAT	inc. VAT each
BD06G	Extension Kit 20m	£15.82	£18.99

Telephone Extension Kit 30m

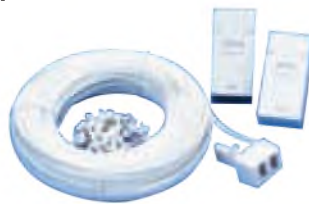

- Everything you need to provide an outlet for a second telephone extension
- Plug into an existing socket
- Pack of suitable cable clips provided
- Kits are approved for private DIY installation and full instructions are supplied

A kit containing everything you need to provide an outlet for a second (or subsequent) telephone extension. The kit simply plugs into an existing socket and provide a new double socket at that point for the existing telephone etc. to plug back into.

Order Code	Mod: 810257	Price each exc. VAT	inc. VAT each
BD07H	Extension Kit 30m	£17.49	£20.99

Compact Telephone Extension Kit 10m



An ultra thin, flat cable telephone extension kits for use in under carpets, behind wallpaper, etc. The kit is completely modular, no tools are required for installation. The cable is terminated at both ends with RJ11 plugs & is supplied with an RJ11 to BT adapter & a slim-line BT socket terminal.

Order Code	Mod: 810259	Price each exc. VAT	inc. VAT each
A24BA	Extension Kit 10m	£9.16	£10.99

BT to US Extension Cable



A BT to RJ11 pin to pin extension cable, suitable as a replacement line cable for most telephones.

Order Code	Mod: 810260	Price each exc. VAT	inc. VAT each
BD00A	Extension Cable 3m	£5.83	£6.99

RJ11 to RJ11 Cable



A RJ11 to RJ11 cable. Suitable for use as a replacement cable for modems requiring a pin to pin connection.

Order Code	Mod: 810235	Price each exc. VAT	inc. VAT each
SK64U	RJ11 3m Modem Lead	£6.66	£7.99

Telephone/Modem RJ11 Extension Cable 10m



A 10m RJ11 to RJ11 flat cable on reel, suitable for use as a telephone or modem extension cable. It is supplied with a RJ11 to UK telephone adapter to plug into a UK socket.

Order Code	Mod: 036283	Price each exc. VAT	inc. VAT each
A26BA	10m Tele/modem reel	£9.15	£10.99

Technical Helpline
0333 400 9500



Surge Protected Modem/Telephone Reel 10m



- Built in surge protection
- Extends your telephone connection up to 15 metres from your existing socket
- Features standard BT and RJ11 sockets allowing the use of telephone and modem

Order Code	Mod.	Price each exc. VAT	inc. VAT each
A27FU	I0 Surge Phone Reel	£13.32	£15.99

Broadband Kit 15m



- Plug in adapter. Simple connection of the extension cable without wiring, leaving existing telephone socket available for use
- 15m telephone cable & cable clips
- Extension socket with built in broadband filter. Use your telephone and broadband lines simultaneously
- Removes the need for an additional unsightly plug in broadband filter
- Compatible with all UK broadband service providers
- Easy installation. Instructions included

Ideal accessory for new broadband installations or as an extension to an existing broadband connection

Order Code	Mod.	Price each exc. VAT	inc. VAT each
A28FU	I5m Broadband Kit	£17.49	£20.99

RJ11 Coiled Handset Cord 2.5m



- 2.5m when extended
- RJ11 both ends
- Ideal replacement for lost or broken cords
- Coiled cord for use with telephone handsets, etc

A range of coiled leads terminated with RJ11 plugs. Suitable for use as replacement cords for telephone handsets.

Order Code	Mod.	Price each exc. VAT	inc. VAT each
BD52G	White Coiled Cord	£6.65	£7.99

Telephone Line Jack Extension Cord with Dual Outlet 5m



A 5m extension cable terminated with a UK telephone plug at one end & a twin BT socket at the other

Order Code	Mod.	Price each exc. VAT	inc. VAT each
FS21X	Double Skt Lead 5m	£7.49	£8.99

Telephone/Modem RJ11 Extension Reel 15m



A 15m RJ11 to RJ11 flat cable on reel, suitable for use as a telephone or modem extension cable. It is supplied with a RJ11 to UK telephone adapter to plug into a UK socket

Order Code	Mod.	Price each exc. VAT	inc. VAT each
GG98G	Compct 15M Tele Ext	£14.15	£16.99

RJ11 Extension Cable 5m



5.0m RJ11 male to female extension cable, suitable for extending modem & fax cables.

Order Code	Mod.	Price each exc. VAT	inc. VAT each
RB50E	RJ11 Ext. Cord 5.0m	£5.82	£6.99

Telephone Socket to Modem Cable 3m



This telephone conversion line cord is 3m (approximately) and has a BT type telephone plug at one end and a US type telephone plug (RJ11) at the other. The conductors are suitably crossed (1-2, 2-1, 3-4 & 4-3) and the cord finds most use in connecting fax/modems, etc.

Order Code	Mod.	Price each exc. VAT	inc. VAT each
RZ75S	Modem Lead 3m	£7.49	£8.99

Anti Twist Telephone Cord Swivel



Use this telephone adapter to keep telephone handset cords from twisting and kinking

Order Code	Mod.	Price each exc. VAT	inc. VAT each
SK76H	Tel Cord Untwister	£4.15	£4.99

Compact Telephone Extension Kit 15m

ORDER IN STORE OR ONLINE



An ultra thin, flat cable telephone extension kits for use in under carpets, behind wallpaper, etc. The kit is completely modular, no tools are required for installation. The cable is terminated at both ends with RJ11 plugs & is supplied with an RJ11 to BT adapter & a slim-line BT socket terminal.

Order Code	Mod.	Price each exc. VAT	inc. VAT each
A23BA	Extension Kit 15m	£8.32	£9.99

Wireless Telephone Extenders

DECT Wireless Phone Line Extender



- Need to add a phone line to another room ...do it fast and simple with this wireless phone extender
- Quickly turns ordinary electrical sockets into telephone outlets
- DECT technology means it works faster and quieter and it has an all round higher specification
- Suitable for use with a PC, set top box, telephone or fax machine
- Wirelless range up to 50m
- No extra wiring required and it is completely portable
- Compatible with PC modems
- Can even be used in your garage or garden shed if you have mains supplied to the them
- Data transmission speeds up to 36kbps

Operates by simply plugging in the base unit near to the master telephone socket, a through connector allows connection to the master socket without interrupting the existing phone. Can then be plugged in anywhere in any room where a mains socket is located to give an additional telephone socket without having unsightly cables. Great if you are creating an office out of a spare bedroom.

This item can be used on an ADSL Enabled Telephone Line, but, you will need to use an ADSL Filter to separate the ADSL Signal from the connection to the Extender (as it cannot carry an ADSL signal, which means it is not suitable for use as an extension for your broadband connection).

Additional slave unit available: Order Code A18JF

Order Code	Mod.	Price each exc. VAT	inc. VAT each
A82FY	Wireless Phone Line Extender	£41.66	£49.99



Browse our entire range at maplin.co.uk

Wireless Phone Extender Slave Unit



- For use with the DECT Wireless Phone Line Extender kit (A82FY)
- 50m range from master socket.

Additional extension unit for use with DECT Wireless Phone Line Extender, (A82FY) allows the use of a second handset up to 50m from master socket

Order Code	Mod:	Price each exc. VAT	inc. VAT each
A18JF	WFJ Additional Unit	£24.99	£29.99

Telephone Couplers & Adapters

Telephone to 2 Telephone Adapter



An adapter that can be plugged into any BT Line Jack unit to convert it to a 2 way outlet for standard BT type 4-way line plugs.

Order Code	Mod:	Price each exc. VAT	inc. VAT each
BD43W	Telephone to 2 Telephone Adapter	£7.49	£8.99

Telephone to 3 Telephone Adapter



An adapter that can be plugged into any BT Line Jack unit to convert it to a 3 way outlet for standard BT type 4-way line plugs.

Order Code	Mod:	Price each exc. VAT	inc. VAT each
BD44X	Telephone to 3 Telephone Adapter	£8.33	£9.99

Telephone to 4 Telephone Adapter



An adapter that can be plugged into any BT Line Jack unit to convert it to a 4 way outlet for standard BT type 4-way line plugs.

Order Code	Mod:	Price each exc. VAT	inc. VAT each
BD45Y	Telephone to 4 Telephone Adapter	£8.33	£9.99

Telephone to RJ45 Adapter PSTN Master



- Allows BT plug telecom equipment to be used with RJ45 wiring
- Converts structured cable installation to the correct impedance to comply with OFTEL standards
- 3 versions available
- RJ45 Plug to BT Socket

PSTN Master, converts impedance to comply with OFTEL standards plus also featuring a ringing capacitor and surge protection. Not suitable for PABX systems

Order Code	Mod:	Price each exc. VAT	inc. VAT each
UN27E	LAU/1 Line Adaptor	£7.49	£8.99

Telephone to RJ45 Adapter PSTN Secondary



- Allows BT plug telecom equipment to be used with RJ45 wiring
- Converts structured cable installation to the correct impedance to comply with OFTEL standards
- 3 versions available
- RJ45 Plug to BT Socket

PSTN Secondary, converts impedance only. Not suitable for PABX systems

Order Code	Mod:	Price each exc. VAT	inc. VAT each
UN29G	Telephone to RJ45 PSTN	£5.83	£6.99

Telephone to RJ45 Adapter PABX Master



- Allows BT plug telecom equipment to be used with RJ45 wiring
- Converts structured cable installation to the correct impedance to comply with OFTEL standards
- 3 versions available
- RJ45 Plug to BT Socket

PABX Master, convert impedance plus also has ringing capacitor. Suitable for PABX systems.

Order Code	Mod:	Price each exc. VAT	inc. VAT each
UN28F	Telephone to RJ45 PABX	£5.83	£6.99

RJ11 to RJ11 Coupler



RJ11 couplers for connecting two RJ11 cables. Connected pin to pin

Order Code	Mod:	Price each exc. VAT	inc. VAT each
UN45F	RJ11 to RJ11 Coupler	£4.99	£5.99

RJ11 to RJ11 Reverse Coupler



RJ11 couplers for connecting two RJ11 cables. Connected cross pin

Order Code	Mod:	Price each exc. VAT	inc. VAT each
SN88V	RJ11 to RJ11 Reverse Coupler	£4.16	£4.99

RJ45 to RJ45 Coupler



- RJ45 couplers for connecting two RJ45 cables

Order Code	Mod:	Price each exc. VAT	inc. VAT each
TZ09K	RJ45 to RJ45 Coupler	£5.83	£6.99

RJ45 to RJ45 Reverse Coupler



- RJ45 couplers for connecting two RJ45 cables

Order Code	Mod:	Price each exc. VAT	inc. VAT each
SN90X	RJ45 to RJ45 Reverse Coupler	£4.99	£5.99

2 Telephone and 1 Modem to Telephone Adapter



- Allows connection of two phones plus modem into one socket
- Built in surge protection
- LED active indicator
- Fits existing UK telephone wall socket
- Slim design
- Easy installation. Instructions included

Order Code	Mod:	Price each exc. VAT	inc. VAT each
A26FU	Phone Surge Adaptor	£14.99	£17.99

RJ11 to Telephone Adapter



This adapter consists of a US-style socket to a BT-style plug, enabling you to connect US-type connectors to BT-type sockets

Order Code	Mod:	Price each exc. VAT	inc. VAT each
AR34M	US To BT Adaptor	£7.49	£8.99

Telephone and Modem to Telephone Adapter



This ingenious device prevents other users in your home or office from interrupting or eavesdropping your phone calls or causing your modem to drop the line whilst surfing the internet. It looks and behaves just like a standard double adapter with a clever difference. When the extension plugged into one socket is answered, the other extension is automatically disconnected. LED indicators light showing when an extension is in use. Completely self-contained, requiring no batteries.

Order Code	Mod: 019756	Price each exc. VAT	inc. VAT each
		1+	5+
NL66W	Privacy Adaptor	£7.49	£8.99

RJ45 to 2 RJ45 Adapter



An adapter for converting a single RJ45 socket to a double outlet.

Order Code	Mod: 022423	Price each exc. VAT	inc. VAT each
		1+	5+
PU96E	RJ45 Double Adaptor	£5.83	£7.00

RJ11 to 2 RJ11 Adapter



An adapter to convert a single RJ11 socket to a double outlet.

Order Code	Mod: 022427	Price each exc. VAT	inc. VAT each
		1+	5+
PU97F	RJ11 Double Adaptor	£6.65	£7.99

Cat 5e Coupler



This RJ45 pin to pin coupler will allow you to join two cat 5 patch leads together to extend their range.

Order Code	Mod: 026761	Price each exc. VAT	inc. VAT each
		1+	5+
SH93B	Cat 5e Coupler	£6.66	£7.99

In-Line FCC 6P6C Coupler



An RJ12 pin to pin coupler for joining two RJ12 (6P6C) leads.

Order Code	Mod: 024633	Price each exc. VAT	inc. VAT each
		1+	5+
SN87U	Coupler 6p6c	£4.15	£4.99

Telephone and Modem RJ11 to Telephone Adapter



This double adapter is designed to enable a telephone and modem to be plugged into the same socket. The plug side

of the adapter is a standard BT style plug and the socket side consists of one BT style socket (for the telephone) and one RJ11 style socket (for the modem).

Order Code	Mod: 012815	Price each exc. VAT	inc. VAT each
		1+	5+
VD35Q	Phone/Modem Doubler	£5.82	£6.99

Standard 4-Way Line Plug 431A



Standard BT type 4-way Line Plug using Insulation Piercing Contacts (IPC), with strain relief. To fit the flat line cord to an IPC plug, simply provide a clean cut across the end, and strip off 11 to 12mm of the outer sheath. Allow the wires to separate from one another by approximately 1mm, then push and tease them gently into the plug, which has locating guides built in for each conductor. Once fully home (the coloured wires can be seen through the slot behind the contacts) use heavy duty pliers or a small vice to press all the gold coloured contacts flush with the plug body; push down the small strain relief members immediately behind the contacts, then force down the cable clamp at rear.

Order Code	Mod: 810309	Price each exc. VAT	inc. VAT each
		1+	5+
BD39N	Standard 4-Way Line Plug 431A	£4.16	£4.99



Friendly expert advice on
0333 400 9500

6-Way Telephone Plug 631A



- For replacing damaged 6-way UK telephone plugs
- Not for use with extension kit cable
- For use with stranded D profile 6-core cable only

Order Code	Mod: 030305	Price each exc. VAT	inc. VAT each
		1+	5+
BD40T	Telephone Plg 6-Pin	£4.99	£5.99

Telephone to RJ11 Adapter



Adapter to connect equipment with a UK plug into an RJ11 socket.

Order Code	Mod: 810268	Price each exc. VAT	inc. VAT each
		1+	5+
RZ79L	Telephone to RJ11 Adapter	£7.49	£8.99

Maplin TV

Home of innovation,
handy tips and
How To videos

Visit our
channel...

youtube.com/maplintv



BT Loud Extension Bell



- Loud indoor bell ringer suitable for warehouses, large offices, garages, shop floors etc
- Never miss a call; even if hearing the phone is normally difficult
- Plugs into a standard BT socket and doesn't require an external power source
- Not suitable for use outdoors

Order Code	Mod: 032827	Price each exc. VAT	inc. VAT each
		1+	5+
A20AF	Loud Ext. Bell	£23.32	£27.99

BT Extension Tone Caller II



- Extension tone caller
- 4 selectable sound options
- Volume control
- Hear your phone ringing
- Connects directly to a BT socket

The ToneCaller from BT, with its loud sound makes it easier to know when your phone is ringing.

It features an extra audible alert if you are having problems hearing your telephone ring. With choice of 4 different pitch settings and a volume control, plug this additional bell into a spare telephone socket or use a socket adapter to plug it in beside your existing phone.

Telephone lines usually have a REN of 4 - they can operate up to four telephone products (e.g., phones, fax, answering machine) each with a REN of 1. This product has a REN of 1. Please note we also have REN Boosters available if your REN exceeds 4.

Cable length - 3m

Contents: Tone Caller

Will require 2 x BT Socket (1 x Tone Caller / 1 x Phone)
See BD43W

Order Code	Mod: 035228	Price each exc. VAT	inc. VAT each
		1+	5+
A24AU	BT Ext. Tone Call	£20.82	£24.99

Electronic Telephone Ringer



This ringer plugs into any telephone line socket to give an audible and visual indication of an incoming call.

Order Code	Mod: 033014	Price each exc. VAT	inc. VAT each
		1+	5+
A28AF	Electronic Ringer	£14.99	£17.99

BT Loud Outdoor Bell



- Loud 80dB mechanical call alert
 - Can be wired into standard BT telephone sockets
- Ideal for outdoor noisy areas such as workshops warehouses etc where the telephone ring needs to be at a high volume in order to be heard

Order Code	Mod: 512873	Price each exc. VAT 1+	inc. VAT each
N99JQ	Outdoor Phone Bell	£33.32	£39.99

Connected Essentials Call Alert Light and Ringer



- Flashing & Audio Call Alert – Works with any landline telephone
- Simple to set up – just plug in – no installation required
- Loud Ringer – up to 120dB
- High Visibility strobe light
- Can be set to audio only or visual alert only
- Easy to follow operating instructions
- Telephone Call Alert unit is fitted with a 2 metre mains lead and a 3 metre telephone lead
- Includes a double telephone adapter to enable you to plug your telephone and the Telephone Call Alert into the same telephone socket
- Wall mounting bracket included
- Simply plugs into a 13 amp mains socket and a BT type telephone socket

The Telephone Call Alert is a mains or battery powered light and ringer that plugs directly into a BT type telephone socket and flashes and/or rings whilst the telephone is ringing. The Telephone Call Alert produces a bright flashing light that makes you aware that the telephone is ringing in situations when you cannot, or do not want to, hear it ring. Ideal for the hard of hearing or noisy environments.

Order Code	Mod: 512882	Price each exc. VAT 1+	inc. VAT each
A04KJ	Telephone Call Alert	£23.32	£27.99

ADSL Accessories

Broadband ADSL Modem Cable



- A replacement cables for Broadband ADSL modems
- Terminated in RJ11 plugs at both ends

Order Code	Mod: 810238	Price each exc. VAT	inc. VAT each
A52BB	ADSL Modem Cable 5m	£9.16	£10.99

High Speed ADSL Modem Cable



An ultra high speed cable for Broadband ADSL modems External tin coated copper braiding screens outside interference to a minimum & gold plated copper contacts ensure optimum connection speed is maintained. Terminated in RJ11 plugs at both ends

Order Code	Mod: 810240	Price each exc. VAT 1+	inc. VAT each
A80CU	HS ADSL Lead 15m	£21.65	£25.99
A83CU	HS ADSL Lead 20m	£24.99	£29.99

Ultra High Speed ADSL Cable



An ultra high speed cable for Broadband ADSL modems External tin coated copper braiding screens outside interference to a minimum & gold plated copper contacts ensure optimum connection speed is maintained. Terminated in RJ11 plugs at both ends

Order Code	Mod: 810244	Price each exc. VAT	inc. VAT each
A97CG	UltraS ADSL Lead 10m	£21.65	£25.99

RJ11 ADSL Microfilter



- Designed to minimise the effect of ADSL noise on your telephone or other telecom products
- Ideal if you have the wires only ADSL service
- Ideal for the Republic of Ireland
- Four can be used on an ADSL line at any one time
- Allows you to connect an ADSL modem and telephone to one telephone socket
- Extension wiring can be plugged into the filter
- RJ11 termination

Order Code	Mod: 045155	Price each exc. VAT 1+	inc. VAT each
A24CG	RJ11 Microfilter	£8.32	£9.99

Broadband Surge Adaptor



- ADSL broadband filter - suitable for both new installations or as a replacement for your existing internet broadband filter
- Built-in surge protection
- Blue light active indicator
- Connect two phones plus internet modem into one socket

- Fits existing UK telephone wall socket
- Slim design
- Easy installation

Order Code	Mod: 097672	Price each exc. VAT 1+	inc. VAT each
A25FU	B/Band Surge Adaptor	£14.99	£17.99

ADSL Microfilter/Splitter



- Designed to minimise interference on your ADSL phone line
- Use in conjunction with an ADSL broadband modem
- One filter is required for each device connected to your telephone sockets

Minimises the effect of ADSL noise when used in conjunction with you broadband router. The unit does not provide surge protection

Order Code	Mod: 034179	Price each exc. VAT 1+	inc. VAT each
A61AK	TUJK ADSL Microfilter	£8.32	£9.99

Leaded ADSL Splitter/ Microfilter



ADSL microfilter designed to minimise the effect of noise on your telephone or other telecom products By separating the high frequency of ADSL and the low frequency analogue, normal telephone equipment can be used without interference. This adapter allows you to connect an ADSL modem and telephone to one telephone socket. Extension wiring can be plugged into the filter. If you have the "wires only" ADSL service you will need an ADSL splitter/microfilter on each of your phone sockets that can be used for ADSL (maximum of 4)

Order Code	Mod: 033169	Price each exc. VAT 1+	inc. VAT each
A72AG	ADSL Microfilter	£8.32	£9.99

Broadband ADSL Extension Cable 10m

This 10m ADSL extension reel has a self-contained ADSL splitter which allows you to connect your telephone and ADSL modem at the same time.



Order Code	Mod: 045160	Price each exc. VAT 1+	inc. VAT each
A91CG	10m Broadband Reel	£14.99	£17.99

Reel Deal Available on marked cables

1/2 PRICE when you buy the full reel

Cut Cable

Equipment Wire

Solid Core Wire (1/0.6)

To DEF61-12 (Part 6) Type 2

A wire having a single solid core ideal for plate-wiring (running wires across a chassis with all wires straight or at right-angles to one another) because wire stays exactly in formed shape without ties.

Specifications:

Single core: 1/0.6mm copper 22AWG (23SWG)
 Sheath 0.3mm PVC
 Overall diameter 1.2mm
 Nom. conductor area: 0.28mm²
 Max. working voltage: 1000V rms
 Colours: black, blue, green, red, white, yellow.

Sold in 10m (approx.) packs and on 100m reels (red & black only).

Order Code	Mod: 006187	Price each exc. VAT 1+	5+	inc. VAT each
BL85G	Bell Wire Black	£2.32	£1.86	£2.79
BL84T	Bell Wire Blue	£2.32	£1.86	£2.79
BL88V	Bell Wire Green	£2.32	£1.86	£2.79
BL92A	Bell Wire Red	£2.32	£1.86	£2.79
BL94C	Bell Wire White	£2.32	£1.86	£2.79
BL95D	Bell Wire Yellow	£2.32	£1.86	£2.79
PA56L	100m Bell Wire Blk	£7.90	£6.32	£9.49
PA61R	100m Bell Wire Red	£7.90	£6.32	£9.49

Light-Duty Equipment (10/0.1)

A flexible wire which is ideal for signal interconnections within apparatus where it is necessary to pack a large number of wires into a small space.

Specifications:

Stranded core, single: 10/0.1mm copper
 Sheath 0.3mm PVC
 Overall diameter 0.9mm
 Nom. conductor area: 0.0785mm²
 Max. working voltage: 1000V rms
 Max. current 0.5A
 Colours available: Black, Blue, Green, Red, White, Yellow.

Supplied on 25m reels only.

Order Code	Mod: 000029	Price each exc. VAT 1+	5+	inc. VAT each
BL46A	L/C Wire Black	£5.32	£4.26	£6.39
BL47B	L/C Wire Blue	£5.32	£4.26	£6.39
BL49D	L/C Wire Green	£5.32	£4.26	£6.39
BL53H	L/C Wire Red	£5.32	£4.26	£6.39
BL55K	L/C Wire White	£5.32	£4.26	£6.39
BL56L	L/C Wire Yellow	£5.32	£4.26	£6.39

Equipment Wire (7/0.2)

• A flexible wire for general interconnections within apparatus

To DEF61-12 (Part 6) Type 2 and BS4808 Part 2

Specifications:

Stranded core, single: 7/0.2mm copper
 Sheath 0.3mm PVC
 Overall diameter 1.2mm
 Nom. conductor area: 0.22mm²
 Max. working voltage: 1000V rms
 Max. current 1.4A
 Colours: Black, blue, green, red, white, yellow.

Supplied in 10 metre (approximate) lengths. Additionally, black and red are available on 100 metre reels.

Order Code	Mod: 006192	Price each exc. VAT 1+	5+	inc. VAT each
BL00A	7/0.2 Wire 10M Blk	£2.32	£1.86	£2.79
BL01B	7/0.2 Wire 10M Blu	£2.32	£1.86	£2.79
BL03D	7/0.2 Wire 10M Grn	£2.32	£1.86	£2.79
BL07H	7/0.2 Wire 10M Red	£2.32	£1.86	£2.79
BL09K	7/0.2 Wire 10M Wht	£2.32	£1.86	£2.79
BL10L	7/0.2 Wire 10M Yel	£2.32	£1.86	£2.79
PA45Y	100m 7/0.2 Wire Blk	£7.49	£5.99	£8.99
PA52G	100m 7/0.2 Wire Red	£7.49	£5.99	£8.99

Equipment Wire (16/0.2)



- A flexible wire for general purpose and heavy-duty interconnections within apparatus
- To DEF61-12 (Part 6) Type 2 and BS4808 (Part 2)
- Colours: black, blue, green, red, white, orange and yellow

Specifications:

Stranded core, single: 16/0.2mm copper
 Sheath 0.3mm PVC
 Overall diameter: 1.6mm
 Nom. conductor area 0.5mm²
 Max. working voltage 1000V rms
 Max. current: 3A
 Colours Black, blue, green, red, white, orange and yellow.

Sold in 10 metre (approximate) lengths. Additionally, black and red are available on 100 metre reels.

Order Code	Mod: 006197	Price each exc. VAT 1+	5+	inc. VAT each
FA26D	16/0.2 Wire 10M Blk	£2.65	£2.12	£3.19
FA27E	16/0.2 Wire 10M Blu	£2.65	£2.12	£3.19
FA29G	16/0.2 Wire 10M Grn	£2.65	£2.12	£3.19
FA33L	16/0.2 Wire 10M Red	£2.65	£2.12	£3.19
FA35Q	16/0.2 Wire 10M Wht	£2.65	£2.12	£3.19
FA31J	16/0.2 Wire 10M Orn	£2.65	£2.12	£3.19
FA36P	16/0.2 Wire 10M Yel	£2.65	£2.12	£3.19
PA64U	100m 16/0.2 Wire Blk	£14.99	£11.99	£17.99
PA71N	100m 16/0.2 Wire Red	£14.99	£11.99	£17.99

Equipment Wire (24/0.2)

To DEF61-12 (Part 6) Type 2 and BS4808 Part 2

A flexible wire for general purpose extra heavy duty interconnections within apparatus.

Specifications:

Stranded core, single: 24/0.2mm copper
 Sheath 0.45mm PVC
 Overall diameter: 2.05mm
 Nom. conductor area 0.75mm²
 Maximum working voltage: 1000V rms
 Maximum current 6A
 Colours Black, blue, green, red, white, yellow.

Supplied in 10 metre (approximate) lengths. Additionally, black and red are available on 100m reels.

Order Code	Mod: 006198	Price each exc. VAT 1+	5+	inc. VAT each
KR31J	24/0.2 Wire 10M Blk	£2.90	£2.32	£3.49
BA36P	24/0.2 Wire 10M Blu	£2.82	£2.26	£3.39
BA40T	24/0.2 Wire 10M Red	£2.82	£2.26	£3.39
BA38R	24/0.2 Wire 10M Grn	£2.82	£2.26	£3.39
BA41U	24/0.2 Wire 10M Wht	£2.82	£2.26	£3.39
BA42V	24/0.2 Wire 10M Yel	£2.82	£2.26	£3.39
CK73D	100m 24/0.2 Wire Blk	£16.65	£14.67	£19.99
CK78K	100m 24/0.2 Wire Red	£16.65	£14.67	£19.99

Equipment Wire (32/0.2)



To DEF61-12 (Part 6) Type 3 and BS4808 Part 2

A flexible wire, for earth and power interconnections within apparatus

Specifications:

Stranded core, single: 32/0.2mm copper
 Sheath 0.6mm PVC
 Overall diameter 2.5mm
 Nom. conductor area: 1.0mm²
 Max. working voltage 1500V rms
 Max. current 6A (commercial rating 10A)
 Colours Black, blue, brown, green, red, white, green/yellow.

This product is sold in units of 1 metre, up to a maximum length in 1 piece of 100 metres.

Orders placed for a quantity of 100 units, or multiples of 100 units will be supplied on a reel, otherwise the cable will be supplied cut to length.

To place an order for this product, order the Maplin order code times the total number of units you require.

Order Code	Mod: 006199	Price each exc. VAT 1+	100+	inc. VAT each
XR32K	Wire 3202 Black (1m)	£1.24	£0.62	£1.49
XR33L	Wire 3202 Blue (1m)	£1.24	£0.62	£1.49
XR34M	Wire 3202 Brown (1m)	£1.24	£0.62	£1.49
XR35Q	Wire 3202 Green (1m)	£1.24	£0.62	£1.49
XR36P	Wire 3202 Red (1m)	£1.24	£0.62	£1.49
XR37S	Wire 3202 White (1m)	£1.24	£0.62	£1.49
XR38R	Wire 3202 Gr/Yell (1m)	£1.24	£0.62	£1.49

High Current Wire (50/0.25)



To BS6231 (Table 6) Type B

A flexible wire for high current applications.

Specifications:

Stranded core, single: 50/0.25mm copper
 Sheath 0.8mm PVC
 Overall diameter 3.81mm
 Nom. conductor area: 2.5mm²
 Max. working voltage 600V
 Max. current 30A
 Colours Black, green, red.

This product is sold in units of 1 metre, up to a maximum length in 1 piece of 50 metres.

Orders placed for a quantity of 50 units, or multiples of 50 units will be supplied on a reel, otherwise the cable will be supplied cut to length.

To place an order for this product, order the Maplin order code times the total number of units you require.

Order Code	Mod: 006200	Price each exc. VAT 1+	50+	inc. VAT each
XR57M	HC Wire Black (1m)	£1.49	£0.74	£1.79
XR59P	HC Wire Red (1m)	£1.49	£0.74	£1.79
XR58N	HC Wire Green (1m)	£1.49	£0.74	£1.79

Extra Flexible Wire



A very flexible wire ideal for test leads and as inter-connection wires which are frequently being moved.

Specifications:

Stranded core, single: 55/0.1mm copper
 Sheath 1mm very flexible PVC
 Overall diameter 2.8mm
 Nom. conductor area: 0.43mm²
 Max. working voltage 650Vdc, 500Vac
 Max. current 2.5A
 Colours Black.

This product is sold in units of 1 metre, up to a maximum length in 1 piece of 25 metres.

Orders placed for a quantity of 25 units, or multiples of 25 units will be supplied on a reel, otherwise the cable will be supplied cut to length.

To place an order for this product, order the Maplin order code times the total number of units you require.

Order Code	Mod: 006203	Price each exc. VAT 1+	25+	inc. VAT each
XR44X	Extra Flex Red (1m)	£1.40	£0.70	£1.69
XR40T	Extra Flex Blk (1m)	£1.40	£0.70	£1.69



We can deliver to your home or office

(UK only)

SCART Cable

9 Way Overall Screened SCART Cable (priced per metre)

REEL DEAL



Contains a bundle of 9 wires colour coded Black, Brown, Red, Orange, Green, Yellow, Blue, Purple and Grey. Each conductor has 7/0.12mm tinned strands. The whole group is wrapped with a metallised mylar film acting as the screen, which is in contact with a single uninsulated tinned stranded earth conductor with 7/0.155mm strands. Ideal for multi-way audio signals where crosstalk is not a problem. Outer sheath is soft matt black PVC to an overall diameter of 6mm. A cable suitable for making up 'Composite Video and Audio' SCART cables. This cable should be used for short runs only, otherwise crosstalk between conductors may become a problem.

Purchasing information and Reel deal

This product is sold in units of 1 metre, up to a maximum length in 1 piece of 100 metres. Orders placed for a quantity of 100 units, or multiples of 100 units will be supplied on a reel, otherwise the cable will be supplied cut to length.

Order Code	Mod: 000287	Price each exc. VAT 1+	100+	inc. VAT each
XS42V	9 Way Cable (1m)	£1.60	£0.70	£1.69

20 Way Overall Screened SCART Cable (priced per metre)

REEL DEAL



Comprising a bundle of 20 insulated wires colour coded black, brown, red, orange, yellow, green, blue, violet, grey, white, brown/black, red/black, orange/black, yellow/black, grey/black, blue/black, violet/black, pink, sky blue and cyan. Each wire has 7/0.12mm tinned strands. The whole group is wrapped with a metallised mylar film acting as the screen, which is in contact with a single uninsulated tinned stranded earth conductor of 7/0.155mm strands. Outer sheath is soft matt black PVC to an overall diameter of 9mm.

A cable suitable for making up 'Universal' SCART cables, where all 21 pins are to be connected. This cable should be used for short runs only, otherwise crosstalk between conductors may become a problem.

Purchasing information and Reel deal

This product is sold in units of 1 metre, up to a maximum length in 1 piece of 100 metres. Orders placed for a quantity of 100 units, or multiples of 100 units will be supplied on a reel, otherwise the cable will be supplied cut to length.

Order Code	Mod: 000290	Price each exc. VAT 1+	100+	inc. VAT each
XS44X	20 Way Cable (1m)	£1.99	£0.99	£2.39

Individually Screened AV SCART Cable (priced per metre)

REEL DEAL



Contains one red and one blue individually screened, stranded conductor, with high density polyethylene insulators which resist deformation, suitable for two-way video signal traffic. Centre cores are 10/0.115mm strands, and are untinned bare copper as are the screens. Another separate bundle comprises single Red, Blue, Yellow and White insulated, bare copper 10/0.11mm stranded

wires, sheathed overall with a metallised film screen in contact with an uninsulated stranded conductor which is soldered together into a solid core, and then in grey PVC. The whole cable is completed by one other isolated, single white 10/0.115mm stranded bare copper wire. The whole group is then wrapped in metallised mylar film, which again includes an uninsulated and soldered, stranded conductor as an earth wire. Outer sheath is soft matt black PVC to an overall diameter of 8mm. A cable suitable for making up 'Composite Video and Audio' SCART cables, where composite Video, Audio and Function Switching connections are to be provided. Individually screened conductors should be used for video in and out signals. 4-way screened conductors should be used for L+R Audio in and out signals. The remaining single conductor should be used for function switching.

Purchasing information and Reel deal

This product is sold in units of 1 metre, up to a maximum length in 1 piece of 100 metres. Orders placed for a quantity of 100 units, or multiples of 100 units will be supplied on a reel, otherwise the cable will be supplied cut to length.

Order Code	Mod: 000292	Price each exc. VAT 1+	100+	inc. VAT each
XS41U	2x Screen Cable (1m)	£1.90	£0.95	£2.29

Individually Screened Universal SCART Cable (priced per metre)

REEL DEAL



An expanded version of XS41U having black, red, yellow, green, blue and white individually screened, stranded cores. Two of the cores with high density polyethylene insulators, also suitable for video signals, the rest with PVC. Centre cores are 10/0.115mm strands, and are untinned bare copper as are the screens. Similarly a separate bundle is also provided comprising single red, black, yellow and white insulated, bare copper 7/0.12mm stranded wires, sheathed overall with a metallised film screen in contact with an uninsulated stranded conductor soldered into a solid core, and then in grey PVC. Four independent insulated blue, red, yellow and white 10/0.115mm stranded bare copper wires are also provided. The whole bundle is then wrapped in metallised mylar film, which again contacts an uninsulated and soldered stranded conductor. Outer sheath is soft matt black PVC to an overall diameter of 10.5mm. A cable suitable for making up 'Universal' SCART cables, where all inputs and outputs are to be connected. The additional individually screened conductors should be used for R, G, B and blanking signals, whilst the additional individual single conductors should be used for data communication signals. Other conductors should be connected as type 3 above.

Purchasing information and Reel deal

This product is sold in units of 1 metre, up to a maximum length in 1 piece of 100 metres. Orders placed for a quantity of 100 units, or multiples of 100 units will be supplied on a reel, otherwise the cable will be supplied cut to length.

Order Code	Mod: 000293	Price each exc. VAT 1+	100+	inc. VAT each
XS43W	6x Screen Cable (1m)	£2.74	£1.37	£3.29

Belden Cables

Webro 8723 UG Belden Equivalent Cable (priced per metre)



- High-density polyethylene sheath (HDPE)
- Suitable for underground use
- 2 Pair 22AWG
- Black Cable
- Priced by the metre

Webro 8723 UG Belden Equivalent cable is a multi conductor computer cable suitable for computer use in EIA RS-232 application.

Webro 8723 UG Belden Equivalent cable consists of two 22AWG pairs. Each pair consists of two cores with stranded tinned copper wire conductor, polypropylene insulation with individual foil screen and drain wire. The cable is sheathed overall in black High-density polyethylene (HDPE) and is 300V rated.

Purchasing information

This product is sold in units of 1 metre, up to a maximum length in 1 piece of 100 metres. Orders placed for a quantity of 100 units, or multiples of 100 units will be supplied on a reel, otherwise the cable will be supplied cut to length.

Order Code	Mod: 1034102	Price each exc. VAT 1+	100+	inc. VAT each
A80RA	8723 U/G Cable (1m)	£0.49	£0.39	£0.59

Webro 9502 Belden Equivalent Cable (priced per metre)



- Low smoke and fume sheath (LSF)
- 2 Pair 24AWG
- Black
- Priced by the metre

Webro 9502 Belden Equivalent cables are typically used with computers, point-of-sale equipment, instrumentation applications and data processing systems.

Webro 9502 Belden Equivalent cable consists of two 24AWG pairs. Each pair consists of a stranded tinned copper wire conductor, semi-rigid PVC insulation with overall foil screen and drain wire. The cable is sheathed overall in Low smoke and fume sheath (LSF) and is 300V rated.

Purchasing information

This product is sold in units of 1 metre, up to a maximum length in 1 piece of 100 metres. Orders placed for a quantity of 100 units, or multiples of 100 units will be supplied on a reel, otherwise the cable will be supplied cut to length.

Order Code	Mod: 1034103	Price each exc. VAT 1+	100+	inc. VAT each
A78RA	9502 Cable (1m)	£0.32	£0.23	£0.39

Webro 8723 Belden Equivalent Cable (priced per metre)



- Low smoke and fume sheath (LSF)
- 2 Pair 22AWG
- Black Cable
- Priced by the metre

Webro 8723 Belden Equivalent cable is a multi conductor computer cable suitable for computer use in EIA RS-232 application.

Webro 8723 Belden Equivalent cable consists of two 22AWG pairs. Each pair consists of two cores with stranded tinned copper wire conductor, polypropylene insulation with individual foil screen and drain wire. The cable is sheathed overall in Low smoke and fume sheath (LSF) and is 300V rated.

Purchasing information

This product is sold in units of 1 metre, up to a maximum length in 1 piece of 100 metres. Orders placed for a quantity of 100 units, or multiples of 100 units will be supplied on a reel, otherwise the cable will be supplied cut to length

Order Code	Mod: 1034104	Price each exc. VAT	inc. VAT each
A79RA	8723 Cable (11m)	£0.40	£0.49

Webro 9501 Belden Equivalent Cable (priced per metre)



- Low smoke and fume sheath (LSF)
- 1 Pair 24AWG
- Black
- Priced by the metre

Webro 9501 Belden Equivalent cables are typically used with computers, point-of-sale equipment, instrumentation applications and data processing systems.

Webro 9501 Belden Equivalent cable consists of one 24AWG pair, which consists of a stranded tinned copper wire conductor, semi-rigid PVC insulation with overall foil screen and drain wire. The cable is sheathed overall in Low smoke and fume sheath (LSF) and is 300V rated.

Purchasing information

This product is sold in units of 1 metre, up to a maximum length in 1 piece of 100 metres. Orders placed for a quantity of 100 units, or multiples of 100 units will be supplied on a reel, otherwise the cable will be supplied cut to length

Order Code	Mod: 1034105	Price each exc. VAT	inc. VAT each
A77RA	9501 Cable (11m)	£0.24	£0.29

Automotive Cable

Power Cable for In-Car Entertainment Systems (priced per metre)



- High quality 8AWG flexible copper cable
- 700 strands of 0.12mm diameter copper
- Available in black or red

This cable is for use with car audio equipment and is NOT intended for connecting to other car electrical accessories

This product is sold in units of 1 metre, up to a maximum length in 1 piece of 50 metres

Orders placed for a quantity of 50 units, or multiples of 50 units will be supplied on a reel, otherwise the cable will be supplied cut to length

To place an order for this product, enter the total number of units you require

Specifications:

Overall diameter: 7mm

Order Code	Mod: 006216	Price each exc. VAT	inc. VAT each
BZ92A	8AWG Cable Red (11m)	£3.90	£4.69
BZ93B	8AWG Cable Black (11m)	£3.90	£4.69

Car Battery Power Cable (priced per 50cm)



- High quality OFC 4AWG copper cable
- 1,050 strands of 0.16mm diameter copper

Intended for use in cars, with high power in-car

entertainment systems, to ensure the very best sound quality output. The cable is intended to be used with the distribution block and fuse holders. It is NOT intended to supply starter motors or other car electrical accessories. Available in red and black

This product is sold in units of 1/2 metre, up to a maximum length in 1 piece of 50 metres. Orders placed for a quantity of 100 units, or multiples of 100 units will be supplied on a reel, otherwise the cable will be supplied cut to length

To place an order for this product, order the Maplin order code times the total number of units you require

Overall diameter	10mm
Construction	1,050/0.16mm
Nom. conductor area	21mm ²
Max. current	70A

Order Code	Mod: 006208	Price each exc. VAT	inc. VAT each
BZ91Y	4AWG Cable Red (50cm)	£3.57	£4.29
CK17T	4AWG Cable Black (50cm)	£3.57	£4.29

OFC Speaker Cable



- Oxygen-free copper for maximum sound quality
- Transparent PVC sheath
- Supplied on handy 10m reels

A range of the highest quality cable for use with the finest hi-fi and in-car entertainment systems. Designed and manufactured to exacting standards by Shark using only the best quality oxygen-free copper and PVC. Ideal for the demanding environment found in cars. Multi-stranded and tightly wound for optimum performance. Two sizes are available: 17AWG with outside dimensions of 3.9 x 8.35mm (KS88V) and 12AWG with outside dimensions of 4.5 x 10.5mm (KS89W). Supplied as a 10m length on a reel

Order Code	Mod: 017717	Price each exc. VAT	inc. VAT each
KS88V	Shark 17AWG 10m Pack	£12.49	£14.99
KS89W	Shark 12AWG 10m Pack	£16.65	£19.99

Shopping for cut cable at maplin

Making your own cables allows you to have bespoke lengths and absolute choice over the type of cable you use. Our order process for lengths of cable is simple, simply order the amount of units that you require and you'll receive that length of cable.

Almost all of the cable is sold in 1-metre units, therefore if you want a 10-metre length of cable you should order 10 pieces of that order code. You'll get a piece of cable that's 10-metres in length, not 10 pieces of 1-metre. If you did want 10 1-metre lengths order them as separate items each with a quantity of 1. Anything that's not sold in 1-metre lengths will be made clear in the information on the item.

We can also supply you with full reels of cable at a discounted rate than that of the by-metre pricing.

There are maximum lengths of cable as we're limited by the length of what comes on a reel, if your need is greater you may need to buy suitable connectors for your chosen cable.

If you need any help or further guidance when shopping for specific lengths of cable please contact our customer service department or visit one of our Maplin stores.



7-Core Trailer Cable (priced per metre)



A 7-core cable primarily intended for low-voltage (max. 50Vdc) trailer connections. The cable has seven cores coloured coded brown, blue, yellow, green, red white and black with the same nominal conductor area. Each core is made from stranded copper with a PVC sheath. This standard 12N cable is suitable for obligatory lighting circuits supplied through 12N series connectors (coloured black).

Purchasing information and Reel deal

This product is sold in units of 1 metre, up to a maximum length in 1 piece of 50 metres. Orders placed for a quantity of 50 units, or multiples of 50 units will be supplied on a reel; otherwise the cable will be supplied cut to length.

Specifications:

Strands	14 x 0.3mm
Nom. conductor area:	1mm ²
Max current:	8.75A
Outer sheath	black PVC

Order Code	Mod.	Price each exc. VAT	inc. VAT each	
		1+	50+	
XR55K	7 Core Cable (1m)	£2.90	£1.45	£3.49

RF Cables

Webro RG223 50 Ohm Coax Cable (priced per metre)



- Low loss 50 Ohm coaxial
- Silver plated copper wire conductor
- Ideal for extending satellite cable runs
- Foam Dielectric
- Price per metre

Webro RG223 Coax Cable is a low loss 50 Ohm coaxial suitable for use on data, video, CATV, CCTV, DBS (Direct Broadcasting Satellite), RF signal and broadcast transmissions.

Webro RG223 Coax Cable consists of a solid 0.9mm silver plated copper wire conductor, foam polyethylene dielectric and two layers of silver plated copper wire braids. Sheathed overall with black PVC.

Purchasing information

This product is sold in units of 1 metre, up to a maximum length in 1 piece of 100 metres. Orders placed for a quantity of 100 units, or multiples of 100 units will be supplied on a reel; otherwise the cable will be supplied cut to length.

Order Code	Mod.	Price each exc. VAT	inc. VAT each	
		1+	100+	
A76RA	RG223 Cable (1m)	£1.32	£1.19	£1.59

Webro URM43 50 Ohm Coax Cable (priced per metre)



- 50 Ohm coaxial
- Compliant with BS2316
- Polyethylene dielectric
- Plain copper wire conductor
- Back cable priced by the metre

Webro URM43 coax cable is a 50 Ohm cable typically used for data, video, CATV, CCTV, RF signal and broadcast transmissions and is compliant with BS2316.

Webro URM43 coax cable consists of a 0.90mm solid plain copper wire conductor, solid polyethylene dielectric and a

plain copper wire braid. Sheathed overall in PVC

Purchasing information

This product is sold in units of 1 metre, up to a maximum length in 1 piece of 100 metres. Orders placed for a quantity of 100 units, or multiples of 100 units will be supplied on a reel; otherwise the cable will be supplied cut to length.

Order Code	Mod.	Price each exc. VAT	inc. VAT each	
		1+	100+	
A71RA	URM43 Cable (1m)	£0.49	£0.39	£0.59

Webro RG58 CU 50 Ohm Coax Cable (priced per metre)



- 50 Ohm coaxial
- Tinned copper wire conductor
- Polyethylene dielectric
- priced per metre

Webro RG58 CU Coax Cable is a 50 ohm cable suitable for use on low power signal and RF transmissions. Webro RG58 CU Coax Cable consists of 19 strands of 0.18 mm tinned copper wire conductor, solid polyethylene dielectric and tinned copper wire braid. Sheathed overall in black PVC.

Purchasing information

This product is sold in units of 1 metre, up to a maximum length in 1 piece of 100 metres. Orders placed for a quantity of 100 units, or multiples of 100 units will be supplied on a reel; otherwise the cable will be supplied cut to length.

Order Code	Mod.	Price each exc. VAT	inc. VAT each	
		1+	100+	
A74RA	RG58 Cable (1m)	£0.40	£0.31	£0.49

Webro Cabnex 59+2core Shotgun cable (priced per metre)



- 75 Ohm
- Inner conductor 0.58 mm CCS
- Camera installation with ease
- Solid polyethylene insulation
- Priced per metre

Webro Cabnex 59+2core Shotgun cable is used for CCTV applications, consisting of an RG59 coax for signal transmission and two power core for providing power to the cameras from a central location.

Webro Cabnex 59+2core Shotgun cable consists of a 0.58 mm copper clad steel conductor with solid polyethylene insulation and copper clad aluminium wire braid. The cable features two 0.50 mm² plain copper wire PVC insulated power cores, and is overall sheathed in PVC.

Purchasing information

This product is sold in units of 1 metre, up to a maximum length in 1 piece of 100 metres. Orders placed for a quantity of 100 units, or multiples of 100 units will be supplied on a reel; otherwise the cable will be supplied cut to length.

Order Code	Mod.	Price each exc. VAT	inc. VAT each	
		1+	100+	
A68RA	59+2C Shotgun (1m)	£0.40	£0.39	£0.49
A69RA	59+2C Shotgun (500m)	£149.99	£142.49	£179.99

Webro URM76 50 Ohm Coax Cable (priced per metre)



- 50 Ohm coaxial
- Compliant with BS2316
- Polyethylene dielectric

- Plain copper wire conductor

- Black cable
- Priced by the metre

Webro URM76 coax cable is a 50 Ohm cable typically used for RF signal and broadcast transmissions and is compliant with BS2316.

Webro URM76 coax cable consists of cable consists of 7 strands of 0.32mm plain copper wire conductor, solid polyethylene dielectric and a plain copper wire braid. Sheathed overall in PVC.

Purchasing information

This product is sold in units of 1 metre, up to a maximum length in 1 piece of 100 metres. Orders placed for a quantity of 100 units, or multiples of 100 units will be supplied on a reel; otherwise the cable will be supplied cut to length.

Order Code	Mod.	Price each exc. VAT	inc. VAT each	
		1+	100+	
A73RA	URM76 Cable (1m)	£0.40	£0.31	£0.49

Webro URM67 50 Ohm Coax Cable (priced per metre)



- 50 Ohm coaxial
- Compliant with BS2316
- Polyethylene dielectric
- Plain copper wire conductor
- Black cable
- Priced by the metre

Webro URM67 coax cable is a 50 Ohm cable typically used for CCTV, video, RF signal and broadcast transmissions and is compliant with BS2316.

Webro URM67 coax cable consists of cable consists of 7 strands of 0.77mm plain copper wire conductor, solid polyethylene dielectric and a plain copper wire braid. Sheathed overall in PVC.

Purchasing information

This product is sold in units of 1 metre, up to a maximum length in 1 piece of 100 metres. Orders placed for a quantity of 100 units, or multiples of 100 units will be supplied on a reel; otherwise the cable will be supplied cut to length.

Order Code	Mod.	Price each exc. VAT	inc. VAT each	
		1+	100+	
A72RA	URM67 Cable (1m)	£0.99	£0.87	£1.19

Webro RG213 50 Ohm Coax Cable (priced per metre)



- Low loss 50 Ohm coaxial
- Annealed copper wire conductor
- Ideal for extending satellite cable runs
- Polyethylene dielectric
- Black cable
- Priced by the metre

Webro RG213 Coax Cable is a low loss 50 Ohm coaxial suitable for video, RF signal and broadcast transmissions. Webro RG213 Coax Cable consists of 7 strands of 0.75mm plain annealed copper wire conductor, solid polyethylene dielectric, a plain annealed copper wire braid and a black PVC sheath.

Purchasing information

This product is sold in units of 1 metre, up to a maximum length in 1 piece of 100 metres. Orders placed for a quantity of 100 units, or multiples of 100 units will be supplied on a reel; otherwise the cable will be supplied cut to length.

Order Code	Mod.	Price each exc. VAT	inc. VAT each	
		1+	100+	
A75RA	RG213 Cable (1m)	£1.07	£0.95	£1.29

Coax URM70 75Ω Low Loss RF Cable Black (priced per metre)



High quality coaxial cable suitable for general VHF and UHF use. Stranded core, 7/0.19mm plain copper conductor with high density polyethylene insulation. Screen is braided plain copper sheathed overall in black PVC.

Purchasing information and Reel deal

This product is sold in units of 1 metre, up to a maximum length in 1 piece of 100 metres. Orders placed for a quantity of 100 units, or multiples of 100 units will be supplied on a reel, otherwise the cable will be supplied cut to length.

Specifications:

Overall diameter	5.8mm
Impedance:	75Ω
Capacitance (core to screen):	67pF/metre
Max. voltage:	14kV DC, 1.8kV peak RF
Attenuation per 10m	1.5dB at 100MHz 5.2dB at 1000MHz

Order Code	Mod: 000266	Price each exc. VAT 1+	inc. VAT each 100+
XS32K	URM70 Cable (1m)	£1.15	£0.57 £1.39

Coax RG59B/U 75Ω Cable Black (priced per metre)



A screened cable having an impedance of 75Ω, single solid centre conductor, high density polyethylene insulator and braided copper & foil screen. Sheathed overall in black PVC.

Purchasing information and Reel deal

This product is sold in units of 1 metre, up to a maximum length in 1 piece of 100 metres. Orders placed for a quantity of 100 units, or multiples of 100 units will be supplied on a reel, otherwise the cable will be supplied cut to length.

Specifications:

Overall dia.:	6mm
Centre conductor	1/0.65mm
Nominal impedance	75Ω
Attenuation per 10m	1.3dB at 100MHz 4.6dB at 1000MHz

Order Code	Mod: 000260	Price each exc. VAT 1+	inc. VAT each 100+
XS52G	RG59 75 ohm (1m)	£1.07	£0.53 £1.29

Coax RG58 50Ω Cable Black (priced per metre)



A screened RF cable having a stranded core 17/0.19mm tinned copper conductor with a solid polyethylene insulator and a braided copper screen. Sheathed overall in black PVC.

Purchasing information and Reel deal

This product is sold in units of 1 metre, up to a maximum length in 1 piece of 100 metres. Orders placed for a quantity of 100 units, or multiples of 100 units will be supplied on a reel, otherwise the cable will be supplied cut to length.

Overall diameter	5mm
Centre conductor	17/0.19mm
Nominal impedance	50Ω
Attenuation per 10m	2dB at 100MHz 7.6dB at 1000MHz

Order Code	Mod: 000256	Price each exc. VAT 1+	inc. VAT each 100+
XS51F	RG58 50 ohm (1m)	£1.24	£0.57 £1.49

Coax URM67 50Ω Cable Black (priced per metre)



A high quality, heavy duty, RF coaxial cable ideal as a transmitter up-lead. Stranded core, 7/0.77mm copper conductor with solid polythene insulation, braided screen and sheathed in black PVC.

Purchasing information and Reel deal

This product is sold in units of 1 metre, up to a maximum length in 1 piece of 50 metres. Orders placed for a quantity of 50 units, or multiples of 50 units will be supplied on a reel, otherwise the cable will be supplied cut to length.

Specifications:

Overall diameter:	10.3mm
Capacitance (core to screen)	100pF/m
Max. voltage:	6.5kV
Nominal impedance:	50Ω
Attenuation per 10m:	0.68dB at 100MHz 2.52dB at 1000MHz

Order Code	Mod: 000257	Price each exc. VAT 1+	inc. VAT each 50+
XR63T	UR67 RF Cable (1m)	£4.24	£2.12 £5.09

Coax URM76 50Ω Low Capacitance Cable Black (priced per metre)



A high quality screened cable for high performance audio connections. Stranded core, 7/0.32mm plain copper conductor with polythene insulation, braided screen and sheathed overall in black PVC.

This cable is also suitable for use at RF and has characteristics superior to UniRadix UR76/RG58C.

Purchasing information and Reel deal

This product is sold in units of 1 metre, up to a maximum length in 1 piece of 100 metres. Orders placed for a quantity of 100 units, or multiples of 100 units will be supplied on a reel, otherwise the cable will be supplied cut to length.

Specifications:

Overall diameter:	5mm
Capacitance (core to screen)	100pF/m
Maximum voltage:	2.0kV
Nominal impedance:	50Ω
Attenuation per 10m:	2.0dB at 100 MHz 7.6dB at 1000 MHz

Order Code	Mod: 000254	Price each exc. VAT 1+	inc. VAT each 100+
XR19V	URM76 Cable (1m)	£1.40	£0.70 £1.69

RG59+2 CCTV Pro Video and Power Cable (priced per metre)



- Video and power can be sent down one piece of cable
- Saves installation time and money fitting 1 cable instead of 2
- Cables run in shotgun style and will split if required
- Braided copper screen RG59 with 0.5mm<x>2<x> twin conductors sheathed overall in black PVC
- Cable metre marked cable to allow for quick run off when installing

Please note: This cable requires termination. Our 75Ω BNC twist on plugs (Order Code: CL03D), 2.1mm Power Plugs (Order Code: HH61R) and Inline 2.1mm Power

Sockets (Order Code: JK11M) can be used to make the cable ready for use.

Purchasing information and Reel deal

This product is sold in units of 1 metre, up to a maximum length in 1 piece of 50 metres. Orders placed for a quantity of 50 units, or multiples of 50 units will be supplied on a reel, otherwise the cable will be supplied cut to length.

Order Code	Mod: 225588	Price each exc. VAT 1+	inc. VAT each 50+
N49GG	RG59+2 CCTV (1m)	£1.82	£0.82 £2.19

Coax RG213/U 50Ω Cable Black (priced per metre)



A high quality coaxial cable to MIL-C-17

Purchasing information and Reel deal

This product is sold in units of 1 metre, up to a maximum length in 1 piece of 100 metres. Orders placed for a quantity of 100 units, or multiples of 100 units will be supplied on a reel, otherwise the cable will be supplied cut to length.

Specifications:

Inner Conductor:	3.1mm ²
No./ size wire	7/0.75
Conductor:	plain annealed copper
Insulation	polyethylene
Outer conductor	plain copper braid
Sheath	PVC
Outside diameter	10.3mm
Capacitance	98pF/m
Attenuation per 100m	6.3dB at 100MHz 23.3dB at 1000MHz

Order Code	Mod: 020661	Price each exc. VAT 1+	inc. VAT each 100+
XS66W	RG 213/U (1m)	£3.49	£2.16 £4.19

Coax RG174 A/U 50Ω Cable Black (priced per metre)



A high quality coaxial cable to MIL-C-17, designed for use with SMA, SMB, SMC and MCX connectors. (see Connectors Section)

Purchasing information and Reel deal

This product is sold in units of 1 metre, up to a maximum length in 1 piece of 100 metres. Orders placed for a quantity of 100 units, or multiples of 100 units will be supplied on a reel, otherwise the cable will be supplied cut to length.

Specifications:

Inner conductor	0.14mm ²
No./ size wire	7/0.16
Conductor:	copper covered steel
Insulation	solid polyethylene
Outer conductor	tinned copper wire braid
Sheath	PVC
Outside diameter	2.8mm
Capacitance	100pF/m
Attenuation per 100m	26.2dB at 100MHz 92.9dB at 1000MHz

Order Code	Mod: 019360	Price each exc. VAT 1+	inc. VAT each 100+
XS62S	RG174 Cable (1m)	£1.15	£0.57 £1.39

Reel Deal
Available on
marked cables



1/2 PRICE when you buy the full reel

DC Power Cable

Twin Core Power Cable
(priced per metre)REEL
DEAL

- Standard 2-core figure-of-8 power cable
- Black and red colour-coded zippable cores.
- PVC operation temperature range: -20C to 80C
- Available as 6A, 10A, 15A and 20A
- Price per metre

Purchasing information

This product is sold in units of 1 metre, up to a maximum length in 1 piece of 100 metres. Orders placed for a quantity of 100 units, or multiples of 100 units will be supplied on a reel; otherwise the cable will be supplied cut to length.

Order Code	Current Rating	Construction Dims	CSA (mm)	(mm ²)
XS72P	15A	2x42/0.19	1.19	6.6x3.3
XS73Q	20A	2x75/0.19	2.12	7.6x3.8
XS70M	6A	2x20/0.19	0.57	5.6x2.8

Order Code	Mod: 1033675	Price each exc. VAT	100+	inc. VAT each
XS70M	6A Figure 8 (11m)	£1.40	£0.70	£1.69
XS72P	15A Figure 8 (11m)	£2.15	£1.07	£2.59
XS73Q	20A figure 8 (11m)	£2.49	£1.24	£2.99

Sleeving

Heat-Shrinkable Sleeving

Heat-shrinkable tube with excellent flame-retardant, flexibility and insulation properties. It is suitable for the electrical insulation and bonding of cables and connectors and for corrosion-proofing of metallic rods, tubes and aerials. Made from chemical, cross-linked (by irradiation), thermally stabilized flame retarded polyolefin. Standards: UL224 VW-1, C-UL CSA C22.2 OFT Operating Temperature: -55°C-125°C Shrinking Temperature: Start at 70°C, and shrunk totally at 115°C Shrink Ratio: 2:1

Order Code	Width	As Supplied diameter	After Shrinkage thickness
BF6T	1.5mm	2.0±0.3mm	0.18±0.05mm
PF21X	1.5mm	2.0±0.3mm	0.18±0.05mm
BF87U	2.5mm	3.0±0.3mm	0.20±0.05mm
PF22Y	2.5mm	3.0±0.3mm	0.20±0.05mm
BF88V	3.5mm	4.0±0.4mm	0.20±0.05mm
PF23A	3.5mm	4.0±0.4mm	0.20±0.05mm
BF89W	5.0mm	5.5±0.4mm	0.23±0.05mm
PF24B	5.0mm	5.5±0.4mm	0.23±0.05mm
BF90X	7.0mm	7.5±0.4mm	0.28±0.05mm
PF25C	7.0mm	7.5±0.4mm	0.28±0.05mm
YR17T	10.0mm	10.8±0.5mm	0.33±0.08mm
KC48C	12mm	13.2±0.5mm	1.6mm
YR18U	13.0mm	13.5±0.5mm	0.33±0.10mm
PE27E	13.0mm	13.5±0.5mm	0.33±0.10mm

Order Code	Diameter	Thickness	Length
BF6T	0.85mm	0.32±0.05mm	1.5m
PF21X	0.85mm	0.32±0.05mm	5m
BF87U	1.25mm	0.38±0.05mm	1m
PF22Y	1.25mm	0.38±0.05mm	5m
BF88V	1.75mm	0.42±0.05mm	1m
PF23A	1.75mm	0.42±0.05mm	5m
BF89W	2.50mm	0.50±0.08mm	1m
PF24B	2.50mm	0.50±0.08mm	5m
BF90X	3.50mm	0.55±0.08mm	1m
PF25C	3.50mm	0.55±0.08mm	5m
YR17T	5.00mm	0.70±0.08mm	1m
KC48C	0.75mm	4.2mm	1m
YR18U	6.50mm	0.65±0.08mm	1m
PE27E	6.50mm	0.65±0.08mm	5m

Order Code	Mod: 000301	Price each exc. VAT	1+	5+	inc. VAT each
KC48C	12mm Adhv H/shrink 1m	£5.24	£4.19	£6.29	
BF86T	1.5mm Heatshrink 1m	£1.82	£1.46	£2.19	
PF21X	1.5mm Heatshrink 5m	£5.90	£4.72	£7.09	
BF87U	2.5mm Heatshrink 1m	£1.90	£1.52	£2.29	
PF22Y	2.5mm Heat Shrink 5m	£6.07	£4.86	£7.29	
BF88V	3.5mm Heatshrink 1m	£2.07	£1.66	£2.49	
PF23A	3.5mm Heatshrink 5m	£6.32	£5.06	£7.59	
BF89W	5.0mm Heatshrink 1m	£2.15	£1.72	£2.59	
PF24B	5.0mm Heatshrink 5m	£7.15	£5.72	£8.59	
BF90X	7.0mm Heatshrink 1m	£2.24	£1.79	£2.69	
PF25C	7.0mm Heatshrink 5m	£2.99	£2.39	£3.59	
YR17T	10mm Heatshrink 1m	£2.57	£2.06	£3.09	
YR18U	13mm Heatshrink 1m	£2.82	£2.26	£3.39	
PF27E	13mm Heatshrink 5m	£8.82	£7.06	£10.59	

Heat-Shrinkable Cable Splicers



- Crimp cable joint
- Adhesive lined heatshrink insulation for splash proof solutions
- Ideal for automotive general electrical connections
- Two sizes available
- Supplied in packs of 10

Order Code	Heat Shrink Colour	Dimensions (mm)	Wire Size (mm ²)	Max. Cable Diameter (mm)
AR60Q	Red	5.3 x 34.5	0.5 - 1.5	4.5
AR61R	Blue	6 x 36	1.5 - 2.5	5

Order Code	Mod: 006860	Price each exc. VAT	1+	5+	inc. VAT each
AR60Q	Cable Splicer Red	£3.15	£2.52	£3.79	
AR61R	Cable Splicer Blue	£3.07	£2.45	£3.69	

Heatshrink Lucky Bag



- Contains an assortment of 15 Heatshrink of randomly assorted values

Order Code	Mod: 1034098	Price each exc. VAT	1+	5+	inc. VAT each
N83FX	L/Bag Heat Shrink	£3.74	£2.99	£4.49	

Rolson 127 Piece Heat Shrink Wire Wrap Assortment



- Contains 7 popular sizes
- Complete with a sectioned lockable storage case
- Contains 2, 2.5, 3.5, 5, 7, 10 and 13mm diameter heat shrink

Kit Contains	Heat shrink diameter:	Length:	Quantity supplied:
	2mm	40mm	30
	2.5mm	40mm	25
	3.5mm	40mm	20
	5mm	40mm	20
	7mm	80mm	16
	10mm	80mm	8
	13mm	85mm	8

Order Code	Mod: 222855	Price each exc. VAT	1+	5+	inc. VAT each
N03FT	Asst Heat Shrink	£3.82	£3.06	£4.59	

Networking & Data Cable

Cat 5e Network Cable UTP Solid
(priced per metre)

- Standard network cable
- Enhanced Category 5 compliant

To TIA/EIA-586B Enhanced Category 5 This is the standard cable for network installation, designed for use on high-speed LAN applications up to 100Mbps/s.

Specifications:

Inner conductor: 0.51mm plain copper
Conductor type: Solid
Construction: 4 twisted-pairs with PE dielectric
Jacket: flame-retardant PVC

This product is sold in units of 1 metre, up to a maximum length in 1 piece of 100 metres

Orders placed for a quantity of 100 units or multiples of 100 units will be supplied on a reel; otherwise the cable will be supplied cut to length

To place an order for this product, order the Maplin order code times the total number of units you require

Also available in industry standard 305m (1000 ft.) pull boxes

Order Code	Mod: 000076	Price each exc. VAT	1+	100+	inc. VAT each
CW45Y	UTP Cat5e Solid (11m)	£0.82	£0.41	£0.99	
SN32K	UTP Cat5e Solid 305m	£66.65		£79.99	

Cat 6 Network Cable UTP Solid
(priced per metre)

To ANSI/TIA/EIA-568-B-2-1

This 4-pair cable is the new standard in networking, Category 6. Designed for use with high speed networks and a fully capable of supporting Gigabit networks. It is also fully backwards compatible with Cat 5e and Cat 5. This cable uses solid strand cores and is suitable for structured cable installation

Specifications:

Inner conductor: 0.57mm plain copper
Conductor type: Solid
Construction: 4 twisted-pairs with PE dielectric
Jacket: flame-retardant PVC
Outside diameter: 6.3mm
Impedance: 100Ω ±15%

This product is sold in units of 1 metre, up to a maximum length in 1 piece of 100 metre

Orders placed for a quantity of 100 units, or multiples of 100 units will be supplied on a reel; otherwise the cable will be supplied cut to length

To place an order for this product, order the Maplin order code times the total number of units you require

Also available in industry standard 305m (1000 ft.) pull boxes

Order Code	Mod: 043891	Price each exc. VAT	1+	100+	inc. VAT each
L82AX	CAT6 Solid (11m)	£0.99	£0.49	£1.19	
L84AX	Cat 6 Solid 305m	£83.32		£99.99	



Over 200 stores nationwide

Want to browse the full range?

Head into store or visit maplin.co.uk



WANT THE ULTIMATE SECURITY SOLUTION?

CCTV & SECURITY

The latest in surveillance technology to protect your home or business

Visit maplin.co.uk for the very latest in security cameras, surveillance systems, alarms and personal safety solutions



<http://goo.gl/9nb6Qq>

SAFE & SECURE

Multi-Core Screened Cable Type 7-1-C (priced per metre)



- To DEF STAN 61-12 parts 4 and 5
- Multi-core cables with overall braided screens
- Stranded cores 7/0.1mm tinned copper conductors with PVC insulation wrapped overall in Melinex tape
- Covered with a braided screen and sheathed in grey PVC

This product is sold in units of 1 metre, up to a maximum length in 1 piece of 100 metres. Orders placed for a quantity of 100 units, or multiples of 100 units will be supplied on a reel, otherwise the cable will be supplied cut to length. To place an order for this product, order the Maplin order code multiplied by the total number of units you require.

Please note: These cables are not intended for use as power cables and must not be used to directly connect equipment to the mains power supply.

Specifications:

Nominal conductor area	0.055mm ²
Maximum working voltage	250Vrms
Maximum current per core:	0.25A
Capacitance (core to screen):	190pF/m

The following sizes are available:

4-core	(overall diameter 3.15mm)
6-core	(overall diameter 3.55mm)
9-core	(overall diameter 4.25mm)
15-core	(overall diameter 5.35mm)
25-core	(overall diameter 6.3mm)

Order Code	Mod: 000230	Price each exc. VAT 1+	100+	inc. VAT each 20+
XR25C	Multi-Core 4Way (11m)	£1.57	£0.78	£1.89
XR26D	Multi-Core 6Way (11m)	£1.90	£0.95	£2.29
XR27E	Multi-Core 9Way (11m)	£2.32	£1.16	£2.79
XR28F	Multi-Core 15W (11m)	£3.57	£1.78	£4.29
XR46A	Multi-Core 25Way (11m)	£3.99	£1.99	£4.79

Grey IDC 0.05in Pitch (priced per 30cm)

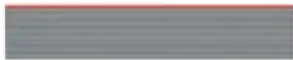

To **UL2651**.

Flat cable for the 0.05in pitch IDC connectors in the Connectors Section of this catalogue, available in 16 and 40 way. The grey insulation has a red identifying strip along one edge.

This product is sold in units of 30 cm, up to a maximum length in 1 piece of 30 metres.

Orders placed for a quantity of 100 units, or multiples of 100 units will be supplied on a reel, otherwise the cable will be supplied cut to length.

To place an order for this product, order the Maplin order code times the total number of units you require.

Order Code	Mod: 000072	Price each exc. VAT 1+	100+	inc. VAT each 20+
XR73Q	Flat IDC 16W (30cm)	£1.24	£0.62	£1.49
XR77J	Flat IDC 40W (30cm)	£1.82	£0.91	£2.19

Cat 6A LSZH S/FTP Stranded Patch Cable (priced per metre)



- 10-Gigabit Ethernet Transmission
- Category 6A Performance
- Individually screened pairs
- Overall Braid
- Low Smoke Zero Halogen
- Stranded pure copper cores
- Grey or blue outer sheath

• Available in 100m reels

Connectix Cabling Systems Category 6A U/FTP patch cable has been designed to provide the exceptional performance required to support extremely high speed network applications, including 10-Gigabit Ethernet. The individually shielded pairs and overall braid ensure maximum transmission, free from the problems of NEXT and alien crosstalk. The outer sheath is a Low Smoke Zero Halogen material as specified in many public buildings.

Compliant with: ANSI/TIA 568C, ISO/IEC 11801 2nd Edition, EN 50173-1, IEEE 802.3 (10Base-T, 100Base-T, 1000Base-T, 10GBase-T)

Purchasing information and Reel deal

This product is sold in units of 1 metre, up to a maximum length in 1 piece of 100 metres. Orders placed for a quantity of 100 units, or multiples of 100 units will be supplied on a reel, otherwise the cable will be supplied cut to length.

Order Code	Mod: 1033698	Price each 1+	exc. VAT 100+	inc. VAT each 1000+
A120Y	CAT6a LSZH Patch (1m) Grey	£1.24	£0.57	£1.49
A130Y	CAT6a LSZH Patch (1m) Blue	£1.24	£0.57	£1.49

Cat 6A LSZH U/FTP Solid Cable (priced per metre)



- 10-Gigabit Ethernet Transmission
- Category 6A Performance
- Individually screened pairs
- Low Smoke Zero Halogen
- Solid 23AWG pure copper cores

Connectix Cabling Systems Category 6A U/FTP patch cable has been designed to provide the exceptional performance required to support extremely high speed network applications, including 10-Gigabit Ethernet. The individually shielded pairs and overall braid ensure maximum transmission, free from the problems of NEXT and alien crosstalk. The outer sheath is a Low Smoke Zero Halogen material as specified in many public buildings.

Compliant with: ANSI/TIA 568C, ISO/IEC 11801 2nd Edition, EN 50173-1, IEEE 802.3 (10Base-T, 100Base-T, 1000Base-T, 10GBase-T)

Purchasing information and Reel deal

This product is sold in units of 1 metre, up to a maximum length in 1 piece of 100 metres. Orders placed for a quantity of 100 units, or multiples of 100 units will be supplied on a reel, otherwise the cable will be supplied cut to length.

Order Code	Mod: 1033700	Price each exc. VAT 1+	100+	inc. VAT each 1000+
A100Y	CAT6a LSZH Solid (1m)	£1.07	£0.49	£1.29

Cat 6A LSZH U/FTP Solid Cable (priced per metre)



- 305m (1000ft) reel in box
- 10-Gigabit Ethernet Transmission
- Category 6A Performance
- Individually screened pairs
- Low Smoke Zero Halogen
- Solid 23AWG pure copper cores

Connectix Cabling Systems Category 6A U/FTP solid cable has been designed to provide the exceptional performance required to support extremely high speed network applications, including 10-Gigabit Ethernet.

The individually shielded pairs ensure maximum transmission, free from the problems of NEXT and alien crosstalk. The outer sheath is a Low Smoke Zero Halogen material as specified in many public buildings. Compliant with: ANSI/TIA 568C, ISO/IEC 11801 2nd Edition, EN 50173-1, IEEE 802.3 (10Base-T, 100Base-T, 1000Base-T, 10GBase-T)

Order Code	Mod: 1033701	Price each exc. VAT 1+	5+	inc. VAT each 20+
A110Y	CAT6a LSZH 305 Solid	£158.32	£154.36	£189.99

Webro Cat5e PE Horizontal Cable (priced per metre)



- Polyethylene Jacket suitable for duct use
- Performance of up to 100MHz
- High density polyethylene insulation
- Plain annealed copper wire
- Suitable for 1000BASE-T
- Black
- Priced by the metre

Webro Category 5e cable PE [Cat5e cable] is a twisted pair cable for carrying signals used most commonly in cabling for computer networks such as Ethernet. Cat5e cables are also used to carry other signals such as telephony and video.

Webro Cat5e PE consists of solid plain annealed copper wire with high density polyethylene insulation and a black polyethylene sheath. The polyethylene sheath enables the cable to be used in ducts.

Webro Cat5e PE cable provides performance of up to 100MHz and is suitable for 10BASE-T, 100BASE-TX (Fast Ethernet) and 1000BASE-T (Gigabit Ethernet).

Purchasing information

This product is sold in units of 1 metre, up to a maximum length in 1 piece of 100 metres. Orders placed for a quantity of 100 units, or multiples of 100 units will be supplied on a reel, otherwise the cable will be supplied cut to length.

Order Code	Mod: 1034106	Price each exc. VAT 1+	100+	inc. VAT each 1000+
A70RA	CAT5 PE (1m)	£0.57	£0.47	£0.69

Cat 5e Network Cable UTP Stranded (priced per metre)



- Highly flexible network patch cable
- Enhanced Category 5 compliant

To TIA/EIA-568-B Enhanced Category 5

High specification network cable for making flexible patch leads.

Purchasing information and Reel deal

This product is sold in units of 1 metre, up to a maximum length in 1 piece of 100 metres. Orders placed for a quantity of 100 units, or multiples of 100 units will be supplied on a reel, otherwise the cable will be supplied cut to length.

Specifications:

Inner conductor:	7 x 0.20mm plain copper
Conductor type	Stranded
Construction	4 twisted-pair
Jacket	PVC
Outside diameter	5.25mm
Impedance	100Ω ±15Ω
Capacitance:	44pF/m

Order Code	Mod: 013230	Price each exc. VAT 1+	100+	inc. VAT each 1000+
VB10L	UTP CAT5e Patch (1m)	£1.07	£0.53	£1.29

Cat 5e UTP Network Cable Solid Low Smoke Zero Halogen Blue (priced per metre)



- LSZH jacket
- Category 5e compliant

To TIA/EIA-568-B Enhanced Category 5 High specification, LSZH (Low Smoke Zero Halogen) jacketed UTP Category 5e solid cable for networking. Purple coloured sheath

Purchasing information and Reel deal

This product is sold in units of 1 metre, up to a maximum length in 1 piece of 100 metres. Orders placed for a quantity of 100 units, or multiples of 100 units will be supplied on a reel, otherwise the cable will be supplied cut to length

Specifications:

Inner conductor: 0.52mm plain copper
 Conductor type: Solid
 Construction: 4 twisted-pairs with PE dielectric
 Jacket: LSZH
 Outside diameter: 5.2mm
 Impedance: 100Ω ± 15Ω
 Capacitance: 46pF/m

Order Code	Mod: 019868	Price each exc. VAT 1+	inc. VAT each 100+
VB20W	UTP CAT5e LSZH (1m)	£1.15	£0.57

Cat 5e Network Cable Foil-Shielded Solid 1m (priced per metre)



- Foil-shielded solid core network cable
- Category 5e compliant

To TIA/EIA-568-B Enhanced Category 5 Foil-shielded twisted-pair (FTP) network cable with solid conductors.

Purchasing information and Reel deal

This product is sold in units of 1 metre, up to a maximum length in 1 piece of 100 metres. Orders placed for a quantity of 100 units, or multiples of 100 units will be supplied on a reel, otherwise the cable will be supplied cut to length

Specifications:

Inner conductor: 0.52mm plain copper
 Conductor type: Solid
 Construction: 4 twisted-pairs with PE dielectric
 Shield: Aluminium/polyester with 0.4mm tinned copper drain wire
 Jacket: PVC to BS 6746 Type 6
 Outside diameter: 5.80mm
 Impedance: 100Ω ± 15Ω
 Capacitance: 46pF/m

Order Code	Mod: 013246	Price each exc. VAT 1+	inc. VAT each 100+
VB22Y	FTP CAT5e Solid (1m)	£1.07	£0.53

Reel Deal
 Available on marked cables



1/2 PRICE when you buy the full reel

Enamelled Copper Wire

Enamelled Copper Wire



Tested to IEC 851/5/4, breakdown 7kVA. Grade 1 enamelled copper wire in rolls of 250g, suitable for coil forming, etc. Available in the following range

Order Code	Dia (mm)	Gauge (swg)	Length (m)
YN79L	2	14	8.75
YN80B	1.6	16	13.5
YN81C	1.25	18	24
YN82D	0.9	20	42.5
YN83E	0.71	22	70
YN84F	0.56	24	112
YN85G	0.45	26	170
YN86T	0.375	28	250
YN87U	0.315	30	350
YN88V	0.28	32	475
YN89W	0.236	34	650
YN91Y	0.15	38	1500
YN92A	0.125	40	2200

Order Code	Mod: 000044	Price each exc. VAT 1+	inc. VAT each 5+
YN79L	250 ECW 2.0mm 14swg	£7.07	£6.43
YN80B	250 ECW 1.6mm 16swg	£7.07	£6.43
YN81C	250 ECW 1.25mm 18swg	£7.07	£6.43
YN82D	250 ECW 0.9mm 20swg	£7.07	£6.43
YN83E	250 ECW 0.71mm 22swg	£7.49	£6.92
YN84F	250 ECW 0.56mm 24swg	£7.49	£6.92
YN85G	250 ECW 0.45mm 26swg	£7.90	£7.30
YN86T	250 ECW 0.375mm 28swg	£7.49	£6.92
YN87U	250 ECW 0.315mm 30swg	£7.90	£7.26
YN88V	250 ECW 0.28mm 32swg	£7.90	£7.26
YN89W	250 ECW 0.236mm 34swg	£7.90	£7.26
YN91Y	250 ECW 0.15mm 38swg	£8.74	£8.06
YN92A	250 ECW 0.125mm 40swg	£9.57	£8.89

Alarm Cable

Burglar Alarm/Signal Cable to BS6360/BS6746 (priced per metre)



To BS4737 Part 3 and to BS6360 and BS6746 4-core, 6-core, 8-core and 12-core signal cables ideal for use with security alarms and other applications where low voltages and low currents are being used. Available in white.

Specifications:

Max. voltage: 60Vrms
 Max. current: 1A per core
 Max. resistance: 92.4Ω/km
 Max. temperature: 70°C
 Conductors: 7/0.2mm annealed copper wire [conforming to BS6360]
 Insulation: 0.2mm PVC [conforming to BS6746]
 Sheath: 0.5mm PVC

Order Code	Mod: 000065	Price each exc. VAT 1+	inc. VAT each 100+
XR89W	4-Wire Burglar (1m)	£0.82	£0.41
XS54J	6-Core Alarm Wht (1m)	£0.99	£0.49
CW70M	8-Wire Burglar (1m)	£1.07	£0.53
XS98C	12-Wire Burglar (1m)	£1.24	£0.62



Browse our entire range at maplin.co.uk

Flat IPC Telephone Cable CW1311 4 Core Light Grey (priced per metre)



To BT specification CW1311 Four-way flat D-section telephone line cord specifically designed for use with standard 4-way phone plugs - see Connectors section The stranded wires are 7 x 0.15mm and sheathed in colour-coded PVC and are sheathed overall in a light grey PVC.

Purchasing information and Reel deal

This product is sold in units of 1 metre, up to a maximum length in 1 piece of 100 metres. Orders placed for a quantity of 100 units, or multiples of 100 units will be supplied on a reel, otherwise the cable will be supplied cut to length

Colour-code

Pin 1: Black
 Pin 2: White
 Pin 3: Green
 Pin 4: Blue

Order Code	Mod: 006222	Price each exc. VAT 1+	inc. VAT each 100+
XR86T	4-Way Flat BT (1m)	£1.07	£0.53

Bell Cable Single Core (priced per metre)



Solid cored low voltage bell wire. The conductors are laid side by side in a flat 'figure of 8' configuration. The solid, plain annealed copper cores are 1/0.50mm.

Purchasing information and Reel deal

This product is sold in units of 1 metre, up to a maximum length in 1 piece of 100 metres. Orders placed for a quantity of 100 units, or multiples of 100 units will be supplied on a reel, otherwise the cable will be supplied cut to length

Order Code	Mod: 023086	Price each exc. VAT 1+	inc. VAT each 100+
XS92A	Bell Wire (1m)	£0.57	£0.28

Buying for business?
 0333 400 9740



FCC68 Data Cable (priced per metre)



Three types of multi-strand telephone/data cord with a flat cross section. Available in 4-core, 6-core and 8-core versions. Designed specifically for use with FCC68 modular connectors. These cables are also suitable for any other application where a multi-way cable is needed. All three types are sheathed in light grey PVC.

This product is sold in units of 1 metre, up to a maximum length in 1 piece of 100 metres

Orders placed for a quantity of 100 units, or multiples of 100 units will be supplied on a reel, otherwise the cable will be supplied cut to length

To place an order for this product, order the Maplin order code times the total number of units you require

Order Code	Mod: 000068	Price each exc. VAT 1+	inc. VAT each 100+
XS27E	FCC68 4 Core (1m)	£0.90	£0.45

Telephone Cable Type CW1308 (priced per metre)



To BT specification CW1308

A high specification cable for use in wiring telephone line outlet sockets. It is also ideal for use in other low voltage, low current applications. The cable contains four solid tinned annealed copper conductors, each 0.5mm diameter, insulated with colour-coded PVC. Overall insulation is in white PVC. The 6-way is also available with black PVC insulation.

Colour-coding

- 1 White - blue
- 2 Blue - white
- 3 White - orange
- 4 Orange - white
- 5 White - green
- 6 Green - white

Specifications

- Nom. conductor area: 0.2mm²
- Max. working voltage: 80V
- Max. current per core: 0.25A

- Overall diameter: 4-core 3.6mm
- 6-core 4.5mm

This product is sold in units of 1 metre, up to a maximum length in 1 piece of 100 metres

Orders placed for a quantity of 100 units, or multiples of 100 units will be supplied on a reel; otherwise the cable will be supplied cut to length

To place an order for this product, order the Maplin order code times the total number of units you require

Order Code	Mod. 000066	Price each exc. VAT 1+	100+	inc. VAT each 1000+
XR66W	4W Phone Whit (1m)	£0.99	£0.49	£1.19

TV, Satellite & Coax Cable

Low-Loss TV Coax Cables (priced per metre)



A low-loss coaxial cable intended for use as aerial downloads for UHF television sets. Solid core, 1/1.0mm copper conductor with cellular polythene insulation, braided screen and sheathed overall in brown and white PVC.

Specifications:

- Overall dia: 6.6mm
- Nom. conductor area: 0.786mm²
- Capacitance (core to screen): 56pF/m
- Nominal impedance: 75Ω
- Attenuation per 10m: 0.75dB at 100MHz
- 2.6dB at 900MHz

This product is sold in units of 1 metre, up to a maximum length in 1 piece of 100 metres

Orders placed for a quantity of 100 units, or multiples of 100 units will be supplied on a reel; otherwise the cable will be supplied cut to length

To place an order for this product, order the Maplin order code times the total number of units you require

Order Code	Mod. 000272	Price each exc. VAT 1+	100+	inc. VAT each 1000+
XR296	Brown TV Coax (1m)	£0.99	£0.49	£1.19
XR87U	White TV Coax (1m)	£0.99	£0.49	£1.19

Webro Foam 100 UG (WF100UG) Coax Cable (priced per metre)



- CAI Approved
- Suitable for underground use
- Foam Dielectric
- Compatible with CT100 cable and connectors
- Impedance 75 ohms
- priced per metre

Webro Foam 100 UG, or WF100UG coax cable is suitable

for many applications, including low power video, video signal and broadband signals. It is also used in high-frequency transmission, especially for transmitters and receivers, computers, radio and TV transmitters.

WF100UG cable consists of a 1.00mm solid plain copper conductor, foam polyethylene dielectric, copper foil tape, plain copper wire braid and a green HDPE sheath for underground use.

WF cable is the UK's most popular coaxial cable for TV and Satellite installations and is widely regarded as the highest quality coaxial cable in the market.

Purchasing information

This product is sold in units of 1 metre, up to a maximum length in 1 piece of 100 metres. Orders placed for a quantity of 100 units, or multiples of 100 units will be supplied on a reel; otherwise the cable will be supplied cut to length.

Order Code	Mod. 1033709	Price each exc. VAT 1+	100+	inc. VAT each 1000+
A46RA	WF100 U/G (1m)	£1.07	£0.95	£1.29
A47RA	WF125 U/G (1m)	£1.40	£1.27	£1.69
A48RA	WF165 U/G (1m)	£1.82		£2.19

Webro RG59 BU Coax Cable (priced per metre)



- CAI Approved
- Ideal for extending satellite cable runs
- Foam Dielectric
- Compatible with RG59 F Plug connectors
- Impedance 75 ohms
- Black cable

RG59 Cable is suitable for use on low power/baseband video, antenna, RF signal and broadcast transmissions. RG59 Cable (version BU) consists of a solid 0.58mm copper clad steel conductor, solid polyethylene dielectric and plain copper wire braid.

Purchasing information

This product is sold in units of 1 metre, up to a maximum length in 1 piece of 100 metres. Orders placed for a quantity of 100 units, or multiples of 100 units will be supplied on a reel; otherwise the cable will be supplied cut to length.

Order Code	Mod. 1033710	Price each exc. VAT 1+	100+	inc. VAT each 1000+
A40RA	RG59BU (1m)	£0.32	£0.23	£0.39
A42RA	RG59BU (250m)	£49.99	£47.49	£59.99
A43RA	RG59BU (500m)	£91.65	£87.07	£109.99

Webro RG59 Cabnex Coax Cable (priced per metre)



- CAI Approved
- Ideal for extending satellite cable runs
- Foam Dielectric
- Compatible with RG59 F Plug connectors
- Impedance 75 ohms
- Black cable
- Priced per metre

RG59 Cable is suitable for use on low power/baseband video, antenna, RF signal and broadcast transmissions. RG59 Cable (Cabnex) consists of a solid 0.58 mm copper clad steel conductor, solid polyethylene dielectric and copper clad aluminium wire braid.

Purchasing information

This product is sold in units of 1 metre, up to a maximum length in 1 piece of 100 metres. Orders placed for a quantity of 100 units, or multiples of 100 units will be supplied on a reel; otherwise the cable will be supplied cut to length.

Order Code	Mod. 1033712	Price each exc. VAT 1+	100+	inc. VAT each 1000+
A44RA	RG59 Cabnex (1m)	£0.32	£0.23	£0.39
A46RA	RG59 Cabnex (250m)	£58.32	£55.40	£69.99
A47RA	RG59 Cabnex (500m)	£83.32	£79.15	£99.99

Webro Foam (WF100LSF) Coax Cable (priced per metre)



- Low smoke and fume sheath (LSF)
- CAI Approved
- Ideal for extending satellite cable runs
- Foam Dielectric
- Compatible with CT100 cable and connectors
- impedance 75 ohms
- Black cable
- Priced by the metre
- 100, 125 or 165 LSF

Webro Foam or WF100LSF coax cable is suitable for many applications, including low power video, video signal and broadband signals. It is also used in high-frequency transmission, especially for transmitters and receivers, computers, radio and TV transmitters.

WF100 cable consists of a 1.00 mm solid plain copper conductor, foam polyethylene dielectric, copper foil tape, plain copper wire braid and a Low smoke and Fume (LSF) sheath.

WF125 cable consists of a 1.25 mm solid plain copper conductor, foam polyethylene dielectric, copper foil tape, plain copper wire braid and a Low smoke and Fume (LSF) sheath.

WF165 cable consists of a 1.65 mm solid plain copper conductor, foam polyethylene dielectric, copper foil tape, plain copper wire braid and a Low smoke and Fume (LSF) sheath.

WF cable is the UK's most popular coaxial cable for TV and Satellite installations and is widely regarded as the highest quality coaxial cable in the market.

Purchasing information

This product is sold in units of 1 metre, up to a maximum length in 1 piece of 100 metres. Orders placed for a quantity of 100 units, or multiples of 100 units will be supplied on a reel; otherwise the cable will be supplied cut to length.

Order Code	Mod. 1033713	Price each exc. VAT 1+	100+	inc. VAT each 1000+
A49RA	WF100 LSF (1m)	£0.57	£0.47	£0.69
A50RA	WF125 LSF (1m)	£0.90		£1.09
A51RA	WF165 LSF (1m)	£1.32		£1.59

Webro Foam Coax Cable (priced per metre)



- CAI Approved
- Ideal for extending satellite cable runs
- Foam Dielectric
- Compatible with CT125 cable and connectors
- Impedance 75 ohms

Webro Foam 125 PE, or WF125PE coax cable is suitable for many applications, including low power video, video signal and broadband signals. It is also used in high-frequency transmission, especially for transmitters and receivers, computers, radio and TV transmitters.

WF125PE cable consists of a 1.25mm solid plain copper conductor, foam polyethylene dielectric, copper foil tape, plain copper wire braid and black PE sheath.

WF165PE cable consists of a 1.65mm solid plain copper conductor, foam polyethylene dielectric, copper foil tape, plain copper wire braid and black PE sheath.

WF cable is the UK's most popular coaxial cable for TV and Satellite installations and is widely regarded as the highest quality coaxial cable in the market.

Purchasing information

This product is sold in units of 1 metre, up to a maximum length in 1 piece of 100 metres. Orders placed for a quantity of 100 units, or multiples of 100 units will be supplied on a reel; otherwise the cable will be supplied cut to length.

Order Code	Mod. 1033714	Price each exc. VAT 1+	100+	inc. VAT each 1000+
A44RA	WF125PE (1m)	£0.65	£0.55	£0.79
A45RA	WF165PE (1m)	£1.24	£1.11	£1.49

Webro WF65 CU Twin Coax Cable (priced per metre)



- CAI Approved
- Ideal for extending twin satellite cable runs
- Foam Dielectric
- Compatible with CT63 Sky cable and connectors
- Impedance 75 ohms
- Black cable
- Priced by the metre or reel

Webro WF65 coax cable is suitable for many applications, including low power video, video signal and broadband signals. It is also be used in high-frequency transmission, especially for transmitters and receivers, computers, radio and TV transmitters.

WF65 cable consists of two 0.65 mm solid plain copper conductors, foam polyethylene dielectric, copper foil tape, plain copper wire braid and black PVC sheath. WF cable is the UK's most popular coaxial cable for TV and Satellite installations and is widely regarded as the highest quality coaxial cable in the market.

Purchasing information

This product is sold in units of 1 metre, up to a maximum length in 1 piece of 100 metres. Orders placed for a quantity of 100 units, or multiples of 100 units will be supplied on a reel, otherwise the cable will be supplied cut to length.

Order Code	Mod: 1033715	Price each exc. VAT 1+	100+	inc. VAT each 1000+
A53RA	WF65 (1m)	£0.57	£0.47	£0.69
A54RA	WF65 (250m)	£133.32	£126.65	£159.99

Webro Foam 100 (WF100) Coax Cable (priced per metre)



- CAI Approved
- Ideal for extending satellite cable runs
- Foam Dielectric
- Compatible with CT100 cable and connectors
- Impedance 75 ohms
- Black cable
- Priced by the metre, reel or 5 core

Webro Foam 100, or WF100 coax cable is suitable for many applications, including low power video, video signal and broadband signals. It is also be used in high-frequency transmission, especially for transmitters and receivers, computers, radio and TV transmitters. WF100 cable consists of a 1.00mm solid plain copper conductor, foam polyethylene dielectric, copper foil tape, plain copper wire braid and black PVC sheath. WF cable is the UK's most popular coaxial cable for TV and Satellite installations and is widely regarded as the highest quality coaxial cable in the market.

Purchasing information

This product is sold in units of 1 metre, up to a maximum length in 1 piece of 100 metres. Orders placed for a quantity of 100 units, or multiples of 100 units will be supplied on a reel, otherwise the cable will be supplied cut to length.

Order Code	Mod: 1033716	Price each exc. VAT 1+	100+	inc. VAT each 1000+
A42RA	WF100 (1m)	£0.40	£0.31	£0.49
A43RA	WF100 (250m)	£66.65	£63.32	£79.99
A52RA	WF100 5 Core (1m)	£2.82	£2.63	£3.39

Webro RG6 CCS Coax Cable (priced per metre)



- CAI Approved
- Foam Dielectric
- Compatible with CT100 cable and connectors
- Impedance 75 ohms
- Black cable

• Priced by the metre or reel

RG6 CCS Coax cable is suitable for many applications, including low power video, video signal and broadband signals. It is also be used in high-frequency transmission, especially for transmitters and receivers, computers, radio and TV transmitters.

RG6 coax cable consists of a 1.00mm solid copper clad steel conductor, foam polyethylene dielectric, aluminium foil tape, an aluminium wire braid and sheathed overall in PVC.

Webro's range of commercial grade TV & Satellite coaxial cables are suitable for use on multiple applications, providing a cost effective counterpart to the high performance WF range.

Purchasing information

This product is sold in units of 1 metre, up to a maximum length in 1 piece of 100 metres. Orders placed for a quantity of 100 units, or multiples of 100 units will be supplied on a reel, otherwise the cable will be supplied cut to length.

Order Code	Mod: 1033717	Price each exc. VAT 1+	100+	inc. VAT each 1000+
A55RA	RG6 CCS (1m)	£0.24	£0.15	£0.29
A56RA	RG6 CCS (250m)	£49.99	£47.49	£59.99

Low Loss Satellite Cable FT125 (priced per metre)



Updated version of FT100 XS16S 5-celled polyethylene insulator. Sheathed overall in black PVC. Compatible with CT125 cable and connectors.

Purchasing information and Reel deal

This product is sold in units of 1 metre, up to a maximum length in 1 piece of 100 metres. Orders placed for a quantity of 100 units, or multiples of 100 units will be supplied on a reel, otherwise the cable will be supplied cut to length.

Specifications:

Overall dia.	7.8mm
Nom. conductor area	1.25mm ²
Nominal impedance:	75Ω
Attenuation per 100m	4.9dB at 100MHz 18.74dB at 1000MHz

Order Code	Mod: 000278	Price each exc. VAT 1+	100+	inc. VAT each 1000+
XS46A	LL Sat Cable (1m)	£2.15	£1.07	£2.59

Satellite TV Cable FT100 (priced per metre)



- Superior quality double-screened, ultra low loss coaxial cable
- Screening comprises a continuous copper-mylar foil beneath a conventional braided copper screen
- Ideal for extending satellite cable runs
- 5-celled polyethylene insulator, sheathed overall in black or white PVC
- Compatible with CT100 cable and connectors
- Overall diameter 6.6mm, impedance 75 ohms

This product is sold in units of 1 metre, up to a maximum length in 1 piece of 100 metres. Orders placed for a quantity of 100 units, or multiples of 100 units will be supplied on a reel, otherwise the cable will be supplied cut to length. To place an order for this product, order the Maplin order code multiplied by the total number of units you require.

Specifications:

Overall dia.	6.6mm
Nom. conductor area	1mm ²
Nominal impedance:	75Ω
Attenuation per 100m	6.4dB at 100MHz 21dB at 1000MHz

Order Code	Mod: 000275	Price each exc. VAT 1+	100+	inc. VAT each 1000+
XS16S	Sat Coax Black (1m)	£1.90	£0.95	£2.29
XS17T	Sat Coax White (1m)	£1.90	£0.95	£2.29

Twin Satellite Coax Cable (priced per metre)



- High quality, twin satellite cable, ideal for dual channel satellite systems
- Compatible with CT100 connectors
- Sold in 1m lengths, order the quantity required for the desired length

Purchasing information and Reel deal

This product is sold in units of 1 metre, up to a maximum length in 1 piece of 100 metres. Orders placed for a quantity of 100 units, or multiples of 100 units will be supplied on a reel, otherwise the cable will be supplied cut to length.

Specifications:

Inner conductor	1.0mm bare copper
Dielectric	4.6mm cell PE
Screening	0.12mm bare copper x 64 plus Cu foil
Jacket size outside diameter:	6.8mm x 2

Order Code	Mod: 219139	Price each exc. VAT 1+	100+	inc. VAT each 1000+
N95CX	2x Sat Coax Bk (1m)	£2.65	£1.32	£3.19

Twin Core Satellite Cable Kit 25m



- Contains 25 metres of black twin core satellite cable and 4 screw-on type F-connectors
- High quality, twin satellite cable, ideal for dual channel satellite systems
- Compatible with CT100 connectors

Upgrade or install a new satellite and wiring solution. Add a new LNB to your existing satellite dish and watch a channel while you record another. Can be used with Sky + boxes and the new range of Freesat boxes. Everything comes in the pack that you need. 25m of cable and 4 F-type connectors.

Order Code	Mod: 613439	Price each exc. VAT 1+	inc. VAT each 1000+
N67KH	Twin Sat Coax Kit	£33.32	£39.99

Satellite Cable Kit 25m



- Contains 25 metres of black satellite cable and 2 screw-on F-type connectors
- Ideal for creating your own extensions or interconnects between satellite receiver and LNB

Order Code	Mod: 219428	Price each exc. VAT 1+	5+	inc. VAT each 1000+
N55CU	25m Sat Cable Kit	£19.15	£17.24	£22.99

Miniature Coax Cable (priced per metre)



- Cable has a 1/0.4mm tinned copper conductor
- Expanded foam insulation
- Good quality braided screen and a thin outer grey sheath.

A very high quality miniature coax cable suitable for short interconnections between, for example, computer and monitor or TV, video recorders and similar applications.

Purchasing information and Reel deal

This product is sold in units of 1 metre, up to a maximum length in 1 piece of 100 metres. Orders placed for a quantity of 100 units, or multiples of 100 units will be supplied on a reel, otherwise the cable will be supplied cut to length

Overall diameter:	2.8mm
Nominal impedance:	75Ω
Capacitance:	75pF/m

Order Code	Mod.	Price each exc. VAT 1+	100+	inc. VAT each
XR88V	Miniature Coax (1m)	£1.32	£0.66	£1.59

Bandridge Satellite/Digital TV Cable (priced per metre)

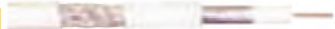

- Double-shielded satellite cable
- Improved shielding for reduced interference
- 99.96% OFC conductor for crystal clear pictures and sound
- Air foam PE insulation layer for purest sound transmission
- Heavy-duty PVC jacket

Purchasing information and Reel deal

This product is sold in units of 1 metre, up to a maximum length in 1 piece of 100 metres. Orders placed for a quantity of 100 units, or multiples of 100 units will be supplied on a reel, otherwise the cable will be supplied cut to length

Specifications:

Conductors:	1
Stranded:	1 x 1.13 OFC
Screening:	i Foil ii Braided 16 x 4 x 0.1
Sheath:	White jacket
Capacitance P1/m:	52Pf/m
Impedance:	75Ω
Overall dimensions:	7mm
Dielectric:	Gas injected foam-PE
Plug diameter:	7mm 2

Order Code	Mod.	Price each exc. VAT 1+	100+	inc. VAT each
N97CK	Low Loss Coax (1m)	£2.15	£1.07	£2.59

High Quality Satellite Cable Kit 20m



- Contains 20 metres of black high quality satellite cable and 2 screw-on type F-connectors
- Ideal for creating your own extensions or interconnects between satellite receiver and LNB
- Suitable for use with Freeview, freesat, Sky+ and Sky HD installations

Nominal Impedance:	75Ω ±30
DC Resistance [20°C]:	Inner <26Ω/km Outer <150Ω/km

Diameter of Inner Conductor:	1.00 ±0.02mm
Dielectric:	Physical Foam PE
Tape Screen:	Pure Copper
Braid Screen:	Pure Copper [55%]
Outer Sheath:	PVC
Overall Diameter:	6.50 ±0.1mm
Bending Radius:	40mm
Flexing Radius:	75mm

Order Code	Mod.	Price each exc. VAT 1+	inc. VAT each
N37GL	20m HQ Sat Cable Kit	£15.82	£18.99

Audio Single Miniature Screened Single Core Grey (priced per metre)



- Single screened cable
- Stranded core, 7/0.1mm copper with PVC insulation
- Lap screened and sheathed overall in grey PVC

A single screened cable ideal for general audio connections especially in equipment where a large number of cables have to be packed into a small area

Purchasing information and Reel deal

This product is sold in units of 1 metre, up to a maximum length in 1 piece of 100 metres. Orders placed for a quantity of 100 units, or multiples of 100 units will be supplied on a reel, otherwise the cable will be supplied cut to length. To place an order for this product, order the Maplin order code times the total number of units you require.

Specifications:

Overall diameter:	2mm
Nom. conductor area:	0.055mm ²
Capacitance (core to screen):	320pF/m
Sold per metre and on 100m reels:	

Order Code	Mod.	Price each exc. VAT 1+	100+	inc. VAT each
XR15R	Min Screened (1m)	£0.82	£0.41	£0.99

Single-Core Lapped Screen (priced per metre)



- Single copper conductor
- Lap screened and sheathed overall in PVC

Available sheathed overall in black, grey or white. Sold per metre and on 100m reels.

Orders placed for a quantity of 100 units, or multiples of 100 units will be supplied on a reel, otherwise the cable will be supplied cut to length.

To place an order for this product, order the Maplin order code times the total number of units you require.

Specifications:

Overall diameter:	3.1mm
Nom. conductor area:	0.122mm ²
Capacitance (core to screen):	320pF/m

Order Code	Mod.	Price each exc. VAT 1+	100+	inc. VAT each
XR13P	Single Grey (1m)	£0.82	£0.41	£0.99
XR12N	Cable Single Bk (1m)	£0.82	£0.41	£0.99
XR14Q	Cable Single Wt (1m)	£0.82	£0.41	£0.99

Audio Single Screened Low Noise Cable Black (priced per metre)



A single screened cable ideal for connections to microphones. Stranded core, 16/0.2mm copper conductor with PVC insulation, braided screen and sheathed overall

in black PVC

Purchasing information and Reel deal

This product is sold in units of 1 metre, up to a maximum length in 1 piece of 100 metres. Orders placed for a quantity of 100 units, or multiples of 100 units will be supplied on a reel, otherwise the cable will be supplied cut to length.

Specifications:

Overall dia:	3.75mm
Nom. conductor area:	0.5mm ²
Capacitance (core to screen):	360pF/m

Order Code	Mod.	Price each exc. VAT 1+	100+	inc. VAT each
XR16S	Mic Cable (1m)	£0.99	£0.49	£1.19

Audio Single Screened Low Noise Cable Black (priced per metre)



- Reel Deal - Half price when bought as a full reel (See below)

A single screened cable ideal for connections to microphones. Stranded core, 16/0.2mm copper conductor with PVC insulation, braided screen and sheathed overall in black PVC.

Purchasing information and Reel deal

This product is sold in units of 1 metre, up to a maximum length in 1 piece of 100 metres. Orders placed for a quantity of 100 units, or multiples of 100 units will be supplied on a reel, otherwise the cable will be supplied cut to length.

Specifications:

Overall dia:	3.75mm
Nom. conductor area:	0.5mm ²
Capacitance (core to screen):	360pF/m

Order Code	Mod.	Price each exc. VAT 1+	100+	inc. VAT each
XR16S	Mic Cable (1m)	£0.99	£0.49	£1.19

Audio Figure of 8 Screened Transparent (priced per metre)



- High quality figure-of-8 screened cable
- Ideal for making hi-fi interconnect leads
- High density braided screen contains blue and red enamelled tracers to indicate polarity
- Transparent PVC outer sheath

Purchasing information and Reel deal

This product is sold in units of 1 metre, up to a maximum length in 1 piece of 100 metres. Orders placed for a quantity of 100 units, or multiples of 100 units will be supplied on a reel, otherwise the cable will be supplied cut to length.

Specifications:

Dimensions:	8mm x 4.0mm
Stranded conductors:	2x 9/0.12mm
Conductor area:	0.102mm ²
Conductor material:	40µin plated copper

Order Code	Mod.	Price each exc. VAT 1+	100+	inc. VAT each
X593B	Twin Aud HiFi (1m)	£1.49	£0.74	£1.79

Shark Audio Coax Single Screened Single Core (priced per metre)



High quality coax cable for use in no-compromise audio

applications. It features high purity, oxygen-free copper (OFC) conductors where each strand is bound tightly for maximum contact area and best electron flow. The centre conductors are multi-strand bare OFC sheathed in a coax insulator sleeve made of high density polyethylene, which is very resistant to deformation and therefore maintains the optimum distance required between the inner and screen throughout the length of the cable. The single bare OFC braided screen is sheathed in transparent extra flexible PVC. Recommended connectors are the Shark High Performance Phonos, N68AR.

Purchasing information and Reel deal

This product is sold in units of 1 metre, up to a maximum length in 1 piece of 50 metres. Orders placed for a quantity of 50 units, or multiples of 50 units will be supplied on a reel, otherwise the cable will be supplied cut to length.

Specifications:

Overall diameter: 5mm
 Insulator diameter: 3mm
 Strands of inner: 156/0.06mm
 Max. working voltage: 200Vpeak
 Capacitance: 95pF/m
 Working temperature: -10°C to +105°C

Order Code	Mod: 000125	Price each exc. VAT 1+	inc. VAT each 50+	inc. VAT each
XS38R	Audio Cable (1m)	£1.90	£0.95	£2.29

Shark Audio/Visual Single Twin Screened Pearlescent White (priced per metre)



A very high quality signal cable for use with audio/visual equipment ideal for conveying audio and/or video signal information. Constructed from oxygen-free copper (OFC), this low capacitance, high performance cable is sheathed in a beautiful pearlescent white. Recommended connectors are the 8mm Gold Phono Connectors, Order Code JZ13P [Black] and JZ14Q [Red].

Purchasing information and Reel deal

This product is sold in units of 1 metre, up to a maximum length in 1 piece of 75 metres. Orders placed for a quantity of 75 units, or multiples of 75 units will be supplied on a reel, otherwise the cable will be supplied cut to length.

Specifications:

Conductor construction: 80 x 0.1mm OFC
 Insulation: Foamed polyethylene
 Shielded: Mylar foil + bare OFC braid
 Overall diameter: 8mm
 Capacitance: 62pF/m
 Impedance: 75Ω nominal

Order Code	Mod: 009512	Price each exc. VAT 1+	inc. VAT each 75+	inc. VAT each
FN74R	Audio/Vid Cable (1m)	£2.74	£1.37	£3.29

Bandridge Audio/Visual Single Screened (priced per metre)



- 5-star press endorsed component cable
- Ideal for long length runs between DVD and TV/projector
- Braided screening for distortion-free pictures
- FPE insulation for optimised picture quality, detail and brightness
- Cable colour marking (red, green, blue) for easy installation

Purchasing information and Reel deal

This product is sold in units of 1 metre, up to a maximum length in 1 piece of 50 metres. Orders placed for a quantity

of 50 units, or multiples of 50 units will be supplied on a reel, otherwise the cable will be supplied cut to length.

Specifications:

Conductors: 3
 Stranded: 3x 23 x 0.12 OFC
 Screening: Copper braiding
 Sheath: Matt blue PVC jacket
 Plug diameter/match: 6mm 2

Order Code	Mod: 220611	Price each exc. VAT 1+	inc. VAT each 50+	inc. VAT each
N06FR	Ban A/V Comp (1m)	£4.49	£2.24	£5.39

Audio/Visual Twin Screened Two Core Grey (priced per metre)



- Stranded cores, 7/0.1mm copper conductors with red and blue PVC insulation
- Lap screened and sheathed overall in grey PVC

A twin screened cable ideal for general audio connections where crosstalk is not a problem. Cores are laid side by side in the cable such that the cable is oval in shape.

Purchasing information and Reel deal

This product is sold in units of 1 metre, up to a maximum length in 1 piece of 100 metres. Orders placed for a quantity of 100 units, or multiples of 100 units will be supplied on a reel, otherwise the cable will be supplied cut to length.

Specifications:

Overall size: 2 x 2.8mm

Order Code	Mod: 000127	Price each exc. VAT 1+	inc. VAT each 100+	inc. VAT each
XR20W	Lapped Pair (1m)	£0.99	£0.49	£1.19

Audio/Visual Single Screened Two Core Grey (priced per metre)



- Two 7/0.2mm copper conductors

Comes with a blue and a red PVC insulation laid side by side, lap-screened and sheathed overall in grey PVC.

Purchasing information and Reel deal

This product is sold in units of 1 metre, up to a maximum length in 1 piece of 100 metres. Orders placed for a quantity of 100 units, or multiples of 100 units will be supplied on a reel, otherwise the cable will be supplied cut to length.

Overall size: 3.1mm x 4.7mm oval
 Capacitance: 272pF core to screen
 148pF core to core

Order Code	Mod: 000129	Price each exc. VAT 1+	inc. VAT each 100+	inc. VAT each
XS23A	Pair 7/0.2mm (1m)	£1.24	£0.62	£1.49

Audio/Visual Twin Screened Two Core Grey (priced per metre)



- Very flexible, high quality twin screened audio cable
- Stranded cores 14/0.18mm copper conductors with red and white PVC insulation
- Individually lap-screened and sheathed overall in grey PVC
- Overall diameter: 6.2mm

Purchasing information and Reel deal

This product is sold in units of 1 metre, up to a maximum length in 1 piece of 100 metres. Orders placed for a

quantity of 100 units, or multiples of 100 units will be supplied on a reel, otherwise the cable will be supplied cut to length.

Order Code	Mod: 000134	Price each exc. VAT 1+	inc. VAT each 100+	inc. VAT each
XR90X	Twin Audio (1m)	£1.49	£0.74	£1.79

Shark Audio/Visual Twin Screened Two Core Blue (priced per metre)



An overall screened pair of conductors within one round screen. The two inner's are identified as red and white and are also screened with metallised mylar film under one braided OFC layer. The centre conductors are stranded 41/0.12mm bare OFC sheathed in a coax insulator sleeve made of high density polyethylene. The outer sleeve is blue.

Purchasing information and Reel deal

This product is sold in units of 1 metre, up to a maximum length in 1 piece of 50 metres. Orders placed for a quantity of 50 units, or multiples of 50 units will be supplied on a reel, otherwise the cable will be supplied cut to length.

Specifications:

Overall diameter: 7.3mm
 Insulator diameter: 2.1mm
 Max. working voltage: 200Vpeak
 Working temperature: 10°C to +105°C
 Capacitance: 112pF/m

Order Code	Mod: 000132	Price each exc. VAT 1+	inc. VAT each 50+	inc. VAT each
XS40T	Common Pair (1m)	£1.90	£0.95	£2.29

Shark Audio Single Screened Single Core Pearlescent White (priced per metre)



A very high quality screened audio oxygen-free copper (OFC) cable with excellent electrical characteristics. Ideal for balanced line feeds in noisy environments and professional studio equipment. Beautiful pearlescent white finish makes it also ideal for top quality hi-fi interconnects. Braid and foil shield ensure that interference and cross-talk are minimised.

Purchasing information and Reel deal

This product is sold in units of 1 metre, up to a maximum length in 1 piece of 50 metres. Orders placed for a quantity of 50 units, or multiples of 50 units will be supplied on a reel, otherwise the cable will be supplied cut to length.

Specifications:

Conductors: 130 x 0.07mm x 2 cables
 Insulation colour: Red/White
 Core construction: 2 cables + 2 supporting strands
 Shielding: Mylar foil & OFC braid (85% min)
 Overall diameter: 8mm
 Capacitance: 58.2pF/m
 Impedance: 81Ω at 1MHz

This product is sold in units of 1 metre, up to a maximum length in 1 piece of 50 metres. Orders placed for a quantity of 50 units will be supplied on a reel, otherwise the cable will be supplied cut to length.

To place an order for this product, order the Maplin order code times the total number of units you require.

Order Code	Mod: 026923	Price each exc. VAT 1+	inc. VAT each 50+	inc. VAT each
XX61R	HQ Twin Audio (1m)	£4.07	£2.03	£4.89

Audio/Visual Twin Screened Two Core Grey (priced per metre)



REEL DEAL

A twin screened cable having each core individually screened and laid side by side in a figure '8' outer sheath thus keeping crosstalk problems to a minimum, but maintaining the advantages of a single cable. Stranded cores, 10/0 12mm copper conductor with PVC insulation, lap screened and sheathed overall in grey PVC

Purchasing information and Reel deal

This product is sold in units of 1 metre, up to a maximum length in 1 piece of 100 metres. Orders placed for a quantity of 100 units, or multiples of 100 units will be supplied on a reel, otherwise the cable will be supplied cut to length.

Specifications:

Overall size: 2.8 x 5.6mm
Nom. conductor area: 0.0785mm²
Capacitance (core to screen): 350pF/m

Order Code	Mod.	Price each exc. VAT 1+	inc. VAT each 100+
XR21X	Cable Twin (1m)	£1.07	£0.53

Audio Twin Screened Two Core (priced per metre)



REEL DEAL

'Figure-of-8' twin lap-screened audio cable with extra flexible outer sheath. Ideal for phono leads

Purchasing information and Reel deal

This product is sold in units of 1 metre, up to a maximum length in 1 piece of 100 metres. Orders placed for a quantity of 100 units, or multiples of 100 units will be supplied on a reel, otherwise the cable will be supplied cut to length.

Specifications:

Stranded conductors: 2 x 16/0 12mm
Overall size: 8.0 x 4.0mm
Nom conductor area: 0.18mm²
Colour: Black

Order Code	Mod.	Price each exc. VAT 1+	inc. VAT each 100+
XS94C	2W Audio Cable (1m)	£1.24	£0.62

Shark Audio Twin Screened Two Core (priced per metre)



REEL DEAL

A dual 'figure-of-8', individually screened pair, where the entire screen of each cable is composed from a layer of metallised mylar film under two layers of OFC (oxygen-free copper) braid, providing the most complete prevention against interference, and having a blue outer sleeve, diameter 6mm. The centre conductors are multi-strand bare OFC sheathed in a coax insulator sleeve made of high density polyethylene. Recommended connectors are the Shark High Performance Phono Plugs AQ56L and AQ57M

Purchasing information and Reel deal

This product is sold in units of 1 metre, up to a maximum length in 1 piece of 50 metres. Orders placed for a quantity of 50 units, or multiples of 50 units will be supplied on a reel, otherwise the cable will be supplied cut to length.

Specifications:

Overall diameter: 6mm
Insulator diameter: 2.7mm
Strands: 91/0 08mm
Max working voltage: 200Vpeak
Capacitance: 105pF/m
Inductance: 0.246mH/m
Working temperature: -10°C to +105°C

Order Code	Mod.	Price each exc. VAT 1+	inc. VAT each 50+
XS39N	Audio Pair (1m)	£4.15	£2.07

Profigold Audio Single Sheath Twin Core (priced per metre)



REEL DEAL

- Twin phono audio cable for custom lengths
- Spiral shielding - Interference free!
- 99.96% OFC conductor for crystal clear sound
- Air foam insulation layer for smoothest transmission
- Heavy duty PVC jacket

Purchasing information and Reel deal

This product is sold in units of 1 metre, up to a maximum length in 1 piece of 50 metres. Orders placed for a quantity of 50 units, or multiples of 50 units will be supplied on a reel, otherwise the cable will be supplied cut to length.

Specifications:

Conductors: 2
Stranded: 2 x 32 x 0.1mm
Screening: 2 x 43 x 0.12mm spiral
Sheath: Anthracite PVC jacket
Overall dimensions: 9.6mm
Plug diameter/match: 5mm2/N02CL

Order Code	Mod.	Price each exc. VAT 1+	inc. VAT each 50+
N93CK	5mm RCA Cable (1m)	£1.74	£0.87

Profigold Audio Twin Screened Two Core (priced per metre)



REEL DEAL

- Double shielded twin RCA audio cable for custom lengths
- Foil and braided double shielding providing interference free sound
- 99.96% OFC conductor for crystal clear sound
- Air foam PE insulation layer for smoothest audio transmission
- Heavy duty PVC jacket

Purchasing information and Reel deal

This product is sold in units of 1 metre, up to a maximum length in 1 piece of 50 metres. Orders placed for a quantity of 50 units, or multiples of 50 units will be supplied on a reel, otherwise the cable will be supplied cut to length.

Specifications:

Conductors: 2
Stranded: 2 x 25 x 0.12 OFC
Screening: i Aluminium foil ii 2 x 16 x 0.12 braided
Sheath: Anthracite PVC jacket
Overall dimensions: 13.9mm
Plug diameter/match: 6mm2/N01CL or N03CL

Order Code	Mod.	Price each exc. VAT 1+	inc. VAT each 50+
N94CK	6mm Str RCA (1m)	£2.40	£1.20

4-Core Overall Lapped Screen



REEL DEAL

A four-core cable with an overall lapped screen available with two different colour outer sheaths. Stranded cores 7/0 12mm copper conductor with PVC insulation, lap screened and sheathed overall in grey or black PVC

Specifications:

Overall diameter: 4.5mm

This product is sold in units of 1 metre, up to a maximum length in 1 piece of 100 metres. Orders placed for a quantity of 100 units, or multiples of 100 units will be supplied on a reel, otherwise the cable will be supplied cut to length.

To place an order for this product, order the Maplin order code times the total number of units you require.

Order Code	Mod.	Price each exc. VAT 1+	inc. VAT each 100+
XR92A	Lapped 4Core Gy (1m)	£1.15	£0.57
XR91Y	Lapped 4Core Bk (1m)	£1.15	£0.57

Audio/Visual Single Individually Screened Four Core Grey (priced per metre)



REEL DEAL

A four-core screened cable having each core individually screened, thus keeping crosstalk to a minimum. Stranded cores, 7/0 1mm copper conductor with yellow, black, red and white polythene insulation, lap screened and sheathed overall in grey PVC.

Purchasing information and Reel deal

This product is sold in units of 1 metre, up to a maximum length in 1 piece of 50 metres. Orders placed for a quantity of 50 units, or multiples of 50 units will be supplied on a reel, otherwise the cable will be supplied cut to length.

Specifications:

Overall size: 5mm
Nom. conductor area: 0.055mm²
Capacitance: 95pF/m (core to screen)

Order Code	Mod.	Price each exc. VAT 1+	inc. VAT each 50+
XR23A	Cable Quad (1m)	£1.32	£0.66

Audio Single Individually Screened Four Core Black (priced per metre)



REEL DEAL

4 core, flat, individually lap-screened audio cable. Ideal for phono leads, bi-amping, in-car hi-fi, etc. Colour coded cores and black outer sheath.

Purchasing information and Reel deal

This product is sold in units of 1 metre, up to a maximum length in 1 piece of 100 metres. Orders placed for a quantity of 100 units, or multiples of 100 units will be supplied on a reel, otherwise the cable will be supplied cut to length.

Specifications:

Stranded cores: 4 x 10/0 12mm
Nominal conductor area: 0.11mm²

Order Code	Mod.	Price each exc. VAT 1+	inc. VAT each 100+
XS95D	4W Audio Cable (1m)	£1.24	£0.62

Browse our entire range at maplin.co.uk

Shark Audio/Visual Twin Screened Single Core Black (priced per metre)



REEL DEAL

Although this coaxial cable is specifically designed for digital audio interconnects such as those used between DVD players and digital decoders for surround sound systems, it would be an excellent alternative to regular 75Ω coax where high signal quality is essential. The cable core is 0.5mm diameter OFC Copper plated in 80µm Silver. The Silver plating takes advantage of the phenomenon of "skin effect". "Skin effect" describes the tendency of ultrahigh frequencies to be conducted on the surface of the wire as opposed to through the wire's total profile. The lower resistance of silver over copper ensures optimum transmission of these ultrahigh frequencies. This core is covered with a PE insulation. The screen is Mylar/Aluminium covered with a tightly woven Pure Copper braid and the sheath is black PVC. Recommended connectors are the Shark 6mm High Performance Phoenix L22BC.

Purchasing information and Reel deal

This product is sold in units of 1 metre, up to a maximum length in 1 piece of 50 metres. Orders placed for a quantity of 50 units, or multiples of 50 units will be supplied on a reel, otherwise the cable will be supplied cut to length.

Specifications:

Overall cable diameter:	6.0mm
Conductor resistance:	85.25Ω/km
Capacitance:	70nF/km at 1KHz
Impedance:	75Ω

Order Code	Mod: 034993	Price each exc. VAT 1+	inc. VAT each 50+
N61AR	DVD Coax Cable (1m)	£2.82	£3.39

Van Damme Plasma Grade Standard Coax Black (priced per metre)



REEL DEAL

- Analogue video transmission up to 100 metres
- Suitable for SP Df digital audio and word clock
- Can be used with serial digital video transmissions up to 138 metres
- Uses RG59 type crimp connectors
- Colour coding suitable for RGBHV, RGBS, YUV and other video formats
- Conductor - Bare ultra pure oxygen free copper
- Stranding - 7x 0.20mm (0.22mm²) AWG 24/7

Van Damme Standard 75 Ohm Plasma Grade Videc Ccax is a high resolution cable designed for use with analogue video signals. Precision performance is combined with flexibility usually only found in microphone cables resulting in an excellent videc cable for dynamic use in the broadcast, videc and presentation markets.

Purchasing information

This product is sold in units of 1 metre, up to a maximum length in 1 piece of 100 metres. Orders placed for a quantity of 100 units, or multiples of 100 units will be supplied on a reel, otherwise the cable will be supplied cut to length.

Specifications:

Conductors:	1
Stranded:	1 x 80 x 0.10 OFC
Screening:	Tin copper braiding
Sheath:	Matt blue PVC jacket
Overall dimensions:	8mm
Plug diameter/match:	6mm2/N03CL

Order Code	Mod: 813230	Price each exc. VAT 1+	inc. VAT each 100+
N03OR	VD Dig Aud Coax (1m)	£1.65	£1.99

Van Damme Video Two Core (priced per metre)



REEL DEAL

- Multicore video signal transmissions - SVHS (YC), YUV, RGBS and RGBHV (VGA)
- Custom length multipin to BNC breakouts
- 30 metre recommended maximum length for analogue video
- Longer run lengths achievable using appropriate distribution amplifiers (DAs)
- All cables use RG179 type connectors and small BNC boots
- Ultra pure oxygen free copper for outstanding sonic integrity

Van Damme Red Series Miniature videc multicore are 2, 4, 5 and 20 way versions of the Van Damme miniature ccax. The 2, 4 and 5 way versions are exceptionally flexible and are designed to seamlessly integrate with industry standard multipin connectors such as SVHS (4 pin mini din), D9 and high density D15 (VGA) connectors. The 20 way ccax is a polyurethane (PUR) jacketed multicore offering strength and reliability for rigorous dynamic use.

Purchasing information

This product is sold in units of 1 metre, up to a maximum length in 1 piece of 100 metres. Orders placed for a quantity of 100 units, or multiples of 100 units will be supplied on a reel, otherwise the cable will be supplied cut to length.

Description	2 x 2.5mm Hi-Fi
Overall diameter	12.00 x 4.00mm
Weight Kg/Km	90
Conductor stranding	7 x (46 x 0.10mm)
Conductor resistance Ohm/Km	24.5

Order Code	Mod: 536235	Price each exc. VAT 1+	inc. VAT each 100+
N05JU	VD Pt Coax 2w (1m)	£3.32	£3.99

Reel Deal
Available on marked cables



1/2 PRICE when you buy the full reel

Van Damme Video Four Core (priced per metre)



REEL DEAL

- Multicore video signal transmissions - SVHS (YC), YUV, RGBS and RGBHV (VGA)
- Custom length multipin to BNC breakouts
- 30 metre recommended maximum length for analogue video
- Longer run lengths achievable using appropriate distribution amplifiers (DAs)
- All cables use RG179 type connectors and small BNC boots
- Ultra pure oxygen free copper for outstanding sonic integrity

Van Damme Red Series Miniature videc multicore are 2, 4, 5 and 20 way versions of the Van Damme miniature ccax. The 2, 4 and 5 way versions are exceptionally flexible

and are designed to seamlessly integrate with industry standard multipin connectors such as SVHS (4 pin mini din), D9 and high density D15 (VGA) connectors. The 20 way ccax is a polyurethane (PUR) jacketed multicore offering strength and reliability for rigorous dynamic use.

Purchasing information

This product is sold in units of 1 metre, up to a maximum length in 1 piece of 100 metres. Orders placed for a quantity of 100 units, or multiples of 100 units will be supplied on a reel, otherwise the cable will be supplied cut to length.

Description	2 x 2.5mm Hi-Fi
Overall diameter	12.00 x 4.00mm
Weight Kg/Km	90
Conductor stranding	7 x (46 x 0.10mm)
Conductor resistance Ohm/Km	24.5

Order Code	Mod: 536236	Price each exc. VAT 1+	inc. VAT each 100+
N06JU	VD Pt Coax 4w (1m)	£10.15	£12.19

Van Damme Red Series Plasma Grade Miniature Video 5 way (priced per metre)



REEL DEAL

- Multicore video signal transmissions - SVHS (YC), YUV, RGBS and RGBHV (VGA)
- Custom length multipin to BNC breakouts
- 30 metre recommended maximum length for analogue video
- Longer run lengths achievable using appropriate distribution amplifiers (DAs)
- All cables use RG179 type connectors and small BNC boots
- Ultra pure oxygen free copper for outstanding sonic integrity

Van Damme Red Series Miniature videc multicore are 2, 4, 5 and 20 way versions of the Van Damme miniature ccax. The 2, 4 and 5 way versions are exceptionally flexible and are designed to seamlessly integrate with industry standard multipin connectors such as SVHS (4 pin mini din), D9 and high density D15 (VGA) connectors. The 20 way ccax is a polyurethane (PUR) jacketed multicore offering strength and reliability for rigorous dynamic use.

Purchasing information

This product is sold in units of 1 metre, up to a maximum length in 1 piece of 100 metres. Orders placed for a quantity of 100 units, or multiples of 100 units will be supplied on a reel, otherwise the cable will be supplied cut to length.

Description	2 x 2.5mm Hi-Fi
Overall diameter	12.00 x 4.00mm
Weight Kg/Km	90
Conductor stranding	7 x (46 x 0.10mm)
Conductor resistance Ohm/Km	24.5

Order Code	Mod: 536237	Price each exc. VAT 1+	inc. VAT each 100+
N07JU	VD Pt Coax 5w (1m)	£12.32	£14.79

Buying for education?
0333 400 9740



Speaker Cable

Miniature Loudspeaker Cable (priced per metre)



A flexible twin cable having a figure-of-8 shape. Ideal for loudspeaker connections, etc.

Available in two colours:
XR39 - White with black stripe
N50HU - Black with white stripe

Specifications:

Stranded core, twin	7/0 2mm copper
Sheath	White PVC with polarity stripe
Overall size	4.0 x 2.0mm
Nom. conductor area:	0.22mm ²
Max. working voltage:	60V RMS
Max. current	1A

This product is sold in units of 1 metre, up to a maximum length in 1 piece of 100 metres

Orders placed for a quantity of 100 units, or multiples of 100 units will be supplied on a reel, otherwise the cable will be supplied cut to length

To place an order for this product, order the Maplin order code times the total number of units you require

Order Code	Mod: 000046	Price each exc. VAT 1+	VAT 100+	inc. VAT each
XR39N	Zip Wire White (1m)	£0.57	£0.28	£0.69
N50HU	Zip Wire Blk (1m)	£0.57	£0.28	£0.69

Loudspeaker Cable (priced per metre)



Flexible twin cable having a figure-of-8 shape. Ideal for loudspeaker connections.

Available in two colours:
XS47 - White with black stripe
N51HU - Black with white stripe

Specifications:

Stranded core, twin	13/0 2mm copper
Sheath	White PVC with polarity stripe
Overall size:	4mm x 2mm
Nom. conductor area:	0.4mm ²
Max. Current	2.5A

This product is sold in units of 1 metre, up to a maximum length in 1 piece of 100 metres

Orders placed for a quantity of 100 units, or multiples of 100 units will be supplied on a reel, otherwise the cable will be supplied cut to length

To place an order for this product, order the Maplin order code multiplied by the total number of units you require.

Order Code	Mod: 000047	Price each exc. VAT 1+	VAT 100+	inc. VAT each
XS47B	Ldsprk Cbl Wht (1m)	£1.15	£0.57	£1.39
N51HU	Ldsprk Cbl Blk (1m)	£1.15	£0.57	£1.39

Heavy Duty Loudspeaker Cable (priced per metre)



A flexible twin cable having a 'figure 8' shape. The cable will carry up to 15A. Suitable for amplifiers up to 500W output.

Available in two colours:
XR60 - White with black stripe
N52HU - Black with white stripe

Specifications:

Stranded core, twin	42/0 2mm copper
---------------------	-----------------

Sheath: White PVC with one side marked with black line for identification

Overall size: 6 x 3mm

Nom. conductor area: 1.32mm²

Max. working voltage: 60Vrms

Max. current: 15A

This product is sold in units of 1 metre, up to a maximum length in 1 piece of 100m

Order Code	Mod: 000049	Price each exc. VAT 1+	VAT 100+	inc. VAT each
XR60Q	HD Ldsprk Wht (1m)	£1.32	£0.65	£1.59
N52HU	HD Ldsprk Blk (1m)	£1.32	£0.66	£1.59

Loudspeaker Cable 20m Drums

- Convenient 20 metre drums of the popular loudspeaker cables
- Suitable for hi-fi loudspeaker to amplifier connections

Please note: These reels of cable are not included in our 'Reel Deal' pricing offer



Specifications:

Code	Cable Construction	Overall Size	Max. Current
N23AP	13/0 2mm copper	4mm x 2mm	2.5A
N20AP	42/0 2mm copper	6mm x 3mm	15A
N17AP	79/0 2mm copper	6mm x 3mm	18A

Order Code	Mod: 115110	Price each exc. VAT 1+	inc. VAT each
N23AP	Loudspeaker Cbl 20m	£10.82	£12.99
N20AP	HD Speaker Cbl 20m	£13.32	£15.99
N17AP	HiFi Speaker Cbl 20m	£22.49	£26.99

High Quality OFC Loudspeaker Connection Cable (priced per metre)



An exceptionally high quality speaker connection wire. Each cable contains hundreds of extremely thin, single strands to improve electron flow at high frequencies. Each cable has a larger than normal overall diameter for absolute minimum impedance, thus ensuring good response at bass frequencies. The strands are made from 100% Oxygen Free Copper (OFC) for maximum sound purity. The extra-flexible, transparent, figure-of-8 sheathing has one side marked with '+' symbols for polarity identification. Available in two versions: Type S12 and Type S10.

Specifications:

Type S12	
Strands	413 strands x 0.1mm dia
Nominal conductor area	3.24mm ²
Sheath outer diameter:	4.4mm
Total sheath width:	9.2mm
Max. working voltage	300V peak
Working temperature range	-10°C to 105°C
Type S10	
Strands	1,050 strands x 0.08mm dia
Nominal conductor area	5.28mm ²
Sheath outer diameter:	5.5mm
Total sheath width:	11.5mm
Max. working voltage	300V peak
Working temperature range	-10°C to 105°C

This product is sold in units of 1 metre, up to a maximum length in 1 piece of 50 metres

Orders placed for a quantity of 50 units, or multiples of 50 units will be supplied on a reel, otherwise the cable will be supplied cut to length

To place an order for this product, order the Maplin order code times the total number of units you require

Order Code	Mod: 000051	Price each exc. VAT 1+	VAT 50+	inc. VAT each
XS37S	Ox Free S12 (1m)	£2.65	£1.32	£3.19
XS36P	Ox Free S10 (1m)	£4.15	£2.07	£4.99

12AWG Shark OFC Speaker Cable



- Oxygen-free copper for maximum sound quality
- Transparent PVC sheath
- Supplied on handy 10m reels
- 4.5 x 10.5mm

A range of the highest quality cable for use with the finest hi-fi and in-car entertainment systems. Designed and manufactured to exacting standards by Shark using only the best quality oxygen-free copper and PVC. Ideal for the demanding environment found in cars. Multi-stranded and tightly wound for optimum performance.

Order Code	Mod: 1034099	Price each exc. VAT 1+	inc. VAT each
KS89W	Shark 12AWG 10m Pack	£16.65	£19.99

17AWG Shark OFC Speaker Cable



- Oxygen-free copper for maximum sound quality
- Transparent PVC sheath
- Supplied on handy 10m reels
- 3.9 x 8.35mm

A range of the highest quality cable for use with the finest hi-fi and in-car entertainment systems. Designed and manufactured to exacting standards by Shark using only the best quality oxygen-free copper and PVC. Ideal for the demanding environment found in cars. Multi-stranded and tightly wound for optimum performance.

Order Code	Mod: 1034100	Price each exc. VAT 1+	inc. VAT each
KS88V	Shark 17AWG 10m Pack	£12.49	£14.99

Hi-Fi Loudspeaker Cable (priced per metre)



A flexible twin cable having a figure-of-8 shape ideally suited for improving the sound from your hi-fi speakers. Recommended by hi-fi experts.

These are sold in lengths of 1m. Please select your length by ordering the quantity you require. You can order a maximum of 100m for one length, higher quantities will be split over multiple reels.

Available in two colours:

XR72 - White with black stripe
N53HU - Black with white stripe

Specifications:

Stranded core, twin	79/0 2mm copper
Sheath	White PVC with polarity stripe
Overall size	6mm x 3mm
Nom. conductor area:	2.5mm ²
Max. working voltage	100V RMS
Max. current	18A

This product is sold in units of 1 metre, up to a maximum length in 1 piece of 100 metres.

Orders placed for a quantity of 100 units, or multiples of 100 units will be supplied on a reel, otherwise the cable will be supplied cut to length

To place an order for this product, order the Maplin order code multiplied by the total number of units you require.

Order Code	Mod: 000050	Price each exc. VAT 1+	VAT 100+	inc. VAT each
XR72P	Hi-Fi Ldsprk Wht (1m)	£1.57	£0.78	£1.89
N53HU	Hi-Fi Ldsprk Blk (1m)	£1.57	£0.78	£1.89

Profigold Speaker Cable 2.5mm 2 Bass Flex (priced per metre)



- **Acclaimed Upgrade speaker cable - ideal for quality Audio /Home Cinema speakers**
- **Solid core conductor produces outstanding Bass response**
- **Stranded OFC produce crystal clear high frequency sound**
- **Presented in low profile transparent sheath**

Purchasing information and Reel deal

This product is sold in units of 1 metre, up to a maximum length in 1 piece of 100 metres. Orders placed for a quantity of 100 units, or multiples of 100 units will be supplied on a reel, otherwise the cable will be supplied cut to length

Specifications:

Conductors: 2 x 2.5mm 2
 Stranded 2 x [1 x 0.75 + 264 x 0.1mm] OFC
 Sheath Transparent PVC jacket
 Overall dimensions 9mm
 Plug match N98CK

Order Code	Mod: 097993	Price each exc. VAT 1+	100+	inc. VAT each
N90CK	2.5mm Spkr Transl 1m	£3.74	£1.86	£4.49

Profigold Bass Flex 1.5mm 2 Speaker Cable (priced per metre)



- **Acclaimed Upgrade speaker cable - ideal for quality Audio /Home Cinema speakers**
- **Solid core conductor produces outstanding Bass response**
- **Stranded OFC produce crystal clear high frequency sound**
- **Presented in low profile transparent sheath**

Purchasing information and Reel deal

This product is sold in units of 1 metre, up to a maximum length in 1 piece of 100 metres. Orders placed for a quantity of 100 units, or multiples of 100 units will be supplied on a reel, otherwise the cable will be supplied cut to length

Specifications:

Conductor: 2 x 1.5mm 2
 Stranded 2 x [1 x 0.5 + 168 x 0.10mm] OFC
 Sheath Transparent PVC jacket
 Overall dimensions 6mm
 Plug match Order Code N98AK

Order Code	Mod: 097990	Price each exc. VAT 1+	100+	inc. VAT each
N89CK	1.5mm Spkr Transl 1m	£2.49	£1.24	£2.99

Soundlab Speaker Cable Extra Flexible Flat 4 core Blue (priced per metre)



High quality 4-core flat loudspeaker cable. Extra flexible for easy routing with oxygen-free copper (ofc) conductors for purer sound. Clearly marked polarity.

Purchasing information and Reel deal

This product is sold in units of 1 metre, up to a maximum length in 1 piece of 100 metres. Orders placed for a quantity of 100 units, or multiples of 100 units will be supplied on a reel, otherwise the cable will be supplied cut to length

Specifications:

4-core:
 Current rating: 12A
 Stranding: 4x[63/0.1 x 2]
 Dimensions: 2.6 x 14mm

Order Code	Mod: 020679	Price each exc. VAT 1+	100+	inc. VAT each
XS85G	4Way 12A Spkr 11m	£2.90	£1.45	£3.49

Flat Flex Speaker Cable (priced per metre)



- **High Performance ultra - flat cable**
- **High Purity OFC conductors ensure low loss/ crystal clear sound**
- **Heavy-duty, anti-oxidisation sheath**
- **Only 2.2mm high cable, ideal for running under carpets**
- **Polarisation markings for easy & correct installation**

Purchasing information and Reel deal

This product is sold in units of 1 metre, up to a maximum length in 1 piece of 100 metres. Orders placed for a quantity of 100 units, or multiples of 100 units will be supplied on a reel, otherwise the cable will be supplied cut to length.

Specifications:

Conductors 2 x 1.33mm²
 Stranded 2 x 76 x 0.14mm OFC
 Sheath White PVC jacket
 Overall dimensions 12mm
 Plug Match: N89CK

Order Code	Mod: 097968	Price each exc. VAT 1+	100+	inc. VAT each
N88CK	1.5mm Spkr Wht 11m	£2.07	£1.03	£2.49

Shark Speaker Cable Flat 4 core (priced per metre)



- **A flat 4-core high quality speaker cable made from high purity OFC bare copper conductor**
- **Stranded tightly into a rectangular cross-section for perfect sound transmission.**

Each core is made from 620 strands and is covered in a very high quality anti-oxidation clear PVC. The cores can easily be separated and the outer cores are colour-coded for identification of positive, and left and right.

Purchasing information and Reel deal

This product is sold in units of 1 metre, up to a maximum length in 1 piece of 50 metres. Orders placed for a quantity of 50 units, or multiples of 50 units will be supplied on a reel, otherwise the cable will be supplied cut to length.

Specifications:

Stranded, each core 93 x 0.07mm x 4 cores
 Sheath: 75 Pclear PVC
 Overall dimensions: 2.8mm x 5.4mm x 23mm
 Max working voltage 300V
 Conductor Area 2.5mm x 4 cores
 Conductor Material: 99.90% Copper

Order Code	Mod: 000055	Price each exc. VAT 1+	50+	inc. VAT each
BZ94C	4W Flat Speaker 11m	£5.40	£2.70	£6.49

Van Damme Speaker Cable Tour Grade 2 x 1.5mm Twin Axial Black (priced per metre)



- **Matt black jacket for on stage use**
- **1.5mm multicore for high power & line array systems**
- **Multicore construction optimised for dynamic use**
- **Ultra pure oxygen free copper for outstanding sonic integrity**
- **This cable comes in lengths of 1m up to 100m for a reel**

Van Damme Black Series Tour Grade Speaker Cable offers a comprehensive conductor size and core count to accommodate almost all potential speaker signals. From 2 core 1.5mm through 8 core 4mm to 18 core 2.5mm the ultra pure copper conductors, cutting edge PVC compounds and dynamic use focused construction provide accurate signal transmission, toughness and flexibility.

Purchasing information

This product is sold in units of 1 metre, up to a maximum length in 1 piece of 100 metres. Orders placed for a quantity of 100 units, or multiples of 100 units will be supplied on a reel, otherwise the cable will be supplied cut to length

Description 2 x 1.5mm Twin-axial
 Overall diameter 6.50mm
 Weight Kg/Km 78
 Conductor stranding 30 x 0.25mm
 Conductor resistance Ohm/Km 12.3

Order Code	Mod: 536228	Price each exc. VAT 1+	100+	inc. VAT each
N00JU	VD2x1.5mm 2x Ax 11m	£2.15	£1.07	£2.59

Van Damme Speaker Cable Tour Grade 2 x 2.5mm Twin Axial Black (priced per metre)



- **Matt black jacket for on stage use**
- **2.5mm multicore for high power & line array systems**
- **Multicore construction optimised for dynamic use**
- **Ultra pure oxygen free copper for outstanding sonic integrity**
- **This cable comes in lengths of 1m up to 100m for a reel**

Van Damme Black Series Tour Grade Speaker Cable offers a comprehensive conductor size and core count to accommodate almost all potential speaker signals. From 2 core 1.5mm through 8 core 4mm to 18 core 2.5mm the ultra pure copper conductors, cutting edge PVC compounds and dynamic use focused construction provide accurate signal transmission, toughness and flexibility.

Purchasing information

This product is sold in units of 1 metre, up to a maximum length in 1 piece of 100 metres. Orders placed for a quantity of 100 units, or multiples of 100 units will be supplied on a reel, otherwise the cable will be supplied cut to length

Description 2 x 2.5mm Twin-axial
 Overall diameter 7.60mm
 Weight Kg/Km 122
 Conductor stranding 50 x 0.25mm
 Conductor resistance Ohm/Km 7.65

Order Code	Mod: 536229	Price each exc. VAT 1+	10+	inc. VAT each
N01JU	VD2x2.5mm 2x Ax 11m	£3.32	£2.90	£3.99

Over 200 stores nationwide

Van Damme Speaker Cable Studio Grade 2 x 1.50mm Twin Axial Blue (priced per metre)



- Critical studio monitoring
- Guitar amplifier to speaker leads
- Installations where low smoke zero halogen is not a requirement
- Conductors use fine stranding for ultimate flexibility
- Ultra pure oxygen free copper for outstanding sonic integrity
- This cable comes in lengths of 1m up to 100m for a reel

Van Damme Blue Series Studio Grade Cable caters not only for the recording studio environment but also for the rehearsal studio, live and presentation markets. All are twin-axial types and range from 0.75mm conductors for 100V line through to 6.00mm conductors for long runs of low impedance signals

Purchasing information

This product is sold in units of 1 metre, up to a maximum length in 1 piece of 100 metres. Orders placed for a quantity of 100 units, or multiples of 100 units will be supplied on a reel, otherwise the cable will be supplied cut to length.

Description	2 x 1.5mm Twin-axial
Overall diameter	6.50mm
Weight Kg/Km	78
Conductor stranding	84 x 0.15mm
Conductor resistance Ohm/Km	12.5

Order Code	Mod: 536230	Price each exc. VAT 1+	100+	inc. VAT each
N02JU	VD 2x1.5mm Ldspkr(1m)	£1.82	£1.09	£2.19

Van Damme Speaker Cable Studio Grade 2 x 2.50mm Twin Axial Blue (priced per metre)



- Critical studio monitoring
- Guitar amplifier to speaker leads
- Installations where low smoke zero halogen is not a requirement
- Conductors use fine stranding for ultimate flexibility
- Ultra pure oxygen free copper for outstanding sonic integrity
- This cable comes in lengths of 1m up to 100m for a reel

Van Damme Blue Series Studio Grade Cable caters not only for the recording studio environment but also for the rehearsal studio, live and presentation markets. All are twin-axial types and range from 0.75mm conductors for 100V line through to 6.00mm conductors for long runs of low impedance signals

Purchasing information

This product is sold in units of 1 metre, up to a maximum length in 1 piece of 100 metres. Orders placed for a quantity of 100 units, or multiples of 100 units will be supplied on a reel, otherwise the cable will be supplied cut to length.

Description	2 x 2.5mm Twin-axial
Overall diameter	7.60mm

Weight Kg/Km 122
Conductor stranding 147 x 0.15mm
Conductor resistance Ohm/Km 7.3

Order Code	Mod: 536231	Price each exc. VAT 1+	100+	inc. VAT each
N03JU	VD 2x2.5mm Ldspkr(1m)	£3.15	£1.57	£3.79

Van Damme Speaker Cable Shotgun Twin Audio Interconnect 2 x 2.5mm Black (priced per metre)



- High end domestic hi-fi cables
- Professional studio near field monitoring
- Shotgun construction for easy conductor separation & identification
- Speaker cables have ultra fine 0.10mm conductors with 7 way plait construction to minimise the skin effect
- Ultra pure oxygen free copper for outstanding sonic integrity
- This cable comes in lengths of 1m up to 100m for a reel

This range comprises a shotgun style twin interconnect cable and 3 conductor sizes of shotgun cable. These cables can be found in many professional environments, in particular the 4mm and 6mm speaker cables are used for critical near field monitoring in many world class recording and mastering studios. It is also the cable of choice for more than one world class hi-fi equipment manufacturer.

Purchasing information

This product is sold in units of 1 metre, up to a maximum length in 1 piece of 100 metres. Orders placed for a quantity of 100 units, or multiples of 100 units will be supplied on a reel, otherwise the cable will be supplied cut to length.

Description	2 x 2.5mm Hi-Fi
Overall diameter	12.00 x 4.00mm
Weight Kg/Km	90
Conductor stranding	7 x (46 x 0.10mm)
Conductor resistance Ohm/Km	24.5

Order Code	Mod: 536232	Price each exc. VAT 1+	100+	inc. VAT each
N04JU	VD Shotgun Audio(1m)	£4.15		£4.99

VDC Contractor Series Multimedia Hybrid Cable (priced per metre)



- Multimedia hybrid cable ideal for flood wiring in current and new build domestic installations
- Contains 2x Cat6 U/UTP, 1x Cat5E U/UTP and 2x quad shielded RG6 precision coaxial cores in one jacket
- Provision for internal network, HDTV (via HDMI Cat X converters) control signals and satellite signal distribution
- Also provides future proofing for HD Base T developments
- Outer jacket PVC, black, with overall diameter 19.5mm +/- 0.10 "

The VDC Contractor Series Multimedia hybrid cable is part of a cable range designed and built specifically for the audio, video and data installation market by the associated trades and user community. The range is competitively priced but still offers "no compromise" mechanical and electrical specifications. The

construction of the cable is as follows: 2x RG6 Coaxial, 2x Cat 6 U/UTP, 1x Cat 5E U/UTP all laid up around a central polyethylene filler, rip cord and PVC jacket.

Order Code	Mod: 1005593	Price each exc. VAT 1+	100+	inc. VAT each
N06DM	VD Hybrid Blk(1m)	£5.24	£2.62	£6.29

VDC Contractor Series LSZH 1 pair audio installation cable (priced per metre)



- Ideal for permanent installation and rack wiring
- Foil screen bonded to outer jacket for one strip removal
- Pair conductor 7x 0.20 mm 24 AWG tinned copper, Red and Black insulation
- Drain wire 7x 0.20mm 24 AWG tinned copper
- Jacket Low Smoke Zero Halogen (LSZH) Thermoplastic, black, overall diameter 3.80mm +/- 0.18
- Available in both PVC and Low Smoke Zero Halogen (LSZH) jacketed version
- LSZH version designed for installation in public buildings or other installations where LSZH materials are specified

The VDC Contractor Series LSZH 1 pair audio installation cable is part of a cable range designed and built specifically for the audio, video and data installation market by the associated trades and user community. The range is competitively priced but still offers "no compromise" mechanical and electrical specifications.

Order Code	Mod: 1005587	Price each exc. VAT 1+	100+	inc. VAT each
N04DM	VDC LSZH 1p Blk(1m)	£0.49	£0.24	£0.59

VDC Contractor Series 2 pair twin audio cable (priced per metre)



- 2x 1 pair foil screen cables bonded together
- Ideal for insert and 2 channel breakout wiring,
- Foil screen bonded to outer jacket - both are removed in one stripping operation
- Pair conductors 7x 30 AWG (22 AWG) tinned copper, red and black insulation
- Jacket in flame retardant PVC, light blue with red polarity stripe

The VDC Contractor Series 2 pair twin audio installation cable is part of a cable range designed and built specifically for the audio, video and data installation market by the associated trades and user community. The range is competitively priced but still offers "no compromise" mechanical and electrical specifications. The construction of the cable is as follows: Twin conductors of tinned copper with poly ethylene insulation twisted together with a tinned copper drain wire. Shielded with aluminium polyester tape. Oversheathed in PVC and bonded to another identical core in a figure of eight configuration. Cores can be easily separated along their length.

Order Code	Mod: 1005589	Price each exc. VAT 1+	100+	inc. VAT each
N05DM	VD 2 Pair Aud(1m)	£1.40	£0.70	£1.69

VDC Contractor Series PVC 1 pair audio installation cable (priced per metre)



- Ideal for permanent installation and rack wiring
- Foil screen bonded to outer jacket for one strip removal
- Pair conductor 7x 0.20 mm 24 AWG tinned copper, Red and Black insulation
- Drain wire 7x 0.20mm 24 AWG tinned copper
- Jacket FR-PVC, black, overall diameter 3.90mm +/- 0.18
- Available in both PVC and Low Smoke Zero Halogen (LSZH) jacketed version

The VDC Contractor Series PVC 1 pair audio installation cable is part of a cable range designed and built specifically for the audio, video and data installation market by the associated trades and user community. The range is competitively priced but still offers “no compromise” mechanical and electrical specifications.

Order Code	Mod: 1005585	Price each exc. VAT 1+ 100+	inc. VAT each
N03DM	VD 1 Par Blk (1m)	£0.49 £0.24	£0.59

Microphone & Stage Cable

Van Damme Tour Grade Classic XKE Starquid microphone cable (priced per metre)



- Microphone level signals in electrically harsh environments; particularly in outside broadcasts and the film industry
- Also suitable for line level analogue balanced audio and particularly recommended for longer runs
- Precise cable geometry and starquid construction for excellent rejection of radio frequency and electromagnetic interference (RFI and EMI)
- Starquid colour coding - white & white (+ve phase) with blue & blue (-ve phase) opposing; pairs should be terminated as above
- Available in blue and black colours
- 98% optical coverage braided screen for exceptional mechanical strength
- Combination of silver plated and plain ultra pure oxygen free copper conductors for unsurpassed sound quality

Van Damme Tour Grade Classic XKE Starquid is specified for individual microphone level analogue audio signals in areas of high electronic interference. Ideal for outside broadcast microphones and any microphone used in areas that may be subject to EMI and RFI - for example in close proximity to lighting dimmer circuits and major power feeds. This cable combines electrical integrity with mechanical strength without compromising flexibility.

To order the required length order the quantity you require in 1m lengths up to 100m

Order Code	Mod: 623207	Price each exc. VAT 1+ 100+	inc. VAT each
N92JT	VD Starquid Bk (1m)	£1.90 £0.95	£2.29
N93JT	VD Starquid Bl (1m)	£1.90 £0.95	£2.29

Van Damme Pro Grade Classic XKE Pro-patch cable (priced per metre)



- For microphone and line level analogue balanced audio
- Bantam patch cords and bantam adaptor cables
- Shorter mic cables and XLR splitter cables
- Midi leads and other DIN connector applications
- Further improved outer jacket ensures cable remains flexible in sub zero temperatures

- Tightly packed cotton fillers ensure no static build up and even capacitance
- Available in Black and Blue colours.
- From 1m to 100m lengths available
- 95% optical coverage braided screen for excellent mechanical strength and EMI/RFI rejection
- Combination of silver plated and plain ultra pure oxygen free copper conductors for unsurpassed sound quality

Van Damme Pro Grade Classic XKE Pro-patch cable has been specifically designed as a 4.85mm overall diameter cable to suit Neutrik and Switchcraft bantam jacks, and other applications requiring a lower OD cable. Its braided screen and tightly packed construction ensure that the smaller size in no way compromises the mechanical and sonic integrity.

To order the required length order the quantity you require in 1m lengths up to 100m

Order Code	Mod: 623210	Price each exc. VAT 1+ 100+	inc. VAT each
N94JT	VD Pro-Patch Bk (1m)	£1.57 £0.78	£1.89
N95JT	VD Pro-Patch Bl (1m)	£1.57 £0.78	£1.89

Van Damme Pro Grade Classic XKE 1 pair install cable (priced per metre)



- For mic and line level analogue balanced audio
- Internal rack and patch panel wiring looms
- Installations not requiring LSZH jacket materials
- Adaptor leads and multipin breakouts
- Foil screen bonded to the outer jacket for a one strip operation when preparing
- Available in Black and Blue colours
- Available in lengths from 1m to 100m
- 24AWG tinned drain wire in close contact to the aluminium/polyester FEF screen
- Combination of silver plated and plain ultra pure oxygen free copper conductors for unsurpassed sound quality

Van Damme Pro Grade Classic XKE 1 pair install cable is a foil screened twisted pair for installation and rack wiring. Tough, flexible and very easy to prepare as the foil screen is bonded to the outer jacket, this cable type is also useful for 'bodge leads', adaptor cables and multipin breakouts where individual tails need to be colour identified or are to be permanently installed.

To order the required length order the quantity you require in 1m lengths up to 100m

Order Code	Mod: 623211	Price each exc. VAT 1+ 100+	inc. VAT each
N96JT	VD Pair Inst Bk (1m)	£0.74 £0.37	£0.89
N97JT	VD Pair Inst Bl (1m)	£0.74 £0.37	£0.89

Van Damme Pro Grade Classic XKE instrument cable (priced per metre)



- Guitar cables
- Keyboard and sound module cables
- Hi-Fi interconnects
- Low noise and high flexibility for on stage use
- Available in Black and Blue colours
- Available in 1m to 100m lengths
- Dual thermoplastic/lapped copper screens for excellent noise rejection
- Ultra pure oxygen free copper for outstanding sonic integrity

Van Damme Pro Grade Classic XKE Instrument Cable is a relatively low capacitance unbalanced audio cable for use with guitars, keyboards and other unbalanced output devices. Its tight construction and dual screens of

conductive thermoplastic and close lapped copper ensure noise free handling and excellent noise rejection making this cable ideal for on stage use.

To order the required length order the quantity you require in 1m lengths up to 100m

Order Code	Mod: 623340	Price each exc. VAT 1+ 100+	inc. VAT each
N98JT	VD Inst Cbl BK (1m)	£1.40 £0.70	£1.69
N99JT	VD Inst Cbl BL (1m)	£1.40 £0.70	£1.69

Van Damme Pro Grade Classic XKE 1 pair install cable (priced per metre)



- For microphone and line level analogue balanced audio
- Ideal for internal rack and patch panel wiring looms or installations not requiring LSZH jacket materials
- Can also be used for adaptor cables and multi-pin breakouts
- Combination of silver plated and plain ultra pure oxygen free copper conductors for unsurpassed sound quality
- Foil screen bonded to the outer jacket for a one strip operation when preparing
- 24 AWG tinned drain wire in close contact to the aluminium/polyester FEF screen
- Available in brown, green, grey, orange, purple, red, white and yellow

Van Damme Pro Grade Classic XKE 1 pair install cable is a foil screened twisted pair for installation and rack wiring. Tough, flexible and very easy to prepare as the foil screen is bonded to the outer jacket, this cable type is also useful for adaptor cables and multi-pin breakouts where individual tails need to be colour identified or are to be permanently installed.

Order Code	Mod: 1033693	Price each exc. VAT 1+ 10+	inc. VAT each
N77DL	VD 1 Pair Red (1m)	£0.77 £0.74	£0.93
N78DL	VD 1 Pair Grn (1m)	£0.77 £0.74	£0.93
N79DL	VD 1 Pair Gry (1m)	£0.77 £0.74	£0.93
N80DL	VD 1 Pair Yel (1m)	£0.77 £0.74	£0.93
N81DL	VD 1 Pair Wht (1m)	£0.77 £0.74	£0.93
N82DL	VD 1 Pair Org (1m)	£0.77 £0.74	£0.93
N83DL	VD 1 Pair Bwn (1m)	£0.77 £0.74	£0.93
N84DL	VD 1 Pair Prp (1m)	£0.77 £0.74	£0.93

Van Damme Pro Grade Classic XKE instrument cable (priced per metre)



- For use with guitars, keyboards, sound modules, other unbalanced output devices and Hi-Fi interconnects
- Ultra pure oxygen free copper for outstanding sonic integrity
- Low noise and high flexibility - ideal for on stage use
- Dual thermoplastic / lapped copper screens for excellent noise rejection
- Available in brown, green, grey, orange, purple, red, white and yellow
- Ideal for application or length colour coding

Van Damme Pro Grade Classic XKE Instrument Cable is a relatively low capacitance unbalanced audio cable for use with guitars, keyboards and other unbalanced output devices. Its tight construction and dual screens of conductive thermoplastic and close lapped copper ensure noise free handling and excellent noise rejection making this cable ideal for on stage use.

Order Code	Mod: 1033694	Price each exc. VAT 1+ 10+	inc. VAT each
N92DL	VD Inst XKE Gry (1m)	£1.32 £1.24	£1.59
N91DL	VD Inst XKE Bwn (1m)	£1.32 £1.40	£1.59
N90DL	VD Inst XKE Prp (1m)	£1.32 £1.24	£1.59
N89DL	VD Inst XKE Org (1m)	£1.32 £1.24	£1.59
N88DL	VD Inst XKE Wht (1m)	£1.32 £1.24	£1.59
N87DL	VD Inst XKE Yel (1m)	£1.32 £1.24	£1.59
N86DL	VD Inst XKE Grn (1m)	£1.32 £1.24	£1.59
N85DL	VD Inst XKE Red (1m)	£1.32 £1.24	£1.59

Van Damme Pro Grade Classic XKE pro-patch cable (priced per metre)



- For microphone and line level analogue balanced audio
- Ideal for bantam patch cords and bantam adapter cables, shorter microphone cables and XLR splitter cables
- Can also be used for Midi cables and other DIN connector applications
- Combination of silver plated and plain ultra pure oxygen free copper conductors for unsurpassed sound quality
- 95% optical coverage braided screen for excellent mechanical strength and EMI/RFI rejection
- Tightly packed cotton fillers ensure no static build up and even capacitance
- Available in brown, green, grey, orange, purple, red, white and yellow

Van Damme Pro Grade Classic XKE Pro-patch cable has been specifically designed as a 4.85mm overall diameter cable to suit Neutrik and Switchcraft bantam jacks, and other applications requiring a lower overall diameter cable. Its braided screen and tightly packed construction ensure that the smaller size in no way compromises the mechanical and sonic integrity.

Order Code	Mod:	1033695	Price each exc. VAT	inc. VAT each
			1+	10+
N69DL	VD Pat Red (1m)		£1.65	£1.49
N70DL	VD Pat Grn (1m)		£1.65	£1.49
N71DL	VD Pat Yel (1m)		£1.65	£1.49
N72DL	VD Pat Gry (1m)		£1.65	£1.49
N73DL	VD Pat Wht (1m)		£1.65	£1.49
N74DL	VD Pat Org (1m)		£1.65	£1.49
N75DL	VD Pat Blw (1m)		£1.65	£1.49
N76DL	VD Pat Ppp (1m)		£1.65	£1.49

Van Damme Tour Grade Classic XKE microphone cable (priced per metre)



- For microphone and line level analogue balanced audio
- Ideal for onstage use
- Combination of silver plated and plain ultra pure oxygen free copper conductors for unsurpassed sound quality
- Close lapped copper screen for the best compromise between effective shielding and flexibility
- Tightly packed cotton fillers ensure no static build up and even capacitance
- Available in

Van Damme Tour Grade Classic XKE Microphone cable combines flexibility, durability, noiseless operation and excellent handling characteristics. Now features enhanced PVC jacketing materials, Van Damme microphone cables can be found in film and recording studios, high street music shops, professional touring applications and the education sector.

Order Code	Mod:	1033696	Price each exc. VAT	inc. VAT each
			1+	10+
N61DL	VD Mic Red (1m)		£1.70	£1.57
N62DL	VD Mic Grn (1m)		£1.70	£1.57
N63DL	VD Mic Gry (1m)		£1.70	£1.57
N64DL	VD Mic Yel (1m)		£1.70	£1.57
N65DL	VD Mic Wht (1m)		£1.70	£1.57
N66DL	VD Mic Org (1m)		£1.70	£1.57
N67DL	VD Mic Bwn (1m)		£1.70	£1.57
N68DL	VD Mic Ppp (1m)		£1.70	£1.57

Van Damme Tour Grade Classic XKE starquad microphone cable (priced per metre)



- For microphone level signals in electrically harsh environments
- Also suitable for analogue level balanced audio, particularly recommended for longer runs
- Starquad colour coding - white & white (+ve phase) with blue & blue (-ve phase) opposing
- 98% optical coverage braided screen for exceptional mechanical strength
- Combination of silver plated and plain ultra pure oxygen free copper conductors for unsurpassed sound quality
- Available in brown, green, grey, orange, purple, red, white and yellow

Van Damme Tour Grade Classic XKE Starquad is specified for individual microphone level analogue audio signals in areas of high electronic interference. Ideal for outside broadcast microphones and any microphone used in areas that may be subject to EMI and RFI - for example in close proximity to lighting dimmer circuits and major power feeds. This cable combines electrical integrity with mechanical strength without compromising flexibility.

Order Code	Mod:	1033697	Price each exc. VAT	inc. VAT each
			1+	10+
N01DM	VD Quad Pro (1m)		£2.12	£1.99
N99DL	VD Quad XKE Bwn (1m)		£2.12	£1.99
N98DL	VD Quad XKE Org (1m)		£2.12	£1.99
N97DL	VD Quad XKE Wht (1m)		£2.12	£1.99
N96DL	VD Quad XKE Yel (1m)		£2.12	£1.99
N95DL	VD Quad XKE Gry (1m)		£2.12	£1.99
N94DL	VD Quad XKE Grn (1m)		£2.12	£1.99
N93DL	VD Quad XKE Red (1m)		£2.12	£1.99

Single-Core Dual Screened Cable (priced per metre)



Ideal for use in guitar leads and instrument cables because of its extra-flexibility and special dual screening. This is a single screened cable which has 20 x 0.12mm copper conductors with PVC insulation, a special semiconducting screen layer, a lapped copper screen and two layers of PVC outer insulation [outer black].

Purchasing information and Reel deal

This product is sold in units of 1 metre, up to a maximum length in 1 piece of 100 metres. Orders placed for a quantity of 100 units, or multiples of 100 units will be supplied on a reel, otherwise the cable will be supplied cut to length.

Specifications:

Overall diameter: 6mm
Nom. conductor area: 0.23mm²
Capacitance (core to screen): 135pF/m

Order Code	Mod:	000123	Price each exc. VAT	inc. VAT each
			1+	100+
XS24B	Single Scrn (1m)		£1.74	£0.87

Bandridge Microphone Cable Stereo Double Shielded Black (priced per metre)



- Double-shielded stereo microphone cable for custom lengths shielding for interference free-sound
- 99.96% OFC conductor for crystal-clear sound
- Air foam PE insulation layer for purest sound transmission
- Heavy-duty PVC Jacket

Purchasing information and Reel deal

This product is sold in units of 1 metre, up to a maximum length in 1 piece of 100 metres. Orders placed for a

quantity of 100 units, or multiples of 100 units will be supplied on a reel, otherwise the cable will be supplied cut to length.

Specifications:

Conductors: 2
Stranded: 2 x 45 x 0.10 OFC
Screening: 1 Foil + Braided
Sheath: Black
Overall dimensions: 6.3mm
Plug type: XLR

Order Code	Mod:	098022	Price each exc. VAT	inc. VAT each
			1+	100+
N96CK	6.3mm Mic Cable (1m)		£1.90	£0.95

Mains Wiring Cable

Oval 2-Core 3A Mains Cable 2192Y (priced per metre)



- To BS6500 1990 Table 15
- 2-core mains cable with double insulation
- Suitable for low power use, lighting etc
- Stranded core, 2 x 16/0.2mm copper conductors
- Brown and blue PVC sheath

This product is sold in units of 1 metre, up to a maximum length in 1 piece of 100 metres. Orders placed for a quantity of 100 units, or multiples of 100 units will be supplied on a reel, otherwise the cable will be supplied cut to length. To place an order for this product, order the Maplin order code multiplied by the total number of units you require.

Specifications:

Sheath: PVC
Overall size: 5.4 x 3.4mm
Nom. conductor area: 0.5mm²
Max. current: 3A
Colours: Black or white

Order Code	Mod:	000080	Price each exc. VAT	inc. VAT each
			1+	100+
XR47B	2Core 3A Flt Bk (1m)		£0.82	£0.41
XR00A	2Core 3A Flt Wht (1m)		£0.82	£0.41

Round 2-Core 3A Mains Cable 2182Y (priced per metre)



To BS6500 1990 Table 15

A 2-core flexible mains cable with double insulation suitable for low power use such as lighting, etc. Stranded copper conductors in blue and brown PVC sheath in a round profile overall PVC sheath.

Specifications:

Sheath: PVC
Nom. conductor area: 0.5mm²
Max. current: 3A
Colours: Black or white

This product is sold in units of 1 metre, up to a maximum length in 1 piece of 100 metres.

Orders placed for a quantity of 100 units, or multiples of 100 units will be supplied on a reel, otherwise the cable will be supplied cut to length.

To place an order for this product, order the Maplin order code times the total number of units you require.

Order Code	Mod:	023087	Price each exc. VAT	inc. VAT each
			1+	100+
XS91Y	2Core 3ARnd Bk (1m)		£1.07	£0.53
XS90X	2Core 3ARnd Wht (1m)		£1.07	£0.53

3-Core 3A Mains Cable 2183Y (priced per metre)



To BS6500 1990 Table 15
A 3-core mains cable ideal for equipment having power ratings up to 750W. Stranded core, three 16/0.2mm copper conductors with brown, blue and green/yellow PVC sheaths in an overall round PVC sheath.

Specifications:

Sheath PVC
Overall Dia: 5.6mm
Nom. Conductor Area: 0.5mm²
Max. Current 3A
Colours: Black or white

This product is sold in units of 1 metre, up to a maximum length in 1 piece of 50 metres

Orders placed for a quantity of 50 units, or multiples of 50 units will be supplied on a reel, otherwise the cable will be supplied cut to length

To place an order for this product, order the Maplin order code times the total number of units you require

Order Code	Mod: 000096	Price each exc. VAT		inc. VAT each
		1+	50+	
XR01B	3Core 3A Black (1m)	£1.15	£0.57	£1.39
XR02C	3Core 3A White (1m)	£1.15	£0.57	£1.39

2-Core 6A Mains Cable 3182Y (priced per metre)



To BS6500 1990 Table 16
A 2-core mains cable with double insulation suitable for use with medium power double insulated appliances. Stranded core, two 24/0.2mm copper conductors with brown and blue PVC sheaths in an overall round PVC sheath.

Specifications:

Sheath PVC
Overall diameter 6.5mm
Nom. conductor area: 0.75mm²
Max. current 6A
Colours: Black or white

This product is sold in units of 1 metre, up to a maximum length in 1 piece of 50 metres

Orders placed for a quantity of 50 units, or multiples of 50 units will be supplied on a reel, otherwise the cable will be supplied cut to length.

To place an order for this product, order the Maplin order code times the total number of units you require.

Order Code	Mod: 000083	Price each exc. VAT		inc. VAT each
		1+	50+	
XR62S	2-Core 6A White (1m)	£1.24	£0.62	£1.49
CW69A	2-Core 6A Black (1m)	£1.24	£0.62	£1.49

3-Core 6A Mains Cable 3183Y (priced per metre)



To BS6500 1990 Table 16
A three-core mains cable with a thick outer sheath. Stranded core, three 24/0.2mm copper conductors with brown, blue and green/yellow PVC sheaths in an overall round PVC sheath.

Specifications:

Sheath PVC
Overall dia.: 6.9mm
Nom. conductor area: 0.75mm²
Max. current 6A
Colours: Black or white

This product is sold in units of 1 metre, up to a maximum length in 1 piece of 100 metres. Orders placed for a quantity of 100 units, or multiples of 100 units will be supplied on a reel; otherwise the cable will be supplied cut to length. To place an order for this product, order the Maplin order code times the total number of units you require

Order Code	Mod: 000203	Price each exc. VAT		inc. VAT each
		1+	100+	
XR03D	3Core 6A Black (1m)	£1.32	£0.66	£1.59
XR04E	3Core 6A White (1m)	£1.32	£0.66	£1.59

3-Core 13A Mains Cable 3183Y (priced per metre)



To BS6500 1990 Table 16
A 3-core mains cable with a thick outer sheath available also in orange for added safety when used as a trailing lead, e.g. on power tools. Stranded core, three 40/0.2mm copper conductors with brown, blue and green/yellow PVC sheaths in an overall round PVC sheath

Specifications:

Sheath PVC
Overall diameter 7.5mm
Nom. conductor area: 1.25mm²
Max. current 13A
Colours: Black, white or orange

This product is sold in units of 1 metre, up to a maximum length in 1 piece of 100 metres

Orders placed for a quantity of 100 units, or multiples of 100 units will be supplied on a reel, otherwise the cable will be supplied cut to length

To place an order for this product, order the Maplin order code times the total number of units you require

Order Code	Mod: 000098	Price each exc. VAT		inc. VAT each
		1+	100+	
XR09K	3Core 13A Black (1m)	£1.49	£0.74	£1.79
XR10L	3Core 13A White (1m)	£1.49	£0.74	£1.79
XR11M	3Core 13A Orange (1m)	£1.49	£0.74	£1.79

Twin and Earth 6242Y cable (priced per metre)



BASEC approved standard house-wiring cable with a grey PVC outer sheath. Product supplied will conform with the new EU wide harmonised colour coding:

Sheath: Grey
Live: Brown
Neutral: Blue
Earth: No colour/bare wire

Conductor Area	Overall Size [mm]	Max Current Use	
		[Surface]	[enclosed]
1.0mm ²	7.5 x 4	15A	11A lighting
1.5mm ²	8.5 x 4.75	20A	14.5A fused spur
2.5mm ²	9.5 x 5.25	27A	19.5A ring mains
6.0mm ²	14 x 7.5	47A	34A cooker/showers

This product is sold in units of 1 metre, up to a maximum length in 1 piece of 50 metres

Orders placed for a quantity of 50 units, or multiples of 50 units will be supplied on a reel; otherwise the cable will be supplied cut to length

To place an order for this product, order the Maplin order code times the total number of units you require

Order Code	Mod: 000109	Price each exc. VAT		inc. VAT each
		1+	50+	
L25BQ	1mm T&E Cable (1m)	£0.82	£0.40	£0.99
L26BQ	1.5mm T&E Cable (1m)	£0.82	£0.40	£0.99
L27BQ	2.5mm T&E Cable (1m)	£1.40	£0.69	£1.69

47A Mains Cable Grey (priced per metre)



To BS6004. A rigid stranded 6mm 2 wire for earth bending applications. Sold in 1m lengths up to 50m for a reel.

Purchasing information and Reel deal

This product is sold in units of 1 metre, up to a maximum length in 1 piece of 50 metres. Orders placed for a quantity of 50 units, or multiples of 50 units will be supplied on a reel, otherwise the cable will be supplied cut to length.

Specifications:

Stranding: 7/1.0
Overall dia: 5.4mm

Nom. conductor area	6mm 2
Maximum current surface	47A [surface] 31A [enclosed]
Voltage rating:	450/750V
Sheath:	1.0mm PVC

Order Code	Mod: 000115	Price each exc. VAT		inc. VAT each
		1+	50+	
VK60Q	Earth Wire 6mm (1m)	£1.65	£0.82	£1.99

Cable Management Cable Protector

Vulcascot Cable Protectors



- Fire retardant to BS 476 Part 7 Class 3 and European equivalent DIN 4102 Part 1 and Class B1
- Low smoke, non toxic and a low fume emission level in the event of fire
- Tested for non conductivity to BS903-C5, 500V
- UV stabilised for extended life
- Available in black or grey
- Available in 1 M, 3 M and 4.5 M lengths

Features a unique membrane located in the base for safe yet simple application. "Snap" open, push in the cables and lay the protection on the floor.

Snap Fit is the ideal cable protector for all types of cables and leads found in offices, shops, laboratories, exhibitions etc

Order Code	Colour	Length
A15QY	Black	1 m
A35QY	Black	3 m
A36QY	Black	1 m
A37QY	Black	3m
A38QY	Black	1 m
A39QY	Black	3 m
A40QY	Grey	1 m
A41QY	Grey	3 m
A42QY	Black	1 m
A43QY	Black	3 m
A44QY	Black	3 m
A45QY	Black	4.5 m

Order Code	Mod: 1033676	Price each exc. VAT		inc. VAT each
		1+	50+	
A45QY	MCP/2 Black 4.5m	£83.32		£99.99
A44QY	MCP/2 Black 3m	£58.32		£69.99
A43QY	MCP/1 Black 3m	£49.99		£59.99
A42QY	MCP/1 Black 1m	£16.65		£19.99
A41QY	Type K Grey 3m	£24.99		£29.99
A40QY	Type K Grey 1m	£10.82		£12.99
A39QY	BNC/2 Black 3m	£41.65		£49.99
A38QY	BNC/2 Black 1m	£14.99		£17.99
A37QY	Type B Black 3m	£37.49		£44.99
A36QY	Type B Black 1m	£13.32		£15.99
A35QY	Standard Black 3m	£31.65		£37.99
A15QY	Standard Black 1m	£10.82		£12.99

Cable Wrap

Cable Zip Tidy



- Tidies up unsightly cables in seconds
- Easy to remove and re-use
- Can be trimmed to the required length
- Available in black or grey
- Will hold up to 6 cables

This is the easiest to use cable management product ever! Simply gather the cables together and attach the special zip clip tool. Feed the cable zip on to the zip clip and slide the clip along the length of the wires. The cable zip is easy to remove and can be re-used. It is supplied in lengths of 1.5m and includes the special zip clip tool. Available in black or grey.

Order Code	Mod: 031844	Price each exc. VAT		inc. VAT each
		1+	5+	
RS62S	Cable Zip Black	£5.65	£4.52	£6.79
RS63T	Cable Zip Grey	£5.65	£4.52	£6.79

Spiral Cable Wrap



An expandable spiral binding that simply wraps around cables to create a cable form. Manufactured from natural coloured polythene (PE) in a range of sizes to suit almost any number of cables in a bundle. Fix ends with a cable tie and spiral around wire bundles in a clockwise direction, leading out wires as necessary. The following table shows: the unexpanded outer diameter (D), the pitch between lead out points (W) and the range of diameters of cable form that can be accommodated by each type:

Code	D	W	Wrapping range
SJ26D	3mm	4.7mm	1.5 - 10mm
SJ27E	8mm	12mm	6 - 30mm
SJ28F	12mm	15mm	9 - 32mm
SJ29G	19mm	19.2mm	15 - 50mm
SJ30H	24mm	21.5mm	20 - 100mm

Order Code	Mod: 026849	Price each exc. VAT 1+		inc. VAT each 5+
SJ26D	3mm Spiral Wrap 10m	£2.24	£1.79	£2.49
SJ27E	8mm Spiral Wrap 10m	£3.15	£2.52	£3.79
SJ28F	12mm Spiral Wrap 10m	£4.32	£3.46	£5.19
SJ29G	19mm Spiral Wrap 10m	£7.07	£5.66	£8.49
SJ30H	24mm Spiral Wrap 10m	£9.15	£7.32	£10.99

Conduit & Trunking

Slim Discreet Flat Screen Cable Management Solution

- A best selling solution for concealing wiring for wall-mounted TV installations
- Easy to add or remove cables
- Saves recessing walls or redecorating
- Self-adhesive backing
- Stylish appearance
- Patented hinged & click-lock lid
- Can be painted
- Contains: 1 x 1.5 metre length of 50mm width, 25mm height cable trunking
- Semi-circular profile
- Available in white or magnolia

D-Line 50x25 profile is ideal for straight drops only, accepting scart and power leads between the table and the TV. This profile is universally popular as it neatly complements both small and wider screens.

Order Code	Mod: 1035425	Price each exc. VAT 1+		inc. VAT each 5+
N80FK	Slim LCD Cbl Mgt Mag	£12.49		£14.99
N79FK	Slim LCD Cbl Mngt Wh	£12.49		£14.99

Trunking Accessory Pack for Slim LCD



- Accessories to be used with N79FK/N80FK
- Provides smooth flush finish
- Can be painted
- Pack includes:
 - 1 Equal Tee
 - 2 End Caps

- Available in white or magnolia

D-Line 50x25 profile is ideal for straight drops only, accepting scart and power leads between the table and the TV. This profile is universally popular as it neatly complements both small and wider screens

Order Code	Mod: 1035427	Price each exc. VAT 1+		inc. VAT each 5+
N52JY	TV Trunking PK2 Mag	£3.74		£4.49
N50JY	TV Trunking PK2 WH	£4.15		£4.99
N51JY	TV Trunking PK1 Mag	£4.99		£5.99

Wide Discreet Flat-Screen Cable Management Solution



- A best selling solution for concealing wiring for wall-mounted TV installations
- Larger profile for extra cable capacity
- Easy to add or remove cables
- Saves recessing walls or redecorating
- Self-adhesive backing
- Stylish appearance
- Hinged and click-lock lid for easy installation
- Simple to cut PVC profile
- Can accept paint
- Contains: 1.5 metre length of 60mm width, 30mm height cable trunking
- Semi-circular profile
- Flush accessories available including radius flat bend and inlet/outlet pieces (order code: N89FK)

Order Code	Mod: 1035429	Price each exc. VAT 1+		inc. VAT each 5+
N83FK	Wide LCD Cbl Mgt Sil	£14.99		£17.99
N82FK	Wide LCD Cbl Mgt Mag	£14.99		£17.99
N81FK	Wide LCD Cbl Mgt Wht	£14.99		£17.99

Trunking Accessory Pack for Wide LCD



- Contents: radius flat bend, 2 x break out couplers, slice coupler, 2 x end caps
- Available in white or magnolia

Order Code	Mod: 1035433	Price each exc. VAT 1+		inc. VAT each 5+
N89FK	60x30 Acc Pack White	£7.49		£8.99
N90FK	60x30 Acc Pk Magnolia	£6.65		£7.99

Maplin TV

Home of innovation,
handy tips and
How To videos

Visit our
channel...

[youtube.com/maplintv](https://www.youtube.com/maplintv)



1/4 Size Decorative Discreet Cable Management Solution



- Quick and easy to fix
- Blends with white skirting
- Shock-absorbing lid
- Self-adhesive backing
- 2 x 1.5 metre lengths of 22mm width, 22mm height cable trunking
- Hinged and click-lock lid
- Simple to cut PVC profile
- Flush fit accessories available, no need to mitre corners - accessory pack order code: N87FK
- Available in white or wood effect

D-Line 22/22 quadrants are designed to be fitted at floor level or along work tops and are ideal for hiding cables around floors or across benches.

Order Code	Mod: 1035435	Price each exc. VAT 1+		inc. VAT each 5+
N78FK	Floor Cable Mgt Wood	£11.65		£13.99
N77FK	Floor Cbl Mgt White	£12.49		£14.99

1/4 Size Cable Trunking Accessory Pack



- Accessories to use with N77FK/N78FK
- Provides smooth flush finish
- Pack Includes:
 - 1 Internal / Flat Bends
 - 2 External Bends
 - 1 Cable Outlets
 - 1 Cable Inlet
 - 1 Connector
 - 2 End Caps (1 left & 1 right)
- Available in white or wood

D-Line 22/22 quadrants are designed to be fitted at floor level or along work tops and are ideal for hiding cables around floors or across benches.

Order Code	Mod: 1035437	Price each exc. VAT 1+		inc. VAT each 5+
N64JY	Sphere Trunking Accs	£4.15		£4.99
N88FK	22x22 Acc Pk Brown	£5.40		£6.49
N87FK	22x22 Acc Pack White	£5.40		£6.49

White Skirting Board Cable Management Solution



Stick On Cable Management Ties 10 Pack



- Arrange and organise audio, TV and computer cables in an instant
- Releasable design allows cables to be removed
- Double sided adhesive pads supplied for easy fixing
- Supplied in a pack of ten

Order Code	Mod.	Price each exc. VAT	inc. VAT each
N68GN	Stick On Cable Mngr	£2.65	£3.19

Cable Tie Kit 100mm to 280mm 650 Pack



A useful selection of cable ties in a sturdy storage canister. Kit comprises 650 ties: 300 are 100mm ties, with 100 in natural and 50 each in red, yellow, blue and green; 300 are 203mm; and 50 are 280mm both natural. All cable ties are manufactured in nylon 66 to UL94V-2, temperature range -40°C to 105°C

Length	Width	Max dia.	Max load
100mm	2.5mm	25mm	8kg

Order Code	Mod.	Price each exc. VAT	inc. VAT each
NL19V	650pc Cable Tie Kit	£8.32	£9.99

Cable Tie Kit 100mm to 280mm 850 Pack



A useful selection of cable ties in a sturdy storage canister. Kit comprises 850 ties: 500 are 100mm ties, with 100 in natural, red, yellow, blue and green, 300 are 203mm; and 50 are 280mm both natural. All cable ties are manufactured in nylon 66 to UL94V-2, temperature

range -40°C to 106°C.

Length	Width	Max dia.	Max load
100mm	2.5mm	25mm	8kg

Order Code	Mod.	Price each exc. VAT	inc. VAT each
NL20W	850pc Cable Tie Kit	£10.82	£12.99

Cable Tie Kit 100mm 1000 Pack



A collection of a thousand coloured cable ties in a handy portable canister. The kit comprises 100 each of 10 different coloured 100mm ties. Manufactured in nylon 66 to UL94V-2, temperature range -40°C to 105°C

Order Code	Mod.	Price each exc. VAT	inc. VAT each
NL18U	1000pc Cable Tie Kit	£6.65	£7.99

Buying for education?
0333 400 9740



Cable Tie Bases

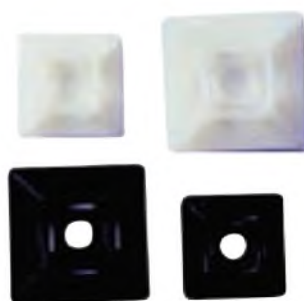

A range of black and natural cable tie fixings including two self-adhesive bases and one screw down. Manufactured from hard-wearing, UL approved nylon 66, 94V-2. The self-adhesive tie mounts are designed for lightweight wire bundles when properly applied to any clean, smooth, grease-free surface. For heavy support, these tie mounts also feature a mounting hole for a screw.

Type	Size (mm)	Max cable tie width (mm)
Small self-adhesive	21 x 21	4.7
Large self-adhesive	28 x 28	5

Order Code	Mod.	Price each exc. VAT	inc. VAT each
SJ13P	Small Base Whit 100Pk	£5.45	£6.79
SJ14Q	Small Base Blk 100Pk	£5.45	£6.79
SJ15R	Large Base Whit 100Pk	£6.45	£7.99
SJ16S	Large Base Blk 100Pk	£6.45	£7.99

Wrap Charger Cable Tidy



- Keep chargers and gadget cables organised
 - 3 pack of cable tidies
 - Can be used for storage or when charger is in use
- With the ever increasing number of portable electronic devices in our homes from mobile phones, toys and digital cameras to music players and games consoles we all now risk twin problems; what charger belongs to what? and drawer spaghetti! Introducing the Wrap Charger Cable Tidy.

Simply clip in the plug before winding the cable and clipping tight, nothing simpler. The Wrap can equally be used for storage and also while in use to simply keep tidy those long trailing cables.

Order Code	Mod.	Price each exc. VAT	inc. VAT each
A62QX	Triple Cable Wrap	£5.40	£6.49

Maplin Cable Tie Wrap 10cm



- 100 Pack of tie wraps
- Colour: Black
- Length: 10cm
- For use on cables and other products

Order Code	Mod.	Price each exc. VAT	inc. VAT each
N03CD	Black Tie Wrap 100pk	£4.32	£5.19

Maplin Cable Tie Wrap Reel



- 450m Reel
- Colour: Black
- Length: cut to length
- For use on cables and other products

Order Code	Mod.	Price each exc. VAT	inc. VAT each
N24CD	TieWraps 450m reel	£33.32	£39.99

Find out more in-store

Our staff can offer friendly and expert advice; we're here to help



Label The Cable Basic 10 Pack



- Can be opened and closed quickly – especially practical for bundling cables
- Reusable
- Two-sided hook-and-loop tape
- Dimensions: Entire length of the hook-and-loop strap is approx. 17 cm
- 10 Pack of ties available in black or white

LTC BASIC is the classic amongst our hook-and-loop straps. With its extra-strong adhesion in velour quality, it bundles any type of cables – whether they are connected to the home entertainment system or used under the desk, in the laptop case, in the workshop or in the photo or music studio. LTC BASIC also remains attached to the cable when in an opened state, which means it is not lost or misplaced. LTC BASIC is suitable for - bundling - colour-coding - all types of cables

Order Code	Mod: 1035414	Price each exc. VAT 1+	inc. VAT each
N21NY	LTC Basic 10PK Mix	£3.99	£4.79
N20NY	LTC Basic 10PK Black	£3.99	£4.79

Label The Cable Labels 16mm 5 Pack



- Attractive design
- Large label (eg for cable identification, origin, function, or even the name of the owner)
- Recess in the label area - also allows a hanging cable.
- Includes removable labels for relabeling
- Heating, cooling and lighting tested
- Dimensions: Cable ties up to a width of 16mm Fits all STC products.
- Available in black, grey, red or mixed colours

This pack of 5 LABEL will put an end to the cable chaos by unlabeled cable ties. In your home entertainment system, under the desk, in charging cables in the laptop bag, in the workshop, the photo or music studio, just wherever cables.

Because the labels are of LABEL THE CABLE all cable ties up to a width of 16mm quickly and easily labelled and neatly arranged and permanently.

Order Code	Mod: 1035418	Price each exc. VAT 1+	inc. VAT each
N57NL	LTC Label 5pk mixed	£3.99	£4.79
N54NL	LTC Label 5pk red	£3.74	£4.49
N55NL	LTC Label 5pk grey	£3.74	£4.49
N53NL	LTC Label 5pk black	£3.74	£4.49

Send direct

If any product is not in stock, we will order it for you and send it with free delivery

Terms and conditions apply.



Label The Cable Basic and Label 170mm 5 Pack



- 5 hook and loop ties loose with 5 different coloured labels for marking
- 5 Major labels (eg for cable identification, origin, function, or even the name of the owner)
- Made from a highly elastic material for space saving wrapped around the cable and is also suitable for sensitive surfaces.
- LTC BASIC is quickly opened and closed - reusable and especially useful for cables and devices of all kinds
- Recess in the label - also allows a hanging cable.
- Black hook and loop with different coloured plastic labels (TPE), 2 black, 1 red, 1 x grey, 1 x semi-transparent / nature
- Heating, cooling and lighting tested
- Dimensions: Length 17 cm hook and loop ties
- Available in black or white

With LABEL THE CABLE BASIC LABELS hook and loop straps you can put an end to the cable chaos. In your home entertainment system, under the desk, in charging cables in the laptop bag, in the workshop, the photo or music studio, just wherever cables. LTC with BASIC and LABELS you can bundle and label everything that is too long or quickly knotted cables up to ropes. You can also simply hold together what belongs together, in devices for consumer electronics as well as in sports or camping equipment. The application possibilities are endless.

Order Code	Mod: 1035416	Price each exc. VAT 1+	inc. VAT each
N44NL	LTC Basic Label Wht	£6.24	£7.49
N43NL	LTC Basic Label Blk	£6.65	£7.99

Technical Helpline

0333 400 9500

For technical information and assistance relating to any Maplin purchase, contact our team of experts



Label The Cable Mini 90mm 10 Pack



- Small and unobtrusive
- Particularly suitable for the cable labelling in cupboards or behind appliances in home entertainment or office
- Ideal for headphone or charger
- Reusable and especially useful for thin cables
- Including cardboard labels for labelling
- Black hook and loop strap with white label and plastic insert
- Dimensions: Overall length 9 cm, width about 1.1 cm hook and loop, label size 3 cm * 1.8 cm
- Weight: 2 g

Arrange with LABEL THE CABLE MINI hook and loop ties and label all cables clear and bundle them up to a diameter of about 2 cm. LTC MINI is particularly suitable for the identification of cables and connectors in cabinets or behind all devices in home entertainment or office. Solves the "who's who" in the cable mess! Also ideal for orderly storage of headphones or charging cables.

Order Code	Mod: 1035420	Price each exc. VAT 1+	inc. VAT each
N47NL	LTC Mini 10pk Mix	£5.40	£6.49
N45NL	LTC Mini 10pk Blk	£5.40	£6.49

Label The Cable Wall Cable Tidy 10 Pack



- 10 self-adhesive hook and loop wall-mount
- LTC WALL is quickly opened and closed
- Partly self-adhesive strap
- Measurements: Total length about 9 cm hook and loop holder, adhesive surface 3 cm x 3.3 cm
- Available in black or white

With LABEL THE CABLE WALL self-adhesive hook and loop wall brackets, you put an end to the cable chaos. Run your cables across and around furniture with a crisp,

clean appearance, safe from snagging or catching.

Order Code	Mod: 1033692	Price each exc. VAT	inc. VAT each
N59NL	LTC Wall 10pk white	£3.49	£4.19
N58NL	LTC Wall 10pk black	£3.49	£4.19

Label The Cable Roll 3m Black 1 Pack



- Double-sided hook and loop tape
- Individual hook and loop length for individual needs and various cables or devices
- LTC ROLL is quickly opened and closed
- Reusable and especially useful for cables and devices of various sizes. Heating, cooling and lighting tested
- Dimensions: Overall length hook and loop about 3 m, width 16mm

With LABEL THE CABLE ROLL hook and loop roll to put an end to the cable chaos. For your home entertainment system, under the desk, your charging in your laptop bag, in the workshop, the photo or music studio, just wherever cables.

With this roll, you determine the length of your cable tie for use in the house, in the office, in the music studio or workshop. You just need a pair of scissors and you can bundle all those long cables together. You can also simply hold together what belongs together, in devices for consumer electronics as well as in sports or camping equipment. The application possibilities are endless.

Order Code	Mod: 676438	Price each exc. VAT	inc. VAT each
N39NL	LTC Roll 3m roll blk	£5.40	£6.49

Label The Cable Rolls 4x1m Cable Ties 1 Pack



- Two-sided hook-and-loop tape
- Velour quality
- Strong adhesion
- Individual hook-and-loop lengths for individual needs

- Reusable and especially practical for cables and devices of different sizes
- Dimensions: Entire length of the hook-and-loop tape is approx. 4 x 1 m, width is 16 mm

With LTC ROLLS you can make hook-and-loop fasteners of any length – whether for use in the home, office, music studio, workshop, for sports, in the garden or even when camping. The two-sided hook-and-loop in velour quality offers extra-strength adhesion for individual applications. Colour-Coding is also possible. The LTC ROLLS is suitable for - binding - colour-coding - all types of cables

Order Code	Mod: 785703	Price each exc. VAT	inc. VAT each
N22NY	LTC Rolls Mixed 4x1m	£5.40	£6.49

Label The Cable Sticker 10 Pack



- Extra strong and fast adhesion
- Particularly stable
- The LABEL should be dry and free of dust before the label is attached
- Can be removed and reapplied

10 replacement labels for original LABEL THE CABLE cable tie. The labels are particularly stable and extra fast and highly adhesive. Of course, but they are removable. Quantity: 10 pieces

Order Code	Mod: 676535	Price each exc. VAT	inc. VAT each
N60NL	LTC Sticker 10 pack	£2.07	£2.49

Label The Cable Tube Black 2m 1 Pack



- Can be cut to length with scissors
- Subsequent attachment to cables possible
- No disconnection of devices
- Soft polyester fabric
- Self-closing
- Diameter adjusts itself (2.5 – 4 cm)
- Reusable
- Dimensions: total length about 2 m, diameter 2.5 – 4 cm

With LTC CABLE TUBE, cables are bundled faster than data flows through them. The lateral opening of the self-closing polyester fabric also makes subsequent

attachment of the cable tube possible without disconnecting the devices. LTC CABLE TUBE adjusts its diameter (2.5 – 4 cm) to the contents, and the later removal or addition of individual cables is no problem. In addition, cutting the high-quality tube to length is child's play. LTC CABLE TUBE is RoHS-compatible and has been temperature-checked from -50 to +150 °C. It is suitable for deployment in extreme locations, but is also at home in every living room. LTC CABLE TUBE is suitable for - bundling all types of cables

Order Code	Mod: 785692	Price each exc. VAT	inc. VAT each
N25NY	LTC Cable Tube	£10.82	£12.99

D-Line Cable Bases



- Hold pesky wires or earphones in place
- Peel & Stick base works with nearly any surface
- Available in Black, grey and white or neon brights

Order Code	Mod: 1033678	Price each exc. VAT	inc. VAT each
A41QX	D-Line Cblbases Col	£5.40	£6.49
A40QX	D-Line Cblbases Blk	£5.40	£6.49

Shopping with us is easy...

In-store



7 days a week, check store listings at the back of the catalogue for address details

Online



maplin.co.uk

24hrs a day, 7 days a week, 365 days a year

Phone



0333 400 9500

Phone lines open 7 days a week

Buying for business?

0333 400 9740

CONNECTORS



CONTENTS

76 - 84 Audio Connectors
 84 - 85 Loudspeaker Connectors
 86 - 87 XLR Audio
 88 - 89 DIN & Multiway Connectors
 90 - 91 Computer Connectors
 92 - 95 TV & Satellite Connectors
 96 - 99 Video & RF Connectors
 100 - 107 Power Connectors
 108 - 109 Crimp Connectors
 110 - 113 PCB Connectors

Audio Connectors

Phono Connectors

Plastic Phono Plug



A standard phono plug with a coloured plastic screw-on body. When the body is unscrewed, the threaded moulding on the plug is exposed, which is colour matched to the body. The body is of hexagonal section and includes a strain relief sleeve. Available in black, red, white, yellow, blue and green to accommodate all common applications

Order Code	Mod: 001000	Price each exc. VAT	inc. VAT each
		1+	5+
FJ89W	Phono Plug Black	£0.99	£0.79
FJ88V	Phono Plug Red	£0.99	£0.79
L75AW	Phono Plug White	£0.99	£0.79
L76AW	Phono Plug Yellow	£0.99	£0.79
L77AW	Phono Plug Blue	£0.99	£0.79
L78AW	Phono Plug Green	£0.99	£0.79

Screw Terminal Phono Plug



- A range of standard phono plugs with screw terminal fitting
- Centre conductor is secured with the screw, the

screen is held with the clamp

- Ideal when quick connections are needed or where soldering tools are not available
- Uses include audio and video applications or CCTV installers or in schools and education
- Available in red, yellow and white

Order Code	Mod: 619464	Price each exc. VAT	inc. VAT each
		1+	5+
N92LH	Solderless Phono Wht	£1.24	£0.99
N94LH	Solderless Phono Yel	£1.24	£0.99
N93LH	Solderless Phono Red	£1.24	£0.99

Maplin Plastic Right Angled Phono Plug Black



A right-angled phono plug having a black plastic body with strain relief sleeve

Order Code	Mod: 001001	Price each exc. VAT	inc. VAT each
		1+	5+
FJ74R	R/A Phono Plug	£1.32	£1.05

Metal Phono Plug



A screened phono plug with a metal barrel and coiled spring cable relief sleeve. Available with colour-coded identification bands in red and white

Order Code	Mod: 001002	Price each exc. VAT	inc. VAT each
		1+	5+
L47AW	Metal Phono Plug Red	£1.40	£1.69
HH01B	Metal Phono Plug Wht	£1.40	£1.69

Gold-Plated Phono Plug



A high quality screened phono plug having a gold-plated body and gold-plated contact surfaces for maximum contact reliability. Plug has a coiled spring relief sleeve. Available with black or red identification bands.

Order Code	Mod: 001003	Price each exc. VAT	inc. VAT each
		1+	5+
FK18U	Gold/Blk Phono Plug	£1.74	£1.39
JH94C	Gold/Red Phono Plug	£1.74	£1.39

Metal Barrel Gold-Plated Phono Plugs 7mm



- High-quality, metal-barrelled phono plug
- Gold-plated contact surfaces for minimum contact resistance and maximum reliability
- Finished in black with knurled grip rings
- 27 x 12mm diameter bodies, 20mm long coil spring strain relief
- Suitable for cables with diameters from 4mm - 7mm

A substantial tubular cable clamp will ensure cable retention. Available with white or red identifier bands around the plug body for left/right identification in stereo applications.

Order Code	Mod: 001006	Price each exc. VAT	inc. VAT each
		1+	5+
JU06G	Gold Phono P1-R-70	£2.40	£1.92
JU07H	Gold Phono P1-W-70	£2.40	£1.92



Friendly expert advice on
0333 400 9500

Neutrik NYS355 Phono To Phono Female Adapter



- Allows two male phono plugs to be connected together
- Neutrik part NYS355

Order Code	Mod: 223965	Price each exc. VAT	VAT	inc. VAT each
N26GB	HO Female Phono Cplr	£2.82	£2.26	£3.39

Gold Plated Phono Socket Splitter



- Used to split or combine phono signals
- Gold plated for clarity
- Input/output socket marked with wider bands around the body

Order Code	Mod: 218491	Price each exc. VAT	VAT	inc. VAT each
N82FA	Phono Skt Splitter	£3.65	£2.92	£4.39

Male to Male Phono Couplers



- Nickel-plated in-line phono couplers designed to connect two leads terminated in phono sockets
- Available in red and black for easy cable identification

Order Code	Mod: 218488	Price each exc. VAT	VAT	inc. VAT each
N80FA	Male Phono Cpler Red	£2.24	£1.79	£2.69
N81FA	Male Phono Cpler Blk	£2.24	£1.79	£2.69

Compact Right-Angled Phono Adaptors

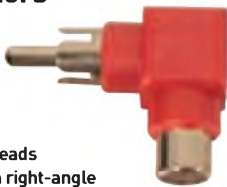

- Ideal for audio equipment close to a wall
- Allows connecting leads to be brought in at a right-angle
- Features a nickel phono plug at one end and phono socket at a 90 degree angle on the other
- Available in red and black versions for easy cable identification

Order Code	Mod: 218484	Price each exc. VAT	VAT	inc. VAT each
N76FA	R/A Phono Adptr Red	£2.24	£1.79	£2.69
N77FA	R/A Phono Adptr Blk	£2.24	£1.79	£2.69



Friendly expert advice on 0333 400 9500

Gold Plated Right Angled Phono Adapter



- Allows the connecting leads to be brought in at a right-angle.
- Ideal for equipment that is close to a wall.

Features a phono plug at one end with a phono socket at 90 degrees to it on the other

Order Code	Mod: 045774	Price each exc. VAT	VAT	inc. VAT each
L11BH	Rt-Angle Phono Adptr	£2.24	£1.79	£2.69



Browse our entire range at maplin.co.uk

Phono T Adapter



- 1 phono plug to 2 phono sockets adapter
- Nickel-plated shell
- Ideal for combining or splitting phono signals

Order Code	Mod: 218942	Price each exc. VAT	VAT	inc. VAT each
N15FB	Phono T Adaptor	£0.82		£0.99

Gold Plated Phono T Adapter



- Allows 2 phono plugs to be connected to one phono socket
- Ideal for use with stage and DJ equipment
- Gold-plated for increased clarity of sound

Order Code	Mod: 218473	Price each exc. VAT	VAT	inc. VAT each
N75FA	2 to 1 T Phono Adptr	£3.24	£2.59	£3.89

Phono Male to Two Phono Female Adapter



Allows two phono plugs to be used with one phono socket

Order Code	Mod: 001018	Price each exc. VAT	VAT	inc. VAT each
YW39N	2 to 1 Phono Adptr	£2.32		£2.79

Gold Plated 2 to 1 Phono Adapter



A high quality adapter which allows two phono plugs to be used with one phono socket.

Order Code	Mod: 034195	Price each exc. VAT	VAT	inc. VAT each
N84AN	2to1 Phono Adpr Gold	£3.07	£2.46	£3.69

Phono Plug to 3.5mm Mono Socket Adapter



Allows a 3.5mm mono jack plug to be used with a phono socket

Order Code	Mod: 001023	Price each exc. VAT	VAT	inc. VAT each
RW06G	3.5mm to Phono Adptr	£2.24	£1.79	£2.69

6.35mm Mono Socket to Phono Plug Adapter



Allows a 1/4in. (6.35mm) mono jack plug to be used with a phono socket.

Order Code	Mod: 001024	Price each exc. VAT	VAT	inc. VAT each
RW05F	6.35mmtoPhonoAdptr	£2.24	£1.79	£2.69

Gold Plated 6.35mm Mono Socket to Phono Plug Adapter



A high quality, gold-plated adapter which allows a 1/4in. (6.35mm) mono jack plug to be used with a phono socket

Order Code	Mod: 034618	Price each exc. VAT	VAT	inc. VAT each
N28AP	6.35F to PhonoM Gold	£3.07	£2.46	£3.69

2.5mm Mono Jacks

2.5mm Plastic Mono Plug



- A 2.5mm mono jack plug with plastic barrel and moulded cable strain relief

Order Code	Mod: 001126	Price each exc. VAT	VAT	inc. VAT each
JK00A	2.5 Plug Plus SR	£0.99	£0.79	£1.19

2.5mm Plastic Mono Line Socket



A 2.5mm mono line jack socket with plastic barrel and moulded cable strain relief

Order Code	Mod: 001138	Price each exc. VAT	VAT	inc. VAT each
HF79L	2.5 Line Socket	£1.15		£1.39

Buying for business?
0333 400 9740



Neutrik NL4MP 4 Pole Male Chassis Speakon Connector

- Standard 4-pole chassis connection for the popular Speakon connections
- Current rating 30 Amp continuous RMS
- Glass reinforced materials make it extremely robust
- Precise keyway for secure mating
- Accurate twist lock latching system and metal insert in locking area
- Mate with all available Speakon products
- Neutrik part NL4MP



Order Code	Mod:	Price each exc. VAT	inc. VAT each
CC730	L/S Chassis Connector	€3.40	€4.09

Neutrik NL4MMX 2 Male Speakon Coupler

A robust adapter for joining 2 male Speakon connectors



Order Code	Mod:	Price each exc. VAT	inc. VAT each
N24AJ	Speakon Coupler	€6.07	€7.29

Neutrik NA4LJX Speakon to 6.35mm Mono Jack Adapter

A robust adapter which allows a 6.35mm mono jack plug to be used with a Speakon socket



Order Code	Mod:	Price each exc. VAT	inc. VAT each
N25AJ	Speakon M - 6.35 F	€6.90	€8.29

Neutrik NLT4MP 4 Pole Male Chassis Speakon Connector

- Current rating 40A continuous, 50A audio with 50% duty cycle
- Robust and durable all metal housing
- Sealing ring provides weatherproof IP54 rating
- Reinforced metal quick lock system for ease and precise locking
- Mates with all available Speakon products
- Neutrik part NLT4MP



The new STX series is the next generation of 4 pole Speakon connectors especially designed for amplifier-loudspeaker applications in harsh and demanding environments such as professional touring. The extremely rugged and durable STX series feature an all metal housing and a built-in gasket providing weatherproof protection to IP54. The 4 pole version is now available as a gender system including male cable and female chassis connector.

Order Code	Mod:	Price each exc. VAT	inc. VAT each
N506B	4P Spkn Chassis Skt	€4.40	€5.29

Loudspeaker Terminals

Multi - Phono Sockets

Chassis mounting phono sockets fixed to paxolin panels. Fixing holes are 3.75mm diameter and the phono sockets require 8.5mm diameter cut outs, if rear-mounted. See specifications tab for the available configurations



Type	Nc. of sockets	Dimensions of mount [mm]	Fixing centres [mm]	Socket centres [mm]
Twin	2	56 x 22	48	20
Quad	4	76 x 24	65	14
2 Square	4	49 x 36	40 x 26	15 x 16
6-Way	6	65 x 36	55 x 26	15 x 16
8-Way	8	80 x 36	70 x 26	15 x 16

Order Code	Mod:	Price each exc. VAT	inc. VAT each
JK15R	Phono Socket Twin	€1.90	€2.29
BW74R	Phono Socket Quad	€2.07	€2.49
JK16S	Phono Socket 2 Square	€2.24	€2.69
JH95D	Phono Socket 6-Way	€2.07	€2.49
JK17T	Phono Socket 8-Way	€2.74	€3.29

Loudspeaker Lever Terminals

- Spring loaded lever action with quick connection terminals that will hold wires in a vice-like grip
- 2-way lever terminal on a round mounting plate has one red and one black lever marked '+' and '-', and 'INPUT'
- Overall diameter is 74mm and requires a 50mm diameter panel cut-out
- Fixing centres: 43.5 x 43.5mm x 3mm clear
- Overall depth: 28mm



Order Code	Mod:	Price each exc. VAT	inc. VAT each
JK18U	Lever Term 2-Way Rnd	€2.49	€2.99

Loudspeaker Lever Terminals

Spring loaded, lever action, quick connection terminals which will hold wires securely. These terminals, originally intended for terminating loudspeaker leads, have many uses.

The 2-way lever terminal on a rectangular mounting plate has one red and one black lever. Dimensions are 55 x 24mm with a maximum depth of 22mm. Fixing centres are 43.5mm x 3mm clear and the two solder tags are 4mm from one edge and 19mm apart.

The 4-way type has two black and two red levers on a base 70 x 24mm with a maximum depth of 22mm. Fixing centres are 58mm x 3mm clear and the four solder tags are 4mm from one edge and 13mm apart.

Order Code	Mod:	Price each exc. VAT	inc. VAT each
BW72P	Lever Term 2-Way	€2.49	€2.99
BW71N	Lever Term 4-Way	€3.32	€3.99

Maplin 2 Pin DIN Plug with Screw Connections

2-pin DIN plug, as widely used on loudspeakers,



with screw terminals

Order Code	Mod:	Price each exc. VAT	inc. VAT each
FM42V	2-Pin DIN Plug	€1.57	€1.89

Right Angled DIN 2 Pin Plug

Right-Angled 2-pin DIN plug, as widely used on loudspeakers, with screw terminals



Order Code	Mod:	Price each exc. VAT	inc. VAT each
FM40T	R/A 2-Pin DIN Plug	€1.49	€1.79

2-Pin DIN Chassis Socket

2-pin DIN socket, as found on loudspeakers, for chassis mounting



Order Code	Mod:	Price each exc. VAT	inc. VAT each
HH31J	DIN Socket 2-Pin	€1.49	€1.79

Gold-Plated Terminal Posts

Gold-plated terminal posts, one with a red and one with a black ring. Each post has a 4mm top socket and a 5mm dia hole in post. Knob size 21.5 x 11mm dia. Fits panels from 1.5mm to 20mm thick. Post shaft requires a 5mm dia. hole



Order Code	Mod:	Price each exc. VAT	inc. VAT each
N46AQ	Gold Term Post Red	€2.24	€2.69
N47AQ	Gold Term Post Black	€2.24	€2.69

Terminal Posts with Gold-Plated Contacts

Gold-plated terminal posts, one with a red and one with a black knob. Each post has a 4mm top socket and a 4mm dia. hole in the post. Knob size 16 x 15mm dia. Fits panels up to 3.5mm thick. Post shaft requires a 5mm dia. hole



Order Code	Mod:	Price each exc. VAT	inc. VAT each
N48AQ	HD Terminal Post Red	€2.07	€2.49
N49AQ	HD Terminal Post Blk	€2.07	€2.49

Twin Terminal Post

Gold-plated brass terminal posts, one with a red and one with a black knob on a twin base having one part red and one part black, so that the part on the outside of the chassis can be either red or black. Rated 10 A at 250 V. Each post has a 4 mm top socket and a 2.1 mm dia. hole in post. Knob size 16 x 15 mm dia. Fits panels from 1.2 mm dia. to 7 mm thick. Panel cut-out requires two 12.7 mm holes on 18.5 mm centres. Bezel size 35 mm x 16 mm



Order Code	Mod:	Price each exc. VAT	inc. VAT each
JK24B	Pair Terminal Posts	€2.82	€3.39

XLR Audio

XLR Connectors

3 Pin XLR Plug



Standard microphone and audio connector. Nickel-plated diecast zinc housing with silver-plated brass contacts. Self-adjusting strain-relief sleeve will prevent damage to cable sheath up to 50kg stress.

Specifications:

Current rating: 15A at 120Vac
 Contact resistance: 5mΩ max
 Overall length: 70mm
 Diameter: 19mm
 Suitable cable diameter: 4-7mm

Order Code	Mod:	Price each exc. VAT	inc. VAT each
		1+	5+
BW89W	3-Pin XLR Plug	£2.74	£3.29

Neutrik NC3MRX Right Angled XLR Male Silver



- Extra slim right-angle connector
- 5 selectable cable outlet positions
- Male connector with improved locking recess without 'window', more stringent housing increases durability
- Improved chuck type strain relief provides higher pull-out force and makes assembly easier and faster
- Boot with polyurethane gland gives high protection to cable bending stresses
- Neutrik part NC3MRX

The RX Series is the right angle version of the XX cable connector series. The successor of the RC series offers several new features which make it more reliable, easier to assemble and improves contact integrity as well cable strain relief, 3 pole right angle male cable connector, nickel housing, silver contacts

Order Code	Mod:	Price each exc. VAT	inc. VAT each
		1+	5+
N34GB	HO/R/A XLR M Slvr	£6.99	£8.39

Neutrik NC3FXX/MXX XLR Male and Female Silver Twin Pack



- A matching XLR pair, one male and female connectors are included
- Unique cage design of female contact for low contact

resistance and high integrity

- Female connector with improved solid metal latch which is larger and easier to handle
- Male connector with improved locking recess without "window", more stringent housing increases durability
- Additional ground spring contacts for better shell ground continuity
- Female contact incorporates a solder barrier to prevent solder running into the contact mating area
- Improved chuck type strain relief provides higher pull-out force and makes assembly easier and faster
- Sleek and ergonomic design - valuable and handy
- Rugged zinc diecast shell, longlasting and dependable
- Neutrik part NC3FXX+MXX

Order Code	Mod:	Price each exc. VAT	inc. VAT each
		1+	5+
N37GB	HO XLR M/XLR F Slvr	£6.07	£7.29

3 Pin XLR Line Socket



Standard microphone and audio connector. Nickel-plated diecast zinc housing with silver-plated brass contacts. Self-adjusting strain-relief sleeve will prevent damage to cable sheath up to 50kg stress

Specifications:

Current rating: 15A at 120Vac
 Contact resistance: 5mΩ max
 Overall length: 90mm
 Diameter [excluding latch release]: 19mm
 Suitable cable diameter: 4-7mm

Order Code	Mod:	Price each exc. VAT	inc. VAT each
		1+	5+
BW91Y	3-Pin XLR Line Skt	£2.74	£3.29

Neutrik NC3FRX Right Angled XLR Female Silver



- Extra slim right-angle connector
- 5 selectable cable outlet positions
- Unique cage design of female contact for low contact resistance and high integrity
- Female contact incorporates a solder barrier to prevent solder running into the contact mating area
- Female connector with improved solid metal latch which is larger and easier to handle
- Additional ground spring contacts for better shell ground continuity
- Improved chuck type strain relief provides higher pull-out force and makes assembly easier and faster
- Boot with polyurethane gland gives high protection to cable bending stresses
- Neutrik part NC3FRX

The RX Series is the right angle version of the XX cable connector series. The successor of the RC series offers several new features which make it more reliable, easier

to assemble and improves contact integrity as well cable strain relief, 3 pole right angle female cable connector, nickel housing, silver contacts

Order Code	Mod:	Price each exc. VAT	inc. VAT each
		1+	5+
N33GB	HO/R/A XLR F Slvr	£6.90	£8.29

3 Pin XLR Chassis Socket

Standard microphone and audio connector. Nickel-plated diecast zinc housing with silver-plated brass contacts.



Specifications:

Current rating: 15A at 120Vac
 Contact resistance: 5mΩ max
 Mounting hole: 19mm dia.
 Bezel: 27 x 36.5mm
 Fixing centres: 26 x 17mm x M3 countersunk
 Overall depth (excl. latch release): 37mm

Order Code	Mod:	Price each exc. VAT	inc. VAT each
		1+	5+
BW90X	3-Pin XLR Chas Skt	£2.74	£3.29

4 Pin XLR Type Plug



With the same design specifications as our standard XLR plug, this connector has 4 pins.

Order Code	Mod:	Price each exc. VAT	inc. VAT each
		1+	5+
L37AZ	4-Pin Mic Plug	£2.99	£3.59

3 Pin XLR Chassis Plug

Standard microphone and audio connector. Nickel-plated diecast zinc housing with silver-plated brass contacts.



Specifications:

Current rating: 15A at 120Vac
 Contact resistance: 5mΩ max
 Mounting hole: 19mm dia
 Bezel: 22.5 x 37mm
 Fixing centres: 27 x M3 countersunk
 Overall depth: 25mm

Order Code	Mod:	Price each exc. VAT	inc. VAT each
		1+	5+
BW92A	3-Pin XLR Chas Plug	£2.74	£3.29

Maplin TV

Home of innovation, handy tips and How To videos

[youtube.com/maplintv](https://www.youtube.com/maplintv)



USB 3.0 Plugs



- Super Speed USB connectors
- Feature a nickel-plated outer shield and strain relief fold-over clamps
- Gold-plated contacts
- Type A has the rectangular cross-section
- Type B has the squarer cross-section

Order Code	Mod:	Price each exc. VAT	inc. VAT each
	511231	1+ 5+	
N09JT	USB 3.0 A Line Plug	£1.82	£1.46
N11JT	USB 3.0 B Line Plug	£1.65	£1.49

USB 3.0 Sockets



- Super Speed USB connectors
- Feature a nickel-plated outer shield, and 9 gold-plated contacts
- Type A has the rectangular cross-section
- Type B has the square cross-section

Order Code	Mod:	Price each exc. VAT	inc. VAT each
	511233	1+ 5+	
N08JT	USB 3.0 A Socket PCB	£1.82	£1.46
N10JT	USB 3.0 B Socket PCB	£1.74	£1.56

Neutrik USB Panel Mount Socket



- Ideal for audio networking and integration of computer based equipment in to audio systems
- Reversible insert offering type A or type B on front or rear end
- Universally accepted standard D-shape housing
- Neutrik part number: NAUSB -W

Order Code	Mod:	Price each exc. VAT	inc. VAT each
	219901	1+ 5+	
N57FL	USB Panel Mount Skt	£4.49	£3.59

Computer Power Connectors

AT Motherboard Power Connector



6-Pin 3.96mm [0.156in.] spacing polarised connector, as used on AT motherboards. The male connector is PCB mounting and rated 7A, 250Vac/dc.

Order Code	Mod:	Price each exc. VAT	inc. VAT each
	001499	1+ 5+	
JW68Y	AT Power Conn Male	£1.49	£1.19

ATX Motherboard Power Connectors



20-Pin 4.2mm [0.165in.] pitch polarised power connectors, as used on ATX motherboards. Both the male and female connectors are line versions, designed for attaching to cables, comprising of a housing and 20 crimp/solder terminals. The female connector has a latching mechanism and is the connector that is commonly found on PC computer PSUs. The housings are made from Nylon 66, to UL94V-2.

Order Code	Mod:	Price each exc. VAT	inc. VAT each
	044019	1+ 5+	
L69AZ	ATX Power Conn Male	£1.99	£1.59
L70AZ	ATX Power Conn Fem	£1.99	£1.59

Floppy Disk Drive 4 Pin Power Connector

4-pin 2.54mm [0.1"] spacing polarised power connector, commonly used on 3½" floppy disk drives. Supplied complete with connector housing and crimp/solder terminals.



Order Code	Mod:	Price each exc. VAT	inc. VAT each
	001319	1+	
JW63T	0.1in Power Conn F	£1.15	£1.39



Over 200 stores nationwide

Hard Disk Drive Power Connectors



- 4 pole connector commonly used in computer drive cable connections
- Male and female versions available
- Ideal for custom cables, extensions or other applications
- Nylon 66 plastic housing
- Brass, tin plated terminals rated at 7A
- Accepts wire 0.81 to 1.29mm²

Order Code	Mod:	Price each exc. VAT	inc. VAT each
	001317	1+ 5+	
JW64U	0.2in Power Conn M	£1.65	£1.32
JW65V	0.2in Power Conn F	£1.65	£1.32

Pin Jumpers

2.54mm (0.1 inch) Miniature Pin Jumpers



Miniature jumpers for bridging "option pins" on computers, disk drives and other electronic hardware. Used in conjunction with 2.54mm [0.1in.] pin strips, these jumpers provide an easy means of being able to select various firmware options. Two versions are available, with or without extraction "handle". **Sold in packs of 10.**

Order Code	Mod:	Price each exc. VAT	inc. VAT each
	034146	1+ 5+	
N24AN	Jumper 10 Pack	£1.82	£1.46
N23AN	Jumper & Extr. 10 Pk	£1.32	£1.06

2.54mm Pin Strip



Pin strips which are used in conjunction with pin jumpers to provide "option pins" on computers, disk drives and other electronic hardware. These pin strips provide an easy means of being able to select various firmware options. Strips may be shortened by cutting at V-notches so any required length may be formed. Supplied in single rows of 36.

Order Code	Mod:	Price each exc. VAT	inc. VAT each
	001500	1+ 5+	
JW59P	Pin Strip 1x36 St	£1.32	£1.06

Network & Telecoms

Maplin Cat 5/Cat 5e Unshielded Cable RJ45 Connectors 10 Pack



- RJ45 crimp-on connectors for use with stranded Cat 5e twisted pair cable
- 30µ" gold plated for reliability
- Supplied in packs of 10

Specifications:

Network compatibility	Cat 5, Cat 5e
Cable type	UTP Stranded
Contact plating	30 micro inch gold plated

Order Code	Mod:	Price each exc. VAT	inc. VAT each
	032111	1+ 5+	
JT49D	RJ45 Cat 5e 10 Pack	£2.74	£2.19

Buy it on the web at maplin.co.uk

Shop for all Maplin products online at our website and check out our latest products and special offers!



TV & Satellite Connectors

TV Aerial Connectors

Plastic Coax Plug

A standard coax plug, as used for TV aerial connections, with plastic covered body and plastic cap.



Order Code	Mod:	Price each exc. VAT	inc. VAT each
YW08J	001604	1+ 5+ £1.65 £1.32	£1.99

Plastic Right Angled Coax Plug



- Standard TV aerial male plug with right-angled cable entry
- Screw terminal for central conductor and crimp for screen
- Ideal when mounting TV's against a wall and cable clearance is tight

Order Code	Mod:	Price each exc. VAT	inc. VAT each
L12BH	045772	1+ 5+ £2.07 £1.66	£2.49

High Quality Metal Coax Plug

- Nickel plated, brass body TV antenna plug
- Ideal for making up or replacing damaged leads
- High quality construction, with retaining grub screw for the centre conductor
- Suits standard TV cable and CT100, FT100 Satellite cable



Order Code	Mod:	Price each exc. VAT	inc. VAT each
FD85G	001606	1+ 5+ £1.91 £1.71	£2.29

High Quality Metal Coax Plug 100 Pack

ORDER IN STORE OR ONLINE



- Nickel plated, brass body TV antenna plug
- Ideal for making up or replacing damaged leads
- High quality construction, with retaining grub screw for the centre conductor
- Suits standard TV cable and CT100, FT100 Satellite cable

Order Code	Mod:	Price each exc. VAT	inc. VAT each
A69QY	1020281	1+ 5+ £24.99 £22.49	£29.99

Gold Plated Coax Plug



- Very high quality coax plug
- Gold plated for maximum signal transfer and reduced corrosion
- The centre conductor is terminated by means of a small grub screw

Order Code	Mod:	Price each exc. VAT	inc. VAT each
N94FZ	223589	1+ 5+ £2.15 £1.72	£2.59

Plastic Coax Line Socket



A standard coax line socket, as used for TV aerial and 'RF out' connections, with a plastic covered body and plastic cap.

Order Code	Mod:	Price each exc. VAT	inc. VAT each
JB16S	001618	1+ £1.65	£1.99

Plastic Right Angled Coax Line Socket



- Standard TV aerial line (female) socket with right-angled cable entry
- Screw terminal for central conductor and crimp for screen.

Order Code	Mod:	Price each exc. VAT	inc. VAT each
L13BH	045773	1+ 5+ £2.07 £1.66	£2.49

High Quality Metal Coax Line Socket

- Nickel plated, brass body TV antenna socket
- Ideal for making up or replacing damaged leads
- High quality construction, with retaining grub screw for the centre conductor
- Suits standard TV cable and CT100, FT100 Satellite cable



Order Code	Mod:	Price each exc. VAT	inc. VAT each
FD86T	001619	1+ 5+ £1.99 £1.59	£2.39

Find out more in-store

Our staff can offer friendly and expert advice; we're here to help



High Quality Metal Coax Line Socket 100 Pack

ORDER IN STORE OR ONLINE



- Nickel plated, brass body TV antenna socket
- Ideal for making up or replacing damaged leads
- High quality construction, with retaining grub screw for the centre conductor
- Suits standard TV cable and CT100, FT100 Satellite cable

Order Code	Mod:	Price each exc. VAT	inc. VAT each
A70QY	1020282	1+ 5+ £29.15 £26.24	£34.99

Gold Plated Coax Line Socket



- Very high quality coax socket
- Gold plated for maximum signal transfer and reduced corrosion
- The centre conductor is terminated by means of a small grub screw

Order Code	Mod:	Price each exc. VAT	inc. VAT each
N95FZ	223590	1+ 5+ £2.15 £1.72	£2.59

High Quality Metal Coax Panel Socket



- Nickel plated, brass body TV antenna panel socket
- Ideal for making up or replacing damaged leads
- High quality construction, with retaining grub screw for the centre conductor
- Solder tags for secure connections
- Requires 9.5mm cut out

Order Code	Mod:	Price each exc. VAT	inc. VAT each
FE10L	001615	1+ £2.32	£2.79

TV Aerial Adapters

Plastic Coax Socket to Coax Socket Coupler



A line connector for connecting two coax plugs together.

Order Code	Mod:	Price each exc. VAT	inc. VAT each
HH11M	001620	1+ 5+ £1.65 £1.49	£1.99

Metal Coax Socket to F Socket Adapter



- Convert coax connections into F connections easily
- Take advantage of your existing leads to make new runs and conversions
- Allows a coax plug to be used with an F plug

Order Code	Mod.	Price each exc. VAT	inc. VAT each
0072P	Coax Skt to F Skt	£2.32	£2.79

F Plug to F Plug Adapter



- Allows two F female connections to be coupled together
- Change the gender from female to male
- Create custom solutions for TV, satellite or CCTV

Order Code	Mod.	Price each exc. VAT	inc. VAT each
N61LN	F Double Male	£1.74	£2.09

Metal Coax Socket to F Socket Adapter 100 Pack

ORDER IN STORE OR ONLINE



- Convert coax connections into F connections easily
- Take advantage of your existing leads to make new runs and conversions
- Allows a coax plug to be used with an F plug
- Value trade pack quantity

Order Code	Mod.	Price each exc. VAT	inc. VAT each
A65QY	F SKT. COAX SKT 100PK	£33.32	£39.99

Metal F Plug to Coax Socket Adapter 100 Pack

ORDER IN STORE OR ONLINE



- Convert coax connections into F connections easily
- Take advantage of your existing leads to make new runs and conversions
- Allows a coax plug to be used with an F socket
- Value trade pack

Order Code	Mod.	Price each exc. VAT	inc. VAT each
A66QY	F PLG COAX SKT 100PK	£37.49	£44.99

Video & RF Connectors

SCART

SCART Line Plug



Standard 21-way SCART plug (also known as a Peritel plug). Used for connecting both audio and video signals between TVs, VCRs, DVD players, etc.

Order Code	Mod.	Price each exc. VAT	inc. VAT each
FJ41U	SCART Line Plug	£2.49	£2.99

SCART PCB Sockets



A 21-way SCART (Peritel) PCB mounting socket for use with audio/video equipment. The socket has M2 or M3.5mm fixing holes on 58.5mm centres, for panel fixing, etc. Panel cut out 48x17mm.

Order Code	Mod.	Price each exc. VAT	inc. VAT each
JW34M	SCART PCB Socket	£2.24	£2.69

HDMI Connectors

HDMI Panel Mount Feed-through Adapters

ORDER IN STORE OR ONLINE



- Transmit any digital TV and PC video format including high-definition video (HDTV)
- HDMI 1.3 feed-through adapters with 19-pole HDMI female receptacles at both ends
- Dust and water resistant to IP65 safety standard
- Universally accepted standard D-shape housing
- Removable screen to chassis grounding
- Available in silver (Order Code: A560Q) and black (Order Code: A570Q)
- Neutrik item numbers: NAHDMI-W (A560Q) and NAHDMI-W-B (A570Q)

HDMI 1.3 feed-through adapters with a D-shaped housing. Neutrik's HDMI solution for the transmission of any digital TV and PC video format including high-definition video (HDTV) can be integrated in to networks very easily.

Contact plating	Au
Contacts	Brass (CuZn39Pb3)
Insert	ABS
Shell	Zinc diecast (ZnAl4Cu1)
Shell plating	Nickel
Flammability	UL 94 V-0
Standard compliance	HDMI 1.3a specifications
Temperature range	-25 °C to +85 °C

Order Code	Mod.	Price each exc. VAT	inc. VAT each
A560Q	HDMI1.3 Fdth Chs	£7.74	£9.29
A570Q	HDMI1.3 Fdth Chs Blk	£7.99	£9.59

BNC Connectors

Twist-on BNC Plugs



Nickel-plated brass BNC plugs with gold-plated pins, available in either 50Ω for use with RG58 and UR76 cable, or 75Ω for use with RG59 cable.

To fit, strip outer sheath then fold the screen back over the outer sheath, then strip the inner sheath and screw the plug on.

Order Code	Mod.	Price each exc. VAT	inc. VAT each
JK21X	BNC Twist Plug 50	£2.07	£2.49
CL03D	BNC Twist Plug 75	£2.32	£2.79

Crimp-On BNC Plugs

- Nickel-plated brass plug with gold-plated centre pin
- Designed to be crimped onto RF cables
- Available in 50Ω for RG58 and UR76 cable or 75Ω for RG59 cable



Order Code	Mod.	Price each exc. VAT	inc. VAT each
JC23A	BNC Crimp Plug 50	£2.32	£2.79
CL06G	BNC Crimp Plug 75	£2.32	£2.79

Maplin 75Ω Crimp On BNC Plug 50 Pack

ORDER IN STORE OR ONLINE



- Nickel-plated brass plug with gold-plated centre pin
- Designed to be crimped onto RF cables
- Ideal for CCTV and Video installations
- Offers solid connection when crimped correctly
- Value trade pack

Order Code	Mod.	Price each exc. VAT	inc. VAT each
A62QY	BNC 75R Crimp 50PK	£24.99	£29.99

Clamp-On BNC Plugs



High quality BNC in-line clamp plugs with gold-plated pins & nickel-plated bodies. Available with 50Ω impedance for PC network and radio applications (RG58, UR76 cable), and 75Ω impedance for audio/video applications (RG59 cable).

Order Code	Mod.	Price each exc. VAT	inc. VAT each
HH17T	BNC Clamp Plug 50	£2.24	£2.69
FE99H	BNC Clamp Plug 75	£2.24	£2.69

BNC Compression Plug



- Suitable for radial and compression fit tools
- Will accommodate RG59 and equivalent cable
- Fast and easy fitting
- Ideal for professional installers

A BNC connector suitable for compression fit tools allowing an easy and speedy installation of CCTV and other RF applications.

Order Code	Mod: 388516	Price each exc. VAT		inc. VAT each
		1+	5+	
N72HT	BNC Compress RG59 75	£2.15	£1.72	£2.59

Quick Click BNC Plug



- Re-usable
- Easy and speedy assembly
- No soldering or crimping required - Clamp connectors require either a solder or crimp pin.
- No crimping required
- Built in gold plated centre contact pin
- Internal Spring mechanism maintains lifelong termination - 'Twist on' connectors cannot contract with the normal temperature cycling and expansion of the cable which causes poor signal quality
- Built in strain relief
- Suits RG59 cable

Order Code	Mod: 394461	Price each exc. VAT		inc. VAT each
		1+	5+	
N78HX	Quick Click BNC Plug	£3.65		£4.39

BNC Male Solderless Connector



- Easy fit, no sophisticated tools required
- 75Ω impedance
- Strain relief with 6mm minimum cable entry but can be cut to a larger size
- Screw terminal for the centre and crimp clamp for the screen

Order Code	Mod: 476116	Price each exc. VAT		inc. VAT each
		1+	5+	
N24HZ	BNC Screw Plug 75	£2.07	£1.66	£2.49

Right Angled BNC Plug

- Right angled design for tight spaces
- Easy fit, no sophisticated tools required
- 75Ω impedance
- Strain relief with 6mm minimum cable entry but can be cut to a larger size



- Screw terminal for the centre and crimp clamp for the screen

Order Code	Mod: 001567	Price each exc. VAT		inc. VAT each
		1+	5+	
FJ72P	BNC R/A Plug	£1.99	£1.79	£2.39

Insulated BNC Chassis Socket



An insulated earth version of the round BNC chassis socket with gold-plated centre pin. Requires a 9.7mm diameter panel cut-out

Order Code	Mod: 001570	Price each exc. VAT		inc. VAT each
		1+	5+	
CK05F	Insulated BNC Skt	£2.49	£1.99	£2.99

Clamp-On BNC Sockets



High quality BNC in-line female clamp sockets with gold-plated contacts & nickel-plated bodies. Available with 50Ω impedance for PC network and radio applications [RG58, UR76 cable], and 75Ω impedance for audio/video applications [RG59 cable].

Order Code	Mod: 034484	Price each exc. VAT		inc. VAT each
		1+	5+	
YW01B	BNC Clamp Skt 50	£1.82	£1.46	£2.19
N87AP	BNC Clamp Skt 75	£1.82	£1.46	£2.19

Round BNC Chassis Socket



Nickel-plated brass chassis socket with gold-plated centre pin and earth tag. Available in 50Ω and 75Ω impedance. Requires 9.7mm diameter panel cut-out

Order Code	Mod: 001569	Price each exc. VAT		inc. VAT each
		1+	5+	
HH18U	BNC Round Skt 50	£1.90		£2.29
FE31J	BNC Round Skt 75	£2.24		£2.69

BNC Boot



- Rubber boot to add strain relief to bespoke cables
- Soft rubber material offers good flexibility
- Designed to work on BNC terminated cables but could work on many different types
- Suits RG58 and RG59 RF cables but can be cut to suit the diameter of the cable

Order Code	Mod: 001562	Price each exc. VAT		inc. VAT each
		1+	5+	
CK08J	BNC Boot	£2.24	£1.79	£2.69

BNC Adapters

BNC Female Coupler



- Couple two BNC leads together
- Form extensions easily
- Use with CCTV or video applications

Allows two BNC plugs to be connected together. Nickel-plated brass construction

Order Code	Mod: 001578	Price each exc. VAT		inc. VAT each
		1+	5+	
YW02C	BNC Straight Adaptor	£2.99	£2.39	£3.59

BNC Male Coupler



- Couple two BNC males together
- Use with customised CCTV or video applications
- Adapt female BNC cable to male

Allows two BNC sockets to be joined together. Nickel-plated brass construction with silver-plated centre pins.

Order Code	Mod: 001580	Price each exc. VAT		inc. VAT each
		1+	5+	
FE86T	BNC Double Male	£2.99	£2.39	£3.59

BNC T Adapter



- Adapt one BNC socket to two
- Connect two feeds from one source
- Ideal for short runs due to signal degradation

Allows two plugs to be connected to a single socket. Typical applications include computer networking

Order Code	Mod: 001582	Price each exc. VAT		inc. VAT each
		1+	5+	
YW03D	BNC T Adaptor	£2.90	£2.32	£3.49

BNC Y Adapter



- High quality adapter for BNC installation
- Split signals from one source in to two
- Fully screened enclosure reduces signal loss
- 75 Ohm impedance
- Use with CCTV, video, networking installations

Order Code	Mod: 001584	Price each exc. VAT		inc. VAT each
		1+	5+	
CK01B	BNC Y Adaptor	£2.99	£2.39	£3.59



Over 200 stores nationwide

BNC Plug to F Socket Adapter



- Allows terminations with F plugs to be connected to BNC sockets
- Ideal in CCTV and video applications
- Can be used with bespoke installations

Order Code	Mod:	Price each exc. VAT	VAT	inc. VAT each
N60LN	BNC Plug to F Socket	£2.90	£2.32	£3.49

BNC Plug to Phono Socket Adapter



- Convert phono leads to work with BNC sockets
- Adapt CCTV cables to accommodate standard video leads
- Ideal for quick hook-ups and bespoke installs

Allows a phono plug to be connected to a BNC socket - particularly useful in video applications.

Order Code	Mod:	Price each exc. VAT	VAT	inc. VAT each
FA11M	Phono Skt/BNC Plg	£2.99	£2.69	£3.59

BNC Plug to Phono Socket Adapter 50 Pack

ORDER IN STORE OR ONLINE



- Convert BNC sockets on CCTV, Video or radio equipment to accept Phono
- Ideal where leads are terminated with Phone connections
- Trade value pack quantity

Order Code	Mod:	Price each exc. VAT	VAT	inc. VAT each
A61QY	BNC M Phono F 50PK	£20.82	£18.74	£24.99

Phono Plug to BNC Socket Adapter



Allows a BNC plug to be connected to a phono socket.

Order Code	Mod:	Price each exc. VAT	VAT	inc. VAT each
FE8BV	BNC Fem/Phono Plug	£2.99	£2.69	£3.59

BNC Plug to Phono Plug Adapter

Allows a BNC socket to be connected to a phono socket

Order Code	Mod:	Price each exc. VAT	VAT	inc. VAT each
UV34M	BNC Plg-phono Adptr	£2.82	£2.54	£3.39

BNC Socket to Phono Socket Adapter



- Allows a phono plug to be connected to a BNC plug
- Particularly useful in video or CCTV applications

Order Code	Mod:	Price each exc. VAT	VAT	inc. VAT each
N34CY	BNC Fem/Phono Socket	£2.82	£2.54	£3.39

SMA Plug to BNC Socket Adapter



Allows a BNC plug to be connected to an SMA socket

Order Code	Mod:	Price each exc. VAT	VAT	inc. VAT each
RS85G	SMA M to BNC F	£2.99	£2.39	£3.59

TNC Plug to BNC Socket Adapter



Allows a BNC plug to be connected to a TNC socket

Order Code	Mod:	Price each exc. VAT	VAT	inc. VAT each
FE83E	TNC Male/BNC Fem	£1.99	£1.59	£2.39

N-Type Connectors

Chassis N Socket

Requires 16mm round cutout. Fixing centres: 18 x 18mm x 6BA (M3) clear



Order Code	Mod:	Price each exc. VAT	VAT	inc. VAT each
FJ80B	N Type Chass Skt 5sq	£3.40	£2.72	£4.09

Clamp N Plugs



Two N plugs to suit two sizes of coaxial cable. Plug N-050 is compatible with coaxial cable of 5mm diameter, such as RG58, URM76. Plug N-011 is compatible with heavy duty RF cable of

10/11mm dia., such as URM67.

Order Code	Mod:	Price each exc. VAT	VAT	inc. VAT each
FJ77J	Plug N-050	£4.24	£3.39	£5.09
FJ78K	Plug N-011	£4.24	£3.39	£5.09

N-Type Adaptors

N Type Female Coupler



Allows two N plugs to be connected

Order Code	Mod:	Price each exc. VAT	VAT	inc. VAT each
FJ81C	N Double Female	£2.99	£2.39	£3.59

N Plug to UHF Socket Adapter



Allows a UHF plug (PL259) to be connected to an N socket.

Order Code	Mod:	Price each exc. VAT	VAT	inc. VAT each
FE97F	N Male/UHF Fem	£2.90	£2.32	£3.49

UHF (PL259) Connectors

Moonraker 6mm Clamp Fitting for Coax PL259



- Suits 6mm cable such as RG58 or URM76
- Easy to fit, just like N-Type connectors
- Perfect if soldering is difficult or unsuitable

Order Code	Mod:	Price each exc. VAT	VAT	inc. VAT each
N43JK	Clamp PL259 RG58	£2.82	£2.26	£3.39

Moonraker 9mm Clamp Fitting for Coax PL259



- Suits 9/10/11mm cable such as URM67 or RG213
- Easy to fit, just like N-Type connectors
- Perfect if soldering is difficult or unsuitable

Order Code	Mod:	Price each exc. VAT	VAT	inc. VAT each
N42JK	Clamp PL259 RG213	£2.82	£2.26	£3.39

Reserve online, collect in-store in 30 minutes



Subscribe to our newsletter for deals and information maplin.co.uk



UHF Plug PL259



Standard radio communication connector. Suits cable with 10/11mm diameter such as URM67. To use with thinner cable such as RG58, use the reducer, below. Size 38 x 19mm diameter.

Order Code	Mod:	Price each	exc. VAT	inc. VAT each
	001605	1+	5+	
BW81C	Plug PL259	£2.49	£1.99	£2.99

UHF Plug Reducer



A reducer that screws into a standard UHF plug (PL259) to enable it to be used with cables around 5.3mm diameter such as RG58 and URM76.

Order Code	Mod:	Price each	exc. VAT	inc. VAT each
	001608	1+		
BW82D	UHF Reducer-Small	£2.07		£2.49

Round UHF Chassis Socket S0239

Designed for mounting through a 16.5mm diameter panel cutout.



Order Code	Mod:	Price each	exc. VAT	inc. VAT each
	001613	1+	5+	
BW84F	UHF Socket Round	£2.07	£1.45	£2.49

Square UHF Chassis Socket S0239

Panel-mounting cut-out is 16.5mm diameter. The fixing centres are 18 x 18mm x 6BA (M3) clear.



Order Code	Mod:	Price each	exc. VAT	inc. VAT each
	001616	1+	5+	
BW85G	Socket S0239	£2.49	£1.99	£2.99

UHF (PL259) Adapters

UHF Female Coupler



Allows two UHF (PL259) plugs to be connected together.

Order Code	Mod:	Price each	exc. VAT	inc. VAT each
	001622	1+	5+	
BW87U	UHF Straight Adaptor	£2.90	£2.32	£3.49

UHF Socket to BNC Plug Adapter



Allows a UHF (PL259) plug to connect to a BNC socket

Order Code	Mod:	Price each	exc. VAT	inc. VAT each
	001634	1+	5+	
YW04E	Adaptor 239	£2.90	£2.32	£3.49

UHF Plug to BNC Socket Adapter



Allows a BNC plug to be connected to a UHF (S0239) socket.

Order Code	Mod:	Price each	exc. VAT	inc. VAT each
	001637	1+	5+	
YW05F	Adaptor 259	£2.90	£2.32	£3.49

TV Aerial Lightning Surge Protector



- Protect your TV/Freeview equipment from over-voltage surges
- UHF on both ends (one male, one female)
- Frequency: 5 - 1000 MHz
- Residual voltage : >800V
- Nominal discharge current: 8kA
- Insertion loss: >1dB
- Impedance: 75 Ohms

Order Code	Mod:	Price each	exc. VAT	inc. VAT each
	339355	1+		
A20JR	Aer Lightning Surge	£8.32		£9.99

SMA Connectors

SMA Crimp Plugs

SMA crimp plugs, with nickel-plated bodies and gold-plated contacts. Available in two sizes:



MM55K is suitable for RG58, RG141, RG303
MM56L is suitable for RG174, RG188, RG316

Order Code	Mod:	Price each	exc. VAT	inc. VAT each
	026627	1+	5+	
MM55K	SMA Crimp Plug RG58	£2.32	£1.86	£2.79
MM56L	SMA Crimp Plug RG174	£2.32	£1.86	£2.79

SMA Coupler

Allows two SMA plugs to be connected; with gold-plated body and contacts.



Order Code	Mod:	Price each	exc. VAT	inc. VAT each
	026630	1+	5+	
MM65V	SMA Coupler	£3.24	£2.59	£3.89

Reverse Polarity SMA Male

High quality RF connectors based on the popular miniature SMA connectors but with the 'hole' on the male, rather than the female. These are widely used for wireless network aerial connections (wireless LAN). Available to suit either RG58 type cable (outer diameter: 5mm) or RG174 type cable (outer diameter: 2.8mm)



Order Code	Mod:	Price each	exc. VAT	inc. VAT each
	044015	1+		
LS8AZ	RevPol SMA Plug/RG58	£2.40		£2.89
LS9AZ	RevPol SMA Plug/RG174	£2.40		£2.89

Reverse Polarity SMA Female

High quality RF connectors based on the popular miniature SMA connectors but with the pin on the female, rather than the male. These are widely used for wireless network aerial connections (wireless LAN). Available to suit either RG58 type cable (outer diameter: 5mm) or RG174 type cable (outer diameter: 2.8mm).



Order Code	Mod:	Price each	exc. VAT	inc. VAT each
	044018	1+		
L60AZ	RevPol SMA Skt/RG58	£2.40		£2.89
L61AZ	RevPol SMA Skt/RG174	£2.40		£2.89

Automotive RF Connectors

Car Aerial Plug



A standard car aerial plug with plastic body and screw-on cap, suitable aerial cable is RG58 (Maplin Order Code: XS51F)

Order Code	Mod:	Price each	exc. VAT	inc. VAT each
	001050	1+		
HH12N	Car AE Plug Plas	£2.49		£2.99

Car Aerial Line Socket



A line socket suitable for extending a standard car aerial lead. Suitable cable is RG58 (Maplin Order Code: XS51F)

Order Code	Mod:	Price each	exc. VAT	inc. VAT each
	001051	1+		
FJ76H	Car AE Line Skt	£2.49		£2.99

Power Connectors

IEC & Mains Connectors

6A Euro Line Socket



- IEC-320 C13: the standard mains power connector used on PCs, test equipment etc
- Rated at 6A, AC 250 V

Order Code	Mod: 219727	Price each exc. VAT	inc. VAT each
		1+	5+
N82CX	Euro Line Socket	£2.07	£1.66 £2.49

6A Side Entry Euro Socket



IEC-320 C13 a standard mains power line socket as used on PCs, etc. with side entry for cable. Rated at 6A 250Vac and includes cable clamp and strain relief.

Order Code	Mod: 001495	Price each exc. VAT	inc. VAT each
		1+	5+
JP19V	Side Eurosocket	£2.74	£2.19 £3.29

6A Euro Chassis Socket



- IEC-320 C13: a mains outlet chassis socket complementary to IEC-320 C14 plugs
- Requires a 32 x 25mm mounting hole
- Overall depth of 35mm
- Fixing centres are 40mm x 6BA or M3, countersunk
- Contacts are rated at 6A at AC 250 V
- Solder tag terminations at rear 6.35(w) x 10(l) mm
- Will accept standard 6.35mm (1/4 inch) push-on connectors

Order Code	Mod: 001361	Price each exc. VAT	inc. VAT each
		1+	5+
FT63T	Euro Outlet Skt P675	£1.90	£2.29

6A Euro Line Plug



- IEC-320 C14: a mains power line plug for use with IEC-320 C13 connectors
- Plug has shielded pins to prevent accidental touching whilst inserting or removing the plug
- Wires are terminated to the connectors using screw

terminals

- Includes cable clamp and strain relief sleeve
- Rated at 6A at AC 250 V

Order Code	Mod: 001360	Price each exc. VAT	inc. VAT each
		1+	5+
FT64U	Euro Plug IEC320 C14	£2.15	£2.59

10A Side Entry Euro Mains Plug



IEC-320 C14: a right-angled, side-entry mains power line plug for use with IEC-320 C13 connectors. The line plug has shielded pins to prevent accidental touching of the pins whilst inserting or removing the plug. Wires are terminated to the connectors using screw terminals. Includes cable clamp and strain relief sleeve. Rated 10A 250Vac

Order Code	Mod: 045364	Price each exc. VAT	inc. VAT each
		1+	5+
L88AZ	Side-Entry Euro Plug	£2.65	£2.12 £3.19

Euro Chassis Plug



IEC-320 C14: the standard mains power inlet for IEC-320 C13 connectors, rated at 10A 250Vac. Terminals 4.7mm solder tags. An insulated cover for the rear of the plug is also available.

Fixing centres: 40 x 6BA [M3] countersunk
Overall depth: 33mm inc. solder tag contacts
Cut Outs: Rear Mounting 23mm x 31mm
Front Mounting 27mm x 19.5mm

Order Code	Mod: 001496	Price each exc. VAT	inc. VAT each
		1+	5+
HL15R	Europlug	£1.82	£1.46 £2.19
JK66W	Ins. Cover for HL15R	£1.33	£1.60

Fused Euro Chassis Plug



IEC-320 C14: a chassis-mounting mains power inlet connector with a built-in fuseholder that accepts a 5x20mm cartridge fuse. The fuse is connected in the Live line only. The fuseholder consists of a small 'drawer' which cannot be withdrawn unless the input lead line socket is removed first. The fuse is automatically disconnected and remains loose in the drawer; changing the fuse is merely a matter of lifting out the old and dropping in the new. Additional space is provided at the front of the drawer to carry a spare fuse. (Fuses are not included). The line socket cannot be inserted without closing the drawer.

Order Code	Mod: 001503	Price each exc. VAT	inc. VAT each
		1+	5+
FT37S	Fused Euro Ch Plug	£2.24	£1.79 £2.69

10A Fused Snap In IEC Chassis Plug with Switch



- Chassis-mounting mains power inlet connector with a built-in fuse holder
- Accepts a 5 x 20mm cartridge fuse
- Designed to stop the fuse being removed unless the mains cable is removed first
- Integral on/off switch for ease of use
- Nylon housing
- Rated at 10A, AC 250 V

Please note: Use only with a 250 V fuse.

Order Code	Mod: 218978	Price each exc. VAT	inc. VAT each
		1+	5+
N94CZ	Switched IEC Chas Skt	£2.90	£2.32 £3.49

Hot Condition Euro Line Socket



- IEC-60320 C15 line socket
- Re-wireable mains hot condition power line socket with cord grip and strain relief
- Commonly referred to as a 'kettle plug', that mates with IEC-60320 C16 plugs
- Rated to 250Vac with 6A and 10A versions available
- Operating temperature up to 80°C

Order Code	Mod: 042706	Price each exc. VAT	inc. VAT each
		1+	5+
MK20W	Hot Cond Euro Skt 6A	£2.32	£1.86 £2.79
N08KC	Hot Con Euro Skt 10A	£2.40	£1.92 £2.89

10A Hot Condition Euro Chassis Plug



- IEC-60320 C16 chassis plug
- High temperature 'hot condition' with lug to prevent normal euro plug insertion
- 10A 250Vac
- Operating temperature -25°C to 85°C
- Mounting hole 26.6 x 20mm
- Fixing centres 50mm

Order Code	Mod: 001497	Price each exc. VAT	inc. VAT each
		1+	5+
MK19V	Hot Chassis Plug	£2.24	£1.79 £2.69

Buy it on the web at maplin.co.uk

Shop for all Maplin products online at our website and check out our latest products and special offers!



2.5A Figure of 8 Mains Power Inlet



- IEC-320 C8: standard 'figure of 8' two-pin mains power inlet
- As found on cassette player, laptops etc
- Rated 2.5A, AC 250 V with 2.8mm solder terminals
- Mounting cutout : 19.8 x 11.7mm/mounting holes at 28mm centres

Order Code	Mod: 012050	Price each exc. VAT	inc. VAT each
		1+	5+
RY16S	Fig 8 Pwr Inlet PMnt	£1.65	£1.32 £1.99

Cloverleaf to Figure of 8 Adapter Black



- IEC-320 C7 2 prong receptacle to IEC-320 C6 plug adapter
- Rated up to 2.5A AC250V or 10A AC 125V
- Convert from IEC-320 C7 2-prong receptacle

Order Code	Mod: 223684	Price each exc. VAT	inc. VAT each
		1+	5+
N126A	C7 to C6 Adaptor	£4.99	£3.99 £5.99

Cloverleaf to IEC Male Adapter Black



- IEC-320 C6 plug to IEC-320 C13 receptacle adapter
- Rated up to 2.5A 250V
- Convert from IEC-320 C6 plug

Order Code	Mod: 224232	Price each exc. VAT	inc. VAT each
		1+	5+
N75GB	C6 to C13 Adaptor	£4.99	£3.99 £5.99

2.5A Moulded IEC C14 to C5 Adapter Black



- IEC-320 C5 receptacle to IEC-320 C14 plug adapter
- Rated up to 2.5A 250V
- Convert from IEC-320 C14 Receptacle

Order Code	Mod: 224231	Price each exc. VAT	inc. VAT each
		1+	5+
N74GB	C14 to C5 Adaptor	£4.99	£3.99 £5.99

Bulgin 6A PX0552 Panel Mount Female Circular Connector



- 8 poles
- Mates with PX0551 and PX0959/P
- 4.8mm tabs

Specifications:

Terminations	4.8mm tab
Max rating	6A, 250Vac (per pin)
Contact resistance:	< 20mΩ
Insulation resistance	> 103MΩ
AC breakdown:	pole-pole 5.2kV poles-accessible parts 2kV
Operating temp. range	-20°C to +70°C
Mouldings	glass-filled nylon
Flammability rating:	UL94 HB
Contacts	brass, tin plated

Order Code	Mod: 001387	Price each exc. VAT	inc. VAT each
		1+	5+
HL40T	Mains Socket P552	£3.74	£2.99 £4.49

Bulgin 6A PX0551 Flex Mount Male Circular Connector



- 8 poles
- Mates with PX0552, PX0956/S and PX0957/S
- Screw terminals

Specifications:

Terminations	Screw terminals
Max rating	6A, 250Vac (per pin)
Contact resistance:	< 20mΩ
Insulation resistance	> 103MΩ
AC breakdown:	pole-pole 5.2kV poles-accessible parts 6kV
Operating temp. range	-20°C to +70°C
Mouldings	glass-filled nylon
Flammability rating:	UL94 HB
Contacts	brass, nickel plated
< + >	

Order Code	Mod: 001386	Price each exc. VAT	inc. VAT each
		1+	
HL39N	Mains Plug P551	£6.24	£7.49

Powercon TRUE 1 - 16A Chassis Outlet - IP65

ORDER IN STORE OR ONLINE



- True mains connector with breaking capacity (CBC)

- Lockable 16 A single phase connector (USA: 20 A)
- Easy and reliable twist lock system
- Extremely robust and reliable
- ENEC certified according to IEC 60320
- UL recognized components
- IP65 – water resistant when mated with ready-made cord sets

Appliance outlet connector, 1/4" flat tab terminals
The powerCON TRUE1 is a locking 16/20 A true mains connector. It replaces appliance couplers wherever a very rugged solution in combination with a locking device is needed in order to guarantee a safe power connection. The powerCON TRUE1 is a connector with breaking capacity (CBC), i.e. it can be connected or disconnected under load or live.

Title
NAC3FPX
Electrical

Contact resistance

Order Code	Mod: 1024908	Price each exc. VAT	inc. VAT each
		1+	
A530Q	16A Chassis out	£3.99	£4.79

Powercon TRUE 1 - 16A Cable Inlet - IP65

ORDER IN STORE OR ONLINE



- True mains connector with breaking capacity (CBC)
- Lockable 16 A single phase connector (USA: 20 A)
- Dust and water resistant according to IP65 in mated condition
- Easy and reliable twist lock system
- Extremely robust and reliable
- Unique Neutrik cable retention
- ENEC certified according to IEC 60320
- UL recognized components

Locking female cable connector, screw terminals
The powerCON TRUE1 is a locking waterproof 16/20 A true mains connector. It replaces appliance couplers wherever a very rugged solution in combination with a locking device is needed in order to guarantee a safe power connection. The powerCON TRUE1 is a connector with breaking capacity (CBC), i.e. it can be connected or disconnected under load or live.

Title
NAC3FX-W
Electrical

Contact resistance

Order Code	Mod: 1024909	Price each exc. VAT	inc. VAT each
		1+	
A540Q	16A Cable in IP65	£5.07	£6.09

Powercon TRUE 1 - 16A Cable Outlet Connector IP65

ORDER IN STORE OR ONLINE



- True mains connector with breaking capacity (CBC)
- Lockable 16 A single phase connector (USA: 20 A)
- Dust and water resistant according to IP65 in mated

condition

- Easy and reliable twist lock system
- Extremely robust and reliable
- Unique Neutrik cable retention
- ENEC certified according to IEC 60320
- UL recognized components

Powercon TRUE 1 - Locking Male Cable Outlet Connector, screw terminals The powerCON TRUE1 is a locking waterproof 16/20 A true mains connector. It replaces appliance couplers wherever a very rugged solution in combination with a locking device is needed in order to guarantee a safe power connection. The powerCON TRUE1 is a connector with breaking capacity (CBC), i.e. it can be connected or disconnected under load or live.

Title
NAC3MX-W
Electrical

Contact resistance

Order Code	Mod: 1024910	Price each exc. VAT 1+	inc. VAT each
A550Q	16A Cable out IP65	£5.07	£6.09

Powercon - 20A Chassis B Outlet Grey

ORDER IN STORE OR ONLINE



- Locking 20 A / 250 V ac appliance coupler
- 3 contacts for line, neutral and pre-mating safety ground
- Power-in (blue) and power-out (grey) versions with different keying to avoid the possibility of intermating
- Fast and easy twist lock latching system
- Extremely robust and reliable
- Ergonomic design
- User friendly latch design for easy handling
- UL, cUL recognized components
- VDE certified
- SEV approved
- Branded with unique hologram - guarantees genuine and authentic Neutrik product

Chassis connector, power-out, 3/16" flat tab terminals, grey The powerCON is a locking 3 conductor equipment AC connector with contacts for line, neutral and pre-mating ground contact. It replaces appliance couplers wherever a very rugged solution in combination with a locking device is needed in order to guarantee a safe power connection. Attention: The powerCON is a connector without breaking capacity, i.e. the powerCON should not be connected or disconnected under load or live!

Title
NAC3MPB-1

Order Code	Mod: 1024907	Price each exc. VAT 1+	inc. VAT each
A520Q	20A Chassis out	£1.99	£2.39

Powercon - 20A Cable 3 Pole B Outlet Connector Grey

ORDER IN STORE OR ONLINE



- Locking 20 A / 250 V ac appliance coupler
- 3 contacts for line, neutral and pre-mating safety ground
- Power-in (blue) and power-out (grey) versions with different keying to avoid the possibility of intermating
- Fast and easy twist lock latching system
- Extremely robust and reliable
- Ergonomic design
- User friendly latch design for easy handling
- Unique Neutrik chuck type strain relief
- UL, cUL recognized components
- VDE certified
- SEV approved
- Branded with unique hologram - guarantees genuine and authentic Neutrik product

Lockable cable connector, power-out, screw terminals, grey The powerCON is a locking 3 conductor equipment AC connector with contacts for line, neutral and pre-mating ground contact. It replaces appliance couplers wherever a very rugged solution in combination with a locking device is needed in order to guarantee a safe power connection. Attention: The powerCON is a connector without breaking capacity, i.e. the powerCON should not be connected or disconnected under load or live!

Title
NAC3FCB

Order Code	Mod: 1024903	Price each exc. VAT 1+	inc. VAT each
A480Q	20A Cable 3p out	£3.90	£4.69

Powercon - 20A Coupler Blue Chassis to Grey Chassis

ORDER IN STORE OR ONLINE



- Locking 20 A / 250 V ac appliance coupler
- 3 contacts for line, neutral and pre-mating safety ground
- Power-in (blue) and power-out (grey) versions with different keying to avoid the possibility of intermating
- Fast and easy twist lock latching system
- Extremely robust and reliable
- Ergonomic design
- User friendly latch design for easy handling
- Unique Neutrik chuck type strain relief
- UL, cUL recognized components
- VDE certified
- SEV approved
- Branded with unique hologram - guarantees genuine and authentic Neutrik product

powerCON NAC3MPA-1 [power in] - powerCON NAC3MPB-1 [power out], coupler for linking cables powerCON 20 A The powerCON is a locking 3 conductor equipment AC connector with contacts for line, neutral and pre-mating ground contact. It replaces appliance couplers wherever a very rugged solution in combination with a locking device is needed in order to guarantee a safe power connection. Attention: The powerCON is a connector without breaking capacity, i.e. the powerCON should not be connected or disconnected under load or live!

Title
NAC3MM-1

Order Code	Mod: 1024905	Price each exc. VAT 1+	inc. VAT each
A500Q	20A Coupler	£11.65	£13.99

Neutrik PowerCon 20A 3 Pole Mains In Line Female



- Locking 20A / AC 250 V appliance coupler
- 3 contacts for line, neutral and pre-mating safety ground
- Power-in (blue) and power-out (grey) versions with different keying to avoid the possibility of intermating
- Fast and easy twist lock latching system
- Extremely robust and reliable
- Ergonomic design
- User friendly latch design for easy handling
- Unique Neutrik chuck type strain relief
- UL, C-UL recognised components
- VDE certified
- SEV approved
- Branded with unique hologram - guarantees genuine and authentic Neutrik product
- Neutrik part NAC3FCA

Cable connector, quick lock with securing lever, A-type for power-in, screw terminals. The PowerCon® is a locking 3 conductor equipment AC connector with contacts for line, neutral and pre-mating ground contact. It replaces appliance couplers wherever a very rugged solution in combination with a locking device is needed in order to guarantee a safe power connection.

Attention: The PowerCon® is a connector without breaking capacity, i.e. the PowerCon® should not be connected or disconnected under load or live!

Order Code	Mod: 224002	Price each exc. VAT 1+	5+	inc. VAT each
N54GB	HQ Powercon Inlet	£5.07	£4.06	£6.09

Neutrik PowerCon® 20A Inlet Chassis Male



- Lockable 3-pole equipment (AC) connector with contacts for line, neutral and pre-mating safety ground.
- High current capacity, rated at 20A / AC 250V
- Fast and easy locking system
- Extremely robust and reliable
- Excellent cable retention
- UL, C-UL recognised components
- VDE and SEV approved
- Neutrik part NAC3MPA-W

Air tight chassis connector, A-type for power-in, flat tab terminals. The PowerCon® is a locking 3 conductor equipment AC connector with contacts for line, neutral and pre-mating ground contact. It replaces appliance couplers wherever a very rugged solution in combination with a locking device is needed in order to guarantee a safe power connection.

Attention: The PowerCon® is a connector without breaking capacity, i.e. the PowerCon® should not be connected or disconnected under load or live!

Order Code	Mod: 224003	Price each exc. VAT 1+	5+	inc. VAT each
N55GB	HQ Powercon In Chas	£2.99	£2.39	£3.59



Friendly expert advice on
0333 400 9500

Powercon - 32A Cable Connector 3 Pole Black

ORDER IN STORE OR ONLINE



- 250 V ac, 32 A single-phase (for ambient temperatures up to 35°C)
- Premating contact for protective earth
- Fast and easy locking system to prevent unintentional disengagement
- Cable O.D. Range: 8 - 20 mm
- Wiring with screw-type terminals for wires 2.5 to 6.0 mm² (AWG 14 - 10)
- Excellent cable handling and protection
- Extremely robust and reliable
- VDE, UL, cUL and JET approved
- Suitable for 32A AC Inlet To Power Distros etc

powerCON 32 A cable connector The 32 A powerCON is an extremely robust and reliable locking single phase AC appliance cable connector for high current capacity (32 A rated). It is conceived as a non-standardized 3 pole connection system without breaking capacity to serve the needs of high power distribution systems and supplies for professional audio and lighting equipment and installations. The connectors comprise of contacts for phase, neutral and protective earth (ground) conductors rated for currents up to 32 A and for voltages up to 250V

Title
NAC3MPC-HC

Order Code	Mod: 1024900	Price each exc. VAT 1+	inc. VAT each
A450Q	32A Chassis 3Pole	£10.82	£12.99

Powercon - 32A Chassis 3 Pole Black

ORDER IN STORE OR ONLINE



- 250 V ac, 32 A single-phase (for ambient temperatures up to 35°C)
- Premating contact for protective earth
- Fast and easy locking system to prevent unintentional disengagement
- Wiring with screw-type terminals for wires 2.5 to 6.0 mm² (AWG 14 - 10)
- Extremely robust and reliable
- VDE, UL, cUL and JET approved

powerCON 32 A chassis connector, power-in The 32 A powerCON is an extremely robust and reliable locking single phase AC appliance cable connector for high current capacity (32 A rated). It is conceived as a non-standardized 3 pole connection system without breaking capacity to serve the needs of high power distribution systems and supplies for professional audio and lighting equipment and installations. The connectors comprise of contacts for phase, neutral and protective earth (ground) conductors rated for currents up to 32 A and for voltages up to 250V

Title
NAC3MP-HC

Order Code	Mod: 1024899	Price each exc. VAT 1+	inc. VAT each
A440Q	32A Cable Con 3Pole	£6.32	£7.59

Powercon - 32A Chassis 5 Pole

ORDER IN STORE OR ONLINE



- 32 Amp Single phase connector with 3 protective earth conductors
- Three earth contacts provide robust and reliable protective earth connection via parallel path or ring configuration
- Third earth contact is additionally connected to metal conduit
- Fast and easy locking system
- High current capacity (32 Amp rated)
- Extremely robust and reliable
- Excellent cable handling and protection

32 Amp Chassis Connector with 3 protective earth conductors The AC installation coupler was designed for power distribution systems in professional IT equipment and desk power supplies for the office environment. The system is designed according to the British Standard BS 7671 section 607 only and is therefore limited to corresponding applications

Operation is only guaranteed for related applications and has the ASTA marks licence number: 845. Note: The PowerCon is a connector without breaking capacity TBA

Order Code	Mod: 1024898	Price each exc. VAT 1+	inc. VAT each
A430Q	32A Chassis 5Pole	£4.65	£5.59

US Style Mains Connectors

7.5A US Mains Plug



A 2-pin 7.5A line plug with flat pins on 12.7mm centres For 110V use only

Order Code	Mod: 001472	Price each exc. VAT 1+	5+	inc. VAT each
HL17T	USA Mains Plug	£1.82	£1.46	£2.19

7.5A US Mains Line Socket



A 2-pin 7.5A line socket to suit our US mains plug For 110V use only

Order Code	Mod: 001476	Price each exc. VAT 1+	5+	inc. VAT each
HL19V	USA Mains Line Skt	£1.82	£1.46	£2.19

7.5A US Mains Chassis Socket



A 3-pin 7.5A chassis socket with snap-in fixing in 23 x 23mm panel cut-cut. Bezel size: 27 x 27mm Overall depth: 32mm. For 110V use only.

Order Code	Mod: 001475	Price each exc. VAT 1+	5+	inc. VAT each
JK19V	USA 3-Pin Socket	£0.57	£0.46	£0.69

DC Power Connectors

DC Power Plugs



- Comprehensive range of common DC power connectors
- Used to replace damaged or faulty PSU leads
- Moulded integrated cable strain relief
- Nickel-plated and easy solder terminals
- Typical rating 12VDC/2A/24W
- Operating Temperature -40°C to +105°C

Order Code	Inside Diameter [mm]	Outside Diameter [mm]	Shaft Length [mm]
L43AY	0.7	2.5	9.5
L44AY	1.1	3	9.5
FK05F	1.3	3.45	9.5
L45AY	1.45	3.45	9.5
L46AY	1.7	4	9.5
L47AY	1.7	4.75	9.5
L48AY	2.1	5	9.5
L49AY	2.5	5	9.5
HH60Q	2.1	5.5	9.5
HH61R	2.1	5.5	14
HH62S	2.5	5.5	9.5
HH63T	2.5	5.5	14
L50AY	2.8	5.5	14
FM47B	3.1	6.5	9.5

Order Code	Mod: 043084	Price each exc. VAT 1+	5+	inc. VAT each
L43AY	DC Plug 0.7mm/2.5mm	£1.65	£1.32	£1.99
L44AY	DC Plug 1.1mm/3.0mm	£1.65	£1.32	£1.99
FK05F	DC Plug 1.3mm/3.45mm	£1.65	£1.32	£1.99
L45AY	DC Plug 1.45/3.45mm	£1.65	£1.32	£1.99
L46AY	DC Plug 1.7mm/4.0mm	£1.65	£1.32	£1.99
L47AY	DC Plug 1.7mm/4.75mm	£1.65	£1.32	£1.99
L48AY	DC Plug 2.1mm/5.0mm	£1.65	£1.32	£1.99
L49AY	DC Plug 2.5mm/5.0mm	£1.65	£1.32	£1.99
HH60Q	DC Plug 2.1mm/5.5mm	£1.65	£1.32	£1.99
HH61R	Long DC Plg 2.1/5.5	£1.65	£1.32	£1.99
HH62S	DC Plug 2.5mm/5.5mm	£1.65	£1.32	£1.99
HH63T	Long DC Plg 2.5/5.5	£1.74	£1.39	£2.09
L50AY	DC Plug 2.8mm/5.5mm	£1.65	£1.32	£1.99
FM47B	DC Plug 3.1mm/6.5mm	£1.74	£1.39	£2.09

DC Power Line Sockets



- Line sockets for 2.1 and 2.5mm DC plugs with 5.5mm outside diameter

- Can be used to make extensions or bespoke cables
- Moulded integrated cable strain relief
- Nickel-plated contacts with easy solder terminals
- JK11M suits plugs with 2.1mm internal diameter (HH60Q or HH61R)
- JK12N suits plugs with 2.5mm internal diameter (HH62S or HH63T)

Order Code	Mod: 043091	Price each exc. VAT	inc. VAT each	
		1+	5+	
JK11M	Power Line Skt 2.1	£1.74	£1.39	£2.09
JK12N	Power Line Skt 2.5	£1.74	£1.39	£2.09

2.1 x 5.5mm DC Socket Plastic



A plastic-bodied 2.1mm DC power socket with break contact. Suits 2.1 x 5.5mm DC plugs. Fixing centres: 15.5mm, hole diameter: 2.5mm.

Order Code	Mod: 001406	Price each exc. VAT	inc. VAT each	
		1+	5+	
FT96E	Plas 2.1 Chas Skt	£1.49	£1.19	£1.79

2.1 x 5.5mm DC Plug Coupler



- Designed to couple two DC power plugs together
- Suits 2.1 x 5.5mm connectors
- Ideal in CCTV applications to extend pre-made leads
- For internal or external applications with suitable weatherproofing

Order Code	Mod: 629681	Price each exc. VAT	inc. VAT each	
		1+	5+	
N94NB	DC Coupler Female	£1.90	£1.52	£2.29

DC Power Plug Adaptors



- Don't throw away your old AC mains adaptor!
- Adapts the most common sized DC power plugs
- Nickel-plated contacts

Order Code	Socket End (in/out dia.)	Plug End (in/out dia.)
FK08J	2.1mm / 5.5mm	1.3mm / 3.45mm
L51AY	2.1mm / 5.5mm	2.5mm / 5.5mm
L52AY	2.5mm / 5.5mm	2.1mm / 5.5mm

Order Code	Mod: 043094	Price each exc. VAT	inc. VAT each	
		1+	5+	
FK08J	DC Adptr 2.1mm/1.3mm	£1.99	£1.59	£2.39
L51AY	DC Adptr 2.5mm/2.1mm	£1.90	£1.52	£2.29
L52AY	DC Adptr 2.1mm/2.5mm	£1.90	£1.52	£2.29

Screw Terminal DC Power Plugs



- Standard power plugs incorporating screw terminals
- Ideal when working on CCTV or remote power lead
- No soldering required, just catch your wire onto the screw point
- 2.1mm and 2.5mm versions with a 14mm length
- Typical rating 12VDC 2A

Order Code	Mod: 612377	Price each exc. VAT	inc. VAT each	
		1+	5+	
N82KT	2.5mm Screw DC Plug	£1.82	£1.46	£2.19
N81KT	2.1mm Screw DC Plug	£1.82	£1.46	£2.19

2.1 x 5.5mm Solderless Plug



- No need for solder
- Ideal for quick connections
- 2.1mm x 5.5mm plug

A range of connections to allow quick, temporary and non specialist tooled connections. Two spring tags allow the wires to be coupled to these popular sized plugs.

Order Code	Mod: 390561	Price each exc. VAT	inc. VAT each	
		1+	5+	
N54GU	Solderless 2.1mm Plg	£3.49	£2.79	£4.19

2.1 x 5.5mm Solderless Socket



- No need for solder
- Ideal for quick connections
- 2.1mm x 5.5mm socket

A range of connections to allow quick, temporary and non specialist tooled connections. Two spring tags allow the wires to be coupled to these popular sized sockets.

Order Code	Mod: 390568	Price each exc. VAT	inc. VAT each	
		1+	5+	
N56GU	Solderless 2.1mm Skt	£3.40	£3.06	£4.09

2.5 x 5.5mm Solderless Plug



- No need for solder
- Ideal for quick connections
- 2.5mm x 5.5mm plug

A range of connections to allow quick, temporary and non specialist tooled connections. Two spring tags allow the wires to be coupled to these popular sized plugs.

Order Code	Mod: 390564	Price each exc. VAT	inc. VAT each	
		1+	5+	
N53GU	Solderless 2.5mm Plg	£3.49	£2.79	£4.19

2.5 x 5.5mm Solderless Socket



- No need for solder
- Ideal for quick connections
- 2.5mm x 5.5mm socket

A range of connections to allow quick, temporary and non specialist tooled connections. Two spring tags allow the wires to be coupled to these popular sized sockets.

Order Code	Mod: 390565	Price each exc. VAT	inc. VAT each	
		1+	5+	
N55GU	Solderless 2.5mm Skt	£3.49	£2.79	£4.19

2.1 x 5.5mm Single Hole Fixing DC Socket



- A 2.1mm DC power socket with break contact
- Suitable for 2.1 x 5.5mm DC plugs. 2.1

Requires a single 8mm panel cut-out. Overall size: 21 x 11mm diameter.

Order Code	Mod: 001407	Price each exc. VAT	inc. VAT each	
		1+	5+	
JK09K	Pan Mnt Pwr Skt 2.1	£1.90		£2.29

2.1mm PCB Mounting DC Socket



A DC power socket, with break contact, designed for soldering to a PCB. Rated 2A 50Vac max.

Order Code	Mod: 001408	Price each exc. VAT	inc. VAT each	
		1+	5+	
RK37S	PC Mtg Power Socket	£1.74	£1.39	£2.09

2.5 X 5.5mm DC Chassis Socket



A plastic-bodied 2.5mm DC power socket with break contact. Suits 2.5 x 5.5mm DC plugs. Fixing centres: 15.5mm, hole diameter: 2.5mm.

Order Code	Mod: 001415	Price each exc. VAT	inc. VAT each	
		1+	5+	
FT97F	Plas 2.5 Chas Skt	£1.49	£1.19	£1.79

Technical Helpline

0333 400 9500

For technical information and assistance relating to any Maplin purchase, contact our team of experts

2.5 X 5.5mm Single Hole Fixing DC Socket



A 2.5mm DC power socket with break contact that suits 2.5 x 5.5mm DC plugs. Requires a single 8mm panel cut-out. Overall size: 21 x 11mm diameter

Order Code	Mod: 001416	Price each exc. VAT		inc. VAT each
		1+	5+	
JK10L	Pan Mnt Pwr Skt 2.5	£1.90		£2.29

2.5mm PCB Mounting DC Socket



A DC power socket, with break contact, designed for soldering to a PCB. Rated 5A 24Vdc max

Order Code	Mod: 001419	Price each exc. VAT		inc. VAT each
		1+	5+	
FK06G	PCB 2.5mm DC Pwr Skt	£1.65	£1.32	£1.99

Power Din Connectors



- A range of high power multi-pole din connectors
- Ideal for assembling power supply and battery charger leads
- PCB socket and inline plug available
- 4 pin and 3 pin versions available
- 20Vdc at 7.5A max
- Cable size 6.5mm

Note: 3 pin version has 2 full power pins and one low pin for data or small signals at 1A

Order Code	Mod: 612338	Price each exc. VAT		inc. VAT each
		1+	5+	
N83KT	PowerDin 3pin Plug	£1.40		£1.69
N84KT	PowerDin 4pin Plug	£1.65		£1.99
N85KT	PowerDin 3pin Ch Soc	£0.90		£1.09
N86KT	PowerDin 4pin Ch Soc	£0.90		£1.09

CN40 High Power Solar Connectors



- A range of self locking connectors used in photo voltaic solar panel installations
- Chassis and line versions for male and female

connections

- Designed for 4mm²²
- Line connectors incorporate a seating gland
- Rated to IP67
- Connector rating up to 25A
- Terminal copper, tin plated

	N52LN	N53LN
Type Name or Model No.	CN40-B038	CN40-B039
Rated Voltage	TUV 1000V DC	TUV 1000V DC
Connector Rating Current	25A	25A
Suitable cable cross sections	4.0-6.0mm	4.0-6.0mm
Pin dimensions	F4.0mm	F4.0mm
Dielectric voltage withstand	6000V AC	6000V AC
Pollution degree	2	2
Over voltage category	III	III
Protection class	Class II	Class II
RTI housing material	105 °C(of enclosure material)	
Contact Resistance	5M Ω	5M Ω
Connector Material	PPO	PPO
Degree of Protection	IP67(IEC 60529)	IP67(IEC 60529)
Withdrawal Force(Connector)	50n	50n
Insertion Force(Connector)	50n	50n
Temperature Range	-40°C~+85°C	-40°C~+85°C
Flame Class	UL94V-0	UL94V-0

	N54LN	N55LN
Type Name or Model No.	CN40-A019	CN40-A020
Rated Voltage	TUV 1000V DC	TUV 1000V DC
Connector Rating Current	25A	25A
Suitable cable cross sections	4.0-6.0mm	4.0-6.0mm
Pin dimensions	F4.0mm	F4.0mm
Dielectric voltage withstand	6000V AC	6000V AC
Pollution degree	2	2
Over voltage category	III	III
Protection class	Class II	Class II
RTI housing material	105 °C(of enclosure material)	
Contact Resistance	5M Ω	5M Ω
Connector Material	PPO	PPO
Degree of Protection	IP67(IEC 60529)	IP67(IEC 60529)
Withdrawal Force(Connector)	50n	50n
Insertion Force(Connector)	50n	50n
Temperature Range	-40°C~+85°C	-40°C~+85°C
Flame Class	UL94V-0	UL94V-0

Order Code	Mod: 625361	Price each exc. VAT		inc. VAT each
		1+	5+	
N52LN	Solar Chass 4mm Male	£2.07	£1.86	£2.49
N53LN	Solar Chass 4mm Fema	£2.07	£1.86	£2.49
N54LN	Solar Line 4mm Male	£2.15	£1.72	£2.59
N55LN	Solar Line 4mm Fema	£2.15	£1.72	£2.59

IP Rated Mains Connectors

IP68 TeeTube Connectors

ORDER IN STORE OR ONLINE [N84LJ & N89LJ]



- A range of IP68 rated external connections
- Wide cable acceptance range
- Tough Polyamide construction
- Safe, convenient and simple to install
- Maximum 32A current

	N83LJ	N84LJ	N89LJ
Number of poles	3	5	3
Cable entry	2	2	3
Overall Length (mm)	115	130	73
Max Diameter (mm)	26.5	32	32
Cable Diameter (mm)	5-13	8-17	5-13.5
Current Rating	32A	32A	32A
Maximum Voltage	450V	450V	250V
Maximum Conductor Size	4mm ²	4mm ²	4mm ²
IP68 Pressure Rating	5 bar	5 bar	2 bar

Order Code	Mod: 625605	Price each exc. VAT		inc. VAT each
		1+	5+	
N83LJ	TeeTube M20 3P IP68	£6.15		£7.39
N84LJ	TeeTube M25 5P IP68	£6.74		£8.09
N89LJ	TeeTube 3Way 3P IP68	£8.32	£7.49	£9.99

TeePlug IP68 Plug and Socket

ORDER IN STORE OR ONLINE [N88LJ & N87LJ]



- Easy to use, fast assembly 3 and 5 pole plug and socket connector
- Keyway protected to prevent incorrect assembly
- Environmentally protected to IP68
- Polyamide construction

	N88LJ	N87LJ	N86LJ
Number of poles	5	3	3
Type	Line/Line	Line/Line	*
Overall Length (mm)	130	130	95
Max Diameter (mm)	36.5	36.5	27
Cable Diameter (mm)	5-14	5-14	7-9.5
Current Rating	16A	24A	16A
Maximum Voltage	400V	400V	400V
Maximum Conductor Size	1.5mm ²	2.5mm ²	1.5mm ²
IP68 Pressure Rating	0.5 bar	0.5 bar	0.5 bar

* N86LJ - Dual Mount, Line/Chassis or Line/Line

Order Code	Mod: 625607	Price each exc. VAT		inc. VAT each
		1+	5+	
N88LJ	TeePlug 5P Inline	£14.15	£12.74	£16.99
N87LJ	TeePlug 3P Inline	£12.49	£11.24	£14.99
N86LJ	TeePlug 3P Line/Chas	£11.65	£9.32	£13.99

Hylec APL 24A IP67 TeeBox 3 Pole Mains Connector



- 3 way, 3 pole IP67 connector
- Wide cable acceptance range
- Tough Polyamide construction
- Safe, convenient and simple to install
- Maximum 24A current

	N85LJ
Number of poles	3
Overall Length (mm)	82
Width (mm)	70
Cable Diameter (mm)	4-9.5mm
Current Rating	24A
Maximum Voltage	450V
Maximum Conductor Size	4mm

Order Code	Mod: 625609	Price each exc. VAT		inc. VAT each
		1+	5+	
N85LJ	TeeBox 3Way 3P IP67	£6.15		£7.39

Battery Connectors

Battery Connectors

- Ideal to make your own racing battery packs
- Standard latching connections with tails
- High temperature silicone insulated red and black wire
- Males have the pins and connect to the battery, females have the sockets and connected to the charger or model

Order Code	Mod: 001397	Price each exc. VAT		inc. VAT each
		1+	5+	
JG04E	Race Pk Lead Male	£2.82	£2.26	£3.39
JG05F	Race Pk Lead Female	£2.82	£2.26	£3.39

Kyosho Race Pack Connector



- Comprising 2 crimp/solder terminals and 1 housing
- Ideal for assembly of custom cables (use BJ40T/BJ41U 32A silicone wire - see cut cable section in the catalogue)
- Also for replacement of broken/damaged connectors on motors, speed controllers, battery packs etc

Connector

Voltage Rating V AC:	300V		
Current Rating:	15A		
Temperature Rating:	-25 to +90°C		
Contact Resistance:	15mΩ		
Wire dia.:	0.2 to 2mmSUP2		
Order Code	Mod: 011474	Price each exc. VAT 1+	inc. VAT each
G2986	Kyosho Connector	£2.32	£2.79

Tamiya Race Pack Connector



- Comprising 2 crimp/solder terminals and 1 housing
- Ideal for assembly of custom cables (use BJ40T/BJ41U 32A silicone wire - see cut cable section in the catalogue)
- Also for replacement of broken/damaged connectors on motors, speed controllers, battery packs etc

Connector

Voltage Rating V AC:	300V		
Current Rating:	15A		
Temperature Rating:	-25 to +90°C		
Contact Resistance:	15mΩ		
Wire dia.:	0.2 to 2mmSUP2		
Order Code	Mod: 011455	Price each exc. VAT 1+	inc. VAT each
G299H	Tamiya Connector	£2.32	£2.79

30A Insulated Battery Clips



- Heavy duty battery clips
- 30A current
- 74mm long, 15mm maximum gap

Large, heavily-sprung clip for use with battery chargers etc. Overall length 74mm; maximum diameter of terminal that can be encompassed 15mm; maximum gap between teeth of jaws when fully opened 10mm. Current rating 30A with very thick PVC insulating cover available in red or black.

Order Code	Mod: 001061	Price each exc. VAT 1+	inc. VAT each
F584T	Large Batt Clip Red	£1.99	£1.59
F587U	Large Batt. Clip Blk	£1.99	£1.59

50A Insulated Battery Clips



Extra-large, heavily-sprung battery clips for connecting to lead-acid batteries. Overall length 110mm; maximum diameter of terminal that can be encompassed 40mm; maximum gap between teeth of jaws when fully opened 25mm. Current rating 50A with very thick PVC insulating cover available in red or black.

Order Code	Mod: 045675	Price each exc. VAT 1+	inc. VAT each
L96BG	50A Battery Clip Red	£2.82	£2.26
L97BG	50A Battery Clip Blk	£2.82	£2.26

Reserve online, collect in-store in 30 minutes

Crocodile Clips

Rolson 24 Part Alligator Clip Assortment



- Make your own low-voltage jumper leads
- Repair broken leads on test equipment and chargers

Contents		Quantity	
Mini alligator clips (uninsulated)		8	
2 inch alligator clip red		2	
2 inch alligator clip black		2	
30 amp charging clip set		1 pair	
25 amp charging clip set		1 pair	
1&half, inch alligator clip red		3	
1&half, inch alligator clip black		3	
10 amp charging clip set		1 pair	
Order Code	Mod: 218252	Price each exc. VAT 1+	inc. VAT each
N02CT	24 Pc Elect. Clips	£3.65	£2.92

Insulated Crocodile Clips



A range of crocodile clips with insulating vinyl covers. Clips are 30mm long and overall length with sleeve is 40mm. Available in six colours - red, black, yellow, green, white and blue.

Order Code	Mod: 001057	Price each exc. VAT 1+	inc. VAT each
FM37S	Red Croc Clip	£1.40	£1.69
FK34M	Black Croc Clip	£1.40	£1.69
FK35Q	Yellow Croc Clip	£1.40	£1.69
FK36P	Green Croc Clip	£1.40	£1.69
FK37S	White Croc Clip	£1.40	£1.69
FM11M	Blue Croc Clip	£1.40	£1.69

Gold-Plated Insulated Crocodile Clips



Gold-plated crocodile clips with insulating vinyl covers. Clips are 30mm long and overall length with sleeve is 40mm. Available in two colours: red and black.

Order Code	Mod: 045708	Price each exc. VAT 1+	inc. VAT each
FS54J	Gold Croc Clip Red	£1.74	£1.39
FS55K	Gold Croc Clip Black	£1.74	£1.39

Large Insulated Crocodile Clips

Crocodile clips with insulating vinyl covers. Clips are 50mm long and overall length with sleeve is 60mm. The cable termination of the clip is formed so that a 4mm plug can be inserted into the back of the plug. Available in red and black.

Order Code	Mod: 001059	Price each exc. VAT 1+	inc. VAT each
HF24B	Large Croc Clip Red	£1.49	£1.19
HF23A	Large Croc Clip Black	£1.49	£1.19

Test Connectors

2mm Plug



2mm plug with solder-bucket termination and screw-on plastic body. Overall length 14mm, pin length 9mm and body diameter 5mm, available in red and black.

Order Code	Mod: 001427	Price each exc. VAT 1+	inc. VAT each
HF41U	2mm Plug Red	£1.07	£0.86
HF38R	2mm Plug Black	£1.07	£0.86

2mm Socket



2mm socket, designed to be panel-mounted. Overall length, including solder tag, is 24mm; requires a 6mm mounting hole. Available in red and black.

Order Code	Mod: 001429	Price each exc. VAT 1+	inc. VAT each
HF44X	2mm Socket Black	£1.07	£0.86
HF47B	2mm Socket Red	£1.07	£0.86

Buying for business?
0333 400 9740

Reserve online and collect at the store of your choice

Long 4mm Plugs



A 4mm plug with sprung, nickel-plated pin to ensure good contact. Pin is 18mm long and overall length is 55mm; available in black and red.

Order Code	Mod: 045775	Price each exc. VAT		inc. VAT each
		1+	5+	
L18BH	4mm Long Plug Red	£1.40	£1.12	£1.69
L19BH	4mm Long Plug Black	£1.40	£1.12	£1.69

4mm "Banana" Plug



A 4mm plug suitable for use with the 4mm sockets below. Sprung plug ensures good contact with socket. Available with red and black handles. Overall length 50mm. Pin length 15mm. Overall diameter 11mm.

Order Code	Mod: 001434	Price each exc. VAT		inc. VAT each
		1+	5+	
JB24B	Banana Plug Red	£1.40		£1.69
JB25C	Banana Plug Black	£1.40		£1.69

4mm Plugs



A 4mm plug with sprung, nickel-plated pin to ensure good contact. Pin is 15mm long and overall length is 43mm. Available with colour-coded sleeve in the following colours: black, blue, green, red and yellow. These plugs are suitable for use with the 4mm sockets, below

Order Code	Mod: 045987	Price each exc. VAT		inc. VAT each
		1+	5+	
L20BH	4mm Plug Black	£1.24	£0.99	£1.49
L21BH	4mm Plug Blue	£1.24	£0.99	£1.49
L22BH	4mm Plug Green	£1.24	£0.99	£1.49
L23BH	4mm Plug Red	£1.24	£0.99	£1.49
L25BH	4mm Plug Yellow	£1.24	£0.99	£1.49

Stackable 4mm Plugs



4mm banana plugs which have an integral 4mm socket allowing plugs to be stacked one into another. The sprung contact ensures good electrical connection with the socket. Available in black & red.

Order Code	Mod: 001442	Price each exc. VAT		inc. VAT each
		1+	5+	
JM00A	Stack Plg 4mm Black	£1.65		£1.99
JM45Y	Stack Plg 4mm Red	£1.57		£1.89

Right Angle 4mm Banana Plug



- 4mm gold plated banana plug
- Accepts up to 4mm diameter cable
- Offers a right angle solution for test lead construction
- Available in red or black
- Screw terminal connection

Order Code	Mod: 507937	Price each exc. VAT		inc. VAT each
		1+	5+	
N08JN	4mm Plug RA Screw BL	£2.15		£2.59
N07JN	4mm Plug RA Screw RD	£2.15		£2.59

Right Angle in-line 4mm Banana Socket



- Gold plated right angle 4mm socket
- For cable up to 5.5mm diameter
- Accepts standard banana plugs
- Fully insulated terminal
- Screw terminal for easy connections

Order Code	Mod: 507935	Price each exc. VAT		inc. VAT each
		1+	5+	
N10JN	4mm Skt RA Screw BL	£1.82	£1.46	£2.19
N09JN	4mm Skt RA Screw RD	£1.82	£1.46	£2.19

4mm Sockets



- 4mm panel-mounting sockets
- Available in black, blue, green, red, white and yellow to complement our 4mm plugs

Specifications:

Rated current	6A
Rated voltage	AC 30 V, DC 60 V
Insulation resistance	<3MΩ
Operational temp	-25° - 75°C
Bezel diameter:	11mm
Length:	17mm(excluding solder tag)
Cut out	8mm
Maximum panel thickness	6.5mm

Order Code	Mod: 034962	Price each exc. VAT		inc. VAT each
		1+	5+	
N32AP	4mm Socket Black	£1.24	£0.99	£1.49
N33AP	4mm Socket Blue	£1.24	£0.99	£1.49
N34AP	4mm Socket Green	£1.15	£1.04	£1.39
N35AP	4mm Socket Red	£1.24	£0.99	£1.49
N36AP	4mm Socket White	£1.77		£2.77
N37AP	4mm Socket Yellow	£1.24	£0.99	£1.49

Terminal Post with Small Handle



- Nickel-plated brass terminal post rated 15A at 250V
- 4mm top socket and 2.1mm diameter hole in post

- Knob size: 14mm x 11.5mm diameter
- Fits panels from 0.9mm to 5mm (20swg to 6swg) thickness

Order Code	Mod: 001075	Price each exc. VAT		inc. VAT each
		1+	5+	
FD69A	Small Term Post Blk	£1.74	£1.39	£2.09
FD72P	Small Term Post Red	£1.90	£1.52	£2.29

Terminal Post with Large Handle



Nickel-plated terminal posts, one with a red and one with a black knob. Each post has a 4mm top socket and a 2.1mm dia hole in the post. Knob size 16.5 x 12.5mm dia. Fits panels up to 3mm thick. Post shaft requires a 5mm dia hole.

Order Code	Mod: 034722	Price each exc. VAT		inc. VAT each
		1+	5+	
NS0AQ	Terminal Post Red	£1.90	£1.52	£2.29
NS1AQ	Terminal Post Black	£1.90	£1.52	£2.29

Maplin Grounding Post with Socket



- Grounding (terminal) post for equipment where a connection needs to be made to the earthed case, e.g. power supplies
- Nickel brass
- Central hole accepts a 4mm plug and a 2mm hole in the post
- Requires a 5.5mm mounting hole
- Dimensions: 21mm x 10mm diameter
- Supplied with locking washer, solder tag and 2 nuts

Order Code	Mod: 001081	Price each exc. VAT		inc. VAT each
		1+	5+	
JL99H	Grounding Post	£1.74	£1.39	£2.09

4mm Patch Cord



50cm [20in.] long patch cords for setting up test gear etc., comprising an extra flexible wire terminated at each end with a piggy-back 4mm plug and integral socket. Any number of these can be stacked. Each plug pin is 18mm long and has high quality sprung contacts. Available in black and red.

Order Code	Mod: 001443	Price each exc. VAT		inc. VAT each
		1+	5+	
ZB25C	4mm Patch Cord Blk	£2.74	£2.19	£3.29
ZB27E	4mm Patch Cord Red	£2.74	£2.19	£3.29

Buying for education?
0333 400 9740



Crimp Connectors

Eyelets & Fork Crimps

Uninsulated Ring and Spade Crimp Terminals



- Tin-plated copper crimp terminals with solder-filled seams
- Suitable for wires from 0.4mm to 1.0mm
- Wire entry 1.7mm inside diameter, 3.3mm outside diameter
- Terminal thickness 0.8mm

Order Code	Type	Int dia (mm)	Length (mm)	Suits bolts (mm / BA)
JH60Q	Eyelet	3.2/5.5	11.2	3/6
JH61R	Eyelet	4.3/8	15.5	4/4
JH62S	Eyelet	5.3/8	15.5	5/2
JH63T	Eyelet	6.4/11.6	21.3	6/0
JH66W	Spade	5.3/8	16	5/2

Supplied in packs of 10

Order Code	Mod: 047682	Price each exc. VAT 1+	5+	inc. VAT each
JH60Q	Eyelet 3.2mm	£1.32	£1.06	£1.59
JH61R	Eyelet 4.3mm	£1.32	£1.06	£1.59
JH62S	Eyelet 5.3mm	£1.32	£1.06	£1.59
JH63T	Eyelet 6.4mm	£1.32	£1.06	£1.59
JH66W	Spade 5.3mm	£1.32	£1.06	£1.59

Insulated Crimp Terminals - Eyelets



Tin-plated copper with vinyl-PVC insulation. The red types are suitable for cable from 0.4 to 1.0mm, the blue 1.1 to 2.6mm and the yellow 2.5 to 6.5mm

Order Code	Type	Int dia (mm)	Length (mm)	Suits bolts (mm / BA)
JH67X	Red	3.2	15.7	3/6
JH68Y	Red	4.3	20	4/3
JH69A	Red	5.3	20	5/2
JH70M	Red	6.4	25.8	6/0
JH71N	Blue	4.3	21	4/3
JH72P	Blue	5.3	21.5	5/2
JH73Q	Blue	6.4	26	6/0
ML91Y	Yellow	4.3	26.8	4/3
ML92A	Yellow	5.3	26.8	5/2
ML93B	Yellow	6.4	30.3	6/0

Supplied in packs of 10.

Order Code	Mod: 042711	Price each exc. VAT 1+	5+	inc. VAT each
JH67X	Ins. Eyelet Red 3.2mm	£1.40	£1.12	£1.69
JH68Y	Ins. Eyelet Red 4.3mm	£1.40	£1.12	£1.69
JH69A	Ins. Eyelet Red 5.3mm	£1.40	£1.12	£1.69
JH70M	Ins. Eyelet Red 6.4mm	£1.40	£1.12	£1.69
JH71N	Ins. Eyelet Blue 4.3	£1.65	£1.32	£1.99
JH72P	Ins. Eyelet Blue 5.3	£1.65	£1.32	£1.99
JH73Q	Ins. Eyelet Blue 6.4	£1.65	£1.32	£1.99
ML91Y	Ins. Eyelet Yel 4.3mm	£1.40	£1.12	£1.69
ML92A	Ins. Eyelet Yel 5.3mm	£1.40	£1.12	£1.69
ML93B	Ins. Eyelet Yel 6.4mm	£1.40	£1.12	£1.69

Insulated Crimp Terminals - Spades



Tin-plated copper with vinyl-PVC insulation. The red types are suitable for cable from 0.4 to 1.0mm, the blue 1.1 to 2.6mm and the yellow 2.5 to 6.5mm.

Order Code	Type	Int dia (mm)	Length (mm)	Suits bolts (mm / BA)
JH74R	Red	3.7	20.5	3.5/4
JH75S	Red	4.3	20.5	4/3
JH77J	Blue	4.3	20.5	4/3
ML90X	Yellow	6.4	30.3	6/0

Supplied in packs of 10

Order Code	Mod: 042715	Price each exc. VAT 1+	5+	inc. VAT each
JH74R	Ins Spade Red 3.7mm	£1.40	£1.12	£1.69
JH75S	Ins Spade Red 4.3mm	£1.40	£1.12	£1.69
JH77J	Ins Spade Blue 4.3mm	£1.65	£1.32	£1.99
ML90X	Ins Spade Yell 6.4mm	£1.49	£1.19	£1.79

Gel Connectors

2 Way Jelly Crimp Connectors 100 Pack



- Quick and efficient way to splice two wires
- Integrated Gel gives robust moisture barrier and chemical resistance
- IDC contact blade makes the connection, no need to strip wires
- Based on the Scotchlock Jelly Crimp used extensively in the Telecoms industry
- Ideal for BT CW1308 and similar solid core network data cables
- Insert the wires into each whole press down on the top

Order Code	Mod: 1026823	Price each exc. VAT 1+	5+	inc. VAT each
N72DV	LJ8A 2Way Gel 100Pk	£4.24		£5.09

3 Way Jelly Crimp Connectors 100 Pack

ORDER IN STORE OR ONLINE



- Quick and efficient way to splice three wires

- Integrated Gel gives robust moisture barrier and chemical resistance
- IDC contact blade makes the connection, no need to strip wires
- Based on the Scotchlock Jelly Crimp used extensively in the Telecoms industry
- Ideal for BT CW1308 and similar solid core network data cables
- Insert the wires into each whole press down on the top

Order Code	Mod: 1026824	Price each exc. VAT 1+	5+	inc. VAT each
N73DV	LJ8B 3Way Gel 100Pk	£7.49	£6.74	£8.99

Bullet Crimps

Insulated Crimp Terminal - Butt Splices



Tin-plated copper with vinyl-PVC insulation. The red types are suitable for cable from 0.4 to 1.0mm, the blue 1.1 to 2.6mm and the yellow 2.5 to 6.5mm

Order Code	Type	Length [mm]
JH79L	Red	25
JH80B	Blue	25
ML87U	Yellow	27.5

Supplied in packs of 10

Order Code	Mod: 042718	Price each exc. VAT 1+	5+	inc. VAT each
JH79L	Ins Butt Red	£1.74	£1.39	£2.09
JH80B	Ins Butt Blue	£1.74	£1.39	£2.09
ML87U	Ins Butt Yell	£1.74	£1.39	£2.09

Insulated Crimp Terminal - Bullet Plugs



Tin-plated brass with vinyl-PVC insulation. The red types are suitable for cable from 0.4 to 1.0mm, the blue 1.1 to 2.6mm and the yellow 2.5 to 6.5mm

Order Code	Type	Length [mm]
JH85G	Red	21
JH86T	Blue	21
ML85G	Yellow	25

Supplied in packs of 10

Order Code	Mod: 042722	Price each exc. VAT 1+	5+	inc. VAT each
JH85G	Ins Bullet Red	£1.74	£1.39	£2.09
JH86T	Ins Bullet Blue	£1.74	£1.39	£2.09
ML85G	Ins Bullet Yell	£1.74	£1.39	£2.09

Find out more in-store

Our staff can offer friendly and expert advice; we're here to help



Insulated Crimp Terminal - Bullet Sockets



- Tin-plated brass with vinyl-PVC insulation.
- Red types are suitable for cable from 0.4 to 1.0mm, blue 1.1 to 2.6mm and yellow 2.5 to 6.5mm
- Supplied in packs of 10

Order Code	Type	Length (mm)
JH83E	Red	23
JH84F	Blue	23
ML86T	Yellow	25

Order Code	Mod: 042724	Price each 1+	exc. VAT 5+	inc. VAT each
JH83E	Ins Bullet Skt Red	£1.74	£1.39	£2.09
JH84F	Ins Bullet Skt Blue	£1.74	£1.39	£2.09
ML86T	Ins Bullet Skt Yell	£1.74	£1.39	£2.09

Blade Crimps

Maplin Miniature Male Spade Connector 10 pack



- Ideal for small interconnects and small PCB where space is at a premium
- Perfect for repairing small wiring looms
- Tin-plated brass terminals with VINYL-PVC insulated shroud enclosing the cable crimp section
- Suitable for cables between 26AWG (0.4mm dia.) and 22AWG (0.64mm dia.)
- Overall length 19.2mm and width 3.8mm
- Can be used with the female counterpart N22AN

Order Code	Mod: 388515	Price each 1+	exc. VAT 5+	inc. VAT each
N10HU	Min Spade Male 10pcs	£1.65	£1.49	£1.99

Maplin Miniature Female Spade Connector 10 pack



- Ideal for small interconnects and small PCB where space is at a premium.
- Tin-plated brass terminals with vinyl-PVC insulated shroud enclosing the cable crimp section
- Suitable for cables between 26AWG (0.4mm dia.) and 22AWG (0.64mm dia.)
- Overall length 16.7mm and width 3.7mm
- Can be used with the male counterpart N10HU

Order Code	Mod: 034145	Price each 1+	exc. VAT 5+	inc. VAT each
N22AN	Min Spade Female	£1.65	£1.49	£1.99



Browse our entire range at maplin.co.uk

Intermediate Size Insulated Crimp Terminal - 'Lucar' Female



- Intermediate size - fits many switch terminals for ease of connection and disconnection
- Tin-plated brass with vinyl-PVC insulation
- Red type suitable for cable diameter 0.4mm to 1.0mm
- Blue type suitable for cable diameter 1.1mm to 2.6mm
- Length: 21mm
- Supplied in packs of 10 pieces

Order Code	Mod: 219181	Price each 1+	exc. VAT 5+	inc. VAT each
N35CY	4.8mm Lucar Fem Blue	£1.74	£1.39	£2.09
N36CY	4.8mm Lucar Fem Red	£1.74	£1.39	£2.09

Insulated Crimp Terminal - 'Lucar' Female



- Standard $\frac{1}{4}$ inch, 6.35mm crimp receptacle
- Tin plated brass with vinyl PVC insulation
- Maximum voltage 300V
- Ideal for a variety of electrical terminations and repairs

Supplied in packs of 10

Specifications:

Order Code	Type	Length [mm]	Current	Typical Cable Sizes
JH87U	Red	21	4A	0.4 to 1.0mm
JH88V	Blue	21	6A	1.1 to 2.6mm
ML84F	Yellow	23	12A	2.5 to 6.5mm

Order Code	Mod: 042725	Price each 1+	exc. VAT 5+	inc. VAT each
JH87U	Lucar Female Red	£1.65	£1.32	£1.99
JH88V	Lucar Female Blue	£1.65	£1.32	£1.99
ML84F	Lucar Female Yellow	£1.65	£1.32	£1.99

Insulated Crimp Terminal - 'Lucar' Male



- Standard $\frac{1}{4}$ inch, 6.35mm crimp terminal
- Tin plated brass with vinyl PVC insulation
- Maximum voltage 300V
- Ideal for a variety of electrical terminations and repairs

Supplied in packs of 10

Specifications:

Order Code	Type	Length [mm]	Current	Typical Cable Sizes
JH89W	Red	21	4A	0.4 to 1.0mm
JH90X	Blue	21	6A	1.1 to 2.6mm
ML82D	Yellow	23	12A	2.5 to 6.5mm

Order Code	Mod: 042727	Price each 1+	exc. VAT 5+	inc. VAT each
JH89W	Lucar Male Red	£1.65	£1.32	£1.99
JH90X	Lucar Male Blue	£1.65	£1.32	£1.99
ML82D	Lucar Male Yellow	£1.65	£1.32	£1.99

Fully Insulated Crimp Terminal - 'Lucar' Female



- Standard $\frac{1}{4}$ inch, 6.35mm spade receptacle
- Tin-plated brass with vinyl-PVC insulation.
- Ideal for automotive applications
- Supplied in packs of 10

Order Code	Type	Length [mm]	Cable Diameter [mm]
JH81C	Red	21.5	0.4 to 1.0
JH82D	Blue	21.5	1.1 to 2.6
ML83E	Yellow	23	2.5 to 6.5

Order Code	Mod: 042728	Price each 1+	exc. VAT 5+	inc. VAT each
JH81C	Ins Lucar Fem Red	£1.74	£1.39	£2.09
JH82D	Ins Lucar Fem Blue	£1.74	£1.39	£2.09
ML83E	Ins Lucar Fem Yellow	£1.74	£1.39	£2.09

'Lucar' Piggy-Back Connectors



Crimp terminal receptacle with a blade terminal angled from the front, allowing another receptacle to be 'piggy-backed' onto the connector. Tin-plated brass with vinyl-PVC insulation. The red types are suitable for cable from 0.4 to 1.0mm, the blue 1.1 to 2.6mm and the yellow 2.5 to 6.5mm

Order Code	Type	Length [mm]
L26AY	Red	23
L27AY	Blue	23
L28AY	Yellow	23

Supplied in packs of 10.

Order Code	Mod: 042729	Price each 1+	exc. VAT 5+	inc. VAT each
L26AY	Piggy-Back Red 10pk	£1.99	£1.59	£2.39
L27AY	Piggy-Back Blue 10pk	£1.99	£1.59	£2.39
L28AY	Piggy-Back Yell 10pk	£1.99	£1.59	£2.39

Maplin Uninsulated Spade Terminal Female Connector



Tin-plated brass crimp or solder $\frac{1}{4}$ " (6.35mm) receptacle

Supplied in packs of ten

Order Code	Mod: 001070	Price each 1+	exc. VAT 5+	inc. VAT each
HF10L	Push-On Receptacle	£1.57	£1.26	£1.89

Maplin Uninsulated Spade Terminal Male Connector



PCB Connectors

PCB Terminal Connectors

0.1Inch Series Straight Plug PCB Header

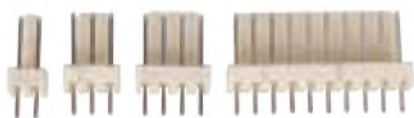

- These connectors are intended as a simple and inexpensive method of making cable to printed circuit board connections
- The pins are at standard 0.1inch (2.54mm) pitch

The header plugs are designed primarily for accepting the matching sockets below allowing cables to be plugged on to circuit boards or circuit boards to be plugged together. The pins protrude 3.4mm from the base and require 1mm diameter holes for soldering to the PCB. The pins are 7.5mm long above the base and the header features a locking and polarising clip. Both plugs and sockets may be butted up end-to-end to form connectors with any number of ways from two upwards. Rated: 2.5A, AC 250 V.

Type:	Length [mm]:
2-way	3.5
3-way	7
4-way	9.5
10-way	24.5

Order Code	Mod: 001487	Price each exc. VAT 1+	5+	inc. VAT each
RK65V	PCB Latch Pl 2w	£0.66	£0.53	£0.80
BX96E	PCB Latch Pl 3w	£0.47	£0.38	£0.57
YW11M	PCB Latch Pl 4w	£0.82	£0.66	£0.99
RK66W	PCB Latch Pl 10w	£1.07	£0.86	£1.29

0.1" Series Socket Housing

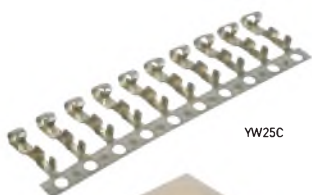

YW25C



BX97F



FY94C



HB58N

A series of sockets that will connect to the 0.1" series PCB plugs. To assemble, solder metal PCB terminals to the

end of your wires and then insert them into the housing, where they lock in securely. This forms a polarised connector that will connect only one way round on the matching PCB header plug. Housings are available from 2 to 10 ways to match the plugs. The metal PCB terminals are sold separately in strips of 10 [Order Code YW25C].

Order Code	Mod: 001490	Price each exc. VAT 1+	5+	inc. VAT each
YW25C	0.1in Slt Terminals	£0.99	£0.79	£1.19
HB59P	PCB Latch Hsng 2-Way	£0.66	£0.53	£0.80
BX97F	PCB Latch Hsng 3-Way	£0.70	£0.55	£0.84
HB58N	PCB Latch Hsng 4-Way	£0.83		£1.00
FY94C	PCB Latch Hsng 10-Way	£1.07	£0.86	£1.29

PCB Terminal Block

16A PCB-Mounting Terminal Blocks



- 5mm pitch, 16A rated
- Rising clamp cable entry
- Interlocking facility for connecting multiple connectors

Available in 2-way and 3-way versions that can be interlinked to make any number way. The 16A rating means these terminal blocks are able to carry any current from 0 to 16 amps.

Specifications:

PCB hole size	1.3mm
Pitch	5mm
Max. cable size	
stranded:	2.5mm
solid:	4mm
Nominal voltage:	250V
Nominal current:	16A

Order Code	Mod: 030049	Price each exc. VAT 1+	5+	inc. VAT each
RH76H	2W 16A Vert 5mm	£1.24	£0.99	£1.49
RH77J	3W 16A Vert 5mm	£1.24	£0.99	£1.49

0.2" Pitch PCB-Mounting Terminal Blocks



- 0.2" (5.08mm) pitch, rated 16A
- Rising clamp cable entry
- Interlocking facility for connecting multiple connectors

Available in 2-way and 3-way versions that can be interlinked to create any number way.

Specifications:

PCB hole size	1.3mm
Pitch	5.08mm [0.2"]
Max. cable size	
Stranded	2.5mm
Solid	4mm
Nominal voltage:	250V
Nominal current:	16A

Order Code	Mod: 030050	Price each exc. VAT 1+	5+	inc. VAT each
RH80B	2W 16A Vert 5.08mm	£1.24	£0.99	£1.49
RH81C	3W 16A Vert 5.08mm	£1.24	£0.99	£1.49

13.5A PCB Mounting Vertical Terminal Blocks 3.5mm

ORDER IN STORE OR ONLINE



- 3.5mm Pitch
- Available as 2 or 3 Pole
- 13.5 Amps

PCB terminals can be used in all sorts of applications and are the perfect way to connect wires safely. With a range of different pitch and poles Maplin will have the right terminal block for your application. Common applications include CCTV, Electrical Repair and many more.

Order Code

No. of Poles
A50QL 2
A51QL 3

Order Code	Mod: 1032715	Price each exc. VAT 1+	inc. VAT each
A51QL	PCBTer 3P 3.5mm	£1.15	£1.39
A50QL	PCBTer 2P 3.5mm	£0.82	£0.99

13.5A PCB Mounting Vertical Terminal Blocks 3.81mm

ORDER IN STORE OR ONLINE



- 3.81mm Pitch
- Available as 2 or 3 Pole
- 13.5 Amps

PCB terminals can be used in all sorts of applications and are the perfect way to connect wires safely. With a range of different pitch and poles Maplin will have the right terminal block for your application. Common applications include CCTV, Electrical Repair and many more.

Order Code

No. of Poles
A52QL 2
A53QL 3

Order Code	Mod: 1032716	Price each exc. VAT 1+	inc. VAT each
A53QL	PCBTer 3P 3.81mm	£1.07	£1.29
A52QL	PCBTer 2P 3.81mm	£0.82	£0.99

17.5A PCB Mounting Vertical Terminal Blocks Cage Clamp 5mm

ORDER IN STORE OR ONLINE



- 5mm Pitch
- Available as 2 or 3 Pole 17.5 Amps

- Cage Clamp
- Vertical

PCB terminals can be used in all sorts of applications and are the perfect way to connect wires safely. With a range of different pitch and poles Maplin will have the right terminal block for your application. Common applications include CCTV, Electrical Repair and many more.

Order Code	No. of Poles
A54QL	2
A55QL	3

Order Code	Mod: 1032717	Price each exc. VAT 1+	inc. VAT each
A55QL	PCBTer 3P 5mm	£0.82	£0.99
A54QL	PCBTer 2P 5mm	£0.57	£0.69

24A PCB Mounting Vertical Terminal Blocks Rising Clamp 5mm

ORDER IN STORE OR ONLINE



- 5mm Pitch
- Available as 2 or 3 Pole
- 24 Amps
- Rising Clamp
- Vertical

PCB terminals can be used in all sorts of applications and are the perfect way to connect wires safely. With a range of different pitch and poles Maplin will have the right terminal block for your application. Common applications include CCTV, Electrical Repair and many more.

Order Code	No. of Poles
A56QL	2
A57QL	3

Order Code	Mod: 1032720	Price each exc. VAT 1+	inc. VAT each
A57QL	PCBTer 3P 5mm	£1.24	£1.49
A56QL	PCBTer 2P 5mm	£0.90	£1.09

16A PCB Mounting Vertical Terminal Blocks Rising Clamp 5.08mm



- 5.08mm Pitch
- Available as 2,3,4 and 8 Pole
- 16 Amps
- Rising Clamp
- Vertical

PCB terminals can be used in all sorts of applications and are the perfect way to connect wires safely. With a range of different pitch and poles Maplin will have the right terminal block for your application. Common applications include CCTV, Electrical Repair and many more.

Order Code	No. of Poles
A58QL	4
A59QL	8
A60QL	2
A61QL	3

Order Code	Mod: 1032721	Price each exc. VAT 1+	inc. VAT each
A61QL	PCBTer 3P 5.08mm	£1.07	£1.29
A60QL	PCBTer 2P 5.08mm	£0.90	£1.09
A59QL	PCBTer 8P 5.08mm	£2.82	£3.39
A58QL	PCBTer 4P 5.08mm	£1.40	£1.69

32A PCB Mounting Vertical Terminal Blocks Rising Clamp 6.35mm

ORDER IN STORE OR ONLINE



- 6.35mm Pitch
- Available as 2 or 3 Pole
- 32 Amps
- Rising Clamp
- Vertical

PCB terminals can be used in all sorts of applications and are the perfect way to connect wires safely. With a range of different pitch and poles Maplin will have the right terminal block for your application. Common applications include CCTV, Electrical Repair and many more.

Order Code	No. of Poles
A62QL	2
A63QL	3

Order Code	Mod: 1032722	Price each exc. VAT 1+	inc. VAT each
A63QL	PCBTer 3P 6.35mm	£1.40	£1.69
A62QL	PCBTer 2P 6.35mm	£1.07	£1.29

16A PCB Mounting Vertical Terminal Blocks Rising Clamp 7.5mm

ORDER IN STORE OR ONLINE



- 7.5mm Pitch
- Available as 2 or 3 Pole
- 16 Amps
- Rising Clamp
- Vertical

PCB terminals can be used in all sorts of applications and are the perfect way to connect wires safely. With a range of different pitch and poles Maplin will have the right terminal block for your application. Common applications include CCTV, Electrical Repair and many more.

Order Code	No. of Poles
A64QL	2

A65QL 3

Order Code	Mod: 1032723	Price each exc. VAT 1+	inc. VAT each
A65QL	PCBTer 3P 7.5mm	£1.15	£1.39
A64QL	PCBTer 2P 7.5mm	£0.90	£1.09

24A PCB Mounting Vertical Terminal Blocks Rising Clamp 7.62mm

ORDER IN STORE OR ONLINE



- 7.62mm Pitch
- Available as 2 or 3 Pole
- 24 Amps
- Rising Clamp
- Vertical

PCB terminals can be used in all sorts of applications and are the perfect way to connect wires safely. With a range of different pitch and poles Maplin will have the right terminal block for your application. Common applications include CCTV, Electrical Repair and many more.

Order Code	No. of Poles
A66QL	2
A67QL	3

Order Code	Mod: 1032724	Price each exc. VAT 1+	inc. VAT each
A67QL	PCBTer 3P 7.62mm	£1.65	£1.99
A66QL	PCBTer 2P 7.62mm	£1.24	£1.49

57A PCB Mounting Vertical Terminal Blocks Rising Clamp 10.16mm

ORDER IN STORE OR ONLINE



- 10.16mm Pitch
- Available as 2 or 3 Pole
- 57 Amps
- Rising Clamp
- Vertical

PCB terminals can be used in all sorts of applications and are the perfect way to connect wires safely. With a range of different pitch and poles Maplin will have the right terminal block for your application. Common applications include CCTV, Electrical Repair and many more.

Order Code	Mod: 1032725	Price each exc. VAT 1+	inc. VAT each
A71QL	PCBTer 3P 10.16mm	£4.15	£4.99
A70QL	PCBTer 2P 10.16mm	£2.90	£3.49



Reserve online and collect at the store of your choice

16A PCB Mounting Vertical Double Deck Terminal Blocks Rising Clamp 5mm

ORDER IN STORE OR ONLINE



- 5mm Pitch
- Available as 2 or 3 Poles
- 16 Amps
- Rising Clamp
- Vertical
- Double Deck

PCB terminals can be used in all sorts of applications and are the perfect way to connect wires safely. With a range of different pitch and poles Maplin will have the right terminal block for your application. Common applications include CCTV, Electrical Repair and many more.

Order Code	Mod.	No. of Poles	Price each exc. VAT 1+	inc. VAT each
A72QL		2		
A73QL		3		
Order Code	Mod. 1032726		Price each exc. VAT 1+	inc. VAT each
A73QL	PCBTer 3+3 5mm		£3.32	£3.99
A72QL	PCBTer 2+2 5mm		£2.07	£2.49

16A PCB Mounting Vertical Double Deck Terminal Blocks Rising Clamp 5.08mm

ORDER IN STORE OR ONLINE



- 5.08mm Pitch
- Available as 2 or 3 Pole
- 16 Amps
- Rising Clamp
- Vertical
- Double Deck

PCB terminals can be used in all sorts of applications and are the perfect way to connect wires safely. With a range of different pitch and poles Maplin will have the right terminal block for your application. Common applications include CCTV, Electrical Repair and many more.

Order Code	Mod.	No. of Poles	Price each exc. VAT 1+	inc. VAT each
A74QL		2		
A75QL		3		
Order Code	Mod. 1032728		Price each exc. VAT 1+	inc. VAT each
A75QL	PCBTer 3+3 5.08mm		£3.32	£3.99
A74QL	PCBTer 2+2 5.08mm		£2.07	£2.49

16A PCB Mounting Vertical Triple Deck Terminal Blocks Rising Clamp 5.08mm

ORDER IN STORE OR ONLINE



- 5.08mm Pitch
- Available as 2 or 3 Pole
- 16 Amps
- Rising Clamp
- Vertical
- Triple Deck

PCB terminals can be used in all sorts of applications and are the perfect way to connect wires safely. With a range of different pitch and poles Maplin will have the right terminal block for your application. Common applications include CCTV, Electrical Repair and many more.

Order Code	Mod.	No. of Poles	Price each exc. VAT 1+	inc. VAT each
A76QL		2		
A77QL		3		
Order Code	Mod. 1032729		Price each exc. VAT 1+	inc. VAT each
A77QL	PCBTer 3+3+3 5.08mm		£5.82	£6.99
A76QL	PCBTer 2+2+2 5.08mm		£3.74	£4.49



Friendly expert advice on 0333 400 9500

10A PCB Mounting Horizontal Terminal Blocks Cage Clamp 5mm

ORDER IN STORE OR ONLINE



- 5mm Pitch
- Available as 2 or 3 Pole
- 10 Amps
- Cage Clamp
- Horizontal

PCB terminals can be used in all sorts of applications and are the perfect way to connect wires safely. With a range of different pitch and poles Maplin will have the right terminal block for your application. Common applications include CCTV, Electrical Repair and many more.

Order Code	Mod.	No. of Poles	Price each exc. VAT 1+	inc. VAT each
A78QL		2		
A79QL		3		
Order Code	Mod. 1032730		Price each exc. VAT 1+	inc. VAT each
A79QL	PCB Pin Head 3P 5mm		£0.82	£0.99
A78QL	PCB Pin Head 2P 5mm		£0.65	£0.79

10A PCB Pinstrip 24 pole 5mm

ORDER IN STORE OR ONLINE

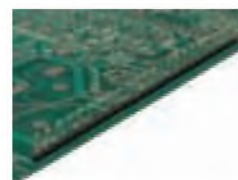

- 5mm Pitch
- 24 Poles
- 10 Amps
- Horizontal

PCB terminals can be used in all sorts of applications and are the perfect way to connect wires safely. With a range of different pitch and poles Maplin will have the right terminal block for your application. Common applications include CCTV, Electrical Repair and many more.

Order Code	Mod.	Price each exc. VAT 1+	inc. VAT each
A80QL	PCB Pinstrip 24P 5mm	£2.49	£2.99

8A PCB Mounting Horizontal Terminal Blocks Rising Clamp 3.81mm

ORDER IN STORE OR ONLINE



- 3.81mm Pitch
- Available as 2,3,4,5,6,7,8,9,10,11 and 12 Pole
- 8 Amps
- Rising Clamp
- Horizontal

PCB terminals can be used in all sorts of applications and are the perfect way to connect wires safely. With a range of different pitch and poles Maplin will have the right terminal block for your application. Common applications include CCTV, Electrical Repair and many more.

Order Code	Mod.	No. of Poles	Order Code	No. of Poles
A81QL		2	A87QL	8
A82QL		3	A88QL	9
A83QL		4	A89QL	10
A84QL		5	A90QL	11
A85QL		6	A91QL	12
A86QL		7		
Order Code	Mod. 1032733		Price each exc. VAT 1+	inc. VAT each
A90QL	PCBTerPlug 11P 3.81		£5.82	£6.99
A91QL	PCBTerPlug 12P 3.81		£6.24	£7.49
A89QL	PCBTerPlug 10P 3.81		£5.40	£6.49
A88QL	PCBTerPlug 9P 3.81mm		£4.57	£5.49
A87QL	PCBTerPlug 8P 3.81mm		£4.15	£4.99
A86QL	PCBTerPlug 7P 3.81mm		£3.57	£4.29
A85QL	PCBTerPlug 6P 3.81mm		£2.90	£3.49
A84QL	PCBTerPlug 5P 3.81mm		£2.24	£2.69
A83QL	PCBTerPlug 4P 3.81mm		£1.90	£2.29
A82QL	PCBTerPlug 3P 3.81mm		£1.24	£1.49
A81QL	PCBTerPlug 2P 3.81mm		£1.07	£1.29

Maplin TV

Home of innovation, handy tips and How To videos
[youtube.com/maplintv](https://www.youtube.com/maplintv)



8A PCB Mounting Vertical Terminal Blocks with Closed Ends Plug-In 3.81mm

ORDER IN STORE OR ONLINE

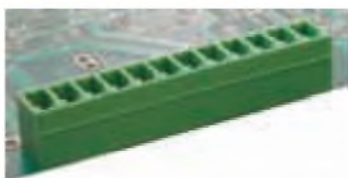

- 3.81mm Pitch
- Available as 2,3,4,5,6,7,8,9,10,11 and 12 Pole
- 8 Amps
- Vertical

PCB terminals can be used in all sorts of applications and are the perfect way to connect wires safely. With a range of different pitch and poles Maplin will have the right terminal block for your application. Common applications include CCTV, Electrical Repair and many more.

Order Code	No. of Poles	Order Code	No. of Poles
A92QL	2	A98QL	8
A93QL	3	A99QL	9
A94QL	4	A00QN	10
A95QL	5	A01QN	11
A96QL	6	A02QN	12
A97QL	7		

Order Code	Mod: 1032952	Price each exc. VAT 1+	inc. VAT each
A02QN	PCBVer Head12P 3.81	£2.49	£2.99
A01QN	PCBVer Head11P 3.81	£2.24	£2.69
A00QN	PCBVer Head10P 3.81	£2.07	£2.49
A99QL	PCBVer Head9P 3.81	£1.90	£2.29
A98QL	PCBVer Head8P 3.81	£1.65	£1.99
A97QL	PCBVer Head7P 3.81	£1.40	£1.69
A96QL	PCBVer Head6P 3.81	£1.24	£1.49
A95QL	PCBVer Head5P 3.81	£1.07	£1.29
A94QL	PCBVer Head4P 3.81	£0.82	£0.99
A93QL	PCBVer Head3P 3.81	£0.57	£0.69
A92QL	PCBVer Head2P 3.81	£0.40	£0.49

8A PCB Mounting Horizontal Terminal Blocks with Closed Ends Plug-In 3.81mm

ORDER IN STORE OR ONLINE



- 3.81mm Pitch
- Available as 2,3,4,5,6,7,8,9,10,11 and 12 Pole
- 8 Amps
- Horizontal

PCB terminals can be used in all sorts of applications and are the perfect way to connect wires safely. With a range of different pitch and poles Maplin will have the right terminal block for your application. Common applications include CCTV, Electrical Repair and many more.

Order Code	No. of Poles	Order Code	No. of Poles
A03QN	2	A09QN	8
A04QN	3	A10QN	9
A05QN	4	A11QN	10
A06QN	5	A12QN	11
A07QN	6	A13QN	12
A08QN	7		

Order Code	Mod: 1032954	Price each exc. VAT 1+	inc. VAT each
A13QN	PCBHor Head12P 3.81	£2.49	£2.99
A12QN	PCBHor Head11P 3.81	£2.32	£2.79
A11QN	PCBHor Head10P 3.81	£2.07	£2.49
A10QN	PCBHor Head9P 3.81	£1.90	£2.29
A09QN	PCBHor Head8P 3.81	£1.65	£1.99
A08QN	PCBHor Head7P 3.81	£1.40	£1.69
A07QN	PCBHor Head6P 3.81	£1.24	£1.49
A06QN	PCBHor Head5P 3.81	£1.07	£1.29
A05QN	PCBHor Head4P 3.81	£0.82	£0.99
A04QN	PCBHor Head3P 3.81	£0.57	£0.69
A03QN	PCBHor Head2P 3.81	£0.40	£0.49

16A PCB Mounting Horizontal Terminal Blocks Raising Clamps 5.08mm

ORDER IN STORE OR ONLINE



- 5.08mm Pitch
- Available as 2,3,4,5,6,7,8,9, 10,11 and 12 Pole
- 16 Amps
- Raising Clamp
- Horizontal

PCB terminals can be used in all sorts of applications and are the perfect way to connect wires safely. With a range of different pitch and poles Maplin will have the right terminal block for your application. Common applications include CCTV, Electrical Repair and many more.

Order Code	No. of Poles	Order Code	No. of Poles
A14QN	2	A20QN	8
A15QN	3	A21QN	9
A16QN	4	A22QN	10
A17QN	5	A23QN	11
A18QN	6	A24QN	12
A19QN	7		

Order Code	Mod: 1032955	Price each exc. VAT 1+	inc. VAT each
A24QL	Vivitar VF12B-ORG	£29.15	£34.99
A23QL	Vivitar VF12B-BLK	£29.15	£34.99
A22QL			
A21QL			
A20QL			
A19QN	PCBTer Plug 7P 5.08	£2.90	£3.49
A18QN	PCBTer Plug 6P 5.08	£2.49	£2.99
A17QN	PCBTer Plug 5P 5.08	£2.07	£2.49
A16QN	PCBTer Plug 4P 5.08	£1.74	£2.09
A15QN	PCBTer Plug 3P 5.08	£1.24	£1.49
A14QN	PCBTer Plug 2P 5.08	£0.90	£1.09

16A PCB Mounting Vertical Terminal Blocks Plug-In with Closed Ends 5.08mm

ORDER IN STORE OR ONLINE



- 5.08mm Pitch
- Available as 2,3,4,5,6,7,8,9,10,11 and 12 Pole
- 16 Amps
- Vertical

PCB terminals can be used in all sorts of applications and are the perfect way to connect wires safely. With a range of different pitch and poles Maplin will have the right terminal block for your application. Common applications include CCTV, Electrical Repair and many more.

Order Code	No. of Poles	Order Code	No. of Poles
A25QN	2	A31QN	8
A26QN	3	A32QN	9
A27QN	4	A33QN	10
A28QN	5	A34QN	11
A29QN	6	A35QN	12
A30QN	7		

Order Code	Mod: 1032967	Price each exc. VAT 1+	inc. VAT each
A35QN	PCBVer Head12P 5.08	£1.90	£2.29
A34QN	PCBVer Head11P 5.08	£1.82	£2.19
A33QN	PCBVer Head10P 5.08	£1.65	£1.99
A32QN	PCBVer Head9P 5.08	£1.49	£1.79
A31QN	PCBVer Head8P 5.08	£1.40	£1.69
A30QN	PCBVer Head7P 5.08	£1.24	£1.49
A29QN	PCBVer Head6P 5.08	£1.07	£1.29
A28QN	PCBVer Head5P 5.08	£0.82	£0.99
A27QN	PCBVer Head4P 5.08	£0.57	£0.69
A26QN	PCBVer Head3P 5.08	£0.40	£0.49
A25QN	PCBVer Head2P 5.08	£0.24	£0.29

16A PCB Mounting Horizontal Terminal Blocks Plug-In with Closed Ends 5.08mm

ORDER IN STORE OR ONLINE

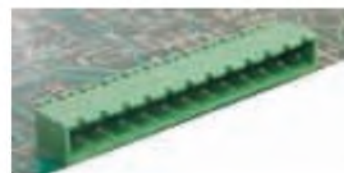

- 5.08mm Pitch
- Available as 2,3,4,5,6,7,8,9,10,11 and 12 Pole
- 16 Amps
- Horizontal

PCB terminals can be used in all sorts of applications and are the perfect way to connect wires safely. With a range of different pitch and poles Maplin will have the right terminal block for your application. Common applications include CCTV, Electrical Repair and many more.

Order Code	No. of Poles	Order Code	No. of Poles
A36QN	2	A42QN	8
A37QN	3	A43QN	9
A38QN	4	A44QN	10
A39QN	5	A45QN	11
A40QN	6	A46QN	12
A41QN	7		

Order Code	Mod: 1032968	Price each exc. VAT 1+	inc. VAT each
A46QN	PCBHor Head12P 5.08	£1.90	£2.29
A45QN	PCBHor Head11P 5.08	£1.82	£2.19
A44QN	PCBHor Head10P 5.08	£1.74	£2.09
A43QN	PCBHor Head9P 5.08	£1.40	£1.69
A42QN	PCBHor Head8P 5.08	£1.24	£1.49
A41QN	PCBHor Head7P 5.08	£1.07	£1.29
A40QN	PCBHor Head6P 5.08	£0.99	£1.19
A39QN	PCBHor Head5P 5.08	£0.82	£0.99
A38QN	PCBHor Head4P 5.08	£0.65	£0.79
A37QN	PCBHor Head3P 5.08	£0.40	£0.49
A36QN	PCBHor Head2P 5.08	£0.32	£0.39

32A PCB Mounting Vertical Terminal Blocks Raising Clamp 9.52mm

ORDER IN STORE OR ONLINE



- 9.52mm Pitch
- Available as 2 and 3 Pole
- 32 Amps
- Raising Clamp
- Vertical

PCB terminals can be used in all sorts of applications and are the perfect way to connect wires safely. With a range of different pitch and poles Maplin will have the right terminal block for your application. Common applications include CCTV, Electrical Repair and many more.

Order Code	No. of Poles	Order Code	No. of Poles
A68QL	2		
A69QL	3		

Order Code	Mod: 1032969	Price each exc. VAT 1+	inc. VAT each
A69QL	PCBTer 3P 9.52mm	£1.65	£1.99
A68QL	PCBTer 2P 9.52mm	£1.24	£1.49

COMPONENTS



CONTENTS

- 114 - 121 Resistors
- 122 - 129 Capacitors
- 130 - 143 Optoelectronics
- 144 - 159 Semiconductors
- 160 - 169 Switches
- 170 - 171 Relays
- 172 - 179 .. Transformers, Ferrites & EMC
- 180 - 187 PCB Development
- 188 - 191 Fuses
- 192 - 195 Motors & Servos
- 196 - 203 Enclosures
- 204 - 205 Component Loudspeakers

Understanding Resistors and Reading Rating Codes

A resistor is a passive two-terminal electrical component that implements electrical resistance as a circuit element.

The current passed through a resistor is in direct proportion to the voltage across the resistor's terminals. So, the ratio of the voltage applied across a resistor's terminals to the intensity of current through the circuit is called resistance. Resistors resist the flow of electricity and are very useful in supplying desired voltages to other electronic components. The resistance of a resistor is measured in Ohms (Ω). Most resistors are so small that it is impossible to print their values on them using normal numbers. Instead they are marked with a code of coloured bands. Resistors with a tolerance of 5% and 10% are marked with 4 bands, while higher precision types, such as 2%, 1% and better, may be marked with 5 bands to allow for an extra digit of precision, and with an extra band showing temperature coefficient.

Resistors in a series circuit are simply added together to find the total resistance. In other words, a 10 Ohm, 150 Ohm and 1000 Ohm resistor connected in series would be the equivalent of a single 1,160 Ohm resistor. The formula is:



Resistors in a parallel circuit are a little more difficult. The formula to use is:

$$R_T = \frac{R1 \times R2}{R1 + R2}$$

Color	1st Digit	2nd Digit	Multiplier	Tolerance
silver			0.01	±10%
gold			0.1	±5%
black	0	0	1	
brown	1	1	10	±1%
red	2	2	100	±2%
orange	3	3	1k	
yellow	4	4	10k	
green	5	5	100k	±0.5%
blue	6	6	1M	±0.25%
purple	7	7	10M	±0.1%
grey	8	8		
white	9	9		±20%

Temperature Coefficient
100ppm
50ppm
10ppm
25ppm

Example A: 2 5 (x1k) ±5% = 25kΩ ±5%

Example B: 6 5 0 (x1k) ±0.5% = 650kΩ ±0.5%

Resistor Colour Codes, 4-Band, 5-Band & 6-Band

On all of the colour-coded resistors, the band at one end will be spaced further apart than the others; the resistor should be 'read' with this band on the right, which also corresponds with the chart and examples. The 6 colour example in the main diagram above (C) shows the Temperature Coefficiency rating band, which is present on some 4 and 5 band codes (making them 5 and 6 respectively), but adding another level of detail in the coding system.

4-Band Codes (Yellow example A, main diagram above)

Reading from the left, bands 1 & 2 are the significant digits [1st red = 2, 2nd green = 5].
 Band 3 is the multiplier [orange = x1000].
 Therefore the value of our example is 25 x 1000 ohms or 25kΩ.
 The 4th band indicates the Tolerance [gold = ±5%].
 A few more 4-band codes can be found to the right of this text.

5-Band Codes (Blue example B, main diagram above)

Reading from the left, bands 1, 2 & 3 are the significant digits [1st blue = 6, 2nd green = 5, 3rd black = 0].
 Band 4 is the multiplier [orange = x1000].
 Therefore the value of our example is 650 x 1000 ohms or 650kΩ.
 The 5th band indicates the Tolerance [green = ±0.5%].
 A few more 5-band codes can be found to the right of this text.

6-Band Codes (Beige example C, main diagram above)

In some high priority systems special components are used which have a sixth band to show the 'Temperature Coefficiency' rating of a resistor, in this case this is shown as a second band after the gap which helps you read a resistor. The rest of this resistor code is read identically to the 4 and 5 band codes.

Please note that our Min Res resistors are usually supplied with the 4-Band Code, but with an additional red band to indicate the 50ppm temperature coefficient after the brown 1% tolerance band. This additional band prevents the code being read backwards accidentally, since no value begins red, brown (21-), in the event that the extra large space between the third and fourth bands is hard to identify.

4 & 5-Band Codes, further examples

Here are some more examples of codes and how to read them, note again they are organised with the tolerance strip (after the bigger gap) to the right. But if you are reading an unknown resistor make sure to be aware that what looks like a 5-band code could be a 4-band code with the Temperature Coefficiency band as shown above. If it is a 5 with the temperature band, it will be obvious as the stripe count will be 6.

- 7 + 0 = 70 x100 = 7kΩ with tolerance of ±2%
- 9 + 0 = 90 x1k = 90kΩ with tolerance of ±1%
- 6 + 5 = 65 x10k = 650kΩ with tolerance of ±1%
- 2 + 5 = 25 x1 = 25Ω with tolerance of ±.5%
- 1 + 5 + 0 = 150 x1k = 150kΩ with tolerance of ±.5%
- 6 + 5 + 0 = 650 x100k = 65MΩ with tolerance of ±.25%
- 6 + 5 + 0 = 650 x1k = 650kΩ with tolerance of ±2%
- 6 + 5 + 0 = 650 x100 = 65kΩ with tolerance of ±1%

Resistors

Resistor Packs and Kits

Resistors Lucky Bag



- Contains an assortment of 200 resistors of randomly assorted values

Order Code	Mod: 807607	Price each exc. VAT	inc. VAT each
		1+	5+
N24BG	L/Bag Resistors	£4.57	£3.74 £5.49

E3 Resistor 480 Piece Pack



High-quality carbon film resistors with a connecting wire that is easily soldered. This pack contains 30 of each of the following values:
100, 220, 470, 1000, 2200, 4700, 1K0, 2K20, 4K70, 10K0, 22K0, 47K0, 100K0, 220K0, 470K0 & 1M0

Order Code	Mod: 042453	Price each exc. VAT	inc. VAT each
		1+	
N63BH	E3 Resistor Pack	£5.82	£6.99

E12 0.25W Resistor 610 Piece Pack



- Ideal way to stock up resistors for the electronics enthusiast
- Contains 610 common resistors excellent value
- 61 values from 10 to 1M0

The kit contains the following values
10, 12, 15, 18, 22, 27, 33, 39, 47, 56, 68 and 820 plus all decade values up to 1M0.

Specifications:			
Quantity	610		
Number of Values	61 [from 10 to 1M]		
Power rating	1/4W		
Operating temperature range:	-55°C to +155°C		
Tolerance	5%		
Maximum operating voltage:	250V		

Order Code	Mod: 002163	Price each exc. VAT	inc. VAT each
		1+	
FA0BJ	E12 Resistor Pack	£6.65	£7.99

Potentiometer Lucky Bag



- Contains an assortment of 20 potentiometers of randomly assorted values

Order Code	Mod: 807606	Price each exc. VAT	inc. VAT each
N25BG	L/Bag Potentiometers	£4.57	£5.49

High Load Resistors Lucky Bag



- Contains an assortment of 50 high load resistors of randomly assorted values

Order Code	Mod: 807605	Price each exc. VAT	inc. VAT each
		1+	
N32BG	L/Bag H/Load Res	£3.74	£4.49

Trimmer Potentiometer Lucky Bag



- Contains an assortment of 50 trimmed potentiometers of randomly assorted values

Order Code	Mod: 807608	Price each exc. VAT	inc. VAT each
		1+	5+
N17GL	L/BAG Trim Pot	£4.40	£3.81 £5.29

Reserve online, collect in-store in 30 minutes



Electronic Component Starter Pack



- Assortment of basic components for electronics enthusiasts
- Supplied in a compartment sorting case
- Includes a wide selection LEDs, ICs, transistors, diodes and other common components
- Ideal for the beginner to electronics who require a good selection of components

Contents

Parts organiser box	1		
BC108	2	22nF Polyester Film	4
BC548	2	4.7nF Polyester Film	4
1N4148	4	10nF Polyester Film	4
1N4001	4	22nF Polyester Film	4
555 Timer IC	2	47nF Polyester Film	4
741 Op-amp	2	100nF Polyester Film	4
Red LED	2	220nF Polyester Film	4
Green LED	2	470nF Polyester Film	4
Stripboard 3939	1	1µF Radial Electrolytic	4
Buzzer 6V	1	4.7µF Radial Electrolytic	4
10k Pot	1	10µF Radial Electrolytic	4
8-pin DIL Socket	2	47µF Radial Electrolytic	4
100pF Ceramic	4	100µF Radial Electrolytic	4
470pF Ceramic	4	220µF Radial Electrolytic	4
1nF Polyester Film	4	470µF Radial Electrolytic	4

Resistors - 10 of each of the following values

10			47	
100	220	330	470	680
1k	2k2	3k3	4k7	6k8
10k	22k	33k	47k	68k
100k	220k	330k	470k	680k
1M				

Order Code	Mod: 013487	Price each exc. VAT	inc. VAT each
		1+	
GT66W	Component StarterKit	£20.82	£24.99

Metal Film

Metal Film 0.6W Resistor



- Ideal replacement for carbon film 1/4W, 1/3W or 1/2W types
- Body size is the same as 1/4W types
- Superior replacement to most metal oxide and thick film resistors

Note that to make up 'odd' values not stocked, resistor networks may be built and if all the resistors in the network have a 1% tolerance, then the tolerance of the whole network will still be 1% tolerance

270	3000	3k3	36k
300	3300	3k6	39k
330	3600	3k9	

To order write M and then the value

E.g. M1R2, M15R, M180R, M2K2, M27K, M330K, M3M9, etc

Specifications

Working voltage max:	250V
Tolerance	±1%
Power rating	0.6W at 70°C
Temperature coefficient	50ppm/°C
Noise level:	Typically 0.01µV/V
Dimensions of body:	6.5 (l) x 2.5 (dia) mm
The following values (Ω) are available:	

10	360	3900	4k3	100	1100	1k2	13k
1.20	390	4300	4k7	110	1200	1k3	15k
1.50	430	4700	5k1	120	1300	1k5	16k
1.80	470	5100	5k6	130	1500	1k6	18k
2.70	560	6200	7k5	150	1600	1k8	20k
3.30	620	7500	8k2	160	1800	2k0	22k
3.90	750	8200	9k1	180	2000	2k2	24k
4.70	820	9100	10k	200	2200	2k4	27k
5.60	910	1k	11k	220	2400	2k7	30k
8.20	1000	1k1	12k	240	2700	3k0	33k

Order Code	Mod:002162	inc. VAT each	Order Code	Mod:002162	inc. VAT each
M1R	Min Res 1R	€0.39	M1R	Min Res 1R	€0.39
M1R2	Min Res 1.2R	€0.39	M1R2	Min Res 1.2R	€0.39
M1R5	Min Res 1.5R	€0.39	M1R5	Min Res 1.5R	€0.39
M1R8	Min Res 1.8R	€0.39	M1R8	Min Res 1.8R	€0.39
M2R2	Min Res 2.2R	€0.39	M2R2	Min Res 2.2R	€0.39
M2R7	Min Res 2.7R	€0.39	M2R7	Min Res 2.7R	€0.39
M3R3	Min Res 3.3R	€0.39	M3R3	Min Res 3.3R	€0.39
M3R9	Min Res 3.9R	€0.39	M3R9	Min Res 3.9R	€0.39
M4R7	sMin Res 4.7R	€0.39	M4R7	sMin Res 4.7R	€0.39
M5R6	Min Res 5.6R	€0.39	M5R6	Min Res 5.6R	€0.39
M6R8	Min Res 6.8R	€0.39	M6R8	Min Res 6.8R	€0.39
M8R2	Min Res 8.2R	€0.39	M8R2	Min Res 8.2R	€0.39
M10R	Min Res 10R	€0.39	M10R	Min Res 10R	€0.39
M11R	Min Res 11R	€0.39	M11R	Min Res 11R	€0.39
M12R	Min Res 12R	€0.39	M12R	Min Res 12R	€0.39
M13R	Min Res 13R	€0.39	M13R	Min Res 13R	€0.39
M15R	Min Res 15R	€0.39	M15R	Min Res 15R	€0.39
M16R	Min Res 16R	€0.39	M16R	Min Res 16R	€0.39
M18R	Min Res 18R	€0.38	M18R	Min Res 18R	€0.38
M20R	Min Res 20R	€0.39	M20R	Min Res 20R	€0.39
M22R	Min Res 22R	€0.39	M22R	Min Res 22R	€0.39
M24R	Min Res 24R	€0.39	M24R	Min Res 24R	€0.39
M27R	Min Res 27R	€0.39	M27R	Min Res 27R	€0.39
M30R	Min Res 30R	€0.39	M30R	Min Res 30R	€0.39
M33R	Min Res 33R	€0.39	M33R	Min Res 33R	€0.39
M36R	Min Res 36R	€0.39	M36R	Min Res 36R	€0.39
M39R	Min Res 39R	€0.39	M39R	Min Res 39R	€0.39
M43R	Min Res 43R	€0.39	M43R	Min Res 43R	€0.39
M47R	Min Res 47R	€0.39	M47R	Min Res 47R	€0.39
M51R	Min Res 51R	€0.39	M51R	Min Res 51R	€0.39
M56R	Min Res 56R	€0.39	M56R	Min Res 56R	€0.39
M62R	Min Res 62R	€0.39	M62R	Min Res 62R	€0.39
M68R	Min Res 68R	€0.39	M68R	Min Res 68R	€0.39
M75R	Min Res 75R	€0.39	M75R	Min Res 75R	€0.39
M82R	Min Res 82R	€0.39	M82R	Min Res 82R	€0.39
M91R	Min Res 91R	€0.39	M91R	Min Res 91R	€0.39
M100R	Min Res 100R	€0.39	M100R	Min Res 100R	€0.39
M110R	Min Res 110R	€0.39	M110R	Min Res 110R	€0.39
M120R	Min Res 120R	€0.39	M120R	Min Res 120R	€0.39
M130R	Min Res 130R	€0.39	M130R	Min Res 130R	€0.39
M150R	Min Res 150R	€0.39	M150R	Min Res 150R	€0.39
M160R	Min Res 160R	€0.39	M160R	Min Res 160R	€0.39
M180R	Min Res 180R	€0.39	M180R	Min Res 180R	€0.39
M200R	Min Res 200R	€0.39	M200R	Min Res 200R	€0.39
M220R	Min Res 220R	€0.39	M220R	Min Res 220R	€0.39
M240R	Min Res 240R	€0.39	M240R	Min Res 240R	€0.39
M270R	Min Res 270R	€0.39	M270R	Min Res 270R	€0.39
M300R	Min Res 300R	€0.39	M300R	Min Res 300R	€0.39
M330R	Min Res 330R	€0.39	M330R	Min Res 330R	€0.39
M360R	Min Res 360R	€0.39	M360R	Min Res 360R	€0.39
M390R	Min Res 390R	€0.39	M390R	Min Res 390R	€0.39
M430R	Min Res 430R	€0.39	M430R	Min Res 430R	€0.39
M470R	Min Res 470R	€0.39	M470R	Min Res 470R	€0.39
M510R	Min Res 510R	€0.39	M510R	Min Res 510R	€0.39
M560R	Min Res 560R	€0.39	M560R	Min Res 560R	€0.39
M620R	Min Res 620R	€0.39	M620R	Min Res 620R	€0.39
M680R	Min Res 680R	€0.39	M680R	Min Res 680R	€0.39
M750R	Min Res 750R	€0.39	M750R	Min Res 750R	€0.39
M820R	Min Res 820R	€0.39	M820R	Min Res 820R	€0.39
M910R	Min Res 910R	€0.39	M910R	Min Res 910R	€0.39
M1K	Min Res 1k	€0.39			

3900 39k
 4700 47k
 6800 100k
 To order write D and then the value
 E.g. D68R, D120R, D1K5, D12K, D470K, D1M, etc

Order Code	Mod:005729	Price each exc. VAT 1+	inc. VAT each 5+
D68R	2W Res 68R	€0.40	€0.33 €0.49
D100R	2W Res 100R	€0.40	€0.33 €0.49
D120R	2W Res 120R	€0.40	€0.33 €0.49
D150R	2W Res 150R	€0.40	€0.35 €0.49
D180R	2W Res 180R	€0.40	€0.33 €0.49
D220R	2W Res 220R	€0.40	€0.33 €0.49
D270R	2W Res 270R	€0.40	€0.33 €0.49
D330R	2W Res 330R	€0.40	€0.33 €0.49
D390R	2W Res 390R	€0.40	€0.33 €0.49
D470R	2W RES 470R	€0.40	€0.33 €0.49
D680R	2W Res 680R	€0.40	€0.33 €0.49
D1K	2W Res 1K	€0.40	€0.33 €0.49
D1K5	2W Res 1K5	€0.40	€0.33 €0.49
D2K2	2W Res 2K2	€0.40	€0.33 €0.49
D4K7	2W Res 4K7	€0.40	€0.33 €0.49
D5K6	2W Res 5K6	€0.40	€0.33 €0.49
D10K	2W Res 10K	€0.40	€0.33 €0.49
D12K	2W Res 12K	€0.40	€0.33 €0.49
D22K	2W Res 22K	€0.40	€0.33 €0.49
D39K	2W Res 39K	€0.40	€0.33 €0.49
D47K	2W Res 47K	€0.40	€0.33 €0.49
D100K	2W Res 100K	€0.40	€0.33 €0.49
D120K	2W Res 120K	€0.40	€0.33 €0.49
D220K	2W Res 220K	€0.40	€0.33 €0.49
D470K	2W Res 470K	€0.40	€0.33 €0.49
D1M	2W Res 1M	€0.40	€0.33 €0.49

High Power Wirewound

3 Watt Wirewound Resistor



A range of high quality wirewound resistors sealed in a high insulation cement box. The box is heat and moisture resistant and non-flammable. The resistors are low noise, very stable and have an overload capability of ten times the rated power for 5 seconds. Values over 500Ω are metal oxide film and these have an overload capability of five times the rated power for 5 seconds.

Power rating: 3W @ 70°C
 Tolerance: ±5%
 Temperature coefficient: ±300ppm/°C
 Working voltage: 200V (400V peak)
 Dimensions of body: 22 x 9 x 10mm (max)

The following values (Ω) are available:

0 10	10	100	1000	1k	10k
0 220	2.20	220	2200	2k2	22k
0 270	2.70	270			
0 330	3.30	330	3300	3k3	
	3.90				
0 470	4.70	470	4700	4k7	
0 680	6.80	680			
	8.20				

Order Code	Mod:002173	Price each exc. VAT 1+	inc. VAT each
W0.1	WW Min 0.1R	€0.57	€0.69
W0.22	WW Min 0.22R	€0.57	€0.69
W0.27	WW Min 0.27R	€0.57	€0.69
W0.33	WW Min 0.33R	€0.57	€0.69
W0.47	WW Min 0.47R	€0.57	€0.69
W0.68	WW Min 0.68R	€0.57	€0.69
W1R	WW Min 1R	€0.57	€0.69
W2R2	WW Min 2.2R	€0.57	€0.69
W2R7	WW Min 2.7R	€0.57	€0.69
W3R3	WW Min 3.3R	€0.57	€0.69
W3R9	WW Min 3.9R	€0.57	€0.69
W4R7	WW Min 4.7R	€0.57	€0.69
W6R8	WW Min 6.8R	€0.57	€0.69
W8R2	WW Min 8.2R	€0.57	€0.69
W10R	WW Min 10R	€0.57	€0.69
W15R	WW Min 15R	€0.57	€0.69
W18R	WW Min 18R	€0.57	€0.69
W22R	WW Min 22R	€0.57	€0.69
W27R	WW Min 27R	€0.57	€0.69
W33R	WW Min 33R	€0.57	€0.69
W47R	WW Min 47R	€0.57	€0.69
W68R	WW Min 68R	€0.57	€0.69
W100R	WW Min 100R	€0.57	€0.69
W150R	WW Min 150R	€0.57	€0.69
W180R	WW Min 180R	€0.57	€0.69
W220R	WW Min 220R	€0.57	€0.69
W330R	WW Min 330R	€0.57	€0.69
W470R	WW Min 470R	€0.57	€0.69
W1K	WW Min 1k	€0.57	€0.69

Order Code	Mod:002173	Price each exc. VAT 1+	inc. VAT each
W1K	WW Min 1k	€0.57	€0.69
W1K5	WW Min 1k5	€0.57	€0.69
W2K2	WW Min 2k2	€0.57	€0.69
W3K3	WW Min 3k3	€0.57	€0.69
W4K7	WW Min 4k7	€0.57	€0.69
W10K	WW Min 10k	€0.57	€0.69
W15K	WW Min 15k	€0.57	€0.69
W22K	WW Min 22k	€0.57	€0.69

Newsletter 

Subscribe to our newsletter for information about the latest innovation and the best deals.

7 Watt Wirewound Resistor



A range of high quality wirewound resistors sealed in a high insulation cement box. The box is heat and moisture resistant and non-flammable. The resistors are low noise, very stable and have an overload capability of ten times the rated power for 5 seconds

Power rating: 7W @ 70°C
 Tolerance: ±5%
 Temperature coefficient: ±300ppm/°C
 Working voltage: 350V (700V peak)
 Dimensions of body: 35 x 10 x 9mm

The following values (Ω) are available:

0 10	10	100	1000	1k
		150		
0 220	2.20	220	2200	
0 330				
	3.90			
0 470	4.70	470	4700	
	5.60			
0 680	6.80			
	8.20			

To order write L and then the value
 E.g. L0.47, L8R2, L10R, L100R, etc.

Order Code	Mod:002179	Price each exc. VAT 1+	inc. VAT each
L0.1	7W WW 0.1R	€0.70	€0.59 €0.84
L0.22	7W WW 0.22R	€0.70	€0.59 €0.84
L0.33	7W WW 0.33R	€0.70	€0.59 €0.84
L0.47	7W WW 0.47R	€0.70	€0.59 €0.84
L0.68	7W WW 0.68R	€0.70	€0.59 €0.84
L1R	7W WW 1R	€0.70	€0.59 €0.84
L2R2	7W WW 2.2R	€0.70	€0.59 €0.84
L3R9	7W WW 3.9R	€0.70	€0.59 €0.84
L4R7	7W WW 4.7R	€0.70	€0.59 €0.84
LSR6	7W WW 5.6R	€0.70	€0.59 €0.84
LSR8	7W WW 6.8R	€0.70	€0.59 €0.84
L8R2	7W WW 8.2R	€0.70	€0.59 €0.84
L10R	7W WW 10R	€0.70	€0.59 €0.84
L15R	7W WW 15R	€0.70	€0.59 €0.84
L22R	7W WW 22R	€0.70	€0.59 €0.84
L47R	7W WW 47R	€0.70	€0.59 €0.84
L100R	7W WW 100R	€0.70	€0.59 €0.84
L220R	7W WW 220R	€0.70	€0.59 €0.84
L470R	7W WW 470R	€0.70	€0.59 €0.84
L1K	7W WW 1k	€0.70	€0.59 €0.84

Technical Helpline 

0333 400 9500

For technical information and assistance relating to any Maplin purchase, contact our team of experts

Metal Film 2W Resistor



A very high quality metal film resistor that is physically the same size as the 1W resistor, yet has a superior specification.

Specifications:
 Working voltage: 500V
 Tolerance: ±1%
 Power rating: 2W at 70°C
 Temperature coefficient: ±50ppm/°C
 Noise level: Typically 0.01μV/V
 Dimensions of body: 16mm long, 5.5mm dia

The following values (Ω) only are available:

680	1k	120k
1000	1k5	220k
1200	2k2	470k
1500	4k7	1M
1800	5k6	
2200	10k	
2700	12k	
3300	22k	

10 Watt Wirewound Resistor



A range of high quality wirewound resistors sealed in a high insulation ceramic block. The block is heat and moisture resistant and non-flammable. The resistors are low noise, very stable and have an overload capability of ten times the rated power for 5 seconds. Value 4k7 is metal oxide film and has an overload capability of five times the rated power for 5 seconds.

Power rating	10W @ 70°C
Tolerance	±5%
Temperature coefficient	±300ppm/°C
Working voltage:	500V (1kV peak)
Dimensions of body	49 x 10 x 9mm

The following values (Ω) are available:

0.10	1.0	100	1000	1k
		150		
0.220	2.20	220		
	3.30	330		
	3.90			
0.470	4.70	470	4700	4k7
0.560	5.60			
	6.80	680		
	8.20			

To order write H and then the value.
E.g. H0.47, H8.2R, H10R, H100R, etc.

Order Code	Mod: 002181	Price each exc. VAT 1+	inc. VAT each 5+
H0.1	10W W/W 0.1R	£0.89	£0.89
H0.22	10W W/W 0.22R	£0.74	£0.89
H0.47	10W W/W 0.47R	£0.74	£0.89
H0.56	10W W/W 0.56R	£0.74	£0.89
H1R	10W W/W 1R	£0.74	£0.89
H2R2	10W W/W 2.2R	£0.74	£0.89
H3R3	10W W/W 3.3R	£0.74	£0.89
H3R9	10W W/W 3.9R	£0.74	£0.89
H4R7	10W W/W 4.7R	£0.74	£0.89
H5R6	10W W/W 5.6R	£0.74	£0.89
H6R8	10W W/W 6.8R	£0.74	£0.89
H8R2	10W W/W 8.2R	£0.74	£0.89
H10R	10W W/W 10R	£0.74	£0.89
H15R	10W W/W 15R	£0.74	£0.89
H22R	10W W/W 22R	£0.74	£0.89
H33R	10W W/W 33R	£0.74	£0.89
H47R	10W W/W 47R	£0.74	£0.89
H68R	10W W/W 68R	£0.74	£0.89
H100R	10W W/W 100R	£0.74	£0.89
H470R	10W W/W 470R	£0.74	£0.89
H1k	10W W/W 1k	£0.74	£0.89
H4k7	10W W/W 4k7	£0.74	£0.89

Thermistors

Bead Thermistors

Bead type thermistors for general applications including temperature measurement and compensation.



Tolerance	±5%
Power [max.]:	250mW
Dissipation factor:	7mW/°C
Response time	1.2 secs
Thermal time constant	11 secs
Temperature range:	-40°C to +125°C reducing to 0° to 55°C at max power

R at 25°C	B [°K]	R at 100°C (approx)	R at 0°C (approx)
4k7	3977	318.40	15.28k0
15k	3740	1.19k0	45.13k0
47k	4090	2.94k0	155.6k0
150k	4370	7.73k0	534.9k0

R at 25°C	Band 1	Band 2	Band 3	Band 4
4k7	Yellow	Violet	Red	Gold
15k	Brown	Green	Orange	Gold
47k	Yellow	Violet	Orange	Gold
150k	Brown	Green	Yellow	Gold

Order Code	Mod: 002218	Price each exc. VAT 1+	inc. VAT each 5+
FX21X	Thermistor 4k7	£0.99	£0.86
FX22Y	Thermistor 15k	£0.99	£0.86
FX42V	Thermistor 47k	£0.99	£0.86
FX43W	Thermistor 150k	£0.99	£0.86

100k Ohm Bead Thermistor

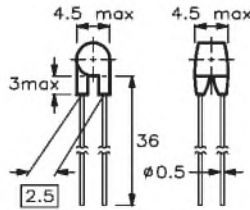

Dimensions in mm

A 100k bead thermistor for general applications, in particular, accurate temperature measurement. The case has a black epoxy resin coating and tinned leads.

Tolerance:	±2%
Power [max.]	350mW at 25°C 220mW at 60°C
Dissipation factor:	3.5mW/K
Heat capacity:	40mJ/K approx
Thermal time constant [air]:	12secs approx
Temperature range	-55°C to +155°C
B value:	4450°K
Approx. resistance at 25°C:	100k0
at 100°C:	4.77k0
at 0°C:	352.4k07

Order Code	Mod: 002220	Price each exc. VAT 1+	inc. VAT each 5+
CR05F	Thermistor 100k	£0.99	£1.19

Light Dependent Resistors

Light Dependent Resistors



All dimensions in mm

A range of light dependent resistors with a power dissipation of 90mW. All types have a maximum voltage rating @10lux of 150V, except Order Code N50AY, which has a maximum rating of 300V. Order Codes N51AY and N52AY have a peak wavelength of 530nm. The peak wavelength of all other types is 600nm.

Specifications:

Order Code N46AY	Min. resistance @ 10lux:	9k0
	Max. resistance @ 10lux:	20k0
	Typ. resistance @ 100lux:	3.5k0
	Dark resistance after 1 sec.:	0.06M0
	Dark resistance after 5 sec.:	0.18M0

Order Code N47AY	Min. resistance @ 10lux:	16k0
	Max. resistance @ 10lux:	33k0
	Typ. resistance @ 100lux:	5k0
	Dark resistance after 1 sec.:	0.18M0
	Dark resistance after 5 sec.:	0.5M0

Order Code N48AY	Min. resistance @ 10lux:	27k0
	Max. resistance @ 10lux:	94k0
	Typ. resistance @ 100lux:	8k0
	Dark resistance after 1 sec.:	0.5M0
	Dark resistance after 5 sec.:	1.5M0

Order Code N49AY

Min. resistance @ 10lux:	77k0
Max. resistance @ 10lux:	340k0
Typ. resistance @ 100lux:	15k0
Dark resistance after 1 sec.:	1.5M0
Dark resistance after 5 sec.:	5M0

Order Code N50AY

Min. resistance @ 10lux:	120k0
Max. resistance @ 10lux:	210k0
Typ. resistance @ 100lux:	35k0
Dark resistance after 1 sec.:	1M0
Dark resistance after 5 sec.:	3M0

Order Code N51AY

Min. resistance @ 10lux:	36k0
Max. resistance @ 10lux:	88k0
Typ. resistance @ 100lux:	12k0
Dark resistance after 1 sec.:	0.4M0
Dark resistance after 5 sec.:	1.2M0

Order Code N52AY

Min. resistance @ 10lux:	70k0
Max. resistance @ 10lux:	200k0
Typ. resistance @ 100lux:	20k0
Dark resistance after 1 sec.:	1M0
Dark resistance after 5 sec.:	3M0

Order Code	Mod: 035962	Price each exc. VAT 1+	inc. VAT each 5+
N46AY	LDR 9k-20k	£1.49	£1.29
N47AY	LDR 16k-33k	£1.49	£1.29
N51AY	LDR 36k-88k	£1.49	£1.29
N48AY	LDR 27k-94k	£1.49	£1.29
N49AY	LDR 77k-340k	£1.49	£1.29
N50AY	LDR 120k-210k	£1.49	£1.29
N52AY	LDR 70k-200k	£1.49	£1.29

Light Dependent Resistors

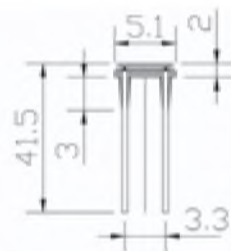

All dimensions in mm

2 light dependent resistors with a power dissipation of 90mW, a maximum voltage rating @10lux of 150V and a peak wavelength of 530nm.

Specifications:

Order Code N53AY	Min. resistance @ 10lux:	9k0
	Max. resistance @ 10lux:	22k0
	Typ. resistance @ 100lux:	7k0
	Dark resistance after 1 sec.:	0.05M0
	Dark resistance after 5 sec.:	0.15M0

Order Code N54AY	Min. resistance @ 10lux:	70k0
	Max. resistance @ 10lux:	200k0
	Typ. resistance @ 100lux:	20k0
	Dark resistance after 1 sec.:	1M0
	Dark resistance after 5 sec.:	3M0

Order Code	Mod: 035963	Price each exc. VAT 1+	inc. VAT each 5+
N53AY	LDR 9-22k	£1.49	£1.29
N54AY	LDR 70-200k	£1.49	£1.29

Light Dependent Resistors

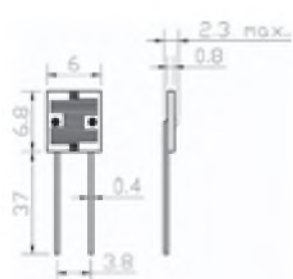

All dimensions in mm

Standard Single Gang Potentiometers



A range of carbon track potentiometers with printed circuit board mounting terminals. Fixing hole required: 10.5mm [13/32in]. Power rating: 0.4W linear, 0.2W log. Max. volt. 500Vdc. Tolerance: ±20%. Overall shaft length 50mm.

The following values are available with a linear track: 1k, 4k7, 10k, 22k, 47k, 100k, 220k, 470k, 1M, 2M2

The following values are available with a logarithmic track: 4k7, 10k, 22k, 47k, 100k, 220k, 470k, 1M, 2M2

Please note: Linear types are marked 'A' and log types are marked 'B'

Order Code	Mod: 002205	Price each exc. VAT 1+	inc. VAT each
FW00A	Pot Lin 1k	£1.57	£1.89
FW01B	Pot Lin 4k7	£1.57	£1.89
FW02C	Pot Lin 10k	£1.57	£1.89
FW03D	Pot Lin 22k	£1.57	£1.89
FW04E	Pot Lin 47k	£1.57	£1.89
FW05F	Pot Lin 100k	£1.57	£1.89
FW06G	Pot Lin 220k	£1.57	£1.89
FW07H	Pot Lin 470k	£1.57	£1.89
FW08J	Pot Lin 1M	£1.57	£1.89
FW09K	Pot Lin 2M2	£1.57	£1.89
FW21X	Pot Log 4k7	£1.57	£1.89
FW22Y	Pot Log 10k	£1.57	£1.89
FW23A	Pot Log 22k	£1.57	£1.89
FW24B	Pot Log 47k	£1.57	£1.89
FW25C	Pot Log 100k	£1.57	£1.89
FW26D	Pot Log 220k	£1.57	£1.89
FW27E	Pot Log 470k	£1.57	£1.89
FW28F	Pot Log 1M	£1.57	£1.89
FW29G	Pot Log 2M2	£1.57	£1.89

Standard Single Gang Potentiometers with Switch



A range of rotary carbon track potentiometers with DPST switch and fitted with printed circuit mounting terminals. All values are linear and are marked 'A'

Fixing hole required: 10.5mm.
 Power rating: 0.4W linear, 0.2W log.
 Max. voltage: 500Vdc.
 Tolerance: ±20%.
 Switch rating: 4A at 250Vac.
 Overall shaft length: 50mm.

The following values are available with a linear track: 4k7, 1k, 10k, 22k, 47k, 100k, 220k, 470k, 1M

Order Code	Mod: 002208	Price each exc. VAT 1+	inc. VAT each
KU91Y	Sw Pot Lin 1k	£1.99	£2.39
FW41U	Sw Pot Lin 4k7	£1.99	£2.39
FW42V	Sw Pot Lin 10k	£1.99	£2.39
FW43W	Sw Pot Lin 22k	£1.90	£2.29
FW44X	Sw Pot Lin 47k	£1.99	£2.39
FW45Y	Sw Pot Lin 100k	£1.99	£2.39
FW46A	Sw Pot Lin 220k	£1.99	£2.39
FW47B	Sw Pot Lin 470k	£1.99	£2.39
FW48C	Sw Pot Lin 1M	£1.90	£2.29

Standard Dual-Gang Potentiometers



A range of rotary dual-gang carbon track potentiometers with printed circuit mounting terminals. Fixing hole required: 10.5mm. Power rating: 0.4W linear, 0.2W log. Max. voltage: 500Vdc. Tolerance: ±20%. Overall shaft length 50mm

The following values are available with a linear track: 4k7, 10k, 22k, 47k, 100k, 220k, 470k

The following values are available with a logarithmic track: 10k, 22k, 47k, 100k, 220k

Please note: Linear types are marked 'A' and log types are marked 'B'

Order Code	Mod: 002207	Price each exc. VAT 1+	inc. VAT each
FW84F	Dual Pot Lin 4k7	£1.99	£2.39
FW85G	Dual Pot Lin 10k	£1.99	£2.39
FW86T	Dual Pot Lin 22k	£1.99	£2.39
FW87U	Dual Pot Lin 47k	£1.99	£2.39
FW88V	Dual Pot Lin 100k	£1.99	£2.39
FW89W	Dual Pot Lin 220k	£1.95	£2.34
FW90X	Dual Pot Lin 470k	£1.99	£2.39
FX09K	Dual Pot Log 10k	£1.99	£2.39
FX10L	Dual Pot Log 22k	£1.99	£2.39
FX11M	Dual Pot Log 47k	£1.99	£2.39
FX12N	Dual Pot Log 100k	£1.99	£2.39
FX13P	Dual Pot Log 220k	£1.99	£2.39

Miniature Dual Gang Linear Potentiometers



Two dual miniature slide track carbon potentiometers with printed circuit board mounting terminals. Potentiometer measures 60mm long x 9mm wide with a 45mm track length. Height above PCB (excluding slide tang) 6.5mm. The pin spacing is not compatible with 2.54mm (0.1in) matrix board. The potentiometer may be attached to a front panel using two M2 bolts, fixing centres 56mm. Slide tang is 15mm long. Available in 10k and 100k versions.

Order Code	Mod: 002215	Price each exc. VAT 1+	inc. VAT each
JM85G	Min Slide Lin 10k	£1.07	£1.29
JM86T	Min Slide Lin 100k	£1.07	£1.29

Resistance Wire

28swg Resistance Wire

A 28.35g (1oz) reel of 28swg Constantan [55-60% copper, 45-40% nickel] wire suitable for making rheostats etc. Can be used as a thermocouple when twisted with copper wire. A temperature difference between the wires of approx 25°C gives around 1mV with temperatures in the range 0°C to 50°C. Resistance: 4.2Ω per metre.



Order Code	Mod: 002196	Price each exc. VAT 1+	inc. VAT each
BL64U	Constantan 28Swg	£6.65	£7.99

1000's more components available in-store & online

Capacitors

Capacitor Packs and Kits

Capacitance Conversion Table

0.000001µF	= 0.001nF	= 1pF
0.00001µF	= 0.01nF	= 10pF
0.0001µF	= 0.1nF	= 100pF
0.001µF	= 1nF	= 1000pF
0.01µF	= 10nF	= 10000pF
0.1µF	= 100nF	= 100000pF
1µF	= 1000nF	= 1000000pF
10µF	= 10000nF	= 10000000pF
100µF	= 100000nF	= 100000000pF

Shopping with us is easy...

In-store



7 days a week, check store listings at the back of the catalogue for address details

Online



maplin.co.uk

24hrs a day, 7 days a week, 365 days a year

Phone



0333 400 9500

Phone lines open 7 days a week

Buying for business?

0333 400 9740

Want to browse the full range?

Head into store or visit maplin.co.uk

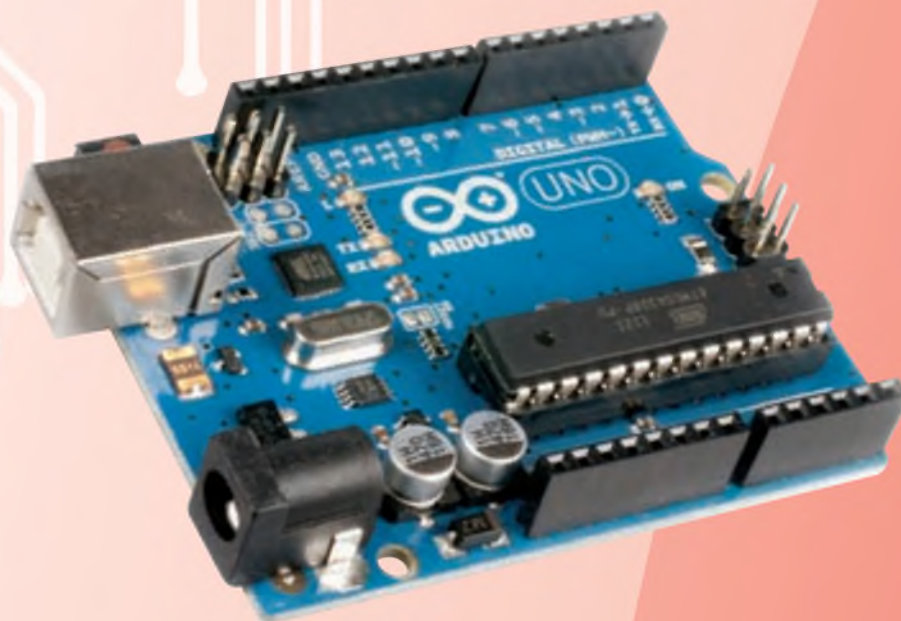

WANT TO EXPLORE ELECTRONICS?

ELECTRONIC DIY

We have all the essentials you need to delve into the world of Maker

Visit maplin.co.uk for the latest Maker tech; 3D printers, mini computers and everything you need to get creative



SCAN ME



<http://goo.gl/W0vYj9>

BUILD YOUR OWN

Trimmer Caps Lucky Bag



- Contains an assortment of 20 Trimmer Capacitors of random mixed values

Order Code	Mod: 807613	Price each exc. VAT 1+	5+	inc. VAT each
N24GL	L/BAG Trimmer Caps	£4.15	£3.36	£4.99

Ceramic Capacitor Lucky Bag



- Contains an assortment of 100 ceramic capacitors of randomly mixed values

Order Code	Mod: 807610	Price each exc. VAT 1+	inc. VAT each
N27BG	L/Bag Ceramic Caps	£4.15	£4.99

Foil Capacitor Lucky Bag



- Contains an assortment of 100 foil capacitors with randomly assorted values

Order Code	Mod: 807612	Price each exc. VAT 1+	5+	inc. VAT each
N31BG	L/Bag Foil Caps	£4.57	£3.74	£5.49

Tantalum and Polyester Capacitor Lucky Bag



- Contains an assortment of 100 Tantalum and Polyester Capacitors of randomly mixed values

Order Code	Mod: 807611	Price each exc. VAT 1+	5+	inc. VAT each
N29BG	L/Bag Tant/Poly Caps	£4.57	£3.95	£5.49

Electrolytic Capacitors Lucky Bag



- Contains an assortment of 50 electrolytic capacitors of randomly mixed values

Order Code	Mod: 807609	Price each exc. VAT 1+	5+	inc. VAT each
N26BG	L/Bag Electro Caps	£4.99	£4.11	£5.99

Ceramic Capacitor 224 Piece Pack



A set of 224 ceramic capacitors, ranging from 10pF to 220nF in 14 values

Value	Quantity
10pF	21
22pF	14
47pF	14
100pF	21
220pF	14
470pF	14
1nF	21
2.2nF	14
4.7nF	14
10nF	21
22nF	14
47nF	14
100nF	21
220nF	7

Order Code	Mod: 044036	Price each exc. VAT 1+	5+	inc. VAT each
N67BT	Ceramic Capacitor Pk	£7.90	£6.74	£9.49

Radial Electrolytic Capacitor 120 Piece Pack



A set of 120 radial electrolytic capacitors, ranging from 1uF to 1000uF, in 10 values

Value	Quantity
1uF/50V	15
2.2uF/50V	15
4.7uF/50V	15
10uF/50V	15
22uF/50V	15
47uF/25V	15
100uF/25V	15
220uF/25V	5
470uF/25V	5
1000uF/25V	5

Order Code	Mod: 044037	Price each exc. VAT 1+	5+	inc. VAT each
N68BT	Elec Capacitor Pk	£8.32	£7.19	£9.99

Ceramic

Metallised Ceramic Plate Capacitors



A miniature ceramic capacitor with a cement-coated case. Values up to and including 220pF are suitable for temperature compensation in tuned circuits where low losses, close tolerance and high stability are required.

Values from 270pF to 4700pF are for use in coupling and decoupling applications, where a non-linear change of capacitance with temperature is permissible. Values 10,000pF and 22,000pF are suitable for use in coupling and decoupling applications, where capacitance stability is not critical.

Specifications

Tolerance	
1.8pF to 4.7pF	±5%
5.6pF to 330pF	±5%
390pF to 4700pF	±10%
10,000pF and 22,000pF	±20%
Working voltage:	
1.8pF to 4700pF	100Vdc
10,000pF and 22,000pF	63Vdc
Insulation resistance:	>1000MO
Temperature coefficient	
1.8pF to 220pF	Zero
270pF to 390pF	+350 to 1000ppm°C
470pF to 3300pF	medium K [±10%]
10,000pF to 20,000pF	high K [+22% -82%]

Power factor

1.8pF to 390pF	10x10 ⁻⁴
470pF to 3300pF	20x10 ⁻⁵
10,000pF	50x10 ⁻²
22,000pF	25x10 ⁻²

Dimensions

Thickness of body	2.25mm max
Lead spacing	5mm
Lead length	25mm

Case Diameters

Value (pF)	Diameter (mm)
------------	---------------

1.8, 2.2, 2.7, 3.3, 4.7, 5.6, 6.8, 8.2, 10, 12, 15, 18, 22, 27, 33, 47, 56, 68, 82, 100, 150, 180, 220, 39, 47, 56, 2700, 10,000, 68, 82, 100, 330, 3300

Order Code	Mod: 000304	Price each exc. VAT 1+	5+	inc. VAT each
WX35Q	Ceramic 1.8	£0.40	£0.33	£0.49
WX36P	Ceramic 2.2	£0.36	£0.32	£0.44
WX37S	Ceramic 2.7	£0.36	£0.32	£0.44
WX38R	Ceramic 3.3	£0.40	£0.31	£0.49
WX40T	Ceramic 4.7	£0.40	£0.35	£0.49
WX41U	Ceramic 5.6	£0.40	£0.33	£0.49
WX42V	Ceramic 6.8	£0.36	£0.32	£0.44
WX43W	Ceramic 8.2	£0.36	£0.32	£0.44
WX44X	Ceramic 10	£0.40	£0.33	£0.49
WX45Y	Ceramic 12	£0.40	£0.33	£0.49
WX46A	Ceramic 15	£0.40	£0.33	£0.49
WX47B	Ceramic 18	£0.36	£0.32	£0.44
WX48C	Ceramic 22	£0.40	£0.33	£0.49
WX49D	Ceramic 27	£0.40	£0.33	£0.49
WX50E	Ceramic 33	£0.40	£0.33	£0.49

Radial Electrolytic Capacitors

- A range of small electrolytic capacitors designed for direct mounting on PCBs
Tolerance: +/-20%
Maximum operating temperature +85°C
Long operating life - up to 2000 hours at low temperatures



Specifications table for radial electrolytic capacitors with columns: Order Code, Value, Voltage, Case Size (mm), Pitch.

Main table for radial electrolytic capacitors listing various models and their specifications.

Price and VAT table for radial electrolytic capacitors with columns: Order Code, Mod, Price each exc. VAT, inc. VAT each.

High Temperature Radial Electrolytic Capacitors



- A range of high temperature, radial electrolytic capacitors
These are superior replacements to standard 85°C capacitors
Offering excellent reliability and long life - up to 2000 hours at 105°C.
Ideal for use in the repair of consumer goods including TV's
At lower operating temperatures, life expectancy is well over 10 to 15 years

Specifications: Temperature: 105°C, Tolerance: +/-20%, Leakage current: <0.01CV or 4µA

Main specifications table for high temperature radial electrolytic capacitors with columns: Maplin Code, Value, Voltage, Diameter, Length, Pitch.

Price and VAT table for high temperature radial electrolytic capacitors.

Price and VAT table for standard radial electrolytic capacitors.

Friendly expert advice on 0333 400 9500

Axial Electrolytic Capacitors



- Axial lead capacitors with values from 1 to 4700µF
Axial offer advantages over radial types with PCB height
Load life of 2000h at 85°C
Wide operating range -40 to +85°C
Leakage current not more than 0.03CV or 4µA

Main specifications table for axial electrolytic capacitors with columns: AT, Value, Voltage, dia x height.

Price and VAT table for axial electrolytic capacitors.

Over 200 stores nationwide

Non-Polarised Electrolytic Capacitors

- A range of non-polarised electrolytic capacitors primarily intended for use in loudspeaker crossover networks
- Also suitable for use in applications where a large capacitance is required in a compact case with a large bipolar signal



Specifications:

Tolerance: ±20%
 Temperature range: 40°C to +85°C
 Leakage current: 0.03CV or 3µA whichever is greater after 5 mins

Cap (µF)	Working voltage (V)	Case size (mm)	Ripple current (mAmax)	Power factor (max)
2.2	100	11	63	0.12
3.3	100	11	63	0.12
10	50	11	63	0.12
47	100	20	13	0.12
100	100	25	16	0.12

Order Code	Mod.	Price each exc. VAT 1+	inc. VAT each 5+
JA78K	NP 2.2µF 100V	£0.49	£0.59
JA77J	NP 3.3µF 100V	£0.49	£0.59
JA75S	NP 10µF 50V	£0.49	£0.59
JA72P	NP 47µF 100V	£0.74	£0.89
VM76H	NP 100µF 100V	£1.24	£1.49

2200µF 63V -40 to +85°C Low Profile Can Solder Electrolytic Capacitor

- Low-profile, can-type electrolytic capacitor offering long life and stability
- Features etched aluminium foil, non-inductively wound with impregnated electrolytic tissue



Value µF: 2200 [max]
 Working Vdc (max): 63
 Leakage current (max): 2.75A
 Ripple current: 5mA
 Power factor: 0.35

Order Code	Mod.	Price each exc. VAT 1+	inc. VAT each 5+
LE01B	2200µF 63V Can	£2.49	£2.99

High Grade Audio Capacitors

- For high grade audio equipment
- Ideal for VTR and CD players
- High resonance frequency
- Low ESR
- Low impedance
- Snap-in terminals
- Manufactured to ISO9001 standard



High quality audio grade capacitors with 2 pins.

Specifications:

Tolerance: ±20%
 Temp range: -40 to +85°C
 Lead life: 2000Hrs @ 85°C

Order Code	Mod.	Price each exc. VAT 1+	inc. VAT each 5+
TX84F	AG 4700µF 63V 2 Pin	£6.07	£7.29
TX85G	AG 6800µF 63V 2 Pin	£6.07	£7.29

Double Layer

Double Layer Backup Capacitors

- Polarised capacitor with high charge density
- Alternative product to rechargeable backup batteries
- Dielectric: electric double layer
- Radial leads, cylindrical case, insulated with a blue vinyl sleeve
- Unlimited charge/discharge cycle numbers
- No charge/discharge control circuitry and no series resistor required
- Maintenance free, no periodic replacement or service necessary
- Ecologically beneficial (no Cd or Li)
- Applications include energy storage, for backup of semiconductor memories (CMOS)



Available in the following values: 0.047F [N98CN], 0.1F [N99CN], 0.22F [N00CQ], 0.33F [N01CQ], 0.47F [N02CQ] and 1F [N03CQ]

Specifications:

Case size: 13 x 7 and 21 x 7.5mm
 Tolerance on Cr at 20°C: -20 to +80%
 Rated voltage, Ur: 5.5V
 Max surge voltage, Us: 6.3V
 Temperature range: -25 to +70°C
 N98CN: 0.047
 N99CN: 0.1
 N00CQ: 0.22
 N01CQ: 0.33
 N03CQ: 1

Order Code	Mod.	Price each exc. VAT 1+	inc. VAT each 5+
N99CN	DLC 5.5V 0.1F	£1.65	£1.99
N00CQ	DLC 5.5V 0.22F	£1.65	£1.99
N01CQ	DLC 5.5V 0.33F	£1.90	£2.29
N03CQ	DLC 5.5V 1F	£3.57	£4.29

Variable

22pF Miniature Film Dielectric Trimmer

A miniature trimmer sturdily constructed on a plastic frame. The dielectric is arranged so as to support the vanes giving a very high degree of stability. Adjustment is by means of a screwdriver slit in the upper face.
 Working voltage: 100Vdc
 Insulation resistance: >10,000MΩ

The following values are available:

Max value: 22pF
 Range: 2 to 22pF
 Body colour: Green
 *Temp. coef: 350
 Hgt above board: 10
 Max diameter: 8.8
 Max dissipation: 0.35W
 *Temperature coefficient is in ppm/°C with a tolerance of ±300

Order Code	Mod.	Price each exc. VAT 1+	inc. VAT each 5+
WL70M	Trimmer 22pF	£0.99	£1.19

Motor Run

LCR Motor Run 1µF Capacitor 250V

- Metallised polypropylene capacitors suitable for 250Vac voltages applications
- Constructed with self healing dielectric and encapsulated in a non flammable plastic case



- Typical uses include domestic appliances, pumps and office machinery
- Terminations are a deck with a 6.35mm spade double amp tag
- Supplied with an M8 stud for secure mounting
- UK manufactured

Specifications:

Capacitance tolerance: ±10%
 Voltage rating: 250V 50/60Hz
 Operating temperature: -25°C to +85°C
 Order Code | C[µF] | Dia. (mm) | Length (mm)

N27KG	1	30	56
N28KG	2	30	56
N29KG	3	30	56
N30KG	4	30	56
N31KG	5	30	56
N32KG	6	30	56
N33KG	8	30	75
N34KG	10	30	75

Order Code	Mod.	Price each exc. VAT 1+	inc. VAT each 5+
N27KG	Motor run 250V 1µF	£1.82	£2.19
N28KG	Motor run 250V 2µF	£2.24	£2.69
N29KG	Motor run 250V 3µF	£1.90	£2.29
N30KG	Motor run 250V 4µF	£2.99	£3.59
N31KG	Motor run 250V 5µF	£2.99	£3.99
N32KG	Motor run 250V 6µF	£2.99	£3.59
N33KG	Motor run 250V 8µF	£3.74	£4.49
N34KG	Motor run 250V 10µF	£3.99	£4.79

Motor Run Capacitors 440V

- Range of high voltage metallised polypropylene capacitors suitable for AC
- Constructed with self healing metallised polypropylene dielectric and encapsulated in a non flammable plastic case
- Suitable for use with single-phase induction motors and single phase supply to three phase induction motors
- Spade or wire terminations depending on value
- UK manufactured



Specifications:

Capacitance tolerance: ±10%
 Voltage rating: 440V 50/60Hz
 Operating temperature: -25°C to +85°C

Order Code	Value (µF)	Dimensions dia x h	Termination Method
N35KG	0.5	25 x 53	120mm Wires
N36KG	1	25 x 53	120mm Wires
N37KG	1.5	25 x 53	120mm Wires
RG62S	2	30 x 53	6.3mm double spade deck
N38KG	2	25 x 53	120mm Wires
N39KC	2.5	25 x 53	120mm Wires
RG63T	3	30 x 53	6.3mm double spade deck
N40KC	3	25 x 75	120mm Wires
RG64U	8	35 x 75	6.3mm double spade deck
RG65V	10	35 x 98	6.3mm double spade deck
RG67X	16	40 x 98	6.3mm double spade deck
RG68Y	20	45 x 98	6.3mm double spade deck
RG69A	30	50 x 98	6.3mm double spade deck

Order Code	Mod.	Price each exc. VAT 1+	inc. VAT each 5+
N35KG	Motor run 0.5µF Wire	£2.07	£2.49
N36KG	Motor run 1µF Wire	£2.74	£3.29
N37KG	Motor run 1.5µF Wire	£2.07	£2.49
RG62S	Motor run 440V 2µF	£3.32	£3.99
N38KG	Motor run 2µF Wire	£2.90	£3.49
N39KC	Motor run 2.5µF Wire	£2.74	£3.29
RG63T	Motor run 440V 3µF	£3.32	£3.99
N40KC	Motor run 3µF Wire	£2.99	£3.59
RG64U	Motor run 440V 8µF	£4.15	£4.99
RG65V	Motor run 440V 10µF	£4.74	£5.69
RG67X	Motor run 440V 16µF	£5.82	£6.99
RG68Y	Motor run 440V 20µF	£7.49	£8.99
RG69A	Motor run 440V 30µF	£8.32	£9.99

Subscribe to our newsletter
 For deals and information
maplin.co.uk



Crystals

General Purpose Crystals

A range of crystals for use with microprocessors and other ICs. They are all supplied in HC-49/U style cans and have an adjustment tolerance of ±30ppm.



Freq	Temp Stability	Load Cap	Order Code
1.8432MHz	±50ppm	32pF	RR77
3.579545MHz	±30ppm	18pF	RN13
4MHz	±30ppm	20pF	FY82
5MHz	±30ppm	20pF	RR79
6MHz	±30ppm	32pF	RN14
8MHz	±30ppm	32pF	UJ06
10MHz	±30ppm	32pF	FY78
12MHz	±30ppm	32pF	UJ07

Order Code	Mod: 000478	Price each exc. VAT 1+	5+	inc. VAT each
RR77J	Crystal 1.8432MHz	£1.40	£1.22	£1.69
RN13P	Crystal 3.579545MHz	£0.99	£0.86	£1.19
FY82D	Crystal 4MHz	£0.99	£0.74	£1.19
RR79L	Crystal 5MHz	£0.82	£0.71	£0.99
RN14Q	Crystal 6MHz	£0.99	£0.86	£1.19
UJ06G	Crystal 8MHz	£0.82	£0.71	£0.99
FY78K	Crystal 10MHz	£1.07	£0.89	£1.29
UJ07H	Crystal 12MHz	£0.82	£0.71	£0.99

General Purpose Crystals in U4 Style Case

A range of crystals for use with microprocessors and other ICs. They are all supplied in U4 style cans and have an adjustment tolerance of ±30ppm. The crystals have a temperature range of -11° to +60°C.



Freq	Temp Stability	Load Cap	Order Code
3.579545MHz	±30ppm	18pF	RR82D
4MHz	±30ppm	20pF	RR83E
8MHz	±30ppm	32pF	RR84F
10MHz	±30ppm	32pF	RR85G
11.0592MHz	±30ppm	32pF	RR86T
12MHz	±30ppm	32pF	RR87U
14.7456MHz	±30ppm	32pF	RR88V
16MHz	±30ppm	32pF	RR89W
20MHz	±30ppm	32pF	RR90X

Order Code	Mod: 031822	Price each exc. VAT 1+	5+	inc. VAT each
RR82D	Crystal 3.579545MHz	£0.82	£0.71	£0.99
RR83E	Crystal 4MHz U4	£1.07	£0.89	£1.29
RR84F	Crystal 8MHz U4	£0.99	£0.86	£1.19
RR85G	Crystal 10MHz U4	£0.99	£0.86	£1.19
RR86T	Crystal 11.0592MHz	£0.99	£0.86	£1.19
RR87U	Crystal 12MHz U4	£0.99	£0.86	£1.19
RR88V	Crystal 14.7456MHz	£0.99	£0.86	£1.19
RR89W	Crystal 16MHz U4	£1.07	£0.89	£1.29
RR90X	Crystal 20MHz U4	£1.07	£0.89	£1.29

Timing Crystals

Two crystals for time keeping purposes, counters etc., using simple flip-flop divider stages. The 32.768kHz crystal is suitable for use as a replacement in most digital watches, and the crystal for generating 50Hz can be used to drive mains operated clocks from a battery when mains fails or in portable applications.



Frequency	Application
32.768kHz	Divide by 2n, 15 times for 1Hz (digital watch crystal)
3.2768MHz	Divide by 2n, 16 times for 50Hz
50Hz	Can be used to drive mains operated clocks from a battery when mains fails or in portable applications.

Order Code	Mod: 000480	Price each exc. VAT 1+	inc. VAT each
UJ02C	Crystal 32.768kHz	£1.07	£1.29
FY86T	Crystal 50Hz X 7.16	£1.24	£1.49

Optoelectronics

LED Light Strips

LED Facts

Most common light emitting diodes (LEDs) are made from semiconductor type materials such as gallium arsenide [GaAs] or gallium arsenide phosphide [GaAsP]. High brightness and super bright LEDs may be made from another material known as Gallium Aluminum Arsenide Phosphide. An LED emits light when it is forward biased, that is, the anode of the diode is positive with respect to its cathode. As electron and hole combine near the junction of the diode energy is released in the form of light. A current limiting resistor is used in series with the LED to limit the current flow through the LED and to prevent the overheating.

terminal pads and cleaned to ensure a good solder joint is achieved. Once the connection is made the joint may need to be sealed to ensure protection from moisture. Power consumption of different lengths of LED strip lengths are shown in the spec table.

Please note: For mail-order and internet sales, the LED light-strip can only be supplied in full reels of 5 metre lengths. For smaller lengths, please check your local Maplin store for availability.

Length of Cut Strip	Approximate Current
5 centimetres (1 unit)	20mA
1 metre (20 units)	400mA
2 metres (40 units)	800mA
3 metres (60 units)	1.2A
4 metres (80 units)	1.6A
5 metres (100 units)	2.0A

Order Code	Mod: 628936	Price each exc. VAT 1+	5+	inc. VAT each
N91NA	IP65 5cm W White LED	£1.40	£1.22	£1.69

12VDC LED Strip



- **Hugely versatile - can be used around the home, for bright signage, in-car use or electronics projects**
 - **Sold per 5cm length so you can buy the correct amount**
 - **Can be cut at 5cm intervals whilst the LEDs continue working**
 - **Maximum length in 1 piece: 5 metres**
 - **Highly visible and flexible**
 - **Self adhesive peel and stick reverse**
 - **Red, Yellow, Blue, White and Green colours available**
- The light-strip can be cut at intervals of 5cm across the marked vertical line. Each 5cm length has three stunning bright LEDs and a diode mounted on to it. When ordered as a full reel of 5 metres (100 x 5cm units), the light strip will be provided with cable terminations already attached as supplied - this is particularly useful for industrial applications where a fast installation is required.

For shorter lengths, the user will be required to solder suitable wire (recommended Order Code: XR40T - black wire and Order Code: XR44X - red wire) to the strip and connect the other end of the wire to a suitable DC 12V power supply. The current requirements for various LED strip lengths are shown in the spec table.

Please note: For mail-order and internet sales, the LED light-strip can only be supplied in full reels of 5 metre lengths. For smaller lengths, please check your local Maplin store for availability.

Order Code	Mod: 218015	Price each exc. VAT 1+	5+	inc. VAT each
N91CX	5cm LED Strip Blue	£1.07	£0.93	£1.29
N84CZ	5cm LED Strip Red	£1.07	£0.93	£1.29
N85CZ	5cm LED Strip Green	£1.07	£0.93	£1.29
N86CZ	5cm LED Strip Yellow	£1.07	£0.93	£1.29
N87CZ	5cm LED Strip Wrm Wht	£1.07	£0.93	£1.29

1000's more components available in-store & online

Warm White 12V IP65 5cm LED Strip



- **Versatile LED strip manufactured with an IP65 waterproof coating**
- **Strong self adhesive backing material sticks to most clean surfaces**
- **Powered from 12VDC constant voltage power supplies**
- **Highly visible warm white colour**
- **Ideal for external illumination for signage, automotive applications, diy lighting solutions**
- **Can be cut at 5cm intervals whilst the LEDs continue working**

This LED light strip features a sealed IP65 coating offering water resistance against strong sprays of water, making this product ideal for low power, high brightness external lighting solutions. Uses include sign manufacture, kitchen or bathroom lighting along with many custom illumination projects around the home, caravan or workplace.

The light-strip is supplied in multiples of 5cm and can be cut at intervals of 5cm across the marked vertical line. Each 5cm length has three stunning bright LEDs and a diode mounted on to it. When ordered as a full reel of 5 metres (100 x 5cm units), the light strip will be provided with cable terminations already attached as supplied - this is particularly useful for industrial applications where a fast installation is required.

When cut into smaller sections the IP65 coating will need to be carefully removed from around the solder

RGB LED Strip



- Extremely versatile - can be used around for bright signage construction, in-car use or in electronics projects
- Add a contemporary lighting solution to your home
- Sold per 10cm length so you can buy the correct amount needed
- Can be cut at 10cm intervals whilst the LEDs continue working
- Maximum length in 1 piece: 5 metres
- Highly visible and flexible
- Self adhesive peel and stick reverse
- Full RGB scale can be achieved from the correct controller
- Operates at 12Vdc 3.0A for the full 5M length

Each strip has four terminals which can be soldered to directly create custom lighting solutions. The system can be used with our 16 button [N36JX] or 4 button [N35JX] RGB LED controllers to give you precise control over your displays. Its ideal for sign illumination, decorative features around the home or office, alternative energy lighting solutions.

Please note: For mail-order and internet sales, the LED light-strip can only be supplied in full reels of 5 metre lengths. For smaller lengths, please check your local Maplin store for availability.

Length of Cut Strip	Approximate Current
10 centimetres (1 unit)	60mA
1 metre (10 units)	600mA
2 metres (20 units)	1200mA
3 metres (30 units)	1800mA
4 metres (40 units)	2400mA
5 metres (50 units)	3000mA

Common anode

Order Code	Mod: 515851	Price each exc. VAT 1+	inc. VAT each
N48JX	10cm LED STRIP RGB	£1.65	£1.99

4 Button RGB LED Controller



- Control RGB LED lighting from a remote
- 11 different display modes
- Select between static of fading displays
- Variable speed control
- Robust metal enclosure with mounting lugs
- 15m transmission range

11 modes:
 Static red
 Static green
 Static mix red and green
 Static blue
 Static mix red and blue
 Static mix green and blue
 Static mix red, green and blue
 Looping of red, green and blue
 Looping of full colours
 Fading of red, green and blue
 Fading of full colours

Specification

Supply Voltage DC 12 to 24V 24V
 Max Current 15A 15A
 Remote Battery 23A (JG91)
 Dimensions (mm) 125 x 65 x 24

Order Code	Mod: 515854	Price each exc. VAT 1+	5+	inc. VAT each
N35JX	4 button RGB Control	£18.32	£15.83	£21.99

16 Button RGB LED Controller



- Multi mode RGB LED lighting controller
- 8 dynamic mode functions and 8 single colour selections
- Memory, even after loss of power
- Select between static of fading displays
- Variable speed, brightness, flash rate control
- Robust metal enclosure with mounting lugs

Mode 1	Red - Green - Blue
Mode 2	Red - Yellow - Green - Orange - Purple
Mode 3	Red - Yellow - White - Orange - Blue
Mode 4	Red - Green - Blue - Yellow - Purple - Orange - White
Mode 5	Red - White - Blue - Purple - White - Yellow - Green - White - Purple
Mode 6	Red - No colour - Green - No colour - Blue - No colour
Mode 7	Red - Yellow - Green - Orange - Blue - Purple - white
Mode 8	White - Purple - Blue - Orange - Green - Yellow - Red

Specification

Supply Voltage DC 12 to 24V
 Max Current 15A
 Remote Battery 27A (ZB55K)
 Dimensions (mm) 125 x 65 x 24

Order Code	Mod: 515856	Price each exc. VAT 1+	5+	inc. VAT each
N36JX	16Button RGB Control	£16.65	£14.39	£19.99

DC 12V Flexible LED Light Strip 400mm

ORDER IN STORE OR ONLINE



- Used to create decorative lighting displays or for customising car interiors
- Low power consumption and long life
- Rugged and reliable (no glass to break)
- Applications include: illuminated wall trim, sign lettering, light-box illumination, decorative lighting and displays
- Fast and easy to install
- High brightness with no colour fade
- Low maintenance
- Operates from DC 12V
- Current consumption: 220mA
- Dimensions: 400(L) x 11(w) x 2(h) mm

36 Ultra bright surface mount LEDs mounted on a 400mm long flexible PCB. The strip has three cut points

along its length that allows the 400mm length to be cut down into shorter 100mm strips if required. The strips can be soldered together end to end to form longer lengths. They can also be mounted using double-sided tape (Order code: N91AL). A suitable power supply is also available (Order code: L47BL) that will operate 5 strips. The strips are available in blue (Order code: N55CF) and white (Order code: N56CF)

Order Code	Mod: 047376	Price each exc. VAT 1+	inc. VAT each
N55CF	Blue Flexistrip RoHS	£15.82	£18.99
N56CF	White Flexistrip RoHS	£20.82	£24.99

LED Kits and Tester

Assorted LED 80 Piece LED Pack



Size in Kit	Colour	Brightness (mcd)	Quantity
3mm	Green	4	15
3mm	Red	1	20
5mm	Green	6	15
5mm	Red	2	20
5mm	Yellow	3.9	10

Order Code	Mod: 045928	Price each exc. VAT 1+	inc. VAT each
N48BX	LEDs 80Pk	£6.65	£7.99

Assorted LED 44 Piece LED Pack



A selection of 3mm, 5mm, 8mm and 10mm LEDs in standard colours supplied in a plastic case. Includes round, rectangular, PCB mounting and side looking LEDs, as well as two seven-segment displays. Comprises 44 parts in total

Order Code	Mod: 031867	Price each exc. VAT 1+	5+	inc. VAT each
RS375	LED Kit	£11.07	£9.57	£13.29

Twin LED Blinker Kit 6V-12V



- Operating voltage is DC 6 or 12V
- Two output alternating flasher
- Flash sequence is approx. 2 to 3 Hz (approx. 120...180 flashing pulses per minute)
- Flashing / rest relation: approx. 50 : 50 %
- Dimensions approx. 18(L) x 16(w) x 4(d) mm

Suitable as flasher or alternating flasher for light emitting diodes. Operating voltage DC 6 or 12V. Flashing period is approx. 2 to 3 Hz (approx. 120 to 180 flash pulses per minute). Protection against change of polarity, short-circuit-safe, built-in current limitation for LED's. Connecting possibilities for 1 upto 10 LED's. Ideal for use in model construction, for adornment picture or caps with built-in LED's, warning flashers, etc

Order Code	Mod: 227089	Price each exc. VAT 1+	inc. VAT each
N26GL	Twin Led Blinker Kit	£3.74	£4.49

LED Tester



With the aid of this test module it is possible to carry out tests with all types of light emitting diodes in order to check function, brightness, colour and polarity. The LEDs can be tested with different currents: approx 1mA, 2.5mA, 5mA, 10mA, 20mA and 50mA. In order to facilitate selection of LEDs of equal brightness, two test sockets with the same current (10mA) have been placed side by side.

Requires 1x9V PP3 battery [Order Code L46AL]

Order Code	Mod:	Price each exc. VAT	inc. VAT each
N71AU	LED Tester	£8.32	£9.99

- Additional lens are available
- Requires a constant current power supply

Specifications:

typ IF=350mA	White
Forward Voltage	3.5v
Viewing Angle	120°
Colour Temp.	6000K
Luminosity (lm)	90

Order Code	Mod:	Price each exc. VAT	inc. VAT each
N67JQ	1W LED White	£1.65	£1.99

1W High Power LED with PCB



- High power, Lambertian LED
- PCB Mounted for easy handling and safer soldering methods
- Water clear lens
- Modern LED for superior lighting solutions
- Perfect for hobby, diy and professional users
- 120° viewing angle
- Heat-sink is required
- Additional lens are available
- Requires a constant current power supply
- PCB 20mm diameter

Specifications:

typ IF=350mA	White	Warm White
Forward Voltage	3.5v	3.5v
Viewing Angle	120°	120°
Colour Temp.	6000K	3000K
Luminosity (lm)	90	81

Order Code	Mod:	Price each exc. VAT	inc. VAT each
N73JQ	1W LED White PCB	£3.40	£4.09
N74JQ	1W LED W White PCB	£3.32	£3.99

3W High Power LED with PCB



- High power, Lambertian LED
- PCB Mounted for easy handling and safer soldering methods
- Water clear lens
- Modern LED for superior lighting solutions
- Perfect for hobby, diy and professional users
- 120° viewing angle
- Heat-sink is required
- Additional lens are available
- Requires a constant current power supply
- PCB 20mm diameter

Viewing Angle	120°	120°	120°
Colour Temperature		6000K	3000K
Luminosity (lm)	52	160	134

Specifications:

Typ IF=700mA	Blue	White	Warm White
Forward Voltage	3.8v	3.8v	3.8v

Order Code	Mod:	Price each exc. VAT	inc. VAT each
N84JQ	3W LED Blue PCB	£4.15	£4.99
N85JQ	3W LED White PCB	£4.15	£4.99
N86JQ	3W LED W White PCB	£4.15	£4.99

High Power LED Lens



- A range of high quality lens for our High Power LED range
- Water clear finish or catoptric finish types
- Can be fixed using common silicone based adhesives
- Ideal finish for architectural lighting, hobby projects, diy lighting jobs or for manufacturing projects

Specifications:

Code	Description	Lens Colour	Viewing Angle	Casing	Dim (mm)
N87JQ	HPH-1	Water Clear	15°	Black	23x14.25
N89JQ	HPI-3	Water Clear	8°	None	26.68x18.76
N90JQ	HPI-4	Catoptrics	60°	White	14x8.49
N88JQ	HPI-2	Water Clear	10°	None	19.7x12.72
N91JQ	HPI-5	Water Clear	30°	Black	21.15x14.5
N92JQ	HPI-6	Water Clear	60°	Black	25.1x14
N93JQ	HPI-7	Water Clear	45°	Black	21.1x15.16
N94JQ	HPI-8	Water Clear	25°	Black	21.1x14.4

Order Code	Mod:	Price each exc. VAT	inc. VAT each
N87JQ	HP LED Lens HPH1	£1.24	£1.49
N88JQ	HP LED Lens HPH2	£1.24	£1.49
N89JQ	HP LED Lens HPH3	£1.24	£1.49
N90JQ	HP LED Lens HPH4	£1.24	£1.49
N91JQ	HP LED Lens HPH5	£1.24	£1.49
N92JQ	HP LED Lens HPH6	£1.24	£1.49
N93JQ	HP LED Lens HPH7	£1.24	£1.49
N94JQ	HP LED Lens HPH8	£1.24	£1.49

Constant Current LED Power Supply



- A range of constant current LED power supplies
- 350mA and 700mA outputs
- Drivers 100 to 230VAC or 12VDC input voltages
- Perfect for powering High Power LEDs

This range of constant current LED drivers provides 350mA and 700mA outputs in power ratings of up to 18W. All products automatically set the current output voltage required with the capability to cover voltages from 3 - 54V. All models are operated from mains voltage except N98JR and N94JR which are operated from a 12Vdc supply.

Specifications

	Output Power	Input Voltage	Output Voltage DC	Output Current
N91JR	1-3W	100 - 240V AC	3-12V	350mA
N92JR	1-8W	100 - 240V AC	3-36V	350mA
N93JR	3-16W	100 - 240V AC	10-54V	350mA
N94JR	1-2W	12V DC	3-10V	350mA
N95JR	3-6W	100 - 240V AC	3-12V	700mA
N96JR	3-9W	100 - 240V AC	3-21V	700mA
N97JR	3-18W	100 - 240V AC	18V	700mA
N98JR	3-9W	12V DC	3-12V	700mA

Order Code	Mod:	Price each exc. VAT	inc. VAT each
N91JR	LED Driver 1-3W 350	£9.99	£11.99
N92JR	LED Driver 1-8W 350	£11.65	£13.99
N93JR	LED Driver 1-16W 350	£14.99	£17.99
N94JR	12V LED Driver 2W	£8.32	£9.99
N95JR	LED Driver 3-6W 700	£9.99	£11.99
N96JR	LED Driver 3-9W 700	£12.49	£14.99
N97JR	LED Driver 3-18W 700	£15.75	£18.90
N98JR	12V LED Driver 9W	£8.32	£9.99

1W High Power LED

ORDER IN STORE OR ONLINE



- High power, Lambertian LED
- Water clear lens
- Modern LED for superior lighting solutions
- Perfect for hobby, diy and professional users
- 120° viewing angle
- Heat-sink is required

3mm LEDs

Calculating the LED Series Resistor

To operate an LED from a given voltage, a resistor needs to be connected in series with it. The correct value in ohms (Ω) can be calculated from the following formula:

$$R = (Vs - Vf) / If$$

Where Vs is the supply voltage, Vf is the forward voltage drop across the LED and If is the forward current through the LED. The values of Vs and If are shown in the specifications of each LED in this catalogue.

Example

For a typical LED

($If = 20mA$ and $Vf = 2.5V$)

To operate from a $12V$ DC supply:

$$R = (12 - 2.5) / 0.02 = 475\Omega$$

The nearest preferred value resistor is 470Ω and in practice would be fine.

For AC operation, connect a diode (e.g. 1N4148) in inverse parallel with the LED and halve the value of the resistor determined by the above formula.

3mm Super Bright LEDs



- A range of high quality 3mm LEDs
- Supplied in water clear package
- Suitable for sign boards, safety equipment, advertising or LCD back lighting
- Ideal for hobbyist or manufacturing projects
- Available in white, blue, red, green, blue, yellow and orange

Specifications

N66KG 3mm LED White	
SunLED Description	LFWA11W
Forward Voltage at IF=20mA	3.3
Forward Current	30
Reverse Voltage	5
Chromatic Co-ordinates	0.31 X 0.31
Typical Intensity at IF=20mA (mcd)	5990
Viewing Angle	34
N67KG 3mm LED Red	
SunLED Description	LZR11WJ
Forward Voltage at IF=20mA [Typical]	1.85
Forward Current	30
Reverse Voltage	5
Wavelength (nm)	660
Typical Intensity at IF=20mA (mcd)	3390
Viewing Angle	34
N68KG 3mm LED Green	
SunLED Description	LDG11W
Forward Voltage at IF=20mA [Typical and Max]	3.3
Forward Current	25
Reverse Voltage	5
Wavelength (nm)	515
Typical Intensity at IF=20mA (mcd)	8990
Viewing Angle	34
N69KG 3mm LED Blue	
SunLED Description	LFBB11W
Forward Voltage at IF=20mA [Typical]	3.3
Forward Current	30
Reverse Voltage	5
Wavelength (nm)	465
Typical Intensity at IF=20mA (mcd)	3990

Viewing Angle 34

N70KG 3mm LED Yellow

SunLED Description	LM2ACY11W
Forward Voltage at IF=20mA [Typical]	2
Forward Current	30
Reverse Voltage	5
Wavelength (nm)	590
Typical Intensity at IF=20mA (mcd)	2790
Viewing Angle	20

N71KG 3mm LED Orange

SunLED Description	LMO11W
Forward Voltage at IF=20mA [Typical]	2
Forward Current	30
Reverse Voltage	5
Wavelength (nm)	610
Typical Intensity at IF=20mA (mcd)	2690
Viewing Angle	34

Order Code	Mod: 587260	Price each exc. VAT 1+	Price each exc. VAT 5+	inc. VAT each
N66KG	3mm LED White	£0.70	£0.61	£0.84
N67KG	3mm LED Red	£0.70	£0.61	£0.84
N68KG	3mm LED Green	£0.70	£0.61	£0.84
N69KG	3mm LED Blue	£0.70	£0.61	£0.84
N70KG	3mm LED Yellow	£0.74	£0.64	£0.89
N71KG	3mm LED Orange	£0.70	£0.61	£0.84

3mm Low Current LEDs



A range of 3mm diameter, very low current (2mA) LEDs available in 4 colours. Features include high light output at low current and low power consumption. All types have a diffused lens and a wide viewing angle of 60° .

Specifications:

Order Code CJ55K:	High Efficiency Red
Kingbright description:	L-934LID
Forward voltage max. at IF=2mA	2.5V
Forward current max.:	30mA
Reverse voltage max.:	5V
Wavelength @ peak IF=2mA	625nm
Power dissipation PT	105mW
Light output min @ 2mA:	0.8mcd
Light output typ @ 2mA	3mcd
Order Code CJ56L:	Green
Kingbright description:	L-934LGD
Forward voltage max. at IF=2mA	2.5V
Forward current max.:	25mA
Reverse voltage max.:	5V
Wavelength @ peak IF=2mA	565nm
Power dissipation PT	105mW
Light output min @ 2mA:	0.8mcd
Light output typ @ 2mA	2mcd
Order Code CJ57M:	Yellow
Kingbright description:	L-934LYD
Forward voltage at IF=2mA:	2.1V
Forward current max.:	30mA
Reverse voltage max.:	5V
Wavelength @ peak IF=2mA	590nm
Power dissipation PT	100mW
Light output min @ 2mA:	0.8mcd
Light output typ @ 2mA	2mcd
Order Code CJ58N:	Super Bright Red
Kingbright description:	L-934LSRD
Forward voltage at IF=2mA:	2.5V
Forward current max.:	30mA
Reverse voltage max.:	5V
Wavelength @ peak IF=2mA	660nm
Power dissipation PT	100mW
Light output min @ 2mA:	8mcd
Light output typ @ 2mA	20mcd

Order Code	Mod: 035736	Price each exc. VAT 1+	Price each exc. VAT 5+	inc. VAT each
CJ55K	2mA 3mm HE Red LED	£0.57	£0.48	£0.69
CJ56L	2mA 3mm Green LED	£0.57	£0.48	£0.69
CJ57M	2mA 3mm Yellow LED	£0.57	£0.48	£0.69
CJ58N	2mA 3mm SB Red LED	£0.57	£0.48	£0.69

3mm LEDs



A range of 3mm high intensity, low power consumption LEDs supplied in a popular T-1 diameter package. The cathode is denoted by the shortest leg. All LEDs have a diffused lens and a viewing angle of 60° .

Specifications:

Order Code WL32K: Bright Red

Kingbright description	L34HD
Forward voltage max. IF=20mA	2.5V
Forward current:	25mA
Reverse current VR=5V @ 10mA	
Wavelength @ peak IF=20mA	700nm
Power dissipation PT	120mW
Light output min @ 10mA	1mcd
Light output typ @ 10mA 3mcd	

Order Code WL33L: Green

Kingbright description	L34GD
Forward voltage max. IF=20mA	2.5V
Forward current:	25mA
Reverse current VR=5V @ 10mA	
Wavelength @ peak IF=20mA	565nm
Power dissipation PT	105mW
Light output min @ 10mA	5mcd
Light output typ @ 10mA 20mcd	

Order Code WL34M: High Efficiency Red

Kingbright description	L34ID
Forward voltage max. IF=20mA	2.5V
Forward current:	30mA
Reverse current VR=5V @ 10mA	
Wavelength @ peak IF=20mA	627nm
Power dissipation PT	105mW
Light output min @ 10mA	8mcd
Light output typ @ 10mA 25mcd	

Order Code YY38R: Yellow

Kingbright description	L34YD
Forward voltage max. IF=20mA	2.5V
Forward current:	30mA
Reverse current VR=5V @ 10mA	
Wavelength @ peak IF=20mA	590nm
Power dissipation PT	105mW
Light output min @ 10mA	5mcd
Light output typ @ 10mA 10mcd	

Order Code CK350: Pure Green

Kingbright description	L34PGD
Forward voltage max. IF=20mA	2.5V
Forward current:	25mA
Reverse current VR=5V @ 10mA	
Wavelength @ peak IF=20mA	555nm
Power dissipation PT	105mW
Light output min @ 10mA	0.7mcd
Light output typ @ 10mA 3mcd	

Order Code	Mod: 035702	Price each exc. VAT 1+	Price each exc. VAT 5+	inc. VAT each
WL32K	Mini 3mm LED SB Red	£0.49	£0.42	£0.59
WL33L	Mini 3mm LED Green	£0.49	£0.42	£0.59
WL34M	Mini 3mm LED HE Red	£0.49	£0.42	£0.59
CK350	Mini LED Pure Green	£0.61	£0.54	£0.74
YY38R	Mini 3mm LED Yellow	£0.49	£0.42	£0.59

Subscribe to our newsletter
For deals and information
maplin.co.uk



3mm Super Bright LEDs



Two 3mm super bright, low current capability LEDs with outstanding material efficiency. The cathode is denoted by the shortest leg.

Specifications:
 Order Code UF72P: Super Bright Red
 Kingbright description: L-934SRC-E
 Lens type: Water clear
 Viewing angle: 50°
 Forward voltage at IF=20mA: 2.5V
 Forward current max: 30mA
 Reverse voltage max: 5V
 Wavelength @ peak IF=20mA: 660nm
 Power dissipation PT: 100mW
 Light output min @ 20mA: 700mcd
 Light output typ @ 20mA: 900mcd
 Order Code UK18U: Super Bright Red
 Kingbright description: L-9345RD-E
 Lens type: Red diffused
 Viewing angle: 60°
 Forward voltage at IF=20mA: 2.5V
 Forward current max: 30mA
 Reverse voltage max: 5V
 Wavelength @ peak IF=20mA: 660nm
 Power dissipation PT: 100mW
 Light output min @ 20mA: 200mcd
 Light output typ @ 20mA: 250mcd

Order Code	Mod: 035732	Price each exc. VAT 1+	VAT 5+	inc. VAT each
UF72P	3mm Red SB Clear LED	£0.65	£0.57	£0.79
UK18U	3mm Red SB Diff LED	£0.65	£0.57	£0.79

3mm Green LED



A 3mm, super bright LED with low power consumption, which is suitable for full colour LED displays, indicators and diagnostic/analytical equipment. It has a water clear lens and a viewing angle of 34°.

Specifications:
 Order Code N61AX: Green
 Kingbright description: L-7104ZGC-G
 Forward current max: 20mA
 Forward voltage max.: 3.2V
 Reverse voltage max.: 5V
 Wavelength @ peak: 520nm
 Power dissipation PT: 120mW
 Light output min @ 20mA: 8000mcd
 Light output typ @ 20mA: 11000mcd

Order Code	Mod: 035877	Price each exc. VAT 1+	VAT 5+	inc. VAT each
N61AX	3mm Green LED 11cd	£1.65	£1.43	£1.99

Super Bright 3mm LED



A range of 3mm LED in water clear finish offering superb clarity different, colours available are red, white, yellow, and blue. The cathode is denoted by the flat on the body and by the short lead.

Specifications	N16FN	N19FN	N20FN	N21FN
F/Voltage	3.5V	2.0V	2.0V	3.5V
F/Current	35mA	50mA	35mA	25mA
R/Voltage	5V	5V	5V	5V
Light Output	5200mcd	5000mcd	5000mcd	12000mcd
Colour	Blue	Yellow	Red	White

Order Code	Mod: 383847	Price each exc. VAT 1+	VAT 5+	inc. VAT each
N16FN	3mm T1 LED Sup Br Bl	£0.61	£0.54	£0.74
N19FN	3mm T1 LED Sup Br Yw	£0.61	£0.54	£0.74
N20FN	3mm T1 LED Sup Br Rd	£0.61	£0.54	£0.74
N21FN	3mm T1 LED White	£0.61	£0.54	£0.74

3mm High Bright Blue LEDs

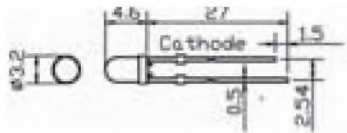

- A range of 3mm high brightness, low power consumption LEDs
- Suitable for full colour displays, indicators and diagnostic/analytical equipment
- Available in diffused blue or clear

Specifications:
 Kingbright description: L-934MBD
 Lens type: Blue diffused
 Viewing angle: 60°
 Forward voltage max. at IF=20mA: 4.5V
 Forward current max.: 30mA
 Reverse voltage max.: 5V
 Wavelength @ peak IF=20mA: 430nm
 Power dissipation PT: 105mW
 Light output min @ 20mA: 20mcd
 Light output typ @ 20mA: 50mcd

Order Code	Mod: 035734	Price each exc. VAT 1+	VAT 5+	inc. VAT each
JA20W	3mm SB LED Diff Blue	£1.07	£0.93	£1.29
JA22Y	3mm SB LED Clr Blue	£1.07	£0.93	£1.29

5V 3mm LEDs



Two 3mm diameter LEDs from the 5V series in a T-1 package. These LEDs have a 5V integral current limiting resistor, which means no external current limiter is required with a 5V supply. Both types have a diffused lens and a wide viewing angle of 60°.

Specifications:
 Order Code CJ64U: High Efficiency Red
 Kingbright description: L-934ID-5V
 Forward voltage max. at 5V: 6.5V
 Forward current VF=5V: 13mA
 Reverse voltage max.: 5V
 Wavelength @ peak VF=5V: 627nm
 Power dissipation PT: 85mW
 Light output min @ 5V: 8mcd
 Light output typ @ 5V: 20mcd
 Order Code CJ65V: Green
 Kingbright description: L-934GD-5V

Forward voltage max. at 5V: 6.5V
 Forward current VF=5V: 13mA
 Reverse voltage max.: 5V
 Wavelength @ peak VF=5V: 565nm
 Power dissipation PT: 85mW
 Light output min @ 5V: 8mcd
 Light output typ @ 5V: 20mcd

Order Code	Mod: 035737	Price each exc. VAT 1+	VAT 5+	inc. VAT each
CJ64U	3mm 5V HE Red LED	£0.65	£0.55	£0.79
CJ65V	3mm 5V LED Green	£0.65	£0.55	£0.79

12V 3mm LEDs



A range of 3mm diameter LEDs from the 12V series in a T-1 package. These LEDs are designed to connect across 12Vdc power supply rails. They have a 12V integral current limiting resistor, which means no external current limiter is required with a 12V supply. All types have a diffused lens and a wide viewing angle of 60°.

Specifications:
 Order Code CJ66W: High Efficiency Red
 Kingbright description: L-934ID-12V
 Forward voltage at 12V: 14V
 Forward current VF=12V: 8.5mA
 Reverse voltage max: 5V
 Wavelength @ peak VF=12V: 627nm
 Power dissipation PT: 120mW
 Light output min @ 12V: 8mcd
 Light output typ @ 12V: 20mcd
 Order Code CJ67X: Green
 Kingbright description: L-934GD-12V
 Forward voltage at 12V: 14V
 Forward current VF=12V: 8.5mA
 Reverse voltage max: 5V
 Wavelength @ peak VF=12V: 565nm
 Power dissipation PT: 120mW
 Light output min @ 12V: 8mcd
 Light output typ @ 12V: 20mcd
 Order Code CJ68Y: Yellow
 Kingbright description: L-934YD-12V
 Forward voltage at 12V: 14V
 Forward current VF=12V: 8.5mA
 Reverse voltage max: 5V
 Wavelength @ peak VF=12V: 590nm
 Power dissipation PT: 120mW
 Light output min @ 12V: 8mcd
 Light output typ @ 12V: 15mcd
 Order Code CJ69A: Super Bright Green
 Kingbright description: L-934SGD-12V
 Forward voltage at 12V: 14V
 Forward current VF=12V: 8.5mA
 Reverse voltage max: 5V
 Wavelength @ peak VF=12V: 565nm
 Power dissipation PT: 120mW
 Light output min @ 12V: 8mcd
 Light output typ @ 12V: 20mcd
 Order Code CJ70M: Super Bright Red
 Kingbright description: L-934SRD-12V
 Forward voltage at 12V: 14V
 Forward current VF=12V: 8.5mA
 Reverse voltage max: 5V
 Wavelength @ peak VF=12V: 660nm
 Power dissipation PT: 120mW
 Light output min @ 12V: 40mcd
 Light output typ @ 12V: 100mcd

Order Code	Mod: 035738	Price each exc. VAT 1+	VAT 5+	inc. VAT each
CJ66W	3mm 12V HE Red LED	£0.65	£0.55	£0.79
CJ67X	3mm 12V LED Green	£0.65	£0.55	£0.79
CJ68Y	3mm 12V LED Yellow	£0.65	£0.55	£0.79
CJ69A	3mm 12V Green SB LED	£0.57	£0.50	£0.69
CJ70M	3mm 12V Red SB LED	£0.65	£0.55	£0.79

3mm Flashing LEDs



A range of LEDs which flash approximately twice a second when a voltage between 3.5V and 14V is connected to them. Within the supply voltage range, no series resistor is required. These LEDs have a built-in blinking IC and have a blinking frequency from 3Hz to 1.5Hz. They are supplied in a T-1 package with rectangular base and the cathode is denoted by the short lead. A panel mounting clip is not available to suit these LEDs. All types have a diffused lens and a viewing angle of 60°.

Specifications:

Order Code UK30H: Bright Red

Kingbright description: L-616BHD
 Forward voltage: 2.5V
 Forward current typ.: 20mA
 Reverse voltage max.: 0.5V
 Wavelength (λ) peak: 700nm
 Power dissipation PT: 310mW
 Light output min (λ) 9V: 1.3mcd
 Light output typ (λ) 9V: 2mcd

Order Code UK31J: Green

Kingbright description: L-616BGD
 Forward voltage: 2.5V
 Forward current typ.: 20mA
 Reverse voltage max.: 0.5V
 Wavelength (λ) peak: 565nm
 Power dissipation PT: 310mW
 Light output min (λ) 9V: 5mcd
 Light output typ (λ) 9V: 15mcd

Order Code UK32K: Yellow

Kingbright description: L-616BYD
 Forward voltage: 2.5V
 Forward current typ.: 21mA
 Reverse voltage max.: 0.5V
 Wavelength (λ) peak: 590nm
 Power dissipation PT: 310mW
 Light output min (λ) 9V: 5mcd
 Light output typ (λ) 9V: 10mcd

Order Code UK33L: High Efficiency Red

Kingbright description: L-616BID
 Forward voltage: 2.5V
 Forward current typ.: 22mA
 Reverse voltage max.: 0.5V
 Wavelength (λ) peak: 627nm
 Power dissipation PT: 310mW
 Light output min (λ) 9V: 12mcd
 Light output typ (λ) 9V: 20mcd

Order Code UK34M: Super Bright Red

Kingbright description: L-616BSRD-B
 Forward voltage: 2.5V
 Forward current typ.: 25mA
 Reverse voltage max.: 0.5V
 Wavelength (λ) peak: 660nm
 Power dissipation PT: 310mW
 Light output min (λ) 9V: 100mcd
 Light output typ (λ) 9V: 200mcd

Order Code	Mod: 002103	Price each exc. VAT 1+	inc. VAT each
UK30H	Flashing LED Red 3mm	£0.65	£0.79
UK31J	Flashing LED Grn 3mm	£0.74	£0.89
UK32K	Flashing LED Ylw 3mm	£0.65	£0.79
UK33L	HiBri Flash Red 3mm	£0.86	£1.04
UK34M	Super Flash Red 3mm	£0.86	£1.04

3mm Flashing Blue LED



A 3mm flashing LED with a blue diffused lens and a viewing angle of 60°. This LED flashes when a voltage between 5V and 14V is connected to it. Its flashing frequency is between 3Hz and 1.5Hz. The cathode is denoted by the shortest leg

Specifications:

Order Code N64AJ: Flashing Blue

Kingbright description: L-36BPBDL
 Forward voltage max. IF=20mA: 4.2V
 Reverse current VR=5V: 10mA
 Wavelength (λ) peak: 468nm
 Power dissipation PT: 102mW
 Light output min: 40mcd
 Light output typ.: 60mcd

Order Code	Mod: 033334	Price each exc. VAT 1+	inc. VAT each
N64AJ	Super Flash 3mm Blue	£1.74	£2.09

5mm LEDs

5mm Super Bright LEDs



- A range of high quality 5mm LEDs
- Supplied in water clear package
- Suitable for sign boards, safety equipment, advertising or LCD back lighting
- Ideal for hobbyist or manufacturing projects
- Available in white, blue, red, green, blue, yellow and orange

Specifications

N72KG 5mm LED White

SunLED Description: LFW512W
 Forward Voltage at IF=20mA: 3.3V
 Forward Current: 30mA
 Reverse Voltage: 5V
 Chromatic Co-ordinates: 0.31 X 0.31
 Typical Intensity at IF=20mA (mcd): 5990
 Viewing Angle: 34°

N73KG 5mm LED Red

SunLED Description: LZR12WF
 Forward Voltage at IF=20mA [Max]: 1.85V
 Forward Current: 30mA
 Reverse Voltage: 5V
 Wavelength (nm): 660nm
 Typical Intensity at IF=20mA (mcd): 3390
 Viewing Angle: 34°

N74KG 5mm LED Green

SunLED Description: LDG12W
 Forward Voltage at IF=20mA [Max]: 3.3V
 Forward Current: 25mA
 Reverse Voltage: 5V
 Wavelength (nm): 515nm
 Typical Intensity at IF=20mA (mcd): 8990
 Viewing Angle: 34°

N75KG 5mm LED Blue

SunLED Description: LCB012W
 Forward Voltage at IF=20mA [Max]: 3.3V
 Forward Current: 30mA
 Reverse Voltage: 5V
 Wavelength (nm): 465nm
 Typical Intensity at IF=20mA (mcd): 3990
 Viewing Angle: 34°

N76KG 5mm LED Yellow

SunLED Description: LM2ACY12W
 Forward Voltage at IF=20mA [Max]: 2V
 Forward Current: 30mA
 Reverse Voltage: 5V
 Wavelength (nm): 590nm
 Typical Intensity at IF=20mA (mcd): 2790
 Viewing Angle: 20°

N77KG 5mm LED Orange

SunLED Description: LMO12W
 Forward Voltage at IF=20mA [Max]: 2V
 Forward Current: 30mA
 Reverse Voltage: 5V
 Wavelength (nm): 610nm
 Typical Intensity at IF=20mA (mcd): 2690
 Viewing Angle: 34°

Order Code	Mod: 587264	Price each exc. VAT 1+	inc. VAT each
N72KG	5mm LED White	£0.74	£0.89
N73KG	5mm LED Red	£0.74	£0.89
N74KG	5mm LED Green	£0.74	£0.89
N75KG	5mm LED Blue	£0.74	£0.89
N76KG	5mm LED Yellow	£0.74	£0.89
N77KG	5mm LED Orange	£0.74	£0.89

5mm Low Current LEDs



A range of 5mm very low current (2mA) LEDs available in 4 colours. The LEDs have low power consumption with high light output at low currents. The cathode is denoted by the shorter of the 2 leads and a flat on the body. All types have diffused lenses and a wide viewing angle of 60°.

Specifications:

Order Code UK48C: High Efficiency Red

Kingbright description: L-53LID
 Forward current max.: 30mA
 Forward voltage max.: 2.5V
 Reverse voltage max.: 5V
 Wavelength (λ) peak: 625nm
 Power dissipation PT: 105mW
 Light output min (λ) 2mA: 0.8mcd
 Light output typ (λ) 2mA: 5mcd

Order Code UK49D: Green

Kingbright description: L-53LGD
 Forward current max.: 25mA
 Forward voltage max.: 2.5V
 Reverse voltage max.: 5V
 Wavelength (λ) peak: 565nm
 Power dissipation PT: 105W
 Light output min (λ) 2mA: 0.8mcd
 Light output typ (λ) 2mA: 2mcd

Order Code UK50E: Yellow

Kingbright description: L-53LYD
 Forward current max.: 30mA
 Forward voltage max.: 2.1V
 Reverse voltage max.: 5V
 Wavelength (λ) peak: 590nm
 Power dissipation PT: 100mW
 Light output min (λ) 2mA: 0.8mcd
 Light output typ (λ) 2mA: 2mcd

Order Code N68AJ: Super Bright Red

Kingbright description: L-53LSRD
 Forward current max.: 30mA
 Forward voltage max.: 2.5V
 Reverse voltage max.: 5V
 Wavelength (λ) peak: 660nm
 Power dissipation PT: 100mW
 Light output min (λ) 2mA: 8mcd
 Light output typ (λ) 2mA: 20mcd

Order Code	Mod: 035771	Price each exc. VAT 1+	inc. VAT each
UK48C	LED HE Red 5mm 2mA	£0.61	£0.74
UK49D	LED Green 5mm 2mA	£0.61	£0.74
UK50E	LED Yellow 5mm 2mA	£0.65	£0.79
N68AJ	LED SB Red 5mm 2mA	£0.74	£0.89

We can deliver to your home or office (UK only)

5mm LEDs



A range of high intensity, low power consumption, standard 5mm LEDs supplied in a popular T-13/4 package and available in 7 colours. The cathode is denoted by the flat on the body and by the short lead. All LEDs have a diffused lens and a viewing angle of 60°

Specifications:

- Order Code WL27E:** **Bright Red**
- Kingbright description: L-53HD
- Forward voltage: 2.5V
- Forward current max: 25mA
- Reverse voltage max: 5V
- Wavelength @ peak: 700nm
- Power dissipation PT: 120mW
- Light output min @ 10mA: 2mcd
- Light output typ @ 10mA: 5mcd
- Order Code WL28F:** **Green**
- Kingbright description: L-53GD
- Forward voltage: 2.5V
- Forward current max: 25mA
- Reverse voltage max: 5V
- Wavelength @ peak: 565nm
- Power dissipation PT: 105mW
- Light output min @ 10mA: 5mcd
- Light output typ @ 10mA: 20mcd
- Order Code WL29G:** **Orange**
- Kingbright description: L-53ED
- Forward voltage: 2.5V
- Forward current max: 30mA
- Reverse voltage max: 5V
- Wavelength @ peak: 627nm
- Power dissipation PT: 105mW
- Light output min @ 10mA: 8mcd
- Light output typ @ 10mA: 30mcd
- Order Code WL30H:** **Yellow**
- Kingbright description: L-53YD
- Forward voltage: 2.5V
- Forward current max: 30mA
- Reverse voltage max: 5V
- Wavelength @ peak: 590nm
- Power dissipation PT: 105mW
- Light output min @ 10mA: 5mcd
- Light output typ @ 10mA: 20mcd
- Order Code WL84F:** **High Efficiency Red**
- Kingbright description: L-53ID
- Forward voltage: 2.5V
- Forward current max: 30mA
- Reverse voltage max: 5V
- Wavelength @ peak: 627nm
- Power dissipation PT: 105W
- Light output min @ 10mA: 8mcd
- Light output typ @ 10mA: 25mcd
- Order Code CK37S:** **Pure Green**
- Kingbright description: L-53PGD
- Forward voltage: 2.5V
- Forward current max: 25mA
- Reverse voltage max: 5V
- Wavelength @ peak: 555nm
- Power dissipation PT: 105mW
- Light output min @ 10mA: 2mcd
- Light output typ @ 10mA: 5mcd
- Order Code CK38R:** **Pure Orange**
- Kingbright description: L-53ND
- Forward voltage: 2.5V
- Forward current max: 30mA
- Reverse voltage max: 5V
- Wavelength @ peak: 607nm
- Power dissipation PT: 105W
- Light output min @ 10mA: 12mcd
- Light output typ @ 10mA: 30mcd

Order Code	Mod: 002047	Price each exc. VAT 1+	inc. VAT each
WL27E	5mm Red LED	£0.53	£0.64
WL28F	5mm Green LED	£0.57	£0.69
WL29G	5mm Orange LED	£0.53	£0.64
WL30H	5mm Yellow LED	£0.57	£0.69
WL84F	5mm Red HB LED	£0.65	£0.79
CK37S	5mm Pure Green LED	£0.61	£0.74
CK38R	5mm Pure Orange LED	£0.65	£0.79

5mm Super Bright LEDs



- High intensity
- Standard T-1 3/4 diameter package
- Small viewing angle, water clear lens
- General purpose leads
- Reliable and rugged
- White, blue, green, yellow and two white versions are available

Order code:	N22FN	N23FN	N25FN
Colour:	Blue	Blue/Green	Yellow
Viewing angle:	18°	20°	10°
Forward Current max:	100mA	100mA	100mA
Forward Voltage max:	4V	4V	2.6V
Reverse Voltage max:	5V	5V	5V
Wavelength @ peak (typ):	466Nm	505Nm	592Nm
Power dissipation:	100mW	100mW	100mW
Light output min. @ 20mA:	9000mcd	15000mcd	800mcd
Light output typ @ 20mA:	12000mcd	20000mcd	14080mcd
Order code:	N26FN	N27FN	N28FN
Colour:	Red	White	White
Viewing angle:	10°	20°	22°
Forward Current max:	100mA	100mA	100mA
Forward Voltage max:	2.4V	4V	3.6V
Reverse Voltage max:	5V	5V	5V
Wavelength @ peak (typ):	630Nm		
Power dissipation:	100mW	100mW	100mW
Light output min. @ 20mA:	9900mcd		12000mcd
Light output typ. @ 20mA:	15840mcd	11000mcd	18000mcd

Order Code	Mod: 220752	Price each exc. VAT 1+	5+	inc. VAT each
N22FN	5mm LED Sup Br Blue	£1.20	£1.04	£1.44
N23FN	5mm LED Sup Br Green	£1.20	£1.04	£1.44
N25FN	5mm LED Yellow	£1.20	£1.04	£1.44
N26FN	5mm LED Sup Br Red	£1.20	£1.04	£1.44
N27FN	5mm LED Warm White	£1.20	£1.04	£1.44
N28FN	5mm LED Bright White	£1.24	£1.07	£1.49

5mm Super Bright LEDs



The cathode is denoted by the flat on the body and the short lead. The LEDs have either a water-clear lens with a narrow viewing angle of 30° or a diffused lens with a wide viewing angle of 60°

Specifications:

- Order Code UK51F:** **Clear Red**
- Kingbright description: L-53SRC-C
- Viewing angle: 30°
- Forward current max: 30mA
- Forward voltage max: 2.5V
- Reverse voltage max: 5V
- Wavelength @ peak: 660nm
- Power dissipation PT: 100mW
- Light output min @ 20mA: 800mcd

- Light output typ @ 20mA: 1000mcd
- Order Code UK20W:** **Clear Red**
- Kingbright description: L-53SRC-E
- Viewing angle: 30°
- Forward current max: 30mA
- Forward voltage max: 2.5V
- Reverse voltage max: 5V
- Wavelength @ peak: 660nm
- Power dissipation PT: 100mW
- Light output min @ 20mA: 2000mcd
- Light output typ @ 20mA: 2800mcd
- Order Code N45AT:** **Clear Red**
- Kingbright description: L-53SRC-F
- Viewing angle: 30°
- Forward current max: 30mA
- Forward voltage max: 2.5V
- Reverse voltage max: 5V
- Wavelength @ peak: 660nm
- Power dissipation PT: 100mW
- Light output min @ 20mA: 3500mcd
- Light output typ @ 20mA: 4000mcd
- Order Code UK19V:** **Diffused Red**
- Kingbright description: L-53SRD-E
- Viewing angle: 60°
- Forward current max: 30mA
- Forward voltage max: 2.5V
- Reverse voltage max: 5V
- Wavelength @ peak: 660nm
- Power dissipation PT: 100mW
- Light output min @ 20mA: 300mcd
- Light output typ @ 20mA: 400mcd

Order Code	Mod: 035746	Price each exc. VAT 1+	5+	inc. VAT each
UK51F	5mm Clr Red 1cd LED	£0.82		£0.99
UK20W	5mm Cl Red 2.8cd LED	£0.65		£0.79
N45AT	5mm Clr Red 4cd LED	£0.82		£0.99
UK19V	Superbr LED Red 5mm	£0.90		£1.09

5mm Extreme Brightness LEDs

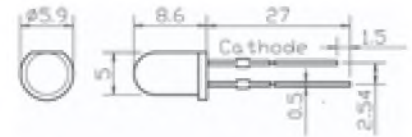

All dimensions in millimetres

- A range of 5mm extreme brightness LEDs with water clear lenses
- Cathode is denoted by the shortest leg. All have a viewing angle of 20°

Specifications:

- Order Code N72AJ:** **Mega Green**
- Kingbright description: L-7113MGC
- Forward voltage max. IF =20mA: 2.5V
- Reverse current VR =5V: 10µA
- Wavelength peak IF =20mA: 574nm
- Power dissipation PT: 105mW
- Light output min. 20mA: 1000mcd
- Light output typ: 480mcd
- Order Code N71AJ: Super Bright Yellow**
- Kingbright description: L-7113SYC-H
- Forward voltage max. IF =20mA: 2.8V
- Reverse current VR =5V: 10µA
- Wavelength peak IF =20mA: 590nm
- Power dissipation PT: 120mW
- Light output min. 20mA: 1500mcd
- Light output typ. 20mA: 2100mcd
- Order Code N70AJ:** **Hyper Orange**
- Kingbright description: L-7113SEC-E
- Forward voltage max. IF =20mA: 2.5V
- Reverse current VR =5V: 10µA
- Wavelength peak IF =20mA: 630nm
- Power dissipation PT: 150mW
- Light output min. 20mA: 1600mcd
- Light output typ. 20mA: 5000mcd
- Order Code N69AJ:** **Hyper Red**
- Kingbright description: L-7113SURC-E
- Forward voltage max. IF =20mA: 2.5V
- Reverse current VR =5V: 10µA
- Wavelength peak IF =20mA: 640nm
- Power dissipation PT: 150mW

Light output min. 20mA:	1600mcd		
Light output typ. 20mA:	2200mcd		
Order Code	Mod: 033370	Price each exc. VAT	inc. VAT each
		1+	5+
N72AJ	5mm Hi-Bri Green LED	£1.11	£0.97 £1.34
N71AJ	5mm Hi-Bri Yellow LED	£1.11	£0.97 £1.34
N70AJ	5mm Hi-Bri Orange LED	£1.15	£1.00 £1.39
N69AJ	5mm Red Hi-Bri LED	£1.15	£1.00 £1.39

5mm Red LED



A high brightness red LED available in miniature and standard sizes. The LEDs fit the appropriate clips listed below. The cathode is denoted by the flat on the body and by the short lead.

Case size [dia.]	5mm		
Light output typical at IF = 20mA	30mcd		
Forward voltage at IF = 20mA	2V		
Forward current [max]	30mA		
Reverse voltage [max]	5V		
Power dissipation [max]	105mW		
Peak wavelength	625nm		
Order Code	Mod: 002057	Price each exc. VAT	inc. VAT each
		1+	5+
WL84F	5mm Red HB LED	£0.65	£0.79

5mm Super Bright Orange LEDs

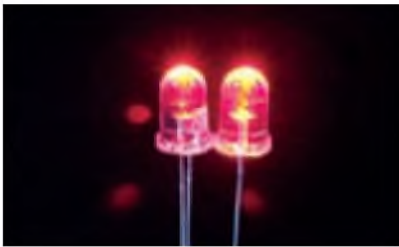

2 very bright orange LEDs with water clear lenses, both having low power consumption and high intensity

Specifications:

Order Code N48AT:	Super Orange		
Kingbright description	L-53SEC-E		
Viewing angle	30°		
Forward voltage:	2.5V		
Forward current max.	40mA		
Reverse voltage max.	5V		
Wavelength @ peak :	630nm		
Power dissipation PT:	150mW		
Light output min @ 20mA	1600mcd		
Light output typ @ 20mA:	5000mcd		
Order Code N49AT:	Hyper Orange		
L-53SEC-H	L-53SEC-H		
Kingbright description	L-53SEC-H		
Viewing angle	20°		
Forward voltage:	2.5V		
Forward current max.	40mA		
Reverse voltage max.	5V		
Wavelength @ peak :	630nm		
Power dissipation PT:	150W		
Light output min @ 20mA	7000mcd		
Light output typ @ 20mA:	10000mcd		
Order Code	Mod: 035754	Price each exc. VAT	inc. VAT each
		1+	5+
N48AT	5mm 5cd Orange LED	£0.65	£0.57 £0.79
N49AT	5mm 10cd Orange LED	£0.82	£0.71 £0.99

5mm Green LED



This 5mm super bright green LED has a water-clear lens with a narrow viewing angle of 20°. It is IC compatible and has a low current capability.

Specifications:

Order Code N62AX:	Green		
Kingbright description:	L-7113ZGC-G		
Forward current max.:	30mA		
Forward voltage max.:	4.1V		
Reverse voltage max.:	5V		
Wavelength @ peak	520nm		
Power dissipation PT	120mW		
Light output min @ 20mA:	12000mcd		
Light output typ @ 20mA	18000mcd		
Order Code	Mod: 035889	Price each exc. VAT	inc. VAT each
		1+	5+
N62AX	5mm Green LED 18cd	£1.65	£1.43 £1.99

5mm Super Bright Green LEDs



A high brightness, 5mm green LED available with either a water clear [Order Code CK39N] or diffused [Order Code CK40T] lens. The cathode is denoted by the flat on the body and by the short lead.

Specifications:

Order Code CK39N:	Clear Green		
Kingbright description:	L-53SGC		
Viewing angle:	30°		
Forward current max.:	25mA		
Forward voltage max.:	2.5V		
Reverse voltage max.:	5V		
Wavelength @ peak	565nm		
Power dissipation PT	105mW		
Light output min @ 10mA:	70mcd		
Light output typ @ 10mA	200mcd		
Order Code CK40T:	Diffused Green		
Kingbright description:	L-53SGD		
Viewing angle:	60°		
Forward current max.:	25mA		
Forward voltage max.:	2.5V		
Reverse voltage max.:	5V		
Wavelength @ peak	565nm		
Power dissipation PT	105mW		
Light output min @ 10mA:	20mcd		
Light output typ @ 10mA	40mcd		
Order Code	Mod: 002058	Price each exc. VAT	inc. VAT each
		1+	5+
CK39N	5mm Grn Clr HB LED	£0.99	£1.19
CK40T	5mm Grn Diff HB LED	£0.99	£1.19

5mm Blue LEDs



5mm high quality, high brightness blue LEDs available with either a blue-transparent, or water-clear casing. These LEDs have a low power consumption and are ideal for full colour LED displays, indicators and analytical equipment.

Specifications:

Order Code JA24B	Diffused Blue		
Kingbright description	L-53MED		
Viewing angle	60°		
Forward voltage at If=20mA	4.0V		
Forward current max.	30mA		
Reverse voltage max.	5V		
Wavelength @ peak	430nm		
Power dissipation PT	105mW		
Light output min @ 20mA	40mcd		
Light output typ @ 20mA	60mcd		
Order Code JA25C:	Clear Blue		
Kingbright description	L-53MEC		
Viewing angle	16°		
Forward voltage at If=20mA	4.0V		
Forward current max.	30mA		
Reverse voltage max.	5V		
Wavelength @ peak	430nm		
Power dissipation PT	105mW		
Light output min @ 20mA	50mcd		
Light output typ @ 20mA	150mcd		
Order Code	Mod: 012703	Price each exc. VAT	inc. VAT each
		1+	5+
JA24B	5mm LED Diffuse Blue	£1.65	£1.43 £1.99
JA25C	5mm LED Clear Blue	£1.65	£1.43 £1.99

Browse our entire range at maplin.co.uk

5mm Blue LED



- Extreme brightness 5mm clear blue LED
- Superior performance in outdoor applications due to its well-defined radiation pattern and wide viewing angle (30°)
- Manufactured using high quality optical grade epoxy for high temperature and moisture resistant applications
- Ideally suited for illumination projects for hobby, home or DIY in bespoke lighting signage and for LCD back lights

Specifications:

Order Code NR84F:	Clear Blue		
Viewing angle	30°		
Forward voltage at 20mA	3.2V		
Forward current max.	25mA		
Reverse voltage max.	5V		
Power dissipation PT	95mW		
Light output typ @ 20mA	3550mcd		
Order Code	Mod: 035769	Price each exc. VAT	inc. VAT each
		1+	5+
NR84F	5mm Blue LED 1.5cd	£2.49	£2.15 £2.99

Browse our entire range at maplin.co.uk

1000's more components available in-store & online

5mm 5V LEDs



- 2 x 5mm diameter LEDs from the 5V series in a T-13/4 package.
- 5V integral current limiting resistor - no external current limiter required with a 5V supply
- Both types have a diffused lens and a wide viewing angle of 60°.

Specifications:

Order Code CK46A:	High Efficiency Red
Kingbright description:	L-531D-5V
Forward current typ.:	13mA
Forward voltage max.:	6.5V
Reverse voltage max.:	5V
Wavelength @ peak :	627nm
Power dissipation PT:	85mW
Light output min. @ 5V:	12mcd
Light output typ. @ 5V:	30mcd
Order Code CK47B:	Green
Kingbright description:	L-53GD-5V
Forward current typ.:	13mA
Forward voltage max.:	6.5V
Reverse voltage max.:	5V
Wavelength @ peak :	565nm
Power dissipation PT:	85mW
Light output min. @ 5V:	8mcd
Light output typ. @ 5V:	20mcd

Order Code	Mod: 035775	Price each exc. VAT		inc. VAT each
		1+	5+	
CK46A	5mm 5V Red LED	£0.65	£0.57	£0.79
CK47B	5mm 5V Green LED	£0.65	£0.57	£0.79

5mm 12V LEDs

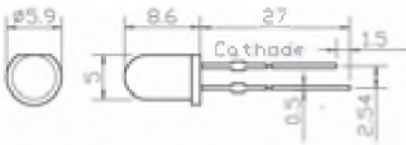

All dimensions in millimetres

A range of 5mm diameter LEDs from the 12V series in a T-13/4 package. These LEDs are designed to connect across 12Vdc power supply rails. They have a 12V integral current limiting resistor, which means no external current limiter is required with a 12V supply. All types have a diffused lens and a wide viewing angle of 60°.

Specifications:

Order Code CK48C:	High Efficiency Red
Kingbright description:	L-531D-12V
Forward current typ.:	8.5mA
Forward voltage max.:	14V
Reverse voltage max.:	5V
Wavelength @ peak :	627nm
Power dissipation PT:	120mW
Light output min. @ 12V:	12mcd
Light output typ. @ 12V:	30mcd
Order Code CK49D:	Green
Kingbright description:	L-53GD-12V
Forward current typ.:	8.5mA
Forward voltage max.:	14V
Reverse voltage max.:	5V
Wavelength @ peak :	565nm
Power dissipation PT:	120mW
Light output min. @ 12V:	8mcd
Light output typ. @ 12V:	20mcd
Order Code CJ61R:	Yellow
Kingbright description:	L-53YD-12V
Forward current typ.:	8.5mA
Forward voltage max.:	14V
Reverse voltage max.:	5V

Wavelength @ peak	590nm
Power dissipation PT	120mW
Light output min. @ 12V:	5mcd
Light output typ. @ 12V:	20mcd
Order Code CJ62S:	Super Bright Green
Kingbright description	L-53SGD-12V
Forward current typ.	8.5mA
Forward voltage max.	14V
Reverse voltage max.:	5V
Wavelength @ peak	565nm
Power dissipation PT	120mW
Light output min. @ 12V:	8mcd
Light output typ. @ 12V:	20mcd
Order Code CJ63T:	Super Bright Red
Kingbright description	L-53SRD-12V
Forward current typ.	8.5mA
Forward voltage max.	14V
Reverse voltage max.:	5V
Wavelength @ peak	660nm
Power dissipation PT	120mW
Light output min. @ 12V:	100mcd
Light output typ. @ 12V:	180mcd

Order Code	Mod: 035782	Price each exc. VAT		inc. VAT each
		1+	5+	
CK48C	5mm 12V HE Red LED	£0.65	£0.57	£0.79
CK49D	5mm 12V Green LED	£0.65	£0.57	£0.79
CJ61R	5mm 12V Yellow LED	£0.65	£0.57	£0.79
CJ62S	5mm 12V Green SB LED	£0.65	£0.57	£0.79
CJ63T	5mm 12V Red SB LED	£0.65	£0.57	£0.79

5mm Flashing LEDs



A range of LEDs which have a built-in blinking IC and a blinking frequency from 3Hz to 1.5Hz. They are supplied in a T-13/4 package and the cathode is denoted by the short lead.

All types have a diffused lens and a viewing angle of 60°

Specifications:

Order Code QY96E:	Red
Kingbright description	L-56BHD
Forward voltage:	2.5V
Forward current max.:	55mA
Reverse voltage max.:	0.5V
Wavelength @ peak	700nm
Power dissipation PT	310mW
Light output min. VF=9V:	2mcd
Light output typ. VF=9V:	5mcd
Order Code QY97F:	Green
Kingbright description	L-56BGD
Forward voltage:	2.5V
Forward current max.:	55mA
Reverse voltage max.:	0.5V
Wavelength @ peak	565nm
Power dissipation PT	310mW
Light output min. VF=9V:	5mcd
Light output typ. VF=9V:	20mcd
Order Code UK35Q:	Yellow
Kingbright description	L-56BYD
Forward voltage:	2.5V
Forward current max.:	55mA
Reverse voltage max.:	0.5V
Wavelength @ peak	590nm
Power dissipation PT	310mW
Light output min. VF=9V:	5mcd
Light output typ. VF=9V:	20mcd
Order Code UK36P:	High Efficiency Red
Kingbright description	L-56BID
Forward voltage:	2.5V
Forward current max.:	55mA
Reverse voltage max.:	0.5V
Wavelength @ peak	627nm
Power dissipation PT	310W
Light output min. VF=9V:	20mcd
Light output typ. VF=9V:	40mcd
Order Code UK37S:	Super Bright Red

Kingbright description	L-56BSRD-B
Forward voltage	2.5V
Forward current max	55mA
Reverse voltage max	0.5V
Wavelength @ peak	660nm
Power dissipation PT	310mW
Light output min. VF=9V	100mcd
Light output typ. VF=9V	200mcd

Order Code	Mod: 035804	Price each exc. VAT		inc. VAT each
		1+	5+	
QY96E	Flashing LED Red 5mm	£0.82	£0.71	£0.99
QY97F	Flashing LED Grn 5mm	£0.74	£0.64	£0.89
UK35Q	Flashing LED Ylw 5mm	£0.82	£0.71	£0.99
UK36P	Flash LED HE Red 5mm	£0.82	£0.71	£0.99
UK37S	Flash LED SB Red 5mm	£1.07	£0.93	£1.29

5mm Flashing Blue LED



A 5mm flashing LED with a blue diffused lens and a viewing angle of 60°. The cathode is denoted by the shortest leg. The LED has a flashing frequency of 3.0Hz-1.5Hz at 3.5V-14V

Specifications:

Order Code N65AJ:	Diffused Blue
Kingbright description	L-56BQBDL-D
Forward voltage max. I F =20mA	4.2
Reverse current V R =5V	10mA
Wavelength peak I F =20mA	468nm
Power dissipation P T	102mW
Light output min. VF = 9V	40mcd
Light output typ. VF = 9V	80mcd

Order Code	Mod: 033347	Price each exc. VAT		inc. VAT each
		1+	5+	
N65AJ	Flashing SB Blue 5mm	£1.57	£1.36	£1.89

8mm LEDs

8mm Super Bright LEDs

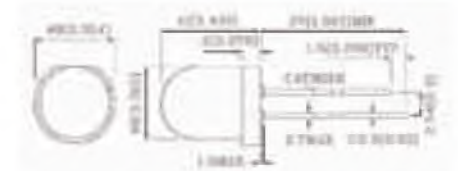

- A range of high quality 8mm LEDs
- Supplied in water clear package
- Suitable for sign boards, safety equipment, panel illuminators
- Ideal for hobbyist or manufacturing projects
- Available in white, blue, red, blue and yellow

Specifications

N78KG 8mm LED White	SunLED Description	LFWS81W
Forward Voltage at IF=20mA		3.3
Forward Current		30
Reverse Voltage		5
Chromatic Co-ordinates		0.31 X 0.31
Typical Intensity at IF=20mA (mcd)		17990
Viewing Angle		15
N79KG 8mm LED Yellow	SunLED Description	LM2ACY81W
Forward Voltage at IF=20mA (Max)		2
Forward Current		30
Reverse Voltage		5
Wavelength (nm)		590
Typical Intensity at IF=20mA (mcd)		4490
Viewing Angle		15
N80KG 8mm LED Blue	SunLED Description	LFBB81W
Forward Voltage at IF=20mA (Max)		3.3
Forward Current		30

Reverse Voltage	5
Wavelength (nm)	465
Typical Intensity at IF=20mA [mcd]	10990
Viewing Angle	12
N82KG 8mm LED Red	
SunLED Description	LM2ACR81W
Forward Voltage at IF=20mA [Max]	1.85
Forward Current	30
Reverse Voltage	5
Wavelength (nm)	640
Typical Intensity at IF=20mA [mcd]	10990
Viewing Angle	15

Order Code	Mod: 587265	Price each 1+	exc. VAT 5+	inc. VAT each
N78KG	8mm LED White	£0.82	£0.71	£0.99
N79KG	8mm LED Yellow	£0.82	£0.71	£0.99
N80KG	8mm LED Blue	£0.82	£0.71	£0.99
N82KG	8mm LED Red	£0.82	£0.71	£0.99

8mm Flashing LEDs



A range of 8mm LEDs which have a built-in blinking IC and a blinking frequency from 3Hz to 1.5Hz. The cathode is denoted by the short lead. All types have a diffused lens and a viewing angle of 60°, except for Order Code UK42V, which has a water clear lens and a viewing angle of 40°.

Order Code	Mod: 033351	Price each 1+	exc. VAT 5+	inc. VAT each
N66AJ	Ultra Flash 8mm Blue	£2.20	£1.90	£2.64

Order Code	Mod: 035813	Price each 1+	exc. VAT 5+	inc. VAT each
UK38R	Flash LED HE Red 8mm	£1.24	£1.07	£1.49
UK39N	Flashing LED Grn 8mm	£1.24	£1.07	£1.49
UK40T	Flashing LED Ylw 8mm	£1.24	£1.07	£1.49
UK41U	Flash LED SB Red 8mm	£1.24	£1.07	£1.49
UK42V	Flash LED UB Red 8mm	£1.49	£1.29	£1.79

8mm Flashing Blue LED



An 8mm flashing LED with a blue diffused lens and a viewing angle of 60°. The cathode is denoted by the shortest leg. The LED has a flashing frequency of 3Hz - 1.5Hz at 5V-14V.

Specifications:	
Order Code N66AJ:	Flashing Blue
Kingbright description:	L-796BQBDL-D
Forward voltage max IF = 20mA	3.5
Forward current	30
Wavelength peak IF = 20mA	468nm
Power dissipation PT	102mW
Light output min	180mcd
Light output typ	500mcd

Order Code	Mod: 033351	Price each 1+	exc. VAT 5+	inc. VAT each
N66AJ	Ultra Flash 8mm Blue	£2.20	£1.90	£2.64

10mm LEDs

10mm Super Bright LEDs

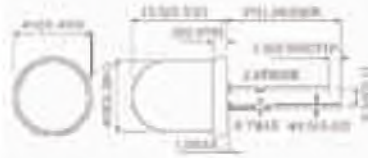

- A range of high quality 10mm LEDs
- Supplied in water clear package
- Suitable for sign boards, safety equipment, panel illuminators
- Ideal for hobbyist or manufacturing projects
- Available in white, blue, red, green, blue and yellow

Order Code	Mod: 035843	Price each 1+	exc. VAT 5+	inc. VAT each
UK43W	Flashing HE Red 10mm	£1.24	£1.07	£1.49
UK44X	Flashing LED Grn 10mm	£1.40	£1.22	£1.69
UK45Y	Flashing LED Ylw 10mm	£1.40	£1.22	£1.69
UK46A	Flashing SB Red 10mm	£1.40	£1.22	£1.69
UK47B	Flashing UB Red 10mm	£1.40	£1.22	£1.69
N67AJ	Ultr Flash 10mm Blue	£2.49	£2.15	£2.99

Reverse Voltage	5
Wavelength (nm)	520
Typical Intensity at IF=20mA [mcd]	14990
Viewing Angle	15
N87KG 10mm LED Red	
SunLED Description	LM2ACR01W
Forward Voltage at IF=20mA [Max]	1.85
Forward Current	30
Reverse Voltage	5
Wavelength (nm)	640
Typical Intensity at IF=20mA [mcd]	10990
Viewing Angle	15

Order Code	Mod: 587417	Price each 1+	exc. VAT 5+	inc. VAT each
N83KG	10mm LED White	£1.15	£1.00	£1.39
N84KG	10mm LED Yellow	£1.15	£1.00	£1.39
N85KG	10mm LED Blue	£1.15	£1.00	£1.39
N86KG	10mm LED Green	£1.15	£1.00	£1.39
N87KG	10mm LED Red	£1.15	£1.00	£1.39

10mm Flashing LEDs



- A range of 10mm LEDs with built in flash controller
- 3Hz to 1.5Hz flash frequency
- Diffused lens with 60° viewing angle
- UK47 has clear lens and 40° viewing angle

Order Code	Mod: 035843	Price each 1+	exc. VAT 5+	inc. VAT each
UK43W	Flashing HE Red 10mm	£1.24	£1.07	£1.49
UK44X	Flashing LED Grn 10mm	£1.40	£1.22	£1.69
UK45Y	Flashing LED Ylw 10mm	£1.40	£1.22	£1.69
UK46A	Flashing SB Red 10mm	£1.40	£1.22	£1.69
UK47B	Flashing UB Red 10mm	£1.40	£1.22	£1.69
N67AJ	Ultr Flash 10mm Blue	£2.49	£2.15	£2.99

Order Code	Mod: 035843	Price each 1+	exc. VAT 5+	inc. VAT each
UK43W	Flashing HE Red 10mm	£1.24	£1.07	£1.49
UK44X	Flashing LED Grn 10mm	£1.40	£1.22	£1.69
UK45Y	Flashing LED Ylw 10mm	£1.40	£1.22	£1.69
UK46A	Flashing SB Red 10mm	£1.40	£1.22	£1.69
UK47B	Flashing UB Red 10mm	£1.40	£1.22	£1.69
N67AJ	Ultr Flash 10mm Blue	£2.49	£2.15	£2.99

Panel Mount LEDs

3mm Rounded Panel Indicator LEDs and Bezels



A range of 3mm LED brass bodied, chrome finished, prominent indicators available in 4 colours. The LEDs are supplied with a washer and locking nut and have a recessed front panel. All colours have a reverse voltage of 5V, a 6mm diameter drilling hole and an M6x0.5 thread. The bezels for this range of LEDs are available separately without the LEDs. They are available in either chrome [Order Code N84AX] or black [Order Code N85AX].

Specifications:

Order Code N64AX: Red
Viewing angle: 50°
Forward voltage max. @20mA: 2.0V
Forward current max.: 30mA
Wavelength @ peak: 635nm
Power dissipation PT: 100mW
Light output typ @ 10mA: 15mcd

Order Code N65AX: Yellow
Viewing angle: 50°
Forward voltage max. @20mA: 2.1V
Forward current max.: 30mA
Wavelength @ peak: 585nm
Power dissipation PT: 100mW
Light output typ @ 10mA: 15mcd

Order Code N66AX: Green
Viewing angle: 50°
Forward voltage max. @20mA: 2.2V
Forward current max.: 25mA
Wavelength @ peak: 565nm
Power dissipation PT: 100mW
Light output typ @ 10mA: 20mcd

Order Code N67AX: Blue
Viewing angle: 90°
Forward voltage max. @20mA: 3.5V
Forward current max.: 30mA
Wavelength @ peak: 750nm
Power dissipation PT: 120mW
Light output typ @ 10mA: 180mcd

Order Code	Mod: 035950	Price each exc. VAT 1+	inc. VAT each 5+
N64AX	3mm Red Prom. LED	£1.28	£1.54
N65AX	3mm Ylw Prom. LED	£0.82	£0.99
N66AX	3mm Grn Prom. LED	£1.32	£1.59
N67AX	3mm Blue Prom. LED	£1.32	£1.59
N84AX	3mm Prom Chr. Holder	£1.11	£1.34
N85AX	3mm Prom Blk. Holder	£1.40	£1.69

5mm Recessed Panel Indicator LEDs and Bezels



A range of 5mm LED brass bodied, chrome finished, recessed indicators available in 5 colours. The LEDs are supplied with a washer and locking nut and have a recessed front panel. All colours have a reverse voltage of 5V, a 6mm diameter drilling hole and a M8x0.75 thread. The bezels for this range of LEDs are available separately without the LEDs. They are available in either chrome [Order Code N90AX] or black [Order Code N91AX].

Specifications:

Order Code N79AX: Red
Viewing angle: 50°
Forward voltage max. @20mA: 2.0V
Forward current max.: 30mA
Wavelength @ peak: 635nm
Power dissipation PT: 100mW
Light output typ @ 10mA: 15mcd

Order Code N80AX: Yellow
Viewing angle: 50°
Forward voltage max. @20mA: 2.1V
Forward current max.: 30mA
Wavelength @ peak: 585nm
Power dissipation PT: 100mW
Light output typ @ 10mA: 15mcd

Order Code N81AX: Green
Viewing angle: 50°
Forward voltage max. @20mA: 2.2V
Forward current max.: 25mA
Wavelength @ peak: 565nm
Power dissipation PT: 100mW
Light output typ @ 10mA: 20mcd

Order Code N83AX: White
Viewing angle: 80°
Forward voltage max. @20mA: 3.5V
Forward current max.: 30mA
Wavelength @ peak: X0.23-0.27/Y0.25-0.33
Power dissipation PT: 120mW
Light output typ @ 10mA: 200mcd

Order Code	Mod: 035953	Price each exc. VAT 1+	inc. VAT each 5+
N79AX	5mm Red Rec. LED	£1.57	£1.89
N80AX	5mm Ylw Rec. LED	£1.53	£1.84
N81AX	5mm Grn Rec. LED	£1.57	£1.89
N83AX	5mm White Rec. LED	£1.53	£1.84
N90AX	5mm Rec. Chr. Holder	£1.24	£1.49
N91AX	5mm Rec. Blk. Holder	£1.20	£1.44

8mm 12V Panel Mount LEDs with Plastic Bezel



A range of 12V, 8mm panel mounting LEDs with plastic bezels available in 5 colours. The LEDs are supplied with a washer and locking nut. All colours have a reverse voltage of 5V, an 8mm diameter drilling hole and a thread size M8x0.75mm.

Specifications:

Order Code N00BB: Red
Viewing angle: 30°
Forward voltage: 10-14V
Forward current [Ic@12V]: 12mA
Wavelength @ peak: 625nm
Power dissipation PT: 105mW
Light output typ @ 10mA: 25mcd

Order Code N01BB: Yellow
Viewing angle: 30°
Forward voltage: 10-14V
Forward current [Ic@12V]: 12mA
Wavelength @ peak: 590nm
Power dissipation PT: 105mW
Light output typ @ 10mA: 15mcd

Order Code N02BB: Green
Viewing angle: 30°
Forward voltage: 10-14V
Forward current [Ic@12V]: 12mA
Wavelength @ peak: 565nm
Power dissipation PT: 105mW
Light output typ @ 10mA: 15mcd

Order Code N03BB: Orange
Viewing angle: 30°

Forward voltage: 10-14V
Forward current [Ic@12V]: 12mA
Wavelength @ peak: 610nm
Power dissipation PT: 105mW
Light output typ @ 10mA: 25mcd

Order Code N04BB: Blue
Viewing angle: 30°
Forward voltage: 10-14V
Forward current [Ic@12V]: 12mA
Wavelength @ peak: 470nm
Power dissipation PT: 120mW
Light output typ @ 10mA: 25mcd

Order Code	Mod: 036398	Price each exc. VAT 1+	inc. VAT each 5+
N00BB	12V Red Plas Pan LED	£1.45	£1.43 £1.99
N01BB	12V Ylw Plas Pan LED	£0.82	£0.71 £0.99
N02BB	12V Grn Plas Pan LED	£1.45	£1.43 £1.99
N03BB	12V Orn Plas Pan LED	£1.45	£1.43 £1.99
N04BB	12V Blu Plas Pan LED	£1.45	£1.43 £1.99

8mm 12V Panel Mount LEDs with Chrome Bezels



A range of 12V, 8mm panel mounting LEDs with chrome bezels available in 5 colours. The LEDs are supplied with a washer and locking nut. All colours have a reverse voltage of 5V, an 8mm diameter drilling hole and a thread size M8x0.75mm.

Specifications:

Order Code N05BB: Red
Viewing angle: 30°
Forward voltage: 10-14V
Forward current [Ic@12V]: 12mA
Wavelength @ peak: 625nm
Power dissipation PT: 105mW
Light output typ @ 10mA: 25mcd

Order Code N06BB: Yellow
Viewing angle: 30°
Forward voltage max. Ic@20mA: 2.1V
Forward voltage: 10-14V
Forward current [Ic@12V]: 12mA
Power dissipation PT: 105mW
Light output typ @ 10mA: 15mcd

Order Code N07BB: Green
Viewing angle: 30°
Forward voltage: 10-14V
Forward current [Ic@12V]: 12mA
Wavelength @ peak: 565nm
Power dissipation PT: 105mW
Light output typ @ 10mA: 15mcd

Order Code N08BB: Orange
Viewing angle: 30°
Forward voltage: 10-14V
Forward current [Ic@12V]: 12mA
Wavelength @ peak: 610nm
Power dissipation PT: 105mW
Light output typ @ 10mA: 25mcd

Order Code N09BB: Blue
Viewing angle: 30°
Forward voltage: 10-14V
Forward current [Ic@12V]: 12mA
Wavelength @ peak: 470nm
Power dissipation PT: 120mW
Light output typ @ 10mA: 25mcd

Order Code	Mod: 036405	Price each exc. VAT 1+	inc. VAT each 5+
N05BB	12V Red Chr. Pan LED	£2.49	£2.15 £2.99
N06BB	12V Ylw Chr. Pan LED	£2.49	£2.15 £2.99
N07BB	12V Grn Chr. Pan LED	£2.49	£2.15 £2.99
N08BB	12V Orn Chr. Pan LED	£2.49	£2.15 £2.99
N09BB	12V Blu Chr. Pan LED	£2.49	£2.15 £2.99

LED Clips and Covers

LED Clips / Covers



Panel mounting clips to suit 3mm, 5mm, 8mm and 10mm round LEDs. The following types are available

	Panel cut-out [diameter]	Bezel size [diameter]	Overall length
3mm Clip	4.4mm	6mm	5mm
5mm Clip	6.35mm	8mm	6.8mm
5mm Clip Convex	8mm	9.5mm	12.5mm
5mm Clip Concave	8mm	9.5mm	15mm
8mm Clip	12mm	14mm	16.5mm
10mm Clip	14mm	16mm	18mm

Order Code	Mod: 002071	Price each exc. VAT 1+	Price each exc. VAT 5+	inc. VAT each
YY39N	LED Clip 3mm	£0.49	£0.42	£0.59
YY40T	LED Clip 5mm	£0.57	£0.50	£0.69
UK14Q	LED Clip Convex 5mm	£0.61	£0.54	£0.74
UK15R	LED Clip Concave 5mm	£0.61	£0.54	£0.74
UK16S	LED Clip 8mm	£0.82	£0.71	£0.99
UK17T	LED Clip 10mm	£0.90	£0.78	£1.09

LED Covers



- Coloured covers for use with 3mm and 5mm LEDs
- Flat top marked with Fresnel rings
- Supplied in singles

A range of coloured covers for use with 3mm and 5mm LEDs, which also serve to clip the LED onto the front panel. The covers increase the viewing angle to 180° and give a finished appearance. They have a flat top marked with Fresnel rings and striated lines for maximum light dispersion. The 5mm covers simply clip into a 6.35mm [1/4in.] panel cut-out, while the 3mm types need a 4.4mm [0.171in.] cut out. The LED then clips in from the rear.

3mm Types:

Suitable for 0.9mm to 1.6mm panel thickness
Overall diameter: 5mm
Overall length: 7.3mm
Available in clear, green and red

5mm Types:

Suitable for 1.6mm to 3.2mm panel thickness
Overall diameter: 7mm
Overall length: 11mm
Available in clear, green, red and yellow.

3mm Types:

Suitable for 0.9mm to 1.6mm panel thickness
Overall diameter: 5mm
Overall length: 7.3mm
Available in clear, green and red

5mm Types:

Suitable for 1.6mm to 3.2mm panel thickness
Overall diameter: 7mm
Overall length: 11mm
Available in clear, green, red and yellow.

Order Code	Mod: 002072	Price each exc. VAT 1+	Price each exc. VAT 5+	inc. VAT each
UF91Y	3mm ClipLite Clear	£0.57	£0.50	£0.69
UF92A	3mm ClipLite Green	£0.57	£0.50	£0.69
YH54J	5mm ClipLite Clear	£0.57	£0.50	£0.69
YH55K	5mm ClipLite Green	£0.65	£0.57	£0.79
YH56L	5mm ClipLite Red	£0.65	£0.57	£0.79
YH57M	5mm ClipLite Yellow	£0.57	£0.50	£0.69

LED Clusters

Red 23mm LED Cluster



A giant round red LED made up from a group of six LEDs in a matrix with separate anodes and cathodes brought out to 12 PCB pins on a DIL matrix. Pins are placed at 2.54mm [0.1in.] intervals into two rows of 6 pins each, spaced 15.24mm [0.6in.] apart. LED body is 23mm in diameter with a dome 10mm high. Material is diffused red. Luminous intensity is 10 to 21.8mcd @ 10mA for each diode.

Specifications:

Forward voltage:	2.5V
Forward current:	30mA

Order Code	Mod: 002063	Price each exc. VAT 1+	Price each exc. VAT 5+	inc. VAT each
GW65V	Giant Red LED	£1.32	£1.14	£1.59

26mm Red/Green LED Cluster

- High visibility
- No. of built-in 5mm LED lamps: Super Bright Red 6 pcs
- Super Bright Green 8 pcs
- Waterproof package with hood suitable for outdoor and indoor information boards.



A 26mm highly visible LED cluster that is housed in a waterproof package with hood, and is suitable for in and outdoor information boards. The cluster has 14 x 5mm LEDs, made up from six super-bright red and eight super-bright green LEDs. This will also allow a 'mixed' orange colour to be generated. Red and green cathodes are denoted by matching coloured wires.

Specification:

[red IF=20mA, green IF=40mA]

Typical Luminous Intensity

Red: 3600mcd (Min. 1800mcd)
Green: 1600mcd (Min. 800mcd)

Viewing angle

Red: 40deg
Green: 40deg

Forward Voltage

Red: 13V (Max 17.5V)
Green: 17.6V (Max 20V)

Peak Wavelength

Red: 660nm
Green: 565nm

Dominant Wavelength

Red: 640nm
Green: 568nm

Spectral Line Halfwidth

Red: 20nm
Green: 30nm

Reverse Current

Red: 20uA
Green: 20uA

Order Code	Mod: 011997	Price each exc. VAT 1+	Price each exc. VAT 5+	inc. VAT each
PD00A	Big LED 26mm	£4.82	£4.17	£5.79

52mm Red LED Cluster



A high intensity 52mm red LED cluster housed in a waterproof plastic housing that is suitable for large in or outdoor display applications such as sign or message boards. The cluster comprises of an array of super-bright GaAlAs LEDs and has a maximum luminous intensity of 23000mcd.

Specifications	[IF=200mA]
Maximum luminous intensity	23000mcd
Viewing angle	40°
Typical forward voltage	9.6V [11.2V]
Peak wavelength	660nm
Maximum reverse current:	100µA @ VR=18V
Power dissipation	2.5W max
DC forward current	250mA max
Reverse voltage	5V max
Operating temperature range	-5°C to +65°C

Order Code	Mod: 012696	Price each exc. VAT 1+	Price each exc. VAT 5+	inc. VAT each
PD01B	52mm Red LED Cluster	£8.32	£7.19	£9.99

Bar & Segment Displays

10 Segment Display



A 10-segment LED ladder encapsulated in a 20-pin DIL package. Designed for use as solid state level indicators, each LED is completely separate from the others in the package. The LEDs may be driven from LM3914, LM3915, LM3916 or equivalent bargraph driver ICs. The displays are available in red or green and may be stacked end to end.

Specifications

	Red	Green
Max forward current per segment	30mA	30mA
Max forward current per package	200mA	160mA
Light output at IF = 20mA	4.0mcd	3.0mcd
Forward voltage at IF = 20mA	2.0V	2.2V
Peak inverse voltage	5V	5V
Package size:	25 x 10 x 8mm high excluding pins	
Pin length	6mm	
Pin spacing	7.26 x 2.54mm [0.3 x 0.1in.] (standard 20-pin DIL IC spacing)	

Order Code	Mod: 002128	Price each exc. VAT 1+	Price each exc. VAT 5+	inc. VAT each
BY65V	Red Bargraph Dspty	£1.24	£1.15	£1.49
YG33L	Green Bargraph Dspty	£1.24	£1.15	£1.39

12.7mm (0.5 Inch) Single Digit Numeric Display

A high brightness 0.5" display featuring highly legible, bold, solid segments which are fast switching and offer low power consumption and compatibility with integrated circuits. Available in common anode [Order Code FR39N] and common cathode [Order Code FR41U] in high efficiency red with a right hand decimal point.



Electrical Connections

Pin No.	Common Anode	Common Cathode
1	Segment E	Segment E
2	Segment D	Segment D
3	Common anode	Common cathode
4	Segment C	Segment C
5	DP	DP
6	Segment B	Segment B
7	Segment A	Segment A
8	Common anode	Common cathode
9	Segment F	Segment F
10	Segment G	Segment G

Specifications:

Order Code FR39N Red, Common Anode
 Kingbright description: SA05-11EWS
 Order Code FR41U Red, Common Cathode
 Kingbright description: SC05-11EWA
 Forward current max.: 30mA
 Forward voltage max.: 2.5V
 Reverse voltage max.: 5V
 Wavelength @ peak: 627nm
 Power dissipation PT: 105mW
 Light output min @10mA: 3000mcd
 Light output typ @10mA: 8000mcd

Order Code	Mod: 002157	Price each exc. VAT 1+	inc. VAT each
FR39N	1/2in Display Type 1	£1.32	£1.59
FR41U	1/2in Display Type 4	£1.32	£1.59

13.2mm (0.52 inch) Single Digit Numeric Display

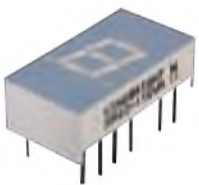

- 13.2mm (0.52 inch) digit height
- Excellent character appearance
- Easy mounting on PC boards or sockets
- IC compatible
- Mechanically rugged
- Standard: grey face, white segment

For full datasheet visit: www.maplin.co.uk

Specifications:

Order Code N10FN: Red Common Anode
 Kingbright description: SA52-11SRWA
 Order Code N11FN: Red Common Cathode
 Kingbright description: SC52-11SRWA
 Forward current max: 30mA
 Forward voltage max: 2.5V
 Reverse voltage max.: 5V
 Wavelength @ peak: 660nm
 PT: 100mW
 Light output min @ 10mA: 4700mcd
 Light output max @ 10mA: 24000mcd

Order Code	Mod: 220106	Price each exc. VAT 1+	inc. VAT each
N10FN	13.2mm SD Display A	£1.32	£1.59
N11FN	13.2mm SD Display B	£1.24	£1.49

14mm (0.56 Inch) Double Digit Numeric Display

A 2-digit display available in high efficiency red [common anode and common cathode] or green [common cathode]. Digits are 14.22mm (0.56in.) high with high contrast and wide viewing angles. All types have a standard grey face, white segment and a right-hand decimal point.



Overall dimensions: 25x19x8mm
 Pin spacing: 15.24x2.54mm [18-pin]
 These displays may be used with direct drive or

multiplexing type drivers

Specifications:

Order Code BY66W Red, Common Anode
 Kingbright description: DA56-11EWA
 Order Code BY68Y Red, Common Cathode
 Kingbright description: DC56-11EWA
 Forward current max.: 30mA
 Forward voltage max.: 2.5V
 Reverse voltage max.: 5V
 Wavelength @ peak: 627nm
 Power dissipation P<->T<->: 105mW
 Light output min @10mA: 1900mcd
 Light output typ @10mA: 8000mcd
 Order Code FA02C Green, Common Cathode
 Kingbright description: DC56-11GWA
 Forward current max.: 25mA
 Forward voltage max.: 2.5V
 Reverse voltage max.: 5V
 Wavelength @ peak: 565nm
 Power dissipation P<->T<->: 105mW
 Light output min @10mA: 3000mcd
 Light output typ @10mA: 10500mcd

Order Code	Mod: 002166	Price each exc. VAT 1+	inc. VAT each
BY66W	DD Display Type A	£1.40	£1.69
BY68Y	DD Display Type C	£1.40	£1.69
FA02C	DD Display Type C Grn	£1.49	£1.79

LCD and OLED Displays

Alphanumeric OLED Character Displays



- Colour Organic Light Emitting Displays with alphanumeric characters
- OLEDs remove the requirement for back lit panels and offer vibrant, sharp colours
- Low power consumption, 5V supply voltage
- Fast response time and wide viewing angle
- Euro font set version included
- Cross-compatible with all applications using HDD44780 equivalent chip sets
- Standard 16 pin interface, chip on board platform
- Upgrade existing displays or use circuit designs that call on LCDs with OLED technology
- Ideal for applications, hobby electronics or replacing faulty screens

Common issues associated traditional LCDs can be overcome by using OLEDs and they don't exhibit the lag with scrolling associated with LCD. Colours are sharp, vibrant and help to produce stunning displays and no back lighting is required. Built around the industry standard HDD44780 chipset, these displays can be used where ordinary LCDs are meant to go. They can add an attractive finish to home built Arduino, Raspberry Pi or other electronic projects.

Specifications

Order Code	Mod: 787316	Price each exc. VAT 1+	5+	inc. VAT each
N04QQ	OLED 2x16 Gh 80x36	£16.65	£14.39	£19.99
N05QQ	OLED 2x16 Wh 80x36	£18.32	£15.83	£21.99
N06QQ	OLED 2x16 Ye 80x36	£16.65	£14.39	£19.99
N07QQ	OLED 2x16 Ye 84x44	£18.32	£15.83	£21.99
N08QQ	OLED 2x20 Gh 116x37	£20.82	£17.99	£24.99
N09QQ	OLED 2x20 Wh 116x37	£20.82	£17.99	£24.99
N10QQ	OLED 2x20 Ye 116x37	£20.82	£17.99	£24.99
N11QQ	OLED 4x20 Ye 98x60	£27.49	£23.75	£32.99

Alphanumeric LCD Modules



- 4 and 8 Bit parallel interface using HD44780 and HD44100 protocols
- High contrast ratios
- Excellent viewing angles
- Ideal for low cost applications, hobby electronics or replacing faulty screens

A range of alphanumeric LCDs, which are all supertwist [Except Order Code N24AZ, which is TN]. All LCDs have black characters on a green/yellow background, except for Order Code N25AZ, which has black characters on a grey background.

Order Code	Mod: 036389	Price each exc. VAT 1+	inc. VAT each
N24AZ	1x16 TN LCD	£4.99	£5.99
N25AZ	2x16 Grey LCD	£8.32	£9.99
N26AZ	1x8 Super-twist LCD	£12.49	£14.99
N27AZ	2x16 5.5x3mm LCD	£12.49	£14.99
N28AZ	2x16 9.5x5.2mm LCD	£12.49	£14.99
N30AZ	4x20 LCD Side LEDs	£12.49	£14.99

LCD and OLED Character Display Development Kit



- Small PCB to help development of character display modules
- EEPROM for configuration and general storage
- Data transfer over USB with USB to RS232 emulation
- Powered from USB port or separate 5V supply.
- Pin compatible with OLED / LCD 16 pin single in line [SIL] and dual in line [DIL] connectors
- Re-programmable via USB port or directly using Microchip ICSP
- On board temperature measurement, LCD contrast and backlight switch
- Kit includes USB cable, pin header, and CD with driver program
- Dimensions: 41.0 mm x 23.5 mm

The straightforward protocol allows full control of all the displays features with the addition of digital contrast adjustment, temperature measurement, LED backlight control and general purpose input/output connections. Ideal for adding a display to your product or for exploring all the features of LCD and OLED character displays.

Specifications

Requirements: PC running Microsoft Windows
 Dimensions: 41 x 23mm

Order Code	Mod: 787689	Price each exc. VAT 1+	5+	inc. VAT each
N130Q	LCD OLED Dev Kit SIL	£16.65	£14.39	£19.99
N120Q	LCD OLED Dev Kit DIL	£16.65	£14.39	£19.99

TFT Display Module

TFT Plug and Play LCD Modules



- TFT modules mounted on a PCB
- 2.4, 2.8 and 3.5" screen sizes available
- Build attractive display systems with these colour TFT panels
- Enhance electronic projects, manufacturing, POS or signage
- Serial UART USB interface
- LED backlight and driver
- Built in controller and 8MB of flash memory
- Includes slide show demonstration
- 5V supply voltage

Specifications

	Screen	Resolution	Viewable	Size (mm)
N14QQ	2.4"	240 X 320	50.6 x 38.4	70.0 x 57.0 x 12.0
N15QQ	2.8"	240 X 320	58.8 x 44.3	78.6 x 63.2 x 13.0
N16QQ	3.5"	320 X 480	74.8 x 50.5	93.5 x 69.0 x 13.0

Order Code	Mod: 787707	Price each exc. VAT 1+	VAT 5+	inc. VAT each
N14QQ	2.4in TFT Ser USB	£37.49	£32.39	£44.99
N15QQ	2.8in TFT Ser USB	£41.65	£35.99	£49.99
N16QQ	3.5in TFT Ser USB	£66.65	£57.59	£79.99

TFT Plug and Play LCD Touch Screen Modules



- TFT touch screen modules on PCB
- 2.4, 2.8 and 3.5" available
- Build attractive display systems with these colour TFT panels
- Enhance electronic projects, manufacturing, POS or signage
- Serial UART USB interface
- LED backlight and driver
- Built in controller and 8MB of flash memory
- Includes slide show demonstration
- 5V supply voltage

Specifications

	Screen	Resolution	Viewable	Size (mm)
N17QQ	2.4"	240 X 320	50.6 x 38.4	70.0 x 57.0 x 12.0
N18QQ	2.8"	240 X 320	58.8 x 44.3	78.6 x 63.2 x 13.0
N19QQ	3.5"	320 X 480	74.8 x 50.5	93.5 x 69.0 x 13.0

Order Code	Mod: 787709	Price each exc. VAT 1+	VAT 5+	inc. VAT each
N17QQ	2.4in Touch TFT USB	£41.65	£35.99	£49.99
N18QQ	2.8in Touch TFT USB	£45.82	£39.59	£54.99
N19QQ	3.5in Touch TFT USB	£70.82	£61.19	£84.99

1000's more components available in-store & online

Optocouplers

Phototransistor Opto Couplers

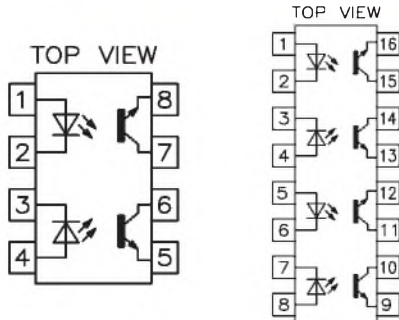

- Optically coupled pair with infrared LED and a silicon NPN phototransistor
- Can be used to replace relays and transformers in many digital interface applications
- YY62 has two isolated channels in a single DIP package; the YY63 has four isolated channels per package
- TTL compatible

Specifications

Parameter	Symbol	Value	Unit
Input			
Peak reverse voltage	VR	3	V
Forward continuous current	IF	30	mA
Power dissipation	Pdiss	100	mW
Output			
Collector-emitter breakdown voltage	BVCEO	20	V
Emitter-collector breakdown voltage	BVECO	5	V
Collector-base breakdown voltage	BVCEO	70	V
Power dissipation Pdiss 150mW	Pdiss	150	mW
Coupler			
Isolation test voltage t = 1.0 sec	Viso	£300	VRMS
Total Package Dissipation			
ILD74	Ptot	400	mW
ILQ74	Ptot	500	mW

Order Code	Mod: 002198	Price each exc. VAT 1+	VAT 5+	inc. VAT each
YY62S	Dual Opto-Isolator	£1.28	£1.11	£1.54
YY63T	Quad Opto-Isolator	£1.45	£1.26	£1.74

High Voltage Opto-Isolator

An opto isolator device in a 6-pin DIL package comprising a gallium arsenide infrared emitting diode optically coupled to a monolithic silicon phototransistor. The input to output isolation can be up to 7,500V peak guaranteed, and the device meets or exceeds all JEDEC registered specifications.



Specifications:

LED forward voltage:	1-1.5V @ IF = 10mA
Capacitance:	18pF
Collector/emitter dark current:	50nA @ VCE = 10V
VCE maximum:	30V
VCB maximum:	70V
HFE:	500
Collector/base capacitance:	19pF @ 1MHz
Collector/emitter sat. voltage:	0-15V
Turn-on time:	2-8µs (LED IF = 10mA)
Isolation voltage:	7,500 Vac @ 60Hz
Isolation resistance:	10 ¹¹ @ 500V
Isolation capacitance:	0-2pF

Order Code	Mod: 002223	Price each exc. VAT 1+	VAT 5+	inc. VAT each
AY44X	4N25	£0.82	£0.71	£0.99

Low Current Opto-Coupler

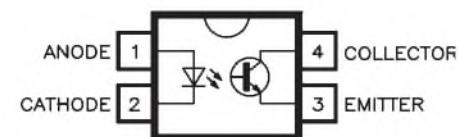

A transistor optocoupler in a DIP-4 package with a low current input and a very high coupling transfer ratio (CTR), typically 120%. The device has good CTR linearity relative to forward current and a high VCEO of 55Vdc. The device can be 'end stacked' if necessary (2.54mm spacing)

Specifications:

Emitter - maximum ratings	
Reverse voltage	6V
DC forward current	50mA
Surge forward current [10µS]	2.5A
Total power dissipation	70mW
Detector maximum ratings	
Voltage	
VCEO	55V
VECO	7V
Collector current	50mA
Surge collector current (1mS)	100mA
Total power dissipation	150mW
Coupling capacitance	0.25pF
IF = 1mA, VCE = 0-5V:	63% tc 125%
IF = 0-5mA, VCE = 1-5V:	75% [32%]

Order Code	Mod: 002228	Price each exc. VAT 1+	inc. VAT each
CY96C	SFH618-2	£1.24	£1.49

Photodiodes

850nm Phototransistor

A highly sensitive linear NPN silicon phototransistor, enclosed in a tubular 5mm plastic package that can be easily mounted into holes and preformed plastic sleeves, e.g., LED mounting assemblies. The device features a clear plastic lens, a 50° acceptance angle and a very low dark current. The collector has the shortest leg and is next to the flat on the package base.



Specifications:

Wavelength of maximum photosensitivity:	850nm
Spectral range of photosensitivity:	420nm to 1130nm
Half angle:	±25°
Capacitance:	6.5pF
Collector-emitter voltage:	35V
Collector current:	50mA
Collector peak current:	100mA (<10µs)
Power dissipation at 25°C:	200mW
Dark current:	5nA
	Photocurrent, collector to emitter
	(1000Lux, Vce = 5V)
	0.63mA to 1.25mA

Order Code	Mod: 017936	Price each exc. VAT 1+	inc. VAT each
NP64U	SFH300-3	£1.32	£1.59

900nm Phototransistor

- 3mm T-1 infrared phototransistor in a clear housing
- Peak wavelength 900nm
- Small package ideal for space limited applications
- Many uses including remote control systems
- The collector is denoted by the shorter lead
- Similar to TIL78



Absolute maximum ratings

Vceo	30V
Vece	5V
PTOT	75mW
Electrical characteristics	
Light current (VCE 5V, 1000Lux)	
Min	8.3mA
Max	13.0mA
Dark current (VCE 10V, 0Lux)	
Max	0.1µA
Peak spectral response 900nm	

Order Code	Mod: 002252	Price each exc. VAT	inc. VAT each
		1+	5+
YY66W	Infra-Red Sensor	£0.65	£0.57
			£0.79

Infrared Devices

Infrared Transmitter & Receiver

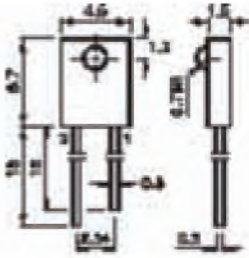

An infrared transmitter diode and a matching receiver photo-transistor in side looking packages, ideal for mounting at the edge of a PCB or where beam break detection or data coupling is required. Maximum forward current for the diode is 100mA continuous, 1A peak (300µps, 1µs pulse). Luminous intensity is 1.8mW at IF=50mA, with a 30° viewing angle. Phototransistor VCEO is 30 Volts, with a max dissipation of 100mW. Light IC = 20mA max and dark current is 100nA max, viewing angle 70°, rise/fall times=5µs @ RL=1K.

Order Code	Mod: 010379	Price each exc. VAT	inc. VAT each
		1+	5+
CH10L	Side Looking IR TX	£1.07	£0.81
CH11M	Side Looking IR RX	£1.07	£0.81

950nm Infrared Emitter

An infrared emitting diode that emits radiation in the near infrared range (950nm peak). The emitted radiation, which can be modulated, is generated by forward flowing current. The device is enclosed in a 5mm plastic package and has a lightly diffused grey plastic lens. This high intensity device has excellent long term stability and is designed to match with photodiode BP103B. A typical application is remote control of colour TV receivers.



Specifications:

Peak wavelength emission	950±20nm
Half angle:	±25°
Switch time I->F<->=100mA:	1µs
Reverse voltage:	5V
Forward current:	130mA
Surge current (t=10µs):	3.5A
Forward voltage:	1.30V
Breakdown voltage:	30V
Reverse current:	0.01µA
Capacity:	40pF
Power dissipation at 25°C:	210mW
Junction temperature:	100°C

Order Code	Mod: 002262	Price each exc. VAT	inc. VAT each
		1+	5+
CV85G	LD271	£1.24	£1.08
			£1.49

940nm Infrared Emitting Diode

- 3mm T-1 infrared emitting diode in a clear housing
- Peak wavelength 940nm
- Small package ideal for space limited applications
- Many uses including remote control systems
- The Cathode is denoted by the shorter lead



Specifications:

Power dissipation:	80mW
Forward current:	60mA
Reverse voltage:	5V
Peak forward current:	1A
Electrical characteristics:	
Forward voltage [Typ]	1.2V
Reverse voltage:	5V
Luminous intensity:	7mW
Peak wavelength:	940nm
Spectral line half width:	50nm

Order Code	Mod: 048038	Price each exc. VAT	inc. VAT each
		1+	
N178U	I/Red emitting diode	£0.74	£0.89

940nm Infrared Emitting Diode

- High power infra-red emitter
- 5mm diameter, clear package
- Similar to TIL38 device
- Primarily used in remote control applications



Specifications

Absolute maximum ratings	
Power dissipation:	100mW
Forward current:	100mA
Reverse voltage:	5V
Electrical characteristics:	
Forward voltage:	1.2V (IF = 20mA)
Peak wavelength:	940nm

Order Code	Mod: 002253	Price each exc. VAT	inc. VAT each
		1+	5+
YH70M	Infra-Red Emitter	£1.03	£0.90
			£1.24

Laser Diode Module

0.85mW 3V Green Laser Module



- A small laser module capable of delivering a visible green beam
- Used in the manufacture of presenter pointers, laser pens, tools and lighting effects
- 532nm wave length
- Working voltage is 3Vdc
- Less than 300mA current consumption
- 0.3-0.85mW power output

CAUTION: This device generates a visible beam of green light that will not burn or cut. However, it is moderately hazardous and should not be viewed by the naked eye on the same axis as the beam.

Fixing thread	M8.5 x 0.5P
---------------	-------------

Dimensions mm

Body	12 x 31.53 ±0.5mm
PCB	9.6 x 16
Beam aperture	2.8

Order Code	Mod: 588716	Price each exc. VAT	inc. VAT each
		1+	
N02KH	Laser Module Green	£8.32	£9.99

1mW 3V Red Laser Module



- A small laser module capable of delivering a visible red beam
- This module is ideal for assembly into finished products for laboratory and field applications
- 650nm wave length
- Working voltage is 3Vdc
- Less than 30mA current consumption
- 0.7-1mW power output

CAUTION: This device generates a visible beam of red light that will not burn or cut. However, it is moderately hazardous and should not be viewed by the naked eye on the same axis as the beam.

Dimensions

Body	10.5mm (dia) x 28mm (L) ±0.5mm
PCB	11.8 x 7.5
Beam aperture	2.8mm

Order Code	Mod: 011712	Price each exc. VAT	inc. VAT each
		1+	5+
LE07H	1mW Laser Module Red	£10.82	£9.35
			£12.99

Send direct

If any product is not in stock, we will order it for you and send it with free delivery. Terms and conditions apply.



Panel Meters

Signal Strength Meter



A square-faced signal strength meter which may be backlit to show up a green scale. Scale is marked 'Signal' and 0 to 5 for calibration.

Insulation Resistance	50MΩ or more @ 500VDC (1min)
Dimensions:	40 x 40 x 29mm

Specifications

Sensitivity:	250µA FSD ±10%
Internal resistance:	650Ω ±5%

Order Code	Mod: 005635	Price each exc. VAT	inc. VAT each
		1+	5+
LB80B	Sig Strength Meter	£3.90	£3.44
			£4.69

Technical Helpline

0333 400 9500

For technical information and assistance relating to any Maplin purchase, contact our team of experts



Reserve online and collect at the store of your choice

Semiconductors

Semiconductor Packs and Kits

Transistor Lucky Bag



- Contains an assortment of 20 transistors of randomly mixed values

Order Code	Mod: 807615	Price each exc. VAT 1+	inc. VAT each 5+
N30BG	L/Bag Transistors	£4.15	£4.99

Mixed Diodes Lucky Bag



- Contains an assortment of 100 mixed diodes of randomly assorted values

Order Code	Mod: 807614	Price each exc. VAT 1+	inc. VAT each 5+
N28BG	L/Bag Diodes	£4.15	£4.99

IC Socket Lucky Bag



- Contains an assortment of 30 IC sockets of randomly mixed values

Order Code	Mod: 807620	Price each exc. VAT 1+	inc. VAT each 5+
N13GL	L/BAG IC Sockets	£4.15	£3.36

Diodes

Signal Diodes



Type	Construction	Case Style	PIV V	IF mA	Reverse Current IR (µA V)
OA90	Ge point contact	D07	30	10	275µA 100V
1N914	Si whiskerless	D035	100	75	25na 25V

Order Code	Mod: 019076	Price each exc. VAT 1+	inc. VAT each 5+
QH71N	OA90	£0.90	£0.78
QL71N	1N914	£0.57	£0.50

1N4148 Switching Diode

- Fast switching speed
- General purpose rectification
- Silicon epitaxial planar construction
- Supplied in a DO-35 style case

Specifications:

Non-repetitive peak reverse voltage	100V
Peak repetitive reverse voltage	75V
DC blocking voltage	75V
RMS reverse voltage	53V
Rectifier output current	150mA
Power dissipation	500mW
Temperature range	-65 to +175°C
Forward voltage (IF=10mA)	1V
Capacitance	4pF
Reverse recovery time	4nS

Order Code	Mod: 046386	Price each exc. VAT 1+	inc. VAT each 5+
QL80B	1N4148	£0.40	£0.35

1A Glass Passivated Rectifiers



- Low forward voltage drop
- High current capability
- High reliability
- High surge current capability
- 0.7mm diameter leads

Specifications:

Max. average forward rectified current	1A
Peak forward surge current	30A
Max. DC reverse current	5µA
Junction capacitance typ.	15pF
Temperature range	-65 to +150°C

Part Number	Max. recurrent peak reverse voltage	Max. RMS voltage	Max. DC blocking voltage
1N4001G	50V	35V	50V
1N4002G	100V	70V	100V
1N4003G	200V	140V	200V
1N4004G	400V	280V	400V
1N4005G	600V	420V	600V
1N4007G	1000V	700V	1000V

Order Code	Mod: 046376	Price each exc. VAT 1+	inc. VAT each 5+
N72CA	1N4001G	£0.40	£0.35
N73CA	1N4002G	£0.40	£0.35
N74CA	1N4003G	£0.40	£0.35
N75CA	1N4004G	£0.40	£0.35
N76CA	1N4005G	£0.40	£0.35
N78CA	1N4007G	£0.40	£0.35

1A Silicon Rectifiers



- Low forward voltage drop
- High current capability
- High reliability
- High surge current capability
- 0.6mm diameter leads

1N4007S	1000V	700V	1000V
---------	-------	------	-------

Specifications:

Max. Average forward rectified current	1A
Peak forward surge current	30A
Max. DC reverse current	5µA
Junction capacitance typ.	15pF

Temperature range: -65 to +150°C

Part number	Max. recurrent peak reverse voltage	Max. RMS voltage	Max. DC blocking voltage
1N4001S	50V	35V	50V
1N4002S	100V	70V	100V
1N4003S	200V	140V	200V
1N4004S	400V	280V	400V
1N4005S	600V	420V	600V
1N4006S	800V	560V	800V

Order Code	Mod: 046385	Price each exc. VAT 1+	inc. VAT each 5+
QL73Q	1N4001S	£0.40	£0.35
QL74R	1N4002S	£0.40	£0.35
QL75S	1N4003S	£0.40	£0.35
QL76H	1N4004S	£0.40	£0.35
QL77J	1N4005S	£0.49	£0.42
QL78K	1N4006S	£0.40	£0.35
QL79L	1N4007S	£0.40	£0.35

1A Fast Recovery Rectifiers



- Low forward voltage drop
- High current capability
- High reliability
- High surge current capability
- All products supplied in DO-41 style cases

Specifications:

Max. Average forward rectified current	1A
Peak forward surge current	30A
Max. DC reverse current	5µA
Junction capacitance typ.	15pF
Temperature range	-65 to +125°C

Part Number	Max. recurrent peak reverse voltage	Max. RMS voltage	Max. DC blocking voltage
1N4933	50V	35V	50V
1N4934	100V	70V	100V
1N4937	600V	420V	600V

Order Code	Mod: 046391	Price each exc. VAT 1+	inc. VAT each 5+
N79CA	1N4933	£0.40	£0.35
N80CA	1N4934	£0.40	£0.35
N83CA	1N4937	£0.49	£0.39

3A Silicon Rectifiers



- Low forward voltage drop
- High current capability
- High reliability
- High surge current capability
- Supplied in a DO-201 style case

Specifications:

Max. Average forward rectified current	3A
Peak forward surge current	200A
Max. DC reverse current	5µA
Junction capacitance typ.	50pF
Temperature range	-65 to +125°C

Part number	Max. recurrent peak reverse voltage	Max. RMS voltage	Max. DC blocking voltage
1N5400	50V	35V	50V
1N5401	100V	70V	100V
1N5402	200V	140V	200V
1N5404	400V	280V	400V
1N5406	600V	420V	600V
1N5408	1000V	700V	1000V

Order Code	Mod: 046405	Price each exc. VAT 1+	inc. VAT each 5+
QL81C	1N5400	£0.49	£0.40
QL82D	1N5401	£0.49	£0.40
QL83E	1N5402	£0.49	£0.40
QL84F	1N5404	£0.49	£0.40
QL85G	1N5406	£0.49	£0.40
QL87U	1N5408	£0.49	£0.40

6A Silicon Rectifiers



- High forward current capability
- High surge current capability
- High temperature soldering guaranteed
- Supplied in a P-600 style case

Specifications:

Max. Average forward rectified current	6A
Peak forward surge current	400A
Max. DC reverse current	5μA
Junction capacitance typ.	150pF
Temperature range:	-50 to +150°C

Part number	Max. recurrent peak reverse voltage	Max. RMS voltage	Max. DC blocking voltage
P600A	50V	35V	50V
P600D	200V	140V	200V
P600J	600V	420V	600V

Order Code	Mod: 046413	Price each exc. VAT 1+	Price each exc. VAT 5+	inc. VAT each
UK59P	P600A	£0.90	£0.78	£1.09
UK60Q	P600D	£0.82	£0.71	£0.99
UK61R	P600J	£0.82	£0.71	£0.99

BAT43 0.2A Schottky Rectifier Diode

Type	Case Style	PIV V	IF A	Max VF drop [V @ A]	Max T °C
BAT43	D035	30	0.2	<100.1	125

Order Code	Mod: 019082	Price each exc. VAT 1+	Price each exc. VAT 5+	inc. VAT each
VR19V	BAT43	£0.40		£0.49

1A Schottky Barrier Rectifiers



- Low forward voltage drop
- High current capability
- High reliability
- High surge current capability
- Supplied in a DO-41 style case

Specifications:

Max. Average forward rectified current:	1A
Peak forward surge current:	25A
Max. DC reverse current:	1μA
Junction capacitance typ.:	110pF
Temperature range:	-65 to +125°C

Part Number	Max. recurrent peak reverse voltage	Max. RMS voltage	Max. DC blocking voltage
1N5817	20V	14V	20V
1N5818	30V	21V	30V
1N5819	40V	28V	40V

Order Code	Mod: 046408	Price each exc. VAT 1+	Price each exc. VAT 5+	inc. VAT each
JA46A	1N5817	£0.49	£0.40	£0.59
JA47B	1N5818	£0.49	£0.40	£0.59
AN07H	1N5819	£0.49	£0.40	£0.59

1N5820TSC 3A Schottky Barrier Rectifiers



- Low forward voltage drop
- High current capability
- High reliability

- High surge current capability
- Supplied in a DO-41 style case

Specifications:

Max. average forward rectified current:	3A
Peak forward surge current:	80A
Max. DC reverse current:	2μA
Junction capacitance typ.:	250pF
Temperature range:	-65 to +125°C

Part number	Max. recurrent peak reverse voltage	Max. RMS voltage	Max. DC blocking voltage
1N5820	20V	14V	20V

Order Code	Mod: 046409	Price each exc. VAT 1+	Price each exc. VAT 5+	inc. VAT each
N91CA	1N5820TSC	£0.49	£0.40	£0.59

MBR1535CT 15A Schottky Barrier Rectifier



- Low power loss, high efficiency
- High current capability
- Low forward voltage drop
- High surge capability
- Guarding for overvoltage protection

A 15A Schottky barrier rectifier ideal for use in low-voltage, high-frequency invertors, free wheeling and polarity protection applications. Supplied in a TO-220 style case.

Specifications:

Max. average forward rectified current:	15A
Peak forward surge current:	150A
Max. reverse surge current:	1mA
Temperature range:	-65 to +150°C
Max. recurrent peak reverse voltage:	35V
Max. RMS voltage:	24V
Max. DC blocking voltage:	35V

Order Code	Mod: 046425	Price each exc. VAT 1+	Price each exc. VAT 5+	inc. VAT each
N13CC	MBR1535CT	£1.65	£1.43	£1.99

MBRF1645 16A Isolation Schottky Barrier Rectifier



- Low power loss, high efficiency
- High current capability
- Low forward voltage drop
- High surge capability
- Guarding for overvoltage protection

An isolation 16A Schottky barrier rectifier ideal for use in low voltage, high frequency invertors, free wheeling and polarity protection applications. The device is supplied in a ITO-220AC style case

Specifications:

Max. Average forward rectified current:	16A
Peak forward surge current:	150A
Temperature range:	-65 to +150°C

Part Number	Max. recurrent peak reverse voltage	Max. RMS voltage	Max. DC blocking voltage
MBRF1645	45V	31V	45V

Order Code	Mod: 046431	Price each exc. VAT 1+	Price each exc. VAT 5+	inc. VAT each
N25CC	MBRF1645	£1.11	£0.97	£1.34

P6KE39A 100A Unidirectional Transient Voltage Suppressor Diode



- Excellent clamping capability

- Low zener impedance
- Fast response time
- Supplied in a DO-15 style case

Specifications:

Peak power dissipation min	£00W
Steady state power dissipation	5W
Peak forward surge current	100A
Temperature range:	-55 to +175°C

Part number	Voltage:	Max. peak surge current:	Max. clamping voltage:
P6KE39A	39V	11.6A	53.9V

Order Code	Mod: 046420	Price each exc. VAT 1+	Price each exc. VAT 5+	inc. VAT each
N10CB	P6KE39A	£0.40		£0.49

P6KE100CA 100A Bidirectional Transient Voltage Suppressor Diode



- Excellent clamping capability
- Low zener impedance
- Fast response time
- Supplied in a DO-15 style case

Specifications:

Peak power dissipation min	£00W
Steady state power dissipation	5W
Peak forward surge current	100A
Temperature range:	-55 to +175°C

Part number	Voltage:	Max. peak surge current:	Max. clamping voltage:
P6KE100CA	100V	3.9A	158V

Order Code	Mod: 046421	Price each exc. VAT 1+	Price each exc. VAT 5+	inc. VAT each
N14CB	P6KE100CA	£0.40		£0.49

1.5KE12A 200A Unidirectional Transient Voltage Suppressor Diode



- Excellent clamping capability
- Low zener impedance
- Fast response time
- Supplied in a DO-201 style case

Specifications:

Peak power dissipation min	1500W
Steady state power dissipation	5W
Peak forward surge current	200A
Temperature range:	-55 to +175°C

Part number	Voltage	Max. peak surge current	Max. clamping voltage
1.5KE12A	12V	94A	16.7V

Order Code	Mod: 046416	Price each exc. VAT 1+	Price each exc. VAT 5+	inc. VAT each
N92CA	1.5KE12A	£0.65	£0.55	£0.79

Look out for our monthly promotions at your local Maplin store now!

Pop in and pick up a copy of our monthly promotional publication, with special offers on dozens of exciting products. See the end of this catalogue for store listings

PNP Transistors in TO92 Case



Type	V _{CEO} V	I _C mA	PTOT mW	HFE min/max	FT MHz
BC558B	-30	-100	500	220/475	100
2N3906	-40	-200	500	100/300	250
2N5401	-150	-600	500	60/240	300
BC327	-45	-500	800	160/400	80
BC556B	-65	-100	500	220/475	100

Order Code	Mod: 033802	Price each exc. VAT 1+	VAT 5+	inc. VAT each
Q017T	BC558C	€0.38	€0.33	€0.46
QR42V	2N3906	€0.49	€0.42	€0.59
QB66W	BC327	€0.49	€0.42	€0.59
N16AF	BC556B	€0.40	€0.35	€0.49
UL37S	2N5401	€0.40	€0.35	€0.49

2N3053 Medium Power NPN Silicon Transistor



- General purpose NPN transistors
- Ideal for low to medium power applications
- Suited for medium current switching and amplifier applications

Type	Case Style	V _{CEO} V	V _{CB0} V	V _{EB0} V	I _C mA	PTOT mW	FT MHz
2N3053	TO39	40	60	5	0.7A	1000	50

Order Code	Mod: 019063	Price each exc. VAT 1+	VAT 5+	inc. VAT each
QR23A	2N3053	€1.49		€1.79

MOS-FET Transistor



- MOS-FET supplied in either TO92 style cases

See specification tab for details

Type:	V _{DS} V	I _D A	PTOT W	Channel:	Case Style:
2N7000	60	0.2	0.35	N	TO92

Order Code	Mod: 033843	Price each exc. VAT 1+	VAT 5+	inc. VAT each
UF89W	2N7000	€0.90	€0.78	€1.09

Power Darlington Transistors



- A range of power Darlington transistors

Type:	V _{DS} V	I _D A	PTOT W	Channel:	Case Style:
BD681	100	4	40	NPN	TO126
BDX33C	100	10	70	NPN	TO220

Order Code	Mod: 033874	Price each exc. VAT 1+	VAT 5+	inc. VAT each
N76AH	BD681	€0.82	€0.71	€0.99
N80AH	BDX33C	€0.74	€0.64	€0.89

Standard Bipolar NPN

Power Transistors



- A range of standard, bipolar, power, NPN transistors in TO style cases

Type:	V _{CEO} V:	I _C A:	PTOT W:	Case Style:
BD237	80	2	25	TO126
MJ802	90	30	200	TO3
2N3055H	60	15	90	TO3
TIP31C	100	3	40	TO220

Order Code	Mod: 033878	Price each exc. VAT 1+	VAT 5+	inc. VAT each
N91AH	BD237	€0.82	€0.71	€0.99
N03AJ	MJ802	€4.49	€3.88	€5.39
UM82D	TIP31C	€0.99		€1.19

Standard Bipolar PNP Power Transistors



A range of standard, bipolar, power, PNP transistors in TO style cases

Type	V _{CEO} V	I _C A	PTOT W	Case Style
BD442	-80	-4	36	TO126
BD912	-100	-15	90	TO220
TIP295E	-60	-15	90	TO218

Order Code	Mod: 033879	Price each exc. VAT 1+	VAT 5+	inc. VAT each
QH55K	TIP295E	€1.65	€1.43	€1.99
N17AJ	BD442	€0.74	€0.64	€0.89
N19AJ	BD912	€1.65	€1.43	€1.99

High Power NPN Silicon Transistors

A range of high power, low frequency, silicon NPN transistors.

Type	Case Style	V _{CEO} V	V _{CB0} V	V _{EB0} V	I _C A	PTOT W	hFE Typ	FT MHz
2N3055	TO3	60	100	7	25	125	20	3
TIP3055	TO247	70	100	7	15	115	45	0.8

Order Code	Mod: 019066	Price each exc. VAT 1+	VAT 5+	inc. VAT each
BL45Y	2N3055	€2.49	€2.15	€2.99
QH56L	TIP3055	€1.82	€1.58	€2.19

Maplin TV

Home of innovation,
handy tips and
How To videos

Visit our
channel...
youtube.com/maplintv



Voltage Regulators

0.1A Positive Fixed Voltage Regulators



- Output current up to 100mA
- No external components required
- Internal overload protection
- Output voltage offered in 4% tolerance

The TL78L00 series of positive voltage regulators are inexpensive, easy to use devices suitable for a multitude of applications that require a regulated supply of up to 100mA. These regulators feature internal current limiting and thermal shutdown making them remarkably rugged. No external components are required in most applications.

These devices offer a substantial performance advantage over the traditional Zener diode-resistor combination, as output impedance and quiescent current are substantially reduced.

Order Code	Part Number	Case Style	Output Voltage V	Line Regulation mV
QL26D	TS78L05CT	TO-92	5V	50
N79BZ	TS78L09CT	TO-92	9V	90
WQ77J	TS78L12CT	TO-92	12V	120

Order Code	Part Number	Load Regulation mV	Output Noise (µV)	Ripple Reject Ratio dB
QL26D	TS78L05CT	20	40	49
N76BZ	TS78L08CT	25	60	57
N79BZ	TS78L09CT	30	60	57
WQ77J	TS78L12CT	40	80	42

Order Code	Mod: 046470	Price each exc. VAT 1+	VAT 5+	inc. VAT each
QL26D	TS78L05CT	€0.82	€0.69	€0.99
N79BZ	TS78L09CT	€0.65	€0.55	€0.79
WQ77J	TS78L12CT	€0.74		€0.89

0.5A Positive Fixed Voltage Regulators



- No external components required
- Internal thermal overload protection
- Internal short circuit current limiting
- Output transistor safe-area compensation
- Output voltage tolerance of 4%

Two positive fixed voltage regulators offered in TO-220 style cases. All order codes have a voltage drop of 2V and a peak output current of 700mA.

Order Code	Part Number	Case Style	Output Voltage V:	Line Regulation mV:
QL28F	TS78M05CZ	TO220	5V	3
QL29	TS78M12CZ	TO220	12V	80

Order Code	Part Number	Load Regulation	Output Noise	Ripple Reject	Input Voltage
QL28F	TS78M05CZ	20	40	80	35
QL29G	TS78M12CZ	25	75	80	35

Order Code	Mod: 046473	Price each exc. VAT 1+	VAT 5+	inc. VAT each
QL28F	TS78M05CZ	€0.90		€1.09
QL29G	TS78M12CZ	€0.87		€1.05

1A Positive Fixed Voltage Regulators



- Output current up to 1A
- No external components required
- Internal thermal overload protection
- Internal short-circuit current limiting
- Output transistor safe-area compensation
- Output voltage offered at 4% tolerance

These voltage regulators are monolithic integrated circuits designed as fixed voltage regulators for a wide variety of applications including local, on-card regulation. The regulators employ internal current limiting, thermal shutdown and safe area compensation. With adequate heatsink they can deliver output currents up to 1A. Although primarily designed as a fixed voltage regulator, these devices can be used with external components to obtain adjustable voltages and currents. This range is offered in TO-220 and ISOWATT-220 style packages.

Order Code:	Part Number:	Case Style:	Output Voltage V:	Line Regulation mV:
QL31J	TS7805CZ	TO220	5V	3
AW69A	TS7806CZ	TO220	6V	5
N37CA	TS7809CZ	TO220	9V	6
N38CA	TS7810CZ	TO220	10V	7
QL32K	TS7812CZ	TO220	12V	10
QL33L	TS7815CZ	TO220	15V	12
N39CA	TS7818CZ	TO220	18V	15
AV11M	TS7824CZ	TO220	24V	18
CR14Q	L7805CP	ISOWATT220	5V	3
CR16S	L7812CP	ISOWATT220	12V	10

Order Code:	Part Number:	Load Regulation mV:	Output Noise μ V:	Input Voltage V:
QL31J	TS7805CZ	15	40	35
AW69A	TS7806CZ	14	45	35
N37CA	TS7809CZ	12	52	35
N38CA	TS7810CZ	12	70	35
QL32K	TS7812CZ	12	75	35
QL33L	TS7815CZ	12	90	35
AV11M	TS7824CZ	12	170	40
CR14Q	L7805CP	15	40	35
CR16S	L7812CP	12	75	35

Order Code	Mod: 046475	Price each exc. VAT 1+	5+	inc. VAT each
QL31J	TS7805CZ	€0.90	€0.78	€1.09
AW69A	TS7806CZ	€1.24	€1.09	€1.49
N37CA	TS7809CZ	€0.90	€0.78	€1.09
N38CA	TS7810CZ	€0.90	€0.78	€1.09
QL32K	TS7812CZ	€0.90	€0.78	€1.09
QL33L	TS7815CZ	€0.90	€0.78	€1.09
AV11M	TS7824CZ	€1.07	€1.07	€1.29
CR14Q	L7805CP	€1.32	€1.12	€1.59
CR16S	L7812CP	€1.24	€1.07	€1.49

1A Negative Fixed Voltage Regulators



- No external components required
- Internal thermal overload protection
- Internal short circuit current limiting
- Output transistor safe-area compensation
- Output voltage tolerance of 2%

These regulators employ current limiting, thermal shutdown and safe-area compensation - making them remarkably rugged under most operating conditions. They are supplied in TO-220 style cases. All order codes have a voltage drop of 1.1V and a peak output current of 2.1A.

Order Code:	Part Number:	Case Style:	Output Voltage V:	Line Regulation mV:	Load Regulation mV:
WQ92A	TS7905CZ	TO220	-5V	3	10
N43CA	TS7912CZ	TO220	-12V	10	12
QL36P	L7915ACV	TO220	-15V	11	12

Order Code:	Part Number:	Output Noise μ V:	Ripple Reject Ratio dB:	Quiescent Current:	Input Current:
WQ92A	TS7905CZ	40	20	3	10
N43CA	TS7912CZ	60	18	10	12
QL36P	L7915ACV	65	18	10	12

Order Code:	Mod: 031737	Price each exc. VAT 1+	5+	inc. VAT each
WQ92A	TS7905CZ	€0.49	€0.42	€0.59
N43CA	TS7912CZ	€0.99	€0.86	€1.19
QL36P	L7915ACV	€0.99	€0.86	€1.19

2A Positive Fixed Voltage Regulators



This range of positive fixed voltage regulators have a quiescent current of 8mA, a short circuit current of 500mA, a ripple rej. of between 46 and 54dB and are housed in a TO220 style case. The output voltage has a tolerance of $\pm 4\%$. The input voltage range has an upper limit of +35V.

Type No	Output Voltage [typ]	Line Reg [max]	Load Reg [max]	Input Voltage Range	Output Noise
78S05	+5V	100mV	80mV	+8V	40
78S09	+9V	130mV	100mV	+12V	60
78S12	+12V	240mV	150mV	+15V	75
78S15	+15V	300mV	150mV	+18V	90

Order Code	Mod: 007939	Price each exc. VAT 1+	5+	inc. VAT each
UJ54J	L78S05CV	€0.82	€0.71	€0.99
UJ55K	L78S09CV	€0.82	€0.71	€0.99
UJ56L	L78S12CV	€0.82	€0.71	€0.99
UJ57M	L78S15CV	€0.82	€0.71	€0.99

LM317LZ 0.1A Positive Variable Regulator



The LM317LZ is a positive variable regulator in a TO92s style case and has the following specifications

Output voltage typ. [V]:	+1.2V to +37V
Line regulation typ. [%/V]:	0.01
Load regulation [%]:	0.1
Ripple rej. [dB]:	80
Quiescent current [mA]:	3.5
Input voltage range [V]:	+3V to +40V
Output noise [μ V]:	150

Order Code	Mod: 012539	Price each exc. VAT 1+	5+	inc. VAT each
RAB7U	LM317LZ	€0.82	€0.71	€0.99

LM2940CT-50 NSC 1A Low Dropout Regulator

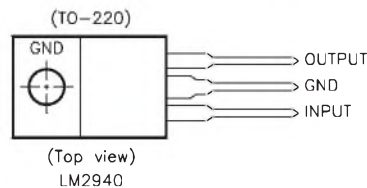
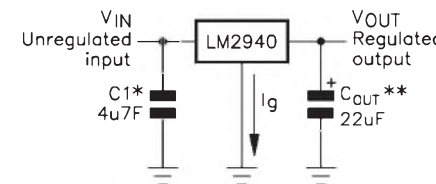

A positive voltage regulator that can source 1A of output current with a dropout voltage of typically 0.5V and a maximum of 1V, over the entire temperature range.

A quiescent current reduction circuit has been included which reduces the ground current when the differential

between the input voltage and the output voltage exceeds approximately 3V.

The quiescent current with 1A of output current and an input-output differential of 5V is therefore only 3mA. Higher quiescent currents only exist when the regulator is in the dropout mode [VIN - VOUT = 3V].

Also designed for vehicular applications, the device, and all regulated circuitry, is protected from reversed battery installation, or double-battery "jump-start" scenarios

During line transients, such as load dump where the input can temporarily exceed max. VIN, the device will shut down to protect its internal circuits and the load

It cannot be harmed by temporary mirror-image insertion. Thermal overload and short-circuit protection is included

Specifications:

Output voltage	5V typical ± 0.15 V max.
Line regulation	20mV
Load regulation:	35mV
Output impedance	35m Ω
Quiescent current:	10mA max
Output noise:	150 μ V rms
Ripple rejection	72dB min
Long term stability:	20mV/1000 hrs
Dropout voltage	0.5V min
Maximum input voltage	26V
Operating temperature range:	0°C to +125°C

Order Code	Mod: 008063	Price each exc. VAT 1+	5+	inc. VAT each
AV22Y	Reg LM2940CT-50 NSC	€1.65		€1.99

TS2940CZ C0 5V 1A Low Dropout Fixed Positive Voltage Regulator



- Output voltage trimmed before assembly
- Internal current limit
- Thermal shutdown protection
- 18V reverse peak voltage

This fixed voltage monolithic micro-power voltage regulator is designed for a wide range of applications. This device is an excellent choice for use in battery powered applications. Furthermore, the quiescent current increases slightly at dropout, which prolongs the battery life. The device is supplied in a TO-220 style case

Specifications:

Output voltage	5V typ
Line regulation	0.05% typ
Load regulation:	0.2% typ
Quiescent current:	15mA typ.
Output noise:	350 μ Vrms
Dropout voltage	300mV typ
Maximum input voltage	35V
Operating temperature	-20° - +85°C

Order Code	Mod: 046321	Price each exc. VAT 1+	5+	inc. VAT each
N67CA	TS2940CZ-50 CO	€0.99	€0.86	€1.19

150mA Ultra Low Dropout Positive Voltage Regulator



- 5.0 and 3.3V regulators
- Low quiescent current and low dropout voltage
- Extremely tight load and line regulation
- Very low temperature coefficient
- Use as regulator or reference
- Stable with low ESR output capacitors
- Current and thermal limiting

These devices are an excellent choice for use in battery powered applications such as cordless telephones, radio control systems, portable computers, etc. They feature very low quiescent current (75µA typ.) and very low dropout voltage (typ. 40µV at light load and 380mV at 100mA). Both devices are offered in a 3-pin TO-92 style package.

Specifications:

Output voltage:	0.95V typ.
Line regulation:	0.04% typ.
Load regulation:	0.1% typ.
Output noise:	160µVrms
Dropout voltage:	380mV typ.
Maximum input voltage:	30V
Operating temperature:	-20° - +85°C

Order Code	Mod: 046323	Price each exc. VAT 1+	5+	inc. VAT each
N47CA	TS2950CT-3.3	£0.82	£0.71	£0.99
N49CA	TS2950CT-5.0	£0.82	£0.71	£0.99

TS1086CZ 3.3V 1.5A Low Dropout Positive Voltage Regulator

- Low dropout voltage 1.3V max.
- Full current rating over line and temperature
- Fast transient response
- Fixed/adjustable output voltage

A high performance positive voltage regulator, designed for use in applications requiring low dropout performance at full rated current.

Provides excellent regulation over variations due to changes in line, load and temperature. Outstanding features include low dropout performance at rated current, fast transient response, internal current limiting and thermal shutdown protection of the output devices. Supplied in TO-220 style case.

Specifications:

Output voltage	1.2V max.
Operating junction temperature	-20°C to +85°C
Line regulation	0.015% typ.
Load regulation	0.05% typ.
Adjustment pin current	120µA
Reference voltage	1.25V typ.
Output noise	0.003%Vout
Ripple reject ratio	72dB
Long term stability	0.5% typ.

Order Code	Mod: 046058	Price each exc. VAT 1+	5+	inc. VAT each
N57CA	TS1086CZ-3.3	£1.15	£1.00	£1.39

5A Low Dropout Positive Voltage Regulators

- Low dropout voltage 1.3V max.
- Full current rating over line and temperature
- Fast transient response
- Fixed/adjustable output voltage

This range of high performance positive voltage regulators are designed for use in applications requiring low dropout performance at full rated current. They also provide excellent regulation over variations due to changes in line, load and temperature. Outstanding features include low dropout performance at rated current, fast transient response, internal current limiting and thermal shutdown protection of the output devices.

Order Codes N47CA and N49CA are supplied in TO-220 style cases.

Specifications:

Input voltage	12V max.
Operating junction temperature:	-25°C to +85°C
Line regulation:	0.015% typ.
Load regulation	0.05% typ.

Adjustment pin current:	90µA
Reference voltage	1.25V typ.
Output noise	0.003%Vout
Ripple reject ratio	72dB
Long term stability	0.5% typ.

Order Code	Mod: 046054	Price each exc. VAT 1+	5+	inc. VAT each
N47CA	TS1084CZ-2.5	£1.24	£1.07	£1.49
N49CA	TS1084CZ-3.3	£1.57	£1.36	£1.89

Send direct

If any product is not in stock, we will order it for you and send it with free delivery

Terms and conditions apply.

LM317 3-Terminal Adjustable Voltage Regulators



- Output adjustable between 1.25V and 37V
- Internal thermal overload protection
- Internal short circuit current limiting constant with temperature
- Output transistor safe-area compensation
- Floating operation for high voltage applications
- Eliminates using many fixed voltages
- Output voltage with 4% tolerance

The LM317 is an adjustable, positive, 3-terminal voltage regulator capable of supplying 100mA (Order Code RA87U) or 1.5A (Order Codes UF27E and N61CA) over an output voltage range of 1.2V to 37V. These voltage regulators are exceptionally easy to use and require only 2 external resistors to set the output voltage. Both line and load regulation are better than standard fixed regulators. Full overload protection is included on-chip with current limiting, thermal and safe area protection. This remains fully functional even if the adjustment terminal is disconnected, making it essentially blow-cut proof. Order Code UF27E is supplied in a TO-220 style case. Order Code RA87U is supplied in a TO-92 style case. Order Code N61CA is supplied in a TO-263 style case.

Specifications:

Output voltage	1.2V to 37V
Input/output differential voltage	40V max.
Operating junction temperature:	-20°C to +125°C
Line regulation:	0.01%/V
Load regulation	0.1%
Adjustment pin current	50µA
Reference voltage	1.25V typical
Output noise:	0.003% of Vout
Ripple rejection ratio:	65dB
Long term stability:	0.3% @ 125°C

Order Code	Mod: 008067	Price each exc. VAT 1+	5+	inc. VAT each
UF27E	LM317T	£0.99	£0.85	£1.19
RA87U	LM317LZ	£0.82	£0.71	£0.99
N61CA	TS137CM	£0.78		£0.94

LM337T NSC 1.5A 3 Terminal Negative Adjustable Regulator

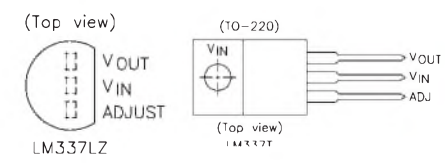

An adjustable, 3-terminal, negative voltage regulator capable of supplying 1.5A over a range of -1.2V to -37V. It is exceptionally easy to use and requires only two external resistors to set the output voltage.

Besides having a higher performance compared with fixed regulators, the LM337 offers full overload protection with current limiting, thermal overload protection and safe area protection. All overload protection circuitry remains fully functional even if the adjustment terminal is disconnected.

The adjustment terminal can be bypassed with a capacitor to ground to achieve very high ripple rejection ratios that are difficult to achieve with standard 3-terminal regulators.

Output voltage is set by connecting a twin resistor divider between output and circuit ground and connecting the adjustment pin to the junction. A precision current regulator can also be made by connecting a fixed resistor only between the adjustment and output pins, and connecting the load to the adjustment pin. The device is available in TO220 package (LM337T).

Specifications:

Output voltage	1.2V to 37V
Input/output differential voltage	40V max.
Operating junction temperature	25°C to +125°C
Line regulation:	0.01%/V
Load regulation	0.1%
Adjustment pin current:	50µA
Reference voltage:	1.25V typical
Output noise	0.003% of Vout
Ripple rejection ratio:	65dB
Long term stability	0.3% @ 125°C

Order Code	Mod: 008065	Price each exc. VAT 1+	inc. VAT each
AV32K	Req LM337T NSC	£1.15	£1.39

L200CV 2A Adjustable Voltage and Current Regulator

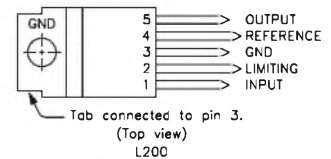

A monolithic IC for adjustable voltage (up to 36V) and current (up to 2A) regulation. It has current and power limiting thermal shutdown and input over voltage protection up to 60V. The device can be used to replace fixed voltage regulators where high output-voltage precision is required, eliminating the need to stock a range of fixed voltage regulators.

Type L200CV has straight pins for vertical mounting onto a PCB.

Specifications:

DC input voltage:	40V max.
Peak input voltage	60V max. for 10ms
Output voltage range	2.85 to 36V
Output current range	0.1A to 2A
Quiescent current	4.2mA
Load regulation	0.15% 2A
Line regulation:	60dB
Supply voltage regulation	60dB 100Hz
Dropout voltage between pins 1 & 5	2V typical
Output noise	80µV
Reference voltage (pin 4)	2.77V

Order Code	Mod: 008064	Price each exc. VAT 1+	5+	inc. VAT each
YY74R	L200CV	£3.32	£2.87	£3.99

1000's more components available in-store & online

LM723 150mA DIL 14 Variable Voltage Regulator

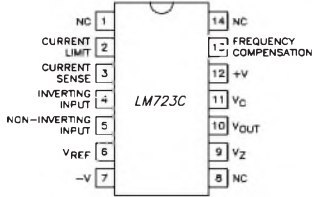

- 150mA output current without external pass transistor
- Output currents in excess of 10A possible by adding external transistors
- Input voltage 40V max.
- Output voltage adjustable from 2V to 37V
- Can be used as either linear or a switching regulator

The LM723 is a voltage regulator designed primarily for series regulator applications. By itself, it will supply output currents up to 150mA; but external transistors can be added to provide any desired load current. The circuit features extremely low standby current drain, and provision is made for either linear or fold back current limiting.

The LM723 is also useful in a wide range of other applications such as a shunt regulator, a current regulator or a temperature controller.

A full datasheet is available on www.maplin.co.uk

Order Code	Mod: 002347	Price each exc. VAT 1+	inc. VAT each 5+	inc. VAT each
QL21X	LM723 DIL 14	£0.82	£0.71	£0.99

ICL7660SCPA 20mA CMOS Voltage Converter

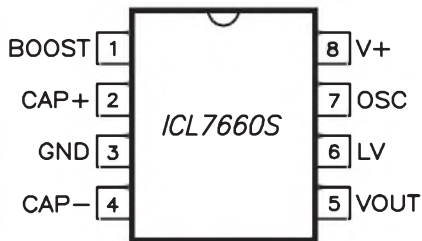

- Simple conversion of +5V logic supply to ±5V supplies

- Power efficiency of 96%
- Wide operating supply 1.5V to 12V

The ICL7660S is a monolithic CMOS voltage converter that guarantees significant improved performance over the industry standard ICL7660. The device has an extended operating supply range up to 12V, lower supply current, and requires no external diode. A frequency boost pin has been added to allow the user to achieve lower output impedance despite using smaller capacitors.

The device performs supply voltage conversion from positive to negative for an input range of 1.5V to 12V, resulting in complementary output voltages of -1.5V to -12V. Only two non-critical capacitors are needed for the charge pump and charge reservoir functions. The IC can be connected to function as a voltage doubler and will generate up to 22.8V with a 12V input. It can also be used as a voltage multiplier or voltage divider. Supplied in an 8-pin plastic DIP package.

Specifications:

Supply voltage high	3V to 12V
Supply voltage low	1.5V to 3V
Supply current	180µA typ
O/P resistance	60Ω typ at 20mA
Oscillator frequency	10kHz/35kHz
Power efficiency	98% typ
Voltage conversion efficiency	99%

Order Code	Mod: 019752	Price each exc. VAT 1+	inc. VAT each 5+	inc. VAT each
NM18U	ICL7660SCPA	£3.82	£3.30	£4.59

Op-Amps

TL071CN, TL072C0 & TL074CN

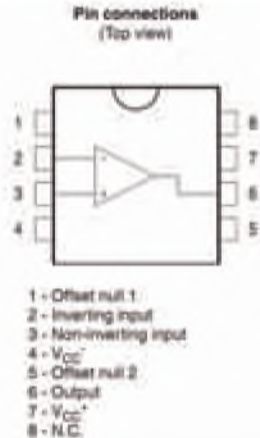

A Range of high speed JFET input operational amplifiers incorporating well matched, high voltage JFET and bipolar transistors in a monolithic integrated circuit. TL07x series are designed as low-noise versions of the TL08x series with low input bias and offset currents and fast slew rates. TL071 is an 8-pin DIL package containing one amplifier, TL072 is an 8-pin DIL package containing two individual amplifiers and TL074 is a 14-pin DIL package with four individual amplifiers.

Order Code	Mod: 537504	Price each exc. VAT 1+	inc. VAT each
RA67X	TL071CN	£0.57	£0.69
RA68Y	TL072CN	£0.57	£0.69
RA69A	TL074CN	£0.57	£0.69

TL081CN, TL082C0 & TL084CN

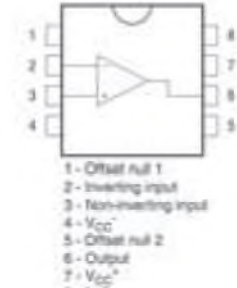

A low-cost general purpose range of JFET op-amps featuring high slew rates, low distortion, low input bias and offset currents, and low offset voltage temperature coefficient. Each device features a well-matched, high voltage JFET and bi-polar transistors in a monolithic IC package. TL081C0 is supplied in an 8-pin DIL package, as is the dual version TL082C0. TL084C0 is a quad version in a 14-pin DIL package.

Order Code	Mod: 537502	Price each exc. VAT 1+	inc. VAT each 5+	inc. VAT each
RA70M	TL081CN	£0.51	£0.45	£0.62
RA71N	TL082CN	£7.77	£7.77	£7.77
RA72P	TL084CN	£0.57	£0.69	£0.69

LM358N

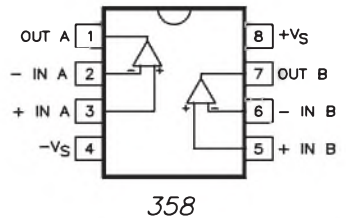

Independent high-gain internally frequency compensated op-amps designed specifically to operate from a single power supply. The output voltage can swing to ground even on single rail power supplies. Channel separation 120dB.

Order Code	Mod: 002857	Price each exc. VAT 1+	inc. VAT each 5+	inc. VAT each
UJ34M	LM358N	£0.90	£0.78	£1.09

TS358

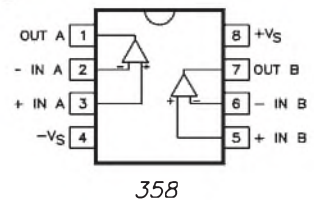

- Short circuit protected outputs
- True differential input stage
- Low input bias currents
- Internally compensated
- Common mode range extends to negative supply
- Single and split supply operation

Dual differential input operational amplifiers feature

Important Notice

To find out more about our products head to maplin.co.uk for downloadable PDF's and supplier information.

If you can't find the information you need in our catalogue then please get in touch with our tech support team at technical@maplin.co.uk

We reserve the right to supply an alternative manufacturer against standard logic items to protect against product allocation and maintain the lowest possible price

low power drain, a common mode input voltage range extending to ground V_{EE} , single supply or split supply operation and pin outs compatible with the popular MC1558 dual operational amplifier. Order Code N70CA is supplied in a DIP-8 style case.

Order Code	Mod: 046375	Price each exc. VAT	inc. VAT each
N70CA	TS358CD C3	£0.49	£0.42

LM741CN

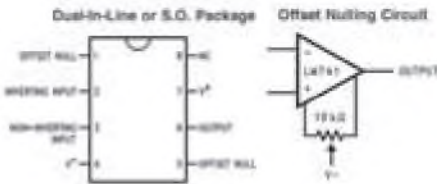

The LM741 is a general purpose operational amplifier which feature improved performance over industry standards like the LM709. They are direct, plug-in replacements for the 709C, LM201, MC1439 and 748 in most applications. The amplifiers offer many features which make their application nearly foolproof: overload protection on the input and output, no latch-up when the common mode range is exceeded, as well as freedom from oscillations.

Order Code	Mod: 002889	Price each exc. VAT	inc. VAT each
QL22Y	LM741CN	£0.90	£0.78

Buy it on the web at maplin.co.uk

Shop for all Maplin products online at our website and check out our latest products and special offers!



LM3900N

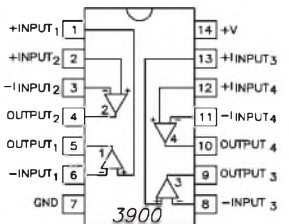

- 4 dual input, internally compensated amplifiers designed primarily for single power rail operation
- Current differencing amplifiers use a current mirror to achieve the non-inverting function

When driving from a low impedance source a resistor should be placed in series to limit the peak input current to less than 20mA.

Absolute max ratings:

Supply voltage range:	4V to 32V or $\pm 2V$ to $\pm 16V$
Power dissipation max.:	570mW
Input current max.:	20mA

Typical ratings at 25°C

Open loop voltage gain:	70dB
Input resistance:	1M Ω
Output resistance:	8 Ω
Unity gain bandwidth:	2.5MHz
Input bias current:	30nA
Slew rate positive output swing:	0.5V/ μ S
Slew rate negative output swing:	20V/ μ S
Supply current:	6.2mA
Output voltage swing:	29.4V
Output current capability:	18mA

Sink: 1.3mA
Power supply rejection ratio: 70dB
Mirror gain: $1\mu A/\mu A \pm 10\%$
Mirror current: $10\mu A$ (500 μA max)
Negative input current: 1mA
Full power bandwidth: 35kHz

Order Code	Mod: 220304	Price each exc. VAT	inc. VAT each
N25CG	LM3900N ROHS	£0.82	£0.99

m Over 200 stores nationwide

NE5532N

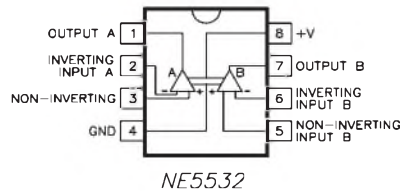

A dual op-amp designed for use in high quality and professional audio equipment. The IC has a typical input noise voltage at 1kHz of 5nV/√Hz. In addition it has better output drive capabilities and much higher small signal and power bandwidths than most other dual op-amps, yet is a direct pin-for-pin replacement for a 1458

Order Code	Mod: 002869	Price each exc. VAT	inc. VAT each
UH35Q	NE5532N	£0.99	£1.19

NE5534AN

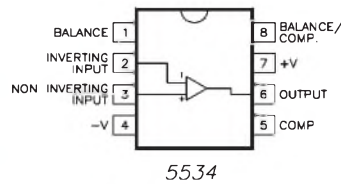

A high performance, low noise op-amp especially suited for professional and high quality audio equipment, as well as instrumentation and control circuits, and telephone channel amplifiers. Compared to standard 741/TL081 op-amps, the device offers better noise figures, improved output drive capability and considerably higher small signal and power bandwidths. The op-amp is internally compensated and the frequency response can be optimised with an external compensation capacitor to suit specific applications

Specifications:

Typical input noise voltage	3.5nV/√Hz
Slew rate	13V/ μ s
Small signal bandwidth	10MHz
Power bandwidth	200kHz
Output drive capability (6000):	10V rms (VS = $\pm 18V$)
Tone Control Circuit	
Turnover frequency is 1kHz	
Treble $\pm 20dB$ at 20kHz	
Bass $\pm 20dB$ at 20Hz	

Suggested Parts List

R1,2,3	Min Res 10k	(M16K)
R4	Min Res 3.3k	(M3K3)
R5	Min Res 68k	(M68K)
VR1,2	Pot Lin 100k	(FW05F)

(for stereo use FW88V)

C1 Tant 1 μ F 35V (WW60Q)
C2,3,4,5 Polyester 0.033 μ F (RA46)

Order Code	Mod: 002870	Price each exc. VAT	inc. VAT each
YY68Y	NE5534AN ROHS	£1.32	£1.59

CA3140EZ

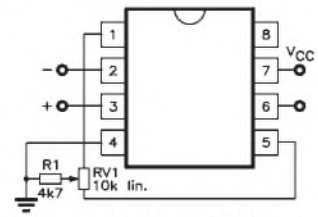

3140 & 3240
Offset Null

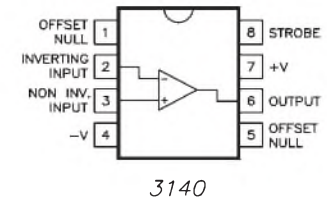

A MOSFET input, bipolar output op-amp that will directly replace the 741 in most applications. It will operate from single or dual supply rails and input terminals can be swung up to 0.5V below negative rail. Internally compensated. Max input terminal current is 1mA. The output can be strobed. Supplied in an 8-pin DIL package. N35CH is RoHS compliant

Order Code	Mod: 002920	Price each exc. VAT	inc. VAT each
N35CH	CA3140EZ	£2.40	£2.09

LF347N



Low-cost high performance JFET input op-amp that will directly replace and out-perform the 741 in most applications. The device is low noise, has distortion figures of less than 0.02% over the audio band, high slew rate (13V/ μ s), high input impedance (1012 Ω) and wide bandwidth

The 347, internal amplifier isolation is 120dB. Additionally, the accurately matched JFET inputs provide very low input bias and offset currents. It is most important that input voltages never go more negative than the negative supply voltage or the device will be destroyed. The ICs are ideal for audio circuits, as well as fast D/A converters, high speed integrators and sample-and-hold circuits. The 347 is supplied in a 14-pin DIL package and is a quad version. Note that since the inputs are JFETs not MOSFETs no special handling is required.

Specifications:

Cut & boost	Bass 20Hz $\pm 20dB$
	Mid 1kHz $\pm 20dB$
	Treble 20kHz $\pm 20dB$

Order Code	Mod: 002924	Price each exc. VAT	inc. VAT each
WQ29G	LF347N	£1.11	£0.97

Free Delivery
on all UK orders over **£10**

(TS&S Apply)

Timers

NE555N Timer

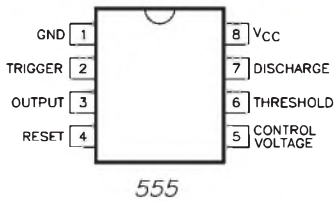

The 555 is a highly stable device for generating accurate time delays or oscillation. Additional terminals are provided for triggering or resetting if desired. In the time delay (monostable) mode of operation the time is precisely controlled by one external resistor and one capacitor. For stable operation as an oscillator, the free running frequency and the duty cycle are both accurately controlled with two external resistors and one capacitor. The circuit may be triggered and reset on falling waveforms and the output structure can source or sink up to 200mA or drive TTL directly. This IC may also be correctly supplied marked as MC1455PI. Supply decoupling must be provided close to the IC to counter the 'crowbar' effect of the device's internal discharge switch, a suitable value is 10 to 100µF as shown in the accompanying diagrams.

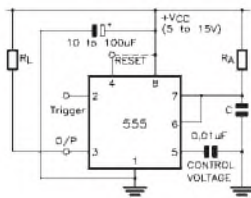

Monostable Mode

On time after triggering (i.e. applying a voltage to pin 2 less than 1/3 supply voltage) is equal to $1.1RC$. The load may be connected to VCC for normally-on operation or between pin 3 and ground for normally-off. Connecting reset to ground during on time, drives the output low until a new trigger pulse occurs. Additional trigger pulses during on time have no effect. If reset is not being used, connect it to VCC.

Astable Mode (Oscillator)

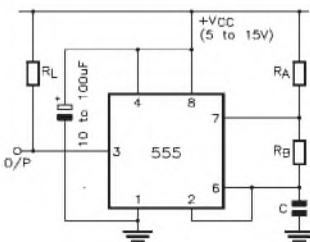

Free Running Frequency vs RA, RB and C

The frequency is equal to $1.44/[(RA + 2RB)C]$. The charge time [output high] is given by $t1 = 0.693(RA + RB)C$ and the discharge time [output low] is given by $t2 = 0.693(RB)C$. Characteristics (typical)

Typical Characteristics

Supply Voltage	4.5V [min], 1.6V [max]
Supply current	3mA (VCC = 5V), 10mA (VCC = 15V)
Threshold voltage:	VCC x 0.667
Trigger voltage	5V (VCC = 15V), 1.67V (VCC = 5V)
Trigger current	0.5µA
Threshold current:	0.1µA
Control voltage level:	10V (VCC = 15V), 3.33V (VCC = 5V)

Order Code	Mod.	Price each exc. VAT 1+	Price each exc. VAT 5+	inc. VAT each
QH66W	NE555N	£0.82	£0.71	£0.99

NE556N Dual Timer

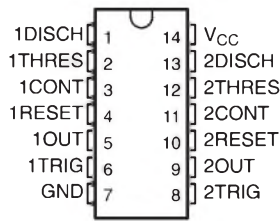

- Two precision timing circuits in one 14 pin DIP package
- These can be configured for astable or monostable operation
- Thousands of applications where precision timers are required
- TTL compatible output can sink or source up to 150 mA

Order Code	Mod.	Price each exc. VAT 1+	Price each exc. VAT 5+	inc. VAT each
QH67X	NE556N	£0.82	£0.71	£0.99



Browse our entire range at maplin.co.uk

Logic Devices

HC CMOS Logic, 74HCXXX



- HC (High-speed CMOS) offers low power and high-noise immunity of CMOS at the speed and performance of low-power Schottky

Order Code	Mod.	Price each exc. VAT 1+	Price each exc. VAT 5+	inc. VAT each
UB00A	74 HC 00 N	£0.82	£0.71	£0.99
UB03D	74 HC 04 N	£0.90	£0.78	£1.09
UB15R	74 HC 32 N	£0.82	£0.71	£0.99
UB19V	74 HC 74 N	£0.82	£0.71	£0.99
UF09K	74 HC 4060 N	£0.82	£0.71	£0.99

HCT CMOS Logic, 74HCTXXX

- HCT (High Speed CMOS)
- Offers the low power and high noise immunity of CMOS
- Speed and performance of Low Power Schottky
- TTL compatible

Order Code	Mod.	Price each exc. VAT 1+	Price each exc. VAT 5+	inc. VAT each
RS18	74HCT32N	£0.82	£0.71	£0.99
AE26	74HCT244N	£0.82	£0.71	£0.99
RS33	74HCT4060N	£0.82	£0.71	£0.99
RS19	74HCT74N	£0.82	£0.71	£0.99
RS21	74HCT125N	£0.82	£0.71	£0.99
RS22	74HCT132N	£0.82	£0.71	£0.99
RS26	74HCT193N	£0.82	£0.71	£0.99
RS28	74HCT393N	£0.82	£0.71	£0.99
RS29	74HCT541N	£0.82	£0.71	£0.99
RS34	74HCT4066N	£0.82	£0.71	£0.99
RS17	74HCT14N	£0.82	£0.71	£0.99

Code	Type	Function
AE20	74HCT00N	Quad 2-input NAND gate
AE24	74HCT138N	3-8 line decoder
AE29	74HCT573N	Octal transparent latches
RS14	74HCT02N	Quad 2-input NOR gate
RS15	74HCT04N	CMOS logic hex inverter
AE23	74HCT08N	Quad 2-input AND gate

Order Code	Mod.	Price each exc. VAT 1+	Price each exc. VAT 5+	inc. VAT each
AE26D	74HCT244N	£0.82	£0.71	£0.99
AE29G	74HCT573N	£0.82	£0.71	£0.99
RS18U	74HCT32N	£0.82	£0.71	£0.99
RS17T	74HCT14N	£0.82	£0.71	£0.99
RS21X	74HCT125N	£0.82	£0.71	£0.99
RS26D	74HCT193N	£0.82	£0.71	£0.99
RS28F	74HCT393N	£0.82	£0.71	£0.99
AE20W	74HCT00N	£0.82	£0.71	£0.99
RS14Q	74HCT02N	£0.82	£0.71	£0.99
RS15R	74HCT04N	£0.90	£0.78	£1.09
AE23A	74HCT08N	£0.82	£0.71	£0.99
RS19V	74HCT74N	£0.82	£0.71	£0.99
RS22Y	74HCT132N	£0.82	£0.71	£0.99
AE24B	74HCT138N	£0.82	£0.71	£0.99
RS29G	74HCT541N	£0.82	£0.71	£0.99
RS33L	74HCT4060N	£0.82	£0.71	£0.99
RS34M	74HCT4066N	£0.82	£0.71	£0.99

Low Power Schottky Bipolar Logic, 74LSXXX



- Low Power Schottky
- Offers a significant reduction in power as well as increases in speed over TTL

Code	Type	Function
YF02	74LS02N	Quad 2-input positive NOR gate
YF04	74LS04N	Hex inverter
YF0E	74LS06N	Hex inverter
N24CG	74LS08N	2-input positive AND gate
YF08	74LS10N	3-input positive NAND gates
YF20	74LS30N	8-input positive NAND gates
YF31	74LS74N	D-Type pos.-edge-triggered flip flops
YF36	74LS86N	Quad 2-input exclusive-OR gates
YF53	74LS138N	3-line to 8-line decoder
RS36	74LS132	Quad 2-input schmitt trigger
QQ56	74LS244N	Octal buffer and line driver with non-inverted 3 state outputs
N96KU	74LS245N	Oct bus transceiver
N32NT	74LS240	Octal buffer and line driver with inverted 3 state outputs

Order Code	Mod.	Price each exc. VAT 1+	Price each exc. VAT 5+	inc. VAT each
N32NT	74LS240	£0.82	£0.71	£0.99
N96KU	74LS245N	£0.82	£0.71	£0.99
YF20W	74LS30N	£7.77	£7.77	£7.77
QQ56L	74LS244N	£0.82	£0.71	£0.99
YF53H	74LS138N	£0.82	£0.71	£0.99
RS36P	74LS132	£0.82	£0.71	£0.99
YF36P	74LS86N	£0.82	£0.71	£0.99
YF05F	74LS05N	£0.82	£0.71	£0.99
YF02C	74LS02N	£0.82	£0.71	£0.99
YF04E	74LS04N	£0.90	£0.78	£1.09
N24CG	74LS08N	£0.82	£0.71	£0.99
YF08J	74LS10N	£0.82	£0.71	£0.99
YF31J	74LS74N	£0.82	£0.71	£0.99

CMOS Logic, HCF/HEF 4000 Series

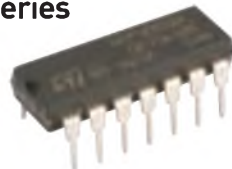

- Industry standard CMOS 4000 series devices
- Supports power supply voltages of up to 15V and rail output swings
- Ideal for hobby, industry and automotive applications
- Used in a wide variety of circuit applications

Code	Type	Function
CX01	4001	Quad 2-Input NOR gate
QW36	4053	2-Channel Analog Multiplexer
CX02	4002	Dual 4-Input NOR Gate
QW40	4060	14-Stage Ripple-Carry Binary Counter

QX05	4011	Buffered Quad 2-Input NAND gate
QX23	4066	Quad bilateral Switch
QX07	4013	Dual D-Type Flip Flop
QX24	4068	8 Input NAND/AND Gate
QW16	4015	Dual 4-Stage Static Shift Register
QX26	4070	Quad Exclusive - OR Gate
QX08	4016	Quad bilateral switch
QW43	4071	Quad 2 input OR gate
QX09	4017	Divide-by-10 counter [5-stage Johnson counter]
QX27	4072	Dual 4-Input OR Gate
QX10	4018	Presetable Divide-By-N Counter
QW44	4073	Triple 3-Input AND Gate
QW17	4019	Quad AND-OR Select Gate
QW45	4075	Triple 3-Input OR Gate
QX11	4020	Ripple-Carry Binary Counter
QW47	4077	Quad Exclusive-NOR gate
RS39	4021	8 Stage Static Shift Register
QW48	4081	Quad 2-Input AND Gate
QX13	4024	7 Stage Ripple-Carry Binary Counter
QW49	4082	Dual 4-Input AND Gate
QX15	4026	Decade Counter/Divider
QW53	4093	Quad 2-Input NAND Schmitt Trigger
QX16	4027	Dual J-K Master-Slave Flip Flop
QW54	4094	Shift-and-Store Bus Register
QX17	4028	BCD to decimal [1-of-10] decoder
QX29	4098	Dual Monostable Multivibrator
QW20	4029	Presetable Up/Down Counter
N26KU	4502	Strobed Hex Inverter
RS41	4033	Decade Counter/Divider
N44BY	4510	Presetable BCD Up/Down counter
QW27	4040	12-Stage Ripple-Carry Binary Counter
QX31	4511	Latch decoder driver
QX19	4042	Quad Clocked D Latch
QW87	4516	4-Bit Decade Counter
QW29	4043	Quad NOR R/S Latch
QX32	4518	Dual BCD Up-Counter
QW30	4044	Quad NAND R/S Latch
QX33	4520	Dual Binary Up-Counter
QW32	4046	MicroPower Phase Locked Loop
RS48	4536	Programmable Timer
QX20	4047	Low Power Multivibrator
QQ47	4541	Programmable Timer
QX22	4050	Hex Non-Inverting Buffer
RS50	4543	7 Segment Latch
QW34	4051	Analog Multiplexer
QW35	4052	4 Channel Analog Multiplexer

Order Code	Mod: U3182U	Price each exc. VAT 1+	inc. VAT each 5+	
QX02C	4002	£0.74	£0.64	£0.89
QX05F	4011	£0.74	£0.64	£0.89
QX07H	4013	£0.74	£0.64	£0.89
QW16S	4015	£0.74	£0.64	£0.89
QX09K	4017	£0.82	£0.71	£0.99
QX08J	4016	£0.74	£0.64	£0.89
QX10L	4018	£0.71	£0.62	£0.86
QW17T	4019	£0.74	£0.64	£0.89
QX11M	4020	£0.74	£0.64	£0.89
RS39N	4021	£0.71	£0.62	£0.86
QX13P	4024	£0.74	£0.64	£0.89
QX15R	4026	£0.74	£0.64	£0.89
QX16S	4027	£0.74	£0.64	£0.89
QX17T	4028	£0.74	£0.64	£0.89
QW20W	4029	£0.71	£0.62	£0.86
RS41U	4033	£0.82	£0.71	£0.99
QW27E	4040	£0.71	£0.62	£0.86
QW29G	4043	£0.71	£0.62	£0.86
QX19V	4042	£0.71	£0.62	£0.86
QW30H	4044	£0.71	£0.62	£0.86
QW32K	4046	£0.74	£0.64	£0.89
QX22Y	4050	£0.74	£0.64	£0.89
QX20W	4047	£0.74	£0.64	£0.89
QX33L	4520	£0.74	£0.64	£0.89
QW34M	4051	£0.74	£0.64	£0.89
QW35O	4052	£0.71	£0.62	£0.86
QW40T	4060	£0.74	£0.64	£0.89
QW36P	4053	£0.71	£0.62	£0.86
QX23A	4066	£0.71	£0.62	£0.86
QX26D	4070	£0.71	£0.62	£0.86
QX24B	4068	£0.71	£0.62	£0.86
QW43W	4071	£0.74	£0.64	£0.89
QX27E	4072	£0.71	£0.62	£0.86
QW44X	4073	£0.74	£0.64	£0.89
QW45Y	4075	£0.74	£0.64	£0.89
QW48C	4081	£0.74	£0.64	£0.89
QW49D	4082	£0.74	£0.64	£0.89
QW47B	4077	£0.74	£0.64	£0.89
QW53H	4093	£0.74	£0.64	£0.89
QW54J	4094	£0.74	£0.64	£0.89
QX29G	4098	£0.74	£0.64	£0.89
N26KU	4502	£0.71	£0.62	£0.86
N44BY	4510	£0.74	£0.64	£0.89
QX31J	4511	£0.74	£0.64	£0.89
QX32K	4518	£0.74	£0.64	£0.89
QW87U	4516	£0.74	£0.64	£0.89
RS48C	4536	£0.71	£0.62	£0.86
QQ47B	4541	£0.71	£0.62	£0.86
RS50E	4543	£0.74	£0.64	£0.89

RS232/233/422

MAX232CPE RS232 Transmitter/Receiver

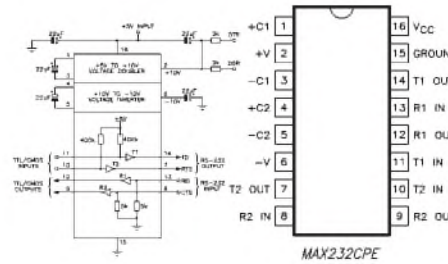

A dual RS-232 receiver/transmitter that meets all the EIA RS-232C specifications while requiring only a single +5V supply. This significantly simplifies system design by removing the need to provide power supply voltages other than +5V. The IC has two on-board charge pump voltage converters which generate +10V and -10V power supplies from the single +5V supply.

The IC contains four level translators, two of which convert TTL/CMOS input levels into ±9V RS-232 outputs ready for transmission, and two of which convert RS-232 inputs to 5V TTL/CMOS levels. The receivers have a nominal threshold of 1.3V, a typical hysteresis of 0.5V, and can operate with up to ±30V inputs.

Characteristics:

Supply voltage	5V ±10%
Output voltage swing	±9V
RS-232 input voltage	±30V max
Propagation delay	0.5µs
Output resistance	300Ω min
RS-232 short circuit current	±10mA

Order Code	Mod: 002383	Price each exc. VAT 1+	inc. VAT each
FD92A	MAX232CPE	£3.07	£3.69

MAX3232CPE 3V/5V RS232 Transceiver

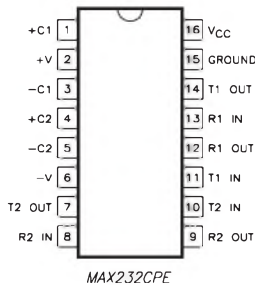

The MAX3232CPE has a proprietary low-dropout transmitter stage enabling true RS232 performance from 3V to 5.5Vdc supplies. The internal power supply consists of a regulated dual charge pump that produces output voltages of +5.5V and -5.5V, from an input voltage range of 3V to 5.5V. Requiring only four 0.1µF external capacitors, for use with the charge pump circuitry, the device is guaranteed to run at data rates of 120kps while maintaining RS232 output levels. The MAX3232CPE has two receivers and two drivers and is ideal for 3.3V systems, mixed 3.3V/5V systems, or 5V systems that require true RS232 performance. The device consumes only 250µA, has a 4V/µs slew rate and is pin and functionally compatible with the industry standard MAX232. Applications include computers, notebooks, palmtops, battery powered equipment, hand-held equipment and peripherals. Supplied in an 18-pin DIP package.

Order Code	Mod: 011979	Price each exc. VAT 1+	inc. VAT each 5+	
DT26D	MAX3232CPE	£4.15	£3.59	£4.99

Voltage Comparator

LM393N



An independent precision voltage comparator designed specifically to operate from a single power supply over a wide range of voltages. Operation from split rails is possible and the low power supply current drain is independent of the magnitude of the power supply voltage. Unique to the LM393 is that the input common-mode voltage range includes ground, even though operated from a single power supply voltage. Designed to directly interface with TTL and CMOS and when operated from a +/- supply will directly interface with MOS logic. The device is similar to the 392, but offers much lower input offset voltage and draws only half the supply current.

Order Code	Mod: 002952	Price each exc. VAT 1+	inc. VAT each
UH30H	LM393N	£0.99	£1.19

LM339N

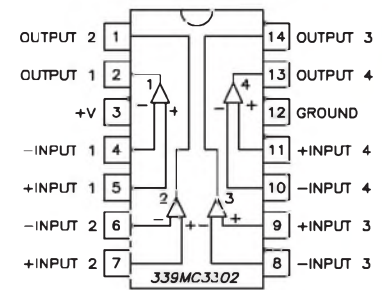

Four independent precision voltage comparators with a typical input offset voltage of 2mV, and designed to operate from a single power supply. The input common-mode voltage range includes ground, even though operated from a single power supply voltage. Identical to the 3302, but offering improved supply voltage range and voltage gain (typically 200). Designed to directly interface with TTL and CMOS and when used with a +/- supply will directly interface with MOS logic, where the low power drain of the LM339 is a distinct advantage over standard comparators.

Order Code	Mod: 002949	Price each exc. VAT 1+	inc. VAT each 5+	
UH31J	LM339N	£0.90	£0.78	£1.09

Power Amps

LM380N

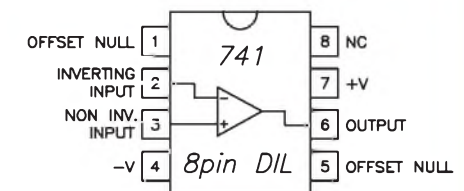

An audio amp in a 14-pin DIP package that requires very few external components to make a complete 2.5W power amplifier. In most cases, however, it is advisable to add a Min Res 2.7Ω and Polyester 0.1µF in series from pin 8 to ground and an Axial 4.7µF from pin 1 to ground.

Order Code	Mod: 002232	Price each exc. VAT 1+	inc. VAT each
QH40T	LM380N	£1.82	£2.19

LM386N-1

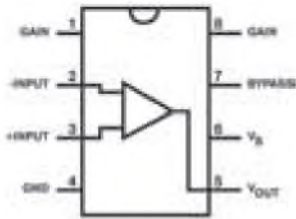

The LM386 is a power amplifier designed for use in low voltage consumer applications...

Specifications:

Table with specifications: Maximum supply voltage: 15Vdc, Quiescent current: 4mA, Output power with 8Ω load: 325mW (6V supply), THD at 125mW with 8Ω load: 0.2% (6V supply), Bandwidth: 300kHz, Input resistance: 50kΩ

Order table for LM386N-1 with columns for Order Code, Mod, Price each exc. VAT, and inc. VAT each.

Microchip PICkit™1

ORDER IN STORE OR ONLINE



- PICkit™1 circuit board with 8-pin PIC12F675
• Breakaway prototype board
• Easy to use PICkit 1 GUI (Graphical User Interface)
• PICkit1 user guide (included on CD-ROM)
• PICkit1 tutorial software for various applications
• MPLAB<->@<->IDE (Integrated Development Environment) software
• Software & hardware "tips & tricks for 8-pin FLASH PIC<->@<-> microcontrollers" handbook
• USB interface cable

Host system requirements: PC compatible system with Intel Pentium® class or higher processor, or equivalent Minimum of 16Mb RAM Minimum of 40Mb of hard disk space CD-ROM drive Available USB port Microsoft Windows®98, Windows NT® 4.0, Windows 2000 or Windows XP Supports 8/14-pin FLASH PICmicro® products

Order table for Microchip PICkit 1 with columns for Order Code, Mod, Price each exc. VAT, and inc. VAT each.

Table with specifications for PIC16F675: Comparators: 1, Timers 8/16-bit: 1/1, Package: 8-pin DIP

PIC16F675



- The 14-pin microcontroller provides the features and intelligence not previously available due to cost and board space limitations
• Ideal for just about any embedded control application

The PIC16F675 microcontroller products merge all the advantage of the mid-range x14 architecture and the flexibility of FLASH program memory into a 14-bit instruction set, small footprint package and a wide operating voltage of 2.0 - 5.5 volts.

Table with specifications for PIC16F675: FLASH (words): 1024, SRAM (bytes): 64, EEPROM (bytes): 128, I/O: 12, 10-bit A/D (ch): 8, Comparators: 1, Timers 8/16-bit: 1/1, Package: 14-pin DIP

Order table for PIC16F675 with columns for Order Code, Mod, Price each exc. VAT, and inc. VAT each.

Microchip Programming Tools

PIC Microcontroller Programmer Kit K8048



- Suitable for programming Microchip2 FLASH PIC™ microcontrollers
• Supports 4 different 300 mil. PICs: 8p, 14p, 18p and 28p
• Test buttons and LED indicators to carry out educational experiments ; includes programming examples
• Easy connection to a PC using the serial port
• software to compile and program your source code is included
• Kit includes a PIC16F627 Flash Microcontroller that can be re-programmed up to 1000 times for experimenting at will

Minimum system requirements: IBM Compatible PC, Pentium or better Windows™ 95/98/ME/NT/2000/XP CD ROM player and mouse Free RS232 port (cable not included) COMPILER / PROGRAM SOFTWARE: controller selection Up to 8 com (RS232) ports Code verify function Possibility to change configuration & IDs More than 19 PIC controllers supported Power supply 12 to 15Vdc, min. 300mA, non-regulated adapter Supports these FLASH PIC12F629, PIC12F675, PIC16F83, PIC16F84(A), PIC16F871, PIC16F872, PIC16F873, PIC16F874, PIC16F876, PIC16F627(A), PIC16F628(A), PIC16F630

Order table for PIC Programmer Kit with columns for Order Code, Mod, Price each exc. VAT, and inc. VAT each.

Microchip PIC Micro Controllers

PIC12C508/509

• The PIC12C509 series fits perfectly in applications ranging from personal care appliances and security systems to low-power remote transmitter/receivers
Table with specifications for PIC12C508/509: Part, Bytes OTP/ RAM, Flash Bytes, I/O Ports, Speed MHz, Packages

Order table for PIC12C509A with columns for Order Code, Mod, Price each exc. VAT, and inc. VAT each.

PIC12F675



The PIC12F675 merge all the advantages of the 12C architecture and the flexibility of FLASH program memory into an 8-pin package. These devices feature a 14-bit instruction set, small package footprint and a wide operating voltage of 2.0 to 5.5 volts.

Table with specifications for PIC12F675: FLASH Words: 1024, SRAM (bytes): 64, EEPROM (bytes): 128, I/O: 6, 10-bit A/D (ch): 4

PIC16F8X

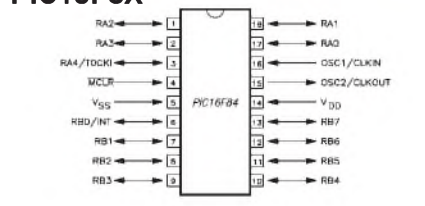

The PIC16F8X fits perfectly in applications ranging from high speed automotive and appliance motor control to low power remote sensors, electronic locks, security devices and smart cards.

Table with specifications for PIC16F84A: Program memory: 1024 words, RAM data: 68 bytes, EEPROM data: 64 bytes, I/O ports: 13, Speed [MHz]: 20MHz, Package: 18-pin DIP

Order table for PIC16F84A with columns for Order Code, Mod, Price each exc. VAT, and inc. VAT each.

PIC16F628-04/P



- Interrupt capability
- 8-level deep hardware stack
- 15 I/O pins with individual direction control
- 16 Bytes of common RAM
- Brown Out Detect (BOD)
- Selectable oscillator options
- Wide operating voltage: 3V to 5.5V

		PIC16F628	
FLASH Program		2048 x 14	
RAM Data		224 x 8	
EEPROM Data		128 x 8	
Order Code	Mod: 029026	Price each exc. VAT 1+	inc. VAT each 5+
RF03D	PIC16F628-04/P	£5.24	£6.29

RF Encoders/Decoders

RF Encoder/Decoder Chipset

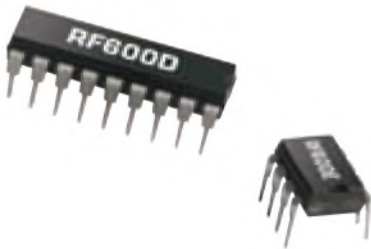

- Highly secure KeeLoq code hopping protocol
 - RF encoder & decoder IC's
 - Can be used with AM or FM radio modules
 - Simple to use, stand alone operation
 - Achieves maximum range from RF modules
 - 1 - 4 switch options (15 states)
 - Decoder digital and serial outputs
 - Led indication of transmission
 - Easy learn feature
 - Up to 50 Transmitters can be learned
 - Optimum range:
 - AM up to 100m
 - FM up to 200m
 - Directly compatible with KeeLoq keyfob encoders
- Typical applications**

- General purpose remote control
- Automotive alarm systems
- Gate and garage openers
- Electronic door locks
- Burglar alarm systems

The RF Solutions RF600E & RF600D are easy to use encoder and decoder I/C's. They have been designed to achieve the maximum possible range from any radio / Infra Red transmitter receiver set

Unlike other encoder /decoder devices the RF600E/600D provide an unprecedented level of security which prevents copying or grabbing whilst also obtaining the optimum range from the transmitter and receiver.

The devices are very easy to use, can be inserted directly into a circuit. The RF600D has an easy learn feature enabling to learn up to 50 unique transmitter encoders. These devices enable a simple but secure remote telemetry application whilst obtaining the maximum range from the radio set.

The Decoder IC may be used with the complete Transmitter Keyfobs, Order Codes RN55K, RN56L & RN57M.

Encoder

20-6.6V operation

Automatic Battery Level Monitor

Manchester modulation

8 pin DIP package

Decoder

18 pin DIP package

4 Digital Outputs (15 States)

Asynchronous serial interface

Low Transmitter Battery Output

4.5V - 5.5V operation

Order Code	Mod: 035636	Price each exc. VAT 1+	inc. VAT each 5+
N49AU	Encoder IC 8Pin PDIP	£2.99	£2.61
NS0AU	Decoder IC 18Pin PDIP	£5.24	£4.53
		£3.59	£6.29

Audio

LM567C0 Audio Video IC

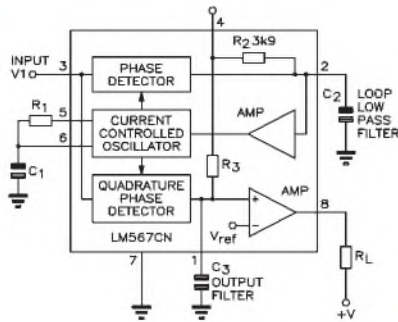
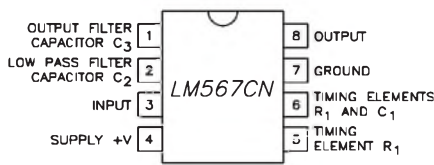

Features:

- Wide frequency range (0.01Hz to 500kHz)
- High stability of centre frequency
- Independently controllable bandwidth (0 to 14%)
- High out-band signal and noise rejection
- Logic compatible output with 100mA current sinking capability
- Inherent immunity to false signals
- Frequency adjustment over a 20 to 1 range with an external resistor

Applications:

- Carrier current remote controls
- Ultrasonic controls (remote TV etc.)
- Communications paging
- Frequency monitoring and control
- Wireless intercom
- Precision oscillator

The LM567C0 is general purpose tone decoder designed to provide a saturated transistor switch to ground when an input signal is present within the passband. The circuit consists of an I and Q detector driven by a voltage controlled oscillator which determines the centre frequency of the decoder. External components are used to independently set centre frequency, bandwidth and output delay.

Characteristics:

Max operating voltage	10V
Positive voltage at input	0.5V above supply
Negative voltage at input	-10Vdc
Output voltage	15Vdc
Operating current range	7mA (12mA activated)

Design Formulae:

$$f_0 = 1.1/R_1 C_1$$

where R1 is between 2kΩ and 20kΩ and f0 is the centre frequency

$$\text{Bandwidth} = 1070(V_i/f_0 C_2)$$

where Vi is the input rms voltage

$$C_3 = 2(C_2)$$

Order Code	Mod: 002716	Price each exc. VAT 1+	inc. VAT each 5+
QH69A	LM567CN	£1.11	£0.97
		£1.34	

LED Driver

LED Driver



An LED driver that will sequentially light ten LEDs when a gradually increasing voltage is applied to pin 5, [dot mode] or in bar mode all LEDs indicating voltages below input are lit. In dot mode there is a slight overlap so that at no point are all LEDs extinguished. A brightness control will set LED current between 2mA and 30mA. The drivers are stackable and displays with 100 or more LEDs are possible. Supply voltage 3V to 18V. The driver that sets the indication points can be referenced to a wide range of voltages. The LM3914 is available with linear steps.

Order Code	Mod: 002909	Price each exc. VAT 1+	inc. VAT each 5+
W041U	LM3914N	£4.07	£3.52
		£4.89	

Maplin TV

Home of innovation, handy tips and How To videos

Visit our channel... youtube.com/maplintv



IC Sockets

Modular Connectors

All dimensions in mm

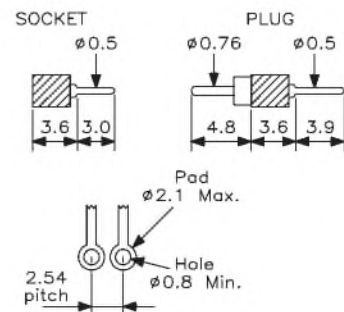

Single row modular 2.54mm pitch sockets and matching plugs, which are intended for mother-daughter board applications. The shrouded socket is fitted with a highly reliable four leaf gold on beryllium copper contact and is also suitable for use with ICs. The un-shrouded tin/lead finished brass plugs are also suitable for cable wiring applications. The 32-way connector strip can be easily cut to size using suitable hand tools. Insulator material: glass filled polyester UL94V-0.

Order Code	Mod: 005348	Price each exc. VAT 1+	inc. VAT each 5+
DC17T	32 Socket Strip	£1.20	£1.04
DC18U	32 Plug Strip	£1.65	£1.43
		£1.44	£1.99

Buy it on the web at maplin.co.uk

Shop for all Maplin products online at our website and check out our latest products and special offers!



Dual-In-Line Sockets

- high quality, low-profile, dual-in-line sockets with black glass-reinforced polyester bodies
- Tin-plated phosphor -bronze contacts
- Contact is made against the flat face of the IC leg for maximum contact area and low insertion pressure
- Sockets may be mounted end to end to achieve longer continuous runs of 2.54mm (0.1in.)
- One end is indented for polarisation



Dimensions:

Pin size 3.3 x 0.6 x 0.15mm
 PCB hole required 0.8mm
 Overall height above PCB: 5.1mm
 Height above PCB to base of IC: 4.1mm
 Distance between sockets (lengthwise): 2.54mm (0.1in.)
 The following types are available:

Type	Pin spacing [mm]	Pin spacing [in.]	Overall length [mm]	Overall length [in.]	Overall width [mm]	Overall width [in.]
6-pin	7.62	0.3	7.62	0.3	10.16	0.4
8-pin	7.62	0.3	10.16	0.4	10.16	0.4
14-pin	7.62	0.3	17.78	0.7	10.16	0.4
16-pin	7.62	0.3	20.32	0.8	10.16	0.4
18-pin	7.62	0.3	22.86	0.9	10.16	0.4
20-pin	7.62	0.3	25.4	1	10.16	0.4
24-pin	15.24	0.6	30.48	1.2	17.78	0.7
28-pin	15.24	0.6	35.56	1.4	17.78	0.7
40-pin	15.24	0.6	50.8	2	17.78	0.7

Order Code	Mod: 002530	Price each exc. VAT 1+	inc. VAT each 5+
CJ79L	DIL Socket 6-Pin	£0.36	£0.44
BL17T	DIL Socket 8-Pin	£0.40	£0.49
BL18U	DIL Socket 14-Pin	£0.49	£0.59
BL19V	DIL Socket 16-Pin	£0.40	£0.49
HQ74H	DIL Socket 18-Pin	£0.57	£0.69
HQ77J	DIL Socket 20-Pin	£0.65	£0.79
BL20W	DIL Socket 24-Pin	£0.40	£0.49
BL21X	DIL Socket 28-Pin	£0.36	£0.44
HQ38R	DIL Socket 40-Pin	£0.65	£0.79

Turned Pins IC Sockets



A range of high quality 200 insertion turned pin DIL IC sockets, for production and replacement use. Manufactured in UL94-V0 filled polyester with beryllium copper contacts. Suitable for end to end and side to side stacking

Specifications:

Contact material: Beryllium copper
 Contact resistance: <4mΩ
 Contact type: Turned pin
 Operating temperature: -55°C to +125°C

Order Code	Mod: 027676	Price each exc. VAT 1+	inc. VAT each 5+
FZ43W	0.3in 6 pin socket	£0.82	£0.99
FZ45Y	0.3in 8 pin socket	£1.15	£1.39
FZ47B	0.3in 14 pin socket	£1.15	£1.39
FZ49D	0.3in 16 pin socket	£1.15	£1.39
FZ51F	0.3in 18 pin socket	£1.07	£1.29
FZ53H	0.3in 20 pin socket	£1.15	£1.39
FZ57M	0.3in 28 pin socket	£1.40	£1.69
FZ63T	0.6in 28 pin socket	£1.07	£1.29

Semiconductor Accessories

IC Pin Straightening Tool



A universal tool for quickly and easily straightening the pins of all sizes of dual in-line ICs. The tool operates like a vice and has two sprung, outer 'jaws' which close upon a centre portion. To use, simply drop the IC pins into the two slots and squeeze both sides of the tool together. The tool is double sided, with the centre portion being 7.62mm (0.3in.) wide on one side for 8, 14, 16, 18 and 20-pin DIL ICs, and 15.24mm (0.6in.) wide for 24, 28, 40, 42 and 48-pin ICs on the other side. To protect CMOS devices, an earth wire may be attached to the screw provided on one face, to neutralise static. Made in moulded black plastic. Dimensions: 81mm long x 37mm wide x 12mm thick

Order Code	Mod: 002553	Price each exc. VAT 1+	inc. VAT each 5+
KU42V	Straightening Tool	£4.99	£4.19

IC Insertion Tool

A high quality tool which makes inserting integrated circuits one simple operation. No more complicated alignment of pins or handling problems



Order Code	Mod: 002558	Price each exc. VAT 1+	inc. VAT each 5+
FR25C	Insertion Tool	£2.49	£2.01

IC Extraction Tool

A pair of plastic-coated, chrome-plated, sprung, steel tweezers with hooked ends for lifting and placing ICs without touching the pins.



Overall length 102mm.

Order Code	Mod: 002555	Price each exc. VAT 1+	inc. VAT each 5+
F054J	Extraction Tool	£2.15	£1.79

Semiconductor Insulators

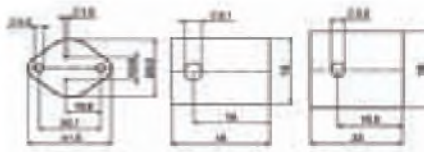

Semiconductor insulating Mica washers that give excellent heat conduction. 3 types are available: T03, TO220 and TOP3

Order Code	Mod: 030387	Price each exc. VAT 1+	inc. VAT each 5+
RN94C	T03 Insulator	£0.53	£0.64
RN96E	TO220 Insulator	£0.57	£0.69
RN97F	TOP3 Insulator	£0.65	£0.79

Bushes for TO220/TOP3 & T03



• A range of three bushes for use with TO220/TOP3 and T03 style cases.

Sold in singles.

Order Code	Case style	Heat resistance
RN91Y	TO220/TOP3	200°C
RN92A	T03	130°C
RN93B	T03	200°C

Order Code	Mod: 030386	Price each exc. VAT 1+	inc. VAT each 5+
RN91Y	Bush TO220/TOP3	£0.49	£0.42
RN92A	Bush T03	£0.49	£0.42
RN93B	Bush T03	£0.49	£0.42

Heatsinks

IC Heatsink 14/16 Pin

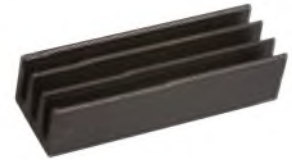

A black anodised finned heatsink for 14/16 pin DIL ICs. The heatsink may be attached using contact adhesive or similar. Heatsink compound should also be utilised. It has a length of 19mm and a temperature rise of 46°C/Watt.

Order Code	Mod: 030375	Price each exc. VAT 1+	inc. VAT each 5+
RN69A	IC Htsk 14/16p 19mm	£1.07	£1.29

DIL IC Heatsinks



A range of black anodised finned heatsinks for 14/16, 24 and 28 pin dual-in-line ICs. Requires no extra board space. The heatsink may be attached using contact adhesive or similar to each end and for best results it should also be smeared with heatsink compound.

Order Code	Length mm	Temperature rise °C/Watt
RN70M	6.3	50
RN71N	33	13
RN72P	37	11.5

Order Code	Mod: 030377	Price each exc. VAT 1+	inc. VAT each 5+
RN70M	IC Htsk 14/16p 6.3mm	£0.99	£0.85
RN71N	IC Heatsink 24 pin	£0.99	£0.85
RN72P	IC Heatsink 28 pin	£0.99	£0.85

Heatsink for T03

A black anodised, staggered vaned heatsink pre-drilled to accept T03 style cases. Temperature rise: 6°C/Watt



Order Code	Mod: 030380	Price each exc. VAT 1+	inc. VAT each 5+
RN74R	T03 Heatsink	£3.24	£3.89

Heatsink for T03, T066, S0T9



Subscribe to our newsletter
 For deals and information
maplin.co.uk



- Large predrilled heatsinks for T03, T066 and similar devices
- Two depth sizes available
- Black anodised aluminium

Specifications		W x H x D (mm)		
RN75		88 x 35 x 37.5		
RN76		88 x 35 x 50		
Order Code	Mod.	Price each exc. VAT 1+	5+	inc. VAT each
RN75S	Htsk T03/66 SOT9	£7.74	£6.49	£9.29
RN76H	Htsk T03/66 SOT9	£6.24	£5.46	£7.49

Heatsink for Case Style T05/T039



Two push-fit, bright aluminium heatsinks for T05/39 style devices.

Order Code	Height mm	Temp. Rise °C/Watt		
RN65V	10	44		
RN66W	8	55		
Order Code	Mod.	Price each exc. VAT 1+	5+	inc. VAT each
RN65V	Htsink T05/39 10mm	£1.07		£1.29
RN66W	Htsink T05/39 8mm	£1.07		£1.29

Twisted Vane Heatsink for T0126

Twisted vane heatsink suitable for one T0126 etc. style device. Base is 19 x 22mm. One hole provided in the centre of 4mm diameter. Height of fins, 19mm. Thermal rating 21° C/W. Black anodised finish.



Order Code	Mod.	Price each exc. VAT 1+	5+	inc. VAT each
JX21X	Vaned Heatsink T0126	£1.82		£2.19

Vertical Twisted Vane PCB Mounting Heatsink

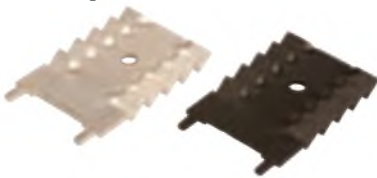

2 low profile, vertical PCB mounting, twisted vane, aluminium heatsinks with a central device fixing hole. Suitable for use with T0220 style semiconductors. RN67X is a push-in version, while RN68Y is solderable

Order Code	Colour	Temp. Rise °C/Watt		
RN67X	black anodised	27		
RN68Y	silver	29.5		
Order Code	Mod.	Price each exc. VAT 1+	5+	inc. VAT each
RN67X	Htsink T0220 pushin	£1.46	£1.26	£1.76
RN68Y	Htsink T0220 Solder	£1.11	£0.97	£1.34

Find out more in-store
Our staff can offer friendly and expert advice; we're here to help



Vaned Heatsink for T0220

- Vaned heatsinks suitable for T0220 style and similar devices
- In black anodised aluminium
- Push in style mounting



Order Code	Mounting Type	Temp. Rise °C/Watt		
RN84F	push-in	20		
Order Code	Mod.	Price each exc. VAT 1+	5+	inc. VAT each
RN84F	Htsink T0220 pushin	£1.74		£2.09



Friendly expert advice on
0333 400 9500

Heatsink for Case Style T0220

Black anodised heatsink with M3 thread for either vertical or horizontal mounting available in 3 different lengths.

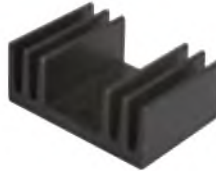

Order Code	Length mm	Temp. Rise °C/Watt	Mounting	
RN77J	20	13.5	horizontal/vertical	
RN78K	35	12	horizontal	
RN79L	50	9.5	horizontal	
Order Code	Mod.	Price each exc. VAT 1+	5+	inc. VAT each
RN77J	Htsk T0220 20mm	£1.65		£1.99
RN78K	Htsk T0220 35mm	£1.65		£1.99
RN79L	Htsk T0220 50mm	£2.07		£2.49

Heatsink for T0220

A black anodised, 35mm long heatsink with an M3 thread for horizontal mounting. Temperature rise: 21°C/W



Order Code	Mod.	Price each exc. VAT 1+	5+	inc. VAT each
RN88V	U-Heatsink T0220	£1.03	£0.90	£1.24

Heatsink for T0126 (SOT32) & T0220

A black anodised, 37.5mm long heatsink with 1 x M3 thread for 1 semiconductor of the case style T0126(SOT32) or T0220. Temperature rise: 5.7°C/W



Order Code	Mod.	Price each exc. VAT 1+	5+	inc. VAT each
RN90X	Htsk T0220 37.5mm	£3.57	£2.99	£4.29

Clip-On T0220 Heatsink

A clip-on black anodised heatsink for vertically mounted T0220 devices, with slotted side vanes. A strong, reinforced clip allows maximum heat transfer and an integral locking tab secures the device in position. Temperature rise in centre of heatsink: 25°C per watt. Dimensions: height 18mm, width 22.86mm, thickness including vanes, 9.52mm



Order Code	Mod.	Price each exc. VAT 1+	5+	inc. VAT each
KU50E	Clip On T0220	£0.99	£0.85	£1.19

Push-Fit Heatsink for T0220

- A black anodised push-fit heatsink for use with T0220 style device cases.



Order Code	Mod.	Price each exc. VAT 1+	5+	inc. VAT each
RN86T	Push-fit T0220 Htsk	£1.90		£2.29

Heatsink for T0220 Style Cases

Black anodised heatsink for T0220 cases which can be fixed using an M3 screw.



Order Code	Mod.	Price each exc. VAT 1+	5+	inc. VAT each
RN87U	T0220 Htsk 25mm	£1.40		£1.69

Universal Vaned Heatsink

A black anodised, staggered vaned heatsink pre-drilled to accept T03, T066, SOT9, SOT32 and T0220 style cases



Temperature rise: 6°C/Watt

Order Code	Mod.	Price each exc. VAT 1+	5+	inc. VAT each
RN73Q	Universal Heatsink	£2.57	£2.22	£3.09

Solderable Heatsink

A powerful versatile and solderable heatsink designed for use with T0202, T0220, T0218 and TOP3 style device packages. As the heatsink is plain undrilled, the device is attached using a retaining clip (order code RN83). This heatsink is available in 3 different lengths.



Order Code	Length mm	Temperature Rise °C/Watt
RN80B	25.4	14

Order Code	Mod.	Price each exc. VAT 1+	5+	inc. VAT each
RN80B	Unvers. Htsk 25.4mm	£2.15	£1.86	£2.59

Universal Heatsink

- A space saving heatsink with 3 x M3 threads (for 3 semiconductors)
- Black anodised and for use with T0220, T0218 (TOP3)
- 94mm long



Order Code	Mod.	Price each exc. VAT 1+	5+	inc. VAT each
RN89W	Unvers.Htsk 94mm	£7.74	£6.69	£9.29

1000's more components available in-store & online

Antistatic

Antistatic Bonding Plug

- Antistatic earth bonding plug
- Ideal for grounding operators and their equipment
- Prevent ESD damage to expensive components
- Earth pin is connected to a 10mm press stud via a 1M Ω resistor
- Used with earth cords such as AS04E or AS06G



Order Code	Mod:	Price each exc. VAT 1+	5+	inc. VAT each
AS38R	Antistatic Earth Plg	£11.65	£9.74	£13.99

Elasticated Anti Static Wrist Strap with Grounding Cable 2.1m



- For use when handling static sensitive devices
- Prevents electrostatic charge from building up
- Elasticated metallic wrist strap
- Flexible coiled ground cord with crocodile clip attached
- 1M Ω resistor in the lead
- Cord measures approximately 50cm when coiled, extends to approximately 2 metres fully uncoiled
- Suitable for wrists from approximately 12cm to 20cm circumference

Order Code	Mod:	Price each exc. VAT 1+	5+	inc. VAT each
N15CH	Elastic Wrist Strap	£10.82	£8.99	£12.99

Anti Static Computer Wrist Strap with Grounding Cable

- Fully adjustable wrist strap with hook and loop fixing
- Easily managed 2 m cord with 4 mm plug and croc clip fixing
- Band resistance of $10^5 - 10^9 \Omega$
- Core fitted with 1M Ω resistor
- Clip to a known good earth or ESD point



Use to remove potentially damaging static charges when handling sensitive electronics.

Order Code	Mod:	Price each exc. VAT 1+	5+	inc. VAT each
ZT91Y	Anti Stat Wrist Strp	£6.24	£5.24	£7.49

Retractable Anti Static Wrist Strap with Grounding Cable 2m

- Protect against static damage to CMOS and other sensitive devices
- Fabric strap woven with conductive threads press against the skin
- Curly cord is terminated with 1M Ω resistor
- Pull the strap to the desired tightness and lock with the clip
- Band resistance: $10^5 - 10^9 \Omega$



Specifications
Material: Acetate fibre

Size	230 x 20mm
Fits wrists from	160 to 200mm circumference
Cable length retracted	430mm (extended: 2m)
Current limiting resistor	1M Ω moulded into
Net weight	22g
Net weight	22g

Order Code	Mod:	Price each exc. VAT 1+	5+	inc. VAT each
FE29G	ESD Wrist Strap	£7.41	£5.99	£8.90

Coiled Earth Cords



- Extremely flexible coiled ground cords for earthing an operator to an antistatic mat or earth plate
- AS04E has 10mm female press studs at each end, which incorporate a 2.2M Ω resistor and strain relief
- AS06G has a 10mm press stud incorporating a 4.4M Ω resistor at one end and a banana plug at the other, fitted with a removable crocodile clip

Order Code	Mod:	Price each exc. VAT 1+	5+	inc. VAT each
AS04E	Antistatic Cord	£6.65	£5.69	£7.99
AS06G	Antistatic Cord 4M4	£9.15	£7.91	£10.99

Field Service Engineer's Kit 595 mm x 595 mm

ORDER IN STORE OR ONLINE



Now a BT approved kit, this portable Static Dissipative Work Station provides a safe working area for use primarily by field service, computer hard-ware and telecom engineers who require a compact, lightweight work surface which can easily be used when working on equipment and/or printed circuit boards which incorporate static sensitive devices and components. The mat has two pockets which enable small tools, components and boards, wrist-straps, coiled cords, bonding plugs, etc. to be stored within the kit. The material from which the kit and pouch are constructed is a tough lightweight material which has the following specifications

1 x mat and carry pouch	
1 x adjustable wrist strap	
1 x coily ground cord	AS04E
1 x straight earth connector	
1 x straight earth connector	
1 x ESP bonding plug	AS38R
1 x conductive tweezers	
Specification (mat and pouch):	
Surface resistivity:	$10^9 \Omega$
Charge decay	<2s (5kV to 37V)
Tensile strength	1.4KN
Elongation at break	20%
Tear strength:	38N
Dimensions	
Mat open:	595 x 595mm
Mat pocket:	200 x 285mm
Pouch	350 x 180mm

Order Code	Mod:	Price each exc. VAT 1+	5+	inc. VAT each
JA62S	Field Service Kit	£41.65	£35.99	£49.99

Conductive Foam Pad 40 mm x 40 mm



- Protect static sensitive IC's and CPU's
- Ideal medium to store static sensitive devices during re-work
- Supplied in a pack of two

Order Code	Mod:	Price each exc. VAT 1+	5+	inc. VAT each
N91HY	Conduct Foam 4x4 cm	£1.49	£1.11	£1.79

Anti Static Metallised Bag 150mm x 250mm



- Medium size ideal for some computer cards and pcb assemblies
- Metallised film to reduce ESD damage
- Ideal for preventing localised charges from damaging sensitive components
- 15cm by 25cm

Order Code	Mod:	Price each exc. VAT 1+	5+	inc. VAT each
N89HY	ESD Shield Bag 15x25	£1.24	£0.96	£1.49

Anti Static Metallised Bag 300mm x 300mm



- Large size ideal for some computer motherboards and pcb assemblies
- Metallised film to reduce ESD damage
- Perfect in preventing localised charges from damaging sensitive components
- 30cm by 30cm

Order Code	Mod:	Price each exc. VAT 1+	5+	inc. VAT each
N88HY	ESD Shield Bag 30x30	£1.40	£1.11	£1.69

Buy it on the web at maplin.co.uk

Shop for all Maplin products online at our website and check out our latest products and special offers!



Switches

Control Stations

Emergency Stop Control Stations



- EN418 fail safe stop switches
- High visibility yellow cover on a black base
- Sealed up to IP56 rating
- M20 cable knock-outs
- Robust ABS plastic construction
- Twist to release and key to release versions
- Compatible with DIN rail and flange brackets (sold separately)
- Key switch comes with 2 keys

Specifications

Contact rating	AC12 Resistive / AC15 Electromagnetic
	240V [3A] / 415V [1.5A]
Mechanical life	1 million operations
Contact material	Silver Bifurcated and serrated
Operating Temperature	10 to +65°C
Dimensions [mm]	73x80x83

Order Code	Mod: 787711	Price each exc. VAT	inc. VAT each
		1+	5+
N200Q	Emerg Stop Station	£12.49	£10.79
N210Q	Emerg Stop Key Stn	£15.82	£13.67

Hylec APL Emergency Start/Stop Control Station Yellow/Black Version



- Control station with start and emergency stop button
- High visibility yellow top case on a black bottom
- Meets EN418 fail safe operation for stop function
- Green actuator for start function
- Sealed IP56 rated enclosure with M20 cable knock-outs
- Robust ABS plastic construction
- Upgrade or repair machine equipment switching systems
- Compatible with DIN rail and flange brackets (sold separately)

Specifications

Contact rating	AC12 Resistive / AC15 Electromagnetic
	240V [3A] / 415V [1.5A]
Mechanical life	1 million operations
Contact material	Silver Bifurcated and serrated
Operating Temperature	10 to +65°C
Dimensions [mm]	106x80x83

Order Code	Mod: 787717	Price each exc. VAT	inc. VAT each
		1+	5+
N300Q	Emerg Start/Stop Stn	£22.49	£18.74

Switching Control Stations

- Grey top cover on a black base
- Sealed IP rated enclosure with M20 cable knock-outs
- Robust ABS plastic construction
- Red stop, green start, selector and key selector versions
- Upgrade or repair machine equipment switching systems
- Add safety control to machine systems
- Compatible with DIN rail and flange brackets (sold separately)
- Key switch comes with 2 keys



Specifications

Contact rating	AC12 Resistive / AC15 Electromagnetic
	240V [3A] / 415V [1.5A]
Mechanical life	1 million operations
Contact material	Silver Bifurcated and serrated
Operating Temperature	10 to +65°C

	Type	IP Rating	Dimensions (mm)
N220Q	Red button	IP66	73x80x63
N240Q	Green button	IP66	73x80x63
N250Q	Selector knob	IP56	73x80x78
N260Q	Key selector	IP56	73x80x73

Order Code	Mod: 787713	Price each exc. VAT	inc. VAT each
		1+	5+
N220Q	Stop Switch Station	£11.65	£13.99
N240Q	Start Switch Station	£12.49	£14.99
N250Q	Selector Sw Station	£12.49	£14.99
N260Q	Key Select Station	£19.15	£22.99

Large Palm/Foot Operated Switch

- Large 95mm diameter button
- IP66 rated switch control station
- Made with robust ABS plastic
- Operated with the palm or foot
- Compatible with flange and DIN rail mounting brackets sold separately
- Red, green and black versions available
- Used to add high visibility stop/start switching for machine operation
- Can be used as props in theatre, plays or in special effects
- Compatible with DIN rail and flange brackets (sold separately)



Specifications

Contact rating	AC12 Resistive / AC15 Electromagnetic
	240V [3A] / 415V [1.5A]
Mechanical life	1 million operations
Contact material	Silver Bifurcated and serrated
Operating Temperature	10 to +65°C
Dimensions [mm]	85x85x103 [button dia. 90mm]

Order Code	Mod: 787715	Price each exc. VAT	inc. VAT each
		1+	5+
N270Q	Palm/Foot Switch Red	£24.99	£21.59
N280Q	Palm/Foot Switch Blk	£24.99	£21.59
N290Q	Palm/Foot Switch Grn	£24.99	£21.59

Switches for Control Stations

ORDER IN STORE OR ONLINE

- Switch inserts for control stations
- Build switch arrays to suit specific needs
- Repair faulty control stations



- 22mm cut-out
- Key switch comes with 2 keys

Specifications

Contact rating	AC12 Resistive / AC15 Electromagnetic
	240V [3A] / 415V [1.5A]
Mechanical life	1 million operations
Contact material	Silver Bifurcated and serrated
Operating Temperature	10 to +65°C

	Type	IP Rating	Dimensions [mm]
N330Q	EN418 Stop	IP56	30x45x80 [button dia. 40mm]
N340Q	EN418 Key Stop	IP56	30x45x70
N350Q	Momentary, flush green	IP66	30x45x60
N360Q	Momentary, flush green	IP66	30x45x60
N370Q	Momentary, flush black	IP66	30x45x60
N380Q	2 position selector	IP56	30x45x75

Order Code	Mod: 787724	Price each exc. VAT	inc. VAT each
		1+	5+
N380Q	2 Pos Selector Sw	£6.65	£5.75
N370Q	Flush Mom Black Sw	£6.65	£5.75
N360Q	Flush Mom Red Switch	£6.65	£5.75
N350Q	Flush Mom Green Sw	£6.65	£5.75
N340Q	Stop Key Button	£10.82	£9.35
N330Q	Stop Button	£8.32	£7.19

Pre-punched Control Station Enclosure

ORDER IN STORE OR ONLINE

- Robust ABS enclosures for mounting 22mm switches
- High visibility yellow top case on black bottom
- Build bespoke control stations
- M20 knock-outs
- Supports IP67 rating with suitable switch
- Pre-punched with mounting holes



	Colour	22mm holes
N390Q	Yellow case top	1 73x80x53
N400Q	Yellow case top	2 106x80x53
N410Q	Grey case top	1 73x80x53
N420Q	Grey case top	2 106x80x53

Order Code	Mod: 787722	Price each exc. VAT	inc. VAT each
		1+	5+
N390Q	Ye/Blk 1 Hole Box S	£6.65	£7.99
N400Q	Ye/Blk 2 Hole Box L	£8.32	£9.99
N410Q	Gry/Blk 1 Hole Box S	£6.65	£7.99
N420Q	Gry/Blk 2 Hole Box L	£7.49	£8.99

Control Station Mounting Brackets

ORDER IN STORE OR ONLINE

- Externally fitted mounting brackets for switch station enclosures
- Manufactured from strong black ABS plastic
- Allows mounting of enclosure without drilling and breaching IP rating
- Flange mounting version N310Q
- DIN rail mounting version N320Q
- Supplied in pairs



Order Code	Mod: 787720	Price each exc. VAT	inc. VAT each
		1+	5+
N320Q	Box Din Bracket Black	£1.65	£1.99
N310Q	Box Wall Bracket Black	£1.07	£1.29

Buying for business?
0333 400 9740



Toggle Switches

Ultra Miniature Toggle Switches



- A range of ultra miniature toggle switches
- Chrome plated brass dolly
- Rated 3A, AC 125V or 1A, AC 250V
- Rated 3A, DC 12V
- Mounting hole: 5.2mm (0.2in.)
- Available in SPST, SPDT and DPDT types

Specification:

Insulation resistance:	>100M Ω	
Contact resistance:	<20m Ω	
Dimensions	Single-pole	Double-pole
Body	8 x 5 x 7mm	8 x 9 x 7mm
Bush length	5.6mm	5.6mm
Tag length	5mm	5mm

Order Code	Mod: 002340	Price each exc. VAT 1+	5+	inc. VAT each
FH97F	SPST Ultra Min Toggle	£2.07	£1.79	£2.49
FH98G	SPDT Ultra Min Toggle	£2.07	£1.79	£2.49
FH99H	DPDT Ultra Min Toggle	£1.99	£1.72	£2.39

Sub-Miniature Toggle Switches



- A range of toggle switches in SPDT and DPDT with a variety of switching actions
- Switches have chrome-plated brass dolly and silver-plated contacts

Rated:	2A	AC 250V
	5A	AC 125V
	5A	DC 30V

Contact resistance:	<20M Ω
Insulation resistance:	>100M Ω
Life:	50,000 make/break cycles at full load

Dimensions(HxLxW)	29.4 x 12.7 x 11.4cm
Mounting hole:	6.35mm [dia.]

Single-pole double-throw (SPDT) types are available in the following switching actions

Type	Action	Description
A	ON-ON	Locking, both ways
B	ON-OFF-ON	Locking both ways, centre off
C	ON-OFF-(ON)	Locking one way, non-locking one way, centre off

Double-pole double-throw (DPDT) types are available in the following switching actions:

Type	Action	Description
E	ON-ON	Locking both ways
F	ON-OFF-ON	Locking both ways, centre off
G	ON-OFF-(ON)	Locking both ways, None locking one way, Centre off
H	(ON)-(OFF)-(ON)	Non-locking both ways, centre off

Order Code	Mod: 002341	Price each exc. VAT 1+	5+	inc. VAT each
FH00A	Sub-Min Toggle A	£2.32	£2.01	£2.79
FH01B	Sub-Min Toggle B	£2.32	£2.01	£2.79
FH02C	Sub-Min Toggle C	£2.24	£1.94	£2.69
FH03D	Sub-Min Toggle D	£2.24	£1.94	£2.69
FH04E	Sub-Min Toggle E	£2.32	£2.01	£2.79
FH05F	Sub-Min Toggle F	£2.32	£2.01	£2.79
FH07H	Sub-Min Toggle H	£2.24	£1.94	£2.69

Toggle Switch 4PDT

- 4 pole changeover toggle switch
- Chrome plated brass dolly, silver plated contacts



Specifications

Body	13 x 22.8 x 12.3mm
Bush length:	8mm
Dolly length:	12mm
Tag length:	4mm
3A	250Vac
6A	125Vac

Order Code	Mod: 002343	Price each exc. VAT 1+	5+	inc. VAT each
FH08J	4-Pole 5M Toggle	£3.32	£2.87	£3.99

IP67 Sealed Toggle Switch

- IP67 sealed toggle switch
- DPDT ON-ON action
- Brass, black finish toggle complete with 'O' ring seal
- Solder terminals sealed with epoxy for maximum ingress protection
- 5A @ 125VAC or 28VDC



Order Code	Mod: 518485	Price each exc. VAT 1+	5+	inc. VAT each
N25KA	IP67 Toggle DPDT	£5.82	£5.03	£6.99

DPDT Toggle Switch

A standard DPDT toggle switch rated 2A 250Vac, 6A 125Vac. Supplied with on/off plate.



Body size:	27.5 x 17 x 14.5mm high
Tag length:	5.5mm
Bush:	M12 x 8.5mm long
Dolly:	14mm long, 5mm dia
Panel cut-out:	12.7mm dia.
Contact resistance:	<50m Ω
Insulation resistance:	>100M Ω
Life:	>20,000 make/break cycles at full load

Order Code	Mod: 002355	Price each exc. VAT 1+	5+	inc. VAT each
FH39N	Toggle Sw	£2.32	£2.01	£2.79

10A Toggle Switches



- Large robust heavy duty toggle switches
- Chrome plated dolly
- 6.35mm spade connections
- Available in a choice of different actions
- SPST, SPDT, DPDT, momentary and centre off types

Rated:	10A	250Vac
	15A	125Vac
Contact resistance:	<50m Ω	

Insulation resistance: >100M Ω

Life: >50,000 make/break cycles at full load

Single pole types

Body size:	29.2 x 15.8 x 17.5mm high
Tag length:	11mm
Bush:	M12 x 11.5mm long
Dolly:	16.5mm long x 6mm dia
Panel cut-out:	12.7mm dia

Double pole types

Body size:	32.5 x 19.5 x 20mm high
Tag length:	11mm
Bush:	M12 x 11.5mm long
Dolly:	16.5mm long x 6mm dia
Panel cut-out:	12.7mm dia

Type	Action	Description
SPST	ON-OFF	Single-pole locking, 2-pin
SPDT-A	ON-CN	Single-pole locking, 3-pin
SPDT-B	ON-OFF-ON	Single-pole locking, 3-pin, centre off
DPST	ON-OFF	Double-pole locking, 2-pin
DPDT-E	ON-CN	Double-pole locking, 3-pin
DPDT-F	ON-OFF-ON	Double-pole locking, 3-pin, centre off
DPDT-Mom	(ON)-(OFF)-(ON)	Double-pole momentary, centre off

Order Code	Mod: 002360	Price each exc. VAT 1+	5+	inc. VAT each
JK25C	10A Toggle SPST	£3.07	£2.46	£3.69
JK27E	10A Toggle SPDT A	£2.99	£2.58	£3.59
JK28F	10A Toggle SPDT B	£2.99	£2.58	£3.59
JK26D	10A Toggle DPST	£2.99	£2.58	£3.59
JK29G	10A Toggle DPDT E	£3.07	£2.49	£3.69
JK30H	10A Toggle DPDT F	£3.07	£2.49	£3.69
N41KR	15A Toggle DPDT Mom	£2.99	£2.58	£3.59

Missile Style Toggle Switch Cover

- Military-style missile switch cover
- Features a red, heavy-duty hinged, spring-return protective cover
- Offers protection against accidental switching of equipment
- Fits onto heavy duty toggle switches with a 12mm mounting hole



Order Code	Mod: 037319	Price each exc. VAT 1+	5+	inc. VAT each
N42AT	Toggle Switch Cover	£3.32	£2.87	£3.99

Sub-Miniature Toggle Switch Cover

- Suitable for sub-miniature toggle switches
- Integral thread for quarter, -40 UNF mounting bushes
- Fits our range of 'Sub-miniature' switches
- Offers splash proof solution when included O ring is fitted correctly



Order Code	Mod: 002348	Price each exc. VAT 1+	5+	inc. VAT each
JR79L	Small Toggle Cover	£1.90	£1.65	£2.29

Large Toggle Switch Cover

- Flexible black PVC boot switch cover
- Integral nut to suit M12 based toggle switches, e.g FH39N
- Splash proof solution when fitted correctly



A black flexible PVC boot with integral nut to suit an M12 thread, e.g FH39N. The cover is splashproof

IP65 Rated Illuminated DPST Rocker Switch

- A Range of large, illuminated DPST rocker switches
- Ideal protections against liquid and dust to IP65 without additional caps
- Connection is made by 6.35mm terminals
- Range includes mains and 24V illumination for Red and Green, mains lit blue and non illuminated black



N55KA Red [24V Illumination]
N56KA Green [24V Illumination]

Specifications:

Rating: 16A, 250Vac resistive
8A, 250Vac motor
Bezel size: 36.6mm x 29.9mm
Panel cut-out: 30mm x 22mm
Length behind bezel: 25.7mm (including terminals)
Standards: EN61058
UL 1054
C 22.2 n° 55-1986

Order Code

N32BQ Red
N33BQ Green
N36CF Blue
N37CF Non illuminated white text on black body

Order Code	Mod: 043595	Price each exc. VAT	inc. VAT each
		1+	5+
N32BQ	IP65 III R/Switch Rd	£3.07	£3.69
N33BQ	IP65 III R/Switch Gn	£2.99	£3.59
N36CF	IP65 III Switch Blue	£2.90	£3.49
N56KA	IP65 24V II Green Sw	£2.90	£3.49
N55KA	IP65 24V III Red Sw	£2.82	£3.39
N37CF	IP65 III Switch Black	£2.90	£3.49

Miniature 6A AC 230V Rocker Switch DPDT

- A very attractive single hole fixing miniature rocker switch available in DPDT
- The switch has a red rocker in a matt finish black frame



Rating: 10A @ AC 125 V, 6A @ AC 250 V
Contact resistance: <20mΩ
Panel cut-out: 18.2mm diameter
Overall depth behind front of panel: 14mm
Overall height in front of panel: 12mm (including rocker)
7.5mm (frame only)
Frame size: 33 x 20mm

Order Code	Mod: 002365	Price each exc. VAT	inc. VAT each
		1+	5+
YX65V	Min Rocker DPDT	£1.74	£2.09

Push Switches

Two Pole Push-Button Switch



- Push-on/push-off locking action
- Wire detent used to select desired operation
- 6 mm square button end for cap
- PCB pins or solder tags
- Contact rating 0.5 A DC 50 V
- Requires a 7.5 mm diameter round cut out

Order Code	Mod: 002596	Price each exc. VAT	inc. VAT each
		1+	5+
FH67X	Latchswitch 2-Pole	£0.11	£0.14

Sub-Miniature Push-to-Make Switch



- A sub-miniature push-to-make switch with non locking action
- Available with red and black actuating button
- Dimensions: 20.5mm(l), 7mm (dia.)
- Rated 0.5A AC 125 V
- Panel cut-out 5.2mm diameter

Order Code	Mod: 002492	Price each exc. VAT	inc. VAT each
		1+	5+
JM01B	Sub Min Push Sw Blk	£1.24	£1.49
JM47B	Sub Min Push Sw Red	£1.24	£1.49

Push-to-Make



Low Cost push to make switch non locking. Available with red or black buttons. Overall size 28mm long, 10.5mm dia. Rated 1A 125Vac. Panel cut-out 7mm dia. Miniature low cost

Order Code	Mod: 002493	Price each exc. VAT	inc. VAT each
		1+	5+
FH59P	Red Push to Make Sw	£1.90	£2.29
ND91Y	Blk Push to Make Sw	£1.57	£1.89

Push-to-Break



- Push-to-break switch
- Available with red or black buttons
- Rated 300mA @ AC 250V

Order Code	Mod: 002494	Price each exc. VAT	inc. VAT each
		1+	5+
FH60Q	Blk Push to Break Sw	£1.57	£1.89
ND92A	Red Push to Break Sw	£1.57	£1.89

50V 1A Large Push-to-Make Switch

- Large red dimpled button and smart chromed bezel
- Action is non-locking push-to-make single pole
- Panel fixing requires 12mm diameter cut-out
- Rated 1A at AC50V



Order Code	Mod: 002495	Price each exc. VAT	inc. VAT each
		1+	5+
FH91Y	Lrg Push-to-Make Sw	£1.90	£2.29



We can deliver to your home or office

(UK only)

Square Push-Button Switches

- Push button switch with silver coloured bezel and button
- SPST with solder terminals
- Locking and non-locking versions available
- 250Vac 1A or 125Vac 3A
- Supplied with nut and lock washer



Dimensions
Bezel 14 x 14mm
Button 10 x 10mm
Cut-out 10mm
Depth from panel 20mm

Order Code	Mod: 002504	Price each exc. VAT	inc. VAT each
		1+	5+
FG46A	PB Silver Alternate	£1.99	£2.39
FG45Y	PB Silver Momentary	£2.07	£2.49

Table Light Switch

- A small push locking switch featuring a white cap and plunger
- Can be used to switch small loads such as lighting
- Ideal to repair or to add a switch an existing lamp



Specifications:
Panel cut-out: 10mm
Max panel thickness: 4mm
Switch body dimensions: 23 x 13 x 8mm
Total Height (mm): 28mm
Rated: 2A at 250Vac
2A at 125Vdc

Order Code	Mod: 002329	Price each exc. VAT	inc. VAT each
		1+	5+
FH94C	Table Light Switch	£1.74	£2.09

Locking Push Switch

Attractive push on, push off locking switch with a large round button in a square bezel. Available with red, green or black buttons in a black bezel.



Specifications:
Rating: 1.5A 250Vac
Bezel size: 18 x 18mm
Button diameter: 12.8mm
Panel cut-out: 15mm diameter
Length behind bezel: 18mm (excluding solder terminals)
Solder terminals: Silver plated Brass

Order Code	Mod: 034857	Price each exc. VAT	inc. VAT each
		1+	5+
N98AQ	Red Lock Push Switch	£2.15	£2.59
N99AQ	Grn Lock Push Switch	£2.15	£2.59
N00AR	Blk Lock Push Switch	£2.15	£2.59

Push-to-Make Switch

- Attractive push-to-make switch with a large round button in a square bezel
- Available with red, green or black buttons in a black bezel



Specifications:
Rating: 1.5A AC 250V
Bezel size: 18 x 18mm
Button diameter: 12.8mm
Panel cut-out: 15mm diameter
Length behind bezel: 18mm (excluding solder terminals)
Solder terminals: Silver-plated brass

250Vac 3A Momentary Action Foot Switch

Hard wearing push to make SPDT switch with strong metal shaft & knob suitable for use as a foot operated switch.

Specifications:

Rating	250Vac 3A
Contacts	Silver solder tags
Body size	13 x 13 x 4 x 13mm
Bush & knob length	20.5mm
Panel cut-out	12mm

Order Code	Mod.	Price each exc. VAT	inc. VAT each
N85AR	SPDT Mom Foot Sw	£4.15	£3.59



Tactile Switches

- A range of small tactile switches of varying sizes
- PCB mount click-effect switches
- Positive click action
- Single pole, push-to-make non locking

Specifications

Rating	12VDC 50mA	
Max contact resistance (<100mA)	100mΩ	
Operating force	160gf	
Operating temperature	-16°C to +63°	
Solder temperature	260 ±5°C	
Dimensions	Body (mm)	Stem Length
KR88	6 x 6	4.3mm
KR89	6 x 6	5mm
KR90	6 x 6	9.5mm
KR91	6 x 6	7mm
KR92	12 x 12	4.3mm

Order Code	Mod.	Price each exc. VAT	inc. VAT each
KR88V	Switch 105	£1.15	£1.00
KR89W	Switch 105A	£1.15	£1.00
KR90X	Switch 105B	£1.15	£1.00
KR91Y	Switch 105T	£1.15	£1.00
KR92A	Switch 12F	£1.15	£1.00



Click-Effect Push Switch

- Small PCB push switch with smooth action
- Finished in a matt blue colour
- Single pole push to make, non locking
- Each contact is connected to two pins for ease of track layout

Specifications:

Contact resistance:	>50mΩ
Bounce:	1ms
Insulation resistance:	>10⁵>5⁵>MΩ
Life:	500,000 operations
Inter-contact capacity at 1MHz:	<1pF
Key travel:	0.8mm
Size of button:	7.7 x 7.7mm
Height of button:	4mm
Overall diameter:	11.5mm
Overall height from pcb:	10.8mm
Pin length:	2.8mm
Pin diameter:	0.8mm
Pin spacing:	5 x 5mm

Order Code	Mod.	Price each exc. VAT	inc. VAT each
FF87U	Click Switch	£1.15	£1.00



Square Locking Switch

- Push-to-make locking switch with large square button
- Rated 3A @ AC 250V
- Available in black and red

Specifications:

Panel cut-out	12.2mm diameter
Overall length:	39mm
Length behind bezel	29mm
Button	10mm²²
Bezel	14mm²²

Order Code	Mod.	Price each exc. VAT	inc. VAT each
YW41U	Square Psh Lck Black	£2.07	£1.79
YW43W	Square Psh Lck Red	£2.07	£1.79



Large Red Push Button

- Large SPST push button
- Non latching in red
- 16 A / AC 250 V
- Snap-in fixing for between 0.7 mm and 2.5 mm
- 6.35mm terminals
- 25 mm diameter cut out

Order Code	Mod.	Price each exc. VAT	inc. VAT each
RK82D	Lqe Red Push Button	£2.24	£2.69



Vandal Resistant Switches

Vandal Resistant Switch

- Robust push to make switch for high impact or vandal resistant applications
- Stainless steel button with a Brass, Chrome plated body
- Screw terminals
- Slow momentary SPNO operation

Diameter	22mm
Cut out	19.2mm

Specifications:	
Operating temperature	-20 to +85°C
Contacts	Silver plated copper
Rating:	1A 50V

Order Code	Mod.	Price each exc. VAT	inc. VAT each
M674R	Vandal Res Switch	£4.57	£5.49



Sealed Vandal Resistant IP68 Switch

- Robust push to make switch for high impact or vandal resistant applications
- Sealed to IP68 for external applications EN60529 1992 [Terminals not sealed]
- Stainless steel button with a Brass, Silver plated body
- Screw terminals
- SPNO momentary action

Specifications:	
Operating temperature	-20 to +85°C
Contacts	Silver plated copper
Diameter	21.5mm
Cut out	19.2mm
Rating:	1A 50V
Contacts	Silver plated copper

Order Code	Mod.	Price each exc. VAT	inc. VAT each
M675S	Vand Res Switch IP68	£4.99	£5.99



Large Anti-Vandal Push Switch

- High quality, big button anti-vandal switch
- Push to make action
- Perfect for applications where abuse could occur or where the installation demands a robust switch
- Brass/nickel plated with screw terminal connections
- 2A @ 48VDC or 125VAC

Max. rating	2A / 48VDC
Operating Temperature	-20 to 50°C
Contacts:	Silver plated
Panel cut-out:	22mm dia

Order Code	Mod.	Price each exc. VAT	inc. VAT each
N36KA	Lq Vandal Switch	£4.15	£3.44



Slide Switches

Double Pole Sub Miniature

A sub miniature DPDT slide switch with wiring tags.



Order Code	Mod.	Price each exc. VAT	inc. VAT each
FH35Q	Sub-Min Slide	£1.57	£1.89

125V 0.3A DPDT Sub-miniature slide switch Double Pole Chrome Tang

A sub-miniature DPDT slide switch with wiring tags and a long tubular turned aluminium tang



Dimensions	
Body	15 x 7 x 7.5mm
Front plate	23 x 7mm
Tang:	13.5mm long (throw 3.5mm)
Tags:	3mm long x 1.8mm wide
Fixing centres	19mm x M2 tapped

Order Code	Mod.	Price each exc. VAT	inc. VAT each
FF79L	Long Chrome Slide	£1.82	£2.19

Double Pole Miniature

A miniature DPDT slide switch with wiring tags.



Front plate:	35 x 12.5mm
Tang:	10mm long (throw 5.5mm)
Tags:	5mm long x 2.5mm wide
Fixing centres:	28mm x M3 tapped
Ratings:	125Vac 0.3A

Order Code	Mod.	Price each exc. VAT	inc. VAT each
FH36P	Std Slide Switch	£1.82	£1.58

[Browse our entire range at maplin.co.uk](http://maplin.co.uk)

Single Pole Sub Miniature

Sub-miniature SPDT slide switch suitable for use as replacements in calculators, clocks etc. Can be PCB mounted.

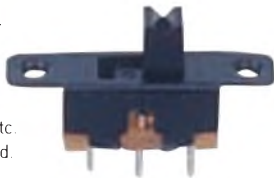

Dimensions: Body: 11 x 5 x 6mm
Front plate: 19 x 5mm
Tang: 3.8mm long (throw 3mm)
Tags: 4mm long x 1.5mm wide
Fixing centres: 15mm x M2 tapped
125Vac 0.3A

Order Code	Mod: 002476	Price each exc. VAT 1+	inc. VAT each 5+
FF77J	SP Slide	£1.90	£2.29

Key Switches

0.5A Miniature Round Type

A single-pole make/break, metal-bodied key switch with a chrome-plated bezel. The key switch uses a round key for extra high security. The switch has two solder buckets at the rear. Supplied with two keys. The key may be withdrawn in either position.



Specifications:
Bezel diameter: 15mm
Panel cut-out: 12mm (the bush is flattened to 10.25mm on opposing sides to prevent twisting)
Bush length: 20mm
Indexing: 90°
Contact rating: 0.5A at 250V AC

Order Code	Mod: 002441	Price each exc. VAT 1+	inc. VAT each 5+
FE44X	Min Key Switch	£2.24	£2.69

0.5A SPST Miniature Short Round Type

A single-pole, single-throw, short, zinc-alloy bodied key switch with a chrome-plated bezel. The key switch uses a round key for extra security. The switch position is indicated by an arrow, the key can be withdrawn from either position. The switch has two solder bucket terminals at the rear. Supplied with two keys.



Specifications:
Bezel diameter: 15mm
Panel cut-out: 12mm dia, 10.8mm across the flats [provided to prevent twisting]
Bush length: 10.3mm
Indexing: 90°
Contact rating: 1A 125Vac
0.5A 250Vac

Order Code	Mod: 002445	Price each exc. VAT 1+	inc. VAT each 5+
CJ92A	Min Round Key Sw	£2.90	£3.49

2A DPST Metal Body Round Type

A top quality, double-pole, single-throw, key switch having a zinc-alloy die-cast housing and cylinder with a chrome plated bezel. The key switch uses a round key for extra security, the key can be withdrawn from either position. The radial cylinder has a seven-pin tumbler mechanism, deterring lock-picking and providing a wide range of key differences. Random supply from 50,000 different combinations. Ideal for alarm and security systems. The switch has four solder tags at the rear. Supplied with two keys.



Specifications:

Bezel diameter: 22mm
Panel cut-out: 19mm dia, 15.8mm across the flats [provided to prevent twisting]
Bush length: 25.5mm
Indexing: 90°
Contact rating: 4A 125Vac
2A 250Vac

Order Code	Mod: 002449	Price each exc. VAT 1+	inc. VAT each 5+
CJ96E	Metal DPST Round Key	£2.90	£3.49

SPST Metal Body

A top quality, single-pole, single-throw, key switch with a zinc-alloy die-cast housing and cylinder with a chrome-plated bezel. The cylinder has a five-disc tumbler mechanism, with dust shutter, to deter lock-picking; the reversible key can be withdrawn from either position. Ideal for burglar alarms and security systems. The switch has two solder bucket terminals at the rear. Supplied with two keys with a range of 150 combinations.



Specifications:

Order Code	Mod: 002455	Price each exc. VAT 1+	inc. VAT each 5+
CJ98G	Metal Key SPST Sw	£2.99	£3.59

19mm Key Switch Cover

- Chrome-plated cover for key switches
- Spring loaded cover provides some weather resistance
- Cover is held in place when fitting a switch
- Designed to work with standard 19mm round switches
- Idea for use with CJ98G, CJ96E



Order Code	Mod: 002460	Price each exc. VAT 1+	inc. VAT each 5+
FE43W	Key Switch Cover	£1.57	£1.89

Micro Switches

Sub Miniature Lever Micro Switch

A low-cost subminiature micro-switch produced to an internationally accepted standard size and operating characteristic. The switch is manufactured from



glass-reinforced thermoplastic to give rugged performance, and is available as single-pole double-throw with an actuator attached. Terminals are suitable for PCB mounting at a standard pitch. The actuator is stainless steel and is 13mm long.

Specifications:

Contact rating: 3A 125Vac
Body size: 12.8 x 6.5 x 5.8mm
Fixing centres: 6.5mm
Fixing hole: 1.2mm diameter [for M1 screws]

Order Code	Mod: 006451	Price each exc. VAT 1+	inc. VAT each 5+
GW67X	Sub-Microsw/Lever	£1.49	£1.79

Miniature Microswitch

A miniature micro-switch of internationally accepted size and operating characteristics. Switches are single-pole double-throw.



Specifications:

Contact rating: 3A 250Vac
Body size: 19.8 x 6.4 x 9.5mm
Fixing centres: 9.5 x 2.9mm
Actuator: 1.3mm above body

Solder tag connections
The switch is also available with a 16.5mm lever and a 14.5mm lever with a roller.

Order Code	Mod: 036835	Price each exc. VAT 1+	inc. VAT each 5+
N95AQ	Min Microswitch	£1.82	£2.19
N96AQ	Min M-Sw with Lever	£1.90	£2.29
N97AQ	Min M-Sw with Roller	£1.74	£2.09

Low Cost Miniature

A low-cost range of miniature microswitches produced to an internationally accepted standard size and operating characteristics. These switches are manufactured from glass-reinforced thermoplastic to give rugged performance. Switches are single-pole double-throw and available with a choice of actuators attached. Terminals are standard solder lugs. The actuators are of stainless steel and either a 16.5mm long lever, or a 18.5mm long lever carrying a roller.



Specifications:

Contact rating: 3A 250Vac
Body size: 19.8 x 10.2 x 6.4mm
Fixing centres: 9.5mm
Fixing hole: 2.35mm diameter [for M2.3 screws]

Order Code	Mod: 006452	Price each exc. VAT 1+	inc. VAT each 5+
GW69A	Min-Microsw/Lever	£1.24	£1.49
GW70M	Min-Microsw/Roller	£1.49	£1.79

Buying for education?
0333 400 9740



Maplin TV

Home of innovation, handy tips and How To videos

Visit our channel...

youtube.com/maplintv



Low Cost Standard Microswitches

- A low-cost range of standard microswitches
- Internationally accepted standard size and operating characteristics



These switches are manufactured from glass-reinforced thermoplastic to give rugged performance. Switches are single-pole double-throw and available in the basic style or with a choice of actuators attached. Terminals are 6.35mm (1/4in.) blade type that can either be soldered or used with push-on connectors (e.g., HF10L). The actuators are of stainless steel and either a 27.5mm long lever, or a 27.5mm long lever carrying a roller.

Specifications:

Contact rating	6A - AC 250V
Body size	27.8 x 15.9 x 10.3mm
Fixing centres:	22.2 x 10.3mm
Fixing hole:	3.1mm diameter

Order Code	Mod: 006453	Price each exc. VAT 1+	5+	inc. VAT each
GW71N	Std.-Microsw	£2.07	£1.79	£2.49
GW72P	Std.-Microsw/Lever	£2.07	£1.79	£2.49
GW73Q	Std.-Microsw/Roller	£2.07	£1.79	£2.49

V3 Style Alarm Tamper Switch



- High quality standard V3 microswitch rated at 3A AC 125 V
- Features a paddle lever 4.1mm (w) x 51mm (l)
- Ideal for quick alignment in security and safety applications

Specifications:

Contact rating	3A AC 125 V
Body size	27.8 x 10.3 x 15.9 mm
Fixing centres:	22.2 x 10.3 mm
Lever size	4.1mm x 51mm

Order Code	Mod: 020406	Price each exc. VAT 1+	inc. VAT each
NF21X	Paddle Microswitch	£2.49	£2.99

Dual In-line Switches

Slimline SPST



DIL switches with dimensions identical to DIL ICs. The pins fit standard IC sockets or can be directly mounted on the pcb. The white levers are numbered 1 to 4, or 1 to 8 depending on size and have a movement of 1mm. The switch is made from UL94V-0 plastics with gold-plated twin contacts to ensure low contact resistance and long operating life. Pin spacing is 7.62 x 2.54mm (0.3in. x 0.1in.). Contact rating.

non-switching:	100mA 50Vdc
switching	100mA 5Vdc
Contact resistance:	<50mΩ
Insulation resistance:	1000MΩ at 100Vdc
Dielectric strength:	500Vdc min.

Capacitance between adjacent switches: Life

for 1 minute

5pF
>2000 operations per pole

Dimensions

Width:	7.62mm
Height	4.3mm
Pin length:	3mm
Actuator height	1mm
Length:	4-pole: 10.12mm 8-pole: 20.28mm

Order Code	Mod: 002387	Price each exc. VAT 1+	5+	inc. VAT each
JH08J	Slimline 4W DIL Sw	£0.90	£0.78	£1.09
OY70M	Slimline 8W DIL Sw	£1.15	£1.00	£1.39

Rotary Switches

Rotary Switches

- Rotary switch moulded in glass-filled nylon
- Indexing 30°
- 6.3mm (1/4in) spindle, 9.5mm (3/8in) bush
- Adjustable rotation limit stop
- Break before make action



The following types are available

1 Pole 12 way:	FF73Q
2 Pole 6 way:	FF74R
3 pole 4 way:	FF75S
4 pole 3 way:	FF76H

Specifications:

Bush length:	8mm
Spindle length:	30mm (with Flat)
Overall length:	58mm
Max voltage:	300Vac or Vdc
Contact resistance:	50mΩ
Contact rating:	150mA at 250Vac or Vdc 300mA at 110Vac or Vdc

Order Code	Mod: 002417	Price each exc. VAT 1+	5+	inc. VAT each
FF73Q	Rotary SW 1 P 12 Way	£1.82	£1.56	£2.19
FF74R	Rotary SW 2 P 6 Way	£1.82	£1.56	£2.19
FF75S	Rotary SW 3 P 4 Way	£1.82	£1.56	£2.19
FF76H	Rotary SW 4 P 3 Way	£1.90	£1.64	£2.29

Thumbwheel Switch

Thumbwheel Switch

- Compact edge switch body in black plastic housing, operated by thumb or finger
- Digits 0 to 9 appear in the aperture as the wheel is revolved
- Contact selection is based on BCD
- Several thumb switches can be clipped together
- Cheek pieces are required to be used to make the whole assembly 'snap in'
- Gold plated contacts on the PCB and wiper ensure reliable operation



Specifications

No	Pin numbers
0	None
1	C and 1
2	C and 2
3	C, 1 and 2
4	C and 4
5	C, 1 and 4
6	C, 2 and 4
7	C, 1, 2 and 4
8	C and 8
9	C, 1 and 8
Switch resistance:	100mΩ max

Current carrying capacity: 1A max
Contact rating: 150mA at 50Vac or 28Vdc
Character height: 5.8mm
Width of switch: 8mm
Overall height: 33mm
Overall depth: 43mm

Order Code	Mod: 002438	Price each exc. VAT 1+	5+	inc. VAT each
JK36P	Thumbwheel BCD	£2.24	£1.94	£2.69
JK37S	Thumbwheel End Cheek	£1.24	£1.11	£1.49

Proximity Switches

Rhodium Plated Reed Switches



- Normally open contacts
- High current and voltage capability
- Overlap contact arrangements
- Quick release, ideal for high speed sensing applications

Standard and miniature sizes available

Type	Standard	Miniature
Glass length (mm)	£2	19
Glass diameter (mm)	5.4	2.6
Overall length (mm)	79	55
Contact arrangement	Single pole	Single pole
Max carrying current	5.0A	3.0A
Max current	3.0A	2.0A
Switching voltage	1500VAC/DC	230VAC/DC
Contact capacitance	0.8pF	0.5pF
Max contact resistance	80mΩ	80mΩ
Bounce time	0.5ms	0.5ms
Release time	0.2ms	0.1ms
Insulation resistance	100	100

Order Code	Mod: 034157	Price each exc. VAT 1+	5+	inc. VAT each
N30AN	Min Reed Switch	£1.49	£1.29	£1.79
N31AN	Std Reed Switch	£3.15	£2.73	£3.79

Miniature Reed Switches



- A range of Rhodium contact reed switches
- Low contact resistance and high speed operation
- Suits many applications including sensors, proximity switching instrumentation and alarm solutions
- Normally open and changeover options available

Normally Open Type

Order Code	CL36P	CL37S	CL38R
Max Switching A	0.5	0.5	1
Carrying Current A	0.8	1	2
Max Switching VAC/DC	140	400	230
Glass Length (mm)	11	14.1	19
Glass Diameter (mm)	2.1	2.3	2.6
Pull-in Sensitivity (AT)	10-40	10-35	20-50
Max Contact Resist	150	150	100
Life (millions Operat)	100	100	100

Changeover Type

Order Code	CL40T
Max Switching A	0.2
Carrying Current A	0.5
Max Switching Vac	230
Glass Length (mm)	14
Glass Diameter (mm)	2.54
Max Contact Resist	100
Life (millions Operat)	100
Life (millions Operat)	100

Order Code	Mod: 012389	Price each exc. VAT 1+	5+	inc. VAT each
CL36P	MicroMin Reed Sw N/O	£1.90	£1.65	£2.29
CL37S	Micro Reed Sw N/O	£1.82		£2.19
CL38R	Mini Reed Sw N/O	£1.90		£2.29
CL40T	Micro Reed Sw C/O	£2.49	£2.15	£2.99

Assemtech RI-90 Micro Changeover Reed Switch



- The RI-90 micro changeover dry-reed switch is hermetically sealed in a gas-filled envelope
- SPDT type having a normally open and a normally closed contact
- Ideal for precise switching, proximity sensors, machine and medical applications
- High quality contact layers made up from ruthenium on gold
- Superior glass-to-metal seal and blade alignment
- Excellent life expectancy and reliability

Specifications

Order Code	N95BT
Max Switching DC mA	400
Carrying Current DC mA	500
Max Switching VAC/DC	125/175
Glass Length (mm)	14.3
Glass Diameter (mm)	2.54
Pull-in Sensitivity (AT)	15-40
Life (millions Operat)	100
Life (millions Operat)	100

Order Code	Mod: 044111	Price each exc. VAT 1+	5+	inc. VAT each
N95BT	Form C switch	£3.32	£3.06	£3.99

Magnets

Round Magnets

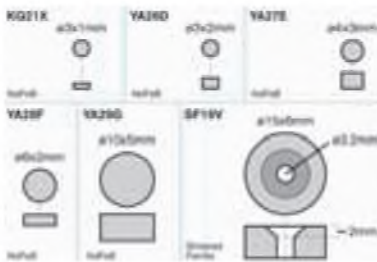

- A range of high quality magnets
- Gauss level typically 2-4 times greater than Alnico magnets
- Ideal for a wide range of applications up to 100°C
- All manufactured from Neodymium Iron Boron except SF19V which is Sintered Ferrite

Order Code	Description	Diameter (mm)	Height (mm)	Nickel Plated
KQ21X	M1219-1	3	1	Yes
YA26D	M1219-2	3	2	Yes
YA27E	M1219-3	4	3	Yes
YA28F	M1219-4	6	2	Yes
YA29G	M1219-5	10	5	Yes
SF19V*	M1218	15	6	No

*SF19V is counter sunk 3.2-7mm

Order Code	Mod: 026348	Price each exc. VAT 1+	5+	inc. VAT each
SF19V	Mgmt with 3.2mm hole	£1.82		£2.19
KQ21X	3x1mm Magnet	£1.07	£0.93	£1.29
YA26D	3x2mm Magnet	£1.07	£0.93	£1.29
YA27E	4x3mm Magnet	£1.57		£1.89
YA28F	6x2mm Magnet	£1.57		£1.89
YA29G	10x5mm Magnet	£1.57		£1.89

Look out for our monthly promotions at your local Maplin store now!

Pop in and pick up a copy of our monthly promotional publication, with special offers on dozens of exciting products. See the end of this catalogue for store listings

Bar Magnets

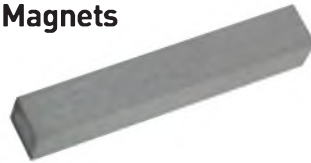

- A range of general purpose Alnico/Alcomax bar magnets
- Ideal for a wide range of applications up to 500°C
- Contains a high nickel for improved corrosion resistance

Order

Code	Description	Length (mm)	Height (mm)
N32AN	Small	19.05	3.18
N33AN	Large	25.4	6.35

Order Code	Mod: 036158	Price each exc. VAT 1+	5+	inc. VAT each
N32AN	Small Magnet	£1.57	£1.36	£1.89
N33AN	Large Magnet	£2.99		£3.59

Tilt & Vibration

Plastic Tilt Switch with Right Angle Pins

A low cost tilt switch with gold plated contacts and right angle PCB pins. The switch has a plastic/polamide housing.



Specifications:

Switching current:	25mA
Switching voltage:	24Vdc
Differential angle typical:	15°C
Moulding size:	11mm x 6mm x 6mm

Order Code	Mod: 030185	Price each exc. VAT 1+	5+	inc. VAT each
RN23A	Hor. Mount. Tilt Sw	£1.15	£1.00	£1.39

Non Mercury Contacts Tilt Switch Module

ORDER IN STORE OR ONLINE



- Fully sealed to provide maximum mechanical protection
- Easily fitted
- Terminated with approximately 30cm of stripped 2-core cable
- Can be mounted either open circuit or closed circuit on 2 axes on the horizontal

Specifications:

Switching Voltage:	60 Vac/dc
Switching Current:	0.25A max
Switching Capacity (Resistive):	3VA max
Differential Angle:	15° max
Contact Resistance:	30mΩ max.
Operating Temperature:	-20°C to +70°C
Case Material:	ABS
Cable / Termination:	2 x 0.142 PVC insulated
Dimensions:	47mm (L) x 12mm (D) x 11mm (H)
Mounting Holes:	9mm (H) x 3.2mm (W) at opposite end to cable, 7mm (W) x 3.2mm (H) at cable end

Order Code	Mod: 099097	Price each exc. VAT 1+	5+	inc. VAT each
N17CT	Tilt Switch Module	£4.65	£4.02	£5.59

Non Mercury Tilt Switch



A hermetically sealed tilt and motion detector ideal for use with industrial control equipment, household goods and security devices. The CM1300 [DP50E] is designed for low level switching applications which are currently using mercury switches. Enclosed in a metal housing for longer life. Features hermetically sealed contacts and filled with an inert gas for stable resistance and quiet operation.

Order Code	Mod: 010116	Price each exc. VAT 1+	inc. VAT each
DP50E	Mini Tilt Switch	£2.24	£2.69

Miniature Tilt Switch

A miniature tilt switch that, due to its low cost, is ideally suited as a position sensor.

When mounted horizontally, contact is made when the device is tipped up and broken when tipped down. Contact is made/broken when the device is 10° from the horizontal.

Max switching voltage	240Vac
Max switching current	300mA
Differential angle	10°
Contact resistance:	1Ω
Body length	10.2mm
Body dia	4.7mm
Lead length:	17mm

Order Code	Mod: 002680	Price each exc. VAT 1+	5+	inc. VAT each
FE11M	Min Tilt Switch	£2.49	£2.15	£2.99

Float Switches

PIC Medium Float Switch

ORDER IN STORE OR ONLINE



- Small magnetic sensor
- Suitable for use with water and diluted acids
- Can be mounted vertically at top or bottom of tank
- Easy to use N/O or N/C configuration

Low-cost range of float switches, ideally suited for a range of applications from domestic to commercial use. Whether at the top or bottom of the tank, this series always supplies the correct signal. It is suited to a wide range of applications such as coffee makers, water dispensers and tank monitoring systems. The PIC float switches are available in three versions, suited to water and dilute acids applications.

Specifications

Switching voltage max	DC 200 V
	AC 140 V
Current rating max	1.0 A
Switching current max	1.2 A
Operating temperature:	-20 to +80°C
Panel cut out required	7mm
Actuator travel max	8.5mm

Order Code	Mod: 221987	Price each exc. VAT 1+	5+	inc. VAT each
N33FU	Float Switch Medium	£10.82	£9.35	£12.99

PIC Large Float Switch

ORDER IN STORE OR ONLINE



- Small magnetic sensor
- Suitable for use with water and diluted acids
- Can be mounted vertically at top or bottom of tank
- Easy to use N/O or N/C configuration

Low-cost range of float switches, ideally suited for a range of applications from domestic to commercial use. Whether at the top or bottom of the tank, this series always supplies the correct signal. It is suited to a wide range of applications such as coffee makers, water dispensers and tank monitoring systems. The PIC float switches are available in three versions, suited to water and dilute acids applications.

Specifications

Switching voltage max	DC 200 V
	AC 140 V
Current rating max	1.2 A
Switching current max	1.0 A
Operating temperature	-20 to +80°C
Panel cut out required	7mm
Actuator travel max	18.5mm

Order Code	Mod:	Price each	exc. VAT	inc. VAT each
		1+	5+	
N34FU	Mod: 221988	£10.82	£9.35	£12.99

Assemtech Compact Float Switch Horizontal Mounting



A horizontal mounting liquid level float switch designed to be mounted on the side of a vessel from the inside. The switch is used to indicate either high or low levels when the pivoted actuator magnet comes close to the reed switch mounted in the main body. Fixing style is compression gland on 16.5mm diameter mounting hole. The case material is polysulphone and nylon it complies to food contact regulations and is resistant to acid and alkali.

Minimum specific gravity	0.7	
Temperature range:	-20°C to +80°C	
Max switching voltage	240Vac/200Vdc	
Max switching current	SPST 50W/0.5A	
Dimensions:	Length O/A	Length
Actuator		
Panel Ftg	90	52

Order Code	Mod:	Price each	exc. VAT	inc. VAT each
		1+	5+	
CL25C	Mod: 012167	£12.49		£14.99

Knobs

Matt Finish Knob for 3mm Spindle

- Secured by a grub screw
- Designed to fit 3mm shafts

An attractive matt black finish grub screw secured knob with serrated finger-grip sides and



a narrow skirt. It is similar in style to the K14 range but is designed to fit 3mm shafts and makes an excellent replacement for knobs fitted to some types of manufactured equipment. External diameter 12mm max, height 12mm.

Order Code	Mod:	Price each	exc. VAT	inc. VAT each
		1+	5+	
JZ86T	Mod: 001799	£0.82	£0.71	£0.99

Low-Profile Knob

- Small knob with serrated sides
- Spun aluminium insert with arrowhead pointer
- Diameter: 21mm
- Height: 13mm



Order Code	Mod:	Price each	exc. VAT	inc. VAT each
		1+	5+	
RX99H	Mod: 001802	£0.99	£0.86	£1.19

Fluted Knobs



- Black fluted knobs with white indicator line
- Narrow skirt and spun aluminium insert

All types have recess for control fixing nut except K7A [Order Code YX01].

Order Code:	Type:	Diameter:	Height:
YX01	K7A	19mm	12mm
YX02	K7B	27mm	16mm
YX03	K7C	33mm	16mm
YX04	K7D	45mm	21mm

Order Code	Mod:	Price each	exc. VAT	inc. VAT each
		1+	5+	
YX01B	Mod: 001819	£0.99	£0.86	£1.19
YX02C	Knob K7B	£1.24	£1.07	£1.49
YX03D	Knob K7C	£1.32	£1.14	£1.59
YX04E	Knob K7D	£1.40	£1.22	£1.69

Small Ridged Knobs



- White pointer line and skirt
- Sides have narrow raised ridges for a firm grip
- Fitted with a spun aluminium insert

KB3 [Order Code RW86T] has recess for control fixing nut. It has a height of 22mm and diameter of 35mm. KB4 [Order Code: RW87U] has a height of 17mm and diameter of 20mm.

Order Code	Mod:	Price each	exc. VAT	inc. VAT each
		1+	5+	
RW87U	Mod: 001803	£1.24	£1.07	£1.49
RW86T	Knob KB3	£1.24	£1.07	£1.49

Heavy Duty Pointer Knob

- A pointer knob with a white line
- Gives a very firm grip for heavy switches, etc.
- Has recess for control fixing nut
- Diameter: 27mm



- Height: 16mm

Order Code	Mod:	Price each	exc. VAT	inc. VAT each
		1+	5+	
FD76H	Mod: 001812	£1.15	£1.00	£1.39

Calibrated and Pointer Pair

- Spun aluminium skirt and serrated sides
- Recess for control fixing nut
- Dimensions: 37mm diameter x 15mm height
- Order Code RX01 is numbered 0 to 10 on the skirt
- Order Code RX02 has a black arrowhead on the skirt



Order Code	Mod:	Price each	exc. VAT	inc. VAT each
		1+	5+	
RX01B	Mod: 001816	£1.24	£1.07	£1.49
RX02C	Knob PK2	£1.24	£1.07	£1.49

Pointer Knobs with Coloured Caps



- Knobs have a pointer bar with a white line
- Serrated sides and coloured cap

These knobs are available in two sizes with blue, green or red caps.

RN15: Length 15mm. Width 13mm. Height 13mm

RN18: Length 23mm. Width 19.3mm. Height 16.5mm

Order Code	Mod:	Price each	exc. VAT	inc. VAT each
		1+	5+	
FE74R	Mod: 001814	£0.99	£0.86	£1.19
FE75S	Knob RN15 Blue	£0.99	£0.86	£1.19
FE76H	Knob RN15 Green	£0.99	£0.86	£1.19
FD65V	Knob RN15 Red	£0.99	£0.86	£1.19
FD66W	Knob RN18 Blue	£1.15	£1.00	£1.39
FD66W	Knob RN18 Green	£1.15	£1.00	£1.39
FD67X	Knob RN18 Red	£1.15	£1.00	£1.39

Calibrated and Pointer Pair

- Spun aluminium insert and a wide aluminium skirt
- Serrated sides
- Recess for control fixing nut
- Dimensions: 30mm diameter x 18mm height
- Maximum Shaft Diameter: 1/4 Inch
- Order Code RW78 is calibrated 0 to 9.8



Order Code	Mod:	Price each	exc. VAT	inc. VAT each
		1+	5+	
RW78K	Mod: 001818	£1.49	£1.29	£1.79

Matt Finish Knobs



- Range of matt black finish knobs
- Serrated finger-grip sides and a narrow skirt

The top of the knob features a shallow channel which matches the serrated finger-grip pattern. One end of the channel has a square, white pointer dot which complements a square cut-out or recess in the skirt. Knob K14D has a recess for a control fixing nut.

2A Miniature DPDT Latching Relay

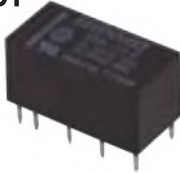

Twin coiled 12V latching relay with high coil sensitivity, which is designed for direct PCB mounting & can also be mounted in a 16 pin DIL socket (order code BL19V).

Contact details
 Maximum current 2A
 Maximum voltage 253Vac, 220Vdc
 Maximum switching power 125VA (AC), 60W(DC)
 Contact resistance <100mΩ
 Operate time 5ms max.
 Release time 5ms max.
 Insulation resistance 100MΩ at 500Vdc
 Mechanical life >100 million operations
 Electrical life >500,000 operations at full load

Coil details:

Order Code	Mod.	Coil	Current at resistance nominal voltage
N38AW	037529	2A DPDT12Vdc LchRly	15mA

Order Code	Mod.	Price each exc. VAT 1+	5+	inc. VAT each
N38AW	037529	£3.74	£3.29	£4.49

Contact resistance 100mΩ
 Operate time 10ms [max]
 Release time 10ms [max]

Dimensions
 Pin length 3.5mm
 Size of base 19.5 x 15.8mm
 Height of body 15mm

Order Code	Mod.	Price each exc. VAT 1+	5+	inc. VAT each
JM67X	12V 10A PCB Relay	£1.65	£1.43	£1.99
RP68Y	6V 10A PCB Relay	£1.65	£1.43	£1.99
N28AW	24V 10A PCB Relay	£1.65	£1.43	£1.99

Maximum current 5A
 Maximum voltage 240Vac, 30Vdc
 Maximum switching power 1200VA resistive
 150W resistive
 Contact resistance <50mΩ
 Operate time 20ms max
 Release time 20ms max
 Insulation resistance 100MΩ at 500Vdc
 Mechanical life >10 million operations
 Electrical life >100,000 operations at full load
 Contact material AgCdO (Silver Cadmium oxide)

Coil details:

Nominal voltage	Operate range[V]	Coil resistance	Current at nominal voltage
12Vdc	9.6-13.2	160Ω±5%	75mA
240Vac	192-264	15700Ω±5%	14mA

Size of Base 63.2 x 30.3mm [4PDT]
 72 x 22.7mm [DPDT]
 Height of body 25.5mm [4PDT]
 30mm [DPDT]

Order Code	Mod.	Price each exc. VAT 1+	5+	inc. VAT each
N13AW	Min 5A DPDT 240Vac	£4.15	£3.59	£4.99
N41AW	Min 5A DPDT 12Vdc	£4.15	£3.59	£4.99
N14AW	Min 5A 4PDT 240Vac	£4.15	£3.59	£4.99
N42AW	Min 5A 4PDT 12Vdc	£4.24	£3.66	£5.09
JG52G	Rly Skt 5A 8-Pin	£2.07	£1.49	£2.49
N36AW	8Pin Rly Skt DIN	£2.07	£1.79	£2.49
N37AW	14 Pin Rly Skt DIN	£2.90	£2.54	£3.49

6 & 12V 5A Miniature Relays

- Double Pole, double throw changeover relays
- Available in 6 or 12V coils
- Dimensions: 30 x 13 x 27mm, excluding pins
- 2 C/O contact arrangement



Contact Details:
 Max current: 5A AC/DC max
 Max voltage: 250Vac/30Vdc

Coil details:
 Nominal voltage 6V 12Vdc
 Coil resistance: 68Ω 270Ω
 Coil Current: 88.2mA 44.4mA
 Operate voltage range: 4.7 to 10.8V 8.6 to 21.6V

Order Code	Mod.	Price each exc. VAT 1+	5+	inc. VAT each
FJ42V	Min 6V 5A Relay	£4.15	£2.99	£4.99
FJ43W	Min 12V 5A Relay	£4.15	£2.99	£4.99

10A DPDT Miniature Relays



- General purpose DPDT relay with spade terminals for quick connection
- PCB and DIN rail sockets are available

Contact details
 Maximum current 10A
 Maximum voltage AC 300 V, DC 30 V
 Maximum switching power 2400VA resistive
 300W resistive
 Contact resistance <50mΩ
 Operate time 20ms max
 Release time 20ms max
 Insulation resistance 100MΩ at DC 50 V
 Mechanical life >10 million operations
 Electrical life >100,000 operations at full load
 Contact material AgCdO (Silver Cadmium oxide)

Coil details:

Nominal voltage	Operating range[V]	Coil resistance	Current at nominal voltage
DC 12 V	9.6-13.2	160Ω±5%	75mA
AC 240 V	192-264	15700Ω±5%	14mA

Size of base: 73 x 24mm
 Height: 30mm

Order Code	Mod.	Price each exc. VAT 1+	5+	inc. VAT each
N08AW	Min 10A DPDT 12Vdc	£4.40	£3.81	£5.29
N09AW	Min 10A DPDT 240Vac	£4.40	£3.81	£5.29
N32AW	8Pin Rly Skt PCB	£2.07	£1.79	£2.49
N34AW	8Pin Rly Skt DIN	£2.07	£1.79	£2.49

15A SPDT Miniature Relay



Ultra-Miniature High Power Mains Relay



- Ultra-miniature relay capable of switching 10A resistive at AC 240 V
- Fully enclosed and designed for direct printed circuit board mounting

Specifications:
 Dimensions 22 x 17.4 x 11.6mm
 high excluding pins
 Pin length 4mm
 Max current DC 10 A, AC 10 A resistive
 DC 10 A, AC 3A inductive
 Max voltage: DC 30 V, AC 240 V
 Life at AC 240 V: 75,000 operations
 Max contact resistance: 50mΩ
 Operate time 6ms
 Release time: 2ms

Coil Details:
 Nominal voltage DC 12 V
 Coil resistance: 320Ω
 Operating voltage range: 9V to 19.2V
 Must release voltage >1.2V

Order Code	Mod.	Price each exc. VAT 1+	5+	inc. VAT each
YX97F	10A Mains Relay	£2.07	£1.79	£2.49

5A Miniature Relay



Fully enclosed general purpose relay available in DPDT & 4PDT solder tag contact arrangements, with 12Vdc & 240Vac coils. PCB & DIN rail sockets are available

Contact details:

Interface Relays

Low cost power relays, fully sealed & designed for direct PCB mounting



Type	N29AW	N31AW	N30AW
DC Coil Voltage	LMR1 3-48V	LMR2 3-48V	LMRH 3-48V
DC Contact Rating	30V 10A	30V 5A	30V 16A
AC Contact Rating	250V 1CA	250V 5A	250V 16A
Nominal Power	0.53W	0.53W	0.53W
Contact arrangement	SFDT	DFDT	SFDT
Dimensions (LxWxH)	29 x 12.5 x 15.5	29 x 12.5 x 15.5	29 x 12.5 x 15.5
Weight (g)	12	12	12

Order Code	Mod.	Price each exc. VAT 1+	5+	inc. VAT each
N29AW	10A SPDT 12Vdc	£2.07	£1.79	£2.49
N30AW	16A SPDT 12Vdc	£2.49	£1.86	£2.99
N31AW	5A DPDT 12Vdc PCB	£2.49	£1.86	£2.99

PCB Mount Low Profile 10A Relays



- PCB mounting relays with single pole change over contacts
- Rated to carry 10A at 240VAC
- Available with coil voltages of 6, 12, 24V
- Fully enclosed with silver plated contacts

Specifications

	RP68Y	JM67X	N28AW
Coil details			
Nominal voltage	6V	12V	24V
Coil resistance	100Ω	400Ω	1600Ω
Operating voltage range	4.5V - 6.6V	9V - 13.2V	18V-26.4V
Must release voltage	>0.6V	>1.2V	>2.4V

Contact details
 Max current [10A] 10A AC/DC 240Vac/24Vdc
 Max voltage 240Vdc/24Vdc

- General purpose SPDT relay with spade terminals for quick connection
- PCB and DIN rail sockets are available.

Contact details:
 Maximum current: 15A
 Maximum voltage: AC 240 V, DC 28 V
 Maximum switching power: 3600VA resistive
 420W resistive

Contact resistance: <50mΩ
 Operate time: 25ms max
 release time: 25ms max
 Insulation resistance: 500MΩ at 500Vdc
 Mechanical life: >10 million operations
 Electrical life: >100,000 operations at full load
 Contact material: AgSnO2 Gold flashed

Nominal voltage:	Operating range[V]:	Coil resistance:	Current at nominal voltage:
DC12 V	9.0-13.2	150Ω±10%	75mA
AC 240 V	192-264	15700Ω±10%	15.3mA

Size of base: 27.4 x 21 x 34.7mm
 Height: 34.7

Order Code	Mod: 037519	Price each exc. VAT 1+	inc. VAT each
N06AW	Min 15A SPDT 12Vdc	£4.40	£3.81
N07AW	Min 15A SPDT 240Vac	£4.40	£3.81
N32AW	8Pin Rly 5kt PCB	£2.07	£1.79
N34AW	8Pin Rly 5kt DIN	£2.07	£1.79

4PDT 10A Power Relay

- Large capacity, general purpose relays have spade terminals for quick connection
- PCB and DIN rail sockets also available



Contact details:
 Maximum current: 10A
 Maximum voltage: AC 240 V, DC 28V
 Maximum switching power: 2400VA resistive
 280W resistive

Contact resistance: <50mΩ
 Operate time: 25ms max.
 release time: 25ms max.
 Insulation resistance: 100MΩ at DC 500V
 Mechanical life: >10 million operations
 Electrical life: >100,000 operations at full load
 Contact material: AgCdO [Silver Cadmium oxide]

Nominal voltage:	Operating range[V]:	Coil resistance:	Current at nominal voltage:
DC12 V	9.6-13.2	100Ω±5%	120mA
DC 24 V	19.2-26.4	350Ω±5%	69mA
AC 240 V:	192-264	6700Ω±5%	

Size of base: 41.5 x 28mm
 Height of body: 36mm

Order Code	Mod: 037514	Price each exc. VAT 1+	inc. VAT each
N10AW	PwrRly 10A 4PDT 12Vdc	£6.07	£7.29
N11AW	PwrRly 10A 4PDT 240Vac	£6.07	£7.29
N12AW	PwrRly 10A 4PDT 24Vdc	£6.24	£7.49

30A SPDT Power Relay

These 30A single pole, double throw relays have spade terminals for quick connection. A DIN rail socket is also available.



Contact details:
 Maximum current: 30A
 Maximum voltage: 300Vac, 28Vdc
 Maximum switching power: 9000VA resistive
 840W resistive

Contact resistance: <50mΩ
 Operate time: 20ms max
 Release time: 20ms max
 Insulation resistance: 1000MΩ at 500Vdc
 Mechanical life: >10 million operations
 Electrical life: >100,000 operations at full load
 Contact material: AgCdO [Silver Cadmium oxide]

Nominal voltage:	Operate range[V]:	Coil resistance:	Current at nominal voltage:
12Vdc	9.6-13.2	120Ω±5%	100mA
24Vdc	19.2-26.4	472Ω±5%	51mA
240Vac	192-264	7200Ω±5%	29mA

Size of base: 35 x 35mm
 Height of body: 52.5mm
 Overall height: 70mm

Order Code	Mod: 037495	Price each exc. VAT 1+	inc. VAT each
N23AW	PwrRly 30A SPDT 12Vdc	£5.82	£4.86
N24AW	PwrRly 30A SPDT 240Vac	£5.82	£4.86
N25AW	PwrRly 30A SPDT 24Vdc	£5.82	£4.86
N19AW	Rly Sckt 30A 11Pin Din	£2.90	£2.51

Round-base 10A Relays

High power standard industrial relays with DPDT contacts on an octal base and 3PDT contacts on an 11-pin base.



The relay is fully enclosed and will plug in to any standard 8-pin or 11-pin round base. It is a direct replacement for all standard industry types. It is available in both double-pole and 3-pole with a choice of three coil voltages: 12V, 24Vdc, and 240Vac

Contact details
 Max current: 10A
 Max voltage: 240Vac, 28Vdc
 Max switching power: 2400V A resistive
 280W resistive

Contact resistance: <50mΩ
 Operate time: 15ms max
 Release time: 15ms max
 Insulation resistance: 100MΩ at 500Vdc
 Mechanical life: >10 million operations
 Electrical life: >100,000 operations at full load
 Contact material: Silver cadmium oxide

Nominal voltage:	Operate range [V]	Coil resistance:	Current at nominal voltage:
12Vdc	9.6 to 13.2	120Ω ±5%	100mA
24Vdc	19.2 to 26.4	472Ω ±5%	51mA
240Vac	192 to 264	9110Ω ±5%	9mA

Relay Dimensions:
 Size: 35 x 35mm
 Height of body: 52.5mm
 Overall height: 70mm

Base Dimensions:
 Size: 51 x 40mm [8-pin]
 51 x 43mm [11-pin]
 Height: 21mm [8-pin]

Order Code	Mod: 002567	Price each exc. VAT 1+	inc. VAT each
J658N	Power Rly 12VDC DPDT	£4.99	£4.19
J659P	Power Rly 24VDC DPDT	£4.99	£4.19
J660Q	Power Rly 240VAC DPDT	£4.99	£4.19
J662S	Power Rly 12VDC 3PDT	£4.99	£4.19
J663T	Power Rly 24VDC 3PDT	£4.99	£4.19
J664U	Power Rly 240VAC 3PDT	£4.99	£4.19
J654J	Rly Sckt 10A 8-Pin	£2.49	£2.15
J653H	Rly Sckt 10A 11-Pin	£2.49	£2.15

Reed Relays

Sealed Reed Relays

- A range of single pole and double pole NO contact relays
- 5V and 12V coil versions
- Switch up to 10VA
- High resistance coil ideal for direct drive logic 74 ICs and logic buffers



Specifications:
 Max carry current: 1A
 Max switching voltage: 100V
 Max switching power: 10VA
 Contact resistance: 150mΩ max
 Operate time: 1ms max including bounce time
 Release time: 0.5ms max including bounce time
 Life: >1 million operations at full load

Nominal Voltage	Resistance	Current	Pull In to Maximum Voltage
5VDC	500Ω ±10%	10mA	3.8 to 11
12VDC	1050Ω ±10%	11.4mA	8.0 to 22

Coil Temp Rise: 30° Max
 Insulation Resistance: >100MΩ at 500VDC
 Dimensions SPST [NO]: 24 x 8 x 9mm
 Dimensions DPST [NO]: 25 x 11 x 9mm

Order Code	Mod: 002605	Price each exc. VAT 1+	inc. VAT each
JH12N	Reed Relay 5V SPST	£2.49	£1.79
JH13P	Reed Relay 12V SPST	£2.07	£1.79
JH15R	Reed Relay 5V DPST	£2.49	£1.79
JH16S	Reed Relay 12V DPST	£1.99	£1.72

DIL Reed Relay



- Epoxy moulded 14 pin DIL package relay
- High isolation between the input and output
- High speed and low driving power
- SPNO action
- 5VDC 0.5A rating

Coil Parameters:
 Nominal coil voltage: 5Vdc
 Pull-in voltage: 3.75Vdc max.
 Drop-out voltage: 0.6Vdc min.
 Operating voltage: 20Vdc max.
 Coil resistance: 500Ω ±10%

Contact Parameters:
 Switching capacity: 10W max
 Switching voltage: 100V AC/DC
 Switching current: 0.5A
 Carry current: 1A max
 Contact resistance: 150mΩ max
 Dielectric strength: 200Vdc min

Relay Parameters:
 Dielectric strength: 1000Vdc coil/ccntact
 Insulation resistance: 1010 ± coil/ccntact
 Storage temperature: -40 to +105°C
 Operating temperature: -35 to +80°C
 Pull-in time incl. bounce time max: 0.5ms
 Drop-out time with diode: 0.5ms
 Weight: 2.3g approx

Order Code	Mod: 002613	Price each exc. VAT 1+	inc. VAT each
FX8BV	Dil Reed Relay 1p 5V	£2.49	£2.01

80VA Toroidal Transformers

ORDER IN STORE OR ONLINE

- High Quality Open Style Toroidal Transformers
- Dual Primary / Secondary Windings
- Thermal fuse fitted to each Primary
- Very low radiated magnetic field
- Supplied with mounting kit
- UL Approved
- Regulation 11%
- Temperature Rise (°C) 50
- Size 39mm x 90mm (HxD) Weight 1Kg
- Available in 2x9V, 2x12V, 2x15V, 2x18V and 2x25V



Order Code	Mod: 1032645	Price each exc. VAT 1+	inc. VAT each
A98QH	80VA Toroidal 2x25V	£16.65	£19.99
A93QH	80VA Toroidal 2x18V	£16.65	£19.99
A87QH	80VA Toroidal 2x15V	£16.65	£19.99
A82QH	80VA Toroidal 2x12V	£16.65	£19.99
A76QH	80VA Toroidal 2x9V	£16.65	£19.99

100VA Toroidal Transformers

ORDER IN STORE OR ONLINE

- High Quality Open Style Toroidal Transformers
- Dual Primary / Secondary Windings
- Thermal fuse fitted to each Primary
- Very low radiated magnetic field
- Supplied with mounting kit
- UL Approved
- Regulation 11%
- Temperature Rise (°C) 53
- Size 45mm x 91mm (HxD) Weight 1.10Kg
- Available 2x9V, 2x12V, 2x15V, 2x18V and 2x25V



Order Code	Mod: 1032648	Price each exc. VAT 1+	inc. VAT each
A31QJ	100VA Toroidal 2x25V	£19.15	£22.99
A15QJ	100VA Toroidal 2x18V	£19.15	£22.99
A10QJ	100VA Toroidal 2x15V	£19.15	£22.99
A06QJ	100VA Toroidal 2x12V	£19.15	£22.99
A01QJ	100VA Toroidal 2x9V	£19.15	£22.99

120VA Toroidal Transformers

ORDER IN STORE OR ONLINE

- High Quality Open Style Toroidal Transformers
- Dual Primary / Secondary Windings
- Thermal fuse fitted to each Primary
- Very low radiated magnetic field



- Supplied with mounting kit
- UL Approved
- Regulation 10%
- Temperature Rise (°C) 55
- Size 45mm x 98mm (HxD) Weight 1.32Kg
- Available 2x15V, 2x18V, 2x25V, 2x30V and 2x55V

Order Code	Mod: 1032650	Price each exc. VAT 1+	inc. VAT each
A41QJ	120VA Toroidal 2x55V	£19.15	£22.99
A40QJ	120VA Toroidal 2x30V	£19.99	£23.99
A39QJ	120VA Toroidal 2x25V	£19.15	£22.99
A38QJ	120VA Toroidal 2x18V	£20.82	£24.99
A37QJ	120VA Toroidal 2x15V	£19.15	£22.99

160VA Toroidal Transformers

ORDER IN STORE OR ONLINE

- High Quality Open Style Toroidal Transformers
- Dual Primary / Secondary Windings
- Thermal fuse fitted to each Primary
- Very low radiated magnetic field
- Supplied with mounting kit
- UL Approved
- Regulation 8%
- Temperature Rise (°C) 55
- Size 47mm x 105mm (HxD) Weight 1.60Kg
- Available 2x15V, 2x18V, 2x25V, 2x30V and 2x55V



Order Code	Mod: 1032660	Price each exc. VAT 1+	inc. VAT each
A43QJ	160VA Toroidal 2x55V	£20.82	£24.99
A44QJ	160VA Toroidal 2x30V	£20.82	£24.99
A45QJ	160VA Toroidal 2x25V	£20.82	£24.99
A46QJ	160VA Toroidal 2x18V	£20.82	£24.99
A47QJ	160VA Toroidal 2x15V	£20.82	£24.99

225VA Toroidal Transformers

ORDER IN STORE OR ONLINE

- High Quality Open Style Toroidal Transformers
- Dual Primary / Secondary Windings
- Thermal fuse fitted to each Primary
- Very low radiated magnetic field
- Supplied with mounting kit
- UL Approved
- Regulation 7%
- Temperature Rise (°C) 60
- Size 51mm x 110mm (HxD) Weight 2.2Kg
- Available 2x12V, 2x15V, 2x18V, 2x25V, 2x30V and 2x55V



Order Code	Mod: 1032670	Price each exc. VAT 1+	inc. VAT each
A63QJ	225VA Toroidal 2x55V	£41.65	£49.99
A62QJ	225VA Toroidal 2x30V	£41.65	£49.99
A61QJ	225VA Toroidal 2x25V	£41.65	£49.99
A60QJ	225VA Toroidal 2x15V	£41.65	£49.99

Order Code	Mod: 1032664	Price each exc. VAT 1+	inc. VAT each
A49QJ	115 / 230V	2 x 15Vac	7.5
A50QJ	115 / 230V	2 x 18Vac	6.3
A51QJ	115 / 230V	2 x 25Vac	4.5
A52QJ	115 / 230V	2 x 30Vac	3.75
A53QJ	225VA Toroidal 2x55V	£27.49	£32.99
A52QJ	225VA Toroidal 2x30V	£27.49	£32.99
A51QJ	225VA Toroidal 2x25V	£27.49	£32.99
A50QJ	225VA Toroidal 2x18V	£27.49	£32.99
A49QJ	225VA Toroidal 2x15V	£27.49	£32.99
A48QJ	225VA Toroidal 2x12V	£27.49	£32.99

300VA Toroidal Transformers

ORDER IN STORE OR ONLINE

- High Quality Open Style Toroidal Transformers
- Dual Primary / Secondary Windings
- Thermal fuse fitted to each Primary
- Very low radiated magnetic field
- Supplied with mounting kit
- UL Approved
- Regulation 6%
- Temperature Rise (°C) 60
- Size 54mm x 125mm (HxD) Weight 2.78Kg
- Available 2x12V, 2x15V, 2x18V, 2x25V and 2x30V



Order Code	Mod: 1032667	Price each exc. VAT 1+	inc. VAT each
A59QJ	300VA Toroidal 2x55V	£29.15	£34.99
A58QJ	300VA Toroidal 2x30V	£29.15	£34.99
A57QJ	300VA Toroidal 2x25V	£33.32	£39.99
A56QJ	300VA Toroidal 2x18V	£29.15	£34.99
A55QJ	300VA Toroidal 2x15V	£29.15	£34.99
A54QJ	300VA Toroidal 2x12V	£29.15	£34.99

500VA Toroidal Transformers

ORDER IN STORE OR ONLINE

- High Quality Open Style Toroidal Transformers
- Dual Primary / Secondary Windings
- Thermal fuse fitted to each Primary
- Very low radiated magnetic field
- Supplied with mounting kit
- UL Approved
- Regulation 6%
- Temperature Rise (°C) 68
- Size 60mm x 136mm (HxD) Weight 4.30Kg
- Available 2x30V, 2x35V, 2x50V and 2x55V



Order Code	Mod: 1032670	Price each exc. VAT 1+	inc. VAT each
A60QJ	500VA Toroidal 2x55V	£41.65	£49.99
A61QJ	500VA Toroidal 2x30V	£41.65	£49.99
A62QJ	500VA Toroidal 2x25V	£41.65	£49.99
A63QJ	500VA Toroidal 2x15V	£41.65	£49.99

Encapsulated Transformers

PCB Miniature Precision Current Transformers

ORDER IN STORE OR ONLINE

- PCB Miniature Precision Current Transformers
- Dielectric Strength: >2000Vac
- Available as 5A and 10A



Precision Current Transformers

Order Code	Input Current	Output Current	Phase Shift
A37QK	100mA (Max 5A)	2.5mA	<12.6
A38QK	5A (Max 10A)	5mA	<31

Order Code	Mod: 1032700	Price each exc. VAT 1+	inc. VAT each
A38QK	10A Current Sens. Trn	£3.32	£3.99
A37QK	5A Current Sens. Tran	£3.32	£3.99

1.5VA Encapsulated PCB Transformers

ORDER IN STORE OR ONLINE



- High Quality Encapsulated Transformers
- Single Primary Winding 0-230V
- Dielectric Strength: 4200 Vrms
- Inherently Short-circuit proof
- Ambient Temperature: +70°C
- Available 2x6V, 2x9V, 2x12V, 2x18V and 2x24V

1.5 VA Encapsulated PCB Transformers

Order Code	Input Voltage	Output Voltage	Output Current
A39QK	0-230V	2 x 6V	125mA
A40QK	0-230V	2 x 9V	83mA
A41QK	0-230V	2 x 12V	62mA
A42QK	0-230V	2 x 15V	50mA
A43QK	0-230V	2 x 18V	42mA
A44QK	0-230V	2 x 24V	31mA

Order Code	Mod: 1032704	Price each exc. VAT 1+	inc. VAT each
A44QK	1.5VA Encaps 2x24V	£2.49	£2.99
A43QK	1.5VA Encaps 2x18V	£2.49	£2.99
A42QK	1.5VA Encaps 2x15V	£2.49	£2.99
A41QK	1.5VA Encaps 2x12V	£2.49	£2.99
A40QK	1.5VA Encaps 2x9V	£2.49	£2.99
A39QK	1.5VA Encaps 2x6V	£2.49	£2.99

2.3VA Encapsulated PCB Transformers

ORDER IN STORE OR ONLINE



- High Quality Encapsulated Transformers

- Single Primary Winding 0-230V
- Dielectric Strength: 4200 Vrms
- Inherently Short-circuit proof
- Ambient Temperature: +70°C
- Available 2x6V, 2x9V, 2x12V, 2x15V, 2x18V and 2x24V

2.3 VA Encapsulated PCB Transformers

Order Code	Input Voltage	Output Voltage	Output Current
A45QK	0-230V	2 x 6V	191mA
A46QK	0-230V	2 x 9V	127mA
A47QK	0-230V	2 x 12V	95mA
A48QK	0-230V	2 x 15V	76mA
A49QK	0-230V	2 x 18V	63mA
A50QK	0-230V	2 x 24V	48mA

Order Code	Mod: 1032706	Price each exc. VAT 1+	inc. VAT each
A50QK	2.3VA Encaps 2x24V	£3.32	£3.99
A49QK	2.3VA Encaps 2x18V	£3.32	£3.99
A48QK	2.3VA Encaps 2x15V	£3.32	£3.99
A47QK	2.3VA Encaps 2x12V	£3.32	£3.99
A46QK	2.3VA Encaps 2x9V	£3.32	£3.99
A45QK	2.3VA Encaps 2x6V	£3.32	£3.99

3.2VA Encapsulated PCB Transformers

ORDER IN STORE OR ONLINE



- High Quality Encapsulated Transformers
- Single Primary Winding 0-230V
- Dielectric Strength: 4200 Vrms
- Inherently Short-circuit proof
- Ambient Temperature: +70°C
- Available 2x6V, 2x9V, 2x12V, 2x15V, 2x18V and 24V

3.2 VA Encapsulated PCB Transformers

Order Code	Input Voltage	Output Voltage	Output Current
A51QK	0-230V	2 x 6V	266mA
A52QK	0-230V	2 x 9V	178mA
A53QK	0-230V	2 x 12V	133mA
A54QK	0-230V	2 x 15V	107mA
A55QK	0-230V	2 x 18V	89mA
A56QK	0-230V	2 x 24V	67mA

Order Code	Mod: 1032711	Price each exc. VAT 1+	inc. VAT each
A56QK	3.2VA Encaps 2x24V	£4.99	£5.99
A55QK	3.2VA Encaps 2x18V	£4.99	£5.99
A54QK	3.2VA Encaps 2x15V	£4.99	£5.99
A53QK	3.2VA Encaps 2x12V	£5.82	£6.99
A52QK	3.2VA Encaps 2x9V	£4.99	£5.99
A51QK	3.2VA Encaps 2x6V	£4.99	£5.99

Auto Transformers

Auto Transformers



- Step-up / Step-down Auto Transformers
- Connection by insulated terminal block
- Used to supply fridges, air conditioners, compressors

Auto Transformers

Order Code	Mod: 1032698	Price each exc. VAT 1+	inc. VAT each
A36QK	1000VA Auto Trans	£83.32	£99.99
A35QK	500VA Auto Trans	£45.82	£54.99
A34QK	250VA Auto Trans	£41.65	£49.99
A33QK	150VA Auto Trans	£33.32	£39.99
A32QK	100VA Auto Trans	£29.15	£34.99
A31QK	50VA Auto Trans	£20.82	£24.99

Audio Transformers

Miniature Audio Transformers



Two economically priced miniature transformers for audio matching. Dimensions 20 x 16 x 15mm. [CT = Centre tapped]. Output type 200mW.

Type No	Application	Primary impedance	Secondary impedance
LT44	Min TR LT44 Driver	20kΩ	1kΩCT
LT700	Min TR LT700 Output	1.2kΩCT	32Ω

Order Code	Mod: 003709	Price each exc. VAT 1+	inc. VAT each
HX82D	Min Tr LT44	£2.49	£2.99
LB14Q	Min Tr LT700	£2.24	£2.69

6.3+6.3 : 1+1 PCB Audio Input Transformer

ORDER IN STORE OR ONLINE

- High quality signal over wide frequency band
- Resin encapsulated in glass filled nylon case
- Foil interwinding screen
- Industry standard 0
- 1in. grid spacing
- Optional Mu-metal, a nickel-iron alloy, screening can (Maplin Code : A300F)



High performance, industry standard PCB mounting audio frequency transformer. The dual primary and secondary windings provide a range of impedance matching ratios to suit many input, interstage and output applications.

Turns Ratio	6.3+6.3	1+1
Primary Impedance	1500	
Secondary Impedance	3.75Ω	
Primary Series Connection	6000	
Secondary Series Connection	150	
Primary Parallel Connection	1500	
Secondary Parallel Connection	3.75Ω	

Order Code	Mod: 1020341	Price each exc. VAT 1+	inc. VAT each
A25QF	6.3+6.3:1+1 PCB Audi	£8.32	£9.99

1+1 : 2+2 PCB Audio Input Transformer

ORDER IN STORE OR ONLINE

- High quality signal over wide frequency band
- Resin encapsulated in glass filled nylon case
- Foil interwinding screen



- Industry standard 0
- 1in. grid spacing
- Optional Mu-metal, a nickel-iron alloy, screening can (Maplin Code A300F)

High performance, industry standard PCB mounting audio frequency transformer. The dual primary and secondary windings provide a range of impedance matching ratios to suit many input, interstage and output applications.

Turns Ratio	1+1	2+2
Primary Impedance	1500	
Secondary Impedance	6000	
Primary Series Connection	6000	
Secondary Series Connection	2.4K0	
Primary Parallel Connection	1500	
Secondary Parallel Connection	6000	

Order Code	Mod:	Price each exc. VAT 1+	inc. VAT each
A26QF	1+1 2+2 PCB Audio	£8.32	£9.99

1+1 : 6.45+6.45 PCB Audio Input Transformer

ORDER IN STORE OR ONLINE

- High quality signal over wide frequency band
- Resin encapsulated in glass filled nylon case
- Foil interwinding screen
- Industry standard 0
- 1in. grid spacing
- Optional Mu-metal, a nickel-iron alloy, screening can (Maplin Code: A300F)



High performance, industry standard PCB mounting audio frequency transformer. The dual primary and secondary windings provide a range of impedance matching ratios to suit many input, interstage and output applications.

Turns Ratio	1+1	6.45+6.45
Primary Impedance	1500	
Secondary Impedance	6.25K0	
Primary Series Connection	6000	
Secondary Series Connection	25K0	
Primary Parallel Connection	1500	
Secondary Parallel Connection	6.25K0	

Order Code	Mod:	Price each exc. VAT 1+	inc. VAT each
A27QF	1+1 6.45+6.45 Audio	£8.32	£9.99

1+1 : 1+1 Audio Input Transformer 150R

ORDER IN STORE OR ONLINE

- High quality signal over wide frequency band
- Resin encapsulated in glass filled nylon case
- Foil interwinding screen
- Industry standard 0
- 1in. grid spacing
- Optional Mu-metal, a nickel-iron alloy, screening can (Maplin Code: A300F)



High performance, industry standard PCB mounting audio frequency transformer. The dual primary and secondary windings provide a range of impedance matching ratios to suit many input, interstage and output applications.

Turns Ratio	1+1	1+1
Primary Impedance	1500	
Secondary Impedance	1500	
Primary Series Connection	6000	
Secondary Series Connection	6000	
Primary Parallel Connection	1500	
Secondary Parallel Connection	1500	

Order Code	Mod:	Price each exc. VAT 1+	inc. VAT each
A28QF	1+1 1+1 Audio 150R	£8.32	£9.99

1+1 : 1+1 Audio Input Transformer 600R

ORDER IN STORE OR ONLINE

- High quality signal over wide frequency band
- Resin encapsulated in glass filled nylon case
- Foil interwinding screen
- Industry standard 0
- 1in. grid spacing
- Optional Mu-metal, a nickel-iron alloy, screening can (Maplin Code: A300F)



High performance, industry standard PCB mounting audio frequency transformer. The dual primary and secondary windings provide a range of impedance matching ratios to suit many input, interstage and output applications.

Turns Ratio	1+1	1+1
Primary Impedance	6000	
Secondary Impedance	6000	
Primary Series Connection	2.4K0	
Secondary Series Connection	2.4K0	
Primary Parallel Connection	6000	
Secondary Parallel Connection	6000	

Order Code	Mod:	Price each exc. VAT 1+	inc. VAT each
A29QF	1+1 1+1 Audio 600R	£8.32	£9.99

Mu-Metal Shield Can

ORDER IN STORE OR ONLINE



High Performance Screening Properties.
Mu-metal, a nickel-iron alloy, screening can

Width	30.00mm
Depth	25.50mm
Height	24.00mm

Order Code	Mod:	Price each exc. VAT 1+	inc. VAT each
A30QF	Mu-Metal Shield Can	£4.15	£4.99

Trigger Transformers

Trigger Transformers

ORDER IN STORE OR ONLINE

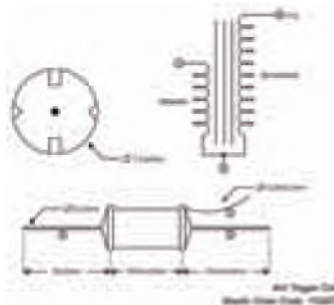

Trigger transformers for use with our xenon tubes and other strobe applications. The 6kV type is suitable with FS79, Beacon Xenon Tube.

Secondary resistance:	17.750	900
Specifications	YQ63T	JE15R
Output voltage	4kV	6kV
Trigger capacitor	0.1µF	0.047µF

Energy (mJ)	0.6	0.9
Primary turns	16.5	15.5
Secondary turns	500	700
Primary inductance	3.81µH ±15%	4µH ±25%
Secondary inductance	2.64mH ±15%	6.5mH ±20%
Primary resistance:	120mΩ	85mΩ
Primary voltage	170V	190V

Order Code	Mod:	Price each exc. VAT 1+	inc. VAT each
YQ63T	4kV Trigger Transfmr	£1.65	£1.34
JE15R	6kV Trigger Transfmr	£2.15	£2.59

1:1 Open PCB Mount HF Pulse Transformer

ORDER IN STORE OR ONLINE

- Open PCB Mount
- Designed for wide band
- Ideal for Triac and Thyristor control systems
- Max Pulse Current 200mA



Open 1:1 PCB Mount HF Pulse Transformer

Winding Ratio	1	1
Primary Inductance	3 mH [Min]	
Secondary Inductance	3 mH [Min]	
Primary DCR	1.10 Ω	
Secondary DCR	1.32 Ω	
Inter Wind Capacitance	20pF	
Leakage Inductance	19µH	
Isolation Voltage	2.8kVac	

Order Code	Mod:	Price each exc. VAT 1+	inc. VAT each
A31QF	1:1 Open Pulse Tran	£3.32	£3.99

1:1+1 Open PCB Mount HF Pulse Transformer

ORDER IN STORE OR ONLINE

- Open PCB Mount
- Designed for wide band
- Ideal for Triac and Thyristor control systems
- Max Pulse Current 200mA



Open 1:1+1 PCB Mount HF Pulse Transformer

Winding Ratio	1	1+1
Primary Inductance	3 mH [Min]	
Secondary Inductance	3 + 3 mH [Min]	
Primary DCR	1.32 Ω	
Secondary DCR	1.10+1.54 Ω	
Inter Wind Capacitance	30pF	
Leakage Inductance	8µH	
Isolation Voltage	2.8kVac	

Order Code	Mod:	Price each exc. VAT 1+	inc. VAT each
A32QF	1:1+1 Open Pulse Tran	£3.32	£3.99

Maplin TV

Home of innovation, handy tips and How To videos

Visit our channel...
youtube.com/maplintv



2:1+1 Open PCB Mount HF Pulse Transformer

ORDER IN STORE OR ONLINE

- Open PCB Mount
- Designed for wide band
- Ideal for Triac and Thyristor control systems
- Max Pulse Current 200mA



Open 2 1+1 PCB Mount HF Pulse Transformer

Winding Ratio	2	1+1
Primary Inductance	12 mH [Min]	
Secondary Inductance	3 + 3 mH [Min]	
Primary DCR	3.36 Ω	
Secondary DCR	1.40+2.0	
Inter Wind Capacitance	26pF	
Leakage Inductance	30uH	
Isolation Voltage	2.8KVac	

Order Code	Mod: 1020349	Price each exc. VAT	inc. VAT each
A330F	2 1+1Open Pulse Tran	£3.32	£3.99

2:1 Open PCB Mount HF Pulse Transformer

ORDER IN STORE OR ONLINE

- Open PCB Mount
- Designed for wide band
- Ideal for Triac and Thyristor control systems
- Max Pulse Current 200mA



Open 2 1 PCB Mount HF Pulse Transformer

Winding Ratio	2	1
Primary Inductance	12 mH [Min]	
Secondary Inductance	3 mH [Min]	
Primary DCR	2.32 Ω	
Secondary DCR	1.45 Ω	
Inter Wind Capacitance	19pF	
Leakage Inductance	115uH	
Isolation Voltage	2.8KVac	

Order Code	Mod: 1020350	Price each exc. VAT	inc. VAT each
A340F	2 1 Open Pulse Tran	£3.32	£3.99

1:1 Encapsulated PCB Mount HF Pulse Transformer

ORDER IN STORE OR ONLINE

- Encapsulated PCB Mount
- Designed for wide band
- Ideal for Triac and Thyristor control systems
- Max Pulse Current 200mA



Encapsulated 1:1 PCB Mount HF Pulse Transformer

Winding Ratio	1	1
Primary Inductance	3 mH [Min]	
Secondary Inductance	3 mH [Min]	
Primary DCR	1.10 Ω	
Secondary DCR	1.32 Ω	
Inter Wind Capacitance	20pF	
Leakage Inductance	19uH	
Isolation Voltage	2.8KVac	

Order Code	Mod: 1020351	Price each exc. VAT	inc. VAT each
A350F	1 1 Encap Pulse 2.8KV	£4.15	£4.99

1:1+1 Encapsulated PCB Mount HF Pulse Transformer

ORDER IN STORE OR ONLINE

- Encapsulated PCB Mount
- Designed for wide band
- Ideal for Triac and Thyristor control systems
- Max Pulse Current 200mA



Encapsulated 1:1+1 PCB Mount HF Pulse Transformer

Winding Ratio	1	1+1
Primary Inductance	3 mH [Min]	
Secondary Inductance	3 + 3 mH [Min]	
Primary DCR	1.32 Ω	
Secondary DCR	1.10+1.54 Ω	
Inter Wind Capacitance	30pF	
Leakage Inductance	8uH	
Isolation Voltage	2.8KVac	

Order Code	Mod: 1020352	Price each exc. VAT	inc. VAT each
A360F	1 1+1 Encap P. 2.8KV	£3.32	£3.99

Over 200 stores nationwide

2:1+1 Encapsulated PCB Mount HF Pulse Transformer

ORDER IN STORE OR ONLINE

- Encapsulated PCB Mount
- Designed for wide band
- Ideal for Triac and Thyristor control systems
- Max Pulse Current 200mA



Encapsulated 2:1+1 PCB Mount HF Pulse Transformer

Winding Ratio	2	1+1
Primary Inductance	12 mH [Min]	
Secondary Inductance	3 + 3 mH [Min]	
Primary DCR	3.36 Ω	
Secondary DCR	1.40+2.0	
Inter Wind Capacitance	26pF	
Leakage Inductance	30uH	
Isolation Voltage	2.8KVac	

Order Code	Mod: 1020353	Price each exc. VAT	inc. VAT each
A370F	2 1+1 Encap P. 2.8KV	£4.15	£4.99

2:1 Encapsulated PCB Mount HF Pulse Transformer

ORDER IN STORE OR ONLINE

- Encapsulated PCB Mount
- Designed for wide band
- Ideal for Triac and Thyristor control systems
- Max Pulse Current 200mA



Encapsulated 2:1 PCB Mount HF Pulse Transformer

Winding Ratio	2	1
Primary Inductance	12 mH [Min]	
Secondary Inductance	3 mH [Min]	
Primary DCR	2.32 Ω	
Secondary DCR	1.45 Ω	
Inter Wind Capacitance	19pF	
Leakage Inductance	115uH	
Isolation Voltage	2.8KVac	

Order Code	Mod: 1020354	Price each exc. VAT	inc. VAT each
A380F	2 1 Encap Puls 2.8KV	£3.32	£3.99

4:1 Encapsulated PCB Mount HF Pulse Transformer

ORDER IN STORE OR ONLINE

- Encapsulated PCB Mount
- Designed for wide band
- Ideal for Triac and Thyristor control systems
- Max Pulse Current 200mA



Encapsulated 4:1 PCB Mount HF Pulse Transformer

Winding Ratio	4	1
Primary Inductance	50 mH [Min]	
Secondary Inductance	3 mH [Min]	
Primary DCR	5.60 Ω	
Secondary DCR	1.85 Ω	
Inter Wind Capacitance	22.5pF	
Leakage Inductance	370uH	
Isolation Voltage	2.8KVac	

Order Code	Mod: 1020355	Price each exc. VAT	inc. VAT each
A390F	4 1 Encap Puls 2.8KV	£3.32	£3.99

1:1 Encapsulated PCB Mount HF Pulse Transformer - High Isolation

ORDER IN STORE OR ONLINE

- Encapsulated PCB Mount
- Designed for wide band
- Ideal for Triac and Thyristor control systems
- Max Pulse Current 200mA



Encapsulated 1:1 PCB Mount HF Pulse Transformer - High Isolation

Winding Ratio	1	1
Primary Inductance	3 mH [Min]	
Secondary Inductance	3 mH [Min]	
Primary DCR	0.80 Ω	
Secondary DCR	0.80 Ω	
Inter Wind Capacitance	5pF	
Leakage Inductance	85uH	
Isolation Voltage	5KVac	

Order Code	Mod: 1020356	Price each exc. VAT	inc. VAT each
A400F	1 1 Encap Pulse 5KV	£3.32	£3.99

2:1 Encapsulated PCB Mount HF Pulse Transformer - High Isolation

ORDER IN STORE OR ONLINE

- Encapsulated PCB Mount
- Designed for wide band
- Ideal for Triac and Thyristor control systems
- Max Pulse Current 200mA



Encapsulated 2:1 PCB Mount HF Pulse Transformer - High Isolation

Winding Ratio	2	1
Primary Inductance	1.5 mH [Min]	
Secondary Inductance	0.4 mH [Min]	
Primary DCR	0.44 Ω	
Secondary DCR	0.20 Ω	
Inter Wind Capacitance	5pF	
Leakage Inductance	85uH	
Isolation Voltage	5KVac	

Order Code	Mod: 1020357	Price each exc. VAT	inc. VAT each
A410F	2 1 Encap Pulse 5KV	£3.32	£3.99

Friendly expert advice on
0333 400 9500

Suppression

R.F. Chokes



A range of RF chokes having a triple barrier against moisture, and high termination strength and reliability. Colour code (as resistors) gives value in μH .

Specifications:

Rating: $\frac{1}{2}$ W

Insulation resistance: $> 10^9 \Omega$

Value (μH)	Test freq	Freq self resonant	Qmin	Max D.C. resistance	Max D.C. current
2.2	7.96	140	55	0.25 Ω	1000mA
4.7	7.96	95	60	0.34 Ω	820mA
10	7.96	35	65	0.49 Ω	680mA
22	2.52	13	50	0.74 Ω	560mA
47	2.52	7.5	40	1.1 Ω	450mA
100	2.52	5	30	1.7 Ω	370mA
470	0.79	2.2	55	7.9 Ω	170mA
1mH	0.79	1.6	50	14 Ω	130mA

Note: Q measured at 20°C and D.C. resistance measured at 70°C

Order Code	Mod: 003660	Price each exc. VAT 1+	inc. VAT each 5+
WH31J	Choke 2.2 μH	£0.82	£0.99
WH33L	Choke 4.7 μH	£0.74	£0.89
WH35Q	Choke 10.0 μH	£0.82	£0.99
WH37S	Choke 22.0 μH	£0.82	£0.99
WH39N	Choke 47.0 μH	£0.82	£0.99
WH41U	Choke 100 μH	£0.82	£0.99
WH45Y	Choke 470 μH	£0.82	£0.99
WH47B	Choke 1mH	£0.82	£0.99

Delta Suppression Filter



- Used for radio interference suppression of small electric motors and domestic appliances
- The delta filter is connected between the live, neutral and earth terminals to reduce RFI
- Best results require installation close to the source of the interference
- Encapsulated thermoplastic, sealed with polyurethane resin
- 250V AC rated
- UK manufactured

Specifications:

Rated voltage:	250Vac
Capacitance tolerance:	$\pm 20\%$
Temperature range:	-25°C to + 85°C
Dimensions:	17 x 32mm
C μF	0.1
C pF	2x4700
R	2.2m Ω

Order Code	Mod: 000501	Price each exc. VAT 1+	inc. VAT each 5+
RG21X	Delta Filter	£2.74	£3.29

Contact Suppressor

- The RC network will suppress arcing and also reduce dv/dt
- RFI can be reduced over a wide frequency range
- Capacitor and resistor are connected in series
- 250V AC rated
- UK manufactured



Specifications:

Capacitance	0.1 μF
Resistor	100 Ω
Maximum Voltage	250Vac (class x)

Power Rating 0.5 W
Terminations 0.8mm tinned copper wire
Dimensions 22 x 8 x 19mm (Lead spacings 22.5mm)
Dimensions 22 x 8 x 19mm (Lead spacings 22.5mm)

Order Code	Mod: 000498	Price each exc. VAT 1+	inc. VAT each 5+
RG22Y	RC Suppressor	£2.40	£2.89

Transient Suppressor MOV

These devices are simply connected directly across the power supply. They have a very high resistance up to the Vm voltage shown in the table below and therefore usually may be ignored, but the moment a transient spike appears on the supply line which exceeds Vm, the impedance of the device drops immediately to a very low level while it dissipates the unwanted energy. For example, Suppressor 275Vac can be connected directly across the UK mains supply.



Please note that the use of AC in the description is simply an indication of its most likely use. Both types can be used equally in AC or DC circuits up to the Vm stated.

* Current ratings are for a typical transient pulse where peak current is reached in 8 μs and the pulse has decayed to 50% of its peak value after a further 12 μs . It is a standard method of rating these devices and is usually described as an 8/20 μs current wave rating.

Type	Device marking	Continuous voltage (max) Vmac Vmdc	Peak current* 2500A	Clamping voltage* 710V
275Vac	VDRS10P275xyE	275V 350V		

Order Code	Mod: 000499	Price each exc. VAT 1+	inc. VAT each 5+
CP76H	Suppressor 275VAC	£0.65	£0.79

Ferrites

Ferrite Rings and Beads



- A range of ferrite rings and beads designed to cure electromagnetic and radio frequency interference at source

Always choose an internal diameter close to that of the cable or wind through several times. Always put ferrites at the noisy end of the cable. The smaller ferrites (Order codes N88CU, N97AB and N98AB are supplied in packs of 10, whilst the other larger sizes are supplied singly.)

Code:	Part number:	Max dia.	Max L	Min Hole dia	Attenuation Ω 25Mhz
100MHz					
N97AB	HEM3020	5.2	18.4	2	128
N98AB	HEM3021	6.2	18.4	3	155
N92AB	HEM3015	14.6	29.1	6.05	255
N91AB	HEM3014	16.05	29.17	6.69	258
N87AB	HEM3010	31.8	22.75	18.5	88
N90AB	HEM3013	28.96	29.33	13.37	158
N88AB	HEM3011	25.6	13.4	15.5	53
QT26	HEM3016	36.8	7.3	24.4	23

Order Code	Mod: 032792	Price each exc. VAT 1+	inc. VAT each 5+
N97AB	Ferrite HEM3020 10PK	£2.07	£2.49
N98AB	Ferrite HEM3021 10PK	£3.57	£4.29
N92AB	Ferrite HEM3015 x 1	£2.74	£3.29
N91AB	Ferrite HEM3014 x 1	£2.49	£2.99
N87AB	Ferrite HEM3010 x 1	£2.65	£3.19
N90AB	Ferrite HEM3013 x 1	£2.74	£3.29
N88AB	Ferrite HEM3011 x 1	£2.74	£3.29
QT26D	Ferrite HEM3016 x 1	£2.49	£2.99

Technical Helpline

0333 400 9500

For technical information and assistance relating to any Maplin purchase, contact our team of experts

Clip-on Ferrites



A range of clip-on ferrite rings designed to cure electromagnetic & radio frequency interference at source. Always choose an internal diameter close to that of the cable or wind through several times. Always put ferrites at the noisy end of the cable.

Order Code	Part number	Max diameter	Max length	Min hole dia	Attenuation (Ω) 25 Mhz
N89AB	HEM3012	13	25.5	2.4	93
N94AB	HEM3017	24.5	13.5	10	105
N95AB	HEM3018	20.5	36	6.5	120
N96AB	HEM3019	15	14	6	103

Ferrite Rod Aerial



Ferrite rod aerial consisting of medium wave and long wave coils around 127mm x 9.525mm rod. The coils can be moved for best performance then fixed with adhesive. Inductance of the medium wave coil is 300 μH and the long wave coil is 3.2mH.

Typical coverage
Medium wave - 550 to 1550KHz (193 to 545M)
Longwave 150 to 280KHz (1070 to 2000M)

Order Code	Mod: 000859	Price each exc. VAT 1+	inc. VAT each 5+
LB12N	MW/LW Aerial	£2.49	£2.99

Buying for business?
0333 400 9740



PCB Development

Development Software

Livewire Circuit Simulator



- Real time interactive circuit simulation
- Large database of component devices
- Schematic design and capture
- Realistic simulation of maximum component ratings and component destruction
- Standard edition includes voltmeter, ammeter and oscilloscope
- Pro edition includes a comprehensive suite of virtual instruments including voltmeter, ammeter, oscilloscope, logic analyser, signal generator and word generator
- Export circuits to PCB Wizard 3 order code N31AJ
- Integrated publishing with text, graphics and spell-checking support
- Free demo and tutorials downloadable from <http://www.new-wave-concepts.com>

Livewire is a powerful software package for designing, simulating and analysing electronic circuits. Switches, transistors, diodes, integrated circuits and hundreds of other components can all be connected together to investigate the behaviour of a circuit. There are no limits to what can be designed and no loose connections or faulty components to worry about. However, if the maximum ratings for any components are exceeded, they'll explode!

The software is supplied on a CD-ROM and requires Microsoft Windows 95, 98, ME, NT 4.0 (with SP6), 2000, XP, Vista or 7. User guide and instructions are included within the software. More information including list of supported components and the differences between Standard and Pro editions can be found at www.new-wave-concepts.com

Order Code	Mod: 033100	Price each exc. VAT		inc. VAT each
		1+	5+	
N29AJ	Livewire Standard	£33.32	£28.79	£39.99
N30AJ	Livewire Pro	£49.99	£43.19	£59.99

PCB Wizard 3 Printed Circuit Board Design Software



- Large database of components
- Schematic design and capture
- Manual PCB design
- Single sided auto-routing for standard version
- Single and double sided auto-routing for professional version
- User-defined components
- Copper pour
- Bill of materials report generator
- Gerber and N.C. drilling export

- Integrated publishing with text, graphics and spell-checking support
- Import circuits from Livewire, order code N29AJ
- Free demo and tutorials downloadable from <http://www.new-wave-concepts.com>

PCB Wizard 3 is a highly innovative package for designing printed circuit boards. Offering unrivalled productivity through powerful design tools and an ultra-friendly user interface, PCB Wizard 3 is the ideal choice for all your project work. Add to that, a wealth of clever features that do away with the steep learning curve normally associated with PCB packages, and PCB Wizard 3 is hard to beat.

The software is supplied on a CD-ROM and requires Microsoft Windows 95, 98, ME, NT 4.0 (with SP6), 2000, XP, Vista or 7. User guide and instructions are included within the software. More information including list of supported components and the differences between Standard and Pro editions can be found at www.new-wave-concepts.com

Order Code	Mod: 033101	Price each exc. VAT		inc. VAT each
		1+	5+	
N31AJ	PCB Wizard 3 Std	£33.32	£28.79	£39.99
N32AJ	PCB Wizard 3 Pro	£49.99	£43.19	£59.99

Circuit Wizard Simulation Software



- World's first interactive circuit and PCB simulation
- Large database of component devices
- Schematic design and capture
- Breadboard simulation
- Manual PCB design
- Single and double sided auto-routing
- Standard edition includes voltmeter, ammeter and oscilloscope
- Pro edition includes a comprehensive suite of virtual instruments including voltmeter, ammeter, oscilloscope, logic analyser, word generator, function generator and DC power supply
- Copper pour
- Bill of materials report generator
- Gerber and N.C. drill export
- Import circuits from Livewire N29AJ and PCB Wizard 3 N31AJ
- Integrated publishing with text, graphics and spell-checking support
- Free demo software downloadable from <http://www.new-wave-concepts.com>

Have you ever designed a PCB only to find that it doesn't work when it's made? Well, with Circuit Wizard that's a thing of the past as you can now simulate PCBs on screen ready for manufacture. Circuit Wizard represents a significant step forward over existing software and offers everything you'll need for your project work including schematic capture and simulation, breadboarding, PCB layout and simulation, bill of materials reporting and file generation for manufacturing.

The software is supplied on a CD-ROM and requires Microsoft Windows 95, 98, ME, NT 4.0 (with SP6), 2000, XP, Vista or 7. User guide and instructions are included within the software. More information including list of supported components and the differences between Standard and Pro editions can be found at www.new-wave-concepts.com

Order Code	Mod: 046480	Price each exc. VAT		inc. VAT each
		1+	5+	
N75CB	Circuit Wizard Std	£49.99	£43.19	£59.99
N76CB	Circuit Wizard Pro	£74.99	£64.79	£89.99

SourceBoost Technologies BoostC 'C' Compiler for PICmicro and SourceBoost IDE



- ANSI 'C' compatible
- Produces optimised code to reduce execution time and memory usage
- Supports devices in the PIC12, PIC16 and PIC18 families
- Automatic code page switching
- Automatic bank switching for variables
- 1, 8, 16 and 32 bit data types
- Automatic context save and restore in interrupt service routines
- Optional C++ language features: function overloading, function templates and references as function arguments
- Source code level debug output
- Code output in industry standard Intel Hex file format
- Compatible with Microchip ICD2 when integrated into Microchip MPLAB
- Code produced is compatible with Velleman K8048 Programmer - Order Code N36AC (kit version) and N61CG (assembled version)

SourceBoost IDE (Integrated Development Environment) features:

- Project manager, profiler and symbol browser
- Built-in debugger with clock accurate simulation
- Source level and assembler level debugging
- Code stepping - step into, step over, step out and the unique step back
- Real world peripheral simulation through device plug-ins

The BoostC 'C' Compiler for PICmicro is the next generation of 'C' compiler from SourceBoost Technologies. It supports over 250 devices in the Microchip PIC12, PIC16 and PIC18 device families. The devices supported are those with 14bit and 16bit instruction op-codes. A complete list of supported devices can be found at <http://www.sourceboost.com>

The software is supplied on a CD-ROM and is compatible with PCs with the following specifications:

Operating system	Microsoft Windows 95/98/ME/NT/2000/XP®
CPU	Pentium Processor or equivalent
RAM	128MB minimum
Disk Space Required:	80MB
Graphics Card	16-bit colour display adaptor capable of displaying at 800 x 600 resolution

License Limitations

License Type	Program Limitations	Usage Limitations
Standard	4k Instructions	Non-commercial only

Order Code	Mod: 099468	Price each exc. VAT		inc. VAT each
		1+	5+	
N36CU	BoostC Standard Ed	£16.65	£14.39	£19.99

Breadboard

RH-10S Silver Plated Plugblock Type



A high quality plugblock with silver-plated contacts for low contact resistance. The plugblock has a total of 640 contacts.

arranged in two blocks of 64 rows of 5 interconnected sockets on a 2.54 x 2.54mm matrix. The distance between the two centre rows of sockets is 7.62mm and the block will hold up to nine 14-pin DIL packages for example. All contact positions are clearly marked on an alpha-numeric grid. Fixing is by self-adhesive foam insulating strip on the base of the block.

Specifications:

Body material: ABS polymer
 Contact resistance: <1mΩ
 Contact rating: 1A
 Contacts: Silver-plated nickel-silver
 Contact life: >5000 insertions
 Dimensions: 172 x 38.5 x 8mm thick

Order Code	Mod.	Price each exc. VAT 1+	inc. VAT each 5+
FD31J	Mod: 001982 Plugblock RH10S	£4.99	£5.99

RH-21B Silver Plated Plugblock Type

ORDER IN STORE OR ONLINE



A plugblock comprising one RH-10S and two RH5DS plugblocks mounted on an attractive blue base with three terminal posts and a component bracket. This unit thus provides a total of 840 contacts.

Body material: ABS polymer

Specifications:

Contact resistance: <1mΩ
 Contact rating: 1A
 Contacts: Silver-plated nickel-silver
 Contact life: >5000 insertions
 Dimensions: 190x118x19mm thick

Order Code	Mod.	Price each exc. VAT 1+	inc. VAT each 5+
YU79L	Mod: 001989 Plugblock RH21B	£9.99	£11.99

RH 32S Silver Plated Plugblock Type



A plugblock comprising two RH-10S and three RH-5DS plugblocks mounted on an attractive blue base with three terminal posts and a component bracket. This unit thus provides a total of 1580 contacts.

Specifications:

Body material: ABS polymer
 Contact resistance: <1mΩ
 Contact rating: 1A
 Contacts: Silver-plated nickel-silver
 Contact life: >5000 insertions
 Dimensions: 190x168x19mm thick

Order Code	Mod.	Price each exc. VAT 1+	inc. VAT each 5+
FD32K	Mod: 001991 Plugblock RH32S	£12.49	£14.99

AD-100 Breadboard



This breadboard will allow prototyping of projects prior to a more permanent assembly solution, it's ideal for hobbyists, students, Lab work or by any one who needs to test a circuit. A self-adhesive pad is attached to the rear of the breadboard, and consists of two sections; a section of 30 blocks of six rows labelled 'A' to 'F', and an identical section labelled 'G' to 'L'. Can also be connected to AD-01[BZ13P], AD-102[AG10L], AD-101[AG09K], or other AD-100 blocks. Dimensions: 42 x 83 x 10mm

Order Code	Mod.	Price each exc. VAT 1+	inc. VAT each 5+
AG08J	Mod: 005195 AD100 Plugblock	£2.49	£2.99

AD-101 Breadboard



This breadboard will allow prototyping of projects prior to a more permanent assembly solution, it's ideal for hobbyists, students, Lab work or by any one who needs to test a circuit. A self-adhesive pad is attached to the rear of the breadboard. Can also be connected to AD-01[BZ13P], AD-100[AG08J], AD-102[AG10L], or other AD-101 blocks. Dimensions: 83x52x10mm.

Order Code	Mod.	Price each exc. VAT 1+	inc. VAT each 5+
AG09K	Mod: 005199 AD101 Plugblock	£3.32	£3.99

AD-102 Breadboard



This breadboard will allow prototyping of projects prior to a more permanent assembly solution, it's ideal for hobbyists, students, Lab work or by any one who needs to test a circuit. A self-adhesive pad is attached to the rear of the breadboard. Can also be connected to AD-01[BZ13P], AD-100[AG08J], AD-101[AG09K], or other AD-102 blocks. Dimensions: 62x83x10mm.

Order Code	Mod.	Price each exc. VAT 1+	inc. VAT each 5+
AG10L	Mod: 005202 AD102 Plugblock	£4.99	£5.99

Advanced Solderless Breadboard



A range of solderless breadboard modules that can interconnect to suit individual requirements. The basic board AD-01 consists of four blocks of six columns of 28 rows, the sockets in each row being interconnected. The blocks are a standard DIP size apart, although MSI and LSI type chips can be used. At both ends of the blocks, there are two power busses. The 'Red' bus is made up of two separate rows of 12 connecting sockets, and the 'Black' bus is one row of 24 connecting sockets.

There is an additional matrix of 30 by 6 sockets for non-dip type components. The six sockets in the vertical plane are interconnected. Each socket will accept solid wire from 20 to 30 swg (0.3 to 0.8mm). The base has a 'sticky' covering to hold the board firm on a workbench or surface. The AD-10 power block has 5 individual screw terminals that will accept 4.5mm Y-terminal, stripped wire or 4mm banana plug. Each terminal is connected to two sockets. The power block will snap lock onto the AD-01 base board to allow connections to the required power bus. The power block has the same 'sticky' base. After use the modules can be unlocked and remade into a different configuration.

AD-01 is 117 x 80mm
 AD-11 is one AD-01 and one AD-10 Size: 147 x 80mm
 AD-12 is two AD-01 and one AD-10 mounted on a blue base board. Size: 183 x 168mm
 AD-13 is three AD-01 and one AD-10 mounted on a blue base board. Size: 265 x 168mm
 AD-14 is four AD-01 and one AD-10 mounted on a blue base board. Size: 335 x 168mm

Order Code	Mod.	Price each exc. VAT 1+	inc. VAT each 5+
BZ13P	Breadboard AD-01	£5.82	£6.99
BZ14Q	Breadboard AD-11	£7.49	£8.99
BZ15R	Breadboard AD-12	£12.49	£14.99
BZ16S	Breadboard AD-13	£15.82	£18.99
BZ17T	Breadboard AD-14	£19.15	£22.99

Flexible Jumper Wires



- Packs of flexible jumper wires for use with our plugblocks
- Wires are terminated in hard pins at each end
- 11 strands of insulated 0.16mm copper conductor with a 7mm long, 0.6mm diameter pin
- Supplies in packs of 10, colour of wire denotes the length

Type	Flexible length	Overall length
50	50mm	75mm
70	70mm	95mm
100	100mm	125mm
150	150mm	175mm
200	200mm	225mm

Order Code	Mod.	Price each exc. VAT 1+	inc. VAT each 5+
FS66W	Mod: 002013 Jump Lead 10Pk	£4.15	£4.99
FS67X	Jump Lead 70 10Pk	£4.99	£5.99
FS68Y	Jump Lead 100 10Pk	£5.40	£6.49
FS69A	Jump Lead 150 10Pk	£5.82	£6.99
FS70M	Jump lead 200 10pk	£6.65	£7.99

Technical Helpline
0333 400 9500
 For technical information and assistance relating to any Maplin purchase, contact our expert team



Jump Wire Kit



A kit containing 14 different length jumper wires for use with our plugblocks. Wires are stripped and formed at 90° at each end. There are 25 wires of each length: 2.54mm [0.1in.] uninsulated, 58mm [0.2in.], 7.62mm [0.3in.], 10.16mm [0.4in.], 12.7mm [0.5in.], 15.24mm [0.6in.], 17.78mm [0.7in.], 20.32mm [0.8in.], 22.86mm [0.9in.], 25.4mm [1in.], 50.8mm [2in.], 76.2mm [3in.], 101.6mm [4in.], 127mm [5in.]. Wires are supplied in various colours. They are 23swg solid tinned copper wire, supplied in an attractive plastic case with a blue base and clear hinged lid with each length wire in a separate compartment. Overall size of box 270 x 124 x 30mm high.

Order Code	Mod: 002014	Price each exc. VAT 1+	inc. VAT each
FS6SV	Jump Wire Kit	£13.74	£16.49

Stripboard

Veroboard Copper Tripad Board 100x160mm

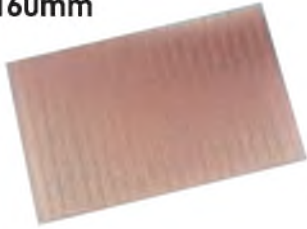

- Turn circuit diagrams into functional projects easily
- Mount dual-in-line integrated circuits and other components
- Transfer your breadboard layouts on to a permanent base
- Simple strip layout makes it easy to build complex circuits
- Copper pads are isolated from each other and can be cut to stop current flow
- 39 copper strips with 62 holes, each strip is divided into 20 3 hole pads so track cutting is virtually eliminated
- SRBP base material is very easy to cut to the required size with simple tools
- 35 micron copper material can handle relatively large currents
- 100x160mm board size

Ideal for development and prototyping work, Veroboard Tripad is designed primarily for hard wiring of discrete components, typically in analogue circuits, but is equally useful where a clusters of isolated components need to be placed within the same board. Veroboard is manufactured from copper clad laminated board which has been pierced with a grid of holes and machined to provide Tripad solder points.

Specifications	
Board dimensions:	100x160mm
Base material:	SRBP
Hole diameter:	1.02mm
Pierced copper tracks:	39
Holes per track:	62
No of 3 hole segments:	20

Order Code	Mod: 1029116	Price each exc. VAT 1+	inc. VAT each
A66RL	Tripad 100x160mm	£5.82	£6.99

Veroboard Copper DIL Stripboard 38.1x214.6mm

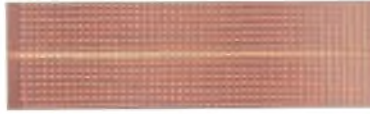

- Turn circuit diagrams into functional projects easily
- Transfer your breadboard layouts on to a permanent base
- Specifically designed to make working with DIL or DIP ICs easy
- One full strip has had the copper removed
- Simple strip layout makes it easy to build complex circuits
- Copper tracks are isolated from each other and can be cut to stop current flow
- SRBP base material is very easy to cut to the required size with simple tools
- 35 micron copper material can handle relatively large currents
- 38.1x214.6mm board size

Ideal for development and prototyping work, Veroboard is designed primarily for hard wiring of discrete components, typically in analogue circuits, but is equally useful where a number of common bus or signal lines are required. Veroboard DIL board is manufactured from copper clad laminated board which has been pierced with a grid of holes. It has a machined isolation strip making it suitable for quick and speedy layouts using Integrated circuits

Specifications	
Board dimensions:	38.1x214.6mm
Base material:	SRBP
Hole diameter:	1.02mm
Pierced copper tracks:	15
Holes per track:	81

Order Code	Mod: 001918	Price each exc. VAT 1+	inc. VAT each
FL17T	Stripboard	£5.24	£6.29

Veroboard Copper Stripboards

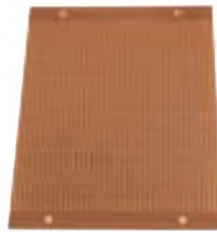

- Turn circuit diagrams into functional projects easily
- Transfer your breadboard layouts on to a permanent base
- Simple strip layout makes it easy to build complex circuits
- Copper tracks are isolated from each other and can be cut to stop current flow
- Solid copper rail for power bus applications
- SRBP base material is very easy to cut to the required size with simple tools
- 35 micron copper material can handle relatively large currents

Ideal for development and prototyping work, Veroboard is designed primarily for hard wiring of discrete components, typically in analogue circuits, but is equally useful where a number of common bus or signal lines are required. Veroboard is manufactured from copper clad laminated board which has been pierced with a grid of holes and machined to provide parallel tracks. Plain matrix Veroboard board designed to map out circuit ideas as an alternative to breadboard or soldering. Components can be tied or fixed to the holes and interconnected with hook up wires to form the circuit

Order Code	Board dimensions	Hole diameter	Pierced copper tracks	Holes per track
A62RL	100x160mm	1.02mm	36	60
A63RL	111x176mm	1.02mm	40	61
A64RL	95x292mm	1.02mm	34	115
A65RL	104x65mm	1.3mm		975
A61RL	121.92x101.60mm	1.02mm	44	41

Order Code	Mod: 1032713	Price each exc. VAT 1+	inc. VAT each
A61RL	Stripboard 121x101mm	£4.15	£4.99
A62RL	Stripboard 100x160mm	£4.99	£5.99
A63RL	Stripboard 111x176mm	£5.82	£6.99
A64RL	Stripboard 95x292mm	£7.07	£8.49
A65RL	Plain Board 104x65mm	£2.49	£2.99

Spot Face Cutter



Designed for accurate and clean breaking of the copper strips on stripboard. For best results use light pressure

Order Code	Mod: 001926	Price each exc. VAT 1+	inc. VAT each
FL25C	Tool 2022	£10.82	£12.99

Printed Circuit Boards

Copper Clad Boards



- A range of copper clad boards for PCB development
- Made from SRBP or fibreglass material in various sizes
- Fibreglass material in single sided or double sided.

	Dimensions (mm)	Dimensions (inches)
Single-sided SRBP:		
HX00A	203 x 102mm	8 x 4in
WF38R	254 x 152mm	10 x 6in
WF39N	305 x 203mm	12 x 8in
Single-sided Fibreglass:		
HX01B	203 x 102mm	8 x 4in
WF40T	254 x 152mm	10 x 6in
WF41U	305 x 203mm	12 x 8in
Double-sided Fibreglass:		
WF42V	254 x 152mm	10 x 6in
FA59P	305 x 203mm	12 x 8in

Order Code	Mod: 002112	Price each exc. VAT 1+	inc. VAT each
HX00A	PCB SRBP 5mil Single	£1.65	£1.99
WF38R	PCB SRBP Med Single	£3.32	£3.99
WF39N	PCB SRBP Lrg Single	£4.99	£5.99
HX01B	PCB F.Glass 5m Single	£2.24	£2.69
WF40T	PCB F.Glass Med Single	£3.32	£3.99
WF41U	PCB F.Glass Lrg Single	£4.99	£5.99
WF42V	PCB F.Glass Med Dble	£5.82	£6.99
FA59P	PCB F.Glass Lrg Dble	£6.65	£7.99

160x100mm FPC-16 Pre-Sensitised PCB Board

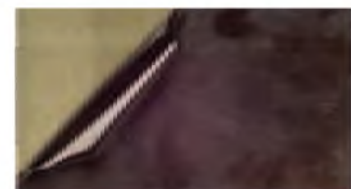

- Single sided copper clad FPC-16 board coated with a positive photo-resist
- FPC-16, sometimes know as FRG50, composite board
- Two fibre glass layers with a paper composite in

- between
- 1oz, 35 micron thickness copper
- This material is light weight, easy to cut and easy to drill
- Suitable for use with our UV exposure box
- Covered with light-proof protective film, which should not be removed until the board is used

The PCB should be exposed using a UV exposure box such as YA36P and a circuit overlay transparency N43KT. Exposure time will vary depending on the strength of the etching solutions used. consult the chemical manufacturers instructions.

Single-sided SRBP: Order Code:
160 x 100mm A98RR

Order Code	Mod: 1032953	Price each exc. VAT 1+	5+	inc. VAT each
A98RR	FPC-16 PEtch 100x160	£3.74	£3.23	£4.49

Pre-Sensitised FR4 Copper-Clad Board

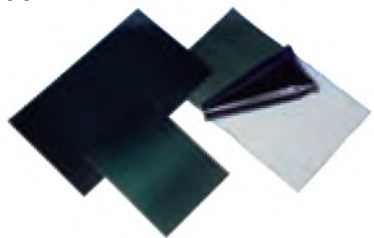

- Single and double-sided copper glass fibre boards coated with a positive photo-resist
- Suitable for use with our UV exposure box
- Covered with light-proof protective film, which should not be removed until the board is used

The PCB should be exposed using our UV exposure box and a circuit overlay transparency. Exposure time will be from 8 to 15 minutes. Mix together 0.5 litres approximately with one teaspoonful of sodium hydroxide (available from most chemists) and pour into a tray (CH38R). Gently rock the exposed PCB in the tray until the unwanted photo resist is dissolved away. Etch the board in a bath of ferric chloride and after rinsing, expose the PCB in the UV box for a further 10 minutes. Wash off all the remaining etch resist in a tray of sodium hydroxide solution.

Sizes available:

Single-sided SRBP:	Order Code:
100 x 75mm	[size 1] JP55K
160 x 100mm	[size 2] JP56L

Single-sided Fibreglass	Order Code:
100 x 75mm	[size 1] FA60Q
160 x 100mm	[size 2] BW19V
220 x 100mm	[size 3] KU13P
233 4 x 160mm	[size 4] KU14Q
300 x 210mm	[size 6] FA63T

Double-sided Fibreglass	Order Code:
100 x 75mm	[size 1] FA61R
160 x 100mm	[size 2] FA62S
300 x 210mm	[size 6] FA64U

Order Code	Mod: 002033	Price each exc. VAT 1+	inc. VAT each
FA60Q	F/Glass Size1 Single	£1.65	£1.99
BW19V	F/Glass Size2 Single	£2.90	£3.49
KU13P	F/Glass Size3 Single	£3.74	£4.49
KU14Q	F/Glass Size4 Single	£4.99	£5.99
FA63T	F/Glass Size6 Single	£12.49	£14.99
FA61R	F/Glass Size1 Double	£2.74	£3.29
FA62S	F/Glass Size2 Double	£3.74	£4.49
FA64U	F/Glass Size6 Double	£10.82	£12.99

Solder Tags

Solder Tags



- A range of heavily tinned metric solder tags
- All types supplied in packs of ten

Order Code	Mod: 029815	Price each exc. VAT 1+	5+	inc. VAT each
RG84T	Isotag M3	£1.24	£1.19	£1.49
RG87U	Isotag M4	£1.24	£1.19	£1.49
RG88V	Isotag M5	£1.24	£1.19	£1.49
RG89W	Isotag M9	£1.49	£1.43	£1.79

5 Way Tagstrip



Five tags mounted on a paxolin strip where the middle tag is for screw fixing.

Order Code	Mod: 001956	Price each exc. VAT 1+	5+	inc. VAT each
FM34M	5-Way Tagstrip	£1.65	£1.41	£1.99

Single Ended Solder Pin 1.0mm 100 Pack



Single-ended pin, 1.0mm [0.04in] diameter. Supplied in packs of 100 pieces.

Dimensions (mm)

Order Code	Hole Diameter	A	B	C	D	E
FL24	1	7.27	4.47	0.93	0.51	1.6

Order Code	Mod: 001933	Price each exc. VAT 1+	5+	inc. VAT each
FL24B	Pin 2145 100Pk	£3.74	£3.14	£4.49

Double Ended Solder Pin 1.0mm 100 Pack



Double-ended pin, 1.0mm [0.04in] diameter. Supplied in packs of 100 pieces.

Specifications:

Order Code	Hole Diameter	A	B	C	D	E
FL23	1	9.7	5.6	1.1	1	4

Order Code	Mod: 001932	Price each exc. VAT 1+	5+	inc. VAT each
FL23A	Pin 2144 100Pk	£4.15	£3.21	£4.99

Single Ended Solder Pin 1.3mm 100 Pack

ORDER IN STORE OR ONLINE



Single-ended pin, 1.3mm [0.052in] diameter. Supplied in packs of 100 pieces.

Specifications:

Order Code	Hole Diameter	A	B	C	D	E
FL21	1.32	7.27	4.47	1.21	0.51	1.94

Order Code	Mod: 001930	Price each exc. VAT 1+	5+	inc. VAT each
FL21X	Pin 2141 100Pk	£3.57	£3.09	£4.29

Double Ended Solder Pin 1.3mm 100 Pack

ORDER IN STORE OR ONLINE



Double-ended pin, 1.3mm [0.052in] diameter. Supplied in packs of 100 pieces.

Specifications:

Order Code	Hole Diameter	A	B	C	D	E
FL20	1.32	11.9	6.7	1.4	1.2	0.5

Order Code	Mod: 001929	Price each exc. VAT 1+	inc. VAT each
FL20W	Pin 2140 100Pk	£3.65	£4.39

Development Equipment

Helping Hands with Magnifier



- An indispensable aid for model-makers, DIYers or professionals
- Features adjustable joints for versatile movement in all directions
- Strong crocodile clamps hold work secure
- Heavy cast iron base for added stability
- Distortion free magnifying glass included
- Ideal for any application where a "third hand" is needed

Order Code	Mod: 006017	Price each exc. VAT 1+	inc. VAT each
N30CH	Helping Hands + Mag	£10.82	£12.99

Subscribe to our newsletter
For deals and information
maplin.co.uk



Printed Circuit Board Etch Resistant Marker Pen



A nylon tipped pen for fast fabrication of perfect printed circuit boards. The ink adheres perfectly to copper and is completely resistant to ferric chloride and other usual etchant solutions. Draw the planned circuit onto a thoroughly cleaned copper laminated board and allow to dry. Then immerse the board in etching fluid until the copper is dissolved. The ink can then be removed with Degreasing Solvent or PCB Cleaner, and the circuit board is then ready to be drilled and assembled. This pen is capable of producing thin, delicate lines allowing for quite a condensed track layout if required. It can also be used as an indelible marker felt tip pen for an enormous range of materials, especially metals.

Order Code	Mod.	Price each exc. VAT	inc. VAT each
HX02C	002104	1+ 5+	£3.32 £2.99
PCB Pen			

Electrically Conductive Silver Paint



- Pure silver is used in the formulation to give excellent conductive properties and a hard resilient surface film.
- Simple to apply
- Highly conductive
- Tough surface film
- Supplied in a 3g phial
- Dries in 15 to 30 minutes

Typical applications include making electrical connections on circuit boards, providing radio frequency interference shielding, repairing broken track on PCBs, repairing demisters on car rear windows, bonding wires together, conductive ink and many more. Once applied the paint will last for many years and after opening will last for at least 2 years in the bottle.

Please note: We are not allowed to sell butane or solvent based products to persons under the age of 18

Order Code	Mod.	Price each exc. VAT	inc. VAT each
N36BA	036275	1+ 5+	£8.32 £7.49
Silver Cond. Paint 3g			

Flux Dispensing Pen



- Chisel tip marker provides exact delivery of flux to surface
- Applies a patented non-corrosive, halide free, organic no-clean flux
- Flux meets Bellcore TR-NWT-000078 and IPC SF-818 for Surface Insulation Resistance
- 9g pen

A pen for applying flux with precision and control.

Order Code	Mod.	Price each exc. VAT	inc. VAT each
N63AA	033849	1+ 5+	£8.32 £7.49
No Clean Flux Disp.			

Rosin Flux Dispensing Pen



- Chisel tip marker provides exact delivery of flux to surface
- Applies a non-corrosive type R flux
- Flux meets MIL-F-14256 E+F Type R and RMA
- 9g pen

A pen for applying flux with precision.

Order Code	Mod.	Price each exc. VAT	inc. VAT each
N65AA	033850	1+ 5+	£10.82 £9.74
Rosin Flux Dispenser			

Abrasive Fibreglass Pencil



- A fibreglass abrasive stick housed in a propelling pencil type case
- Designed for removing protective lacquer coatings on PCB boards
- Can also be used for generally cleaning copper track for soldering
- A spare fibreglass stick is available (Order Code: KR62S)

Warning: A certain amount of fibreglass dust is produced which should be removed with great care. Avoid touching with exposed skin as the particles can easily penetrate flesh and be extremely uncomfortable. Avoid contact with eyes.

Order Code	Mod.	Price each exc. VAT	inc. VAT each
KR61R	003932	1+	£6.24
Fibreglass Pencil			

Fibreglass Pencil Refill



- Spare fibreglass abrasive stick for the KR61R pencil

Warning: A certain amount of fibreglass dust is produced which should be removed with great care. Avoid touching with exposed skin as the particles can easily penetrate flesh and be extremely uncomfortable. Avoid contact with eyes.

Order Code	Mod.	Price each exc. VAT	inc. VAT each
KR62S	678107	1+ 5+	£1.24 £1.11
Pencil Refill			

Abrasive Polishing Block



- Made from a fine, non-metallic polishing compound bonded in an elastic material for even wear
- Designed to clean, degrease and polish copper board prior to PCB etching
- It can be used to clean contacts, switch gear, potentiometers and adjustable transformers

- Other uses include cleaning and preparation of model railway track

Order Code	Mod.	Price each exc. VAT	inc. VAT each
HX04E	002109	1+ 5+	£4.15 £2.99
Polish Block			

Beginner's Etching Set



- Simple kit for creating high quality PCBs
- Includes 3 copper clad PCB boards and one photo sensitive board
- Sachet of developer and sachet of Sodium Persulfate is provided
- This kit is an ideal way to make bespoke and one off PCBs

Please note safety gloves and eye protection should be worn when using the chemicals

Contents	Quantity
Etch tray	1
Tweezers	1
Etching Powder 100g	1
Photo developer (makes 1l)	1
Photo board [80 x 100mm]	1
PCB [55 x 100mm]	3
PCB [100 x 100mm]	1
PCB [100 x 130mm]	1

Order Code	Mod.	Price each exc. VAT	inc. VAT each
N64BX	045873	1+	£14.15
Beginners Etch Set			

LaserStar PCB Printing Film

ORDER IN STORE OR ONLINE



- 10 clear transparencies suitable for direct printing with laser printers
- Print your PCB designs directly onto this material ready for etching
- Compatible with most laser printers
- LaserStar has a 75 micron base with a special coating for high resolution keying and fixing
- This film will accept copier toner to use artworks from pre-printed originals
- Allows consistent and professional PCB's to be produced
- Film is the same on both sides so its very easy to work with
- More reliable than ink or transfer based systems

Order Code	Mod.	Price each exc. VAT	inc. VAT each
N43KT	611666	1+ 5+	£10.82 £7.94
Laser PCB Film 10pk			

Reserve online, collect in-store in 30 minutes



Press and Peel PCB Transfer System



- Create professional and quick PCB layouts every time
- PCB images are printed onto the film using your laser printer or photo copier
- Iron the film onto the copper clad board using an iron
- The film is removed leaving the circuit behind ready for etching
- Supplied in packs of 5
- Size 216 x 279mm (8.5 x 11")

Order Code	Mod: 013464	Price each exc. VAT 1+	inc. VAT each 5+
AB15R	Press-N-Peel PCB	£16.65	£14.39

UV Exposure Unit

ORDER IN STORE OR ONLINE



- The steel-cased LV models are the most cost effective UV units offered
- All controls are conveniently front mounted
- 6-minute mechanical timer, also acts as a switch
- UV output 2 x 8W (2.5 mW/cm²)

The tube is in the base, which means the artwork has to be registered on the UV sensitive area and then placed face down onto the exposure area. Coloured black, each unit has a hinged lid containing a pressure pad which, when the lid is held closed by the two retaining clips, acts to force the artwork and sensitive material firmly together on the UV illuminated area. When the control knob is rotated to the required time the power is turned on and the exposure commences. The timer clicks off as soon as the exposure is completed.

Additional spare tube order code YA39N

Order Code	Mod: 026301	Price each exc. VAT 1+	inc. VAT each 5+
YA36P	Small UV Expsre Unit	£116.65	£139.99
YA39N	Spare UV tubes	£13.32	£15.99

Professional Bubble Tank With Heater

ORDER IN STORE OR ONLINE



- Create professional PCBs with this bubble etch tank
- Integrated heater and thermostat for a quick etch time, 5-7 minutes with Ferric
- Forced air pump and twin bubble bars provide even

and efficient etching

- Illuminated switch panel with splash resistant covers
- 5 litre capacity
- Etch boards up to 250 x 300mm (10 x 12inch)

Specifications

Board Size	260mm x 300mm
Integral Pump & Bubble Bar Assembly	Yes
Heater	500W
Thermostat	Yes, variable to 50°C
Etching Time	5-7 minutes with Ferric
Tank Capacity	5 litres
Inner Tank	Injection moulded one piece
Outer Wrapper	CNC cut and welded outer in 6mm Polypropylene with slinging front panel to house controls

Power Cord via separate mains lead and IEC fused socket

Order Code	Mod: 762094	Price each exc. VAT 1+	inc. VAT each 5+
N29QF	Pro Bubble Tank	£229.15	£208.99

Etching Tray



- White PCB etching/cleaning tray made from 'Talc Feel Polypropylene'
- Dimensions: 370(l) x 275(w) x 60(h)mm

Order Code	Mod: 010440	Price each exc. VAT 1+	inc. VAT each 5+
CH38R	Etch Tray	£7.49	£6.47

Etching Fluid 1 Litre



- Ferric Chloride fluid to etch printed circuit boards
- Can be used as supplied or be diluted further
- Robust plastic bottle with childproof cap
- 1 Litre of fluid

Order Code	Mod: 988122	Price each exc. VAT 1+	inc. VAT each 5+
N540F	1L Etch Fluid	£16.65	£19.99

Etching Fluid 250ml

- Ferric Chloride fluid to etch printed circuit boards
- Can be used as supplied or be diluted further
- Robust plastic bottle with childproof cap



Order Code	Mod: 002102	Price each exc. VAT 1+	inc. VAT each 5+
WF10L	250ml Etch Fluid	£10.82	£7.49

Positive Photo Resist

ORDER IN STORE OR ONLINE

- Fast drying positive photoresist in an aerosol
- Used for reproduction of circuits, images, PCBs, signs and diagrams
- Fine resolution, develops using UV or sunlight
- Ideal for prototyping or small scale production



Order Code	Mod: 587586	Price each exc. VAT 1+	inc. VAT each 5+
N17KH	PCB Photo Resist Spr	£10.82	£7.49

Universal PCB Developer

A sodium-hydroxide free PCB developer that is supplied in free flowing odourless granules and is ready for dilution with water. Suitable for single or double sided PCBs, and all applications such as prototype work is 10g of granules with 100ml of water, or the full 250g would make up to 2.5 litres of developer.

The ideal temperature for dilution and developing is room temperature, i.e. approximately 20°C. Development time will depend on the complexity of the board design, dilution ratio of the solution and the temperature.

After development, the board should be rinsed thoroughly and dried either in air or an oven. Always wear protective gloves and goggles and avoid contact with the eyes and skin but, in case of contact, flush liberally with water. Ensure all containers and utensils used with this product are made from strong chemical-resistant plastics or glass.

Do not use any equipment made from metal.

Order Code	Mod: 002085	Price each exc. VAT 1+	inc. VAT each 5+
AP01B	PCB Developer	£8.32	£7.19

Maplin PCB Lacquer

- Fast drying acrylic lacquer coating
- Acid and alkali resistant
- Multi-application
- Seals printed circuitry
- Use for over-lacquering of metal and paint work
- Ideal as a waterproof coating for maps and technical documents
- Supplied in a 200ml can



Please note: We are not allowed to sell butane or solvent based products to persons under the age of 18

Order Code	Mod: 025345	Price each exc. VAT 1+	inc. VAT each 5+
N67AN	PCB Lacquer 200ml	£4.15	£4.15

Buying for business?

0333 400 9740



Servisol PCB Lacquer

- Protective coating for PCBs and electronic components
- Protects against humidity, air pollution and environmental damage
- Film can be soldered through to facilitate "spot" repairs
- Operational to 200°C
- Supplied in a 200ml aerosol can



Please note: We are not allowed to sell butane or solvent based products to persons under the age of 18.

Order Code	Mod: 029005	Price each exc. VAT	inc. VAT each
		1+	5+
RE80B	PCB Lacquer 200ml	£4.99	£4.79 £5.99

PCB Compounds

PX804C Epoxy Resin



- A good alternative to PX700K
- High electrical insulating characteristics
- Non-toxic
- Good thermal conductivity
- Low shrinkage
- High adhesion
- Flame retardant to UL94-V0 @ 3mm
- Good chemical and water resistance
- Meets the requirements of WEEE and RoHS

This epoxy resin PX804C potting compound is a non-toxic general purpose flame retardant potting and encapsulating compound. It is a safer alternative to the popular PX700 and can be used for the same applications.

PX804C has a long usable life and may be hot or cold cured. The system exhibits good surface finish, high electrical strength, good thermal conductivity, low exotherm and low cure shrinkage.

The semi-flexible nature allows thermal expansion without cured stress and this makes PX804C compatible with most circuit board components and materials over a wide temperature range. Adhesion is excellent to most plastics and substrates.

The combination of properties and the ease of use of the material will lend itself to a wide range of applications. PX804C does not contain halogens or heavy metals and is available in 50g, 250g, 500g and 1Kg form. The finish colour is black.

Specification	
Colour	Black
Specific Gravity g/ml	1.7
Viscosity m.Pa @ 25° C	9000
Approvals	
RoHS compliant	Yes
UL94-V0	Yes
REACH (SVHC concentration)	0%
Mix ratio by weight	8.6 : 1
Mix ratio by volume	4.8 : 1
Useable life [15.0g @ 25° C]	120 Minutes
Gel time [1.50g @ 2.5° C]	360 minutes
Cure schedule	
Minimum cure	Full cure
24 hrs @ 20° C	1 week
2 hrs @ 60° C	4 hours
1 hr @ 80° C	2 hours

Typical properties
Peak exotherm [1.50g @ 2.5° C] 40

Shrinkage % [volume]	0.3
Thermal conductivity	0.85 W/m K
Operating temperature range	-5.5 to + 13.0° C [application & geometry dependent]

Electric strength	18 kV/mm
Volume resistivity	11 Log 10 ohm - cm
Shore D hardness	80
Flammability	UL94 - V0 3 mm
Tensile strength	50 mPa
Compressive strength	60 mPa
Deflection temperature	50° C
Co-efficient of expansion	35 - 5.5 ppm/° C
Loss Tangent	0.060 @ 50Hz
Permittivity	4.8 @ 50 Hz
Continuous tracking ind ex	>850 V
Water absorption	0.3% (30 days @ 20° C)
Elongation at break	2-5%

Order Code	Mod: 391533	Price each exc. VAT	inc. VAT each
		1+	5+
N90HW	PX804C Epoxy 50g	£6.65	£5.99 £7.99
N91HW	PX804C Epoxy 250g	£8.32	£7.49 £9.99
N92HW	PX804C Epoxy 500g	£11.65	£10.49 £13.99
N93HW	PX804C Epoxy 1Kg	£14.99	£13.49 £17.99



We can deliver to your home or office

(UK only)

Heat Transfer Compound



- Excellent non-creep characteristics
- Wide operating temperature [-50°C to +130°C]
- High thermal conductivity [0.9 W/mK]

This silicone free heat transfer compound is for use on electrical and electronic components that require improved thermal conductivity or the efficient dissipation of heat. It is supplied in 10ml and 35ml syringes, which allows pin point application and economy of use.

Please note: We are not allowed to sell butane or solvent based products to persons under the age of 18.

Order Code	Mod: 030171	Price each exc. VAT	inc. VAT each
		1+	5+
RE97F	Heat Trans. Comp 10ml	£5.40	£4.86 £6.49
RE98B	Heat. Trans. Comp 35ml	£9.15	£8.24 £10.99

Servisol High Thermal Conductivity Heatsink Compound



- Features:**
- High thermal conductivity
 - Excellent contact material when mounting semiconductor devices onto heatsinks
 - Low moisture and metallic impurity content
 - Suitable for a wide variety of applications
 - Operational from -50°C to +200°C
 - Supplied in a handy 25g tube

Order Code	Mod: 033695	Price each exc. VAT	inc. VAT each
		1+	5+
N57AL	Hsink Compound 25g	£3.32	£2.99 £3.99

1000's more components available in-store & online

Fuses

Fuse Wire

5A/15A/30A Fuse Wire 3 Pack

- 3 lengths of fuse wire
- 70" of 5 amp fuse wire for use in lighting circuits. Max circuit loading 1kW
- 28" of 15 amp fuse wire for use in kettles, small heaters and water heaters. Max circuit loading 3kW
- 20" of 30 amp fuse wire for cookers and ring circuits, larger heaters, wash boilers and immersion heaters. Max circuit loading 7kW



Order Code	Mod: 000494	Price each exc. VAT	inc. VAT each
		1+	5+
HB51F	Fuse Wire	£1.90	£2.29

Household Fuses

1 Inch (25.4mm) Type Domestic Mains Fuses



- Standard electrical fuses to BS1362
- Size: 25.4 x 6.4mm

[1 x 1/4 inch]. Available in 10 packs of 3A, 5A and 13A ratings. Also available as a handy mixed pack, containing 2 x 3A, 3 x 5A and 5 x 13A fuses

Order Code	Pack Size	Fuse Type
AR37S	10	3A
AR38R	10	5A
AR41U	10	13A
L80AG	10	2 x 3A, 3 x 5A, 5 x 13A

Order Code	Mod: 004526	Price each exc. VAT	inc. VAT each
		1+	5+
AR37S	Plug Fuse 3A 10 Pk	£2.90	£2.51 £3.49
AR38R	Plug Fuse 5A 10 Pk	£2.90	£2.51 £3.49
AR41U	Plug Fuse 13A 10 Pk	£2.90	£2.51 £3.49
L80AG	Mixed Fuses 10 Pack	£3.07	£2.61 £3.69

Find out more in-store

Our staff can offer friendly and expert advice; we're here to help



10A 230V Mains Plug Fuses 4 Pack

- Standard electrical fuses to BS1362
- Size: 25.4 x 6.4mm



Order Code	Mod: 635925	Price each exc. VAT	inc. VAT each
		1+	5+
N52NF	Plug Fuse 10A 4 Pk	£1.24	£1.07 £1.49

1A 230V Shaver Adapter Plug

Fuse 2 Pack



- 20mm x 5mm
- Conforms to BS646
- Supplied in pack of 2

Replacement fuse for 13A plug style adapters for 230V, electric shavers, toothbrushes and other low power appliances.

Order Code	Mod: 045786	Price each exc. VAT 1+	inc. VAT each 5+
N49BY	1A Shaver Fuses 2Pk	£1.65	£1.26

Consumer Unit Fuses BS1361

- Suitable for consumer fuse units taking cartridge fuses
- Used to replace blown fuses
- Manufactured to BS1361
- Available in the 5A, 15A, 20A and 30A ratings
- Sold individually



Order Code	Mod: 018113	Price each exc. VAT 1+	inc. VAT each 5+
MU79L	5A HRC Fuse C55	£2.49	£2.15
MU80B	15A HRC Fuse C1515	£2.40	£2.09
MU81C	20A HRC Fuse C1520	£1.90	£1.64
MU82D	30A HRC Fuse C3030	£2.49	£2.16

Glass Fuses

Bag of 30 Fuses



- Contains an assortment of fuses
- Approx 30 fuses per bag

Order Code	Component Type	Quantity (approx.)	Price each exc. VAT 1+	inc. VAT each 5+
N12GL	Fuses	30	£3.32	£2.87

20mm Glass Quickblow (F) Fuses 100mA



A handy pack of 10 fuses with nickel-finish brass end caps. Overall size 20mm length x 5mm diameter. Designed to IEC127 with SEMKO, UL, BSI and VDE approvals. Rated at 250Vac with a breaking capacity of 35A or 10 times the rated current, whichever is greater

Order Code	Mod: 633040	Price each exc. VAT 1+	inc. VAT each 5+
GJ72P	20mm OB 100mA 10 Pk	£1.90	£2.29

20mm Glass Quickblow



A range of fuses with nickel-finish brass end caps, overall size 20 x 5mm diameter. Designed to IEC127 with SEMKO, UL, BSI and VDE approvals. Rated at 250Vac with a breaking capacity of 35A or 10 times the rated current, whichever is greater.

Available in the following ratings:
100mA, 160mA, 200mA, 250mA, 315mA, 400mA, 500mA, 630mA, 800mA, 1A, 1.25A, 1.6A, 2A, 2.5A, 3.15A, 4A, 5A, 6.3A, 10A

Supplied in packs of 10

Order Code	Mod: 000451	Price each exc. VAT 1+	inc. VAT each 5+
GJ72P	20mm OB 100mA 10 Pk	£1.90	£2.29
GJ80B	20mm OB 160mA 10 PK	£1.90	£1.64
GJ83E	20mm OB 200mA 10 PK	£1.90	£1.64
GJ84F	20mm OB 250mA 10 PK	£1.90	£1.64
GJ85G	20mm OB 315mA 10 PK	£1.90	£1.64
GJ86T	20mm OB 400mA 10 PK	£1.90	£1.64
GJ87U	20mm OB 500mA 10 PK	£1.90	£1.64
GJ88V	20mm OB 630mA 10 PK	£1.90	£1.64
GJ89W	20mm OB 800mA 10 PK	£1.90	£1.64
GJ90X	20mm OB 1A 10 PK	£1.90	£1.64
GJ91Y	20mm OB 1.25A 10 PK	£1.90	£1.64
GJ92A	20mm OB 1.6A 10 PK	£1.90	£1.64
GG2AD	20mm OB 2A 10 PK	£1.90	£1.64
GJ93B	20mm OB 2.5A 10 PK	£1.90	£1.64
GJ94C	20mm OB 3.15A 10 PK	£1.90	£1.64
GJ95D	20mm OB 4A 10 PK	£1.90	£1.64
GJ96E	20mm OB 5A 10 PK	£1.90	£1.64
GJ97F	20mm OB 6.3A 10 PK	£1.90	£1.64
GJ98G	20mm OB 10A 10 PK	£1.90	£1.64

20mm Glass Time Delay Fuses



Glass tube, time-delay acting fuses with nickel-finish brass end caps. Overall size 20 x 5mm diameter. Recommended for where high start currents or surge currents are expected. Designed to IEC127 with SEMKO, UL, BSI and VDE approvals. Rated at AC 250V with a breaking capacity of 35A or 10x rated current, whichever is greater. Supplied in packs of 10 and available in the following ratings:

100mA, 160mA, 200mA, 250mA, 315mA, 400mA, 500mA, 630mA, 800mA, 1A, 1.25A, 1.6A, 2A, 2.5A, 3.15A, 4A, 5A, 6.3A, 10A

Order Code	Mod: 000452	Price each exc. VAT 1+	inc. VAT each 5+
GL35Q	20mm A/S 100mA 10PK	£2.65	£2.31
GL51F	20mm A/S 160mA 10 PK	£2.65	£2.31
GL52G	20mm A/S 200mA 10 PK	£2.65	£2.31
GL53H	20mm A/S 250mA 10 PK	£2.65	£2.31
GL54J	20mm A/S 315mA 10 PK	£2.65	£2.31
GL55K	20mm A/S 400mA 10 PK	£2.65	£2.31
GL56L	20mm A/S 500mA 10 PK	£2.65	£2.31
GL57M	20mm A/S 630mA 10 PK	£2.65	£2.31
GL58N	20mm A/S 800mA 10 PK	£2.65	£2.31
GL59P	20mm A/S 1A 10 PK	£2.65	£2.31
GL60Q	20mm A/S 1.25A 10 PK	£2.65	£2.31
GL61R	20mm A/S 1.6A 10 PK	£2.65	£2.31
GL62S	20mm A/S 2A 10 PK	£2.65	£2.31
GL63T	20mm A/S 2.5A 10 PK	£2.65	£2.31
GL64U	20mm A/S 3.15A 10 PK	£2.65	£2.31
N98JC	20mm A/S 4A 10 PK	£2.65	£2.24
GL65V	20mm A/S 5A 10 PK	£2.65	£2.31
GL66W	20mm A/S 6.3A 10 PK	£2.65	£2.31
GL67X	20mm A/S 10A 10 PK	£2.65	£2.31

31mm Quickblow 1¼ inch



Glass tube, fast acting fuses with nickel-finish brass end caps, overall size 31.8 x 6.35mm [1¼ quarter, x ¼ quarter, in.] diameter. Designed to IEC127. Rated at 60Vac. Supplied in 12 different ratings in packs of 10.

Order Code	Rating	Voltage	Breaking capacity
GL70M	250mA	60Vac	35A
GL71N	500mA	60Vac	35A
GL74R	1A	60Vac	35A
GL76H	1.6A	60Vac	100A
GL77J	2A	60Vac	100A
GL78K	2.5A	60Vac	100A
GL79L	3.15A	60Vac	100A
GL80B	4A	60Vac	200A
GL81C	5A	60Vac	200A
GL82D	6.3A	60Vac	200A
GL83E	10A	60Vac	200A
GL84F	15A	60Vac	200A

Order Code	Mod: 000461	Price each exc. VAT 1+	inc. VAT each 5+
GL70M	1 ¼ OB 250ma 10 PK	£1.90	£1.64
GL71N	1 ¼ OB 500ma 10 PK	£1.90	£1.64
GL74R	1 ¼ OB 1A 10 PK	£1.90	£1.64
GL76H	1 ¼ OB 1.6A 10 PK	£1.90	£1.64
GL77J	1 ¼ OB 2A 10 PK	£1.90	£1.64
GL78K	1 ¼ OB 2.5A 10 PK	£1.90	£1.64
GL79L	1 ¼ OB 3.15A 10 PK	£1.90	£1.64
GL80B	1 ¼ OB 4A 10 PK	£1.90	£1.64
GL81C	1 ¼ OB 5A 10 PK	£1.90	£1.64
GL82D	1 ¼ OB 6.3A 10 PK	£1.90	£1.64
GL83E	1 ¼ OB 10A 10 PK	£1.90	£1.64
GL84F	1 ¼ OB 15A 10 PK	£1.90	£1.64

31mm Time Delay 1¼ inch



Glass tube, time-delay acting fuses with nickel-finish brass end caps, overall size 31.8 x 6.35mm [1¼ quarter, x ¼ quarter, in.] diameter. Recommended for where high starting currents or surge currents are expected. Designed to IEC127. Rated at 60Vac with a breaking capacity of 35A for fuses up to 1A, 100A for fuses up to 3.5A and 200A for those rated over 3.5A.

Available in the following ratings:
250mA, 500mA, 1A, 1.6A, 2A, 3.15A, 5A, 6.3A, 10A, 16A
Supplied in packs of 10.

Order Code	Mod: 000462	Price each exc. VAT 1+	inc. VAT each 5+
GL87U	1 ¼ A/S 250ma 10PK	£2.74	£2.39
GL88V	1 ¼ A/S 500ma 10PK	£2.74	£2.39
GL91Y	1 ¼ A/S 1A 10PK	£2.74	£2.39
GL93B	1 ¼ A/S 1.6A 10 PK	£2.74	£2.39
GL94C	1 ¼ A/S 2A 10 PK	£2.74	£2.39
GL96E	1 ¼ A/S 3.15A 10PK	£2.74	£2.39
GL97F	1 ¼ A/S 5A 10 PK	£2.74	£2.39
GL98G	1 ¼ A/S 6.3A 10 PK	£2.74	£2.39
GG21X	1 ¼ A/S 10A 10 PK	£2.74	£2.39
GG25C	1 ¼ A/S 16A 10PK	£2.74	£2.39

Buy it on the web at maplin.co.uk

Shop for all Maplin products online at our website and check out our latest products and special offers!



Ceramic Fuses

Ceramic Time Delay (T) Fuse



A range of ceramic bodied, time delay fuses with electroplated end caps. The fuses are ideal for use in microwave ovens and other applications where a high break capacity is needed. Rated at 250Vac with breaking capacity of 200A.

Code	Size	Rating
PC91Y	20 x 5mm	8A
PC92A	20 x 5mm	10A
PG02C	1 1/4"	8A
PG03D	1 1/4"	10A

Supplied in packs of 10.

Order Code	Mod: 026084	Price each exc. VAT		inc. VAT each
		1+	5+	
PC91Y	M/w 20mm TD 8A	£2.90	£2.31	£3.49
PC92A	M/w 20mm TD 10A	£2.90	£2.31	£3.49
PG02C	M/w 1 1/4 TD 8A	£3.82	£3.36	£4.59
PG03D	M/w 1 1/4 TD 10A	£3.82	£3.36	£4.59

Fuse Kit

180 Part Fuse Kit



A handy fuse kit containing 18 of the most popular fuse types. Ideal for the person who requires convenient access to a range of fuses, such as maintenance or repair technicians. Each compartment is clearly labelled with the type and size of fuse it contains. The robust plastic container prevents fragile fuses from being damaged and has a close fitting lid to prevent spillage. Contains 10 each of the following fuses:

20mm Quick Blow (F) 500mA, 1A, 1.6A, 2A, 2.5A, 3.15A, 4A, 5A, 6.3A, 10A

20mm Time Delay (T) 1A, 2A, 3.15A, 5A
1 1/4" Quick Blow (F) 1A, 2A, 5A, 10A

Order Code	Mod: 017384	Price each exc. VAT		inc. VAT each
		1+	5+	
MS00A	Fuse Kit	£13.32		£15.99

Car Fuses

Car Fuse Set



- The ultimate car fuse set
- 120 fuses contained in tidy storage box

The set contains 20 each of 5, 10, 15, 20, 25 and 30 amp fuses.

Order Code	Mod: 037360	Price each exc. VAT		inc. VAT each
		1+	5+	
N08AU	120 Pc Car Fuse Set	£10.82		£12.99

SuperMini Blade Car Fuses



A mixed pack of super-miniature blade fuses for car use. Pack contains 3 x 10A, 5 x 15A and 2 x 20A fuses.

Order Code	Mod: 648296	Price each exc. VAT		inc. VAT each
		1+	5+	
N91LZ	SuperMini Blade Fuse	£1.65	£1.43	£1.99

Mini Blade Car Fuses

A range of miniature blade fuses for car use. Transparent, coloured bodies denote the rating. Rated at 32V. Available in the following ratings:

Order Code	Mod: 013328	Price each exc. VAT		inc. VAT each
		1+	5+	
VJ48C	Mini Blade Fuse 3A	£0.49	£0.41	£0.59
VJ49D	Mini Blade Fuse 5A	£0.49	£0.41	£0.59
VJ50E	Mini Blade Fuse 7.5A	£0.49	£0.41	£0.59
VJ51F	Mini Blade Fuse 10A	£0.49	£0.41	£0.59
VJ52G	Mini Blade Fuse 15A	£0.49	£0.41	£0.59
VJ53H	Mini Blade Fuse 20A	£0.49	£0.41	£0.59
VJ54J	Mini Blade Fuse 25A	£0.49	£0.41	£0.59
VJ55K	Mini Blade Fuse 30A	£0.49	£0.41	£0.59

Smart Mini-Blade Car Fuse with LED



- Save time and money on expensive garage bills
- Instant fault diagnosis without testing
- Ideal for troublesome circuits where fuses often blow
- Blown fuses glow
- Universal colour coded by ampere
- Easy to install - no tool required

Glow fuses work in an effective way when it comes to maintaining your vehicle, even with very limited knowledge of car electrics. The faulty fuse is quickly identified as it glows when the fuse is blown. Supplied in packs of 4.

Order Code	Mod: 049004	Price each exc. VAT		inc. VAT each
		1+	5+	
N01CH	5A Min Fuse + Lamp	£2.07	£1.79	£2.49
N03CH	10A Min Fuse + Lamp	£2.07	£1.79	£2.49
N05CH	20A Min Fuse + Lamp	£2.07	£1.79	£2.49
N07CH	30A Min Fuse + Lamp	£2.07	£1.79	£2.49

Smart Blade Car Fuse with LED



- Save time and money on expensive garage bills
- Instant fault diagnosis without testing
- Ideal for troublesome circuits where fuses often blow
- Blown fuses glow
- Universal colour coded by ampere

- Easy to install - no tool required

Glow fuses work in an effective way when it comes to maintaining your vehicle, even with very limited knowledge of car electrics. The faulty fuse is quickly identified as it glows when the fuse is blown. Supplied in packs of 4.

Order Code	Mod: 049003	Price each exc. VAT		inc. VAT each
		1+	5+	
N92CG	5A Fuse with Lamp	£2.07	£1.79	£2.49
N94CG	10A Fuse with Lamp	£1.90	£1.65	£2.29
N95CG	15A Fuse with Lamp	£1.99	£1.72	£2.39
N96CG	20A Fuse with Lamp	£1.99	£1.71	£2.39
N98CG	30A Fuse with Lamp	£2.07	£1.79	£2.49

Blade-Type Fuses

Fuses intended as standard plug-in replacements for fuses fitted in recent European cars. Supplied individually.



Order Code	Mod: 010140	Price each exc. VAT		inc. VAT each
		1+	5+	
CN83E	Blade Fuse 3A	£0.65	£0.51	£0.79
CN85G	Blade Fuse 5A	£0.65	£0.51	£0.79
CN86T	Blade Fuse 7.5A	£0.65	£0.51	£0.79
CN87U	Blade Fuse 10A	£0.65	£0.51	£0.79
CN88V	Blade Fuse 15A	£0.65	£0.51	£0.79
CN89W	Blade Fuse 20A	£0.65	£0.51	£0.79
CN90X	Blade Fuse 25A	£0.65	£0.51	£0.79
DR80B	Blade Fuse 30A	£0.65	£0.51	£0.79
DR81C	Blade Fuse 35A	£0.65	£0.51	£0.79

Gold Plated Maxi Fuse Kit



16 pack of Gold-Plated Maxi fuses for automotive uses. The pack contains two of each value 20A, 30A, 35A, 40A, 50A, 60A, 70A & 80A. The fuses are colour coded for easy identification. A fuseholder is available, Order Code MX15R.

Fuse value	Colour
20A	Yellow
30A	Green
35A	Pink
40A	Orange
50A	Red
60A	Blue
70A	Brown
80A	Clear

Order Code	Mod: 048026	Price each exc. VAT		inc. VAT each
		1+	5+	
N54CG	Gold Pltd Maxi Fuses	£8.32	£6.74	£9.99

Black In Line Blade Fuse Holder



Black nylon in-line fuseholder suitable for use with the standard plug-in type blade fuses. To use, cut the red wire connected between both terminals to give lead-outs to each terminal. Access to the fuse is by means of a snap-fit lid on the top of the holder, and several of these holders can be fitted together by virtue of a tongue and groove moulded into opposite sides of the casing. Rated up to 15A. Dimensions of body (lid closed): 27mm long, 37.5mm high, 18mm wide.

Order Code	Mod: 000444	Price each exc. VAT	inc. VAT each
		1+	5+
KU34M	15A Blade Fuse Hldr	£1.99	£1.71 £2.39

Black Splashproof Blade Fuse Holder



An in-line, splashproof fuseholder for standard blade fuses. The protective cover seals in the fuse for use in harsh environments. Moulded out of flexible black Alcryn thermoplastic on to 12AWG (3mm<x>2<x>) PVC insulated stranded wire. Maximum current 30A.

Order Code	Mod: 024539	Price each exc. VAT	inc. VAT each
		1+	5+
KK80B	30A Blade Fuseholder	£2.07	£1.79 £2.49

Water-Resistant Maxi Fuse Holder



- Waterproof Maxi blade fuse holder
- Connected with 8AWG cable
- Cut loop and connect ends to use

This fuse holder is water resistant and designed for a single Maxi type blade fuse. To use cut the wire loop and connect the ends in series with the circuit. The wire loop is 8AWG and approximately 300mm long. A pack of gold plated maxi fuses is available. Order Code N54CG, containing 16 fuses (2 of each value).

Order Code	Mod: 030444	Price each exc. VAT	inc. VAT each
		1+	5+
MX15R	Maxi Fuse Holder	£1.65	£1.43 £1.99
N54CG	Gold Pltd Maxi Fuses	£8.32	£6.74 £9.99

AGU Fuses 5 Pack



- High capacity in car fuses
- Five AGU (also known as 5AG) type fuses in each pack
- Protect expensive in car audio installations
- 24Kt gold-plated conductors help reduce the build up of oxides
- Rated up to 32V
- Available in 30, 40 and 60 Amp packs of five

Order Code	Mod: 030339	Price each exc. VAT	inc. VAT each
		1+	5+
QR96E	30A AGU Fuse 5 Pack	£1.65	£1.43 £1.99
QR97F	40A AGU Fuse 5 Pack	£1.65	£1.43 £1.99
QR99H	60A AGU Fuse 5 Pack	£1.65	£1.43 £1.99



Browse our entire range at maplin.co.uk

Gold plated Water Resistant Fuse Holder



- 24Kt gold-plated for clarity of sound
- For use with AGU (also known as 5AG) type fuses
- Connect with 4AWG or 8AWG cable
- Water resistant

This fuseholder is designed for a single fuse and comprises a water-resistant clear acrylic case with black screw on end caps with rubber seals. It can be used with 4AWG and 8AWG cables. The base has two 4mm diameter fixing holes.

Order Code	Mod: 030428	Price each exc. VAT	inc. VAT each
		1+	5+
DR84F	Water-Res Fuseholder	£3.32	£2.87 £3.99

In Line Fuse Holder



- Bayonet-action, in-line car type fuse-holder
- Moulded body
- Suitable for 32 mm (1 & quarter;") fuses
- Length: 60 mm
- Diameter 16 mm
- Rated at 5 A

Order Code	Mod: 000449	Price each exc. VAT	inc. VAT each
		1+	5+
DR79L	Car Fuseholder	£0.65	£0.57 £0.79

In-Line Fuse Holders



In-car type fuse holder moulded from clear plastic in two parts. These screw-together items house two collars and a spring. Termination is via screw terminals. Cable acceptance: 1mm to 2.64mm.

Rated at 10A, AC 250V when used within equipment, otherwise the maximum voltage is limited to AC/DC 50V.

Order Code	Mod: 000418	Price each exc. VAT	inc. VAT each
		1+	5+
RC70M	In-line F/H 1 1/4in	£1.90	£1.64 £2.29
RC71N	In-line F/H 20mm	£1.65	£1.43 £1.99

Thermal Fuses

Thermal Fuses



A range of thermal fuses which will protect equipment from excessive temperature rises. They are not resettable and must be replaced if 'blown'. NOTE: when installing any of these devices, never solder directly to the wire leads - you must use screw terminals, terminal blocks or crimped on connectors.

Specifications

Size of body	14mm long x 4mm dia
Lead lengths	
Long lead	34mm
Short lead	15mm
Rating	240V 10A max
Rupture current	40A (resistive), 20A (inductive)
Open circuit break -	
down voltage	1200Vac
Opening threshold	
temperature tolerance	+0°C 4°C

Order Code	Mod: 000470	Price each exc. VAT	inc. VAT each
		1+	5+
RA14Q	Thermal Fuse 93C	£0.82	£0.66 £0.99
RA64U	Thermal Fuse 110C	£0.82	£0.66 £0.99
RA15R	Thermal Fuse 128C	£0.82	£0.66 £0.99
RA17T	Thermal Fuse 152C	£0.82	£0.66 £0.99
RA18U	Thermal Fuse 167C	£0.82	£0.66 £0.99
RA19V	Thermal Fuse 184C	£0.82	£0.66 £0.99
RA20W	Thermal Fuse 192C	£0.82	£0.66 £0.99
RA22Y	Thermal Fuse 228C	£0.82	£0.66 £0.99
RA23A	Thermal Fuse 240C	£0.82	£0.66 £0.99

Circuit Breakers

Auto-Reset Circuit Breakers



A range of compact circuit breakers with an auto-reset facility. Designed to withstand overload but to trip quickly on short circuits, the circuit breaker latches into an 'off' state under fault conditions and automatically returns to the 'on' state after a set period of time. If the fault condition still exists, the unit will immediately latch 'off' again. This process of checking the circuit will continue until the fault is cleared. The range is suitable for working at voltages up to AC 250V, and offers seven rated 'holding-current' values. Connections are via two solder tags 7mm long. Overall dimensions: 29 x 12.5 x 6mm. Supplied individually in the following ratings: 1.0A, 1.6A, 2.2A, 3.0A, 5.0A, 7.0A, 10.0A.

Order Code	Mod: 000493	Price each exc. VAT	inc. VAT each
		1+	5+
AK07H	Auto Breaker 1.0A	£1.40	£1.19 £1.69
AK08J	Auto Breaker 1.6A	£1.40	£1.19 £1.69
AK09K	Auto Breaker 2.2A	£1.40	£1.19 £1.69
AK10L	Auto Breaker 3.0A	£1.40	£1.19 £1.69
AK11M	Auto Breaker 5.0A	£1.40	£1.19 £1.69
AK12N	Auto Breaker 7.0A	£1.32	£1.14 £1.59
AK13P	Auto Breaker 10.0A	£1.40	£1.19 £1.69

Panel Fuseholders

Panel Mount 20mm Fuseholder



- Panel mount fuse holder with threaded cap fuse carrier
- SEMKO, UL and CSA approval

Please note: A fuse should be inserted before assembling the product.

Specifications:

Electrical rating	AC 250V, 6.3A, 2.5W
Contact resistance	10mΩ
Insulation resistance	10MΩ
Dielectric strength	AC 2000V
Flammability rating	UL94V0
Panel cut-out	12.7mm diameter flattened
Overall length	35mm

Order Code	Mod: 004223	Price each exc. VAT	inc. VAT each
		1+	5+
DA59P	20mm P/Mount F/Holder	£1.40	£1.22 £1.69

Flush Fitting Panel Mount 20mm Fuseholder



A flush-mounting 20mm panel fuseholder with screwdriver release to meet the latest safety regulations. Rated 10A at 250V. Overall length 33mm (plus 5.5mm tag). Bezel diameter 16mm. Panel cut-out 12mm diameter flattened to 11mm on opposing sides to provide anti-twisting lock.

Order Code	Mod.	Price each exc. VAT	inc. VAT each
KU33L	000392	£1.40	£1.11
	Fuseholder 20 Flush	1+	5+
		£1.69	

Panel Mount Screw In 20mm Fuseholder



A black round panel mounting fuse holder for 5 x 20mm fuses. The fuse fits into the cap which is screwed onto the holder. Panel hole clearance 12mm diameter. Thread length approximately 4mm. overall length approximately 30mm. Rated at 5A max.

A black round 5 x 20mm panel mounting fuse holder. The fuse fits into the cap which is screwed onto the holder. The panel hole clearance is 12mm diameter.

Order Code	Mod.	Price each exc. VAT	inc. VAT each
GU73Q	011649	£0.82	£0.71
	Panel Fuseholder	1+	5+
		£0.99	

Finger Release Panel 20mm Fuseholder



Finger release panel fuseholder. Fits a range of panel thicknesses from 1.0 to 3.5mm and has an anti-rotation spigot. Rated at 10A, AC 250V, UL and CSA approved.

Dimensions:

Fixing hole diameter	11.5mm
Cap diameter	17.0mm
Overall length	43.0mm

Order Code	Mod.	Price each exc. VAT	inc. VAT each
CT90X	012124	£0.90	£0.78
	Panel Fholder 20x5	1+	5+
		£1.09	

Panel Mount 31mm Fuseholder

ORDER IN STORE OR ONLINE



A panel mounting 31mm fuseholder with a square flush fitting red coloured cap bearing the legend 'FUSE' in black. Fuse cartridge is simply inserted into the cap which pushes into the body, but the latch must align with slot in bezel. Only a small narrow screwdriver or similar tool can

be pushed down into the slot to release the latch in order to gain access to the fuse. Restrain the cap to prevent it flying out of the body. Complies with BS standards.

Max rating 6A @ AC 250V

Length: 50mm. Bezel 16mm x 16mm square. Panel cut-out 15mm (5/8in.)

Order Code	Mod.	Price each exc. VAT	inc. VAT each
FA39N	000413	£0.65	£0.51
	1 1/4 Clickcatch F/H	1+	5+
		£0.79	

Fuseholder 6.3 x 32mm

ORDER IN STORE OR ONLINE



- Panel mount touchproof fuseholder to IEC 127/6 category PC2 for 6.3 x 32mm (1.25 x 0.25 inches) fuses
- Low profile, screwdriver release screw cap
- Terminals are nickel-plated copper alloy, solder type

Rating & approvals	15A @ 250V UL & CSA
Overall length:	43.8mm
Bezel dia	15mm
Depth behind panel	39.8mm
Panel cutout	13mm
Panel thickness:	1 to 8mm
Blade terminal width	4.7mm

Order Code	Mod.	Price each exc. VAT	inc. VAT each
NH89W	019529	£2.49	£2.15
	15A Panel F/Holder	1+	5+
		£2.99	

Fuseholder Insulating Boot



A pliable PVC insulating boot for enclosing and covering cables connected to the terminals at the rear of any of our panel mounting cartridge fuseholders.

Order Code	Mod.	Price each exc. VAT	inc. VAT each
FT35Q	000408	£0.82	£0.71
	Fuseholder Boot	1+	5+
		£0.99	

Chassis Fuseholders

Chassis Mounting 20mm Fuseholder



A chassis mounting 20mm fuseholder with a 3mm diameter recessed fixing hole moulded from flame-retardant plastic to UL94-V1. Size 40mm long, 14mm high, 11mm wide. Rated at AC 250V/10A.

Order Code	Mod.	Price each exc. VAT	inc. VAT each
KC01B	000432	£0.65	£0.51
	Chassis F/H 20mm	1+	5+
		£0.79	

Find out more in-store

Our staff can offer friendly and expert advice; we're here to help



Fuse holder 31mm with Lugs



Heavy duty 31mm fuse holder with 6.35mm (1/4in.) spade lugs. Nickel-plated clips rated at 30A. There is a 4mm dia. recessed fixing hole and two 3mm dia. plugs on the underside of the holder to locate the holder onto additional holes drilled in the chassis, which prevents unwanted movement.

Overall size: 66mm long, 22mm high, 12mm wide.

Order Code	Mod.	Price each exc. VAT	inc. VAT each
KU30H	000423	£0.74	£0.59
	31mm F/H with Lugs	1+	5+
		£0.89	

Fuse Block Covers



Covers designed to fit 20mm or 32mm (1/4in.) fuse blocks for added protection.

Overall dimensions

For 20mm version (VJ56L)	24 x 8 x 13mm External 21.8 x 6 x 11.4mm Internal
For 32mm version (VJ57M)	33.5 x 12 x 15mm External 30.9 x 9.6 x 13mm Internal

Order Code	Mod.	Price each exc. VAT	inc. VAT each
VJ56L	013329	£0.40	£0.35
VJ57M	1 1/4 Fuse Cover	£0.82	£0.51
		£0.99	



Over 200 stores nationwide

Plug Top 20mm and 25mm (1 Inch) Fused Terminal Block



- 3-pole terminal strip with 5x20mm and 6.3mmx25mm fuse holder to IEC257
- Interlocking fuseholder CMFTB/1
- Anti-rotation spigot
- IP20 finger protection
- Cable entry 10mm (3x1.5 & 2x2.5mm)
- Standard 3 pole with earth screw, without wire protectors
- Meets creepage and clearance requirements of IEC (8mm air gap between line and neutral terminals)
- 16mm fixing hole

Specifications:

Voltage rating:	250V
Current rating:	13A
Working temp:	125°C
Moulding:	UL94-V0 flame retardant polyamide 66
Terminal:	Brass, nickel plated
Fuse clip:	Phosphor bronze
Fuse size:	5x20mm and 1 x (6.3x25mm)
Screws:	M3.5, 7µm zinc, colour passivated and tropicalised

Order Code	Mod.	Price each exc. VAT	inc. VAT each
TZ17T	022570	£1.49	£1.79
	Fused Terminal Block	1+	

Voltage	12 - 24Vdc	
Weight	76g	
Reduction table		
Gear ratio	RPM @ 12V	RPM @ 15V
	2100	2625
	525	656
	131	164
	33	42
	8	10
4096:1	2	2

Order Code	Mod: 025246	Price each exc. VAT	inc. VAT each
WC65V	Multi:GBox/SmallMot	£7.08	£8.50
WC66W	Multi:GBox/Med Motor	£6.65	£7.99
SN36P	Multi:Ratio Gearbox	£9.15	£10.99

MFA Geared Motor Kit



Enables students, designers and modellers to motorise projects. This high quality kit consists of a multi ratio geared motor, a selection of drives (chain, rack & pinion, worm drive, etc.), coupling, axles, wheels, perforated metal sheet and strip, plastic wheels, nuts & bolts, toggle switch, etc. The kit also includes a 'D' cell dry battery

Order Code	Mod: 024813	Price each exc. VAT	inc. VAT each
UZ15R	Geared Motor Kit	£18.32	£21.99

MFA Panel Mounted Speed Regulator Module



- Compact design
- Robust construction
- Versatile
- Simple installation

This neat panel mounted speed regulator module has a variety of uses including controlling the RPM of motors and small hobby drills. Pulse width modulation provides proportional speed output control whilst maintaining torque.

Specifications:

Input voltage:	6 - 15V
Output voltage:	modulated relative to input
Loading:	3A cont. 5A peak
Weight:	30g
Dimensions:	61 x 41 x 40mm

Order Code	Mod: 030310	Price each exc. VAT	inc. VAT each
RN41U	Panel Speed Regultr	£13.32	£15.99

MFA Motor Speed Regulation Unit

ORDER IN STORE OR ONLINE



A speed regulator unit for use with electric motors, miniature drills, etc. Its small size allows it to be easily installed. Speed adjustment is by a miniature slotted screwdriver (supplied). The input power lead is terminated in a spade connector, allowing easy connection with rechargeable batteries. It has a variable pulse width modulated [PWM] output that can vary the speed of a motor while maintaining torque

Specifications:

Input Voltage:	6-15V
Output Voltage:	modulated relative to input
Output Current:	3A cont. 5A peak
Weight	24g
Dimensions	33 x 25 x 15mm

Order Code	Mod: 009312	Price each exc. VAT	inc. VAT each
WC76H	Speed Regulator Unit	£13.32	£15.99

MFA Anti Vibration Motor Mounts

ORDER IN STORE OR ONLINE



These mounts will help to reduce noise vibration from motors

Order Code	Mod: 043552	Price each exc. VAT	inc. VAT each
N17BQ	Anti-Vibration Mnts	£5.82	£6.99

Gears & Pulleys

Gear Sets



A range of packs containing gears in the sizes and quantities indicated in the table below

Order Code	Size	No in Pack
WC78K	Ratio gear 2.9mm bore x 48/12 teeth Ratio gear 3.1mm bore x 48/12 teeth Pinion gear 2.9mm bore x 10 teeth	2 4 1
WC81C	Spur gear 2.9mm bore x 40 teeth Pinion gear 2.9mm	1 1

bore x 20 teeth	1
Pinion gear 2.9mm bore x 10 teeth	1

Order Code	Mod: 030962	Price each exc. VAT	inc. VAT each
WC78K	Gear Set	£3.57	£4.29
WC81C	Sour Gear Set	£2.49	£2.99

Worm Drive Sets

ORDER IN STORE OR ONLINE



A choice of two packs containing worm drive components. One (WC80B) contains a worm gear (total length: 35mm) and a 2.9mm bore x 40 teeth gear spur gear and the other contains ten 35mm worm gears (HA68Y). For spur gears, see Gear Sets

Order Code	Mod: 011942	Price each exc. VAT	inc. VAT each
WC80B	Worm Drive Set	£2.49	£2.99
HA68Y	Worm Drive 10Pk	£4.15	£4.99

Bevel Gears

ORDER IN STORE OR ONLINE



A choice of two pairs of 1:1 ratio bevel gears which mesh at right angles, allowing the output shaft to be perpendicular to the input shaft

Order Code	Shaft diameter	Outer diameter
N08BQ	4mm	17.2mm
N09BQ	6mm	30.7mm

Order Code	Mod: 043519	Price each exc. VAT	inc. VAT each
N08BQ	Bev/Gears 4mm Shaft	£4.15	£4.99
N09BQ	Bev/Gears 6mm Shaft	£4.99	£5.99

MFA Bevelled Gearbox

ORDER IN STORE OR ONLINE



This 1:1 ratio Bevelled Gear unit has steel gears & 5mm diameter shafts running in ballraces & scintered bronze bearings, one ballrace & scintered bronze bearing per shaft. The former act as thrust races protecting the bevel gears from external pressures of varying loads. The housing mouldings are 30% glass filled nylon for strength & have four pre-drilled mounting holes

Order Code	Mod: 043541	Price each exc. VAT	inc. VAT each
N16BQ	Bev/Gearbox	£14.99	£17.99

Buying for business?
0333 400 9740



Friendly expert advice on
0333 400 9500

- Ideally suited for mounting printed circuit boards or DIN rail mounted components
- Moulded in light grey, general purpose ABS plastic
- Available with grey or clear lids
- All boxes finished in grey - see specifications for dimensions and lid colour options

Watertight ABS plastic enclosure designed to meet IP65. Ideally suited for mounting printed circuit boards or DIN rail mounted components. Material carries a UL flammability rating of UL94HB. Gasketed lid with two-piece "tongue and groove" construction provides protection against access of oil, dust and water. Lid includes smooth recessed area for membrane, label or silkscreen and is secured with self-captivating M3.5 stainless steel machine screws (included), threaded into integral stainless steel bushes.

Specifications:

Order Code	Description:	Lid colour:	L mm	W mm	H mm
N02HG	RP1025	Grey	65	65	40
N17GC	RP1065	Grey	85	80	55
N03HG	RP1135	Grey	125	85	55
N04HG	RP1215	Grey	145	105	60
N18GC	RP1175	Grey	165	85	55
N19GC	RP1245	Grey	165	125	75
N05HG	RP1025C	Clear	65	60	40
N06HG	RP1065C	Clear	85	80	55
N07HG	RP1135C	Clear	125	85	55
N08HG	RP1215C	Clear	145	105	60
N09HG	RP1175C	Clear	165	85	55
N10HG	RP1245C	Clear	165	125	75

Order Code	Mod:	Description:	Price each exc. VAT 1+	VAT 5+	inc. VAT each
N02HG	Box	RP1025	£4.15	£3.99	£4.99
N17GC	Box	RP1065	£4.40	£4.23	£5.29
N03HG	Box	RP1135	£5.24	£5.03	£6.29
N04HG	Box	RP1215	£7.49	£7.19	£8.99
N18GC	Box	RP1175	£7.74	£7.43	£9.29
N19GC	Box	RP1245	£7.74	£7.43	£9.29
N05HG	Box	RP1025C	£4.15	£3.99	£4.99
N06HG	Box	RP1065C	£5.24	£5.03	£6.29
N07HG	Box	RP1135C	£5.82	£5.59	£6.99
N08HG	Box	RP1215C	£8.99	£8.63	£10.79
N09HG	Box	RP1175C	£6.65	£6.39	£7.99
N10HG	Box	RP1245C	£9.15	£8.79	£10.99

Weatherproof Boxes

ORDER IN STORE OR ONLINE

- Durable and hard wearing
- Resistant to shock and various environmental agents
- Light grey ABS techno-polymer has high impact resistance and strength, sealed and rated to IP55 or IP65
- Working temperature -15°C to +60°C
- Internal fixing pillars to allow increased internal working area



A range of external waterproof boxes in a self-extinguishing, thermoplastic material, which is highly resistant to impact, heat, chemical and atmospheric agents. The medium size is also available with a transparent polycarbonate cover.

Order Code	Transparent Lid	IP Rating	External Dimensions mm		
			L	W	H
YM90X	No	IP55	100	100	60
N12GJ	No	IP55	130	55	60
N06GJ	No	IP55	130	90	60
YM91Y	No	IP55	150	110	75
YM93B	Yes	IP65	150	110	75
N07GJ	No	IP55	170	170	75
N10GJ	No	IP55	170	170	120
N08GJ	No	IP55	190	140	75
N09GJ	Yes	IP65	190	140	75
YM92A	No	IP55	240	190	90
N11GJ	Yes	IP65	310	240	100

Order Code	Mod:	Description:	Price each exc. VAT 1+	VAT 5+	inc. VAT each
YM90X	IP55	Box 100x100x60	£5.24	£5.03	£6.29
N12GJ	IP55	Box 130x55x60	£4.99	£4.79	£5.99
N06GJ	IP55	Box 130x90x60	£5.24	£5.03	£6.29
YM91Y	IP55	Box 150x110x75	£6.90	£6.63	£8.29
YM93B	IP65	Box 150x110x75Cl	£10.40	£9.99	£12.49
N07GJ	IP55	Box 170x170x75	£12.07	£11.59	£14.49
N10GJ	IP55	Box 170x170x120	£15.40	£14.79	£18.49
N08GJ	IP55	Box 190x140x75	£14.57	£13.99	£17.49
N09GJ	IP65	Box 190x140x75CL	£16.65	£15.99	£19.99
YM92A	IP55	Box 240x190x90	£17.49	£16.79	£20.99
N11GJ	IP65	Box 310x240x100	£33.32	£31.99	£39.99

IP Rated Cable Glands

IP68 Polyamide Gland

ORDER IN STORE OR ONLINE



The IP68 submersion proof round top cable gland is rated to IP68 and suitable for use in areas where a lot of moisture is present and a high degree of protection is required. It has a temperature range of -30°C to +100°C and has a neoprene seal. The gland comes with a locknut and is available in dark or light grey and black.

Code	Size	External diam.x pitch	Cable Diam.	Thread length
UP89W	16mm	16x1.5	5-10	6
UP93B	20mm	20x1.5	8-13	8
UP94C	25mm	25x1.5	11-17	8
UP95D	PG7	12.5 x 1.27	3.6-5	8
UP96E	PG9	15.2 x 1.41	4-8	8
UP97F	PG11	18.6 x 1.41	5-10	8
UP98G	PG13.5	20.4 x 1.41	6-12	9

Order Code	Mod:	Description:	Price each exc. VAT 1+	VAT 5+	inc. VAT each
UP89W	Polyamide Gland	16mm	£1.99	£1.91	£2.39
UP93B	Polyamide Gland	20mm	£1.82	£1.75	£2.19
UP94C	Polyamide Gland	25mm	£2.32	£2.23	£2.79
UP95D	Polyamide Gland	PG7	£1.74	£1.67	£2.09
UP96E	Polyamide Gland	PG9	£1.74	£1.67	£2.09
UP97F	Polyamide Gland	PG11	£1.74	£1.67	£2.09
UP98G	Polyamide Gland	PG13.5	£1.74	£1.67	£2.09

Instrument Cases

Slim Extruded Aluminium Instrument Enclosures

ORDER IN STORE OR ONLINE

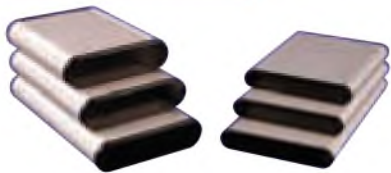

- Slimline extruded aluminium enclosure in A and B sizes
- Designed to house 1 or 2 PC boards or for equipment interfacing
- PC boards mount horizontally by sliding into internal slots extruded into the enclosure body
- Rugged body constructed from extruded aluminium with a minimum thickness of 1.5 mm (0.06-inch)
- Rounded design better for hand held ergonomics
- Clear anodised finish

Order Code	Type	Length mm	Width mm	Height mm
N60FK	1455A802	80	70	12
N61FK	1455B802	80	71.7	19
N62FK	1455A1002	100	70	12

N63FK	1455B1002	100	71.7	19
N64FK	1455A1202	120	70	12
N65FK	1455B1202	120	71.7	19

Order Code	Mod:	Description:	Price each exc. VAT 1+	VAT 5+	inc. VAT each
N60FK	Alu. Box	1455A802	£4.99	£4.79	£5.99
N61FK	Alu. Box	1455B802	£5.65	£5.43	£6.79
N62FK	Alu. Box	1455A1002	£4.99	£4.79	£5.99
N63FK	Alu. Box	1455B1002	£6.07	£5.83	£7.29
N64FK	Alu. Box	1455A1202	£5.82	£5.59	£6.99
N65FK	Alu. Box	1455B1202	£6.07	£5.83	£7.29

Aluminium Instrument Enclosures

ORDER IN STORE OR ONLINE



- Designed to house PCBs or for equipment interfacing
- PCBs mount horizontally by sliding into internal slots extruded into the enclosure body
- Rugged body constructed from extruded aluminium, with a minimum thickness of 0.06"/1.5mm
- Hardware and self-adhesive rubber feet included
- Available in clear or black anodised finish
- Available with either plastic end caps or aluminium end panels

Order Code	Type	L mm	W mm	H mm	Colour	End panels:
N82AL	1455C801	80	54	23	Clear	Aluminium
N83AL	1455K1201	120	54	23	Clear	Aluminium
N84AL	1455K1201	120	78	43	Clear	Aluminium
N85AL	1455N1601	160	103	43	Clear	Aluminium
N74AL	1455C802	80	54	23	Clear	Plastic
N75AL	1455C1202	120	54	23	Clear	Plastic
N76AL	1455K1202	120	78	43	Clear	Plastic
N77AL	1455N1602	160	103	43	Clear	Plastic
N78AL	1455C802BK	80	54	23	Black	Plastic
N79AL	1455C1202BK	120	54	23	Black	Plastic
N80AL	1455K1202BK	120	78	43	Black	Plastic
N81AL	1455N1602BK	160	103	43	Black	Plastic

Order Code	Mod:	Description:	Price each exc. VAT 1+	VAT 5+	inc. VAT each
N82AL	Alu. Box	1455C801	£9.57	£9.19	£11.49
N83AL	Alu. Box	1455C1201	£9.57	£9.19	£11.49
N84AL	Alu. Box	1455K1201	£10.82	£10.39	£12.99
N85AL	Alu. Box	1455N1601	£12.49	£11.99	£14.99
N74AL	Alu. Box	1455C802	£6.07	£5.83	£7.29
N75AL	Alu. Box	1455C1202	£6.90	£6.63	£8.29
N76AL	Alu. Box	1455K1202	£9.57	£9.19	£11.49
N77AL	Alu. Box	1455N1602	£12.90	£12.39	£15.49
N78AL	Alu. Box	1455C802BK	£6.90	£6.63	£8.29
N79AL	Alu. Box	1455C1202BK	£7.74	£7.43	£9.29
N80AL	Alu. Box	1455K1202BK	£9.57	£9.19	£11.49
N81AL	Alu. Box	1455N1602BK	£12.90	£12.39	£15.49

Power Supply Cases

PSU Box

A power supply style case with an attractive rugged appearance, moulded in black ABS. The case will house E154, S35 or S147 size transformers with space for other components. The top and base are held together by four fixing screws (supplied). Overall dimensions: 117 x 63 x 62mm.



Order Code	Mod:	Description:	Price each exc. VAT 1+	VAT 5+	inc. VAT each
YN38R	Power Supply Case		£3.15	£3.03	£3.79

We can deliver to your home or office

(UK only)

Vented PSU Enclosures

- Ideally suited for housing power supplies
- Manufactured from UL-94 rated flame resistant SE-100 Resin
- Ideal for mounting PCBs
- Pre-cut cable exit
- Screws required (included)
- Vents in top and bottom of unit



Order Code	Vents	PCB Holders	Screw holes	Internal Dimensions mm	External Dimensions mm
N26KH	Yes	Yes	3	102 x 53 x 45.5	107 x 58 x 48.5
N28KH	Yes	Yes	4	156 x 86 x 58.5	161 x 91.5 x 64
N29KH	Yes	Yes	4	167 x 81 x 44.5	179 x 86 x 50.5
N10KH	Yes	Yes	4	149 x 70 x 39	151 x 71.5 x 45
N11KH	Yes	Yes	4	152 x 82 x 46	156 x 88 x 49
N12KH	Yes	Yes	4	115 x 75 x 59	120 x 80 x 64
N13KH	No	Yes	No	103 x 58 x 34	105 x 63 x 38

Order Code	Mod: 612693	Price each exc. VAT 1+	5+	inc. VAT each
N06KH	107x58x49mm PSU Box	£3.40	£3.27	£4.09
N08KH	161x97x64mm PSU Box	£4.57	£4.39	£5.49
N09KH	179x86x51mm PSU Box	£3.40	£3.27	£4.09
N10KH	151x72x45mm PSU Box	£2.82	£2.71	£3.39
N11KH	156x88x49mm PSU Box	£3.24	£3.11	£3.89
N12KH	120x80x64mm PSU Box	£3.24	£3.11	£3.89

PSU Enclosures

- Ideally suited for housing power supplies
- Manufactured from UL-94 rated flame resistant SE-100 Resin
- Ideal for mounting PCBs
- No screws required
- Pre-cut cable exit



Order Code	Vents	PCB Holders	Screw holes	Internal Dimensions mm	External Dimensions mm
N23KH	No	Yes	No	69.5 x 45 x 38.5	74.3 x 47.5 x 40
N24KH	No	Yes	No	77 x 53 x 42.5	82 x 56.5 x 47
N25KH	No	Yes	No	76 x 53.5 x 45.5	82 x 56.5 x 48.5
N27KH	No	Yes	No	74.5 x 49 x 43	81 x 56 x 48.5
N13KH	No	Yes	No	103 x 58 x 34	105 x 63 x 38

Order Code	Mod: 612692	Price each exc. VAT 1+	5+	inc. VAT each
N03KH	74x49x40mm PSU Box	£1.82	£1.75	£2.19
N04KH	82x27x49mm PSU Box	£2.82	£2.71	£3.39
N05KH	82x57x49mm PSU Box	£2.24	£2.15	£2.69
N07KH	81x56x49mm PSU Box	£2.24	£2.15	£2.69
N13KH	105x63x38mm PSU Box	£2.24	£2.15	£2.69

Free Standing PSU Box

- Ideal for housing free standing power supplies
- Flame retardant



A neatly styled black plastic box, moulded in two parts and held together by four screws. The box is primarily intended to house a free standing power supply. Both case parts have ventilation slots to facilitate cooling of transformer/regulator, etc. For cable entry grommet, use JM16S.

Flame retardant to UL94 V-1
 External dimensions: 129.5 x 91.5 x 70mm

Order Code	Mod: 001697	Price each exc. VAT 1+	5+	inc. VAT each
YU32K	Free Standing PSU Box	£3.24	£3.11	£3.89

Small Cable Exit Grommet

- A neat, flexible cable exit grommet
- Moulded in black plastic
- Accepts cable



- diameter of 2mm
- Size: 5mm x 18mm

Order Code	Mod: 001704	Price each exc. VAT 1+	5+	inc. VAT each
JP42V	Small PSU Grommet	£0.90	£0.87	£1.09

Cable Exit Grommet

- A neat, flexible cable exit grommet
- Moulded in black plastic
- Requires a 9.7 x 7.4mm rectangular slot



Although intended for use with the free standing PSU box [order code: YU32K], the grommet will find uses in many other applications

Order Code	Mod: 001706	Price each exc. VAT 1+	5+	inc. VAT each
JM16S	PSU Grommet	£0.90	£0.87	£1.09

Diecast Enclosures

Eddystone Die-cast Aluminium Shallow Lid Thin Wall

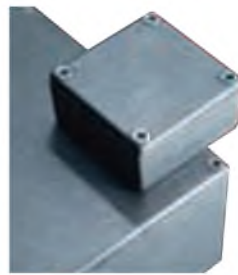

- Rugged lightweight, die cast aluminium alloy (robust yet easy to machine), electronic instrument enclosure
- Two piece 'lap joint' construction provides protection against dust accumulation and splashing water
- Lids are close fitting being retained by 4 - M3.5 x 12 machine screws into countersunk lid holes
- Aluminium alloy to BS1490, LM2M
- Designed to meet IP54

Enclosures are supplied unpainted with vibra finish for a smooth appearance and will accept most finishes with minimum preparation.

Order Code	Type	External Dimensions (mm)		
		L	W	H
N87BQ	11451PSLA	53	38	31
N88BQ	27969PSLA	92	38	31
N89BQ	27134PSLA	111	60	31
N90BQ	29830PSLA	120	95	34
N91BQ	26908PSLA	120	95	57
N71FK	11130PSLA	125	125	79
N92BQ	10758PSLA	145	95	49
N93BQ	26827PSLA	188	120	57
N72FK	26357PSLA	188	120	82

Order Code	Mod: 043713	Price each exc. VAT 1+	5+	inc. VAT each
N87BQ	Alloy Box 53x38x27	£3.40	£3.27	£4.09
N88BQ	Alloy Box 92x38x27	£3.82	£3.67	£4.59
N89BQ	Alloy Box 111x60x27	£4.40	£4.23	£5.29
N90BQ	Alloy Box 120x95x30	£6.49	£6.23	£7.79
N91BQ	Alloy Box 120x95x53	£7.74	£7.43	£9.29
N71FK	Alloy Box 125x125x75	£10.40	£9.99	£12.49
N92BQ	Alloy Box 145x95x45	£9.57	£9.19	£11.49
N93BQ	Alloy Box 188x120x53	£10.40	£9.99	£12.49
N72FK	Alloy Box 188x120x78	£13.74	£13.19	£16.49

Waterproof Extruded Aluminium Electronic Instrument Enclosures

ORDER IN STORE OR ONLINE

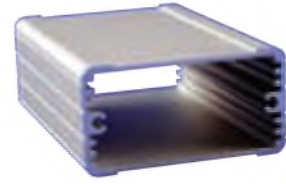

- PC boards mount horizontally by sliding into internal slots extruded into the enclosure body
- Designed to meet IP65
- Standard or flanged end panel versions available
- Profiles feature recessed areas for surface or keypad membranes

A range of watertight extruded aluminium enclosures designed to house PC boards for use as an electronic instrument enclosure. The rugged case is made from extruded aluminium with two die cast end panels. The end panels are available with flange (for shelf or wall mounting) or without flange. The extruded profile is supplied with a clear anodised finish. Die cast end panels are supplied in a black textured paint finish. Designed to meet IP65 with the use of o-ring seals and gaskets. Hardware and self-adhesive feet included.

Order Code	Description	Colour:	L	W	H
N29HG	1457C801	Clear Anodised /Black End Caps	80	59	30.9
N31HG	1457K1201	Clear Anodised /Black End Caps	120	84	44.1
N32HG	1457N1601	Clear Anodised /Black End Caps	160	104	54.6

Order Code	Mod: 265983	Price each exc. VAT 1+	5+	inc. VAT each
N29HG	Box 1457C801	£13.32	£12.79	£15.99
N31HG	Box 1457K1201	£21.65	£20.79	£25.99
N32HG	Box 1457N1601	£24.15	£23.19	£28.99

Rack Mounting Cases

Standard Rack Mounting Instrument Cases

ORDER IN STORE OR ONLINE



- High quality rack mounting cases
- Mild steel and finished in a hard wearing semi-matt black epoxy coating
- Top cover is provided with ventilation slots to assist cooling
- Black anodised aluminium front panel has four holes punched to facilitate fixing the case in a rack
- Supplied assembled
- Available in 1U, 2U, 3U and 4U standard sizes

Order Code	Type	External Dimensions (mm)		
		L	W	H
N34AN	1U	300	482.6	44.4
N35AN	2U	300	482.6	88.9
N36AN	3U	300	482.6	113.4
N37AN	4U	300	482.6	177.8

Order Code	Mod: 034159	Price each exc. VAT 1+	inc. VAT each
N34AN	1U 19in Rack Case	£33.32	£39.99
N35AN	2U 19in Rack Case	£41.65	£49.99
N36AN	3U 19in Rack Case	£49.99	£59.99
N37AN	4U 19in Rack Case	£49.99	£59.99

Buying for education?
0333 400 9740



Technical Helpline



0333 400 9500

For technical information and assistance relating to any Maplin purchase, contact our team of experts

Undrilled Standard Rack Mounting Panels

ORDER IN STORE OR ONLINE



Plain black painted aluminium 483mm [19in.] rack panels undrilled except for the standard four rack mounting holes at the corners. Panels are 3mm thick. Available in sizes 1U, 2U, 3U and 4U.

Order Code	Mod: 001785	Price each exc. VAT	inc. VAT each
ZA96E	Front Panel 1U	£8.32	£9.99
ZA97F	Front Panel 2U	£10.40	£12.49
ZA98G	Front Panel 3U	£12.49	£14.99
ZA99H	Front Panel 4U	£14.99	£17.99

19in Utility Rack Shelf

ORDER IN STORE OR ONLINE

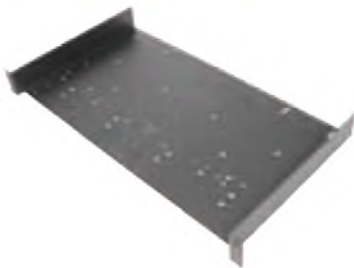

- A 19" rack shelf punched with a matrix of holes for securing equipment

Dimensions [mm]

Order Code	Mod: 032296	Price each exc. VAT	inc. VAT each
N85AA	Utility Rack Shelf	£16.65	£19.99

Enclosure Accessories

Maplin Snap Rivets 3mm 10 Pack



- Cheap alternative to screws and nuts
- Requires 3mm minimum hole diameter
- Supplied in packs of 10

Small plastic rivets which can be used as a quick and cheap alternative to screws and nuts for holding together

panels, PCBs onto brackets and chassis, etc, providing the fixture is reasonably permanent. The rivet comes in two parts, the head and sleeve. The sleeve pushes through holes in the items to be attached, and the pin is pushed into the sleeve. The insertion of the pin makes the sides of the sleeve splay out, providing a secure grip

Specification

Overall Diameter:	mm
Pack Size:	10 Pack
Overall Thickness:	mm
Cable Hole Diameter:	N/A
Chassis Hole Diameter:	3mm
Maximum Panel Thickness:	N/A
Colour:	Black
Product Width:	mm
Product Depth:	mm
Product Height:	mm
Product Weight:	g

Order Code	Mod: 001900	Price each exc. VAT	inc. VAT each
BK87U	Snap Rivet	£1.32	£1.27

Hexagonal Threaded Spacer



- A range of plastic hexagonal threaded spacers
- Made from UL approved nylon 66, 94V-2
- Supplied in a pack of 10

Code	A mm	B mm	C mm	Length mm
QT79	5.6	6	3	6
QT80	5.6	6	3	12.7
QT82	5.6	6	3	20

Order Code	Mod: 029864	Price each exc. VAT	inc. VAT each
QT79K	Hex Thread Spacer 6	£2.15	£2.07
QT80B	Hex Thread Spacer 12	£2.15	£2.07
QT82D	Hex Thread Spacer 20	£2.15	£2.07

Hexagonal Tapped Spacer



- A range of hexagonal tapped spacers
- Made from from UL approved nylon 66, 94V-2
- Supplied in packs of 10

Code	Length mm	A mm	C mm
QT86T	8.0	5.5	3
QT87U	12.7	5.5	3
QT90X	25.0	5.5	3
QT91Y	30.0	5.5	3

Order Code	Mod: 029866	Price each exc. VAT	inc. VAT each
QT86T	Hex Tap Spacer 8	£2.15	£2.07
QT87U	Hex Tap Spacer 12	£2.32	£2.23
QT90X	Hex Tap Spacer 25	£2.40	£2.31
QT91Y	Hex Tap Spacer 30	£2.40	£2.31

Free Delivery
on all UK orders over **£10**

(T&Cs Apply)

PCB Stand-Offs



- Plastic snap-in stand-offs that eliminate the need for nuts and bolts when mounting printed circuit boards etc
- Made from UL approved nylon 66, 94V-2
- Supplied in packs of 10

The bottom snaps permanently into a chassis hole 5mm diameter in any chassis with a thickness 1mm to 2.5mm. The top snaps into a 4mm diameter hole in the printed circuit board, allowing the PCB to be easily removed and re-fitted as required. These stand-offs provide mechanically secure, insulated mounting, yet boards can be quickly removed. Available in two lengths - 6.4mm [$\frac{1}{4}$ inch] and 19.1mm [$\frac{3}{4}$ inch].

Order Code	Mod: 219941	Price each exc. VAT	inc. VAT each
N17CH	1/4in. Standoff 10Pk	£1.24	£1.19
N18CH	3/4in. Standoff 10Pk	£1.40	£1.35



Browse our entire range at maplin.co.uk

Rubber Grommets



- Prevent cables chaffing when passing through panels
- Supplied in packs of 10

Order Code	Hole Dia [C] [mm]	Chassis Hole Dia [B] [mm]	Overall Dia [A] [mm]	Overall Thkns [D] [mm]	Chassis Thkns [E] [mm]
QT92A	3.0	6.0	8.5	4.7	1.7
QT93B	5.0	7.2	10.2	4.7	1.7
QT94C	6.4	10.0	13.3	6.3	1.7
QT95D	15.5	20.1	23.7	6.1	1.7

Order Code	Mod: 029915	Price each exc. VAT	inc. VAT each
QT92A	Open Grommet 0603	£1.99	£1.91
QT93B	Open Grommet 0705	£1.99	£1.91
QT94C	Open Grommet 1006	£2.15	£2.07
QT95D	Open Grommet 2015	£2.82	£2.71

Maplin TV

Home of innovation, handy tips and How To videos

Visit our channel...
youtube.com/maplintv



Cable Sealing Grommets



- Provides a seal around cables when passing through panels
- Supplied in packs of ten

Order Code	Hole Dia (mm)	Chassis Hole Dia (mm)	Overall Dia (mm)	Overall Thkns (mm)	Chassis Thkns (mm)
QT98G	15.5	20.1	23.7	6.1	1.7
QT99H	18.9	25.1	29.9	7.2	1.5

Order Code	Mod: 029938	Price each exc. VAT 1+	VAT 5+	inc. VAT each
QT98G	Closed Grommet 2015	£2.99	£2.87	£3.59
QT99H	Closed Grommet 2518	£3.24	£3.11	£3.89

Maplin Cable Exit Gland 15mm with Sleeve



- Coiled design to prevent chafing
- Accepts cables up to 5mm diameter

A sealed cable exit gland combined with a coiled strain relief sleeve designed to prevent chafing when cables exit an enclosure. The gland contains a rubber grommet which will accept cables up to 5mm diameter, but this may be removed so that the whole gland will accommodate a 10mm diameter loom. The threaded sleeve part screws into the gland and squeezes a separate plastic collet ring to grip the cable. The gland body has a 12mm long thread and is attached to the enclosure with a nut, and includes a neoprene sealing washer. Requires a panel hole diameter of 15mm (5/8in.). Maximum panel thickness is 4mm. Sleeve length is 50mm. Colour black.

Specification

Overall Diameter	15mm
Overall Thickness	12mm
Cable Hole Diameter:	5mm
Chassis Hole Diameter:	10mm
Maximum Panel Thickness:	4mm
Colour:	Black
Product Width:	15mm
Product Depth:	50mm
Product Height:	15mm
Product Weight:	g

Order Code	Mod: 001792	Price each exc. VAT 1+	VAT 5+	inc. VAT each
JZ43W	Cable Exit Gland	£3.24	£3.11	£3.89

Maplin Hole Plug Grommet 9.5mm 10 Pack



- Black grommet for blanking-off holes in panels
- Made from UL approved Nylon 66, 94V-2
- Supplied in a pack of ten

Overall Diameter	13mm
Overall Thickness	10.5mm
Cable Hole Diameter	N/A
Chassis Hole Diameter	9.5mm
Maximum Panel Thickness	N/A
Colour	Black
Product Width	13mm
Product Depth	10.5mm
Product Height	13mm
Product Weight	g

Order Code	Mod: 029944	Price each exc. VAT 1+	VAT 5+	inc. VAT each
R678K	Hole Plug 9.5mm	£1.82	£1.75	£2.19

Component Loudspeakers

Mylar & Paper Speakers

1.5W Mylar Speaker RoHS Compliant 50mm



- 50mm Mylar speaker
- 1.5W, 8Ω

Specifications:

Rated impedance	8Ω ±15%
Power [nominal]	1.5W
Power [Max]	2.0W
Resonant frequency	550 ±20% Hz
Rated frequency level:	f ~ 4500 Hz
Rated sound output level (0.1W/0.1m)	89 ±3dB
Cone material	Clear mylar
Housing material	Metal
Magnet material: Nd-Fe-B	12.5 x 2.5
Operating temperature range	-20°C to +55°C
Storage temperature range	-30°C to +60°C
Weight	18g (±5%)

Order Code	Mod: 098088	Price each exc. VAT 1+	VAT 5+	inc. VAT each
N07CL	Speaker Transducer	£1.90		£2.29

Mylar Speakers



- A range of mylar cone speakers with ferrite magnets
- Designed primarily for use in sirens and buzzers
- Two types available - round (available in 3 sizes) and square (available in 2 sizes)

The mylar cone and plastic centre dome combined with a card gasket around the cone, make the units fully weather and splashproof from the front. They are therefore ideal for use as sounders in portable equipment and in external burglar alarm boxes.

The round type are 18mm deep whilst the square type feature a metal mounting chassis and are 27mm deep.

Specifications:

	Round	Round	Round
	49mm	56mm	66mm
Order Code	VC84F	VC85G	VC86T

Power [max]:	0.5W	0.5W	0.8W
Power [nominal]	0.25W	0.25W	0.5W
Power output	82dB	84dB	87dB
Freq. range	200Hz -20kHz	200Hz -20kHz	100Hz -20kHz
Resonance frequency:	480Hz ±9.6Hz	480Hz ±9.4Hz	350Hz ±3Hz
Impedance	8Ω	8Ω	8Ω

	Square	Square
	77mm	87mm
Order Code	VC88V	VC89W
Power [max]:	5W	10W
Power [nominal]	3W	8W
Power output	97dB	97dB
Freq. range	75Hz -20kHz	150Hz -20kHz

Resonance frequency:	500Hz ±80Hz	550Hz ±110Hz
Impedance	8Ω	8Ω

Order Code	Mod: 003275	Price each exc. VAT 1+	VAT 5+	inc. VAT each
VC84F	Mylar Speaker 49mm	£2.90	£2.51	£3.49
VC85G	Mylar Speaker 56mm	£2.90	£2.51	£3.49
VC86T	Mylar Speaker 66mm	£2.90	£2.51	£3.49
VC88V	Mylar Spkr 77mm Sqr	£4.15	£3.44	£4.99
VC89W	Mylar Spkr 87mm Sqr	£4.15	£3.44	£4.99

Super-Thin Mylar Speakers



- Magnetically shielded - safe for use near TV and monitor screens
- Rare-earth magnet for maximum strength in minimum space
- Water-proof mylar cone

These super-thin speakers use the strongest magnetic material, NdFeB (Neodymium Iron Boron), so that the magnet size can be minimised. The mylar plastic material means the speakers are suitable for use close to sources of moisture or outdoors.

Specifications:

	L68AA	L69AA	L70AA
Diameter	45mm/13/4	50mm/2	57mm/21/4
Depth	9.5mm	8.5mm	11.5mm
Impedance (at 1kHz)	8 ohm ± 15%	8 ohm ± 15%	8 ohm ± 15%
Resonance frequency	600Hz ± 120Hz	600Hz ± 120Hz	520Hz ± 104Hz
S.P. Level (0.2W, 50cm)	80dB/W ± 3dB	80dB/W ± 3dB	80dB/W ± 3dB
Response [-10dB max]	fo - 4kHz	fo - 13kHz	fo - 12kHz
Nominal Input Power	0.2W	0.2W	0.2W
Handling Capacity:	0.3W	0.5W	0.5W

Order Code	Mod: 032371	Price each exc. VAT 1+	VAT 5+	inc. VAT each
L68AA	Super Thin Spkr 45mm	£2.90	£2.54	£3.49
L69AA	Super Thin Spkr 50mm	£3.07	£2.61	£3.49
L70AA	Super Thin Spkr 57mm	£2.99	£2.58	£3.59

Mylar & Paper Speakers



- A range of low profile mylar and paper cone speakers with Neodymium Iron Boron (Nd-Fe-B) magnets
- Designed primarily for use in sirens and buzzers
- Three types available - round (available in 6 sizes), square and rectangular

Specifications:

	Round 20mm	Round 29mm	Round 40mm
Order Code:	N92FU	N93FU	N94FU
Power (max.):	0.2W	0.5W	0.5W
Power (nominal):	0.1W	0.25W	0.25W
Power output	75 ±3dB	90 ±3dB	93 ±3dB
Freq. range	0Hz	0Hz	0Hz
	- 5kHz	- 3kHz	- 4kHz
Resonance frequency:	1000Hz	700Hz	450Hz
	±20%	±25%	±20%
Impedance:	8 ±15%Ω	8 ±15%Ω	8
			±15%Ω

	Round 45mm	Round 50mm	Round 28mm
Order Code:	N95FU	N96FU	N97FU
Power (max.):	0.5W	1.5W	3W
Power (nominal):	0.25W	1W	1.5W
Power output	85 ±3dB	94 ±3dB	92 ±3dB
Freq. range	0Hz	0Hz	0Hz
	- 5 kHz	- 20kHz	- 9kHz
Resonance frequency:	500Hz	350Hz	550Hz
	±25%	±20%	±20%
Impedance:	32 ±15%Ω	8 ±15%Ω	8 ±15%Ω

	Square 32 x 32mm	Rectangular 20 x 40mm
Order Code:	N98FU	N99FU
Power (max.):	0.4W	3W
Power (nominal):	0.2W	2W
Power output	90 ±3dB	93 ±3dB
Freq. range	0Hz	200Hz
	- 7kHz	- 20kHz
Resonance frequency:	900Hz	400Hz
	±180Hz	±20%
Impedance:	8 ±15%Ω	8 ±15%Ω

Order Code	Mod: 227369	Price each exc. VAT 1+	5+	inc. VAT each
N92FU	Mylar Speaker 20mm	£1.90	£1.49	£2.29
N93FU	Mylar Speaker 29mm	£1.90		£2.29
N94FU	Mylar Speaker 40mm	£1.90		£2.29
N95FU	Mylar Speaker 45mm	£1.90		£2.29
N96FU	Mylar Speaker 50mm	£1.90		£2.29
N97FU	Paper Speaker 28mm	£2.49		£3.29
N98FU	Square Speaker 30mm	£2.74		£3.29
N99FU	Speaker 20x40mm	£2.74		£3.29

1W Enclosed 8Ω 2W Speaker

- Speaker mounted in pre-moulded case with wires attached
- Low profile paper cone speaker with Neodymium Iron Boron (Nd-Fe-B) magnet
- Designed primarily for use in sirens and buzzers
- RoHS compliant
- Easy to mount and fix

Rated impedance:	8 ±15% Ω
Rated power:	1.0 W
Maximum power:	2.0 W
Resonant frequency:	700 ±20% Hz/1V
Rated sound output @1W/1m:	98 ±3 dB
Frequency range:	0-20 kHz
Cone material:	Paper and cloth
Housing material:	ABS
Wire	UL1571, AWG28#

Connector:	Molex E1021-0200		
equivalent Weight	28 g		
Order Code	Mod: 591712	Price each exc. VAT 1+	inc. VAT each
N24KJ	Enc Speaker 20x40mm	£4.15	£4.99

4W High-power Miniature Speaker

- 40mm x 28mm rectangular speaker
- High power up to 4W
- Low profile, paper and cloth cone speaker with (Neodymium Iron Boron Nd-Fe-B) magnet
- Designed primarily for use in sirens and buzzers
- RoHS compliant
- Easy to mount with 4 fixing holes

Rated impedance	4 ±15% Ω
Rated power:	2.0 W
Maximum power	4.0 W
Resonant frequency	380 ±20% Hz
Rated sound output @1W/1m	84 ±3 dB
Frequency range	0-20 kHz
Cone material	Paper and cloth
Housing material	ABS
Weight	12 g ±5%

Order Code	Mod: 591713	Price each exc. VAT 1+	inc. VAT each
N25KJ	Speaker 28x40mm	£2.74	£3.29

3W 8Ω Elliptical Speaker

ORDER IN STORE OR ONLINE



- Elliptical shaped loudspeaker
- Ideal replacement in portable audio equipment and CRT televisions
- 8Ω nominal impedance
- 3W output power
- Frequency response 145Hz - 22KHz

Order Code	Size	Depth	Power	Freq. Response
GL16S	125 x 77 mm	36 mm	3W	145Hz - 22kHz

Order Code	Mod: 003277	Price each exc. VAT 1+	5+	inc. VAT each
GL16S	Oval Speaker 77x125mm	£5.82	£5.03	£6.99

Buzzers & Sounders**Piezo Transducers**

These ceramic piezo transducer elements generate a range of audible tones and frequencies when energised by 3V peak square wave. They can be driven direct from CMOS ICs with low power consumption. They are supplied unmounted and with wires attached. Provided they are mounted rigidly in the prescribed manner, outputs of up to 90dB can be achieved. In addition to a wide range of applications where audible warnings or indications are preferred to visual, other uses include toys, clocks and watches, calculators and electronic games, using the transducer in place of a speaker. Because there are no moving parts to wear out, these elements are reliable for use in professional, commercial and industrial applications. They withstand severe environmental conditions and prove durable in domestic appliances without causing r.f. interference. A range of different sizes are available.

Specifications:

Piezo Transducer	27mm/1.8kHz
Resonant frequency:	1.8kHz ±0.5kHz
Impedance at resonance	300
Capacitance:	25nF ±30%
Maximum input voltage	30V p-p
Operating temperature:	-20°C to +70°C
Piezo Transducer	27mm/4.2kHz
Resonant frequency:	4.2kHz ±0.5kHz
Impedance at resonance	500
Capacitance:	14nF ±30%
Maximum input voltage	30V p-p
Operating temperature:	-20°C to +70°C
Piezo Transducer	35mm/2.8kHz
Resonant frequency:	2.8kHz ±0.5kHz
Impedance at resonance	4500
Capacitance:	20nF ±30%
Maximum input voltage	30V p-p
Operating temperature:	-20°C to +70°C
Piezo Transducer	41mm/2.0kHz for speech
Resonant frequency:	2.0kHz ±0.5kHz
Frequency range:	750Hz to 20kHz
Impedance at resonance	600
Capacitance:	40nF ±30%
Maximum input voltage	15V p-p
Operating temperature:	-20°C to +70°C
Piezo Transducer	50mm/2.8kHz
Resonant frequency:	2.8kHz ±0.5kHz
Impedance at resonance	500
Capacitance:	20nF ±30%
Maximum input voltage	30V p-p
Operating temperature:	-20°C to +70°C
Nodal ring diameter	34mm

Note: These transducers are supplied unmounted and with wires attached. If it is required to remove/reattach wires this must be carried out extremely carefully. Soldering to the silvered electrode must be done with the minimum of heat for a fraction of a second, or destruction of the silvering begins to occur. The brass rim of the transducer acts as a heatsink and will require more heat, but the minimum of solder should be used. The transducers may be mounted to a surface using any suitable adh.

Order Code	Mod: 003202	Price each exc. VAT 1+	5+	inc. VAT each
YU87U	Piezo Xducer 27/1.8	£1.15	£1.00	£1.39
OY13P	Piezo Xducer 27/4.2	£1.24	£1.07	£1.49
YU85G	Piezo Xducer 35/2.8	£1.32	£1.14	£1.59
YU83E	Piezo Xducer 41/2.0S	£1.40	£1.22	£1.69
YU82D	Piezo Xducer 50/2.8	£1.49	£1.29	£1.79

30V Very Low Profile Piezo Sounder 4mm

A piezo electric sounder which can supply levels of over 100 dB at a distance of 30 cm, yet is only 4 mm high. It can therefore be used wherever space is at an absolute premium. It requires an external driver which should operate on, or as near as possible to, the buzzer's resonant frequency of 5,500 Hz. This source should present a maximum drive voltage of 30 V peak-to-peak to the buzzer. 100 mm lead-out wires with tinned ends are provided. Mounting lugs with 2.5mm holes are moulded into the buzzer's cream-coloured case.

Specifications:

Resonant frequency	5500Hz ±500Hz
Resonant resistance	3000 max
Electrostatic capacitance	12000 pF (±30%)

Order Code	Mod: 003208	Price each exc. VAT 1+	5+	inc. VAT each
KU57M	Low Profile Sounder	£1.65	£1.41	£1.99

9Vp-p PCB Piezo Transducer

ORDER IN STORE OR ONLINE

- RoHS compliant
- Material: Black Noryl



Specifications:
 Rated voltage (V_{p-p} Square Wave) 9V_{p-p}
 Operating voltage 1-30V_{p-p}
 Rated current at rated voltage: 3mA
 Capacitance at 120Hz 17000±30%pF
 Sound output at 4000Hz at 10cm, at rated voltage: >85dB
 Resonant frequency: 4000±500Hz
 Operating temperature -20 ~ +60°C
 Storage temperature -30 ~ +70°C
 Weight: 3g

Order Code	Mod: 098114	Price each 1+	exc. VAT 5+	inc. VAT each
N18CL	9Vp-p PCB Piezo	£2.07	£1.79	£2.49

12V PCB Electro Mechanical Indicator

ORDER IN STORE OR ONLINE

- RoHS compliant
- Built in oscillating circuit
- Wave solderable and washable
- Material: Black Noryl



Specifications:
 Rated voltage: 12Vdc
 Operating voltage 8 ~ 16Vdc
 Rated current at rated voltage: 30mA
 Sound output at 30cm, at rated voltage: >85dB
 Resonant frequency at rated voltage: 2300±300Hz
 Operating temperature -20 ~ +70°C
 Storage temperature -30 ~ +80°C
 Material: Black Noryl
 Weight: 2g

Order Code	Mod: 098110	Price each 1+	exc. VAT 5+	inc. VAT each
N14CL	12V PCB Emech Ind	£1.90	£1.65	£2.29

12V PCB Mount Indicator

ORDER IN STORE OR ONLINE

- Built in oscillating circuit
- Wave solderable and washable
- Low power consumption
- RoHS compliant



Specifications:
 Rated voltage: 12Vdc
 Operating voltage 3-16Vdc
 Rated current at rated voltage: <7ma
 Sound output at 10cm at rated voltage: >80dB
 Resonant frequency at rated voltage: 4000±500Hz
 Tone Continuous
 Operating temperature -20 ~ +70°C
 Storage temperature -30 ~ +80°C
 Material: Black Noryl
 Weight: 1g

Order Code	Mod: 098104	Price each 1+	exc. VAT 5+	inc. VAT each
N08CL	12V PCB Indicator	£1.65	£1.43	£1.99

Low Profile PCB Mounting Buzzer

ORDER IN STORE OR ONLINE



A miniature solid state, PCB mounting buzzer having a loud but pleasant 75dB tone and operating from a 12Vdc supply. It is only 7mm high when mounted on the PCB. It will work with supply voltages ranging from 3 to 24Vdc. Supply polarity is marked on the bottom of the case as an aid to installation. Two 2mm dia. holes are required 18mm apart. The case is finished in a cream colour.

Specifications:
 Resonant frequency 3.5kHz
 Operating voltage: 3 to 24Vdc
 Current consumption at 12V 5mA
 Sound output at 12V DC 75dB at 30cm
 Temperature range -20 to 70°C
 Diameter 23mm
 Height (without leads) 7mm
 Lead length 8mm

Order Code	Mod: 003216	Price each 1+	exc. VAT 5+	inc. VAT each
KU58N	PCB Buzzer	£2.49		£2.99

Round Buzzer



- Small, round electronic buzzer similar in principle to the miniature solid state buzzer above (FL40T), but louder
- 12V type is available
- Dimensions: 41mm across mounting lugs, 26.4mm diameter and 17.6mm high
- Fixing centres: 32mm.

Specifications:

Order Code	Voltage range:	Current:	Frequency:	Output at 30cm:
FK81C	4 to 9V	35mA	450Hz	80dB
FK82D	9 to 20V	35mA	450Hz	80dB

Order Code	Mod: 003215	Price each 1+	exc. VAT 5+	inc. VAT each
FK81C	6V Buzzer	£2.49	£2.15	£2.99
FK82D	12V Buzzer	£2.74	£2.24	£3.29

DC Operated Piezo Buzzer



An extremely loud PCB-mounting, piezoelectric buzzer designed to operate over a wide range of supply voltages. It has a built-in driver circuit and requires only a DC voltage to drive it. Working with a 24Vdc supply voltage, this tiny unit can supply sound levels of over 95 dB at a 30 cm distance. The unit will operate well with 5V TTL voltages, drawing only around 2 mA. It will therefore make an excellent 'bell' or warning alarm for digital systems. Two 1.5 mm dia. holes are required 16mm apart. The case is finished in a cream colour, and features a dot to indicate the side with the positive terminal.

Specifications:
 Resonant frequency 2700Hz ±500Hz
 Operating voltage: 3 to 24Vdc
 Current at 12V DC 10mA max.

Order Code	Mod: 003217	Price each 1+	exc. VAT 5+	inc. VAT each
KU56L	DC Piezo Buzzer	£2.49	£2.01	£2.99

Miniature Buzzer



- Miniature solid state buzzer
- Long life, high reliability, low current drain
- No moving contacts, no arcing, no RF noise
- Small but with a clear penetrating sound
- Finished in cream plastic
- Dimensions: 23.0 x 16.5 x 15.5 mm
- Fixing centres: 27.5mm x 8BA
- Overall length: 33.5mm

Specifications:

Type	Voltage	Impedance	Frequency	Output at range 30cm
6V	4 to 9V	240Ω	400Hz	75dB
12V	9 to 12V	240Ω	500Hz	80dB

Order Code	Mod: 003213	Price each 1+	exc. VAT 5+	inc. VAT each
FL39N	Buzzer 6V	£2.49	£2.01	£2.99
FL40T	Buzzer 12V	£2.49		£2.99

12V 8mA Leaded Piezo Indicator

ORDER IN STORE OR ONLINE

- Built in oscillating circuit
- Lead wire: UL1095 AWG28
- Black ABS
- RoHS compliant



Specifications:
 Rated voltage: 12Vdc
 Operating voltage 3-16Vdc
 Rated current at rated voltage 8mA
 Sound output at 30cm, at rated voltage >90dB
 Resonant frequency at rated voltage 3700±500Hz
 Operating temperature -20 ~ +60°C
 Storage temperature -30 ~ +80°C
 Material: Black ABS
 Weight: 5g

Order Code	Mod: 098106	Price each 1+	exc. VAT 5+	inc. VAT each
N10CL	12V Leaded Piezo	£1.65		£1.99

Wire Ended Piezo Buzzer



A buzzer with a loud, clear, penetrating tone for use where direct PCB mounting is not convenient. The buzzer has two 3.5 mm clear mounting holes 38 mm apart, and two wires are provided for making the connection.

Specifications:
 Resonant frequency 2kHz ±500Hz
 Operating voltage 3 to 15Vdc

Order Code	Mod: 003219	Price each 1+	exc. VAT 5+	inc. VAT each
CR34M	DC Piezo Buzzer Wire	£2.49	£2.15	£2.99

12V 10mA Leaded Piezo Indicator



- RoHS compliant
- Built in oscillating circuit
- Lead wire: UL1007 AWG28
- Material: Black ABS

Specifications:
 Rated voltage: 12Vdc
 Operating voltage 1.5 ~ 20Vdc
 Rated current at rated voltage 10mA
 Sound output at 30cm, at rated voltage >96dB
 Resonant frequency at rated voltage 2800±500Hz

1000's more components available in-store & online

Operating temperature: -20 ~ +60°C
Storage temperature -30 ~ +70°C
Material: Black ABS
Weight: 15g

Order Code	Mod.	Price each exc. VAT 1+	inc. VAT each 5+
N15CL	12V Leaded Piezo	£2.90	£3.49

High Power Buzzer

An extremely loud piezo electric buzzer with integral drive circuit and a very wide operating voltage range



Specifications:

Resonant frequency: 3kHz
Impedance: 1kΩ approx.
Voltage range: 3V to 24Vdc
Output at 12V: 103dB at 1m

Order Code	Mod.	Price each exc. VAT 1+	5+	inc. VAT each
FK84F	HP Buzzer	£3.32	£2.69	£3.99

Ultrasonics

32.8kHz 16mm Open Ultrasonic Transmitter

ORDER IN STORE OR ONLINE

- Air ultrasonic ceramic transmitter - open type
- 32.8kHz frequency
- 16mm diameter
- Aluminium case

Industry standard open faced transmitter/receiver pair. Widely used in hobbyist and industrial markets for robotics, distance measurement, security, pest repellent and gas/wind detection

Centre frequency: 32.8 kHz ± 1.0 kHz
Bandwidth: 2.5 kHz
Transmitting SPL: 115 dB (min)
Receiving sensitivity: -67 dB (min)
Capacitance @ 1kHz: 2400 pF
Max driving voltage: 20 Vrms
Total beam angle: 100° typ

Order Code	Mod.	Price each exc. VAT 1+	5+	inc. VAT each
N04KK	Usnc Tx 32.8k 16mm A	£3.82	£3.30	£4.59

32.8kHz 16mm Open Ultrasonic Receiver

ORDER IN STORE OR ONLINE

- Air ultrasonic ceramic receiver - open type
- 32.8kHz frequency
- 16mm diameter
- Aluminium case

Industry standard open faced transmitter/receiver pair. Widely used in hobbyist and industrial markets for robotics, distance measurement, security, pest repellent and gas/wind detection

Centre frequency: 32.8 kHz ± 1.0 kHz
Bandwidth: 2.5 kHz
Transmitting SPL: 115 dB (min)
Receiving sensitivity: -67 dB (min)
Capacitance @ 1kHz: 2400 pF
Max driving voltage: 20 Vrms
Total beam angle: 100° typ

Order Code	Mod.	Price each exc. VAT 1+	5+	inc. VAT each
N05KK	Usnc Rx 32.8k 16mm A	£3.82	£3.30	£4.59



Friendly expert advice on
0333 400 9500

40kHz 18mm Closed Ultrasonic Transmitter

ORDER IN STORE OR ONLINE

- Air ultrasonic ceramic transmitter - closed type
- 40kHz frequency
- 18mm diameter
- Aluminium case

Industry standard closed faced transmitter/receiver pair. Widely used in hobbyist and industrial markets for robotics, distance measurement, security, pest repellent and gas/wind detection

Centre frequency: 40.0 kHz ± 1.0 kHz
Bandwidth: 1.5 kHz
Transmitting SPL: 115 dB (min)
Receiving sensitivity: -70 dB (min)
Capacitance @ 1kHz: 2400 pF
Max driving voltage: 20 Vrms
Total beam angle: 30° typ

Order Code	Mod.	Price each exc. VAT 1+	5+	inc. VAT each
N23KK	Usnc Tx 40k 18mm A	£6.65	£5.75	£7.99



Reserve online and collect at the store of your choice

40kHz 18mm Closed Ultrasonic Receiver

ORDER IN STORE OR ONLINE

- Air ultrasonic ceramic receiver - closed type
- 40kHz frequency
- 18mm diameter
- Aluminium case

Industry standard closed faced transmitter/receiver pair. Widely used in hobbyist and industrial markets for robotics, distance measurement, security, pest repellent and gas/wind detection

Centre frequency: 40.0 kHz ± 1.0 kHz
Bandwidth: 1.5 kHz
Transmitting SPL: 115 dB (min)
Receiving sensitivity: -70 dB (min)
Capacitance @ 1kHz: 2400 pF
Max driving voltage: 20 Vrms
Total beam angle: 30° typ

Order Code	Mod.	Price each exc. VAT 1+	5+	inc. VAT each
N24KK	Usnc Rx 40k 18mm A	£6.65	£5.75	£7.99



40kHz 25mm Closed Ultrasonic Transmitter

ORDER IN STORE OR ONLINE

- Air ultrasonic ceramic transmitter - closed type
- 40kHz frequency
- 25mm diameter
- Aluminium case

Industry standard closed faced transmitter/receiver pair. Widely used in hobbyist and industrial markets for robotics, distance measurement, security, pest repellent and gas/wind detection

Centre frequency: 40.0 kHz ± 1.0 kHz
Bandwidth: 1.0 kHz
Transmitting SPL: 115 dB (min)
Receiving sensitivity: -70 dB (min)
Capacitance @ 1kHz: 2400 pF
Max driving voltage: 20 Vrms
Total beam angle: 30° typ

Order Code	Mod.	Price each exc. VAT 1+	5+	inc. VAT each
N25KK	Usnc Tx 40k 25mm a	£6.65	£5.75	£7.99



40kHz 12mm Open Plastic Ultrasonic Transceiver

ORDER IN STORE OR ONLINE

- Air ultrasonic ceramic transceiver - open type
- 40kHz frequency
- 12mm diameter
- Plastic case

Industry standard open faced transceiver. Widely used in hobbyist and industrial markets for robotics, distance measurement, security, pest repellent and gas/wind detection

Centre frequency: 40.0 kHz ± 1.0 kHz
Bandwidth: 2.0 kHz
Transmitting SPL: 117 dB (min)
Receiving sensitivity: -65 dB (min)
Capacitance @ 1kHz: 2400 pF
Max driving voltage: 20 Vrms
Total beam angle: 55° typ
Nominal impedance: 10000
Ringing: 1.2 ms (max)

Order Code	Mod.	Price each exc. VAT 1+	5+	inc. VAT each
N10KK	Usnc Txvr 40k 12mm P	£3.57	£3.09	£4.29



Ultrasonic Transceiver - 40kHz 14mm Enclosed

ORDER IN STORE OR ONLINE

- Air ultrasonic ceramic transceiver - closed type
- 40kHz frequency
- 14mm diameter
- Plastic case

Industry standard open faced transceiver. Widely used in hobbyist and industrial markets for robotics, distance measurement, security, pest repellent and gas/wind detection

Centre frequency: 40.0 kHz ± 1.0 kHz
Bandwidth: 2.0 kHz
Transmitting SPL: 103 dB (min)
Receiving sensitivity: -78 dB (min)
Capacitance @ 1kHz: 1600 pF
Max driving voltage: 20 Vrms
Total beam angle: 65° typ
Nominal impedance: 10000
Ringing: 1.2 ms (max)

Order Code	Mod.	Price each exc. VAT 1+	5+	inc. VAT each
N13KK	Usnc Txvr 40k 14mm A	£8.32	£7.19	£9.99



200.0 kHz Underwater Ultrasonic Transducer

ORDER IN STORE OR ONLINE

- Underwater ultrasonic transducer
- 200kHz frequency
- Plastic housing

Industry standard underwater ultrasonic transducer. Widely used in hobbyist and industrial markets for robotics, distance measurement, security, pest repellent and gas/wind detection

Centre frequency: 200.0 kHz ± 10.0 kHz
Bandwidth: 25.0 kHz
Transmitting SPL: 160 dB (min)
Receiving sensitivity: -180 dB (min)
Capacitance @ 1kHz: 2400 pF
Input power (pulse drive): 50 W
Total beam angle: 20° typ
Submerged impedance: 2000
Cable length: 4.5 m

Order Code	Mod.	Price each exc. VAT 1+	inc. VAT each
N16KK	Usnc Txdr 200k Wprf	£49.99	£59.99



POWER



CONTENTS

206 - 213	Electrical Cables
214 - 215	Surge Protection & RCD
216 - 229	Renewable Energy
230 - 253	Batteries
254 - 259	Household Wiring
260 - 285	Power Supplies
286 - 295	Bulbs
296 - 297	Security Lighting

Electrical Cables

Multi-Plugs

Two Socket 13A Multi Plug White

- Allows up to 2 appliances to be plugged into a standard 13A socket
- 3-pin adapter (13 amp rating)
- Shuttered sockets
- Unfused
- Supplied in white



Order Code	Mod: 001183	Price each exc. VAT 1+	inc. VAT each
HL62S	Mains Adaptor 2-Way	£4.74	£5.69

Three Socket 13A Multi Plug White

- Allows up to 3 appliances to be plugged into a standard 13A socket
- 3-pin adapter (13 amp rating)
- Shuttered sockets
- Includes fuse
- Supplied in white



Order Code	Mod: 001185	Price each exc. VAT 1+	inc. VAT each
HL63T	Mains Adaptor 3-Way	£6.40	£7.69

Three Socket Individually Switched Adapter White/Green

- 3-way adapter with each socket individually switched
- Neon indicator identifies which socket has power turned on
- Small, compact design
- Maximum connected load of 13A
- Fused



Order Code	Mod: 508295	Price each exc. VAT 1+	inc. VAT each
N49JK	3W Switched Plug	£4.57	£5.49

Extension Cables & Reels

25m Four Socket Extension Reel Grey



- Thermal protection against over heating
- 25m of 13A rated high quality cable
- Easily wound cable reel design
- Rated at 3120W

Designed to be used around the home and garden, this cable reel is ideal for use with most power and garden tools. Ideal for use with our RCD adapter socket [Order Code QS21X] to protect yourself from the risk of electrocution when using garden power tools.

Specifications:

Diameter: 205mm
Depth [excluding winding knob]: 75mm
Depth [including winding knob]: 100mm

Order Code	Mod: 988593	Price each exc. VAT 1+	inc. VAT each
N18DA	4Skt 25m Cable Reel	£29.15	£34.99

15m Four Socket Extension Reel Grey



- Thermal protection against over heating
- 15m of 13A rated high quality cable
- Easily wound cable reel design
- Rated at 3120W

Designed to be used around the home and garden, this cable reel is ideal for use with most power and garden tools. Ideal for use with our RCD adapter socket [Order Code QS21X] to protect yourself from the risk of electrocution when using garden power tools.

Specifications:

Diameter: 205mm
Depth [excluding winding knob]: 75mm
Depth [including winding knob]: 100mm

Order Code	Mod: 988592	Price each exc. VAT 1+	inc. VAT each
N17DA	4Skt 15m Cable Reel	£24.99	£29.99

10m Four Socket Pro Reel



- Unique patented reel design offers a smooth winding action
- 10m of 10A high visible cable for safety
- Rubberised grip to ensure it sits firmly in the hand during use
- Rated at 2400W
- Tested and certified to BSEN61242 and ASTA approved

The Pro Reel Range features include friction free technology, better stability and heat dispersion for the best power solution available. Suitable for home, garden and on the work site the Pro Range has the features that suit each environment superbly.

Specifications:

Diameter: 205mm
Depth [excluding winding knob]: 75mm
Depth [including winding knob]: 100mm

Order Code	Mod: 988594	Price each exc. VAT 1+	inc. VAT each
N19DA	4Skt 10m Cable R Pro	£20.82	£24.99



We can deliver to your home or office

(UK only)

2m One Socket Extension Cable White



- 1 socket connected to 2m of mains cable
- Complete with a fitted 13A mains plug
- An excellent value model

Order Code	Mod: 399924	Price each exc. VAT 1+	inc. VAT each
N82HZ	1W 2m Ext Lead	£4.99	£5.99

5m One Socket Extension Cable White



- 13A plug at one end with trailing socket on the other end
- Non-moulded plug and socket means they can easily be changed or replaced
- Suitable for appliances up to 3000W
- Supplied in white

Order Code	Mod: 001207	Price each exc. VAT 1+	inc. VAT each
ZB82D	1W 5m Ext Lead	£8.32	£9.99

2m Individually Switched Six Socket Extension Cable White



- 6 sockets connected to 2m of mains cable
- Complete with a fitted 13A mains plug
- Individually switched sockets so you can control the power to each socket independently
- Simple to add more sockets right where you need them
- A handy short length of cable
- Red light illuminates when power is on

Order Code	Mod: 997954	Price each exc. VAT 1+	inc. VAT each
N86FN	6W Ind Switch Ext 2m	£16.65	£19.99

Technical Helpline

0333 400 9500

For technical information and assistance relating to any Maplin purchase, contact our team of experts

5m Two Socket Extension Cable White



- 13A plug at one end and a twin trailing socket at the other
- Non-moulded plug and socket means they can easily be changed or replaced
- Suitable for appliances up to a total of 3120W
- The cable should be unwound fully before use

Order Code	Mod.	Price each exc. VAT	inc. VAT each
L95AL	2 Skt 5m Ext. Lead	£10.82	£12.99

2m Two Socket Extension Cable White



- 2 sockets connected to 2m of mains cable
- Complete with a fitted 13A mains plug
- An excellent value model

Order Code	Mod.	Price each exc. VAT	inc. VAT each
N83HZ	2W Extn Lead 2m Wht	£6.65	£7.99

10m Two Socket Extension Cable White



- 13A plug at one end and a twin trailing socket at the other
- Non-moulded plug and socket enables them to easily be changed or replaced
- Maximum load for both sockets is 3120W
- Cable should be fully unwound before use

Order Code	Mod.	Price each exc. VAT	inc. VAT each
L94AL	2 Skt 10m Ext. Lead	£14.15	£16.99

0.75m Four Socket Extension Cable White



- 4 sockets connected to 0.75m of mains cable
- Complete with a fitted 13A mains plug
- An excellent value model
- Simple to add more sockets right where you need them
- A handy short length of cable

Order Code	Mod.	Price each exc. VAT	inc. VAT each
N84HZ	4W Extn Lead 75cm Wht	£4.15	£4.99

2m Four Socket Extension Cable White



- 4 sockets connected to 2m of mains cable
- Orange light illuminates when power is on
- Terminated in a 13 A mains plug
- An excellent value model
- Simple to add more sockets right where you need them
- Model supplied may vary slightly from that illustrated

Order Code	Mod.	Price each exc. VAT	inc. VAT each
BN02C	4W Extn Lead 2m Wht	£8.32	£9.99

5m Four Socket Extension Cable White



- Increase the number of appliances you can connect to the mains
- Fitted with a 13A mains plug

Order Code	Mod.	Price each exc. VAT	inc. VAT each
GF88V	4W Extn Lead 5m Wht	£12.49	£14.99

2m Six Socket Extension Cable White



- 6 sockets connected to 2m of mains cable
- Complete with a fitted 13A mains plug
- An excellent value model
- Simple to add more sockets right where you need them

Order Code	Mod.	Price each exc. VAT	inc. VAT each
VJ91Y	6W Extn Lead 2m Wht	£10.82	£12.99

0.75m Individually Switched Six Socket Extension Cable White



- 6 sockets connected to 0.75m of mains cable
- Complete with a fitted 13A mains plug
- Individually switched sockets so you can control the power to each socket independently
- Simple to add more sockets right where you need them
- A handy short length of cable
- Red light illuminates when power is on

Order Code	Mod.	Price each exc. VAT	inc. VAT each
N42DA	6Skt Switched 0.75m	£12.49	£14.99

0.75m Individually Switched Four Socket Extension Cable White



- 4 sockets connected to 0.75m of mains cable
- Complete with a fitted 13A mains plug
- Individually switched sockets so you can control the power to each socket independently
- Simple to add more sockets right where you need them
- A handy short length of cable
- Red light illuminates when power is on

Order Code	Mod.	Price each exc. VAT	inc. VAT each
N87HZ	4w Swt Extn Lead 75cm	£10.82	£12.99

2m Individually Switched Four Socket Extension Cable White



- Connect up to 4 extra appliances using the extension sockets
- Long 2m lead and 13A rated plug attached
- Switch one or all appliances off with ease
- Save money and energy

Order Code	Mod.	Price each exc. VAT	inc. VAT each
VJ94C	4w Swt Extn Lead 2m	£13.32	£15.99

Find out more in-store

Our staff can offer friendly and expert advice; we're here to help



0.75m Six Socket Extension Cable White



- 6 sockets connected to 0.75m of mains cable
- Complete with a fitted 13A mains plug
- An excellent value model
- Simple to add more sockets right where you need them
- A handy short length of cable

Order Code	Mod.	Price each exc. VAT	inc. VAT each
N85HZ	399950 6W Extn Lead 75cmWht	£8.32	£9.99

5m Six Socket Extension Cable White



- 6 sockets connected to 5m of mains cable
- Complete with a fitted 13A mains plug
- An excellent value model
- Simple to add more sockets right where you need them
- A handy 5m length of cable ideal for use in offices

Order Code	Mod.	Price each exc. VAT	inc. VAT each
N86HZ	399955 6W Extn Lead 5m Wht	£14.99	£17.99

10m Four Socket Extension Reel Grey



- Thermal protection against over heating
- 10m of 13A rated high quality cable
- Easily wound cable reel design
- Rated at 3120W

Designed to be used around the home and garden, this cable reel is ideal for use with most power and garden tools. Ideal for use with our RCD adapter socket [Order Code QS21X] to protect yourself from the risk of electrocution when using garden power tools.

Specifications:

Diameter:	205mm
Depth (excluding winding knob):	75mm
Depth (including winding knob):	100mm

Order Code	Mod.	Price each exc. VAT	inc. VAT each
N16DA	988576 4Skt 10m Cable Reel	£18.32	£21.99

10m Four Socket Extension Reel Green/Orange



- 4 childproof shuttered sockets
- 10m of 10A rated high visibility orange cable
- Easily wound cable reel design
- Rated at 2400W

Designed to be used around the home and garden, this cable reel is ideal for use with most power and garden tools. The high visibility cable prevents damage to the cable and reduces the risk of tripping over the cable, whilst four sockets provide extra connectivity. Ideal for use with our RCD adapter socket [Order Code QS21X] to protect yourself from the risk of electrocution when using garden power tools.

Specifications:

Diameter:	205mm
Depth (excluding winding knob):	75mm
Depth (including winding knob):	100mm

Order Code	Mod.	Price each exc. VAT	inc. VAT each
L87BK	047635 10m 10A Cable Reel	£14.99	£17.99

5m Two Socket Extension Reel Black



- Easy to wind and unwind
- 2 extension sockets on cable reel
- 5 metre cable length
- Rated at 10A, 2400W when fully unwound

Designed to be used around the home, office and garden, this cable reel is ideal for use with most power and garden tools. The high visibility cable prevents damage to the cable and reduces the risk of tripping over the cable, whilst two sockets provide extra connectivity. Ideal for use with our RCD adapter socket [Order Code QS21X] to protect yourself from the risk of electrocution when using garden power tools. The maximum current that should be passed through the cable reel whilst fully wound is 3 amps (780 watts), and when unwound the maximum current is 10 amps (2400 watts).

Specifications:

Diameter:	235mm
Depth (excluding winding knob):	65mm
Depth (including winding knob):	100mm

Order Code	Mod.	Price each exc. VAT	inc. VAT each
N21JH	521802 5m 10A 2W CabReel	£12.49	£14.99

13A Hard Wearing Trailing Single Socket White

A single 13A socket moulded in unbreakable rubber. Designed to be fitted to the end of an extension lead.



Order Code	Mod.	Price each exc. VAT	inc. VAT each
HL730	812400 Trailing Skt Wht	£3.74	£4.49

13A Hard Wearing Trailing Single Socket Black



A single 13A socket moulded in unbreakable rubber. Designed to be fitted to the end of an extension lead.

Order Code	Mod.	Price each exc. VAT	inc. VAT each
VJ84F	812401 Trailing Skt Blk	£3.74	£4.49

Hard Wearing Trailing Double Socket White



A double 13A unswitched socket moulded in unbreakable rubber. Both sockets are shuttered and a cord grip is included. Designed to be fitted to the end of an extension lead.

Order Code	Mod.	Price each exc. VAT	inc. VAT each
VJ88V	812402 Trailing Dbl Skt Wht	£4.57	£5.49

Hard Wearing Trailing Double Socket Black



A double 13A unswitched socket moulded in unbreakable rubber. Both sockets are shuttered and a cord grip is included. Designed to be fitted to the end of an extension lead.

Order Code	Mod.	Price each exc. VAT	inc. VAT each
ZB41U	812403 Trailing Dbl Skt Blk	£4.57	£5.49

Newsletter

Subscribe to our newsletter for information about the latest innovation and the best deals.



Maplin TV

Home of innovation, handy tips and How To videos

Visit our channel...

youtube.com/maplintv



PowerCube Extended 1.5m



- 1.5m extension cord with 5 power outlets
- Mount it anywhere, horizontal, vertical and even upside down
- Included removable adhesive docking station
- Plugs do not obstruct each other
- Grounded power outlets

This PowerCube has a 1.5 metre extension cord fitted to it, so it can be mounted to have a power outlet within reach. To do this, a stick-on dock is included. An ideal location is your desktop, there is no more need to duck beneath your desk to plug in your laptop!

230v, 13A fused, 2990W (grounded) 1.5m cable

Color	Boston Red
Voltage	110-240V
Outlets	5
Cable	1.5m/5ft.
Mounting dock	Included
Cable fix	Included
Grounded	Yes
Child proofing	Yes

Order Code	Mod:	Price each exc. VAT 1+	inc. VAT each
A94GX	PowerCube Ext1.5m	£10.40	£12.49

PowerCube Extended USB 1.5m



- 1.5m extension cord with 5 power outlets and 2 USB ports
- Mount it anywhere, horizontal, vertical and even upside down
- Included removable adhesive docking station
- Plugs do not obstruct each other
- Grounded power outlets

This is the most extensive version of the PowerCube. It has a 1.5 metre extension cord fitted to it, so it can be mounted to have a power outlet within reach. To do this, a stick-on dock is included. An ideal location is your desktop, there is no more need to duck beneath your desk to plug in your laptop! Besides the extension cord, also a USB port is included, so your mobile devices can be recharged from your desktop!

Technical specifications

Color	Trolley Grey
Voltage	110-240V
Outlets	4
Cable	1.5m/5ft.
Mounting dock	Included
Cable fix	Included
Grounded	Yes
USB Output [V]	2 x 5V
USB Output [A]	2100 mA

Order Code	Mod:	Price each exc. VAT 1+	inc. VAT each
A95GX	PowerCube Ext USB	£17.49	£20.99

Mains Conditioners

Tacima 2m Six Socket Flat Screen and HDTV Surge Protector and Mains Filter



- Ideal for use with HDTV, LCD and plasma screens, home cinema, hi-fis and PCs
- Protects delicate circuits from sudden spikes
- Keeps sound and images free from interference
- 2 metres of mains cable

Designed with studio visual equipment in mind, Ultra Dam™ is a combined mains surge protection and interference rejection system that protects delicate circuits from sudden energy spikes while helping to keep your sounds and images free from unwanted signals coming through the mains supply.

Order Code	Mod:	Price each exc. VAT 1+	inc. VAT each
N44FB	6W AV Surge	£20.82	£24.99

Tacima 2m Six Socket Mains Conditioner Plus RFI Filter for Home Cinema and HiFi



- Powerful mains conditioner to reduce interference
- Improves picture and sound quality from AV equipment
- Includes surge protection
- 2 metre screened lead

This unit contains a powerful mains conditioning filter which will reduce or eliminate interference coming through the mains electricity supply and help to enhance the sound and picture quality from your AV equipment. The filters are specifically designed to combat both 'asymmetrical' as well as 'symmetrical' interference, both being effectively suppressed by the introduction of high frequency capacitors and a single choke. In addition the unit also incorporates an earth line choke to stop interference through the mains earth line and uses a screened mains cable to eliminate the effects of radiated noise interference.

Operating voltage:	AC 220-250V
Product weight	830g
Max. current rating	13A
Max. surge current	6500A
Frequency	Insertion Loss*
150kHz	62dB
3 MHz	35dB
30 MHz	30dB
1 GHz	15dB

* Insertion loss measurements carried out asymmetrically

Order Code	Mod:	Price each exc. VAT 1+	inc. VAT each
L07BK	Mains Conditioner 6W	£35.82	£42.99

Newsletter

Subscribe to our newsletter for information about the latest innovation and the best deals.



Power Cables

5m Power Lead with Cloverleaf Connector Black



An IEC-320 type C5 moulded 'cloverleaf' connector on 5m of 3-core cable with a moulded 13A UK mains plug. Typically used on laptop computers. This lead is rated at 250Vac 5A and the 13A plug carries a 3A fuse.

Order Code	Mod:	Price each exc. VAT 1+	inc. VAT each
N48DA	C5 Black 5m	£12.49	£14.99

2m Power Lead with Figure of 8 Connector White



Moulded figure-of-8 connector on 2 m of 2-core cable with a moulded 13A UK mains plug. Typically used on laptops, cassette players, radios, etc. This lead is rated at 250Vac, 2.5A and the 13A plug carries a 3A fuse.

Order Code	Mod:	Price each exc. VAT 1+	inc. VAT each
N46DA	Fig8 White 2m	£9.15	£10.99

Screened IEC C15 Mains Cable 1.5m Black



- Upgrade replacement for your standard IEC mains lead
- Double screened to reduce RFI interference

This replacement IEC lead is ideal for the home-cinema or hi-fi enthusiast to upgrade from their standard IEC lead provided with high-end audio visual equipment. 1.5 metres in length, and double-screened and oversheathed in clear PVC, the screening consisting of Melinex tape, aluminium tape and cross-hatch braiding. The lead uses 1.5mm 3-core mains cable and a high-quality MK plug for added value & is terminated in a 10A IEC-320 type C15 connector to BS4491 standard.

Order Code	Mod:	Price each exc. VAT 1+	inc. VAT each
L85AZ	HD Screened IEC Lead	£37.49	£44.99

Technical Helpline



0333 400 9500

For technical information and assistance relating to any Maplin purchase, contact our team of experts

2 m Power Lead with IEC Connector Black



Moulded, high quality IEC-320 type C13 socket to moulded, non-rewirable cable assembly rated at 5 A 250 Vac. The plug is supplied with a 5 A fuse. This is the standard power lead as used by PCs, test equipment, etc.

Order Code	Mod: 812380	Price each exc. VAT 1+	inc. VAT each
MK41U	Euro 3pin Ld 2m Blk	£9.15	£10.99

3m Power Lead with IEC Connector Black



Moulded, high quality IEC-320 type C13 socket to moulded, non-rewirable cable assembly rated at 5 A 250 Vac. The plug is supplied with a 5 A fuse. This is the standard power lead as used by PCs, test equipment, etc.

Order Code	Mod: 812381	Price each exc. VAT 1+	inc. VAT each
QN99H	Euro 3pin Ld 3m Blk	£9.99	£11.99

5m Power Lead with IEC Connector White



Moulded, high quality IEC-320 type C13 socket to moulded, non-rewirable cable assembly rated at 5 A 250Vac. The plug is supplied with a 5A fuse. This is the standard power lead as used by PCs, test equipment, etc.

Order Code	Mod: 997955	Price each exc. VAT 1+	inc. VAT each
N44DA	IEC-IEC 5m White	£12.49	£14.99

Find out more in-store

Our staff can offer friendly and expert advice; we're here to help



5m Power Lead with IEC Connector



Moulded, high quality IEC-320 type C13 socket to moulded, non-rewirable cable assembly rated at 5 A 250 Vac. The plug is supplied with a 5 A fuse. This is the standard power lead as used by PCs, test equipment, etc.

Order Code	Mod: 812382	Price each exc. VAT 1+	inc. VAT each
QZ82D	Euro 3pin Ld 5m Blk	£12.49	£14.99

Buying for business?
0333 400 9740



2m Power Lead with IEC Connector White



Moulded, high quality IEC-320 type C13 socket to moulded, non-rewirable cable assembly rated at 5 A 250Vac. The plug is supplied with a 5A fuse. This is the standard power lead as used by PCs, test equipment, etc.

Order Code	Mod: 812383	Price each exc. VAT 1+	inc. VAT each
PU48C	Euro 3pin Ld 2m Whit	£9.15	£10.99

2m Power Lead with Right Angled IEC Connector Black



- Neater and simpler mains connections
- Right angled connector is ideal for placing equipment close to walls
- Ideal for computer installations

Moulded, high quality, right-angled IEC-320 type C13 socket to moulded, non-rewirable cable assembly. Rated at 5A AC250V, the plug is supplied with a 5A fuse. The lead is supplied in black. This is the standard power lead as used by PCs, test equipment, etc. The right-angled connector makes it easier to place equipment close to walls.

Order Code	Mod: 812384	Price each exc. VAT 1+	inc. VAT each
PU49D	R/A IEC Lead 2m Blk	£9.15	£10.99

3m Power Lead with Right Angled IEC Connector Black



- Neater and simpler mains connections
- Right angled connector is ideal for placing equipment close to walls
- Ideal for computer installations
- Available with a 2m lead (Order Code PU49D) and a 3m lead (Order Code N86GT)

Moulded, high quality, right-angled IEC-320 type C13 socket to moulded, non-rewirable cable assembly. Rated at 5A AC250V, the plug is supplied with a 5A fuse. The lead is supplied in black. This is the standard power lead as used by PCs, test equipment, etc. The right-angled connector makes it easier to place equipment close to walls.

Order Code	Mod: 812385	Price each exc. VAT 1+	inc. VAT each
N86GT	R/A IEC Lead 3m Blk	£9.99	£11.99

1.8m Twin Socket IEC Mains Cable Black



- Neater and simpler mains connection
- Ideal for computer installations

A mains lead featuring a BSI approved solid, moulded UK plug fitted with a 13A fuse at one end connected via a 'Y' joint to two fully approved (BSI, VDE, D, N, S, FI, VE, IMQ, etc.) moulded IEC-320 type C13 connectors at the other. The length of cable between the UK plug and 'Y' joint is 1.8m and between each IEC connector and 'Y' joint is 0.5m.

Order Code	Mod: 026767	Price each exc. VAT 1+	inc. VAT each
SH97F	IEC Mains Y Lead	£9.15	£10.99

2m IEC Male to IEC Female Power Cable Black



- Moulded, high quality, IEC-320 type C13 socket to type C14 plug cable assembly
- Typically used for the power connection between a PC monitor and the base unit
- Ideal for extending other IEC mains leads
- Rated at 250V 6A

Supplied in black with a 2m lead

Order Code	Mod: 812386	Price each exc. VAT 1+	inc. VAT each
MK24B	Euro Mains CordSet 2m	£9.15	£10.99



We can deliver to your home or office

(UK only)

IEC Male to IEC Female Power Cable 3m Black



- Moulded, high quality, IEC-320 type C13 socket to type C14 plug cable assembly
- Typically used for the power connection between a PC monitor and the base unit
- Ideal for extending other IEC mains leads
- Rated at 250V 6A

Supplied in black with a 3m lead.

Order Code	Mod:	Price each exc. VAT	inc. VAT each
N28HH	812387 EuroMains CordSet 3m	£9.99	£11.99

2.2m 2 Way Male to Female IEC Splitter Black



- Neat and simple connection
- Ideal for computer installations

A lead featuring an approved IEC320 type C14 straight male cold connector at one end connected via a "Y" joint to two approved straight female IEC320 type C13 cold connectors at the other. The length of cable between the male connector and "Y" joint is 2.2m [approx] and between each female IEC connector and "Y" joint is 0.85m [approx].

Order Code	Mod:	Price each exc. VAT	inc. VAT each
VV375	031093 IEC 2 Way Splitter	£9.15	£10.99

1.2m Folding Thin Plug Power Lead with Figure of 8 Connector Black

- The smallest UK plug in the world: ultra slim, ultra light and safe
- The first BS 1363 approved UK folding plug with non-moving live pins
- ThinPlug has no protruding pins that can damage your valuable equipment
- World smallest 13amp plug



Folding ThinPlug to Fig 8 Mains Power Lead. 1.2m. ThinPlug is a newly designed and patented award winning UK folding plug. Its unique feature is the double-jointed earth pin. In closed position, the earth pin is housed within the central column connected to the main body, and lies horizontally flat between the neutral and live pins. This is the world smallest 13amp plug fitted with a figure8 socket.

Order Code	Mod:	Price each exc. VAT	inc. VAT each
N48CE	1001217 Thin Plug Fig of 8	£9.15	£10.99

5m Power Lead with Figure of 8 Connector Black



Moulded 'figure-of-8' connector on 5m of 2-core cable with a moulded 13A UK mains plug. Typically used on laptops, cassette players, radios, etc. This lead is rated at 250Vac, 2.5A and the 13A plug carries a 3A fuse.

Order Code	Mod:	Price each exc. VAT	inc. VAT each
N45DA	997956 Fig8 Black 5m	£12.49	£14.99

2m Power Lead with Figure of 8 Connector Black



Moulded 'figure-of-8' connector on 2m of 2-core cable with a moulded 13A UK mains plug. Typically used on laptops, cassette players, radios, etc. This lead is rated at 250Vac, 2.5A and the 13A plug carries a 3A fuse.

Order Code	Mod:	Price each exc. VAT	inc. VAT each
AK16S	001168 2.5A Mains Lead	£9.15	£10.99

2m Power Lead with Cloverleaf Connector Black



An IEC-320 type C5 moulded 'cloverleaf' connector on 2m of 3-core cable with a moulded 13A UK mains plug. Typically used on laptop computers. This lead is rated at 250Vac 5A and the 13A plug carries a 3A fuse

Order Code	Mod:	Price each exc. VAT	inc. VAT each
QN62S	029240 Moulded C5 Lead 2m	£9.15	£10.99

1.5m IEC Socket Lead to Bare Wire Cable Black



An IEC-320 type C13 line socket moulded to 1.5m of 3-core flex, rated at 6A. Approved to BSI, VDE, SEMKO, SEV, NEMKO, DEMKO and IMQ standards. For equipment use only - refer to a qualified engineer.

Order Code	Mod:	Price each exc. VAT	inc. VAT each
BW99H	001173 Euro 3pin 1.5m Bare	£6.65	£7.99

2m Power Lead with Cloverleaf Connector White



An IEC-320 type C5 moulded 'cloverleaf' connector on 2m of 3-core cable with a moulded 13A UK mains plug. Typically used on laptop computers. This lead is rated at 250Vac 5A and the 13A plug carries a 3A fuse.

Order Code	Mod:	Price each exc. VAT	inc. VAT each
N47DA	997962 C5 White 2m	£9.15	£10.99

2m Right Angled IEC Socket Bare Wired Lead Black



A right-angled IEC-320 type C13 socket moulded to a 2m length of 3-core flex terminated in stripped bare ends. Rated at 6A.

For equipment use only - refer to a qualified engineer

Order Code	Mod:	Price each exc. VAT	inc. VAT each
AP08J	001174 R/A IEC Lead 2m Bare	£6.65	£7.99

1.2m Figure of 8 Connector Bare Wired Lead Black



An IEC-320 type C7 moulded 'figure-of-8' connector on 1.2m of 2-core cable terminated in stripped ends. Typically used on laptops, cassette players, radios, etc. For equipment use only - refer to a qualified engineer

Order Code	Mod:	Price each exc. VAT	inc. VAT each
RW66W	001167 Cas. Lead Telefunken	£6.65	£7.99

Cloverleaf to Figure of 8 Adapter Black



- IEC-320 C7 2 prong receptacle to IEC-320 C6 plug adapter
- Rated up to 2.5A AC250V or 10A AC 125V
- Convert from IEC-320 C7 2-prong receptacle

Order Code	Mod:	Price each exc. VAT	inc. VAT each
N12GA	223684 C7 to C6 Adaptor	£4.99	£5.99

Cloverleaf to IEC Male Adapter Black



- IEC-320 C6 plug to IEC-320 C13 receptacle adapter
- Rated up to 2.5A 250V
- Convert from IEC-320 C6 plug

Order Code	Mod:	Price each exc. VAT	inc. VAT each
N75GB	C6 to C13 Adaptor	£4.99	£5.99

2.5A Moulded IEC C14 to C5 Adapter Black



- IEC-320 C5 receptacle to IEC-320 C14 plug adapter
- Rated up to 2.5A 250V
- Convert from IEC-320 C14 Receptacle

Order Code	Mod:	Price each exc. VAT	inc. VAT each
N74GB	C14 to C5 Adaptor	£4.99	£5.99

Surge Protection & RCD

Surge Protection

2m Four Socket Individually Switched Surge Protected Extension Cable Black



- Extend your connectivity and help save the environment
- 4 sockets that can be individually switched on and off
- Protect valuable equipment and data from being damaged by electrical surges and spikes
- Save money and energy by switching individual appliances off standby
- Power on neon indicator
- 2m of 13A cable with fitted plug

Order Code	Mod:	Price each exc. VAT	inc. VAT each
N41DA	4Skt Srg Switched 2m	£14.15	£16.99

2m Four Socket Surge Protected Extension Cable Black



- Extend your connectivity and help save the environment
- Protect valuable equipment and data from being damaged by electrical surges and spikes
- Surge active indicator

- 2m of 13A cable with fitted plug

Order Code	Mod:	Price each exc. VAT	inc. VAT each
N38DA	4Skt Surge Black 2m	£9.99	£11.99

2m Six Socket Surge Protected Extension Cable White



- Extend your connectivity and help save the environment
- Protect valuable equipment and data from being damaged by electrical surges and spikes
- Surge active indicator
- 2m of 13A cable with fitted plug

Order Code	Mod:	Price each exc. VAT	inc. VAT each
N39DA	4Skt Surge White 2m	£14.15	£16.99

2m Four Socket Surge Protected Extension Cable White



- Extend your connectivity and help save the environment
- Protect valuable equipment and data from being damaged by electrical surges and spikes
- Surge active indicator
- 2m of 13A cable with fitted plug

Order Code	Mod:	Price each exc. VAT	inc. VAT each
N37DA	4Skt Surge White 2m	£9.99	£11.99

Buy it on the web at maplin.co.uk

Shop for all Maplin products online at our website and check out our latest products and special offers!



5m Four Socket Individually Switched Surge Protected Extension Cable Black



- Extend your connectivity and help save the environment
- 4 sockets that can be individually switched on and off

- Protect valuable equipment and data from being damaged by electrical surges and spikes
- Save money and energy by switching individual appliances off standby
- Power on neon indicator
- 5m of 13A cable with fitted plug

Order Code	Mod:	Price each exc. VAT	inc. VAT each
N40DA	4Skt Srg Switch 5M	£16.65	£19.99

Find out more in-store

Our staff can offer friendly and expert advice; we're here to help



One Socket Surge Protector 10A White

- Surge protected adapter to provide protection for sensitive electronic equipment
- Provides protection during mains power surges and lightning strikes
- LED indicator lights show that equipment is protected and that the power is on
- Child safety shutters protect objects being inserted into the socket
- Rated at 10A and 2500W



Technical specifications:

Power rating	10A / 2500W
Maximum power	2500W
Surge rating:	306J
Maximum spike current	12,000A
Maximum spike voltage	6kV
Response time	<1 Nanosecond

Order Code	Mod:	Price each exc. VAT	inc. VAT each
N01FY	Surge Plug	£6.65	£7.99

Three Socket Surge Protected Adapter White

- Protects PCs, hi-fi, TVs, etc
- Conforms to BS1363/3 & BS6651

Protect your sensitive equipment from the potential hazards of voltage spikes and surges.



Order Code	Mod:	Price each exc. VAT	inc. VAT each
W94C	3-Way Surge Adaptor	£9.99	£11.99

Maplin TV

Home of innovation, handy tips and How To videos

Visit our channel...



youtube.com/maplintv

Five Socket Individually Switched Surge Protected Adapter White



- Protect valuable equipment and data from being damaged by electrical surges and spikes Neatly extend your connectivity - no trailing cables
- Converts a single socket into 5 independent sockets
- 4 sockets can be individually switched on and off
- Does not block the 2nd socket of a double wall socket
- Individually switched sockets have neon power indicator lights
- Save money and energy by switching individual appliances off standby
- Ideal for use with raised and flush sockets
- Green surge active indicator light
- Rated at 13A
- Maximum load should not exceed 3000W
- Thermal cut out to avoid overloading

Instantly converts a single socket into five independent sockets, enabling you to run 5 separate appliances from the same socket.

Surge protected with four individually switched sockets to save energy and money by allowing you to turn individual appliances off standby.

Technical specifications:

No of sockets:	5
Voltage:	240V / 50HZ
Maximum current :	13A
Maximum load:	3000W
Maximum surge energy:	375 Joules
Clamping voltage:	775 Volts
Response time	<10ns
3-channel protection:	Yes
Thermal cut-out	Yes
Neon surge protector	Yes

Order Code	Mod:	Price each exc. VAT 1+	inc. VAT each
N48JK	Ito5W Up SurgeAdpctr	£9.99	£11.99

1.5m Six Socket UFO Surge Protected Extension Cable Black

- 6 x surge extension sockets on a 1.5 metre cable
- Protect your electronic equipment from damaging surges of electricity
- 13A fitted plug
- Rated at 3250W
- Wide spacing between sockets accommodates bulky transformer type plugs
- Green surge protection status indicator light
- Red power on indicator light
- Wall / ceiling mounting eyelets on rear of unit



Order Code	Mod:	Price each exc. VAT 1+	inc. VAT each
N75GA	6 Way UFO Surge	£10.40	£12.49

Send direct

If any product is not in stock, we will order it for you and send it with free delivery

Terms and conditions apply.



5m Six Socket Individually Switched Surge Protected Extension Cable Black

- Extend your connectivity and help save the environment
- 6 sockets that can be individually switched on and off
- Protect valuable equipment and data from being damaged by electrical surges and spikes
- Save money and energy by switching individual appliances off standby
- Power on neon indicator
- 5m of 13A cable with fitted plug



Order Code	Mod:	Price each exc. VAT 1+	inc. VAT each
N49DA	6 Skt Srg Switch 5M	£20.82	£24.99

2m Six Socket Individually Switched Surge Protected Extension Cable Black



- Extend your connectivity and help save the environment
- 6 sockets that can be individually switched on and off
- Protect valuable equipment and data from being damaged by electrical surges and spikes
- Save money and energy by switching individual appliances off standby
- Power on neon indicator
- 2m of 13A cable with fitted plug

Order Code	Mod:	Price each exc. VAT 1+	inc. VAT each
N36DA	6Skt Srg Switched 2m	£17.49	£20.99

2m Eight Socket Surge Protected Extension Cable White



- Protect valuable equipment and data from being damaged by electrical surges and spikes
- Ideal for use with laptops, TVs, hi-fis, satellite receivers and multimedia equipment
- Red light illuminates when power is on
- Surge active indicator

- Complete with a fitted 13A mains plug
- Thermally fused
- Rated at 13A, 240V, 3120W
- Maximum peak current: 4500Amp at 8/20 microsecond

Order Code	Mod:	Price each exc. VAT 1+	inc. VAT each
N97HZ	8W 2.0m Surge White	£16.65	£19.99

1.5m Eight Socket Folding Surge Protected Extension Cable White



- Add extra sockets where they are needed the most
- 8 sockets on a 1.5m cable
- Unique folding design fits into a 90° corner
- Protects electrical equipment from damaging electrical surges and spikes
- Yellow power on LED
- Green surge active LED
- Rated at 13A and 3250W

Order Code	Mod:	Price each exc. VAT 1+	inc. VAT each
N50GH	8-Way Folding Surge	£14.99	£17.99

2m Ten Socket Surge Protected Mini Tower White

- Extend your connectivity by ten times
- 10 sockets from 1 mains outlet on a 2m cable
- Protect against mains voltage surges and spikes
- Includes surge protection indicator



Dimensions:
390[h] x 140[w] x 140[d] mm

Order Code	Mod:	Price each exc. VAT 1+	inc. VAT each
N62GC	10W mini Surge Tower	£13.32	£15.99

2m Ten Socket Surge Protected Tower White

- Protects equipment from surges and spikes
- Add extra sockets where needed
- Switch all plugged in appliances on and off, reducing the need for standby, saving money and energy
- 2m cable and fitted plug with 10 sockets rated at 13A
- 2 transformer style sockets with wider spacing for bulky plugs
- Power on/off switch
- Surge active and power on indicators
- Thermal fused protection



- Neat solution to cable management for up to 10 appliances

Order Code	Mod: 220694	Price each exc. VAT 1+	inc. VAT each
N85FN	10Way 2m Surge Tower	£24.99	£29.99

Quirky Pivot Power Multiplug



- Five adjustable outlets
- Flexible form that bends into circular, semi-circular, and zig-zag shapes
- 500 joules surge protection
- 1.2m cord with a flat head plug
- Pivots around furniture and hard to reach places

With the number of bulky charging units, and power supplies we have to plug in, you inevitably find that it's difficult to fit them all next to each other.

Pivot Power designed to not only fit all of your power sockets, but to pivot around furniture, walls and other hard to reach places.

Dimensions: 390(h) x 140(w) x 140(d) mm

Order Code	Mod: 788014	Price each exc. VAT 1+	inc. VAT each
N57QH	Pivot Power	£16.65	£19.99

Shopping with us is easy...

In-store

7 days a week, check store listings at the back of the catalogue for address details

Online

maplin.co.uk

24hrs a day, 7 days a week, 365 days a year

Phone

0333 400 9500

Phone lines open 7 days a week

Buying for business?

0333 400 9740

RCD

Safety Breaker

- Simple 2-button design
- Easy to use
- Prominent indicator window
- Protects against electric shocks

Protect you and your family with this precision-engineered RCD adapter that gives protection against electrocution. This versatile adapter can be used both inside and outside the home and is ideal for use with a multitude of household devices - in the kitchen where water can be particularly hazardous, in the garden with gardening appliances such as lawnmowers and hedge trimmers, and it is also ideal for use with potentially dangerous power tools. Conforms with BS7071.



Please note: We reserve the right to supply a product of the same or higher specification that may differ in appearance from the image shown.

Specifications:

Operating voltage	230Vac
Maximum current	13A
Rated trip current	30mA
Trip speed	<30mS
Contact break type	Double pcle

Order Code	Mod: 029769	Price each exc. VAT 1+	inc. VAT each
0S21X	RCD Sckt Adaptor	£12.07	£14.49

Find out more in-store

Our staff can offer friendly and expert advice; we're here to help



Renewable Energy

Wind Turbines

12V LE-300 Wind Turbine Kit



- Provides the basis of an off-grid power system for home and work
- Can deliver outputs of 300W
- Add wind power to an existing off-grid power system to compliment Solar PV - more power in the winter months or a diesel generator - cut down your fuel usage and save money
- Ideal for powering equipment in remote places. Electric fences, water pumps, lighting and power in farm buildings, data-loggers all require power in places where there isn't a mains connection readily available
- Lightweight turbine head reduces the loading on the support structure and makes it easier to install on high masts in difficult locations
- Whisper™Blade technology means low acoustic

emissions from the advanced aerofoil blade design developed specifically for the LE-300

- Fully marinised aluminium alloy and stainless steel components are protected from the elements with aerospace grade coatings and anodising
 - Easy Installation: Fit the blades, nose cone and make the electrical connections - all explained in an excellent user manual with detailed written explanations and diagrams.
 - Originally designed for industrial applications, durability and reliability is the corner stone of the LE-300 architecture
 - 5 year warranty backed up with excellent customer service from Leading Edge Turbines in the UK
- This bundle of equipment includes all of the basic equipment (turbine, run/stop switch and diversions charge controller) that you will need to get a LE-300 wind turbine up and running on a basic battery charging system

The LE-300 is a quiet, powerful yet lightweight 300 watt generator for any application. Fully optimised for marine conditions, the LE-300 wind turbine is also used extensively in a variety of industrial applications, such as powering communication and remote monitoring stations, and in very extreme environments such as Antarctica. Manufactured in the UK, the LE-300 has a proven track record in applications as diverse as powering an Antarctic research station, charging batteries on boats and industrial applications such as road signage. Its excellent power production stems from an exceptionally low start-up wind speed and superb high wind speed output. Designed to withstand the most extreme wind conditions and environments, the LE-300 is also extremely easy to integrate with solar panels for hybrid systems and can be left running through the strongest winds.

Available in 12V [Order Code: N24QU] 24V [Order Code: N25QU] for battery charging applications, the LE-300 wind turbine can also be grid connected.

Pack contents:

- LE-300 wind turbine
- Run / Stop switch - used to allow the turbine to be safely braked and electrically isolated from the circuit
- DL-300 Diversion charge controller - used to divert excess power to a dump load when your batteries are full

Technical specifications:

Output voltage	12V
Rotor diameter	1m
Rotor height	n/a
Rotor type	3-blade up-wind
Blade material	Glass reinforced nylon
Rated output	85W @ 8m/s (17.8mph)
Maximum output	300W
Rated rpm	800rpm
Cut-in	3m/s (6.7mph)
Weight	6kg
Generator type	3-Phase Brushless NIB rotor PMA
Tower mount Diameter	48.3mm (1.90 inches) or 50.0mm (1.96 inches)

Order Code	Mod: 790615	Price each exc. VAT 1+	inc. VAT each
N24QU	12V LE300WindTurbine	£541.65	£649.99

Maplin TV

Home of innovation, handy tips and How To videos

Visit our channel...

youtube.com/maplintv



24V LE-300 Wind Turbine Kit



- Provides the basis of an off-grid power system for home and work
- Can deliver outputs of 300W
- Kit includes wind turbine, run/stop switch and diversion charge controller
- Add wind power to an existing off-grid power system to compliment Solar PV - more power in the winter months or a diesel generator - cut down your fuel usage and save money
- Ideal for powering equipment in remote places. Electric fences, water pumps, lighting and power in farm buildings, data-loggers all require power in places where there isn't a mains connection readily available
- Lightweight turbine head reduces the loading on the support structure and makes it easier to install on high masts in difficult locations
- 'Whisper' Blade technology means low acoustic emissions from the advanced aerofoil blade design developed specifically for the LE-300
- Fully marinised aluminium alloy and stainless steel components are protected from the elements with aerospace grade coatings and anodising
- Easy Installation: Fit the blades, nose cone and make the electrical connections - all explained in an excellent user manual with detailed written explanations and diagrams.
- Originally designed for industrial applications, durability and reliability is the corner stone of the LE-300 architecture
- 5 year warranty backed up with excellent customer service from Leading Edge Turbines in the UK

This bundle of equipment includes all of the basic equipment (turbine, run/stop switch and diversions charge controller) that you will need to get a LE-300 wind turbine up and running on a basic battery charging system.

The LE-300 is a quiet, powerful yet lightweight 300 watt wind generator for any application. Fully optimised for marine conditions, the LE-300 wind turbine is also used extensively in a variety of industrial applications, such as powering communication and remote monitoring stations, and in very extreme environments such as Antarctica. Manufactured in the UK, the LE-300 has a proven track record in applications as diverse as powering an Antarctic research station, charging batteries on boats and industrial applications such as road signage. Its excellent power production stems from an exceptionally low start-up wind speed and superb high wind speed output. Designed to withstand the most extreme wind conditions and environments, the LE-300 is also extremely easy to integrate with solar panels for hybrid systems and can be left running through the strongest winds.

Available in 12V [Order Code: N24QU] 24V [Order Code: N25QU] for battery charging applications, the LE-300 wind turbine can also be grid connected.

Pack contents:

- LE-300 wind turbine
- Run / Stop switch - used to allow the turbine to be safely braked and electrically isolated from the circuit
- DL-300 Diversion charge controller - used to divert excess power to a dump load when your batteries are full

Technical specifications:

Output voltage: 24V

Rotor diameter: 1m
 Rotor height: n/a
 Rotor type: 3-blade up-wind
 Blade material: Glass reinforced nylon
 Rated output: 86W @ 8m/s (17.8mph)
 Maximum output: 300W
 Rated rpm: 800rpm
 Cut-in: 3m/s (6.7mph) 350rpm
 Weight: 6kg
 Generator type: 3-Phase Brushless NIB rotor PMA
 Tower mount Diameter: 48.3mm (1.90 inches) or 50.0mm (1.96 inches)

Order Code	Mod: 790616	Price each exc. VAT 1+	inc. VAT each
N25QU	24V LE300WindTurbine	£541.65	£649.99

12V LE-V50 Vertical Axis Wind Turbine



- Ideal for motor homes, camping, marine and outdoor use
- Not sensitive to wind direction
- Does not need a separate charge controller
- Silent Operation - absolutely no noise as the turbine operates
- Small compact size - easy to install in places where space is a premium
- Lightweight - at only 9kg it can be installed with ease
- Safe - the rotating blades cannot cause injury
- Reliable - with only one moving set of parts and no brushes to wear out
- Indestructible - designed and proven to survive 120mph Antarctic winds

The LE-V50 is a compact, silent and lightweight vertical axis turbine designed to trickle charge your batteries or provide power for low power electronic devices such as data-logging or telemetry equipment.

The LE-V50 was originally designed to provide power for industrial data monitoring equipment in the most extreme and remote places on the planet. Since then, the LE-V50 has become a regular sight at marinas and caravan parks providing a trickle charge to valuable batteries whilst the vehicle owners are away. This saves owners money by not having to connect to 'shore power' or repair and replace expensive batteries that have been damaged by becoming discharged. In the yachting world, the LE-V50 also reduces the effects of mains induced electrolysis and corrosion on the boat as well as meaning that owners can go on extended cruises without need to run the engine. The LE-V50 can also be found all over the world powering small electronic systems in remote places where there is no other power source, such as supplementing Solar PV panels in 'off-grid' renewable energy systems and powering LED street lights and other lighting systems.

Technical specifications:

Output voltage: 12V
 Rotor diameter: 270mm
 Rotor height: 457.5mm
 Rotor type: 3-blade savonius
 Blade material: Aluminium alloy
 Rated output: 11W @ 8m/s (18mph)
 Maximum output: 70W
 Rated rpm: 200rpm
 Cut-in: 5m/s (11.1mph)

130rpm
 Weight: 9kg
 Generator type: 3-Phase Brushless NIB rotor PMA
 Tower mount Diameter: Side mount flange

Order Code	Mod: 803447	Price each exc. VAT 1+	inc. VAT each
N26QU	12V LEV50WindTurbine	£499.99	£599.99

24V LE-750 Down Wind Turbine Kit



- Provides the basis of an off-grid power system for home and work and caters for future system expansion
- Can deliver peak output of 750W
- Kit includes wind turbine, run/stop switch, diversion charge controller and dump load
- Add wind power to an existing off-grid power system to compliment Solar PV - more power in the winter months
- Add wind power to an existing off-grid power system to compliment a diesel generator - cut down your fuel usage and save money
- Ideal for powering equipment in remote places. Electric fences, water pumps, lighting and power in farm buildings, data-loggers all require power in places where there isn't a mains connection readily available
- Lightweight turbine head makes it easier to install on high masts in difficult locations
- 'Downwind' layout gives a small visual impact with no tail boom to vibrate and fail through fatigue
- 'Whisper'™ Blade technology means low acoustic emissions from the advanced aerofoil blade design
- Fully marinised aluminium alloy and stainless steel components are protected from the elements with aerospace grade coatings and anodising
- Easy Installation: Fit the blades, nose cone and make the electrical connections - all explained in an excellent user manual with detailed written explanations and diagrams.
- Originally designed for industrial applications, durability and reliability is the corner stone of the LE-600 architecture
- 2 year warranty backed up with excellent customer service from Leading Edge Turbines in the UK

The LE-600 is designed around a unique low inertia axial flux generator which utilises Neodymium rare earth magnetic materials. This alternator has zero 'cogging', which, together with its highly efficient and low 'TSR' Whisper Blades, allows the turbine to spin in the lightest of breezes and to react quickly to gusts. Furthermore, the LE-600 has a wild 3-phase output which is then converted to DC by an external regulator (supplied) which can be located near to the battery bank. This results in the most efficient way of transmitting power for long-distances between the turbine and the battery bank. Not only does this mean that you can save money by purchasing smaller less expensive transmission cables, but it means that you can put the turbine further away from the battery bank, in a position where it can be exposed to optimum wind conditions.

Pack contents:

- LE-600 24V wind turbine
- Run / Stop switch - used to allow the turbine to be safely braked and electrically isolated from the circuit

- Morningstar Tristar TS-45 Diversion Load Controller - used to divert excess power to a dump load when your batteries are full
- 1000W DC Dump Load - used to burn off excess power when your batteries are full

Technical specifications:

Output voltage: 24V
 Rotor diameter: 1.54m
 Rotor height: n/a
 Rotor type: 3-blade down-wind
 Blade material: Glass reinforced nylon
 Rated output: 160W @ 7.2m/s (16mph)
 Maximum output: 700W
 Rated rpm: 550rpm
 Cut-in: 3m/s (6.7mph)
 290rpm
 Weight: 19kg
 Generator type: 3-Phase Brushless NIB rotor PMA
 Tower mount Diameter: 60.3mm (2.37 inches)

Order Code	Mod.	Price each exc. VAT 1+	inc. VAT each
N27QU	24V LE600WindTurbine	£999.99	£1199.99

Solar Gadgets

Maplin 20L Solar Shower

- Easy to fill shower bag with 20-litre maximum water capacity
- Ideal for camping, back-packing, boating and more
- Simply leave in the sun for around 3 hours to warm the water
- Includes shower head, flow control and hanging cord
- Dimensions: 55cm (l) x 40cm (w)



Caution: The water in the solar shower can reach temperatures in excess of 120°F (50°C). Test water before use and add cold water as necessary
Please note that the shower bag should not be used as a canister for storing drinking water.

Order Code	Mod.	Price each exc. VAT 1+	inc. VAT each
N62NT	20L Solar Shower	£5.82	£6.99

Solar Powered Thermometer

- Small Amorphous solar panel
- Reads temperatures from -25°C to 59.5°C +/-1°C (-13°F to 139.1°F)
- Suction cup for attaching to windows or glass
- Convertible temperature unit between °C & °F
- Daily min/max display recorded for reference
- Temperature trend indicator
- Display updated every seconds



This small solar powered thermometer has been given a modern translucent design, allowing light to power and give you a clear view on the temperature. Supplied with a suction cup for easy placement on windows, glass or plastics

Order Code	Mod.	Price each exc. VAT 1+	inc. VAT each
N60NT	Solar Thermometer	£4.57	£5.49

Solar Simulated Car Alarm

- Blue LED flashes every 3 seconds when it is dark, simulating a real car alarm
- Acts as a deterrent to thieves and vandals
- Recharges via the integrated solar panel during the day
- Embedded CDS light sensor



Order Code	Mod.	Price each exc. VAT 1+	inc. VAT each
N37JJ	Solar Fake Car Alarm	£6.65	£7.99

Solar Shed Lights

HUBi 2k Solar Lighting and Power system



- Simple and efficient way to generate lighting and power in remote locations
- Easy Set up - all plug and play
- Highly efficient industrial crystalline solar panel produces power in all daylight conditions
- Very latest lithium battery pack to store power ready for use
- Battery pack has multiple power outputs - 3 x 12v and 2 x 5v USB
- Supplied with 2 x LUMi lights each capable if illuminating a 9sqm area

Supplied with

- 5w Solar Panel
- Solar Panel Stand
- 2 x Lumi 12v lights and mounting hooks
- Main HUBi 2A unit
- All connecting cables
- Two year worldwide warranty

Order Code	Mod.	Price each exc. VAT 1+	inc. VAT each
N18EK	HUBi 2k Solar L&P system	£83.33	£99.99

HUBi 10k Solar Lighting and Power system



- Simple and efficient way to generate lighting and power in remote locations
- Easy Set up - all plug and play

- Highly efficient industrial crystalline solar panel produces power in all daylight conditions
- Very latest lithium battery pack to store power ready for use
- Battery pack has multiple power outputs - 3 x 12v and 2 x 5v USB
- Supplied with 2 x LUMi lights each capable if illuminating a 9sqm area

Unlike the HUBi 2k the HUBi 10k not only has a battery 5 times bigger but it is expandable, allowing you to connect up to 3 units together giving you a huge amount of power

Supplied with

- 20w Solar Panel
- Solar Panel Stand
- 2 x Lumi 12v lights and mounting hooks
- Main HUBi 10A unit
- All connecting cables
- Two year worldwide warranty

Order Code	Mod.	Price each exc. VAT 1+	inc. VAT each
N19EK	HUBi 10k Solar L&P system	£179.99	£179.99

HUBi 10k Solar Lighting and Power system expansion pack



- Increase power storage capacity by up to 300%
 - Expand the HUBi 10K system with up to two additional HUBi 10k Expansion packs
 - Easy interconnection between each HUBi pack
 - Ideal for higher power demands or multiple users
- The HUBi 10k LIGHTING AND POWER SYSTEM

Add one or two additional Solar Hubs to the original to increase power capacity by up to 300%. Supplied with linking cable

Order Code	Mod.	Price each exc. VAT 1+	inc. VAT each
N20EK	HUBi 10k Solar L&P exp. pack	£91.67	£109.99

HUBi 10k Solar Lighting and Power system 20 w Expansion Panel



- Pre-wired with interconnection cable to easily connect to the original solar panel supplied
- HUBi Solar Expansion Pack

Select this Expansion pack if faster recharge times are needed for a single HUBi 10K

The Expansion Panel is supplied with a linking cable so it can be connected directly into the cable fitted to the original solar panel supplied with the HUBi 10K. This ensures there is only one cable running from the panel(s) to the HUBi(s)

Order Code	Mod.	Price each exc. VAT 1+	inc. VAT each
N21EK	HUBi 10k Solar L&P 20w exp. pack	£58.33	£69.99



Browse our entire range at maplin.co.uk

10 LED Portable Solar Light with Remote Control



- Quick and easy way to provide lighting for small buildings such as sheds, stables, summer houses or when camping
- Installed in minutes and with no extra power costs
- 10 super bright LED's provide light to an area of 7m²
- Provides up to 3 hours' light per day
- Activated by a manual on/off switch or by the supplied remote control
- Remote control requires 2 x AAA batteries (Order Code: L42AL - sold separately)

This portable solar light is an easy way to provide light inside small buildings where there is no access to mains electricity. It is ideal for use in sheds, garages, stables, summer houses as well as for camping and other outdoor activities.

The solar panel charges the three internal AA rechargeable batteries, located in the light unit, during the day ready for operation at dusk. This portable solar light has 10 super bright LEDs and can be activated either by the on/off switch located on the light unit or by using the supplied remote control. The light is connected to the remote solar panel using the included 1.7m cable.

Contents:

- 10-LED light fitted with 3 x AA rechargeable batteries
- Solar panel with 1.7m fitted cable
- Remote control (requires 2 x AAA batteries - sold separately)
- Mounting bracket
- Mounting hardware
- Full instruction manual

Order Code	Mod: 223425	Price each exc. VAT 1+	inc. VAT each
N30FY	RC Solar Light	£19.15	£22.99

15 LED Solar PIR Light



- Security around the house and garden
- Add light to any outdoor space with no other power source
- Quick and easy way to provide lighting outside small buildings such as sheds, stables, garages etc
- 15 super bright white LEDs provide strong light (9000mcd)
- Installed in minutes - no wiring required, no electricity costs
- 0.6W crystalline solar panel collects sunlight to charge the unit even on cloudy days
- The PIR motion sensor switches light on when movement is detected within its range
- PIR sensor has a 2m to 6.5m detection range
- Light stays on for 25 seconds once activated
- Includes 3 x AA 600mAh NiMH rechargeable batteries

This portable solar light is an easy way to provide light inside small buildings where there is no access to mains electricity. It is ideal for use in sheds, garages, stables, summer houses as well as for camping and other outdoor activities.

The solar panel charges the three internal AA

rechargeable batteries, located in the light unit, during the day ready for operation at dusk. The PIR automatically turns the light on when movement is detected and the light stays on for 25 seconds once movement has been detected.

Order Code	Mod: 509258	Price each exc. VAT 1+	inc. VAT each
N10JF	15LED Solar PIR Light	£20.82	£24.99

Solar PIR Security Lights

Solar LED Wall PIR Light

- Security around the house, office or garden
 - 3 White LED's
 - Add light to any outdoor space with no other power source
 - Built in light sensor, automatically come on at dusk
 - 180° motion detection
 - Stays on for 20 seconds after no movement is detected
 - Solar cell charges the batteries during the day to provide an ambient light at night
 - Durable plastic construction
 - 80mm x 80mm solar panel complete with 4.8m power cable
 - 3 x AA 600mAh NiMH rechargeable batteries included
- This solar PIR light is an environmentally friendly product as it is powered by solar energy through the solar panel. During the day, the solar panel converts sunlight into energy, which is stored in the rechargeable battery. The integrated PIR sensor activates the light when motion is detected, helping keep your home safe and secure.



Technical Specification:

Light Source:	3 x white LED
Solar Panel Type:	Polycrystalline
Solar Panel Power:	5.5W / 100mA
Battery:	3x 600mAh AA Ni-MH rechargeable
Cable Length:	4.8m
Dimensions:	155 x 139 x 110mm

Order Code	Mod: 787849	Price each exc. VAT 1+	inc. VAT each
N64NT	Solar Wall PIR Light	£12.49	£14.99

Solar Mate Secure LED PIR Light



- Solar powered PIR / movement activated security light where mains power is inaccessible
- Uses 3 x double sized LEDs, to flood a 5m area with light
- Auto switch on at night only
- Sensitivity and burn time (30 seconds to 20 minutes) adjustable
- 2m power cord between solar panel and light unit for optimum positioning
- Uses ultra efficient German RWE solar cell
- Supplied with 3 x AA rechargeable batteries
- Wall fixings and comprehensive instructions included
- Light head is waterproof and suitable for outdoor use

Order Code	Mod: 225015	Price each exc. VAT 1+	inc. VAT each
N54GF	Solar Mate Secure	£16.65	£19.99

Twin Head LED Solar Light with PIR Sensor



- Security around the house and garden
- No wiring required, no electricity costs
- Light can be mounted anywhere inside and out (mounting kit included)
- Charged by solar panel during the day
- 18 high-output LEDs in each light
- The PIR motion sensor switches lights on when movement is detected within its range
- Fully adjustable spotlight head (with built-in PIR sensor) and solar panel
- Includes 3 x AA size 600mAh Ni-Mh rechargeable batteries
- Waterproof design

Order Code	Mod: 351569	Price each exc. VAT 1+	inc. VAT each
N12HN	Twin Solar PIR Light	£24.99	£29.99

Solar LED PIR Light

- Security for the house and garden
- Add light to any outdoor space with no other power source
- Quick and easy way to provide lighting outside small building such as sheds, stables, garage, etc.
- Installed in minutes - no wiring required, no electricity costs
- 36 super bright white LEDs provide strong light (150 lumens)
- The PIR motion sensor switches light on when movement is detected within its range
- Durable plastic construction
- Automatically turns on at dusk
- Rechargeable 3 x AA batteries included
- Dimensions: 16 x 12 x 20cm



This solar LED security light is an environmentally friendly product as it is powered by solar energy. During the day, the solar panel converts sunlight into energy, which is stored in the rechargeable battery. The integrated Passive InfraRed (PIR) sensor activates the light when motion is detected, helping keep your home safe and secure.

Technical specifications:

Light source:	36 x white LED
Solar panel type:	Crystalline
Solar panel power:	6W/100mA
Battery:	3x 600mAh AA Ni-MH rechargeable
Cable Length:	3m
PIR detective range:	8m x 100°
Dimensions:	16 x 12 x 20cm

Order Code	Mod: 670689	Price each exc. VAT 1+	inc. VAT each
N90NC	Solar LED PIR Light	£29.15	£34.99

Solar 8 LED 0.5 W PIR Floodlight

- Security around the house and garden
- Add light to any outdoor space with no other power source
- Quick and easy way to provide lighting for small buildings such as sheds, stables, garages, greenhouses, gazebos etc
- Bright white LEDs provide strong, lasting light



- Installed in minutes - no wiring required, no electricity costs
- Can be mounted anywhere inside and out (mounting kit included)
- Amorphous solar panel collects sunlight to charge the unit even on cloudy days
- 90° adjustable solar panel helps to maximize power output
- Easy to adjust settings on PIR
- The PIR motion sensor switches light on when movement is detected within its range
- Sensor level switch allows you to set the PIR to be activated later than dusk
- Duration switch allows you to determine how long the light stays on for
- PIR sensor can be swivelled up or down and has a 10 m / 150° detection range
- Rechargeable battery included and fitted
- In an emergency, batteries can also be charged using a 6 V 500 mAh power supply (Order Code: L66BQ, not included)
- Waterproof design
- Manual on/off switch

This solar floodlight is an easy way to provide light inside small buildings where there is no access to mains electricity. It is ideal for use in sheds, garages, stables, summer houses as well as for camping and other outdoor activities. The solar panel charges the internal rechargeable battery, located in the light unit, during the day ready for operation at dusk. This solar flood light has 8 super bright 0.5W Samsung LEDs and is connected to the remote solar panel using the included 5m cable. Although designed to be charged via the solar panels, there is also a power socket enabling you to charge the batteries using a 6V 500mAh power supply (not included - Order Code L66BQ)

Contents:

- Waterproof amorphous solar panel
- 5m connecting cable
- 8 x 0.5W Samsung LED light with mounting base
- 3 x 2200mAh rechargeable batteries
- Mounting screws and wall plugs
- Full instruction manual

Specifications:

Bulb type:	8 x 0.5W Samsung LEDs
Material:	Plastic
Battery type:	3 x 2200mAh rechargeable batteries
Solar panel dimensions:	150 x 200mm
Solar panel:	Amorphous solar cell
PIR detection angle:	Maximum distance 150°
PIR detection area:	Maximum distance 10m
Light-up time:	10±5 seconds to 60 seconds adjustable
Lux control:	2 - 200 lux adjustable
Waterproof rating:	IP44
Cable length:	5m

Order Code	Mod:	Price each exc. VAT 1+	inc. VAT each
N01HT	LED PIR Solar Flood	£41.65	£49.99

Solar Trickle Chargers

Solar Powered 12V 1.5W Battery Auto Trickle Charger

- Keep your battery topped up with solar power, even if the weather overcast or dull
- Ideal for cars, caravans, boats etc
- Interchangeable connectors: cigarette lighter plug and crocodile clips
- Blue flashing LED charge indicator
- Durable ABS outer casing
- Built-in diode prevents reverse charging



Suction cups for easy mounting

Designed to trickle charge 12V lead acid batteries with no additional running costs. Ideal for cars that will be left standing for long periods, as well as for maintaining batteries in caravans and boats. The built-in blocking diode prevents reverse charging from the battery to the solar panel at night.

Specifications:

Output power:	1.5W @ 17.5V
Testing condition:	AM1.5, 100mW/cm ²
Cigarette lighter plug fuse rating:	0.5A
Cable length:	2.7m (9ft)
Dimensions:	352 x 125 x 14mm
Weight:	£70g

Solar Powered 12V 2.4W Battery Trickle Charger

- Keep your battery topped up with solar power, even if the weather overcast or dull
- Interchangeable connectors: cigarette lighter plug and crocodile clips
- Durable ABS outer casing
- Built-in diode prevents reverse charging
- Suction cups for easy mounting
- Ideal for cars, caravans, boats etc.
- Suitable for indoor and outdoor use



Designed to trickle charge 12V lead acid batteries with no additional running costs. Ideal for cars that will be left standing for long periods, as well as for maintaining batteries in caravans and boats. The built-in blocking diode prevents reverse charging from the battery to the solar panel at night.

Technical specifications:

Peak output power:	2.4W
Voltage (@max. power):	17.5V
Current (@max. power):	137mA
Open circuit voltage:	21V
Short circuit current:	225mA
Tested under standard condition:	AM1.5, 100mW/100cm ² @ 25°
Cigarette lighter plug fuse rating:	0.5A
Cable length:	2.7m (9ft)
Dimensions:	350(l) x 215(w) x 14(d)
Weight:	1150g

Order Code	Mod:	Price each exc. VAT 1+	inc. VAT each
N59FU	2.4W Solar Panel	£20.82	£24.99

Solar Powered 12V 4.8W Battery Charger



- Converts daylight into electricity to charge 12V batteries, extending battery life
- Ideal for batteries stored in caravans, boats and vehicles in long-term storage
- Suitable for trickle charging a wide range of batteries and power packs
- Amorphous solar panel charges even in cloudy and

overcast weather

- Requires only daylight (not direct sunlight)
- Built-in blocking diode to prevent reverse charging
- Pre-cut holes for easy mounting
- Supplied with battery clips and cigarette lighter plug
- Panel is weatherproof and suitable for use outdoors

Specifications:

Peak power output:	4.8W
Optimum working voltage:	17.5V
Optimum working current:	260mA
Pack contents:	4.8W amorphous solar panel with 3m cable Connecting cable with battery clips Connecting cable with cigarette lighter adaptor 4 stainless steel mounting screws

Order Code	Mod:	Price each exc. VAT 1+	inc. VAT each
N30CX	4.8W Solar Panel	£33.32	£39.99

Solar Briefcase Generator

4W Solar Briefcase

- Designed to charge 12V lead-acid batteries with no additional running costs
- Portable solar generator built into a protective briefcase making it ideal for camping, caravanning or marine use
- This charger requires only daylight to work, charges even if the weather is overcast or dull
- Ideal for cars that will be left standing for long periods of time, as well as for maintaining batteries in caravans and boats
- Built-in blocking diode prevents reverse charging from the battery to solar panel
- Flashing charge indicator
- Interchangeable connectors: cigarette lighter plug and crocodile clips
- Durable ABS outer casing
- Integrated adjustable angle support
- Easy storage

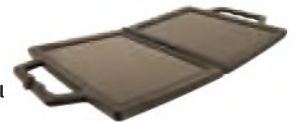

Designed to trickle charge 12V lead acid batteries with no additional running costs. Ideal for cars that will be left standing for long periods, as well as for maintaining batteries in caravans and boats. The built-in blocking diode prevents reverse charging from the battery to the solar panel at night. The briefcase comes complete with an adjustable angle support that allows you to position the solar panels in prime sunlight. The solar panel is an amorphous receptor and is ideally suited to the northern European climate to enable the optimum use of daylight hours. It can even operate behind glass.

Technical specifications:

Peak output power:	4W
Current (@max. power):	220mA
Open circuit voltage:	18V
Tested under standard condition:	AM1.5, 100mW/100cm ² @ 25°
Cigarette lighter plug fuse rating:	0.5A
Cable length:	1.2m (4ft)
Dimensions open:	445mm (l) x 235mm (w) x 14mm (d)
Dimensions closed:	245mm (l) x 235mm (w) x 28mm (d)
Weight:	890g

Contents:

- 4W folding amorphous solar panel with 1.2m cable
- Connecting cable with battery clips
- Connecting cable with cigarette lighter adaptor
- 2 built-in angle support stands

Order Code	Mod:	Price each exc. VAT 1+	inc. VAT each
N05HN	4W Solar Briefcase	£24.99	£29.99



Over 200 stores nationwide



/maplin



@maplintweet



/+maplin



/maplinonline



/maplintv

as powering electric fences or charging small power tools* The 10 watt panel provides a continuous trickle feed maintaining and extending the life of any 12 volt battery. The 10 watt solar panel is supplied with all the necessary cable (5m), connectors and detailed installation instructions

* Please note An inverter is required to power or charge 240Vac appliances - not included
Please note The 10W panel kit does not require a charge controller if the battery to be used is larger than 70Ah.

Specifications:

Power: 10 watts
Peak Output: 660mAh @ 16.8V
Approximate watt-hours per day*: 70
Approximate amp-hours per day*: 4.62
Dimensions: 397 x 278 x 25mm
Weight: 1.6kg

** Based on 7 hours of average daily peak sunlight hours

Order Code	Mod: 096897	Price each exc. VAT 1+	inc. VAT each
L14BR	10W Solar Panel Kit	£58.32	£69.99
L25BR	Solar Panel Stand	£10.82	£12.99

18W Solar Panel Kit



- High efficiency crystalline cell for all-weather charging
- Perfect for 12V appliances such as TVs or for maintaining a 12V caravan battery over a weekly period
- Water-resistant, robust construction for outdoor use
- 20 year cell warranty and 10 year module warranty

Ideal for charging consumer appliances such as mobile phones, electric toothbrushes, digital cameras etc. The 18 watt panel provides a continuous trickle feed maintaining and extending the life of any 12 volt battery. The 18 watt solar panel is supplied with a 4 amp charge controller, all the necessary cable (5m), connectors and detailed installation instructions

A universal stand (Order Code L25BR) is also available. It quickly and easily fits to the panels enabling them to be used "free standing", angled to suit the time of day/year and conditions.

Specifications:

Power: 18 watts
Peak Output: 1.21A @ 16.8V
Approximate watt-hours per day*: 126
Approximate amp-hours per day*: 8.47
Dimensions: 638 x 278 x 25mm
Weight: 2.2kg

* Based on 7 hours of average daily peak sunlight hours

Order Code	Mod: 096902	Price each exc. VAT 1+	inc. VAT each
L15BR	18W Solar Panel Kit	£91.65	£109.99
L25BR	Solar Panel Stand	£10.82	£12.99

28W Solar Panel Kit



- High efficiency crystalline cell for all-weather charging
- Perfect for powering laptop computers and use in larger caravans over a period of a week
- Water-resistant, robust construction for outdoor use
- 20 year cell warranty and 10 year module warranty

The 28W panel provides a continuous trickle feed maintaining and extending the life of any 12V battery. It is supplied with a 4A charge controller, all the necessary cable (5m), connectors and detailed installation instructions

A universal stand (Order Code L25BR) is also available. It quickly and easily fits to the panels enabling them to be used "free standing", angled to suit the time of day/year and conditions.

*Please note An inverter is required to power or charge 240Vac appliances - not included

Specifications:

Power: 28 watts
Peak Output: 1.70A @ 17.6V
Approximate watt-hours per day*: 196
Approximate amp-hours per day*: 11.9
Dimensions: 559 x 407 x 25mm
Weight: 2.8kg

* Based on 7 hours of average daily peak sunlight hours

Order Code	Mod: 097375	Price each exc. VAT 1+	inc. VAT each
L16BR	28W Solar Panel Kit	£124.99	£149.99
L25BR	Solar Panel Stand	£10.82	£12.99

Solar Stand



Order Code	Mod: 812450	Price each exc. VAT 1+	inc. VAT each
L25BR	Solar Panel Stand	£10.82	£12.99

43W Solar Panel Kit

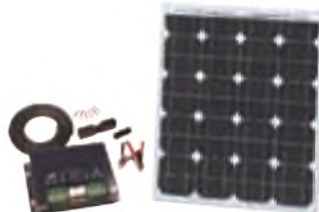

- High efficiency crystalline cell for all weather charging
- Perfect for powering colour TVs and for use in larger caravans over a two week period
- Water-resistant, robust construction for outdoor use

• 20 year cell warranty and 10 year module warranty

The 43W panel provides much higher power demands and includes bypass diodes to minimise the effect of shadows. It delivers maximum power in the smallest module size saving weight and space. It is supplied with a 4A charge controller, all the necessary cable (5m), connectors and detailed installation instructions.

A universal stand (Order Code L25BR) is also available. It quickly and easily fits to the panels enabling them to be used "free standing", angled to suit the time of day/year and conditions.

*Please note: An inverter is required to power or charge 240Vac appliances - not included

Specifications:

Power: 43 watts
Peak Output: 2.5A @ 17.6V
Approximate watt-hours per day*: 301
Approximate amp-hours per day*: 17.5
Dimensions: 634 x 534 x 35mm
Weight: 4.3kg

* Based on 7 hours of average daily peak sunlight hours

Order Code	Mod: 097377	Price each exc. VAT 1+	inc. VAT each
L17BR	43W Solar Panel Kit	£191.65	£229.99
L25BR	Solar Panel Stand	£10.82	£12.99

60W Solar Panel Kit

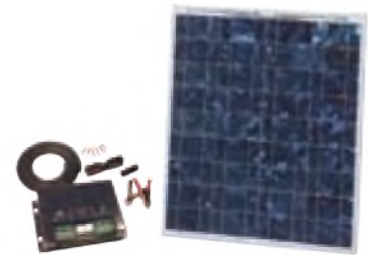

- High efficiency crystalline cell for all weather charging
- Perfect for slow cooker operation, boat trips and long-term caravan touring trips
- Water resistant, robust construction for outdoor use
- 20 year cell warranty and 10 year module warranty

The 60W panel provides much higher power demands and includes bypass diodes to minimise the effect of shadows. It delivers maximum power in the smallest module size saving weight and space. It is supplied with an 4A charge controller, all the necessary cable (5m), connectors and detailed installation instructions.

A universal stand (Order Code L25BR) is also available. It quickly and easily fits to the panels enabling them to be used "free standing", angled to suit the time of day/year and conditions.

*Please note: An inverter is required to power or charge 240Vac appliances - not included

Specifications:

Power: 60 watts
Peak Output: 3.97A @ 17.2V
Approximate watt-hours per day*: 420
Approximate amp-hours per day*: 27.79
Dimensions: 670 x 694 x 35mm
Weight: 6.3kg

* Based on 7 hours of average daily peak sunlight hours

Order Code	Mod: 097378	Price each exc. VAT 1+	inc. VAT each
L18BR	60W Solar Panel Kit	£224.99	£269.99
L25BR	Solar Panel Stand	£10.82	£12.99

Buy it on the web at maplin.co.uk

Shop for all Maplin products online at our website and check out our latest products and special offers!



Find out more in-store

Our staff can offer friendly and expert advice; we're here to help



80W Solar Panel Kit

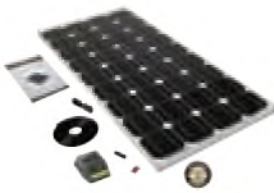

- High efficiency crystalline cell for all weather charging
- Perfect for TV operation, 240V appliances and for permanent fitting
- Water-resistant, robust construction for outdoor use
- 20 year cell warranty and 10 year module warranty

The 80W panel provides much higher power demands and includes bypass diodes to minimise the effect of shadows. It delivers maximum power in the smallest module size saving weight and space. It is supplied with an 8A charge controller, all the necessary cable (5m), connectors and detailed installation instructions.

*Please note: An inverter is required to power or charge 240Vac appliances - not included.

Specifications:

Power:	80 watts
Peak Output:	5.0A @ 17.2V
Approximate watt-hours per day*:	560
Approximate amp-hours per day*:	35
Dimensions:	1196 x 541 x 35mm
Weight:	7.9kg

* Based on 7 hours of average daily peak sunlight hours

Order Code	Mod:	Price each exc. VAT	inc. VAT each
L19BR	80W Solar Panel Kit	£333.32	£399.99

120W Solar Panel Kit

- High efficiency crystalline cell for all weather charging
- Perfect for TV operation, 240V appliances and for permanent fitting
- Water-resistant, robust construction for outdoor use
- 20 year cell warranty and 10 year module warranty

The 120W panel provides much higher power demands and includes bypass diodes to minimise the effect of shadows. It delivers maximum power in the smallest module size saving weight and space. It is supplied with an 8A charge controller, all the necessary cable (5m), connectors and detailed installation instructions.

*Please note: An inverter is required to power or charge 240Vac appliances - not included.

Specifications:

Power:	120 watts
Peak Output:	7.93A @ 17.2V
Approximate watt-hours per day*:	840
Approximate amp-hours per day*:	55.1
Dimensions:	1365 x 668 x 35mm
Weight:	11.5kg

* Based on 7 hours of average daily peak sunlight hours

Order Code	Mod:	Price each exc. VAT	inc. VAT each
L20BR	120W Solar Panel Kit	£249.99	£299.99

150W Solar Panel Kit

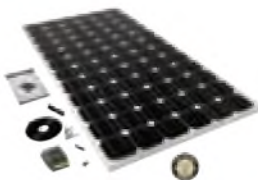

- High efficiency crystalline cell for all weather charging
- Perfect for 240V appliances such as TV operation and

for permanent fitting

- Water-resistant, robust construction for outdoor use
- 20 year cell warranty and 10 year module warranty

The 150W panel provides much higher power demands and includes bypass diodes to minimise the effect of shadows. It delivers maximum power in the smallest module size saving weight and space.

The kit comes supplied with

150W Solar Panel
12A charge controller
All the necessary cable (5m) and connectors
Comprehensive installation instructions

*Please note: An inverter is required to power or charge 240Vac appliances - not included

Specifications:

Power:	150 watts
Peak Output:	9.72A @ 17.2V
Approximate watt-hours per day*:	1050
Approximate amp-hours per day*:	68.04
Dimensions:	1490 x 670 x 35mm
Weight:	13.5kg

* Based on 7 hours of average daily peak sunlight hours

Order Code	Mod:	Price each exc. VAT	inc. VAT each
L21BR	150W Solar Panel Kit	£441.65	£529.99

Solar Panel Combiner 12V or 24V



- Combine up to 8 solar panels to increase your power output
- DIY your own solar power kit - panels are connected in parallel
- Compatible with both 12V and 24V systems
- Handles up to 30A maximum solar charging - 500W for a 12V system
- Maximum input per port is 8A or maximum 125W solar panel

Order Code	Mod:	Price each exc. VAT	inc. VAT each
N29KR	Solar Combiner	£14.57	£17.49

Solar Power Stations

60W Solar Power Station



- Ideal way to achieve energy self sufficiency
- Supplied with a high power solar panel, battery, charge controller and inverter
- Can power most appliances found in the home, office and workplace - such as TVs, stereos, games consoles, laptops, fax, power tools etc.
- Easy to install without the need for a qualified electrician
- The power station can be packed away and re-located anytime

This kit is the starting point for achieving power self sufficiency in a home, business, holiday cottage or anywhere that may be subject to power cuts or where the cost of installing mains cable is prohibitively high and to provide long term insulation from future energy price increases.

The kit contains all the necessary parts to be producing your own power within one hour from new.

The solar panel must be located outside and is supplied with a robust aluminium stand that allows firm location either on the ground or on a flat roof (the multi position

stand ensures the panel is always positioned at the optimum angle - summer and winter). The supplied cable then runs from the solar panel and connects directly into the waterproof battery box, which contains a high performance 85Ah sealed deep cycle solar battery and a charge controller. The battery output cable then needs to enter the building and is then connected to the supplied power inverter. The inverter has a UK 3-pin socket where a multi gang extension cable (not supplied) can be attached to run multiple electrical appliances simultaneously.

Additionally, a 12V "power cut" plug and socket is fitting in the battery box so that 12V appliances can be run directly. The SPS60 kit delivers up to 300 watt hours per day and can be used in many areas such as garages, workshops, stables, agricultural buildings, garden sheds, beach huts etc. It can typically power appliances such as lighting, power tools, power tool battery chargers, car vac, horse clippers, alarm systems etc for between 2 - 4 hours per day. If longer run times or additional appliances need to be powered a bigger SPS kit should be considered or the addition of an SPS expansion kit.

Contents:

- 1 x STP060 60W solar panel
- 1 x Multi position aluminium rack
- 1 x 85Ah deep cycle battery
- 1 x INV300 - 300W inverter
- 1 x Waterproof battery box
- 1 x STSPR10 12Ah charge controller
- 1 x 20m cable bundle
- 1 x Power RCD socket
- 1 x Connectors, fuses and terminals
- 1 x Digital multi meter
- 1 x Detailed user manual

Order Code	Mod:	Price each exc. VAT	inc. VAT each
N44HA	60W Solar Power Station	£583.32	£699.99

80W Solar Power Station



- Ideal way to achieve energy self sufficiency
- Supplied with a high power solar panel, battery, charge controller and inverter
- Can power most appliances found in the home, office and workplace - such as TVs, stereos, games consoles, laptops, fax, power tools etc.
- Easy to install without the need for a qualified electrician
- The power station can be packed away and re-located anytime

Contents:

- 1 x STP080 80W solar panel
- 1 x Multi position aluminium rack
- 1 x 85Ah Deep cycle battery
- 1 x INV300 - 300W inverter
- 1 x Waterproof battery box
- 1 x STSPR10 12Ah charge controller
- 1 x 20m cable bundle
- 1 x Power RCD socket
- 1 x Connectors, fuses and terminals
- 1 x Digital multi meter
- 1 x Detailed user manual

Order Code	Mod:	Price each exc. VAT	inc. VAT each
N45HA	80W Solar Power Station	£824.99	£989.99

Buying for business?
0333 400 9740



120W Solar Power Station



- Ideal way to achieve energy self sufficiency
- Supplied with a high power solar panel, battery, charge controller and inverter
- Can power most appliances found in the home, office and workplace – such as TVs, stereos, games consoles, laptops, fax, power tools etc
- Easy to install without the need for a qualified electrician
- The power station can be packed away and re-located anytime

Contents:

- 1 x STP120 120W solar panel
- 1 x Multi position aluminium rack
- 1 x 85Ah deep cycle battery
- 1 x INV300 - 300W inverter
- 1 x Waterproof battery box
- 1 x STSPR20 20Ah charge controller
- 1 x 20m cable bundle
- 1 x Power RCD socket
- 1 x Connectors, fuses and terminals
- 1 x Digital multi meter
- 1 x Detailed user manual

Order Code	Mod: 264913	Price each exc. VAT 1+	inc. VAT each
N46HA	120wSolarPowrStation	£749.99	£899.99

150W Solar Power Station



- Ideal way to achieve energy self sufficiency
- Supplied with a high power solar panel, battery, charge controller and inverter
- Can power most appliances found in the home, office and workplace – such as TVs, stereos, games consoles, laptops, fax, power tools etc.
- Easy to install without the need for a qualified electrician
- The power station can be packed away and re-located anytime

Contents:

- 1 x STP150 150W solar panel
- 1 x Multi position aluminium rack
- 1 x 85Ah deep cycle battery
- 1 x INV300 - 300W inverter
- 1 x Waterproof battery box
- 1 x STSPR20 20Ah charge controller
- 1 x 20m cable bundle
- 1 x Power RCD socket
- 1 x Connectors, fuses and terminals
- 1 x Digital multi meter
- 1 x Detailed user manual

Order Code	Mod: 264922	Price each exc. VAT 1+	inc. VAT each
N47HA	150wSolarPowrStation	£833.32	£999.99

Solar Power Station 12V Lighting Kit

- A simple and effective way to add 2 x 60W



- equivalent 12V lights onto any Solar Power Station
- Easy plug in system
- Includes bulbs, bulb holders, cable, wall switch and fuse

The SPS 12V Lighting Kit is an ideal way to provide mains quality lighting to a building. It quickly connects directly to the battery box supplied with all Solar Power Station kits [Order Codes: N44HA, N45HA, N46HA and N47HA] and operates on energy efficient 12V, hence uses minimal energy (22W per hour). Please note that the battery box is not supplied with this solar lighting kit, but is available to purchase separately [Order Code: N49HA], should you not have bought one of the 4 solar power station kits.

A spare 12V 9W bulb is available: N42NZ [sold separately]

Contents:

- 2 x 11W, CFL, 12V bulb
- 2 x bulb holder
- 1 x wall switch
- 1 x 10m cable bundle
- 1 x fuse

Order Code	Mod: 264931	Price each exc. VAT 1+	inc. VAT each
N48HA	SolarLightKit	£33.32	£39.99
N42NZ	N48HA Spare12V9WBulb	£8.32	£9.99

12V 9W Replacement CFL Bulb

- Replacement CFL bulb for use with 12V Solar Lighting Kit [Order Code: N48HA]
- Rated at 12V, 9W [equivalent to a 45W standard bulb]
- E27 base fitting



Order Code	Mod: 687240	Price each exc. VAT 1+	inc. VAT each
N42NZ	N48HA Spare12V9WBulb	£8.32	£9.99

Flexible Solar Panel Kits

10W Flexi PV Solar Panel Kit



- Super tough and powerful flexible solar panel
- Crystalline cell for maximum energy per m
- Fully weather sealed system – even against salt water
- Ideal for deck tops, caravan roofs and camper vans
- In built diode prevents battery discharge
- 2 year panel manufacturer warranty and 20 year cell performance warranty*

The Flexi PV range of is a tough, fully weather resistant flexible solar panel designed for use in the harshest environmental conditions. Suitable for permanent fixing or stand alone use, the 10wp Flexi PV kit is ideal for boat battery maintenance, camping / caravanning and many more applications and comes complete with a 4m extension cable with crocodile clips, ring terminals and fitting instructions.

Please note: A charge controller is not needed if the battery is 70Ah or larger.

Technical specifications:

Maximum power	10 watts
Maximum current (Imp)	570mA
Approximate watt-hours per day*	70
Approximate amp-hours per day*	3.99
Dimensions:	357 x 268 x 2mm
Weight:	400g

* Based on 7 hours of average daily peak sunlight hours

Order Code	Mod: 636868	Price each exc. VAT 1+	inc. VAT each
N46NG	10W FlexiSolarPanKit	£66.65	£79.99

20W Flexi PV Solar Panel Kit



- Super tough and powerful flexible solar panel
- Crystalline cell for maximum energy per m
- Fully weather sealed system – even against salt water
- Ideal for deck tops, caravan roofs and camper vans
- 2 year panel manufacturer warranty and 20 year cell performance warranty*
- Supplied with a 8Ah charge regulator

The Flexi PV range of is a tough, fully weather resistant flexible solar panel designed for use in the harshest environmental conditions. Suitable for permanent fixing or stand alone use, the 20w Flexi PV kit is ideal for boat battery charging, camping / caravanning and many more applications and comes complete with a 4m extension cable, ring terminals, 8Ah charge controller and fitting instructions.

Technical specifications:

Maximum power	20 watts
Maximum current (Imp)	1.15A
Approximate watt-hours per day*	140
Approximate amp-hours per day*	8.05
Dimensions:	495 x 350 x 2mm
Weight:	700g

* Based on 7 hours of average daily peak sunlight hours

Order Code	Mod: 636867	Price each exc. VAT 1+	inc. VAT each
N65NG	20W FlexiSolarPanKit	£208.32	£249.99

40W Flexi PV Solar Panel Kit



- Super tough and powerful flexible solar panel
- Crystalline cell for maximum energy per m
- Fully weather sealed system – even against salt water
- Ideal for deck tops, caravan roofs and camper vans
- 2 year panel manufacturer warranty and 20 year cell performance warranty*
- Supplied with a 8Ah charge regulator

The Flexi PV range of is a tough, fully weather resistant flexible solar panel designed for use in the harshest environmental conditions. Suitable for permanent fixing or stand alone use, the 40wp Flexi PV kit is ideal for boat battery charging, camping / caravanning and many more applications and comes complete with a 4m extension cable, ring terminals, 8Ah charge controller and fitting instructions.

Technical specifications:

Maximum power	40 watts
Maximum current (Imp)	2.29A
Approximate watt-hours per day*	280
Approximate amp-hours per day*	16.03
Dimensions:	662 x 503 x 2mm
Weight:	1400g

* Based on 7 hours of average daily peak sunlight hours

Order Code	Mod: 636866	Price each exc. VAT 1+	inc. VAT each
N66NG	40W FlexiSolarPanKit	£374.99	£449.99

60W Flexi PV Premium Solar Panel Kit



- Super tough and powerful semi flexible solar panel with 6063 alloy back plate and rugged Dupont Tedlar and PET cell cover for extreme conditions
- Crystalline cell for maximum energy per m
- Fully weather sealed system – even against salt water
- Ideal for deck tops, caravan roofs and camper vans where maximum resilience is needed
- Thin (4mm) and extremely light weight compared to a glass front module – only 3.8kg
- Extended 5 year manufacturer panel warranty and 20 year cell performance warranty
- Includes 8Ah charge regulator

Flexi PV Premium is the only choice if a higher power output is required in really harsh environments – whether intense heat, salt water or ice and snow – the Flexi PV Premium will cope – guaranteed!

Suitable for permanent fixing or stand alone use, the 60wp Flexi PV Premium kit is ideal for boat battery charging, camping / caravanning and many more applications and comes complete with a 4m pre-wired cable, ring terminals, 8Ah charge controller and fitting instructions.

Technical specifications:

Maximum power:	60 watts
Maximum current (Imp):	3.43A
Approximate watt-hours per day*:	420
Approximate amp-hours per day*:	24.01
Dimensions:	700 x 660 x 4mm
Weight:	3800g

* Based on 7 hours of average daily peak sunlight hours

Order Code	Mod: 636865	Price each exc. VAT 1+	inc. VAT each
N67NG	60W FlexiSolarPanelKit	£499.99	£599.99

80W Flexi PV Premium Solar Panel Kit



- Super tough and powerful semi flexible solar panel with 6063 alloy back plate and rugged Dupont Tedlar and PET cell cover for extreme conditions
- Crystalline cell for maximum energy per m
- Fully weather sealed system – even against salt water
- Ideal for deck tops, caravan roofs and camper vans where maximum resilience is needed
- Thin (4mm) and extremely light weight compared to a glass front module – only 4.7kg
- Extended 5 year manufacturer panel warranty and 20 year cell performance warranty
- Includes 8Ah charge regulator

Flexi PV Premium is the only choice if a higher power output is required in really harsh environments – whether intense heat, salt water or ice and snow – the Flexi PV Premium will cope – guaranteed!

Suitable for permanent fixing or stand alone use, the 80wp Flexi PV Premium kit is ideal for boat battery

charging, camping / caravanning and many more applications and comes complete with a 4m pre-wired cable, ring terminals, 8Ah charge controller and fitting instructions.

Technical specifications:

Maximum power:	80 watts
Maximum current (Imp):	4.57A
Approximate watt-hours per day*:	560
Approximate amp-hours per day*:	31.99
Dimensions:	880 x 660 x 4mm
Weight:	4700g

* Based on 7 hours of average daily peak sunlight hours

Order Code	Mod: 636864	Price each exc. VAT 1+	inc. VAT each
N68NG	80W FlexiSolarPanelKit	£524.99	£629.99

Folding Solar Panels

40W Folding Solar Panel



- High quality crystalline solar cell for year round 12V battery charging
- 8Ah charge controller with built-in diode to prevent reverse battery feed
- Fold away, fully adjustable support legs
- Cable and connections to attach direct to battery
- Suitable for outdoor use
- 20 year manufacturer solar cell warranty and 10 year manufacturer solar panel warranty

A premium crystalline twin solar panel system that neatly folds into briefcase style makes this tough and portable solar panel perfect where space, weight and convenience is crucial. The Foldup Solar Panel is ideal for caravans, boats and motorhomes and connects directly to the battery thanks to its integral charge controller. It is supplied with; 40w Foldup Solar Panel, fold away support legs, extension cable with crocodile clips, premium padded carry bag and full fitting instructions.

Technical specifications:

Maximum power:	40 watts
Maximum current (Imp):	2.39A
Approximate watt-hours per day*:	280
Approximate amp-hours per day*:	16.73
Dimensions:	353 x 500 x 76mm
Weight:	7kg

* Based on 7 hours of average daily peak sunlight hours

Order Code	Mod: 636875	Price each exc. VAT 1+	inc. VAT each
N69NG	40W FoldingSolarPanel	£191.65	£229.99

60W Folding Solar Panel



- High quality crystalline solar cell for year round 12V battery charging
- 8Ah charge controller with built-in diode to prevent reverse battery feed
- Fold away, fully adjustable support legs

- Cable and connections to attach direct to battery
- Suitable for outdoor use
- 20 year manufacturer solar cell warranty and 10 year manufacturer solar panel warranty

A premium crystalline twin solar panel system that neatly folds into briefcase style makes this tough and portable solar panel perfect where space, weight and convenience is crucial. The Foldup Solar Panel is ideal for caravans, boats and motorhomes and connects directly to the battery thanks to its integral charge controller. It is supplied with; 60w Foldup Solar Panel, fold away support legs, extension cable with crocodile clips, premium padded carry bag and full fitting instructions.

Technical specifications:

Maximum power:	60 watts
Maximum current (Imp):	3.43A
Approximate watt-hours per day*:	420
Approximate amp-hours per day*:	24.01
Dimensions:	500 x 500 x 76mm
Weight:	8.5kg

* Based on 7 hours of average daily peak sunlight hours

Order Code	Mod: 636874	Price each exc. VAT 1+	inc. VAT each
N70NG	60W FoldingSolarPanel	£224.99	£269.99

90W Folding Solar Panel



- High quality crystalline solar cell for year round 12V battery charging
- 8Ah charge controller with built-in diode to prevent reverse battery feed
- Fold away, fully adjustable support legs
- Cable and connections to attach direct to battery
- Suitable for outdoor use
- 20 year manufacturer solar cell warranty and 10 year manufacturer solar panel warranty

A premium crystalline twin solar panel system that neatly folds into briefcase style makes this tough and portable solar panel perfect where space, weight and convenience is crucial. The Foldup Solar Panel is ideal for caravans, boats and motorhomes and connects directly to the battery thanks to its integral charge controller. It is supplied with; 90w Foldup Solar Panel, fold away support legs, extension cable with crocodile clips, premium padded carry bag and full fitting instructions.

Technical specifications:

Maximum power:	90 watts
Maximum current (Imp):	5.15A
Approximate watt-hours per day*:	630
Approximate amp-hours per day*:	36.05
Dimensions:	700 x 500 x 76mm
Weight:	11.5kg

* Based on 7 hours of average daily peak sunlight hours

Order Code	Mod: 636873	Price each exc. VAT 1+	inc. VAT each
N71NG	90W FoldingSolarPanel	£249.99	£299.99

Buy it on the web at
maplin.co.uk

Shop for all Maplin products online at our website and check out our latest products and special offers!



Solar Motorhome Kits

43W Solar Panel Motorhome Kit with Premium Roof Fixings



- Complete kit for permanent fitting of a solar panel to the roof of a camper van, motorhome or caravan
- Crystalline solar cell for maximum efficiency
- Includes premium ABS roof profiles for a solid, none penetrative and professional finish
- 10 year manufacturer panel warranty and 20 year manufacturer cell performance warranty

The 43w kit is ideal for use on small motor homes where power consumption is mainly limited to running the interior lights and water pump and / or use is during the summer months. The kit comprises: 43w solar panel, 4Ah charge controller, 7m cable bundle, premium corner profile fixings, cable feed gland, tube SIKA 252 bonding agent, digital solar test meter, fuse, ring terminals and fitting instructions

Specifications:

Maximum power:	43 watts
Maximum current (Imp):	2.5A
Approximate watt-hours per day*	301
Approximate amp-hours per day*	17.5
Dimensions:	634 x 535 x 25mm
Weight:	4.5kg

* Based on 7 hours of average daily peak sunlight hours

Order Code	Mod:	Price each exc. VAT 1+	inc. VAT each
N76NG	43W SolMotorHomeKit	£291.65	£349.99

60W Solar Panel Motorhome Kit with Premium Roof Fixings



- Complete kit for permanent fitting of a solar panel to the roof of a camper van, motorhome or caravan
- Crystalline solar cell for maximum efficiency
- Includes premium ABS roof profiles for a solid, none penetrative and professional finish
- 10 year manufacturer panel warranty and 20 year manufacturer cell performance warranty

The 60w kit is ideal for use on small / medium sized motor homes where power consumption is mainly limited to running the interior lights and water pump and / or use will only be during spring, summer and autumn. The kit comprises: 60w solar panel, 4Ah charge controller, 7m cable bundle, premium corner profile fixings, cable feed gland, tube SIKA 252 bonding agent, digital solar test meter, fuse, ring terminals and fitting instructions.

Specifications:

Maximum power:	60 watts
Maximum current (Imp):	3.97A
Approximate watt-hours per day*	420
Approximate amp-hours per day*	27.79
Dimensions:	694 x 670 x 35mm

Weight: 6.0kg
* Based on 7 hours of average daily peak sunlight hours

Order Code	Mod:	Price each exc. VAT 1+	inc. VAT each
N77NG	60W SolMotorHomeKit	£316.65	£379.99

80W Solar Panel Motorhome Kit with Premium Roof Fixings



- Complete kit for permanent fitting of a solar panel to the roof of a camper van, motor home or caravan
- Crystalline solar cell for maximum efficiency
- Includes premium ABS roof profiles for a solid, none penetrative and professional finish
- 10 year manufacturer panel warranty and 20 year manufacturer cell performance warranty

The 80w kit is ideal for use on medium sized motor homes where the power is used to run the lights, water pump, television, lap top computer etc mainly during spring, summer and autumn

The kit comprises: 80w solar panel, 8 Ah charge controller, 7 m cable bundle, premium profile fixings, cable feed gland, tube SIKA 252 bonding agent, digital solar test meter, fuse, ring terminals and fitting instructions

Specifications:

Maximum power	80 watts
Maximum current (Imp)	5.0 A
Approximate watt-hours per day*	560
Approximate amp-hours per day*	35
Product Width:	670 mm
Product Depth:	815 mm
Product Height:	35 mm
Ring terminals	6
Fitting Instructions	1
Product Weight	7.5 kg

* Based on 7 hours of average daily peak sunlight hours

Kit Contents:

Kit Contents:	Qty
80w Premium Solar Panel	1
1.5mm, 2 core cable	5 m
Premium Profile Fixing Kit	1
Cable Feed Gland	1
300cc Tube Simpson ISR Bonding Agent	1
Fuse and holder	1

Order Code	Mod:	Price each exc. VAT 1+	inc. VAT each
N78NG	80W SolMotorHomeKit	£333.32	£399.99

120W Solar Panel Motorhome Kit with Premium Roof Fixings



- Complete kit for permanent fitting of a solar panel to the roof of a camper

Order Code	Mod:	Price each exc. VAT 1+	inc. VAT each
N79NG	120W SolMotorHomeKit	£408.33	£489.99

150W Solar Panel Motorhome Kit with Premium Roof Fixings



- Complete kit for permanent fitting of a solar panel to the roof of a camper van, motorhome or caravan
- Crystalline solar cell for maximum efficiency
- Includes premium ABS roof profiles for a solid, none penetrative and professional finish
- 10 year manufacturer panel warranty and 20 year manufacturer cell performance warranty

The 150w kit is ideal for use on US or very large sized motor homes where the power is used to run the lights, water pump, television, lap top computer etc throughout the year or for extended touring periods. The kit comprises: 150w solar panel, 12Ah charge controller, 7m cable bundle, premium corner and centre support profile fixings, cable feed gland, tube SIKA 252 bonding agent, digital solar test meter, fuse, ring terminals and fitting instructions.

Specifications:

Maximum power	150 watts
Maximum current (Imp):	9.72A
Approximate watt-hours per day*	1050
Approximate amp-hours per day*	68.04
Dimensions:	1490 x 670 x 35mm
Weight:	15.2kg

* Based on 7 hours of average daily peak sunlight hours

Order Code	Mod:	Price each exc. VAT 1+	inc. VAT each
N80NG	150W SolMotorHomeKit	£449.99	£539.99

Charge Regulators

Solar Charging Regulator



- An electronic controller that switches on the connection to the batteries solar cells if the battery is empty
- Switches off again when the battery is fully charged
- Power consumption approximately 2.5mA

Specifications:

Input voltage	
Solar cell panels voltage	DC 14-22 V open circuit
Nominal voltage	DC 12 V
Maximum input current:	5A
Inrush voltage:	Battery voltage
Interrupting voltage:	Battery voltage > approx. 14.4V
Displays	1 LED for charging 1 LED for battery full
Dimensions:	72(l) x 50 (w) x 42(d) mm

Order Code	Mod:	Price each exc. VAT 1+	inc. VAT each
N82AU	Solar Charging Cont	£15.40	£18.49

Free Delivery
on all UK orders over **£10**

(T&Cs Apply)

12V 16A Dual Solar Charge Regulator

- Ideal for connecting 12V solar panels to 1 or 2 batteries
- Separately charges 2 batteries
- Maximum charging capability: 2 x 8A or 1 x 16A
- The battery with the lowest charging voltage will receive more charging current
- LED status lights
- Power consumption of <2mA is taken from the battery
- Reverse current protected (no additional diode required)



The maximum charge current is a total of 16A. Two batteries with a maximum of 8A each or 1 battery can be connected in parallel to both outputs up to a maximum of 16A. If you are connecting only one battery, it must be connected to connection 2. There are 3 LED lights, one to show that battery one is charging, one to show that battery two is charging and one to show that both batteries are fully charged. An F16A fuse is required, but not supplied.

Specifications:

Solar panel input voltage:	15-22V
Open circuit voltage:	12V
Switch-on voltage:	13.4V ± 5%
Switch-off voltage:	14.4V ± 5%
Dimensions:	87 x 60 x 32 mm

Order Code	Mod.	Price each exc. VAT 1+	inc. VAT each
N35HG	Dual Solar Charge Reg	£20.82	£24.99

12V 7A Solar Charge Regulator

- Regulates the charging and discharging cycles of 12V batteries
- Fixing holes to permanently mount the unit
- Battery reverse polarity protection
- Overload and overcharge protection
- Battery open circuit protection
- Load short circuit protection
- Deep discharge protection
- Suitable for loads up to 7A (80W solar panel)



A 7A charge regulator designed to control the charging process from the solar panel to the battery as well as the power drawn from the battery to feed the outputs.

Therefore keep the whole solar system at proper working condition.

All solar panels generally require a voltage regulator to ensure that the battery is not overcharged.

The charge regulator is an electronic controller that switches on the connection to the batteries solar cells if the battery is empty and switches off again when the battery is fully charged.

It provides over-charging, over-discharging, short circuit, over-load and reverse polarity protection, therefore ensuring your solar system works at best capacity.

Technical specifications:

Max solar input current:	7A
Max solar voltage input (Voc):	22V
Max load current:	7A
Over discharge voltage:	11V ± 0.3V
Output voltage:	DC12V
Operating temperature:	-10° - +42°

Order Code	Mod.	Price each exc. VAT 1+	inc. VAT each
N94NG	7A Solar Charge Reg	£29.15	£34.99

12V 30A Solar Charge Regulator

- Regulates the charging and discharging cycles of 12V batteries
- Large LCD screen for easy reading
- Fixing holes to permanently mount the unit
- Battery reverse polarity protection
- Overload and overcharge protection
- Battery open circuit protection
- Load short circuit protection
- Deep discharge protection
- Suitable for loads up to 30A (500W solar panel)



A 30A charge regulator designed to control the charging process from the solar panel to the battery as well as the power drawn from the battery to feed the outputs.

All solar panels generally require a voltage regulator to ensure that the battery is not overcharged. The charge regulator is an electronic controller that switches on the connection to the batteries solar cells if the battery is empty and switches off again when the battery is fully charged.

It provides over-charging, over-discharging, short circuit, over-load and reverse polarity protection, therefore ensuring your solar system works at best capacity. This solar charge regulator uses the latest Microcomputer-chip for intelligent control and a PWM (pulse width modulation) charging circuit is used for higher efficiency.

Technical specifications:

Max solar input current:	30A
Max solar voltage input (Voc):	28V
Max load current:	30A
Over discharge voltage:	10.7V ± 0.4V
Output voltage:	DC12V
No-load loss:	<25mA
Voltage loss charging circuit:	
Voltage loss of discharging circuit:	
Operating temperature:	-25° - +40°

Order Code	Mod.	Price each exc. VAT 1+	inc. VAT each
N28KR	12V 30A Charge Reg	£35.82	£42.99

24V 30A Solar Charge Regulator

- Regulates the charging and discharging cycles of batteries
- Large LCD screen for easy reading
- Fixing holes to permanently mount the unit
- Battery reverse polarity protection
- Overload and overcharge protection
- Battery open circuit protection
- Load short circuit protection
- Deep discharge protection
- Suitable for loads up to 30A (500W solar panel)



Technical specifications:

Max solar input current:	30A
Max load current:	30A
Rated output voltage:	DC24V
Over charge voltage:	29V ± 0.5V
Over discharge protection:	21.4V ± 0.5V
No load loss:	<25mA
Control method:	PWM charging
Operating temperature:	-25° - 40°
Low voltage reconnection:	24.0V ± 0.5V
Float voltage adjustment range:	26.5 ± 0.5V

Order Code	Mod.	Price each exc. VAT 1+	inc. VAT each
N63NT	24V 30A Charge Reg	£33.32	£39.99



Reserve online and collect at the store of your choice

Charge Controllers

- Battery reverse feed protection
- Overload protection
- Battery open circuit protection
- Lightning surge protection
- Deep discharge protection



A range of charge controllers for use with our range of solar panel kits, which offer charge current protection up to 20A.

All solar panels (except the 5W and 10W) require a voltage regulator to ensure that the battery is not overcharged.

Order Code	Description	Voltage
L26BR	4A Charge Controller	12V
L22BR	8A Charge Controller	12V
L23BR	12A Charge Controller	12V
L24BR	20A Charge Controller	12V cr 24V

Order Code	Mod.	Price each exc. VAT 1+	inc. VAT each
L26BR	4Ah Regulator	£24.15	£28.99
L22BR	8Ah Regulator	£26.65	£31.99
L23BR	12Ah Regulator	£59.99	£71.99
L24BR	20Ah Charge Control	£110.82	£132.99

8Ah Charge Controller

- Battery reverse feed protection
- Overload protection
- Battery open circuit protection
- Lightning surge protection
- Deep discharge protection



A charge controller for use with our solar panel kits, which offer charge current protection up to 20A.

All solar panels (except the 5W and 10W) require a voltage regulator to ensure that the battery is not overcharged.

Order Code	Description	Voltage
L22BR	8A Charge Controller	12V

Order Code	Mod.	Price each exc. VAT 1+	inc. VAT each
L22BR	8Ah Regulator	£26.65	£31.99

12Ah Charge Controller

- Battery reverse feed protection
- Overload protection
- Battery open circuit protection
- Lightning surge protection
- Deep discharge protection



A charge controller for use with our solar panel kits, which offer charge current protection up to 20A.

All solar panels (except the 5W and 10W) require a voltage regulator to ensure that the battery is not overcharged.

Order Code	Description	Voltage
L23BR	12A Charge Controller	12V

Order Code	Mod.	Price each exc. VAT 1+	inc. VAT each
L23BR	12Ah Regulator	£59.99	£71.99

Maplin TV

Home of innovation,
handy tips and
How To videos

Visit our
channel...

youtube.com/maplintv



20Ah Charge Controller

- Battery reverse feed protection
- Overload protection
- Battery open circuit protection
- Lightning surge protection
- Deep discharge protection



A charge controller for use with solar panel kits, which offer charge current protection up to 20A.

All solar panels (except the 5W and 10W) require a voltage regulator to ensure that the battery is not overcharged.

Order Code Description Voltage

L24BR 20A Charge Controller 12V

Order Code	Mod:	Price each exc. VAT 1+	inc. VAT each
L24BR	812467	£110.82	£132.99

Solar Accessories

Solar Crimping Tool

- One crimp tool complete with two interchangeable die heads
- Die heads can be easily switched by hand
- Die head MC3 & MC4 both suitable for 2.5, 4.0, 6.0mm² connectors
- Ratchet to prevent tool accidentally opening
- Easy to adjust for various pressure strengths
- Includes quick release lever
- Comfortable rubberised grip
- Overall length: 220mm (8.7")



This solar crimp tool can be used with MC3 and MC4 crimp connectors primarily found on solar equipment.

Suitable for use with the following high power solar connectors:

- N52LN Solar Chass 4mm Male
- N53LN Solar Chass 4mm Female
- N54LN Solar Line 4mm Male
- N55LN Solar Line 4mm Female

Order Code	Mod:	Price each exc. VAT 1+	inc. VAT each
N61NT	785712	£20.82	£24.99

Solar SAE 3m Extension Cable

- Ideal for extending the distance between your solar panel and battery
- 3m cable terminated in an SAE connector at both ends
- Compatible with all the cables in the accessory kit (Order Code: N71JK, sold separately)
- 7A maximum current carrying capability
- Suitable for use with solar panels up to 80W



Order Code	Mod:	Price each exc. VAT 1+	inc. VAT each
N72JK	511177	£11.24	£13.49

Solar Cable Feed Gland



- Ideal for use where a waterproof seal is required around the cable entry
- Holds 6.35mm cable diameter cables

Order Code	Mod:	Price each exc. VAT 1+	inc. VAT each
L36BR	097388	£13.32	£15.99

Solar Bonding Agent

- Bonds all panel mounts
- Supplied in 310ml tubes

The perfect way to bond all panel mounts onto aluminium, steel and other clean, smooth surfaces. One tube is sufficient for fitting one complete kit.



Order Code	Mod:	Price each exc. VAT 1+	inc. VAT each
L30BR	097387	£21.65	£25.99

Solar Panel Mounting Accessories

- An ideal way to fix solar panels on the roof or deck of motor homes, caravans and boats
- The mounts can be safely bonded to the surface removing the need to drill holes
- Mounts also act as a wind deflector and maintain the correct air gap between the solar panel and the roof top / deck
- The panel corner moulds protect the corners of the solar panels from damage
- The 180mm panel mounts (Order Code: L27BR) can also be used in conjunction with the panel corner moulds (Order Code: L27BR) and the 530mm panel mount (Order Code: L28BR)



Please note the 180mm panel mounts (Order Code L29BR) and 530mm panel mounts (Order Code L28BR) are sold in packs of 2. The corner panel mounts (Order Code L27BR) are sold in packs of 4.

Order Code	Description	Compatible with:
L27BR	Panel Corner Moulds	10W Order Code L14BR 18W Order Code L15BR 28W Order Code L16BR 43W Order Code L17BR 60W Order Code L18BR 120W Order Code L20BR 150W Order Code L21BR

Order Code	Description	Compatible with:
L28BR	530mm Panel Mount	80W Order Code L19BR
L29BR	180mm Panel Mount	80W Order Code L19BR 120W Order Code L20BR 150W Order Code L21BR

Order Code	Mod:	Price each exc. VAT 1+	inc. VAT each
L27BR	097386	£33.32	£39.99
L28BR		£33.32	£39.99
L29BR		£24.99	£29.99

Solar Panel 530mm Mount

- An ideal way to fix solar panels on the roof or deck of motor homes, caravans and boats
- The mounts can be safely bonded to the surface removing the need to drill holes
- Mounts also act as a wind deflector and maintain the correct air gap between the solar panel and the roof top / deck

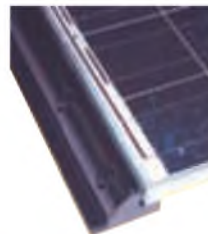

Please note the 530mm panel mounts are sold in packs of 2.

Order Code	Description	Compatible with:
L28BR	530mm Panel Mount	80W Order Code L19BR

Order Code	Mod:	Price each exc. VAT 1+	inc. VAT each
L28BR	812469	£33.32	£39.99

Solar Panel 180mm Mount

- An ideal way to fix solar panels on the roof or deck of motor homes, caravans and boats
- The mounts can be safely bonded to the surface removing the need to drill holes
- Mounts also act as a wind deflector and maintain the correct air gap between the solar panel and the roof top / deck
- The panel corner moulds protect the corners of the solar panels from damage
- The 180mm panel mounts can also be used in conjunction with the panel corner moulds (Order Code: L27BR) and the 530mm panel mount (Order Code: L28BR)

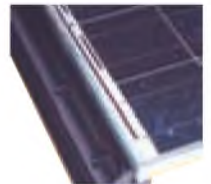

Please note the 180mm panel mounts are sold in packs of 2.

Order Code	Description	Compatible with:
L29BR	180mm Panel Mount	80W Order Code L19BR 120W Order Code L20BR

Order Code	Mod:	Price each exc. VAT 1+	inc. VAT each
L29BR	812470	£24.99	£29.99

CN40 High Power Solar Connectors

- A range of self locking connectors used in photo voltaic solar panel installations
- Chassis and line versions for male and female connections
- Designed for 4mm²
- Line connectors incorporate a sealing gland
- Rated to IP67
- Connector rating up to 25A
- Terminal copper, tin plated



Model No.	N52LN	N53LN
Rated Voltage	CN40-B038 TUV 1000V DC	CN40-B039 TUV 1000V DC
Connector Rating Current	25A	25A
Suitable cable cross sections	4.0-6.0mm ²	4.0-6.0mm ²
Pin dimensions	F4.0mm	F4.0mm
Dielectric voltage withstand	6000VAC	6000VAC
Pollution degree	2	2
Over voltage category	III	III
Protection class	Class II	Class II
RTI housing material	105 °C	105 °C
Contact Material	Copper Tin Plated	Copper Tin Plated
Contact Resistance Connector Material	FFO	FFO
Degree of Protection	IP67 (IEC 60529)	IP67 (IEC 60529)
Temperature Range	-40°C - +85°C	-40°C - +85°C
Flammability Class	UL94V-0	UL94V-0

Model No.	N54LN	N55LN
Rated Voltage	CN40-A019 TUV 1000V DC	CN40-A020 TUV 1000V DC
Connector Rating Current	25A	25A
Suitable cable cross sections	4.0-6.0mm ²	4.0-6.0mm ²
Pin dimensions	F4.0mm	F4.0mm
Dielectric voltage withstand	6000VAC	6000VAC
Pollution degree	2	2
Over voltage category	III	III
Protection class	Class II	Class II
RTI housing material	105 °C	105 °C
Contact Material	Copper Tin Plated	Copper Tin Plated
Contact Resistance Connector Material	FFO	FFO
Degree of Protection	IP67 (IEC 60529)	IP67 (IEC 60529)
Temperature Range	-40°C - +85°C	-40°C - +85°C
Flammability Class	UL94V-0	UL94V-0

Order Code	Mod:	Price each exc. VAT 1+	inc. VAT each
N52LN	625361	£2.07	£1.86
N53LN		£2.07	£1.86
N54LN		£2.15	£1.72
N55LN		£2.15	£1.72

Solar Batteries

Rechargeable 600mAh AA Batteries for Solar Lights 4 Pack

- Replacement batteries for solar lights requiring AA NiMH rechargeable batteries
- 600mAh cell capacity
- Designed for constant charge
- Sold in packs of 4



Order Code	Mod.	Price each exc. VAT 1+	inc. VAT each
N55NN	AA 600mAh SolarBatts	£8.32	£9.99

12V Sealed Lead Acid Deep Cycle Solar Batteries

- Deep cycle capability
- Ideal for solar applications
- Sealed casing for safe, spill free performance



6 different batteries are available:

Order Code:

Capacity:	Voltage:	Dimensions:	Weight:
N69HF	7Ah	12V 151 x 65 x 94mm	2.66kg
N70HF	12Ah	12V 151 x 98 x 95mm	4.2kg
N71HF	18Ah	12V 181 x 77 x 167mm	5.7kg
N72HF	26Ah	12V 175 x 66 x 125mm	8.6kg
N73HF	34Ah	12V 195 x 130 x 159mm	10.2kg
N74HF	42Ah	12V 197 x 165 x 170mm	13.5kg

Order Code	Mod.	Price each exc. VAT 1+	inc. VAT each
N69HF	7Ah Solar Battery	£24.99	£29.99
N70HF	12Ah Solar Battery	£33.32	£39.99
N71HF	18Ah Solar Battery	£49.99	£59.99
N72HF	26Ah Solar Battery	£70.82	£84.99
N73HF	34Ah Solar Battery	£99.99	£119.99
N74HF	42Ah Solar Battery	£138.32	£165.99

Solar 12V 100Ah Battery 1 Pack



- Best recommended where long-term solar installations are being used
- The sealed, deep cycle battery gives exceptional performance throughout the charging curve
- Is completely maintenance-free

A VRLA battery is a recombinant reaction battery.

This means that the oxygen normally produced on the positive plates of all lead-acid batteries is absorbed by the negative plate. This suppresses the production of hydrogen at the negative plate. Water [H2O] is produced instead, retaining the moisture within the battery. It never needs watering, and should never be opened as this would damage the battery with additional oxygen from the air.

Specifications:

Dimensions [l x w x h]: 305mm x 168mm x 210mm
Weight: 31kg

Order Code	Mod.	Price each exc. VAT 1+	inc. VAT each
L35BR	12V 100Ah Solar Batt	£108.32	£129.99

Solar Battery Box

- Perfect system for keeping all batteries dry when used outdoors
- Houses all batteries up to 110Ah
- Includes 1 input and 1 output sockets plus battery test meter



The all weather battery box is ideal to hold a battery (up to 110Ah) in a dry and safe environment. With 1 x input terminal (1 positive and 1 negative) for the solar panel and 1 x output socket (12V cigarette lighter style), it enables any installation to be housed in a tidy professional way. The battery box incorporates a simple meter indicating battery power levels.

Please note that batteries are sold separately.

Dimensions:

Outer box size	46 x 30 x 30cm
Inner box size	37 x 21.5 x 23cm

Order Code	Mod.	Price each exc. VAT 1+	inc. VAT each
N49HA	Solar Battery Box	£54.15	£64.99

Solar Grid Tie Inverters

GW1500TL Growatt Inverter for Grid Connection

- Leading edge efficiency of up to 97.8%
- All weather design - IP65
- Transformer less - no noise and lightweight
- Multi function LCD data panel
- G83/1, TUV and CE certified
- 5 year warranty



A well proven inverter to efficiently convert electricity from a solar PV array into mains compatible voltage. This inverter is for grid connection and as such should only be fitted by a qualified electrician or solar installer.

The GW1500TL is ideal for any solar array between 1000w and 1700w. The GW1500TL is supplied with a wall bracket, fixings and full instructions.

Max DC input Isc current:	15A
Max number of parallel strings	1
PV voltage range MPPT:	120V - 450V
Dimensions:	362 x 329 x 132mm
Weight:	11.5kg
Technical specifications	
Max DC power:	1700W
Max DC voltage:	450V

Order Code	Mod.	Price each exc. VAT 1+	inc. VAT each
N00KG	1500W OnGridInverter	£833.32	£999.99

GW2000TL Growatt Inverter for Grid Connection

- Leading edge efficiency of up to 97.8%
- All weather design - IP65
- Transformer less - no noise and lightweight
- Multi function LCD data panel
- G83/1, TUV and CE certified
- 5 year warranty



A well proven inverter to efficiently convert electricity from a solar PV array into mains compatible voltage. This inverter is for grid connection and as such should only be fitted by a qualified electrician or solar installer.

The GW2000TL is ideal for any solar array between 1700w and 2300w. The GW2000TL is supplied with a wall bracket, fixings and full instructions.

Technical specifications

Max DC power:	2300W
Max DC voltage:	500V
Max DC input Isc current:	15A
Max number of parallel strings:	2
PV voltage range MPPT:	120V - 450V
Dimensions:	362 x 329 x 132mm
Weight:	11.7kg

Order Code	Mod.	Price each exc. VAT 1+	inc. VAT each
N01KG	2000W OnGridInverter	£983.32	£1179.99

GW3000TL Growatt Inverter for Grid Connection

- Leading edge efficiency of up to 97.8%
- All weather design - IP65
- Transformer less - no noise and lightweight
- Multi function LCD data panel
- G83/1, TUV and CE certified
- 5 year warranty



A well proven inverter to efficiently convert electricity from a solar PV array into mains compatible voltage. This inverter is for grid connection and as such should only be fitted by a qualified electrician or solar installer. The GW3000TL is ideal for any solar array between 2500w and 3150w. The GW3000TL is supplied with a wall bracket, fixings and full instructions.

Technical specifications

Max DC power:	3150W
Max DC voltage:	500V
Max DC input Isc current:	20A
Max number of parallel strings:	2
PV voltage range MPPT:	120V - 450V
Dimensions:	362 x 329 x 132mm
Weight:	12.2kg

Order Code	Mod.	Price each exc. VAT 1+	inc. VAT each
N02KG	3000W OnGridInverter	£1358.32	£1629.99

GW4400TL Growatt Inverter for Grid Connection

- Leading edge efficiency of up to 97.8%
- All weather design - IP65
- Transformer less - no noise and lightweight
- Multi function LCD data panel
- G83/1, TUV and CE certified
- 5 year warranty



A well proven inverter to efficiently convert electricity from a solar PV array into mains compatible voltage. This inverter is for grid connection and as such should only be fitted by a qualified electrician or solar installer. The GW4400TL is ideal for any solar array between 3500w and 4400w. The GW4400TL is supplied with a wall bracket, fixings and full instructions.

Technical specifications

Max DC power:	4600W
Max DC voltage:	580V
Max DC input Isc current:	27A
Max number of parallel strings:	3
PV voltage range MPPT:	280V - 500V
Dimensions:	406 x 406 x 192mm
Weight:	21kg

Order Code	Mod.	Price each exc. VAT 1+	inc. VAT each
N03KG	4400W OnGridInverter	£1833.32	£2199.99

Hydrogen

Brunton Hydrogen Reactor Portable Power Bank - Black



- Robust, state of the art mobile USB power source for smartphones and tablets, UV water purifiers, rechargeable lights, portable game consoles, GPS transceivers and more.
- Runs from refillable Hydrocores - (canisters that contain hydrogen) - each core develops 4500mAh of power, equivalent to 3 full iPhone charges.
- Weighing in at 146g Reactor, 242g with Hydrogen Core; it is ideal as emergency power source for expedition communications and is aeroplane approved technology.
- Combines hydrogen from the rechargeable fuel cell and oxygen from the atmosphere to produce electricity
- Lock the hydrocore fuel cell into the Reactor to create power
- No external charging required
- Self-contained power production
- No chemicals to pollute the environment
- Solid-state with no natural discharge
- Includes 2 hydrogen core cells

Combines hydrogen and oxygen to produce electricity. Power on the move and under any condition. Simply lock the Hydrocore fuel into the Reactor to power USB devices.

The Hydrogen Reactor Portable Power Bank from Brunton is a 2 Amp portable power system that never needs charging. The self-contained unit combines hydrogen from rechargeable cells with oxygen from the atmosphere to generate power. When a cell is discharged, replace it with a full cell and keep charging.

This high-science device combines hydrogen and oxygen to produce electricity on-the-move and under any condition. Simply lock the Hydrogen Core fuel into the Hydrogen Reactor™ to power USB devices like smartphones, tablet computers, UV water purifiers, rechargeable lights, portable game consoles, GPS transceivers and more.

The solid-state design means there is no natural discharge over time, so it is perfect for emergency preparedness. Since it generates power through a chemical process with naturally occurring elements, there are no harmful chemicals or by products. The Hydrogen Reactor is an environmentally-friendly way to power tablets, cell phones, GPS units or most small electronics. The compact and lightweight design provides power without taking up a lot of space.

Available in yellow and orange

Order Code	Mod: 1016404	Price each exc. VAT 1+	inc. VAT each
N39DT	Hydrogen Reactor Bk	£83.32	£99.99

Look out for our monthly promotions at your local Maplin store now!

Pop in and pick up a copy of our monthly promotional publication, with special offers on dozens of exciting products. See the end of this catalogue for store listings

Technical Helpline



0333 400 9500

For technical information and assistance relating to any Maplin purchase, contact our team of experts

Brunton Hydrolyser Recharge Station

- Recharge unit for Hydrocores - fills the Hydrocores with the captured, compressed, hydrogen (electrically separates hydrogen from water)
- Environmentally safe power, no harmful or toxic chemicals involved
- Fill the Hydrolyzer with distilled or de-ionised water, plug the Hydrolyzer into the mains and it will refill your Hydrocores - turn water into electricity!



Personal hydrogen refill station. Clean, safe hydrogen power made from de-ionized or distilled water for charging Brunton Hydrocores

Solid-State hydrogen storage is stable, safe and airplane approved and recharged from water.

The Hydrolyser Recharge Station from Brunton is used to recharge the Hydrocore cartridges for the Hydrogen Reactor portable power system. This energy solution separates the hydrogen and oxygen molecules from distilled or de-ionized water. The hydrogen gets stored in the safe and stable solid-state Hydrocore cartridges. When the hydrolysed cartridges are loaded into the Reactor, it gets converted into clean energy without chemicals or pollutants. Green and Red LED indicators clearly show the status of the Hydrolyser and Hydrocore cartridge throughout the charging process.

This high-science device combines hydrogen and oxygen to produce electricity on-the-move and under any condition. Simply lock the Hydrogen Core fuel into the Hydrogen Reactor™ to power USB devices like smartphones, tablet computers, UV water purifiers, rechargeable lights, portable game consoles, GPS transceivers and more.

Live Swappable Energy - Just exchange empty for full and keep charging without waiting, ideal for disaster readiness; solid state with no natural discharge.

Environmentally Safe - No toxic chemicals. Recharged from water.

Hydrogen Power - Lock rechargeable Hydrogen Core to Hydrogen Reactor for hours of power off-the-grid and on-the-go

Specification

7.62 x 1.9 cm

Product Width:
Product Depth:
Product Height:
Product Weight: 105g

Order Code	Mod: 1019577	Price each exc. VAT 1+	inc. VAT each
N68DS	Hydralizer	£274.99	£329.99

Brunton Hydrocore Power Pack

- Hydrocores are refillable hydrogen cartridges that power the Brunton Hydrogen Reactor, made from lightweight but durable metal
- Each full core delivers 4500mAh of power, equivalent to 3 full iPhone charges (when plugged into the reactor)
- Cores must be refilled once used. They are refilled with the Hydrolyzer recharger, or exchanged for full cores at selected Maplin stores *see online for list of Maplin stores



The Brunton HydroCore Refillable Hydrogen Cartridge is intended for use with the Brunton Hydrogen Reactor Battery Charger, designed for powering smart phones, UV water purifiers, and many on-the-go devices

Solid state power storage will not lose power over time like traditional batteries. Ideal for off-the-grid safety and disaster preparedness, the Hydrocore develops 4500mAh of power.

Specification

Product Width: 14.5 x 15.3 x 20.8 cm
Product Depth: 145mm
Product Height: 153mm
Product Weight: 208mm
Product Weight: 1.9 Kg

Order Code	Mod: 1019578	Price each exc. VAT 1+	inc. VAT each
N69DS	Brunton Hydrocore	£10.82	£12.99

Shopping with us is easy...

In-store



7 days a week, check store listings at the back of the catalogue for address details

Online



maplin.co.uk

24hrs a day, 7 days a week, 365 days a year

Phone



0333 400 9500

Phone lines open 7 days a week

Buying for business?

0333 400 9740

POWER

Renewable Energy

Batteries

Alkaline Batteries

Alkaline LR1 Batteries 2 Pack



- The LR1 is a popular small 'N' type battery
- Commonly used in clocks and alarms
- 1.5V cells

Also referred to as R1, LR1, LR01, MN9100, MN9100/N, N, E90, 4001, KN, XN-2, AM5, UM5, Lady, 810 and 910A

Order Code	Mod: 400037	Price each exc. VAT 1+	inc. VAT each
N10BX	N/LR1/E90 2-Pack	£3.57	£4.29

Extra Long Life Alkaline Batteries



- Amazing value-for-money
- Specially designed for high-drain and digital applications
- Advanced formula offers 20% higher capacity than standard alkaline batteries
- Superb leak-proof technology

Maplin provides a superb range of high-performance batteries, direct from one of the world's leading battery manufacturers. Using the latest advanced battery technology, these batteries offer 20% higher capacity than standard alkaline batteries.

Available in the following extra-value pack sizes:

Type:	Pack Size:	Order Code:
AAA:	4-Pack	L42AL
AA:	4-Pack	L43AL
C:	2-Pack	L44AL
D:	2-Pack	L45AL
9V:	Single	L46AL
AAAA:	4-Pack	N30GA

Order Code	Mod: 037063	Price each exc. VAT 1+	5+	inc. VAT each
L42AL	Maplin AAA 4-Pack	£2.49		£2.99
L43AL	Maplin AA 4-Pack	£2.49		£2.99
L44AL	Maplin C 2-Pack	£2.49		£2.99
L45AL	Maplin D 2-Pack	£2.49		£2.99
L46AL	Maplin 9V PP3	£2.49		£2.99
N30GA	Maplin AAAA 4-Pack	£4.40	£3.96	£5.29

Extra Long Life Alkaline Mixed AA and AAA Combo Packs



- 2 handy mixed packs containing AA and AAA batteries
- Specially designed for high-drain and digital applications
- Advanced formula for higher capacity
- 20% more capacity than standard alkaline
- Superb leak-proof technology
- Amazing value for money

If you are short on power then Maplin have the answer with quality AAA and AA batteries. Great for a multitude of uses from TV remote controls to remote control toys and also for cameras, MP3 players, torches, pocket TV and games machines... in fact pretty much any small, portable electronic and electrical device.

Available in 2 different mixed pack sizes
 Order Code: N99KQ: 12 x AA and 8 x AAA
 Order Code: N00KR: 40 x AA and 20 x AAA

Order Code: Number of AA Batteries:

Number of AAA Batteries:	12	8
N99KQ	12	8
N00KR	40	20

Order Code	Mod: 599980	Price each exc. VAT 1+	5+	inc. VAT each
N99KQ	Maplin AA12Pk+AAA8Pk	£8.32	£7.49	£9.99
N00KR	Maplin AA40Pk+AAA20Pk	£16.65	£14.99	£19.99

Extra Long Life Alkaline AA and AAA 12-Pack



- Specially designed for high-drain and digital applications
- Advanced formula for higher capacity
- 20% more capacity than standard alkaline
- Superb leak-proof technology
- Amazing value for money

If you are short on power then Maplin have the answer with our range of quality AAA and AA batteries. Great for a multitude of uses from TV remote controls to remote control toys and also for cameras, MP3 players, torches, pocket TV and games machines... in fact pretty much any small, portable electronic and electrical device.

Order Code	Mod: 047938	Price each exc. VAT 1+	5+	inc. VAT each
L39BF	Maplin AA 12 Pack	£4.15	£3.74	£4.99
L40BF	Maplin AAA 12 Pack	£4.15	£3.74	£4.99

Extra Long-Life Alkaline Battery Value Packs



- Extra value-for-money multi-packs
- Specially designed for high-drain and digital applications
- Advanced formula for higher capacity
- 20% more capacity than standard alkaline
- Superb leak-proof technology

Maplin provides a superb range of high performance batteries. Using the latest advanced battery technology, these batteries offer 20% higher capacity than standard alkaline batteries.

Available in the following extra-value pack sizes:

Type:	Pack Size:	Order Code:
AA	40	L47AL

AAA	40	L07AN
AA	100	N43CY
AAA	100	N42CY

Order Code	Mod: 037067	Price each exc. VAT 1+	5+	inc. VAT each
L47AL	Maplin AA 40-Pack	£14.99	£13.49	£17.99
L07AN	Maplin AAA 40-Pack	£14.99	£13.49	£17.99
N43CY	Maplin AA 100-Pack	£24.99	£22.49	£29.99
N42CY	Maplin AAA 100-Pack	£24.99	£22.49	£29.99

Maplin Extra Long Life Alkaline 9V Batteries 3 Pack



- Extra value-for-money multi-pack
- Specially designed for high-drain and digital applications
- Advanced formula for higher capacity
- 20% more capacity than standard alkaline
- Superb leak-proof technology

Order Code	Mod: 636627	Price each exc. VAT 1+	5+	inc. VAT each
N17NG	Maplin 9V PP3 3Pk	£4.15	£3.74	£4.99

Maplin Alkaline 9V Batteries 6 Pack



- Extra value-for-money multi-packs
- Specially designed for high-drain and digital applications
- Advanced formula for higher capacity
- 20% more capacity than standard alkaline
- Superb leak-proof technology

Maplin Electronics presents a superb range of high performance batteries, direct from one of the world's leading battery manufacturers. Using the latest advanced battery technology, these batteries offer 20% higher capacity than standard alkaline batteries.

Order Code	Mod: 217846	Price each exc. VAT 1+	5+	inc. VAT each
N44CY	Maplin 9V 6-Pack	£10.82	£9.74	£12.99

Maplin Alkaline Batteries



- Amazing value-for-money
- Specially designed for high-drain applications
- Advanced formula offers 10% higher capacity than standard alkaline batteries
- Superb leak-proof technology

Maplin provides a superb range of high-performance batteries, direct from one of the world's leading battery

manufacturers. Using the latest advanced battery technology, these batteries offer 10% higher capacity than standard alkaline batteries.

Available in the following extra-value pack sizes:

Type:	Pack Size:	Order Code:
AAA:	24	N77HQ
AA:	24	N79HQ
C:	6	N79HQ
D:	6	N80HQ
9V:	3	N81HQ

Order Code	Mod: 383607	Price each exc. VAT		inc. VAT each
		1+	5+	
N77HQ	Maplin AAA 24-Pack	£7.49	£6.74	£8.99
N78HQ	Maplin AA 24-Pack	£7.49	£6.74	£8.99
N79HQ	Maplin C 6-Pack	£7.49	£6.74	£8.99
N80HQ	Maplin D 6-Pack	£7.49	£6.74	£8.99
N81HQ	Maplin 9V PP3 3-Pack	£7.49	£6.74	£8.99

Panasonic Pro Power – Premium Alkaline Batteries

- Premium alkaline range: developed to provide reliable and dependable power, any place any time.
- Ideal for high and medium drain appliances.
- Ideal for toys, radios, CD players, remote controls, smoke detectors, torches and electronic games
- Up to 80% longer lasting than Panasonic Standard Power*
- Available in all popular cell types and in various pack sizes



*Maximum difference measured between Panasonic Pro Power production 2012 and Panasonic Standard Power.

Battery Type:	Pack Quantity:	Order Code:
AAA	4	N16NA
AAA	8	N21NA
AAA	24	N27NA
AA	4	N15NA
AA	8	N20NA
AA	12	N25NA
AA	24	N26NA
9V	1	N17NA
9V	2	N22NA
C	2	N18NA
C	4	N23NA
D	2	N19NA
D	4	N24NA

Order Code	Mod: 629686	Price each exc. VAT		inc. VAT each
		1+	5+	
N16NA	FAN ProPower AAA 4Pk	£3.32	£2.99	£3.99
N21NA	FAN ProPower AAA 8Pk	£5.82	£2.99	£6.99
N27NA	FAN ProPower AAA 24Pk	£13.32	£11.99	£15.99
N15NA	FAN Pro Power AA 4Pk	£3.32		£3.99
N20NA	FAN Pro Power AA 8Pk	£5.82		£6.99
N25NA	FAN Pro Power AA 12Pk	£7.49	£6.74	£8.99
N68DW	FAN Pro Power AAA 12Pk	£7.49		£8.99
N26NA	FAN ProPower AA 24Pk	£13.32	£11.99	£15.99
N17NA	FAN Pro Power 9V 1Pk	£3.32	£2.99	£3.99
N22NA	FAN Pro Power 9V 2Pk	£5.82	£5.24	£6.99
N18NA	FAN Pro Power C 2Pk	£3.15	£2.84	£3.79
N23NA	FAN Pro Power C 4Pk	£5.82	£5.24	£6.99
N19NA	FAN Pro Power D 2Pk	£3.15	£2.84	£3.79
N24NA	FAN Pro Power D 4Pk	£5.82		£6.99

EVOLTA High Premium Alkaline Batteries



- Panasonic's No 1 long lasting alkaline battery
- Developed to meet the

- power needs of today's power hungry electronic appliances
- Record product performance in the high premium alkaline category
- Delivering exceptional performance in low, mid and high drain products
- Panasonic's 'eco ideas'; higher energy efficiency = less batteries needed = energy resource preservation*
- EVOLTA outperforms high premium competitors in commonly accepted industry performance tests**
- Increased performance made possible by patented technological advancements
- Mr EVOLTA – the record-breaking robot, proved to everyone that Panasonic EVOLTA is "Panasonic's No 1 long lasting alkaline battery"

* 20% longer lasting [vs. Panasonic Alkaline Standard Power Silver 2010 – based on average PI of IEC internal testing]

** On commonly used industry tests [Internal testing summer 2011]

Battery Type:	Pack Quantity:	Order Code:
AAA	4	N80KU
AA	4	N81KU
9V	1	N82KU
C	2	N83KU
D	2	N84KU

Order Code	Mod: 617529	Price each exc. VAT		inc. VAT each
		1+	5+	
N80KU	FAN EVOLTA AAA 4PK	£3.32	£3.32	£3.99
N81KU	FAN EVOLTA AA 4PK	£3.32	£3.32	£3.99
N82KU	FAN EVOLTA 9V 1PK	£3.32	£3.32	£3.99
N83KU	FAN EVOLTA C 2PK	£3.32	£3.32	£3.99
N84KU	FAN EVOLTA D 2PK	£3.32	£3.32	£3.99

Browse our entire range at maplin.co.uk

Alkaline Battery Cross Reference Chart

Ref USA	Voltage	IEC	ANSI	Duracell	Varta	Energizer	Kodak	Panasonic	Rayovac	Others	Maplin Code
AAAA	1.5	LR8D425	25A(C)	MN2500	4061	E96	K4A	-	-	-	N30GA
AAA	1.5	LR03	24A(C)	MN2400	4003	E92	K3A	LR03	824	AM4, Micro	L42AL
AA	1.5	LR6	15A(C)	MN1500	4006	E91	KA	LR6	815	AM3, Mignon	L43AL
C	1.5	LR14	14A(C)	MN1400	4014	E93	KC	LR14	814	AM2, Baby	L44AL
D	1.5	LR20	13A(C)	MN1300	4020	E95	KD	LR20	813	AM1, Mono	L45AL
PP3	9	6LR61	1604A(C)	MN1604	4022	522	K9V	6LR61	A1604	6AM6, E-Block	L46AL
N	1.5	LR1	910A	MN9100	4001	E90	KN	LR1	810	AM5, Lady	N10BX
J	6	4LR61	1412AP	7K67	4018	539	KJ	4LR61	-	4AM6	N03BX
-	6	-	-	MN11	-	A11	-	-	-	11A	ZB53H
-	6	4LR43	-	-	-	PX27A	-	-	-	PX27A	L99A0
-	6	4LR44	1414A	PX28A	-	A544	K28A	-	-	4G13, PX28A	ZB54J
-	12	-	-	MN2I	V23GA	A23	K23A	LRV08	-	23A	JG91Y
-	12	-	-	MN27	-	A27	-	-	-	27A	ZB55K
-	15	10F20	208	-	-	-	-	-	-	BLR121, 411	FM07H
-	6	4R25	915A(C)	MN915	-	-	-	-	-	528, 992	YJ23A
-	6	4R25	908A(C)	MN908	-	-	-	-	-	529, 996	ZB65V
-	6	4R25-2	918A(C)	MN918	-	-	-	-	-	521, 1231	ZB66W
-	1.5	LR43	1167A	D186A	V12GA	186	-	LR43	RW84	see SR43	FM29G
-	1.5	LR44	1166A	PX76A	V13GA	A76	KA76	LR44	RW82	see SR44	FM28F
-	1.5	LR54	1168A	D189A	V10GA	189	-	LR54	RW89	see SR54	FM31J
-	1.5	LR9	-	PX625A	V625U	EPX625G	KA625	-	R625	MR9, HD625	VQ76H*

* Alkaline equivalent of mercury battery

Duracell Plus Alkaline Batteries

- High quality alkaline batteries - advanced longer life
- Mercury and Cadmium free
- SCG (Super Conductive Graphite) Technology
- Reliable Energy Source
- For use in radios, toys, smoke alarms and many more applications



Duracell alkaline cells are most suited to medium and high-drain applications.

Order Code	Mod: 024380	Price each exc. VAT		inc. VAT each
		1+	5+	
AR42V	DuracellPlus AAA 4Pk	£4.15	£3.74	£4.99
AB97F	DuracellPlus AA 8Pk	£7.07		£8.49
AR43W	DuracellPlus AA 4Pk	£4.15	£3.74	£4.99
AR45Y	DuracellPlus C 2Pk	£4.15	£3.74	£4.99
AR44X	DuracellPlus D 2Pk	£4.15	£3.74	£4.99
AR46A	DuracellPlus PP3 1Pk	£4.15	£3.74	£4.99
AB96E	DuracellPlus PP3 2Pk	£6.65	£5.99	£7.99

Duracell 'Ultra Power' Alkaline Batteries

- Perfect for today's high-tech appliances
- Lasts up to 50% longer in high current devices
- Ideal for digital cameras, mini TVs, portable CD players and many more!



A range of high capacity cells designed specifically for use with today's high power portable appliances. Making use of both

improved materials and construction techniques, these batteries offer a reduced internal resistance on higher loads compared to standard alkaline cells. Available in AAA, AA, C, D and PP3 sizes.

Order Code	Mod: 020425	Price each exc. VAT		inc. VAT each
		1+	5+	
NF70M	Dur UltPower AAA 4Pk	£4.99	£4.49	£5.99
YA16S	Dur UltPower AAA 8Pk	£9.15	£8.24	£10.99
NF69A	Dur UltPower AA 4Pk	£4.99	£4.49	£5.99
PM15R	Dur UltPower AA 8Pk	£9.15	£8.24	£10.99
YA17T	Dur UltPower AA 12Pk	£10.82	£9.74	£12.99
YA08J	Dur UltPower C 2Pk	£4.99	£4.49	£5.99
YA14Q	Dur UltPower C 4Pk	£9.15	£8.24	£10.99
YA13P	Duracell Ultra D 4Pk	£9.15	£8.24	£10.99
YA12N	Dur UltPower PP3 1Pk	£4.99	£4.49	£5.99

Lithium High Power Batteries

Extra Long Life Lithium Batteries



- Specially designed for use in high drain and digital devices
- Lasts up to 7x longer than standard alkaline batteries
- Ideal for digital cameras, MP3 players and GPS etc
- Performs in temperatures of -20°C to +60°C
- Hold their charge - these batteries have a 10 year shelf life!
- Takes over 100 pictures on your digital camera*

*Number of images may vary depending on the type of camera used

Order Code:Size:
N28GG AA
N29GG AAA

Pack Size:
4
4

Order Code	Mod: 228566	Price each exc. VAT		inc. VAT each
		1+	5+	
N28GG	Map Lithium AA 4Pk	£4.99	£4.79	£5.99
N29GG	Map Lithium AAA 4Pk	£4.99	£4.79	£5.99

Lithium 9V Battery 1 Pack

Now there's no need to change batteries every year to keep your home and family protected by working smoke detectors.

This battery uses the latest lithium technology and has been designed especially for low-energy equipment like smoke detectors and wireless alarm PIRs. Enjoy years of peace of mind!



Order Code	Mod: 010449	Price each exc. VAT		inc. VAT each
		1+	5+	
FC35Q	Lithium PP3	£8.32		£9.99

Rechargeable Batteries

Nickel Zinc Rechargeable Batteries 4 Pack



- High 1.6V cell voltage (higher than alkaline, NiCd and NiMH Batteries)
- Extra-high capacity 550mAh / 1000mWh Ni-ZN rechargeable batteries
- High current discharge ability
- Lower self-discharge due to 50% higher energy density than standard NiMH rechargeable batteries
- Better performance than standard NiMH rechargeable batteries
- Last much longer than standard rechargeable batteries
- Recharge up to 1000 times
- Environmentally friendly rechargeable battery: 0% mercury, 0% lead, 0% cadmium
- Uses Zinc in place of toxic cadmium
- Perform well in low temperatures
- Suitable for temperatures between -20°C to +65°C

These extra-high capacity nickel-zinc rechargeable batteries offer amazing value for money. Up to 1,000 charge/discharge cycles can be expected and a single charge outlasts most standard NiMH rechargeable batteries. While 550mAh NiMH rechargeable batteries will enable you to take 200 photos with a digital camera, 550mAh Ni-Zn batteries will allow you to take 400 photos! This makes these the ideal choice for today's power-hungry digital devices such as digital cameras, MP3 players, hand-held games etc. These batteries are rated at 550mAh with a capacity of 1000mWh and have a voltage of 1.6V - this higher voltage can be useful in various applications. 3 Ni-ZN batteries have the same capabilities as 4 standard NiMH rechargeable batteries.

Order Code	Mod: 635958	Price each exc. VAT		inc. VAT each
		1+	5+	
N28NC	NickelZinc AAA 4Pk	£10.82		£12.99
N37KA	NickelZinc AA 4Pk	£10.82		£12.99

Hybrid - The Next Generation Rechargeable Battery

- Hybrid batteries are the next generation of rechargeable batteries combining the benefits of alkaline batteries with the performance of rechargeable batteries
- Supplied fully charged and ready to use out of the box
- Can be used to power low drain devices (clocks, remote controls) as well as high drain devices (digital cameras)
- Long storage and shelf life and retain their charge for up to 12 months
- Use with any NiMH battery charger
- Provide high power even at low temperatures down to -10°C
- Re-charged over and over again - up to 1000 times
- Low cost per use (less than 2p per charge) in comparison to disposable alkaline batteries
- Long life cycle and use of non-toxic materials makes them the eco-friendly alternative to disposable alkaline batteries



Whereas standard rechargeable batteries must be charged before first use, Hybrid batteries are supplied fully charged and ready to use. They have a very slow discharge rate and can retain their charge for up to 12 months, which makes them ideal for use in a wide range of devices. They are suitable for use in high drain applications such as digital cameras as well as low drain devices such as clocks and remote controls. Hybrid batteries perform especially well in low temperatures - as low as -10°C - making them ideal for outdoor use in winter as well as in high temperatures during the summer.

Hybrid batteries can be used in any standard battery charger with a charge time of 1 hour or more, but it is not recommended to charge the batteries in a 30-minute or 15-minute charger as this could affect the battery performance.

With up to 1000 life cycles, these batteries can be charged over and over again, which means their cost per use is much lower than a disposable alkaline battery (approximately 2p per charge per cell) and as they contain no harmful materials and are recyclable they are the environmentally friendly option.

Technical Specifications:

Order Code	Battery Type	Capacity	Voltage
N46CY	AA Hybrid 2100mAh	1.2V	4
N47CY	AAA Hybrid 800mAh	1.2V	4
N92GK	9V PP3 Hybrid	200mAh	8 4V
N45HX	C Hybrid 3000mAh	1.2V	2
N46HX	D Hybrid 3000mAh	1.2V	2

Order Code	Mod: 219932	Price each exc. VAT		inc. VAT each
		1+	5+	
N46CY	Hybrid AA 2100mAh 4Pk	£9.15		£10.99
N47CY	Hybrid AAA 800mAh 4Pk	£9.15		£10.99
N92GK	Hybrid 9V 200mAh 1Pk	£9.15		£10.99
N45HX	Hybrid C 3000mAh 2Pk	£9.15		£10.99
N46HX	Hybrid D 3000mAh 2Pk	£9.15		£10.99

Send direct

If any product is not in stock, we will order it for you and send it with free delivery

Terms and conditions apply.



Extra-High Capacity Rechargeable Batteries



- Extra-high capacity NiMH rechargeable batteries
- Recharge up to 1000 times
- 0% mercury, 0% lead, 0% cadmium
- Save money and save the environment

These extra-high capacity nickel metal hydride rechargeable batteries offer amazing value for money. Up to 1,000 charge/discharge cycles can be expected and a single charge outlasts most standard alkaline batteries. This makes these the ideal choice for today's battery-hungry digital devices such as digital cameras, MP3 players, hand-held games etc.

These are all extra-high capacity batteries with an ultra-high AA (2400mAh) also available for the most demanding applications.

Order Code	Battery Size	Capacity (mAh)	Pack Size	Voltage
N42HJ	AAA	700	4	1.2
N06BW	AAA	950	4	1.2
N04BW	AA	2000	4	1.2
N05BW	AA	2400	4	1.2
N07BW	C	2900	2	1.2
N09BW	D	2900	2	1.2
N09BW	PP3 9V	200	1	9.4

Order Code	Mod: 045787	Price each exc. VAT 1+	inc. VAT each
N42HJ	Map 700mAh AAA 4Pk	£7.49	£8.99
N06BW	Map 950mAh AAA 4Pk	£8.32	£9.99
N43HJ	Map 1300mAh AA 4Pk	£6.65	£7.99
N04BW	Map 2000mAh AA 4 Pk	£8.32	£9.99
N05BW	Map 2400mAh AA 4Pk	£11.65	£13.99
N07BW	Map 2800mAh C 2 Pk	£8.32	£9.99
N08BW	Map 2800mAh D 2 Pk	£8.32	£9.99
N09BW	Map 200mAh 9V PP3	£8.32	£9.99

Extra-High Capacity NiMH Rechargeable Battery Value Packs



- Value-for-money packs of Maplin's top quality NiMH rechargeable batteries
- Recharge up to 1000 times
- 0% mercury, 0% lead, 0% cadmium
- Save money & save the environment!

These extra-high capacity nickel metal hydride rechargeable batteries offer amazing value for money. Up to 1,000 charge/discharge cycles can be expected and a single charge outlasts most standard alkaline batteries. This makes these the ideal choice for today's battery-hungry digital devices such as digital cameras, MP3 players, hand-held games etc.

Order Code	Battery Size	Capacity (mAh)	Pack Size	Voltage
L29BJ	AAA	950	12	1.2
L30BJ	AA	2000	12	1.2
L32BJ	AA	2400	9	1.2
L31BJ	9V	200	3	9.4

Order Code	Mod: 046414	Price each exc. VAT 1+	inc. VAT each
L29BJ	Map 950mAh AAA 12Pk	£19.15	£22.99
L30BJ	Map 2000mAh AA 12-Pk	£19.15	£22.99
L32BJ	Map 2400mAh AA 8Pk	£19.15	£22.99
L31BJ	Map 200mAh 9V 3-Pk	£19.15	£22.99

Imedion Ultra-High Capacity Rechargeable Batteries



- Retains 85% of charge for one year
- Specially designed to work well in all high-drain applications
- Significantly higher capacities than other brands
- Excellent performance in digital cameras, remote control vehicles, metal detectors, torches etc
- Rechargeable up to 1000 times

Imedion Rechargeable Batteries are designed to hold their charge for extraordinary periods of time, whilst retaining a significant capacity Imedion technology means that unlike a normal battery that would lose 85% of its charge, an Imedion battery can retain 85% of its charge for an entire year

Order Code: Battery size: Capacity (mAh): Pack size:

N45GZ	AA	2100	4
N46GZ	AAA	900	4

Order Code	Mod: 262164	Price each exc. VAT 1+	inc. VAT each
N45GZ	Imedion AA2100mAh4Pk	£12.49	£14.99
N46GZ	Imedion AAA900mAh4Pk	£12.07	£14.49

Battery Chargers

Nickel-Zinc AA Battery Charger



- Charges 4 of AA or 2 of AAA Ni-Zn batteries
- Charges Ni-Zn batteries only (not suitable for charging NiCd or NiMH batteries)
- Nickel Zinc batteries offer higher performance versus NiMH rechargeable batteries (Order Code: N37KA, sold separately)
- 2 independent charging channels
- Timer control
- Trickle charge function keeps batteries topped up when fully charged
- Overcharge, over discharge, short circuit and reverse polarity protection
- Faulty battery detection
- Low battery leakage current
- LEDs indicates charging status
- Worldwide voltage range (100V-240V subject to use with a suitable travel adaptor)
- 5-9 hours average charge time

This plug-in charger is suitable for charging 2 or 4 AA or 2 AAA Ni-Zn batteries. Ni-Zn rechargeable batteries are rated at 1.6V and are able to fulfil the highest power demands and provide higher voltage and energy density than regular NiMH rechargeable batteries, making them ideal for power hungry devices. 3 Ni-ZN batteries have the same capabilities as 4 standard NiMH rechargeable batteries

AA Nickel-Zinc batteries are rated at 1500mAh / 2500mWh and have a voltage of 1.6V, making them ideal for power hungry devices

The following additional Hybrid batteries are also available:

Order Code: N37KA - NickelZinc AA 4Pk
Order Code: N28NC - NickelZinc AAA 4Pk

Technical specifications:

Battery type	Size	Capacity	Charge time 1 cell
Ni-Zn	AA	1500mAh	4.8 hours
	AAA	900mAh	7.4 hours

Order Code	Mod: 624781	Price each exc. VAT 1+	inc. VAT each
N38KA	NickelZinc AACharger	£10.82	£12.99
N37KA	NickelZinc AA 4Pk	£10.82	£12.99

Maplin Hybrid AAA and AA Compact Battery Charger



- Compact charger for AA and AAA rechargeable Hybrid and standard NiCd/ NiMH batteries
- Will charge 2 or 4 batteries at a time
- Supplied with 4 x 800mAh AAA Hybrid rechargeable batteries
- LEDs indicate charging status
- Charge 2 or 4 batteries at a time
- Automatic charging current selection for AA and AAA

Hybrid batteries are the next generation of rechargeable batteries that combine the benefits of alkaline batteries with the performance of rechargeable batteries. Where standard rechargeable batteries must be charged before first use, Hybrid batteries are supplied fully charged and ready to use. They have a very slow discharge rate and can retain their charge for up to 12 months, which makes them ideal for use in a wide range of devices. They are suitable for use in high drain applications such as digital cameras as well as low drain devices such as clocks and remote controls. Hybrid batteries perform especially well in low temperatures - as low as -10°C - making them ideal for outdoor use in winter as well as in high temperatures during the summer.

Hybrid batteries can be used in any standard battery charger with a charge time of 1 hour or more, but it is not recommended to charge the batteries in a 30-minute or 15-minute charger as this could affect the battery performance

The following additional Hybrid batteries are also available:

Order Code: N46CY - Hybrid AA 4-Pack 2100mAh
Order Code: N47CY - Hybrid AAA 4-Pack 800mAh

Please note: the charge times below are applicable to both standard re-chargeable batteries and Hybrid rechargeable batteries.

Battery type	Capacity	Charging time
AAA	800mAh	7-8 hours
600-900mAh	240-320mAh	5-7 hours
900-1000mAh	320-400mAh	7-8 hours
1000-1200mAh	400-500mAh	8-10 hours
1200-1400mAh	500-600mAh	10-12 hours
1400-1900mAh	600-750mAh	12-15 hours
1900-2500mAh	750-850mAh	15-18 hours

Order Code	Mod: 219525	Price each exc. VAT 1+	inc. VAT each
N73FK	Hybrid Battery Chqgr	£12.49	£14.99

Maplin Hybrid AAA and AA Battery Charger with LCD Display



- Fast charger for AA and AAA rechargeable Hybrid and standard NiMH batteries
- Will charge 2 or 4 batteries at a time
- Supplied with 4 x 2100mAh AA Hybrid rechargeable batteries
- Adjusts automatically to any voltage from AC 100-240V for international use
- 'Negative delta V' detection switches off charger when batteries are fully charged
- LCD screen displays charging status

Hybrid batteries are the next generation of rechargeable batteries that combine the benefits of alkaline batteries with the performance of rechargeable batteries. Whereas standard rechargeable batteries must be charged before first use, Hybrid batteries are supplied fully charged and ready to use. They have a very slow discharge rate and can retain their charge for up to 12 months, which makes them ideal for use in a wide range of devices. They are suitable for use in high drain applications such as digital cameras as well as low drain devices such as clocks and remote controls. Hybrid batteries perform especially well in low temperatures - as low as -10°C - making them ideal for outdoor use in winter as well as in high temperatures during the summer.

Hybrid batteries can be used in any standard battery charger with a charge time of 1 hour or more, but it is not recommended to charge the batteries in a 30-minute or 15-minute charger as this could affect the battery performance.

The following additional Hybrid batteries are also available
 Order Code: N46CY - Hybrid AA 2100mAh 4Pk
 Order Code: N47CY - Hybrid AAA 800mAh 4Pk
 Order Code: N92GK - Hybrid 9V 200mAh 1Pk
 Order Code: N45HX - Hybrid C 3000mAh 2Pk
 Order Code: N46HX - Hybrid D 3000mAh 2Pk

Please note that this charger is not suitable for charging NiCd rechargeable batteries

Charging times (charge time apply to both Hybrid and standard NiMH batteries)

AA	2 Cells	4 Cells
1800mAh	90 minutes	135 minutes
2000mAh	100 minutes	150 minutes
2200mAh	110 minutes	165 minutes
2400mAh	120 minutes	180 minutes
2600mAh	130 minutes	195 minutes
2800mAh	140 minutes	210 minutes
AAA		
700mAh	70 minutes	
800mAh	80 minutes	
900mAh	90 minutes	
1000mAh	100 minutes	
1100mAh	110 minutes	

Order Code	Mod: 219394	Price each exc. VAT 1+	inc. VAT each
N42FK	Hybrid LCD B/Charger	£20.82	£24.99

Maplin AAA and AA NiMH Mini Battery Charger



- Excellent for charging your MP3 player batteries
- Charges AA and AAA NiMH, NiCd or Hybrid rechargeable batteries
- Can charge one or two batteries at a time
- Lightweight and compact
- Complete with 2 x AAA 950mAh NiMH batteries
- Suitable for MP3 players, digital cameras or any high-drain appliance

Charging time

AA	AAA
600 - 800mAh 5 - 7 Hours	240 - 320mAh 4.5 - 6 Hours
1000 - 1200mAh 8 - 10 Hours	500 - 600mAh 9 - 11 Hours
1300 - 1500mAh 10 - 12 Hours	600 - 750mAh 11 - 13.5 Hours
1600 - 1800mAh 12 - 14 Hours	750 - 1000mAh 13.5 - 16 Hours
1800 - 2000mAh 14 - 16 Hours	
2100 - 2300mAh 16 - 18 Hours	
2300 - 2700mAh 18 - 22 Hours	

Order Code	Mod: 115142	Price each exc. VAT 1+	inc. VAT each
N51CX	Audio Charger	£7.07	£8.49

Maplin Compact Battery Charger NiMH, NiCd Hybrid AAA, AA and 9V



- Includes 4 x AA high-capacity batteries
- Recharges 2 or 4 x AA or AAA size or 1 or 2 9V size NiMH, NiCd or Hybrid batteries at a time
- Automatic charging current selection for size AA and AAA batteries
- LED display indicates proper charging
- Compact plug-in design

This amazing value charger offers great features and includes 4 x AA 2000mAh NiMH rechargeable batteries

Specifications:

Power supply AC 230 V / 50Hz
 Operating temperature 0°C - 35°C

Size:	Capacity:	Charge Time:
AA	600-800mAh	5-6 hours
	1100-1300mAh	9-11 hours
	1400-1600mAh	11-13 hours
	1800-2100mAh	15-18 hours
	2200-2500mAh	19-21 hours
AAA	180-240mAh	4-5 hours
	500-650mAh	11-15 hours

9V	700-900mAh	16-21 hours
	110-120mAh	9-10 hours
	150-160mAh	13-14 hours
	200mAh	17 hours

*Charge times will vary depending on the brand, capacity and condition of battery being charged

Order Code	Mod: 045794	Price each exc. VAT 1+	inc. VAT each
N10EW	Map EasyCharger	£14.15	£16.99

Maplin NiMH AAA and AA Slimline Battery Charger with USB



- Recharges 2 or 4 AAA or AA NiMH batteries at a time
- Includes 4 x AA 2400mAh rechargeable batteries
- Built-in USB port for charging mobile phones, MP3s, iPod and other devices that can be powered via USB
- Short circuit and reverse polarity protection
- Automatic charge current selection for AA and AAA batteries
- 2 LEDs indicate charge status
- Bad cell detection
- 'Negative Delta V' detection switches off charger when batteries are fully charged
- Overcharging prevented by timer protection
- Worldwide voltage range (100V-240V subject to use with a suitable travel adapter)

Order Code	Mod: 350312	Price each exc. VAT 1+	inc. VAT each
N11HN	4Hr USB Batt Charger	£16.65	£19.99

Maplin NiMH and Hybrid AAA and AA Fast Battery Charger with LCD Screen



- Fast charger for AA and AAA rechargeable NiMH and hybrid batteries
- Will charge 2 or 4 batteries at a time
- Adjusts automatically to any voltage from AC 100-240V for international use
- 'Negative delta V' detection switches off charger when batteries are fully charged
- LCD screen displays charging status
- Supplied with 4 x 2400mAh AA NiMH batteries

Please note that this charger is not suitable for charging NiCd rechargeable batteries.

Order Code	Mod: 221547	Price each exc. VAT 1+	inc. VAT each
N52FT	LCD Batt Charger	£18.32	£21.99

Newsletter

Subscribe to our newsletter for information about the latest innovation and the best deals.

Maplin NiMH, NiCd and Hybrid AAA and AA Super Easy 8 Way Battery Charger



- Ideal for charging bulk quantities of batteries
- Supplied with 4 x AA and 4 x AAA high capacity NiMH rechargeable batteries
- Recharges 2, 4, 6 or 8 high capacity AA or AAA size, NiMH, NiCd or Hybrid batteries at a time
- Powered by the supplied AC 230 V mains adapter or DC 12 V car adapter
- Overcharging prevented by timer protection
- Automatic charging current selection for size AA and AAA batteries
- LED display for rapid charge/trickle charge

This 8-way charger is an ideal choice for anyone who requires a quick charge time for charging bulk quantities of AAA or AA batteries. For maximum flexibility, the charger is supplied with two power options (mains and in-car) and is supplied with four AA 2000mAh and four AAA 950mAh NiMH batteries. A great choice for keeping radio-controlled cars on the road or for high drain appliances such as digital cameras.

Specifications:

Mains power supply	AC 230 V 50Hz
In-car power supply	12Vdc
Charge rate	AA 320mA / AAA 120mA
Trickle mode	AAA / AA 20mA
Operating temperature:	0°C - 35°C

Size	Capacity	Charging time
AA	600-900mAh	2-3 hours
	1300-1600mAh	4-5 hours
	1800-2000mAh	6 hours
	2100-2500mAh	7 hours
AAA	180-300mAh	2-3 hours
	500-600mAh	5-6 hours
	650-900mAh	7 hours

*Charge time will vary depending upon the brand, capacity and condition of batteries being charged

Order Code	Mod.	Price each exc. VAT 1+	inc. VAT each
N11BW	Map SuperEasy Chrger	£20.82	£24.99

Maplin NiCd, NiMH and Hybrid PP3 Compact Battery Charger

- Charges 1 or 2 9V (PP3) NiCd or NiMH or Hybrid batteries
- Built-in timer control for overcharge protection
- LED indication for charging and 'ready'
- Plug-in, space saving design
- Supplied with 1 x 200mAh PP3 NiMH battery



Specifications:

Power supply:	AC 230 V, 50Hz
Dimensions:	75 x 50 x 40mm [not including pins]

Size:	Capacity:	Charging time:
9V NiCd	100mAh	4.5 hours
9V NiCd	120mAh	5.5 hours
9V NiMH	150mAh	7 hours
9V NiMH	170mAh	8 hours

Order Code	Mod.	Price each exc. VAT 1+	inc. VAT each
L37AK	PP3 Battery Charger	£14.15	£16.99

Maplin NiCd, NiMH and Hybrid AAA, AA, C, D and PP3 Universal Battery Charger



- For use with NiCd, NiMH and Hybrid rechargeable batteries
- Full charge in 4-8 hours
- Charges AA, AAA, C, D or PP3 sizes
- Timer controlled
- Automatic switch off
- LEDs indicate charging status

Order Code	Mod.	Price each exc. VAT 1+	inc. VAT each
N65CX	V-1199B 4/8 Hour Uni	£14.15	£16.99

Maplin NiMH, NiCd and Hybrid AAA, AA, C and D Super Universal Battery Charger

- Recharges 2 or 4 AAA, AA, C, D or 1 to 2 9 V size NiMH, NiCd or Hybrid rechargeable batteries at a time
- Powered by the supplied AC 230 V mains adapter when used in home or DC 12 V car adapter when used in a vehicle
- 'Negative delta V' detection switches off charger immediately the batteries are fully charged
- Overcharging prevented by timer protection
- Automatic charging current selection for different size batteries
- LEDs indicate when charging properly and when batteries are ready

Specifications:

Mains power supply :	AC 230 V, 50 Hz		
In-car power supply:	DC 12 V		
Operating temperature:	0°C - 35°C		
Size	Charging current	Capacity	Charging time
AAA	40.0mA	900 mAh	2.5 hours
AA	850 mA	2500 mAh	3.5 hours
C	850 mA	4500 mAh	6 hours
D	850 mA	8500 mAh	12 hours
9V	15 mA	200 mAh	16 hours

*Charge time will vary depending upon the brand, capacity and condition of batteries being charged

Order Code	Mod.	Price each exc. VAT 1+	inc. VAT each
N12BW	Map Universal Chrger	£19.15	£22.99

Maplin NiCd and NiMH AAA, AA, C, D and 9V PP3 Universal Battery Charger

- NiCd and NiMH rechargeable batteries can be charged at the same time
- Charges up to 8 batteries simultaneously
- Charges AA, AAA, C, D and 9V PP3 batteries
- Charges 1-6 pieces of AAA / AA batteries or 1-4 pieces of C / D batteries plus 1-2 pieces of 9V batteries
- Automatically detects and analyses the status of each battery in 3 seconds
- Faulty battery detection - damaged batteries are identified on the LEDs
- Independent charge channel for each battery
- Batteries are automatically charged when placed in the charger
- 3-5 hours average charge time



- Overcharging prevented by timer protection
- Temperature control prevents batteries from overcharging
- 'Negative delta V' detection switches off charger immediately the batteries are fully charged
- LEDs indicate charging status of each individual battery
- Automatic charging current selection for different size batteries
- Automatically switches to trickle charge mode once the batteries are fully charged
- Worldwide voltage (travel adapter maybe required)

Charge times:

Battery type	Capacity	Size
Charging time (approx.)		
NiMH/NiCd 800mAh	AAA,	180 minutes
NiMH/NiCd 2100mAh	AA	150 minutes
NiMH/NiCd 3500mAh	C	260 minutes
NiMH/NiCd 4000mAh	D	300 minutes
NiMH/NiCd 200mAh	9V	240 minutes

Order Code	Mod.	Price each exc. VAT 1+	inc. VAT each
N04KR	UniversalCharger Pro	£22.49	£26.99

Lithium Ion NiMH and NiCd AAA/AA and 9V Universal Battery Charger with USB



- Charges most battery types
- Automatically detects battery voltage and polarity
- Will charge 2 x AA or AAA or 1 x 9V NiMH/NiCd rechargeable batteries
- Will also charge 3.6V and 7.2V-7.4V digital camera, camcorder and mobile phone lithium-ion batteries (auto detection function)
- Built-in USB output port for directly charging mobile phones and MP3s (USB cable not included)
- Charges from any mains voltage around the world (additional travel adapter may be required)
- 12V cigarette lighter adapter for charging from car/boat/caravan without loss of charge performance
- Intelligent charging detects when batteries are fully charged and switches to a top-up trickle charge
- Auto cut-off and built-in timer protection
- LED charging indicator
- Safety features: bad cell detection, short circuit protection, reverse polarity protection
- Charges AA and AAA batteries in 1-4 hours and lithium-ion batteries in 2-3 hours
- Will simultaneously charge one battery while the USB port is being used

Contents:

Charger
12V cigarette lighter plug
UK mains plug for 230V mains supply
Instruction manual

Specifications:

Input voltage:	DC 12V 1000mA maximum
Input voltage:	AC100 - 240V / 50-60Hz
Lithium ion charging:	3.6V - 3.7V: DC4.2V / 700mA 7.2V - 7.4V: DC8.4V / 700mA
NiMH charging:	2 x AA or 2 x AAA: 2.8V / DC3.8V / 700mA 9V: 80mA
USB port output:	5V 500mA
Weight charger:	105g

Dimensions: 135 [l] x 61 [w] x 30mm [h]
Will accept a maximum battery depth of 50mm

Order Code	Mod.	Price each exc. VAT 1+	inc. VAT each
N14KR	Li-ion*NiMH UniChrger	£19.15	£22.99

Powerex NiMH AA and AAA Compact Fast Battery Charger



- Supplied with 4 x AA 2700mA NiMH rechargeable batteries
- Compact and lightweight weighs only 112g
- Battery conditioning feature – bring dead batteries back to life
- Recharge 2 x AA or 2 x AAA batteries in around 1 hour
- Recharge 4 x AA / AAA batteries in about two hours
- Worldwide operation 100-240V 50/60Hz international power supply (travel adapter not included)

The MH-C204W has a 5th generation Powerex microprocessor that features an unique four stage charging process: ramp-up, rapid charging, top-off charging and maintenance charging.

The ramp-up jolts the batteries if needed to revive old batteries. This jolting feature is a series of carefully timed high current pulses that can activate both new and inactive batteries.

The MH-C204W is designed with an intermediate, medium current, top-off charge so that the battery will retain most of its charge.

The maintenance charging feature is an extremely low current pulse charging that gives the batteries a brief pulse charge periodically to ensure the batteries are charged but not overcharged.

Specifications:

Detection: Negative delta V, zero delta V and temperature

Charge current: 2,000mA [AA], 700mA [AAA]

Trickle current: 50mA

Order Code	Mod: 262168	Price each exc. VAT 1+	inc. VAT each
N42GZ	MH-C204W WorldChgr	£30.82	£36.99

Powerex NiMH and NiCd AAA and AA Cool Charger with 4 Batteries



- Four independent charge circuits to individually charge each battery
- Charges AA/AAA NiMH and NiCd batteries
- Unique FLEX negative pulse charging algorithm gives a more complete charge

Unlike some ultra-fast chargers on the market, the MH-C401FS charger has four independently controlled channels to charge and monitor each battery individually. This allows each battery to be charged to its full potential without risk of overcharging. The charger can charge one, two, three or four batteries.

Specifications:

Rapid charge current: 1000mA [AA], 500mA [AAA]

Trickle charge current: 50mA

Slow charge current: 300mA [AA], 200mA [AAA]

Microprocessor: Negative delta V, four independent channels

Power supply voltage: 12V 1000mA

Order Code	Mod: 262167	Price each exc. VAT 1+	inc. VAT each
N43GZ	MH-C401FS Bat Chgr	£34.99	£41.99

Powerex NiMH, NiCd AAA and AA Battery Charger with LCD Display



- Designed for today's high performance batteries
- Charges one to eight AA / AAA / NiMH or NiCd in any combination
- Rapid recharge of AA / AAA in 1-2 hours
- LCD displays charging status for each battery independently
- Choose between a soft charge or a rapid charge mode
- Low-temperature charging algorithm – low charging temperature maximises battery life and performance
- Built-in high-rate battery conditioner will charge, deep-discharge and recharge batteries automatically
- Worldwide compatibility 100 – 240V 50/60Hz universal mains adapter

The MH-C800S charger incorporates a large LCD screen displaying the charging status of each battery. The display [CHARGE, DONE, CONDITIONING, etc] replaces traditional LED indicators. The charger is embedded with a high-rate battery conditioner that will charge, deep-discharge and recharge batteries automatically for maximum rejuvenation.

Specifications:

Supported batteries: 1-8 x AA, AAA NiMH and NiCd

Rapid charge current: 1000mA

Charge time: 1-2 hours (Normal),

3-4 hours (Soft Charging)

Order Code	Mod: 262165	Price each exc. VAT 1+	inc. VAT each
N44GZ	MHC800S 8Bat LCD Chg	£41.65	£49.99

Powerex NiMH Fast 9V Battery Charger



- Ten individual charging channels capable of charging up to ten 9V rechargeable batteries at a time
- Will charge 9.6V rechargeable batteries in 2 hours or less
- Charges each battery to its full potential without risk of overcharging
- Microprocessor automatically switches to trickle charge after batteries are finished charging so that they maintain their charge
- Compatible with 7.2V, 8.4V, and 9.6V rechargeable 9V batteries

The Powerex MH-C1090F 9V fast charger was designed with the high battery power demands in mind. Before the powered C1090F there wasn't a dependable 9V charger that delivered a full fast charge to rechargeable 9.6V batteries. Using other chargers, it could take 12 to 14 hours to charge even two 9V batteries, with no guarantee that they would be fully charged.

Specifications:

Charging current: 70-90mA rapid charge

Maintenance charging current: 10mA

Charge time: 120-160 minutes

Charger input power: 15V 1.0A

Adaptor input: 100-240V 50/60Hz

Order Code	Mod: 262166	Price each exc. VAT 1+	inc. VAT each
N41GZ	MH-C1090F 10x9V Chrg	£41.65	£49.99



Friendly expert advice on
0333 400 9500

Coin Cells

Lithium Coin Cell Batteries

- Lithium manganese cells with a nominal voltage of 3V
- For use where very low quiescent currents need to be maintained for very long periods with only occasional demands for high current drain



Order Code:	Battery type:	Dimensions: (mm)
ZB77J	CR1220	12.5 x 2
ZB81C	CR1616	16 x 1.6
GU11M	CR1620	16 x 2.0
N74HW	CR1632	16 x 3.2
ZB71N	CR2016	20 x 1.6
ZB73Q	CR2025	20 x 2.5
ZB74R	CR2032	20 x 3.2
ZB76	CR2430	24 x 3
L66AJ	CR2450	24 x 5

Order Code	Mod: 004470	Price each exc. VAT 1+	inc. VAT each 5+
ZB77J	CR1220	£3.15	£2.84
ZB81C	CR1616	£3.74	£3.49
GU11M	CR1620	£3.15	£2.84
N74HW	CR1632	£3.74	£3.49
ZB71N	CR2016	£3.32	£2.99
ZB73Q	CR2025	£3.32	£2.99
ZB74R	CR2032	£3.32	£2.99
ZB76H	CR2430	£3.74	£3.49
L66AJ	CR2450	£3.40	£3.06

Lithium Coin Cell CR1616 3V Battery 1 Pack

- Lithium manganese cells with a nominal voltage of 3V
- For use where very low quiescent currents need to be maintained for very long periods with only occasional demands for high current drain



Product also known as

MAPLIN	ZB81C
IEC	CR1616
ANSI	5021LC
DURACELL	DL1616
VARTA	CR1616
ENERGIZER	1616
KODAK	-
FANASONIC	CR1616, BR1616
OTHERS	-
OTHERS	-

Order Code	Mod: 512113	Price each exc. VAT 1+	inc. VAT each
ZB81C	CR1616	£3.74	£4.49

Lithium Coin Cell CR1620 3V Battery 1 Pack

- Lithium manganese cells with a nominal voltage of 3V
- For use where very low quiescent currents need to be maintained for very long periods with only occasional demands for high current drain



Product also known as

MAPLIN	GU11M
IEC	CR1620
ANSI	-
DURACELL	DL1620
VARTA	-
ENERGIZER	1620
KODAK	-
FANASONIC	CR1620
RAYOVAC	-
OTHERS	-

Order Code	Mod: 512118	Price each exc. VAT	inc. VAT each
GU11M	CR1620	£3.15	£3.79

Lithium Coin Cell CR1632 3V Battery 1 Pack

- Lithium manganese cells with a nominal voltage of 3V
- For use where very low quiescent currents need to be maintained for very long periods with only occasional demands for high current drain



Product also known as:

MAPLIN	N74HW
IEC	CR1632
ANSI	
DURACELL	DL1632
VARTA	CR1632
ENERGIZER	1632
KODAK	KL1632
PANASONIC	BR1632
RAYOVAC	CR1632
OTHERS	

Order Code	Mod: 512996	Price each exc. VAT	inc. VAT each
N74HW	CR1632	£3.74	£4.49

Lithium Coin Cell CR2016 3V Battery 1 Pack

- Lithium manganese cells with a nominal voltage of 3V
- For use where very low quiescent



currents need to be maintained for very long periods with only occasional demands for high current drain

Product also known as

MAPLIN	ZB71N
IEC	CR2016
ANSI	5000LC
DURACELL	DL2016
VARTA	CR2016
ENERGIZER	2016
KODAK	KL2016
PANASONIC	CR2016
RAYOVAC	CR2016
OTHERS	LF1/4V

Order Code	Mod: 512121	Price each exc. VAT	inc. VAT each
ZB71N	CR2016	£3.32	£3.99

Lithium Coin Cell CR2025 3V Battery 1 Pack

- Lithium manganese cells with a nominal voltage of 3V
- For use where very low quiescent currents need to be maintained for very long periods with only occasional demands for high current drain



Product also known as

MAPLIN	ZB73Q
IEC	CR2025
ANSI	5003LC
DURACELL	DL2025
VARTA	CR2025
ENERGIZER	2025
KODAK	KL2025
PANASONIC	CR2025
RAYOVAC	CR2025
OTHERS	-

Order Code	Mod: 512123	Price each exc. VAT	inc. VAT each
ZB73Q	CR2025	£3.32	£3.99

Lithium Coin Cell CR2032 3V Battery 1 Pack

- Lithium manganese cells with a nominal voltage of 3V
- For use where very low quiescent currents need to be maintained for very long periods with only occasional demands for high current drain



Product also known as:

MAPLIN	ZB74R
IEC	CR2032
ANSI	5004LC
DURACELL	DL2032
VARTA	CR2032
ENERGIZER	2032
KODAK	KL2032
PANASONIC	CR2032, BR2032
RAYOVAC	CR2032
OTHERS	LF-1/2V

Order Code	Mod: 512149	Price each exc. VAT	inc. VAT each
ZB74R	CR2032	£3.32	£3.99

Buying for business?
0333 400 9740



Lithium Battery Cross Reference Chart

IEC	ANSI	Duracell	Varta	Energizer	Kodak	Panasonic	Rayovac	Others	Maplin Code
CR17345	5018LC	DL123A	CR123A	EL123	K123LA	CR123A	RL123R	-	N07BX
CR-P2	5024LC	DL223A	VL223	EL223	K223LA	CRP2P	CR-P2R	C9-P2S	N02BX
2CR5	5032LC	DL245	2CR5	EL2CR5	KL2CR	2CR5M	2CR5R	-	N05BX
CR17355	-	-	CR-V3	ELCRV3	-	-	-	CR-V3	N08BX
CR2	-	DLCR2	CR2	CR2	KCR2	CR2	-	-	N06BX
CR11108	5008LC	DL1/3N	CR1/3N	2L76	K58L	-	-	-	VP26D
CR1220	-	DL1220	CR1220	1220	-	CR1220	-	-	ZB77J
CR1616	5021LC	DL1616	CR1616	1616	-	CR1616, BR1616	CR1616	-	ZB81C
CR1620	-	DL1620	-	1620	-	CR1620	-	-	GU11M
CR1632	-	DL1632	CR1632	1632	KL1632	BR1632	CR1632	-	N74HW
CR2016	5000LC	DL2016	CR2016	2016	KL2016	CR2016	CR2016	LF1/4V	ZB71N
CR2025	5003LC	DL2025	CR2025	2025	KL2025	CR2025	CR2025	-	ZB73Q
CR2032	5004LC	DL2032	CR2032	2032	KL2032	CR2032, BR2032	CR2032	LF - 1/2V	ZB74R
CR2430	5011C	DL2430	CR2430	2430	-	CR2430	CR2430	LF - 1/2W	ZB76H
CR2450	5029LC	DL2450	CR2450	2450	-	CR2450	CR2450	-	L66AJ

POWER

Batteries



/maplin



@maplintweet



/+maplin



/maplinonline



/maplintv

Lithium Coin Cell CR2430 3V Battery 1 Pack



- Lithium manganese cells with a nominal voltage of 3V
- For use where very low quiescent currents need to be maintained for very long periods with only occasional demands for high current drain

Also known as:

MAPLIN	ZB76H
IEC	CR2430
ANSI	5011LC
DURACELL	DL2430
VARTA	CR2430
ENERGIZER	2430
KODAK	-
FANASONIC	CR2430
RAYOVAC	CR2430

Order Code	Mod: 512152	Price each exc. VAT 1+	5+	inc. VAT each
ZB76H	CR2430	£3.74		£4.49

Lithium Coin Cell CR2450 3V Battery 1 Pack



- Lithium manganese cells with a nominal voltage of 3V
- For use where very low quiescent currents need to be maintained for very long periods with only occasional demands for high current drain

Product also known as:

MAPLIN	L66AJ
IEC	CR2450
ANSI	5029LC
DURACELL	DL2450
VARTA	CR2450
ENERGIZER	2450
KODAK	-
FANASONIC	CR2450
RAYOVAC	CR2450
OTHERS	-

Order Code	Mod: 512155	Price each exc. VAT 1+	5+	inc. VAT each
L66AJ	CR2450	£3.40	£3.06	£4.09

Panasonic Lithium Coin Cell CR2016 3V Batteries 6 Pack



- Lithium manganese cells with a nominal voltage of 3V
- Designed to provide reliable and long-lasting power

Product also known as:

IEC	CR2016
ANSI	5000LC
DURACELL	DL2016
VARTA	CR2016
ENERGIZER	2016
KODAK	KL2016
FANASONIC	CR2016
RAYOVAC	CR2016
OTHERS	LF1/4V

Order Code	Mod: 634706	Price each exc. VAT 1+	5+	inc. VAT each
N40NA	FAN CR2016 6Pk	£9.57		£11.49

Panasonic Lithium Coin Cell CR2025 3V Batteries 6 Pack



- Lithium manganese cells with a nominal voltage of 3V
- Designed to provide reliable and long-lasting power

Product also known as:

MAPLIN	ZB71N
IEC	CR2025
ANSI	5003LC
DURACELL	DL2025
VARTA	CR2025
ENERGIZER	2025
KODAK	KL2025
FANASONIC	CR2025
RAYOVAC	CR2025

Order Code	Mod: 634710	Price each exc. VAT 1+	5+	inc. VAT each
N41NA	FAN CR2025 6Pk	£7.49		£8.99

Panasonic Lithium Coin Cell CR2032 3V Batteries 6 Pack



- Lithium manganese cells with a nominal voltage of 3V
- Designed to provide reliable and long-lasting power

Product also known as:

IEC	CR2032
ANSI	5004LC
DURACELL	DL2032
VARTA	CR2032
ENERGIZER	2032
KODAK	KL2032
FANASONIC	CR2032, BR2032
RAYOVAC	CR2032
OTHERS	LF-1/2V

Order Code	Mod: 634712	Price each exc. VAT 1+	5+	inc. VAT each
N42NA	FAN CR2032 6Pk	£9.57		£11.49

Button Cells

Super Silver Oxide Batteries

Especially recommended for quartz watches and small calculators where the long and stable discharge characteristics are important. See the Silver Oxide Watch Battery Cross Reference to help identify your battery. In all instances, SRxx provides a superior replacement for LRxx, e.g. SR44 replaces LR44. Nominal voltage of all types 1.5V



Ccode	Type	Dimensions (dia x h mm)	Nominal capacity	Weight
JK33L	SR63	5.8 x 2.1	10mAh	0.3g
FM36P	SR60	6.8 x 2.1	12mAh	0.34g
JG83E	SR66	6.8 x 2.6	20mAh	0.4g
FM33L	SR58	7.9 x 2.1	16mAh	0.45g
FM35Q	SR59	7.9 x 2.6	23mAh	0.5g
FM30H	SR41	7.9 x 3.6	30mAh	0.7g
FM32K	SR48	7.9 x 5.4	58mAh	1.1g
FS76H	SR69	9.5 x 2.1	25mAh	0.6g
FS75S	SR57	9.5 x 2.6	34mAh	0.75g

FS74R	SR45	9.5 x 3.6	52mAh	1.0g
FS73Q	SR55	11.6 x 2.1	35mAh	0.9g
FM31J	SR54	11.6 x 3.1	64mAh	1.3g
FM29G	SR43	11.6 x 4.2	110mAh	1.8g
FM28F	SR44	11.6 x 5.4	150mAh	2.7g

Order Code	Mod: 268822	Price each exc. VAT 1+	5+	inc. VAT each
JK33L	Silver Batt SR63	£2.49	£2.24	£2.99
FM36P	Silver Batt SR60	£2.49	£2.24	£2.99
JG83E	Silver Batt SR66	£2.49	£2.24	£2.99
FM33L	Silver Batt SR58	£2.49	£2.24	£2.99
FM35Q	Silver Batt SR59	£2.49	£2.24	£2.99
FM30H	Silver Batt SR41	£2.65	£2.39	£3.19
FM32K	Silver Batt SR48	£2.49	£2.24	£2.99

Technical Helpline

0333 400 9500

For technical information and assistance relating to any Maplin purchase, contact our team of experts

Super Silver Oxide SR60 1.5V Battery 1 Pack

- Ideal for watches and calculators
- Long and stable discharge
- Nominal voltage 1.5V
- Capacity: 12mAh
- Dimensions (diameter x h): 6.8 x 2.1mm
- Weight: 0.34g

Battery also known as:

Code	FM36P
IEC	SR60
IEC	SR621SW
ANSI	1175S0
JIS	GS1
DURACELL/VARTA	364
ENERGIZER	364
FANASONIC	SP364
RAYOVAC/VIDOR:	RW320
SEIKO	SB-AG, SB-DG
OTHERS	SG1

Order Code	Mod: 512049	Price each exc. VAT 1+	5+	inc. VAT each
FM36P	Silver Batt SR60	£2.49	£2.24	£2.99

Super Silver Oxide SR66 1.5V Battery 1 Pack

- Ideal for watches and calculators
- Long and stable discharge
- Nominal voltage 1.5V
- Capacity: 20mAh
- Dimensions (diameter x h): 6.8 x 2.6mm
- Weight: 0.4g

Battery also known as:

Code	JG83E
IEC	SR66
IEC	SR626W
ANSI	-
JIS:	G4.GS4
DURACELL/VARTA	377
ENERGIZER	376377
FANASONIC	SP376.SP377
RAYOVAC/VIDOR:	RW329
SEIKO	SB-AW,SB-BW
CITIZEN	280-39
OTHERS:	CX626

Order Code	Mod: 512048	Price each exc. VAT 1+	5+	inc. VAT each
JG83E	Silver Batt SR66	£2.49	£2.24	£2.99



Browse our entire range at maplin.co.uk



IN-STORE
over 200 stores nationwide



ONLINE
over 20,000 lines at maplin.co.uk



PHONE
order on 0333 400 9500



DELIVERY
to your home or office

Super Silver Oxide SR58 1.5V Battery 1 Pack

- Ideal for watches and calculators
- Long and stable discharge
- Nominal voltage 1.5V
- Capacity: 16mAh
- Dimensions (diameter x h): 7.9 x 2.1mm
- Weight: 0.45g



Battery also known as:

Code	FM33L
IEC	SR58
IEC	SR721W
ANSI	115850
JIS	G11
DURACELL/ VARTA	361362
ENERGIZER	361362
PANASONIC	SP361,SP362
RAYOVAC/VIDOR	RW310,RW410
SEIKO	SB-AK
CITIZEN	280-29
OTHERS	CX721

Order Code	Mod: 512086	Price each exc. VAT	inc. VAT each
FM33L	Silver Batt SR58	£2.49	£2.24 £2.99

7.9 x 2.6mm
• Weight: 0.5g
OTHERS: SG2

Battery also known as:

Code	FM35Q
IEC	SR59
IEC	SR726W
ANSI	116350, 116450
JIS	G2, GS2
DURACELL/ VARTA	396397
ENERGIZER	396397
PANASONIC	SP369, SP399
RAYOVAC/VIDOR	RW411, RW311
SEIKO	SB-AL, SB-BL

Order Code	Mod: 512088	Price each exc. VAT	inc. VAT each
FM35Q	Silver Batt SR59	£2.49	£2.24 £2.99

Super Silver Oxide SR41 1.5V Battery 1 Pack

- Ideal for watches and calculators
- Long and stable discharge
- Nominal voltage 1.5V
- Capacity: 30mAh
- Dimensions (diameter x h): 7.9 x 3.6mm
- Weight: 0.7g



Battery also known as:

Code	FM30H
IEC	SR41
IEC	SR736SW
ANSI	113450,113550
JIS	G3,GS3

DURACELL/ VARTA	384325392
ENERGIZER	384392
PANASONIC	SP384,SP392
RAYOVAC/VIDOR	RW37, RW47
SEIKO	SB-A1,SB-B1

OTHERS SG3

Order Code	Mod: 512089	Price each exc. VAT	inc. VAT each
FM30H	Silver Batt SR41	£2.65	£2.39 £3.19

Super Silver Oxide SR48 1.5V Battery 1 Pack

- Ideal for watches and calculators
- Long and stable discharge
- Nominal voltage 1.5V
- Capacity: 58mAh
- Dimensions (diameter x h): 7.9 x 5.4mm
- Weight: 1.1g



Battery also known as:

Code	FM32K
IEC	SR48
IEC	SR754SW
ANSI	113650,113750
JIS	G5,GS5
DURACELL/ VARTA	393
ENERGIZER	309393
PANASONIC	WH-6,SP393
RAYOVAC/VIDOR	RW48
SEIKO	SB-B3
CITIZEN	-
OTHERS	SG5

Order Code	Mod: 512090	Price each exc. VAT	inc. VAT each
FM32K	Silver Batt SR48	£2.49	£2.24 £2.99

Super Silver Oxide SR59 1.5V Battery 1 Pack

- Ideal for watches and calculators
- Long and stable discharge
- Nominal voltage 1.5V
- Capacity: 23mAh
- Dimensions (diameter x h):



Silver Oxide Battery Cross Reference Chart

IEC	IEC	Ansi	JIS	Duracell (D1) / Varta (V)	Energizer	Panasonic	Rayovac / Vidor	Seiko	Citizen	Others	Maplin Code
SR63	SR521SW	-	-	379	379	SP379	RW327	SB-AC, SB-DC	280-59	CX521	JK33L
SR60	SR621SW	117550	G51	364	364	SP364	RW320	SB-AG, SB-DG	280-34	SG1	FM36P
SR66	SR626W	-	G4, G54	377	376, 377	SP376, SP377	RW329	SB-AW, SB-BW	280-39	CX626	JG83E
SR58	SR721W	115850	G11	361, 362	361, 362	SP361, SP362	RW310, RW410	SB-AK	280-29	CX721	FM33L
SR59	SR726W	116350, 116450	G2, GS2	396, 397	396, 397	SP369, SP399	RW411, RW311	SB-AL, SB-BL	280-52, 280-28	SG2	FM35Q
SR41	SR736SW	13450, 113550	G3, GS3	384, 325, 392	384, 392	SP384, SP392	RW37, RW47	SB-A1, SB-B1	280-18, 280-13	SG3	FM30H
SR48	SR754SW	113650, 113750	G5, GS5	393	309, 393	WH-6, SP393	RW48	SB-B3	-	SG5	FM32K
SR69	SR920W	-	G6, GS6	370, 371	370, 371	SP370, RW315	RW315, RW415	SB-AN, SB-BN	280-31, 280-51	CX921	FS76H
SR57	SR927SW	116250, 116550	G7, GS7	395, 399	395, 399	SP395, SP399	RW313, RW413	SB-AP	280-48, 280-44	CX926	FS755
SR45	SR936SW	-	GS9	394	394	SR936SW	RW33	SB-A4	280-17	CX936	FS74R
SR55	SR1120SW	116050	GS8	381, 391, V8GA	381, 391	SR1120W, SP391	RW40, RW30	SB-B5, SB-AD	280-30, 280-27	SG8	FS730
SR54	SR1130SW	113850	G10, GS10	389, 390	389, 390	SP389, WS-10	RW39, RW49	SB-BU, AB-AU	280-15, 280-24	SG10	FM31J
SR43	SR1142SW	113250, 113350	G12, GS12	301, 354, 386	301, 386	SP301, SP386	RW34, RW44	SB-A8, SB-BB	280-21, 280-01	SG12	FM29G
SR44	SR1154W	113150	G13	357, 313, 303	357	NP313, SP357	RW32, RW42	SB-A9, SB-B9	280-08	SG13	FM28F
4SR44	-	-	-	PX28S, V28PX	544	4SR44	-	V4034PX	GP476	KS28	QE47B

* Silver Oxide Watch Batteries - all 1.5V (except 4SR44 - 6V)

Super Silver Oxide SR69 1.5V Battery 1 Pack

- Ideal for watches and calculators
- Long and stable discharge
- Nominal voltage 1.5V
- Capacity: 25mAh
- Dimensions (diameter x h): 9.5 x 2.1mm
- Weight: 0.6g



Battery also known as:

Code:	FS76H
IEC:	SR69
IEC:	SR920W
ANSI:	-
JIS:	G6,GS6
DURACELL/VARTA:	370371
ENERGIZER:	370371
FANASONIC:	SF370,RW315
RAYOVAC/VIDOR:	RW315,RW415
SEIKO:	SB-AN,SB-BN
CITIZEN:	280-31,280-51
OTHERS:	CX921

Order Code	Mod:	Price each exc. VAT	inc. VAT each	
		1+	5+	
FS76H	Silver Batt SR69	£2.49	£2.24	£2.99

Super Silver Oxide SR55 1.5V Battery 1 Pack

- Ideal for watches and calculators
- Long and stable discharge
- Nominal voltage 1.5V
- Capacity: 35mAh
- Dimensions (diameter x h): 11.6 x 2.1mm
- Weight: 0.9g



Battery also known as:

Code:	FS73Q
IEC:	SR55
IEC:	SR1120SW
ANSI:	1160S0
JIS:	GS8
DURACELL/VARTA:	381.391,V8GA
ENERGIZER:	381391
FANASONIC:	SR1120W,SF391
RAYOVAC/VIDOR:	RW40,RW30
SEIKO:	SB-BS,SB-AD
CITIZEN:	280-30,280-27
OTHERS:	SG8

Order Code	Mod:	Price each exc. VAT	inc. VAT each	
		1+	5+	
FS73Q	Silver Batt SR55	£2.49	£2.24	£2.99

Super Silver Oxide SR44 1.5V Battery 1 Pack

- Ideal for watches and calculators
- Long and stable discharge
- Nominal voltage 1.5V
- Capacity: 150mAh
- Dimensions (diameter x h): 11.6 x 5.4mm
- Weight: 2.7g



Battery also known as:

Code:	FM28F
IEC:	SR44
IEC:	SR1154W
ANSI:	1131S0
JIS:	G13
DURACELL/VARTA:	357313303
ENERGIZER:	357
FANASONIC:	NF313,SF557
RAYOVAC/VIDOR:	RW32,RW42
SEIKO:	SB-A9,SB-B9
CITIZEN:	280-08
OTHERS:	SG13

Order Code	Mod:	Price each exc. VAT	inc. VAT each	
		1+	5+	
FM28F	Silver Batt SR44	£2.65	£2.39	£3.19

Super Silver Oxide SR57 1.5V Battery 1 Pack

- Ideal for watches and calculators
- Long and stable discharge
- Nominal voltage 1.5V
- Capacity: 34mAh
- Dimensions (diameter x h): 9.5 x 2.6mm
- Weight: 0.75g



OTHERS: CX926

Battery also known as:

Code:	FS75S
IEC:	SR57
IEC:	SR927SW
ANSI:	1162S0,1165S0
JIS:	G7,GS7
DURACELL/VARTA:	395399
ENERGIZER:	395399
FANASONIC:	SF395,SF399
RAYOVAC/VIDOR:	RW313,RW413
SEIKO:	SB-AF
CITIZEN:	280-48,280-44

Order Code	Mod:	Price each exc. VAT	inc. VAT each	
		1+	5+	
FS75S	Silver Batt SR57	£2.49	£2.24	£2.99

Super Silver Oxide SR54 1.5V Battery 1 Pack

- Ideal for watches and calculators
- Long and stable discharge
- Nominal voltage 1.5V
- Capacity: 64mAh
- Dimensions (diameter x h): 11.6 x 3.1mm
- Weight: 1.3g



Battery also known as:

Code:	FM31J
IEC:	SR54
IEC:	SR1130SW
ANSI:	1138S0
JIS:	G10,GS10
DURACELL/VARTA:	389390
ENERGIZER:	389390
FANASONIC:	SF389,WS-10
RAYOVAC/VIDOR:	RF399,RW49
SEIKO:	SB-BU,AB-AU
CITIZEN:	280-15,280-24
OTHERS:	SG10

Order Code	Mod:	Price each exc. VAT	inc. VAT each	
		1+	5+	
FM31J	Silver Batt SR54	£2.65	£2.39	£3.19

Panasonic LR44 Batteries 6 Pack

- Ideal for watches and calculators
- Nominal voltage 1.5V
- Value-for-money 6-pack



Product also known as

IEC:	SR44
IEC:	SR1154W
ANSI:	1131S0
JIS:	G13
DURACELL/VARTA:	357313303
ENERGIZER:	357
FANASONIC:	NF313,SF557
RAYOVAC/VIDOR:	RW32,RW42
SEIKO:	SB-A9,SB-B9
OTHERS:	LF1/4V
OTHERS:	SG13

Order Code	Mod:	Price each exc. VAT	inc. VAT each	
		1+	5+	
N45NA	FAN LR44 Batt 6Pck	£9.57		£11.49

Portable Power

Lithium Ion 5000mAh Portable Power Bank



- Compatible with the majority of mobile phones, MP3s, GPS, game consoles and more
- USB connector powers and charges your digital devices
- Allows you to top up power to your portable device while on the go
- Reusable reserve power pack - no batteries required
- 5000 mAh high power built-in Lithium-ion battery pack
- Multiple LEDs to indicate battery level and charging status
- Over current, over charge, over discharge, overheating and short circuit protection
- Supplied with USB cable and micro and mini USB connectors
- Rechargeable over 500 times

Charge any compatible device on the move! It comes 60%

Super Silver Oxide SR45 1.5V Battery 1 Pack

- Ideal for watches and calculators
- Long and stable discharge
- Nominal voltage 1.5V
- Capacity: 52mAh
- Dimensions (diameter x h): 9.5 x 3.6mm
- Weight: 1.0g



Battery also known as:

Code:	FS74R
IEC:	SR45
IEC:	SR936SW
ANSI:	-
JIS:	GS9
DURACELL/VARTA:	394
ENERGIZER:	394
FANASONIC:	SR936SW
RAYOVAC/VIDOR:	RW33
SEIKO:	SB-A4
CITIZEN:	280-17
OTHERS:	CX936

Order Code	Mod:	Price each exc. VAT	inc. VAT each	
		1+	5+	
FS74R	Silver Batt SR45	£2.49	£2.24	£2.99

Super Silver Oxide SR43 1.5V Battery 1 Pack

- Ideal for watches and calculators
- Long and stable discharge
- Nominal voltage 1.5V
- Capacity: 110mAh
- Dimensions (diameter x h): 11.6 x 4.2mm
- Weight: 1.8g



Battery also known as:

Code:	FM29G
IEC:	SR43
IEC:	SR1142SW
ANSI:	1132S0,1133S0
JIS:	G12,GS12
DURACELL/VARTA:	301354386
ENERGIZER:	301386
FANASONIC:	SP301,SF386
RAYOVAC/VIDOR:	RW34,RW44
SEIKO:	SB-A8,SB-BE
CITIZEN:	280-21,280-01
OTHERS:	SG12

Order Code	Mod:	Price each exc. VAT	inc. VAT each	
		1+	5+	
FM29G	Silver Batt SR43	£2.65	£2.39	£3.19

pre-charged so is ready to use.

Specifications:

Capacity: 5000 mAh
 Input Voltage and Current: 5V 1 A
 Output Voltage and Current: 5V 2.1 A
 Dimensions: 113.5 mm [l] x 73.5 mm [w] x 17.5 mm [d]
 Weight: 160 g
 Number of Charging Life Cycles: 1000 times
 Number of Smartphone / iPhone charges: 2.5
 Number of Tablet / iPad charges: 80%
 Charge time on USB 500 ma: 10 hours
 Charging time Mains 1 A: 6 hours
 Operating Temperature: 0 - 50°C

Contents:

5000 mAh Portable power pack
 USB power cable
 Mini USB connector
 Micro USB connector
 Instruction manual

Order Code	Mod: 612208	Price each exc. VAT 1+	inc. VAT each
N98KQ	Power Walker 5000mAh	£20.82	£24.99

Lithium Ion 6000mAh Portable Power Bank

- **Compatible with the majority of mobile phones, MP3s, GPS, game consoles, tablet PCs and more**
- **USB connector powers and charges your digital devices and allows you to top up power to your portable device while on the go**
- **Reusable reserve power pack - no batteries required**
- **6000mAh high power built-in Lithium-ion battery pack**
- **Multiple LEDs to indicate battery level and charging status**
- **Over current, over charge, over discharge, overheating and short circuit protection**
- **Supplied with USB cable and micro and mini USB connectors**
- **Rechargeable over 500 times**



Charge any compatible device on the move! It comes 60% pre-charged so is ready to use.

Specifications:

Capacity: 6000mAh
 DC output: 5V / 1A
 USB input: 5V / 1A
 Charging life cycles: 1000 times
 Charging time from 2A USB adaptor: 7-8 hours
 Charging time from USB port of PC: 22 - 24 hours
 Operating temperature: 0 - 50°C
 Dimensions: 115mm [l] x 61mm [w] x 15.4mm [d]
 Weight: 200g

Contents:

6000mAh Portable power pack
 USB IN and OUT power cables
 Mini USB connector
 Micro USB connector

Samsung connector
 Sony-Ericsson connector
 Storage pouch for connectors
 Instruction manual

Order Code	Mod: 625614	Price each exc. VAT 1+	inc. VAT each
N48LK	6000mAh BatteryBank	£24.99	£29.99

Maplin Portable Power Bank 10,000mAh

- **Compatible with the majority of mobile phones, MP3s, GPS, game consoles, tablet PCs and more**
- **USB connector powers and charges your digital devices**
- **Allows you to top up power to your portable device while on the go**
- **Reusable reserve power pack - no batteries required**
- **10,000mAh high power built-in Lithium-ion battery pack**
- **Multiple LEDs to indicate battery level and charging status**
- **Over current, over charge, over discharge, overheating and short circuit protection**
- **Supplied with USB cable and micro and mini USB connectors**
- **Rechargeable over 1000 times**



Charge any compatible device on the move! It comes 60% pre-charged so is ready to use.

Specifications:

Capacity: 10000mAh
 DC output: 5V / 2A and 1A output port [real output]
 USB input: 5V / 2A. mini USB input
 Charging life cycles: 1000 times
 Charging time from 2A USB adapter: 7-8 hours
 Charging time from USB port of PC: 22-24 hours
 Operating temperature: 0 - 50°C
 Dimensions: 107mm [w] x 13.7mm [d]
 Weight: 330g
 Number of Smartphone / iPhone charges: 5
 Number of Tablet / iPad charges: 1.5

Contents:

10000mAh Portable power pack
 USB power cable
 Mini USB connector
 Micro USB connector
 Instruction manual

Order Code	Mod: 625352	Price each exc. VAT 1+	inc. VAT each
N95LH	PowerWalker 10000mAh	£33.32	£39.99

Maplin Waterproof Power Bank 7800mAh

- **High capacity 7800mAh charger can charge your smart phone**
- **Waterproof & dustproof design - IP65 rated**
- **Built in USB socket suitable for all digital devices that are USB powered**
- **5V 1A output and input**
- **Includes USB charge cable and 4 device connectors (iPhone, Micro USB, Mini USB and Nokia)**
- **Suitable for charging devices on the move, phones, tablets, cameras**
- **Power bank is a great back up for travel, festivals or all outdoor activities without a power source**
- **LED torch**
- **90% charge capacity after one month on standby**



Portable power in your pocket, handbag or rucksack. This Maplin Waterproof Power Bank is a high capacity backup battery designed to recharge your favourite phone or tablet on the move, especially when you have no access to mains power. It's waterproof and dustproof shell combined with rugged design, allows it to be used whilst camping, hiking or during festivals. Its high capacity Lithium Ion battery will ensure you never run out of power during your travels.

Specification

Number Of Inputs: 1
 Number Of Outputs: 1
 Input Voltage and Current: 5V 1A
 Output Voltage and Current: 5V 1A
 Charging Time: 7-8hrs
 Colour: Black / Green
 Product Width: 77mm
 Product Depth: 20mm
 Product Height: 101mm
 Product Weight: 209g
 Number of Charging Life Cycles: 500 times
 Number of Smartphone / iPhone charges: 3
 Number of Tablet / iPad charges: 40%
 Charge time on USB 500ma: 16 hours
 Charging time Mains 1A: 8 hours
 Operating Temperature: -10 - 50°C

Order Code	Mod: 853750	Price each exc. VAT 1+	inc. VAT each
N03QN	7800mAh WaterproofBatt	£33.32	£39.99

Veho Pebble Smartstick Plus Ayrton Senna Limited Edition Portable Power Bank



- **Lithium ion battery 3,000 mAh**
 - **Limited edition Ayrton Senna Pebble Smartstick Plus in titanium finish**
 - **Will charge your smartphone up to 3 times over**
 - **Includes Apple 30 pin, Mini USB and Micro USB, and USB cable**
 - **Comes with limited edition Ayrton Senna pin badge, Travel sock, Metal body with screw top to protect from dust and Karabiner**
- Emergency power back up for your smartphone or any USB device.

The stylish Ayrton Senna Signature Collection Pebble™ Smartstick+ emergency portable battery pack charger for mobile devices has been enhanced with an increased 3000mAh power supply, ergonomic re-design with protective port dust cap and handy clip on karabiner. Also includes limited edition signature Ayrton Senna collector's badge

Charge your portable device on the move without the need for mains power. Small and light enough to carry around in your bag, or clip on your rucksack, the Ayrton Senna Signature Collection Pebble™ Smartstick+ portable emergency charger will provide your mobile device with over one additional charge, charging most popular devices including; Apple 30 pin, Blackberry and devices that use mini or micro USB.

The USB port on the Pebble™ Smartstick also allows you to charge your mobile device with the supplied manufacturer's cable

The stylish new design in a polished titanium grey incorporates a screw on cap to protect the Smartstick+ ports and also allow the Pebble™ karabiner to connect so you can hook onto anything

For every unit sold Veho make a contribution to the Ayrton Senna Institute. Proceeds obtained from the licensing of the Ayrton Senna Institute brand is 100% invested in the Ayrton Senna Institute.

Order Code	Mod: 1016313	Price each exc. VAT 1+	inc. VAT each
N51DT	Pebble Smrtstk AS	£24.99	£29.99

Mili Power Visa Portable Power Bank

- Lithium ion battery 1200 mAh charges most smartphones
- Credit card sized that easily fits into wallets
- Only 4.8 mm thick, almost half the thickness of an iPhone
- Supports charging of iPhone 4/4s, 30pin iPod series, Smartphone
- Same port for input and output, with one cable and one port, for self charging as well as charging mobile phones



The thinnest mobile power bank in the world! The Mili Power Visa is a must-have piece of technology for your iPhone or USB powered device that easily allows you to charge your devices on the go, without having access to the mains or USB. Its diminutive size means it fits easily in your car, handbag or even your pocket.

Order Code	Mod: 1016314	Price each exc. VAT 1+	inc. VAT each
N110T	Power Visa-s	£29.15	£34.99

Brunton Torpedo 2800 Portable Power Bank - Silver

- Lithium Ion battery -2800mAh
- Fully charges most smartphones
- Charge from your the 12V input in your car
- Output - USB 2.0
- 1 Amp, dual standard USB output
- Compact and lightweight design



Designed for fast paced commuters and drivers who want to stay connected but never tied down. Brunton's Torpedo 2800 charges from the 12V socket in your car. Features on board lithium battery, so you can take the charger with you when you go.

The silver Torpedo 2800 rechargeable power bank from Brunton is a compact, 2800mAh rechargeable power station. It features two standard USB output ports to connect most small electronic devices using their USB charging cables. The permanent internal battery is charged using a Micro USB cable that can be connected to any USB port, USB/AC plug or DC 12V car/vehicle accessory socket. This power station is ideal for charging smart phones, MP3 players, cameras, radios or most other small electronic devices. Compact and lightweight. LEDs show if it is activated or charging and the available power.

Also available in black

Order Code	Mod: 1016315	Price each exc. VAT 1+	inc. VAT each
N280T	Torpedo 2800 Silver	£29.15	£34.99

Veho Pebble Aria Portable Power Bank and Speaker



- Powerful 3,500mAh charger can charge your smartphone 2.5 times over
- 2 Watt speaker so you can listen to your music whilst charging your phone
- Comes with 3.5mm jack cable and USB cable

The Pebble™ Aria from Veho combines two of the most popular Veho products in one, portable power and portable audio for your mobile device.

With 3500mAh to charge most smartphones at least twice and a built in 2W speaker to blast out your tunes the Pebble Aria is the perfect travel companion.

The handy 3.5mm interconnecting jack for the speaker acts as the perfect stand for your smartphone so that when it is connected your smartphone is supported with the screen easily accessible.

The Pebble™ Aria with integrated portable power and speaker function is the ideal gadget for travellers, business users, camping, festivals or students.

Order Code	Mod: 1016316	Price each exc. VAT 1+	inc. VAT each
N500T	Pebble Aria	£24.99	£29.99

iWALK Chameleon Battery Pack for iPhone 5 and 5s- Steel Grey



- 1900mAh capacity Lithium-ion rechargeable battery
- Apple Certified - "Made for iPhone"
- One-piece protective case, shockproof, sleek and slim design
- Simultaneously charge your iPhone and Chameleon Charger
- Compatible with iPhone 5 and 5s

The iPhone 5 / 5S Power Case is equipped with a 1900mAh lithium polymer battery to fully charge your iPhone 5 / 5S and provide up to 9 hours of additional talk time. The LED battery indicator shows charge and discharge status, and the sleek design and easy-grip exterior give it a great feel. Its ON / OFF switch preserves power and allows you to keep the case on your phone when not in use. You'll also have full access to all controls and ports. The earphone jack port provides complete access even for L-shaped plugs. Pass-through technology allows you to charge your power case and iPhone 5 / 5S at the same time. You can even sync to iTunes through this power case, using the supplied Micro USB cable.

Order Code	Mod: 1016309	Price each exc. VAT 1+	inc. VAT each
N040T	iPhone5 Case Charger	£37.49	£44.99

iWALK Chameleon Battery Pack for iPhone 5 and 5s - White



- 1900mAh capacity Lithium-ion rechargeable battery

- One-piece protective case, shockproof, sleek and slim design
- Compatible with iPhone 5 and 5s

The iPhone 5 / 5S Power Case is equipped with a 1900mAh lithium polymer battery to fully charge your iPhone 5 / 5S and provide up to 9 hours of additional talk time. The LED battery indicator shows charge and discharge status, and the sleek design and easy-grip exterior give it a great feel. Its ON / OFF switch preserves power and allows you to keep the case on your phone when not in use. You'll also have full access to all controls and ports. The earphone jack port provides complete access even for L-shaped plugs. Pass-through technology allows you to charge your power case and iPhone 5 / 5S at the same time. You can even sync to iTunes through this power case, using the supplied Micro USB cable.

Order Code	Mod: 1016310	Price each exc. VAT 1+	inc. VAT each
N050T	iPhone5 Case Charger	£37.49	£44.99

YE!! Energy BLOCK - Portable Power Bank



- Compact multifunction power bank which can charge portable devices, some laptops and can even jump start up to 6 litre petrol vehicles
- 12,000mAh can charge your smartphone up to 7 times
- 2.1A USB Mobile Phone/Tablet Port and 19V/3.5A Laptop/Notebook charger
- Super Bright LED Emergency Flashlight
- Additional 12V/2.0A output for powering small devices such as camping refrigerators
- 15 LED Power Indicators
- ON/OFF SWITCH
- Fused Car Jump Starter Leads

This YE!! Energy BLOCK has been specifically developed to be the ultimate All-in-one Power Bank. It can do everything from charging your small devices such as Mobile Phones/Tablets and Laptops right up to Jump Starting a 6L Petrol Vehicle. It has a powerful in-built LED Flashlight for those emergency situations as well as 15 LED power level indicators for checking the power level at the touch of a button. This compact device is very portable to carry around with you in your bag wherever you go or to store in your glove compartment or car boot for that emergency situation. Never be concerned about your mobile phone/tablet or Laptop running low on power ever again. If your car won't start you don't have to panic or call a tow truck service for assistance. This truly is the SWISS Army knife of the portable power bank world. It's so easy and convenient to use that every driver should keep one in the car at all times. It's a great travel companion that you can take with you on the GO to charge all of your portable electronic devices such as smart phones, tablet, MP3 Players, camcorders, cameras, Portable gaming units, GPS Units, Travel Fridges and many many more devices. The Ultra bright LED Flashlight has a constant on light so whether your outdoors camping or just working in the dark or low light conditions this is the perfect companion without having to take an additional flashlight out with you. If you're outdoors camping and find yourself in an emergency situation you can use the SOS signal light flash to attract attention. Once activated the SOS signal flash will stay on continuously until switched off.

Order Code	Mod: 1016302	Price each exc. VAT 1+	inc. VAT each
N100T	YE!! Energy Block	£120.82	£144.99

Free Delivery
on all UK orders over **£10**

T&Cs Apply

Brunton Hydrogen Reactor Portable Power Bank - Black



- **Robust, state of the art mobile USB power source for smartphones and tablets, UV water purifiers, rechargeable lights, portable game consoles, GPS transceivers and more.**
- **Runs from refillable Hydrocores – (canisters that contain hydrogen) – each core develops 4500mAh of power, equivalent to 3 full iPhone charges.**
- **Weighing in at 146g Reactor, 242g with Hydrogen Core; it is ideal as emergency power source for expedition communications and is aeroplane approved technology.**
- **Combines hydrogen from the rechargeable fuel cell and oxygen from the atmosphere to produce electricity**
- **Lock the hydrocore fuel cell into the Reactor to create power**
- **No external charging required**
- **Self-contained power production**
- **No chemicals to pollute the environment**
- **Solid-state with no natural discharge**
- **Includes 2 hydrogen core cells**

Combines hydrogen and oxygen to produce electricity. Power on the move and under any condition. Simply lock the Hydrocore fuel into the Reactor to power USB devices.

The Hydrogen Reactor Portable Power Bank from Brunton is a 2 Amp portable power system that never needs charging. The self-contained unit combines hydrogen from rechargeable cells with oxygen from the atmosphere to generate power. When a cell is discharged, replace it with a full cell and keep charging.

This high-science device combines hydrogen and oxygen to produce electricity on-the-move and under any condition. Simply lock the Hydrogen Core fuel into the Hydrogen Reactor™ to power USB devices like smartphones, tablet computers, UV water purifiers, rechargeable lights, portable game consoles, GPS transceivers and more.

The solid-state design means there is no natural discharge over time, so it is perfect for emergency preparedness. Since it generates power through a chemical process with naturally occurring elements, there are no harmful chemicals or by products. The Hydrogen Reactor is an environmentally-friendly way to power tablets, cell phones, GPS units or most small electronics. The compact and lightweight design provides power without taking up a lot of space.

Available in yellow and orange

Order Code	Mod: 1016404	Price each exc. VAT	inc. VAT each
N39DT	Hydrogen Reactor Blk	£83.32	£99.99

Brunton Hydrolyser Recharge Station



- **Recharge unit for Hydrocores –fills the Hydrocores with the captured, compressed, hydrogen (electrically separates hydrogen from water)**
- **Environmentally safe power, no harmful or toxic chemicals involved**
- **Fill the Hydrolyzer with distilled or de-ionised water,**

plug the Hydrolyzer into the mains and it will refill your Hydrocores – turn water into electricity!

Personal hydrogen refill station. Clean, safe hydrogen power made from de-ionized or distilled water for charging Brunton Hydrocores

Solid-State hydrogen storage is stable, safe and airplane approved and recharged from water.

The Hydrolyser Recharge Station from Brunton is used to recharge the Hydrocore cartridges for the Hydrogen Reactor portable power system. This energy solution separates the hydrogen and oxygen molecules from distilled or de-ionized water. The hydrogen gets stored in the safe and stable solid-state Hydrocore cartridges. When the hydrolysed cartridges are loaded into the Reactor, it gets converted into clean energy without chemicals or pollutants. Green and Red LED indicators clearly show the status of the Hydrolyser and Hydrocore cartridge throughout the charging process.

This high-science device combines hydrogen and oxygen to produce electricity on-the-move and under any condition. Simply lock the Hydrogen Core fuel into the Hydrogen Reactor™ to power USB devices like smartphones, tablet computers, UV water purifiers, rechargeable lights, portable game consoles, GPS transceivers and more.

Live Swappable Energy – Just exchange empty for full and keep charging without waiting, ideal for disaster readiness; solid state with no natural discharge.

Environmentally Safe – No toxic chemicals. Recharged from water.

Hydrogen Power – Lock rechargeable Hydrogen Core to Hydrogen Reactor for hours of power off-the-grid and on-the-go

Specification

Product Width:	7.62 x 1.9 cm
Product Depth:	
Product Height:	
Product Weight:	105g

Order Code	Mod: 1019577	Price each exc. VAT	inc. VAT each
N68DS	Hydralizer	£274.99	£329.99

**Buy it on the web at
maplin.co.uk**

Shop for all Maplin products online at our website and check out our latest products and special offers!



Brunton Hydrocore Power Pack

- **Hydrocores are refillable hydrogen cartridges that power the Brunton Hydrogen Reactor, made from lightweight but durable metal**
- **Each full core delivers 4500mAh of power, equivalent to 3 full iPhone charges (when plugged into the reactor)**
- **Cores must be refilled once used. They are refilled with the Hydrolyzer recharger, or exchanged for full cores at selected Maplin stores *see online for list of Maplin stores**

The Brunton HydroCore Refillable Hydrogen Cartridge is intended for use with the Brunton Hydrogen Reactor Battery Charger, designed for powering smart phones, UV water purifiers, and many on-the-go devices.



Solid state power storage will not lose power over time like traditional batteries. Ideal for off-the-grid safety and disaster preparedness, the Hydrocore develops 4500mAh of power.

Specification

Product Width:	14.5 x 15.3 x 20.8 cm
Product Depth:	145mm
Product Height:	153mm
Product Weight:	208mm
	1.9 Kg

Order Code	Mod: 1019578	Price each exc. VAT	inc. VAT each
N69DS	Brunton Hydrocore	£10.82	£12.99

Freelander Isis hybrid HD Portable Solar Power Bank



- **4000mAh battery**
- **Charge your smartphone up to 3 times**
- **Integrated micro USB and lighting charging cables.**
- **Integrated USB output**
- **Power / charge two devices at once.**
- **New HD solar panel technology.**
- **Charge from USB or solar and take the power with you.**
- **Rugged water and drop resistant design**
- **Built in stand and LCD screen**

Simply the best battery pack and solar charger in the market, the new Freelander Isis gives you all the power you need for today's power hungry portable devices. Never be without power again!

Super compact and lightweight, the ISIS solar powered battery bank delivers class leading charging performance – providing a full day's charge for all your electronic gadgets.

With an all-weather solar cell that's upto 50% more efficient than the competition, ISIS is the perfect companion for smartphone, tablet, MP3 player, camera and console, thanks to its integrated charging arms (Lightning & micro USB) and an USB socket.

Quality materials, rugged construction and a tough case ensures that ISIS is built for real world use, and an attachment strap means it can be securely fixed to any bag.

4000mAh battery
Charge via solar or USB
220mA HD solar Panels

Order Code	Mod: 1019040	Price each exc. VAT	inc. VAT each
A74ZZ	Freelander Isis	£54.15	£64.99

**Technical
Helpline**

0333 400 9500

For technical information and assistance relating to any Maplin purchase, contact our team of experts

Freeloader Supercharger 5W portable solar panel

- 5W HD solar panel
- Integrated USB output
- Power / Charge your device
- Rugged water and drop resistant design
- Complete with 2 Velcro straps to attached to your bag, backpack, pannier etc



The New Supercharger now gives you the "extra" you were asking for. Not only can you boost the charging time on the new freeloader but it will now directly charge the portable devices without the need to have a freeloader

Introducing the Supercharger, the adaptable, portable solar charger that directly charges a full range of electronic gadgets, including smartphones, MP3s, GPS, E-readers and tablets - just add daylight!

With advanced, high-density solar cells, the 5W Supercharger works in all daylight conditions, and at temperatures from -20°C to +60°C, so you can have power wherever your adventures take you

Dependable and built to last, it features a tough, rubberised and waterproof body, and comes supplied with two sturdy Velcro straps, so that it can be easily secured to your bag, bike, kayak or sled

Weighing in at a featherweight 340g, the adaptable Supercharger can also be used as a booster panel for the Freeloader ISIS and Pico 2 solar chargers, significantly reducing their charging time and providing extra power for your adventures.

5W HD solar panel
USB output

Order Code	Mod: 1019041	Price each exc. VAT 1+	inc. VAT each
A75ZZ	Supercharger 5w	£41.65	£49.99

Brunton Ember Hybrid Solar Power Bank



- 2800 mAh capacity, can fully charge an average smartphone
- Can be charged by USB, mains AC or from the sun
- Includes 3 in 1 USB cable to connect to your device
- Output current of 1 Amp at 5V
- Water resistant housing
- 3 in 1 USB cable houses mini, micro and Apple connectors
- Internal rechargeable lithium polymer battery
- Power gauge and auto shut off
- 100 mA solar panel

Compact hybrid portable power charger with integrated solar panel. The Ember is optimised for hand held devices like smart phones and MP3 players.

Designed with the every-day user in mind, the Ember power pack is recharged from your home computer, from the wall socket or from the integrated solar panel, but tucks easily away in a pack or pocket. You won't notice it until you need it.

Includes 3 in 1 USB cable.

Order Code	Mod: 1016403	Price each exc. VAT 1+	inc. VAT each
N91DS	Brunton Ember	£33.32	£39.99

Powertraveller Powermonkey eXplorer®

- Tough and water-resistant
- Includes the solar-slave
- Instant power, wherever you are
- The lightest, most versatile charger
- Includes mains travel charger for use in 150 countries - 110V to 240V
- LCD screen displays battery capacity and level of charge in the powermonkey
- Short-circuit protection
- Over-charging and over-discharging protection
- USB connectors power up iPods and accessories, MP3 players, PDAs, smart mobile phones, digital cameras, games consoles, BlackBerrys, Bluetooth® headsets and many more digital devices
- powermonkey-eXplorer® provides power to digital cameras but does not charge them



Ever been unable to make that one call because your mobile phone has just run out of battery power, have been relaxing on a beach and your phone runs flat or in the beautiful countryside and your camera battery's dead? With the new solar-slave, the powermonkey-eXplorer® kit lets you charge wherever, whenever. Make sure your powermonkey's got full power at all times by charging it with the handy solar-slave, which can be attached to a rucksack, hung from a window, left in a car or taken anywhere the sun shines! The solar-slave can also be used to charge many of your digital devices, so you have back-up power at all times.

Maximum reserve power available:

- All iPods - 40 hours
- Mobile phones - 96 hours
- Digital cameras - 1600 pictures
- PSPs - 5 hours
- MP3s/MP4s - 6 hours
- PDAs - 48 hours

Specifications powermonkey eXplorer

- Battery Capacity: 2000mAh
- Input interface: DC 3.5 x 1.1mm
- Input Voltage: 5V 600mA
- Output Interface: DC 3.5 x 1.1mm
- Output Voltage: 4.5 - 5.5V
- Output Current: 700mA max
- Weight: 83g
- Dimensions: 90 x 45 x 38 mm
- Water Resistant
- solar-slave
- Output Interface: 3.5 x 1.1mm
- Output Voltage: 5V
- Output Current: 200mA - can vary depending on solar strength

- Weight: 82g
- Dimensions: 110 x 70 x 10mm when folded.
- Complete kit weight: 553g

Each kit contains:

- 1 x powermonkey-eXplorer unit
- 1 x solar-slave
- 1 x universal mains charger which will work in over 150 countries and has interchangeable heads for UK, AU, Australia and Europe
- Nokia & Mini Nokia, Motorola V66, Samsung E900, Siemens C25 and Sony Ericsson wide connectors
- 1 x mini USB for Motorola Razr V series, Blackberrys and Bluetooth headsets
- 1 x USB for smart phones, PDAs and other devices
- 1 x iPod connector
- 1 x connector for Sony PSP and most digital cameras
- Black travel pouch
- Storage case

Order Code	Mod: 220936	Price each exc. VAT 1+	inc. VAT each
N46FR	PowerMonk Xplorer Gry	£58.32	£69.99

Powertraveller Minigorilla™



- Powers your tablet, mobile phone and other digital devices
- Comes pre-charged and ready to use
- High density lithium polymer battery technology
- Can be used internationally
- Extremely robust, compact and portable - weighs only 265g
- Easy to use one button technology
- Auto shut-down after 2 minutes when not in use or when device is fully charged
- Auto turn off to save power
- Variable voltages: 8.4 / 9.5 / 10.5 / 12 / 19V or 5V from USB port
- LCD backlit screen
- Voltage indicated on LCD screen
- Voltage and current limitation protection
- Short circuit, overcharge and anti-discharge protection
- Low battery warning
- Long battery storage life

Roam wild with pocket power for your tablet - Minigorilla is the portable charger to keep your tablet going for hours and hours. This rechargeable mini charger also provides instant power to devices via the USB port (5.5V) and a number of other digital products including e-readers via the DC out socket

Compatible with most netbooks, mobile phones, digital cameras, camcorders, game consoles, GPS Navigators, iPods, MP3/MP4 players and many more

Specifications: Output capacity:

- 5V 6000mAh
- 8.4V 4000mAh
- 9.5V 3500mAh
- 10.5V 3200mAh
- 12V 2800mAh
- 19V 2000mAh

Output current:

- 5.5V 700mA maximum
- 8.4V, 9.5V, 10.5V and 12V 3A maximum
- 19V 1.5A maximum

Contents
Minigorilla

Neoprene zip case
Additional compartment for connectors
11-piece netbook connector pack 1:
Fits Sony, Toshiba, ACER, IBM, ASUS, EeePC, Samsung, HP, Compaq, Lenovo and many
Mobile phone and gaming connector pack 2:
Tips for Nokia, Motorola, LG, Samsung, Sony Ericsson (wide connector); mini USB, Motorola RAZR, BlackBerry, Sat Navs, PSP & Nintendo DS Lite
Worldwide mains A/C adaptor which works in over 150
Interchangeable heads for UK, US/Japan/China, Australia and Europe
User guide

Order Code	Mod: 346013	Price each exc. VAT 1+	inc. VAT each
N58HL	Mini Gorilla	£83.32	£99.99

We can deliver to your home or office

(UK only)

Powertraveller Powermonkey Extreme Solar Portable Power Bank Black



- The Powermonkey extreme houses a massive 9000 mAh capacity Lithium Polymer battery and offers users real power in a compact, durable shell.
- Charge your smartphone up to 6 times
- The unit is capable of recharging most 5 V devices,
- The Powermonkey extreme is waterproof for 30 minutes up to 1 metre and shock resistant - perfect for the outdoor, marine & adventure enthusiast, as well as military & aid agencies.
- Available in black, blue, green, red, yellow

The award-winning Powermonkey extreme just got even better.

Originally launched in 2011 after five years in development, the Powermonkey extreme is the culmination of feedback from real power users in some of the most remote locations on the planet and completely embodies Powertraveller's understanding of customer's power requirements when they are "off-grid".

As of March 2013, the Powermonkey extreme has undergone some serious upgrades to further cement the product's reputation as "charger of choice" in the outdoor and adventure travel market.

The Powermonkey extreme houses a massive 9000mAh capacity Lithium Polymer battery and offers users real power in a compact, durable shell. The unit is capable of recharging most 5V devices, (including an iPhone/smart phones up to 4 times, a Garmin Edge 800 up to 6 times, standard mobiles up to 8 times and iPad up to 2 times depending on the model), but it is the 2013 model that really pushes the boundaries.

The most important improvement for 2013 is the change to the Powermonkey extreme's DC output option. The standard 5V USB socket remains but the DC port has been upgraded to output 12V (previously 5V), meaning that the Powermonkey extreme is now capable of charging SLR camera batteries, portable DVD players and much more directly from the unit. This upgrade alone pushes the Powermonkey extreme out ahead of its nearest competitors in terms of charging capabilities, whilst the kit remains lightweight and compact enough for even the most space-conscious traveller.

The updated model also includes a female in-car socket so if users only have an in-car charger for their device, they can now recharge it directly from the Powermonkey extreme.

The Powermonkey extreme is capable of charging iPads and tablets too. iPad 1, iPad 2, iPad 3 and iPad mini can be plugged directly into the extreme's USB socket via customer's Apple-supplied white sync / charge cable and will recharge up to 2 times depending on the model of your iPad. The iPad 4 has slightly different charging requirements and so the 2013 Powermonkey extreme includes a gorilla-pad adapter specifically for this model. The gorilla-pad plugs into the 12V DC socket and is used together with customer's Apple sync / charge cable to charge iPad 4. You can also use the gorilla-pad for the other iPads/tablets or to give yourself another 5V USB socket if required.

The Powermonkey extreme is waterproof for 30 minutes up to 1 metre and shock resistant - perfect for the outdoor, marine & adventure enthusiast, as well as military & aid agencies. When used in conjunction with

the aquastrap, the Powermonkey extreme will be kept watertight whilst it charges your devices

For 2013, changes to the LCD screen which displays battery capacity level and working status complete the upgrades to the Powermonkey extreme. Rather than bars indicating how much power is in the unit, the new Powermonkey extreme has a digital read out numbered from 01 (requires charging) to 99 (fully charged). When the unit requires charging, the battery icon in the bottom corner will flash. Whilst the unit is charging, the LCD screen will turn red and then green once charging is complete. During normal operation, the LCD screen will be blue.

Its unique one touch friction swipe ON/OFF control is designed so the friction switch can only be turned on if swiped from left to right, which helps to reduce the risk of it being accidentally turning on when not in use. To turn the Powermonkey extreme on, swipe the panel from left to right with your thumb. To turn off, swipe with your thumb from right to left. When the 5V device or tablet computer is fully charged, the auto shut-off function means the Powermonkey extreme will turn itself off after 2 minutes, so the user does not have to monitor the charge state of the device being charged - thus saving power.

The Powermonkey extreme can be recharged in three ways; via the universal mains charger, via the solar panel or via USB. Whilst the unit is recharging, the LCD screen will be red, once fully charged, the screen will turn green. When the unit is in use, the screen will be blue!

The rugged, clam-shell design solar panel offers 3 Watt max output, allowing full recharge of the Powermonkey extreme within 18-22 hours in optimum light conditions. The Powermonkey extreme also has a solar energy detection feature which activates the incorporated state-of-the-art MPPT (maximum power point tracker) technology, allowing the solar panel to charge the Powermonkey unit more efficiently in low light conditions. Users can also simultaneously use the solar panel to charge the Powermonkey extreme whilst it is charging their device.

The solar panel can be attached to tents or rucksacks via the included Velcro strap, so is perfect for hiking and is designed to take the knocks and spills of both the power hungry adventurer and the busy traveller.

The Polysilicon solar panel offers photovoltaic efficiency up to 17% and features a USB output, fully supporting Apple iPhone/iPod, mobile phones and other 5V gadgets such as portable games consoles, handheld GPS systems, etc. The solar panel can fully charge the Powermonkey extreme in approx 18-22 hours.

The Powermonkey extreme unit weighs 242g and measures 152 x 59.5 x 28mm, whilst the solar panel weighs 214g, measures 171 x 90 mm and is 18mm deep when folded. The unit has a very low static wastage (meaning you can leave it for up to 1 year and it will still hold 75% of its charge) and includes a whole host of safety features to give you total peace of mind. The Powermonkey extreme comes complete with a useful, durable zipped travel case and is available in four striking colours: Sleek Black, Electric Blue, Graphite Grey, Safety Yellow and Vibrant Red.

You may also want to consider the aquastrap - a clever accessory designed specifically for the Powermonkey extreme to keep it watertight whilst it charges your devices!

Order Code	Mod.	Price each exc. VAT	inc. VAT each
N07DC	Powermonkey Ext Chr	£99.99	£119.99

Powertraveller Solargorilla Rugged Water Resistant Solar Panel Charger



- Solar panel charger - 5v to 20v power direct from the sun
- Adapters supplied for all major laptop and mobile brands (You need to use your own Apple sync cable)
- Multi-voltage functionality and simultaneous charging via 5V USB
- USB supports iPhone, Ipad & 5v tablets

Solargorilla rugged water resistant solar panel, designed by Powertraveller's understanding of customer's power requirements when they are "off-grid". Designed as a charging solution for the powergorilla - solargorilla is also a viable charging option for laptops under 40 watts and it can even charge your mobile phone, iPod, handheld games consoles and many more devices from the 5V USB output.

A rugged foldable design easy to carry in your rucksack with a supply of different power adapters/tips to charge a vast range of products - SLR Cameras, Hand-held Cameras/Action Cameras, iPads/Tablets, PDAs, iPhones/Smart Phones, Mobile Phone, iPods/MP3/MP4, PSP/Hand-held/Games Consoles, Sat-Navs/GPS, Head Torches. <p>Solargorilla works via two PV (photovoltaic) solar panels, which generate electric current when they are exposed to sunlight.

The solar panels are made of glass which greatly improves the performance of the solargorilla as well as making the aesthetics of the unit better. The green LED on the solargorilla indicates the strength of charge - the more UV intensity - the better it will work! The technically advanced solar panels ensure superb power and reliable performance, all housed in a tough outer casing.

Solargorilla is a charging option. It is primarily designed to be used in conjunction with the powergorilla and may not work with some laptops over 40 watts directly. It relies on the UV intensity of the sun. Therefore, at certain times of the year it may not be suitable for use in the Northern Hemisphere unless combined with the powergorilla. The solargorilla solar charger has been trialled successfully in the Southern Hemisphere by aid agencies, emergency services, the military and adventure travellers, where power is a crucial element of their communications strategy.

Order Code	Mod.	Price each exc. VAT	inc. VAT each
N27DT	Solargorilla Charger	£120.82	£144.99

Technical Helpline

0333 400 9500

For technical information and assistance relating to any Maplin purchase, contact our team of experts

Reserve online, collect in-store in 30 minutes



Powertraveller PowerGorilla Charger



- Provides 2-6 hours of laptop/notebook power
 - Can also charge iPads/tablets (3/4 times), iPhones/smartphones (6/10 times), GPS and Mobile Phones (8 - 10 times)
 - Can be used to charge Powergorilla (not supplied)
- Roam wild with the ultimate portable charger...

It came from an unknown land far, far away. The Powergorilla traversed stormy seas and scaled impossible summits to reach us here at Powertraveller. Ever wanted a portable charger for your laptop? Well fear not - we've answered your prayers.

The powergorilla laptop charger will give you an extra 2-5 hours of power, depending on your laptop's specification, and over 20 hours on various other electronic devices.

Powergorilla will work with devices up to 24volts - so from your laptop, right the way down to your mobile phone or iPod! Just select which voltage you require: 5v, 8.4v, 9.5, 12v, 16v, 19v or 24v and the LCD screen will indicate which setting has been chosen. Then simply hook up your gadget and away you go! You can even daisy-chain, so whilst the powergorilla is charging your laptop, you can charge the powergorilla from the mains power supply. Or you can charge your laptop and your mobile phone simultaneously!

One-touch button technology means the powergorilla charger for laptops is easy to use and its sleek, aluminium casing with shock resistant rubber protection strips makes it a stylish accessory for your laptop.

The powergorilla has input voltage auto recognition which means that if you use your own AC laptop charger (between 16 - 24V only), the powergorilla will automatically detect the voltage level and set the LCD display accordingly! It also has a permanent on feature so that when the powergorilla detects it has been connected to a device, the LCD screen will flash and the user can double-click the on/off button to permanently lock the powergorilla on.

By selecting the 8.8 option on the LCD screen, the USB will be locked permanently on - this is beneficial if charging a low power consumption device from USB.

Powergorilla also has many safety features including output auto-lock, voltage limitation protection, short circuit protection, over charging protection and over heat protection.

When used in conjunction with the solargorilla, you'll have a totally portable power station! Plus, the powergorilla features solargorilla auto recognition, which means when you connect the solargorilla, the powergorilla will shut off unnecessary internal circuits to improve charging time by up to 2 hours and the little solar logo in the LCD screen will confirm this!

The powergorilla has also been on field tests out in Afghanistan, Madagascar, Zambia, Antarctica and Norway. Being subjected to extremely hot and very cold temperatures, the powergorilla has successfully charged numerous laptops without fault!

All current stock of Powertraveller minigorilla and

powergorilla is compatible with the Apple iPad via the gorilla-pad connector.

Powergorilla cannot be charged with any mains charger which is less than 16V. Charging with a mains charger that is less than 16V may cause damage to your powergorilla battery.

Order Code	Mod: 1016406	Price each exc. VAT 1+	inc. VAT each
N26DT	PowerGorilla Charger	£133.32	£159.99

Camera & Camcorder Batteries

Extra Long Life Lithium Batteries



- Specially designed for use in high drain and digital devices
 - Lasts up to 7x longer than standard alkaline batteries
 - Ideal for digital cameras, MP3 players and GPS etc
 - Performs in temperatures of -20°C to +60°C
 - Hold their charge - these batteries have a 10 year shelf life!
 - Takes over 100 pictures on your digital camera*
- *Number of images may vary depending on the type of camera used

Order Code	Size:	Pack Size:	Price each exc. VAT 1+	5+	inc. VAT each
N28GG	AA	4	£4.99	£4.79	£5.99
N29GG	AAA	4	£4.99	£4.79	£5.99

Lithium 9V Battery 1 Pack

- Ideal for smoke detectors and PIRs
- Up to 10 year life in smoke detectors
- 1.2Ah capacity
- Can also be used in controllers for radio controlled cars



Now there's no need to change batteries every year to keep your home and family protected by working smoke detectors. This battery uses the latest lithium technology and has been designed especially for low-energy equipment like smoke detectors and wireless alarm PIRs. Enjoy years of peace of mind!

Order Code	Mod: 010449	Price each exc. VAT 1+	inc. VAT each
FC35Q	Lithium PP3	£8.32	£9.99

CRP2 Lithium Camera 6V Battery 1 Pack

- Long-life lithium battery specifically designed for use in cameras
- Also known as EL223AP



Specifications:

Voltage 6V
Capacity 1400mAh
Dimensions 36 x 34 x 19.5mm

Order Code	Mod: 046312	Price each exc. VAT 1+	inc. VAT each
N02BX	Li Photo EL223AP/CRP2	£7.07	£8.49

2CR5 Lithium Camera 6V Battery 1 Pack

- Long-life lithium battery
- Specifically designed for use in cameras



Specifications:

Voltage 6V
Capacity 1500mAh
Dimensions 45 x 34 x 17mm

Order Code	Mod: 046313	Price each exc. VAT 1+	inc. VAT each
N05BX	Li Photo 2CR5	£7.32	£8.79

CR123 Lithium Camera 3V Battery 1 Pack

- Long-life lithium battery
- Specifically designed for use in cameras
- Also increasingly used in LED torches



Specifications:

Voltage 3V
Capacity 1500mAh
Dimensions 34.5 x 17 (dia) mm

Order Code	Mod: 046314	Price each exc. VAT 1+	inc. VAT each
N07BX	Li Photo CR123A	£7.32	£8.79

CR2 Lithium Camera 3V Battery 1 Pack

- Long-life lithium battery
- Specifically designed for use in cameras



Specifications:

Voltage 3V
Capacity 800mAh
Dimensions 27 x 15.6 (dia) mm

Order Code	Mod: 046315	Price each exc. VAT 1+	inc. VAT each
N06BX	Li Photo CR2	£7.32	£8.79

CR1/3N Lithium Camera 3V Battery 1 Pack

- Long-life lithium battery
- Specifically designed for use in cameras
- Also known as K58, 2L76, CR11108 and DL1/3N



Specifications:

Voltage: 3V
Capacity: 160mAh
Dimensions: 10.8 x 11.6 [dia.]mm

Order Code	Mod:	Price each exc. VAT	inc. VAT each
VP26D	Li Photo CR1/3N	£7.49	£8.99

18650 Lithium Ion Rechargeable Battery 1 Pack

- High quality Li-Ion battery
- 2600mah high capacity
- No memory effect
- Precise digital protection circuit built-in
- Ideal for use in high power torches



Order Code	Mod:	Price each exc. VAT	inc. VAT each
A09LC	3.7V 18650 2600mAh	£13.32	£15.99

Compatible Canon Camera Battery NB4L 3.7V

- 3.7V and 720mAh
- Lithium Ion
- Covered by 3 year warranty



Order Code	Mod:	Price each exc. VAT	inc. VAT each
N17CD	DUR Canon NB4L	£12.49	£14.99

Compatible Nikon Camera Battery ENEL5 3.7V

- 3.7V and 1150mAh
- Lithium Ion
- Covered by 3 year warranty



Order Code	Mod:	Price each exc. VAT	inc. VAT each
N16CD	DUR Nikon ENEL5	£12.49	£14.99

Compatible Panasonic Camera Battery CGAS006 3.7V

- 3.7V and 630mAh
- Lithium Ion
- Covered by year warranty



Order Code	Mod:	Price each exc. VAT	inc. VAT each
N15CD	DUR Pan CGAS006	£12.49	£14.99

Find out more in-store

Our staff can offer friendly and expert advice; we're here to help



Lithium Ion NiMH and NiCd AAA/AA and 9V Universal Battery Charger with USB



- Charges most battery types
- Automatically detects battery voltage and polarity
- Will charge 2 x AA or AAA or 1 x 9V NiMH/NiCd rechargeable batteries
- Will also charge 3.6V and 7.2V-7.4V digital camera, camcorder and mobile phone lithium-ion batteries (auto detection function)
- Built-in USB output port for directly charging mobile phones and MP3s (USB cable not included)
- Charges from any mains voltage around the world (additional travel adapter may be required)
- 12V cigarette lighter adapter for charging from car/boat/caravan without loss of charge performance
- Intelligent charging detects when batteries are fully charged and switches to a top-up trickle charge
- Auto cut-off and built-in timer protection
- LED charging indicator
- Safety features: bad cell detection, short circuit protection, reverse polarity protection
- Charges AA and AAA batteries in 1-4 hours and lithium-ion batteries in 2-3 hours
- Will simultaneously charge one battery while the USB port is being used

Contents:

Charger
12V cigarette lighter plug
UK mains plug for 230V mains supply
Instruction manual

Specifications:

Input voltage: DC 12V 1000mA maximum
AC100 - 240V / 50-60Hz
Input voltage: 3.6V - 3.7V: DC4 2V / 700mA
7.2V - 7.4V: DC8 4V / 700mA
Lithium ion charging: 2 x AA or 2 x AAA: 2.8V / DC3 8V / 700mA
NiMH charging: 9V: 80mA
USB port output: 5V 500mA
Weight charger: 105g

Dimensions: 135 [l] x 61 [w] x 30mm [h]
Will accept a maximum battery depth of 50mm

Order Code	Mod:	Price each exc. VAT	inc. VAT each
N14KR	Li-ion+NiMH UniChrg	£19.15	£22.99

Find out more in-store

Our staff can offer friendly and expert advice; we're here to help



2-Power Lithium Ion and NiMH Universal Battery Charger



- Designed to charge Li-Ion battery packs for digital cameras, camcorders and smart phones
- Suitable for charging 3.6V, 3.7V, 7.2V and 7.4V Lithium Ion battery packs
- Can also charge NiMH AA & AAA rechargeable batteries
- Charges through mains power and in the car
- Also features a 1A USB charging port

Order Code	Mod:	Price each exc. VAT	inc. VAT each
N18CD	Universal BattChrg	£20.82	£24.99

Newsletter



Subscribe to our newsletter for information about the latest innovation and the best deals.

Universal Lithium Battery Charger



- Will charge AA & AAA NiMH/NiCd rechargeable batteries, digital camera, camcorder and mobile phone lithium-ion batteries
- Suitable for use with 3.6V, 3.7V and 7.2V digital camera batteries

- Charges from any mains voltage around the world (additional travel adapter may be required)

- 12V Cigar lighter adapter for charging from car/boat/caravan without loss of charge performance
- Intelligent charging detects when batteries are fully charged and switches to a top-up trickle charge
- USB socket included for charging USB devices
- LED charging indicator
- Safety features: bad cell detection, short circuit protection, reverse polarity protection, timed switch off (8.5 hours)
- Charges AA and AAA batteries in 1-4 hours and lithium-ion batteries in 2-3 hours
- 100-240V AC or 12V DC input
- Dimensions: 120 x 60 x 30mm
- Weight: 203g

This battery charger is fully compatible with not only the Inov8 range of batteries but also both other 3rd party brands and the original unit supplied with the camera. This gives it the versatility to be of use for years at home, in the car and on holiday. Please note that this charger will not charge 18650 lithium batteries

Order Code	Mod:	Price each exc. VAT	inc. VAT each
N46JT	INOV8 Uni Charger	£24.99	£29.99

Maplin TV

Home of innovation, handy tips and How To videos

Visit our channel...

youtube.com/maplintv



Camera and Camcorder Battery Charger/Discharger



- For use with 3.6V-12V NiCd, NiMH, Li-Ion and SLA batteries
- Interchangeable adapter plates fits most popular digital cameras and camcorders
- LED indicators for discharge, charge and fully charged functions
- Over charge, short circuit and back-up timer protection
- Charge batteries by mains (230V) or in-car (DC12V)

A versatile camcorder and digital camera battery charger that can be used both in the home and while on the move as this charger is powered by both mains and DC12V operation. It is supplied complete with 3 interchangeable adapter plates and is suitable for use with Li-Ion, NiMH, NiCd and SLA batteries, making it ideal for use with the most popular digital camera and camcorder batteries.

Specifications:

Battery Capacity	Approx. Charge Time
1200mAh	80 minutes
1350mAh	95 minutes
1500mAh	105 minutes
1800mAh	125 minutes
2400mAh	170 minutes
2700mAh	190 minutes
3000mAh	210 minutes
3600mAh	255 minutes

Order Code	Mod:	Price each exc. VAT 1+	inc. VAT each
L57AJ	Uni Cam/Dig Cam Chgr	£29.15	£34.99

Cordless Phone Batteries

2/3AAA Phone Batteries 2 Pack

- Ideal for use as a replacement phone battery
- 400mAh NiMH battery contains no harmful substances
- Sold in packs of 2



Order Code	Mod:	Price each exc. VAT 1+	inc. VAT each
N73KQ	2x2/3AAA PhoneBatts	£9.15	£10.99

2/3 AAA Rechargeable Phone Batteries 3 Pack



- Ideal for use as a replacement battery for cordless DECT phones
- 1.2V, 400mAh NiMH batteries contain no harmful substances
- Sold in packs of 3

Order Code	Mod:	Price each exc. VAT 1+	inc. VAT each
N39KA	3x2/3AAA 400mAhBatt	£9.57	£11.49

1/2 AA Cordless Telephone Batteries 3 Pack

A quality replacement rechargeable battery pack for use with the phones listed below. The pack is fitted with a universal fit plug and removable retaining collar to enable leads to be switched. Check + and - requirements of phone. Dimensions: 28 x 42mm PT100686 - 3 6V



Order Code	Mod:	Price each exc. VAT 1+	inc. VAT each
M854J	3x1/2AA PhonePak 04	£9.99	£11.99

AAA 3.6V 600mAh Cordless Telephone Batteries 3 Pack

A quality replacement rechargeable battery pack for use with the phones listed below.



Check + and - requirements of phone. JST-EHR2

Order Code	Mod:	Price each exc. VAT 1+	inc. VAT each
VW31J	3xAAA PhonePak 08	£9.99	£11.99

AA Cordless Phone Batteries Pack 2 Pack



Order Code	Mod:	Price each exc. VAT 1+	inc. VAT each
SC50E	2xAA Phone Bat 12H	£9.99	£11.99

3.6V Cordless Telephone Battery



A quality rechargeable cordless telephone battery pack. Dimensions - 41x30x15mm. Check + and - requirements of phone.

Order Code	Mod:	Price each exc. VAT 1+	inc. VAT each
F209K	Phone Battery 15C	£9.99	£11.99

AAA 2.4V Cordless Telephone Batteries 2 Pack



A quality rechargeable cordless telephone battery pack for use with the following telephones. Check + and - requirements of phone.

Order Code	Mod:	Price each exc. VAT 1+	inc. VAT each
W54J	2xAAA PhonePak 34	£9.99	£11.99

AAA 1.2V Cordless Telephone Batteries 3 Pack

- 4 x 1.2V AAA batteries
- For use with cordless telephones listed below



Order Code	Mod:	Price each exc. VAT 1+	inc. VAT each
W53H	4xAAA Phone Batts	£9.99	£11.99

Panasonic AAA DECT Phone Batteries 2 Pack

- 2 x 1.2V AAA batteries
- Rated at 750mAh
- Designed specifically as replacement batteries for use in DECT cordless telephones



Battery Type:	Pack Quantity:	Capacity:	Order Code:
AAA	2	750	N28NA

Order Code	Mod:	Price each exc. VAT 1+	inc. VAT each
N28NA	Dect AAA 750mAh 2Pk	£9.16	£10.99

AAA Cordless Telephone Batteries 2 Pack CP37NM

- Replacement rechargeable battery pack for cordless phones
- 2.4V with 600mAh capacity
- Energizer part: CP37NM
- Uniross part: BC101286 (59H)
- For use with the Alcatel, Binatone, BT, Panasonic, Philips, Samsung, Siemens and other phones



Order Code	Mod:	Price each exc. VAT 1+	inc. VAT each
N93HB	2xAAA Phone Batts	£9.15	£10.99

Panasonic AA DECT Phone Batteries 2 Pack

- 2 x 1.2V AA batteries
- Rated at 1000mAh
- Designed specifically as replacement batteries for use in DECT cordless telephones



Battery Type:	Pack Quantity:	Capacity:	Order Code:
AA	2	1100	N29NA

Order Code	Mod:	Price each exc. VAT 1+	inc. VAT each
N29NA	Dect AA 1000mAh 2Pk	£9.16	£10.99



Browse our entire range at maplin.co.uk

AA Cordless Telephone Batteries 2 Pack CP20NM

- Replacement rechargeable battery pack for cordless phones
- 2.4V with 1300mAh capacity
- Energizer part: CP20NM
- Uniross part: BC101624 (12H)
- For use with Binatone, BT, Panasonic, Philips, Siemens and Vtech phones

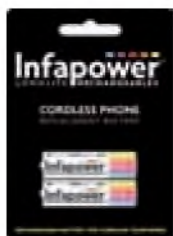

Order Code	Mod:	Price each exc. VAT 1+	inc. VAT each
N86GF	2xAA Phone Batts	£9.99	£11.99

Prismatic Cordless Telephone Battery Pack 2.4V

A quality rechargeable cordless telephone battery pack for use with the telephones listed below:
Samsung: SPR6100, 6150



Order Code	Mod:	Price each exc. VAT 1+	inc. VAT each
L78AG	2 x Phone Batts 82H	£9.99	£11.99

2/3 AAA Cordless Telephone Batteries 3 Pack CP34NM

- Replacement rechargeable battery pack for cordless phones
- 3.6V with 400mAh capacity
- Energizer part: CP34NM
- Uniross part: BC1021711(84H)
- For use with the Binatone and BT phones
- Fitted with a universal connector



Order Code	Mod:	Price each exc. VAT 1+	inc. VAT each
L75AC	2/3AAA PhoneBat 3Pk	£9.99	£11.99

Cordless Telephone Battery Pack CP52NM



- Replacement rechargeable battery pack for cordless phones
- 2.4V with 1300mAh capacity
- Energizer part: CP52NM
- Uniross part: BC102910 (88C)
- For use with the Binatone and BT phones

Order Code	Mod:	Price each exc. VAT 1+	inc. VAT each
N81BR	2AA PhonePak 88	£9.99	£11.99

AAA Cordless Phone Batteries 2 Pack

- A quality replacement rechargeable battery pack



- For use with the Philips Aleor 300, Kala 300 VOX, 3322, 3350, 3351, 3352, Zenia 300 voice and 300 voice duo

Order Code	Mod:	Price each exc. VAT 1+	inc. VAT each
N82BR	2x2/3AAA PhonePak 89	£9.99	£11.99

Sealed Lead-Acid Batteries

Maplin Sealed Lead-Acid Batteries



- Low pressure relief valve
- Can be used in any position
- Excellent recovery from deep discharge
- Low self discharge of just 3% per month

A range of 6V and 12V maintenance-free sealed lead-acid batteries. Ideal replacements for all applications, including security alarms, children's toys, emergency lighting and back-up power supplies. Connections are via 1/4" spade terminals.

Code:	Voltage:	Capacity:	Dimensions (l x w x h):	Weight:
N33FR	6V	7Ah	151 x 35 x 94mm	1.12kg
L21AC	6V	4.5Ah	70x 48 x 101mm	0.9kg
N33FR	6V	7Ah	151 x 35 x 94mm	1.12kg
UD07	6V	10Ah	151 x 51 x 94mm	1.8kg
UD08	6V	12Ah	151 x 51 x 94mm	1.9kg
MM22	12V	1.3Ah	97 x 43 x 52mm	0.6kg
MM23	12V	2.2Ah	178 x 34 x 60mm	1.0kg
MM24	12V	3.2Ah	134 x 67 x 60mm	1.3kg
L53AC	12V	4.2Ah	90 x 70 x 100mm	1.6kg
MM26	12V	7.2Ah	151 x 65 x 95mm	2.5kg
UD03	12V	12Ah	151 x 99 x 96mm	4.0kg

Order Code	Mod:	Price each exc. VAT 1+	inc. VAT each
UD05F	6V 1.3Ah SLA	£13.32	£15.99
L21AC	6V 4.5Ah SLA	£14.15	£16.99
N33FR	6V 7Ah SLA Battery	£15.82	£18.99
UD07H	6V 10Ah SLA	£19.15	£22.99
UD08J	6V 12Ah SLA	£22.49	£26.99
MM22Y	12V 1.3Ah SLA	£19.15	£22.99
MM23A	12V 2.2Ah SLA	£22.49	£26.99
MM24B	12V 3.2Ah SLA	£26.65	£31.99
L53AC	12V 4.2Ah SLA	£27.49	£32.99
MM26D	12V 7.2Ah SLA	£31.65	£37.99
UD03D	12V 12Ah SLA	£34.15	£40.99

Yuasa Lead-Acid Batteries



- Maintenance-free, sealed construction lead-acid batteries
- Combine small size with high output and long life

The batteries are classified as "non-spillable", having unique sealing techniques to guarantee that no electrolyte leakage can occur. A service life of 5 years can be expected if the batteries are used most often in the "floating" or "standby" modes of operation. When charging do not exceed 25% of the battery charge rate e.g. 8Ah capacity, max charge should be 2A. All the batteries have a pair of moulded-in blade terminals which can accept the 1/4" (6.35mm) push-on connectors shown in the connectors section.

Specifications:

Order Code	Voltage	Capacity	Dimensions (mm)	Weight (kg)
YJ67X	6V	1.2Ah	97x54x25	0.3
YJ69A	12V	1.2Ah	97x55x47	0.6
XG74R	12V	2.1Ah	178x66x34	0.83
XG75S	12V	2.8Ah	134x64x68	1.1
MG47B	12V	7Ah	151x98x65	2.65

Order Code	Mod:	Price each exc. VAT 1+	inc. VAT each
YJ67X	1.2Ah Ld Acid Bat 6V	£20.82	£24.99
YJ69A	1.2Ah L/Acid Bat 12V	£27.49	£32.99
XG74R	2.1Ah L/Acid Bat 12V	£29.15	£34.99
XG75S	2.8Ah L/Acid Bat 12V	£33.32	£39.99
MG47B	7Ah L/Acid Bat 12V	£33.32	£39.99

12V Sealed Lead Acid Battery Charger 15Ah



- Specifically designed for 12V sealed lead-acid batteries
- Suitable for capacity of 6Ah to 15Ah
- Automatically switches to trickle charge once the battery is full
- Reverse polarity, short-circuit and over-voltage protection

Specifications:

Input voltage	230 Vac
Output voltages	14.4 to 15.0 Vdc [bulk charging] 13.6 to 13.8 Vdc [float charging]
Output current	1A ± 10%
Transition current	180mA ± 10%
Transition voltage	12.6 Vdc ± 5%
Indicators	bulk charge red LED float charge green LED fault condition both LEDs extinguished
Dimensions:	90 x 70 x 130mm

Order Code	Mod:	Price each exc. VAT 1+	inc. VAT each
JC87U	12V 1.5A SLA Charger	£34.99	£41.99

2V,6V and 12V Sealed Lead Acid Battery Charger



- Suitable for charging 2V, 6V and 12V batteries
- Automatically switches to trickle charge once battery is full
- LED indicator shows charging state
- 1 switch with 3 modes to select appropriate charge for correct voltage battery
- Short circuit and reverse polarity protection

A plug-in charger suitable for 2 to 12V sealed lead-acid type batteries up to 9 Ah. Connect the leads to the battery terminal and the LED lights to show correct charging. At the end of the charge cycle the current decreases to a trickle charge at constant voltage, to keep the battery fully charged, and the LED starts to flash. One switch with 3 settings to set to the type of battery you are charging, either 2, 6 or 12 V.

Input voltage	230 Vac
Output voltages	2V battery 2.3 V @ 900 mA 6V battery 6.9 V @ 700 mA 12V battery 13.8 V @ 600 mA
Dimensions:	106 x 68 x 51 mm

Order Code	Mod:	Price each exc. VAT 1+	inc. VAT each
L06AB	Multi Charger	£24.99	£29.99

Buy it on the web at maplin.co.uk

Shop for all Maplin products online at our website and check out our latest products and special offers!



Solar Batteries

12V Sealed Lead Acid Deep Cycle Solar Batteries

- Deep cycle capability
- Ideal for solar applications
- Sealed casing for safe, spill free performance



6 different batteries are available:

Order Code	Capacity:	Voltage:	Dimensions:	Weight:
N69HF	7Ah	12V	151 x 65 x 94mm	2.66kg
N70HF	12Ah	12V	151 x 93 x 95mm	4.2kg
N71HF	18Ah	12V	131 x 77 x 167mm	5.7kg
N72HF	26Ah	12V	175 x 66 x 125mm	9.6kg
N73HF	34Ah	12V	195 x 130 x 159mm	10.2kg
N74HF	42Ah	12V	197 x 165 x 170mm	13.5kg

Order Code	Mod: 265437	Price each exc. VAT	inc. VAT each
N69HF	7Ah Solar Battery	£24.99	£29.99
N70HF	12Ah Solar Battery	£33.32	£39.99
N71HF	18Ah Solar Battery	£49.99	£59.99
N72HF	26Ah Solar Battery	£70.82	£84.99
N73HF	34Ah Solar Battery	£99.99	£119.99
N74HF	42Ah Solar Battery	£138.32	£165.99

Keyfob Batteries

Keyfob Battery 12V Type 23A 1 Pack

- Small high voltage, high capacity alkaline battery
- Ideal for use in keyfob remote controls, cigarette lighters, photographic equipment, etc.
- Dimensions: 10 (dia) x 28mm
- Weight: 7.5g
- Voltage: 12V



Order Code	Mod: 031508	Price each exc. VAT	inc. VAT each
JG91Y	12V Alk Battery 23A	£2.90	£3.49

Panasonic Keyfob Battery 12V 23A 2 Pack

- Small high voltage, high capacity alkaline battery
- Designed to provide reliable and long-lasting power
- Ideal for use in keyfob remote controls, cigarette lighters, photographic equipment, etc.
- Value-for-money 2-pack



Order Code	Mod: 634715	Price each exc. VAT	inc. VAT each
N44NA	FAN A23 Batt 2Pk	£5.24	£6.29

Look out for our monthly promotions at your local Maplin store now!

Pop in and pick up a copy of our monthly promotional publication, with special offers on dozens of exciting products. See the end of this catalogue for store listings

Keyfob Battery 12V 27A 1 Pack

- Small high voltage, high capacity alkaline battery
- Ideal for use in keyfob remote controls, cigarette lighters, photographic equipment, etc.
- Dimensions: 7.7 (dia) x 28mm
- Capacity: 18mAh
- Weight: 4.5g
- Voltage: 12V



Order Code	Mod: 031507	Price each exc. VAT	inc. VAT each
ZB55K	12V Alk Battery 27A	£3.32	£3.99

Keyfob Battery 6V 11A 1 Pack

- Small high voltage, high capacity alkaline battery
- Ideal for use in keyfob remote controls, cigarette lighters, photographic equipment, etc.
- Dimensions: 10 (dia) x 16mm
- Weight: 4g
- Voltage: 6V
- Capacity: 38mAh



Order Code	Mod: 031504	Price each exc. VAT	inc. VAT each
ZB53H	6V Alk Battery 11A	£2.74	£3.29

Keyfob Battery 6V PX27A 1 Pack

- Small high voltage, high capacity alkaline battery
- Ideal for use in keyfob remote controls, cigarette lighters, photographic equipment, etc.
- Dimensions: 12.7 (dia) x 20.5mm
- Weight: 7.8g
- Voltage: 6V
- Capacity: 70 mAh under 20K ohm discharge, 24hrs/day with EPV 3.6V



Order Code	Mod: 037455	Price each exc. VAT	inc. VAT each
L99AQ	6V Alk Battery PX27A	£3.32	£3.99

Keyfob Battery 6V PX28A 1 Pack

- Small high voltage, high capacity alkaline battery
- Ideal for use in keyfob remote controls, cigarette lighters,



- photographic equipment, etc.
- Dimensions: 13 (dia) x 25.2mm
- Weight: 10g
- Voltage: 6V
- Capacity: 105mAh

Order Code	Mod: 031509	Price each exc. VAT	inc. VAT each
ZB54J	6V Alk Battery PX28A	£3.32	£3.99

Keyfob Battery 15V BLR121 1 Pack



- Small high voltage, high capacity alkaline battery
- Ideal for use in test meters and photographic equipment, etc.
- Dimensions: 27 x 16 x 37mm
- Weight: 16.1g
- Voltage: 15V
- Capacity: 40mAh

Order Code	Mod: 031510	Price each exc. VAT	inc. VAT each
FM07H	15V Alkaline BLR121	£10.82	£12.99

Lantern Batteries

4.5V Lantern Battery

- Zinc carbon specialist lantern battery
- Flat spring terminal connections



Specifications:

Voltage	4.5V
Capacity	2,300mAh
Dimensions	62x22x67mm
Weight	113g
Cross ref.	IEC.3R12. 312G, 2703

Order Code	Mod: 031494	Price each exc. VAT	inc. VAT each
ZB63T	4.5V Zinc 312 Batt	£3.57	£4.29

9V PP9 Battery

- Ideal for use in a variety of meters, vintage radios and other devices
- The PP9 is also known as 276, 6F100 and 6F100A
- Batteries originally developed for the 'new' transistorised



equipment, where high capacity in the minimum space was required.

Please note that product supplied may differ from the image shown.

Voltage	Dimensions [mm]	Type	Terminals
9V	65 x 50 x 81 high	FF9	PP9-type
Order Code	Mod: 629172	Price each exc. VAT 1+	inc. VAT each 5+
ZB67X	9V Zinc Carbon PP9	£8.32	£7.49 £9.99

6V Lantern Battery with Spring Terminals

- Carbon Zinc specialist lantern battery with coiled spring terminal connections
- Ideal for torches



Specifications:

Voltage:	6V
Capacity:	1,100mAh
Dimensions:	66.7 x 66.7 x 112mm
Weight:	611g
Cross ref.:	IEC 4R25, ANSI 908D, 1209, 996

Order Code	Mod: 031491	Price each exc. VAT 1+	inc. VAT each 5+
ZB65V	6V Zinc Carbon 908D	£8.32	£9.99

Back-up Batteries

Silver Oxide 4SR44 6V Battery 1 Pack

- Silver oxide battery ideal for use in cameras
- Increased capacity compared to alkaline versions
- Nominal voltage 6.2V
- Capacity: 165mAh
- Dimensions: 13mm(dia) x 25.2mm



JIS:	-
DURACELL/ VARTA	FX28S, V2&FX
ENERGIZER	544
FANASONIC:	4SR44
RAYOVAC/IDOR:	-
SEIKO	V4034FX
CITIZEN	GF-476
OTHERS:	KS28

Battery also known as:

Code	QE47
IEC	4SR44
IEC	-
ANSI	-

V625 Alkaline Battery (PX625 Mercury Equivalent)

- A modern alkaline equivalent for the popular mercury-based PX625 battery that is no longer being produced
- Ideal for use in cameras, test meters etc



Compatible with devices that require one of the following batteries:
1124MF, 4370, 4371, 4625, 625, 625A, 8930, E625G, E625N, EPX13, EFX625, H1560, HD1560, HD625, HG-625R, KA625, KX615, L1560, LR9, M01, M20B, MR09, MR9, MR9F, FN625, PX625, FX625A, R625, RM625, RM-625R, RFX625, V13PX, V625PX, V625U

Specifications:

Voltage:	1.5V
Capacity	200mAh
Dimensions	15.5 x 6.2mm
Weight:	3.3g

Order Code	Mod: 031478	Price each exc. VAT 1+	inc. VAT each 5+
VQ76H	Mercury Equiv PX625	£3.57	£4.29

Maxell ER3S Lithium Battery

- Ideal for Apple Macs
- A Lithium Thionyl Chloride cell for use in backup applications such as computers.



Type	Voltage
ER3S	3.6V
Capacity	Dimensions
790mAh	14.5 x 25.4mm

Order Code	Mod: 026673	Price each exc. VAT 1+	inc. VAT each 5+
QE49D	Maxell ER 3S-TC	£10.82	£12.99

Buying for business?

0333 400 9740



Maxell ER6C Lithium Battery

A Lithium Thionyl Chloride cell for use in backup applications such as computers.



Type	Voltage
ER6C	3.6V
Capacity	Dimensions
1800mAh	14.5x50.5mm

Order Code	Mod: 026669	Price each exc. VAT 1+	inc. VAT each 5+
QE50E	Maxell ER 6C#5TC	£8.32	£9.99

PCB Mounted NiMH Batteries



- Long life
- Requires no maintenance
- Withstands constant trickle charge
- PCB mounting
- Low self discharge
- Fully charged in approx. 14 hours

The H-series mempac range of rechargeable Nickel Metal Hydride batteries, particularly suitable for backing up CMOS and NMOS memories. These batteries are suitable for use as replacements for NiCd batteries in most applications.

Specifications:

Order Code	Description	Voltage (V)	Capacity (mAh)
BN22Y	3/V80H	3.6	70
JC85G	3/V15H	3.6	15
BN24B	3/V150H	3.6	160

Order Code	Mod: 030958	Price each exc. VAT 1+	inc. VAT each 5+
BN22Y	PCB NiMH 3/V80H	£4.99	£5.99
JC85G	PCB NiMH 3/V15H	£4.57	£5.49
BN24B	PCB NiMH 3/V150H	£6.66	£7.99

Specialist Rechargeable Batteries

Tagged Industrial High Capacity NiCd Batteries



- Replacement batteries for use in alarm systems, power tools, medical and military equipment
- Only for use in industrial applications
- Not designed for use in consumer electronics

Code	Type	Size	Capacity	Dimensions	Charge
VN48C	Standard	AA	1050mAh	50 x 14mm	150mAh
VN39N	Tagged	AA	1050mAh	50 x 14mm	150mAh
VN45Y	Tagged	4/5 Sub C	1250mAh	34 x 22mm	125mAh
JF99H	Tagged	Sub C	2000mAh	43 x 23mm	200mAh
VN44X	Tagged	C	2800mAh	49 x 25.5mm	280mAh
VN47B	Tagged	D	5500mAh	59 x 32	550mAh

Order Code	Mod: 225150	Price each exc. VAT 1+	inc. VAT each 5+
VN48C	Ind NiCd AA 1050mAh	£4.15	£4.99
VN39N	Ind NiCd 1050 AA Tag	£4.40	£5.29
VN45Y	Ind NiCd 4/5SubC Tag	£4.40	£5.29
JF99H	Ind NiCd SubC Tagged	£5.24	£6.29
VN44X	Ind NiCd C 2800 Tag	£7.07	£8.49
VN47B	Ind NiCd D Tagged	£7.07	£8.49

Tagged NiMH Batteries



- NiMH technology means no 'memory' effect
- 500 to 1,000 charge/discharge cycles can be expected
- Performance is normally 30% to 50% better than that of equivalent NiCd cells
- Tagged for easy connection

Voltage level is maintained at 1.2V or more during 80% of the discharge cycle and up to 100% of the nominal capacity at a rate of 3C10A is possible. A resealing safety vent guards against possible misuse

Order Code	Size	Capacity	Dimensions	Weight	Charge*
VN23A	AAA	700mAh	10.5 x 43.7mm	15g	55mA
VN25C	2/3AA	650mAh	14.5 x 28.7mm	12g	60mA
VN19V	AA	1600mAh	14.5 x 48.2	26g	130mA
L25AR	AA	2000mAh	14.5 x 47.5mm	24g	200mA
AG29G	2/3AF	1000mAh	17 x 28.7mm	19g	90mA
AG30H	4/5AF	1810mAh	17 x 43mm	30g	150mA
AG32K	7/5AF	3800mAh	17 x 66mm	46g	300mA

Order Code	Mod: 004486	Price each exc. VAT 1+	inc. VAT each 5+
VN23A	NiMH AAA Cell Tagged	£4.40	£5.29
VN25C	NiMH 2/3AA Tagged	£3.57	£4.29
VN19V	NiMH AA Cell Tagged	£4.40	£5.29
L25AR	NiMH AA Cell Tagged	£5.24	£6.29
AG29G	NiMH 2/3AF Tagged	£4.57	£5.49
AG30H	NiMH 4/5AF Tagged	£5.82	£6.99
AG32K	NiMH 7/5AF 3800 Tagd	£6.65	£7.99

Technical Helpline

0333 400 9500

For technical information and assistance relating to any Maplin purchase, contact our team of experts

Battery Testers

Compact Battery Tester

- Low-cost, versatile and compact battery tester
- Suitable for checking the state of both alkaline and rechargeable batteries
- Will test AAA, AA, C, D, 9V PP3, N and button cell batteries
- Lets you know when the battery is good, needs recharging or replacing
- Uses the power of the battery you are testing to power itself - no need for additional batteries
- Dimensions: 62 x 61 x 29mm



A great pocket sized little gadget that tells you when your batteries are dead or need recharging. Easy to use and stops you throwing away perfectly good batteries. One battery can be tested at a time and the meter indicates the capacity of the battery.

When testing a battery, the state is shown as 'Replace', 'Weak' and 'Good' on the meter. The spring-loaded arm is used for testing 'N', 'AAA', 'AA', 'C' and 'D' size batteries, while 9V PP3 batteries are held against two contacts on the bottom of the unit. In addition, the spring-loaded arm can also be used to test button cells from watches and calculators. This unit is not suitable for testing CR123 batteries.

Please note: The unit draws up to 220mA from the battery being tested, so button cells should not be tested regularly! If a button cell has a rating of less than 220mAh, it should not be tested using this charger as the charger will completely discharge the cell.

Order Code	Mod.	Price each exc. VAT 1+	inc. VAT each 5+
N94JX	Mini Battery Tester	£3.57	£4.29

Rolson Battery Bulb and Fuse Tester

- Checks power level of most 1.5V and 9V batteries
- Checks most fuses and bulbs
- Supplied with a 9V battery [Order Code: L46AL for replacements]

Please note the 9V battery is only required when testing fuses in the unit. Batteries are tested using their own power, and do not draw power from the 9V battery



Order Code	Mod.	Price each exc. VAT 1+	inc. VAT each 5+
N11GA	Batt/Bulb/Fuse Test	£6.65	£7.99

Battery Size Convertors

AA, C and D Battery Adaptors



- Turn a AAA battery into a AA, or a AA battery into a C or D
- Ideal for most applications
- Supplied in packs of 4 adaptors

• Available in AA, C and D sizes

Have you ever needed a AA battery, but realised you only have a AAA battery in the house? Not to worry with these handy adaptors. Simply insert your AAA battery into the AA battery adaptor, and you instantly have the battery you require. Ideal for use with most applications, these adaptors are great to keep handy - just in case.

There are 3 different adaptors available AA, C and D sizes. To use the AA adaptor you will need to insert a AAA battery, and to use the C or D adaptors you will need a AA battery (or use the AA battery adaptor!)

L63AQ - AA battery adaptor

L64AQ - C battery adaptor

L65AQ - D battery adaptor

Order Code	Mod.	Price each exc. VAT 1+	inc. VAT each 5+
L63AQ	AA Batt. Convertor 4Pk	£2.07	£2.49
L64AQ	C Batt. Convertor 4Pk	£2.49	£2.99
L65AQ	D Batt. Convertor 4Pk	£2.49	£2.99

Battery Boxes

4 AA/AAA Battery Storage Box

- Stores 4 x AA or AAA batteries
- Keeps loose batteries in pristine condition
- Ideal for keeping batteries tidy in drawers as well storing them while travelling

Fed up with searching for loose batteries in the bottom of drawers?

This is the ideal solution for you - a simple box that is able to store either 4 x AA or AAA batteries. Ideal for storing them in drawers at home as well as safely transporting them while in transit. Supplied in a pack of 3 storage cases. N.B. Batteries not included.



Order Code	Mod.	Price each exc. VAT 1+	inc. VAT each 5+
L23AR	4AA/AAA BattHold 3Pk	£2.74	£3.29

Lithium Battery Holders



- PCB-mounting holders for lithium coin cell batteries
- Pin spacing is 8mm for the CR1220 type
- Pin spacing is 20mm for the CR2032 type

Order Code	Mod.	Price each exc. VAT 1+	inc. VAT each 5+
L01AC	CR2032 Holder	£1.24	£1.49
L02AC	CR1220 Holder	£1.24	£1.49

PCB Mounting Battery Boxes



- A range of black plastic PCB-mounting battery boxes
- | Type | Size | Order Code |
|---------|------------|------------|
| AAA x 4 | 50x47x13mm | CL15R |
| AA x 1 | 51x13x16mm | CL16S |

AA x 2	58x30x15mm	CL17T
AA x 3	57x49x17mm	CL18U
AA x 4	57x60x15mm	CL19V

Order Code	Mod.	Price each exc. VAT 1+	inc. VAT each 5+
CL15R	PCB Mt. 4AAA Bat Box	£1.65	£1.99
CL16S	PCB Mtg AA Batt Box	£1.24	£1.49
CL17T	PCB Mtg 2AA Batt Box	£1.24	£1.49
CL18U	PCB Mtg 3AA Batt Box	£1.65	£1.99
CL19V	PCB Mtg 4AA Batt Box	£1.65	£1.99

1 N Battery Box



- A battery holder to suit standard N size batteries
- Moulded in black polythene
- Designed to fit 1 x N battery

Holds	Size (mm)	Connection	Code
1 battery	36x14x14	solder tag	JB84F

Order Code	Mod.	Price each exc. VAT 1+	inc. VAT each 5+
JB84F	N Batt Box	£1.24	£1.49

AAA Size Battery Holders



- A range of battery holders to suit standard AAA size batteries
- The holders are moulded in black polythene

Holds	Size (mm)	Connection	Code
1 battery	51x14x14	solder tag	JY45Y
2 batteries	51x24x13	solder tag	JB83E
4 batteries	51x25x24	PP3 clip	JG79L

Order Code	Mod.	Price each exc. VAT 1+	inc. VAT each 5+
JY45Y	1AAA Battery Box	£1.24	£1.49
JB83E	2AAA Battery Box	£1.24	£1.49
JG79L	4AAA Battery Box	£1.49	£1.79

AA Size Battery Holders



- A range of battery holders to suit standard AA size batteries
- The holders are moulded in black polythene

Holds	Size (mm)	Connection	Code
1 battery	56x16x13	solder tag	YR59P
2 batteries	57x30x15	PP3 clip	YR60Q
3 batteries	57x48x16	PP3 clip	YR61R
4 batteries	57x30x27	PP3 clip	HF29G
4 batteries	109x26x16	PP3 clip	HF94C
6 batteries	58x44x28	PP3 clip	HQ01B
8 batteries	58x64x29	PP3 clip	RK44X
10 batteries	58x75x29	PP3 clip	RK45Y

Order Code	Mod: 031427	Price each exc. VAT	inc. VAT each
YR59P	1AA Battery Box	£1.24	£1.49
YR60Q	2AA Battery Box	£1.32	£1.59
YR61R	3AA Battery Box	£1.40	£1.69
HF29G	4AA Battery Box	£1.49	£1.79
HF94C	4AA Battery Box Long	£1.49	£1.79
HQ01B	6AA Battery Box	£1.49	£1.79
RK44X	8AA Battery Box	£1.40	£1.69
RK45Y	10AA Battery Box	£1.40	£1.69

C Size Battery Holders



- A range of battery holders to suit standard C size batteries

- The holders are moulded in black polythene

Holds	Size (mm)	Connection	Code
1 battery	61x29x25	solder tag	BK45Y
2 batteries	60x55x24	PP3 clip	JG75S
4 batteries	109x53x25	PP3 clip	HF95D

Order Code	Mod: 031428	Price each exc. VAT	inc. VAT each
BK45Y	1C Battery Box	£1.24	£1.49
JG75S	2C Battery Box	£1.49	£1.79
HF95D	4C Battery Box	£1.90	£2.29

D Size Battery Holders



- A range of battery holders to suit standard D size batteries

- The holders are moulded in black polythene

Holds	Size (mm)	Connection	Code
1 battery	68x35x27	solder tag	BK46A
2 batteries	70x70x31	PP3 clip	JG72P
3 batteries	115x70x28	PP3 clip	YU28F
4 batteries	140x70x32	solder tag	JK34M
6 batteries	106.5x70.5x57	PP9 clip	L79AA

Order Code	Mod: 031429	Price each exc. VAT	inc. VAT each
BK46A	1D Battery Box	£1.24	£1.49
JG72P	2D Battery Box	£1.49	£1.79
YU28F	3D Battery Box	£1.65	£1.99
JK34M	4D Battery Box	£1.90	£2.29
L79AA	6D Battery Box		

1 9V Battery Box



- Securely holds one PP3 battery
- 3 countersunk holes in the base allow the box to be screwed to a suitable surface
- Internal battery contacts are connected to two 130mm leads (black and red) for easy connection
- Overall size: 55 x 30 x 21mm.

Order Code	Mod: 000265	Price each exc. VAT	inc. VAT each
CK65V	PP3 Batt Box	£2.07	£2.49

1 9V Switched Battery Box



- Ideal for projects and backup power applications
- Designed for standard PP3 type 9V battery
- Includes on/off switch

This battery holder has a slide top for easy access with a firm 'snap' closing action. The internal battery contacts are connected to two 130mm leads (black and red) for easy connection. The top of the box has a simple on/off slide switch. Dimensions: 68 x 33 x 21mm

Order Code	Mod: 036403	Price each exc. VAT	inc. VAT each
L90AN	9V Battery Box	£2.07	£2.49

Battery Clips

PP3 Snap Battery Clip

Standard battery clip for 9V (PP3-type and PP6-type) batteries. Insulated overall with twin wire lead approximately 150mm (6") long.



Order Code	Mod: 044392	Price each exc. VAT	inc. VAT each
HF28F	PP3 Clip	£1.49	£1.79

PP3 Rigid Battery Clip

A rigid plastic battery clip for 9V (PP3 type) batteries. The special 'safety' design completely covers the exposed metal studs on the top of the battery once fitted. With 150mm (6") of black and red flexible wire with tinned ends.



Order Code	Mod: 031743	Price each exc. VAT	inc. VAT each
NE19V	Rigid PP3 Clip	£1.24	£1.49

PP3 T Shape Battery Clip



Standard 'T-shaped' battery clip for 9V (PP3-type and PP6-type) batteries. Insulated overall with twin wire lead approximately 150mm (6") long.

Order Code	Mod: 032571	Price each exc. VAT	inc. VAT each
L85AB	T-Shaped PP3 Clip	£1.32	£1.59

Household Wiring

Mains Plugs

13A Rough Service Mains Plug White



Resistant rough service 13A mains plug supplied fitted with 13A fuse. Conforms to BS1363A

Note: Plugs supplied may vary slightly from those illustrated

Order Code	Mod: 812388	Price each exc. VAT	inc. VAT each
RW67X	BS1363A Plug Wht	£1.40	£1.69

13A Rough Service Mains Plug Black



Resistant rough service 13A mains plug supplied fitted with 13A fuse. Conforms to BS1363A

Note: Plugs supplied may vary slightly from those illustrated

Order Code	Mod: 812389	Price each exc. VAT	inc. VAT each
NH65V	BS1363A Plug Blk	£1.40	£1.69

13A Hard Wearing Plug White



A 13A mains plug moulded in unbreakable rubber and fitted with a 13A fuse and cord grip. This plug conforms to BS1363A

Order Code	Mod: 812390	Price each exc. VAT	inc. VAT each
HL58N	13A Rubber Plug Wht	£1.82	£2.19

13A Hard Wearing Mains Plug Black



A 13A mains plug moulded in unbreakable rubber and fitted with a 13A fuse and cord grip. This plug conforms to BS1363A

Order Code	Mod: 812391	Price each exc. VAT	inc. VAT each
VJ75S	13A Rubber Plug Blk	£1.82	£2.19



Friendly expert advice on
0333 400 9500

10A Two Pin Flex Connector Orange



A heavy duty thermoplastic 2-pin flex connector rated at 10A - 250Vac. This connector is reversible. Available in orange, as typically used by portable gardening equipment. To BS5733.

Order Code	Mod: 013176	Price each exc. VAT 1+	inc. VAT each
VJ78K	2-Pin Connector Orn.	£4.57	£5.49

10A Three Pin Flex Connector Black



- A 3-pin heavy-duty flex connector in thermoplastic
- Rated at 10A - 250Vac with offset earth pin so that the connector is non-reversible
- Conforms to BS5733

Order Code	Mod: 812392	Price each exc. VAT 1+	inc. VAT each
VJ79L	3-Pin Connector Blk	£4.57	£5.49

10A Three Pin Flex Connector White



- A 3-pin heavy-duty flex connector in thermoplastic
- Rated at 10A - 250Vac with offset earth pin so that the connector is non-reversible
- Conforms to BS5733

Order Code	Mod: 812393	Price each exc. VAT 1+	inc. VAT each
VJ80B	3-Pin Connector Wht.	£4.57	£5.49

5A Permanent Mains Flex Connector 2 Core White



A flex connector, with two terminals and rated at 5A-250Vac. In durable white PVC with cord grips at each end. It is designed for use where two pieces of flex need to be joined permanently. Complies to BS5733: 1979.

Order Code	Mod: 812394	Price each exc. VAT 1+	inc. VAT each
VJ81C	2-Core 5A Mains Con.	£2.82	£3.39

13A Permanent Mains Flex Connector 3 Core White



A flex connector, with three terminals and rated at 13A - 250Vac. In durable white PVC with cord grips at each end. It is designed for use where two pieces of flex need to be joined permanently. Complies to BS5733: 1979.

Order Code	Mod: 812395	Price each exc. VAT 1+	inc. VAT each
VJ82D	3-Core 13A Mains Con.	£2.82	£3.39

Mains Wall Plates

Unswitched Twin Socket 13A White



- Shuttered, 13A unswitched twin sockets conforming to BS1363
- Supplied with fixing screws
- Finished in white

Order Code	Mod: 988596	Price each exc. VAT 1+	inc. VAT each
N20DA	2Skt Unswitched Skt	£2.90	£3.49

Unswitched Single Socket 13A White



- Shuttered, 13A unswitched socket conforming to BS1363
- Supplied with fixing screws
- Finished in white

Order Code	Mod: 220088	Price each exc. VAT 1+	inc. VAT each
HL68Y	Single Skt Unswitched	£2.74	£3.29

Switched Single Socket 13A White



- Shuttered 13A socket with single pole switch that switches live only

- Conforms to BS1363
- Supplied with fixing screws
- Finished in white

Order Code	Mod: 001198	Price each exc. VAT 1+	inc. VAT each
HL71N	Single Sw Socket	£2.82	£3.39

Switched Double Socket 13A White



- Double shuttered 13A socket each with its own single pole switch that switches live only
- Conforming to BS1363
- Supplied with fixing screws
- Finished in white

Order Code	Mod: 001201	Price each exc. VAT 1+	inc. VAT each
HL72P	Double Sw Socket	£4.07	£4.89

Spur Outlet Fused 13A White



- An unswitched connecting unit fitted with a 13A fuse
- Supplied with fixing screws
- Complies to BS3676

Order Code	Mod: 013207	Price each exc. VAT 1+	inc. VAT each
VK08J	Unswitched Spur	£3.99	£4.79

Spur Outlet Switched 13A White



- A connecting unit with a maximum load of 13A
- Fused flex outlet has a double pole switch and neon indicator
- Conforms to BS1363
- Supplied with fixing screws

Order Code	Mod: 001233	Price each exc. VAT 1+	inc. VAT each
HL83E	Switched Flex Outlet	£4.90	£5.89

Single Gang 20A Switch with Neon



- Neon illuminated switch with a maximum 20A load
- Great for most kitchen appliances
- Made from high quality plastic

Order Code	Mod:	Price each exc. VAT	inc. VAT each
N35DA	997898	1+	£8.99
	20A Neon Switch	£7.49	

Single Surface Pattress 16mm White



Single white plastic surface pattress

Order Code	Mod:	Price each exc. VAT	inc. VAT each
YB14Q	812408	1+	£2.19
	Sur Patt 16mm single	£1.82	

Single Surface Pattress 25mm White



Single white plastic surface pattress

Order Code	Mod:	Price each exc. VAT	inc. VAT each
YB15R	812409	1+	£2.39
	Sur Patt 25mm Single	£1.99	

Single Surface Pattress 46mm White



Single white plastic surface pattress

Order Code	Mod:	Price each exc. VAT	inc. VAT each
ZB40T	812410	1+	£2.59
	Sur Patt 46mm Single	£2.15	

Double Surface Pattress 25mm White



A 25mm deep pattress, suitable for all double-panel sockets, switches, etc.

Order Code	Mod:	Price each exc. VAT	inc. VAT each
YB16S	001288	1+	£3.19
	Sur Patt 25mm Dble	£2.65	

Single Dry Line Box 83mm x 83mm White



Requires a cut-out 74 x 74mm and a depth of 35mm. Suitable for socket outlets and plate switches.

Finished in white, overall size 83 x 83mm.

Order Code	Mod:	Price each exc. VAT	inc. VAT each
KC70M	001294	1+	£2.29
	Dry Line Single	£1.90	

Double Dry Line Box 145mm x 83mm White



Requires a cut-out 135 x 74mm and a depth of 35mm. Suitable for all double panels except cooker and shaver. Finished in white, overall size 145x83mm.

Order Code	Mod:	Price each exc. VAT	inc. VAT each
KC71N	001295	1+	£2.59
	Dry Line Double	£2.15	

Replacement Pattress Screws 35mm



- Supplied in packs of four

Spare screws as replacements for those supplied with switch plates, blanking plates, sockets etc. The standard 35mm length are ideal for replacing lost or missing originals. Sold in handy packs of four screws

Order Code	Mod:	Price each exc. VAT	inc. VAT each
L12BB	812411	1+	£1.89
	35mm Pattress Screws	£1.57	

Replacement Pattress Screws 50mm



- Supplied in packs of four

Spare screws as replacements for those supplied with

switch plates, blanking plates, sockets etc. The 50mm variety are for use for deep or recessed pattresses. Sold in handy packs of four screws.

Order Code	Mod:	Price each exc. VAT	inc. VAT each
L13BB	812412	1+	£1.89
	50mm Pattress Screws	£1.57	

Blanking Plates

Single Blanking Plate White



- A white plate that will blank off any spare single mounting box
- Conforms to BS1363
- Supplied with fixing screws

Order Code	Mod:	Price each exc. VAT	inc. VAT each
HL86T	001239	1+	£1.89
	Blanking Plate	£1.57	

Double Blanking Plate White



- A white plate which can be used to blank off any spare double mounting box
- Complies to BS1363
- Supplied with fixing screws

Order Code	Mod:	Price each exc. VAT	inc. VAT each
ZB49D	001241	1+	£2.19
	Dbl Blank Plate	£1.82	

Light Switches

Single Light One Way Switch White



- A single switch rated at 5A, complying with BS1363
- Also suitable for fluorescent fittings
- Fixing screws supplied

The one-way switch is for normal switching

Order Code	Mod:	Price each exc. VAT	inc. VAT each
HL89W	812404	1+	£2.39
	Light Swch ST Single	£1.99	

Buy it on the web at
maplin.co.uk

Shop for all Maplin products online at our website and check out our latest products and special offers!



Single Light Two Way Switch White

- A single switch rated at 5A, complying with BS1363
- Also suitable for fluorescent fittings
- Fixing screws supplied

The two-way switch is for use where two switches are used to operate the same lights, e.g. hall and stairway (Order Code: HL90X)



Order Code	Mod.	Price each exc. VAT 1+	inc. VAT each
HL90X	812405	£2.40	£2.89

Double Light Switch 5A White

- Two separate two-way switches rated at 5A
- Also suitable for fluorescent fittings
- Supplied with fixing screws
- Conforms to BS3676



Order Code	Mod.	Price each exc. VAT 1+	inc. VAT each
HL91Y	001257	£2.82	£3.39

Ceiling Pull Switch 45A White with Neon

- Ceiling Pull switch for use in bathrooms
- Supplied with fitted pull cord
- Super bright neon power indicator

A ceiling mounted, cord operated light switch to BS3676 for use in bathrooms (wall mounted switches are not permitted in bathrooms). Fitting has a two-way switch, but can also be used as a one-way switch. Rated at 45A and suitable for fluorescent fittings. White with tough white nylon pull-cord. Fixing centres 51mm



Order Code	Mod.	Price each exc. VAT 1+	inc. VAT each
N22DA	988599	£8.32	£9.99

Ceiling Pull Switch 6A White



A ceiling mounted, cord operated light switch to BS3676 for use in bathrooms (wall mounted switches are not permitted in bathrooms). Fitting has a two-way switch, but can also be used as a one-way switch. Rated at 6A and suitable for fluorescent fittings. White with tough white nylon pull-cord. Fixing centres 51mm

Order Code	Mod.	Price each exc. VAT 1+	inc. VAT each
F000A	001247	£3.65	£4.39

Single Dimmer 250W White



A single dimmer switch suitable for loads of up to 250W of incandescent lighting. This dimmer will replace any standard single light switch designed for 1-way switching and fits a standard single pattress. Not suitable for use with fluorescent lamps.

Order Code	Mod.	Price each exc. VAT 1+	inc. VAT each
LS7BC	045037	£9.99	£11.99

Double Dimmer 400W White



- Replaces standard double light switch
- Conforms to BS800 & BS5518

A double 400W dimmer suitable for controlling two 1-way lighting circuits. Fits standard single pattress. Not suitable for use with fluorescent lamps

Order Code	Mod.	Price each exc. VAT 1+	inc. VAT each
VW93B	031311	£17.49	£20.99

Spare Pull Cord for Ceiling Switch



- Spare pull cord for ceiling switch
- Mainly found in bathrooms

Order Code	Mod.	Price each exc. VAT 1+	inc. VAT each
N21DA	988598	£1.24	£1.49

Cord Switch 5A 250Vac White

A three terminal line cordswitch rated at 5A 250Vac. Suitable for table lamps, etc. Dimensions: 78mm(l) x 25mm(d). Available in white



Order Code	Mod.	Price each exc. VAT 1+	inc. VAT each
VJ8E	013156	£2.57	£3.09

Over 200 stores nationwide

Energy Saving Monitors

13A Plug In Energy Saving Monitor



- Monitor energy consumption from any appliance plugged into a socket
- Great for seeing how much power your appliances are consuming
- Can display the cost of electricity and power used
- Large LCD display
- Set up in less than 2 minutes
- Up to 9 different types of data displayed
- Memory function
- Maximum current 13 A / maximum power 3120 W

By simply entering the unit cost of your electricity and plugging an appliance or extension lead into the power monitor, the LCD screen, enables you to easily see the cost of the plugged in appliances. It allows you to see useful data such as: cost generated by a socket, tariff, power factor, kilowatt hours used (as found on your electricity bill), active watts consumed, apparent power, voltage from the socket, amps used and frequency of the electricity (mains power is normally 50Hz)

Technical specifications:
 Ratings: AC 100 V-240 V / 50 - 60Hz / maximum 13A
 Range of the measuring power: 0.2W - 3120W;
 Range of the measuring voltage: 90V - 250V (tolerance ±[1%-1])
 Range of the measuring current: 0A - 13A (tolerance ±[1.5%-2.5])
 Range of the measuring frequency: 50 - 60Hz (tolerance ±1)
 Range of the displaying amount of electricity used: 0.001 - 9999kWh
 Range of the unit price setting: 0.00 - 99.99 / kWh
 Operating temperature: -10 to +40 °C
 Humidity: 85%RH
 IP rating: IP20
 Up to altitude of 2000m (indoor use)

Order Code	Mod.	Price each exc. VAT 1+	inc. VAT each
N67FU	223573	£8.32	£9.99

15A Plug In Energy Saving Monitor



- Measures voltage (V), amps (A), watts (W), volt-amps(VA), hertz (Hz) and power factor (PF)
 - Great for seeing how much power your appliances are consuming
 - Maximum current: 15 A / maximum power: 3750 VA
 - Large, clear LCD screen
- Specifications:**

Function	Range	Accuracy	Typical	Max

RMS Voltage	180-250V rms	0.002	0.01
RMS Current	0-15.00A rms	0.003	0.01
Active Power	0-3750W	0.005	0.02
Line Frequency	47.0-63.0 Hz	0.1Hz	0.02
Power Factor	0.00-1.00	0.01	0.03
Power Consumption	20W max		

Order Code	Mod.	Price each exc. VAT	inc. VAT each
L61AQ	Power Monitor Socket	£16.65	£19.99

Efergy Elite Wireless Energy Saving Monitor



- Monitor and calculate the cost of running your home or office appliances
- Instant, historical and average consumption data
- Memory feature stores data
- Fast installation with no expert knowledge required - simply attach the sensor and transmitter to your electricity meter
- Easy to use and portable display unit instantly tells you how much energy you are using
- Start saving money and the environment immediately
- High use warning alarm
- Backlit display
- Displays currencies in £ Pounds, € Euros and \$ Dollars
- Day, week and month usage view
- Data storage capacity of 2 years

The elite wireless energy monitor updates every 6 seconds so you can instantly see the impact of turning a light on or off, boiling the kettle or using your tumble dryer. It has an innovative memory function that allows you to see how much you have used today, yesterday and in the last week or month. The elite monitor also displays your daily average so you can see when you are using more electricity than normal and see how your average usage reduces as you change the way you do things.

The Efergy Elite electricity monitor is simple to install and use. The sensor wirelessly sends information about the amount of electricity you are using to the display monitor. The monitor converts this into kilowatt-hours, the standard unit which the electricity company uses to charge you. This shows how much you are using in the same units that are on your bill. Input the amount your energy company charges you for each kilowatt-hour and you can see how much you are spending in electricity instantly. Make instant changes to save money, energy and the environment.

Both the transmitter and monitor are battery powered and require 3 x AA batteries each.

If you are operating a 3-phase supply then you will require two additional sensors. The Elite is supplied with one sensor and additional sensors are available (Order Code: N87HL, sold separately).

Technical specifications:

Frequency:	433.92MHz
Measuring voltage of sensor:	110V - 400V
Measuring current of sensor:	50mA-95A
Portable display:	Yes
Wireless transmitter:	Yes
Up to 40m indoor range:	Yes
Easy to connect:	Yes
Easy to read display:	Yes
Three phase compatible:	Yes
Economy 7 compatible:	Yes
Frequency of transmission:	6 / 12 / 18 seconds

Transmitter range:	40 - 70m
High use warning alarm:	Yes
Display currencies:	£, \$
Voltage settings:	Variable
Max Amos input rating (per phase):	100A
DC adaptor input:	Yes
DC adaptor included:	Sold separately
Instant kW consumption:	Yes
Instant cost per hour view:	Yes
Tonnes CO2 per year view:	Yes
Memory function:	Yes
On-board usage history view:	Yes
Day/week/month usage view:	Yes
Daily/weekly/monthly average view:	Yes
Data storage capacity:	2 years
Date / time display:	Yes
Backlit display:	Yes
Transmitter batteries separately:	3 x AA (sold separately)
Display dimensions:	106mm x 78mm x 32mm
Sensor dimensions:	57mm x 35mm x 21mm
Transmitter dimensions:	95mm x 63mm x 29mm

Order Code	Mod.	Price each exc. VAT	inc. VAT each
N26GG	Efergy Elite monitor	£41.65	£49.99

Efergy Engage Hub Kit



- Upgrade your energy monitor and go online: check your energy consumption anytime from anywhere
- Free online platform with no subscription or monthly fees
- Free Android and iPhone apps available
- View your daily, weekly, monthly or average costs in easy-to-read graphics
- Set your monthly budget and see how close you are to meeting it
- Discover and reduce your carbon footprint

The engage hub kit provides you with all you need to start monitoring your energy use through the engage online platform. Through this new technology it is now possible for you to view your home energy anytime, from anywhere!

How it works

The engage hub is simple to install and use. A small sensor is clipped on to the supply cables in your breaker panel. A lead from the sensor is connected to the efergy transmitter, which then wirelessly sends real time data to the engage hub. The engage hub is connected to your internet router via Ethernet cable. When you go online to the Efergy web portal or onto your smartphone app, the router wirelessly uploads your energy data and converts this data into kilo-watt hours. The web platform or app will then show you how much energy you are using in the same units that are on your bill. You can also see how much energy you are saving compared to other web platform users, compare energy saving tips, and set energy consumption targets.

In the box

- 1 x engage hub gateway
- 1 x Transmitter
- 1 x Mini CT sensor

- 1 x Ethernet cable
- 1 x AC/DC Adapter
- 1 x Quick Start Guide

Technical Specification

Frequency: 433 MHz
Transmission Time: 6 sec
Transmission Range: 40 m - 70 m
Sensor Voltage Range: 90 V-600 V
Measuring Current: 50 mA - 120 A

Order Code	Mod.	Price each exc. VAT	inc. VAT each
N67NW	Engage Hub Kit	£49.99	£59.99

Efergy Engage Hub Solo



- Access your energy data anytime, from anywhere
- See your energy data on our FREE platform and apps for Android, iPhone and iPad
- Eliminate bill shock, monitor your energy costs in real time
- View your daily, weekly, monthly or average costs in easy-to-read graphics
- Energy Report - download your daily, weekly, and monthly energy data onto your PC/Mac
- Compare your energy over 12 months and see where your costs are highest
- Choose to view your energy data in £'s, kWh or CO2
- Use the engage hub solo kit to track reductions in your household energy

Already an efergy user? Upgrade to online monitoring with the engage hub solo. If you already have an efergy monitor (e2 or elite) then you can use your existing sensor and transmitter to start monitoring your home energy use online and in real-time through. See your energy data through the engage, our FREE online platform and the engage apps for Android, iPhone and iPad. The engage hub receives a wireless signal from your fuse box and connects to the internet to send your usage data to your secure engage account.

The engage online platform gives you all the information you need to make positive changes to your consumption behaviour. By monitoring and understanding how much electricity your home is using you can save energy and money.

NOTE: The engage hub solo is only compatible with version 2 or higher of our elite classic and e2 monitors. Check what your version is by looking at your sensor version 1 or version 2. This product is compatible with the e2 and elite Optical. It is not compatible with the ecotouch and the HM01 monitor.

Order Code	Mod.	Price each exc. VAT	inc. VAT each
N41DD	Engage Hub Solo	£33.29	£39.95

Technical Helpline

0333 400 9500

For technical information and assistance relating to any Maplin purchase, contact our team of experts

Lighting Fittings

In-Line BC Lampholder White

A standard BC lampholder to BS5042. With cord-grip and sprung plungers, plus wide skirt. White.



Order Code	Mod.	Price each exc. VAT 1+	inc. VAT each
FQ02C	BC Lampholder	£1.90	£2.29

In-Line Switched BC Lampholder 60W White

- Standard T1 60W lampholder
- On/off switch
- Conforms to BS5042



Order Code	Mod.	Price each exc. VAT 1+	inc. VAT each
GC44X	T1 Switched Bulb/Hldr	£2.24	£2.69

Screw Mounted BC Lampholder White

A standard T2 BC lampholder to BS5042 in a plastic mount with wide skirt. This batten holder has sprung plungers and is finished in white. Diameter of base 65mm, fixing centres 52mm, overall height 67mm.



Order Code	Mod.	Price each exc. VAT 1+	inc. VAT each
LB63T	Bayonet L/Hldr	£2.24	£2.69

Replacement Ceiling Rose

- Replacement ceiling rose for your light fitting
- Colour : White



Order Code	Mod.	Price each exc. VAT 1+	inc. VAT each
N24DA	Replace Ceiling Rose	£1.65	£1.99

Ceiling Rose Pendant White 175mm



- Bayonet connection with 175mm of cable
- Ceiling rose and lamp holder pre assembled

Lampholder type FQ02C with a ceiling rose pre-wired together with approx. 175mm of white flex

Order Code	Mod.	Price each exc. VAT 1+	inc. VAT each
N23DA	9in Pendant Set	£3.32	£3.99

Junction Box 5A White



A 4-terminal junction box rated 5A per terminal. White. Size 58mm diameter (2.25"). ES6220 : 1991

Order Code	Mod.	Price each exc. VAT 1+	inc. VAT each
VQ63T	5 Amp Junction Box	£1.90	£2.29

Junction Box 20A White



A 4-terminal junction box rated 20A per terminal. White. Size 76mm (3") diameter. ES6220 : 1991.

Order Code	Mod.	Price each exc. VAT 1+	inc. VAT each
VQ64U	20A Junction Box	£1.99	£2.39

Junction Box 30A White



A 3-terminal junction box rated 30A per terminal. For inter-connections in ring main circuits. White. Size 85mm diameter. ES6220 : 1991

Order Code	Mod.	Price each exc. VAT 1+	inc. VAT each
VQ65V	30A Junction Box	£2.07	£2.49

Weatherproof Wiring

IP66 Rated Outdoor Switch 2G 2W

- Waterproof class IP66 rated
- Cost effective solution
- Made from high impact polycarbonate
- Suitable for up to 10A



Made from high impact polycarbonate material, this weather proof range offers a cost effective solution to outdoor power control. The switch is IP66 rated in use and the sockets IP66 rated when the lid is closed. Ideal for use with mowers, trimmers and garden power tools.

Order Code Description
N15CK 1 gang 2 way switch

Order Code	Mod.	Price each exc. VAT 1+	inc. VAT each
N29DA	2Gang IP66 Switch	£10.82	£12.99

IP66 Rated Outdoor Switch 1G 2W



- Waterproof class IP66 rated
- Cost effective solution
- Made from high impact polycarbonate
- Suitable for up to 10A

Made from high impact polycarbonate material, this weather proof range offers a cost effective solution to outdoor power control. The switch is IP66 rated in use and the sockets IP66 rated when the lid is closed. Ideal for use with mowers, trimmers and garden power tools.

Order Code Description
N15CK 1 gang 2 way switch

Order Code	Mod.	Price each exc. VAT 1+	inc. VAT each
N28DA	1Gang IP66 Switch	£8.32	£9.99

IP66 Rated Weatherproof Outdoor Socket 13A



- Waterproof class IP66 rated
- Suitable for severe weather conditions
- Made from high impact polycarbonate

Made from industrial grade high impact polycarbonate, oil, alkaline and UV resistant. Suitable for severe weather conditions, withstands pressure washer force, even when a 13 amp plug is fitted to the socket. IP66 Rated. Can be used for long term projects in all weather conditions. Ideal for lighting, garden features, power tools, pond equipment etc.

Order Code Description
N05CK 13A Outdoor Socket

Order Code	Mod.	Price each exc. VAT 1+	inc. VAT each
N05CK	13A Outdoor Socket	£16.65	£19.99

IP66 Rated Weatherproof RCD Protected Outdoor Socket 13A



- Double pole protected
- Weather protection to IP66

Weather protected while the plug is in the socket

Suitable for severe weather conditions, withstands pressure washer force, even when a 13 amp plug is fitted to the socket. IP66 Rated. Can be used for long term projects in all weather conditions.

Order Code	Mod: 1007094	Price each exc. VAT 1+	inc. VAT each
A86NF	IP66 RCD Socket	£29.15	£34.99

IP66 Rated Weatherproof Double Outdoor Socket 13A



- Waterproof class IP66 rated
- Suitable for severe weather conditions
- Made from high impact polycarbonate

Made from industrial grade high impact polycarbonate, oil, alkaline and UV resistant. Suitable for severe weather conditions, withstands pressure washer force, even when a 13 amp plug is fitted to the socket. IP66 Rated. Can be used for long term projects in all weather conditions. Ideal for lighting, garden features, power tools, pond equipment etc.

Order Code	Description
N06CK	13A Double Outdoor Socket

Order Code	Mod: 812416	Price each exc. VAT 1+	inc. VAT each
N06CK	13A Double OD Socket	£18.32	£21.99

IP66 Rated Outdoor Socket with Mechanical Timer



- Waterproof class IP66 rated
- Suitable for severe weather conditions
- Made from high impact polycarbonate
- With mechanical timer control socket
- With child protector
- Timer with an on/off switch

Made from industrial grade high impact polycarbonate, oil, alkaline and UV resistant. Suitable for severe weather conditions, withstands pressure washer force, even when a 13 amp plug is fitted into the sockets. IP66 Rated. Can be used for long term projects in all weather conditions. Ideal for lighting, garden features, power tools, pond equipment etc.

Order Code	Mod: 098623	Price each exc. VAT 1+	inc. VAT each
N08CK	OD Timer Socket	£24.99	£29.99

Find out more in-store

Our staff can offer friendly and expert advice; we're here to help



IP66 Rated Outdoor Remote Controlled Single Socket



- Includes transmitter
- Waterproof class IP66 rated
- Suitable for severe weather conditions
- Made from high impact polycarbonate

Made from industrial grade high impact polycarbonate, oil, alkaline and UV resistant. Suitable for severe weather conditions, withstands pressure washer force, even when a 13 amp plug is fitted into the socket. Can be used for long term projects in all weather conditions. Ideal for lighting, garden features, power tools, pond equipment etc.

Allows control of on/off feature through remote control transmitter - 50mtr range. Manual override switch built into socket, outlet IP66 Rated

Order Code	Mod: 098624	Price each exc. VAT 1+	inc. VAT each
N09CK	OD RC Socket	£31.65	£37.99

IP55 Rated Outdoor Junction Box 5T 4C



- Ideal for lighting, garden features, power tools, pond equipment etc
- Waterproof class IP55 rated
- Suitable for severe weather conditions
- Withstands pressure washer force, even when a 13 amp plug is fitted into the socket
- Made from high-impact polycarbonate
- Flame retardant to 150°C
- Oil, alkaline and UV resistant.
- 440V for 1.5mm-2.5mm 2 wire

Order Code:	Description:	Dimensions:
N10CK	5 terminals, 4 cable entries	70 (dia) x 40mm

Order Code	Mod: 812417	Price each exc. VAT 1+	inc. VAT each
N10CK	5T 4C Junction Box	£4.57	£5.49

IP55 Rated Outdoor Junction Box 5T 6C



- Ideal for lighting, garden features, power tools, pond

equipment etc

- Waterproof class IP55 rated
- Suitable for severe weather conditions
- Withstands pressure washer force, even when a 13 amp plug is fitted into the socket
- Made from high-impact polycarbonate
- Flame retardant to 150°C
- Oil, alkaline and UV resistant.
- 440V for 1.5mm-2.5mm 2 wire

Order Code:	Description:	Dimensions:
N11CK	5 terminals, 6 cable entries	80 (dia) x 80 x 45mm

Order Code	Mod: 812418	Price each exc. VAT 1+	inc. VAT each
N11CK	5T 6C Jctn Box Sml	£5.40	£6.49

Timeguard IP66 Rated Weathersafe Outdoor Multi Connector Box



- Tough and durable housing
- Easy solution for CCTV installations
- 20mm cable knock out (mains into socket strip)
- 2 gang, 13A socket strip included inside
- Up to 3 cable seal outlets (to appliances)
- IP66 weatherproof rating
- Keyhole slot for temporary locating and insitu alignment
- Dimensions: 230 (h) x 156 (w) x 107 (d) mm

Comes complete with a 2 way, 13 amp socket strip providing the ideal solution for outdoor plug-in power. Ideal for CCTV applications, transformer linked garden lighting, fountain pumps, pool filters etc

Order Code	Mod: 223333	Price each exc. VAT 1+	inc. VAT each
N97FY	2W Outdoor Box	£12.90	£15.49

Electrical & Wiring Books

17th Edition Electric Wiring for Domestic Installers

- A clear and reliable guide to the practical aspects of domestic electrical wiring
- Provides essential up-to-date information on modern methods and materials in a simple and concise way
- Explains step-by-step what needs to be done so that work can be carried out safely and correctly first time
- Fully updated in line with the 17th Edition Wiring Regulations and latest best practice
- Handy format with clear and straightforward text make this book popular as a quick guide to best practice for electricians
- Essential reading for anyone obtaining a Domestic Installer Scheme Qualification which relates to Part P of the Building Regulations
- Although not intended as a DIY manual, non-qualified persons will also find this book useful reading.

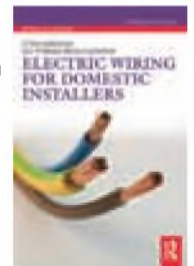

Order Code	Mod: 629976	Price each exc. VAT 1+	inc. VAT each
A72LG	Elect Wiring Dom 14e	£12.99	£12.99

Power Supplies

USB Power Supplies

2 in 1 USB Dual Charger



- Great USB charger for iPad, iPhone, iPod, GPS, PDA, Digital cameras...and many more USB powered devices
- Built-in IC chip and safety fuse
- Protection: over voltage, over current, short circuit protection
- Built in Car Charger

This 2-in-1 Charger for Phones with USB Connection has an all around compact 2 piece design with the convenience of a power charger and a travel charger in one unit.

Comes equipped with a LED status indicator light. The travel charger will work with any standard UK wall outlet. This Universal Charger also allows users to charge their gadget in the car via a car charger adapter that comes with it; users can just plug the charger into the cigarette lighter socket to do the charging work.

Another interesting feature of this Universal Charger is the dual USB port which allows users to charge two devices at the same time. Users will be notified when their devices are fully charged by a change of colour in the two LEDs mounted Super compatibility

Suitable for most of the digital mobile phones, MP3, MP4, ETC, GPS, The PSP, NDS, Bluetooth headsets, digital cameras and other mainstream digital equipment.

IC short circuit protection

The internal circuit after the IC short circuit protection design. Short-circuit protection, the current output is stable and secure, and extend battery life. Build-in protection circuit and buck-boost circuit, with anti-overcharger, anti-over-discharge, anti-electric current, anti-short circuit and temperature protection design, allowing you to use more peace of mind

Order Code	Mod:	Price each exc. VAT 1+	inc. VAT each
N57DP	1006346	£24.99	£29.99

ThinCharger

- The UK's first ever fold-flat USB charger
- USB socket with maximum 2.1A power output to support iPads, smart phones and more
- Manufactured with ultrasonic welding for long life durability

ThinCharger is a newly designed and patented award winning UK folding charger. Its unique feature is the double-jointed earth pin. In closed position the earth



pin is housed within the central column connected to the main body, and lies horizontally flat between the neutral and live pins

Input: AC 100-230V / 50-60Hz / 100mA

Output: DC 5V / 2100mA

Insulation strength: AC 3000V / 10mA for 1 minute
Insulation resistance: Input to output = 50 MΩ with 1 minute, DC 500V

Working conditions: 0°C-40°C, 5%-90%RH
Storage conditions: -20°C-85°C, 5%-90%RH

Order Code	Mod:	Price each exc. VAT 1+	inc. VAT each
N47CE	988126	£12.49	£14.99

Maplin 5V Micro USB Power Supply



- Charge your USB devices without a computer
- Compact light portable design, ideal for mobile phones and other devices
- Fitted with one micro USB connector
- Stabilised output, low ripple and low interference
- DC 5V, 1000mA output
- Can be used with the Raspberry Pi system

***** This power supply may not work on some BlackBerry models manufactured after 2011 due to their design *****

Input Power Plug: UK 3 Pin Mains Plug
Input Voltage: AC 100-230V 50 Hz
Output Voltage: DC 5V
Output Current: 1000mA

Order Code	Mod:	Price each exc. VAT 1+	inc. VAT each
N19HX	393067	£14.15	£16.99

Maplin 5V Mini USB Power Supply



- Charge your USB devices without the aid of a computer
- Compact light portable design
- Fitted with one mini USB (B) connector
- Stabilised output, low ripple and low interference

- DC 5V, 2500mA output

Input Voltage: AC 100 - 230V, 50Hz
Input Power Plug: UK 3 Pin Mains Plug
Output Voltage: DC 5V
Output Current: 2.5A (2500mA)
Output Voltage Type: Fixed
Output Power (Max): 12.5W
Regulated Output: Yes
Reversible Polarity: No
Number of Tips or Sockets: 1
Output Tips/Socket Type: Mini USB B Plug

Number of USB Sockets: 1
Output Power Cord Length: 1.5m
Switched Mode Supply: Yes
Efficiency: 73%
Dimensions: 80(l) x 30(w) x 54(d) mm
Weight: 120g

Order Code	Mod:	Price each exc. VAT 1+	inc. VAT each 5+
N31FU	224397	£14.15	£16.99

Maplin Twin 1.0A Output USB Power Supply

- The smallest twin USB output in the range
- 1A maximum current output
- Ideal for use with USB powered devices including mobile phones or digital cameras
- Fitted with two USB power sockets
- Ideal replacement or secondary power supply



Specifications:

Input Voltage: AC 100 - 230V, 50Hz
Input Power Plug: UK
Output Voltage: DC 5V
Output Current: 1000 mA
Output Voltage Type: Fixed
Output Power (Max): 5W
Regulated Output: Yes
Output Tips/Socket Type: USB A Socket
Number of USB Sockets: 2
Switched Mode Supply: Yes
Efficiency: 66%
Dimensions: 58(l) x 51(w) x 46(d) mm
Weight: 40g

Order Code	Mod:	Price each exc. VAT 1+	inc. VAT each 5+
N15GN	227633	£11.65	£13.99

Maplin Twin 2.1A Compact USB Power Supply

- Charge your mobile devices without using computer
- Ideal for most electronics devices like iPhone, iPad, Android tablet PC's plus MP3 and mobile phones
- High power 2.1A max output to suit large screen gadgets
- Includes two sockets so you can charge two devices at the same time (1A Max)
- Low power consumption on standby



Specifications:

Input Voltage: AC 120 - 230V, 50Hz
Input Power Plug: UK
Output Voltage: DC 5V
Output Current: 2.1A Max
Output Voltage Type: Fixed
Output Power (Max): 10.5W
Regulated Output: Yes
Output Tips/Socket Type: USB A Socket
Number of USB Sockets: 2
Switched Mode Supply: Yes
Efficiency: 66%
Dimensions: 77(l) x 40(w) x 45(d) mm
Weight: 77g

Order Code	Mod:	Price each exc. VAT 1+	inc. VAT each 5+
N13KG	562310	£14.99	£17.99

Maplin Twin 2.1A Travel USB Power Supply



- USB power adapter with two USB sockets to charge mobile phone or tablet computer
- 2.1A output, supporting thousands of devices - ideal for charging the iPad
- Supplied with UK, USA, European and Australasian power input plugs
- Use in over 150 countries, makes charging when travelling much easier

Specifications:

Input Voltage	AC 100 - 230V, 50Hz
Input Power Plug	UK, EU, USA & Australasian
Output Voltage:	DC 5V
Output Current	2.1A (2100mA)
Output Voltage Type:	Fixed
Output Power (Max):	10.5W
Regulated Output:	Yes
Reversible Polarity:	No
Output Tips/Socket Type:	USB A Socket
Number of USB Sockets:	2
Switched Mode Supply	Yes
Efficiency	>50%
Weight (including plugs):	110g

Order Code	Mod: 513509	Price each exc. VAT 1+	inc. VAT each 5+
N06JT	Travel USB PSU 2.1A	£18.32	£21.99

Maplin Twin 3.1A USB Power Supply

- High power USB adapter capable of charging tablets, smart phones, GPS and other USB devices
- 3.1A maximum output means you can charge devices like modern tablets and phones like iPads and iPhone
- Two USB sockets for multiple charging
- Charge your portable devices without being tied to your computer
- Lightweight and very portable



Specifications:

Input Voltage	AC 100 - 230V, 50Hz
Input Power Plug	UK
Output Voltage:	DC 5V
Output Current	3.1A max [2.1A + 1.0A]
Output Voltage Type:	Fixed
Output Power (Max):	15.5W
Regulated Output:	Yes
Reversible Polarity:	No
Output Tips/Socket Type:	USB A Socket
Number of USB Sockets:	2
Switched Mode Supply	Yes
Efficiency	>50%
Weight (including plugs):	92g

Order Code	Mod: 629936	Price each exc. VAT 1+	inc. VAT each 5+
N22NC	3.1A Dual USB PSU	£20.82	£24.99

Amacrox 4 Port High Power USB Charger



- Handy 4 port USB power supply to charge USB devices without a computer
- Small and compact size makes this easy to take travelling
- Clean up untidy desks and workstations with one neat power supply
- One socket is rated at 2.1A for tablets like iPad and three 1.0A for smartphones, GPS, gaming controllers
- Supplied with AC cable

Specifications:

Input Voltage:	AC 100 - 230V, 50Hz
Input Power Plug:	UK
Output Voltage	DC 5V
Output Current (Total Sockets)	5.1A (5100mA)
Output Voltage Type	Fixed
Output Power (Max)	25W
Regulated Output:	Yes
Reversible Polarity	No
Output Tips/Socket Type	USB A Socket
Number of USB Sockets:	4
Switched Mode Supply	Yes
Efficiency	>50%
Weight (including plugs)	110g

Order Code	Mod: 783581	Price each exc. VAT 1+	inc. VAT each 5+
N230Q	4 Port USB Charger	£20.82	£18.74 £24.99

Belkin 2.1 Amp Wall Charger in Pink



- Charge any mobile device at home
- Double Shielded
- Easily charge any portable device via the active USB port
- 2.1 Amp
- Part of the colourful and stylish mix-it range

Order Code	Mod: 858255	Price each exc. VAT 1+	inc. VAT each 5+
A68LZ	Bk 2.1A W/Chgr: Pnk	£14.99	£17.99

Belkin 2.1 Amp Wall Charger in Red



- Charge any mobile device at home
- Double Shielded
- Easily charge any portable device via the active USB port
- 2.1 Amp
- Part of the colourful and stylish mix-it range

Order Code	Mod: 858261	Price each exc. VAT 1+	inc. VAT each 5+
A70LZ	Bk 2.1A W/Chgr: Red	£14.99	£17.99

Maplin 2.1A Micro USB Home Charger



- For Micro USB products
- Worldwide use - Universal voltage AC 100-230V
- Single output DC 5V, 2.1A
- Reliable & high efficiency - Low energy consumption
- Safe charge - Stabilised output & low ripple
- Compact size & light weight
- Overload & short circuit protection

This Micro USB Home Charger, which is compact and light weight, is ideal as a secondary source to charge your mobile phones and tablets. You can keep it in your office as well as travelling with you. This charger equips with a fixed cable with Micro USB plug, which allows you to use instantly after plugging the charger into the wall. You do not need a separate USB cable. It is convenient for use.

Order Code	Mod: 1020779	Price each exc. VAT 1+	inc. VAT each 5+
N240Q	2.1A Micro USB PSU	£14.15	£16.99

Maplin 2.4A USB Home Charger



- With built-in smart charging IC for auto detection
- Worldwide use - Universal voltage AC 100-230V
- Single output DC 5V, 2.4A
- Reliable & high efficiency
- Low energy consumption
- Safe charge - Stabilised output & low ripple
- Compact size & light weight
- Overload & short circuit protection

This USB Home Charger, which is compact and light weight, is an ideal charger to charge your mobile phones and tablets from different brands, such as Apple, Samsung, Sony etc.. This charger equips with a smart chip, which provides a quick charge to your mobile devices. You can now just keep one charger at home, at office or for travel and you can enjoy quick charge for your all your devices.

Order Code	Mod: 1020777	Price each exc. VAT 1+	inc. VAT each 5+
N74DP	2.4A USB Home charg	£16.65	£19.99

Laptop Power Supplies

Universal Ultrabook and Tablet Power Supply



- 45-Watt Universal Power Adapter to charge selected brands and models of Ultrabooks and Tablets
- USB socket with maximum 2.1A power output to support iPads, smart phones and more
- Portable and compact universal adapter for modern Ultrabooks and Tablets

Tips Available: Asus, Hp Compaq, Fujitsu, P-B, Toshiba, Dell, Sony, Acer, HP Compaq, Asus, Samsung, Samsung Galaxy Tab, iPhone/iPad

Input / Output Power Cord Length: 1.8m
Output Voltage: 9V/10.5V/12.15V/19V
Output Current: 9/10.5V-3A; 12V/15V/19V-1.5A

USB Current: 2.1A
Output Power [Max]: 45W Max
Polarity: Centre Positive
Reversible Polarity: No
USB to Micro USB: 110cm
Switched Mode Supply: Yes
Dimensions: 35(W) x 109(H) x 70(D) mm
Weight: 230g

Order Code	Mod: 988128	Price each exc. VAT 1+	inc. VAT each
N46CE	45W Ultrabook and Ta	£24.99	£29.99

Maplin 40W Universal Netbook Power Supply



- Universal voltage power supply designed for netbook and ultrabook computers
- Ideal as a spare to make travelling between home and office easier
- Equipped with 9 different laptop tips which select the voltage required
- DC 9.5, 12, 19, 20V output, ideal for most netbook computers
- 3.3 amp or 2 amp current, dependent on voltage setting
- This device is intended for mini book and netbook PC's and not suitable for laptops

Specifications:
Input Voltage: AC 100 - 240V, 50Hz
Input Power Plug: UK 3 Pin Mains Plug
Input / Output: 1m / 1.4m
Power Cord Length: 1m / 1.4m
Output Voltage: DC 9.5, 12, 19, 20V
Output Current: DC 9.5, 12V - 3.3A (3300mA), DC 19, 20V 2A (2000mA)
Output Voltage Type: Variable

Output Power [Max]: 40W
Regulated Output: Yes
Polarity: Centre Positive
Reversible Polarity: No
Number of Tips or Sockets: 5
Output Tips/Socket Type: 4.8 x 1.7 x 12mm [DC 9.5V]
Asus, Acer: 4.8 x 1.7 x 12mm [DC 12V]

Asus: 4.75 x 1.7 x 12mm [DC 19V]
Acer, Dell, Fujitsu: 4.0 x 1.7 x 12mm [DC 19V]

HP/Compaq: 5.5 x 2.5 x 12mm [DC 20V]

MSI, Lenovo: 2.5 x 0.7 x 8mm [DC 19V]

Asus: 1.7 x 5.5 x 12mm [DC 19V]

Acer, Toshiba, Delta: 5.0 x 7.4 x 12mm [DC 19V]

HP/Compaq [with chip]: 5.0 x 7.4 x 12mm [DC 19V]

Order Code	Mod: 229072	Price each exc. VAT 1+	inc. VAT each
N59GU	40W Uni Netbook PSU	£24.99	£29.99

Maplin 90W Universal Slim Laptop Power Supply with USB Charger



- Universal 90 watt laptop power adapter with integrated USB charging function
- Voltages that can be selected are DC 12 / 15 / 16 / 18 / 18.5 / 19 / 19.5 / 20V
- 4.5A current; dependent on voltage setting
- Supplied complete with mains lead and popular power tips
- Stabilised output, low ripple and low interference
- Universal input voltage for use all over the world with suitable travel adapter
- 8 tips are included and additional tips can be purchased

Due to the wide variety in brands and models and the frequent release of new laptop models, it is likely that this power supply will work with your laptop, but please check the size of the tip, voltage and current of your laptop with the specifications below.

Specifications:
Input Voltage: AC 100 - 230V, 50Hz
Input Power Plug: UK 3 Pin Mains Plug
Input Power Cord Length: 1.3m
Output Voltage: DC 12, 15, 16, 18, 18.5, 19, 19.5, 20V
USB 5V
Output Current: 4.5A [4500mA] for DC 12 to 20V
1A [1000mA] for USB

Output Voltage Type: Variable
Output Power [Max]: 90W
Regulated Output: Yes
Polarity: Centre Positive
Reversible Polarity: No
Number of Tips or Sockets: 8
Number of USB Sockets: 1
Output Power Cord Length: 1.4m
Switched Mode Supply: Yes

Dimensions: 144 x 75 x 18.5mm
Weight: 264g
Tip Letter
A: 6.0 x 1.0
B: 6.3 x 3.0
C: 5.5 x 2.5
D: 5.5 x 2.1
E: 5.5 x 1.7
F: 4.8 x 1.7
G: 4.0 x 1.7
H: 5.1 x 1.0

Order Code	Mod: 455060	Price each exc. VAT 1+	inc. VAT each
N07JC	Slim 90W Adaptor	£39.15	£46.99

Maplin 90W Universal Laptop Power Supply with Travel Adapter Plugs



- Mains, in-flight and in car connections for a truly portable mobile power solution
- Includes 10 tips for many of the popular laptop brands and 9 mobile accessory tips including DSi, Micro USB, Mini USB etc
- LED voltage display and simple button to select the required output
- 90W of power for the laptop and USB connection
- 18.5V and 19.5V support

This Laptop power solution is perfect for the traveller with technology. Boasting 10 laptop tips, 9 mobile tips, USB lead, EmPower™ plane socket and car cigarette plug you have the perfect travel companion. To use the mains in different countries make sure you pack the travel plug adapter for that region.

Due to the wide variety in brands and models and the frequent release of new laptop models, it is likely that this power supply will work with your laptop, but please check if the plug type and power rating fits your laptop's requirements.

Technical Specifications
Input: 120V AC or 230V AC
In Car Adapter: 12V
In Flight Adapter: 120V AC or 230V AC
12V DC
Input Voltage: UK, EU, USA, AUS
Input Power Plug: 1.2M
Input Power Cord Length: 12, 15, 16, 18, 19, 20V @ 4.5A
Output Voltage: 22V, 24V @ 3.75A
5V USB @ 1A
Output Power Cord Length: 1.3M
Output Voltage Type: Variable
Output Power [Max]: 90W

Order Code	Mod: 341898	Price each exc. VAT 1+	inc. VAT each
N40HJ	90W Worldwide Laptop	£41.65	£49.99

Maplin USB Charge Tip Pack



- Complete USB tip pack including the cable to easily charge your many portable
- With 5 power tips to charge all popular mobile phone, MP3 and camera devices
- Travel light: Compact and light-weight solution to take anywhere
- Works instantly with any USB port on notebook, desktop PC or MAC, car audio player etc
- Ideal to extend your laptop, netbook or ultrabook with USB charge port to a universal charging solution

Order Code	Mod: 622756	Price each exc. VAT	inc. VAT each
		1+	5+
N31LJ	USB Power Tips	£5.82	£6.99

Maplin Universal Laptop Power Tip Selection



- Ideal replacements for lost or broken tips
- Eight common sizes included
- Uses 2.1 X 5.5MM connection found on many universal laptop supplies
- Suits Maplin models N37FK, N28GH, N40HJ, N19GU, N07JC

A range of power tips to fit laptop power supplies which use the round 5.5MM X 2.1mm socket system on the leads of popular universal laptop adapters.

Specifications

Size in mm	Tip Letter
6.0 x 1.0	A
6.3 x 3.0	B
5.5 x 2.5	C
5.5 x 2.1	D
5.5 x 1.7	E
4.8 x 1.7	F
4.0 x 1.7	G
5.1 x 1.0	H

Order Code	Mod: 352647	Price each exc. VAT	inc. VAT each
		1+	5+
N31HA	Laptop Tips Kit 1	£6.65	£7.99

Maplin Laptop Power Tip Selection



- Ideal to more function to your universal laptop adapter
- Eight sizes included and support for brands such as Apple, HP, Dell and more
- Uses 2.1 X 5.5MM connection found on many universal laptop supplies
- Suits Maplin models N37FK, N28GH, N40HJ, N19GU, N07JC

Add more laptop compatibility to your universal laptop adapter with this selection of eight power tips.

Please note: It is essential to check the voltage of your adapter is correct for your computer, these tips will not auto select the required voltage.

5.0 x 7.4 x 0.6
5.0 x 7.4 x 0.6
6.8 x 7.9 x 2.3
1.8 x 5.5
3 Pin Dell
4 Pin Toshiba
Tip Dim. (mm)
2.5 x 0.7
5.6 x 7.9 x 0.9

Order Code	Mod: 475774	Price each exc. VAT	inc. VAT each
		1+	5+
N06JF	Laptop Tips Kit 2	£8.32	£9.99

HP Compaq
Dell
Apple
Acer
Dell
Toshiba
Laptop Brand Suggestion
Asus
Lenovo, IBM

Maplin 120W Slim Mains Laptop Power Supply With USB



- 120W output suits most over 17" laptops
- Replace faulty 18.5V to 19.5V original laptop power supplies
- Upgrade your existing laptop adapter with this slim design
- Features a 2.1A USB port to charge tablets, smartphones or other USB powered equipment
- Includes 7 of the most popular power tips for maximum compatibility
- Supplied complete with mains lead

Input Voltage:	AC 100 - 230V, 50Hz
Input Power Plug:	UK 3 Pin Mains Plug
Input / Output Power	
Cord Length	1.2m / 1.5m
Output Voltage	19V
Output Current:	6.3A (6300mA)
USB Socket	1
Output Voltage Type	2.1A
Output Power (Max)	Fixed
Regulated Output:	120W
Polarity:	Centre Positive
Reversible Polarity	No
Number of Tips or Sockets	7
Tip Dimensions:	1.7 x 5.5 x 12mm 1.7 x 4.75 x 10mm 0.6 (pin) x 7.4 x 12.5mm 2.5 x 5.5 x 12mm 0.9 (pin) x 7.9 x 11.5mm 1.0 (pin) x 5.0 x 11.5mm 1.4 (pin) x 6.5 x 12mm

Switched Mode Supply	Yes
Efficiency:	
Dimensions	122(l) x 75(w) x 18.5(d) mm
Weight	316g

Order Code	Mod: 785223	Price each exc. VAT	inc. VAT each
		1+	5+
N27QK	120W 19V Slim USB	£49.99	£59.99

Maplin 65W Slim Mains Laptop Power Supply with USB



- 65 W output suits many up to 15" laptops
- Replace faulty 18.5 V to 19.5 V original laptop power supplies
- Upgrade your existing laptop adapter with this slim design

- Features a 2.1 A USB port to charge tablets, smartphones or other USB powered equipment
- Includes 7 of the most popular power tips for maximum compatibility
- Supplied complete with mains lead

Input Voltage	AC 100 - 230 AC V, 50 Hz
Input Power Plug	UK 3 Pin Mains Plug
Input / Output	
Power Cord Length	1.2 m / 1.5 m
Output Voltage	19 V DC
Output Current	3.14 A (3140 mA)
USB Socket	1
Output Voltage Type	2.1 A
Output Power (Max)	Fixed
Regulated Output	65 W
Polarity	Centre Positive
Reversible Polarity	No
Number of Tips or Sockets	7
Tip Dimensions	1.7 x 5.5 x 12 mm 1.7 x 4.75 x 10 mm 0.6 (pin) x 7.4 x 12.5 mm 2.5 x 5.5 x 12 mm 0.9 (pin) x 7.9 x 11.5 mm 1.0 (pin) x 5.0 x 11.5 mm 1.4 (pin) x 6.5 x 12 mm

Switched Mode Supply	Yes
Efficiency	87%
Dimensions:	114(l) x 55(w) x 17.5(h) mm
Weight	240 g

Order Code	Mod: 785227	Price each exc. VAT	inc. VAT each
		1+	5+
N28QK	65W 19V Slim USB	£33.32	£39.99

Acer Compatible 65W Laptop Power Supply



- Replacement adapter for Acer laptops
- Designed to be compatible with many models
- Compact lightweight and ideal size to travel with
- Perfect solution if you want an additional supply
- Output is fixed to 19V dc and 3.42A maximum
- Power tip is fixed to ensure a good connection with models

Specifications:	
Input Voltage	AC 100 - 230V, 50Hz
Input Power Plug	UK 3 Pin Mains Plug
Input / Output	
Power Cord Length	1m / 1.4m
Output Voltage	19V dc
Output Current	3.42A
Output Voltage Type	Fixed
Output Power (Max)	65W
Regulated Output	Yes
Polarity	Centre Positive
Reversible Polarity	No
Output Tips/Socket Type	5.5 x 1.7mm
Switched Mode Supply	Yes
Efficiency	85%
Dimensions (LxWxH) mm	108 x 54.6 x 29
Weight	200g

Order Code	Mod: 785206	Price each exc. VAT	inc. VAT each
		1+	5+
N21QK	Compatible Acer 65W	£41.65	£49.99

Reserve online, collect in-store in 30 minutes



Acer 65W Laptop Power Supply



- Acer branded AC Adapter
- Designed to meet or exceed original adapter specifications
- Compatible with many laptop models
- UK mains lead included

OEM Laptop power supply

Specifications:

Input Voltage:	AC 100 - 230V, 50Hz
Input Power Plug:	UK 3 Pin Mains Plug
Input / Output	
Power Cord Length	1.2m / 1.8m
Output Voltage:	DC 19V
Output Current:	3.42A (3420mA)
Output Voltage Type:	Fixed
Output Power [Max]:	65W
Regulated Output:	Yes

Compatibility List

Suits hundreds of:
Tavelmate
Extensa
Aspire
models

Order Code	Mod.	Price each exc. VAT 1+	inc. VAT each
N30HN	Acer 65W 19V Ac	£49.99	£59.99

Apple Original 85W MacBook MagSafe Mains Laptop Power Supply



- Genuine adapter for MacBook Pro 15 and 17 inch computers
- Apple part number MC556B/C
- Replace lost or faulty power supplies
- Ideal as a second adapter to leave at the home or office

Order Code	Mod.	Price each exc. VAT 1+	inc. VAT each
N42DQ	Apple MagSafe 85W	£66.65	£79.99

Dell Compatible 65W Laptop Power Supply



- Replacement adapter for Dell laptops
- Designed to be compatible with many models
- Compact lightweight and ideal size to travel with
- Perfect solution if you want an additional supply

- Output is fixed to 19.5V dc and 3.34A maximum
- Power tip is fixed to ensure a good connection with models

Specifications:

Input Voltage:	AC 100 - 230V, 50Hz
Input Power Plug:	UK 3 Pin Mains Plug
Input / Output	
Power Cord Length	1m / 1.4m
Output Voltage:	19.5V dc
Output Current:	3.34A
Output Voltage Type:	Fixed
Output Power [Max]:	65W
Regulated Output:	Yes
Polarity:	Centre Positive
Reversible Polarity:	No
Output Tips/Socket Type:	7.4 x 5.0 x 13mm, 0.6mm centre pin - Octal type tip
Switched Mode Supply:	Yes
Efficiency:	85%
Dimensions [LxWxH] mm:	108 x 46 x 29
Weight:	192g

Order Code	Mod.	Price each exc. VAT 1+	inc. VAT each
N220K	Compatible Dell 65W	£41.65	£49.99

Dell Compatible 90W Mains Laptop Power Supply



- Replacement adapter for Dell laptops
- Designed to be compatible with many models
- Compact lightweight and ideal size to travel with
- Perfect solution if you want an additional supply
- Output is fixed to 19.5V dc and 4.62A maximum
- Power tip is fixed to ensure a good connection with models

Specifications:

Input Voltage:	AC 100 - 230V, 50Hz
Input Power Plug:	UK 3 Pin Mains Plug
Input / Output	
Power Cord Length	1m / 1.4m
Output Voltage:	19.5V dc
Output Current:	4.62A
Output Voltage Type:	Fixed
Output Power [Max]:	90W
Regulated Output:	Yes
Polarity:	Centre Positive
Reversible Polarity:	No
Output Tips/Socket Type:	7.4 x 5.0 x 13mm, 0.6mm centre pin
Switched Mode Supply:	Yes
Efficiency:	85%
Dimensions [LxWxH] mm:	127 x 58 x 31
Weight:	260g

Order Code	Mod.	Price each exc. VAT 1+	inc. VAT each
N85KB	Compatible Dell 90W	£41.65	£49.99

Dell Original 65W Mains Laptop Power Supply



- Direct replacement for Dell computers
- Designed to meet or exceed original adapter

specifications

- Compatible with many laptop models
- UK mains lead included

OEM Laptop power supply

Specifications:

Input Voltage:	AC 100-230V, 50hz
Input Power Plug:	UK 3 Pin Mains Plug
Input / Output	
Power Cord Length	1.8m
Output Voltage:	19.5V
Output Current:	3.34A
Output Voltage Type:	FIXED
Output Power [Max]:	65W
Tip Size:	7.4mm x 5.1mm
Regulated Output:	YES
Polarity:	n/a
Compatibility List:	Dell Inspiron 1501, 1520, 1521, 300m 500m, 510m, 6000, 630m, 6400, 640m, M301, D400, D410, D420, D505, D510, D520, D530, D531, D600, D620, D630, E4200, Studio 1340, 1555.

Order Code	Mod.	Price each exc. VAT 1+	inc. VAT each
N75KU	Dell Lat. 19.5v 65W	£33.32	£39.99

Dell Original 90W Laptop Power Supply



- OEM AC adapter to fit Dell branded notebooks and laptops
- Direct Replacement for multiple Latitude, Inspiron models and many more
- Guaranteed to charge your DELL laptop unlike most universal power supplies
- Supplied with the AC power input cord
- 19.5V and 4.62A

OEM Laptop power supply, please note actual version may vary from that shown in the image

Compatible Laptops

Genuine OEM Dell YY20N 90W Replacement AC Adapter for Dell Notebook Model: Inspiron 17R (N7110), Latitude E5430, Latitude E5530, Latitude E6230, 100%

Compatible with P/N: R8D4D, 331-6301, 450-16686, MK947, ADP-90LD B, DA90PM111, YY20N, FA90PM111, MV2MM, AA90PM111, YD9W8, LA90PM111, PA-1900-32D

Specifications:

Input Voltage:	AC 100 - 230V, 50Hz
Input Power Plug:	UK 3 Pin Mains Plug
Input / Output	
Power Cord Length	1.2m / 1.8m
Output Voltage:	DC 19.5V
Output Current:	4.62A (4620mA)
Output Voltage Type:	Fixed
Output Power [Max]:	90W
Regulated Output:	Yes
Polarity:	Centre Positive
Reversible Polarity:	No
Number of Tips or Sockets:	1
Output Tips/Socket Type:	7.4mm, 5.0mm, 13mm with centre pin 0.6mm
Switched Mode Supply:	Yes
Efficiency:	0.7
Dimensions:	130 mm x 58 mm x 32 mm
Weight:	380g

Order Code	Mod.	Price each exc. VAT 1+	inc. VAT each
N46DP	Dell AC adapter	£33.32	£39.99

HP Original Mini 30W Mains Laptop Power Supply



- Direct replacement for HP computers
- Designed to meet or exceed original adapter specifications
- Compatible with many laptop models
- UK mains lead included

OEM Laptop power supply

Specifications:

Input Voltage	AC 100-230V, 50hz
Input Power Plug	UK 3 Pin Mains Plug
Input / Output	
Power Cord Length	1.8m
Output Voltage:	19V
Output Current	1.58A
Output Voltage Type:	FIXED
Output Power (Max):	30W
Tip Size:	4.8mm x 1.7mm
Regulated Output:	YES
Polarity:	n/a
Compatibility List:	HP Mini 1000, 1010, 1030, 1035, 1018, 1019, 1020, 1097, 1098, 1099, 110, 1101, 1111, 1120, 1122, 1123, 1124, 1125, 1126, 1127, 1128, 1130, 1140, 1150, 1160, 1170, 1180, 1190, 1198, 1199

Order Code	Mod:	Price each exc. VAT 1+	inc. VAT each
N69KU	HP/Compaq Mini 30W	£54.15	£64.99

HP/Compaq Compatible 90W Laptop Power Supply



- Replacement adapter for HP/Compaq laptops
- Designed to be compatible with many models
- Compact lightweight and ideal size to travel with
- Perfect solution if you want an additional supply
- Output is fixed to 18.5V dc and 4.68A maximum
- Power tip is fixed to ensure a good connection with models

Specifications:

Input Voltage:	AC 100 - 230V, 50Hz
Input Power Plug:	UK 3 Pin Mains Plug
Input / Output	
Power Cord Length	1m / 1.4m
Output Voltage:	18.5V dc
Output Current:	4.68A
Output Voltage Type:	Fixed
Output Power (Max):	90W
Regulated Output:	Yes
Polarity:	Centre Positive
Reversible Polarity:	No
Output Tips/Socket Type:	5.5 x 1.7mm
Switched Mode Supply:	Yes
Efficiency:	85%
Dimensions [LxWxH] mm:	127 x 58 x 31
Weight:	283g

Order Code	Mod:	Price each exc. VAT 1+	5+	inc. VAT each
N24QK	Compatible HP 90W	£41.65	£37.49	£49.99

Samsung Original 65W Laptop Power Supply



- Direct replacement for Samsung computers
- Designed to meet or exceed original adapter specifications
- Compatible with many laptop models
- UK mains lead included

OEM Laptop power supply

Specifications:

Input Voltage	AC 100-230V, 50hz
Input Power Plug	UK 3 Pin Mains Plug
Input / Output	
Power Cord Length	1.8m
Output Voltage:	19V
Output Current	3.42A
Output Voltage Type:	FIXED
Output Power (Max):	65W
Tip Size:	5.5mm x 3mm
Regulated Output:	YES
Polarity:	n/a
Compatibility List:	Samsung A10, GT6000, GT7000, GT8000, M40, P200, P28, P29, P30, P35, P40, Q1, Q30, R40, R45, R510, R530, R55, R60, VM8000, X05, X10, X11, X15, X30

Order Code	Mod:	Price each exc. VAT 1+	inc. VAT each
N72KU	Samsung 65W 19v	£59.99	£71.99

HP/Compaq Compatible 65W Mains Laptop Power Supply



- Replacement adapter for HP/Compaq laptops
- Designed to be compatible with many models
- Compact lightweight and ideal size to travel with
- Perfect solution if you want an additional supply
- Output is fixed to 18.5V dc and 3.5A maximum
- Power tip is fixed to ensure a good connection with models

Specifications:

Input Voltage	AC 100 - 230V, 50Hz
Input Power Plug	UK 3 Pin Mains Plug
Input / Output	
Power Cord Length	1m / 1.4m
Output Voltage:	18.5V dc
Output Current	3.5A
Output Voltage Type:	Fixed
Output Power (Max):	65W
Regulated Output:	Yes
Polarity:	Centre Positive
Reversible Polarity:	No
Output Tips/Socket Type:	7.4 x 5.0 x 13mm, 0.6mm centre pin
Switched Mode Supply:	Yes
Efficiency:	85%
Dimensions [LxWxH] mm:	108 x 46 x 29
Weight:	204g

Order Code	Mod:	Price each exc. VAT 1+	inc. VAT each
N84KB	Compatible HP 65W	£41.65	£49.99

IBM/Lenovo Compatible 80W Laptop Power Supply



- Replacement adapter for IBM/Lenovo laptops
- Designed to be compatible with many models
- Compact lightweight and ideal size to travel with
- Perfect solution if you want an additional supply
- Output is fixed to 19V dc and 4.21A maximum
- Power tip is fixed to ensure a good connection with models

Specifications:

Input Voltage:	AC 100 - 230V, 50Hz
Input Power Plug:	UK 3 Pin Mains Plug
Input / Output	
Power Cord Length	1m / 1.4m
Output Voltage:	19V dc
Output Current:	4.21A
Output Voltage Type:	Fixed
Output Power (Max):	80W
Regulated Output:	Yes
Polarity:	Centre Positive
Reversible Polarity:	No
Output Tips/Socket Type:	5.5 x 2.5mm
Switched Mode Supply:	Yes
Efficiency:	85%
Dimensions [LxWxH] mm:	127 x 58 x 31
Weight:	280g

Order Code	Mod:	Price each exc. VAT 1+	5+	inc. VAT each
N23QK	Compatible IBM 80W	£41.65	£37.49	£49.99

Tips, Cables & Testing

Maplin 3-15V AC and DC Polarity Checker



- Compact and easy to use
- Checks 3V to 15V (AC and DC)
- Suitable for 2.1mm and 1.3mm DC power plugs and 3.5mm mono jack plug
- Identifies if centre pin positive or negative or AC
- Can help prevent potential damage to expensive equipment

Order Code	Mod:	Price each exc. VAT 1+	5+	inc. VAT each
R587U	PSU Polarity Checker	£2.90	£2.61	£3.49

Buy it on the web at
maplin.co.uk

Shop for all Maplin products online at our website and check out our latest products and special offers!



Power Tip Connector C



- Standard DC tip for use with universal power supplies
- Ideal to replace lost or broken tips
- Suited for the Maplin DC lead AQ81C
- Covers many power sockets found on personal music, toys and games

Order Code	Type	Size (mm)	Price each exc. VAT 1+	Price each exc. VAT 5+	inc. VAT each
AQ86T	C	3 x 1	£1.74	£1.56	£2.09

Power Tip Connector D



- Standard DC tip for use with universal power supplies
- Ideal to replace lost or broken tips
- Suited for the Maplin DC lead AQ81C
- Covers many power sockets found on personal music, toys and games

Order Code	Type	Size (mm)	Price each exc. VAT 1+	Price each exc. VAT 5+	inc. VAT each
AQ87U	D	5 x 2.1	£1.65	£1.49	£1.99

Power Tip Connector E



- Standard DC tip for use with universal power supplies
- Ideal to replace lost or broken tips
- Suited for the Maplin DC lead AQ81C
- Covers many power sockets found on personal music, toys and games

Order Code	Type	Size (mm)	Price each exc. VAT 1+	Price each exc. VAT 5+	inc. VAT each
AQ88V	E	5.5 x 2.1	£1.65	£1.49	£1.99

Power Tip Connector F



- Standard DC tip for use with universal power supplies
- Ideal to replace lost or broken tips
- Suited for the Maplin DC lead AQ81C
- Covers many power sockets found on personal music, toys and games

Order Code	Type	Size (mm)	Price each exc. VAT 1+	Price each exc. VAT 5+	inc. VAT each
AQ89W	F	5 x 2.5	£1.74	£1.56	£2.09

Power Tip Connector G



- Standard DC tip for use with universal power supplies
- Ideal to replace lost or broken tips
- Suited for the Maplin DC lead AQ81C
- Covers many power sockets found on personal music, toys and games

Order Code	Type	Size (mm)	Price each exc. VAT 1+	Price each exc. VAT 5+	inc. VAT each
AQ90X	G	5.5 x 2.5	£1.65	£1.49	£1.99

Power Tip Connector H



- Standard DC tips for use with universal power supplies
- Ideal to replace lost or broken tips
- Suited for the Maplin DC lead AQ81C
- Covers many power sockets found on personal music, toys and games

Order Code	Type	Size (mm)	Price each exc. VAT 1+	Price each exc. VAT 5+	inc. VAT each
AQ91Y	H	3.5 x 1.35	£1.74	£1.56	£2.09

Power Tip Connector I



- Standard DC tips for use with universal power supplies
- Ideal to replace lost or broken tips
- Suited for the Maplin DC lead AQ81C
- Covers many power sockets found on personal music, toys and games

Order Code	Type	Size (mm)	Price each exc. VAT 1+	Price each exc. VAT 5+	inc. VAT each
AR22Y	I	4 x 1.7	£1.65	£1.49	£1.99

Power Tip Connector J



- Standard DC tips for use with universal power supplies
- Ideal to replace lost or broken tips
- Suited for the Maplin DC lead AQ81C
- Covers many power sockets found on personal music, toys and games

Order Code	Type	Size (mm)	Price each exc. VAT 1+	Price each exc. VAT 5+	inc. VAT each
AR23A	J	4.75 x 1.75	£1.65	£1.49	£1.99

Power Tip Connector Q



- Standard DC tips for use with universal power supplies
- Ideal to replace lost or broken tips
- Suited for the Maplin DC lead AQ81C
- Covers many power sockets found on personal music, toys and games

Order Code	Type	Size (mm)	Price each exc. VAT 1+	Price each exc. VAT 5+	inc. VAT each
AR27E	Q	6.3 x 3	£1.65	£1.49	£1.99

Power Tip Connector S



- Standard DC tips for use with universal power supplies
- Ideal to replace lost or broken tips
- Suited for the Maplin DC lead AQ81C
- Covers many power sockets found on personal music, toys and games

Order Code	Type	Size (mm)	Price each exc. VAT 1+	Price each exc. VAT 5+	inc. VAT each
AR29G	S	2.35 x 0.75	£1.90	£1.74	£2.29

3A DC Output Power Supply Cable 1.8m



- Ideal way to repair or build power supply leads
- Moulded socket to accept reversible polarity plugs
- Tip + marking for correct tip insertion
- White trace to indicate positive terminal, 1.8m cable length
- Compatible with tip connectors from many different power supplies
- Capable of carrying loads up to 3A

Order Code	Mod.	Price each exc. VAT 1+	Price each exc. VAT 5+	inc. VAT each
AQ81C	DC Output Lead	£2.07	£1.86	£2.49

DC Power Extension Cable Set 2.1mm 1m



- 2.1mm 'daisy chain' adapter
- DC line socket to 5 DC plugs
- Used to power several devices with one suitable

power supply

- Ideal for many applications including CCTV or guitar effects pedals
- Overall length 1M, rated 1A 75Vdc

Order Code	Mod: 001410	Price each exc. VAT	inc. VAT each
JR94C	Pwr Ext Lead 2.1mm	£5.82	£6.99

Technical Helpline



0333 400 9500

For technical information and assistance relating to any Maplin purchase, contact our team of experts

DC Output Plug Set - Pack A



A range of DC power plugs featuring the 2-pin connector that fits the connector found on the lead of most AC mains adapters. This selection of popular DC plugs offers plugs that are seen on personal stereos, radios, portable CD players, games etc. The following plugs are included:

Size	Type
2.5mm mono jack plug	A
3.5mm mono jack plug	B
5 x 2.1mm hollow	D
5.5 x 2.5mm hollow	G
3.5 x 1.35mm hollow	H
4 x 1.7mm hollow	I
5.5 x 1.5mm hollow	N
2.35 x 0.78mm hollow	S

Order Code	Mod: 042948	Price each exc. VAT	inc. VAT each
N96AP	Power Tips Pack A	£6.65	£7.99

DC Output Plug Set - Pack B



- A range of DC power plugs
- Selection of plugs commonly found on small DC powered equipment

A range of DC power plugs featuring the 2-pin connector that fits the connector found on the lead of most AC mains adapters. This range has been put together to integrate out top sellers with a selection of plugs commonly found on small DC powered equipment, in one handy set. The following plugs are included:

Size	Type
5.5 x 2.1mm hollow	E
5.5 x 2.5mm hollow	G
3.5 x 1.35mm hollow	H
4 x 1.7mm hollow	I
4.75 x 1.75mm hollow	J
2.35 x 0.78mm hollow	S
6.5 x 1mm hollow	AA
5.5 x 7.5mm hollow	AB

Order Code	Mod: 042951	Price each exc. VAT	inc. VAT each
N97AP	Power Tips Pack B	£7.49	£8.99

Maplin Slim Mains Laptop Power Supply Tips



- Convenient to carry
- Can be used in various brands computers
- 7 detachable plugs include
- Suitable for Maplin Codes (N280K and N270K)

The detachable plugs can be used in various brands' computers. They are easy to carry too

- E: 4.0x6.5x12.0mm
 - G: 3.5x5.0x11.5mm
 - N: 5.5x7.9x11.5mm
 - P: 2.5x5.5x12.0mm
 - QV2: 5.0x7.45x12.5mm
 - T: 1.7x4.75x10.0mm
 - X: 1.7x5.5x12.0mm
- Different brands' computers includes:
- E: Fujitsu - FMV-BIBLO, Lifebook, Stylistic series;
 - Panasonic - all series; Sony - PictureBook, VAIO seriesG;
 - SamsungN IBM - 3000C, 3000N, 3000V series; Lencov - 3000 seriesP
 - Fujitsu - Amilo, Lifebook Acer; Asus, Compaq, Gateway HP, IBM, Panasonic, Samsung, Sharp, Toshiba, HitachiQV2 HP - Compaq 6000, 8000 seriesT HP - Pavilion series, Folic, Nctebck PC seriesX. Acer - Aspire Timeline, Timeline Ultra series"

Order Code	Mod: 1021260	Price each exc. VAT	inc. VAT each
N270Q	N280K N270K Tips	£6.65	£7.99

Send direct

If any product is not in stock, we will order it for you and send it with free delivery

Terms and conditions apply



Power Supply Adapters

3A AC/AC Fixed Voltage 12V Power Supply



- AC to AC adapter - ideal for domestic lighting, certain telecoms and toy applications
- Supplied with 2 of the most popular power tips
- 1.8m lead from mains plug to power supply
- 1.8m lead from power supply output to appliance

Please note: Prior to use, please be sure that it is an AC output supply that you require for your use. Most consumer electronics devices use a DC current for power. If you are in any doubt, please consult a member of staff for further information.

Using an AC output adapter on an appliance that requires a DC current may cause permanent and irreversible damage to your equipment. Maplin Electronics accepts no responsibility for damage caused to equipment by using the wrong type of power supply.

Specifications:

Input Voltage	AC 230V, 50Hz
Input Power Plug	UK 3 Pin Mains Plug
Input / Output Power Cord Length	1.8m / 1.8m
Output Voltage	AC 12V 3A

Order Code	Mod: 1001587	Price each exc. VAT	inc. VAT each
N57DL	AC/AC 12V 3A PSU	£21.65	£25.99

Newsletter



Subscribe to our newsletter for information about the latest innovation and the best deals.

Maplin 6W Switched Mode AC/DC Fixed Voltage 3V Power Supply



- High quality fixed voltage adapters
- Regulated switched mode output voltages
- Provided with 8 of the most popular power tips
- User selectable polarity

Weight	82g
Switched Mode Supply	Yes
Output Power (Max)	6W
Output Voltage Type	Fixed
Output Current	1200mA
Input Voltage	AC 230V, 50Hz
Output Voltage	3V
Number of Tips or Sockets	8
Output Tips/Socket Type	
2.35 x 0.7 x 10.5mm	5.0 x 2.1 x 12mm
4.0 x 1.7 x 9.5mm	5.5 x 2.5 x 12mm
4.75 x 1.7 x 9.5mm	6.3 x 3.0 x 14mm
Input Power Plug	UK 3 Pin Mains Plug
Polarity	Centre Positive
Reversible Polarity	Yes
Output Power Cord Length	1.8m

Order Code	Mod: 807302	Price each exc. VAT	inc. VAT each
MG76H	AC/DC PSU 3V 1200mA	£10.82	£12.99

Maplin TV

Home of innovation, handy tips and How To videos

Visit our channel...

youtube.com/maplintv



Maplin 6W Switched Mode AC/DC Fixed Voltage 4.5V Power Supply



- High quality fixed voltage adapters
- Regulated switched mode output voltages
- Provided with 8 of the most popular power tips
- User selectable polarity

Switched Mode Supply	Yes
Output Power [Max]:	6W
Output Voltage Type	Fixed
Output Current	1200mA
Input Voltage	AC 230V, 50Hz
Output Voltage:	4.5V
Output Tips/Socket Type:	
2.35 x 0.7 x 10.5mm	5.0 x 2.1 x 12mm
4.0 x 1.7 x 9.5mm	5.5 x 2.5 x 12mm
4.75 x 1.7 x 9.5mm	6.3 x 3.0 x 14mm
Output Power Cord Length:	1.8m
Input Power Plug:	UK 3 Pin Mains Plug
Polarity:	Centre Positive
Reversible Polarity:	Yes
Weight:	82g

Order Code	Mod.	807303	Price each exc. VAT 1+	5+	inc. VAT each
M677J	AC/DC PSU 4.5V 1.2A		£10.82		£12.99

Maplin 6W Switched Mode AC/DC Fixed Voltage 6V Power Supply



- High quality fixed voltage adapters
- Regulated switched mode output voltages
- Provided with 8 of the most popular power tips
- User selectable polarity

Weight:	82 g
Switched Mode Supply	Yes
Output Power [Max]:	6 W
Output Voltage Type	Fixed
Output Current	1000 mA
Input Voltage	AC 230 V, 50 Hz
Output Voltage:	6 V
Input Power Plug:	UK 3 Pin Mains Plug
Number of Tips or Sockets	8
Output Tips/Socket Type:	
2.35 x 0.7 x 10.5 mm	5.0 x 2.1 x 12 mm
4.0 x 1.7 x 9.5 mm	5.5 x 2.5 x 12 mm
4.75 x 1.7 x 9.5 mm	6.3 x 3.0 x 14 mm
Polarity:	Centre Positive
Reversible Polarity:	Yes
Output Power Cord Length:	1.8 m

Order Code	Mod.	807304	Price each exc. VAT 1+	5+	inc. VAT each
L66BQ	AC/DC PSU 6V 1000mA		£10.82		£12.99

Maplin 6W Switched Mode AC/DC Fixed Voltage 9V Power Supply



- High quality fixed voltage adapters
- Regulated switched mode output voltages
- Provided with 8 of the most popular power tips
- User selectable polarity

Weight	82g
Switched Mode Supply:	Yes
Output Power [Max]	6W
Output Voltage Type:	Fixed
Output Current:	600mA
Output Voltage:	9V
Input Voltage:	AC 230V, 50Hz
Number of Tips or Sockets:	8
Output Tips/Socket Type	
2.35 x 0.7 x 10.5mm	5.0 x 2.1 x 12mm
4.0 x 1.7 x 9.5mm	5.5 x 2.5 x 12mm
4.75 x 1.7 x 9.5mm	6.3 x 3.0 x 14mm
Input Power Plug:	UK 3 Pin Mains Plug
Polarity:	Centre Positive
Reversible Polarity:	Yes
Output Power Cord Length	1.8m

Order Code	Mod.	807305	Price each exc. VAT 1+	5+	inc. VAT each
L67BQ	AC/DC PSU 9V 600mA		£10.82		£12.99

Maplin 6W Switched Mode AC/DC Fixed Voltage 12V Power Supply



- High quality fixed voltage adapters
- Regulated switched mode output voltages
- Provided with 8 of the most popular power tips
- User selectable polarity

Weight	82 g
Switched Mode Supply:	Yes
Output Power [Max]	6 W
Output Voltage Type:	Fixed
Output Current:	500 mA
Input Voltage:	AC 230 V, 50 Hz
Output Voltage:	12 V
No of Tips/Sockets	8
Output Tips/Socket Type	
2.35 x 0.7 x 10.5 mm	5.0 x 2.1 x 12 mm
4.0 x 1.7 x 9.5 mm	5.5 x 2.5 x 12 mm
4.75 x 1.7 x 9.5 mm	6.3 x 3.0 x 14 mm
Input Power Plug:	UK 3 Pin Mains Plug
Polarity:	Centre Positive
Reversible Polarity:	Yes
Output Power Cord Length	1.8 m

Order Code	Mod.	807306	Price each exc. VAT 1+	5+	inc. VAT each
M681C	AC/DC PSU 12V 500mA		£10.82		£12.99

Maplin 20W Switched Mode AC/DC Fixed Voltage 5V Worldwide Power Supply



- A switched mode power supply
- Ideal to power keyboards, toys, computer equipment and many more devices around the home
- Wide input voltage of AC 100 - 230V for worldwide use with the necessary plug adapters
- Supplied with 6 of the most popular power tips

Specifications:

Switched Mode Supply	Yes
Output Power [Max]:	20W
Output Voltage Type	Fixed
Output Current	2250mA
Input Voltage	AC 100 - 230V, 50Hz
Output Voltage	DC 5V
Number of Tips or Sockets	6
Output Tips/Socket Type	
3.5 x 1.35 x 10mm	5.5 x 2.5 x 12mm
5.0 x 2.1 x 12mm	2.5mm mono jack plug
5.5 x 1.5 x 12mm	3.5mm mono jack plug
Dimensions	78(l) x 48(w) x 64(d) mm
Regulated Output	Yes
Input Power Plug	UK 3 Pin Mains Plug
Polarity	Centre Positive
Reversible Polarity:	Yes
Efficiency	71%

Order Code	Mod.	807307	Price each exc. VAT 1+	5+	inc. VAT each
L45BL	5V 2.25A		£16.65	£14.99	£19.99

Maplin 20W Switched Mode AC/DC Fixed Voltage 9V Worldwide Power Supply



- A switched mode power supply
- Ideal to power keyboards, toys, computer equipment and many more devices around the home
- Wide input voltage of AC 100 - 230 V for worldwide use with the necessary plug adapters
- Supplied with 6 of the most popular power tips

Specifications:

Switched Mode Supply	Yes
Output Power [Max]:	20 W
Output Voltage Type	Fixed
Output Current	2250 mA
Input Voltage	AC 100 - 230 V, 50 Hz
Output Voltage	DC 9 V
Number of Tips or Sockets	6
Output Tips/Socket Type	
3.5 x 1.35 x 10 mm	5.5 x 2.5 x 12 mm
5.0 x 2.1 x 12 mm	2.5 mm mono jack plug
5.5 x 1.5 x 12 mm	3.5 mm mono jack plug
Dimensions	78(l) x 48(w) x 64(d) mm
Regulated Output	Yes
Input Power Plug	UK 3 Pin Mains Plug
Polarity	Centre Positive
Reversible Polarity:	Yes

Order Code	Mod.	807308	Price each exc. VAT 1+	5+	inc. VAT each
L46BL	9V 2.25A		£16.65	£14.99	£19.99

Look out for our monthly promotions at your local Maplin store now!

Pop in and pick up a copy of our monthly promotional publication, with special offers on dozens of exciting products. See the end of this catalogue for store listings

Maplin 20W Switched Mode AC/DC Fixed Voltage 12V Worldwide Power Supply



- A switched mode power supply
- Ideal to power keyboards, toys, computer equipment and many more devices around the home
- Wide input voltage of AC 100 - 230V for worldwide use with the necessary plug adapters
- Supplied with 6 of the most popular power tips

Specifications:

Switched Mode Supply	Yes
Output Power [Max]	20W
Output Voltage Type	Fixed
Input Voltage	AC 100 - 230V, 50Hz
Input Power Plug	UK 3 Pin Mains Plug
Number of Tips or Sockets:	6
Output Tips/Socket Type:	
3.5 x 1.35 x 10mm	5.5 x 2.5 x 12mm
5.0 x 2.1 x 12mm	2.5mm mono jack plug
5.5 x 1.5 x 12mm	3.5mm mono jack plug
Dimensions:	78(l) x 48(w) x 64(d) mm
Polarity:	Centre Positive
Reversible Polarity:	Yes
Output Power Cord Length:	1.8m
Efficiency:	71%

Order Code	Mod: 807309	Price each exc. VAT 1+	inc. VAT each 5+
L47BL	12V 1.5A	£16.65	£19.99

Maplin 20W Switched Mode AC/DC Fixed Voltage 15V Worldwide Power Supply



- A switched mode power supply
- Ideal to power keyboards, toys, computer equipment and many more devices around the home
- Wide input voltage of AC 100 - 230V for worldwide use with the necessary plug adapters
- Supplied with 6 of the most popular power tips

Specifications:

Switched Mode Supply	Yes
Output Power [Max]	20W
Output Voltage Type	Fixed
Output Current	1200mA
Input Voltage	AC 100 - 230V, 50Hz
Output Voltage:	DC 15V
Number of Tips or Sockets:	6
Output Tips/Socket Type:	
3.5 x 1.35 x 10mm	5.5 x 2.5 x 12mm
5.0 x 2.1 x 12mm	2.5mm mono jack plug
5.5 x 1.5 x 12mm	3.5mm mono jack plug
Input Power Plug	UK 3 Pin Mains Plug
Regulated Output:	Yes
Polarity:	Centre Positive
Reversible Polarity:	Yes

Order Code	Mod: 807310	Price each exc. VAT 1+	inc. VAT each 5+
L48BL	15V 1.2A	£16.65	£19.99

Maplin 20W Switched Mode AC/DC Fixed Voltage 24V Worldwide Power Supply



- A switched mode power supply
- Ideal to power keyboards, toys, computer equipment and many more devices around the home
- Wide input voltage of AC 100 - 230V for worldwide use with the necessary plug adapters
- Supplied with 6 of the most popular power tips

Specifications:

Switched Mode Supply	Yes
Output Power [Max]	20W
Output Voltage Type	Fixed
Output Current:	750mA
Input Voltage:	AC 100 - 230V, 50Hz
Output Voltage	DC 24V
Number of Tips or Sockets:	6
Output Tips/Socket Type	
3.5 x 1.35 x 10mm	5.5 x 2.5 x 12mm
5.0 x 2.1 x 12mm	2.5mm mono jack plug
5.5 x 1.5 x 12mm	3.5mm mono jack plug
Dimensions:	78(l) x 48(w) x 64(d) mm
Input Power Plug:	UK 3 Pin Mains Plug
Regulated Output:	Yes
Polarity:	Centre Positive
Reversible Polarity:	Yes
Output Power Cord Length:	1.8m
Efficiency:	0.71

Order Code	Mod: 807312	Price each exc. VAT 1+	inc. VAT each 5+
L50BL	24V 0.750A	£19.15	£22.99

Power Pax 60W Switched Mode DC Fixed Voltage 12V Power Supply



- 12V 5A replacement desktop power supply
- High quality, ultra compact 60W switch mode power supply
- Ideal for high power applications such as CCTV, Lighting, LCD screens, routers and other PC equipment

• Led power indicator

• Requires C13 (order code MK41)

Specifications:

Switched Mode Supply	Yes
Output Power [Max]	60W
Output Voltage Type	Fixed
Output Current	5000mA
Input Voltage:	AC 100 - 230V, 50Hz
Output Voltage	12V DC
Output Tip:	5.5 x 2.1 x 12mm
Dimensions:	115(l) x 53(w) x 38(d) mm
Output Power Cord Length:	1.5m
Regulated Output:	Yes
Polarity:	Centre Positive
Efficiency:	85%

Order Code	Mod: 807313	Price each exc. VAT 1+	inc. VAT each 5+
N95JU	DC 12V 5A 2.1mm	£24.99	£29.99

Power Pax 120W Switched Mode DC Fixed Voltage 12V Power Supply



- 12V 10A replacement desktop power supply
- High quality, ultra compact 120w switch mode power supply
- Ideal for high power applications such as CCTV, Lighting, LCD screens, routers and other PC equipment
- Led power indicator
- Requires C13 (order code MK41)

Specifications:

Switched Mode Supply	Yes
Output Power [Max]	120 W
Output Voltage Type	Fixed
Output Current	10 A
Input Voltage	AC 100 - 230 V, 50 Hz
Output Voltage	12 V DC
Output Tip	5.5 x 2.1 x 12 mm
Dimensions:	179(l) x 65(w) x 40(d) mm
Output Power Cord Length	1.5 m
Polarity	Centre Positive
Efficiency	87%

Order Code	Mod: 807315	Price each exc. VAT 1+	inc. VAT each 5+
N96JU	DC 12V 10A 2.1mm	£33.32	£39.99

Power Pax 65W Switched Mode AC/DC Fixed Voltage 24V Power Supply



- 24V 2.7A replacement desktop power supply
- High quality, compact 65W switch mode power supply
- Ideal for high power applications such as CCTV, Lighting, LCD screens, routers and other PC equipment
- Led power indicator
- Requires C13 (order code MK41)

A high quality, ultra compact 65 watt desktop switch mode power supply with full international safety approvals including CB, UL, cUL, BSMI, PSE, GS, RCM, CE and LPS. These power supplies come with short circuit, over voltage and over load current protection as standard

Specifications:

Input Voltage	AC 100 - 230V, 50Hz
Output Voltage	24V DC
Output Current	2.7A
Output Power [Max]	65W
Regulated Output	Yes
Polarity	Centre Positive
Output Tip	5.5 x 2.1 x 12mm
Output Power Cord Length	1.5m
Switched Mode Supply	Yes
Efficiency	87%
Dimensions:	115(l) x 53(w) x 40(d) mm
Weight	288g

Order Code	Mod: 629248	Price each exc. VAT 1+	inc. VAT each 5+
N10NB	DC 24V 2.7A Desk PSU	£16.65	£19.99

Power Pax 30W Switched Mode AC/DC Fixed Voltage 24V Power Supply



- 24V 1.25A replacement desktop power supply
- High quality, ultra compact 30W switch mode power supply
- Ideal for high power applications such as CCTV, Lighting, LCD screens, routers and other PC equipment
- Led power indicator
- Requires C8 (order code AK165)

A high quality, compact 30 watt desktop switch mode power supply with full international safety approvals including CB, UL, cUL, BSMI, PSE, GS, RCM, CE and LPS. These switch mode power supplies have a short circuit, over voltage and over load current protection as standard

Specifications:

Input Voltage:	AC 100 - 230V, 50Hz
Output Voltage:	24V DC
Output Current:	1.25A
Output Power [Max]:	30W
Regulated Output:	Yes
Polarity:	Centre Positive
Output Tip:	5.5 x 2.1 x 12mm
Output Power Cord Length:	1.5m
Switched Mode Supply:	Yes
Efficiency:	813%
Dimensions:	95(l) x 59(w) x 34(d) mm
Weight:	214g

Order Code	Mod:	Price each exc. VAT 1+	inc. VAT each
N11NB	DC 24V 1.25A Desk PS	£16.65	£19.99

6W Switched Mode AC/DC Fixed Voltage 12V Power Supply



- Compact 12V 0.5A power supply
- Fixed 2.1mm connection, found on many devices
- Lightweight, compact design
- Ideal for CCTV, LED lighting, computer equipment, set top boxes or other electronic devices that require 12V power

Specifications

Input Voltage:	AC 100 - 230V, 50Hz
Input Power Plug:	UK 3 Pin Mains Plug
Output Voltage:	12V DC
Output Current:	500mA
Output Power [Max]:	6W
Regulated Output:	Yes
Polarity:	Centre Positive
Switched Mode Supply:	Yes
Output Tip:	5.5 x 2.1 x 12mm
Output Power Cord Length:	1.5m
Efficiency:	64%
Dimensions:	61(l) x 46.5(w) x 45(d) mm

Weight 65g

Order Code	Mod:	Price each exc. VAT 1+	5+	inc. VAT each
N93JU	DC 12V 0.5A 2.1mm	£8.32	£7.49	£9.99

12W Switched Mode AC/DC Fixed Voltage 12V Power Supply



- Compact 12V 1A power supply
- Fixed 2.1mm connection, found on many devices
- Lightweight, compact design
- Ideal for CCTV, LED lighting, computer equipment, set top boxes or other electronic devices that require 12V power

Specifications:

Input Voltage:	AC 100 - 230V, 50Hz
Input Power Plug:	UK 3 Pin Mains Plug
Output Voltage:	12V DC
Output Current:	1000mA
Output Power [Max]:	12W
Regulated Output:	Yes
Polarity:	Centre Positive
Output Tip:	5.5 x 2.1 x 12mm
Output Power Cord Length:	1.5m
Efficiency:	64%
Dimensions:	76(l) x 43(w) x 36(d) mm
Weight:	100g

Order Code	Mod:	Price each exc. VAT 1+	5+	inc. VAT each
N94JU	DC 12V 1A 2.1mm	£14.99		£17.99

Maplin 6W SMPS AC/DC Multi Voltage Power Supply



- Selectable output voltages: DC 3, 4.5, 5, 6, 9, 12 V
- 6 W output
- Provided with 8 popular tips
- Interchangeable output plugs
- LED indicator

Input Voltage:	AC 230 V, 50 Hz
Input Power Plug:	UK 3 Pin Mains Plug
Output Voltage:	DC 3, 4.5, 5, 6, 9, 12 V
Output Current [1]:	0.5 A at 12 V
Output Current [2]:	0.65 A at 9 V
Output Current [3]:	1 A at 6 V
Output Current [4]:	1.2 A at 3, 4.5 and 5 V
Output Voltage Type:	Variable
Output Power [Max]:	6 W
Regulated Output:	Yes
Polarity:	Centre Positive
Reversible Polarity:	Yes
Number of Tips or Sockets:	8
Output Tips/Socket Type:	2.35 x 0.7 x 10.5 mm
	3.5 x 1.4 x 10 mm
	4.0 x 1.7 x 9.5 mm
	4.75 x 1.7 x 9.5 mm
Switched Mode Supply:	Yes

Dimensions 68(l) x 29(w) x 43(d) mm
Weight: 82 g

Order Code	Mod:	Price each exc. VAT 1+	5+	inc. VAT each
XX09K	AC Adptr 500mA	£12.49		£14.99

Maplin 12W AC/DC Multi Voltage Power Supply



- Selectable DC 3, 4.5, 5, 6, 9, 12 V
- Maximum output current 1000 mA
- Provided with 8 of the most popular power tips
- Tips can be inserted to provide centre-positive or centre-negative polarity
- LED power indicator

Specifications:

Input Voltage:	AC 230 V, 50 Hz
Input Power Plug:	UK 3 Pin Mains Plug
Output Voltage:	3, 4.5, 5, 5.9, 12 V
Output Current:	1 A (1000 mA)
Output Voltage Type:	Variable
Regulated Output:	Yes
Polarity:	Centre Positive
Reversible Polarity:	Yes
Number of Tips or Sockets:	8
Output Tips/Socket Type:	2.35 x 0.7 x 10.5 mm
	3.5 x 1.4 x 10 mm
	4.0 x 1.7 x 9.5 mm
	4.75 x 1.7 x 9.5 mm
Output Power Cord Length:	1.6m
Dimensions:	81(l) x 30.5(w) x 65(d) mm
Weight:	110 g

Order Code	Mod:	Price each exc. VAT 1+	5+	inc. VAT each
L82BF	AC/DC Adptr 1A	£14.99	£12.74	£17.99

Maplin 17W Switched Mode AC/DC Multi Voltage Power Supply



- Small, compact design that works on a wide input voltage range
- 7 output voltages DC 5, 6, 7.5, 9, 12, 13.2 V
- Maximum current 2500 mA
- Provided with 8 of the most popular power tips
- LED power indicator

Input Voltage:	AC 100 - 230 V, 50 Hz
Input Power Plug:	UK 3 Pin Mains Plug
Output Voltage:	5 V, 5 V @ 2.5 A 7.5 V @ 2 A 9 V, 12 V @ 1.7 A 13.2 V @ 1.5 A
Output Voltage Type:	Variable

Output Power (Max):	16.8 W
Regulated Output:	Yes
Polarity:	Centre Positive
Reversible Polarity:	Yes
Number of Tips or Sockets:	8
Output Tips/Socket Type:	
2.35 x 0.7 x 10.5 mm	5.0 x 2.1 x 12 mm
3.5 x 1.4 x 10 mm	5.5 x 2.1 x 12 mm
4.0 x 1.7 x 9.5 mm	5.5 x 2.5 x 12 mm
4.75 x 1.7 x 9.5 mm	6.3 x 3.0 x 14 mm
Output Power Cord Length:	1.6 m
Switched Mode Supply:	Yes
Efficiency:	0.75
Dimensions:	85(L) x 50.5(W) x 50.5(H) mm
Weight:	179 g

Order Code	Mod: 049063	Price each exc. VAT	inc. VAT each
L06BR	M-Volt Plug Top SMPS	£16.65	£19.99



Reserve online and collect at the store of your choice

Maplin 20W Switched Mode AC/DC Multi Voltage Power Supply



- Selectable output voltages - DC 5,6,7,5,9,12,13,2 V
- Interchangeable output plugs
- Output 1.5 - 2.5 A depending on voltage selected
- Short circuit and over voltage protection
- LED power on indicator

Input Voltage:	AC 230 V, 50 Hz
Input Power Plug:	UK 3 Pin Mains Plug
Input/Output Power Cord Length:	1.2 m / 1.6 m
Output Voltage:	DC 5,6,7,5,9,12,13,2 V
Output Current (Max):	1.5 - 2.5 A depending on voltage

Regulated Output:	Yes
Polarity:	Centre Positive
Reversible Polarity:	Yes
Number of Tips or Sockets:	8
Output Tips/Socket Type:	
2.35 x 0.7 x 10.5 mm	5.0 x 2.1 x 12 mm
3.5 x 1.4 x 10 mm	5.5 x 2.1 x 12 mm
4.0 x 1.7 x 9.5 mm	5.5 x 2.5 x 12 mm
4.75 x 1.7 x 9.5 mm	6.3 x 3.0 x 14 mm
Switched Mode Supply:	Yes
Dimensions:	154 mm(L) x 79 mm(W) x 64 mm(H)
Weight:	1190 g

Order Code	Mod: 492134	Price each exc. VAT	inc. VAT each
VN10L	Var Mains Adptr 20W	£19.15	£22.99

Maplin TV

Home of innovation,
handy tips and
How To videos

Visit our
channel...

youtube.com/maplintv



Maplin 36W Switched Mode AC/DC Multi Voltage Worldwide Power Supply



- Regulated switched-mode power supply
- Up to 3000mA (3.0A) maximum output current
- DC 5, 6, 7.5, 9, 12, 13.5, 15V
- Complete with 8 of the most popular power tips
- Ideal for the frequent traveller - supplied with interchangeable mains plug adapters

Specifications:

Switched Mode Supply:	Yes
Output Power (Max):	36W
Regulated Output:	Yes
Output Voltage Type:	Variable
Output Current:	3.0A [3000mA] Maximum
depending on voltage:	
Input Voltage:	AC 100 - 230V, 50Hz
Input Power Plug:	UK, EU, USA &
Australasian:	
Number of Tips or Sockets:	8

Output Tips/Socket Type:

2.35 x 0.75 x 8mm	5 x 2.1 x 12mm
3.5 x 1.35 x 10mm	5.5 x 2.1 x 12mm
4 x 1.7 x 10mm	5.5 x 2.5 x 12mm
4.75 x 1.75 x 10mm	6.3 x 3 x 12mm
Output Voltage:	DC 5, 6, 7.5, 9, 12, 13.5, 15V

Input / Output:	
Power Cord Length:	1.6m / 1.6m
Polarity:	Centre Positive
Reversible Polarity:	Yes

Order Code	Mod: 807319	Price each exc. VAT	inc. VAT each
L48BQ	Worldwide AC/DC PSU	£24.99	£29.99

Maplin 60W Switched Mode AC/DC Multi Voltage Power Supply



- Regulated switched mode power supply that can be used worldwide
- 6 different selectable output voltages DC 5, 6, 9, 12, 13.5, 15V
- Fig 8 mains power lead with UK plug and 8 of the most popular power tips included
- Maximum current 4A
- LED power indicator

Specifications:

Switched Mode Supply:	Yes
Output Power (Max):	60W
Output Voltage Type:	Variable
Output Voltage:	DC 5 - 6 - 9 - 12 - 13.5 - 15V
Output Current:	4A [4000mA]
Input Voltage:	AC 100 - 230V, 50Hz
Input Power Plug:	UK 3 Pin Mains Plug
Output Tips:	8
Output Tips/Socket Type:	
2.35 x 0.7 x 10.5mm	5.0 x 2.1 x 12mm

3.5 x 1.4 x 10mm	5.5 x 2.1 x 12mm
4.0 x 1.7 x 9.5mm	5.5 x 2.5 x 12mm
4.75 x 1.7 x 9.5mm	6.3 x 3.0 x 14mm
Dimensions:	117.5(l) x 51.5(w) x 33.5(h) mm
Input Output:	
Power Cord Length:	1.5m / 1.8m
Polarity:	Centre Positive or Negative
Reversible Polarity:	Yes

Order Code	Mod: 807317	Price each exc. VAT	inc. VAT each
L11BQ	Multi-Volt 60W SMPS	£29.15	£34.99

Newsletter



Subscribe to our newsletter for information about the latest innovation and the best deals.

Stontronics 3A AC/AC Fixed Voltage Weatherproof 12V Power Supply



- AC/AC transformer built into an IP66 rated enclosure
- Designed for powering garden & seasonal lighting, AC motors, or aquatic equipment that requires AC out voltages
- Enclosure can be wall mounted and is supplied with cable glands
- Termination is supplied with screw terminal posts
- Manufactured in the UK

Please note: Prior to use, please be sure that it is an AC output supply that you require for your use. If you are in any doubt, please consult a member of staff for further information. Using an AC output adapter on an appliance that requires a DC current may cause permanent and irreversible damage to your equipment.

Input Voltage:	230VAC	
External Dimensions (W x D x H mm):	210 x 125 x 95	
Weight (g):	1000	
IP Rating:	IP66	
Code:	Input Current	Description
Input Gland Range:	Output Gland Range	Input fuse
Output fuse:		
T5318AD	0.2A	12VAC 3A 16mm
20mm	T0.63A TD	F3.15A QB

Order Code	Mod: 807321	Price each exc. VAT	inc. VAT each
N67NC	12VAC 3A IP66 PSU	£21.65	£25.99

Buy it on the web at maplin.co.uk

Shop for all Maplin products online at our website and check out our latest products and special offers!



Stontronics 5A AC/AC Fixed Voltage Weatherproof 12V Power Supply



- AC/AC transformer built into an IP66 rated enclosure
- Designed for powering garden & seasonal lighting, AC motors, or aquatic equipment that requires AC out voltages
- Enclosure can be wall mounted and is supplied with cable glands
- Termination is supplied with screw terminal posts
- Manufactured in the UK

Please note: Prior to use, please be sure that it is an AC output supply that you require for your use. If you are in any doubt, please consult a member of staff for further information.

Using an AC output adapter on an appliance that requires a DC current may cause permanent and irreversible damage to your equipment.

Input Voltage	230VAC
External Dimensions (W x D x H mm)	210 x 125 x 95
Weight (g)	1000
IP Rating	IP66
Code	Input Current Description Input
Gland Range	Output Gland Range Input
	Output fuse
T5317AD	0.3A 12VAC 5A 16mm 20mm
T0 63A TD	F5A QB

Order Code	Mod: 807322	Price each exc. VAT 1+	inc. VAT each
N68NC	12VAC 5A IP66 PSU	£29.15	£34.99

Stontronics 5A AC/AC Fixed Voltage Weatherproof 24V Power Supply



- AC/AC transformer built into an IP66 rated enclosure
- Designed for powering garden & seasonal lighting, AC motors, or aquatic equipment that requires AC out voltages
- Enclosure can be wall mounted and is supplied with cable glands
- Termination is supplied with screw terminal posts
- Manufactured in the UK

Please note: Prior to use, please be sure that it is an AC output supply that you require for your use. If you are in any doubt, please consult a member of staff for further information.

Using an AC output adapter on an appliance that requires a DC current may cause permanent and irreversible damage to your equipment.

Input Voltage	230VAC
External Dimensions (W x D x H mm)	210 x 125 x 95
Weight (g)	1000
IP Rating	IP66

Order Code	Mod: 807324	Price each exc. VAT 1+	inc. VAT each
N70NC	24VAC 5A IP66 PSU	£37.49	£44.99

FSP 60W AC/DC Fixed Voltage 12V Power Supply



- Designed to replace your faulty LCD, LED, Plasma TV/monitor power supply
- DC 12V output, 60 watts, 5 amps
- Supplied with 6 output tips for compatibility with many TV and monitors
- Can be used on other devices that require 12V up to 5A power
- Fixed centre-positive polarity - power tips can only be inserted one way round

Specifications:

Input Voltage:	AC 230V, 50Hz
Input Power Plug:	UK 3 Pin Mains Plug
Input Power Cord Length:	1.8m
Output Voltage:	DC 12V
Output Current:	5A (5000mA)
Output Voltage Type:	Fixed
Output Power (Max):	60W
Regulated Output:	Yes
Polarity:	Centre Positive
Reversible Polarity:	Yes
Number of Tips or Sockets:	6
Output Tips/Socket Type:	3.4 x 1.3 x 11mm 3.8 x 1.1 x 11mm 4 x 1.7 x 9.5mm 4.75 x 1.7 x 9.5mm 5.5 x 2.1 x 12mm 5.5 x 2.5 x 12mm

Output Power Cord Length:	1.5m
Switched Mode Supply:	Nc
Efficiency:	80%
Overload Protection:	Yes
Short Circuit Protection:	Yes
Operating Temperature:	0 - 40°
Outdoors Use:	Nc
Dimensions:	110(l) x 62(w) x 31.5(d)mm
Weight:	710g

Order Code	Mod: 218077	Price each exc. VAT 1+ 5+	inc. VAT each
N93CZ	LCD Monitor PSU	£31.65	£37.99

Power Pax 192W Switched Mode AC/DC Fixed Voltage 12V Power Supply



- Replace your faulty LCD, LED, Plasma TV/monitor power supply
- 12V 16A (16000mA) output
- Supplied with a 4pin Power Din for compatibility with many TV and monitors
- LED power indicator
- Fixed polarity - power tips can only be inserted one way round
- Require C13 power lead (order code MK41)

Specifications:

Input Voltage:	AC 100 - 240V, 50Hz
Output Power Cord Length:	1.2m
Output Voltage:	DC 12V
Output Current:	16A (16000mA)
Output Voltage Type:	Fixed

Output Power (Max):	192W
Regulated Output:	Yes
Reversible Polarity:	No
Number of Tips or Sockets:	1
Output Tip:	4 pin DIN
Switched Mode Supply:	Yes
Efficiency:	87%
Dimensions:	183(l) x 81(w) x 42.3(h) mm
Weight:	800g

Order Code	Mod: 513523	Price each exc. VAT 1+	inc. VAT each
N98JU	DC 12V 16A 4pin plug	£41.65	£49.99

Power Pax 84W Switched Mode AC/DC Fixed Voltage 12V Power Supply



- Replace your faulty LCD, LED, Plasma TV/monitor power supply
- 12V 7A (7000mA) output
- Supplied with a 4pin Power Din for compatibility with many TV and monitors
- LED power indicator
- Fixed polarity - power tips can only be inserted one way round
- Require C5 power lead (order code QN62)

Specifications:

Switched Mode Supply:	Yes
Output Power (Max):	84W
Output Voltage Type:	Fixed
Output Current:	7A (7000mA)
Input Voltage:	AC 100 - 240V, 50Hz
Output Voltage:	DC 12V
Output Tip:	4 pin DIN
Dimensions:	139(l) x 61(w) x 36(h) mm
Output Power Cord Length:	1.0m
Regulated Output:	Yes
Reversible Polarity:	Nc
Number of Tips or Sockets:	1
Efficiency:	85%

Order Code	Mod: 807328	Price each exc. VAT 1+ 5+	inc. VAT each
N97JU	DC 12V 7A 4pin plug	£36.65	£43.99

Power Pax 65W Switched Mode AC/DC Fixed Voltage 24V Power Supply



- Power supply suited for CCTV, LED and other permanent electronic installations
- 24VDC 65W regulated output
- Supplied bare wire for electrical installation
- Fitted with a 2.1mm DC plug and 1.8m long output cord
- Lugged base for permanent mounting, 4mm fixing holes

A 24V power supply offering up to 65W of continuous output power supplied in a compact housing which features fixing lugs at either end allowing the PSU to be secured to any flat surface. This supply also comes

with a fixed input lead helping to prevent accidental disconnection from the mains supply. All power supplies offered in this series are CE, LVD, EMC approved and also meet the latest ErP stage 2 requirements for energy efficiency

Specifications:

Input Voltage:	AC 100 -240V, 50Hz
Input Power Plug:	Bare wire
Input / Output	
Power Cord Length	1.5m / 1.8m
Output Voltage:	DC 24V
Output Current:	2.7A (2700mA)
Output Voltage Type:	Fixed
Output Power (Max):	65W
Regulated Output:	Yes
Polarity:	Centre Positive
Reversible Polarity:	No
Number of Tips or Sockets:	1
Output Tips/Socket Type	12 x 2.1 x 5.5mm
Switched Mode Supply:	Yes
Efficiency:	87%
Dimensions:	138(l) x 56(w) x 37(h) mm
Weight:	358g

Order Code	Mod: 629244	Price each exc. VAT 1+	inc. VAT each
N09NB	DC 24V 2.7A Lug PSU	£16.65	£19.99

Find out more in-store

Our staff can offer friendly and expert advice; we're here to help



Maplin 12W Switched Mode AC/DC Fixed Voltage 12V Power Supply



- Ideal for most CCTV cameras, LED lighting and other permanent electronic installations
- 1A (1000mA) regulated output
- Fitted with 2.1mm DC plug and 1.8m long output cord
- Lugged base for permanent mounting, 4mm fixing holes

Specifications:

Input Voltage:	AC 100 -240V, 50Hz
Input Power Plug:	UK 3 Pin Mains Plug
Input / Output	
Power Cord Length	1.8m / 1.8m
Output Voltage:	DC 12V
Output Current:	1A (1000mA)
Output Voltage Type:	Fixed
Output Power (Max):	12W
Regulated Output:	Yes
Polarity:	Centre Positive
Reversible Polarity:	No
Number of Tips or Sockets:	1
Output Tips/Socket Type	12 x 2.1 x 5.5mm
Switched Mode Supply	Yes
Efficiency:	75%
Dimensions:	92.2(l) x 49.8(w) x 26.3(d) mm
Weight:	135g

Order Code	Mod: 227631	Price each exc. VAT 1+	inc. VAT each 5+
N12GN	DC 12V 1A Lug PSU	£19.15	£22.99

Buy it on the web at maplin.co.uk

Shop for all Maplin products online at our website and check out our latest products and special offers!



Maplin 36W Switched Mode AC/DC Fixed Voltage 12V Power Supply



- High power adapter for CCTV, LED and other permanent electronic installations
- 3A (3000mA) regulated output
- Ideal to power multiple CCTV cameras using one power point
- Fitted with 2.1mm DC plug and 1.8m long output cord
- Lugged base for permanent mounting, 4mm fixing holes

Specifications:

Input Voltage:	AC 100 -240V, 50Hz
Input Power Plug:	UK 3 Pin Mains Plug
Input / Output	
Power Cord Length	1.8m / 1.8m
Output Voltage:	DC 12V
Output Current:	3A (3000mA)
Output Voltage Type:	Fixed
Output Power (Max):	36W
Regulated Output:	Yes
Polarity:	Centre Positive
Reversible Polarity:	Nc
Number of Tips or Sockets:	1
Output Tips/Socket Type:	12 x 2.1 x 5.5mm
Switched Mode Supply:	Yes
Efficiency:	84%
Dimensions:	115(l) x 51(w) x 30.6(h) mm
Weight:	314g

Order Code	Mod: 513668	Price each exc. VAT 1+	5+	inc. VAT each
N22JU	DC 12V 3A Lug PSU	£24.99		£29.99

Maplin 12W AC/DC Fixed Voltage 12V Power Supply



- Use in-car equipment at home
- AC 230 V mains input to DC 12 V output
- Maximum 1 A output via a cigarette lighter socket
- Ideal for mobile phones, GPS units and many other items that can be powered from the car cigarette lighter socket
- Socket inline on 170 mm cable

Caution: before use, ensure the appliance you are plugging in to the cigarette lighter socket does not draw a

current of more than 1 amp

Specifications:

Input Voltage:	AC 230 V, 50 Hz
Input Power Plug:	UK 3 Pin Mains Plug
Output Voltage:	DC 12 V
Output Current:	1 A (1000 mA)
Output Voltage Type:	Fixed
Output Power (Max):	12 W
Regulated Output:	No
Polarity:	Centre Positive
Reversible Polarity:	No
Number of Tips or Sockets:	1
Output Tips/Socket Type:	Car Type Cigarette Socket
Switched Mode Supply:	No
Dimensions:	80(l) x 30(w) x 46(d) mm
Weight:	126 g

Order Code	Mod: 036397	Price each exc. VAT 1+	inc. VAT each
N35AZ	12V 1A Cigar Skt PSU	£9.99	£11.99

Maplin 60W Linear AC/DC Fixed Voltage 12V Power Supply



- Ideal for using in-car equipment whilst at home
- Converts AC 230V input to DC 12V output
- 5 amp maximum output current
- Great for in-car coolers or GPS products
- Lightweight design, ideal for travelling
- Green LED on the front indicates when unit is plugged in to the mains

Caution: before use, ensure the appliance you are plugging in to this adapter socket does not draw a current of more than 5 amps. If in any doubt, seek guidance

Specifications:

Input Voltage:	AC 230V, 50Hz
Input Power Plug:	UK 3 Pin Mains Plug
Input Power Cord Length:	2m
Output Voltage:	DC 12V
Output Current:	5A (5000mA)
Output Voltage Type:	Fixed
Output Power (Max):	60W
Regulated Output:	Nc
Polarity:	Centre Positive
Reversible Polarity:	Nc
Number of Tips or Sockets:	1
Output Tips/Socket Type:	Car Type Cigar Socket
Output Power Cord Length:	0.5m
Switched Mode Supply:	Nc
Efficiency:	80%
Overload Protection:	Yes
Short Circuit Protection:	Yes
Operating Temperature:	0 - 40°
Outdoors Use:	Nc
Dimensions:	90(l) x 130(w) x 70(d) mm
Weight:	500g

Order Code	Mod: 042702	Price each exc. VAT 1+	inc. VAT each
L25AY	12V 5A Cig Skt PSU	£16.65	£19.99

Send direct

If any product is not in stock, we will order it for you and send it with free delivery



Terms and conditions apply

Power Pax 150W Switch Mode AC/DC Multi Voltage Power Supply



- Enclosed switch mode power supply with full international safety approval
- Screw terminal for input and output connections
- Short circuit, over voltage and over load protections are provided as standard
- Air cooled design for noise and vibration free, efficient operation
- AC input range selectable 230Vac or 115Vac
- Fixed switching frequency at 25KHz

The regulated output voltage can be adjusted by + or - 10% of the rated output by way of a simple adjustable pot. (i.e. 12v units can be adjusted from 10.8vdc to 13.2vdc)

Specifications

Input Voltage Range	88 - 132Vac / 176 - 264Vac
Frequency Range	47 - 63Hz
Input Current	3.2A / 115Vac or 1.6A / 230Vac
DC Voltage	12V
Rated Current	12.5A
Current Range	0 - 12.5A
Rated Power	150W
Ripple Noise [Max.]	180mVp-p
Voltage Adj. Range	10.6 - 13.2V
Holdup Time [Typ.]	28ms at full load

Order Code	Mod.	Price each exc. VAT 1+	inc. VAT each
N52KH	811329	£41.65	£49.99

Power Pax 156W Switch Mode AC/DC Multi Voltage Power Supply



- Enclosed switch mode power supply with full international safety approval
- Screw terminal for input and output connections
- Short circuit, over voltage and over load protections are provided as standard
- Air cooled design for noise and vibration free, efficient operation
- AC input range selectable 230Vac or 115Vac
- Fixed switching frequency at 25KHz

The regulated output voltage can be adjusted by + or - 10% of the rated output by way of a simple adjustable pot. (i.e. 12v units can be adjusted from 10.8vdc to 13.2vdc)

Specifications

Input Voltage Range	88 - 132Vac / 176 - 264Vac
Frequency Range	47 - 63Hz
Input Current	3.2A / 115Vac or 1.6A / 230Vac
DC Voltage	24V
Rated Current	6.5A
Current Range	0 - 6.5A
Rated Power	156W
Ripple Noise [Max.]	240mVp-p
Voltage Adj. Range	21 - 28V

Holdup Time [Typ.] 28ms at full load

Order Code	Mod.	Price each exc. VAT 1+	inc. VAT each
N53KH	811330	£41.65	£49.99

Power Pax 60W Switch Mode AC/DC 12V Power Supply



- Enclosed switch mode power supply with full international safety approval
- Screw terminal for input and output connections
- Short circuit, over voltage and over load protections are provided as standard
- Air cooled design for noise and vibration free, efficient operation
- AC input range selectable 230Vac or 115Vac
- Fixed switching frequency at 25KHz

The regulated output voltage can be adjusted by + or - 10% of the rated output by way of a simple adjustable pot. (i.e. 12v units can be adjusted from 10.8vdc to 13.2vdc)

Specifications

Input Voltage Range	88 - 132Vac / 176 - 264Vac
Frequency Range	47 - 63Hz
Input Current	2A / 115Vac or 1A / 230Vac
DC Voltage	12V
Rated Current	5A
Current Range	0 - 5A
Rated Power	60W
Ripple Noise [Max.]	120mVp-p
Voltage Adj.	± 10%
Holdup Time [Typ.]	90ms at full load

Order Code	Mod.	Price each exc. VAT 1+	inc. VAT each
N59KH	811331	£33.32	£39.99

Power Pax 60W Switch Mode AC/DC 24V Power Supply



- Enclosed switch mode power supply with full international safety approval
- Screw terminal for input and output connections
- Short circuit, over voltage and over load protections are provided as standard
- Air cooled design for noise and vibration free, efficient operation
- AC input range selectable 230Vac or 115Vac
- Fixed switching frequency at 25KHz

The regulated output voltage can be adjusted by + or - 10% of the rated output by way of a simple adjustable pot. (i.e. 12v units can be adjusted from 10.8vdc to 13.2vdc)

Specifications

Input Voltage Range	88 - 132Vac / 176 - 264Vac
Frequency Range	47 - 63Hz
Input Current	2A / 115Vac or 1A / 230Vac
DC Voltage	24V
Rated Current	2.5A
Current Range	0 - 2.5A
Rated Power	60W

Ripple Noise [Max.] 150mVp-p

Voltage Adj. ± 10%

Holdup Time [Typ.]

Order Code	Mod.	Price each exc. VAT 1+	inc. VAT each
N60KH	811332	£29.15	£34.99

12V Inverters

Nikkai 12V Modified Sinewave 150W Inverter with USB Charging Socket



- Run mains powered equipment direct from your car DC 12V socket
- Includes a 500mA USB charging port for modern devices
- Suitable for mobile phones, camcorders, AV equipment, laptops and portable work lights
- 150 watts continuous power with 450 watts surge
- Automatic alarm and shutdown protection against overload, over temperature and low-battery conditions

If you need to run small mains powered equipment up to 150W, then the solution is to use this DC 12V to AC 230V power inverter. This portable unit can power devices such as laptops, TVs, stereos, games consoles and more. This unit also boasts a 500mA USB socket that can charge your small electronics devices. The unit connects directly into the vehicle's cigarette lighter socket

Specifications:

Input voltage range	DC 10-15V
Standby input current	<0.5A
Output voltage:	AC 230V ±5%
Output frequency	50Hz
Output power:	150W continuous
Peak output power	450W surge
Output waveform	Modified sine wave
Efficiency	90%
Dimensions	120(l) x 73(w) x 73(w) mm
Weight:	560g

Order Code	Mod.	Price each exc. VAT 1+	inc. VAT each
A00JZ	392915	£33.32	£39.99

Ring 12V Modified Sinewave 150W Can Inverter with USB Charging Socket

- 3-pin socket
- USB charging point, ideal for charging your iPod
- Brushed-aluminium finish with soft-touch trim
- Slots into your car cup holder
- DC plug includes a spring tension switch to allow for safe, secure connection for different sized sockets
- Coiled DC lead for convenient storage
- Overload and temperature protection
- NB: iPod not included



Specifications:

Capacity	150W
Peak Power Rating	300W

Input Voltage Rate	10-15V		
Order Code	Mod: 097788	Price each exc. VAT 1+	inc. VAT each
A41GB	150W Can Invert+USB	£29.15	£34.99

Portable Power Pack with 200W Inverter and USB Charging Socket



- Mains power, USB power, 12V cigarette lighter socket and more
- An essential source of emergency power whilst on the move
- Battery power, or can be continuously powered from 12V socket
- Mains power: 200W inverter
- 12V power: 2x DC accessory sockets
- USB power: 1 x USB charging socket
- Worklight: LED light
- Supplied with cables to provide continuous power to inverter via 12V cigarette lighter socket
- Can also be charged up via mains power supply (included)

Order Code	Mod: 225153	Price each exc. VAT 1+	inc. VAT each
A10HZ	200W Portable Pwr Pk	£49.99	£59.99

Maplin 12V Modified Sinewave 300W Inverter with USB Charging Socket



- Run mains powered equipment direct from your car battery or DC 12 V socket - both types of cables included
- Also includes a USB charging port for ancillary devices
- Suitable for mobile phones, camcorders, AV equipment, laptops, and portable work lights
- 300 watts' continuous power with 900 watts' surge
- Automatic alarm and shutdown protection against overload, over temperature and low-battery conditions

The portable DC 12 V to AC 230 V Power Inverter is an ideal solution for running small mains powered equipment up to 300 W. Suitable for powering devices such as laptops, TVs, stereos, games consoles and more, this power inverter has a USB socket that charges small modern electronics devices. The unit is supplied with socket cables that give you the choice to connect directly to your car's battery or plug into the car's cigarette socket.

Order Code	Mod: 518798	Price each exc. VAT 1+	inc. VAT each
N66JU	300W Inverter + USB	£41.65	£49.99



Friendly expert advice on
0333 400 9500

Maplin TV

Home of innovation,
handy tips and
How To videos

Visit our
channel...
youtube.com/maplintv



Maplin 12V Modified Sinewave 600W Inverter



- Run mains-powered electrical equipment from a car battery
- 600 watts continuous power with 1500 watts surge
- Modified sine wave
- Automatic alarm and shutdown protection against overload, over temperature and low battery conditions
- One, three prong grounded UK mains AC outlet
- Quiet operation

If you need a means to use your mains powered equipment whilst out in the car then the 12 V to 240 V power inverter is the answer. This portable power source will happily run equipment such as mobile phone chargers, laptop computers, camcorders, AV equipment, PC printers, small TVs, portable work lights and small power tools etc. [Not suitable for use with fluorescent lighting or inductive loads]. The inverter is powered via direct connection to the car battery using the supplied leads - please note that the wattage of this inverter is too high for connection via the cigarette lighter socket

Specifications	
Dimensions	200 x 173 x 65 mm
Weight	2 Kg
Standby Current:	<0.5 A

Order Code	Mod: 048724	Price each exc. VAT 1+	inc. VAT each
A18FG	600W 12V Inverter	£58.32	£69.99

Maplin 12V Modified Sinewave 1000W Inverter



- Provides two AC sockets that can be powered from a DC 12V source
- Connect direct to your car or other 12V battery
- Includes 3-metre battery lead for versatility
- Ideal for heavy duty applications
- Suitable for powering laptops, radios, TVs and other high wattage products

If you need a means to use your mains powered

equipment whilst out in the car then the 12V to mains 240V power inverter is the answer. This portable power source will happily run equipment that demand more power as it provides 1000 watts (not suitable for use with fluorescent lighting or inductive loads). The inverter is powered via direct connection to the car battery using the supplied leads
Please note: the wattage of this inverter is too high for connection via the cigarette lighter socket

Specifications:

Input voltage range:	DC 10 - 15V
Input full load current	100A
Standby input current	<0.7A
Output voltage	AC 230V ±5%
Output frequency	50Hz
Output power	1000W continuous over 20 minutes (at 23° ambient temperature)

Peak output power	2400W maximum
Output waveform	Modified sine wave
Efficiency	85-90%
Dimensions:	300(l) x 198(w) x 80(h) mm

Order Code	Mod: 811781	Price each exc. VAT 1+	inc. VAT each
A12HQ	1000W 12V Inverter	£116.65	£139.99

Maplin 12V Modified Sinewave 3000W Inverter



- Mains power directly from a 12V car battery
- Twin UK sockets
- Supplied complete with 1 black and 1 red 60mm<x>2<x> power cord, each measuring approximately 900mm
- Overload and overheat protection together with low battery warning and shutdown
- Base features mounting screw holes for permanent installation

Specifications:

Peak output power	6000W
Max power rating (30 minutes)	3000W (at 25°C ambient temperature)
Max power rating (60 minutes)	2800W (at 25°C ambient temperature)

Input voltage range	DC 10-15V
Input full load current	300A
Standby input current	<0.9A
Output voltage:	AC 230 V ±5%
Output waveform	Modified sinewave
Output frequency	50Hz
Efficiency	85-90%
Low battery pre-alarm	10.5V ±0.5V
Low battery shutdown	10V ±0.5V
Thermal protection	60°C ±5°C
Fuse	25A x 16 pcs
Dimensions	360(l) x 169(w) x 152(h) mm

Order Code	Mod: 811783	Price each exc. VAT 1+	inc. VAT each
A13HQ	3000W 12V Inverter	£291.65	£349.99

Buy it on the web at
maplin.co.uk

Shop for all Maplin products
online at our website and
check out our latest
products and special offers!



Maplin Inverter Remote Control



- Wired 5 metre remote control for Maplin 12V Inverters
- Works with Order Codes A12HQ, A13HQ and A34JY

Order Code	Mod.	Price each exc. VAT 1+	inc. VAT each
A84HZ	A12/13HQ/A34JY Remot	£16.65	£19.99

Maplin 12V Pure Sinewave 150W Inverter



- 150 watts' continuous power with 300 watts' peak output
- Automatic alarm and shutdown protection against overload, over temperature and low-battery conditions
- One three pronged UK mains AC outlet
- Eliminates electrical interference that may cause annoying humming sounds if products are powered using a modified sine wave inverter
- Ideal for inductive loads such as pumps, power tools and refrigerators
- Ideal for devices that cannot be powered by a modified sine wave inverter

Specifications:

Input voltage range:	DC 10-15V
Standby input current:	<0.8A
Output voltage:	AC 220V-240V
Output frequency:	50Hz
Output power:	150W
Peak output power:	300W
Output waveform:	Pure sine wave
Efficiency:	>85%
Dimensions:	225(l) x 117(w) x 62(h) mm
Weight:	1.01kg

Protection Features:

Low battery pre-alarm:	10.5V ±0.5V
Low battery shutdown:	10V ±0.5V
Thermal protection:	65°C ±5°C
Overload protection:	Yes
Short circuit output protection:	Yes
External battery protection:	Yes
Battery polarity protection:	Yes [provided by 1 x 15A fuse]

Order Code	Mod.	Price each exc. VAT 1+	inc. VAT each
A71JW	150W 12V PSW Invertr	£66.65	£79.99

Maplin 12V Pure Sinewave 300W Inverter



- 300 watts' continuous power with 500 watts' peak output

- Automatic alarm and shutdown protection against overload, over temperature and low-battery conditions
- One three pronged UK mains AC outlet
- Eliminates electrical interference that may cause annoying humming sounds if products are powered using a modified sine wave inverter
- Ideal for inductive loads such as pumps, power tools and refrigerators
- Ideal for devices that cannot be powered by a modified sine wave inverter

Specifications:

Input voltage range:	DC 10-15V
Standby input current:	<0.9A
Output voltage:	AC 220V-240V
Output frequency:	50Hz
Output power:	300W
Peak output power:	500W
Output waveform:	Pure sine wave
Efficiency:	>85%
Dimensions:	245(l) x 117(w) x 62(h) mm
Weight:	1.2kg

Protection Features:

Low battery pre-alarm:	10.5V ±0.5V
Low battery shutdown:	10V ±0.5V
Thermal protection:	65°C ±5°
Overload protection:	Yes
Short circuit output protection:	Yes
External battery protection:	Yes
Battery polarity protection:	Yes [provided by 2 x 25A fuses]

Order Code	Mod.	Price each exc. VAT 1+	inc. VAT each
A26JG	300W 12V PSW Invertr	£83.32	£99.99

Maplin 12V Pure Sinewave 600W Inverter



- 600 watts' continuous power with 1000 watts' peak output
- Automatic alarm and shutdown protection against overload, over temperature and low-battery conditions
- One three pronged UK mains AC outlet
- Eliminates electrical interference that may cause annoying humming sounds if products are powered using a modified sine wave inverter
- Ideal for inductive loads such as pumps, power tools and refrigerators
- Ideal for devices that cannot be powered by a modified sine wave inverter

Specifications:

Input voltage range:	DC 10-15V
Standby input current:	<1.3A
Output voltage:	AC 220V-240V
Output frequency:	50Hz
Output power:	600W
Peak output power:	1000W
Output waveform:	Pure sine wave
Efficiency:	>85%
Dimensions:	295(l) x 117(w) x 62(h) mm
Weight:	1.7kg

Protection Features:

Low battery pre-alarm:	10.5V ±0.5V
Low battery shutdown:	10V ±0.5V
Thermal protection:	65°C ±5°
Overload protection:	Yes
Short circuit output protection:	Yes
External battery protection:	Yes
Battery polarity protection:	Yes [provided by 3 x 25A fuses]

Order Code	Mod.	Price each exc. VAT 1+	inc. VAT each
A27JG	600W 12V PSW Invertr	£141.65	£169.99

Maplin 12V Pure Sinewave 1000W Inverter



- 1000 watts continuous power with 1200 watts peak output
- Automatic alarm and shutdown protection against overload, over temperature and low-battery conditions
- One three pronged UK mains AC outlet
- Eliminates electrical interference that may cause annoying humming sounds if products are powered using a modified sine wave inverter
- Ideal for inductive loads such as pumps, power tools and refrigerators
- Ideal for devices that cannot be powered by a modified sine wave inverter

Specifications:

Input voltage range:	DC 10-15V
Standby input current:	<1.3A
Output voltage:	AC 220V-240V
Output frequency:	50Hz
Output power:	1000W
Peak output power:	1200W [10 minutes]
Output waveform:	Pure sine wave
Efficiency:	>85%
Dimensions:	360(l) x 195(w) x 80(h) mm
Weight:	4.1kg

Protection Features:

Low battery pre-alarm:	10.5V ±0.5V
Low battery shutdown:	10V ±0.5V
Thermal protection:	60°C ±5°C
Overload protection:	Yes [Micro-controller based]
Short circuit output protection:	Yes [Micro-controller based]
External battery protection:	Yes [Micro-controller based]
Battery polarity protection:	Yes [provided by 6 x 25A fuses]

Order Code	Mod.	Price each exc. VAT 1+	inc. VAT each
A34JY	1000W 12V PSW Invertr	£149.99	£179.99

Merlin M-Power 12V Pure Sinewave 700W Inverter



- Pure Sine wave Output
- Extremely compact, efficient & reliable
- Easy to install and use
- Built in display provides battery and inverter status
- Huge surge power ability for starting difficult loads
- Optional remote On/Off panel (N15JT)

M-Power inverters simply and silently convert 12V DC battery power to 230V AC electricity. Ideal for operating mains powered devices on board boats and vehicles. M-Power employs state of the art switch-mode power conversion techniques to provide compact, efficient and reliable power. Our Pure Sine wave output ensures compatibility with all AC appliance [Modified Sine wave/ Square wave inverters are not compatible with sensitive electronics, variable speed power tools, some chargers and motors].

Connections are via a heavy duty studs on the rear of the

unit AC output connects directly to the UK socket on the front panel. A digital display provides the user with battery and inverter status information.

M-Power inverters interface with an optional remote panel. This provides inverter status information, remote On/Off switch and an ignition inhibit circuit. If connected, the ignition inhibit circuit automatically switches the inverter off when the engine is turned off - perfect for the service van use, where the inverters being left inadvertently on is a regular problem.

As these Pure Sine Wave Inverters transfer a lot of energy a standard wiring kit cannot be provided as it has to be tailored to the distance from the battery to the unit. You will need to provide your own cables and connectors for use with these inverters.

	M-Power 700W
Maplin part number	N12JT
Nominal Input Voltage	12V DC
Input Voltage Range	700W
Surge Capacity (Peak)	1400W
AC Output Frequency	50Hz +/- 0.5Hz
AC Output Voltage Range	230 V AC +/- 10%
Output Waveform	Pure Sine Wave
Efficiency	90%
No Load Current Draw	<1000mA
Low Battery Alarm	Audible, 11V DC
Low Battery Cutout	10.5V DC
Operating Temperature Range	0°C - 40°C
AC Receptacle	UK - Three Pin
Digital Display (Front Of Unit)	V DC, AC Output Power & Error Codes
Dimensions (H x W x L)	93 x 185 x 310mm
Weight	2.7Kg
Remote On/Off Panel (25" Cable)	Optional

Order Code	Mod: 811785	Price each exc. VAT 1+	inc. VAT each
N12JT	Merlin M-Power 700W	£249.99	£299.99

Merlin M-Power 12V Pure Sinewave 1400W Inverter



- Pure Sine wave Output
- Extremely compact, efficient & reliable
- Easy to install and use
- Built in display provides battery and inverter status
- Huge surge power ability for starting difficult loads
- Optional remote On/Off panel (N15JT)

M-Power inverters simply and silently convert 12V DC battery power to 230V AC electricity. Ideal for operating mains powered devices on board boats and vehicles. M-Power employs state of the art switch-mode power conversion techniques to provide compact, efficient and reliable power. Our Pure Sine wave output ensures compatibility with all AC appliance (Modified Sine wave/ Square wave inverters are not compatible with sensitive electronics, variable speed power tools, some chargers and motors).

Connections are via a heavy duty studs on the rear of the unit. AC output connects directly to the UK socket on the front panel. A digital display provides the user with battery and inverter status information.

M-Power inverters interface with an optional remote panel. This provides inverter status information, remote

On/Off switch and an ignition inhibit circuit. If connected, the ignition inhibit circuit automatically switches the inverter off when the engine is turned off - perfect for the service van use, where the inverters being left inadvertently on is a regular problem.

As these Pure Sine Wave Inverters transfer a lot of energy a standard wiring kit cannot be provided as it has to be tailored to the distance from the battery to the unit. You will need to provide your own cables and connectors for use with these inverters.

Maplin part number	N13JT
Nominal Input Voltage	12V DC
Input Voltage Range	1400W
Surge Capacity (Peak)	2800W
AC Output Frequency	50Hz +/- 0.5Hz
AC Output Voltage Range	230 V AC +/- 10%
Output Waveform	Pure Sine Wave
Efficiency	90%
No Load Current Draw	<1000mA
Low Battery Alarm	Audible, 11V DC
Low Battery Cutout	10.5V DC
Operating Temperature Range	0°C - 40°C
AC Receptacle	UK - Three Pin
Digital Display (Front Of Unit)	V DC, AC Output Power & Error Codes
Dimensions (H x W x L)	115 x 240 x 369mm
Weight	4.7Kg
Remote On/Off Panel (25" Cable)	Optional

Order Code	Mod: 811786	Price each exc. VAT 1+	inc. VAT each
N13JT	Merlin M-Power 1400W	£349.99	£419.99

Merlin M-Power On/Off Panel for Merlin Inverters



M-Power inverters simply and silently convert 12V DC battery power to 230V AC electricity. Ideal for operating mains powered devices on board boats and vehicles. M-Power employs state of the art switch-mode power conversion techniques to provide compact, efficient and reliable power. Our Pure Sine wave output ensures compatibility with all AC appliance (Modified Sine wave/ Square wave inverters are not compatible with sensitive electronics, variable speed power tools, some chargers and motors).

Connections are via a heavy duty studs on the rear of the unit. AC output connects directly to the UK socket on the front panel. A digital display provides the user with battery and inverter status information.

M-Power inverters interface with an optional remote panel. This provides inverter status information, remote On/Off switch and an ignition inhibit circuit. If connected, the ignition inhibit circuit automatically switches the inverter off when the engine is turned off - perfect for the service van use, where the inverters being left inadvertently on is a regular problem.

As these Pure Sine Wave Inverters transfer a lot of energy a standard wiring kit cannot be provided as it has to be tailored to the distance from the battery to the unit. You will need to provide your own cables and connectors for use with these inverters.

Order Code	Mod: 811788	Price each exc. VAT 1+	inc. VAT each
N15JT	Merlin Remote Panel	£20.82	£24.99

12v DC - 240v AC 150w Digital Inverter - Single Socket



- Includes 12v power socket lead
- Suitable for appliances up to 150w
- Up to 4 hours of continuous use
- Surge power rating (up to 1sec) 300 watts
- Standby current 0.15amp

Features a USB charging point & digital display showing battery voltage (state of your battery) & consumption in watts (to check on power usage) allowing you to monitor operating time

It simply plugs into your 12v cigarette lighter socket to then allow you to power mains devices straight from your car. Waveform Modified Sine (MSW) Input Voltage 11-15 vclts DC Fuse 15amp (external) Efficiency 90% Cable Length 0.8m

Order Code	Mod: 1006066	Price each exc. VAT 1+	inc. VAT each
A27TB	150W Digital Inverter	£37.49	£44.99

12v DC - 240v AC 300w Digital Inverter - Single Socket



- Includes 12v power socket & battery leads
- Suitable up to 300w
- Continuous power up to 4 hours (240w)
- Surge power rating (up to 1sec) 600 watts
- Standby current 0.25amps

Features a USB charging point & digital display showing battery voltage (state of your battery) & consumption in watts (to check on power usage) allowing you to monitor operating time

Waveform Modified Sine (MSW) Input Voltage 11-15 vclts DC Fuse 15amp (external) Efficiency 90% Cable Length 0.8m

Order Code	Mod: 1006068	Price each exc. VAT 1+	inc. VAT each
A28TB	300W Digital Inverter	£49.99	£59.99

Maplin TV

Home of innovation, handy tips and How To videos

Visit our channel... [youtube.com/maplintv](https://www.youtube.com/maplintv)



12v DC - 240v AC 500w Digital Inverter - Single Socket

- Includes +/- 0.8m battery leads
- Suitable for appliances up to 500w
- Continuous power rating (up to 4hrs) 400 watts
- Surge power rating (up to 1sec) 1000 watts
- Standby current 0.30amps



A stylish modern range of inverters that include a digital display to show the battery voltage and the appliance consumption wattage allowing you to monitor operating time before low battery shut down and alarm. Includes a USB charging socket to allow recharging of electronic devices including mobile phones and MP3 players.

Features a USB charging point & digital display showing battery voltage (state of your battery) & consumption in watts (to check on power usage) allowing you to monitor operating time
Waveform: Modified Sine (MSW) Input Voltage: 11-15 volts DC Fuse: 70amp (external) Efficiency: 90% Cable Length: 0.8m

Order Code	Mod.	Price each exc. VAT	inc. VAT each
A297B	1006070	£74.99	£89.99

Ring Automotive 12V 150W Inverter with 2.1A USB Charging Socket

- The Ring RINVU150 provides the power to run mains equipment from a 12V battery (leisure battery, car battery etc.) and is fitted with a standard cigar lighter plug for operating directly from car cigar lighter socket.
- Transform your vehicle into a mobile office or home from home and never be caught short of electrical power again!
- Simply connect Ring PowerSource RINVU150 Inverter to your vehicle power socket using the cigar lighter and plug in any mains appliance upto 150w
- Suitable for Many Electrical items needing up to 150W like: Small televisions, Camcorders, Stereos, small Fridges, Mobile Phone Charger, Games Charger, Laptop, Inkjet type printers and many other applications.



The 12v, 150w single socket PowerSource Inverter is simple and safe to use on equipment rated up to 150w such as televisions, DVD players, lighting, mobile phone chargers, electronic note pads, videos and computer consoles.

Order Code	Mod.	Price each exc. VAT	inc. VAT each
A08LW	857117	£20.82	£24.99

Ring Automotive 12V 300W Inverter with 2.1A USB Charging Socket

- The Ring RINVU300 provides the power to run mains equipment from a 12V battery (leisure battery, car



battery etc.) and is supplied with crocodile clips for operating directly from a battery.

- Transform your vehicle into a mobile office or home from home and never be caught short of electrical power again!
- Simply connect Ring PowerSource RINVU300 Inverter to your vehicle battery using the battery clips and plug in any mains appliance upto 300w
- Suitable for Many Electrical items needing up to 300W like: Small televisions, Camcorders, Stereos, small Fridges, Mobile Phone Charger, Games Charger, Laptop, Inkjet type printers and many other applications.
- Clips included for connection
The 12v, 300w single socket PowerSource Inverter is simple and safe to use on applications listed under RINVU300 and on equipment rated up to 300w such as laptop computers, camcorders, stereos, small fridges, small power tools and many other applications.

Order Code	Mod.	Price each exc. VAT	inc. VAT each
A09LW	857118	£29.15	£34.99

Ring Automotive 12V 500W Inverter with 2.1A USB Charging Socket

- 12v - 240V 3 Pin UK Mains Socket, 500w Power mains equipment from a 12V source
- The Ring RINVU500 provides the power to run mains equipment from a 12V battery (leisure battery, car battery etc.) and is supplied with crocodile clips for operating directly from a battery.
- Transform your vehicle into a mobile office or home from home and never be caught short of electrical power again!
- Simply connect Ring PowerSource RINVU500 Inverter to your vehicle battery using the battery clips and plug in any mains appliance upto 500w
- Suitable for Many Electrical items needing up to 500W like: LCD TV's LED TV's, Stereo with amplifier, electric drill/driver, hedge trimmer, strimmer, camcorders, Stereos, small Fridges, Mobile Phone Charger, Games Charger, Laptop, and many other applications."



The 12v, 500w single socket PowerSource Inverter is simple and safe to use on applications listed under RINVU500 and on equipment rated up to 500w such as laptop computers, camcorders, stereos, small fridges, small power tools and many other applications.

Order Code	Mod.	Price each exc. VAT	inc. VAT each
A10LW	857119	£41.65	£49.99

Compact Inverter with USB Socket

- Ultra slim design
- High power 2A USB socket
- Suitable for recharging smart phones, MP3 players and tablets
- Coiled DC lead for convenient storage
- Supplied with hook and eye fixing tape to allow secure in-vehicle positioning



12v DC - 240v AC, 120w MP120 Compact Inverter with USB Socket - Single Socket
Small but powerful, the MP.120 compact inverter gives up to 120 watts of in-car 240 volt mains power and a USB charging point. The coiled cable positioning is both discreet and flexible and MP.120 is removable by using

hook & loop tape provided
Max power rating (5 mins): 120wContinuous power rating (4 hours): 100wPeak power rating: 240wNo load current draw: 0.1AWaveform: MSWUSB output: 5v/2.0APower connection: DC PlugWeight: 0.27Kg

Order Code	Mod.	Price each exc. VAT	inc. VAT each
A87UK	1013156	£29.15	£34.99

60w MP60 Travel Inverter - Single Socket



- Flexible design to suit different vehicles
- Compact & lightweight allows it to be easily stored
- For recharging mobile phones and other small wattage appliances

12v DC - 240v AC, 60w MP60 Travel Inverter - Single Socket

60w of power ideal for recharging mobile phones and other small wattage appliances
Max power rating (5 mins): 60wContinuous power rating (4 hrs): 45wPeak power rating: 120wNo load current draw: 0.1AWaveform: MSWPower connection: DC PlugWeight: 0.25Kg

Order Code	Mod.	Price each exc. VAT	inc. VAT each
A88UK	1013158	£16.65	£19.99

75 W MP75 Travel Inverter - Single Socket

- 75 W of power for recharging small electronic appliances
- LED indicator displays connection status
- Flexible design to suit different vehicles
- Compact & lightweight, allows for easy storage



12v DC - 240v AC, 75w MP75 Travel Inverter - Single Socket

Transform your vehicle into a mobile office or home from home and never be caught short of electrical power again! Simply insert the MP75 into your car's cigarette lighter socket and plug in any appliance up to 75 W e.g. laptop

Max power rating (5 mins): 75 WContinuous power rating (4 hours): 56 WPeak power rating: 150 WNo load current draw: 0.1 AWaveform: MSWPower connection: DC PlugWeight: 0.25Kg

Order Code	Mod.	Price each exc. VAT	inc. VAT each
A20FC	1013160	£23.32	£27.99

Ring Automotive 1000W Pure Sine Wave Inverter

- Lower distortion rate than modified sine wave inverters
- Replicates normal 240 volt mains supply
- Compatible with all inductive and capacitive loads
- Improved performance for audio and video equipment
- 1000W continuous power



- 2000W surge power (1 second)
- Automatic alarm and shutdown protection against overload
- Over temperature and low-battery conditions
- Ideal for devices that cannot be powered by a modified sine wave inverter

The PowerSource range of professional inverters are the ideal choice for powering tools and equipment in demanding environments such as service vehicles, commercial applications and remote locations without a normal mains supply.

Order Code	Mod:	Price each exc. VAT 1+	inc. VAT each
A57QY	1020265	£308.32	£369.99

Ring Automotive 2000W Pure Sine Wave Inverter

- Lower distortion rate than modified sine wave inverters
- Replicates normal 240 volt mains supply
- Compatible with all inductive and capacitive loads
- Improved performance for audio and video equipment
- 2000W continuous power
- 4000W surge power (1 second)
- Automatic alarm and shutdown protection against overload
- Over temperature and low-battery conditions
- Ideal for devices that cannot be powered by a modified sine wave inverter



The PowerSource range of professional inverters are the ideal choice for powering tools and equipment in demanding environments such as service vehicles, commercial applications and remote locations without a normal mains supply.

Order Code	Mod:	Price each exc. VAT 1+	inc. VAT each
A58QY	1020267	£458.32	£549.99

Maplin DC to AC 300W Inverter with Built-In Solar Charger Controller

- 2 in 1 design, includes solar charge controller and inverter
- Automatic alarm to signal low battery, overheating and overload
- 300W continuous power with 900W peak output
- One three pronged UK mains AC outlet
- Output waveform: modified sinewave
- Output voltage: 220V - 240V
- Input full load current: 30A



Ideal for powering devices such as laptops, tablets, mobile phones, small fridges, radios and TVs

Order Code	Mod:	Price each exc. VAT 1+	inc. VAT each
A56LZ	1023572	£83.32	£99.99

Maplin DC to AC 4000W Power Inverter

- 4000W continuous power with 8000W peak output
- Automatic alarm to signal low battery, overheating and overload
- Two three pronged UK mains AC outlets
- Output waveform: modified sinewave



- Output voltage: 220V - 240V
 - Input full load current: 400A
- Ideal for powering devices such as laptops, tablets, mobile phones, small fridges, radios and TVs

Order Code	Mod:	Price each exc. VAT 1+	inc. VAT each
A58LZ	1023608	£416.65	£499.99

Maplin DC to AC 600W Inverter with Built-In Solar Charger Controller

- 2 in 1 design, includes solar charge controller and inverter
- Automatic alarm to signal low battery, overheating and overload
- 600W continuous power with 1500W peak output
- One three pronged UK mains AC outlet
- Output waveform: modified sinewave
- Output voltage: 220V - 240V
- Input full load current: 60A



Ideal for powering devices such as laptops, tablets, mobile phones, small fridges, radios and TVs

Order Code	Mod:	Price each exc. VAT 1+	inc. VAT each
A57LZ	1023593	£124.99	£149.99

Maplin DC to AC 5000W Power Inverter

- 5000W continuous power with 10000W peak output
- Automatic alarm to signal low battery, overheating and overload
- Two three pronged UK mains AC outlets
- Output waveform: modified sinewave
- Output voltage: 220V - 240V
- Input full load current: 500A



Ideal for powering devices such as laptops, tablets, mobile phones, small fridges, radios and TVs

Order Code	Mod:	Price each exc. VAT 1+	inc. VAT each
A59LZ	1023620	£499.99	£599.99

Mains Voltage Converters

300W UK to USA Voltage Converter

- Allows you to operate USA equipment in the UK
 - Two output sockets that will accept 2 or 3-pin USA type plugs
 - Full encapsulation of the transformer improves heat dissipation and prevents ingress of moisture
 - The toroidal construction benefits from smaller size and reduced weight compared to laminated transformers
 - Designed and manufactured in Britain
- Toroidal technology is more energy/weight efficient and cheaper to run when compared to traditional laminated transformers.



Specifications:

Input Voltage:	AC 220 - 240, 50/60Hz
Input Power Plug:	UK
Output Voltage:	AC 110 - 120V
Output Current:	2.50A (2500mA)

Output Voltage Type	Fixed
Output Power (Max)	300W
Regulated Output	Nc
Number of Tips or Sockets	2
Output Tips/Socket Type	USA 3 Pin Mains Socket
Switched Mode Supply	Nc

Order Code	Mod:	Price each exc. VAT 1+	inc. VAT each
N53HF	265201	£62.49	£74.99

Maplin 230V to 110V 45W Voltage Converter

- Allows equipment from the USA to operate in the UK
- Robust plug top ABS housing
- Thermal fuse protection
- Output sockets UL/CSA listed
- NB: This product is not suitable for appliances requiring an earth



Specifications:

Input Voltage	AC 230 V, 50 Hz
Input Power Plug	UK 3 Pin Mains Plug
Output Voltage	AC 110 V
Output Current	0.38 A (380 mA)
Output Voltage Type	Fixed
Output Power (Max)	45 W
Regulated Output	Nc
Number of Tips or Sockets	1
Output Tips/Socket Type	USA 2 Pin Mains Socket
Switched Mode Supply	Nc
Efficiency	87%
Dimensions:	62(l) x 88(w) x 80(d) mm
Weight	450 g

Order Code	Mod:	Price each exc. VAT 1+	inc. VAT each
RP90X	019413	£13.32	£15.99

Maplin 230V to 110V 100W Voltage Converter

- Operate devices intended for North American power
- Great for gadgets bought on holiday or online auction purchases that wont work from UK 230Vac voltage
- Lightweight and portable so it could be taken while travelling
- For equipment rated below 100W.



For loads of 70W or higher please ensure the converter is not used for more than one hour

Specifications:

Input Voltage	AC 230V, 50Hz
Input Power Plug	UK 3 Pin Mains Plug
Input Power Cord Length	1.8m
Output Voltage	AC 110V
Output Current	0.83A (830mA)
Output Voltage Type	Fixed
Output Power (Max)	100W
Regulated Output	Nc
Number of Tips or Sockets	1
Output Tips/Socket Type	USA 2 Pin Mains Socket
Switched Mode Supply	Nc
Efficiency	90%
Overload Protection	Yes
Short Circuit Protection	Yes
Operating Temperature:	0 - 40°
Outdoors Use	Nc
Dimensions:	115 x 84 x 68.7mm
Weight	1304g

Order Code	Mod:	Price each exc. VAT 1+	inc. VAT each
R559P	031899	£19.15	£22.99

Maplin 230V to 110V 300W Voltage Converter

- Allows you to operate USA equipment in the UK
- Desktop housing made from durable ABS plastic
- Thermal fuse protection
- Output sockets UL/CSA listed
- Operates equipment up to 300W



Specifications:

Switched Mode Supply	No
Output Power [Max]:	300W
Output Voltage Type	Fixed
Output Current	2.5A
Input voltage:	AC 230V, 50Hz
Output Voltage:	AC 110V
Output Tips/Socket Type:	USA 2 Pin Mains Socket
Dimensions:	198[l] x 136[w] x 101[d] mm
Output Tips/Socket Type:	USA 2 Pin Mains Socket
Input Power Cord Length	1.8m
Regulated Output:	No
Efficiency	91%

Order Code	Mod:	Price each exc. VAT	inc. VAT each
VR05F	UK/US StepDown 300VA	£27.49	£32.99

- (PS3) and Xbox 360 US models for use in the UK
 - Full encapsulation of the transformer improves heat dissipation and prevents ingress of moisture
 - The toroidal construction benefits from smaller size and reduced weight compared to laminated transformers
 - Designed and manufactured in Britain
- Toroidal technology is more energy/weight efficient and cheaper to run when compared to traditional laminated transformers. Suitable products include most AC mains adapters, calculators, electric razors, radios, ghetto blasters, CD players, some handheld games consoles, air purifiers, Christmas tree lights, nebulisers, laptop and desktop computers, TVs and Hi-fis (ensure the rating is correct). Ideal for multimedia and AV equipment.

Specifications:

Input Voltage:	AC 220 - 240, 50/60Hz
Input Power Plug:	UK
Output Voltage:	AC 110 - 120V
Output Current:	16.67A [16670mA]
Output Voltage Type:	Fixed
Output Power [Max]:	2000W
Regulated Output:	No
Number of Tips or Sockets:	2
Output Tips/Socket Type:	USA 3 Pin Mains Socket
Switched Mode Supply:	No

Order Code	Mod:	Price each exc. VAT	inc. VAT each
N56HF	UK/US StepDown2000VA	£187.49	£224.99

Tacima 230V to 110V 1000W Voltage Converter

- Allows you to operate USA equipment in the UK
- Two output sockets that will accept 2 or 3-pin USA type plugs
- Ideal for 3 (PS3) and Xbox 360 US models for use in the UK
- Full encapsulation of the transformer improves heat dissipation and prevents ingress of moisture
- The toroidal construction benefits from smaller size and reduced weight compared to laminated transformers
- Designed and manufactured in Britain



Toroidal technology is more energy/weight efficient and cheaper to run when compared to traditional laminated transformers. Suitable products include most AC mains adapters, calculators, electric razors, radios, ghetto blasters, CD players, some handheld games consoles, air purifiers, Christmas tree lights, nebulisers and laptop and desktop computers. TVs and Hi-fis (ensure the rating is correct). Ideal for multimedia and AV equipment

Specifications:

Input Voltage	AC 220 - 240, 50/60Hz
Input Power Plug:	UK
Output Voltage:	AC 110 - 120V
Output Current	8.3A [8300mA]
Output Voltage Type	Fixed
Output Power [Max]:	1000W
Regulated Output:	No
Number of Tips or Sockets	2
Output Tips/Socket Type:	USA 3 Pin Mains Socket
Switched Mode Supply	No

Order Code	Mod:	Price each exc. VAT	inc. VAT each
N54HF	UK/US StepDown1000VA	£124.99	£149.99

Maplin 110V to 230V 100W Voltage Converter

- Allows you to operate UK equipment in the USA
- Robust desktop ABS housings
- Thermal fuse protection
- Output sockets UL/CSA listed
- Operates equipment up to 100W



Specifications:

Input voltage	AC 110V, 50Hz
Input Power Plug:	USA Mains Socket
Input Power Cord Length	1.8m
Output Voltage:	AC 230V
Output Current:	435mA
Output Voltage Type:	Fixed
Output Power [Max]:	100W
Regulated Output:	No
Number of Tips or Sockets:	1
Output Tips/Socket Type	UK 3 Pin Mains Plug
Switched Mode Supply:	No
Efficiency:	91%
Dimensions	130[l] x 84[w] x 67[d] mm
Weight	1130g

Order Code	Mod:	Price each exc. VAT	inc. VAT each
UP90X	US/UK StepUp 100VA	£20.82	£24.99

Maplin 110V to 230V 300W Voltage Converter

- Allows you to operate UK equipment in the USA
- Robust desktop ABS housings
- Thermal fuse protection
- Output sockets UL/CSA listed
- Operates equipment up to 300W



Specifications:

Input voltage	AC 110V, 50Hz
Input Power Plug:	USA Mains Socket
Input Power Cord Length	1.8m
Output Voltage:	AC 230V
Output Current:	1300mA
Output Voltage Type:	Fixed

Output Power [Max]:	300W
Regulated Output	No
Number of Tips or Sockets	1
Output Tips/Socket Type	UK 3 Pin Plug
Switched Mode Supply	No
Efficiency	91%
Dimensions	96[l] x 136[w] x 19[d] mm
Weight:	3190g

Order Code	Mod:	Price each exc. VAT	inc. VAT each
UP91Y	US/UK StepUp 300VA	£33.32	£39.99

Tacima 110V to 230V 500W Voltage Converter

- Allows you to operate UK equipment in the USA
- Output socket accept 3-pin UK type plug
- Full encapsulation of the transformer improves heat dissipation and prevents ingress of moisture
- The toroidal construction benefits from smaller size and reduced weight compared to laminated transformers
- Designed and manufactured in Britain



Toroidal technology is more energy/weight efficient and cheaper to run when compared to traditional laminated transformers. Suitable products include most AC mains adapters, calculators, electric razors, radios, ghetto blasters, CD players, some handheld games consoles, air purifiers, Christmas tree lights, nebulisers, laptop and desktop computers, TVs and Hi-fis (ensure the rating is correct). Ideal for multimedia and AV equipment

Specifications:

Input Voltage	AC 110 - 120V
Input Power Plug	USA
Output Voltage	AC 220 - 240V
Output Current	2.08A [2080mA]
Output Voltage Type	Fixed
Output Power [Max]:	500W
Regulated Output:	No
Number of Tips or Sockets	1
Output Tips/Socket Type	UK 3 Pin Mains Socket
Switched Mode Supply	No

Order Code	Mod:	Price each exc. VAT	inc. VAT each
N59HF	US/UK StepUp 500VA	£66.65	£79.99

Tacima 110V to 230V 1000W Voltage Converter

- Allows you to operate UK equipment in the USA
- Output socket accept 3-pin UK type plug
- Full encapsulation of the transformer improves heat dissipation and prevents ingress of moisture
- The toroidal construction benefits from smaller size and reduced weight compared to laminated transformers
- Designed and manufactured in Britain



Toroidal technology is more energy/weight efficient and cheaper to run when compared to traditional laminated transformers. Suitable products include most AC mains adapters, calculators, electric razors, radios, ghetto blasters, CD players, some handheld games consoles, air purifiers, Christmas tree lights, nebulisers and laptop and desktop computers, TVs and Hi-fis (ensure the rating is correct). Ideal for multimedia and AV equipment

Specifications:

Tacima 230V to 110V 2000W Voltage Converter

- Allows you to operate USA equipment in the UK
- Two output sockets that will accept 2 or 3-pin USA type plugs
- Ideal for Playstation 3



Input Voltage AC 110 - 120V
 Input Power Plug USA
 Output Voltage: AC 220 - 240V
 Output Current 4.16A (4160mA)
 Output Voltage Type: Fixed
 Output Power (Max): 1000W
 Regulated Output: Nc
 Number of Tips or Sockets: 1
 Output Tips/Socket Type: UK 3 Pin Mains Socket
 Switched Mode Supply: Nc

Order Code	Mod: 265223	Price each exc. VAT 1+	inc. VAT each
N60HF	US/UK Step Up 1000VA	£124.99	£149.99

Bench Power Supplies

Maplin 36W Switched Mode DC Variable Voltage Compact Bench Power Supply

- Ideal for the electronics hobbyist, CB radios or CCTV applications
- 6 output voltages - DC 3 - 4.5 - 6 - 7.5 - 9 and 12V
- Continuous 3000mA current across all voltage outputs
- Screw terminal posts that also accept banana plugs
- Complete with banana plugs to crocodile clips and banana plugs to DC 12V cigarette lighter socket test leads



Specifications:
 Input Voltage: AC 240V, 50Hz
 Input Power Plug: UK 3 Pin Mains Plug
 Input / Output: 2m / 1m
 Power Cord Length: DC 3 - 4.5 - 6 - 7.5 - 9 and 12V
 Output Voltage: 3A (3000mA)
 Output Current: Variable
 Output Voltage Type: 36W
 Output Power (Max): Regulated Output: Yes
 Reversible Polarity: Nc
 Number of Tips or Sockets: 1
 Output Tips/Socket Type: Terminal Post / 4mm Socket / Crocodile Clips
 Switched Mode Supply: Yes
 Efficiency: 75%
 Dimensions: 93(l) x 55(w) x 135(d) mm
 Weight: 700g

Order Code	Mod: 096963	Price each exc. VAT 1+	inc. VAT each
L10BR	3A 3-12V Bench SMPS	£29.15	£34.99

Maplin 41W DC Fixed Voltage Bench Power Supply

- Fixed 13.8V regulated bench power supply
- Ideally suited for CB and PMR radio applications
- Useful when bench testing and setting up in car equipment
- Robust steel case construction, with illuminated rocker switch
- Binding post termination
- Features short-term overload and short circuit protection



Please note these power supplies are designed for use in well ventilated areas.

Specifications:
 Input: 240Vac 50Hz
 Output voltage: 13.8V
 Output current: 5A
 Overall dims WxDxH: 141 x 141 x 82mm
 Weight: 1.95kg

Continuous 50% Duty Surge
 Cycle 2A 3A 5A

Order Code	Mod: 807330	Price each exc. VAT 1+	inc. VAT each
XM20W	3A 13.8V DC PSU	£24.99	£29.99

Maplin 69W DC Fixed Voltage Bench Power Supply



- Fixed 13.8V regulated bench power supply
- Ideally suited for CB and PMR radio applications
- Useful when bench testing and setting up in car equipment
- Robust steel case construction, with illuminated rocker switch
- Binding post termination
- Features short-term overload and short circuit protection

Please note these power supplies are designed for use in well ventilated areas

Specifications:
 Input: 240Vac 50Hz
 Output voltage: 13.8V
 Continuous 50% Duty Surge
 Cycle 3A 5A 7A
 Overall dims WxDxH: 141 x 141 x 82mm
 Weight: 2.9kg

Order Code	Mod: 807331	Price each exc. VAT 1+	inc. VAT each
XM22Y	5A 13.8V DC PSU	£31.65	£37.99

Maplin 97W DC Fixed Voltage Bench Power Supply

- Fixed 13.8V regulated bench power supply
- Ideally suited for CB and PMR radio applications
- Useful when bench testing and setting up in car equipment
- Robust steel case construction, with illuminated rocker switch
- Binding post termination
- Features short-term overload and short circuit protection



Please note these power supplies are designed for use in well ventilated areas

Specifications:
 Input: 240Vac 50Hz
 Output voltage: 13.8V
 Output current: 7A
 Continuous 50% Duty Surge
 Cycle 5A 9A
 Overall dims WxDxH: 187 x 181 x 113mm

Order Code	Mod: 807332	Price each exc. VAT 1+	inc. VAT each
XM21X	7A 13.8V DC PSU	£37.49	£44.99

207W Switched Mode DC Fixed Voltage Bench Power Supply



- DC 13.8V fixed

- 15A/18A max
- DC output 4mm sockets and cigarette lighter socket
- Fan assisted cooling
- Mains power cord and mounting brackets included

This quiet running, switching mode power supply is designed for radco equipment. It is exceptionally immune to Radio Frequency Interference at close range. The thermstatic variable speed cooling fan is hardly audible even at its maximum speed. It has the small footprint of popular radio transceivers, and a low profile casing

Specification
 Input Voltage: AC 230V, 50Hz
 Input Power Plug: UK
 Input Power Cord Length: 2m
 Output Voltage: DC 13.3 to 14.5V
 Output Current: 15A (15000mA)
 Output Voltage Type: Variable
 Output Power (Max): 207W
 Regulated Output: Yes
 Reversible Polarity: Nc
 Number of Tips or Sockets: 2
 Output Tips/Socket Type: Car Type Cigar Socket (10A Max) 4mm Binding Post (15A Max)
 Switched Mode Supply: Yes
 Dimensions: 181(w) x 63(l) x 190(d) mm
 Weight: Apporx 1700g
 Status Indicator: Green = Operate Red = Overload

Order Code	Mod: 227053	Price each exc. VAT 1+	inc. VAT each
N316K	DC 13.8V 15A PSU	£58.32	£69.99

75W DC Variable Voltage Bench Power Supply

- DC 0 - 30V (2.5A), fixed DC 5 and 12V (0.5A) outputs
- Separate analogue voltmeter and ammeter
- Current can be limited from 0 to 2.5A using the 'current' control.
- Fixed outputs through 'snap-on' terminals and variable supply available at pair of terminal posts
- Overload and short circuit protected



Specifications:
 Input Voltage: AC 240V, 50Hz
 Input Power Plug: UK 3 Pin Mains Plug
 Input Power Cord Length: 1.7m
 Output Voltage: DC 0 - 30V (2.5A max) DC 5V (0.5A max) DC 12V (0.5A max)
 Ripple & noise: 5mV
 Line regulation: 0.05% + 10mV
 Load regulation: 0.05% + 10mV
 Output Current: 2.5A (2500mA)
 Output Voltage Type: Variable
 Output Power (Max): 75W
 Regulated Output: Yes
 Reversible Polarity: Nc
 Number of Output Sockets: 3
 Output Tips/Socket Type: Terminal Post / 4mm Socket
 Efficiency: 60%
 Dimensions mm (HxWxD): 150) x 130 x 225
 Weight: 5250g

Order Code	Mod: 005925	Price each exc. VAT 1+	inc. VAT each
GW02C	Bench PSU 30V/12V/5V	£70.82	£84.99

Look out for our monthly promotions at your local Maplin store now!

Pop in and pick up a copy of our monthly promotional publication, with special offers on dozens of exciting products. See the end of this catalogue for store listings

Moonraker 375W Switched Mode DC Variable Voltage Compact Bench Power Supply



- Output current: 30A max. 25A continuous
- Output Voltage: 9-15VDC variable, 13.8V default setting
- Variable noise offset function
- Choice of three output terminals
- 25/30A 4mm sockets at the rear for neatness, 3A wire terminals on the front panel and 10A Cigar socket for mobile accessories

This is a high efficiency, compact, lightweight, high performance switch mode power supply. It is engineered to minimize the switching noise specifically for amateur radio use, when minor noise does occur it can be eliminated with the Noise-Offset function. Includes pre-set voltage for 13.8V and back lit meter displaying Voltage or Current as standard, three output sockets for various shack equipment

Output Voltage:	9-15VDC variable
Output voltage regulation:	Less than 2%
Output current	30A max. 25A continuous
Ripple:	Less than 15mVp-p at rated load
Fuse:	5A
Dimensions:	190mm [W] X 69mm [H] X 181mm [D]
Weight	2.3kg

Order Code	Mod:	Price each exc. VAT	inc. VAT each	
		1+	5+	
N87JN	PS30SWII 25A SMPS	£74.99	£67.49	£89.99

80W Switched Mode DC Multi Voltage Slim Bench Power Supply



- High specification bench power supply that can be used as a stand alone, master or slave unit
- Slim tower housing - ideal for workbenches where space is limited
- Features current limiting, preview voltage and current, upper voltage limit alarm and remote sensing terminal
- Rated load is DC 16V / 5A, DC 27V / 3A and DC 36V / 2.2A
- Short circuit, overload and over temperature protection
- Mains power input cord included

Specifications		
Input AC Voltage Range:	AC 100 - 240V	
No load Input Current at AC 230V:	0.1A	
Full Load Input Current at AC 230V:	0.5A	
AC Input Frequency:	47 - 63Hz-	
Efficiency:	75%	
Power Factor:	0.9	
Constant Voltage and Current Range Selection		
0-16V / 5A selection I:	DC 0 - 16.4V	0 - 5.1A
0-27V / 3A selection II:	DC 0 - 27.6V	0 - 3.1A
0-36V / 2.2A selection III:	DC 0 - 36.8V	0 - 2.3A
Voltage Resolution:	DC 0.1V	
Current Resolution:	0.01A	
Constant Voltage Characteristics		
Load Regulation [0-100%]:	20mV	
Line Regulation [±10%]:	4mV	
Ripple & Noise (peak to peak):	<30mV	
Ripple and noise (RMS):	<5mV	
Constant Current Characteristics		

Load Regulation [0-100%]:	<10mA
Line Regulation [±10%]:	<10mA
Meter Accuracy:	
Voltmeter Accuracy:	±1% +2 counts
Ammeter Accuracy:	±1% +2 counts
Protection:	Adjustable Upper Voltage Limit, Current Limiting Protection, Short Circuit, Overload, Over Temperature

Protection	
Output Terminals:	Front and Back of housing
Additional Functions:	Remote Sensing
CE Approvals:	LVD : EN 61010, EMC : EN 55011
Cooling:	Natural Convection
Dimensions:	53.5[w] x 127[h] x 330[d]
mm	
Weight:	1.9 kg

Order Code	Mod:	Price each exc. VAT	inc. VAT each
		1+	5+
N27GG	80W Switching PSU	£83.32	£99.99

100W Slim Bench Power Supply

- Ideal power supply for use in labs, schools or workshops
- High quality selectable output, 1 to 20V and 0 to 5A
- Large clear illuminated 3-digit LCD screen shows voltage and current
- Slim tower housing - ideal for workbenches where space is tight
- Output on/off button for safety
- Short circuit, overload and over temperature protection



Specifications:	
Input voltage:	AC 230 V
Output voltage:	1-20 volts, user adjustable at 0.1V intervals
Output current:	0-5 amps, user adjustable at 0.01A intervals
Voltage regulation:	
Load from 10% to 100% variation:	70mV
Line from AC 180 V to AC 264 V variation:	20mV
Ripple and noise (RMS):	5mV
Ripple and noise (peak to peak):	30mV
Current regulation:	
Load from 10% to 100% variation:	20mA
Line from AC 180 V to AC 264 V variation:	20mA
Ripple and noise (peak to peak):	20mA
Efficiency at maximum power:	84%
Dimensions:	70[w] x 150[h] x 250[d], mm
Weight:	2kg

Order Code	Mod:	Price each exc. VAT	inc. VAT each	
		1+	5+	
N93CX	1-20V 0-5A Bench PSU	£74.99	£67.49	£89.99

375W Linear DC Variable Voltage Bench Power Supply

- 3V to 15V variable
- 25A/30A max
- Thermostatically controlled cooling fan
- 10mV RMS noise & ripple
- Volt and current metering
- Over current warning indicator
- Short circuit protection
- DC output 4mm sockets & 2 pairs of snap-in terminals
- Dimensions 150x145x300mm



Model Number:	RP10L
Output Voltage:	3-15V DC
Output Current:	25A
Output Current Max:	30A

Output Current (Snap-On Output Terminals)	3A
Ripple & Noise	<10mVrms
Line Regulation	15mV
Load Regulation [0-100% Load]	100mV
Power Source	230Vac/50Hz
Meters Type	ANALOG METERS
Cooling Fan:	YES
Dimension WxHxD/mm	150 x 145 x 300
Weight [Approx.]	9kg

Order Code	Mod:	Price each exc. VAT	inc. VAT each	
		1+	5+	
RP10L	Palstar PS-30	£83.32	£79.99	£99.99

GW Instek PSM-6003 Programmable Dual Range Linear DC Power Supply

- Single Output Dual Range Max. 200W
- High Resolution: 1mV/1mA Stable & Clear Power: 0.01% Load/Line Regulation, 350 Vrms Ripple
- 100 Sets Memory
- Auto Step Running With Timer Setting
- Safety Design: OVP, OCP & OTP ; Output ON/OFF Control (OCP Provides Delay Setting to Prevent Trip of High Start-Up Current)
- Self-Test and Software Calibration
- Highly Visible Vacuum-Fluorescent Display
- Front and Rear Output Terminal
- Standard Interface : RS-232C, GPIB
- Optional European Jack Type Terminal"



The PSM-Series is single output / dual range, 120W or 200W, programmable linear DC power supplies. OVP, OCP, OTP, and output On/Off control protect the PSM-Series and their load from unexpected conditions. High resolution, high regulation, and low ripple are maintained at 1mV/1mA, 0.01%, and <350 Vrms, respectively. Operation and configuration is simplified with a digital interface and a clear LCD display. Standard features include: store/recall output memories, automatic stepping with timers for continuous testing and self-testing and software calibration features to reduce maintenance overhead. SCPI programming, LabVIEW drivers, RS-232C and GPIB interfaces enable easy automated test system integration and remote control. The PSM-Series is an ideal choice for high precision applications such as QA verification and product development.

Order Code	Mod:	Price each exc. VAT	inc. VAT each
		1+	5+
N30DG	PSM-6003 200W PSU	£524.99	£629.99

GW GPD-2303S Multi-output programmable Linear DC Power Supply

- 2 Independent Isolated Output
- 4 LED Display Sets : 3 Digits After Decimal Point (GPD-2303S/3303S/4303S)
- Minimum Resolution : (1mV/1mA)
- Digital Panel Control (Rotary Encoder Switch, Rubber Key With Indicator)
- User-Friendly Operation, Coarse / Fine Volume Control
- 4 Sets Save / Recall
- Key-Lock- Output ON/OFF
- Tracking Series and Parallel Mode
- Smart Cooling Fan Achieving Low Noise
- Compact Design & PC Software & USB Driver & USB Standard Interface



• Optional European Jack Type Terminal

Order Code	Mod: 1011072	Price each exc. VAT 1+	inc. VAT each
N310G	GPD-4303S DC PSU	£391.65	£469.99

GW Instek GPD-4303S Multi-output programmable Linear DC Power Supply

- 2, 3 and 4 Independent Isolated Output
- 4 LED Display Sets : 3 Digits After Decimal Point (GPD-2303S/3303S/4303S)
- Minimum Resolution : [1mV/1mA]
- Digital Panel Control (Rotary Encoder Switch, Rubber Key With Indicator)
- User-Friendly Operation, Coarse / Fine Volume Control
- 4 Sets Save / Recall
- Key-Lock
- Output ON/OFF
- Tracking Series and Parallel Mode
- Smart Cooling Fan Achieving Low Noise
- Compact Design & PC Software & USB Driver & USB Standard Interface
- Optional European Jack Type Terminal



Order Code	Mod: 1011074	Price each exc. VAT 1+	inc. VAT each
N320G	GPD-3303S DC PSU	£341.65	£409.99

GW Instek GPD-3303D Multi-output Programmable Linear DC Power Supply

- 2,3 Independent isolated output
- 4 LED Display Sets : 3 Digits After Decimal Point (GPD-2303S/3303S/4303S)
- Minimum resolution : [100mV/10mA]
- Digital panel control (Rotary Encoder Switch, Rubber Key With Indicator)
- User-Friendly Operation, Coarse / Fine Volume Control
- 4 sets - save / recall
- Key lock
- Output ON/OFF
- Tracking Series and Parallel Mode
- Smart Cooling Fan Achieving Low Noise
- Compact Design & PC Software & USB Driver & USB Standard Interface
- Optional European Jack Type Terminal



Order Code	Mod: 1011076	Price each exc. VAT 1+	inc. VAT each
N330G	GPD-2303S DC PSU	£308.32	£369.99

GW Instek GPS-4303 Multi-output Linear DC Power Supply

- 2,3 and 4 Independent Isolated Output
- Four "3 Digits" LED Displays
- 0.01% Load and Line Regulation
- Low Ripple and Noise
- Tracking Operation and Auto Series/Parallel Operation
- Output ON/OFF Switch Output Voltage and Current Setting When Output Disable (Except for GPS-2303)
- Fan Speed Control Circuit to Minimize Fan Noise
- Over Load and Reverse Polarity Protection
- Optional European Jack Type Terminal



Order Code	Mod: 1011124	Price each exc. VAT 1+	inc. VAT each
N340G	GPD-3303D DC PSU	£299.99	£359.99

GW Instek GPS-3303 Multi-Output Linear DC Power Supply

- 2, 3 independent isolated output
- Four 3 digit LED displays
- 0.01% load and line regulation
- Low ripple and noise
- Tracking operation and auto series/parallel operation
- Output on/off switch
- Output voltage and current setting when output disable (Except for GPS-2303)
- Fan speed control circuit to minimize fan noise
- Over load and reverse polarity protection
- Optional European jack type terminal



Order Code	Mod: 1011132	Price each exc. VAT 1+	inc. VAT each
N350G	GPS-4303 DC PSU	£266.65	£319.99

GW Instek GPS-2303 Multi-output Linear DC Power Supply

- 2, 3 independent isolated output
- Four 3 digit LED displays
- 0.01% load and line regulation
- Low ripple and noise
- Tracking operation and auto series/parallel operation
- Output on/off switch
- Output voltage and current setting when output disable (Except for GPS-2303)
- Fan speed control circuit to minimize fan noise
- Over load and reverse polarity protection
- Optional European jack type terminal



Order Code	Mod: 1011135	Price each exc. VAT 1+	inc. VAT each
N360G	GPS-3303 DC PSU	£224.99	£269.99

GW Instek GPS-2303 (S) Programmable Switching Multi-Range DC Power Supply

- 2, 3 independent isolated output
- Four 3 digit LED displays
- 0.01% load and line regulation
- Low ripple and noise
- Tracking operation and auto series/parallel operation
- Output on/off switch
- Output voltage and current setting when output disable (Except for GPS-2303)
- Fan speed control circuit to minimize fan noise
- Over load and reverse polarity protection
- Optional European jack type terminal



Order Code	Mod: 1011137	Price each exc. VAT 1+	inc. VAT each
N370G	GPS-2303 DC PSU	£199.99	£239.99

GW Instek PSW 30-36 Programmable Switching Multi-Range DC Power Supply

- Voltage rating: 30V, output power rating: 360W
- Constant power output for multi-range (V & I) operation
- C.V / C.C priority - particularly suitable for the battery and LED industry
- Adjustable slew rate
- Series and parallel operation



- [2 units in series /3 units in parallel maximum]
- High efficiency and high power density
- 1/2, 1/3, 1/6 rack mount size design (EIA/JIS standard) for 360W, 720W, 1080W S-2303)
- Standard interface: LAN, USB, analogue control interface
- Optional interface: GPIB-USB adapter
- Lab VIEW driver

Order Code	Mod: 1011157	Price each exc. VAT 1+	inc. VAT each
N380G	PSW30-36 360W DC PSU	£1024.99	£1229.99

GW Instek PSW 30-72 Programmable Switching Multi-Range DC Power Supply

- Voltage rating: 30V, output power rating: 720W
- Constant power output for multi-range (V & I) operation
- C.V / C.C priority - particularly suitable for the battery and LED industry
- Adjustable slew rate
- Series and parallel operation (2 units in series / 3 units in parallel maximum)
- High efficiency and high power density
- 1/2, 1/3, 1/6 rack mount size design (EIA/JIS standard) for 360W, 720W, 1080W S-2303)
- Standard interface: LAN, USB, analogue control interface
- Optional interface: GPIB-USB adapter
- Lab VIEW driver



Order Code	Mod: 1011164	Price each exc. VAT 1+	inc. VAT each
N390G	PSW30-72 720W DC PSU	£1208.32	£1449.99

Check online for full range and specifications

GW Instek PSW 30-108 Programmable Switching Multi-Range DC Power Supply

- Voltage rating: 30 V, output power rating: 1080 W
- Constant power output for multi-range (V & I) operation
- C.V / C.C priority - particularly suitable for the battery and LED industry
- Adjustable slew rate
- Series and parallel operation (2 units in series / 3 units in parallel maximum)
- High efficiency and high power density
- 1/2, 1/3, 1/6 rack mount size design (EIA/JIS standard) for 360 W, 720 W, 1080 W S-2303)
- Standard interface: LAN, USB, analogue control interface
- Optional interface: GPIB-USB adapter
- Lab VIEW driver



Order Code	Mod: 1011166	Price each exc. VAT 1+	inc. VAT each
N400G	PSW30-108 DC PSU	£1583.32	£1899.99

Browse our entire range at maplin.co.uk

GW Instek PSW 80-13.5 Programmable Switching Multi-Range D.C. Power Supply

- Output power rating 360W
- Voltage rating 80V
- Constant power output for multi-range (V&I) operation
- Particularly suitable for the battery and LED industry - C.V / C.C priority
- Adjustable slew rate
- Series and parallel operation (2 units in series/3 units in parallel maximum)
- High efficiency and high power density
- Standard interface LAN, USB, analogue control interface
- Optional interface GPIB-USB Adapter
- LabVIEW Driver
- 1/2, 1/3, 1/6 Rack Mount Size Design (EIA/JIS Standard) for 360W, 720W, 1080W S-2303



Order Code	Mod:	Price each exc. VAT 1+	inc. VAT each
N41DG	PSW80-13.5 DC PSU	£1008.32	£1209.99

GW Instek PSW 80-27 Programmable Switching Multi-Range D.C. Power Supply

- Output power rating 720W
- Voltage rating 80V
- Constant power output for multi-range (V&I) operation
- Particularly suitable for the battery and LED industry - C.V / C.C priority
- Adjustable slew rate
- Series and parallel operation (2 units in series/3 units in parallel maximum)
- High efficiency and high power density
- Standard interface LAN, USB, analogue control interface
- Optional interface GPIB-USB Adapter
- LabVIEW Driver
- 1/2, 1/3, 1/6 Rack Mount Size Design (EIA/JIS Standard) for 360W, 720W, 1080W S-2303



Order Code	Mod:	Price each exc. VAT 1+	inc. VAT each
N42DG	PSW80-27 DC PSU	£1224.99	£1469.99

GW Instek PSW 160-7.2 Programmable Switching Multi-Range D.C. Power Supply

- Output power rating 360W
- Voltage rating 160V
- Constant power output for multi-range (V&I) operation
- Particularly suitable for the battery and LED industry - C.V / C.C priority
- Adjustable slew rate
- Series and parallel operation (2 units in series/3 units in parallel maximum)
- High efficiency and high power density
- Standard interface LAN, USB, analogue control interface
- Optional interface GPIB-USB Adapter
- LabVIEW Driver
- 1/2, 1/3, 1/6 Rack Mount Size Design (EIA/JIS Standard) for 360W, 720W, 1080W S-2303



Order Code	Mod:	Price each exc. VAT 1+	inc. VAT each
N44DG	PSW160-7.2 DC PSU	£1124.99	£1349.99

GW Instek PSW 80-40.5 Programmable Switching Multi-Range D.C. Power Supply

- Output power rating 1080W
- Voltage rating 80V
- Constant power output for multi-range (V&I) operation
- Particularly suitable for the battery and LED industry - C.V / C.C priority
- Adjustable slew rate
- Series and parallel operation (2 units in series/3 units in parallel maximum)
- High efficiency and high power density
- Standard interface LAN, USB, analogue control interface
- Optional interface GPIB-USB Adapter
- LabVIEW Driver
- 1/2, 1/3, 1/6 Rack Mount Size Design (EIA/JIS Standard) for 360W, 720W, 1080W S-2303



Order Code	Mod:	Price each exc. VAT 1+	inc. VAT each
N43DG	PSW80-40.5 DC PSU	£1583.32	£1899.99

GW Instek PSW 160-14.4 Programmable Switching Multi-Range D.C. Power Supply

- Output power rating 720W
- Voltage rating 160V
- Constant power output for multi-range (V&I) operation
- Particularly suitable for the battery and LED industry - C.V / C.C priority
- Adjustable slew rate
- Series and parallel operation (2 units in series/3 units in parallel maximum)
- High efficiency and high power density
- Standard interface LAN, USB, analogue control interface
- Optional interface GPIB-USB Adapter
- LabVIEW Driver
- 1/2, 1/3, 1/6 Rack Mount Size Design (EIA/JIS Standard) for 360W, 720W, 1080W S-2303



Order Code	Mod:	Price each exc. VAT 1+	inc. VAT each
N45DG	PSW160-14.4 DC PSU	£1333.32	£1599.99

GW Instek PSW 160-21.6 Programmable Switching Multi-Range D.C. Power Supply

- Output power rating 1080W
- Voltage rating 160V
- Constant power output for multi-range (V&I) operation
- Particularly suitable for the battery and LED industry - C.V / C.C priority
- Adjustable slew rate
- Series and parallel operation (2 units in series/3 units in parallel maximum)
- High efficiency and high power density
- Standard interface LAN, USB, analogue control interface
- Optional interface GPIB-USB Adapter
- LabVIEW Driver
- 1/2, 1/3, 1/6 Rack Mount Size Design (EIA/JIS Standard) for 360W, 720W, 1080W S-2303



Order Code	Mod:	Price each exc. VAT 1+	inc. VAT each
N46DG	PSW160-21.6 DC PSU	£1708.32	£2049.99

GW Instek SPS-1230 Switching DC Power Supply

- Dual measurement display
- 0.01 % high regulation
- Constant voltage and constant current operation
- High efficiency
- High power density
- Over voltage protection remote output on/off control

Order Code	Mod:	Price each exc. VAT 1+	inc. VAT each
N47DG	SPS-1230 DC PSU	£274.99	£329.99

GW Instek SPS-1820 Switching DC Power Supply

- Dual measurement display
- 0.01 % high regulation
- Constant voltage and constant current operation
- High efficiency
- High power density
- Over voltage protection remote output on/off control



Order Code	Mod:	Price each exc. VAT 1+	inc. VAT each
N48DG	SPS-1820 DC PSU	£283.32	£339.99

GW Instek SPS-2415 Switching DC Power Supply

- Dual measurement display
- 0.01 % high regulation
- Constant voltage and constant current operation
- High efficiency
- High power density
- Over voltage protection remote output on/off control



Order Code	Mod:	Price each exc. VAT 1+	inc. VAT each
N49DG	SPS-2415 DC PSU	£283.32	£339.99

GW Instek SPS-3610 Switching DC Power Supply

- Dual measurement display
- 0.01 % high regulation
- Constant voltage and constant current operation
- High efficiency
- High power density
- Over voltage protection remote output on/off control



Order Code	Mod:	Price each exc. VAT 1+	inc. VAT each
N50DG	SPS-3610 DC PSU	£249.99	£299.99

GW Instek SPS-606 Switching DC Power Supply

- Dual measurement display
- 0.01 % high regulation
- Constant voltage and constant current operation
- High efficiency
- High power density
- Over voltage protection remote output on/off control



Order Code	Mod:	Price each exc. VAT 1+	inc. VAT each
N51DG	SPS-606 DC PSU	£316.65	£379.99

Free Delivery
on all UK orders over **£10**

IT&CS Apply

Bulbs

Energy Saving Bulbs

Soft Lite Low Energy GLS

- Energy Efficient
- Excellent colour rendering
- Long life: 10,000 hours
- Instant start
- Warm White 2700K



The new Eveready Soft Lite range of low energy lamps bring warm comforting light to your home.

Order Code	Wattage	Equivalent	Fitting	Lamp Size
N00NJ	9W	40W	BC (B22)	54mm x 112mm
N01NJ	9W	40W	ES (E27)	54mm x 112mm
N91NL	11W	60W	BC (B22)	60mm x 106mm
N92NL	11W	60W	ES (E27)	60mm x 106mm
N05NJ	20W	100W	BC (B22)	65mm x 154mm
N06NJ	20W	100W	ES (E27)	65mm x 154mm

Order Code	Mod: 394447	Price each exc. VAT 1+	inc. VAT each
N00NJ	9W B22 SL GLS	£3.32	£3.99
N01NJ	9W E27 SL GLS	£3.32	£3.99
N91NL	11W B22 SL GLS	£3.32	£3.99
N92NL	11W E27 SL GLS	£3.32	£3.99
N05NJ	20W B22 SL GLS	£4.15	£4.99
N06NJ	20W E27 SL GLS	£4.15	£4.99

Soft Lite Low Energy Golf

- Energy Efficient
- Excellent colour rendering
- Long life: 10,000 hours
- Instant start
- Warm White 2700K



The new Eveready Soft Lite range of low energy lamps bring warm comforting light to your home.

Order Code	Wattage	Equivalent	Fitting	Lamp Size
N07NJ	7W	35W	BC (B22)	45mm x 80mm
N08NJ	7W	35W	SBC (B15)	45mm x 80mm
N09NJ	7W	35W	ES (E27)	45mm x 80mm
N10NJ	7W	35W	SES (E14)	45mm x 80mm

Order Code	Mod: 394451	Price each exc. VAT 1+	inc. VAT each
N07NJ	7W B22 SL Golf	£3.32	£3.99
N08NJ	7W B15 SL Golf	£3.32	£3.99
N09NJ	7W E27 SL Golf	£3.32	£3.99
N10NJ	7W E14 SL Golf	£3.32	£3.99

Soft Lite Low Energy Candle

- Energy Efficient
- Excellent colour rendering
- Long life: 10,000 hours
- Instant start
- Warm White 2700K



The new Eveready Soft Lite range of low energy lamps bring warm comforting light to your home.

Order Code	Wattage	Equivalent	Fitting	Lamp Size
N32NJ	7W	35W	BC (B22)	37mm x 105mm
N33NJ	7W	35W	ES (E27)	37mm x 105mm
N35NJ	7W	35W	SES (E14)	37mm x 105mm
N36NJ	11W	60W	BC (B22)	43mm x 133mm
N38NJ	11W	60W	ES (E27)	43mm x 133mm
N39NJ	11W	60W	SES (E14)	43mm x 133mm

Order Code	Mod: 394472	Price each exc. VAT 1+	inc. VAT each
N32NJ	7W B22 SL Mandle	£3.74	£4.49
N33NJ	7W E27 SL Mandle	£3.32	£3.99
N35NJ	7W E14 SL Mandle	£3.32	£3.99
N36NJ	11W B22 SL Candle	£3.32	£3.99
N38NJ	11W E27 SL Candle	£3.32	£3.99
N39NJ	11W E14 SL Candle	£3.74	£4.49

Find out more in-store

Our staff can offer friendly and expert advice; we're here to help



Soft Lite Low Energy Reflectors

- Energy Efficient
- Excellent colour rendering
- Long life: 10,000 hours
- Instant start
- Warm White 2700K



The new Eveready Soft Lite range of low energy lamps bring warm comforting light to your home.

Order Code	Wattage	Equivalent	Fitting	Lamp Size
N11NJ	9W (R50)	40W	SES (E14)	50mm x 100mm
N12NJ	11W (R63)	60W	ES (E27)	63mm x 110mm
N13NJ	15W (R80)	75W	ES (E27)	80mm x 132mm

Order Code	Mod: 394460	Price each exc. VAT 1+	inc. VAT each
N11NJ	9W E14 R50 SL Refl	£7.77	£7.77
N12NJ	11W E27 R63 SL Refl	£4.15	£4.99
N13NJ	15W E27 R80 SL Refl	£7.77	£7.77

Maplin TV

Home of innovation, handy tips and How To videos

Visit our channel...
youtube.com/maplintv



Soft Lite Low Energy Micro Spirals

- Energy Efficient
- Excellent colour rendering
- Long life: 10,000 hours
- Instant start
- Warm White 2700K



The new Eveready Soft Lite range of low energy lamps bring warm comforting light to your home.

Order Code	Wattage	Equivalent	Fitting	Lamp Size
N20NJ	9W	40W	BC (B22)	38mm x 102mm
N21NJ	9W	40W	ES (E27)	38mm x 102mm
N22NJ	9W	40W	SBC (B15)	38mm x 102mm
N23NJ	9W	40W	SES (E14)	38mm x 102mm
N24NJ	11W	60W	BC (B22)	38mm x 105mm
N25NJ	11W	60W	ES (E27)	38mm x 105mm
N26NJ	15W	75W	BC (B22)	38mm x 105mm
N27NJ	15W	75W	ES (E27)	38mm x 105mm
N28NJ	20W	100W	BC (B22)	48mm x 127mm
N29NJ	20W	100W	ES (E27)	48mm x 127mm
N30NJ	35W	150W	BC (B22)	68mm x 170mm
N31NJ	46W	200W	BC (B22)	80mm x 190mm

Order Code	Mod: 394469	Price each exc. VAT 1+	inc. VAT each
N20NJ	9W B22 SL MSpiral	£3.32	£3.99
N21NJ	9W E27 SL MSpiral	£3.32	£3.99
N22NJ	9W B15 SL MSpiral	£2.90	£3.49
N23NJ	9W E14 SL MSpiral	£3.32	£3.99
N24NJ	11W B22 SL MSpiral	£3.32	£3.99
N25NJ	11W E27 SL MSpiral	£2.90	£3.49
N26NJ	15W B22 SL MSpiral	£3.32	£3.99
N27NJ	15W E27 SL MSpiral	£3.32	£3.99
N28NJ	20W B22 SL MSpiral	£3.74	£4.49
N29NJ	20W E27 SL MSpiral	£3.74	£4.49
N30NJ	35W B22 SL MSpiral	£6.65	£7.99
N31NJ	46W B22 SL MSpiral	£8.32	£9.99

Eveready Energy Saving Linear Bulb 24W

- Direct replacement for 100W - 300W halogen linears
- Ideal for outdoor PIR security lighting
- Equivalent light output to 120W halogen
- Instant start
- Daylight white (6400K)
- 10,000 Hour life
- Fits most conventional housings
- Dimensions 118mm x 48mm x 73mm



Order Code	Mod: 394476	Price each exc. VAT 1+	inc. VAT each
N69NJ	24W Linear Tube	£8.32	£9.99

Eco Halogen Bulbs

Energy Saving Halogen MR16 and GU10 Twin Packs



- Reduce running costs by up to 30%
- Equivalent output to a range of standard MR16 reflectors
- Direct replacement for traditional halogen MR16 bulbs
- Instant light
- Clear finish
- 2 years' average lamp life (Based on 3 hours' use / day)
- Dimmable, unlike CFLs
- Supplied in a twin pack

Energy Saving Halogens, or often called Eco Halogens differ to traditional incandescent lamps by using a more economical Halogen filament contained within a traditional glass envelope.

The benefits of using Eco Halogen bulbs are:

- Lower wattage than normal incandescent bulbs, using typically 30% less energy
- Outstanding quality of light (CRI of 100)
- More appealing aesthetic than some compact fluorescent lamps (CFLs)
- Fully retrofit to traditional bulbs
- Longer lifespan, typically 2,000 hours
- Compatible with dimming systems
- No mercury or hazardous materials

Order Code	Voltage	Wattage	Equivalent	Beam Angle	Fitting
N19GZ	12V	35W	50W	38°	MR16
N20GZ	240V	28W	35W	38°	GU10
N21GZ	240V	40W	50W	38°	GU10

Order Code	Mod: 263637	Price each exc. VAT 1+	inc. VAT each
N19GZ	Halogen MR16 35W	£4.15	£4.99
N20GZ	Halogen GU10 28W	£5.82	£6.99
N21GZ	Halogen GU10 40W	£5.82	£6.99

Look out for our monthly promotions at your local Maplin store now!

Pop in and pick up a copy of our monthly promotional publication, with special offers on dozens of exciting products. See the end of this catalogue for store listings

Over 200 stores nationwide

Energy Saving Halogen GLS Bulbs



- Reduce running costs by 30%
- Equivalent output to a range of GLS bulbs
- Looks like a standard GLS
- Instant light
- Clear finish
- 2 years' average lamp life (Based on 3 hours' use / day)
- Dimmable, unlike CFLs

Energy Saving Halogens, or often called Eco Halogens differ to traditional incandescent lamps by using a more economical Halogen filament contained within a traditional glass envelope.

The benefits of using Eco Halogen bulbs are;

- Lower wattage than normal incandescent bulbs, using typically 30% less energy
- Outstanding quality of light (CRI of 100)
- More appealing aesthetic than some compact fluorescent lamps (CFLs)
- Fully retrofit to traditional bulbs
- Longer lifespan, typically 2,000 hours
- Compatible with dimming systems
- No mercury or hazardous materials

Order Code	Wattage	Equivalent Wattage	Finish	Fitting
N91GY	28W	40W	Clear	ES
N92GY	28W	40W	Clear	BC
N93GY	42W	60W	Clear	ES
N94GY	42W	60W	Clear	BC
N95GY	70W	100W	Clear	ES
N97GY	70W	100W	Clear	BC
N98GY	100W	150W	Clear	ES
N99GY	100W	150W	Clear	BC

Order Code	Mod: 261528	Price each exc. VAT 1+	inc. VAT each
N91GY	Halogen GLS 28WES	£2.49	£2.99
N92GY	Halogen GLS 28WBC	£2.49	£2.99
N93GY	Halogen GLS 42WES	£2.49	£2.99
N94GY	Halogen GLS 42WBC	£2.49	£2.99
N95GY	Halogen GLS 70WES	£2.49	£2.99
N97GY	Halogen GLS 70WBC	£2.49	£2.99
N98GY	Halogen GLS 100WES	£2.49	£2.99
N99GY	Halogen GLS 100WBC	£2.49	£2.99

Energy Saving Halogen Golf Bulbs Twin Pack



- Reduce running costs by 30%
- Equivalent output to a range of standard Golf Bulbs
- Looks like a standard golf bulb
- Instant light
- Clear finish
- 2 years' average lamp life (Based on 3 hours' use / day)
- Dimmable, unlike CFLs
- Supplied in a twin pack

Energy Saving Halogens, or often called Eco Halogens differ to traditional incandescent lamps by using a more economical Halogen filament contained within a traditional glass envelope.

The benefits of using Eco Halogen bulbs are;

- Lower wattage than normal incandescent bulbs, using typically 30% less energy
- Outstanding quality of light (CRI of 100)
- More appealing aesthetic than some compact fluorescent lamps (CFLs)

- Fully retrofit to traditional bulbs
- Longer lifespan, typically 2,000 hours
- Compatible with dimming systems
- No mercury or hazardous materials

Order Code	Wattage	Equivalent Wattage	Finish	Fitting
N08GZ	28W	40W	Clear	BC
N09GZ	28W	40W	Clear	SBC
N10GZ	28W	40W	Clear	ES
N11GZ	28W	40W	Clear	SES

Order Code	Mod: 261988	Price each exc. VAT 1+	inc. VAT each
N08GZ	Halogen Golf 28WBC	£3.74	£4.49
N09GZ	Hal Golf 28W SBC 2pk	£3.74	£4.49
N10GZ	Halogen Golf 28WES	£3.74	£4.49
N11GZ	Hal Golf 28W SES 2pk	£3.74	£4.49

Energy Saving Halogen Candle Bulbs Twin Pack



- Reduce running costs by 30%
- Equivalent output to a range of GLS bulbs
- Looks like a standard Candle
- Instant light
- Clear finish
- 2 years' average lamp life (Based on 3 hours' use / day)
- Dimmable, unlike CFLs
- Supplied in a twin pack

Energy Saving Halogens, or often called Eco Halogens differ to traditional incandescent lamps by using a more economical Halogen filament contained within a traditional glass envelope.

The benefits of using Eco Halogen bulbs are;

- Lower wattage than normal incandescent bulbs, using typically 30% less energy
- Outstanding quality of light (CRI of 100)
- More appealing aesthetic than some compact fluorescent lamps (CFLs)
- Fully retrofit to traditional bulbs
- Longer lifespan, typically 2,000 hours
- Compatible with dimming systems
- No mercury or hazardous materials

Order Code	Wattage	Equivalent Wattage	Finish	Fitting
N12GZ	28W	40W	Clear	BC
N13GZ	28W	40W	Clear	SBC
N14GZ	28W	40W	Clear	ES
N15GZ	28W	40W	Clear	SES

Order Code	Mod: 261992	Price each exc. VAT 1+	inc. VAT each
N12GZ	Hal Can 28W BC 2pk	£3.74	£4.49
N13GZ	Hal Can 28W SBC 2pk	£3.74	£4.49
N14GZ	Hal Can 28W ES 2pk	£3.74	£4.49
N15GZ	Hal Can 28W SES 2pk	£3.74	£4.49

Energy Saving Halogen Reflector Bulbs



- Reduce running costs by 30%
- Same size as a regular incandescent reflector
- Instant light
- 2 years' average lamp life (Based on 3 hours' use / day)
- Dimmable, unlike CFLs
- Available in R50, R63 and R80 sizes
- R50 and R63 supplied as a twin pack. R80 sold individually
- Edison Screw (E27) Fitting

Energy Saving Halogens, or often called Eco Halogens differ to traditional incandescent lamps by using a

more economical Halogen filament contained within a traditional glass envelope.

The benefits of using Eco Halogen bulbs are;

- Lower wattage than normal incandescent bulbs, using typically 30% less energy
- Outstanding quality of light (CRI of 100)
- More appealing aesthetic than some compact fluorescent lamps (CFLs)
- Fully retrofit to traditional bulbs
- Longer lifespan, typically 2,000 hours
- Compatible with dimming systems
- No mercury or hazardous materials

Order Code	Wattage	Equivalent Wattage	Diameter	Fitting
A12KQ	28W	40W	50mm (R50)	ES
A13KQ	42W	60W	63mm (R63)	ES
A14KQ	42W	60W	80mm (R80)	ES

Order Code	Mod: 513201	Price each exc. VAT 1+	inc. VAT each
A12KQ	R50 Reflect 28W 2 Pk	£4.15	£4.99
A13KQ	R63 Reflect 42W 2 Pk	£4.15	£4.99
A14KQ	R80 Reflector 42W	£2.49	£2.99

Energy Saving Halogen G4 and G9 Capsules



- Reduce running costs by up to 30%
- Direct replacement to traditional capsules lamps
- 2 years' average lamp life (based on 3 hours' use / day)
- Clear finish
- Available in G4 or G9 sizes
- Supplied in a twin pack

Energy Saving Halogens, or often called Eco Halogens differ to traditional incandescent lamps by using a more economical Halogen filament contained within a traditional glass envelope.

The benefits of using Eco Halogen bulbs are;

- Lower wattage than normal incandescent bulbs, using typically 30% less energy
- Outstanding quality of light (CRI of 100)
- More appealing aesthetic than some compact fluorescent lamps (CFLs)
- Fully retrofit to traditional bulbs
- Longer lifespan, typically 2,000 hours
- Compatible with dimming systems
- No mercury or hazardous materials

When fitting, care should be taken to avoid touching the glass body. Oil deposits from skin can drastically reduce operational life of the product.

Order Code	Voltage	Wattage	Equivalent	Finish	Fitting
N16GZ	12V	14W	20W	Clear	G4
N17GZ	240V	28W	40W	Clear	G9

Order Code	Mod: 263631	Price each exc. VAT 1+	inc. VAT each
N17GZ	Hal 28W Clr G9 Cap	£4.99	£5.99
N16GZ	Halogen 14W G4 Cap	£4.15	£4.99

Energy Saving Linear Halogen Lamps



- Direct replacements for Linear Halogen Lamps
- Same light output but using less power
- 2,000 Hour life
- Available in a range of wattages and lengths
- For use in floodlights and security lighting

Energy Saving Halogens, or often called Eco Halogens differ to traditional incandescent lamps by using a more economical Halogen filament contained within a traditional glass envelope.

The benefits of using Eco Halogen bulbs are:

- Lower wattage than normal incandescent bulbs, using typically 30% less energy
- Outstanding quality of light (CRI of 100)
- More appealing aesthetic than some compact fluorescent lamps (CFLs)
- Fully retrofit to traditional bulbs
- Longer lifespan, typically 2,000 hours
- Compatible with dimming systems
- No mercury or hazardous materials

When fitting, care should be taken to avoid touching the glass body. Oil deposits from skin can drastically reduce operational life of the product.

N71NJ 230W 300W R7 [K9] 118mm x 9mm
N72NJ 400W 500W R7 [K1] 118mm x 9mm

Order Code	Wattage	Equivalent	Fitting	Lamp Size:
A10KQ	80W	100W	R7 [K12]	78mm x 9mm
N70NJ	120W	150W	R7 [K12]	78mm x 9mm
A11KQ	160W	200W	R7 [K12]	118mm x 9mm

Order Code	Mod: 394652	Price each exc. VAT 1+	inc. VAT each
A10KQ	80WES Linear (100W)	£3.32	£3.99
N70NJ	120WES Linear (150W)	£3.32	£3.99
A11KQ	160WES Linear (200W)	£3.32	£3.99
N71NJ	230WES Linear (300W)	£3.32	£3.99
N72NJ	400WES Linear (500W)	£3.32	£3.99

Incandescent Bulbs

60W Fireglow Lamp

A 60W standard bulb with bayonet cap [BC] fitting, laquered red for use in flame-effect electric fires, etc.



Order Code	Mod: 027332	Price each exc. VAT 1+	inc. VAT each
DP92A	60W BC Fireglow	£2.90	£3.49

Golf Ball Bulbs Twin Pack

- Available in 25W, 40W and 60W power ratings
- Supplied in clear finish
- Fittings available include ES and SES base fittings
- Supplied in packs of 2

A range of attractive golf ball bulbs, ideal for use in table lamps, chandeliers and other lighting effects where the bulb may be visible.



Order Code:	Wattage:	Base:	Finish
N98BY	25W	SES [E14]	Clear
N96BY	40W	SES [E27]	Clear
N99BY	40W	SES [E14]	Clear
N00BZ	60W	SES [E14]	Clear

Order Code	Mod: 263973	Price each exc. VAT 1+	inc. VAT each
N98BY	25W Golf Clr SES 2Pk	£2.49	£2.99
N96BY	40W Golf Clr ES 2Pk	£2.49	£2.99
N99BY	40W Golf Clr SES 2Pk	£2.49	£2.99
N00BZ	60W Golf Clr SES 2Pk	£2.49	£2.99

Candle Bulbs Twin Pack



- Available in 25W, 40W and 60W
- Clear finish
- Supplied in packs of 2

A range of candle bulbs ideal for standard ceiling and wall lights. The bulbs are supplied with 3 different base fittings: SES, BC and SBC.

Order Code:	Wattage	Base	Finish:
N72BY	25W	BC	Clear
N76BY	25W	SES	Clear
N78BY	40W	BC	Clear
N82BY	40W	SES	Clear
N84BY	60W	BC	Clear

Order Code	Mod: 033573	Price each exc. VAT 1+	inc. VAT each
N72BY	25WCandle Clr BC 2Pk	£2.49	£2.99
N76BY	25WCandle Clr SES 2Pk	£2.49	£2.99
N78BY	40WCandle Clr BC 2Pk	£2.49	£2.99
N82BY	40WCandle Clr SES 2Pk	£2.49	£2.99
N84BY	60WCandle Clr BC 2Pk	£2.49	£2.99

3W Flicker Flame Candle Bulb



- This clear bulb, bayonet cap (BC) fitting has neon flickering flames effect
- Gives an authentic lit flame appearance
- 240 volts, 3 Watts

Order Code	Mod: 046019	Price each exc. VAT 1+	inc. VAT each
N70BY	Candle BC Flame	£3.32	£3.99

Buying for education?
0333 400 9740



7W 'NiteLite' Lamps



- 7W Nightlight bulbs
- Available in 2 base sizes - E12 and E14
- Available as 2 pack and single

GC55H and N63CA compatible with our Nightlight (GC55K)

Order Code	Base fitting	Pack size
GC55K	E12	1
N63CA	E12	2
A32KQ	E14	2

Order Code	Mod: 027361	Price each exc. VAT 1+	inc. VAT each
GC55K	Night Light Bulb	£1.65	£1.99
N63CA	NiteLight 7W E12 2Pk	£2.49	£2.99
A32KQ	NiteLight 7W E14 2Pk	£2.49	£2.99

Strip Lights



- Double ended strip lights
- Supplied in 30W and 60W power rating
- Available in 221mm and 284mm length
- Supplied in clear and opal versions

Ideal replacements for picture and shaver lights and other kitchen and bathroom lighting.

Order Code:	Voltage:	Wattage:	Colour:	Lamp Size
N30BZ	240V	30W	Clear	221mm
N31BZ	240V	30W	Opal	221mm
N32BZ	240V	60W	Clear	221mm
N33BZ	240V	60W	Opal	221mm
N34BZ	240V	30W	Clear	284mm
N35BZ	240V	30W	Opal	284mm
N36BZ	240V	60W	Clear	284mm
N37BZ	240V	60W	Opal	284mm

Order Code	Mod: 046018	Price each exc. VAT 1+	inc. VAT each
N30BZ	Strip 30W Clr 221mm	£3.32	£3.99
N31BZ	Strip 30W Opal 221mm	£3.32	£3.99
N32BZ	Strip 60W Clr 221mm	£3.32	£3.99
N33BZ	Strip 60W Opal 221mm	£3.32	£3.99
N34BZ	Strip 30W Clr 284mm	£3.32	£3.99
N35BZ	Strip 30W Opal 284mm	£3.32	£3.99
N36BZ	Strip 60W Clr 284mm	£3.32	£3.99
N37BZ	Strip 60W Opal 284mm	£3.32	£3.99

Rough Service GLS Light Bulbs 10 Pack

- GLS light bulbs, ideal for use in industrial applications
- 'Rough service' grade glass for added safety
- Available in a range of wattages and base fittings
- Extra value 10 pack
- Pearl Finish



Rough service lamps are fully retrofit with traditional GLS lamps. Featuring identical light properties to normal household incandescent lamps, their internal construction benefits from a reinforced filament and glass envelope, this makes them ideal for use in harsher environments or industrial applications.

Available in a range of wattages and base styles (Edison screw or bayonet cap) Supplied in packs of ten

Order Code	Mod: 513947	Price each exc. VAT 1+	inc. VAT each
A29KQ	100W ES Pearl 10 Pk	£5.82	£6.99
A28KQ	100W BC Pearl 10 Pk	£5.82	£6.99
A27KQ	60W ES Pearl 10 Pack	£5.82	£6.99
A26KQ	60W BC Pearl 10 Pack	£5.82	£6.99
A25KQ	40W ES Pearl 10 Pack	£5.82	£6.99
A24KQ	40W BC Pearl 10 Pack	£5.82	£6.99

Maplin TV

Home of innovation, handy tips and How To videos

Visit our channel...

[youtube.com/maplintv](https://www.youtube.com/maplintv)



Rough Service 150W and 200W GLS Bulbs

- High wattage incandescent lamps, ideal for industrial use
- 'Rough service' coating for added safety
- Bayonet cap fitting (B22)
- Pearl finish
- Sold as singles



Rough service lamps are fully retrofit with traditional GLS lamps. Featuring identical light properties to normal household incandescent lamps, their internal construction benefits from a reinforced filament and glass envelope, this makes them ideal for use in harsher environments or industrial applications.

Available in a range of wattages and base styles (edison screw or bayonet cap)

Order Code	Mod: 513953	Price each exc. VAT 1+	inc. VAT each
A31KQ	200W BC Pearl RS	£2.07	£2.49
A30KQ	150W BC Pearl RS	£2.07	£2.49

Daylight Simulation GLS Lamps

- Simulates natural daylight and helps eyes rest
- Available with BC and ES base fittings
- Available in 60W and 100W power rating
- Rated at 230V AC



These lamps simulate natural daylight by increasing the blue and reducing the red content of the light.

Order Code	Wattage:	Base:	Colour:
PG57M	60W	BC	Daylight
PG59P	100W	BC	Daylight
PG60Q	100W	ES	Daylight

Order Code	Mod: 020690	Price each exc. VAT 1+	inc. VAT each
PG57M	60W BC Daylight	£3.32	£3.99
PG59P	100W BC Daylight	£3.32	£3.99
PG60Q	100W ES Daylight	£3.32	£3.99

25W SES Tube Bulb



- Tubular shape appliance lamp
- SES fitting
- 25W
- 240V AC

Code	Base	Power	Shape
L79AH	E14 (SES)	25W	Tubular
SK14Q	E14 (SES)	40W	Candle

Order Code	Mod: 025157	Price each exc. VAT 1+	inc. VAT each
L79AH	25W SES Tube Bulb	£2.07	£2.49

Replacement Maglite / AA Bulbs Twin Pack

- Replacement bulbs suitable for all twin cell Mini Mag AA Torches
- Pack of 2.
- Official Maglite replacement
- Product Model: LM2A001



Order Code	Mod: 512214	Price each exc. VAT 1+	inc. VAT each
SJ73Q	Solitar/AA Mag Bulb	£3.32	£3.99

Reflector Bulbs

R39 Reflector Bulbs



- 39mm (R39) Reflectors
- SES (E14) fitting
- Diffused finish

Order Code	Voltage:	Wattage:	Fitting:	Reflector Size
N02BR	240V	25W	SES [E14]	39mm [R39]
N03BR	240V	30W	SES [E14]	39mm [R39]

Order Code	Mod: 043756	Price each exc. VAT 1+	inc. VAT each
N02BR	25W 39mm SES Spot	£7.77	£7.77
N03BR	30W 39mm SES Spot	£1.90	£2.29

R50 Reflector Bulbs



- 50mm (R50) Reflectors
- SES (E14) fitting
- Diffused finish

Order Code	Voltage:	Wattage:	Fitting:	Reflector Size
N04BR	240V	25W	SES [E14]	50mm [R50]
N05BR	240V	40W	SES [E14]	50mm [R50]

Order Code	Mod: 043767	Price each exc. VAT 1+	inc. VAT each
N04BR	25W 50mm SES Spot	£2.07	£2.49
N05BR	40W 50mm SES Spot	£2.07	£2.49

R63 Reflector Bulbs



- 63mm (R39) Reflectors
- BC (B22) and ES (E27) fittings
- Diffused finish

Order Code	Voltage:	Wattage:	Fitting:	Reflector Size
N13BZ	240V	40W	ES [E27]	63mm [R63]
DP93B	240V	60W	BC [B22]	63mm [R63]

DP94C 240V 60W ES [E27] 63mm [R63]

Order Code	Mod: 027327	Price each exc. VAT 1+	inc. VAT each
N13BZ	40W 63mm ES Spot	£2.49	£2.99
DP93B	60W 63mm BC Spot	£2.49	£2.99
DP94C	60W 63mm ES Spot	£2.49	£2.99

R80 Reflector Bulbs



- 80mm (R80) Reflector
- Available in 60W and 100W power rating
- Supplied in ES and BC base fittings

Order Code	Voltage:	Wattage:	Fitting:	Reflector Size
DP95D	240V	60W	BC [B22]	80mm [R80]
DP98G	240V	60W	ES [E27]	80mm [R80]
DS04E	240V	100W	ES [E27]	80mm [R80]
N78FQ	240V	100W	BC [B22]	80mm [R80]

Order Code	Mod: 027328	Price each exc. VAT 1+	inc. VAT each
DP95D	60W 80mm BC Spot	£2.49	£2.99
DP98G	60W 80mm ES Spot	£2.49	£2.99
DS04E	100W 80mm ES Spot	£2.49	£2.99
N78FQ	100W 80mm BC Spot	£2.49	£2.99

R80 60W Coloured Reflector Bulbs



- 80mm (R80) Reflector
- 60W output
- ES (E27) fitting
- Available in a range of colours
- 1,500 hour life

A range of coloured reflector bulbs as used for decorative and particularly disco lighting.

Order Code	Voltage:	Wattage:	Fitting:	Ccolour	Reflector Size:
MW50	240V	60W	ES [E27]	Red	80mm [R80]
MW51	240V	60W	ES [E27]	Blue	80mm [R80]
MW52	240V	60W	ES [E27]	Yellow	80mm [R80]
MW53	240V	60W	ES [E27]	Green	80mm [R80]
PU33	240V	60W	ES [E27]	Orange	80mm [R80]

Order Code	Mod: 019420	Price each exc. VAT 1+	inc. VAT each
MW50E	R80 ES Red	£2.49	£2.99
MW51F	R80 ES Blue	£2.49	£2.99
MW52G	R80 ES Yellow	£2.49	£2.99
MW53H	R80 ES Green	£2.49	£2.99
PU33L	R80 Orange	£2.49	£2.99

PAR38 80W Economy Floodlamp

- Tungsten floodlight designed for optimum efficiency and economy
- This 80W lamp offers the same light output as a conventional 100W floodlight, thus providing a 20% saving in running costs
- Ideal for use in recessed down lighters, security lighting etc
- Rating: 250Vac. Diameter: 125mm. Overall depth: 135mm



Order Code	Mod: 001338	Price each exc. VAT 1+	inc. VAT each
RZ26D	PAR38 Floodlight	£4.15	£4.99

Technical Helpline

0333 400 9500

For technical information and assistance relating to any Maplin purchase, contact our team of experts

Eveready 35W AR111 Halogen Reflector



- High performance halogen reflector
- Suitable for a wide range of applications in display, accent lighting and general lighting
- 3,000 Hour life
- 38° beam angle

Order Code	Mod.	Price each exc. VAT 1+	inc. VAT each
N73NJ	AR111 35W (50W)	£4.15	£4.99

PAR 36 Bulb



- Standard parabolic focused narrow beam bulb
- Low wattage, high light output, low heat output
- Rated at 6V (30W)
- Clear, ideal for use with filters / gels
- Ideal for use in the products within the disco lighting effects range

Order Code	Mod.	Price each exc. VAT 1+	inc. VAT each
BE27E	Par 36 Bulb	£5.40	£6.49

Appliance Bulbs

BC Coloured Pygmy Bulbs



- Ideal for use in confined spaces
- Bayonet Cap base fitting
- Rated at 15W
- Available in amber, red, blue, green and pink

Five standard bayonet (BC) fitting pygmy bulbs suitable for use in confined spaces and used extensively in display cabinets etc.

Order Code	Voltage	Wattage	Fitting	Colour	Lamp Size
DS49D	240V	15W	BC [B22]	Red	28mm x 58mm
DS50E	240V	15W	BC [B22]	Amber	28mm x 58mm
N58BQ	240V	15W	BC [B22]	Blue	28mm x 58mm
N59BQ	240V	15W	BC [B22]	Green	28mm x 58mm

Order Code	Mod.	Price each exc. VAT 1+	inc. VAT each
DS49D	15W BC Red Pygmy	£2.49	£2.99
DS50E	15W BC Amb Pygmy	£2.49	£2.99
N58BQ	15W BC Blue Pygmy	£2.49	£2.99
N59BQ	15W BC Green Pygmy	£2.49	£2.99

Look out for our monthly promotions at your local Maplin store now!

Pop in and pick up a copy of our monthly promotional publication, with special offers on dozens of exciting products. See the end of this catalogue for store listings

15W BC Pygmy Lamp



- Ideal for display fittings
- BC (B22) fitting
- 15W
- Rated at 200V to 250V
- Average life of 1000 hours

Order Code: Voltage: Wattage: Fitting: Colour: Lamp Size
BT60Q 240V 15W BC [B22] Clear 28mm x 58mm

Order Code	Mod.	Price each exc. VAT 1+	inc. VAT each
BT60Q	15W Pygmy BC Clr	£2.07	£2.49

SES and SBC Pygmy Bulbs



- Suitable for use with display fittings
- Available in SES or SBC base fittings
- Rated at 15W and 25W

Order Code: Voltage: Wattage: Fitting: Colour: Lamp Size
DS47 240V 15W SBC [B15] Clear 26mm x 58mm
DS48 240V 15W SES [E14] Clear 26mm x 58mm
N76FQ 240V 25W SBC [B15] Clear 26mm x 58mm
N77FQ 240V 25W SES [E14] Clear 26mm x 58mm

Order Code	Mod.	Price each exc. VAT 1+	inc. VAT each
DS47B	15W SBC Pygmy	£2.07	£2.49
DS48C	15W SES Pygmy	£2.07	£2.49
N76FQ	25W Pygmy SBC Clr	£2.07	£2.49
N77FQ	25W Pygmy SES Clr	£2.07	£2.49

15W Tubular Fridge Lamp



- Ideal replacement bulb for most fridges
- Internally fused for additional safety
- Size: 22 x 55mm
- SES fitting

Order Code	Mod.	Price each exc. VAT 1+	inc. VAT each
N66CA	Fridge Lamp	£3.32	£3.99

15W Microwave Oven Lamp



A lamp to suit Japanese microwave ovens with non-standard 17mm diameter screw cap. It is tubular type and

is 22 x 57mm 250V 15W

Order Code	Mod.	Price each exc. VAT 1+	inc. VAT each
BT62S	Microwave Tubular	£3.32	£3.99

25W Oven Lamp



- Specially constructed to withstand the high temperatures (300°C) found in ovens
- Dimensions: bulb diameter 25(dia.) x 55mm
- 240V, 25W, and has an E14 screw cap

Order Code	Mod.	Price each exc. VAT 1+	inc. VAT each
BT64U	Oven Lamp 25W	£3.32	£3.99

40W Oven Lamp



- Withstands high temperatures in ovens (up to 300°C)
- E14 (SES) screw cap fitting
- Dimensions 72(h)x45(w)mm
- Supplied single

Order Code	Mod.	Price each exc. VAT 1+	inc. VAT each
N13BR	Oven Lamp 40W	£3.32	£3.99

40W Cooker Hood Bulbs 2 Pack



- Replacement cooker hood bulbs
- Bulb dimension: 84 x 25mm
- 230V 40W
- E14 SES cap

Order Code	Mod.	Price each exc. VAT 1+	inc. VAT each
N54BU	40W Cookerhood Bulbs	£4.15	£4.99

Maplin TV

Home of innovation, handy tips and How To videos

Visit our channel...

youtube.com/maplintv



Halogen Bulbs

MR11 Dichroic Lamps



- Low voltage dichroic lamps
- MR11 (G4) Fitting
- Available in wattages from 5W - 20W
- 35mm diameter with an open front

Order Code	Voltage	Wattage	Fitting	Beam Angle	Lamp Size
------------	---------	---------	---------	------------	-----------

SK44X	6V	5W	MR11 (G4)	10°	35mm x 34mm
SK45Y	6V	10W	MR11 (G4)	10°	35mm x 34mm
SK41U	12V	5W	MR11 (G4)	10°	35mm x 34mm
SK42V	12V	10W	MR11 (G4)	10°	35mm x 34mm
SK43W	12V	15W	MR11 (G4)	30°	35mm x 34mm
L80AN	12V	20W	MR11 (G4)	30°	35mm x 34mm

Order Code	Mod.	Price each exc. VAT 1+	inc. VAT each
SK41U	MR11 Dichroic 12V 5W	£2.49	£2.99
SK42V	MR11 Dichroic 12V 10W	£2.49	£2.99
SK43W	MR11 Dichroic 12V 15W	£2.49	£2.99
L80AN	MR11 Dichroic 12V 20W	£2.49	£2.99
SK44X	MR11 Dichroic 6V 5W	£2.49	£2.99
SK45Y	MR11 Dichroic 6V 10W	£2.49	£2.99

Coloured MR11 Dichroic Lamps



- 12V 50W Coloured dichroic lamps
- MR11 (G4) Fitting
- 13° beam angle

A range of 12V 20W low voltage dichroic lamps in brilliant colours, ideal for imaginative lighting schemes and displays. Unlike cheaper versions that just laquer the front glass, these have specially coated coloured reflectors for maximum coloured light output. These lamps have a 35mm diameter and a G4 base fitting. The bulbs are glass fronted. Available in red, blue.

Order Code	Voltage	Wattage	Fitting	Colour	Beam Angle
------------	---------	---------	---------	--------	------------

QL90	12V	20W	MR11 (G4)	Red	13°
QL91	12V	20W	MR11 (G4)	Blue	13°

MR16 Halogen Lamps 10 Pack



- Popular 38° version
- Ideal for recessed ceiling down-lights
- 2000 hour life
- Clear finish
- Available in 50W, 35W and 20W versions

Order Code	Mod.	Price each exc. VAT 1+	inc. VAT each
N26JU	50W MR16 Hal 10pk	£16.65	£19.99
N25JU	35W MR16 Hal 10pk	£16.65	£19.99
N24JU	20W MR16 Hal 10pk	£16.65	£19.99

12V MR16 Twin Packs



- Low voltage MR16
- 38° beam angle
- 2,000H life time

Order Code	Voltage	Wattage	Fitting	Lamp Size
------------	---------	---------	---------	-----------

N20GR	12V	20W	MR16 (GU5.3)	49mm x 42mm
N53FZ	12V	35W	MR16 (GU5.3)	49mm x 42mm
N54FZ	12V	50W	MR16 (GU5.3)	49mm x 42mm

Coloured MR16 Dichroic Lamps



- 12V 50W Coloured dichroic lamps
- MR16 (GU5.3) Fitting
- 13° beam angle

A range of 12V 50W low voltage dichroic lamps in brilliant colours, ideal for imaginative lighting schemes and displays. Unlike cheaper versions that just laquer the front glass, these have specially coated coloured reflectors for maximum coloured light output.

Order Code	Voltage	Wattage	Fitting	Colour	Beam Angle
------------	---------	---------	---------	--------	------------

SN84	12V	50W	MR16 (GU5.3)	Blue	13°
QL12	12V	50W	MR16 (GU5.3)	Lilac	13°
QL89	12V	50W	MR16 (GU5.3)	Pink	13°

MR16 Low Voltage Dichroic Lamps



- Wide range of power ratings and beam angles
- Sealed glass front for safety
- Superior colour rendition
- 2,000 hour life

A range of 12V dichroic lamps in a variety of power ratings and beam angles with bi-pin single-ended GU5.3 caps. The dichroic reflector has the advantage that it radiates the majority of the heat in the opposite direction to the light beam, meaning that little infra-red is radiated forward. Dichroic lamps also have high light output (a 50W lamp has the same light intensity as a 150W PAR lamp), longer life and superior colour rendition when compared to standard PAR lamps.

Order	ANSI Code	Voltage	Wattage
-------	-----------	---------	---------

QH99H	-	12V	10W
AB73Q	ESX/CG	12V	20W
AB74R	BAB/CG	12V	20W
AB76H	EXZ/CG	12V	50W
AB77J	EXN/CG	12V	50W
AB78K	FNV/CG	12V	50W

Order	Fitting	Beam Angle	Lamp Size
-------	---------	------------	-----------

AB78K MR16 (GU5.3) 60° 50mm x 45mm

Order Code	Mod.	Price each exc. VAT 1+	inc. VAT each
QH99H	12V10W/CG	£2.07	£2.49
AB73Q	Dichroic Lamp ESX/CG	£2.49	£2.99
AB74R	BAB/CG	£2.49	£2.99
AB76H	EXZ/CG	£2.49	£2.99
AB77J	EXN/CG	£2.49	£2.99
AB78K	FNV/CG	£2.49	£2.99

GU10 Mains Voltage Lamps Twin Pack



- Does not require an additional transformer for power, instead draws it directly from the mains
- Available in three varieties, 20W, 35W and 50W 35°.
- Only to be used with GU10 style lampholders
- 2,000 Hour life

Order Code	Voltage	Wattage	Fitting	Lamp Size
------------	---------	---------	---------	-----------

N54BN	240V	20W	GU10	49mm x 50mm
N55BN	240V	35W	GU10	49mm x 50mm
N56BN	240V	50W	GU10	49mm x 50mm

Order Code	Mod.	Price each exc. VAT 1+	inc. VAT each
------------	------	------------------------	---------------

N54BN	20W GU10 Hal Bulb 2Pk	£5.40	£6.49
N55BN	35W GU10 Hal Bulb 2Pk	£5.40	£6.49
N56BN	50W GU10 Hal Bulb 2Pk	£5.40	£6.49

A Class Projection Lamps

- High quality projection lamps
- Suitable for a wide range of applications
- 50 Hours life span average (GT28 - 35 Hours)



A range of halogen bulbs for use in cine projectors, overhead projectors, disco lighting etc. Average life is 50 hours [except for GT28, which is 35 hours]

Order Code	LIF Code	ANSI Code	Voltage	Wattage	Fitting	Type*
------------	----------	-----------	---------	---------	---------	-------

FU88	A1/215	FCR	12V	100W	GY6.35	C
MS82	A1/216	FCS	24V	150W	G6.35	C
VR89	A1/220	BRL	12V	50W	G6.35	C
GT86	A1/223	EHJ	24V	250W	G6.35	C
FU89	A1/231	EFP	12V	100W	G6.35	D
MS84	A1/232	EFR	15V	150W	G6.35	D
MS86	A1/239	EVC	36V	400W	G6.35	C
GT28	A1/259	ELC	24V	250W	GX5.3	D

Halogen Capsule Lamps



- Class M Halogen bulbs
- G4 and G6.35 fittings
- Found in a range of low voltage decorative lighting
- Available a range of voltages and wattages (see specification table)

Order Code	Type	Voltage	Wattage	Fitting
------------	------	---------	---------	---------

L52AH	-	6V	5W	G4
L53AH	M42	6V	10W	G4

L52AK	13283	12V	5W	G4
UN34M	M91	12V	10W	G4
UN47B	M47	12V	20W	G4
TZ48C	M95	12V	35W	G6.35
UN48C	M32	12V	50W	G6.35
TZ36P*	M74	12V	50W	GY6.35
TZ38R	M28	12V	100W	GY6.35

* All lamps have a transverse filament, except TZ36P which is axial.

Order Code	Mod: 023112	Price each exc. VAT 1+	inc. VAT each
L52AH	6V 5W Halogen Bulb	£3.32	£3.99
L53AH	6V 10W Halogen Bulb	£3.32	£3.99
L52AK	Capsule Lamp 5W	£2.49	£2.99
UN34M	M91 Capsule Lamp 10W	£2.49	£2.99
UN47B	M47 Capsule Lamp 20W	£2.49	£2.99
TZ48C	M95 Capsule Lamp 35W	£2.49	£2.99
UN48C	M32 Capsule Lamp 50W	£2.49	£2.99
TZ36P	M74 Capsule Lamp 50W	£2.49	£2.99
TZ38R	M28 Capsule Lamp 100W	£2.49	£2.99

Low Voltage Halogen Capsule Twin Packs

- High quality halogen capsules
- G4 and G6.35
- 2,000 hour life
- Supplied as packs of two



Order Code	Voltage	Wattage	Fitting	Colour	Lamp Size
N40FZ	12V	10W	G4	Clear	8mm x 30mm
N41FZ	12V	20W	G4	Clear	8mm x 30mm

Order Code	Mod: 394584	Price each exc. VAT 1+	inc. VAT each
N40FZ	G4 10W CL x2	£3.74	£4.49
N41FZ	G4 20W CL x2	£3.74	£4.49

Mains Voltage Halogen Capsule Twin Packs

- High quality mains voltage halogen capsules
- G9 Fitting
- 2,000 hour life
- Supplied as packs of two



Order Code	Voltage	Wattage	Fitting	Colour	Lamp Size
N46FZ	240V	25W	G9	Clear	13mm x 47mm
N48FZ	240V	40W	G9	Clear	13mm x 47mm

Order Code	Mod: 394585	Price each exc. VAT 1+	inc. VAT each
N46FZ	G9 25W CL x2	£5.82	£6.99
N48FZ	G9 40W CL x2	£5.82	£6.99

Fluorescent Lighting

Fluorescent Starter Twin Pack



- Fluorescent starter twin packs
- Suitable for a wide range of lighting applications
- Three power options available

Fluorescent tube starters suitable for use with most domestic fluorescent tubes and having standard 2-pin pygmy connectors. Available in three power options and supplied as packs of two.

Order Code	Mod: 513403	Price each exc. VAT 1+	inc. VAT each
A04KQ	Starter 4-22W 2 Pk	£3.32	£3.99
A05KQ	Starter 4-65W 2 Pk	£3.32	£3.99
A06KQ	Starter 70-125W 2 Pk	£3.32	£3.99

Reserve online and collect at the store of your choice

Fluorescent Tube Starters



Fluorescent tube starters suitable for use with most domestic fluorescent tubes and having standard 2-pin pygmy connectors. Two differently rated types are available. MW09K is suitable for every tube from the mini 4W tube up to 5ft long. 65W tubes [excluding modular fittings]; JZ29G is suitable for all tubes up to 125W, including all 6ft, 70-75W tubes and 8ft, 100-125W tubes



Order Code	Mod: 001324	Price each exc. VAT 1+	5+	15+	inc. VAT each
MW09K	65W Starter	£2.15	£1.68	£2.59	
JZ29G	Starter 125W	£1.90		£2.29	

Find out more in-store
Our staff can offer friendly and expert advice; we're here to help

Fluorescent Tubes



- Low power fluorescent tubes
- Typically used in portable and under-cabinet lighting
- Available in a choice of lengths and wattages

Order Code	Part Number	Power	Diameter	Length
JX45	F4T5/D	4W	16mm	150mm
GS98	F6T5/D	6W	16mm	225mm
LQ11	F8T5/D	8W	16mm	300mm
N18HA	F13T5/D	13W	16mm	525mm

Order Code	Mod: 020608	Price each exc. VAT 1+	inc. VAT each
JX45Y	4W 150mm Tube	£2.90	£3.49
GS98G	6W 225mm Tube	£3.32	£3.99
LQ11M	8W 300mm Tube	£3.82	£4.59
N18HA	13W 525mm Tube	£4.16	£4.99

Circular Fluorescent Tubes



- Circular fluorescent lamps
- T9 diameter tube
- Available in a range of wattages and dimensions

Order Code	Wattage	Tube Size	Colour	Diameter
AP90	22W	T9	6500K	210mm
A07KQ	40W	T9	3500K	400mm
A08KQ	60W	T9	3500K	400mm

Order Code	Mod: 029825	Price each exc. VAT 1+	inc. VAT each
AP90X	22W FC8T9D Circ Lamp	£7.49	£8.99
A07KQ	40W Circular T9 Tube	£12.49	£14.99
A08KQ	60W Circular T9 Tube	£12.49	£14.99

2D Energy Saving Tube



- Available in a range of wattages
- 2 and 4 pin fittings
- 8,000 hour life
- White (3500K)
- Daylight (6400K) A03KQ Only

Order Code	Wattage	Fitting
N29BZ	38W	4 Pin
A03KQ	55W	4 Pin
GG45Y	16W	2 Pin
N32BR	16W	4 Pin
A02KQ	28W	2 Pin
N33BR	28W	4 Pin

Order Code	Colour	Lamp Size
N29BZ	White (3500K)	207mm x 205mm x 33mm
A03KQ	Daylight (6400K)	207mm x 205mm x 33mm
GG45Y	White (3500K)	141mm x 138mm x 27.5mm
N32BR	White (3500K)	141mm x 138mm x 27.5mm
A02KQ	White (3500K)	207mm x 205mm x 33mm
N33BR	White (3500K)	207mm x 205mm x 33mm

Order Code	Mod: 018097	Price each exc. VAT 1+	inc. VAT each
GG45Y	2D 16W 2-Pin Wht	£7.07	£8.49
N32BR	2D 16W 4-pin Wht	£8.32	£9.99
A02KQ	2D 28W 2-Pin Wht	£8.32	£9.99
N33BR	2D 28W 4-pin Wht	£11.24	£13.49
N29BZ	2D 38W 4-pin Wht	£12.49	£14.99
A03KQ	2D 55W 4-Pin Wht	£12.49	£14.99

PLC Energy Saving Lamps



- Covered energy saving lamps
- Short compact fluorescent lamp
- Cool white (4000K)
- Available in a range of wattages
- 2 and 4 pin options

Order Code	Wattage	Fitting	Colour	Lamp Size
A33KQ	13	PLC 4 Pin	4000K	34mm x 142mm
A34KQ	18	PLC 2 Pin	4000K	34mm x 152mm
A35KQ	18	PLC 4 Pin	4000K	34mm x 152mm
N22HA	26	PLC 2 Pin	4000K	34mm x 169mm
N23HA	26	PLC 4 Pin	4000K	34mm x 169mm

Order Code	Mod: 513169	Price each exc. VAT 1+	inc. VAT each
A33KQ	13W PLC 4 Pin	£4.57	£5.49
A34KQ	18W PLC 2 Pin	£4.57	£5.49
A35KQ	18W PLC 4 Pin	£4.57	£5.49
N22HA	26W PLC Col 2 Pin	£4.57	£5.49
N23HA	26W PLC Col 4 Pin	£4.57	£5.49

PLS Energy Saving Lamps



- Covered energy saving lamps
- Twin tube short compact fluorescent lamp
- Cool white (4000K)

Order Code	Wattage	Fitting	Colour	Lamp Size
N20HA	7W	PLS 2Pin	4000K	31mm x 137mm
N60CQ	9W	PLS 2Pin	4000K	31mm x 167mm
N21HA	11W	PLS 2Pin	4000K	31mm x 237mm

Order Code	Mod: 098610	Price each exc. VAT 1+	inc. VAT each
N20HA	7W PLS Col 2 Pin	£4.15	£4.99
N60CQ	9W PLS COL 82 2 PIN	£4.15	£4.99
N21HA	11W PLS Col 2 Pin	£4.15	£4.99

Ultraviolet Blacklight Lighting

Blacklight UV Bulb



- Great for parties!
- Available in Bayonet Cap (BC) or Edison Screw (ES)
- Rated at 75W

A standard size light bulb with a special coating that produces a deep purple light and large amounts of Ultra Violet light. This invisible light is reflected back in the visible spectrum by fluorescent materials and dyes. White clothes glow brightly in the dark, fluorescent paints light up brilliantly! Rated at 75W, 240V and available with either BC (bayonet cap) or ES (edison screw) base.

Order Code	Mod: 024245	Price each exc. VAT 1+	inc. VAT each
KJ64U	75W Blacklight BC	£4.15	£4.99
KJ65V	75W Blacklight ES	£4.15	£4.99

Compact UV Bulb



- Saves up to 80% energy!
- Fits into a standard lamp base
- Lasts up to 8 times longer than ordinary lamps
- Ideal for parties

Compact fluorescent lamps are a direct replacement for standard light bulbs. However, this bulb has the added feature of a special coating that produces a deep purple light and large amounts of Ultra Violet light. This invisible light is reflected back in the visible spectrum by fluorescent materials and dyes. White clothes glow brightly in the dark, fluorescent paints light up brilliantly! Not suitable for use with dimmers.

Order Code	Wattage:	Equivalent:	Fitting:
L31AF	15W	75W	ES (E27)
L16AN	11W	60W	BC (B22)

Order Code	Mod: 033124	Price each exc. VAT 1+	inc. VAT each
L31AF	Compact UV Lamp	£7.49	£8.99
L16AN	BC Compact UV Lamp	£8.32	£9.99

Ultraviolet (UV) Blacklight Fluorescent Tubes



- UV Tubes for use in Disco and specialist lighting
- T8 and T12 diameters
- N29CH spare part for Maplin UV Blacklight (L28BB)

Order Code	Part No	Wattage:	Diameter	Length	Fitting
N29CH	F1818BLB	18W	T8 (25mm)	600mm (2 ft)	Medium bi-pin (G13)
PC63T	F40121BLB	40W	T12 (38mm)	1200mm (4 ft)	Medium bi-pin (G13)

Order Code	Mod: 020609	Price each exc. VAT 1+	inc. VAT each
N29CH	2ft 1in Dia UV Tube	£8.32	£9.99
PC63T	4ft 1200mm UV Tube	£16.65	£19.99

W Fluorescent UV Tube



- Ultraviolet fluorescent tube (UV)
- Peak light wavelength 368nm
- Ideal for use in disco lighting and counterfeit note detectors (MW36)

Order Code	Part No	Wattage:	Diameter:	Length:
CR48C	F4T5BLB	4W	15mm [5/8]	134mm [6]

Miniature bi-pin (G5)

Order Code	Mod: 033462	Price each exc. VAT 1+	inc. VAT each
CR48C	4W Biik Lt UV Tube	£5.40	£6.49

Insect Killer UV Tubes



- A range of UV (Ultra Violet) tubes designed for use in insect killers
- Available in a range of wattages
- Bi pin fitting
- 350nm wavelength

Order Code	Part Number	Wavelength
N00NL	F4T5BL350	350nm
N01NL	F6T5BL350	350nm
N02NL	F8T5BL350	350nm
N03NL	F15T8BL350	350nm
N04NL	F20T12BL350	350nm
N05NL	F40T12BL350	350nm

Order Code	Wattage:	Type:	Length
N00NL	4W	T5	150mm [6in]
N01NL	6W	T5	225mm [8in]
N02NL	8W	T5	300mm [12in]
N03NL	15W	T8	450mm [18in]
N04NL	20W	T12	600mm [2ft]
N05NL	40W	T12	1200mm [4ft]

Order Code	Mod: 653243	Price each exc. VAT 1+	inc. VAT each
N00NL	6in T5 4W UV Tube	£4.99	£5.99
N01NL	9in T5 6W UV Tube	£5.82	£6.99
N02NL	12in T5 8W UV Tube	£6.65	£7.99
N03NL	18in T8 15W UV Tube	£7.49	£8.99
N04NL	2ft T12 UV Tube	£8.32	£9.99

Small Bulbs & Lamps

Lilliput LES Bulb



- Lilliput Edison Screw (LES)
- Dimensions: 5.1 x 16mm
- Available in a range of voltages

Order Code	Voltage:	Current:	Lumens:	Life span:
BU12	6V	60mA	1	5000
WL75	12V	80mA	2	5000
BU14	12V	120mA	5.2	5000
BU15	14V	50mA	3	1000
BU16	24V	40mA	3	10000
BU17	28V	40mA	3.7	25000

Order Code	Mod: 001968	Price each exc. VAT 1+	inc. VAT each
BU12N	LES Lamp 6V	£0.90	£1.09
WL75S	LES Bulb 12V	£0.90	£1.09
BU14Q	LES Lamp 12V	£0.90	£1.09
BU15R	LES Lamp 14V	£0.90	£1.09
BU16S	LES Lamp 24V	£0.90	£1.09
BU17T	LES Lamp 28V	£0.90	£1.09

Round MES Type (E10)



Volts	Watts	Amps	Nominal Lumens	Nom Life [hours]
1.25	0.31	0.25	-	10
2.5	0.75	0.3	-	100
3.5	0.7	0.2	1.5	1000
3.5	1.05	0.3	-	1000
4.8	1.44	0.3	-	-
6	0.36	0.06	-	1000
6	0.6	0.1	3	1000
6.5	0.97	0.15	-	3000
6.5	1.95	0.3	12	3000
12	1.2	0.1	5	1000
12	2.2	0.18	11	3000
24	3	0.12	11	1000

Order Code	Mod: 001977	Price each exc. VAT 1+	inc. VAT each
BT95D	Bulb MES 1.25V 0.31W	£0.82	£0.99
BT96E	Bulb MES 2.5V 0.75W	£0.82	£0.99
WL76H	Bulb MES 3.5V	£0.82	£0.99
BT97F	Bulb MES 3.5V 1.05W	£0.82	£0.99
RZ39N	Bulb MES 4.8V 1.44W	£0.90	£1.09
BT99H	Bulb MES 6V 0.36W	£0.82	£0.99
WL78K	Bulb MES 6V 0.6W	£0.82	£0.99
BU00A	Bulb MES 6.5V 0.97W	£0.82	£0.99
WL79L	Bulb MES 6.5V 1.95W	£0.82	£0.99
WL80B	Bulb MES 12V 1.2W	£0.82	£0.99
WL81C	Bulb MES 12V 2.2W	£0.82	£0.99
WL82D	Bulb MES 24V 3W	£0.82	£0.99

Lens End MES Type



- Two voltages available: 2.2V 250mA (average life 5 hours) and 3.7V 300mA (10 hours)

Order Code	Mod: 001990	Price each exc. VAT 1+	inc. VAT each
BT69A	MES Lens 2.2V	£0.90	£1.09
BT70M	MES Lens 3.7V	£0.90	£1.09

MES Tubular R10 Type



Volts	mA	Watts	Av Life [hours]
6.5	150	0.97	1000
6.5	300	1.95	1000
12	100	1.2	1000
12	183	2.2	1000
24	50	1.2	1000
24	125	3	1000

Order Code	Mod: 001976	Price each exc. VAT 1+	inc. VAT each
BU18U	R10 MES 6.5V 150mA	£0.99	£1.19
BU19V	R10 MES 6.5V 300mA	£0.99	£1.19
BU20W	R10 MES 12V 100mA	£0.99	£1.19
BU21X	R10 MES 12V 183mA	£0.99	£1.19
BU22Y	R10 MES 24V 50mA	£0.99	£1.19
BU23A	R10 MES 24V 125mA	£0.99	£1.19

240V SES 1648 Tubular



Compact mains lamp with E14 (SES) screw cap, size 49.5 x 16mm

Volts	mA	Watts	Av Life [hours]
220 to 260	26	5 to 7	2000

Order Code	Mod: 001983	Price each exc. VAT 1+	inc. VAT each
BT75S	SES Tubular 240V	£1.11	£1.34

Krypton Bulbs



A range of high light intensity Krypton bulbs. 70% brighter than standard bulbs. Supplied only in packs of 2

Maplin Code	Voltage	Current Rating	Dimensions [dia] x L
PG90X	2.4V	750mA	13.5 x 28mm

POWER

Bulbs

PG91Y	3.6V	750mA	13.5 x 28mm
PG92A	4.8V	750mA	13.5 x 28mm
Order Code	Mod: 020730	Price each exc. VAT 1+	inc. VAT each
PG90X	2.4V Krypton 2 Pack	£1.90	£2.29
PG91Y	3.6V Krypton 2 Pack	£1.90	£2.29
PG92A	4.8V Krypton 2 Pack	£1.90	£2.29

Pre-Focus Bulb

- Cap fitting: size 30.5 x 11.5mm

Volts	Amps	Watts	Nom. Life (hours)
2.4	0.5	1.2	5
6	0.5	3	15

Order Code	Mod: 001995	Price each exc. VAT 1+	inc. VAT each
BT66W	Bulb 2.4V Prefocus	£0.66	£0.79
BT68Y	Bulb 6V Prefocus	£0.65	£0.79



28V Midget Flange Bulb

A miniature bulb known as a midget flange type because of the mounting flange on the base. This bulb finds use in display panels and keyring torches, etc. Lamp size is T1 and is available in 28 volts.

Volts	mA	Lumens	Av. life (hours)
28	40	3.7	25000

Order Code	Mod: 001962	Price each exc. VAT 1+	inc. VAT each
BT51F	Midget Flange 28V	£0.74	£0.89



28V 40mA Midget Groove T 13/4 Type

One voltage available

Volts	mA	Lumens	Av. life (hours)
28	40	3.7	25000

Order Code	Mod: 001964	Price each exc. VAT 1+	inc. VAT each
BT53H	Midget Groove 28V	£0.49	£0.59



MCC Tubular R10 Bulb

A range of voltages are available with the Ba9s (MCC) base, size 10 x 27.5mm

Volts	mA	Watts	Av. Life (hours)
6	200	1.2	1000
6.3	150	0.95	20000
12	183	2.2	1000
12	340	4	1000
24	50	1.2	1000
24	83	2	1000
24	125	3	1000
130	20	2.6	1000
240		3 to 4	1000

Order Code	Mod: 001974	Price each exc. VAT 1+	inc. VAT each
BT79L	R10 MCC 6V 200mA	£0.82	£0.99
BT81C	R10 MCC 6.3V 150mA	£0.82	£0.99
BT83E	R10 MCC 12V 183mA	£0.82	£0.99
BT84F	R10 MCC 12V 340mA	£0.99	£1.19
BT85G	R10 MCC 24V 50mA	£0.99	£1.19
BT86T	R10 MCC 24V 83mA	£0.99	£1.19
BT87U	R10 MCC 24V 125mA	£0.99	£1.19
BT93B	R10 MCC 130V 20mA	£1.29	£1.55
BT94C	R10 MCC 240V	£1.53	£1.84



6V 55W High Power Halogen Bulb

- 6V Halogen bulb



- 55W output
- Replacement for Maplin Rechargeable Lantern (Order code QN74)

Order Code	Mod: 033680	Price each exc. VAT 1+	inc. VAT each
QN77J	H3 Bulb 6V 55W	£4.15	£4.99

30mA Wedge Base Capless Type



Rated at 24 to 30V, current 30mA. Average life 1000 hours.

Order Code	Mod: 001967	Price each exc. VAT 1+	inc. VAT each
BT47B	Capless Wedge 30mA	£0.82	£0.99

Wire Terminal Type

A small wire terminal type, 3.17mm dia. and 6.35mm long (excl. wire), two voltages available; 12V, 60mA average life 16000 hours and 28V, 24mA average life 5000 hours.

Order Code	Mod: 001955	Price each exc. VAT 1+	5+	inc. VAT each 15+
BT43W	Wire Lamp 12V	£1.15		£1.39
BT44X	Wire Lamp 28V	£1.24		£1.49



Coloured Subminiature Bulbs



A range of coloured wire-ended sub-miniature bulbs ideal for applications such as backlighting etc. Dimensions: 3.2(dia) x 8.2(l)mm, wire leads 23mm long. Average life is 3,000 hours.

Code	Colour	Voltage	Current
PG78K	Red	12V	65mA
PG79L	Green	12V	65mA
PG80B	Blue	12V	65mA
PG81C	Yellow	12V	65mA

Order Code	Mod: 025545	Price each exc. VAT 1+	inc. VAT each
PG78K	12V Submin Red	£0.82	£0.99
PG79L	12V Submin Green	£0.82	£0.99
PG80B	12V Submin Blue	£0.82	£0.99
PG81C	12V Submin Yellow	£0.82	£0.99

12V 0.96W Wire Ended Filament Type

A wire-ended filament type bulb, dia. 5mm, 12V, 0.08A, 0.96W, 2 Lumens (nom). Nominal life: 5000 hours.

Order Code	Mod: 001954	Price each exc. VAT 1+	inc. VAT each
WQ13P	Wire Bulb 12V	£1.24	£1.49



Small Bulb Lampholders

LES Lampholder

A miniature LES lampholder with two soldertags for making the connections. Overall size 15mm across tags, 6mm diameter, 9mm high.



Order Code	Mod: 001942	Price each exc. VAT 1+	inc. VAT each
UJ72P	LES Lampholder	£0.82	£0.99

LES (E5) PCB Lampholder

- A PCB mounting lampholder for miniature bulbs with LES (E5) base
- The legs are 10mm long and spaced 3mm apart
- Height of the holder excluding legs is 9mm



Order Code	Mod: 031615	Price each exc. VAT 1+	inc. VAT each
WW65V	LES PCB Lampholder	£0.82	£0.99

LES Coloured Lampholder

A range of panel-mounting lampholders with a smart chromed bezel and a translucent, coloured cap. Available in red, green or amber. Designed for use with standard LES (E5) bulbs. Requires an 11.2mm diameter panel cutout and, once fitted, lamp can be removed from either side of the panel.



Specifications:

Cap:	acrylic (UL flame 94HB)
Body:	phenolic (UL flame: 94V-1)
Terminals:	nickel plated brass
Temp range:	-20°C to +80°C
Dimensions (max):	31.2(l) x 14(dia)mm

Order Code	Mod: 032116	Price each exc. VAT 1+	inc. VAT each
L03AA	LES Holder Green	£0.82	£0.99
L04AA	LES Holder Amber	£0.70	£0.84

MES (E10) Batten Holder

An MES bulb holder in a bakelite base, with screw terminals. Dimensions: Dia. of base: 31mm, Fixing centres: 23mm, Total height: 18mm.



Order Code	Mod: 001941	Price each exc. VAT 1+	inc. VAT each
RX86T	MES Batten Hldr	£1.65	£1.99

MES (E10) Lampholder

A miniature MES lampholder with two solder tags for making the connection. Dimensions: Overall size: 19mm, Across tags: 10mm, Diameter: 13mm high.



Order Code	Mod: 001938	Price each exc. VAT 1+	inc. VAT each
JX87U	Min MES Lampholder	£1.65	£1.99

MES (E10) PCB Lampholder

A PCB-mounting lampholder for bulbs with a MES base. The mounting legs are approximately 8mm long by 1mm wide.



Order Code	Mod: 024246	Price each exc. VAT 1+	inc. VAT each
KJ81C	MES (E10) Lampholder	£1.07	£1.29

Send direct

If any product is not in stock, we will order it for you and send it with free delivery



Terms and conditions apply.

SES (E14) Lampholder

An SES lampholder in a bakelite base, with screw terminals.



Dimensions:
Dia of base: 38mm
Fixing centres: 30mm
Total height: 25mm

Order Code	Mod.	Price each exc. VAT 1+	inc. VAT each
N24BW	E14 Lampholder	£2.49	£2.99

MCC Bayonet Bulb Lampholder

A panel-mounting lampholder with a smart chromed bezel and a translucent, coloured cap. Available in red or green. Designed for use with standard MCC (Ba9s) bayonet bulbs, e.g. 12V 4W bulb, (Order Code BT84F). Requires a 16.2mm diameter panel cutout and, once fitted, lamp can be removed from either side of the panel.



Specifications:

Cap: acrylic (UL flame: 94HB)
Body: phenolic (UL flame: 94V-1)
Terminals: nickel plated brass
Temp. range: -20°C to +80°C
Dimensions (max.): 47.1(l) x 19(dia)mm

Order Code	Mod.	Price each exc. VAT 1+	inc. VAT each
L54AB	MCC Lampholder Red	£0.99	£1.19
L55AB	MCC Lampholder Green	£0.99	£1.19

MCC (Ba9s) Bayonet Lampholder

A miniature bayonet base lampholder with mounting/solder tags.



Order Code	Mod.	Price each exc. VAT 1+	inc. VAT each
KJ71N	Ba9s Lampholder Lug	£2.49	£2.99

G4 Porcelain Lampholder

A heat-resistant porcelain lampholder for lamps with a G4 two-pin base.



Order Code	Mod.	Price each exc. VAT 1+	inc. VAT each
KJ77J	G4 Ceramic Lamphldr	£3.32	£3.99

GX5.3 Porcelain Lamp Holder



- Porcelain lamp holder
- GX5.3 base
- 100mm long flying leads
- 100W rated
- Ideal for low voltage dichroic lamps

Order Code	Mod.	Price each exc. VAT 1+	inc. VAT each
VJ11M	Dichroic Lamp Holder	£2.90	£3.49

G6.3 Porcelain Lampholder

A heat-resistant base for use with lamps with a G6.3 base. Leads approximately 140mm long.



Order Code	Mod.	Price each exc. VAT 1+	inc. VAT each
KH72P	G6.3 Cer. Lampholder	£2.90	£3.49

GU10 Lampholder

- A high quality porcelain GU10 lampholder with heat resistant leads
- Leads approximately 150mm long



Order Code	Mod.	Price each exc. VAT 1+	inc. VAT each
N896K	GU10 Lampholder	£3.32	£3.99

Neon Lamps

Miniature Round Panel Neon

Moulded body with built-in resistance for 220-240V use. Available with red, green or amber lens. Requires a 7mm mounting cut-out in panel. Overall dimensions 29mm long, 8mm diameter round lens.



Order Code	Mod.	Price each exc. VAT 1+	inc. VAT each
BK52G	Min Neon Red	£0.99	£1.19
BK53H	Min Neon Green	£0.99	£1.19
BK54J	Min Neon Amber	£0.99	£1.19

Square Panel Neon

Moulded body with built-in resistance for 220-240V use. Available with red, green or amber lens. Requires a 10mm mounting cut-out in panel. Overall dimensions 38mm long, 12mm square lens.



Order Code	Mod.	Price each exc. VAT 1+	inc. VAT each
RX83E	Pan Neon Red	£1.07	£1.29
BK51F	Pan Neon Green	£1.07	£1.29
RX82D	Pan Neon Amber	£1.07	£1.29

220-240Vac Blue Snap In Neon Indicator Lamp

Moulded body with integral retaining ears which lock onto the edge of a panel when the lamp is snapped-in. The lamp has built-in resistance for 220-240Vac operation. Connection is via two 1/4" (6.35mm) push on blade terminals separated by a plastic insulator. Requires a 10mm diameter panel cutout. Overall length is 32mm excluding blade terminals and lens diameter is 11.5mm.



Order Code	Mod.	Price each exc. VAT 1+	inc. VAT each
N92BN	Snap-in Neon Blue	£1.24	£1.49

Snap-In Neon

Moulded body with integral retaining ears which lock onto the edge of a panel when the lamp is snapped-in. The lamp has built-in resistance for 220-240Vac operation. Available with a red, green or amber lens. Connection is via two 1/4" (6.35mm) push on blade terminals separated by a plastic insulator. Requires a 10mm diameter panel cutout. Overall length is 33mm and lens diameter is 12mm.



Order Code	Mod.	Price each exc. VAT 1+	inc. VAT each
WV69A	Snap-in Neon Red	£1.24	£1.49
WV70M	Snap-in Neon Green	£1.24	£1.49
WV71N	Snap-in Neon Amber	£1.24	£1.49



Friendly expert advice on
0333 400 9500

Xenon Lamps

Beacon Xenon Tube

A U-shaped high quality flash tube designed for use in warning and alarm beacons.



Specifications:

Minimum anode voltage: 250V
Maximum anode voltage: 500V
Nominal anode voltage: 400V
Maximum energy input per flash: 10W/second Maximum flash rate at maximum input power: 0.3 - 4
Life with max energy and max flash rate: 2 million flashes
Minimum trigger voltage: 6kV
Diameter of tube: 6mm
Width of whole unit: 16mm
Length of unit(excl. glass seal): 40mm plus 40mm pins

Order Code	Mod.	Price each exc. VAT 1+	inc. VAT each
FS79L	Xenon Tube Beacon	£2.40	£2.89

Send direct

If any product is not in stock, we will order it for you and send it with free delivery. Terms and conditions apply.



Mains Lampholders

In-Line BC Lampholder White

A standard BC lampholder to BS5042. With cord-grip and sprung plungers, plus wide skirt. White.



Order Code	Mod.	Price each exc. VAT 1+	inc. VAT each
FQ02C	BC Lampholder	£1.90	£2.29

In-Line Switched BC Lampholder 60W White

- Standard T1 60W lampholder
- On/off switch
- Conforms to BS5042



Order Code	Mod.	Price each exc. VAT 1+	inc. VAT each
GC44X	T1 Switched Bulb/Hld	£2.24	£2.69

Ceiling Rose Pendant White 150mm



Lampholder type FQ02C with a ceiling rose pre-wired together with approx. 150mm of white flex.

Order Code	Mod.	Price each exc. VAT 1+	inc. VAT each
JG37S	Rose and Pendant 6in	£7.77	£7.77

Buying for education?
0333 400 9740



Screw Mounted BC Lampholder White

A standard T2 BC lampholder to BS5042 in a plastic mount with wide skirt. This batten holder has spring plungers and is finished in white. Diameter of base 65mm, fixing centres 52mm, overall height 67mm.

Order Code	Mod: 001312	Price each exc. VAT 1+	inc. VAT each
LB63T	Bayonet L/Hldr	£2.24	£2.69

Brass BC Lampholders



Smart brass bayonet cap (BC) lampholder with 1/2" threaded base. The body is joined by a solid brass threaded collar and another threaded ring is provided for securing a lamphshade. The base includes a screw terminal for an earth wire. Two types are available, one type is unswitched and the other has an integral push-bar on-off switch. These lampholders must be earthed, therefore a 3-core mains cable is required. Maximum rating 250W, complies with BS5042-T2.

Order Code	Mod: 001329	Price each exc. VAT 1+	inc. VAT each
ZB84F	Sw Brass BC Holder	£3.74	£4.49
ZB85G	Brass BC Holder	£3.74	£4.49

BC (B22d) Porcelain Lampholder



Rated at 4A, 250V. This BC lampholder takes standard bayonet cap bulbs. Its porcelain construction makes it particularly suitable for high temperature environments such as light boxes and spotlights.

Order Code	Mod: 024237	Price each exc. VAT 1+	inc. VAT each
KJ730	B22d Lampholder	£3.74	£4.49

ES (E27) Porcelain Lampholder

This ES lampholder takes standard screw cap bulbs. Its porcelain construction makes it particularly suitable for high temperature environments such as light boxes and spotlights. Cable connection is via screw terminals and cable entry can be affected from the side. Rated at 4A, 250V. Approvals: VDE, DEMKO and Kema Keur.



Order Code	Mod: 026765	Price each exc. VAT 1+	inc. VAT each
SH95D	ES Porcelain L/holder	£3.32	£3.99

Newsletter

Subscribe to our newsletter for information about the latest innovation and the best deals.



ES (E27) Plastic Lampholder

This ES lampholder accepts standard screw cap bulbs. It is constructed from temperature-resistant plastic rated at T210°. Cable connection is via push fit snap-in terminals. Rated at 4A, 250V. Approvals: VDE, DEMKO, NEMKO, SEMKO, FEMKO and Kema Keur.



Order Code	Mod: 026766	Price each exc. VAT 1+	inc. VAT each
SH96E	ES Plastic L/holder	£3.32	£3.99

Linear Halogen Lampholder



- Double-ended linear halogen lampholder
- For use with type R7 lamps (K9 and K1)
- Suitable for use with 300W and 500W tubes
- Rated at 6A, 250V
- Complies with BS/EN 60598-1

Order Code	Mod: 013837	Price each exc. VAT 1+	inc. VAT each
GC47B	Halogen Lampholder	£2.49	£2.99

E.S. to B.C. Adapter

- Converts Edison Screw lampholder to Bayonet Cap
- Black bakelite moulding
- 250V AC
- Max 60W



Order Code	Mod: 001331	Price each exc. VAT 1+	inc. VAT each
BK69A	ES to BC Adapter	£4.15	£4.99

B.C. to E.S. Adapter

- Converts Bayonet lampholder to Edison Screw
- Black bakelite moulding
- 250V AC
- Max 60W



Order Code	Mod: 001333	Price each exc. VAT 1+	inc. VAT each
BK70M	BC to ES Adapter	£4.15	£4.99

Lighting Transformers & Accessories

Dichroic Lamp Retainer Clip

A metal spring clip for retaining dichroic lamps in ceiling fittings.



Order Code	Mod: 012803	Price each exc. VAT 1+	inc. VAT each
VJ10L	Lamp Spring Clip	£0.57	£0.69

GX5.3 Porcelain Lamp Holder



- Porcelain lamp holder
- GX5.3 base
- 100mm long flying leads
- 100W rated

• Ideal for low voltage dichroic lamps

Order Code	Mod: 012802	Price each exc. VAT 1+	inc. VAT each
VJ11M	Dichroic Lamp Holder	£2.90	£3.49

Buy it on the web at maplin.co.uk

Shop for all Maplin products online at our website and check out our latest products and special offers!



Low-Voltage Lighting Transformer

- 12V dimmable electronic transformers
- RFI suppressed
- Short circuit and overload protected
- Thermal overload protected
- Available in 60VA and 105VA (sold separately)



Two electronic transformers for low voltage (12V halogen) lighting. The 60VA will handle 3 x 20W bulbs or 1 x 50W and the 105VA will handle 5 x 20W or 2 x 50W. Safety certified to EN61347-2-2 EMC certified to EN55015, EN61547, EN61000-3-2 and EN61000-3-3.

Order Code	Mod: 029782	Price each exc. VAT 1+	inc. VAT each
NL50E	LV Transformer 60VA	£9.15	£10.99
NL48C	LV Transformer 105VA	£13.32	£15.99

LED Lighting Transformers



- Designed specifically for use with LED lighting
- Available in a two power ratings
- 12V DC constant voltage
- Short circuit and temperature overload protection

A range of RoHS compliant single output Constant Voltage LED Lighting Power Supplies suitable for LED lighting applications indoor and outdoors.

Order Code:	Input Voltage	Output Voltage	Wattage
N28JU	100-240V AC	12V DC	18W
N27JU	180-264V AC	12V DC	10W

Order Code	Mod: 517253	Price each exc. VAT 1+	inc. VAT each
N28JU	18W LED Transformer	£10.82	£12.99
N27JU	10W LED Transformer	£8.32	£9.99

Maplin TV

Home of innovation, handy tips and How To videos

Visit our channel...

youtube.com/maplintv



Security Lighting

Floodlighting & PIR Lighting

Maplin LED 10W PIR Security Light



- Single super bright LED
- Up to 50,000 hour lifespan
- Detects movement up to 12 m
- No heat emissions
- 180° PIR sensor
- Adjustable sensitivity
- Hardwearing powder coated finish
- Tempered glass
- IP 44 rated

Consuming just 10 W of energy the Maplin LED PIR Security Light is ideal for use as security or general outdoor lighting around the home. Featuring adjustable detection distance and activation time the PIR offers full 180° coverage up to 12 m.

Order Code	Mod:	Price each exc. VAT 1+	inc. VAT each
A58LG	10W LED PIR Light	£29.15	£34.99

Twin Light Halogen 120W Motion Activated PIR Security Light



- Twin 120W Halogen lights
- PIR motion activated light
- Detection range 12m x 110°
- Adjustable time and light sensitivity settings
- 2 x 120W tubes included
- IP44 rated for outdoor use
- Metal construction
- Black finish
- 2500 lumens
- 1000h lifespan
- Includes bracket for 90° corner mounting

Order Code	Mod:	Price each exc. VAT 1+	inc. VAT each
A61KJ	Twin Security Light	£20.82	£24.99

PIR Motion Unit

- Up to 10 metre detection range
- 180 degree angle detection
- Adjustable time on and dusk till dawn controls
- IP44 rated
- Fixing pack and installation guide included



Order Code	Mod:	Price each exc. VAT 1+	inc. VAT each
A21HR	PIR Unit Blk	£8.32	£9.99

Energy Efficient Halogen 120W Floodlight



- 120W Energy Efficient halogen tube included (equivalent to a 150W)
- Die cast aluminium construction with toughened glass cover
- IP44 rated
- Durable waterproof seal
- Fixing pack and instructions included

Order Code	Mod:	Price each exc. VAT 1+	inc. VAT each
A11HR	Floodlight Blk 120W	£4.99	£5.99

Energy Efficient Halogen 400W Floodlight



- Die cast aluminium construction with toughened glass cover
- 400W Energy Efficient halogen tube included (equivalent to a 500W)
- Quick and easy installation
- IP44 rated
- Durable weatherproof seal
- Fixing pack and installation instructions included

Order Code	Mod:	Price each exc. VAT 1+	inc. VAT each
A12HR	Floodlight Blk 400W	£5.82	£6.99

Energy Efficient Halogen 120W PIR Floodlight



- 140 degree field of detection and up to 10 metres detection range
- 120W Energy Efficient halogen tube included (equivalent to a 150W)
- Die cast aluminium construction
- Adjustable time on and dusk controls
- Pulsed manual override feature
- IP44 rated
- Large accessible wiring box
- Fixing pack and installation guide included

Order Code	Mod:	Price each exc. VAT 1+	inc. VAT each
A13HR	F light/PIR Blk 120W	£8.32	£9.99

Energy Efficient Halogen 400W PIR Floodlight



- 140 degree field of detection and up to 10 meters detection range
- Die cast aluminium construction
- Adjustable time on and dusk controls
- Pulsed manual override
- IP44 rated
- Large accessible wiring box
- 400W Energy Efficient halogen tube included (equivalent to a 500W)
- Fixing pack and installation guide included

Order Code	Mod:	Price each exc. VAT 1+	inc. VAT each
A16HR	F light/PIR Blk 400W	£10.82	£12.99

Elro Energy Saving 24W PIR Sensor Security Light



- Motion activated security light for the home
- Low wattage Energy Saving CFL tube uses just 24W
- Suitable for indoor or outdoor use
- 160° beam angle detects up to 10m
- 24W lamp included
- 2 year guarantee

Order Code	Mod:	Price each exc. VAT 1+	inc. VAT each
A09RW	24W Security Light	£20.82	£24.99

NightWatcher 120W Motorised Halogen Floodlight



- 3X passive infrared sensors with varying degrees of protection, Zones 1 and 3 covering 60°, Zone 2 covering 100° with a total detection zone of 220°.
- Light activates for 3 minutes (Fixed) upon detection of heat/movement. Fitting automatically re-centers when light deactivates.
- Robotic head rotates left and right with total movement of 70° left and right.
- Programmable functions for day & night and night only activation.
- IP54 Rated

A NightWatcher Security Light is a proven and an effective method of deterring intruders from your home and business

The NightWatcher is a patent pending motion tracking feature, built into a PIR lamp. The NightWatcher detects an intruder's motion within the field of vision of the PIR and points the lamp directly at the intruder. As the intruder moves across the PIR field of vision, the

motorised NighWatcher lamp head takes aim and follows.

Contents

- Light and wall fitting
- Mounting screws and wall plugs
- Full Instruction Manual

Detection Method	Passive Infrared Sensor (with continuous detect function)		
Bulb Type (energy saving bulb)	1 x Grade C 120w halogen		
Material	Cast metal/plastic		
Power Supply	AC240V 50Hz		
PIR Direction Angle	220°		
PIR Direction Area	10m x 210° (maximum)		
Light-up Time	3 Minutes		
Waterproof Rating	IP54		
Order Code	Mod: 513441	Price each exc. VAT	inc. VAT each
A53KN	NW Halogen Light		

an excellent amount of light for just 30W. Light output equivalent to 300w Halogen bulb

- **Input voltage:** AC85-264V(50/60HZ)
- **Power consumption:** 35W MAX
- **Beam Angle:** 100°
- **Colour temp.:** 5500-6500K
- **CPI(Ra):** 75
- **Luminous Flux(max):** 2400lm
- **Ave. lifespan:** 50000H
- **Size:** 225*185*130mm
- **Input wire:** Single-phase 3 wire
- **Material:** Die-casting Alu.
- **IP grade:** IP65
- **Net weight:** 2758g

Order Code	Mod: 513561	Price each exc. VAT	inc. VAT each
A65KN	230V 30W LED FloodL	£41.65	£49.99

Professional LED 50W Floodlight



- This 230V AC floodlight has a single LED and provides an excellent amount of light for just 50W. Light output equivalent to 500w Halogen bulb
- **Input voltage:** AC85-264V(50/60HZ)
- **Power consumption:** 50W
- **Beam Angle:** 100°
- **Colour temp.:** 5500-6500K
- **CPI(Ra):** 75
- **Luminous Flux(max):** 4000lm
- **Ave. lifespan:** 50000H
- **Size:** 285*235*160mm
- **Input wire:** Single-phase 3 wire
- **Material:** Die-casting Alu.
- **IP grade:** IP65
- **Net weight:** 3770g

Order Code	Mod: 513562	Price each exc. VAT	inc. VAT each
A66KN	230V 50W LED FloodL	£74.99	£89.99

Look out for our monthly promotions at your local Maplin store now!

Pop in and pick up a copy of our monthly promotional publication, with special offers on dozens of exciting products. See the end of this catalogue for store listings

Buying for business?
0333 400 9740

Professional LED 10W Floodlight



- This 230V AC floodlight has a single LED and provides an excellent amount of light for just 10W. Light output equivalent to 100w Halogen bulb
- **Input voltage:** AC85-264V(50/60HZ)
- **Power consumption:** 10W
- **Beam Angle:** 100°
- **Colour temp.:** 5500-6500K
- **CPI(Ra):** 75
- **Luminous Flux(max):** 800lm
- **Ave. lifespan:** 50000H
- **Size:** 115*90*90mm
- **Input wire:** Single-phase 3 wire
- **Material:** Die-casting Alu.
- **IP grade:** IP65
- **Net weight:** 832g

Order Code	Mod: 513557	Price each exc. VAT	inc. VAT each
A64KN	230V 10W LED FloodL	£16.65	£19.99

Professional 30W LED Floodlight



- This 230V AC floodlight has a single LED and provides

hobbyists

- **Shadow-free light with almost no heat emission**
- **High quality 125mm (5 inch) 5 dioptre glass lens**
- **Spring balanced metal arms and locking knobs allow the unit to be secured in any position**
- **Multi position G-clamp mounting bracket**
- **Spare tube available (Order code: N11CH)**

The Maplin 22W Magnifying lamp provides crisp, artefact and shadow free light with almost no heat emissions. Combined with a high quality 5 dioptre glass magnifying lens, it makes even the most intricate jobs manageable. The sprung steel arms and multi position G-clamp offer a full range of adjustments for a truly flexible lighting instrument

Order Code	Mod: 047980	Price each exc. VAT	inc. VAT each
A29FF	22W Magnifying Lamp	£33.32	£39.99
N11CH	Spare tube for A29FF	£5.82	£6.99

Outdoor & Underwater Lighting

Elro Bulkhead Light 60W with PIR Sensor

- Bulk head light with PIR sensor
- 110° angle of activation
- Senses movement up to a range of 12m
- Suitable for indoor or outdoor use
- Max 60W E27 lamp (not included)



Order Code	Mod: 625935	Price each exc. VAT	inc. VAT each
A11RW	PIR Bulkhead	£15.82	£18.99

Elro Bulkhead Light 60W with Dusk to Dawn Sensor

- Bulk head light with dusk to dawn sensor
- Activates light when ambient light drops
- Suitable for indoor or outdoor use
- Silver finish
- Max 60W E27 lamp (not included)



Order Code	Mod: 625937	Price each exc. VAT	inc. VAT each
A10RW	Dusk/Dawn Bulkhead	£10.82	£12.99

Magnifier Lamps

22W Fluorescent Daylight Magnifier Lamp



- Ideal for intricate work for electronic engineers and

Technical Helpline

0333 400 9500

For technical information and assistance relating to any Maplin purchase, contact our team of experts

TOOLS



CONTENTS

298 - 327	Hand Tools
328 - 333	Power Tools
334 - 341	Soldering
342 - 359	Test & Measurement
360 - 365	Fixings
366 - 375	Tape & Glues
376 - 381	Cleaning & Aerosols
382 - 387	Tool Storage

Hand Tools

Screwdrivers

Maplin 2-Piece Screwdriver Set



- Magnetic tips and cushion grip handles
- Includes slotted 5 x 100mm and Pozi PZ2 x 100mm

1 x slotted screwdriver: 5 x 100mm

1 x Pozi screwdriver: PZ2 x 100mm

Warranty: 5 years

Order Code	Mod: 1032896	Price each exc. VAT 1+	inc. VAT each
A43QU	Map 2PcScrewdrivSet	£2.90	£3.49

Maplin 8-Piece Precision Screwdriver Set



- Ideal for intricate work on PCs, electronics, jewellery and more
- Bits are stored in the handle for easy access
- Includes 4 double-ended screwdriver bits (slotted to Phillips)

1 x screwdriver handle with bit holder

1 x slotted 1.5 to PH1 screwdriver bit

1 x slotted 2.0 to PH0 screwdriver bit

1 x slotted 2.5 to PH00 screwdriver bit

1 x slotted 3.0 to PH1 screwdriver bit

Warranty: 5 years

Order Code	Mod: 1032874	Price each exc. VAT 1+	inc. VAT each
A16QU	Map 8Pc Prec SD Set	£2.90	£3.49

Maplin 6-Piece Precision Screwdriver Set



- Ideal for intricate work on PCs, electronics, jewellery and more
- Includes 2 Phillips and 4 slotted screwdrivers
- Handles rotate for greater torque
- Supplied in a handy storage case

2 x Phillips screwdrivers: PH0 and PH1

4 x slotted screwdrivers: 1.4, 2.0, 2.4 and 3mm

Warranty: 5 years

Order Code	Mod: 1032875	Price each exc. VAT 1+	inc. VAT each
A17QU	Map 6Pc Prec SD Set	£2.90	£3.49

Maplin 6-in-1 Precision Screwdriver



- Comprises aluminium screwdriver body with 6 bits
- Bits are stored in screwdriver handle
- Supplied with handy pocket clip

3 x slotted bits: 1.5, 2.0 and 3.0

3 x Phillips bit: PH00, PH0 and PH1 x screwdriver handle

Warranty: 5 years

Order Code	Mod: 1032876	Price each exc. VAT 1+	inc. VAT each
A18QU	Map Prec Sdriver	£2.90	£3.49

Maplin 16-Piece Precision Screwdriver Set



- Ideal for hobby, electronic, model or engineering use
- 16 tools in total including spanners, hex keys, nut drivers and screwdrivers
- The tools range in length from approximately 70mm to 100mm

- Handles have a swivel end cap
- Supplied in a handy storage case

6 x slotted screwdrivers: 1.0, 1.4, 2.0, 2.4, 3.0 and 3.5mm

4 x Phillips screwdrivers: PH0-2 PH0, PH1-2, PH1-1

3 x hex drivers: 1.5, 2.0 and 2.5mm

3 x nut spinners: 3.0, 4.0 and 5.0mm

1 x handy plastic storage box

Warranty: 5 years

Order Code	Mod: 1032873	Price each exc. VAT 1+	inc. VAT each
A15QU	Map 21PcPrecisionSet	£4.15	£4.99

Maplin 6-Piece Precision Screwdriver Set

- Soft grip handle with swivel end cap
- Includes 3 slotted and 3 Phillips precision screwdrivers
- Supplied in a handy storage case

3 x slotted screwdrivers

2.0, 2.5, 3.0mm

3 x Phillips screwdrivers: PH000,

PH00, PH0

1 x handy storage case

Warranty: 5 years

Order Code	Mod: 1032881	Price each exc. VAT 1+	inc. VAT each
A23QU	Map 6Pc Prec Sdriver	£4.15	£4.99

Maplin 6-Piece Precision Star Driver Set

- Soft grip handle with swivel end cap
- Includes 6 of the most popular sized star screwdrivers
- Supplied in a handy storage case

6 x star screwdrivers: T6,

T7, T8, T9, T10 and T15

1 x handy storage case

Warranty: 5 years

Order Code	Mod: 1032882	Price each exc. VAT 1+	inc. VAT each
A25QU	Map 6PcPrecStarDrive	£4.15	£4.99



Maplin 18-Piece Screwdriver and Bit Set

- Ideal for intricate work on PCs, electronics, jewellery and more
- Includes screwdriver handle and magnetic extension bar
- Contains 16 bits including star, slotted and Phillips
- Supplied in a handy storage case

1 x screwdriver handle

1 x magnetic extension bar

6 x star bits: T5, T6, T7, T8, T9 and T10

4 x slotted bits: 1.5, 2.0, 2.5 and 3.0mm

6 x Phillips bits: 2 x PH00, 2 x PH0 and 2 x PH1

1 x handy storage case

Warranty: 5 years

Order Code	Mod: 1032877	Price each exc. VAT 1+	inc. VAT each
A19QU	Map 18Pc SD Bit Set	£5.82	£6.99



Maplin 7-Piece iPhone Tool Kit



- Includes T0.8 and Philips PH1.5 screwdrivers
- Mini suction cup for removing the glass screens on iPhone and iPod Touch
- 2 prying tools for opening the case without scratching the cover
- 2 x levers to open the housing easily without damaging any parts

Warranty: 5 years

Order Code	Mod: 1032880	Price each exc. VAT 1+	inc. VAT each
A22QU	Map 7PciPhoneToolKit	£5.82	£6.99



Over 200 stores nationwide

Maplin 22-Piece Precision Screwdriver Set



- Ideal for intricate work on PCs, electronics, jewellery and more
- Includes soft rubber grip screwdriver handle
- Also includes a 20-piece set of 28mm screwdriver bits
- Contains 110mm curved tip tweezers
- Supplied in a handy storage case

1 x screwdriver handle
 5 x 28mm slotted screwdriver bits: 1.5, 2, 2.5, 3 and 4mm
 4 x 28mm crosspoint screwdriver bits: PH000, PH00, PH0 and PH1
 5 x 28mm standard star screwdriver bits: T5, T6, T7, T9, and T15
 3 x 28mm security star screwdriver bits: T8, T10 and T15
 1 x 28mm spanner slotted bit: 2.6mm
 1 x 28mm tri-wing bit: 3.0mm
 1 x 28mm triangle bit: 3.0mm
 1 x tweezers
 1 x handy storage case
 Warranty: 5 years

Order Code	Mod: 1032884	Price each exc. VAT 1+	inc. VAT each
A27QU	Map 22Pc PrecBitSet	£5.82	£6.99

Maplin Big Eye Precision Screwdriver



- Set includes precision screwdriver with selection of double-ended precision screwdriver bits
- Magnifier built into handle - great for inspecting small items or for use as a reading aid

Double-ended precision screwdriver bits: PH0/3, PH00/2.5, T6/H1.5 and T7/H2
 Warranty: 5 years

Order Code	Mod: 1032888	Price each exc. VAT 1+	inc. VAT each
A31QU	Map BigEye Prec SD	£4.99	£5.99

Maplin 12-in-1 Angle Ratchet Screwdriver



- Includes 60 degree angle ratchet screwdriver
- Contains 12 x 25 mm screwdriver bits, including slot, Phillips, star and hex

- Bits can be stored in the handle
- 1 x 60 degree angle ratchet screwdriver
 3 x 25 mm slotted bits: 5, 6 and 7 mm
 3 x 25 mm Phillips bits: PH1, PH2 and PH3
 3 x 25 mm star bits: T15, T20 and T25
 3 x 25 mm hex bits: 3, 4 and 5 mm
 Warranty: 5 years

Order Code	Mod: 1032907	Price each exc. VAT 1+	inc. VAT each
A49QU	Map 12in1 AngleRatch	£6.65	£7.99

Maplin 33-Piece Precision Screwdriver Set



- Ideal for intricate work on PCs, electronics, jewellery and more
- Includes precision screwdriver handle and selection of 28mm interchangeable bits
- Also includes standard and flexible bit extension bars and a magnifier
- Supplied in a handy storage case

1 x precision screwdriver handle
 1 x 110mm bit extension bar
 1 x 190mm flexible bit extension bar
 1 x magnifier (25mm diameter and 3x magnification)
 8 x 28mm Phillips bits: 2 x PH000, 2 x PH00, 2 x PH0 and 2 x PH1
 3 x 28mm Pozi bits: PZ000, PZ0 and PZ17 x 28mm slotted bits: SL1, SL1.5, SL2, SL2.5, SL3, SL3.5 and SL4
 4 x 28mm hex bits: H1.5, H2, H2.5 and H3
 8 x 28mm star bits: T5, T6, T7, T8, T9, T10, T15 and T20
 1 x handy storage case
 Warranty: 5 years

Order Code	Mod: 1032878	Price each exc. VAT 1+	inc. VAT each
A20QU	Map 33Pc Prec SD Set	£6.65	£7.99

Maplin 31-Piece Precision Screwdriver Set



- Ideal for intricate work on PCs, electronics, jewellery and more
- Includes precision screwdriver handle and a 30-piece set of assorted 28mm precision bits
- Supplied in a handy storage case

1 x precision screwdriver handle
 8 x 28mm Phillips bits: 2 x PH000, 2 x PH00, 2 x PH0 and 2 x PH1
 3 x 28mm Pozi bits: PZ00, PZ0 and PZ1
 7 x 28mm slotted bits: SL1, SL1.5, SL2, SL2.5, SL3, SL3.5 and SL4
 4 x 28mm hex bits: H1.5, H2, H2.5 and H3
 8 x 28mm star bits: T5, T6, T7, T8, T9, T10, T15 and T20
 1 x handy storage case
 Warranty: 5 years

Order Code	Mod: 1032879	Price each exc. VAT 1+	inc. VAT each
A21QU	Map 31Pc Prec SD Set	£6.65	£7.99

Find out more in-store

Our staff can offer friendly and expert advice; we're here to help



Maplin 12-in-1 Pocket Precision Screwdriver Set



- Ideal for repairing glasses, mobile phones, PCs and precision equipment
- Supplied in a pocket sized folding wallet
- Swivel end cap for ease of use

3 x Phillips tips: PH0, PH00 and PH000
 3 x slotted tips: 2, 2.5 and 3mm
 6 x star tips: T5, T6, T7, T8, T9 and T10
 Warranty: 5 years

Order Code	Mod: 1032885	Price each exc. VAT 1+	inc. VAT each
A28QU	Map12in1PocketSDSet	£6.65	£7.99

Maplin 13-in-1 Ratchet Screwdriver



- 3 position reversible ratchet
- Includes 12 high quality bits, stored in handle in a revolving bit cartridge
- Compact screw guide holds and guides screws in correct position without wobbling or disengaging from the bit
- Powerful magnet to hold bits and screws tightly

4 x slotted bits: 3, 5, 6 and 7mm
 4 x Phillips bits: PH0, PH1, PH2 and PH3
 2 x hex bits: 4 and 5mm
 2 x star bits: T10 and T20
 1 x 240mm magnetic pick-up tool
 1 x ratchet screwdriver
 Warranty: 5 years

Order Code	Mod: 1032909	Price each exc. VAT 1+	inc. VAT each
A46QU	Map 13in1Screwdriver	£6.65	£7.99

Maplin 6-Piece Screwdriver Set



- 6-piece screwdriver set with 3 slotted and 3 Phillips screwdrivers
- Long handles for reaching recessed screws in electronic equipment
- Moulded plastic grip handles

3 x slotted screwdrivers: 2.5mm, 3.0 mm and 3.5mm
 3 x Phillips screwdrivers: PH0, PH00 and PH000
 Warranty: 5 years

Order Code	Mod: 1032910	Price each exc. VAT 1+	inc. VAT each
A45QU	Map 6PcScrewdriverSet	£6.65	£7.99

Maplin 32-Piece Precision Screwdriver Set

- Ideal for intricate work on PCs, electronics, jewellery and more
- Screwdriver handle has soft touch grip and swivel end cap
- Includes a 30-piece set of assorted 28mm precision bits



- Also includes a pair of tweezers
 - Supplied in a handy storage case
- 4 x Phillips bits: PH000, PH00, PH0 and PH1
2 x Pozzi bits: PZ0 and PZ01
7 x slotted bits: 1.0, 1.5, 2.0, 2.5, 3.0, 3.5 and 4.0mm
9 x torx bits: T4, T5, T6, T7, T8, T9, T10, T15 and T20
8 x hex bits: 0.7, 0.9, 1.3, 1.5, 2.0, 2.5, 3.0 and 4.0mm
1 x screwdriver bit holder
1 x tweezers
1 x handy storage case
Warranty: 5 years

Order Code	Mod: 1032883	Price each exc. VAT 1+	inc. VAT each
A26QU	Map 32Pc Prec SDSet	£7.49	£8.99

Maplin 18-in-1 Precision Screwdriver Set



- Set includes precision screwdriver with aluminium handle
- Also includes selection of double ended precision screwdriver bits

1 x screwdriver
4 x double-ended star bits: T4/T8, T5/T9, T6/T10 and T7/T15
5 x mixed double-ended screwdriver bits: SL1.5/PH00, SL1.5/PH00, SL2/PH0, SL2/PH0 and SL2.5/SL3
Warranty: 5 years

Order Code	Mod: 1032889	Price each exc. VAT 1+	inc. VAT each
A32QU	Map 18in1 Prec SDSet	£6.65	£7.99

Maplin 26-Piece Tri-Fold Precision Tool Kit



- Contains 6-piece precision screwdriver set
 - Includes socket set and interchangeable screwdriver bits
 - Also includes pliers, cutters and tweezers
 - Supplied in a folding storage case
- 1 x mini long nose pliers
1 x mini side cutters

1 x tweezers
1 x 75mm extension bar
4 x sockets: 5mm, 6mm, 8mm and 10mm
1 x magnetic bit holder
3 x slotted screwdriver bits: 5mm, 6mm and 7mm
3 x Phillips screwdriver bits: PH1, PH2 and PH3
3 x star screwdriver bits: T10, T15 and T20 x bit adaptor
6 x precision screwdrivers
1 x folding storage case
Warranty: 5 years

Order Code	Mod: 1032893	Price each exc. VAT 1+	inc. VAT each
A38QU	Map Prec Tool Kit	£7.49	£8.99

Maplin 30-Piece Precision Screwdriver Set

- An ideal precision tool set for small, delicate jobs
- Includes selection of Phillips, star, hex and pozi precision screwdriver bits

7 x slotted bits: 1.0, 1.5, 2.0, 2.5, 3.0, 3.5 and 4.0mm
8 x Phillips bits: 2 x PH000, 2 x PH00, 2 x PH0 and 2 x PH1
8 x star bits: T5, T6, T7, T8, T9, T10, T15 and T20
4 x hex bits: H1.5, H2.0, H2.5 and H3.0
3 x Pozzi bits: PZ00, PZ0 and PZ1
1 x precision screwdriver handle
Warranty: 5 years

Order Code	Mod: 1032894	Price each exc. VAT 1+	inc. VAT each
A55QX	Map 30in1 PrecSD Set	£6.65	£7.99

Maplin 15-Piece Precision Ratchet Screwdriver



- Cushion handle grip for comfortable long-time operation
 - Includes slotted: 1.5, 2, 2.5 and 3 mm, Phillips: PH1, PH0, PH00, PH000
 - Also includes star bit: T6, T7, T8, T9, T10, T15, T20
- Warranty: 5 years

Order Code	Mod: 1033062	Price each exc. VAT 1+	inc. VAT each
N60DV	Map 15Pc RatchPrecSD	£6.65	£7.99

Maplin TV

Home of innovation, handy tips and How To videos
[youtube.com/maplintv](https://www.youtube.com/maplintv)



Maplin 6-Piece Screwdriver Set



- Set contains 3 Phillips and 3 slotted screwdrivers
- 75mm - 120mm screwdriver length
- Screwdrivers contained in a plastic rack for easy storage

3 x Phillips screwdrivers: PH0 x 75mm, PH1 x 100mm and PH2 x 125mm
3 x slotted screwdrivers: 3.5 x 75mm, 4.0 x 100mm and 5.5 x 125mm
1 x plastic rack
Warranty: 5 years

Order Code	Mod: 1032906	Price each exc. VAT 1+	inc. VAT each
A56QX	Map6PcScrewdriverSet	£8.32	£9.99

Maplin Screwdriver with Wire Stripper



- Screwdriver with ergonomic handle
 - Built-in wire stripper, wire cutter and cable stripper
 - Strips wires: 0.8, 1.0, 1.3, 1.6, 2.0 and 2.6 mm
- Warranty: 5 years

Order Code	Mod: 1032908	Price each exc. VAT 1+	inc. VAT each
A47QU	Map WireStripper SD	£8.32	£9.99

Maplin 52-Piece Screwdriver and Bit Set



- Consists of precision ratchet handle screwdriver with soft grip
- Also includes T-handle stubby ratchet screwdriver
- Supplied with 30 x 28mm precision bits and 20 x 25mm standard screwdriver bits

1 x precision ratchet handle
7 x 28mm slotted precision bits: 1.0, 1.5, 2.0, 2.5, 3.0, 3.5 and 4.0mm
8 x 28mm Phillips precision bits: 2 x PH000, 2 x PH00, 2 x PH0 and 2 x PH18 x 2
8mm star precision bits: T5, T6, T7, T8, T9, T10, T15 and T20
4 x 28mm hex precision bits: 1.5, 2.0, 2.5 and 3.0mm
3 x 28mm Pzci precision bits: PZ00, PZ0 and PZ1
1 x T-handle stubby screwdriver
4 x 25mm slotted screwdriver bits: 3, 4, 5 and 6mm
4 x 25mm Phillips screwdriver bits: PH0, PH1, PH2 and PH3
4 x 25mm Pzci screwdriver bits: PZ0, PZ1, PZ2 and PZ3
4 x 25mm star screwdriver bits: T10, T15, T20, and T30
4 x 25mm hex screwdriver bits: 3, 4, 5 and 6mm
1 x handy storage case
Warranty: 5 years

Order Code	Mod: 1032886	Price each exc. VAT 1+	inc. VAT each
A29QU	Map 52Pc SD Bit Set	£9.15	£10.99

Maplin 32-Piece Screwdriver and Bit Set



- The ultimate set of bits, including a ratchet screwdriver and bit holder all contained in a handy storage box
- Includes star, spanner, hex, tri-wing, Phillips and slotted bits

3 x slotted bits: 5, 6 and 7mm
 2 x Phillips bits PH1 and PH2
 7 x star bits: T4, T5, T6, T10, T15, T20 and T30
 3 x hex bits H4, H5 and H6
 1 x Tri-wing No.31 x spanner bit: No.6
 2 x Pozidriv bits: PZ2 and PZ3
 1 x bit adaptor
 9 x sockets: 5, 6, 7, 8, 9, 10, 11, 12 and 13mm
 1 x screwdriver handle
 Warranty: 5 years

Order Code	Mod.	Price each exc. VAT 1+	inc. VAT each
A410U	Map 32pcSecurityBits	£12.49	£14.99

Maplin 58-Piece Ratchet Handle Screwdriver Bit and Socket Set



- Includes 3-way ratchet with ergonomic handle
- Also includes 6.3mm x 200mm long flexi extension
- Set also contains a 42-piece bit set and a 14-piece socket set

Warranty: 5 years

Order Code	Mod.	Price each exc. VAT 1+	inc. VAT each
A400U	Map 58pcBits/Ratchet	£12.49	£14.99

Maplin 15-Piece Precision Screwdriver Set



- Cushion handle grip for comfortable long-time operation
- Includes slotted: 1.5, 2, 2.5 and 3 mm, Phillips: PH1, PH0, PH00, PH000
- Also includes star bit: T6, T7, T8, T9, T10, T15, T20

Warranty: 5 years

Order Code	Mod.	Price each exc. VAT 1+	inc. VAT each
A300U	Map 15Pc Prec SDSet	£12.49	£14.99

Maplin 10-Piece Screwdriver Set



- Set contains 5 Phillips and 5 slotted screwdrivers
- 75mm - 150mm screwdriver length
- Screwdrivers contained in a plastic case for easy storage

5 x slotted screwdrivers: 3 x 75, 5 x 100, 6 x 40, 6 x 100 and 8 x 150mm
 5 x Phillips screwdrivers: PH0 x 75, PH1 x 100, PH2 x 40, PH2 x 100 and PH3 x 150mm
 1 x handy storage case
 Warranty: 5 years

Order Code	Mod.	Price each exc. VAT 1+	inc. VAT each
A570X	Map 10PcScrewDriverSet	£12.49	£14.99

Maplin Auto-Loading Ratchet Screwdriver



- Auto-load mechanism for quick and easy bit changes
 - Includes variety of bits for all applications
 - Includes 25 chrome-vanadium screwdriver bits
- 6 x slotted bits: 1 x SL3, 2 x SL4, 1 x SL5 and 2 x SL6
 6 x Phillips bits: 2 x PH0, 2 x PH1 and 2 x PH2
 7 x Pozidriv bits: 2 x PZ0, 2 x PZ1 and 2 x PZ2
 6 x star bits: T8, T9, T10, T15, T20 and T25
 1 x auto-loading ratchet screwdriver
 Warranty: 5 years

Order Code	Mod.	Price each exc. VAT 1+	inc. VAT each
A480U	MapAutoLoadRatchSD	£12.49	£14.99

Maplin 8-Piece VDE Screwdriver Set



- Fully insulated handles and blades tested to 1000V
- Dual compound handles for comfort and maximum torque
- Set includes 3 Phillips and 4 slotted screwdrivers
- Also includes multi purpose voltage tester

3 x Phillips VDE screwdrivers: PH0 x 60mm, PH1 x 80mm and PH2 x 100mm,
 4 x slotted VDE screwdrivers: 6.5 x 150mm, 4 x 100mm, 5.5 x 125 mm and 3 x 75mm
 1 x voltage tester
 Warranty: 5 years

Order Code	Mod.	Price each exc. VAT 1+	inc. VAT each
A390U	Map 8Pc VDE SD Set	£12.49	£14.99

Maplin Dual Drive Precision Screwdriver



- Ergonomic handle with anti-slip rubber grip
- Patented dual drive technology - 2x faster than standard ratcheting
- Convenient forward/reverse thumb switch
- Includes selection of precision screwdriver bits

1 x dual drive precision screwdriver
 5 x 28mm Phillips precisions bits: PH000, PH00 x 2, PH0 and PH1
 5 x 28mm slotted precision bits: 1.5, 2, 2.5 and 3mm
 2 x 28mm star precision bits: T5 and T6
 Warranty: 5 years

Order Code	Mod.	Price each exc. VAT 1+	inc. VAT each
A330U	Map Dual Drive PrecSD	£12.49	£14.99

Maplin 8-in-1 Battery Powered Precision Cordless Screwdriver



- Ideal for precision tightening of screws
- Durable aluminium housing with non-slip grip
- Forward and reverse action
- No load speed: 120rpm
- 1/8-Inch Dr. Super-torque screwdriver head
- Includes 8 double-ended chrome vanadium bits
- Powered by 3 x AAA batteries (included)

1 x cordless precision screwdriver
 8 x double end precision screwdriver bits: H000/2, PH0/3, T6/H1.5, PH00/2.5, T7/H2, T8/2.5, T9/H3 and T10/H3.5
 Warranty: 5 years

Order Code	Mod.	Price each exc. VAT 1+	inc. VAT each
A360U	MapBin1BattPrecSDrvr	£12.49	£14.99

Buying for business?

0333 400 9740



Maplin 45-Piece Screwdriver and Bit Set

- Includes screwdriver handle with magnetic bit holder
- Contains 30 bits, including star, hex, Phillips and slotted bits
- Also contains 6 standard screwdrivers and 6 precision screwdrivers (slotted and Phillips)
- Also supplied with 150mm combination pliers and side cutters



3 x slotted screwdrivers: 3.5x75mm, 4x100mm and 5.5x125mm
 3 x Phillips screwdrivers: PH0 x 75mm, PH1 x 100mm and PH2 x 125mm
 1 x 150mm combination Pliers
 1 x 150mm side cutters
 6 x precision screwdrivers: PH00, PH0, PH1, SL2.0, SL2.4 and SL3.0mm
 13 x slotted bits: 3 x 4mm, 4 x 5mm, 4 x 6mm and 1 x 7mm
 6 x Phillips bits: 1 x PH0, 2 x PH1, 2 x PH2, 1 x PH31
 1 x Pozi bits: 1 x PZ0, 4 x PZ1, 4 x PZ2, 2 x PZ3
 1 x screwdriver handle
 1 x magnetic bit holder
 Warranty 5 years

Order Code	Mod: 1032911	Price each exc. VAT 1+	inc. VAT each
A42QU	Map 45Pc SdrvrSet	£16.65	£19.99

Stanley Multi-bit Ratchet Screwdriver with 10 Bits



- Multi-bit ratchet screwdriver
- Magnetic bit holder for quick, secure change
- Tri-lobular bi-material handle with textured finish
- Supplied with 10 bits
- Maximum torque

The Stanley product has a patented bit storage system for ease of visibility, access and security. It also has a spring loaded, hard wearing, ball bearing indexing mechanism for quick and easy access.

It also has a magnetic bit holder for quick, secure changeover of standard 1/4-Inch bits and a top quality patented, 3-position, audible, ratcheting mechanism (forward, reverse and fixed) for life long efficiency. Stanley have used the most up to date materials in their screwdrivers. The tri-lobular, bi-material handle with textured finish will give users maximum torque on any type of screw with the minimum of effort. The screwdriver is supplied in a unique holder which contains 4 bits in addition to the 6 bits held in the screwdrivers' integral storage magazine.

In total, it is supplied with 10 bits to suit a variety of purposes.

Slotted: 3 and 6mm, Phillips: PH1 and 2 x PH2, Pozi: PZ1 and 2 x PZ2, Torx: T10 and T15.

Order Code	Mod: 1032971	Price each exc. VAT 1+	inc. VAT each
A66RF	Stan Driver & Bits	£12.49	£14.99

Wera Kraftform 160i VDE Insulated Screwdriver Slotted Tip 2.5 x 80mm



- VDE insulated for safe working with loads up to 1,000V
- Kraftform handle which uniquely fits to the shape of the hand during screwdriver use
- Blade length 80mm
- Tip 2.5mm

Wera Slotted 160i VDE insulated screwdrivers are tested individually for dielectric strength under a load of 10,000 volts so as to ensure safe working with loads up to 1,000 volts. Patented ergonomic, multi-component Kraftform handle which uniquely fits to the shape of the hand during screwdriver use.

Please note: WER00610 does not have a Lasertip

Order Code	Mod: 1032936	Price each exc. VAT 1+	inc. VAT each
A79RF	Wera Driver2.5/80mm	£3.74	£4.49

Wera Kraftform 160i VDE Insulated Screwdriver Slotted Tip 3.5 x 100mm



- VDE insulated for safe working with loads up to 1,000V
- Features a silver nickel lasertip
- Kraftform handle which uniquely fits to the shape of the hand during screwdriver use
- Blade Length 100mm
- Tip 3.5mm

Wera Slotted 160i VDE insulated screwdrivers are tested individually for dielectric strength under a load of 10,000 volts so as to ensure safe working with loads up to 1,000 volts. They have a Silver Nickel Lasertip - a laser roughened surface which literally bites into the screwhead, reducing cam-out. Patented ergonomic, multi-component Kraftform handle which uniquely fits to the shape of the hand during screwdriver use.

Order Code	Mod: 1032942	Price each exc. VAT 1+	inc. VAT each
AB0RF	Wera Driver3.5/100mm	£4.15	£4.99

Wera Kraftform 160i VDE Insulated Screwdriver Slotted Tip 5.5 x 125mm



- VDE insulated for safe working with loads up to 1,000V
- Features a silver nickel lasertip
- Kraftform handle which uniquely fits to the shape of the hand during screwdriver use

- Blade length 125mm
- Tip 5.5mm

Wera Slotted 160i VDE insulated screwdrivers are tested individually for dielectric strength under a load of 10,000 volts so as to ensure safe working with loads up to 1,000 volts. They have a Silver Nickel Lasertip - a laser roughened surface which literally bites into the screwhead, reducing cam-out. Patented ergonomic, multi-component Kraftform handle which uniquely fits to the shape of the hand during screwdriver use.

Order Code	Mod: 1032940	Price each exc. VAT 1+	inc. VAT each
AB1RF	Wera Driver5.5/125mm	£5.82	£6.99

Wera Kraftform 160i VDE Insulated Screwdriver Slotted Tip 6.5 x 150mm



- VDE insulated for safe working with loads up to 1,000V
- Features a silver nickel lasertip
- Kraftform handle which uniquely fits to the shape of the hand during screwdriver use
- Blade length 150mm
- Tip 6.5mm

Wera Slotted 160i VDE insulated screwdrivers are tested individually for dielectric strength under a load of 10,000 volts so as to ensure safe working with loads up to 1,000 volts. They have a Silver Nickel Lasertip - a laser roughened surface which literally bites into the screwhead, reducing cam-out. Patented ergonomic, multi-component Kraftform handle which uniquely fits to the shape of the hand during screwdriver use.

Order Code	Mod: 1032941	Price each exc. VAT 1+	inc. VAT each
AB2RF	Wera Driver6.5/150mm	£7.07	£8.49

Wera Kraftform 160i VDE Insulated Screwdriver Slotted Tip 8.0 x 175mm



- VDE insulated for safe working with loads up to 1,000V
- Features a silver nickel lasertip
- Kraftform handle which uniquely fits to the shape of the hand during screwdriver use
- Blade length 155mm
- Tip 8.0mm

Wera Slotted 160i VDE insulated screwdrivers are tested individually for dielectric strength under a load of 10,000 volts so as to ensure safe working with loads up to 1,000 volts. They have a Silver Nickel Lasertip - a laser roughened surface which literally bites into the screwhead, reducing cam-out. Patented ergonomic, multi-component Kraftform handle which uniquely fits to the shape of the hand during screwdriver use.

Order Code	Mod: 1032944	Price each exc. VAT 1+	inc. VAT each
AB3RF	Wera Driver8.0/175mm	£9.57	£11.49

Wera Kraftform Plus 160iS VDE Slimline Screwdriver Slotted Tip 4 x 100mm



- Ultra slim screwdriver blade, with full VDE protection
- VDE insulated for safe working with loads up to 1,000V
- Ideal for use in confined spaces or for recessed screws
- Drop tested at extreme temperatures to ensure insulation won't fail in tough conditions
- Slotted Head - 4 x 100mm

Ultra Slim screwdriver blade, with full VDE protection. Kraftform Plus 160iS VDE Slimline slotted screwdriver. Allows use in confined spaces or for recessed screws - ideal for use on sprung cage terminal blocks and RCBO's. Unbeatable safety: individually tested at 10,000V to guarantee safety at 1,000V. Drop tested at extreme temperatures to ensure insulation won't fail in tough conditions.

Order Code	Mod: 1032938	Price each exc. VAT 1+	inc. VAT each
A86RF	Wera Slimline S/D	£7.07	£8.49

Wera Kraftform 162i VDE Insulated Screwdriver Phillips PH2 x 100mm



- VDE insulated for safe working with loads up to 1,000V
- Features a silver nickel lasertip
- Kraftform handle which uniquely fits to the shape of the hand during screwdriver use
- Blade Length 100mm
- Tip Phillips PH2

Wera series 162i Phillips insulated screwdrivers are tested individually for dielectric strength under a load of 10,000 volts so as to ensure safe working with loads up to 1,000 volts. They have a premium Lasertip, a tip which has a laser roughened surface which literally bites into the screwhead, reducing cam-out and eliminating the need for two-handed screwdriving. They have a significantly extended service life due to bit-grade steel used in all Wera screwdrivers and have the patented Kraftform handle which is ergonomic, multi-component and which uniquely fits to the shape of the hand during screwdriver use, reducing fatigue and increasing speed. Smooth, soft zones offer improved grip, hard zones allow easy hand repositioning.

Order Code	Mod: 1032937	Price each exc. VAT 1+	inc. VAT each
A84RF	Wera Driver 2X100mm	£7.07	£8.49

Newsletter



Subscribe to our newsletter for information about the latest innovation and the best deals.

Wera Kraftform 165i VDE Insulated Screwdriver Pozidrive PZ2 x 100mm



- VDE insulated for safe working with loads up to 1,000V
- Features premium lasertip which bites into the screw head
- Kraftform handle which uniquely fits to the shape of the hand during screwdriver use
- Blade length: 100mm
- Tip: Pozidrive PZ2

Wera series 165i Pozidriv insulated screwdrivers are tested individually for dielectric strength under a load of 10,000 volts so as to ensure safe working with loads up to 1,000 volts. They have a premium Lasertip, a tip which has a laser roughened surface which literally bites into the screw head, reducing cam-out and eliminating the need for two-handed screwdriving.

They have a significantly extended service life due to bit-grade steel used in all Wera screwdrivers and have the patented Kraftform handle which is ergonomic, multi-component and which uniquely fits to the shape of the hand during screwdriver use, reducing fatigue and increasing speed. Smooth, soft zones offer improved grip, hard zones allow easy hand repositioning.

Order Code	Mod: 1032939	Price each exc. VAT 1+	inc. VAT each
A85RF	Wera Driver 2X100mm	£7.90	£9.49

Wera Kraftform VDE Plus Minus Screwdriver Set Pozi / Slotted



- VDE insulated for safe working with loads up to 1,000V
- For use on the combination screw heads increasingly found in modern consumer units
- 2-piece Slotted and Pozi screwdriver set

Kraftform Plus 2pc set of Plus Minus/MCB tips - Pozi/ Slotted for combinations screws found in consumer units. Individually tested for dielectric strength under a 10,000V load, to guarantee safe working at 1,000V. Drop tested at extreme temperatures to ensure insulation won't fail in tough jobsite conditions.

For use on the combination screwheads increasingly found in modern consumer units. The Kraftform Plus handle uses multi-component materials and uniquely fits the shape of the hand during screwdriver use. All screwdrivers feature the gold lasertip - a laser roughened surface which literally bites into the screwhead, reducing slipping and cam-out.

Order Code	Mod: 1032948	Price each exc. VAT 1+	inc. VAT each
A88RF	Wera Driver Pz/Sl	£15.82	£18.99

Wera Kraftform 932 Chisel Driver Slotted Tip 10 x 175mm



- Wera chisel driver has been designed to be hit with a hammer
- Features impact cap and pound-thru hexagon blade
- The blade is made from bit-grade steel
- Hexagonal profile for added strength
- Hexagonal bolster allows spanner leverage for increased torque
- Blade length: 175mm
- Tip size: 10mm

The Wera 932 series rugged flared slotted tipped chisel driver has been designed to be hit with a hammer, whilst remaining fully useable as a screwdriver, with impact cap and pound-thru hexagon blade.

The blade is made from same bit-grade steel as all Wera products, and has a hexagonal profile for added strength, the hexagonal bolster allows spanner leverage for increased torque.

Application: Slotted Screws and Light Chisel work Handle: Three Combinations with Anti - Roll Protection.

Order Code	Mod: 1032947	Price each exc. VAT 1+	inc. VAT each
A91RF	Wera Slot 10x175mm	£12.07	£14.49

Wera 855/4 Impaktor Insert Bit Pozi PZ2 50mm Carded



- 1/4 in hexagon driver with Pozi bits 50mm long
- Impaktor technology delivers under extreme conditions
- Rough diamond coating reduces the danger of any screw head slipping
- Tip size PZ2

Wera Impaktor 855/1 Pozi bits 50mm long with 1/4 in hexagon drive, suitable for DIN 3126-F 6.3, ISO 1173 bit holders.

The Impaktor technology ensures an above-average service life even under extreme conditions thanks to a best-possible utilisation of the material properties and optimally designed geometry, particularly suitable for use with conventional impact drivers, the rough diamond coating reduces the danger of any slipping out of the screw head due to the enhanced frictional resistance.

Order Code	Mod: 1032945	Price each exc. VAT 1+	inc. VAT each
A92RF	Wera 851/4 Impaktor	£4.15	£4.99

Wera 897/4 Impaktor Ring Magnet Holder



- Holder with retaining ring
- Magnet impaktor holder to cushion extreme impulse peaks
- Special torsion effect from the double-torsion spring
- Equipped with a ring magnet to easily hold longer and heavier screws
- Particularly suitable for use with impact drivers

The Wera 897/4 IMP R Impaktor holder with retaining Ring Magnet for secure holding of screws up to 10in. Impaktor holder to cushion extreme impulse peaks, special torsion effect from the double-torsion spring, equipped with a ring magnet to easily hold longer.

and heavier screws, also ideal for above-head work, particularly suitable for use with impact drivers, the magnet can be retracted and in this way be disabled Output Suitable for bits with 1/4in hexagon head drive as per DIN 3126-C 6.3 and Wera Series 1 Design Impaktor technology ensures an above-average service life even under extreme conditions thanks to a best possible utilisation of the material properties and optimally designed geometry (two coupled torsion zones that perform successively), fitted with retaining ring and magnet

Order Code	Mod: 1032950	Price each exc. VAT 1+	inc. VAT each
A93RF	Wera 897/4 Impaktor	£16.65	£19.99

Wera Kraftform VDE Screwdriver Set of 7



- VDE insulated for safe working with loads up to 1,000V
- Premium gold lasertip which has roughened surface which bites into the screwhead
- Made from bit-grade steel
- Ergonomic handle

Wera series 160 i/7 Insulated screwdriver sets are tested individually for dielectric strength under a load of 10,000 volts so as to ensure safe working with loads up to 1,000 volts. They have a premium Gold Lasertip a tip which has a laser roughened surface which literally bites into the screwhead, reducing cam-out and eliminating the need for two-handed screwdriving

They have a significantly extended service life due to bit-grade steel used in all Wera screwdrivers and have the patented Kraftform handle which is ergonomic, multi-component and which uniquely fits to the shape of the hand during screwdriver use, reducing fatigue and increasing speed. Smooth, soft zones offer improved grip, hard zones allow easy hand repositioning Set of 7 consists of 1 each of the following Slotted: 2.5 x 80mm, 3.5 x 100mm, 4.0 x 100mm, 5.5 x 125mm.

Pozi: PZ1 x 80mm, PZ2 x 100mm. Voltage tester 3.0 x 70mm.

Order Code	Mod: 1032949	Price each exc. VAT 1+	inc. VAT each
A87RF	Wera Driver 7Pc	£29.15	£34.99

Wera Kraftform VDE Kompakt Screwdriver Set of 7



- VDE insulated for safe working with loads up to 1,000V
- 7 piece interchangeable blade kit
- VDE handle with blade auto-lok system and 6 VDE blades
- Supplied in a rugged belt pouch

- Screwdriver tip is made from power bit grade steel for unbeatable strength

Wera Kompakt VDE screwdriver set - 7 piece interchangeable blade kit VDE handle with blade auto-lok system and 6 VDE blades - supplied in a rugged belt pouch. The Kraftform design handle uniquely fits the hands contours during use. Individually tested for dielectric strength under a 10,000V load, to guarantee safe working at 1,000V. Drop tested at extreme temperatures to ensure insulation won't fail in tough jobsite conditions.

The screwdriver tip is made from power bit grade steel for unbeatable strength.

The 7 Piece VDE 60/65i/7 consists of 1 x 817 VDE handle 4 x Slotted blades 2.5, 3.5, 4 and 5.5mm 2 x Pozi blades PZ1 and PZ2

Order Code	Mod: 1032943	Price each exc. VAT 1+	inc. VAT each
A89RF	Wera S/Driver Set	£33.32	£39.99

Wera Kraftform Kompakt Slim line VDE Screwdriver Set of 16



- VDE insulated for safe working with loads up to 1,000V
- Slim line set of 16 VDE screwdrivers
- Hand held bit holder with VDE interchangeable blades
- Also included is a Single-pole voltage tester

The Wera Kompakt interchangeable Slimline VDE Screwdriver Set of 16 includes a Kraftform hand-held bit holder 817 VDE for Wera VDE interchangeable blades. The VDE interchangeable blades (each 154 mm long) have a reduced blade diameter with integrated protective insulation which allows sunken screws and spring elements to be accessed and actuated. Also included is a Single-pole voltage tester

The set contains:

- 1 x 817 VDE handle 9 x 102mm
- 1 x Single-pole voltage tester - Slotted 0.5 x 3.0 x 70mm
- Interchangeable Blades, all 154mm long
- 4 x Slotted: 0.4 x 2.5mm, 0.6 x 3.5mm, 0.8 x 4.0mm, 1.0 x 5.5mm
- 2 x Phillips PH1, PH2
- 2 x Pozi: PZ1, PZ2
- 2 x PlusMinus Pozi: PZ/S1 PZ/S2
- 4 x TORX®: TX10, TX15, TX20, TX25

Order Code	Mod: 1032946	Price each exc. VAT 1+	inc. VAT each
A90RF	Wera Pouch Set 16Pc	£58.32	£69.99

Screwdriver Accessories

Maplin Magnetiser/Demagnetiser

- Magnetises or demagnetises most steel screwdrivers or other small tools
- Small compact design

Warranty: 5 years



Order Code	Mod: 1032903	Price each exc. VAT 1+	inc. VAT each
A78QU	Map Magnet/Demagnet	£4.15	£4.99

Maplin 6-Piece Damaged Screw and Bolt Remover



- Removes screws and bolts that cannot be removed by a conventional screwdriver

- Ideal for damaged threads and heads
- Suitable for screws and bolts up to size 14
- Designed for professional use

3 x drills: 2mm, 3.2mm and 4.2mm 3 x screw removers: #1 [3-5], #2 [6-10] and #3 [12-14] Warranty: 5 years

Order Code	Mod: 1032899	Price each exc. VAT 1+	inc. VAT each
A91QU	Map6PcScrewExtractor	£8.32	£9.99

Maplin Quick Release Chuck and 16-Piece Bit Set

- Includes quick release chuck
- Contains 16 x PZ2 bits
- Complete with belt clip unit

Warranty: 5 years



Order Code	Mod: 1032897	Price each exc. VAT 1+	inc. VAT each
A89QU	Map0.Chuck&16x2PzBit	£4.15	£4.99

Maplin Magnetic Bit Holder 150mm



- 150mm (6-inch) magnetic bit holder
- Suitable for use with standard 6.35mm (1/4 inch) screwdriver bits
- Compact design

Warranty: 5 years

Order Code	Mod: 1032904	Price each exc. VAT 1+	inc. VAT each
A77QU	Map 150mmMagBitHold	£4.15	£4.99

Technical Helpline

0333 400 9500

For technical information and assistance relating to any Maplin purchase, contact our team of experts

Maplin 33-Piece Security Bit Set



- Ideal for use with all standard 6.35mm (1/4 inch) screwdrivers
- Suitable for use with hand and power tools
- Contains 31 bits which can be used on most current tamper-proof fasteners
- The bits are housed in a bit tidy with lid
- Includes a 60mm magnetic bit holder

9 x centre-pin star bits: T8H, T10H, T15H, T20H, T25H, T27H, T30H, T35H and T40H
 6 x centre-pin hex bits: 5/64, 3/32, 7/64, 1/8, 9/64 and 5/32
 4 x Tri-wing bits: No. 1, 2, 3 and 4
 4 x spanner bits: No. 4, 6, 8 and 10
 3 x torq bits: No. 6, 8 and 10
 5 x hex key bits: 2, 2.5, 3, 4, 5 and 6mm
 1 x 1/4 inch drive to 1/4 inch hex adapter
 Warranty: 5 years

Order Code	Mod: 1032901	Price each exc. VAT 1+	inc. VAT each
A87QU	Map33PcSecurityBitSet	£7.49	£8.99

- Supplied with two blade storage tidies made from rubberised plastic
- Each tidy will hold 32 x 25mm long blades and a holder

5 x flat slot bits: 3, 4, 5, 6, 7mm
 7 x Pozi bits: 2 x PZ1, 3 x PZ2 and 2 x PZ3
 8 x Phillips: 1 x PH0, 2 x PH1, 3 x PH2 and 2 x PH3
 6 x star security bits: T10, T15, T20, T25, T30 and T40
 6 x hexagonal bits: 2, 2.5, 3, 4, 5 and 6mm
 1 x 60mm long magnetised blade holder
 Warranty: 5 years

Order Code	Mod: 1032915	Price each exc. VAT 1+	inc. VAT each
A86QU	Map 33PcHexBladeSet	£7.49	£8.99

Maplin 9-Piece Screwdriver Blade Set

- A high quality set of precision 150mm long blades
- Ideal for use with 6.35mm (1/4 inch) hex screwdrivers

3 x slotted blades: 3, 5 and 7mm
 3 x Pozi blades: 1, 2 and 3
 3 x Phillips blades: 1, 2 and 3
 Warranty: 5 years



Order Code	Mod: 1032916	Price each exc. VAT 1+	inc. VAT each
A79QU	Map 9pcLgHexBladeSet	£6.65	£7.99

Maplin 16-Piece Bit Set with Belt Clip



- Includes belt clip for easy access on the job
- Supplied with 15 x 25mm screwdriver bits
- Also supplied with magnetic bit holder

3 x slotted bits: 4, 5 and 6mm
 9 x Phillip bits: 2 x PH1, 5 x PH2 and 2 x PH3
 3 x Pozi bits: PZ1, PZ2 and PZ3
 1 x magnetic bit holder
 1 x belt clip bit holder
 Warranty: 5 years

Order Code	Mod: 1032902	Price each exc. VAT 1+	inc. VAT each
A85QU	Map 16pcBeltClipBits	£6.65	£7.99

Maplin 33-Piece Screwdriver Bit Set



- Ideal for use with all standard 6.35mm (1/4-inch) screwdrivers
- Suitable for use with hand and power tools

Maplin 29-Piece Combination Bit Set



- Includes selection of 25mm and 50mm bits
- Bits include slotted, Pozi, Phillips, star and hex
- Also includes extension bar and drill guide
- Supplied in a handy storage box

1 x 50mm slotted bit: 5mm
 1 x 50mm Pozi bit: PZ2
 5 x 25mm slotted bits: 3, 4, 5, 6 and 7mm
 5 x 25mm Phillips bits: 1 x PH1, 2 x PH2 and 3 x PH3
 5 x 25mm Pozi bits: 1 x PZ1, 2 x PZ2 and 2 x PZ3
 5 x 25mm star bits: T10, T15, T20, T25 and T30
 4 x 25mm hex bits: H3, H4, H5 and H6
 1 x 80mm extension bar
 1 x drill guide
 1 x handy storage box
 Warranty: 5 years

Order Code	Mod: 1032898	Price each exc. VAT 1+	inc. VAT each
A90QU	Map 29Pc ComboBitSet	£9.15	£10.99

Maplin 100-Piece Power Bit Set



- Excellent value all-purpose bit set
- Suitable for use with hand and power tools
- 53 standard bits and 43 security bits
- Supplied in a handy plastic storage case

3 x clutch bits: 1, 2 and 3
 3 x torq bits: 6, 8 and 10
 3 x spline bits: M5, M6 and M8
 4 x triwing bits: 1, 2, 3 and 4
 4 x square bits: 0, 1, 2 and 3
 4 x spanner bits: 4, 6, 8 and 10
 9 x slotted bits: 3, 4, 4.5, 5, 5.5, 6, 6.5, 7 and 8mm
 8 x Phillips bits: 1 x PH0, 1 x PH1, 5 x PH2 and 1 x PH3
 8 x Pozi bits: 1 x PZ0, 1 x PZ1, 5 x PZ2, 1 x PZ3
 9 x metric hex bits: 1.5, 2, 2.5, 3, 4, 5, 5.5, 6 and 8mm
 10 x imperial hex bits: 1/16, 5/64, 3/32, 7/64, 1/8, 9/64, 5/32, 3/16, 7/32 and 1/4-inch
 6 x imperial security hex bits: 5/64, 3/32, 7/64, 1/8, 9/64 and 5/32-inch
 6 x metric security hex bits: 2, 2.5, 3, 4, 5 and 6mm
 9 x star bits: T8, T10, T15, T20, T25, T27, T30, T40 and T45
 9 x star security bits: T8H, T10H, T15H, T20H, T25H, T27H, T30H, T35H and T40H
 1 x Y-type bit for screwing in eye bolts or hocks
 1 x coupler
 1 x magnetic holder
 1 x 25mm bit adapter
 1 x 50mm bit adapter
 Warranty: 5 years

Order Code	Mod: 1032900	Price each exc. VAT 1+	inc. VAT each
A88QU	Map 100PcPowerBitSet	£10.82	£12.99

Maplin 3-Piece Magnetic Tool Holder Set



- A great addition for any tool shop or storage area
 - Keeps tools off the floor and organised
 - Powerful magnets hold tools in place
 - Complete with installation hardware
 - Sizes: 203mm, 305mm and 457mm
- Warranty: 5 years

Order Code	Mod: 1032790	Price each exc. VAT 1+	inc. VAT each
A84QU	Map MagnetTool Hold	£9.99	£11.99

Tool Kits

Maplin Essentials 180-Piece Starter Tool Kit



- An ideal first tool kit
- Contains hammer, saw, screwdrivers, knives and tape measure
- Also contains spirit level, clamps, padlock and hardware selection
- Supplied in a tool box
- 1 x 8oz claw hammer
- 50 x cable clips



- 100 x hardware assortments
 - 1 x 20mm brass padlock
 - 2 x D-rings: 6mm and 7mm
 - 6 x precision screwdrivers
 - 7 x screwdriver bits
 - 2 x screwdrivers
 - 1 x 6-inch mini saw
 - 4 x spring clamps: 2 x 1/2-inch and 2 x 3/4-inch
 - 1 x 9-inch spirit level
 - 1 x LED bottle opener
 - 1 x 2m x 6mm tape measure
 - 1 x mini scraper
 - 1 x 9mm snap off utility knife
 - 1 x 18mm snap off utility knife
 - 1 x 330mm plastic tool box
- Warranty: 1 year

Order Code	Mod: 1032798	Price each exc. VAT 1+	inc. VAT each
A99QW	Map 180Pc ToolBoxKit	£12.49	£14.99

Maplin 36-Piece Precision Tool Kit

18



- An ideal precision tool set for small, delicate jobs
- Contains mini pliers, magnifier, scissors, magnetic bowl and tape measure
- Also includes precision screwdrivers, pick-up tool, hobby knife set and glasses repair kit

- 1 x mini long nose pliers
 - 1 x mini combination pliers
 - 1 x end nippers
 - 1 x magnifier
 - 1 x 125mm scissors
 - 1 x magnetic bowl
 - 1 x 2m tape measure
 - 6 x precision screwdrivers
 - 1 x magnetic pick up tool
 - 17-piece hobby knife kit
 - 1 x glasses repair kit (with 5 different parts)
- Warranty: 5 years

Order Code	Mod: 1032892	Price each exc. VAT 1+	inc. VAT each
A37QU	Map 36PcPrecToolSet	£12.49	£14.99

Maplin 5-Piece Household Tool Kit

18



- Ideal starter tool kit for any home
- Includes tape measure, knife and pliers
- Also includes screwdriver and hammer

- Supplied in a handy storage case
 - 1 x 5m tape measure
 - 1 x utility knife
 - 1 x 6-inch combination pliers
 - 1 x 7-in-1 screwdriver [bit sizes: slotted: 5mm and 6mm, Phillips: PH1 and PH2 x 2pcs and star: T15 and T20]
 - 1 x 12oz claw hammer
 - 1 x handy storage box
- Warranty: 5 years

Order Code	Mod: 1032802	Price each exc. VAT 1+	inc. VAT each
A49QY	5Pc HomeToolKit	£12.49	£14.99

Maplin 22-Piece Tool Kit



- Ideal tool kit for precision and general jobs
- Includes 5 pairs of miniature pliers and 6 precision screwdrivers
- Also includes screwdriver handle and selection of bits
- Supplied in a handy storage case

- 1 x mini combination pliers
 - 1 x mini long nose pliers
 - 1 x mini side cutters
 - 1 x mini end nippers
 - 1 x mini combination pliers
 - 3 x slotted precision screwdrivers: 2.0, 2.5 and 3.0
 - 3 x Phillips precision screwdrivers: PH000, PH00 and PH0
 - 1 x screwdriver handle
 - 3 x slotted screwdriver bits: 4, 5 and 6mm
 - 3 x Phillips screwdriver bits: PH1, PH2 and PH3
 - 2 x pozi screwdriver bits: PZ1 and PZ2
 - 2 x star screwdriver bits: T15 and T20
 - 1 x handy storage case
- Warranty: 5 years

Order Code	Mod: 1032804	Price each exc. VAT 1+	inc. VAT each
A50QY	22-Pc Tool Kit	£16.65	£19.99

Maplin 43 Part Computer Tool Kit



- Ideal for upgrades and repairs, as well as general adjustments and maintenance
- All tools are demagnetized to protect your equipment

- Includes screwdriver, bits, sockets, hex keys, pliers, cable ties, IC extractor
- Also includes tweezers, storage container, antistatic wrist strap and much more
- Supplied in a handy zipped case

- Contents:**
- 1 x reversible ratchet handle
 - 1 x flexible shaft
 - 1 x wire stripper
 - 1 x IC inserter / extractor
 - 1 x needle nose pliers
 - 1 x 3-claw pick-up tool
 - 1 x tweezers
 - 1 x spare parts container (with 8 x screws, 4 jumpers and 4 washers)
 - 10 x cable ties
 - 1 x antistatic wrist band
 - 5-piece socket set (6, 7, 8, 9 and 10mm)
 - 5 x star bits: T8, T10, T15, T20 and T25
 - 2 x Phillips bits: PH1 and PH2
 - 2 x slotted bits: 5mm and 6mm
 - 1 x adapter bit for socket
 - 9 x hex keys
 - 1 x durable zipper storage case

Order Code	Mod: 399579	Price each exc. VAT 1+	inc. VAT each
N91HU	43Pc PC Tool Kit	£16.65	£19.99

Maplin 14 Part Electronics Tool Kit

18



- Ideal for electronic courses at schools and colleges as well as for electronic enthusiasts and the DIYer
- Includes 30 W soldering iron, solder, desoldering pump, voltage tester and pliers
- Also includes screwdrivers, tweezers and knife
- Supplied in a zipped carry case

- Contents:**
- 2 x slotted screwdrivers: 5mm x 75mm and 6mm x 125mm
 - 2 x Phillips screwdrivers: 5mm x 75mm and 6mm x 125mm
 - 1 x voltage tester
 - 1 x tweezers (long nose)
 - 1 x 30W soldering iron
 - 1 x desoldering pump
 - 1 x solder tube
 - 1 x 6-inch diagonal cutting pliers
 - 1 x 6-inch long nose pliers
 - 1 x 6-inch combination pliers
 - 1 x knife
 - 1 x zipped nylon bag

Order Code	Mod: 1006276	Price each exc. VAT 1+	inc. VAT each
N26DE	14PcSolderingToolKit	£20.82	£24.99

**Buy it on the web at
maplin.co.uk**

Shop for all Maplin products online at our website and check out our latest products and special offers!



Maplin 20 Part Electronics Tool Kit



- Ideal for electronic courses at schools and colleges as well as for electronic enthusiasts and the DIYer
- Includes soldering iron, solder, multimeter & test leads, voltage tester and pliers
- Also includes screwdrivers, tweezers, crimping tool, wire stripper & cutter and soldering tool set
- Supplied in a zipped carry case

Contents:

- 1 x slotted screwdrivers: 5mm x 100mm
- 1 x Phillips screwdrivers: 5mm x 100mm
- 1 x slotted precision screwdrivers: 2.5mm x 75mm
- 1 x Phillips precision screwdrivers: 2.5mm x 75mm
- 1 x voltage tester
- 6-piece soldering tool set
- 1 x multimeter & test leads
- 1 x wire stripper & cutter
- 1 x soldering iron
- 1 x long nose plier
- 1 x diagonal cutting plier
- 1 x tweezers (long nose)
- 1 x solder wire
- 1 x crimping tool
- 1 x zipped nylon bag
- 1 x knife

Please note that, under the Offensive Weapons Act 1996, this product cannot be sold to anyone under the age of 18

Order Code	Mod:	Price each exc. VAT 1+	inc. VAT each
N01DP	Electronics Tool Kit	£24.99	£29.99

Maplin 34-Piece VDE Electrician's Tool Kit



- Ideal tool kit for DIY and electrical jobs
- Contains 4 VDE screwdrivers and 3 VDE pliers
- Includes 3 precision screwdrivers, circuit tester tweezers, crimping pliers and cable ties
- Supplied in an aluminium storage case

- 3 x precision screwdrivers: PH00, PH0 and SL1.5mm
- 4 x VDE screwdrivers: PH 1x80mm, PH2x100mm, SL3x75mm and SL4x100mm
- 1 x 180mm VDE diagonal pliers
- 1 x 180mm VDE combination pliers
- 1 x 160mm VDE wire stripper
- 1 x 200mm crimping pliers
- 20 x cable ties (3.5 x 180mm)
- 1 x 140mm circuit tester
- 1 x pair of tweezers
- 1 x torch (requires 2 x AA batteries)
- 1 x aluminium storage case

Warranty: 5 years

Order Code	Mod:	Price each exc. VAT 1+	inc. VAT each
A51QY	34Pc VDE ToolKit	£41.65	£49.99

Rolson 127 Part Tool Kit in Aluminium Case

ORDER IN STORE OR ONLINE



- Contains comprehensive selection of screwdrivers, pliers, spanners, wrenches, sockets, extension bars and ratchets
- Also includes knife, tape measure, centre punches, saw, files, calliper, tester and torch
- Supplied in a robust aluminium storage case

Contents

- Slotted screwdrivers: 5 x 75 mm and 6 x 100 mm
- Cross point screwdrivers: PH1 x 75 mm and PH2 x 100 mm
- 6-in-1 precision screwdriver
- 200 mm long nose pliers
- 150 mm diagonal cutting pliers
- 175 mm combination pliers
- 150 mm circlip pliers
- 250 mm water pump pliers
- 200 mm carpenter pincers
- 175 mm cable cutter
- 9-piece combination spanners: 8, 10, 11, 12, 13, 15, 17, 19, 22 mm
- 250 mm adjustable wrench
- 9-piece hex key set 1.5, 2, 2.5, 3, 4, 5, 6, 8, 10mm
- 200 mm half round file
- 150 mm junior hacksaw
- 40-piece terminals (20 red and 20 blue)
- Retractable knife
- 4-piece centre punch set: 0.8 x 125 mm, 1.5 x 125 mm, 2.5 x 125 mm and 3 x 125 mm
- 225 mm wire stripper
- 300 mm aluminium level
- 1/2 inch Dr ratchet handle
- 1/4 inch Dr ratchet handle
- Ratchet wrench
- 2-piece 1/2 inch Dr spark plug socket set 16 mm and 21 mm
- 13-piece 1/2 inch Dr socket set 10, 13, 14, 16, 17, 18, 19, 20, 22, 24, 27, 30 and 32 mm
- 13-piece 1/2 inch Dr socket set 4, 4.5, 5, 5.5, 6, 7, 8, 9, 10, 11, 12, 13 and 14 mm
- 2-piece universal adaptor set
- 1/4 inch Dr coupler
- 1/2 inch and 3/4 inch Dr sliding "T" bar
- 4-piece extension bar set: 3/4 inch Dr x 50 mm, 100 mm, 1/2 inch Dr x 125 mm, 250 mm
- 30 mm socket adaptor
- 150 mm vernier calliper
- 300 g machinist hammer
- 5 m x 19 mm tape measure
- 30 x 25 mm bit set
- 60 mm magnetic bit holder
- 110-250 V tester
- Aluminium torch (requires 2 x AA batteries - Order Code: L42AL - sold separately)
- Aluminium case (450 x 330 x 145 mm) with two latches and carry handle

Please note that, under the Offensive Weapons Act 1996, this product cannot be sold to anyone under the age of 18

Order Code	Mod:	Price each exc. VAT 1+	inc. VAT each
N91GL	127Pc Toolkit in Case	£116.65	£139.99

Maplin Cable Access Kit



- Reinforced rods to route cables over ceilings, under floors, through wall cavities or trunking
- 10 x 330mm fibreglass rods
- Mini eye, mini hook, flexi-lead and tough carry tube
- Requires 8mm access hole
- Thread pitch is M3 x 7mm

Warranty: 5 years

Order Code	Mod:	Price each exc. VAT 1+	inc. VAT each
A77QW	Map Cable Access Kit	£12.49	£14.99

Hex & Utility Keys

Maplin 8 Part Folding Aluminium Metric Key Set



- Includes 8-piece metric ball-ended key set
- Set is pocket-sized and folds flat for easy, compact storage
- Strong and durable construction
- Made from chrome vanadium steel

Contents:

- 8 x metric ball-ended keys: 1.5, 2, 2.5, 3, 4, 5, 6 and 8mm

Order Code	Mod:	Price each exc. VAT 1+	inc. VAT each
N19JY	Mini 6-Pc HexKeySet	£2.90	£3.49

Maplin 8 Part Folding Aluminium Star Key Set



- Hex key set is pocket-sized and folds flat for easy, compact storage
- Sizes: T6, T7, T8, T9, T10, T15, T20 and T25
- Strong and durable construction
- Made from chrome vanadium steel
- Folded dimensions: 9.5cm x 1.5cm

Order Code	Mod:	Price each exc. VAT 1+	inc. VAT each
N22JY	8Pc Torx Key Set	£2.90	£3.49



Browse our entire range at maplin.co.uk

Maplin 3 Part Folding Mini Hex Key Set



- Includes 7-piece metric, 9-piece SAE ball-ended keys and 8-piece star key set
- Keys fold flat for easy, compact storage
- Strong and durable construction
- Made from chrome vanadium steel

Contents:

7 x metric keys 1.5, 2, 2.5, 3, 4, 5 and 6mm
 9 x SAE keys 1/16, 5/64, 3/32, 7/64, 1/8, 9/64, 5/32, 3/16 and 1/4-inch
 8 x star keys T6, T7, T8, T9, T10, T15, T20 and T25

Order Code	Mod: 534402	Price each exc. VAT 1+	inc. VAT each
N26JY	3Pc Mini HexKeySet	£5.83	£7.00

Maplin 3 Part Folding Aluminium Hex Key Set



- Includes 8-piece metric ball-ended set, 9-piece SAE ball-ended keys and 8-piece star key set
- Keys fold flat for easy, compact storage
- Strong and durable construction
- Made from chrome vanadium steel

Contents:

8 x metric ball-ended keys 1.5, 2, 2.5, 3, 4, 5, 6 and 8mm
 9 x SAE ball ended keys 5/64, 3/32, 7/64, 1/8, 9/64, 5/32, 3/16, 7/32 and 1/4-inch
 8 x star keys T9, T10, T15, T20, T25, T27, T30 and T40

Order Code	Mod: 534404	Price each exc. VAT 1+	inc. VAT each
N25JY	3Pc FoldingHexKeySet	£8.32	£9.99

Maplin 7-Piece Miniature Hex Key Set



- Miniature hex key set ranging from 0.7 - 3.0mm
- Consists of 7 hex keys in total

7 x mini hex keys: 0.7, 0.9, 1.3, 1.5, 2, 2.5 and 3mm
 Warranty 5 years

Order Code	Mod: 1032800	Price each exc. VAT 1+	inc. VAT each
A48QW	Map 7-Pc Hex Key Set	£3.32	£3.99

Buy it on the web at maplin.co.uk

Shop for all Maplin products online at our website and check out our latest products and special offers!



Maplin 9 Part Short Arm Metric Hex Key Set



- Heavy-duty set of ball-ended hex keys for a multitude of uses
- Sizes range from 1.5mm to 10mm
- Supplied in a folding plastic holder with size markings
- Made from chrome vanadium steel for maximum performance
- Slip resistant coating for improved grip
- Chamfered tips for easy entry into openings

Contents:

1.5, 2, 2.5, 3, 4, 5, 6, 8 and 10mm

Order Code	Mod: 531684	Price each exc. VAT 1+	inc. VAT each
N78KB	9PcShrtArmBallKey mm	£5.82	£6.99

Maplin 9 Part Short Arm Imperial Hex Key Set



- Heavy-duty set of ball-ended hex keys for a multitude of uses
- Sizes range from 1/16-inch to 3/8-inch
- Supplied in a folding plastic holder with size markings
- Made from chrome vanadium steel for maximum performance
- Slip resistant coating for improved grip
- Chamfered tips for easy entry into openings

Contents:

1/16, 5/64, 3/32, 1/8, 5/32, 3/16, 1/4, 5/16 and 3/8-inch

Order Code	Mod: 531683	Price each exc. VAT 1+	inc. VAT each
N77KB	9PcShrtArmBallKeyImp	£5.82	£6.99

Maplin 9 Part Short Arm Star Key Set



- Heavy-duty set of star keys for a multitude of uses
- Sizes range from T10 to T50
- Supplied in a folding plastic holder with size markings
- Made from chrome vanadium steel for maximum performance

- Slip resistant coating for improved grip
- Chamfered tips for easy entry into openings

Contents:

T10, T15, T20, T25, T27, T30, T40, T45 and T50

Order Code	Mod: 531682	Price each exc. VAT 1+	inc. VAT each
N76KB	9PcShortArm TorxKeys	£5.82	£6.99

Maplin 9 Part Long Arm Metric Hex Key Set



- Heavy-duty set of ball-ended hex keys for a multitude of uses
- Sizes range from 1.5mm to 10mm
- Supplied in a folding plastic holder with size markings
- Made from chrome vanadium steel for maximum performance
- Slip resistant coating for improved grip
- Chamfered tips for easy entry into openings

Contents:

1.5, 2, 2.5, 3, 4, 5, 6, 8 and 10mm

Order Code	Mod: 531686	Price each exc. VAT 1+	inc. VAT each
N80KB	9PcLongArmBallKey mm	£7.49	£8.99

Maplin 9 Part Long Arm Imperial Hex Key Set



- Heavy-duty set of ball-ended hex keys for a multitude of uses
- Sizes range from 1/16-inch to 3/8-inch
- Supplied in a folding plastic holder with size markings
- Made from chrome vanadium steel for maximum performance
- Slip resistant coating for improved grip
- Chamfered tips for easy entry into openings

Contents:

1/16, 5/64, 3/32, 1/8, 5/32, 3/16, 1/4, 5/16 and 3/8-inch

Order Code	Mod: 531685	Price each exc. VAT 1+	inc. VAT each
N79KB	9PcLongArmBallKeyImp	£7.49	£8.99

Maplin TV

Home of innovation, handy tips and How To videos

Visit our channel...

youtube.com/maplintv



Maplin 9 Part Long Arm Star Key Set



- Heavy-duty set of star keys for a multitude of uses
- Sizes range from T10 to T50
- Supplied in a folding plastic holder with size markings
- Made from chrome vanadium steel for maximum performance
- Slip resistant coating for improved grip
- Chamfered tips for easy entry into openings

Contents:

T10, T15, T20, T25, T27, T30, T40, T45 and T50

Order Code	Mod:	Price each exc. VAT	inc. VAT each
N75KB	9Pc LongArm TorxKeys	£7.49	£8.99

Maplin 30-Piece Assorted Hex Key Set



- Comprehensive set of metric and imperial hex keys
- Short arm hex keys are metric
- Long arm hex keys are imperial
- Supplied in a handy storage case

15 x long arm hex keys: 0.028, 0.035, 0.05, 1/16, 5/64, 3/32, 7/64, 1/8, 9/64, 5/32, 3/16, 7/32, 1/4, 5/16 and 3/8 inches
15 x short arm hex keys: 0.7, 0.9, 1.3, 1.5, 2, 2.5, 3, 4, 4.5, 5, 5.5, 6, 7, 8 and 10mm

Warranty: 5 years

Order Code	Mod:	Price each exc. VAT	inc. VAT each
A49QW	Map 30Pc Hex Key Set	£8.32	£9.99

Maplin 4 Way Service Utility Key



- Suitable for opening service cabinets such as water, electricity and gas

Warranty: 5 years

Order Code	Mod:	Price each exc. VAT	inc. VAT each
A85QW	Map 4WayUtilityKey	£2.90	£3.49

Socket Sets

Maplin 21-Piece Precision Ratchet Bit and Socket Set



- Includes mini ratchet with reverse action
- Also includes coupler, 4 sockets and 15 screwdriver bits

• Supplied in a handy storage case

1 x ratchet spanner
1 x coupler adaptor
4 x sockets: 7, 8, 9 and 10mm
3 x star bits: T15, T20 and T25
4 x Phillips bits: 1 x PH1
2 x PH2 and 1 x PH32 x Pozzi bits: PZ2 and PZ3
3 x slotted bits: 4.0, 5.0 and 6.0mm
3 x hex bits: H3, H4 and H5
1 x handy storage case
Warranty: 5 years

Order Code	Mod:	Price each exc. VAT	inc. VAT each
A50QW	Map20PcRatchSocketBit	£5.82	£6.99

Maplin 16-Piece Ratcheting Socket Set



- Chrome-plated forged steel construction for automotive or agricultural use
- Supplied in a handy storage box

11 x 1/2-inch sockets: 4, 4.5, 5, 5.5, 6, 7, 8, 9, 10, 11 and 13mm

2 x 1/2-inch extension bar: 50mm and 150mm
1 x 1/2-inch round bar
1 x 1/2-inch wobbling extension bar: 100mm
1 x 1/2-inch ratchet handle
Warranty: 5 years

Order Code	Mod:	Price each exc. VAT	inc. VAT each
A61QW	Map16Pc RatchSocketSet	£6.65	£7.99

Maplin 21-Piece T Handle Socket and Bit Set



- 2-in-1 T-shaped handle for additional torque
- Supplied with 10 x 25mm screwdriver bits and magnetic bit holder contained in a plastic storage case

• Also contains 9-piece socket set supplied on a rail
4 x 25mm slotted bits: 4mm, 5mm, 6mm and 7mm
4 x 25mm Phillips bits: 2 x PH2 and 2 x PH3
2 x 25mm star bits: T15 and T20
1 x 50mm magnetic bit holder
9 x 1/4-inch Dr. sockets: 5, 6, 7, 8, 9, 10, 11, 12 and 13mm [supplied on rail]
Warranty: 5 years

Order Code	Mod:	Price each exc. VAT	inc. VAT each
A53QW	Map 21Pc TbarBitSock	£6.65	£7.99

Maplin 23-Piece Socket and Bit Set

- Ratchet handle with an assortment of 1/4 inch drive bits
- Also includes socket adaptor, 8-piece socket set and extension bar
- Supplied in a handy storage case

4 x 1/4-inch drive Phillips bits
1 x #1, 2 x #2 and 1 x #3
4 x 1/4-inch drive slotted bits:
1 x 4mm, 1 x 5mm and 2 x 6mm
4 x 1/4-inch drive Pozzi bits: 1 x PZ1, 2 x PZ2 and 1 x PZ3
8 x 1/4-inch Dr. Socket 5mm, 6mm, 7mm, 8mm, 9mm, 10mm, 11mm and 12mm
1 x 1/4-inch Dr. Coupler
1 x 1/4-inch 50mm extension bar
1 x handy storage case
Warranty: 5 years

Order Code	Mod:	Price each exc. VAT	inc. VAT each
A51QW	Map23PcSocketBitSet	£6.65	£7.99

Maplin 23-Piece Offset Ratchet Socket and Bit Set

- Includes 11 x 25mm screwdriver bits, bit adaptor and 50mm extension bar
- Also includes 9 x Dr. sockets and reversible Dr. ratchet handle
- Supplied in a handy storage case

4 x 25mm slotted screwdriver bits:
1 x 4mm, 1 x 5mm and 2 x 6mm
3 x 25mm Phillips screwdriver bits: PH1, PH2 and PH3
4 x 25mm Pozzi screwdriver bits: 1 x PZ1, 2 x PZ2 and 1 x PZ3

1 x bit adaptor
9 x 1/4-inch Dr sockets: 5, 6, 7, 8, 9, 10, 11, 12 and 13mm
1 x 50mm extension bar
1 x reversible 1/4-inch Dr ratchet handle
1 x handy storage case
Warranty: 5 years

Order Code	Mod:	Price each exc. VAT	inc. VAT each
A52QW	Map 23Pc OffsetRatch	£6.65	£7.99

Buying for education?
0333 400 9740



Maplin 40-Piece Socket Set



- Ideal for automotive or agricultural use
- Set contains reversible ratchet, extension bar and adaptor
- Includes spin disc, spinner handle and spark plug socket
- Contains selection of metric and imperial sockets
- Supplied in a handy storage case

1 x 3/8 inch diameter reversible ratchet
 1 x 3/8-inch diameter 75mm extension bar
 1 x 1/4-inch [M] x 3/8inch [F] adaptor
 1 x 3/8-inch diameter x 21mm spark plug socket
 1 x 150mm spinner handle
 1 x spin disc
 12 x 1/4-inch diameter imperial sockets: 5/32, 3/16, 7/32, 1/4, 9/32, 5/16, 11/32, 3/8, 13/32, 7/16, 15/32 and 1/2 inch
 3 x 1/2-inch diameter [8-point] imperial sockets: 1/4, 5/16 and 3/8 inch
 3 x 3/8-inch diameter imperial sockets: 9/16, 11/16 and 3/4 inch
 12 x 1/2-inch diameter metric sockets: 4, 4.5, 5, 5.5, 6, 7, 8, 9, 10, 11, 12 and 13mm
 3 x 3/8-inch diameter metric sockets: 14, 16 and 17mm
 Warranty: 5 years

Order Code	Mod:	Price each exc. VAT 1+	inc. VAT each
A62QW	Map 40pc Socket Set	£11.65	£13.99

Maplin 53-Piece Socket and Bit Set



- Dual 1/4 and 3/8-inch ratchet, stubby adjustable wrench with measurement scale
 - Also includes stubby ratchet screwdriver and extension bar
 - Contains selection of 25mm bits, 3/8 and 1/4-inch sockets and 2 adaptors
 - Comfortable rubber cushion grip handles
- 1 x dual 1/4-inch and 3/8-inch Dr. stubby 72 teeth ratchet, stubby adjustable wrench with measurement scale
 1 x stubby ratchet screwdriver
 1 x 75mm 3/8-inch Dr. extension bar
 5 x 25mm bits- slot 4, 5, 5.5, 6 and 8mm
 3 x 25mm bits: P21, P22 and P23
 3 x 25mm bits- square drive S1, S2 and S3
 4 x 25mm bits: hex 4, 5, 5.5 and 6mm
 6 x 25mm bits: star T15, T20, T25, T27, T30 and T40
 5 x 3/8-inch Dr. sockets 13, 14, 15mm and 9/16 and 5/8 inch
 16 x Dr. sockets 5, 6, 7, 8, 9, 10, 11, 12mm and 7/32, 1/4, 9/32, 5/16, 11/32, 3/8, 7/16, 15/32-inch
 2 x adaptors
 Warranty: 5 years

Order Code	Mod:	Price each exc. VAT 1+	inc. VAT each
A54QW	Map 53Pc Socket Bit	£13.32	£15.99

Spanners & Wrenches

Maplin Adjustable Wrench 150mm



- Total length 150mm (6 inches)
 - Heavy-duty design
 - Rubberised comfortable soft grip
- Warranty: 5 years

Order Code	Mod:	Price each exc. VAT 1+	inc. VAT each
A55QW	Map 6in Adjust Wrench	£4.99	£5.99

Maplin Adjustable Wrench 200mm



- Total length 200mm (8 inches)
 - Heavy-duty design
 - Rubberised comfortable soft grip
- Warranty: 5 years

Order Code	Mod:	Price each exc. VAT 1+	inc. VAT each
A56QW	Map 8in Adjust Wrench	£5.82	£6.99

Maplin Adjustable Wrench 250mm



- Total length 250mm (10 inches)
 - Heavy-duty design
 - Rubberised comfortable soft grip
- Warranty: 5 years

Order Code	Mod:	Price each exc. VAT 1+	inc. VAT each
A57QW	Map 10in Adjust Wrench	£6.65	£7.99

Maplin 10 Part Mini Combination Spanner Set



- Manufactured from heat-treated, high carbon steel
 - Supplied with a handy storage pouch
- Supplied in the following sizes

4.5 x 4.0
 4.0 x 4.5
 5.0 x 5.5
 5.0 x 6.0
 5.5 x 6.0
 6.0 x 7.0
 7.0 x 8.0
 8.0 x 9.0
 9.0 x 10.0
 10.0 x 11.0

Warranty: 5 years

Order Code	Mod:	Price each exc. VAT 1+	inc. VAT each
N21HY	10Pc Mini Spanner Set	£7.77	£7.77

Maplin 10-Piece Metric Combination Spanner Set



- Dual-ended spanners - open one end, ring on the other
- 12-point flank drive ring provides 25% more torque
- Open end sizes range from 4.5mm to 10mm
- Ring end sizes range from 4mm to 11mm

Open ends: 4mm, 4.5mm, 5mm, 5.5mm, 6mm, 7mm, 8mm, 9mm and 10mm
 Ring ends: 4mm, 4.5mm, 5mm, 5.5mm, 6mm, 7mm, 8mm, 9mm and 10mm

Warranty: 5 years

Order Code	Mod:	Price each exc. VAT 1+	inc. VAT each
A58QW	Map 10pc Spanner Set Met	£9.15	£10.99

Maplin 7-Piece Stubby Combination Spanner Set



- Dual-ended stubby spanners - open one end, ring on the other
- 12-point flank drive ring provides 25% more torque
- Open end sizes range from 10mm to 19mm
- Ring end sizes range from 10mm to 19mm

Open ends: 10mm, 12mm, 13mm, 14mm, 15mm, 17mm and 19mm
 Ring ends: 10mm, 12mm, 13mm, 14mm, 15mm, 17mm and 19mm

Warranty: 5 years

Order Code	Mod:	Price each exc. VAT 1+	inc. VAT each
A59QW	Map 7Pc Stubby Spanner	£11.65	£13.99



Over 200 stores nationwide

Maplin 11-Piece Combination Metric Spanner Set



- Dual-ended stubby spanners - open one end, ring on the other
- 12-point flank drive ring provides 25% more torque
- Open end sizes range from 6mm to 19mm
- Ring end sizes range from 6mm to 19mm

Open ends 6mm, 7mm, 8mm, 9mm, 10mm, 11mm, 12mm, 13mm, 14mm, 17mm and 19mm
 Ring ends 6mm, 7mm, 8mm, 9mm, 10mm, 11mm, 12mm, 13mm, 14mm, 17mm and 19mm

Warranty: 5 years

Order Code	Mod:	Price each exc. VAT 1+	inc. VAT each
A60QW	Map 11PcMetricSpanSet	£11.65	£13.99

Pliers, Cutters & Forceps

Maplin Miniature Wire Cutters 94mm



- Ideal for cutting small or inaccessible items
- 10mm jaw length
- 94mm overall length

Warranty: 5 years

Order Code	Mod:	Price each exc. VAT 1+	inc. VAT each
A92QU	Map Mini SnipCuts	£4.99	£5.99

Maplin Miniature Snip Cutter 120mm



- A pair of cutters designed for cropping cables on PCBs
- The head is angled at 45 degree for use in tight spaces
- Insulated sprung handles
- 15mm jaw length
- 120mm overall length

Warranty: 5 years

Order Code	Mod:	Price each exc. VAT 1+	inc. VAT each
A18QW	Map Snip Cutter	£5.82	£6.99

Maplin Miniature Side Cutters 110mm



- Ideal for use in electronic assembly
- 10mm jaw length
- 110mm overall length

Warranty: 5 years

Order Code	Mod:	Price each exc. VAT 1+	inc. VAT each
A20QW	Map 110mm SideCuts	£4.99	£5.99

Maplin Side Cutters 150mm



- Ideal for cutting hard and soft wires
- 18mm jaw length
- 150mm overall length

Warranty: 5 years

Order Code	Mod:	Price each exc. VAT 1+	inc. VAT each
A25QW	Map 150mm SideCuts	£5.82	£6.99

Maplin Side Cutters 180mm



- Diagonal cutting pliers with a polished edge
- 25mm jaw length
- 180mm overall length

Warranty: 5 years

Order Code	Mod:	Price each exc. VAT 1+	inc. VAT each
A26QW	Map 180mm SideCuts	£5.82	£6.99

Maplin Cable Cutters 240mm



- Ideal for cutting hard and soft wires
- 35mm jaw length
- 240mm overall length

Warranty: 5 years

Order Code	Mod:	Price each exc. VAT 1+	inc. VAT each
A27QW	Map 240mm CableCuts	£7.49	£8.99

Maplin Miniature Long Nose Pliers 120mm



- Ideal for accurate handling of small objects in inaccessible areas
- 25mm jaw length
- 120mm overall length

Warranty: 5 years

Order Code	Mod:	Price each exc. VAT 1+	inc. VAT each
A22QW	Map 120mmMiniLongNose	£4.99	£5.99

Maplin ESD Long Nose Pliers 150mm



- High-quality precision tool designed for fine assembly and adjustment operations on electronic circuits
- The pliers are supplied with a conductive handle for ESD (electro-static discharge)
- 35mm jaw length
- 150mm overall length

Warranty: 5 years

Order Code	Mod:	Price each exc. VAT 1+	inc. VAT each
A24QW	MapESDLongNosePlier	£6.65	£7.99

Maplin Miniature Needle Nose Pliers 120mm



- Provides access to tight and confined spaces
- Ideal for retrieving dropped screws
- 55mm jaw length
- 120mm overall length

Warranty: 5 years

Order Code	Mod:	Price each exc. VAT 1+	inc. VAT each
A21QW	Map 120mmNeedleNose	£4.99	£5.99



Browse our entire range at maplin.co.uk

Maplin Miniature Combination Pliers 125mm



- Smooth ground heads, serrated jaws and side cutter in one set of pliers
- Spring-loaded bow handles with rubberised grip
- 15mm jaw length
- 125mm overall length

Warranty: 5 years

Order Code	Mod:	Price each exc. VAT	inc. VAT each
A23QW	Map125mmComboPlier	£4.99	£5.99

Maplin Combination Pliers 200mm



- Strong, flat serrated jaws for gripping flat surfaces
- Rounded section for gripping pipes, tubes and uneven objects
- Side cutter for cutting wire
- 30mm jaw length
- 200mm overall length

Warranty: 5 years

Order Code	Mod:	Price each exc. VAT	inc. VAT each
A29QW	Map200mmComboPlier	£5.82	£6.99

Maplin Adjustable Grips 250mm



- Adjustable grips with 6-positions
- 50mm maximum jaw capacity
- 250mm overall length

Warranty: 5 years

Order Code	Mod:	Price each exc. VAT	inc. VAT each
A30QW	Map10inAdjustGrips	£6.65	£7.99

Maplin Wire Stripper and Cutter 125mm



- Versatile tool that can cut with one end and strip with the other
- Stripper self adjusts to wire size
- Strips soft copper wire size 26AWG - 16AWG
- 10mm jaw length
- 125mm overall length

Warranty: 5 years

Order Code	Mod:	Price each exc. VAT	inc. VAT each
A19QW	Map2in1WireStrip&Cut	£6.65	£7.99

Maplin Circlip Plier Set



- Ideal for the removal of interior and exterior circlips
- Supplied with 4 sets of interchangeable jaws
- The interchangeable jaws slot into one of 2 pairs of lugs

1 x circlip pliers

1 x set of jaws with 90° tips

1 x set of jaws with 45° tips

2 x sets of straight tip jaws

Warranty: 5 years

Order Code	Mod:	Price each exc. VAT	inc. VAT each
A45QW	MapCirclipSet	£8.32	£9.99

Maplin 3-Piece Miniature Plier and Cutter Set



- Mini side cutter, mini combination pliers and mini long nose pliers all in one handy pack

Warranty: 5 years

Order Code	Mod:	Price each exc. VAT	inc. VAT each
A31QW	Map3PcMiniPlierSet	£9.15	£10.99

Maplin 3-Piece Hole Punch Kit



- Kit includes 3 tools, grommets and penta-claw buttons
- Ideal for making holes in leather and other soft materials
- Suitable for making additional holes in belts etc

- Also suitable for fixing penta-claw buttons on clothes
 - 6 punch hole sizes: 2mm, 2.5mm, 2.8mm, 3.2mm, 4mm and 4.8mm
 - Pivoting jaw ends with auto-release function
- 1 x hole punch tool with 2mm, 2.5mm, 2.8mm, 3.2mm, 4mm and 4.8mm heads
 1 x grommet setting tool
 100 x grommets (ideal for shoes or belts)
 1x penta-claw button fixer
 50 x penta-claw buttons
 Warranty: 5 years

Order Code	Mod:	Price each exc. VAT	inc. VAT each
A46QW	MapLeathHolePunchKit	£7.49	£8.99

Knipex Combination Pliers VDE Certified Grip 160mm

ORDER IN STORE OR ONLINE



- Special tool steel
- Cutting edges for hard and soft wire
- Oil hardened and tempered
- VDE tested up to 1000V
- Gripping zones for flat and round material
- Size: 160mm (6 1/4 in)

Order Code	Mod:	Price each exc. VAT	inc. VAT each
A94RF	Knipex Pliers 160mm	£24.57	£29.49

Knipex Combination Pliers VDE Certified Grip 180mm

ORDER IN STORE OR ONLINE



- Special tool steel ideal for cutting edges on hard and soft wire
- Oil hardened and tempered
- VDE tested up to 1000V
- Gripping zones for flat and round material

Order Code	Mod:	Price each exc. VAT	inc. VAT each
A40RF	Knipex Plier180mmVde	£27.49	£32.99

Knipex Diagonal Cutting Pliers VDE Certified Grip 160mm

ORDER IN STORE OR ONLINE



- For cutting soft and hard wire
- Induction-hardened precision cutting edges
- Edge hardness approximately 62 HRC
- Head chrome plated
- Handles insulated VDE tested to 1000V

Order Code	Mod:	Price each exc. VAT	inc. VAT each
A38RF	Knipex Diag160mmVde	£29.15	£34.99

Knipex High Leverage Combination Pliers VDE Certified Grip 200mm

ORDER IN STORE OR ONLINE



- High leverage, eccentric joint combination pliers
- Powerful gripping, seizing and cutting
- Oil hardened and tempered
- Quality high grade tool steel
- Handles with heavy-duty insulation
- VDE tested 1000V

Order Code	Mod: 1029394	Price each exc. VAT 1+	inc. VAT each
A41RF	Knipex Plier200mmVde	£31.65	£37.99

Knipex Bent Long Nose Side Cutters VDE Certified Grip 200mm

ORDER IN STORE OR ONLINE



- Long flat round bent jaws
- Heavy insulated, VDE tested 1000V
- Cutting edges separately induction hardened
- Edge hardness approx. 61 HRC
- Special tool steel, oil hardened

Order Code	Mod: 1029400	Price each exc. VAT 1+	inc. VAT each
A46RF	KnipexCutter200mmVde	£34.57	£41.49

Knipex Electrical Installation Pliers VDE Certified Sprung

ORDER IN STORE OR ONLINE



- Electrical installation pliers
- 6 functions
- Can strip, cut, deburr, widen, grip and crimp
- Locking mechanism protects cutting edge
- Slim dimensions for easy access

Order Code	Mod: 1033053	Price each exc. VAT 1+	inc. VAT each
A42RF	Knipex SprungVde	£52.90	£63.49

Knipex Cable Shears VDE Certified Grip 165mm

ORDER IN STORE OR ONLINE



- Ideal for copper and aluminium cables
- Precision ground, sharp hardened blades
- Easy cutting with one hand operation
- Made from high-grade vanadium special tool steel
- Low effort required due to high transmission ratio and new blade geometry
- VDE tested 1000V

Order Code	Mod: 1033060	Price each exc. VAT 1+	inc. VAT each
A43RF	Knipex Shear165mmVde	£43.32	£51.99

Knipex Cable Shears VDE Certified Grip 200mm

ORDER IN STORE OR ONLINE



- Ideal for copper and aluminium cables
- Made from high-grade vanadium special tool steel
- Precision ground, sharp hardened blades
- Easy cutting with one hand operation
- Low effort required due to high transmission ratio and new blade geometry

Order Code	Mod: 1029161	Price each exc. VAT 1+	inc. VAT each
A44RF	Knipex Shear200mmVde	£53.32	£63.99

Knipex Diagonal Cutting Pliers VDE Certified Grip 180mm

ORDER IN STORE OR ONLINE



- For soft and hard wire
- Induction-hardened precision cutting edges
- Edge hardness approximately 62 HRC
- Head chrome plated
- Handles insulated VDE tested to 1000v
- Length: 180mm (7 in)
- Cutting capacity : Soft wire 4.0 mm, medium / hard wire 3.0 mm, piano wire 2.5 mm

Knipex High Leverage Diagonal Cutting Pliers VDE Certified Grip 200mm

ORDER IN STORE OR ONLINE



- VDE handles for added comfort, protection and a better grip
- Strong durable edges
- Induction-hardened
- Top quality high grade tool steel
- High leverage

Order Code	Mod: 1033032	Price each exc. VAT 1+	inc. VAT each
A45RF	Knipex Diag 200mmVde	£40.82	£48.99

Knipex Long Nose Side Cutters VDE Certified Grip 200mm

ORDER IN STORE OR ONLINE



- Long flat round jaws
- Highly loadable, elastic precision points blades
- Cutting edges separately induction hardened
- Special tool steel, oil hardened
- Heavy insulated VDE handles
- Length: 200mm (8 in)
- VDE tested to 1,000v

Order Code	Mod: 1033055	Price each exc. VAT 1+	inc. VAT each
A95RF	Knipex Cutters 200mm	£32.49	£38.99

Knipex X-Cut Compact Diagonal Cutters VDE Certified Grip 160mm

ORDER IN STORE OR ONLINE



- Compact and light
- Excellent precision
- Large jaw opening for multi-stranded cables
- Zero backlash movement
- Slim head for easy access
- Soft wire: 4.8mm, medium hard wire: 3.8mm, hard wire: 2.7mm, piano wire: 2.2mm, multi-stranded wire: 12mm
- Weight: 175g

Order Code	Mod: 1033029	Price each exc. VAT 1+	inc. VAT each
A37RF	Knipex XCut160mmVde	£42.07	£50.49

Free Delivery
on all UK orders over **£10**

T&Cs Apply!

Buying for business?
0333 400 9740



Knipex Elektro VDE Certified Set of 3 Pliers

ORDER IN STORE OR ONLINE



- For soft and hard wire
- Induction-hardened precision cutting edges
- Edge hardness approximately 62 HRC
- Head chrome plated
- Handles insulated VDE tested to 1000V

Order Code	Mod:	Price each exc. VAT 1+	inc. VAT each
A97RF	Knipex Plier Set	£78.32	£93.99

Knipex Cobra® Waterpump Pliers PVC Grip 46mm Capacity 250mm

ORDER IN STORE OR ONLINE



- Very large gripping capacity
- Good access to the workpiece
- High load capacity having a slim design
- Guard prevents operators fingers being pinched
- Chrome vanadium electric steel, forged, oil-hardened
- Length: 250mm (10 in)
- Capacity pipes: 50mm, capacity nuts: 46mm
- Adjustment positions: 25

Order Code	Mod:	Price each exc. VAT 1+	inc. VAT each
A47RF	Knipex Pliers250mm	£31.65	£37.99

Knipex Alligator® Waterpump Pliers VDE Certified Grip 250mm

ORDER IN STORE OR ONLINE



- Very large gripping capacity
- Good access to the workpiece
- High load capacity having a slim design
- Guard prevents operators fingers being pinched
- Chrome vanadium electric steel, forged, oil-hardened
- Length 250mm (10 in)
- Positions: 7
- Chrome plated head
- Handles: heavy insulated VDE
- Tested up to 1,000V
- Pipe capacity: 50mm, nut capacity: 46mm

Order Code	Mod:	Price each exc. VAT 1+	inc. VAT each
A48RF	Knipex Plier250mmVde	£34.15	£40.99

Wire Strippers & Crimpers

Maplin Wire Stripper 150mm



- Ideal for cutting hard and soft wire
- Pliers have a locknut and return spring and can be set using a brass screw
- 25mm jaw length
- 150mm overall length

Warranty: 5 years

Order Code	Mod:	Price each exc. VAT 1+	inc. VAT each
A28QW	Map 150mm WireStripp	£8.32	£9.99

Maplin Crimping, Stripping and Cutting Tool



- A useful combination tool with cushioned plastic handles
- Tool has a wire cutter and bolt cutters for M2.5, M3, M3.5, M4 and M5 bolts
- Includes strippers for wires of conductor area 0.75, 1.0, 1.5, 2.5, 4.0 and 6.0mm²
- Also includes a crimping tool for red, blue and yellow insulated crimp connectors and 1.5, 2.5 and 6mm² non-insulated crimp connectors
- Overall length: 232mm

Warranty: 5 years

Order Code	Mod:	Price each exc. VAT 1+	inc. VAT each
A32QW	Map Crimp Tool	£8.32	£9.99

Maplin Wire Cutting and Stripping Tool



- A quick and very easy to use wire stripping tool
- Tool has jaws to grip the wire sheath, whilst a pair of blades strip off the insulation
- Strips wires of conductor area 0.75mm² - 4.0mm²
- Internally sprung - applies correct pressure
- Thumb screw adjustment

Warranty: 5 years

Order Code	Mod:	Price each exc. VAT 1+	inc. VAT each
A34QW	Map Cutter/Stripper	£11.65	£13.99

Maplin Universal Cable Stripper



- Will strip cables with a minimum diameter of 7mm and conductor area of 0.2mm² - 6mm²
- Place cable in jaws and squeeze handles to operate
- Jaws hold the cable and cut the outer sheath
- Can also be used for crimping

Warranty: 5 years

Order Code	Mod:	Price each exc. VAT 1+	inc. VAT each
A36QW	Map UnivsCableStrppr	£12.49	£14.99

Maplin Coaxial Cable Stripper



- A stripper which removes the inner and outer sheath of co-axial cables simultaneously
- Cables from 4mm to 7mm outside diameter can be accommodated
- The tool is set at the factory to suit RG58 and RG59 cable
- Overall length: 104mm

Warranty: 5 years

Order Code	Mod:	Price each exc. VAT 1+	inc. VAT each
A37QW	Map Co-Ax Stripper	£13.32	£15.99

Maplin Automatic Wire Stripper



- Strong, durable die cast body frame
- Clearly marked metric sizes
- Adjustable stripping length guide provides consistency
- Stripper works on 0.5, 1.2, 1.6, 2.0, 2.6 and 3.2mm wires

Warranty: 5 years

Order Code	Mod:	Price each exc. VAT 1+	inc. VAT each
A35QW	Map AutoWireStripper	£13.32	£15.99

Maplin IDC Insertion Tool



- Ideal for connecting telephone cables into non-screw sockets
- Can also be used for connecting telephone cables to junction boxes
- Position the cable over the contact and push down

Warranty: 5 years

Order Code	Mod:	Price each exc. VAT 1+	inc. VAT each
FT51F	BT IPC Insrtn Tool	£6.24	£7.49

Maplin Telephone Plug Crimp Tool



- Ideal for crimping on standard 4-way or 6-way UK telephone plugs
- Simple operation

Order Code	Mod.	Price each exc. VAT 1+	inc. VAT each
MU65V	BT Plg Crimp Tool	£8.32	£9.99

Maplin Impact Punch Down Tool



- A useful combination tool
- Tool has a wire cutter and bolt cutters for M2.5, M3, M3.5, M4 and M5 bolts
- Includes strippers for wires of conductor area 0.75, 1.0, 1.5, 2.5, 4.0 and 6.0mm²
- Also includes a crimping tool for red, blue and yellow insulated crimp connectors and 1.5, 2.5 and 6mm² non-insulated crimp connectors
- Overall length: 232mm
- Contains 99-piece assorted connector set

Warranty: 5 years

Order Code	Mod.	Price each exc. VAT 1+	inc. VAT each
A440W	Map PunchDownTool	£13.32	£15.99

Telecom Impact Tool



- Ideal for inserting BT IPC cable into master and secondary jack units
- Reversible blade which also cuts off excess cable
- Tough resin handle reinforced with fibre glass

This handy tool is ideal for inserting BT IPC cable into the connectors in master and secondary jack units. It features a reversible blade, one end of which is used to force the four wires of the line cord into the insulation piercing connectors of the jack unit. The other does the same job but also includes a blade to cut off any excess wire once connection is made.

Order Code	Mod.	Price each exc. VAT 1+	inc. VAT each
BP42V	Punch Down Tool	£12.49	£14.99

Maplin RJ45 / RJ11 / RJ12 Networking and Telecoms Crimping Tool



- Cuts and strips
- For RJ45/11 and RJ12/11 modular connectors
- The steel frame gives long term durability and dependability
- Provides easier and faster operation

Warranty: 5 years

Order Code	Mod.	Price each exc. VAT 1+	inc. VAT each
A410W	Map NetworkCrimpTool	£13.32	£15.99

Maplin RJ45 Crimping Tool



- Crimps 8-position modular plugs
- Spring loaded handles for automatic opening
- Cuts and strips with the 2 separate blades built into the handle
- Suitable for use with FCC68 modular connectors
- Can be used on computers and American telephones
- Overall length: 200 mm

Warranty: 5 years

Order Code	Mod.	Price each exc. VAT 1+	inc. VAT each
A420W	Map FCC68Crimp 8P8C	£16.65	£19.99

Maplin Coaxial Connector Crimping Tool



- 5 separate sections
- Adjustable pressure - can be adjusted for individual requirements
- Accepts 1.72, 2.5, 5.4, 6.48 and 8.2mm connectors

Warranty: 5 years

Order Code	Mod.	Price each exc. VAT 1+	inc. VAT each
A380W	Map Coax Crimper	£16.65	£19.99

Maplin Heavy Duty Ratchet Crimping Tool



- Ideal for use with red, yellow and blue insulated crimp terminals
- Ratchet to prevent tool accidentally opening
- Overall length: 225mm

Warranty: 5 years

Order Code	Mod.	Price each exc. VAT 1+	inc. VAT each
A390W	Map CrimpToolRatch	£16.65	£19.99

Maplin RJ11 and RJ45 Crimping Tool and Cable Stripper Set



- Cut, strip and terminate plugs for RJ45 network and RJ11 phone cables
- Crimp tool can be used with stranded and solid core cable
- Includes 5 x RJ45 (8P8C) and 5 x RJ11 (6P4C) connectors for use with stranded core cable

Warranty: 5 years

Order Code	Mod.	Price each exc. VAT 1+	inc. VAT each
A430W	Map Crimp&Strip Set	£16.65	£19.99

Maplin Riveter Kit



- Kit includes a heavy-duty hand riveter with 4 heads and a spanner
- Includes a 40-piece assorted rivet set

1 x rivet tool

10 x 2.4mm x 6mm rivets

10 x 3.2mm x 6mm rivets

10 x 4mm x 6mm rivets

10 x 4.8mm x 6mm rivets

Warranty: 5 years

Order Code	Mod.	Price each exc. VAT 1+	inc. VAT each
A400W	Map Riveter Kit	£8.32	£9.99

Staplers, Nail Guns & Tackers

Maplin 3 in 1 Staple / Nail Gun Kit



- Hand operated nail and staple gun
- Suitable for many types of fixing including upholstery, hardboard, fabrics etc
- Accepts 4-14mm standard staples, 10-12mm rounded

- staples and also accepts 10-14mm nails
- Impact pressure adjustment and handle lock
- Includes 600 staples

1 x staple gun
600 x staples
1 x handy storage case
Warranty 5 years

Order Code	Mod: 1032853	Price each exc. VAT	inc. VAT each
A47QW	Map Staple Gun	£8.32	£9.99

Maplin Staples 1000-Pack



- Work with the majority of staple guns
- Size: 8 x 1.2 x 11mm

Warranty 5 years

Order Code	Mod: 1032787	Price each exc. VAT	inc. VAT each
A52QX	Map Staples 1000Pk	£1.24	£1.49

Stanley 2-in-1 Cable Tacker



- 2-in-1 cable tacker fires round and flat staples for wire and general tacking
- Hi/Lo adjustment for use of different surfaces
- Captive reload no loose parts, easy to reload
- Patented anti-jam for less down time and product failure
- Easy squeeze less force in more power out

Order Code	Mod: 1031912	Price each exc. VAT	inc. VAT each
A31RF	Stanley 2-In-1 Tacker	£25.40	£30.49

Stanley OTR250 Heavy-Duty Staple & Nail Gun



- Pinch point free design for added safety
- Easy push handle
- Aluminium cast housing
- Easy access staple and brad insertion
- Lock down handle for easier storage

Order Code	Mod: 1032981	Price each exc. VAT	inc. VAT each
A73RF	Stanl HD Staple Gun	£24.99	£29.99

Stanley Heavy-Duty 8mm Staples 1000 Pack

- Heavy-duty staples
- Type G
- Also known as type 4, 11 or 140
- Size: 8mm
- Pack of 1,000



Order Code	Mod: 1032987	Price each exc. VAT	inc. VAT each
A75RF	Stan HD Staple 8mm	£2.49	£2.99

Stanley TRA704T Heavy-Duty 6mm Staples 1000 Pack

- Heavy-duty staples
- Type G
- Also known as type 4, 11 or 140
- Size: 6mm
- Pack of 1,000



Order Code	Mod: 1032983	Price each exc. VAT	inc. VAT each
A74RF	Stan HD Staple 6mm	£2.49	£2.99

Stanley TRA706T Heavy-Duty 10mm Staples 1000 Pack

- Heavy-duty staples
- Type G
- Also known as type 4, 11 or 140
- Size: 10mm
- Pack of 1,000



Order Code	Mod: 1032989	Price each exc. VAT	inc. VAT each
A76RF	Stan HD Staple 10mm	£2.49	£2.99

Stanley TRA709T Heavy-Duty 14mm Staples 1000 Pack

- Heavy duty staples
- Type G
- Also known as type 4, 11 or 140
- Size: 14mm
- Pack of 1,000



Order Code	Mod: 1032993	Price each exc. VAT	inc. VAT each
A78RF	Stan HD Staple 14mm	£2.90	£3.49

Chisels

Stanley Fatmax Folding Pocket Chisel 25mm



- Ideal for jobsite work
- Blade folds within the handle to fit in the pocket
- Prevents blade damage and trouser cutting
- Made from hardened and tempered carbon steel for edge retention
- The handle is bi-material for comfort and has a steel strike cap, which is suitable for use with a hammer
- Blade size: 25mm

The Stanley FatMax Folding Pocket Chisel is ideal for jobsite work. The blade folds within the handle to fit in the pocket, whilst preventing blade damage and trouser cutting.

The blade is made from hardened and tempered carbon steel for edge retention. The handle is bi-material for comfort and has a steel strike cap, which is suitable for use with a hammer.

Blade size: 25mm.

Order Code	Mod: 1033010	Price each exc. VAT	inc. VAT each
A70RF	Stan Fatmax Chisel	£14.15	£16.99

Hammers

Maplin 10oz Stubby Hammer

- 10oz stubby claw hammer
- Soft rubber cushion grip
- Magnetised nail holder

Warranty: 5 years



Order Code	Mod: 1032789	Price each exc. VAT	inc. VAT each
A87QW	Map Stubby Hammer	£4.15	£4.99

Stanley Curved Claw Hammer Fibreglass Shaft 450g 16oz



- Curved claw hammer
- Heat-treated, high-carbon steel head
- Fully polished and tempered for durability
- Fibreglass handle
- Textured rubber grip for comfort

This Stanley curved claw hammer has a heat treated, forged, high-carbon steel curved claw head. The head is fully polished and rim tempered for durability and safety. The fibreglass handle absorbs shock and vibration, and the textured rubber ensures a comfortable, secure grip.

Order Code	Mod: 1033087	Price each exc. VAT	inc. VAT each
A71RF	Stanley Claw Hammer	£8.32	£9.99



Browse our entire range at maplin.co.uk

Tweezers, Probes, Forceps and Clamps

Rolson Stainless Steel Straight Forceps 140mm



- Locking forceps manufactured in stainless steel with serrated jaws
- Can be used as needle nose pliers, a clamp, heat sink, vice etc.

Order Code	Mod.	Price each exc. VAT 1+	inc. VAT each
N09FA	219407 140mm Strght Forceps	£3.32	£3.99

Rolson Stainless Steel Curved Forceps 140mm



- Locking forceps manufactured in stainless steel with serrated jaws
- Can be used as needle nose pliers, a clamp, heat sink, vice etc.

Order Code	Mod.	Price each exc. VAT 1+	inc. VAT each
N10FA	219408 140mm Curved Forceps	£3.32	£3.99

Rolson LED Light Tweezers



- 95mm tweezers with finger grips and LED light
- Ideal for hobbyist, modelling as well as beauty applications, etc
- Supplied with 3 x LR41 batteries

Order Code	Mod.	Price each exc. VAT 1+	inc. VAT each
N82JA	476655 LED Tweezers	£2.50	£3.00

Rolson Part Tweezer Set



- A selection of 4 different types of tweezers
- Includes most popular types

Order Code	Mod.	Price each exc. VAT 1+	inc. VAT each
RM59P	030485 4pc Tweezer Set	£5.82	£6.99

Rolson 6 Part Stainless Steel Epoxy Coated Tweezers



- Manufactured from epoxy-coated stainless steel
- Specially designed for electronic and semi conductor industries
- Sizes include: 5, 3C, 7A, 00, 2A, SS0

Order Code	Mod.	Price each exc. VAT 1+	inc. VAT each
N02FA	219389 6pc Tweezer Set	£9.15	£10.99

Rolson 12 Part Stainless Steel Probe Set



- Stainless steel construction which is rust-resistant and durable
- An assortment of double and single ended probes suitable for wax and clay carving, cake decorating etc.

Order Code	Mod.	Price each exc. VAT 1+	inc. VAT each
N18FA	219888 12pc Probe Set	£8.32	£9.99

Rolson 5 Part Mini G Clamp Set



- Ideal for model making and clamping delicate items
- 4 x 25mm G-Clamps supplied with stand for extended and hands free use
- Manufactured from carbon steel

Order Code	Mod.	Price each exc. VAT 1+	inc. VAT each
N276C	224885 5pc Mini G Clamp Set	£4.15	£4.99

Multi Function Tools

Maplin 9 Function Multi-Tool



- Manufactured from stainless steel with rubber inserts on grip
- Functions include knife, saw, nail file, bottle opener, hammer, combination pliers, wire stripper, slotted screwdriver and cross point screwdriver
- Supplied with canvas storage pouch

Warranty: 5 years

Order Code	Mod.	Price each exc. VAT 1+	inc. VAT each
A730W	1032828 Map Multitool Hammer	£8.32	£9.99

Maplin Multi Function Axe



- Ideal for hiking, camping and other outdoor activities
- Compact 9-in-1 all-purpose tool includes: hammer, nut holder (sizes 16 and 12mm), axe, cross point screwdriver, mini saw, file, ruler, and knife
- Polished steel body with wood handles
- Suitable for home and outdoor use
- Includes canvas storage pouch
- Folded size: 165mm

Warranty: 5 years

Order Code	Mod.	Price each exc. VAT 1+	inc. VAT each
A740W	1032829 Map MultiTool Axe	£8.32	£9.99

Multi-Tool with Wire Stripper



- Functions include wire stripper and cutter, 3-in-1 file, drywall saw and spudger
- Also contains Phillips screwdriver, knife, cable splicer, large slotted screwdriver and small slotted screwdriver
- Storage pouch included
- Rugged, versatile and compact design
- Foldable for easy storage

Warranty: 5 years

Order Code	Mod.	Price each exc. VAT 1+	inc. VAT each
A750W	1032830 MapMultToolStrippers	£10.82	£12.99



PLEASE NOTE: Please note that, under the Offensive Weapons Act 1996, this product cannot be sold to anyone under the age of 18.

Maplin 12-Piece Multi-Tool Set



- 12-in-1 multi knife with long nose pliers, standard pliers, wire cutter, saw, awl and knife
- Also includes can opener, file, small and medium slotted screwdrivers and Phillips screwdriver
- Contains 3.5 inch, one-handed opening knife
- Knife is made from high quality stainless steel

Warranty: 5 years

Order Code	Mod:	Price each exc. VAT 1+	inc. VAT each
A76QW	Map 2pc MultiToolSet	£12.49	£14.99

Stanley 14-Piece Multi-tool



- Multi-tool includes knife, serrated blade, file and bit holder
- With 1/4 inch drive sockets, slotted, Phillips and hex screwdriver bits
- Blades and file lock into position at 180 degrees
- Bit holder can lock at 3 different angles - ideal for working in confined spaces

The Stanley 14-in-1 Multi-tool contains the following tools:

- 1 x knife
- 1 x serrated blade
- 1 x file
- 1 x bit holder
- 4 x 1/4 inch square drive sockets: 10mm, 11mm, 12mm and 13mm
- 2 x Slotted screwdriver bits: 6-8mm and 8-10mm
- 2 x Phillips screwdriver bits: PH1 and PH2
- 2 x Hex bits: 5mm and 6mm

The blades and file lock into position at 180°. The bit holder lock at 90°, 135° and 180° for working at different angles in confined spaces.

Order Code	Mod:	Price each exc. VAT 1+	inc. VAT each
A65RF	Stan Tool 14 In 1	£16.65	£19.99

Knives & Cutting Tools

Stanley Tools Window Scraper



- Uses a standard trimming knife blade
- Ideal for scraping excess paint from window panes

- It has a comfortable plastic handle with detachable blade guard
- Blade guard attachment allows use as a car ice scraper

Order Code	Mod:	Price each exc. VAT 1+	inc. VAT each
A64RF	Stanley Wind Scraper	£1.65	£1.99

Maplin Spare Knife Blades 10-Pack



- Replacement blades for use with retractable and lock-back knives
- Supplied in a handy storage dispenser

Warranty: 5 years

Order Code	Mod:	Price each exc. VAT 1+	inc. VAT each
A63QW	Map 10Pc Blade Set	£1.65	£1.99

Stanley Knife Blades Heavy-Duty Pack of 10



- Fits all standard Stanley knives
- Heavy-duty and general purpose blades
- Trapezoid in shape for a highly resistant performance
- Great for use on carpets, vinyl and other materials requiring a stiffer and stronger blade

Order Code	Mod:	Price each exc. VAT 1+	inc. VAT each
A30RF	Stanley Knife Blades	£2.90	£3.49

Maplin Spare Knife Blades 100-Pack



- Replacement blades for use with retractable and lock-back knives
- Supplied in a handy storage dispenser

Warranty: 5 years

Order Code	Mod:	Price each exc. VAT 1+	inc. VAT each
A64QW	Map SpareBlades100Pk	£2.90	£3.49

Reserve online, collect in-store in 30 minutes



Maplin Fixed Blade Knife



- Precision die cast, ergonomic handle
- Supplied with 3 spare blades stored in the handle

Warranty: 5 years

Order Code	Mod:	Price each exc. VAT 1+	inc. VAT each
A68QW	Map Fixed BladeKnife	£3.32	£3.99

Maplin Soft Grip Knife



- Aluminium die cast handle
- Rubber inserts give secure grip
- Supplied with 1 blade

Warranty: 5 years

Order Code	Mod:	Price each exc. VAT 1+	inc. VAT each
A69QW	Map Soft Grip Knife	£3.32	£3.99

Maplin Mini Folding Lock Back Utility Knife



- One-handed opening
- 70mm in length, blade folds into body
- Lightweight aluminium handle
- Supplied with handy keychain

Warranty: 5 years

Order Code	Mod:	Price each exc. VAT 1+	inc. VAT each
A65QW	Map Mini Knife	£4.15	£4.99

Maplin Quick Change Knife



- Quick change button allows faster blade change
- Supplied with 5 blades stored in the handle

Warranty: 5 years

Order Code	Mod:	Price each exc. VAT 1+	inc. VAT each
A70QW	Map QuickChangeKnife	£5.82	£6.99

Maplin Folding Lock Blade Utility Knife

18



- Lightweight knife features aluminium handle with clip
- Quick change mechanism
- One-handed opening mechanism
- Includes 11 blades

Warranty 5 years

Order Code	Mod:	Price each exc. VAT 1+	inc. VAT each
A66QW	MapHO LightwghtKnife	£8.32	£9.99

Maplin 2-in-1 Tradesman Knife

18



- Lightweight knife features aluminium handle with clip
- Quick change mechanism
- Both blades can be folded away
- Supplied with 10 spare blades in a dispenser

Warranty 5 years

Order Code	Mod:	Price each exc. VAT 1+	inc. VAT each
A67QW	Map Dual Blade Knife	£8.32	£9.99

Stanley FatMax Retractable Utility Knife

18



- Instant blade change mechanism – 5 blades included
- Blade clamp for heavy-duty use
- Thumb pad and ergonomic cutting angle for comfort
- Ideal for flooring applications
- Auto rise storage holder

Order Code	Mod:	Price each exc. VAT 1+	inc. VAT each
A29RF	Stanley Retra Knife	£12.49	£14.99

Rolson 17 Part Hobby Knife Set

18



- Suitable for cutting, etching, scraping, layout and model making
- Includes a variety of 13 hardened blades, pair of tweezers and 3 aluminium handles
- Supplied in a plastic storage case

Order Code	Mod:	Price each exc. VAT 1+	inc. VAT each
L63BR	17 Piece Knife Set	£5.82	£6.99

Maplin 2-Piece Mini Knife

18



- 60mm plastic handle
- Folding design with key chain
- Blade length: 50mm

Warranty 5 years

Order Code	Mod:	Price each exc. VAT 1+	inc. VAT each
A71QW	Map2Pc MiniLockKnife	£4.15	£4.99

Maplin 2-Piece Mini Multi-Tool Set

18



- 6-in-1 mini multi-tool with functions that include knife, bottle opener, saw, cross point screwdriver, pliers, and key ring
- 10-in-1 mini multi knife with can opener, knife, scissors, bottle opener, slotted screwdriver, crosspoint screwdriver, corkscrew, nail file/cleaner and key ring

Warranty 5 years

Order Code	Mod:	Price each exc. VAT 1+	inc. VAT each
A72QW	Map 2Pc MiniMultiTool	£8.32	£9.99

Rolson A3 Cutting Mat



- Ideal protection for desk or worktop
- Non-slip surface
- Self-healing - knife marks totally disappear
- Both sides of the mat can be used as a cutting surface
- One side of the mat has gridlines as a cutting guide
- Dimensions: 450 (l) x 300 (w) x 3mm (d)

Order Code	Mod:	Price each exc. VAT 1+	inc. VAT each
CB15R	A3 Cutting Mat	£4.57	£5.49

Saws

Stanley Junior Hacksaw 150mm 6in

18



- Square steel frame
- Moulded grip handle
- Lower blade tensioner
- Easy blade changing thanks to a lever in the handle
- Deep throat for good work capacity

Order Code	Mod:	Price each exc. VAT 1+	inc. VAT each
A68RF	Stan Junior Hacksaw	£4.99	£5.99

Stanley Junior Blades 150mm 6in 5-Pack

18



- Spare blades to fit the Stanley Junior Hacksaw
- Size 150mm (6 in)
- Supplied in packs of 5

Order Code	Mod:	Price each exc. VAT 1+	inc. VAT each
A69RF	Stanley Junior Blade	£2.07	£2.49

Stanley Enclosed Grip Hacksaw 300mm (12in)

18



- Solid steel frame hacksaw
- Blade length 300mm (12in)
- High speed steel blade designed for cutting all metal types
- Enclosed shatterproof plastic handle for good comfort and grip
- Frame allows 4 difference blade positions
- Ideal for vertical and horizontal cutting

Order Code	Mod:	Price each exc. VAT 1+	inc. VAT each
A682Q	Stan 300mm Hacksaw	£9.15	£10.99

Subscribe to our newsletter
For deals and information
maplin.co.uk



18

PLEASE NOTE: Please note that, under the Offensive Weapons Act 1996, this product cannot be sold to anyone under the age of 18.

Irwin Jack 880 UN Universal Panel Saw 500mm (20in) 8tpi



- High quality C75 steel blade
- Unique Triple Ground tooth design
- Blade is treated with a water based lacquer
- Ultra sonic welded soft-grip
- 90 and 45 degree angles integrated in the handle
- Length 500mm (20 inch) with 8 teeth per inch

Order Code	Mod: 1033080	Price each exc. VAT 1+	inc. VAT each
A99RF	Jack Hand Saw 20in	£9.99	£11.99

Stanley FatMax Folding Jabsaw 130mm



- Three blade locking angle mechanism
- Triple bevelled teeth allows easier cutting that is up to 50% faster
- The blade's sharp point is ideal for punching through plasterboard
- Anti-slip ergonomic bi-material handle for a comfortable and secure grip

Order Code	Mod: 1033004	Price each exc. VAT 1+	inc. VAT each
A67RF	Stan Fatmax Jabsaw	£14.15	£16.99

Vices, Workbenches & Trolleys

Maplin Vacuum Base Vice



- Ideal for craft, hobbies and electronics
- Powerful suction base with easy-lock handle
- Removable rubber jaw faces
- Lightweight plastic body
- 60mm jaw width
- Height 200mm
- Head tilt 180° and head swivel is 360°

Warranty: 5 years

Order Code	Mod: 1032796	Price each exc. VAT 1+	inc. VAT each
A86QW	Map VacuumBaseVice	£12.49	£14.99

Maplin 60mm Swivel Table Vice



- Locking swivel base turns 360°
- Mounting clamp opens to 45mm
- Jaws open to a maximum of 60mm
- Paint coated body with heat treated jaws

Warranty: 5 years

Order Code	Mod: 1032797	Price each exc. VAT 1+	inc. VAT each
A83QW	Map 60mm Swivel Vice	£14.15	£16.99

Multi Purpose Workbench



- Suitable for home and workshop use
- Ideal for sawing, cutting and drilling
- Folds flat for easy storage
- Lightweight design for easy transportation
- Pre-drilled holes in bench top
- Includes 4 vice pegs to stabilize item being worked on
- Ruler markings in cm and inches
- Protractor markings for measuring angles

Please note: Supplied flat packed with assembly instructions

Technical specifications:

Maximum jaw opening	95mm
Maximum clamping width	with vice pegs: 240mm
Dimensions	785 (h) x 620 (w) x 560mm (d)
Maximum load	70kg
Weight	7.5kg

Order Code	Mod: 476517	Price each exc. VAT 1+	inc. VAT each
N07JF	Portable Work Bench	£16.65	£19.99

70kg Folding Trolley

- Ideal for the home, office, small workshop or travel
- 70kg load capacity
- Rugged, lightweight design
- Extends to 1m
- Folds flat for easy storage
- Includes elastic bungee cord to hold contents in place

Specifications:

Load capacity:	70kg
Height open:	1m
Height closed:	640mm



Width: 390mm
 Toe plate: 280 x 385mm
 Rubber wheel: 125mm diameter
 Weight: 3kg

Order Code	Mod: 511924	Price each exc. VAT 1+	inc. VAT each
N48JQ	70kg Folding Trolley	£24.99	£29.99

Measurement Hand Tools

Electronic Digital Calliper



- Electronic 25 mm LCD screen
- Imperial or metric reading
- Suitable for internal and external measurement
- Resets the zero point of the instrument
- Point is memorised even if the unit is switched off
- Adjustable via a friction thumb roller
- Power off button
- Lightweight and durable
- Complete with carry case
- Supplied with 1 x SR44 battery

Specifications:

Measuring range	0-150mm/0-6 inches
Resolution	0.01mm/0.0005 inches
Accuracy	±0.02mm/0.001inches (<100mm) ±0.03mm/0.001inches (>100-200mm) ±0.04mm/0.0005 inches (>200-300mm)

Repeatability: 0.01mm/0.0005 inches

Order Code	Mod: 032198	Price each exc. VAT 1+	inc. VAT each
N48AA	Elec Digital Caliper	£13.32	£15.99

Maplin Mini Combination Square 150mm



- Heavy-duty die cast metal body with built-in spirit level
- A traditional and versatile measuring tool
- Brass nut and scriber fittings
- Hardened steel 150mm rule is etched with clear graduations

Warranty: 5 years

Order Code	Mod: 1032793	Price each exc. VAT 1+	inc. VAT each
A78QW	Map 6 inch Square	£4.15	£4.99

Technical Helpline

0333 400 9500

For technical information and assistance relating to any Maplin purchase, contact our team of experts

Stanley Combination Metal Square 300mm (12in)



- Combination square with metal body with three machined faces
- Steel blade is stamped with metric and imperial sizes
- Fitted with a 360° vial for all round visibility
- Scriber for convenience and marking out
- Can be used as a try and mitre square, depth or height gauge and spirit level
- Size 300 mm (12in)

Order Code	Mod:	Price each exc. VAT	inc. VAT each
A61RF	Stanl.MetComb Square	£9.99	£11.99

Maplin Six Scale Triangle Ruler 300mm



- 300mm (12 inches) in length
 - Six scale options
- Six scale options: 1:201:251:501:751:1001:125
- Warranty: 5 years

Order Code	Mod:	Price each exc. VAT	inc. VAT each
A79QW	Map 12inTriangleRule	£3.32	£3.99

Maplin Stainless Steel Ruler 600mm



- Metric and imperial graduations on one side
 - Conversion tables on the reverse
 - 600mm (24 inches) overall length
- Warranty: 5 years

Order Code	Mod:	Price each exc. VAT	inc. VAT each
A89QW	Map 24in Steel Ruler	£4.15	£4.99

Maplin Essential Tape Measure 5m



- 5m length and 19mm blade width
- Sliding thumb operated lock
- Belt clip
- Impact resistant plastic housing with rubber outer cover
- Inch and metric graduation

Warranty: 1 year

Order Code	Mod:	Price each exc. VAT	inc. VAT each
N37DU	5m Tape Measure	£1.66	£2.00

Maplin High-Grip Tape Measure 7.5m



- Metric and imperial measurements
 - 25mm blade width / 7.5m length
 - Ergonomic high-grip case with finger slots for added comfort
 - Thumb-operated pause button on reverse
 - Automatic blade lock
- Warranty: 5 years

Order Code	Mod:	Price each exc. VAT	inc. VAT each
AB1QW	Map TapeMeasure 7.5m	£4.15	£4.99

Stanley Pocket Tape 5m/16ft (Width 19mm)



- Corrosion resistant long life nylon coated blade
- Bi-material case for improved grip
- Positive blade lock for accurate measurements
- Belt clip, 3-rivet tru-zero hook, reduces risk of breakage
- Class II accuracy
- Length: 5m (16 ft) Blade width 19m

Order Code	Mod:	Price each exc. VAT	inc. VAT each
A55RF	Stanley PocketTape5M	£5.82	£6.99

Stanley Pocket Tape 8m / 26ft (Width 25mm)



- Corrosion resistant long life nylon coated blade
- Bi-material case for improved grip
- Positive blade lock for accurate measurements
- With belt clip, and 3-rivet tru-zero hook, reduces risk

of breakage

- Class II accuracy
- Length 8m (26 ft). Blade width 25mm

Order Code	Mod:	Price each exc. VAT	inc. VAT each
A56RF	Stanley PocketTape8M	£9.99	£11.99

Maplin Digital Tape Measure 5m



- Metric and imperial measurements
 - 19mm (3/4 inch) blade width
 - 5m (16 feet) length
 - Ergonomic high-grip case with finger slots for added comfort
 - Thumb-operated pause button on reverse
 - Automatic blade lock
 - Impact-resistant plastic
- Warranty: 5 years

Order Code	Mod:	Price each exc. VAT	inc. VAT each
A82QW	Map Dig Tape5mx19mm	£20.82	£24.99

NWS Electricians Fish Tape 50ft



- Pulls cables through conduit
- Made from flexible sprung steel
- Durable plastic container with side handle and brake

Order Code	Mod:	Price each exc. VAT	inc. VAT each
N26DW	C/TractFishTape50Ft	£16.65	£19.99

Stanley Torpedo Level 230mm Magnetic Level



- Heavy-duty aluminium cast body
- Large top reading vial window
- Magnetic base
- 3 tinted fixed vials - plumb, horizontal and 45° which can be replaced if damaged
- Length 230mm (9in)

Order Code	Mod: 1033079	Price each exc. VAT 1+	inc. VAT each
A60RF	Stanley Torp Level	£11.65	£13.99

Stanley Classic Box Level 2 Vial 60cm



- Strong construction
- Soft end caps
- Shock resistant
- Magnified central vial
- Large tubular side vial

Order Code	Mod: 1033071	Price each exc. VAT 1+	inc. VAT each
A58RF	Stan Box Level 60cm	£16.65	£19.99

Stanley Classic Box Level 3 Vial 120cm



- Strong construction
- Soft end caps
- Shock resistant
- Magnified central vial
- Large tubular side vial

Stanley Chalk Line 30m Blue Chalk & Level



- Ergonomic design
- High impact ABS case for durability
- 30g chalk capacity
- Supplied with 113g blue chalk and line level

Order Code	Mod: 1033075	Price each exc. VAT 1+	inc. VAT each
A62RF	Stanley ChalkLine	£8.32	£9.99

Stanley Black Fine Tip Permanent Markers 2 Pack



- Black fine tip permanent marker pens
- Quick drying water resistant ink
- Marks on almost any surface
- Supplied as a pack of 2

Order Code	Mod: 1033078	Price each exc. VAT 1+	inc. VAT each
A28RF	Stan Blk Tip Markers	£2.07	£2.49

Watch & Jewellery Tools

Rolson Spring Hook Remover for Watch Straps



- For the safe removal and installation of most types of watch spring bars from between watch lugs
- Heavy duty all metal construction with hardened steel replaceable tips
- Complete with measuring scale in both metric and imperial

Order Code	Mod: 224890	Price each exc. VAT 1+	inc. VAT each
N32GC	Spring Hook Remover	£3.32	£3.99

Rolson Spring Bar Assortment



- Single shoulder spring bar for ultra thin clasps
- Includes 5 of the most popular sizes
- Short tips: 8-19mm with 1mm diameter

Order Code	Mod: 265796	Price each exc. VAT 1+	inc. VAT each
N77GK	Spring Bar Assortmt	£4.99	£5.99

Rolson Watch Case Opener



- Adjusts easily to open most screw back type watch cases
- Knurled handle for grip
- Adjustable thumb wheel

Order Code	Mod: 099706	Price each exc. VAT 1+	inc. VAT each
N06CW	Watch Case Opener	£6.66	£7.99

Rolson 2 Part Watch Case Opener Set

18



- Adjustable screw type watch case opener
- Angled pins for better grip
- Double edged knife with cushion grip for opening press on type watch cases

Order Code	Mod: 265800	Price each exc. VAT 1+	inc. VAT each
N81GK	2Pc Watch Case Opener	£8.32	£9.99

Rolson Watch Case Holder



- Four adjustable nylon pins for holding watch cases
- Adjustable solid aluminium base

Order Code	Mod: 265805	Price each exc. VAT 1+	inc. VAT each
N86GK	WatchCaseHolderVice	£8.32	£9.99

Rolson 4 Part Watch Repair Kit



- Watch case opener adjusts easily to open most screw back type cases
- Knurled handle for easy grip and adjustable thumb wheel
- Dusting pump with metal nozzle for cleaning and dusting delicate objects
- 75mm dusting brush with plastic handle and nylon bristles
- 115mm No7 tweezers with extra fine curved points
- Supplied with canvas storage pouch

Order Code	Mod: 228858	Price each exc. VAT 1+	inc. VAT each
N63GN	4Pc Watch Care Set	£10.82	£12.99

Buying for business?
0333 400 9740



Telescopic/Retrieval Tools

Rolson Pick Up Tool Approx 14mm



- For picking up small objects
- Ideal for objects dropped in inaccessible places
- 600mm flexible stem with a small set of jaws at one end (approx 14mm apart at full extension)
- Spring-loaded plunger on handle opens jaws

Order Code	Mod:	Price each exc. VAT 1+	inc. VAT each
BN98G	010318 Pick Up Tool	£3.32	£3.99

Rolson Telescopic Magnetic Pick-Up Tool 645mm



- Powerful magnet lifts 3.5kg (8lbs)
- Pocket size and easy to carry
- Supplied with a belt clip
- Ideal for home, shop, garage, work place etc.

An extendable magnetic tool for picking up small metallic objects from inaccessible areas. The rod extends from 133mm [5 1/4"] to 645mm [25 1/2"]

Order Code	Mod:	Price each exc. VAT 1+	inc. VAT each
RM35Q	030608 Magnetic Pick Up	£3.74	£4.49

Hobbyist Tools

Rolson 4 Part Pin Vice Set



- The body is hollow for holding long wires etc
- Ideal for holding miniature broaches, taps and drills
- Sizes 0 - 0.8mm, 0.8 - 1.3mm, 1.3 - 3.1mm and 3.1 - 4.8mm

Order Code	Mod:	Price each exc. VAT 1+	inc. VAT each
N796K	265798 4Pc Pin Vices	£6.24	£7.49

Rolson Miniature Precision Hand Drill



- Plastic hand drill for wire twisting and drilling 0-0.9mm
- Sturdy and smooth operation
- Adjustable chuck accepts any drill bit up to 0.9mm
- Ample power and speed provided by gear ratio

Order Code	Mod:	Price each exc. VAT 1+	inc. VAT each
N27FA	219907 Precision Hand Drill	£4.99	£5.99

Rolson PCB Spiral Push Drill 185mm



- A small hand drill operated by depressing the body of the drill downwards
- Supplied with 2 collets giving a capacity of 0-2mm
- Length: 185mm

Order Code	Mod:	Price each exc. VAT 1+	inc. VAT each
N29FA	219909 PCB Drill	£4.99	£5.99

Rolson 12 Part Stainless Steel Wax Carver Set



- An assortment of double-ended carving tools suitable for sculpture work with clay, ceramics, wax and other soft materials
- Ideal for craftsmen and hobby applications

Order Code	Mod:	Price each exc. VAT 1+	inc. VAT each
N19FA	219889 12pc Wax Carver Set	£7.49	£8.99

Buy it on the web at maplin.co.uk

Shop for all Maplin products online at our website and check out our latest products and special offers!



Rolson 3 Part Mini Brass Plane Kit



- A set of 3 miniature woodworking planes manufactured from hardwood and brass components
- Miniature block plane, bull nose plane and scraper plane complete with storage pouch

Order Code	Mod:	Price each exc. VAT 1+	inc. VAT each
N41FA	219920 3pc Brass Plane Kit	£13.32	£15.99

Rolson 5 Part Mini Woodworking Kit



- Marking gauge, mitre and dovetail square, sliding bevel and try square
- Marking gauge is made from hardwood with brass screw and single marking pin
- Mitre square manufactured from hardwood, 2 brass faces and blue steel blade
- Dovetail square made from hardwood, brass face and blue steel
- Sliding bevel with polished hardwood stock and brass end
- Try square with brass face and polished hardwood stock

Order Code	Mod:	Price each exc. VAT 1+	inc. VAT each
N42FA	219921 5pc Wood Working Set	£13.32	£15.99

Rolson 31 Part Miniature HSS Tap and Die Set



- Ideal for model makers and intricate engineering
- Includes 9 un-split dies, 18 hand taps, wrench, die and tap linings

Contents:
 9 x un-split dies [M1, 1.1, 1.2, 1.4, 1.6, 1.8, 2, 2.2, 2.5]
 18 x hand taps, taper and plug [M1, 1.1, 1.2, 1.4, 1.6, 1.8, 2, 2.2, 2.5]
 2 x tap linings
 Wrench
 Die lining

Order Code	Mod:	Price each exc. VAT 1+	inc. VAT each
N31GC	224889 31pc Mini Tap&DieSet	£33.32	£39.99

Magnifiers & Microscopes

Maplin Pocket 6x Magnifier



- Slides away into a protective plastic housing when not in use
- 30mm glass magnifying lens
- 6x magnification factor
- Low distortion
- Supplied with a handy keychain

Order Code	Mod.	Price each exc. VAT	inc. VAT each
ZF02C	Pocket Magnifier	£4.99	£5.99

Rolson 3 Part Eye Loupe Set



- Manufactured with black plastic body
- 3 focal lengths/magnifications 5x, 7x, 10x

Order Code	Mod.	Price each exc. VAT	inc. VAT each
N39FA	3pc Eye Loupe Set	£5.82	£6.99

Lumagpy 100x Microscope



- Get up close and see real detail
- Magnifies to x100
- Bright LED light
- Battery included

With this amazing microscope you can magnify things x100! Try pressing it against fabric and you can see the weave in great detail. Take a look at your strands of hair and see how each strand is formed. This microscope is ideal for people that work with fine detail.

Order Code	Mod.	Price each exc. VAT	inc. VAT each
L11BK	100x Microscope	£6.65	£7.99

Subscribe to our newsletter
For deals and information
maplin.co.uk



Maplin 6x Linen Tester Magnifier



- 6x linen tester magnifier
- Precision glass lens
- Folding metal case with scale
- Supplied with carry pouch

Order Code	Mod.	Price each exc. VAT	inc. VAT each
A82AW	6X Linen Tester Mag	£6.65	£7.99

Rolson Double Magnifying Glass for Spectacles



- Clip-on spectacle eye loupe
- Spring loaded clip attaches to spectacle frame
- May be flipped up when not required
- High quality 25mm diameter lens
- Sizes 3.3x and 5x, which together create 16.5x magnification

Order Code	Mod.	Price each exc. VAT	inc. VAT each
N30GC	Double Glasses Mag	£7.49	£8.99

Rolson Hands Free Magnifier with Light



- Mains lens diameter 105mm
- 2x and 4x magnification
- Clip on light supplied with 2 x AA batteries and neck cord
- Ideal for reading, embroidery, knitting, model making etc.

Order Code	Mod.	Price each exc. VAT	inc. VAT each
N836Z	Hands Free Magnifier	£6.65	£7.99

Maplin 4 LED Dual Powered Illuminated Clip on Magnifier



- The ideal vision aid with wide illumination range
- Ideal for map reading, hobby, electronic and craft applications
- Can be battery or USB powered
- Clamp for attaching to books, tables, workbenches and more
- Table-top stand to mount onto clip for free-standing use
- 165mm gooseneck adjusts the angle of the magnifying head
- Frameless design for extended field of vision
- Main aspheric lens has 100mm diameter with 2x magnification
- Inset lens has 20mm diameter with 4x magnification
- 4 LEDs to illuminate the magnifier for detailed work
- Simple on/off switch to operate the LEDs
- USB power cable included
- Requires 2 x AAA batteries (Order Code: L42AL, not included)
- Weight: 242g

Order Code	Mod.	Price each exc. VAT	inc. VAT each
N85HR	Large Ill Magnifier	£9.15	£10.99

Shopping with us is easy...

In-store



7 days a week, check store listings at the back of the catalogue for address details

Online



maplin.co.uk

24hrs a day, 7 days a week, 365 days a year

Phone



0333 400 9500

Phone lines open 7 days a week

Buying for business?

0333 400 9740

Rolson 2 LED Magnifying Visor



- 2 directional light LEDs
- 4 different magnification levels for the lens: 1.2x, 1.8x, 2.5x and 3.5x
- Adjustable head - visor can be flipped up when not required
- Visor can be used over spectacles if required
- Supplied with 2xAAA batteries

Order Code	Mod: 219971	Price each exc. VAT 1+	inc. VAT each
N70FK	Precision 2LED Visor	£14.99	£17.99

22W Fluorescent Daylight Magnifier Lamp



- Ideal for intricate work for electronic engineers and hobbyists
- Shadow-free light with no heat emission
- High quality 125mm (5 inch) 5 dioptr glass lens
- Spring balanced metal arms and locking knobs allow the unit to be secured in any position
- Multi position G-clamp mounting bracket
- Spare tube available (Order code: N11CH)

The Maplin 22 W Magnifying lamp provides crisp, artefact and shadow free light with almost no heat emissions. Combined with a high quality 5 dioptr glass magnifying lens, it makes even the most intricate jobs manageable. The sprung steel arms and multi position G-clamp offer a full range of adjustments for a truly flexible lighting instrument.

Order Code	Mod: 809893	Price each exc. VAT 1+	inc. VAT each
A29FF	22W Magnifying Lamp	£33.32	£39.99

22W Fluorescent Daylight Magnifier Lamp Spare Tube



- Spare tube for A29FF, 22W Fluorescent Daylight Magnifying Lamp

Order Code	Mod: 809894	Price each exc. VAT 1+	inc. VAT each
N11CH	Spare tube for A29FF	£5.82	£6.99

USB Digital Microscope with 300x Magnification



- Has many different uses from education, nature, science and industry through to the hobbyist and just for fun
- Ideal for inspecting photos, fibres, bank-notes, PCBs, insects and print
- Can also be used to view teeth, hair, skin, etc
- 10x to 300x magnification
- Supports USB 1.1 and 2.0 - no additional power supply required
- Takes digital stills as snapshots, video streaming and time lapsed video function
- 6-LED light
- Linear size measurement function
- Windows XP and Vista compatible

This universal digital microscope is a versatile camera that shows objects in "live view" with up to 300x magnification on the computer screen. Powered by the USB port of the computer, this digital magnifier is ideal for quality checking and industrial inspection such as examining PCBs, textile and printing. It can also be used during the manufacturing process, for skin and scalp examinations and enlarging small print. The digital microscope can be used by coin, stamp and stone collectors, for science, nature and education, as a reading aid or just for fun! It has a multitude of uses - the only limitations are your imagination!

Contents
 USB digital microscope
 USB cable
 CD with application software and instruction manual
 Stand

Specifications:

Type	USB
Lens Strength	300x
Image Sensor	1.3 Megapixel
Maximum Resolution	1280 x 1024
Compatible Operating Systems	Windows XP, Win 7, Win 8
Interface	USB1.1, USB2.0

Product Width	34mm
Product Depth	34mm
Product Height	10mm
Product Weight	60g

Order Code	Mod: 812026	Price each exc. VAT 1+	inc. VAT each
N46HF	USB Microscope	£24.99	£29.99

USB Digital Microscope with 400x Magnification



- Discover the microscopic world via your PC/laptop
- Multiple uses - education, science and industry to the hobbyist and just for fun
- 1.3MP (2.0MP interpolated) USB-powered microscope
- Massive 400x magnification
- Takes digital stills as snapshots and supports video recording
- 4 ultra bright white LED lights
- Supplied with stand

Image sensor:	2MP [interpolated], 1.3MP CMOS
Max. capture resolution:	1600x1200
Colour:	24-bit RGB
Focus range	Manual, 10mm to
Flicker frequency	50/60 Hz
Frame rate:	<30fps @ 600 Lux
Magnification ratio	20x-400x
Shutter speed	1/1000 to 1 sec
Video format	AVI
Still image format	JPG / BMP
White balance	Auto
Exposure:	Auto
Light source	4 white LED
PC interface:	Mini USB2.0
Operating systems	Win 98SE/ME/2K/XP/Vista 32
OSD language	English
Power supply	5V from USB
Bundled software	MicroCapture
Dimensions [L x]	110 x 33 mm

Order Code	Mod: 286566	Price each exc. VAT 1+	inc. VAT each
N43HH	400x USB DigMScope	£41.65	£49.99

Maplin TV

Home of innovation, handy tips and How To videos
youtube.com/maplintv



Maplin TV

Home of innovation, handy tips and How To videos

Visit our channel...

youtube.com/maplintv



Veho 5 MP Discovery Microscope



- 5 megapixel image sensor
- Suitable for use at home, education, science and industry
- Optical and digital zoom
- LCD display with 8 LED adjustable light source
- Rechargeable lithium battery
- microSD card slot for saving images or video

The VMS-005-LCD standalone Discovery microscope from Veho has been designed for both home and commercial purposes. With up to 1200x digital magnification at home this microscope is the perfect educational companion for all the family as well as a great tool for the hobby enthusiast. As a commercial instrument the microscope has a wide range of commercial uses including inspection of electronics, print, hallmarks and of course medical conditions. The LCD screen and rechargeable battery make this the perfect microscope for activities out in the field or on the road. The on board micro SD slot means that images and video can be saved internally on the microscope and downloaded to a PC, Mac or iPad at a later date. Alternatively connect the microscope to a PC or Mac and used the supplied software to calibrate and measure objects. The time-lapse functionality allows timed photographs magnified at up to 1200x to enable time-lapse movies such as growing mould or decaying food.

Contents

VMS-005-LCD
Quick start guide
Software CD
Battery
4 GB microSD card
USB Cable
TV cable
Calibration chart
Cleaning fabric

Image Sensor	5 megapixel
Controller	High Speed DSP
Flicker Rate	50 Hz/60 Hz
Focus Range	Manual Focus From 10 mm to 30 mm
Light Source	8 LEDs with Adjustable Brightness
Magnification - Digital	1200x
Magnification - Optical	300x
Battery	Rechargeable 1050 mAh Lith-ion Battery
Working Time	2 hours
Charge Time	3 hours

Software Compatibility	Windows XP SP2/ Vista/7/8 and Mac 10.6-10.8
Video Format	AVI
Video Capture Resolution	VGA, QVGA - 30 fps
Software Languages	English, German, French, Spanish, Russian, Italian, Portuguese, Dutch, Polish, Japanese, Korean, Chinese
On Screen Display Languages	English, German, French, Spanish, Italian, Portuguese, Dutch, Japanese, Chinese Simplified, Chinese Traditional
LCD Screen	3.5" LCD screen, 4:3 ratio
microSD Card Capacity	Up to 32 GB microSDHC
TV Output	Yes

Order Code	Mod: 1007148	Price each exc. VAT	inc. VAT each
N78DP	Veho5MP Microscope	£166.65	£199.99

- Over mould case and switch
- Improved grip
- Supplied with 1 x 1.5Ah Li-Ion, 30 screwdriver bits, a charger, and a grip case.

The Ryobi CSD-4130GN 4 volt Lithium-Ion cordless screwdriver comes with lithium-ion battery for more autonomy and enhanced comfort. The 12 torque setting positions offer optimum control with an automatic spindle lock, and aluminium gear guard. Reverse action for driving and unscrewing, and innovative QuickChange system for changing accessories quickly with one hand. Includes a built-in LED light for lighting nooks and crannies and mechanical torque setting, with GripZone coating.

Order Code	Mod: 1033103	Price each exc. VAT	inc. VAT each
N57DV	Ryobi 4V Li-Ion SD	£66.65	£79.99

Power Tools

Cordless Screwdrivers

Maplin 4.8V Cordless Screwdriver



- Forward and reverse action
- Palm-sized compact design
- Supplied with screwdriver bits and AC/DC mains charger
- Built-in LED indicators
- Soft comfort grip handle

Warranty: 5 years

Order Code	Mod: 1032869	Price each exc. VAT	inc. VAT each
A92QW	Map 4.8V CL Sdriver	£13.32	£15.99

Ryobi CSD4130GN 4V Lithium Ion Cordless Screwdriver



- Secure quick change chuck
- 12 torque settings
- LED light for dimly lit areas

Cordless Drills

Maplin 18V Lithium Ion Cordless Drill



- Great for all those DIY jobs and ideal for wood, metal, plastic, etc.
- 3/8-inch keyless drill chuck
- 23 adjustable torque settings
- Maximum torque: 15 Nm
- Variable speed: 0-550 rpm
- Forward and reverse
- Soft grip handle
- Supplied with an assortment of drill and power bits
- Includes 1300mAh lithium-ion battery and charger
- 3-5 hour battery charge time
- Drilling capacity of 10 mm in steel
- Drilling capacity of 25 mm in wood
- Supplied in a blow moulded carry case
- Weight: 1.55 kg

A spare battery is also available Order Code N30QF [sold separately]

Contents:

1 x cordless drill
1 x 1300 mAh lithium-ion battery
1 x battery charger
1 x bit holder
6 x HSS twist wood drills: 1.5, 2.5, 3, 4, 5 and 6 mm
2 x 25 mm Phillips screwdriver bits: PH1 and PH2
2 x 25 mm Pozidriv screwdriver bits: PZ1 and PZ2
2 x 25 mm slotted screwdriver bits: 4 mm and 6 mm
1 x instruction manual

Order Code	Mod: 812093	Price each exc. VAT	inc. VAT each
N29LK	18V Li-Ion CL Drill	£33.32	£39.99



We can deliver to your home or office

(UK only)

Einhell BT-CD18 Drill Driver 18 Volt 1 x 1.3Ah NiCd



- Quick change chuck
- Quick-Stop
- Torque selector
- Lightweight design
- Electronic speed control
- Standard accessories : 3 - 5 hour charger and transport/storage case
- Idle speed : 0-550 min-1
- Torque settings : 22
- Charging time : 3-5 hours

This Einhell BT-CD18 is a powerful 18 Volt cordless drill driver and, with all its quality features, will be a welcome addition to any DIY enthusiast's tool kit. Fitted with a 10mm double-sleeve keyless chuck that holds the drill bit more securely so there is no slipping when tackling the most demanding of jobs, and the quick-stop system to ensure easy tool operation at all times. It also has an excellent electronic system that gives the user the control for gentle starting and high torque, thereby making all drilling and screwdriving work child's play.

This Einhell drill driver has soft-grip design for added comfort and safety and an on-board magnetic screw tray so that the screws are with you at all times and are not rolling around the floor.

A powerful motor is fitted to this cordless drill that gives greater torque and power. This makes drilling work and brickwork jobs a 'breeze'.

Order Code	Mod:	Price each exc. VAT 1+	inc. VAT each
N59DV	Einhell 18V CL Drill	£37.49	£44.99

Ryobi 18V Lithium Ion Cordless Drill Twin Pack



- 1 x CDC1802 One+ Drill/Driver
- 1 x LLCD18022 One+ Combi Hammer Drill
- 2 x One+ 18 Volt 1.3Ah Li-Ion Batteries
- 1 x Charger
- 1 x 17 piece screwdriver bit set

The versatile LLCD18022 is ideal for drilling into masonry, metal and wood and for screwdriving. Its 2 speed metal gear box increases its durability, whilst its planetary gears ensures that it is compact and lightweight. The 13mm single sleeve keyless chuck allows the drilling of a variety of hole sizes and one handed bit changing.

The CDC1802 One+ Drill/Driver features electronic speed control, along with reverse and brake for total control. It has two gears, meaning that it will suit most materials and applications. It also has 24 torque settings and GripZone™ overmould technology, providing improved comfort with a positive grip. Lastly, it has a 10mm keyless chuck and comes with a magnetic screw and bit holder.

The kit includes two RBC18LL13 1.3Ah Lithium Ion batteries and a charger

Order Code	Mod:	Price each exc. VAT 1+	inc. VAT each
A49RF	Ryobi R18CK2C-Li13S	£149.99	£179.99

Corded Drills

Einhell BT-ID650E Impact Drill



- 650 Watt, 240 Volt
- Soft grip
- Continuous operation button
- Electronic speed control
- Ergonomic design
- Integrated electronic controls
- No Load Speed: 0-2,600/min
- Impact rate: 0-39,000/bpm
- Drilling Capacity: concrete: 10mm, steel: 13mm, wood: 25mm, chuck: 13mm
- Keyless
- Weight: 2.10kg
- Items supplied: metal depth stop and additional handle

The Einhell BT-ID 650 E impact drill is a handy tool for beginners, which performs solidly on drilling and impact drilling jobs in the home and hobby room. Using the integrated electronic controls the speed can be pre selected and precisely adjusted. Reversing is also possible.

The adjustable drilling depth stop made of metal enables exact, repeat drilling depths of the BT-ID 650 E. The soft grip and the additional handle enable safe and comfortable handling of the machine. The ON button can be locked in position for continuous operation. The housing surface is soft-painted to provide a particularly good grip.

The Impact drill can be used universally. Working with this machine does not tire due to the smooth run, the electronic speed control and the ergonomic design.

Order Code	Mod:	Price each exc. VAT 1+	inc. VAT each
A50RF	Einhell Drill 650W	£33.32	£39.99

Milwaukee Kango 540S Combi Breaking Hammer - SDS Max 1100 Watt 240 Volt



- 2 mode SDS-Max combi hammer drill, suitable for hammer drilling and chiselling
- Roto-stop and multi position chisel function give 12 different positions to optimise the working angle
- Robust magnesium gear housing for tough environments
- Mains powered 240V version with 1100W power

The Milwaukee 540S Combi SDS-Max Breaking Hammer is a 2 mode SDS-Max combi hammer, suitable for hammer drilling and chiseling. Its rctc-stop and multi position chisel function give 12 different positions to optimise the working angle. The Kango 540S has robust magnesium gear housing for tough environments, exact seat fitting of gear components and better cooling. Its safety clutch protects both the operator and machine if the drill bit jams. Low vibration construction enhances usage time per day, and a soft-grip main side handle provides comfort.

Weight: 6.3kg
 Toolholder: SDS-Max
 Mode: Hammer Drill & Chisel
 Input power: 1,100 Watt
 Impact Rate: 3,000/bpm
 Blow Energy: 7.5 Joules

Order Code	Mod:	Price each exc. VAT 1+	inc. VAT each
A12RC	Milwaukee 540S 240V	£365.82	£438.99

Drill Accessories

Maplin Automatic Centre Punch



- Hardened tip for instant marking
- No hammer needed
- Knurled brass handle
- Dimensions: 130mm (l) x 13mm (dia.)

Warranty: 5 years

Order Code	Mod:	Price each exc. VAT 1+	inc. VAT each
A88QW	Map Centre Punch	£4.15	£4.99

Maplin Keyless Chuck



- 3-jaw keyless pin chuck
- Ideal for handling shank diameter of up to 6.35mm (1/4-inch)
- Overall length: 62mm
- Overall diameter: 26mm

Warranty: 5 years

Order Code	Mod:	Price each exc. VAT 1+	inc. VAT each
A95QW	Map 1/4in Chuck	£4.99	£5.99

Maplin 2-Piece Quick Release Bit Holder Set



- Sizes 60mm and 150mm
- Quick change 1/4 inch shank with built-in magnet to hold bits securely in place
- Accepts all standard 1/4 inch hexagon driver bits

Warranty: 5 years

Order Code	Mod:	Price each exc. VAT 1+	inc. VAT each
A96QW	Map 2pc Quick Chuck	£4.99	£5.99

Maplin 16-Piece Hole Saw Kit



- Cut smooth accurate holes through up to 1-inch thick wood, dry wall and plaster
- Includes 12 steel cutting heads and all the bits you need to connect them to your drill
- Cutting heads range from 19mm - 127mm (¾-inch to 5-inch) diameter
- Supplied in a handy plastic storage case

Warranty: 5 years

Order Code	Mod: 1032864	Price each exc. VAT 1+	inc. VAT each
A90QW	Map 16Pc HoleSaw Kit	£8.32	£9.99

Maplin 19-Piece HSS Titanium Coated Drill Bit Set

- 19-piece metric titanium HSS drill set
- Suitable for drilling wood, metal and plastic
- Sizes: 1, 1.5, 2, 2.5, 3, 3.5, 4, 4.5, 5, 5.5, 6, 6.5, 7, 7.5, 8, 8.5, 9, 9.5 and 10mm

Warranty: 5 years



Order Code	Mod: 1032865	Price each exc. VAT 1+	inc. VAT each
A93QW	Map 19Pc Drill Set	£9.15	£10.99

Maplin 21-Piece Miniature Drill Bit Set with Pin Vice



- Micro HSS titanium coated drill set in a plastic indexed box with sliding window
- Includes pin vice and 20 bits ranging from 0.3mm to 1.6mm
- Each bit has its own individually marked case
- Handy dispenser box adjusts to release individual bits

20 miniature drill bits: 0.3, 0.35, 0.4, 0.45, 0.5, 0.55, 0.6, 0.65, 0.7, 0.75, 0.8, 0.85, 0.9, 0.95, 1.0, 1.2, 1.3, 1.4, 1.5 and 1.6mm

1 x pin vice

Warranty: 5 years

Order Code	Mod: 1032866	Price each exc. VAT 1+	inc. VAT each
A94QW	Map MicroMetricSet	£8.32	£9.99

Maplin 20-Piece Drill Bit Set



- Set contains 8 hex shank drills
 - Also includes 8 x 50mm bits, 3 nut drivers and magnetic bit holder
 - Supplied in a handy storage case
- 8 x hex shank drills: 2 x 1.5mm, 2 x 2.5mm, 3.0mm, 4.0mm, 5.0mm and 6.0mm
 2 x 50mm slotted bits: 4mm and 5mm
 2 x 50mm Phillips bits: PH1 and PH2
 2 x 50mm Pozidriv bits: PZ1 and PZ22 x 50mm star bits T10 and T15
 3 x nut drivers: 5, 6 and 8mm
 1 x magnetic bit holder
 1 x handy storage case
 Warranty: 5 years

Order Code	Mod: 1032870	Price each exc. VAT 1+	inc. VAT each
A98QW	Map 20Pc DrillBitSet	£9.15	£10.99

Maplin 17-Piece Twist Drill Set



- Ideal for drilling aluminium, wood, metal and plastic
- Quality drill bits with advanced 118 degrees split point
- Sizes: 2 x 1.5mm, 2 x 2.0mm, 2 x 2.5mm, 2 x 3.0mm, 2 x 3.2mm, 1 x 3.5mm, 2 x 4.0mm, 2 x 5.0mm, 1 x 5.5mm and 1 x 6.0mm

Warranty: 5 years

Order Code	Mod: 1032871	Price each exc. VAT 1+	inc. VAT each
A97QW	Map 17Pc TwistDrills	£9.15	£10.99

Maplin 3-Piece 40cm SDS Drill Bit Set



- For use on concrete, masonry and stone
- Sizes 12, 16 and 25mm diameter with 40cm length
- Manufactured with tungsten carbide tip and ground centre point
- Copper brazed with shot blast finish

Warranty: 5 years

Order Code	Mod: 1032860	Price each exc. VAT 1+	inc. VAT each
A51QX	Map40cm DrillBit 3Pk	£10.82	£12.99

Maplin 3-Piece Titanium Step Drill Set

- Titanium coated for durability
 - Sizes 4 - 12mm, 4 - 20mm and 4 - 32mm
 - Steps in 2mm increments
- Warranty: 5 years



Order Code	Mod: 1032867	Price each exc. VAT 1+	inc. VAT each
A91QW	Map 3-Pc Step Drill	£16.66	£19.99

Irwin Speedhammer Plus Drill Bits



- Suitable for SDS drilling and designed for more aggressive cutting angles
- Patented extra short drill bit head and high performance carbide tip
- Self-centring for easier control
- Range of diameters and lengths available

The Irwin SDS Speedhammer Plus Drill Bits are designed for SDS drilling. They drill exceptionally fast into brick, block, masonry, concrete and granite. The patented, unique single flute design ensures efficient, speedy removal of dust and lower vibrations and 28% greater capacity meaning more efficient waste removal. They have a patented extra short drill bit head which means the head takes 80% of the workload, ensuring higher durability and speed. Clears drilling dust directly into the flute, reducing the risk of clogging. The bits have 25% more tungsten carbide for extra strength and they drill 25% faster than competitive drill bits with the same high durability. In addition, they have more aggressive cutting angles and self-centring for faster drilling

Code	Diameter	Working length	Total Length
A03RC	7.0mm	100mm	160mm
A04RC	8.0mm	400mm	460mm
A05RC	10.0mm	400mm	460mm
A06RC	12.0mm	400mm	460mm
A07RC	14.0mm	400mm	460mm
A08RC	16.0mm	400mm	460mm
A09RC	18.0mm	400mm	460mm

Order Code	Mod: 1031190	Price each exc. VAT 1+	inc. VAT each
A03RC	Irwin Drillbit7x160	£3.74	£4.49
A04RC	Irwin Drillbit8x460	£11.66	£13.99
A05RC	Irwin Drillbit10x460	£12.08	£14.49
A06RC	Irwin Drillbit12x460	£12.49	£14.99
A07RC	Irwin Drillbit14x460	£12.91	£15.49
A08RC	Irwin Drillbit16x460	£13.71	£16.49
A09RC	Irwin Drillbit18x460	£21.66	£25.99

Find out more in-store

Our staff can offer friendly and expert advice; we're here to help



Over 200 stores nationwide

Irwin Drill Bit Set for Cordless Machines Set of 5

- Set of 5 drill bit pieces designed for cordless multipurpose drilling
- Four-facet ground carbide tip for lower drilling pressure and better centring
- Will drill a wide selection of different materials



The Irwin cordless drill bits have been designed for cordless low/min multi-purpose drilling. In tests they produced between 90-129% more holes per battery charge than leading competitors. They have a four-facet ground carbide tip for lower drilling pressure and better centring and allow for combined drilling into wood and brickwork. The cordless drill bit is excellent for such drilling jobs where you drill through wood into brickwork. Only one drill bit is needed to do the job and will drill a wide selection of different materials like:

- Brickwork
- Ceramic Tiles
- Breeze Block
- Wood
- Dry Wall
- Gypsum Board
- Limestone
- Slate
- Marble
- Eternite
- Plastics/Reinforced plastics.

Set of 5 drill bits - 5, 5.5, 6, 8 and 10 mm.

Order Code	Mod: 1029402	Price each exc. VAT 1+	inc. VAT each
A01RC	Irwin Drillbit 5Pc	£18.32	£21.99

Irwin Drill Bit Set for Cordless Machines Set of 7

- Set of 7 Drill bit pieces designed for cordless multipurpose drilling
- Four-facet ground carbide tip for lower drilling pressure and better centring
- Will drill a wide selection of different materials



The Irwin Cordless Drill Bits have been designed for cordless low/min multi-purpose drilling. In tests they produced between 90-129% more holes per battery charge than leading competitors. They have a four-facet ground carbide tip for lower drilling pressure and better centring and allow for combined drilling into wood and brickwork: the Cordless Drillbit is excellent for such drilling jobs - where you drill through wood into brickwork. Only one drillbit is needed to do the job and will drill a wide selection of different materials.

Set contains: 4, 5, 6, 7, 8, 10 and 12 mm drillbit sizes.

Order Code	Mod: 1031220	Price each exc. VAT 1+	inc. VAT each
A02RC	Irwin Drillbit 7Pc	£25.40	£30.49

Buying for business?

0333 400 9740



Rotary Tools

130W Variable Speed Rotary Tool and 172 Piece Accessory Set



- Drills, cuts, sharpens, cleans, polishes and engraves most surfaces
- Ideal hobby and craft tool
- Variable speed control: 8,000-33,000rpm
- Spindle lock to easily change accessories
- Includes 172 accessories for multipurpose use
- Supplied in a wall mountable or free standing handy storage case

Cordless	No
Variable Speed	Yes
Type	Rotary Tool
Motor Voltage	230V
Minimum to Maximum RPM	8,000 to 33,000rpm

Order Code	Mod: 223105	Price each exc. VAT 1+	inc. VAT each
N03FY	172pc Rotary Tool	£29.15	£34.99

130W Variable Speed Rotary Tool and 119 Piece Accessory Set



- Drills, cuts, sharpens, cleans, polishes and engraves most surfaces
- Variable speed control: 8000-30,000rpm
- Spindle lock to easily change accessories
- Includes 119 accessories for multipurpose use
- Half transparent storage case
- Ideal hobby and craft tool

Accessory Set Contents:

Qty	Accessory	Dimensions
10	sanding bands	6.35 x 12.7mm
10	sanding bands	12.7 x 12.7mm
2	aluminum oxide grinding wheel	12.7 x 9.5mm
2	silicon carbide grinding wheel	10.3 x 4mm
1	nylon brush axial	5 x 44.5mm
1	nylon brush axial	12.7 x 44.5mm
1	stainless steel brush axial	5 x 44.5mm
1	stainless steel brush axial	12.7 x 44.5mm
1	brass brush axial	5 x 44.5mm
1	brass brush axial	12.7 x 44.5mm
1	sanding shank	12.7 x 12.7mm
1	sanding shank	6.35 x 12.7mm
4	aluminum oxide grinding wheel	19 x 3.2mm
4	silicon carbide grinding wheel	19 x 3.2mm
6	diamond cutters	3.2mm, 2.4mm, 1.6mm
3	hss cutters	3.2mm x 2 / 2.4mm x 2 / 1.6mm x 2
3	chrome plated collet	

6	hss drills	
1	polishing compound	
45	sanding discs	
5	fibre glas cut-off wheel	
1	cloth wheel	25.4 x 3.2mm
1	felt wheel	25.4 x 6.35mm
2	felt wheel	12.7 x 9.5mm
1	felt wheel point	19 x 9.5mm
1	mandrel for cut off wheel	
1	mandrel for cloth wheel	
1	mandrel for felt wheel	
1	wrench	9.5mm

Order Code	Mod: 228660	Price each exc. VAT 1+	inc. VAT each
N60GR	119Pc Rotary Tool	£29.15	£34.99

170W Variable Speed Rotary Tool with LCD and 219 Piece Accessory Set



- Drills, cuts, sharpens, cleans, polishes and engraves most surfaces
- Ideal hobby, craft and restoration tool
- Removable handle for additional support and control
- Digital speed selector via up/down buttons
- Speed is displayed on LCD in rpm
- Variable speed control: 8,000 - 35,000 rpm (in increments of 1,000)
- 1 mm - 3.2 mm collet size
- Spindle lock to easily change accessories
- Includes pen grip flexi-drive shaft - ideal for intricate work
- Includes 219 accessories for multipurpose use
- Supplied in handy storage case

Technical specifications:

Cordless	No
Collet size:	1mm - 3.2mm
Variable Speed	Yes
Voltage	V 230 ac
Type	Rotary Tool
Frequency	50Hz
Motor Voltage	230V
Power rating	170W
Minimum to Maximum RPM	8,000 to 35,000rpm

Contents:

- 1 x 170W rotary tool
- 1 x plastic storage box
- 35 x regular cut-off wheels (24mm x 6mm)
- 30 x heavy duty cut-off wheels (24mm x 8mm)
- 36 x sanding discs (180 grit)
- 36 x sanding discs (320 grit)
- 1 x polishing compound
- 3 x brass brushes
- 3 x steel brushes
- 1 x pen nylon brush
- 1 x flap wheel (80 grit)
- 10 x grinding stones
- 1 x mandrel for sanding bands (12.7mm x 12.7mm)
- 1 x mandrel for sanding bands (6.35mm x 12.7mm)
- 6 x drill bits (2 each of 1.5mm, 3mm and 3.2mm)
- 1 x cloth wheel (25.4 x 4.7mm)
- 1 x felt wheel (25.4 x 6.7mm)
- 1 x rubber emery wheel (22 x 4mm)
- 1 x felt wheel point (19.5 x 19mm)
- 4 x felt wheel (21.2 x 6mm)
- 6 x aluminium oxide grinding wheels (20 x 3.2mm)
- 6 x silicon carbide grinding wheels (20 x 3.2mm)
- 1 x whet stone (25 x 9 x 9mm)
- 5 x diamond grinders
- 3 x mandrels for cut-off wheels
- 1 x mandrel for felt wheels
- 1 x hss cutters

- 1 x spindle lock for flexible shaft
- 1 x spanner
- 4 x collets (1pc x 1.5mm, 2pcs x 2.3mm and 1pc x 3.2mm)
- 4 x sanding bands (12.7mm x 12.7mm)
- 8 x sanding bands (6.35mm x 12.7mm)
- 5 x cut-off wheel fibre glass (732 x 1mm)
- 1 x flexible shaft
- 1 x removable handle

Order Code	Mod: 813375	Price each exc. VAT 1+	inc. VAT each
N17QN	LCD Rotary Tool	£41.65	£49.99

Rotary Tool Accessories

180 Part Rotary Accessory Kit



- Complete range of polishing, drilling, grinding and cutting pieces for use with most mini-rotary tools
- Can be used on wood, plastic, fibreglass, metal and stone
- Ideal for hobbies, restoration, electronics and DIY
- Everything you need to replenish stocks for your rotary tool

Order Code	Mod: 812091	Price each exc. VAT 1+	inc. VAT each
N61GR	180Pc Rotary Acc Set	£9.99	£11.99

400 Part Rotary Tool Accessory Kit



- Complete range of polishing, drilling, grinding and cutting pieces for use with most mini-rotary tools
- Can be used on wood, plastic, fibreglass, metal and stone
- Ideal for hobbies, restoration, electronics and DIY
- Everything you need to replenish stocks for your rotary tool
- Case doubles up as an on-the-move carry case, fixed wall unit or free stands on a work bench

Order Code	Mod: 812092	Price each exc. VAT 1+	inc. VAT each
N63BX	400pc Rotary Acc Set	£19.15	£22.99

Angle Grinders

Einhell BT-AG500 115mm Mini Grinder



- 500 Watt, 240 Volt
- Lightweight
- Spindle lock enables fast and easy tool change
- Robust, flat metal gear head
- Additional handle
- Soft painted housing surface
- No load speed: 11,000/min
- Disc diameter: 115mm, M14
- Weight: 1.56kg

The Einhell BT-AG 500 angle grinder is suitable for DIY enthusiasts, it is a light-weight and handy tool which provides good service on cutting, grinding and roughing jobs in the garden, workshop and garage. The tool has a disk guard for high safety during operation. Its spindle lock enables fast and easy tool change.

The BT-AG 500 is equipped with a robust, flat metal gear head which ensures good power transmission and is very helpful in places which are difficult to access. An additional handle which can be adjusted in two positions enables user-friendly and safe handling even during long work sessions. The housing surface is 'soft-painted' to provide a particularly good grip. A flange nut wrench is also provided.

Order Code	Mod: 1033025	Price each exc. VAT 1+	inc. VAT each
A54RF	Einhell Grinder 500W	£24.99	£29.99

Ryobi EAG-600RS 115mm Angle Grinder



- High torque gear box
- 600 Watt, 240 Volt
- Lock on switch
- 2 position handle
- Left or right handed operations
- Easy wheel and accessory change

The Ryobi EAG-600RS is a 115mm mini angle grinder with a powerful 600 Watt mini grinder and high torque gear box. Featuring a lock on switch for continued use and a 2 position handle for left or right handed operations. Spindle lock offers easy wheel and accessory change.

Specification: input Power: 600 Watt, load speed: 11,000/min, disc diameter: 115mm M14 thread

Order Code	Mod: 1032996	Price each exc. VAT 1+	inc. VAT each
N58DV	Ryobi 600W AngGrind	£49.99	£59.99

Diamond Cutting Blade 115mm



- 115mm diameter segmented dry cutting blade
- Ideal for cutting concrete, stone, bricks etc
- Ideal for use with most 115mm angle grinders

Order Code	Mod: 219344	Price each exc. VAT 1+	inc. VAT each
N73CY	115mm Diamond Blade	£2.49	£2.99

Powered Saws

Einhell BT-JS400E Variable Speed Jigsaw 400W



- Electronic speed control
- 400 Watt, 240 Volt
- Dust extraction by adaptor
- Adjustable saw plate, tiltable up to 45° to the left and right
- Soft-painted housing surface
- Standard accessory: 1 saw blade for wood
- Stroke rate: 500 - 3,000 min
- Keyless blade change
- Cutting depths: wood max. 55mm, steel max. 6mm, plastic max. 10mm

Order Code	Mod: 1033002	Price each exc. VAT 1+	inc. VAT each
A52RF	Einhell Jigsaw 400W	£24.99	£29.99

Sander

Einhell BT-OS150 Orbital Sander 1/3rd Sheet



- 150 Watt, 240 Volt
- Lightweight
- Integrated dust extraction adaptor
- Quiet operation allows fatigue-free use
- Soft grip handle
- Additional handle for optimum control
- Items supplied: abrasive paper and dust extractor adaptor
- No load speed: 11,500/min
- Oscillating diameter: 2.0mm
- Base plate: 187 x 90mm

Einhell 1/3rd BT-OS150 Sheet lightweight sander with integrated dust extraction adaptor, makes quick and smooth sanding of various materials easy. Its quiet operation allows fatigue-free use. It has both a soft grip handle, and an additional handle for optimum control. The abrasive disc also features a clamp.

Order Code	Mod: 1033020	Price each exc. VAT 1+	inc. VAT each
A53RF	Einhell Sander 1/3Rd	£19.15	£22.99



Reserve online and collect at the store of your choice



Over 200 stores nationwide

Multi-Function Tool

Einhell BT-MG 220 E Multitool Kit With Electronic Speed Control



- 220 Watt, 240 Volt
- Scraping, sanding and cutting heads
- Quick change attachments
- Soft-grip handle
- Electronic speed control
- Precise control
- No load speed: 15,000 - 22,000/min
- Grinding area: 90 x 90 x 90 mm
- Oscillation angle: 3°
- Product weight: 1.3kg
- Supplied with: triangle sanding disc, scraper, sanding paper, plunge cut saw blade for wood, dust extraction device for triangle sanding disc, dust extraction adaptor, 2 x Allen keys

The Einhell BT-MG220E Multitool kit is a versatile multi-purpose tool with scraping, sanding and cutting heads with quick change attachments for quick and easy tool free changing between sanding and sawing. It has a soft-grip handle and electronic speed control for precise control.

Order Code	Mod.	Price each exc. VAT 1+	inc. VAT each
A51RF	Einhell Tool Kit	£58.32	£69.99

Glue Guns

20W Electric Glue Gun



- Ideal for gluing wood and plastic
- Maximum temperature 170°
- Lightweight and compact
- Flow of glue is delivered by a trigger mechanism
- Supplied with 2 glue sticks - size 11mm x 100mm

Please note that, under the Offensive Weapons Act 1996, this product cannot be sold to anyone under the age of 18.

Order Code	Mod.	Price each exc. VAT 1+	inc. VAT each
A800W	Map Electric GlueGun	£9.15	£10.99

Glue Sticks 10-Pack



- All purpose glue sticks
- Size: 11mm x 100mm

Warranty: 5 years

Please note that, under the Offensive Weapons Act 1996, this product cannot be sold to anyone under the age of 18.

Order Code	Mod.	Price each exc. VAT 1+	inc. VAT each
A500X	Map GlueSticks 10Pk	£3.32	£3.99

Soldering

Battery & Gas Irons

Maplin Battery Powered Soldering Iron



- Fully functioning 4.5V 8W battery powered soldering iron
- Reaches working temperature in just 15 seconds
- Small and compact for portability
- Powered by 3xAA batteries (not included)
- Runs for approximately 1 hour on new batteries
- Includes iron plated long life tip, easily replaced by unscrewing the tip holder
- Also includes approximately 90cm of solder and a safety cap which locks the switch in the off position
- Operated by sliding the power switch to the on position and holding the power button down
- Spare element and tip (combined) available - Order Code: N40JG

Order Code	Mod.	Price each exc. VAT 1+	inc. VAT each
N05HW	Batt Soldering Iron	£12.49	£14.99

Maplin Battery Powered Soldering Iron 3 Additional Tips



- A set of three fine point tips for use with the N05HW Battery Powered Soldering Iron

Order Code	Mod.	Price each exc. VAT 1+	inc. VAT each
N40JG	N05HW Bits 3 Pk	£3.32	£3.99

Maplin 30W 3-in-1 Gas Soldering Iron Kit



- 3-in-1 design, soldering iron, torch and hot air blower
- Adjustable gas power range from 30W to 100W
- Ideal starter kit for students or beginners to soldering
- Complete with plastic storage case, interchangeable tips, solder and sponge
- Ergonomic handheld design for comfortable use

Everything you need to solder, braze, heat shrink and strip paint. This 30W 3-in-1 Soldering Iron kit is refillable with standard butane gas and has an on / off switch and built in stand for safety. Comes complete with interchangeable tips for different usage: micro torch tip, hot knife tip, chisel point tip, large solder tip, hot blower and a fine solder tip. Ideal kit for electrical repair, tin or plastic melting, heat shrinking, car repairs, hobby / jewellery repair or even arts and craft use on timber or paper.

Temperature Range	1300°C
Tips Included	Yes
Head Material	Metal alloy
Handle Material	Plastic
Colour	Blue
Cylinder Capacity	20ml
Operating Capacity	60min
Battery Life	N/A
Product Width	20mm
Product Depth	20mm
Product Height	213mm
Product Weight	59g

Order Code	Mod.	Price each exc. VAT 1+	inc. VAT each
N25DE	3-In-1 Solder GasKit	£16.65	£19.99

Pro-Iroda Solderpro 50 Gas Soldering Iron



- Pin point 1300°C adjustable flame
- Long lasting quick heat-up catalytic tips
- Range of attachments
- Protective cap with igniter
- Visible fuel window

The Solderpro 50 is a powerful tool packed into a very small package, for the serious technician or hobbyist who needs the versatility of a multifunction heated tool that is truly pocket sized.

Specifications:

Length	140mm [with soldering tip]
Weight	60g (filled)
Soldering tip temperature	210°C - 400°C
Torch temperature	1300°C
Gas container capacity	7ml
Operating time on a full tank	30 minutes at mid setting

Please note these are supplied unfilled. Butane gas available separately. | Order Code N59AN |

Order Code	Mod.	Price each exc. VAT 1+	inc. VAT each
N11AR	Solderpro 50	£24.99	£29.99

Pro-Iroda Solderpro 50 Gas Soldering Iron Kit



- The World's most popular pocket sized butane powered soldering iron
- 1mm catalytic soldering tip, torch head for pinpoint flame and hot knife attachment
- Hot air blower, tip cleaning sponge and coil of solder
- Rugged case to withstand knocks

The World's most popular pocket sized butane powered soldering irons. The Pro-50 is a multi-function heat tool specifically designed for the hobby/DIY enthusiast. 30W-70W equivalent electrical power.

Equivalent to a power range 30-70 Watt Cordless, simple, safe operation anywhere. Ready to use 20 seconds after ignition. Tank capacity for 30 minutes of operation. No cords, can be used anywhere. No electrical interference. Comes with soldering tip and protective cap. Perfect compact size for shirt or pants pocket.

Applications

- Electrical/Electronic Circuit Repair
- Light Plumbing
- Jewelry, Eyeglass Frame Repair
- Model Building
- Arts and Crafts
- Dental Wax Corrections
- Thawing Frozen Locks

Please note: These kits are supplied empty. Butane gas refills are available separately (Order Code: N59AN)

Specification

Length w/cap	153 mm [6.0 in]
Length w/soldering tip	140 mm [5.5 in]
Length w/blow torch tip	142 mm [5.6 in]
Weight (when gas-filled)	60 g
Approximate temperature soldering tip	210-400°C [410-750°F]
Torch	1300°C [2400°F]
Gas container capacity	7 ml
Operating capacity (one gas filling)	30 min. at mid setting

Order Code	Mod: 034956	Price each exc. VAT 1+	inc. VAT each 5+
N12AR	Solderpro 50 Kit	£33.32	£30.65 £39.99

Pro-Iroda Solderpro 50 Gas Soldering Iron Tip Pack 1



- A tip to suit the Solderpro 50 gas soldering iron and Solderpro 50 Kit
- Pack 1: 2 x 1mm pointed tip and 2 x 2mm chisel tip

Order Code	Mod: 810345	Price each exc. VAT 1+	inc. VAT each 5+
N86FA	SolderPro 50 Tip Pk1	£14.15	£13.59 £16.99

Pro-Iroda Solderpro 50 Gas Soldering Iron Tip Pack 2



- A tip to suit the Solderpro 50 gas soldering iron and Solderpro 50 Kit
- Pack 2: 1 x 1mm pointed tip, 1 x hot knife tip, 1 x blow torch tip and 1 x heat blower tip

Order Code	Mod: 810346	Price each exc. VAT 1+	inc. VAT each 5+
N87FA	SolderPro 50 Tip Pk2	£14.15	£13.59 £16.99



Browse our entire range at maplin.co.uk

Pro-Iroda Deflector Soldering Iron Tip S-30 for Solderpro 50 and Solderpro 70

- Deflector soldering iron tip
- Ideal for use with the Solderpro 50 and Solderpro 70 gas soldering irons and kits

Order Code	Mod: 035027	Price each exc. VAT 1+	inc. VAT each 5+
N08AQ	S-30 Solder Tip	£2.32	£2.79

Buy it on the web at maplin.co.uk

Shop for all Maplin products online at our website and check out our latest products and special offers!



Pro-Iroda Solder Pro 70 Gas Soldering Iron



- Solder anywhere! No need for inconvenient mains cabling
- Equivalent power to a 70 W mains iron
- Built-in flint ignitor
- Adjustable fuel regulator controls the tip temperature up to a maximum of 450°C
- Supplied with instructions

The strong nylon casing will hold sufficient liquid butane for one hour's continuous use. The iron is supplied with a 1 mm soldering tip fitted as standard and a protective cap, which has an integral flint lighter and a pocket clip

Max tip temperature	450°C
Max torch temperature	1300°C
Flint life	900 cycles
Length	220 mm
Weight	55 g

Order Code	Mod: 810347	Price each exc. VAT 1+	inc. VAT each 5+
N95AP	Solderpro 70	£33.32	£39.99

Pro-Iroda Solderpro 70 Gas Soldering Iron Kit



- A compact kit with an iron and accessories to cope with a multitude of soldering/hot air applications
- Kit includes: 1mm catalytic soldering tip, torch head for pinpoint flame, hot knife attachment and hot air blower
- Also contains a tip-cleaning sponge, coil of lead free solder and heavy-duty box

The strong nylon casing will hold sufficient liquid butane for one hour's continuous use. The iron is supplied with a 1mm soldering tip fitted as standard and a protective cap, which has an integral flint lighter and a pocket clip. A range of spare tips are available separately

A manual ignition tool (power range 25w-80w) with three extra tips plus cored solder and a cleaning sponge. All packed in a tough polypropylene carrying case

Contents

- 1mm Catalytic Soldering Tip
- Torch Head for Pinpoint Flame
- Hot Knife Attachment
- Hot Air Blower
- Tip Cleaning Sponge
- Coil of Tin/Silver Solder
- Heavy Duty Ultra-Box

Order Code	Mod: 810351	Price each exc. VAT 1+	inc. VAT each 5+
N13AR	Solderpro 70 Kit	£41.65	£37.49 £49.99

Pro-Iroda Solderpro 70 Gas Soldering Iron Tip Pack 1



- A tip to suit the Solderpro 70 gas soldering iron
- Pack 1: 1 x 2mm pointed tip, 1 x 2mm chisel tip, 1 x 4mm chisel tip and 1 x 3mm angle tip

Suitable for both single and kit version of the Solderpro 70

Order Code	Mod: 810349	Price each exc. VAT 1+	inc. VAT each 5+
N88FA	SolderPro 70 Tip Pk1	£14.99	£14.39 £17.99

Pro-Iroda Solderpro 70 Gas Soldering Iron Tips Pack 2



- A tip to suit the Solderpro 70 gas soldering iron
- Pack 2: 1 x 1mm pointed tip, 1 x hot knife tip, 1 x blow torch tip and 1 x heat blower tip

Suitable for both single and kit version of the Solderpro 70

Order Code	Mod: 810350	Price each exc. VAT 1+	inc. VAT each 5+
N89FA	Solderpro 70 Tip Pk2	£14.99	£14.24 £17.99

Pro-Iroda Solderpro 120 Gas Soldering Iron



- A sturdy butane gas (lighter fuel) powered soldering iron
- Self igniting soldering iron - no need for matches
- Ideal for 'meatier' soldering tasks
- Offers equivalent power output to a 120W mains iron

This iron avoids the restrictions often imposed by cables and the availability of a suitable electricity supply. The iron is supplied with a fine point soldering tip

A range of spare tips are available separately - Order Code N90FA

Specifications	
Maximum tip temperature	500°C
Maximum torch temperature	1300°C
Ignition type	Piezo
Maximum operating time	1 hour

Please note these are supplied empty. Butane gas available separately. (Order Code N59AN)

Order Code	Mod: 035515	Price each exc. VAT 1+	inc. VAT each 5+
N14AR	Solderpro 120	£41.65	£49.99



/maplin



@maplintweet



/+maplin



/maplinonline



/maplintv

The Art of Soldering

Getting to know the basics about soldering...

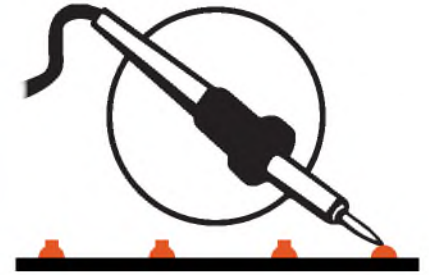

What is soldering all about?

Soldering is a method for joining two metallic parts to give both a mechanical bond and electrical conductivity. A soldered joint is achieved by the melting of fusible alloys to join two metallic parts so that a thin film of alloy is used to fuse the two parts together.

To solder or not to solder, that is the question?

Soldering is the preferred choice for small electrical connections except where the joint will be exposed to heat or movement. With exposure to heat, the preference is to crimp a joint such as might be used with the connection of a thermal fuse. Exposure to excessive movement or vibration can cause premature failure of a soldered joint in which case additional mechanical support is normally used. However for the normal day to day joining of small wires, components and general PCB work, soldering is the accepted norm. Although the mass production process is very different to what we use for making repairs, modifications, R&D and prototype work, the basic idea is the same. That is an effective and efficient way of making electrical connectivity, to a variety of electronic parts with simple low cost equipment, which is accessible to everyone.

What equipment will I need to solder?

As a minimum you will need a soldering iron and some solder, right? Or that's the commonly held myth. However in reality if you want to make a good job of soldering there is a little more equipment needed, which will not only help you solder to a better standard, but will also protect both you and your environment from heat damage. So here's a list of what we might need and the reasons why that would be useful.

Equipment required:

- Soldering iron (suitable for job intended)
- Solder with flux
- Helping hands
- Cutters (wire strippers)
- Heat shunt (freezer spray)
- De-solder tool
- Good light (magnifier)
- Ventilation
- Steady hands (more on this later)

Your choice of soldering iron in some part should be determined by the kind of soldering you are planning to do. As a service engineer whose time is short a 100W solder gun may be most practical for general purpose work, however if you want to get in amongst ICs on PCBs then a fine tipped low power iron would be best. Or you could choose either a battery or gas powered iron to allow you to work with complete freedom from the mains and the workshop. As a rough guide 12-15W for fine board work, 18-25W for general purpose and if funds allow a solder station with thermostatic control would be best as it can handle a wide variety of work, with a change of tip size. The size of the tip will also determine the size of the parts to be soldered, fine work will require a fine pointed or slant cut tip, likewise heavier work or thick cables will require a larger slant cut or chisel tip surface to distribute the heat evenly.

Solder again is down to choice and the planned work, however most electronics solder is lead-free by default nowadays. There are also alloys that include varying amounts of silver for use on precious metals - be aware these have a higher melting temperature and are not suitable for all irons because of this. Most electronics solder is flux cored so no additional flux should be required.

However you can get a pen containing flux solution which can be precisely applied if needed, normally only in surface mount applications.

A helping hands tool such as order code N30CH will hold the job steady whilst you solder. This provides the added advantage of being able to pre-position the joint before you apply heat and solder. If that were not enough reason to have one they don't flinch when things get hot, so save your fingers from heat damage.

Cutters are an invaluable tool either used in conjunction with wire strippers or for the experienced engineer in place of. There is a range of specialist tools such as bend and cut tools for PCB work or antistatic cutters / pliers for use in sensitive electrostatic areas. Again cutters etc. need to be chosen according to the size of the parts to be worked with. For general use a small pair of cutters that are have a good cutting edge are most useful - lightweight and small cutters are useful for limited access areas.

Heat shunt or freezer spray can be essential if you are planning to solder components that are sensitive to overheating. The shunt is a gentle way of drawing heat away from the joint whereas freezer spray provides more aggressive cooling, which in itself can be counter-productive to the joint construction with the rapid cooling possibly causing stress fractures.

De-solder tools are required if you need to de-solder a joint or re-work a previous job (e.g remove a faulty component from a PCB). Whether you use a suction pump or braid does not matter unless the suction is at risk of removing more than just the solder.

A good working light such as order code A29FF is essential for soldering well. A circular light source eliminates shadows. If you can get a working light that includes a magnifier then this enables you to perform intricate work accurately.

Ventilation is so often overlooked whilst soldering; for best results use a soldering extractor fan (order code: N33CH).

How to make a good solder joint?

Firstly, preparation is the key; a rushed solder job often has to be revisited, so take the time to do it properly. Spend time cutting everything to the right length, set up your helping hands, work light and

ensure good ventilation.

Make sure you have all the components to be joined, then tin all parts before joining together, tinning being the process where you wet the piece to be soldered by melting solder onto it before bringing the parts together. If done properly, the need for additional solder at the joining process is almost eliminated, reducing the chance for excess solder and a potential short or dry joint etc.

When making a joint, using a heat bridge will help the heat transfer much faster; this is the application of a small amount of solder to the tip before bringing the hot iron to the joint. This may not be necessary if you have already wet the parts to be joined as solder will be present on the tip. Always apply solder to the parts not the iron, this ensures that the parts are hot enough for the solder to wet and bond the parts together. Remember solder will run toward the heat source; applying the solder from the opposite side from the iron will help to deliver an equal spread of solder on the joint. For large joints remember to add the solder in continuous pulses and not dump it all in one lot as this will ensure a fresh supply of active flux in the joint. The time taken should always be as short as possible; aim for a soldering time of less than 10 seconds to achieve a properly constructed joint.

Remember that when you have finished the joint always remove the solder first and then the iron. Remove the iron quickly to prevent leaving a solder spike as the iron is removed. Then clean the tip ready for the next joint.

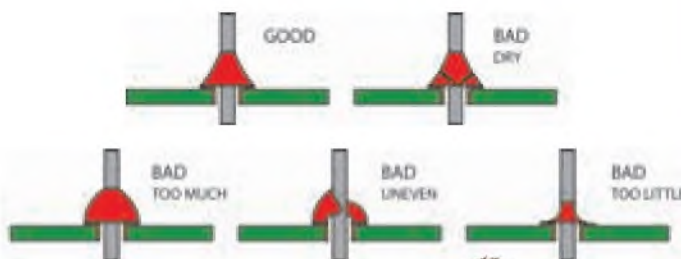

maplineer tip:

If your hands are a little unsteady it has been shown that one single clap of the hands can improve stability.



Pro-Iroda Solderpro 120 Gas Soldering Iron Kit

- Equivalent to a power range of 30-125 Watts
- Cordless, simple, safe operation anywhere
- Ready to use 15 seconds after ignition
- Tank capacity for 120 minutes of operation
- No electrical interference
- Comfortable ergonomic grip



The SOLDERPRO 120 Kit is the most popular portable multi-function heating tool on the market. The soldering iron features a power range of 30-125 watts with automatic Piezo ignition. The tool is completely cordless, easy to use, light weight and features an ergonomic grip that is comfortable and easy to handle. The soldering iron converts to an adjustable windproof flame in seconds! The kit includes the SOLDERPRO 120 torch and soldering iron, 1.6mm soldering tip, 2.4mm chisel tip, hot knife, heat blow tip, deflector, solder coil and cleaning sponge all housed in a rugged carrying case.

Tool is refills in seconds with standard butane. Can be used for hundreds of jobs where a reliable cordless soldering iron and torch is required.

Order Code	Mod.	Price each exc. VAT	inc. VAT each
N15AR	035516	£49.99	£59.99

Pro-Iroda Solderpro 120 Gas Soldering Iron Tips



- A pack of tips to suit the Solderpro 120 gas soldering iron (Order Code: N14AR) and Solderpro 120 kit (Order Code: N14AR)
- 1 x 2mm pointed tip, 1 x 3mm chisel tip, 1 x 3mm angle tip and 1 x heat blower (Order Code: N90FA)

Order Code	Mod.	Price each exc. VAT	inc. VAT each
N90FA	218508	£19.15	£22.99

Blow Torches

Pro-Iroda Micro Jet Gas Torch



- A self-igniting gas torch offering the ultimate in portability
- Runs solely on butane gas and is filled by simply buying a disposable lighter
- Ideal for the hobbyist, electrician, repair person and DIY expert
- Supplied with full operating instructions

Order Code	Mod.	Price each exc. VAT	inc. VAT each
F299H	027919	£10.82	£12.99

Pro-Iroda PT200 Blow Torch



- State of the art waterproof, piezo electronic ignition system
- Lightweight ergonomic design
- Flame temperature up to 1300°C
- Adjustable high output flame
- Runs a minimum of 60 minutes on each refuelling
- Child-resistant ignition for safety

Please note these are supplied unfilled. Butane gas available separately (Order Code N59AN).

Order Code	Mod.	Price each exc. VAT	inc. VAT each
N16AR	035518	£20.82	£24.99

Mains Soldering Irons

Antex 12W Miniature Soldering Iron Type M



- Ideal for SMD (Surface Mounted Devices) re-work and general soldering purposes
- Fitted with a No. 10 soldering bit
- Highly efficient heat transfer from element to bit
- Fitted with 1.8m mains cable
- Replacement elements are available - Order Code JR55K

Order Code	Mod.	Price each exc. VAT	inc. VAT each
YU90X	810353	£19.15	£22.99

Antex 12W Miniature Soldering Iron Type M Replacement Element



- Replacement element for 12W Miniature Soldering Iron Type M

Order Code	Mod.	Price each exc. VAT	inc. VAT each
JR55K	810354	£10.82	£12.99

Antex Type M,C and TC25 Soldering Iron Replacement 0.5mm Pointed Tips 3 Pack



- Set 1: 3 x 0.5mm pointed tip

Order Code	Mod.	Price each exc. VAT	inc. VAT each
N12FR	810364	£11.65	£13.99

Antex Type M,C and TC25 Soldering Iron Replacement Tips



- Set 2: 1 x 2.3mm angle tip, 1 x 1mm needle tip and 1 x 3mm angle tip

Order Code	Mod.	Price each exc. VAT	inc. VAT each
N13FR	810365	£11.65	£13.99

Antex 15W/30W Fabric-Master Craft Kit



- Dual temperature heated Fabric Master tool
- Switchable between two heat settings 15W/30W
- Fuse pieces of fabric together and create unique works of art
- 7 Fabric distressing tips
- A pack of fabric samples
- Safety stand for when iron not in use

Fuse pieces of fabric together and create unique works of art. The required fabrics can be purchased from many textile shops. Materials that work well for fabric distressing include polyester, nylon, rayon and felt. Felt is good for using as a backing for your work and materials melt well onto it. You can create pictures, pouches, or decorate bags & purses. To enhance your work use embroidery beads and sequins. You can even attach the fabrics directly onto card.

Order Code	Mod.	Price each exc. VAT	inc. VAT each
N19DT	1010533	£20.82	£24.99

Antex 15W/30W Pyro-Master Craft Kit



- Dual temperature heated Pyro Master tool
- Switchable between two heat settings 15 W/30 W
- Ideal for simple designs on wood or leather
- Safety stand for when iron not in use
- 10 stamping / branding tips
- 9 different shading and drawing tips
- Wooden keyring with leather fridge magnet

The Pyro Master from Antex has been designed to give excellent results when working with wood or leather. You can create pictures, decorate eggcups, key rings, brooches, and name plates. Almost any wood or leather object can be personalised in this way. With a bit of imagination you can create exciting and different works of art.

Comes complete with 10 branding tips, and 9 different

drawing or shading tips. You will find that you can adapt your own preferred method of working and find that each tip will give you different results

Order Code	Mod:	Price each exc. VAT	inc. VAT each
N18DT	PyroMaster craft	£20.82	£24.99

Antex 18W Mains Powered Soldering Iron Type CS (PVC Cable)



- Ideal for use with miniature components
- Stainless steel outer sleeve for added strength
- Fitted with bit No. 1100
- 1.4m PVC mains lead
- 230V mains operation
- Spare elements are available Order Code FY95D

Specifications:

Power consumption	18W
Breakdown voltage	>2,500V
Leakage current	<2µA
Max bit temperature	390°C
Length	183mm

Order Code	Mod:	Price each exc. VAT	inc. VAT each
FY62S	Iron CS18	£19.15	£22.99

Antex Type CS Soldering Iron Replacement Element



- Replacement element for Antex Type CS Soldering Irons (Order Code: FY62S)
- Supplied singly

Order Code	Mod:	Price each exc. VAT	inc. VAT each
FY95D	Element CS 230V	£6.65	£7.99

Antex Type CS, TCS and TC50 Soldering Iron Replacement 2.3mm Angled Tips 3 Pack



- A range of tips to suit the Antex CS, TCS and TC50 type irons (Order Codes: FY62S and XJ45Y)
- Set : 3 x 2.3mm angle tip as supplied with the soldering iron

Order Code	Mod:	Price each exc. VAT	inc. VAT each
N14FR	Antex Tips Set3 3Pk	£11.65	£13.99

Antex Type CS, TCS and TC50 Soldering Iron Replacement Tips



- A range of tips to suit the Antex CS, TCS and TC50 type irons (Order Codes: FY62S and XJ45Y)
- Set : 1 x 3mm chisel tip, 1 x 0.5mm pointed tip and 1 x 1mm angle tip

Order Code	Mod:	Price each exc. VAT	inc. VAT each
N15FR	Antex Tip Set4 3Pk	£11.65	£13.99

Antex 25W Soldering Iron Type XS (PVC Cable)



- Ideal for soldering transistors, ICs and other small components
- Low leakage current
- Shatterproof handle and detachable hook
- Fitted with bit No. 51
- 1.4m PVC mains lead
- 230V mains operation
- Replacement elements are available - Order Code FY96E

Specifications:

Power consumption:	25W
Breakdown voltage:	>2,500V
Leakage current:	<2µA
Max bit temperature	420°C
Length:	193mm

Order Code	Mod:	Price each exc. VAT	inc. VAT each
FR12N	Iron XS	£20.82	£24.99

Antex 25W Soldering Iron Type XS (Silicone Cable)



- Ideal for soldering transistors, ICs and other small components
- Low leakage current
- Shatterproof handle and detachable hook
- Fitted with bit No. 51
- 1.4m mains lead
- 230V mains operation
- Replacement elements are available - Order Code FY96E

Specifications:

Power consumption:	25W
Breakdown voltage:	>2,500V
Leakage current:	<2µA
Max bit temperature	420°C
Length:	193mm
Weight:	42g

A silicone cabled version is also available (Order Code ND94C)

Order Code	Mod:	Price each exc. VAT	inc. VAT each
ND94C	Iron XS Silicone	£23.32	£27.99

Antex Type XS Soldering Iron Replacement Element



- Replacement element for Antex Type XS Soldering Irons (Order Codes: FR12N and ND94C)
- Supplied singly

Order Code	Mod:	Price each exc. VAT	inc. VAT each
FY96E	Element XS 230V	£10.82	£12.99

Antex XS Type Soldering Iron Replacement 2.3mm Angled Tips 3 Pack



- A range of tips to suit the Antex XS type irons (Order Codes: FR12N, FY69A and FR13P)
- Set : 3 x 2.3mm angle tip as supplied with the soldering iron (Order Code: N16FR)

Order Code	Mod:	Price each exc. VAT	inc. VAT each
N16FR	Antex Tip Set5 3Pk	£11.65	£13.99

Antex XS Type Soldering Iron Replacement Tips



- A range of tips to suit the Antex XS type irons
- Set : 1 x 3mm angle tip, 1 x 2.3mm needle tip and 1 x 0.5mm pointed tip

Order Code	Mod:	Price each exc. VAT	inc. VAT each
N17FR	Antex Tip Set6 3Pk	£11.65	£13.99

Maplin 30W Soldering Iron



- Ideal for general purpose soldering
- Fitted with a fine point soldering bit
- Bit held in place by a grub screw
- Replacement tips are available (Order Code N00FB)

Type:	Soldering Iron
Wattage:	30W
Warm Up Time	10 minutes
Temperature Range	420°C - 460°C
Tips Included	yes
Cable Length:	1.2m
Head Material:	Stainless Steel
Handle Material:	Plastic
Colour:	Blue
Product Width:	28mm
Product Depth:	28mm
Product Height:	212mm
Product Weight:	156g

Order Code	Mod:	Price each exc. VAT	inc. VAT each
N38AC	30W Soldering Iron	£9.99	£11.99

30W Soldering Iron (N38AC) Replacement Tips



- A pack of three tips to fit the N38AC 30W Soldering Iron
- 2 x fine pointed tips and 1 x chisel tip

Order Code	Mod:	Price each exc. VAT	inc. VAT each
N00FB	N38AC Tips 3 Pk	£6.65	£7.99



Reserve online and collect at the store of your choice

Antex 30W Soldering Iron - Includes stand



- Robust 30W general purpose soldering iron
- Includes stand
- Replacement bit available separately, Order Code: N74CW
- AC 230V powered

Order Code	Mod:	Price each exc. VAT	inc. VAT each
N11BY	Antex 30W Iron	£13.32	£15.99

Antex 30W Soldering Iron Replacement Bit



- Replacement Bit for Antex 30W Soldering Iron

Order Code	Mod:	Price each exc. VAT	inc. VAT each
N74CW	Spare Tip Antex ER30	£3.32	£3.99

Maplin 30W Instant Heat Soldering Gun



- Soldering gun suitable for both the electronic hobbyist or industry use
- Quick heat up button increases wattage to 30W in seconds
- Comfortable rubberised pistol grip design
- Quick heat trigger
- Power on LED indicator
- Soldering iron element
- Tip cover

This pistol shaped soldering gun features a trigger for quickly increasing the iron power to maximum of 30W in a matter of seconds.

Its comfortable rubberised grip design gives you full control making it easy to view the tip whilst soldering. Ideal iron for the electrical hobbyist, arts & craft, automotive repair and industry.

Order Code	Mod:	Price each exc. VAT	inc. VAT each
N76DG	30WSolderingGun	£9.99	£11.99

40W Soldering Kit



- The perfect starter kit for those new to soldering
- Mains powered 40W soldering iron
- Complete with de-soldering pump, stand and solder
- 10g/1.35 m tube of 1.0mm diameter lead-free solder in a handy dispenser tube
- Spare tips available in a pack of three, Order code: N29KT

Contents:
1x 40W mains soldering iron

- 1x De-soldering pump
- 1x Soldering iron stand
- 1x Tube of lead free solder
- 1x Instruction Manual

Wattage	40W
Warm Up Time	10minutes
Temperature Range	450°C - 480°C
Tips Included	Yes - 1
Cable Length:	1.2m
Head Material:	Steel
Handle Material:	Plastic
Colour	Black / Grey
Product Width	30mm
Product Depth	30mm
Product Height	210mm
Product Weight	160g

Solder composition	99.3% tin 0.7% copper
--------------------	--------------------------

Order Code	Mod:	Price each exc. VAT	inc. VAT each
N72HY	40W Soldering Kit	£20.82	£24.99

40W Soldering Kit (N72HY) Replacement Tips



- A pack of three tips to fit the N72HY 40W Soldering Kit
- 0.6mm fine pointed tip, 2mm wide angled tip and 45° chisel tip

Order Code	Mod:	Price each exc. VAT	inc. VAT each
N29KT	N72HY Tips 3 Pk	£3.90	£4.69

Antex 50W Temperature Controlled Iron Type TCS 220/240V



- A 50W mains (AC 230V) operated temperature controlled soldering iron
- The temperature controller is built-in the handle
- Fitted with 1.2 metre mains lead
- Includes bit no. 1100 (bits for the CS iron will also fit this unit)

The thermocouple near the tip of the heating element provides feedback for temperature control within the range 200 to 450°C, with an accuracy of ±1%. The temperature may be selected by using a screwdriver inserted into an adjuster in the body of the iron. The iron comes fitted with a bit no. 1100, but many alternative bits are available. The iron is compatible with the European EMC and CE regulations.

Specifications:	
Power consumption	50W
Voltage to element:	AC 230V
Warm up time	60 seconds to 450°C
Control:	Analogue proportional
Temperature range	200 - 450°C
Control accuracy	±1% typical
Length:	222mm

Order Code	Mod:	Price each exc. VAT	inc. VAT each
XJ45Y	50W Iron	£45.82	£54.99

Maplin 100W Mains Soldering Iron



This 100W mains soldering iron is high powered iron designed for heavy-duty use. Ideal for industrial repairs and electrical work where a large tip mass is required. It is particularly handy when working with electrical wires or large contacts rather than smaller PCB work.

Warm up time	10 minute
Temperature Range	480-5000C
Tips Included	1
Cable Length	1.2m
Head Material	Copper
Handle Material	Nylon
Colour	Grey
Product Width	34.5mm
Product Depth	315mm
Product Height	34.5mm
Product Weight	320g

Order Code	Mod:	Price each exc. VAT	inc. VAT each
N00DP	100W Soldering Iron	£12.49	£14.99

Soldering Stations

Maplin 50W Solder Station



- Ideal for general electronics and electrical repairs
 - 50W temperature controlled soldering station with adjustable range
 - High quality compact design includes safety guard iron holder
 - Anti-static ground output
 - LED power indicator
 - Pack of 3 assorted tips available separately (Order Code: N79AR)
 - Supplied with a sponge, stand and one spike point tip
- The Maplin 50W Solder Station is low-cost and ideal for individuals working on budget equipment, as well as for general electronic and electrical repairs. The tip temperature can be controlled, from 350°F (180°C) to 900°F (480°C) without the need to change the tip or heating element. Additionally, a pack of three assorted tips for this solder station can be purchased separately (Order Code: N79AR).

Type	Mains Solder Station
Wattage	50W
Warm Up Time	10 minutes
Spike point tip	
Temperature Range	180°C - 480°C
Tips Included	Yes
Cable Length	1.2m
Head Material	Steel
Handle Material	Plastic
Colour	Blue
Product Width	85 mm
Product Depth	137mm
Product Height	170 mm
Product Weight	604 g

Order Code	Mod:	Price each exc. VAT	inc. VAT each
N78AR	50W Solder Station	£20.82	£24.99

Subscribe to our newsletter
For deals and information
maplin.co.uk



50W Solder Station Additional Solder Tips



- A set of three assorted tips for use with the N78AR 50W Solder Station

Order Code	Mod: 615511	Price each exc. VAT	inc. VAT each
N79AR	N78AR Slidr Stn Bits	£6.65	£7.99

48W Professional 2-Line LCD Solder Station



- Professional soldering station with 2-line LCD screen
- Temperature indication on the display (set and real)
- Heating power: 48W
- Temperature range: 150° - 450°C
- Iron voltage: 24V
- Includes station, iron and stand

Order Code	Mod: 810380	Price each exc. VAT	inc. VAT each
N34FB	48W LCD Solder Stn	£41.65	£49.99

Spare 48W Solder Station Soldering Iron Tips



- A set of spare soldering iron tips
- Suitable for use with the irons in the following solder station:

N34FB - 48W LCD screen soldering station

Order Code	Mod: 346021	Price each exc. VAT	inc. VAT each
N72CW	BP53/N16CH/N34FBTps	£5.82	£6.99

Replacement Heat Element for Solder Stations



- Suitable as a replacement heat element for the following solder station:

N34FB - 48W LCD screen soldering station

Order Code	Mod: 346016	Price each exc. VAT	inc. VAT each
N78GZ	SolderStationElement	£3.32	£3.99

48W LCD Display Solder Station Replacement Soldering Iron



- A replacement soldering iron suitable for use with the solder station N34FB
- White handle with yellow grip

Order Code	Mod: 346022	Price each exc. VAT	inc. VAT each
N79GZ	N16CH Spare Iron	£9.15	£10.99

60W Professional LCD Solder Station with ESD Protection



- ESD safe – suitable for anti-static work
- Large white on blue LCD screen for clear and convenient reading of temperature in °C or °F
- Three preset temperature buttons that can be configured to users own required temperatures
- Temperature range of 150°C–450°C (302°F–842°F)
- On/off switch on side of unit
- Supplied with detachable soldering iron, stand and sponge
- Additional range of soldering tips available separately, Order Code: A19KK
- Additional tip set includes a 0.8mm fine tip, 2.4mm general tip and a precision tip for highly detailed work
- Spare/replacement irons are also available - Order Code: A40KX

Order Code	Mod: 511927	Price each exc. VAT	inc. VAT each
A55KJ	60W LCD Solder Stn	£49.99	£59.99

Replacement Tips for 60W Professional LCD Solder Station (A55KJ)



- Contains three different tips for A55KJ 60W Solder Station
- 0.8mm fine tip, 2.4mm general tip and precision tip for detailed work

Order Code	Mod: 678067	Price each exc. VAT	inc. VAT each
A19KK	A55KJ Tips 3 Pk	£5.65	£6.79

Replacement Iron for 60W Professional LCD Solder Station (A55KJ)



- Replacement iron for the A55KJ 60W Professional LCD Solder Station

Order Code	Mod: 678068	Price each exc. VAT	inc. VAT each
A40KX	A55KJ Spare Iron	£9.99	£11.99

Replacement Iron for 60W LCD Solder Station (N89CZ)



- A replacement soldering iron for the 60W LCD Solder Station (Order Code: N89CZ)

Order Code	Mod: 678124	Price each exc. VAT	inc. VAT each
N91FA	Spare Iron for N89CZ	£9.15	£10.99

Antex 760RWK Rework Station 230V 700W



- Professional digital soldering and hot air rework station
- Temperature range continually adjustable from 200°C to 450°C
- 700 watt hot air rework tool variable from 100°C to 500°C
- 2 x hot air rework nozzles
- Hot air tool also suitable for heat-shrinking
- Digital display
- Digital temperature calibration can be calibrated by the user
- LEDs indicate mains power and iron power
- Housed in a robust metal enclosure, which is suitable for the most demanding industrial and educational environments
- Replacement bits and soldering irons are available separately
- Supply voltage - 230V AC
- Iron voltage - 24V
- Iron power - 50 Watts
- Leakage current <2.0µA

The 760RWK hot air rework and digital soldering station from Antex is a complete temperature controlled station for professional users. Station includes power supply, Antex ST6A iron stand and a lightweight 50W industrial grade soldering iron fitted with silicone heat-resistant cable and a 2.3mm (1100) bit.

Use 1100 series bits with this iron. Maplin order code: N86DS 2.3MM No.1100 BIT

Order Code	Mod: 1011174	Price each exc. VAT	inc. VAT each
N75DS	760 reworkstation	£166.65	£199.99

Reserve online, collect in-store in 30 minutes



Reserve online and collect at the store of your choice

12V Soldering Irons

Antex Low Voltage Soldering Iron MLXS25



- A low voltage 25W soldering iron designed to work from a 12V car battery
- Supplied with a 3mm bit (bit no. 51), two large crocodile clips for connection to battery terminals and 4.5m of pre-fitted 2-core lead
- Also includes a small quantity of solder and an instruction leaflet "How to Solder"

This soldering iron has the same specifications as the XS mains iron (Order Code: FR12N). The bits are interchangeable with the XS iron

Order Code	Mod: 004067	Price each exc. VAT 1+	5+	inc. VAT each
FR13P	12V Iron MLXS	£23.32		£27.99

Solder

Lead-Free Solder 2m Tube



- A lead-free alloy solder that is better for the environment
- Contains non-corrosive flux
- Contains 99.3% tin and 0.7% copper
- Available in 1mm 100g, 250g and 500g reels and a 2m tube

Order Code	Mod: 810385	Price each exc. VAT 1+	5+	inc. VAT each
N50AW	LeadFree Solder Tube	£4.15	£3.74	£4.99

Lead-Free Solder 100g

- A lead-free alloy solder that is better for the environment
- Contains non-corrosive flux
- Contains 99.3% tin and 0.7% copper



Order Code	Mod: 810386	Price each exc. VAT 1+	5+	inc. VAT each
N29AR	LeadFree Solder 100g	£7.49	£6.74	£8.99

Lead-Free Solder 250g

- A lead-free alloy solder that is better for the environment
- Contains non-corrosive flux
- Contains 99.3% tin and 0.7% copper



Order Code	Mod: 810387	Price each exc. VAT 1+	5+	inc. VAT each
N30AR	LeadFree Solder 250g	£16.65	£14.99	£19.99

Lead-Free Solder 500g

- A lead-free alloy solder that is better for the environment
- Contains non-corrosive flux
- Contains 99.3% tin and 0.7% copper



Order Code	Mod: 810388	Price each exc. VAT 1+	5+	inc. VAT each
N31AR	LeadFree Solder 500g	£24.99	£23.99	£29.99

Lead-Free Silver Solder Tube



- A lead-free alloy solder containing a non-corrosive flux
 - Improved conductivity and flow
 - Lower melting point
- This solder is 4% silver, 95.5% tin and 0.5% copper. We recommend this solder for use with the iron-clad and nickel-clad bits supplied with our soldering irons. Solder is 1mm diameter. The high silver content improves the conductivity of the solder and lowers the melting point, improving the flow

Order Code	Mod: 810389	Price each exc. VAT 1+	5+	inc. VAT each
N51AW	Silver Solder Tube	£5.40	£4.86	£6.49

Lead-Free Silver Solder Roll 100g

- A lead-free alloy solder containing a non-corrosive flux
- Improved conductivity and flow
- Lower melting point



This solder is 4% silver, 95.5% tin and 0.5% copper. We recommend this solder for use with the iron-clad and nickel-clad bits supplied with our soldering irons. Solder is 1mm diameter. The high silver content improves the conductivity of the solder and lowers the melting point, improving the flow

Order Code	Mod: 810390	Price each exc. VAT 1+	5+	inc. VAT each
N32AR	Silver Solder 100g	£13.32	£12.79	£15.99

Antex Lead-Free Solder 2m

- Handy sized dispenser
- Ideal for use on micro electronics, fine wires and most other electrical and electronic soldering operations
- ROHS compliant
- Suitable for use with all Antex irons

A lead-free solder from Antex, supplied in a handy sized dispenser. The 0.8mm solder wire is quick melting and easy to use.

Specifications:

Composition 99.25% tin
0.75% copper

Order Code	Mod: 810391	Price each exc. VAT 1+	5+	inc. VAT each
N34BJ	Lead Free Solder 2m	£4.99		£5.99

Antex Lead-Free Solder 4m



- Handy sized dispenser
- Ideal for use on micro electronics, fine wires and most other electrical and electronic soldering operations
- ROHS compliant
- Suitable for use with all Antex irons

A lead-free solder from Antex, supplied in a handy sized dispenser. The 0.8mm solder wire is quick melting and easy to use.

Specifications:

Composition 99.25% tin
0.75% copper

Order Code	Mod: 810392	Price each exc. VAT 1+	5+	inc. VAT each
N35BJ	Lead Free Solder 4m	£6.65		£7.99

Soldering Accessories

Desktop Soldering Iron Stand

- A safe and stable stand for all types of soldering irons
- Ideal for use by both the hobbyist and professional
- Recessed sponge tray for cleaning the tip (sponge included).



Order Code	Mod: 048131	Price each exc. VAT 1+	5+	inc. VAT each
N55CG	Soldering Iron Stand	£6.65	£5.99	£7.99

Antex Soldering Iron Stand ST4

- Ideal for use with the smaller Antex soldering irons
- Manufactured from a high grade insulation material
- Chromium-plated strong steel spring
- Sponge tray for keeping the bits clean
- Spare bits can be accommodated on the stand



Order Code	Mod: 810393	Price each exc. VAT 1+	5+	inc. VAT each
FR20W	Stand ST4	£9.15		£10.99

Antex Replacement Sponge

- Spare sponge for use with soldering iron stands, typically ST4 (Order Code FR20W)
- Can also be used with temperature controlled soldering iron system TCSU-1

Will also fit stands ST5 and ST6



Order Code	Mod: 004078	Price each exc. VAT 1+	5+	inc. VAT each
RK33L	Sponge ST4	£2.07		£2.49

Buying for education?
0333 400 9740



Solder Fume Extractor

- Removes solder fumes
- High performance fan
- Replaceable activated carbon filter
- Can significantly reduce headaches, eye irritation and nausea
- Adjustable angle for accurate placement



Specifications:

Power consumption	23W
Dimensions:	222(w) x 270(h) x 168(d) mm
Weight:	1400g

Activated Carbon Filter

Amount of activated carbon filter: 7g (0.02lb)

Order Code	Mod:	Price each exc. VAT 1+	inc. VAT each 5+
N33CH	Smoke Fume Extractor	£19.99	£23.99

Solder Fume Extractor Filter

- Spare filters for the solder fume extractor [Order code N33CH]



Order Code	Mod:	Price each exc. VAT 1+	inc. VAT each 5+
N34CH	Fume Extractor Filter	£4.15	£3.74

6-Piece Soldering Aid Set



- Ideal for printed circuit board work
- Each tool has 2 different ends

Order Code	Mod:	Price each exc. VAT 1+	inc. VAT each 5+
N18AN	6 Pce Solder Aid Set	£8.32	£7.49

Heat Shunt



- A pair of locking metal tweezers
- Clip to an electronic component to prevent the heat of soldering reaching the device

Order Code	Mod:	Price each exc. VAT 1+	inc. VAT each 5+
FR10L	Heat Sink Tweezers	£2.90	£3.49

Tip Tinner/Cleaner

- Cleans, wets and tins soldering iron tips
- Removes stubborn tin and iron residues that are resistant to resin based fluxes
- 15g weight



A block of electronics-grade solder powder and chemicals compacted into the shape of a thick disc. It is packaged in a metal container, complete with lid and self adhesive pad on the underside so that it can be fixed to any convenient surface. A single wipe of the iron across the block at once

cleans, wets and tins the tip.

The composition will remove the stubborn tin/iron inter-metallic layer that forms on iron-plated tips and resists resin based fluxes. The Tip/Tinner Cleaner does all the work of sponges or wipes and acid-cored solder wire.

Order Code	Mod:	Price each exc. VAT 1+	inc. VAT each 5+
J06G	Tip Tinner Cleaner	£8.32	£7.90

De-soldering Tools

De-soldering Braid 1mm Width

- Flux-impregnated, copper braid that speedily removes unwanted solder from a joint
- Uses a 'No-Clean' flux
- Faster de-soldering
- Excellent thermal conductivity



How to use

Place the cold braid end on the solder that is to be removed. Place the hot soldering iron tip on top of the braid. Remove the braid and the hot iron at the same time. Cut off the end that contains the unwanted solder. The temperature of the soldering iron bit must be sufficient to liquefy the solder efficiently. The braid comes in 1.5m length and width of 1mm

Order Code	Mod:	Price each exc. VAT 1+	inc. VAT each 5+
N47FX	Solderbraid 1mm	£3.32	£3.99

De-soldering Braid 1.5mm Width

- Flux-impregnated, copper braid that speedily removes unwanted solder from a joint
- Uses a 'No-Clean' flux
- Faster de-soldering
- Excellent thermal conductivity



How to use

Place the cold braid end on the solder that is to be removed. Place the hot soldering iron tip on top of the braid. Remove the braid and the hot iron at the same time. Cut off the end that contains the unwanted solder. The temperature of the soldering iron bit must be sufficient to liquefy the solder efficiently. The braid comes in 1.5m length and width of 1.5mm

Order Code	Mod:	Price each exc. VAT 1+	inc. VAT each 5+
N48FX	Solderbraid 1.5mm	£3.32	£3.99

De-soldering Braid 2mm Width

- Flux-impregnated, copper braid that speedily removes unwanted solder from a joint
- Uses a 'No-Clean' flux
- Faster de-soldering
- Excellent thermal conductivity



How to use

Place the cold braid end on the solder that is to be removed. Place the hot soldering iron tip on top of the braid. Remove the braid and the hot iron at the same time. Cut off the end that contains the unwanted solder. The temperature of the soldering iron bit must be sufficient to liquefy the solder efficiently. The braid comes in 1.5m length and width of 2mm

Order Code	Mod:	Price each exc. VAT 1+	inc. VAT each 5+
N49FX	Solderbraid 2mm	£3.32	£3.99

De-soldering Reels 10m Length 1.5mm Width



- Improved solder absorption which means faster de-soldering is achieved
- Free from colophony resin, a known respiratory sensitizer
- Improved health and safety benefits
- Uses a No-Clean flux
- Any residue is non-conductive and need not be cleaned
- Excellent thermal conductivity for faster desoldering at lower temperatures
- Vacuum sealed packaging prolongs life of braid and protects from moisture
- Uses include freeing components, desoldering plated through holes, remove solder bridges (prevent short-circuit)

Order Code	Mod:	Price each exc. VAT 1+	inc. VAT each 5+
N58AL	Soldamop 1.5mmx10m	£10.82	£10.39

De-Solder Pump



- Quickly removes molten solder from joints
- Spring loaded piston with one button release
- Glass filled nylon body
- Nozzle is easily removed for cleaning
- Plunger has a plastic body for added safety

Order Code	Mod:	Price each exc. VAT 1+	inc. VAT each 5+
N40CH	Desolder Pump	£8.32	£9.99

Electric De-Solder Pump 268mm Length



- One tool does it all
- Melts and removes solder quickly and easily
- Powerful de-solder pump
- Plunger has a plastic shroud for added safety

Overall length	268mm
Cylinder diameter	20mm
Suction volume	4468mm ³

Order Code	Mod:	Price each exc. VAT 1+	inc. VAT each 5+
N37CH	Elec Desolder Pump	£12.49	£14.99

**Buy it on the web at
maplin.co.uk**

Shop for all Maplin products online at our website and check out our latest products and special offers!



**Technical Helpline
0333 400 9500**



Test & Measurement

Multimeters

Maplin Domestic Multimeter

- Ideal for the home, schools and offices
- Check bulbs, fuses and batteries
- Includes a transistor and diode tester
- Measure AC and DC voltage, resistance and DC current up to 10A
- Includes test leads
- Low battery indication
- Basic accuracy $\pm 0.5\%$



Please note:
Product supplied may vary from image shown
Maplin battery replacement order code: L42AL

Specifications:

DC Voltage	
0-200mV	$\pm 0.25\%$
2, 20, 200, 1000V	$\pm 0.5\%$
AC Voltage	
200, 750V	$\pm 1.2\%$
DC Current	
200 μ , 2m, 20mA	$\pm 1.0\%$
200mA	$\pm 1.2\%$
10A	$\pm 2.0\%$
Resistance	
200, 2k, 20k, 200k Ω	$\pm 0.8\%$
2M Ω	$\pm 1.0\%$
Transistor hFE	
Diode test	
Power (battery):	2 x AAA 1.5V (included)
Dimensions:	69 x 128 x 24 mm
Weight:	225 g

Order Code	Mod.	Price each exc. VAT 1+	inc. VAT each 5+
N20AX	Domestic Tester	£8.32	£9.99

Maplin General Purpose Analogue Multimeter

- Small compact analogue multimeter
- Clear, easy to read display
- Capable of measuring DC voltage, AC voltage, DC current, resistance
- Battery checking function for 1.5V and 9V
- Supplied with integrated test leads which conveniently coil around the meter for tidy storage



Specifications:

	Measurement Ranges	Accuracy % \pm of full scale
DC voltage:	10/50/250/500	5
AC voltage:	50/250/500	5
DC current:	25/250mA	5
Resistance:	x10, x1000 (up to 2M Ω)	5
Battery Test	1.5V - 125mA	10
	9V - 25mA	10

Order Code	Mod.	Price each exc. VAT 1+	inc. VAT each 5+
UZ82D	Analogue Multimeter	£10.82	£9.74 £12.99

Maplin Pocket Sized Autoranging Multimeter



- Pocket sized auto ranging test meter
- Measures AC, DC voltages, resistance, continuity and diode checking
- Functions include frequency, duty cycle and capacitance
- Supplied with moulded test leads and a rigid protective case
- Ranges are selected automatically

Specifications:

Function	Max range	Accuracy
Voltage DC	500V	$\pm 1.0\%$
Voltage AC	500V	$\pm 2.3\%$
Resistance	40M Ω	$\pm 0.8\%$
Capacitance	200 μ F	$\pm 10\%$
Frequency	10MHz	$\pm 2\%$
Duty Cycle	0.1-99%	
Diode check		
Continuity test	<60 Ω	
Size (H x W x D)	108 x 56 x 11.5	
Weight	50g	

Order Code	Mod.	Price each exc. VAT 1+	inc. VAT each 5+
N59JK	Pocket Auto Range DM	£12.49	£12.11 £14.99

Uni-Trend UT30B Digital Compact Multimeter

- Small in size but packed with functionality
- DC & AC voltage and DC current
- Resistance, transistor, diode, data hold and low battery display
- Complete with battery, test leads and manual



Specifications:

Basic function	Range	Best Accuracy
DC voltage:	200mV/2000mV/20V/200V/500V	$\pm 0.5\%$
AC voltage:	200V/500V	$\pm 1.2\%$
DC current:	200 μ A/2000 μ A/20mA/200mA/10A	$\pm 1\%$
Resistance:	200 Ω /2000 Ω /20k Ω /200k Ω /20M Ω	$\pm 0.8\%$
I/P impedance for voltage measurement:		10M Ω

Max display:	1999
LCD size:	16 x 48mm
Product size (L x W x H):	130 x 74 x 41mm
Product weight:	160g
Battery (supplied):	1 x 9V PP3 (Order Code L46AL)

Order Code	Mod.	Price each exc. VAT 1+	inc. VAT each 5+
N15BY	Uni-T UT30B DMM	£13.32	£15.99

Uni-Trend UT132A Digital Multimeter with Square Wave Generator

- Compact and lightweight multimeter, ideal for carrying in a toolbox or pocket
- DC & AC voltage and DC current can be tested easily
- Resistance, transistor and diode testing, plus a data hold function
- 50Hz square wave generator for injecting into audio applications



Specifications:

Basic function	Range	Best Accuracy
DC voltage:	200mV/2000mV/20V/200V/250V	$\pm 0.5\% + 2$
AC voltage:	200V/250V	$\pm 1.2\% + 3$
DC current:	200 μ A/20mA/200mA/10A	$\pm 1\% + 2$
Resistance:	200 Ω /2000 Ω /20k Ω /200k Ω /2000 Ω /20M Ω	$\pm 0.8\% + 5$

I/P impedance for DC voltage measurement:	10M Ω
Square Wave Output	approx. 50Hz

Max display:	1999
LCD size:	49 x 18mm
Product size (L x W x H):	137 x 72 x 37mm
Product weight:	210g
Battery (supplied):	1 x 9V PP3 (Order Code L46AL)

Order Code	Mod.	Price each exc. VAT 1+	inc. VAT each 5+
N99JZ	UT132A DMM & Sq Wave	£12.49	£12.11 £14.99

3 in 1 Autoranging Multimeter with Non Contact Detector

- Simple multimeter for basic electrical testing around the home or workplace
- Incorporates a non-contact voltage detector that lights up an LED in the presence of high voltages
- Auto range function allows measurements of unknown values to be taken easily
- AC/DC voltages and current can be measured
- Resistance, continuity and diode checking can be performed
- LED Flashlight and a robust double molded housing



Specifications:

Function	Max range	Accuracy
Voltage DC	600V	$\pm 0.5\%$
Voltage AC	600V	$\pm 1.2\%$
Current DC	200mA	$\pm 2.0\%$
Current AC	200mA	$\pm 2.5\%$
Resistance	20M Ω	$\pm 0.8\%$
Non-contact voltage	VAC: 100V to 600V	
Diode check		
Continuity test		
Size (H x W x D)	104 x 55 x 32.5mm	
Weight	14.5g	

Order Code	Mod.	Price each exc. VAT 1+	inc. VAT each 5+
N73BZ	3-in-1 e-tester	£15.82	£15.35 £18.99

Maplin Digital Multimeter

- Multimeter with a wide variety of functions for testing electronic and electrical applications
- Easy to use, just select the test type and range with the dial and use the probes supplied
- Measures up to 600Vdc and 600Vac and up to 10A current
- Accurate measurements of resistance and diode testing and a data hold function
- Ideal for hobbyist, workshop, DIY and home use



Specifications:

DC Voltage Min / Max Range	200mV ($\pm 0.5\%$) / 600V ($\pm 0.8\%$)
DC Current Min / Max Range	2000 μ A ($\pm 1.0\%$) / 10A ($\pm 2.0\%$)
AC Voltage Min / Max Range	200V / 600V ($\pm 1.2\%$)
Resistance Min / Max Range	200 Ω ($\pm 0.8\%$), 2000k Ω ($\pm 1.0\%$)
Battery Type	9V PP3 (included)
Audible Continuity	Yes
Product Width	66mm
Product Depth	38mm
Product Height	138mm
Product Weight	208g

Order Code	Mod.	Price each exc. VAT 1+	inc. VAT each 5+
N19BW	DMM/Transistor Test	£20.82	£24.99



Browse our entire range at maplin.co.uk

Precision Gold PG017 Digital Multimeter



- Highly specified digital multimeter for professional and amateur use
- A comprehensive range of testing functions can be carried out
- AC & DC voltage to 600V and current to 10A
- Resistance, capacitance and frequency can be measured accurately
- Diode and transistor Hfe testing
- Fuses and bulbs can easily be checked with the continuity buzzer
- Supplied with shock resistant case and battery

Specifications:

DC voltage range:	200mV to 600V
AC voltage range:	200mV to 600V
DC current range:	2mA to 10A
AC current range:	2mA to 10A
Resistance range:	up to 20MΩ
Frequency range:	2KHz-15MHz
Input impedance:	10MΩ
Dimensions:	151 x 70 x 38mm
Battery:	9V PP3 type

Order Code	Mod:	Price each exc. VAT	inc. VAT each
		1+	5+
GW24B	Model PG017 M/M	£33.32	£29.99
			£39.99

Free Delivery
on all UK orders over **£10**

IT&CS Apply

Mini Digital Multimeter with Voltage detector



- Ultra compact multimeter
- Ideal for home, DIY or basic electronics
- Includes a non contact voltage detector designed to give an indication if a cable is live
- Measures AC, DC voltage and DC current and hold function
- Resistance can be accurately measured
- Features audio continuity testing for fuses and bulb checking

Specifications:

Function	Max range	Accuracy
Voltage DC	500V	±0.5%
Voltage AC:	500V	±1.8%
Current DC	200mA	±1.0%
Resistance:	2MΩ	±0.8%
Battery check	9V 10mV	
Non-contact voltage	VAC: 100V to 600V	
Diode check		
Continuity test		
Size [H x W x D]	108 x 53 x 32mm	
Weight	102g	

Order Code	Mod:	Price each exc. VAT	inc. VAT each
		1+	5+
N61LK	DMM & Volt Detector	£16.65	£14.99
			£19.99



Over 200 stores nationwide

Uni-Trend UT118A Digital Pen Type Multimeter



- Compact hand held probing multimeter
- Resistance and capacitance can be accurately measured
- Diode, continuity functions are included
- LED light to illuminate probe placement and LCD screen
- Last reading can be held with the hold function
- Auto ranging measurements taken

Specifications

DC Voltage	3V/30V/300V ±1%+ 3]
AC Voltage	3V/30V/300V ±1%+ 4]
Resistance	300Ω to 30MΩ ±[1%+ 3]
Capacitance	3nF to 300µF ±[3%+ 5]
Diode	Yes
Continuity Buzzer	Yes
Sleep Mode	Around 10 Minutes
Low Battery Display	Yes
Input Impedance for DC	
Voltage Measurement	10mW
Data Hold	Yes
Max / Min Mode	Yes
Display Backlight	Yes
Penlight	Yes
Max Display	3000
Powcr	3V CR2032
LCD Size	28 x 14 mm
Product Size	20 x 27 x 182mm
Standard Accessories	Test Lead, Battery, Manual

Order Code	Mod:	Price each exc. VAT	inc. VAT each
		1+	5+
N13KJ	UT118 Pen Type Meter	£20.82	£19.99
			£24.99

Multimeter Features

Name	Code	Display	Backlit?	DC Voltage	AC Voltage	DC Current	AC Current	Resistance	Capacitance	Temperature	Frequency	Duty Cycle	Size	Page
Maplin Domestic MM	N20AX	49x17mm [1999]	•	•	•	•	•	•					128x69x24mm 225g	342
Maplin General Purpose Analogue MM	UZ82D	[Analogue]		•	•	•	•	•					118x85x26mm 155g	342
Maplin Pocket Sized Autoranging MM	N59LK	45x17 [1999]		•	•	•	•	•	•				108x56x11.5mm 50g	342
Uni-T UT30B Compact MM	N15BY	48x16mm [1999]	•	•	•	•	•	•	•				130x74x41mm 160g	342
Uni-T UT1332A MM with Sq Wave Gen	N99JZ	49x18mm [1999]	•	•	•	•	•	•	•				137x72x37mm 200g	342
3-in-1 Autoranging MM with NC Detector	N73BZ	35x20mm [1999]	•	•	•	•	•	•	•				104x55x32.5mm 145g	342
Maplin Digital MM	N19BW	45x28mm [1999]	•	•	•	•	•	•	•				138x66x38mm 208g	342
Precision Gold PG017 Digital MM	GW24B	50x17mm [1999]	•	•	•	•	•	•	•	•			151x70x38mm 200g	343
Mini Digital MM with Voltage Detector	N61LK	35x21mm [1999]	•	•	•	•	•	•	•				108x53x32mm 102g	343
Uni-T UT118A Pen Type MM	N13KJ	28x14mm [3999]	•	•	•	•	•	•	•				20x182x27mm 90g	343
Digital MM with Temperature Test	N73CG	42x18mm [1999]	•	•	•	•	•	•	•	•			140x67x38mm 210g	344
Uni-T UT50A Manual Range MM	N77CB	59x25mm [1999]	•	•	•	•	•	•	•	•			165x80x38mm 275g	344
Uni-T UT50C Temp and Freq Digital MM	N78CB	59x25mm [1999]	•	•	•	•	•	•	•	•			165x80x38mm 275g	344
Uni-T UT58A Digital MM	N16BY	60x54mm [1999]	•	•	•	•	•	•	•	•			179x88x39mm 350g	344
Uni-T UT58C Digital MM	N79CB	60x54mm [1999]	•	•	•	•	•	•	•	•			179x88x39mm 350g	344
Precision Gold Digital MM	GW20W	48x16mm [1999]	•	•	•	•	•	•	•	•			172x78x46mm 200g	345
Precision Gold PG10B Digital MM	GW18U	50x17mm [1999]	•	•	•	•	•	•	•	•			151x70x38mm 200g	345
Uni-T UT60A Digital PC Interface MM	N80CB	63x13mm [3999]	•	•	•	•	•	•	•	•	•	•	175x85x40mm 340g	345
Uni-T UT60E Digital RMS PC Interface MM	N81CB	63x13mm [3999]	•	•	•	•	•	•	•	•	•	•	175x85x40mm 340g	345
Uni-T UT801 Bench MM	N43KH	108x35mm [1999]	•	•	•	•	•	•	•	•	•	•	300x105x245mm 1650g	345

Digital Multimeter with Temperature Test



- Compact multimeter for a wide range of applications around the home, workshop or in education
- Measure DC and AC voltage, resistance, current, resistance and continuity
- Temperature can be accurately measured up to 1300°C
- Complete with protective holster, test leads and comprehensive instructions

Specifications:

DC voltage:	600Vdc ±0.5%
AC voltage:	600Vac ±1.2%
DC current:	10A ±3.0%
Resistance:	2000kΩ ±1.0%
Transistor:	0-1000 hFE of NPN and PNP
Temperature:	-20°C to 1370°C ±3.0%
Continuity:	Audible buzzer below 100

Order Code	Mod.	Price each exc. VAT	inc. VAT each
		1+	5+
N73CG	DMM with Temp. Tester	£20.82	£18.74
			£24.99

Uni-Trend UT50A Manual Ranging Digital Multimeter



- DC & AC voltage/current
- Resistance, capacitance, diode, continuity
- Data hold
- Auto sensing display backlight
- Low battery display and sleep mode

Specifications:

Basic Functions		
DC Voltage [V]	min range	200mV
	max range	1000V
	best accuracy	±0.5%
AC Voltage [V]	min range	200mV
	max range	750V
	best accuracy	±0.8%
DC Current [A]	min range	20µA
	max range	20A
	best accuracy	±0.8%
AC Current [A]	min range	20µA
	max range	20A
	best accuracy	±1%
Resistance [Ohms]	min range	200Ω
	max range	200MΩ
	best accuracy	0.80%
Capacitance [F]	min range	2nF
	max range	100µF

Special Functions

Diode	Yes
Continuity Buzzer	Yes
Data Hold	Yes
Display Backlight	Auto
Max. Display	1999
Battery (supplied)	1 x 9V PP3 (Order Code L46AL)

Order Code	Mod.	Price each exc. VAT	inc. VAT each
		1+	5+
N77CB	Uni-T UT50A DMM	£20.82	£19.99
			£24.99

Uni-Trend UT50C Digital Multimeter with Temperature & Frequency



- DC & AC voltage/current
- Resistance, capacitance, diode, continuity
- Data hold
- Auto sensing display backlight

• **Low battery display and sleep mode**

Specifications:

Basic Functions		
DC Voltage [V]	min range	200mV
	max range	1000V
	best accuracy	±0.5%
AC Voltage [V]	min range	2V
	max range	750V
	best accuracy	±0.8%
DC Current [A]	min range	20mA
	max range	20A
	best accuracy	±0.8%
AC Current [A]	min range	20mA
	max range	20A
	best accuracy	±1%
Resistance [Ohms]	min range	200Ω
	max range	200MΩ
	best accuracy	0.80%
Capacitance [F]	min range	20nF
	max range	100µF
Temperature [°C]	min range	-40°C
	max range	1000°C
Temperature [°F]	min range	-40°F
	max range	1832°F
Frequency [Hz]	min range	2kHz
	max range	20kHz

Special Functions

Diode	Yes
Continuity Buzzer	Yes
Data Held	Yes
Display Backlight	Auto
Max. Display	1999

Order Code	Mod.	Price each exc. VAT	inc. VAT each
		1+	5+
N78CB	Uni-T UT50C DMM	£24.99	£23.99
			£29.99

Uni-Trend UT58A Digital Handheld Multimeter



- Large LCD screen with probe socket indicator
- Wide ranging measurements including reading 1000VDC and 20A
- Ideal for professional and education testing
- The meter has data hold, low battery display and a max display count of 1999
- Complete with manual, test leads, multi-purpose socket, holster and battery

The UT58A DMM is a very reliable hand-held digital multimeter. The meter has a large 3.5" LCD that highlights to the user which sockets to plug test leads into. The meter comes complete with test leads, holster and comprehensive instruction manual.

Specifications:

Basic Functions		
DC Voltage [V]	min range	200mV
	max range	1000V
	best accuracy	±0.5%
AC Voltage [V]	min range	2V
	max range	750V
	best accuracy	±0.8%
DC Current [A]	min range	20µA
	max range	20A
	best accuracy	±0.8%
AC Current [A]	min range	2mA
	max range	20A
	best accuracy	±1%
Resistance [Ohms]	min range	200Ω
	max range	20MΩ
	best accuracy	0.8%
Capacitance [F]	min range	2nF
	max range	100µF
	best accuracy	4.0%

Special Functions

Diode	Yes
Continuity Buzzer	Yes
Transistor	Yes
Data Hold	Yes
Max. Display	1999

Battery (supplied)	1 x 9V PF3 (Order Code L46AL)		
Order Code	Mod.	Price each exc. VAT	inc. VAT each
		1+	5+
N16BY	Uni-T UT58A DMM	£27.49	£24.99
			£32.99

Uni-Trend UT58C Digital Handheld Multimeter



- Large LCD screen with probe socket indicator
- Wide ranging measurements including reading 1000VDC and 20A
- Ideal for professional and educational use
- Meter has diode, transistor and continuity test
- Also features data hold function and maximum display count of 1999

The UT58C DMM is a very reliable hand-held digital multimeter. The meter has a large 3.5" LCD that highlights to the user which sockets to plug test leads into. The meter comes complete with test leads and comprehensive instruction manual.

Specifications:

Basic Functions		
DC Voltage [V]	min range	200mV
	max range	1000V
	best accuracy	±0.5%
AC Voltage [V]	min range	2V
	max range	750V
	best accuracy	±0.8%
DC Current [A]	min range	20µA
	max range	20A
	best accuracy	±0.8%
AC Current [A]	min range	2mA
	max range	20A
	best accuracy	±1%
Resistance [Ohms]	min range	200Ω
	max range	20MΩ
	best accuracy	0.8%
Capacitance [F]	min range	2nF
	max range	100µF
Temperature [°C]	min range	-40°C
	max range	1000°C
Frequency [Hz]	min range	2kHz
	max range	20kHz

Special Functions

Diode	Yes
Continuity Buzzer	Yes
Transistor	Yes
Data Hold	Yes
Max. Display	1999
Battery (supplied)	1 x 9V PP3 (Order Code L46AL)

Order Code	Mod.	Price each exc. VAT	inc. VAT each
		1+	5+
N79CB	Uni-T UT58C DMM	£29.15	£26.24
			£34.99

Precision Gold Digital Multimeter



- 3½ digit LCD
- Autoranging frequency counter to 15MHz ±(0.5%rdg + 1dgt)
- Capacitance to 20µF in 5 ranges ±(5%rdg + 10dpts)
- Continuity and diode test
- Transistor hFE

A sensitive, accurate, multimeter for the more serious electronics enthusiast, offering an auto-ranging frequency function in addition to the normal basic functions.

DC Voltage Range	200mV to 600V
AC Voltage Range:	200mV to 600V
Resistance Range	200Ω to 200MΩ
Capacitance Range	2000pF to 20µF (5 ranges)

Test frequency:	400Hz
Frequency (autoranging):	to 15MHz
Sensitivity	
Trig Lo:	1V rms min [TTL signal only]
Trig Hi:	2V rms min [TTL signal only]
Overload protection:	500Vdc or AC rms
Continuity	
Audible indication	<400 ±200
Overload protection:	500V DC or AC rms

Order Code	Mod: 004404	Price each exc. VAT	inc. VAT each
		1+	5+
GW20W	Model PG012 Digi M/M	£29.15	£34.99

Precision Gold PG10B Digital Multimeter



- Highly specified digital multimeter for professional and hobby use
- Packed with functions for a wide variety of tests including battery testing
- Measure AC & DC voltages up to 600V and DC current up to 10A
- Includes audible continuity, diode test and hFE transistor testing
- Supplied with battery and tough rubberised case

A well specified low-cost multimeter with DC current function, battery and continuity test. With the exception of the 200Ω range, all resistance ranges are low power which allows accurate in-circuit resistance measurements to be made. Ideal for students and hobbyists on a budget.

Specifications:

DC voltage range:	200mV to 600V
AC voltage range:	200V to 600V
DC current range:	2mA to 10A
Resistance range:	2000 to 20MΩ
Battery test range:	1.5V to 9V
Continuity:	Audible indication: <400 ±200
	Overload protection: 500Vdc or AC rms

Dimensions:	151 x 70 x 38mm
Weight:	200g including battery
Battery:	9V PP3 type

Order Code	Mod: 004402	Price each exc. VAT	inc. VAT each
		1+	5+
GW18U	Model PG10B Digi M/M	£24.99	£29.99

Uni-Trend UT60A Autoranging Digital Multimeter with PC Interface



- Autoranging
- RS232 PC Interface
- DC/AC voltage and current
- Resistance, capacitance, frequency, diode and continuity functions
- Data hold function
- 3999 max display

Specifications:

Basic Functions		
DC Voltage [V]	min range	400mV
	max range	1000V
	best accuracy	±0.8%
AC Voltage [V]	min range	4V
	max range	750V
	best accuracy	±1.0%
DC Current [A]	min range	400uA
	max range	10A
	best accuracy	±1.0%
AC Current [A]	min range	400uA
	max range	10A
	best accuracy	±1.5%
Resistance [Ohms]	min range	400Ω
	max range	40MΩ

Capacitance [F]	best accuracy	±1%
	min range	40nF
	max range	100uF
Frequency [Hz]	min range	10Hz
	max range	10MHz
Duty Cycle [%]	Yes	
Special Functions		
Fused 10A Range	Yes	
Auto Ranging	Yes	
Diode	Yes	
Continuity Buzzer	Yes	
Relative Mode	Yes	
Data Hold	Yes	
RS232C	Yes	
Max. Display	3999	

Order Code	Mod: 808836	Price each exc. VAT	inc. VAT each
		1+	5+
N80CB	Uni-T UT60A DMM	£33.32	£39.99

Uni-Trend UT60E RMS Autoranging Digital Multimeter with PC Interface



- Professional multimeter capable of measuring true RMS AC
- Autoranging selection
- RS232 serial PC interface cable and software supplied (USB only computers will need an adapter)
- Accurate DC/AC voltage and current measurements
- Resistance, capacitance, temperature, diode and continuity can easily be measured
- Extended features include temperature, frequency and duty cycle

Specifications:

Basic Functions		
DC Voltage [V]	min range	400mV
	max range	1000V
	best accuracy	±0.8%
AC Voltage [V]	min range	4V
	max range	750V
	best accuracy	±1%
DC Current [A]	min range	400uA
	max range	10A
	best accuracy	±1%
AC Current [A]	min range	400uA
	max range	10A
	best accuracy	±1.5%
Resistance [Ohms]	min range	400Ω
	max range	40MΩ
	best accuracy	1%
Capacitance [F]	min range	40nF
	max range	100uF
Temperature [°C]	min range	-40°C
	max range	1000°C
Frequency [Hz]	min range	10Hz
	max range	10MHz
Special Functions		
Duty cycle	0.1% - 99.9%	
Fused 10A Range	Yes	
Auto Ranging	Yes	
Diode	Yes	
Continuity Buzzer	Yes	
True RMS [AC]	Yes	
Relative Mode	Yes	
Data Hold	Yes	
RS232C Serial Cable	Yes	
Display Backlight	Yes	
Max. Display	3999	
Battery [supplied]	1 x 9V PP3	
	[Order Code L46AL]	

Order Code	Mod: 046458	Price each exc. VAT	inc. VAT each
		1+	5+
N81CB	UT60E RMS PC DMM	£41.65	£49.99

Uni-Trend UT801 Bench Multimeter



- A sophisticated multi test system, perfect for bench applications in laboratories, education, workshops or just in the home
- A broad range of electrical tests can be carried out with this precise instrument
- Maximum ranges exceed values found on most hand held multimeters
- Temperature, frequency, capacitance, resistance, transistor hFE plus AC & DC voltage and current can be accurately measured
- Other functions include illuminated display and data hold function
- The system can be powered from batteries and used in portable field applications if required
- DC adapter, multi test socket, 230°C temperature probe and probe lead set is included in this pack

The UT-801 is a flexible and reliable multimeter ideal for many applications in the workplace. Whether you are servicing equipment, making repairs, fault finding or performing routine measurements then this is the must-have instrument. It features an impressively large 3½ digit display with a maximum reading of 1999 and a clear backlit LCD panel. In addition to the conventional features expected from a multimeter, this bench meter will accurately measure AC or DC high voltage current to 10A, temperature up to 1000°C (with compatible K-type probe) and audible continuity - features which are hard to find on standard hand meters in this price range.

Specifications:

Function	Range Setting
DC Voltage	200mV/2V/20V/200V/1000V
AC Voltage	2V/20V/200V/750V
DC Current	200uA/2mA/20mA/200mA/10A
AC Current	2mA/20mA/200mA/10A
Resistance	20MΩ
Capacitance	20nF/2uF/200uF
Frequency	2kHz/200kHz
Temperature °C	-40 to 1000
Transistor	hFE

Additional features

Sleep Mode	1%
Diode	
Continuity Buzzer	
Display Backlight	
Misuse Alarm	
Low Battery Display	
Input Impedance for DC voltage measurement	>10MΩ
Data Hold	
Max. Display	1999
Power	9VDC PSU (included) or 6 x C cells [not included]
LCD Size	108 x 35mm
Standard Accessories	Test lead, DC adapter, manual, temperature probe, multi-purpose socket

Order Code	Mod: 589599	Price each exc. VAT	inc. VAT each
		1+	5+
N43KH	Bench multimeter 801	£49.99	£59.99

Buy it on the web at maplin.co.uk

Shop for all Maplin products online at our website and check out our latest products and special offers!



Browse our entire range at maplin.co.uk



Small Soft Carry Case Multimeter

A black soft PVC carry case designed for smaller multimeters and portable instruments and offers protection from scratches, knocks and damage from everyday use.

It suits Maplin order codes GW19U, GW20W, GW26D & GW24B but will fit many more in our range. The three-quarter zip case has a convenient carry handle and internal pouch for test leads, spare fuses etc. Approximate internal dimensions 100 x 145 x 30mm



Order Code	Mod.	Price each exc. VAT	inc. VAT each
AN84F	Small Soft Meter Cas	£5.40	£6.49

Large Soft Carry Case Multimeter

A black soft PVC carry case designed for larger multimeters and portable instruments and offers protection from scratches, knocks and damage from everyday use.

The three-quarter zip case has a convenient carry handle and internal pouch for test leads, spare fuses etc. Approximate internal dimensions 110 x 195 x 35mm



Order Code	Mod.	Price each exc. VAT	inc. VAT each
JA21X	Large Soft Meter Cas	£7.07	£8.49

Clamp Meters

Mini Clamp Meter

- Entry level clamp meter with basic testing functions
- Integrated jaw clamp for inductive measurements
- Easy to read 3½ digits LCD/ max. reading 1999
- Data-hold function
- Low battery indication and built in overload protection
- Audible continuity for checking fuses or broken connections
- Complies with CAT II 600V



Specifications

Voltage DC:	600V
Voltage AC:	600V
Current AC:	20A/200A/400A
Resistance:	2kΩ /200kΩ
Continuity:	<=300
Diode Check:	2.8V/1mA
Diode Check:	2.8V/1mA
Power:	CR2032x3
Dimensions(WxHxD):	65x151x34 mm
Weight:	127g (with battery)

Order Code	Mod.	Price each exc. VAT	inc. VAT each
N54FU	Clamp meter	£13.32	£15.99

Uni Trend Autoranging AC Digital Clamp Multimeter

- Clamp meter and digital multimeter
- Measure AC, DC voltage and AC current
- Resistance, diode and continuity test



- Max and data hold functions
- Low battery display and sleep mode
- 35.6 x 18mm 1999 max. LCD
- Complete with test leads, batteries, manual and carrying bag

Specifications:

Basic Functions:

DC Voltage (V)	min range 200mV max range 600V best accuracy ±0.8%
AC Voltage (V)	min range 2V max range 600V best accuracy ±1.2%
AC Current (A)	min range 2A max range 400A best accuracy ±1.5%
Resistance (Ohms)	min range 200Ω max range 20MΩ best accuracy 1.0%

Special Functions

Autoranging	Yes
Diode	Yes
Continuity Buzzer	Yes
Max Hold	Yes
Data Hold	Yes
Max Display	3999

Order Code	Mod.	Price each exc. VAT	inc. VAT each
N82CB	Uni-T UT201 Clamp	£29.15	£34.99

Uni Trend 203 DC/AC Current Clamp Multimeter

- Clamp meter and digital multimeter with DC and AC current
- Measure AC, DC voltages
- Resistance, diode, continuity test, frequency and duty cycle
- Max and data hold functions
- Low battery display and sleep mode
- Ideal for automotive applications
- 35.6 x 18mm 1999 max. LCD
- Complete with test leads, batteries, manual and carrying bag
- Ideal for automotive and fault finding applications



Specifications:

Basic Functions:

DC Voltage (V)	min range 400mV max range 600V best accuracy ±0.8%
AC Voltage (V)	min range 4V max range 600V best accuracy ±1%
DC Current (A)	min range 40A max range 400A best accuracy ±2%
AC Current (A)	min range 40A max range 400A best accuracy ±2.5%
Resistance (Ohms)	min range 400Ω max range 40MΩ best accuracy ±1.0%

Special Functions

Autoranging	Yes
Diode	Yes
Continuity Buzzer	Yes
Frequency	10Hz to 10MHz
Max Display	3999
Max Display	3999
Data Hold	Yes
Max Display	3999

Order Code	Mod.	Price each exc. VAT	inc. VAT each
N41NC	UT203 DC Clamp Meter	£33.32	£39.99

Test Lead Kits

4mm Test Cable Set with Probe Tip Covers



- Probe test cable with protective covers
- Supplied as a pair, red and black
- 1300mm long with a 4mm plug
- CATIII 1000V, 10A

Order Code	Mod.	Price each exc. VAT	inc. VAT each
N23CB	Probe Test Leads	£7.07	£8.49

4mm Test Cable Kit

- Customise your test cable needs with this universal test lead kit
- Make up bespoke cable arrangements
- Standard 1m red and black lead with moulded 4mm banana plug



Choose from:

27mm long tip in a 86mm long x 9mm diameter handle probe prod

4mm (minimum) spade terminals

38mm long crocodile clips

20mm long x 2mm diameter needle point plugs

4mm banana plugs

Order Code	Mod.	Price each exc. VAT	inc. VAT each
FK21X	4mm Test Lead Kit	£8.32	£9.99

4mm Test Cables

- A set of spare test cables for common ranges of digital multimeters
- Ideal as a replacement for faulty originals
- Sold as a pair, red and black
- 1000mm long



Order Code	Mod.	Price each exc. VAT	inc. VAT each
GW92A	Test Leads	£7.90	£9.49

4mm Extra Long Test Cable Set

- A pair of test cables, 1 red and 1 black
- 1300mm long terminated in a 4mm plug at each end
- Rated to CATIII 1000V, 10A
- Can be used with alligator clips N31CB



Order Code	Mod.	Price each exc. VAT	inc. VAT each
N35CB	Long Test Lead Set	£5.82	£6.99

4mm Right Angle Long Test Cables



- A pair of right angled long test cables, one red and one black
- Used to connect test equipment to clip accessories

Subscribe to our newsletter
for deals and information
maplin.co.uk



- The cables are 1200mm long and terminated in 4mm plugs
- Rated to CATIII 1000V, 10A

Order Code	Mod: 046253	Price each exc. VAT	inc. VAT each
		1+ 5+	
N34CB	R/A Exten Lead Set	£4.15	£3.74 £4.99

4mm Probe Clip Test Cables

- Spring loaded probe clip
- Supplied in pairs, red and black
- 270mm long cable
- 4mm socket connection
- CATII 300V, 10A



Order Code	Mod: 046225	Price each exc. VAT	inc. VAT each
		1+ 5+	
N21CB	Min probe test leads	£4.40	£3.96 £5.29

4mm Shrouded Plug Meter Probes

- Shrouded 4mm socket for higher specification meters
- Pin point probes for accurate testing
- 1000mm long
- Support for JG13P alligator clips



Order Code	Mod: 027249	Price each exc. VAT	inc. VAT each
		1+ 5+	
KW08J	Shroud Plug/Probes	£7.07	£6.36 £8.49

4mm Banana Type Connection Multimeter Test Cables

- Standard 4mm banana type connection
- Supplied as a pair, red and black
- 1000mm long
- Can be used with the JG13P alligator clips



Order Code	Mod: 027246	Price each exc. VAT	inc. VAT each
		1+ 5+	
KW07H	Banana Plug/Probes	£6.07	£5.46 £7.29

4mm Banana Plug Test Cable Set

- Multimeter probes suitable to measure large diameter terminals
- Supplied as a pair, red and black
- 1400mm long with 4mm plug
- CATIII 1000V, 10A



Order Code	Mod: 046226	Price each exc. VAT	inc. VAT each
		1+ 5+	
N22CB	Banana Plug Leads	£8.32	£7.49 £9.99

Maplin TV

Home of innovation, handy tips and How To videos
[youtube.com/maplintv](https://www.youtube.com/maplintv)



Probes

Sub Miniature Probe Clip Black



Ideally suited for use with our extra flexible wire, these probe clips feature a spring-loaded wire hooked probe which retracts into the probe moulding. Probe material is phosphor bronze plate 0.3mm thick. Housing is nylon. Sold individually.

Dielectric strength: 2kV for 1 minute
 Insulation resistance: >100MΩ, at 50V DC
 Length: 43mm
 Cap diameter: 8mm
 Cap stroke: 3.5mm
 Probe tip: 2x3mm
 Wire entry hole: 2.2mm

Order Code	Mod: 808846	Price each exc. VAT	inc. VAT each
		1+ 5+	
FE16S	Sub-Min Probe Black	£1.24	£1.11 £1.49

Sub Miniature Probe Clip Red



Ideally suited for use with our extra flexible wire, these probe clips feature a spring-loaded wire hooked probe which retracts into the probe moulding. Probe material is phosphor bronze plate 0.3mm thick. Housing is nylon. Sold individually.

Dielectric strength: 2kV for 1 minute
 Insulation resistance: >100MΩ, at 50V DC
 Length: 43mm
 Cap diameter: 8mm
 Cap stroke: 3.5mm
 Probe tip: 2x3mm
 Wire entry hole: 2.2mm

Order Code	Mod: 808847	Price each exc. VAT	inc. VAT each
		1+ 5+	
FE19V	Sub-Min Probe Red	£1.24	£1.11 £1.49

Miniature Probe Clip Black



These probe clips feature a spring loaded wire hooked probe which retracts into the probe moulding. The probe material is copper and the housing is ABS.

Specifications:
 Length: 54.5mm
 Cap diameter: 10.5mm
 Cap stroke: 3.5mm
 Probe tip: 4.3 x 2.5mm
 Wire entry hole: 3mm
 Probe length: 4.4mm
 Contact resistance: <10mΩ
 Insulation resistance: >10MΩ
 Withstand voltage: D=150V
 Current rating: D=150V/0.5A

Order Code	Mod: 808848	Price each exc. VAT	inc. VAT each
		1+ 5+	
N60BY	Min Probe Black	£1.40	£1.26 £1.69

Miniature Probe Clip Red



These probe clips feature a spring loaded wire hooked probe which retracts into the probe moulding. The probe material is copper and the housing is

ABS

ABS

Specifications:
 Length: 54.5mm
 Cap diameter: 10.5mm
 Cap stroke: 3.5mm
 Probe tip: 4.3 x 2.5mm
 Wire entry hole: 3mm
 Probe length: 4.4mm
 Contact resistance: <10mΩ
 Insulation resistance: >10MΩ
 Withstand voltage: D=150V
 Current rating: D=150V/0.5A

Order Code	Mod: 808849	Price each exc. VAT	inc. VAT each
		1+ 5+	
N618Y	Min Probe Red	£1.40	£1.26 £1.69

Large Probe Clip Black



These probe clips feature a spring loaded wire hooked probe which retracts into the probe moulding. The probe material is copper and the housing is ABS.

Specifications:
 Length: 90.5mm
 Cap diameter: 14mm
 Cap stroke: 3.5mm
 Probe tip: 4.3 x 2.5mm
 Wire entry hole: 3mm
 Probe length: 4.4mm
 Contact resistance: <10mΩ
 Insulation resistance: >10MΩ
 Withstand voltage: D=150V
 Current rating: D=150V/0.5A

Order Code	Mod: 808850	Price each exc. VAT	inc. VAT each
		1+ 5+	
N628Y	Large Probe Black	£1.65	£1.50 £1.99

Large Probe Clip Red



These probe clips feature a spring loaded wire hooked probe which retracts into the probe moulding. The probe material is copper and the housing is ABS.

Specifications:
 Length: 90.5mm
 Cap diameter: 14mm
 Cap stroke: 3.5mm
 Probe tip: 4.3 x 2.5mm
 Wire entry hole: 3mm
 Probe length: 4.4mm
 Contact resistance: <10mΩ
 Insulation resistance: >10MΩ
 Withstand voltage: D=150V
 Current rating: D=150V/0.5A

Order Code	Mod: 808851	Price each exc. VAT	inc. VAT each
		1+ 5+	
N638Y	Large Probe Red	£1.65	£1.50 £1.99

6mm Long Test Probes

- A pair of test probes, red and black
- Pin point 6mm tips and 108mm x 8mm handles
- Terminated with 4mm male connector, requires 4mm female connection
- Rated at CATII 600V, 10A



Order Code	Mod: 046244	Price each exc. VAT	inc. VAT each
		1+ 5+	
N27CB	Long Probes+Covers	£3.57	£3.21 £4.29

2mm Molded Test Probe Cables

- Ideal replacements for use with multimeters fitted with 2mm sockets
- Moulded cables supplied in pairs, red and black
- Terminated in heavy duty moulded PVC test prods
- 750mm long



Order Code	Mod:	Price each	exc. VAT	VAT	inc. VAT each
		1+	5+		
HF32K	Moulded Test Probe	£4.57	£4.11		£5.49

100mm Test Hook Probes

- Long reach 100mm test probes
- 2mm hook with 4mm cable socket
- Designed for bench testing applications or inaccessible equipment
- Supplied with red and black colour tips
- Rated at CATII 1000V, 10A



Order Code	Mod:	Price each	exc. VAT	VAT	inc. VAT each
		1+	5+		
N58KQ	10A Long Probe Clips	£12.49	£11.99		£14.99

4mm Moulded Test Probe Cables

- Ideal replacements for use with multimeters fitted with 4mm sockets
- Moulded cables supplied in pairs, red and black
- Terminated in heavy duty moulded PVC test prods
- 750mm long



Order Code	Mod:	Price each	exc. VAT	VAT	inc. VAT each
		1+	5+		
HF33L	4mm Test Probe	£4.57	£4.11		£5.49

10mm Component Tweezer Multimeter Probe



- Standard multimeter set terminated with a tweezer probe
- Ideal for measuring surface mount components or narrow terminals
- 10mm opening
- 30VAC, 60VDC at 2A maximum

Order Code	Mod:	Price each	exc. VAT	VAT	inc. VAT each
		1+	5+		
N59KQ	Component Probes	£4.99	£4.53		£5.99

57mm Probe to Croc Clip Cables

- A pair of red and black quick hook cable set
- 57mm probe clip to 35mm crocodile clip
- 1000mm long



Order Code	Mod:	Price each	exc. VAT	VAT	inc. VAT each
		1+	5+		
FE23A	Probe/Croc Clip Lead	£4.99	£4.49		£5.99

Low Cost Probes

This low cost scope probe is a useful all purpose probe ideal for general testing.



Specifications

Nominal Impedance 50Ω
 Operating Voltage Shield 30 VAC / 60 VDC
 Inner conductor/Shield: 500 Vrms

Order Code	Mod:	Price each	exc. VAT	VAT	inc. VAT each
		1+	5+		
YR95D	Lo-Cost Scope Probe	£4.57	£4.11		£5.49

60MHz Oscilloscope Probe



- 60MHz high-quality passive oscilloscope probe
- X1 and X10 setting selector
- Different termination options included
- Compensation adjustment is available
- Two channel identifier clips, spring loaded hook, ground lead, insulating tip, IC test tip, operating manual and insulated adjustment tool

Input Capacitance Approx. 12pF
 Compensation Range 10 to 30pF
 Max. Input Voltage 600V CAT I, 300V CAT II (DC + peak AC) derating with frequency

Position X1

Attenuation Ratio
 Bandwidth DC to 25MHz
 Rise Time 14nS
 Input Resistance 1MΩ (oscilloscope input resistance)

Input Capacitance Approx. 49pF
 Max. Input Voltage 300V CAT I, 150V CAT II (DC + peak AC) derating with frequency

Operating Temperature 0°C to 50°C
 Humidity 85% RH or less (at 35°C)
 Safety Meets EN61010-031 CAT II
 Cable Length 1.2 Meter

Specifications

Position X10

Attenuation Ratio
 Bandwidth DC to 60MHz
 Rise Time 5.8nS
 10MΩ when used with oscilloscopes which have 1MΩ input

Order Code	Mod:	Price each	exc. VAT	VAT	inc. VAT each
		1+	5+		
AQ58N	60MHz Scope Probe	£12.49	£11.24		£14.99

Clips

Alligator Clips

- Ideal to convert compatible test leads into insulated clips
- Clips screw onto KW07H and KW08J test leads
- Sold as a pair, red and black



Order Code	Mod:	Price each	exc. VAT	VAT	inc. VAT each
		1+	5+		
JG13P	Alligator Clip	£2.74	£2.46		£3.29

4mm Alligator Clips 50mm Long



- A pair of alligator clips, one red and one black.
- The clips are 50mm long and have a 4mm socket with insulating sleeve.
- Overall length with insulating sleeve is 66mm

Order Code	Mod:	Price each	exc. VAT	VAT	inc. VAT each
		1+	5+		
N30CB	Alligator Clips	£3.07	£2.76		£3.69

370mm Quick Hook Up Test Cable



- 10 piece croc to croc hook-up set
- 2 of each of 5 colours: black, green, red, white and yellow
- 370mm long terminated at each end with a small insulated crocodile clip

Order Code	Mod:	Price each	exc. VAT	VAT	inc. VAT each
		1+	5+		
N90AP	Croc Lead Kit	£6.65	£5.99		£7.99

100mm Large Alligator Clips



- A pair of large jaw alligator clips, one red and one black
- The clips are 100mm long and the jaws open to 30mm
- Rated to CATIII 1000V, 10A

Order Code	Mod:	Price each	exc. VAT	VAT	inc. VAT each
		1+	5+		
N31CB	Lrg Alligator Clips	£8.32	£8.18		£9.99

900mm Car Fuse Adapter Lead Set Maxi Blade



- Identifies the circuit draining your car battery
- Connects your multimeter directly into the car fuse box
- Simply plugs into any blade type fuse holder
- Quality test leads
- Measures up to 48V/ 20A
- Cable length: 900mm

Order Code	Mod:	Price each	exc. VAT	VAT	inc. VAT each
		1+	5+		
N50CY	Car Test Lead Max	£7.07	£6.36		£8.49

900mm Car Fuse Adapter Lead Set Mini Blade

- Identifies the circuit draining your car battery
- Connects your multimeter directly into the car fuse box
- Simply plugs into any blade type fuse holder
- Quality test leads
- Measures up to 48V/ 20A
- Cable length: 900mm



Order Code	Mod:	Price each exc. VAT 1+	5+	inc. VAT each
N51CY	Car Test Lead Mini	£7.07	£6.36	£8.49

400mm Automotive Current Tester Maxi Blade

- Identifies the circuit draining your car battery
- Available for mini or maxi fuses
- Provides an easy-to-read LCD display of the circuit's performance
- Simply plugs into standard blade type fuse holder
- Measures up to 48V/ 20A
- Cable length: 400mm
- Weight: 68g
- Dimensions: 86(l) x 37(w) x 28.5(d)mm
- 12V A23 type battery (spares available, Order Code: JG91Y)



Order Code	Mod:	Price each exc. VAT 1+	5+	inc. VAT each
N48CY	Auto Curr. Tester Max	£11.07	£9.96	£13.29

400mm Automotive Current Tester Mini Blade

- Identifies the circuit draining your car battery
- Available for mini or maxi fuses
- Provides an easy-to-read LCD display of the circuit's performance
- Simply plugs into standard blade type fuse holder
- Measures up to 48V/ 20A
- Cable length: 400mm
- Weight: 68g
- Dimensions: 86(l) x 37(w) x 28.5(d)mm
- 12V A23 type battery (spares available, Order Code: JG91Y)



Order Code	Mod:	Price each exc. VAT 1+	5+	inc. VAT each
N49CY	Auto Curr. Test Mini	£11.07	£9.96	£13.29

Voltage Testers

Continuity Tester



- Can be used to detect continuity and therefore for checking fuses or lamps
- Other uses include short circuit tests, tracking broken cables, microwave oven radiation testing and television emission tests.
- Supplied with batteries (battery life of approximately 5 hours continuous use)
- Dimensions 136 x 20mm including clip

Order Code	Mod:	Price each exc. VAT 1+	5+	inc. VAT each
AS26D	Continuity Tester	£4.99	£4.49	£5.99

Digital Voltage Tester



- Easy and safe to use
- Accurately measure voltage for quick reference checking
- Ideal for measuring AC and DC voltage from 12V to 250V

Order Code	Mod:	Price each exc. VAT 1+	5+	inc. VAT each
RM69A	Digital Volt. Tester	£5.40	£4.86	£6.49

Mains Socket Tester

- Essential mains safety tester
 - Simple plug-in operation
 - Three neon indicators
- Check all new and existing mains installations with this easy-to-use tester. Simply plug into any normal mains socket you want to test. If everything is OK all three indicators light up. Other sequences warn of specific problems such as Live and Neutral reversed, no Earth, etc.



Order Code	Mod:	Price each exc. VAT 1+	inc. VAT each
WD53H	Mains Socket Tester	£5.82	£6.99

Non Contact AC Voltage Detector



- Non-contact detection of AC voltage from 100 to 600 Vac (CAT III 1000V)
- Rugged, double-moulded case
- Complete with a bright white LED torch
- Flashing red AC voltage light indicator
- For use on 50/60 Hz circuits

Order Code	Mod:	Price each exc. VAT 1+	5+	inc. VAT each
N10BY	AC Voltage Detector	£14.15	£12.74	£16.99

PAT Testing Labels

ORDER IN STORE OR ONLINE

- PAT testing pass labels
- Labels supplied in packs of 500
- Ideal value pack sizes for mobile test engineers



Order Code	Mod:	Price each exc. VAT 1+	inc. VAT each
N24JG	Pat Test Pass Labels	£12.49	£14.99

Maplin USB Power Meter

- Displays Current and Voltage from any USB device or charger
 - 4 modes of measurement
 - Real time Current, Voltage, maximum Current and minimum Voltage
 - Easily identify problems with current or voltage from USB devices and chargers
- The Maplin USB Power Meter is a must have product for testing USB devices and chargers. Its small LCD display



shows current and voltage values whilst plugged into any USB socket. (mains USB power supply or laptop / computer USB socket) Simply plug your USB device inline to easily test and identify problems.

Specification

Min Voltage Range	0.05V
Max Voltage Range	5V
Min Current Range	0.02A
Max Current Range	2.0A
Colour:	Translucent
Product Width:	22mm
Product Depth	10mm
Product Height	65.8mm
Product Weight	13g

Order Code	Mod:	Price each exc. VAT 1+	inc. VAT each
N55CE	USB Power Meter	£16.65	£19.99

Maplin USB DC Voltage Data Logger



- Designed to record voltage values from 0-30V
- Memory for 32,000 readings
- Data can be downloaded to PC software via USB interface
- Sampling time can be adjusted and the data can be displayed in graph form whilst viewing on PC software
- Selectable sampling time: 400Hz (2.5ms): 0.0025s, 2s, 5s, 10s, 30s, 1m, 5m, 10m, 30m, 1hr, 2hr, 3hr, 6hr, 12hr and 24hr
- Triple LED light to indicate running state
- Smallest detectable voltage is 33mV
- User selectable low and high alarm values
- Auto and manual modes used for activating data logging
- Measurement accuracy: $\pm 0.5\%$
- Low battery indication
- Operating temperature: 0 to 50°C (32 to 122°F)
- Storage temperature: -20 to 60°C (-4 to 140°F)
- Operating humidity: <80% RH
- Storage humidity: <80% RH
- Size: 130 x 30 x 25mm
- Weight 20g

The Maplin USB DC Voltage Data Logger is designed to record tested voltage values taken at specific timings. This device can store up to 32,000 voltage readings with a measurement range between 0V and 30V. Users can adjust the sampling rate to suit their requirements and even setup high and low alarm values through the supplied Data Logger PC software. The recorded data can then be downloaded to your computer and viewed in a graphical form or exported to an excel format.

Order Code	Mod:	Price each exc. VAT 1+	inc. VAT each
N70DP	DC Voltage Data Logger	£29.15	£34.99

Technical Helpline

0333 400 9500

For technical information and assistance relating to any Maplin purchase, contact our team of experts

GW Instek GPT-9801 AC Withstanding Voltage Tester

ORDER IN STORE OR ONLINE



- 200VA AC test capacity
- 240 x 64 ice blue dot matrix LCD
- Manual/ auto mode
- Function key for quick selecting
- High intensity flash for caution & status indication
- Safety interlock function
- Zero crossing turn-on operation
- Controllable ramp-up time
- True RMS current measurement
- High resolution : 1 A for measuring current, 2V for setting voltage
- PWM switching amplifier to enhance the power efficiency and reliable testing
- Max. 100 memory block for test condition (step) setting. Each step can be named individually
- Remote terminal on the front panel for "start" & "stop" control by external
- Interface : RS-232C, USB device, signal I/O and GPIB (optional)

Order Code	Mod.	Price each exc. VAT 1+	inc. VAT each 5+
N59DG	1012873 GPT-9801 Volt Test	£749.99	£899.99

Temperature Measurement

Pen Type Pocket Infrared Thermometer



- Wide ranging IR thermometer in a lightweight pen design
- -33 to +250°C range
- Easy to read back lit display
- Measures °C or °F
- Last reading hold function
- Constant live readings when button is pressed
- 1:1 Distance to spot ratio

Used for measuring the surface of an object without exposing the user to risk. Ideal for balancing radiators, looking for heat or cold spot in heating, kitchens or machinery.

Order Code	Mod.	Price each exc. VAT 1+	inc. VAT each 5+
N78LL	626124 Pocket IR Thermomete	£13.32	£12.92

Pocket Infrared Thermometer

- Pocket-sized point and shoot thermometer
- Precise, non-contact temperature measurement for a wide range of applications
- Automatic data hold
- °C/°F modes
- MAX, MIN and LOCK functions
- 1:1 field of view ratio



Specification	Value
Range:	-35°C to +230°C [-31°F to +446°F]
Resolution:	0.1°C / 0.1°F
Response time	<1 second
Infrared accuracy	±2% of reading or ±2°C/4°F

Storage temperature:	-10°C to -35°C: ±4°C 14°F to -13°F: ±7°F
Relative humidity	10%-90% RH operating, <80% RH storage
Field of view	1:1 optics ratio
Battery life:	40 hours' continuous use
Battery	CR2032 (Order code: ZB74R)
Display	LCD
Dimensions	75(h) x 40(w) x 20(d)mm
Weight	33g

Order Code	Mod.	Price each exc. VAT 1+	inc. VAT each 5+
N19FR	220790 Pkt IR Thermometer	£16.65	£15.99

Mini Digital Probe Thermometer

- Wide ranging probe type thermometer: -20°C to +1000°C (-4°F to +1832°F)
- Ideal for taking measurements of liquids or soft materials
- Strong metal probe with pointed tip to aid insertion
- Metal probe measures 61 mm
- Perfect for use in schools, labs or even the kitchen to check food is cooked properly
- °C/°F switchable, data hold function
- 2000 count LCD screen with °C, °F, HOLD, LOW BAT indication
- Auto power off function
- Includes 2 x LR44 batteries (Order code: FM28F)
- Dimensions: 18.8 x 6.45 x 2.45cm



Order Code	Mod.	Price each exc. VAT 1+	inc. VAT each 5+
N84FR	221046 Digital Thermometer	£16.65	£14.99

Handheld Non Contact Thermometer

- Take accurate temperature readings off a variety of surfaces
- Switchable laser pointer to assist precise aiming
- Ideal for many applications in industry, education or around the home and DIY
- Wide temperature range -20 to 350°C
- LCD, with illumination, select between °C or °F units



This Infrared Thermometer is perfect for applications that require surface measurements to be taken at moderate distances. The wide temperature range and the inclusion of a laser target point to ensure consistent accuracy during use. Applications include checking of air conditioning and heating systems, balancing radiators or identifying hot and cold spots across a variety of surfaces as well as monitoring the performance of equipment to comply with legislation

Specification:	Value
Temperature range	-20 to 350°C [0 to 608°F]
Accuracy	0 to 180°C ± 2% +2°C
Response time	
Operating temperature	0 to 50°C
Distance to spot	
Emissivity	0.95
Weight (without battery):	137g
Power supply	1x9V Alkaline type PP3 battery

Order Code	Mod.	Price each exc. VAT 1+	inc. VAT each 5+
N75KH	590711 Infrared Thermometer	£24.99	£23.99

Infrared Thermometer with Laser Targeting

- Compact thermometer with a wide -35°C to 365°C temperature range
- Built-in laser pointer for accurate readings
- Automatic data hold and real-time MAX temperature reading
- Last measurement memory recall
- Large, easy to read display with 15-second hold
- Fixed emissivity (0.95) covers 90% of surface applications
- Distance to spot ratio: (D:S) 8:1
- Auto shut off
- Large LCD screen with backlight
- °C/°F selectable
- Uses 2 x AAA batteries (supplied separately - order code L42AL)



This pistol grip type infrared thermometer has a laser and backlight for easier targeting and operation. With the large -35°C to 365°C temperature range, real time maximum reading and an power saving auto shut off mode this infrared thermometer is a great option for accurately measuring the temperatures of a number of surfaces on a limited budget. <p>

Specifications:	Value
Temperature range:	-35 to 365°C [-31 to 689°F]
Temperature resolution:	0.2°C / 0.5°F
Emissivity	Fixed at 0.95
Optical resolution	8:1 Distance to spot size ratio
Basic accuracy:	±2.5% of reading or 2.5°C / 4.5°F
Response time	<1 second
Diode laser:	Output <1mW at 630-670nm class II laser product
Power supply	2 x AAA battery (Order Code L42AL)
Weight:	113g
Dimensions:	63.5(w) x 33.9(d) x 166.4(h) mm

Order Code	Mod.	Price each exc. VAT 1+	inc. VAT each 5+
N92FX	223005 IR Thermometer	£33.32	£39.99

Infrared Thermometer with Dual-Laser Targeting

- Dual laser sighting system that merges into a single laser point when the unit is at the optimal distance from the object being measured
- Easy to use - pull the trigger and shoot
- Wide temperature range from -50°C to +550°C (-58°F - +1022°F)
- Distance to spot size ratio is 12:1
- Impact-resistant double moulded ABS case
- Response time less than 150 milliseconds
- Large back lit LCD screen with function indicators
- Automatic data hold when trigger released
- Auto power off / over range indication
- Comes with carry case
- Includes 1 x 9V PP3 battery (Order code: L46AL)



Specifications:	Value
IR temperature range	-50°C - +550°C [-58°F - +1022°F]
IR temperature resolution	0.1° up to 1000°, 1° over 1000°
Emissivity:	0.95 fixed
Basic accuracy	±1.0% of reading
Response time	<150ms
Spectral response	8 - 14µm
Size:	146(h) x 104(w) x 43(d)mm
Weight:	163g
Power	9V PP3 battery

Order Code	Mod: 221048	Price each exc. VAT	inc. VAT each
N85FR	Dual Laser IR Therm	£45.82	£41.24

Environmental Testers

4 in 1 Multi Function Environment Meter

ORDER IN STORE OR ONLINE



- Simple to use environment meter
- Measure sound, light, temperature & humidity
- Large LCD display with robust casing
- Great for use in studios, office, factories, schools or home
- 9V battery (included)

The 4 in 1 multi-function environment meter has been designed to combine the functions of sound meter, light meter, humidity meter & thermometer into one easy to use instrument with scores of practical applications in schools, offices, factories, homes etc.

Specifications	
Sound Meter	
Low	35-100dB
High	65-130dB
Frequency weighting	A,C
Resolution	0.1dB
Light	
Ranges	20.00, 200.0, 2000 Lux 20000 Lux (x10 Lux)
Resolution	0.1 Lux
Temperature	
Ranges	
Low	-20°C-200°C -4°F-200°F
High	-20°C-750°C -4°F-1440°F
Resolution	0.1°C, 0.1°F
Humidity	
Ranges	25%-95% RH
Resolution	0.1% RH
Measurement rate	1.5 times per second, nominal
MAX HOLD & DATA HOLD functions	
OL over range indication	
Low battery indication	
Type K thermocouple included	
Photo detector included	
Humidity probe included	
Carry case included	
Powered by 1 x 9V battery (included)	

Order Code	Mod: 034518	Price each exc. VAT	inc. VAT each
N09AQ	4in1 Enviro Meter	£58.32	£55.99

Send direct

If any product is not in stock, we will order it for you and send it with free delivery

Terms and conditions apply



Humidity and Temperature Probe Meter

- Rugged thermo-hygrometer with integral probe for convenient one-hand operation
- Measure temperature and relative humidity accurately
- Fast response time and quality performance
- Illuminated LCD screen
- Humidity range: 0% to 100%RH
- Temperature range: -20 to 60°C / -4 to 140°F
- User selectable °C / °F
- Data Hold, Min/Max Function and Auto shut off
- Carrying case and battery included

Specifications:

Range	Humidity: 0% to 100% RH
Temperature:	-20°C to 60°C [-4°F to 140°F]
Accuracy	
Humidity:	±3.5% RH
Temperature:	±2°C, ±3°F
Resolution:	0.1% RH, 0.1°C(0.1°F)
Battery:	PP3 9V (included, replacement order code: L46AL)
Dimensions	225(h) x 45(w) x 34(d)
Weight	200g

Order Code	Mod: 220815	Price each exc. VAT	inc. VAT each
N18FR	Humidity & Temp Mtr	£24.99	£22.49



Moisture Meter

- Simple to use
- Suitable for use with wood and other building materials
- 2 hardened steel pins
- Impact-proof plastic housing
- LCD screen
- Includes 3 x CR2032 coin cell batteries (Order code: ZB74R)
- Spare pins included

This simple to use moisture meter has two hardened steel pins which are pushed into the wood or material to be measured to obtain a reading of moisture content on the LCD screen. The pins are protected by a cover when not in use.

Specifications:

Measuring principle	Electrical resistance
Electrode length	8mm
Electrodes:	Integrated, replaceable
Measuring range	Wood: 6 - 44% Building material: 0.2 - 2% Wood: ±1% Building material: ±0.05%
Accuracy	
Battery:	3 x CR2032 coin cell batteries
Dimensions	140(l) x 48(w) x 33(d) mm
Weight	100g

Order Code	Mod: 220803	Price each exc. VAT	inc. VAT each
N20FR	Moisture Meter	£24.99	£23.99

Technotrade Air Quality Meter

- Programmable humidity alarm - measures indoor humidity and temperature and alerts when your pre-programmed values are reached
 - Colour room-comfort indicator tells you if the room is too hot or too cold
 - Mould alarm with LED symbol
 - Display shows the last 12 hours humidity history
- Use this Air Quality Meter to monitor the humidity of your home. You can follow the humidity trend of the last 12 hours.



To avoid mould you have the option of programming your personal limit - you will be warned if this limit is reached. In addition the unit also provides information about the current temperature/ humidity and the minimum and maximum values.

Order Code	Mod: 1017612	Price each exc. VAT	inc. VAT each
N180Q	Air Quality Meter	£16.65	£19.99

Digital Multimeter with Environment Testing

- Measure sound, relative humidity, temperature & light levels all from this hand held meter
- A multi-function sensor is used to measure the range under test
- This device is a fully featured digital multimeter making it perfect for electrical installers, education or home DIY
- Multimeter function will measure DC and AC voltage up to 600 V
- DC current up to 10 A as well as resistance, diode testing, continuity and transistor testing
- Includes test leads, K-Type adapter, external temperature probe (1300°C) and 1 x 9 V battery (Order code: L46AL)



This comprehensive testing station makes analysing a wide range of variables in the field quick and easy. You can measure sound, light, humidity and temperature without the need to take other devices with you or have to invest in separate pieces of kit to take occasional measurements. These great features are built onto a high quality multimeter that can be used for general electronic and electrical testing.

Specifications	Range	Resolution
Sound Level	35-100 dB, C-weighting	0.1 dB
Light	200 Lux 20,000 Lux	0.1 Lux 10 Lux
Temperature with probe	-20°C - 200°C -20°C - 1300°C	0.1°C 1°C
Multimeter		
DCV	200 mV, 20V, 600V	0.1 mV, 10 mV, 1V
ACV	200 V, 600 V	100 mV, 1V
DCA	200 uA, 200 mA, 10 A	0.1 uA, 0.1 mA, 10 mA
Resistance	200Ω, 2kΩ, 200Ω, 2MΩ	0.1Ω, 10Ω, 10kΩ
hFE	0-1000hFE PNP or NPN transistors;	
Diode	Test current 1.4 mA; Open circuit	
Continuity	Threshold 50Ω; Continuity beeper	
Battery	9V FFP3 (included, replacement)	

Order Code	Mod: 220808	Price each exc. VAT	inc. VAT each
N21FR	5in1 Enviro Meter	£29.15	£26.24

Maplin TV

Home of innovation, handy tips and How To videos

Visit our channel...

youtube.com/maplintv



/maplin



@maplintweet



/+maplin



/maplinonline



/maplintv

Mini Sound Level Meter

- Suitable for audio and general purpose applications in warehouses, manufacturing units, offices, schools, pubs, clubs etc
- High performance and auto LCD backlight
- High and low measurement ranges
- Maximum hold
- Auto power off
- 1/2 inch electret condenser microphone
- Measuring level range 40 to 130 dB
- LCD display



High quality mini meter which is ideal for measurement of noise levels in various environments including warehouses, manufacturing units, offices, schools, pubs and clubs.

Specification

Frequency range: 31.5Hz - 8KHz
 Measuring level range: 40 - 130 dB
 Frequency weighting: C
 Microphone: 1/2 inch electret condenser microphone
 Display: LCD
 Digital Display: 4 digits

Resolution: 0.1 dB
 Display Update: 0.5 sec.
 FAST (125ms)
 Accuracy: ± 3.5dB @ 1KHz, 94dB [under reference conditions]
 Alarm function: "OVER" is shown when input is out of range (>130dB)
 Auto Power off: Meter automatically shuts down after approx. 15 minutes of inactivity

Power supply: One 9V battery, 006P or IEC 6F22 or NEDA 1604
 Operation temperature: 0 to 40° C (32 to 104° F)
 Operation humidity: 10 to 90% RH
 Storage Temperature: -10 to 60° C (14 to 104° F)
 Dimension [LxWxH]: 210x55x32mm
 Weight: 135g (including battery)
 Accessories: 9V battery, Instruction manual

Order Code	Mod:	Price each exc. VAT 1+	Price each exc. VAT 5+	inc. VAT each
N336J	Mini Sound Meter	£24.99	£22.49	£29.99

Digital Sound Level Meter



- Suitable for audio and general purpose applications in warehouses, manufacturing units, offices, schools, pubs, clubs etc
- LCD read out
- High and low measurement ranges
- Maximum hold
- A and C frequency weighting of sound level
- Selectable slow and fast response
- Auto power off
- Low battery indicator
- Supplied with a handy storage/carry case
- Size: 210(l) x 55(w) x 32(h)mm

Specifications:

Measurement frequency range: 31.5Hz-8KHz
 Measurement level range: 30 - 130dB
 Low: 30 - 100dB
 High: 60 - 130dB
 Accuracy: +/- 1.5dB
 Microphone: 12.7mm (1/2 inch) [Dia]

Digital display

Time weighting: Power

Dimensions

Order Code	Mod:	Price each exc. VAT 1+	Price each exc. VAT 5+	inc. VAT each
N05CC	Digital Sound Meter	£41.65	£40.40	£49.99

electric condenser microphone
 4 digit LCD, 0.1dB resolution updated every 0.5 sec.
 Fast: 125ms / Slow: 1 sec.
 9V battery
 [Order Code: L46AL]
 210(l) x 55(w) x 32(h) mm

dimensions: 188 x 64.5 x 24.5mm
 weight: 160g

Order Code	Mod:	Price each exc. VAT 1+	Price each exc. VAT 5+	inc. VAT each
N76CC	Lux Light Meter	£24.99	£22.49	£29.99

Microwave Radiation Tester

ORDER IN STORE OR ONLINE

- Detects microwave radiation emitted from devices such as mobile phones, wireless CCTV cameras, microwave ovens etc
- Ideal for finding out exactly what is emitting radio or microwaves, including hidden sources
- No battery required
- Easy to use
- Detection frequency range: 3MHz to 3GHz



Order Code	Mod:	Price each exc. VAT 1+	Price each exc. VAT 5+	inc. VAT each
N53FU	M/Wave Rad Tester	£3.32		£3.99

Digital Hygrometer with Thermometer



- Dual display for humidity and temperature
- Relative humidity function
- Large diameter base for standing up
- Lightweight and very portable
- Humidity 20 to 95% and temperature -20 to 60°C
- Min/Max recall function

Order Code	Mod:	Price each exc. VAT 1+	Price each exc. VAT 5+	inc. VAT each
N63LK	Compact Hygrometer	£16.65	£16.15	£19.99

Digital Light Meter

- Get precise measurements of light level with this portable light meter
- Photo detector is attached to a coiled extension cord for best positioning
- Ideal for photography, movie or scene setting applications or for lab, schools or industrial places
- Output is displayed in Lux and the range is 0.01 to 50000 Lux
- Easy to use with single function switch
- Pocket-sized device and includes protective cover for the photo detector
- 31/2 digit LCD display with low-battery & over-range indication



Specifications:

measuring range: 200, 2000, 20000lux (20000lux range reading x10) and 50000lux (50000lux range reading x100)
 accuracy: < 10000lux: ± 5% of rdg + 10 digits
 > 10000lux: ± 10% of rdg + 10 digits ± 2%
 repeatability: temperature characteristics ± 0.1%/°C
 photo detector: one silicon photo diode with filter
 power supply: 1 x 12V A23 battery (included)
 measurement rate: 1.5 times per second, nominal
 storage temperature: -10°C to +60°C
 photo detector dimensions: 115 x 60 x 27mm

Thermocouples

Unit Trend K Type Multi Purpose Adapter



- Test socket adapter for some Uni-T multimeters
- Gives K-type socket for standard temperature probes
- NPN and PNP transistor adapter break out points
- Compatible with N16BY, N79CB, N56AQ

Order Code	Mod:	Price each exc. VAT 1+	Price each exc. VAT 5+	inc. VAT each
N16KJ	Meter Temp Adaptor	£3.57	£3.21	£4.29

960mm K Type Wire Thermocouple

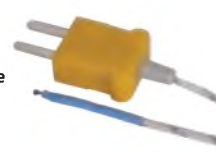

- Wire K-Type thermocouple
- Temperature range of 0°C to 250°C
- The wire is 960mm long
- For use with a meter with temperature reading facility

Order Code	Mod:	Price each exc. VAT 1+	Price each exc. VAT 5+	inc. VAT each
N37CB	K-Type Wire	£3.57	£3.21	£4.29

740mm K Type Metal Thermocouple

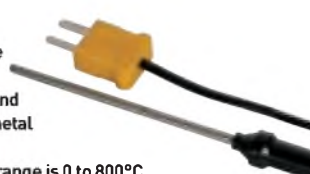

- A K-Type Thermocouple
- The wire is 740mm long and has a 3-inch metal type probe
- Temperature range is 0 to 800°C
- For use with a meter with temperature reading facility

Order Code	Mod:	Price each exc. VAT 1+	Price each exc. VAT 5+	inc. VAT each
N38CB	K-Type Metal Probe	£4.99	£4.49	£5.99

Oscilloscopes & Function Generators

Velleman 40MHz Sampling Handheld Oscilloscope

ORDER IN STORE OR ONLINE



- 40MHz sampling rate
- 12MHz analogue bandwidth
- 0.1mV sensitivity
- 5mV to 20V/div in 12 steps
- 50ns to 1hour/div time base in 34 steps
- Full auto set up
- Adjustable trigger level
- X and Y position signal shift
- DVM readout
- Audio power calculation (rms and peak) in 2, 4, 8, 16 & 32 ohm
- dBm, dBV, DC, rms ...measurements

- Signal markers for Volt and Time
- Frequency readout (through markers)
- Recorder function (roll mode)
- Signal storage (2 memories)
- High resolution LCD 192x112 pixels
- LCD backlight
- USB output for PC
- Built in rechargeable battery

The HPS50 is a user-friendly, feature-packed and genuinely "hand-held" oscilloscope. Features include low noise, high sensitivity, modest weight, a backlit LCD and a choice between regular batteries or rechargeable ones. Furthermore, the scope also offers a selection of 5 different screen layouts. Both novices and professional users will admire the fast and fully automatic setup function, allowing them to perform measurements without physically touching the unit! Floating measurements are completely safe thanks to the battery-powered operation and the [included] fully insulated measuring probe. These features make the HPS50 indispensable to the professional user, service centres and even to the hobbyist.

Contains:
HPS50 unit
user manual
flexible carry bag
insulated safety probe
USB connection lead

Order Code	Mod: 034528	Price each exc. VAT 1+	inc. VAT each
N10AQ	HPS50 Scope	£166.65	£199.99

Velleman 40MHz Handheld Pocket Oscilloscope

- 40MHz samples/sec in real time
- Bandwidth up to 10MHz
- Full auto range option (or manual)
- Sensitivity down to 0.1mV
- Signal markers for amplitude, frequency and time
- Memory hold function and hold function
- Direct audio power measurement
- Up to six hours operation on full charge
- USB battery charger included
- Requires a scope probe, Order Code A058N
- Replacement rechargeable battery available, Order Code N72KF



The HPS140 Handheld Pocket Scope is a powerful and reliable oscilloscope that delivers a high sensitivity level of 0.1mV. It features an impressive 40 mega samples/sec in real-time, 10MHz bandwidth, full auto and manual range option, direct audio power measurement, signal markers for amplitude, time memory, and hold function. This portable oscilloscope can be charged via a USB port, car or mains socket.

It is suitable for anyone working with electronics, components and associated devices, including students, automotive and communication technicians. Amateur electronics enthusiasts will also find the HPS140 Handheld Pocket Scope very useful for a variety of applications - from examining signal waveforms to observing distortion or ringing, comparing levels in AC or audio circuits and checking alternate ground paths for noise.

Specifications:

Bandwidth:	Up to 10 MHz (-3dB or -4dB at selected ranges)
Input range:	1mV to 20V/division in 14 steps
Input coupling:	DC, AC and GND
Real-time sample rate:	Up to 40MS/s
AD resolution:	8 bits
Time base:	250ns to 1h per division
Readcuts:	DC, AC+DC, True RMS, dBm, Vpp, Min-Max (±2.5%)

Auto set-up function (or manual)

Probe x10 readcut option

Audio power measurement from 2 to 32 chms

Hold & store function
Time and Voltage markers readout
Max. 100Vp AC+DC
White LED backlight
For use on CLASS II pollution degree II installations
Operates on NiMH rechargeable battery pack (included)
Operates up to 6 hours on one charge
Charging power supply 9Vdc/200mA
Dimensions 74 x 114 x 29mm / 2.9 x 4.5 x 1.14"

Order Code	Mod: 808838	Price each exc. VAT 1+	inc. VAT each
N55JN	Velleman HPS140	£99.99	£119.99

Velleman Spare Battery for HPS140 Oscilloscope

ORDER IN STORE OR ONLINE

- Replacement battery pack for Velleman HPS140 series
- Manufacturers part number BPHPS140
- NIMH type 4.8V 800mAh



Order Code	Mod: 687245	Price each exc. VAT 1+	inc. VAT each
N72KF	Battery for N55JN	£3.74	£4.49

Pico DrDAQ Data Logger & Oscilloscope

ORDER IN STORE OR ONLINE



- Use the DrDAQ as a data logger, oscilloscope or signal generator
- The kit features a range of on board sensors for light, sound and temperature
- Accept input from standard external PH, temperature sensors and scope leads etc (sold separately)
- Digital outputs are provided for custom interfacing with a variety of sensors
- Comprehensive software PicoLog and PicoScope is provided to turn your PC into a complete test station
- USB connectivity and power supporting Windows XP(SP2), Vista and Windows 7

Sensors

Thanks to the built-in sensors for light, sound and temperature you can start using your USB DrDAQ Data Logger straight out of the box. The USB DrDAQ also has an RGB LED that you can program to show any 1 of 16.7 million colours. When you want to do more with your DrDAQ you can thanks to the external sensor sockets. Simply buy an external sensor and your DrDAQ can measure humidity, oxygen levels, external temperatures and more. We provide you with all you need to know to connect external sensors to your DrDAQ so you can even design and use your own sensors.

More than just a data logger

Thanks to the power of your DrDAQ you can also use it as an oscilloscope or spectrum analyzer. Just run the supplied PicoScope software and your DrDAQ becomes a single-channel scope with a 100 kHz bandwidth, 8-bit resolution and the ability to measure voltages of up to ±10 volts.

Digital I/Os

Your USB DrDAQ also includes 4 digital input/outputs. In input mode these give you even more monitoring options.

When used as outputs they enable you to use your DrDAQ to control external devices. 2 of the digital I/Os include a pulse-counting function when used as inputs, and a pulse-width modulation (PWM) output capability.

DrDAQ also includes a signal generator, the signal generator output not only includes a standard function generator, but also an arbitrary waveform generator (AWG) too. Using the AWG function you can create your own waveforms.

A PC-based data logger is only as good as its software, that's why the USB DrDAQ comes with a complete software package that enables you not only to use your DrDAQ as a data logger but also as an oscilloscope and AWG too. Both PicoLog and PicoScope are fast and easy to use.

Order Code	Mod: 612231	Price each exc. VAT 1+	inc. VAT each
N88KT	DrDAQ Scope/Data Log	£99.99	£119.99

PicoScope 2105 25MHz Handheld Scope

ORDER IN STORE OR ONLINE



- Convert your computer into a powerful oscilloscope
- Ergonomically designed wand fits perfectly in your hand
- 25MHz bandwidth and 14ns rise time
- Max single shot sample rate is 100MS/s
- Up to 24000 samples buffer memory
- Powered by the USB interface
- Supplied with the renowned PicoScope PC Oscilloscope and PicoLog data software suites
- Tip has built in illumination for probing accuracy

The PicoScope 2105 are portable handheld oscilloscopes that are ideally suited for use by hobbyists, students, technicians, and anyone looking for an easy-to-use and affordable, single-channel PC oscilloscope. Designed for single handed operation, the oscilloscope can be controlled using a button located on the top of the scope. Press the button to start the oscilloscope; the button will flash green to indicate the scope is running. Maximum sampling rate (single shot) 100 MS/s.

Specifications

Bandwidth	25 MHz
Rise time (calculated)	14 ns
Input channels	1
Vertical resolution	8 bits
Enhanced vertical resolution	12 bits
DC accuracy	±3%
Linearity	< 1 LSB at 25 °C
Input characteristics	1 MΩ in parallel with 20 pF
Input type	Oscilloscope probe
Input coupling	Software selectable AC/DC
Input ranges (full scale)	±100 mV to ±20 V in 8 ranges
Overload protection	±50 V (DC+AC peak)
Sampling rate	2 GS/s
Maximum sampling rate	1 kS/s (Record length limited to 65 kS in PicoScope, unlimited when using the supplied SDK)
Buffer memory	24,000 samples
Waveform buffer	Up to 10,000 waveforms
Timebase ranges	100 ns/div to 200 s/div (5 ns/div to 200 s/div with ETS)

Order Code	Mod: 784749	Price each exc. VAT 1+	inc. VAT each
N92QJ	PicoScope 2105 25MHz	£166.65	£199.99

GW Instek GDS-1052U 50MHz Dual Channel TFT Oscilloscope

ORDER IN STORE OR ONLINE



- Dual channel 50MHz scope with PC connectivity
- 250MSa/s real-time and 25GSa/s equivalent-time sampling
- 5.6" TFT colour LCD screen means clear and sharp resolution
- LCD panel reduces the weight and size compared with conventional scopes
- 4K memory length per channel
- Save and recall 15 front panel settings and waveforms
- 19 auto measurements and auto configure function
- PC connectivity including cable and software
- Data logging function

USB host: 1 set

Specifications

N60LH	
Model no	GDS-1052U
Bandwidth	50MHz
Channels	2
Record Length	4k points maximum
Real Time Sample rate	250MS/s
Equal Time Sample rate	25GS/s
Display	5.7" TFT LCD
Horizontal range	1ns-50S
Vertical range	2mV-10V/div
Math function	+, -, FFT
Trigger mode	Auto, Normal, Single, TV, Edge, Plus
Auto measurement function	19
Panel Setup memory	15 sets
Waveform memory	15 sets
On-line help function	Yes
Multi-Language	Yes
Enhance CAL function	Yes
GO/NO-GO Function	Yes
Zoom-FFT	Nil
Data logger	Yes
USB Device	1 sets
USB device:	1 set
PC software:	Yes (Freeware)

Order Code	Mod.	Price each exc. VAT 1+	inc. VAT each
N60LH	50MHz Dual Scope TFT	£249.99	£299.99

GW Instek GDS-1072AU 70MHz Dual Channel TFT Oscilloscope

ORDER IN STORE OR ONLINE



- Dual channel 70MHz scope with PC connectivity
- Up to 1GSa/s real time sample rate and 25GSa/s equivalent sample rate
- 5.6" TFT colour LCD screen means clear and sharp resolution
- LCD panel reduces the weight and size compared with conventional scopes
- Up to 2M memory length

- Save and recall 15 front panel settings and waveforms
- 27 auto measurements and auto configure function
- PC connectivity including cable and software
- Data logging function
- Includes two 1X and 10X scope probes

Specifications

N53NA	
Model no	GDS-1072A-U
Bandwidth	70MHz
Channels	2
Record Length	1 CH: 2M 2 CH: 2M points maximum
Real Time Sample rate	1 CH: 1GSa/s 2 CH: 500MSa/s
Equal Time Sample rate	25GS/s
Display	5.7" TFT LCD
Horizontal range	1ns/div-50s/div [1-2.5-5 increments]
Vertical range	2mV-10V/div [1-2-5 increments]
Math function	+, -, *, FFT, FFTrms, Zoom FFT
Trigger mode	Auto, Normal, Single, TV Edge, Plus width
Auto measurement function	27
Panel Setup memory	15 sets
Waveform memory	15 sets
On-line help function	Yes
Multi-Language	Yes
Enhance CAL function	Yes
GO/NO-GO Function	Yes
Zoom-FFT	Yes
Data logger	Yes
USB Host	1 sets

Order Code	Mod.	Price each exc. VAT 1+	inc. VAT each
N53NA	70MHz Dual Scope TFT	£308.32	£369.99

GW Instek GOS-630 30MHz Analog Oscilloscope Dual Channel

ORDER IN STORE OR ONLINE



- Dual channel 30MHz scope
- TV Synchronization
- Z Axis Modulation Input
- CH1 Output
- ALT Triggering Function
- Hold Off Function
- Trigger Level Lock Function

This GOS-600G Series is an example of classic analog oscilloscope design. It covers a broad range of industry application such as electronic design, assembly line, manufacturing as well as service and maintenance. The series is even listed as the base standard for testing equipment for some educational institutions. The GOS-600G Series still features update rate and a simple robust user interface unmatched by today's digital storage oscilloscope. The ALT trigger mode allows engineer to compare two signal side by side by triggering each channel alternately. The built-in delayed sweep function is ideal for observing signal edges. The GOS-600G Series is recognized for its high standard level of function and reliable industrial design that is often used in various measurement fields. All models of the series are available in a full range of 20/35/50MHz bandwidth, including GOS-653G(50MHz), GOS-652G(50MHz), GOS-635G(35MHz), GOS-622G(20MHz)

Order Code	Mod.	Price each exc. VAT 1+	inc. VAT each
N170G	GOS-630 30MHz AnaScp	£249.99	£299.99

GW Instek GLA1016 Logic Analyser

ORDER IN STORE OR ONLINE



- 16 Input Channel
- Time Analysis: Up to 200MHz Internal Sampling Rate
- State Analysis: Up to 100MHz External Input Clock
- Memory Depth: Up to 2Mbits/1Mbit (Half/Full Channels)
- Advanced Trigger: Count, Page, Time Delay and Clock Event Delay
- Data Compression: Up to 255 Times Data Capture
- Signal Analyzer: I2C, RS-232C, SPI Protocol Analyzer and Signal Statistics
- Manual Trigger Start Button
- High-Speed Communication: USB2.0 (1.1 compatible)
- USB Powered, Without External AC Power
- Operating System: WinXP/Vista/Win7

This GLA-1000 Series is palm-sized PC based logic analyzer with functionality matching that of a desktop device. A maximum 32 channels, 32Mbits of data memory (GLA-1032), a 200MHz internal sampling rate and advanced trigger setting provide high accuracy and lengthy data analysis results. Features such as Data-loss-less compression, Enable Qualifier and Serial Bus Protocol Analyzer provide you with a tool to adequately analyze today's complex digital system. All data and configuration can be saved into a PC for further data analysis. The GLA-1000 Series operates over a high speed USB 2.0 connection and is fully powered by the USB bus

Order Code	Mod.	Price each exc. VAT 1+	inc. VAT each
N19DG	GLA1016LogicAnalyser	£583.32	£699.99

GW Instek GRF-1300 RF and Communication Trainer

ORDER IN STORE OR ONLINE



- Waveform Support: Sine Wave: 0.1 to 3MHz, Square Wave: 0.1 to 3MHz, Traiangle Wave: 0.1 to 3MHz
- RF Frequency: 870 to 920MHz
- AM Modulation & FM Modulation
- 5 On/Off Switches and 5 Test Points to Simulate 8 Failure Conditions for Learning Outcome Test
- USB Interface to Provide Remote Control

GRF-1300 RF communication trainer, as the counterpart of GSP-730 for the basic RF communication experiment system, is capable of generating a baseband signal and a RF carrier signal for the built-in AM and FM communication operations. The baseband signal output contains the selections of Sine, Triangle, and Square waveform in the frequency range of 100kHz to 3MHz, whereas the RF signal output is a frequency-variable Sine wave in the range of 870 to 920 MHz. Connecting the baseband signal output with AM or FM inputs on the panel, GRF-1300 produces AM or FM signal output respectively by using the internal RF signal as the modulation carrier according to users' selected frequency

Order Code	Mod.	Price each exc. VAT 1+	inc. VAT each
N230G	GRF1300SpectrumAnlznr	£333.32	£399.99

We can deliver to your home or office (UK only)

GW Instek AFG-2005 5MHz Arbitrary Function Generator With Frequency Counter

ORDER IN STORE OR ONLINE



- 0.1Hz to 5MHz with 0.1Hz resolution
- Supports sine, square, triangular, noise and arbitrary wave forms
- 20MSa/s sampling rate, 10 bit vertical resolution
- Waveform characteristics easily with numeric keypad and knob selections
- Vibrant colour 3.5" LCD screen is very easy to read
- USB interface allows remote control and waveform editing
- Waveform editing software included
- Integrated frequency counter

The AFG-2005 function generator is a DDS (Direct Digital Synthesized) based signal generator designed for education, industry and laboratory requirements. It is an accurate signal source covering the output of sine, square, ramp (triangle), noise and arbitrary waveforms. The 20MSa/s sampling rate, 10 bit vertical resolution and 4k point memory of this generator provide user with a flexible environment for creating the specific waveform output as needed. The user friendly interface of AFG-2005 allows you to set waveform parameters, including waveform type, frequency, amplitude, DC offset, modulation type, and duty cycle, through keypad entry and/or the knob selection, and display the set parameters on the 3.5" LCD screen. Integrated USB provides a convenient method to control and edit the waveform, software is provided.

Order Code	Mod:	Price each exc. VAT 1+	inc. VAT each
N260G	AFG-2005 Func Gen	£208.32	£249.99

GW Instek AFG-2105 5MHz Arbitrary Function Generator With Frequency Counter

ORDER IN STORE OR ONLINE



- 0.1Hz to 5MHz with 0.1Hz resolution
- Supports sine, square, triangular, noise and arbitrary wave forms
- 20MSa/s sampling rate, 10 bit vertical resolution
- Waveform characteristics easily with numeric keypad and knob selections
- Vibrant colour 3.5" LCD screen is very easy to read
- AM/FM/FSK modulation modes
- Integrated frequency counter
- USB interface allows remote control and waveform editing
- Waveform editing software included

Specifications	
Arbitrary Waveform	Sine, Square, Ramp, Noise, Arbitrary Waveform
Sample Rate	20 MSa/s
Repetition Rate	10MHz
Waveform Length	4k points
Amplitude Resolution	10 bit

Frequency Characteristics	Range	Sine, Square Ramp	0.1Hz-5MHz 0.1Hz-1MHz
Resolution Accuracy	Sine, Square, Ramp	0.1Hz	±20 ppm
	Aging		±1 ppm per 1 year
	Tolerance		? 1 mHz
AM Modulation	Carrier Waveforms	Sine, Square, Triangle	
	Modulating Waveforms	Sine, Square, Triangle	
	Modulating Frequency	2 mHz to 20 kHz (Int) DC to 20kHz (Ext)	
FM Modulation	Carrier Waveforms	Sine, Square, Triangle	
	Modulating Waveforms	Sine, Square, Triangle	
	Modulating Frequency	2 mHz to 20 kHz (Int) DC to 20kHz (Ext)	
	Deviation		DC to Max Frequency
	Source		Internal / External
SWEEP	Waveforms	Sine, Square, Triangle	
	Type	Linear or Logarithmic	
	Start / Stop F		0.1Hz to Max Frequency
	Sweep Time		1 ms to 500 s
	Source		Internal / External
FSK	Carrier Waveforms	Sine, Square, Triangle	
	Modulating Waveforms	50% duty cycle square	
	Modulation Rate	2mHz to 100kHz (INT) DC to 100kHz (Ext)	
	Frequency Range		0.1Hz to Max Frequency
	Source		Internal / External
Frequency Counter	Range		5Hz to 150MHz
	Accuracy		Time Base accuracy ±1count ±20ppm (23±5°C) after 30 minutes warm up
	Time base		Resolution 100nHz for 1Hz, 0.1Hz for 100MHz
	Resolution		1kΩ/1pF
	Input Impedance		35mVrms - 30Vrms (5Hz to 150MHz)
	Sensitivity		
System Characteristics	Store/Recall		10 Groups of Setting Memories
	Interface		USB (Device)
	Display		LCD
General Specifications	Power Source		AC100-240V, 50-60Hz
	Power Consumption		25VA
	Dimensions (WxHxD)		266x107x293mm
	Weight		Approx. 2.5 kg

Order Code	Mod:	Price each exc. VAT 1+	inc. VAT each
N90QC	AFG-2105 Func Gen	£249.99	£299.99

GW Instek GFG-8215 3MHz Function Generator

ORDER IN STORE OR ONLINE

- Low distortion waveforms
- Sine, triangle, square and ramp waveforms
- Signal output in seven decade stages



The GFG-8215 is a stable low distortion instrument which generates signals of a frequency up to 3MHz. Typical

applications include a wide range of audio response testing applications, vibration testing, servc system evaluation, ultra-sound applications, etc

Specifications:

Frequency range	0.3Hz - 3MHz (7 ranges)
Amplitude	>10Vpp (into 50Ω load)
Impedance	500 ± 10%
Attenuator	-20dB ± 1dB x 2
DC offset	5V
Duty Control	80% 20% 20% to 1MHz Continued variable <->

Order Code	Mod:	Price each exc. VAT 1+	inc. VAT each
QT19V	3MHz Function Gen	£124.99	£124.24 £149.99

Look out for our monthly promotions at your local Maplin store now!

Pop in and pick up a copy of our monthly promotional publication, with special offers on dozens of exciting products. See the end of this catalogue for store listings

GW Instek GFG-8216A 3MHz Function Generator with Built In 6 Digit Counter

ORDER IN STORE OR ONLINE



- Frequency range: 0.3Hz-3MHz
- Waveforms: sine, triangle, square, ramp, TTL & CMOS output
- External voltage controlled frequency (VCF)
- Duty cycle control with signal inversion capability
- Variable DC offset control
- Two-step (-20dBx2) & variable attenuator
- Built-in 6 digit counter with INT/EXT function to 150MHz/high resolution

This GFG-8216A 3MHz Function Generator from GW Instek has a built-in 6 digit counter. It is suitable for a wide range of testing and evaluation applications.

Frequency range:	0.3Hz-3MHz (7 ranges)
Amplitude:	>10Vpp (into 50Ω load)
Sine Wave	
Distortion	<1%, 0.3Hz-200kHz THD <-35dB
Triangle Wave	

Order Code	Mod:	Price each exc. VAT 1+	inc. VAT each
NZ99H	3MHz FG with Counter	£166.65	£161.65 £199.99

Technical Helpline

0333 400 9500

For technical information and assistance relating to any Maplin purchase, contact our team of experts

Component Testers

Atlas LCR40 Passive Component Analyser

ORDER IN STORE OR ONLINE



- Automatic component type detection: Inductor, Capacitor or Resistors
- Automatic test frequency selection: DC to 200kHz.
- Inductance measurement also shows DC winding resistance.
- Test frequency displayed for all measurements
- Typical accuracy of 1.5% for inductors and capacitors (see spec table for details)
- Typical accuracy of 1% for resistors
- Ideal for manufacturers to QA components used in production, designing or repairing audio and RF equipment like crossovers, amplifiers or HF equipment
- Designed and manufactured in the UK

Handheld component analyser providing measurements for inductance, capacitance and resistance. The LCR40 is very easy to use - the component type is automatically detected for you, just connect and press "test" and the test frequency is automatically selected to provide the best measurement resolution.

Test frequencies include DC, 1kHz, 15kHz and 200kHz. Inductance from 1µH to 10mH, minimum resolution of 1µH, typical accuracy of ±1.5% between 100µH and 100mH

Capacitance from 1pF to 10,000µF, minimum resolution of 1pF typical accuracy of ±1.5% between 200pF and 500nF. Resistance from 1Ω to 2MΩ, typical accuracy of ±1%.

Test frequency is displayed with the measurement and inductor DC resistance also displayed when testing inductors. Supplied with removable gold plated hook probes, battery and user guide it is compatible with standard 2mm test connectors. Not designed for in-circuit use.

Order Code	Mod: 629930	Price each exc. VAT 1+	inc. VAT each 5+	inc. VAT each
N23NC	Atlas LCR Meter	£79.15	£76.78	£94.99

Atlas ESR70 Plus Capacitance and Equivalent Series Resistance Meter

ORDER IN STORE OR ONLINE



- Audible alerts for ESR measurements of different values
- Automatic capacitor discharge function, prevents accidental damage
- Measure both capacitance and ESR (equivalent series resistance) to establish health of a capacitor
- Can be used for measuring low resistances such as short tracing
- Wide capacitance range from 1µF to 22,000µF
- ESR range from 0.01 to 40.0Ω
- Gold plated 2mm plugs and sockets and gold plated removable croc clips
- Designed and manufactured in the UK
- ESR70 has audible alerts

Order Code	Mod: 629932	Price each exc. VAT 1+	inc. VAT each 5+	inc. VAT each
N24NC	Atlas ESR70 Meter	£83.32		£99.99

GW Instek LCR-816 High Precision LCR Meter

ORDER IN STORE OR ONLINE



- 100Hz – 2kHz
- Measurement accuracy 0.05 – 0.1%
- 100 memory sets for save / recall of settings
- R/Q, C/D, C/R, L/Q Test Modes for all Models; Z/? , L/R for LCR-821 Only
- Displays condition and test result simultaneously
- Display 240 x 128 dot matrix LCD display
- RS-232C interface (option: LCR-816)
- Free PC software (DMM-viewer), & LabVIEW Driver

The LCR-800 Series is high-end digital LCR meters for component/material measurements, applicable to various R&D activities and assembly lines. The large 240 x 128 dot matrix LCD display provides ample room for two measurement items and setup parameters allowing you to grasp measurement results quickly. All test modes are able to measure supplementary factors such as, R/Q, C/D, C/R, and L/Q. LCR-821 also contains precise resistance measurements as a combination of absolute value and phase angle. 100 sets of measurement setup memory allow sharing a single unit among multiple testing conditions or sites. For a better viewing experience with a standard PC monitor, proprietary Windows based software is accessible via the RS-232C terminal. The handler interface is also standard feature for LCR-826/827/829.

Order Code	Mod: 1016591	Price each exc. VAT 1+	inc. VAT each
N56DG	LCR-816 LCR Meter	£583.32	£699.99

Atlas ATPK2 Dual DCA and LCR Component Analyser Kit

ORDER IN STORE OR ONLINE



- Dual instrument pack ideal for electronic hobbyists, technicians, bench engineers or manufacturing and QA
- Comprising of the Peak Atlas DCA55 and LCR40 component analysers
- Designed to enhance fault finding or component selections
- Measure semiconductor function, capacitances, inductance
- Both instruments are supplied in a rigid flight case with leads, instructions and batteries
- Designed and manufactured in the UK
- ATPK2 includes spare battery and storage case

Order Code	Mod: 629934	Price each exc. VAT 1+	inc. VAT each 5+	inc. VAT each
N25NC	LCR DCA Analyser Kit	£124.99	£121.24	£149.99

Buy it on the web at maplin.co.uk

Shop for all Maplin products online at our website and check out our latest products and special offers!



Atlas ESR60 Equivalent Series Resistance Meter and Capacitor Analyser

- Automatic capacitor discharge function
- Measure both capacitance and ESR (equivalent series resistance)
- Can be used for measuring low resistances such as short tracing
- Capacitance range from 1µF to 22,000µF
- ESR range from 0.01Ω to 20.0Ω
- Gold plated 2mm plugs and sockets
- Gold plated removable croc clips
- Designed and manufactured in the UK



Measuring a capacitor's ESR (equivalent series resistance) is a great indicator of capacitor condition. The Atlas ESR60 offers instant results, just connect the probes and press test. You can even use the Atlas ESR60 in-circuit, saving you the trouble of removing capacitors. When testing capacitors out-of-circuit, the unit will also display the capacitance.

Traditionally, ESR can be a tricky thing to measure, which is a shame, it's a very useful diagnostic parameter. Of course, ESR meters are available from various sources, some are very famous in the repair sector, but the Atlas ESR60 is more than just another ESR meter. For a start, it's smart, both in looks and in brain. It can measure and compensate for the effects of measuring in-circuit, it also knows that you don't want to be hassled with capacitor polarity.

It's designed with the real world in mind. Some capacitors can be charged up, a lot, but the Atlas ESR doesn't mind. If your capacitor is charged, the unit will automatically carry out a controlled discharge procedure before measuring the capacitance and ESR.

Specifications:

Parameter	Min	Typ
Peak test current into S/C	±20mA	±25mA
Peak test voltage across O/C	±2.5V	±3.0V
Capacitance measurement range	1µF	22000µF
Capacitance accuracy	±4%	±0.2µF
ESR measurement range	0Ω	20Ω
Resolution for ESR<1Ω	0.01Ω	0.02Ω
Resolution for ESR>1Ω	0.1Ω	0.2Ω
Accuracy for ESR<1Ω	±2%	±0.02Ω
Accuracy for ESR>1Ω	±2%	±0.2Ω
Abuse voltage (C<10µF)	±400V	
Abuse voltage (C>10µF)	±40V	
Battery type	Order code JG91Y	
Battery voltage range	8.5V	12V
Dimensions	103 x 70 x 20mm	
Operating temperature	10°C	40°C

Order Code	Mod: 043095	Price each exc. VAT 1+	inc. VAT each 5+	inc. VAT each
N43BJ	Atlas ESR60 Meter	£70.82	£68.70	£84.99

Atlas SCR100 Thyristor and Triac Analyser

ORDER IN STORE OR ONLINE



- Automatic pinout detection and identification, connect any way round
- Automatic Triac/Thyristor detection
- Generates gate currents from 100µA up to 90mA
- Gate sensitivity category displayed
- Constant load test of 12V at 100mA regardless of battery condition
- Supplied with gold plated red/green/blue universal hook probes
- Designed and manufactured in the UK

The Atlas SCR100 is specifically designed to automatically analyse a wide range of Triacs and Thyristors (SCRs). Connect the part any way round and press test. The part type is identified (Triac or Thyristor), the pinout is identified and the gate sensitivity is displayed in 1 of 9 sensitivity categories as well as gate voltage. Suitable for parts that require a gate trigger current from less than 100µA up to 90mA. Load tests are performed with an internally generated load of 12V at 100mA, all from a single AAA alkaline battery (supplied). Not designed for in-circuit use.

Specifications:

	Min	Typical	Max
Gate test Current:		100µA	90mA
Load test current:	90mA	100mA	120mA
Gate trigger duration:	100µS		
Main current duration:	200µS		
Peak D/C test voltage:		12V	12.5V
Peak S/C test current:		100mA	120mA
Battery type:	Order code JG91Y		
Overall Dimensions:	103 (l) x 70 (w) x 20 (d) mm		

Order Code	Mod:	Price each exc. VAT 1+	inc. VAT each 5+
N44BJ	Atlas SCR Analyser	£74.99	£89.99

Atlas DCA75 Pro Semiconductor Analyser and Curve Tracer



- An advanced component analyser with PC interface for data logging
- Designed to display the specs of a component to determine it is faulty or within spec
- Thousands of parameters are pre-programmed
- Can be used stand alone or with the PC to identify pinout of unknown devices
- Measure a range of component parameters such as gain, leakages, MOSFET and IGBT threshold
- PC software can show range curve trace, traces can be pasted in to Excel for graphing analysis
- Test voltages upto 12Vdc and 15mA, the DCA Pro keeps these low to prevent damage to unknown components

The instrument can be used to identify characteristics of unknown components or to check that the characteristics of a selection of components have the expected values. When connected to a PC using the supplied USB cable a range of curve-tracing function can be performed, many predefined and user adjustable graphs are available. The DCA75 Pro supports all of the components in the popular DCA55 but adds many more. Supported components include:

Transistors: Silicon and Germanium types
 MOSFETs: enhancement mode and depletion mode types
 JFETs including normally off SiC types
 IGBT, Diodes and Diode networks
 LEDs and bi-colour LEDs (2 and 3 lead types)
 Zener diodes with a measurement of up to 12V
 Voltage regulators (measures regulation voltage, drop-out voltage, quiescent current)

Order Code	Mod:	Price each exc. VAT 1+	inc. VAT each 5+
N49NQ	Atlas DCA Pro	£99.99	£119.99

Atlas DCA55 Semiconductor Analyser



- Designed and manufactured in the UK
- Automatic pinout detection and identification, connect any way round
- Automatic part type identification
- Supports semiconductor including transistors, MOSFETs, diodes, LEDs, JFETs and much more
- Detection of special component features such as transistors with diodes or transistors with built-in resistors
- Transistor gain measurement
- Transistor leakage measurement
- MOSFET gate threshold measurement
- Semiconductor voltage drop measurement
- Supplied with gold plated red/green/blue universal hook probes
- Designed and manufactured in the UK

Connect any way round to automatically identify and measure a wide range of semiconductor devices. The DCA55 will automatically identify the type of the part, pinout and many component parameters. Components supported include bipolar NPN/PNP transistors, darlington, diode-protected transistors, transistors with built-in resistors, enhancement mode MOSFETs, depletion mode MOSFETs, diodes, diode networks, LEDs, 2 and 3 lead bicolour LEDs, JFETs and many more. Further measurements are displayed including transistor gain, leakage current, pn voltage drops, LED voltages, MOSFET threshold voltages and much more. Even if you don't know anything about the part, just connect it in any configuration and the DCA55 will identify the type of part for you and also identify all the leads. Supplied with universal gold plated hook probes, battery and illustrated user guide. Not designed for in-circuit testing.

Order Code	Mod:	Price each exc. VAT 1+	inc. VAT each 5+
R087U	Component Analyser	£45.82	£54.99

Logic Probe



- Logic probe for use with TTL, DTL and CMOS ICs
- Memory function which can detect the occurrence of single pulses or logic level
- One shot and low repeat rate narrow pulses, are easily detectable and visible
- The probe has three LEDs, red for high logic level, green for low logic level and yellow for pulse
- LED intensity is directly proportional to the duty cycle of the signal observed

Specification

Detection Levels

Logic	Lights LED	DTL/TTL	CMOS
1	Red (Hi)	>2.3V ±0.2V	>70% of VS ±10%
0	Green (Lo)	<3.8V ±0.2V	<30% of VS ±10%
Bad	No indication	0.8V to 2.3V	30% to 70% of VS

Detectable pulse width: 30ns min
 Input impedance: >1MΩ
 Input signal Frequency: >17MHz
 Input overload Protection: ±220V DC/AC for <15s
 Probe power: 25mA to 40mA

Probe power at 5V to 15V DC protection: ±20V max with lead
 Dimensions: 212 x 26.5 x 18mm
 Weight: 65g

Order Code	Mod:	Price each exc. VAT 1+	inc. VAT each 5+
FY73Q	Logic Probe	£13.32	£15.99

Free Delivery

on all UK orders over **£10**

(T&Cs Apply)

Battery Testers

Compact Battery Tester



- Low-cost, versatile and compact battery tester
- Suitable for checking the state of both alkaline and rechargeable batteries
- Will test AAA, AA, C, D, 9V PP3, N and button cell batteries
- Lets you know when the battery is good, needs recharging or replacing
- Uses the power of the battery you are testing to power itself - no need for additional batteries
- Dimensions: 62 x 61 x 29mm

A great pocket sized little gadget that tells you when your batteries are dead or need recharging. Easy to use and stops you throwing away perfectly good batteries. One battery can be tested at a time and the meter indicates the capacity of the battery.

When testing a battery, the state is shown as 'Replace', 'Weak' and 'Good' on the meter. The spring-loaded arm is used for testing 'N', 'AAA', 'AA', 'C' and 'D' size batteries, while 9V PP3 batteries are held against two contacts on the bottom of the unit. In addition, the spring-loaded arm can also be used to test button cells from watches and calculators. This unit is not suitable for testing CR123 batteries.

Please note: The unit draws up to 220mA from the battery being tested, so button cells should not be tested regularly! If a button cell has a rating of less than 220mAh, it should not be tested using this charger as the charger will completely discharge the cell.

Order Code	Mod:	Price each exc. VAT 1+	inc. VAT each 5+
N94JX	Mini Battery Tester	£3.57	£4.29

Maplin TV

Home of innovation,
handy tips and
How To videos

Visit our channel...

youtube.com/maplintv

Rolson Battery Bulb and Fuse Tester

ORDER IN STORE OR ONLINE

- Checks power level of most 1.5V and 9V batteries
- Checks most fuses and bulbs
- Supplied with a 9V battery

Please note the 9V battery is only required when testing fuses in the unit. Batteries are tested using their own power, and do not draw power from the 9V battery



Order Code	Mod:	Price each exc. VAT	inc. VAT each
N116A	Batt/Bulb/Fuse Test	£6.65	£7.99

Network Testing

RJ45 & RJ11 Network Cable Tester



- Quickly and easily check your network cables
- Checks open and short terminals, straight through or crossover wiring types
- Ideal for enthusiasts who wish to make their own network cables
- Operates from a single 9V PP3 battery (not supplied)

Order Code	Mod:	Price each exc. VAT	inc. VAT each
N21CL	RJ45 & RJ11 Tester	£10.82	£9.74

LAN Network Cable Tester



- Pocket sized cable tester with remote slave sender
- Easy to use and easy to read the LED display
- Token ring support via built in BNC socket
- Ability to test cables over large distances or in places that are not easy accessible
- Tests for continuity, open, shorted and crossed wire pairs cables
- RJ45, RJ11, RJ12, 10 Base-T and Token Ring
- Supplied with a carry bag and instructions
- Powered by PP3 battery (Order code: L46AL)

Order Code	Mod:	Price each exc. VAT	inc. VAT each
N59BY	LAN Tester	£16.65	£14.99

Mini LAN Tester

- Can Test RJ45/UTP, RJ45/STP cabling
- OPEN, SHORT, STRAIGHT and CROSS test function
- Full LED indication lights
- Beep sound warning
- Manual/Auto select function
- Measures just 90 x 50 x 24 mm (H x W x D)
- Carry case included



Order Code	Mod:	Price each exc. VAT	inc. VAT each
A35CJ	Mini LAN tester	£16.65	£19.99

Cable Tracker with Tone Generator

- Network tester: consists of a tone generator and a probe
- Use the tone generator and the probe to determine where a cable is going and whether or not (and where) the cable is interrupted
- Signal viewing in 3 modes: lamp (L), speaker (SP) or both (S&L)
- Tone generator output (square waveform): single (900Hz) or dual (900 - 1000Hz)
- Includes soft carrying bag
- Requires 2 x 9V PP3 batteries (Not supplied)



Working voltage	9Vdc ±15%
Working current	10mA (intermittent tone) / 20mA (continuous tone)
Output wave form	square wave signals ±10Vpp
Single audio frequency	±900Hz
Dual audio frequency:	±900Hz - 1000Hz
Dimensions	115 x 62 x 27mm
Weight	130g (approx.)
Probe	
Working voltage	9Vdc ±15%
Working current	25mA (L)/80mA (max SP volume) / 100mA (max S&L volume)
Max reception sensitivity	> 30mV
Maximum output volume	±120dB
Dimensions	205 x 40 x 38mm
Weight	80g (approx.)

Order Code	Mod:	Price each exc. VAT	inc. VAT each
N74CC	Cable Tracer	£24.99	£24.24

Atlas IT UTP05 Network Cable Analyser

ORDER IN STORE OR ONLINE

- Designed and manufactured in the UK
- Automatic identification of patch cables (straight through) & cross-over cables (PC to PC links or hub to hub links) and token ring cables
- Fault identification & highlighting for shorted lines, open lines & swapped lines
- Supplied with leads to allow testing of sockets as well as cables
- Clear, user-friendly scrollable display
- Support for up to 150 metres of cable
- Designed and manufactured in the UK



Handheld network cable analyser UTP05 for testing RJ45 (Cat5/5e/6) style network cabling. Connect the Atlas IT UTP05 cable analyser at one end of your cabling and one of the supplied terminators to the other end. The Atlas IT UTP05 will then analyse all the lines from one end to the other and identify the connection pattern (such as straight-through, crossover, token-ring, voice/data and many more types). Any wiring faults are clearly displayed including breaks, shorts or swaps. Mini patch cables are also included to enable the testing of RJ45 sockets and

their associated cabling. The Atlas IT is compatible with optional "Identified" terminators allowing for the easy analysis and identification of multiple cable runs. Suitable for Cat 5, Cat 5e and Cat 6 cabling with RJ45 style plugs or sockets (shielding not tested). A full colour Ethernet connection chart is included in the user guide. Supplied in a tough padded carry case, spare battery, 2 terminators, 2 patch cables and a user guide. Space is provided in the carry case for up to 24 identified terminators. This instrument does not measure the connection speed capability or cable length

Order Code	Mod:	Price each exc. VAT	inc. VAT each
RS67X	Network Cable Tester	£66.65	£64.65

Measurement Hand Tools

Metal and Voltage Detector

- Compact lightweight tool to identify pipes, nails or cables
- Locates any metal objects, such as reinforcing steel rod, gas & water pipes, etc. inside walls
- Detects AC voltage carrying wires
- Audio and visual indicators
- Used on the surface so no probing of the wall is required
- Ideal for DIY or handyman



Order Code	Mod:	Price each exc. VAT	inc. VAT each
YP30H	Metal/Volt Detector	£12.49	£11.24

3 in 1 Stud/Metal/AC Voltage Finder with Laser Line Level

- Laser levelling, layout and stud locating on vertical and horizontal surfaces
- Detects wood up to 20mm (3/4 inch) depth
- 18° pivoting laser plane with level and plumb vials
- 6m (20ft) laser line projection on to work surface with 90° squaring
- 2 self-contained hang pins to mount unit to work surface (vertical or horizontal)
- LCD sensing and mode display with new target graphics
- LED screen with continuous live wire detection
- Thumb dial adjustable feet for levelling the laser
- Easy key pad operation
- Ergonomically designed for comfort and grip



Order Code	Mod:	Price each exc. VAT	inc. VAT each
N31FR	3 in 1 Stud / Metal	£21.65	£25.99

Ultrasonic Distance Meter with Area & Volume Calculator

- Measure distances up to 15m with this non-contact ultrasonic distance meter
- Laser pointer to locate the target spot to measure
- Measurements can be taken in Feet or Meters and converted back
- 3 memories allow you to measure and to store 3 different measurements
- Calculation of area and volume from the stored values
- Addition and subtraction functions



This Ultrasonic Distance Meter is perfect for estate agents, building industry professionals or anyone who needs to take quick and accurate measurements or to calculate area and volume of a room. You can measure distances in a straight line from 0.91M to 15M using

non contact ultrasonic waves to the point you want to measure. Measurements can be stored in the built-in memory and those values can be used in calculations on the device

Specifications

Measure units:	Feet or Meter
Accuracy:	0.5%
Frequency:	40 kHz (ultrasonic pickup)
Working temperature:	0° to 43°C
Range:	0.91 to 15m
Dimensions mm HxWxD:	147x73x47
Weight (without battery):	130g
Power supply:	1x9V Alkaline type PP3 battery

Order Code	Mod: 590709	Price each exc. VAT	inc. VAT each
		1+	5+
N76KH	Ultrasonic Meter	£13.32	£12.79 £15.99

Ultrasonic Distance Meter with Laser Pointer



- Compact and unique design - ideal for D.I.Y, builders, estate agents, surveyors etc
- Accurately measures distances from 0.6m (2ft) to 15m (50ft)
- Laser pointer to help determine target
- Conversion of reading between metric and imperial
- Calculates square and cube automatically
- Memory function
- Uses 1 x PP3 9V battery (sold separately) [Order Code: L46AL]

A unique tool combining the latest laser and ultrasonic technologies allowing the user to take distance measurements easily. With simple, single-handed operation, the device can measure not only distance but also convert those measurements to square and cube readings automatically.

Order Code	Mod: 034589	Price each exc. VAT	inc. VAT each
		1+	5+
N70CX	Ultrasonic Distance	£16.65	£16.15 £19.99

Maplin Laser Level



- Compact sized laser level – fits in your pocket
- Projects a laser line for checking horizontal & vertical levels with built in spirit level
- Aluminium construction with magnetic base for securing onto metal surfaces
- Includes a ruler for small measurements
- Suitable for construction sites, workshops, manufacturing and home DIY
- Includes a carry case with 3x LR44 batteries

This Laser Level has a laser beam that can be used to spot check the straightness on horizontal and vertical levels up to a radius of 10m. Comes complete with a magnetic base, ruler, handy clip and also has a built in spirit level to aid your alignment. Great for indoor use on applications such as water pipes, lighting, plumbing, window positioning and many more.

Maplin replacement battery order code: FM28

Specification

Laser Line Output:	1mW
Laser Wavelength:	635±10nm
Laser Radius Min / Max:	0 to 10m
Operating Temperature Range:	15°C to 60°C
Battery Type:	LR44 x 3
Colour:	Yellow
Product Width:	128mm
Product Depth:	22mm
Product Height:	27mm
Product Weight:	105g

Order Code	Mod: 1008080	Price each exc. VAT	inc. VAT each
		1+	5+
N69DP	Laser Level	£20.82	£24.99

Stanley Intelli Tools Cubix Self Levelling Cross Line Laser



- Sturdy ABS/TPR construction
- Pendulum mounted laser
- Universal mounting bracket
- For use on architrave, window sills, shelves and poles

The Stanley Cubix Self-Levelling Crossline Laser is accurate to 0.5mm/m. It has a sturdy ABS/TPR construction. The Cubix features a pendulum mounted laser and is supplied with a universal mounting bracket with multiple attachment points for use on architrave, window sills, shelves and poles.

Order Code	Mod: 1029046	Price each exc. VAT	inc. VAT each
		1+	
A63RF	Stanley Cubix Cross	£49.99	£59.99

Fixings

Nails

75 Part Nail Kit

- Contains 75 pieces of 18 x 30mm nails
- Supplied in a handy storage case



Order Code	Mod: 636913	Price each exc. VAT	inc. VAT each
		1+	5+
N67NF	75Pc Nail Set	£0.90	£0.81 £1.09

100 Part Nail Kit

- Contains 100 pieces of 25mm nails
- Supplied in a handy storage case



Order Code	Mod: 636909	Price each exc. VAT	inc. VAT each
		1+	5+
N63NF	100Pc Nail Set	£0.90	£0.81 £1.09

350 Part Nail Kit



- Contains a selection of 20mm, 25mm and 30mm nails
- Supplied in a handy storage case

Contents:
200 x nails (20mm)
130 x nails (25mm)
20 x nails (30mm)

Order Code	Mod: 636902	Price each exc. VAT	inc. VAT each
		1+	5+
N56NF	350Pc Nail Set	£0.90	£0.81 £1.09

Subscribe to our newsletter
For deals and information
maplin.co.uk



500 Part Nail Kit



- Contains a selection of 20mm and 25mm nails
- Supplied in a handy storage case

Contents:
250 x nails (20mm)
250 x nails (25mm)

Order Code	Mod: 636901	Price each exc. VAT	inc. VAT each
		1+	5+
N55NF	500Pc Nail Set	£0.90	£0.81 £1.09

480 Part Nail Kit



- Contains 20mm and 25mm nails in 2 different finishes
- Supplied in a handy storage case

Contents:
120 x nails (20mm, zinc finish)
120 x nails (25mm, zinc finish)
120 x nails (20mm, yellow zinc finish)
120 x nails (25mm, yellow zinc finish)

Order Code	Mod: 636903	Price each exc. VAT	inc. VAT each
		1+	5+
N58NF	480Pc Nail Set	£1.32	£1.19 £1.59

220 Part Nail and Screw Kit



- Contains a selection of nails and self-tapping screws
- Supplied in a handy storage case

15 x self-tapping screws (3.5 x 25mm)
Contents:
90 x nails (20mm)
90 x nails (25mm)
40 x self-tapping screws (5.5mm)

Order Code	Mod: 636919	Price each exc. VAT	inc. VAT each
		1+	5+
N71NF	ST Screw&Nail Set	£1.15	£1.04 £1.39

Screws

12 Part Self Tapping Screw Kit

- Contains 12 pieces of 4 x 50mm self-tapping screws
- Supplied in a handy storage case



Order Code	Mod: 636910	Price each exc. VAT	inc. VAT each
		1+	5+
N64NF	12Pc SelfTap Screws	£0.90	£0.81 £1.09

35 Part Wall Plug and Wood Screw Kit



- Contains 15 wall plugs and 20 wood screws
- Supplied in a handy storage case

Contents:

- 10 x wall plugs (30mm)
- 5 x wall plugs (40mm)
- 10 x wood screws (20mm)
- 5 x wood screws (30mm)
- 5 x wood screws (40mm)

Order Code	Mod: 636892	Price each exc. VAT	inc. VAT each
		1+	5+
N47NF	35Pc AnchorWoodScrew	€0.90	€0.81 €1.09

40 Part Self Tapping Screw Kit



- Contains 40 pieces of 3 x 20mm self-tapping screws
- Supplied in a handy storage case

Order Code	Mod: 636911	Price each exc. VAT	inc. VAT each
		1+	5+
N65NF	40Pc SelfTap Screws	€0.90	€0.81 €1.09

40 Part Wood Screw Kit



- Contains 40 wood screws
- Supplied in a handy storage case

Contents:

- 20 x wood screws (20mm)
- 5 x wood screws (25mm)
- 10 x wood screws (30mm)
- 5 x wood screws (50mm)

Order Code	Mod: 636895	Price each exc. VAT	inc. VAT each
		1+	5+
N50NF	40Pc Wood Screw Kit	€0.90	€0.81 €1.09

44 Part Self Tapping Screw Kit



- Contains 44 pieces of 3 x 16mm self-tapping screws
- Supplied in a handy storage case

Order Code	Mod: 636912	Price each exc. VAT	inc. VAT each
		1+	5+
N66NF	44Pc SelfTap Screws	€0.90	€0.81 €1.09

57 Part Screw Kit



- Contains 57 self-tapping screws
- Supplied in a handy storage case

Contents:

- 6 x self-tapping screws (3.5 x 25mm)
- 4 x self-tapping screws (4 x 30mm)
- 4 x self-tapping screws (4 x 40mm)
- 4 x self-tapping screws (4 x 45mm)
- 26 x self-tapping screws (3 x 16mm)

Order Code	Mod: 636907	Price each exc. VAT	inc. VAT each
		1+	5+
N61NF	57Pc ST Screw Set	€0.90	€0.81 €1.09

65 Part Screw and Nut Kit



- Contains 26 screws and 39 nuts
- Supplied in a handy storage case

Contents:

- 6 x screws (5 x 25mm)
- 26 x nuts (M4)
- 13 x nuts (M5)
- 8 x screws (4 x 12mm)
- 5 x screws (4 x 30mm)
- 7 x screws (5 x 20mm)

Order Code	Mod: 636906	Price each exc. VAT	inc. VAT each
		1+	5+
N60NF	65Pc Nut&Screw Set	€0.90	€0.81 €1.09

61 Part Screw Kit



- Contains 26 self-tapping screws, 3 wall plugs, anchors and bit
- Supplied in a handy storage case

Contents:

- 2 x anchors (6 x 50mm)
- 15 x wall plugs (5mm)
- 14 x wall plugs (6mm)
- 3 x wall plugs (8mm)
- 15 x self-tapping screws (3 x 12mm)
- 5 x self-tapping screws (3 x 30mm)
- 6 x self-tapping screws (4 x 40mm)

Order Code	Mod: 636905	Price each exc. VAT	inc. VAT each
		1+	5+
N59NF	61Pc Anchor&ScrewSet	€1.32	€1.19 €1.59

90 Part Wall Plug and Self Tapping Screw Kit



- Contains 45 wall plugs and 45 self-tapping screws
- Supplied in a handy storage case

Contents:

- 15 x self-tapping screws (5mm)
- 15 x self-tapping screws (5.5mm)
- 15 x self-tapping screws (7mm)
- 15 x wall plugs (5mm)
- 15 x wall plugs (5.5mm)
- 15 x wall plugs (7mm)

Order Code	Mod: 636899	Price each exc. VAT	inc. VAT each
		1+	5+
NS4NF	90PcAnchor&STScrews	€1.32	€1.19 €1.59

107 Part Screw and Nut Kit



- Contains 20 wood screws, 20 nuts, 20 flat washers and 47 self-tapping screws
- Supplied in a handy storage case

Contents:

- 14 x self-tapping screws (5 x 12mm)
- 13 x self-tapping screws (5 x 25mm)
- 20 x nuts (M4)
- 20 x flat washers (M4)
- 12 x wood screws (4 x 12mm)
- 8 x wood screws (4 x 25mm)
- 10 x self-tapping screws (3.5 x 25mm)
- 10 x self-tapping screws (4 x 30mm)

Order Code	Mod: 636904	Price each exc. VAT	inc. VAT each
		1+	5+
N57NF	107PcNut&Washers	€1.32	€1.19 €1.59

140 Part Wall Plug and Screw Kit



- Contains 70 wall plugs and 70 screws
- Supplied in a handy storage case

Contents:

- 20 x wood screw (5mm)
- 20 x wood screw (5.5mm)
- 30 x wood screw (7mm)
- 20 x wall plugs (5mm)
- 20 x wall plugs (5.5mm)
- 30 x wall plugs (7mm)

Order Code	Mod: 636898	Price each exc. VAT	inc. VAT each
		1+	5+
N53NF	140PcAnchor&ScrewSet	£1.32	£1.19 £1.59

215 Part Metal Screw Set



- Contains a handy selection of metal screws
- Supplied in a handy, refillable storage case

Contents:

4 x screws (3.5 x 12mm)
 45 x screws (3.5 x 19mm)
 30 x screws (4 x 19mm)
 20 x screws (4 x 25mm)
 30 x screws (4 x 30mm)
 20 x screws (5 x 19mm)
 20 x screws (5 x 30mm)
 10 x screws (5 x 60mm)
 1 x handy, refillable storage case

Order Code	Mod: 504428	Price each exc. VAT	inc. VAT each
		1+	5+
N66JC	215Pc MetalScrew Set	£2.40	£2.16 £2.89

224 Part Machine Screw and Nut Set



- Contains a handy selection of machine screws and nuts
- Supplied in a handy, refillable storage case

Contents:

30 x machine screws (4 x 16mm)
 20 x machine screws (4 x 25mm)
 20 x machine screws (5 x 12mm)
 20 x machine screws (5 x 19mm)
 10 x machine screws (5 x 30mm)
 10 x machine screws (6 x 38mm)
 2 x machine screws (6 x 80mm)
 50 x nuts (M4)
 50 x nuts (M5)
 12 x nuts (M6)
 1 x handy, refillable storage case

Order Code	Mod: 504421	Price each exc. VAT	inc. VAT each
		1+	5+
N62JC	224Pc Screw&Nut Set	£3.15	£3.79

180 Part Screw and Nut Set



- Contains a handy selection of 90 screws and 90 bolts
- Supplied in a handy, refillable storage case

Contents:

20 x screws (M2.5 x 12mm)
 20 x screws (M2.5 x 19mm)
 20 x screws (M3 x 12mm)
 20 x screws (M3 x 19mm)
 10 x screws (M3 x 25mm)
 40 x nuts (M2.5)
 50 x nuts (M3)
 1 x handy, refillable storage case

Order Code	Mod: 044480	Price each exc. VAT	inc. VAT each
		1+	5+
N52BU	180pc Phil Screw Kit	£3.57	£4.29

120 Part Hex Head Self Drilling Screw Assortment



- Zinc plated carbon steel with super sharp point
- Contains eight popular sizes
- Supplied in a handy, refillable storage case

Contents:

16-pieces of #8 x 12.5mm
 16-pieces of #8 x 16mm
 16-pieces of #8 x 19mm
 16-pieces of #8 x 25mm
 14-pieces of #10 x 10mm
 14-pieces of #10 x 12.5mm
 14-pieces of #10 x 20mm
 14-pieces of #10 x 25mm
 1 x handy storage case

Order Code	Mod: 476574	Price each exc. VAT	inc. VAT each
		1+	5+
N97CR	120 Pc Hex Screws	£3.65	£3.29 £4.39

330 Part Nut, Washer and Screw Set



- Contains a handy selection of 110 screws, nuts and washers
- Supplied in a handy, refillable storage case

Contents:

20 x screws (M2 x 12mm)
 20 x screws (M2 x 19mm)
 20 x screws (M3 x 12mm)
 20 x screws (M3 x 19mm)
 20 x screws (M4 x 12mm)
 10 x screws (M4 x 25mm)
 40 x nuts (M2)
 40 x nuts (M3)
 30 x nuts (M4)
 40 x washers (M2)
 40 x washers (M3)
 30 x washers (M4)
 1 x handy, refillable storage case

Order Code	Mod: 044481	Price each exc. VAT	inc. VAT each
		1+	5+
N53BU	330pc Phil Screw Kit	£4.57	£5.49

Forgefix Plasterboard Spring Toggle M5 x 50mm 4 Pack



- All metal construction
- Ideal for applications where heat resistance is required
- Wide wing span spreads load
- Excellent holding in lathe and plaster
- Quick and easy to use

Order Code	Mod: 1032354	Price each exc. VAT	inc. VAT each
		1+	5+
N38DV	M5x50SpringTog 4Pck	£1.49	£1.79

Forgefix Cavity Wall Nylon Speed Plug 4.0mm 25 Pack



- Nylon plug - suitable for electrical installation
- Specially designed cutting tip to pierce plasterboard
- Supplied complete with screw
- Countersunk head allows flush fitting
- Easy to use

Order Code	Mod: 1032352	Price each exc. VAT	inc. VAT each
		1+	5+
N34DV	SpeedplugCavNyl 25Pk	£2.91	£3.49

Wall Plugs

10 Part Wall Plug Kit



- Contains 10 wall plugs
- Supplied in a handy storage case

Contents:

10 x wall plugs (7mm)

Order Code	Mod: 636908	Price each exc. VAT	inc. VAT each
		1+	5+
N62NF	10Pc Wall Plug Set	£0.90	£0.81 £1.09

Buying for business?
0333 400 9740



Forgefix Cavity Wall Fixing Plug 4.0mm Screw 10 Pack



- Ideal for light-duty fixing in plasterboard
- Made from Nylon for durability
- Easy to fix
- Oversized ribs for firm anchorage
- Splaying toggles

Order Code	Mod: 1032313	Price each exc. VAT 1+	inc. VAT each
N42DU	CavityFixing 10Pk	£1.24	£1.49

Forgefix Plastic Wall Plug Assorted 60 Pack



- All-purpose fixing
- Anti-rotation moulding
- Ideal for lightweight fixing applications
- Conforms tightly to the wall
- Suitable for most types of threaded screws

Order Code	Mod: 1032319	Price each exc. VAT 1+	inc. VAT each
N53DU	WallPlug Multi 60Pk	£1.66	£1.99

Forgefix Cavity Wall Anchor ZP M5 x 37mm 10 Pack



- Specialist plasterboard fixing
- Full metal construction
- Zinc plated
- Heat and corrosion resistant
- Ideal for heavy-duty tasks, such as wall units

Order Code	Mod: 1032321	Price each exc. VAT 1+	inc. VAT each
N70DU	M5x37 CavAnchor 10Pk	£2.33	£2.79

Forgefix Modesty Block White for 3.5mm-4.5mm Screws 25 Pack



- Durable modesty blocks made from polyamide
- Suitable for 6 and 8 gauge (3.5 - 4.5 mm) screws

- Used when joining timber and carcass assembly
- These Forgefix Modesty Blocks are versatile joining blocks. Manufactured from durable polyamide. Suitable for 6 and 8 gauge (3.5 - 4.5 mm) screws. Used when joining timber and carcass assembly in many joinery applications. Widely used in flat pack furniture assembly.

Order Code	Mod: 1032323	Price each exc. VAT 1+	inc. VAT each
N72DU	ModestyBlockWhit 25Pk	£2.33	£2.79

Nuts, Bolts & Washers

150 Part Fibre Washer Set



- Contains 14 popular sizes of fibre washers
- Supplied in a handy, refillable storage case

Contents:

- 10-pieces of 10 x 5mm
- 10-pieces of 10 x 6mm
- 10-pieces of 10 x 7mm
- 10-pieces of 12 x 8mm
- 10-pieces of 12 x 10mm
- 10-pieces of 14 x 10mm
- 10-pieces of 17 x 10mm
- 10-pieces of 18 x 14mm
- 10-pieces of 20 x 14mm
- 10-pieces of 20 x 15mm
- 10-pieces of 22 x 16mm
- 10-pieces of 24 x 16mm
- 10-pieces of 24 x 18mm
- 20-pieces of 20 x 12mm

Order Code	Mod: 497980	Price each exc. VAT 1+	5+	inc. VAT each
N00JF	150-Pc Fibre Washers	£3.40	£3.06	£4.09

350 Part Lock and Flat Washer Set



- Contains 6 popular sizes
- Supplied in a handy, refillable storage case

Contents:

- 100-pieces of #6
- 80-pieces of #8
- 60-pieces of #10
- 50-pieces of 1/4-inch
- 30-pieces of 5/16-inch
- 30-pieces of 3/8-inch

Order Code	Mod: 497985	Price each exc. VAT 1+	5+	inc. VAT each
N01JF	350PcLock&Flatwasher	£3.40	£3.06	£4.09

30 Part Nut and Bolt Kit



- Contains 15 nuts and 15 matching bolts
- Supplied in a handy storage case

Contents:

- 5 x bolts [4 x 20mm]
- 5 x bolts [4 x 25mm]
- 3 x bolts [5 x 20mm]
- 2 x bolts [5 x 38mm]
- 15 x nuts

Order Code	Mod: 636893	Price each exc. VAT 1+	5+	inc. VAT each
N48NF	30Pc Nut & Bolt Kit	£0.90	£0.81	£1.09

Rolson 180 Piece Nut and Bolt Set



- Contains 19 popular sizes
- Comprises ten different sizes of bolts and 4 sizes of nuts
- Supplied in a refillable case
- Ideal for metal and woodwork

Size	Quantity
M4 x 12mm	10
M4 x 20mm	10
M5 x 16mm	10
M5 x 25mm	8
M6 x 20mm	5
M6 x 30mm	5
M8 x 25mm	3
M8 x 40mm	3
M10 x 40mm	3
M10 x 16mm	3
M4 Nut	20
M5 Nut	18
M6 Nut	10
M8 Nut	6
M10	6
Washer Dia 4	20
Washer Dia 5	18
Washer Dia 6	10
Washer Dia 8	6
Washer Dia 10	6

Order Code	Mod: 098652	Price each exc. VAT 1+	5+	inc. VAT each
N32CG	180Pc Nut & Bolt Set	£3.82	£3.44	£4.59

105 Part Flat Washer Kit



- Contains 105 flat washers
- Supplied in a handy storage case

Contents:

- 30 x flat washers (3mm)
- 25 x flat washers (4mm)
- 21 x flat washers (5mm)
- 15 x flat washers (6mm)

8 x flat washers (8mm)
6 x flat washers (10mm)

Order Code	Mod.	Price each exc. VAT	inc. VAT each
		1+	5+
N49NF	105Pc FlatWasher Kit	£0.90	£1.09

125 Part Flat Washer Kit



- Contains a selection of 4, 5 and 6mm diameter flat washers
- Supplied in a handy storage case

Contents:

60 x flat washers (4mm diameter)
45 x flat washers (5mm diameter)
20 x flat washers (6mm diameter)

Order Code	Mod.	Price each exc. VAT	inc. VAT each
		1+	5+
N72NF	Flat Washer Set	£1.32	£1.59

225 Part O-Ring Assortment



- Contains eighteen popular sizes
- Supplied in a handy, refillable storage case

Contents:

20-pieces of 3 x 1
20-pieces of 4 x 1
20-pieces of 4.5 x 2
20-pieces of 5 x 2
20-pieces of 6 x 2
20-pieces of 6 x 2.5
20-pieces of 6 x 3
20-pieces of 7 x 2
20-pieces of 8 x 2
5-pieces of 9 x 2
5-pieces of 10 x 2
5-pieces of 12 x 3
5-pieces of 13 x 3
5-pieces of 14 x 2.5
5-pieces of 17 x 2.5
5-pieces of 18 x 4
5-pieces of 20 x 2
5-pieces of 22 x 2
1 x handy refillable storage case

Order Code	Mod.	Price each exc. VAT	inc. VAT each
		1+	5+
N94CR	225 Pc O-Ring Asst d	£2.99	£3.59

100 Part Locknut Assortment



- Ideal for high vibration applications
- Nylon insert eliminates the need for lock washers
- Supplied in a handy, refillable storage case

Contents :

25 x M4
25 x M5
20 x M6
15 x M8
10 x M10
5 x M12
1 x handy storage case

Order Code	Mod.	Price each exc. VAT	inc. VAT each
		1+	5+
N95CR	100 Pc Locknut Asst d	£3.40	£4.09

720 Part Washer Assortment



- 3 types of the most popular washers available in 6 different sizes
- Supplied in a handy, refillable storage case

Contents:

50-pieces #6 C-type
50-pieces #6 star type
50-pieces #6 circle star type
50-pieces #8 C-type
50-pieces #8 star type
50-pieces #8 circle star type
50-pieces #10 C-type
50-pieces #10 star type
50-pieces #10 circle star type
40-pieces 6.4mm C-type
40-pieces 6.4mm star type
40-pieces 6.4mm circle star type
30-pieces 8.0mm C-type
30-pieces 8.0mm star type
30-pieces 8.0mm circle star type
20-pieces 9.5mm C-type
20-pieces 9.5mm star type
20-pieces 9.5mm circle star type
1 x handy, refillable storage case

Order Code	Mod.	Price each exc. VAT	inc. VAT each
		1+	5+
N96CR	720 Pc Washer Asst d	£2.99	£3.59

Picture Hanging

132 Part Picture Hanging Kit



- Contains nails, hangers, hooks and picture wire
- Supplied in a handy storage case

Contents:

108 x nails
10 x hangers
2 x 36-inch wire
12 x hook eyes

Order Code	Mod.	Price each exc. VAT	inc. VAT each
		1+	5+
N51NF	132-Pc PicturHangKit	£0.90	£1.09

Fixing Clips

300 Part E Clip Assortment



- Contains nine of the most popular sizes
- Supplied in a handy, refillable storage case

Contents:

30 x 1.6mm
30 x 3.2mm
40 x 4.8mm
50 x 6.4mm
50 x 9.5mm
40 x 12.7mm
20 x 15.9mm
20 x 19.1mm
20 x 22.2mm

Order Code	Mod.	Price each exc. VAT	inc. VAT each
		1+	5+
N01CT	300 Pc E-Clip Asst d	£3.65	£4.39

26 Part Hose Clamp Assortment



- Worm gear type with zinc plating
- Contains six of the most popular sizes
- For use in securing hoses around taps or pipes
- Also for automotive use in securing hoses
- Supplied in a handy, refillable storage case

Contents:

8-pieces of 16mm
6-pieces of 22mm
4-pieces of 25mm
2-pieces of 28mm
2-pieces of 35mm
4-pieces of 40mm
1 x handy, refillable storage case

Order Code	Mod.	Price each exc. VAT	inc. VAT each
		1+	5+
N14CT	26 Pc Hose Clamp Ast	£4.99	£5.99

**Buy it on the web at
maplin.co.uk**

Shop for all Maplin products online at our website and check out our latest products and special offers!



Springs

150 Part Spring Assortment



- Wide selection of hard to find springs
- Contains 20 popular sizes of extended and compressed springs
- Supplied in a handy, refillable storage case

Contents:

Extended springs:

- 8 pieces of 5.2 x 20.6mm
- 8 pieces of 5.6 x 25.4mm
- 8 pieces of 6.5 x 22.2mm
- 7 pieces of 8.7 x 46.8mm
- 7 pieces of 7.1 x 50.8mm
- 6 pieces of 7.1 x 38.1mm
- 7 pieces of 8.7 x 36.5mm
- 6 pieces of 7.9 x 28.6mm
- 6 pieces of 8.0 x 31.8mm
- 7 pieces of 8.4 x 44.5mm
- 7 pieces of 4.0 x 79.4mm
- 5 pieces of 4.8 x 44.5mm

Compressed Springs:

- 10 pieces of 7.1 x 12.7mm
- 10 pieces of 6.4 x 10.3mm
- 10 pieces of 7.1 x 19.1mm
- 6 pieces of 9.5 x 15.9mm
- 9 pieces of 9.5 x 19.1mm
- 5 pieces of 9.1 x 34.9mm
- 8 pieces of 5.6 x 38.1mm
- 10 pieces of 5.6 x 17.5mm

Order Code	Mod: 219939	Price each exc. VAT	inc. VAT each
		1+	5+
N06CT	150 Pc Spring Set	£2.99	£2.69 £3.59

Hooks

Maplin Stainless Steel Hook Kit 3.0mm x 38mm 8 Pack



- Contains 8 pieces of 3 x 38mm hooks
- Supplied in a handy storage case

Order Code	Mod: 636916	Price each exc. VAT	inc. VAT each
		1+	5+
N68NF	8Pc 3x38mm Hooks	£0.90	£0.81 £1.09

Maplin TV

Home of innovation, handy tips and How To videos
[youtube.com/maplintv](https://www.youtube.com/maplintv)



Maplin Stainless Steel Hook Kit 3.5mm x 60mm 4 Pack



- Contains 4 pieces of 3.5 x 60mm hooks
- Supplied in a handy storage case

Order Code	Mod: 636917	Price each exc. VAT	inc. VAT each
		1+	5+
N69NF	4Pc 3.5x60mm Hooks	£0.90	£0.81 £1.09

Maplin Stainless Steel Hook Kit 2.5mm x 30mm 12 Pack



- Contains 12 pieces of 2.5 x 30mm hooks
- Supplied in a handy storage case

Order Code	Mod: 636918	Price each exc. VAT	inc. VAT each
		1+	5+
N70NF	12Pc 2.5x30mm Hooks	£0.90	£0.81 £1.09

Forgefix Clothes Line Hook & Plug Kit ZP 2 Pack



- Fix clothes lines from point to point
- Simple to fit and use
- Zinc plated for corrosion resistance
- Two hooks and plugs per pack
- Wall plug not required if the hook is screwed into timber

Order Code	Mod: 1032317	Price each exc. VAT	inc. VAT each
		1+	5+
N43DU	Hook and Plug 2Pk	£1.66	£1.99

Tape & Glues

Tape

PVC Insulation Tape

- 19mm tape width
- Available in 4.5m, 20m or 33m length
- Available in 9 colours

A range of strong, flame retardant PVC tape suitable for general electrical insulation work, which



is certified to BS3924. Its low cost makes this tape ideal for tagging and colour coding as well as insulating cables. The tapes all have a width of 19mm and are available in 9 colours and 3 lengths.

Order Code	Colour	Length
FT20W	Black	4.5m
FT24B	White	4.5m
FM84F	Black	20m
NF94C	Red	20m
NG31J	White	20m
N03AN	Green	20m
NG32K	Black	33m
NG33L	Red	33m
NG37S	White	33m
NG38R	Green/Yellow	33m

Order Code	Mod: 004096	Price each exc. VAT	inc. VAT each
		1+	
FT20W	4.5m Black PVC Tape	£1.40	£1.69
FT24B	4.5m White PVC Tape	£1.40	£1.69
FM84F	20m Black PVC Tape	£1.90	£2.29
NF94C	20m Red PVC Tape	£1.90	£2.29
NG31J	20m White PVC Tape Sngl	£1.90	£2.29
N03AN	20m Green PVC Tape	£1.90	£2.29
NG32K	33m Black PVC Tape	£2.32	£2.79
NG33L	33m Red PVC Tape	£2.32	£2.79
NG37S	33m White PVC Tape	£2.32	£2.79
NG38R	33m GRN/Ylw PVC Tape	£2.32	£2.79

PVC Insulation Tape 4.5m 10 Pack



Strong, self adhesive, flame resistant PVC tape suitable for general electrical insulation work. The tape is certified to BS3924 and is supplied in a 10 pack of 5 assorted colours. All tapes are 19mm wide and 4.5m long.

Order Code	Mod: 045681	Price each exc. VAT	inc. VAT each
		1+	5+
N14BY	PVC Tape 4.5m 10Pk	£4.15	£3.74 £4.99

PVC Insulation Tape 20m 10 Pack



Strong, self adhesive, flame resistant PVC tape suitable for general electrical insulation work. The tape is certified to BS3924 and is supplied in a 10 pack of 5 assorted colours. All tapes are 19mm wide and 20m long.

Order Code	Mod: 034783	Price each exc. VAT	inc. VAT each
		1+	5+
N61AQ	PVC Ins. Tape 10Pk	£5.82	£5.24 £6.99

Magic Wrap X-Treme Tape 3mm Black

- Forms a non-conductive air and water tight insulating seal when wrapped under tension
- Stops all types of leaks instantly. For use on steam, water, salt water, petrol, diesel, acid and other chemicals



- Temperature range from -50° to +260°C
- Tensile strength of 600 psi, insulates to 8000 volts, class H insulator
- For use indoor and outdoor - UV resistant
- Can be used for assorted electrical, plumbing,

automotive and marine repairs or protection

Originally developed for the military Magic Wrap X-Treme Tape is a self-bonding wrap made from a special high quality silicone rubber compound which adheres to itself when wrapped under tension. Magic Wrap X-treme tape forms a non-conductive air and water tight insulating tape. This tape will not melt up to +260°C [+500°F]. Remains flexible down to -50°C and insulates to 8000 volts/mil. Tensile strength of 600psi.

Some of the many Magic Wrap X-Treme tape uses Emergency radiator hose repair, extension cord repair, insulation for radioactive areas, auto exhaust pipes, electrical wiring insulations, central heating pipes, hydraulic pipes, plumbing and waste pipes.

Order Code	Mod: 998127	Price each exc. VAT 1+	inc. VAT each 5+
N88DG	Magic Wrap Xtreme	£8.32	£7.49 £9.99

Paper Masking Tapes

A general purpose masking tape with a sticky backing, ideal for protecting windows, skirting board and other areas prior to painting, spraying, etc. Available in two widths of 50m roll lengths.



Order Code	Width	Length
DF17T	19mm	50m
RP19V	38mm	50m

Order Code	Mod: 036479	Price each exc. VAT 1+	inc. VAT each 5+
DF17T	19 Masking Tape 50M	£1.65	£1.49 £1.99
RP19V	38 Masking Tape 50m	£2.07	£1.86 £2.49

Double-Sided Carpet Tape

- Double-sided PVC film with an adhesive coating on each side
- Strong and very sticky, making it ideal for carpet fitting and other heavy-duty applications



Order code:	Dimensions:
N37BA	50mm x 10m
N22CF	50mm x 25m

Order Code	Mod: 033776	Price each exc. VAT 1+	inc. VAT each 5+
N37BA	Carpet Tape 50mmx10m	£2.49	£2.99
N22CF	Carpet Tape 50mmx25m	£3.15	£2.69 £3.79

Gaffer Tape

The famous duct tape, suitable for a multitude of applications including repairing polythene sheets, sealing boxes, binding and securing cables, bundling pipes, joining carpets, temporary repairs and the like.



A strong, very tough, waterproof, cloth tape, that can still be torn by hand. Suitable for both indoor and outdoor use. The Rhino cloth tapes are available in 3 colours and 2 lengths.

Order Code	Colour	Dimensions
N89AL	Silver	50mm x 10m
N86AL	White	50mm x 50m
N87AL	Black	50mm x 50m
N88AL	Silver	50mm x 50m

Order Code	Mod: 033752	Price each exc. VAT 1+	inc. VAT each 5+
N86AL	Rhino Tape White 50m	£5.82	£6.99
N87AL	Rhino Tape Black 50m	£5.82	£6.99
N88AL	Rhino Tape Silver 50m	£5.82	£6.99
N89AL	Rhino Silv 10m	£3.32	£2.99 £3.99

Heavy Duty Gaffer Tape

A thicker, stronger, stickier version of the Rhino cloth gaffer tapes. It is recommended for the toughest of applications. It is available on 50mm x 50m rolls in silver [Order Code N90AL] and black [Order Code N57BH].



Order Code	Mod: 033764	Price each exc. VAT 1+	inc. VAT each 5+
N90AL	HD Cloth Tape 50m	£5.82	£6.99
N57BH	HD Cloth Tape Blk 50m	£7.49	£6.74 £8.99

Hazard Tape

- 50mm width
- 33m length
- Ideal for marking factory floors, gangways or hazardous zones
- Available in yellow/black [GU58N] or red/white [RP11M]



This tape has an aggressive pressure sensitive adhesive, good abrasion resistance and conformability together with minimum creep-back. It is self-extinguishing if it catches fire.

Order Code	Mod: 011904	Price each exc. VAT 1+	inc. VAT each 5+
GU58N	Yell/Blk Hazard Tape	£4.15	£3.74 £4.99
RP11M	Red/Wh Hazard Tape	£4.15	£3.74 £4.99

Aluminium Tape

A self-adhesive, 30µm thick aluminium tape which has many applications, particularly within the field of electronics and electric. For example, it can be used for PCB repair, screening enclosures and circuits susceptible to RFI, and when applied to windows it can be used as a very cost-effective 'broken window detector' for security systems. Order Code N46CF performs well in temperatures of up to 90°C, has excellent heat reflection properties and is flame retardant. It is a 45.7mtr roll supplied on a paper release liner for easier application.



Order Code	Reel Size	Backing Paper
KW30H	25mm x 4.6m	Nc
N46CF	50mm x 45.7m	Yes

Order Code	Mod: 004098	Price each exc. VAT 1+	inc. VAT each 5+
KW30H	Aluminium Tape	£2.49	£2.24 £2.99
N46CF	Aluminium Foil Tape	£5.40	£4.86 £6.49

Self Amalgamating Waterproof Tape 10m Black

A very useful derivative of insulating tape which can be used for waterproofing connections. To use, the top protective layer is peeled off and the rubbery self-amalgamating tape underneath is wrapped tightly around the connection to be waterproofed. Eventually, the layers of this tape will merge together and create a waterproof seal. This tape is highly recommended for automotive work and also aerial installations, particularly those for satellite TV where cables enter the LNB and polariser. The tape is black, 19mm wide and is supplied on 10m reels.



Order Code	Mod: 004099	Price each exc. VAT 1+	inc. VAT each 5+
KW29G	Self Amalgamate Tape	£7.49	£6.74 £8.99

Silicone Self Fusing Repair Tape 3.6m x 24mm

- Self-fusing 'wrap 'n' repair' silicone based tape
- Supplied on a 3.6m x 24mm roll
- Repair high pressure water leaks up to 700psi
- Exhaust and automotive repair and much more
- Thermal stability ranging from -65°C to 260°C
- Ideal for sealing connections to make them waterproof
- Colour available is transparent



Kraken Tape® is non-sticky to the touch and actually fuses to itself creating a permanent, durable and flexible seal. With up to an incredible 700psi strength, up to 7,000 volts/20mil (0.51mm) dielectric strength [EN60454-2 2007, EN60243-1 1990] and thermal stability ranging from -65°C to 260°C. Kraken Tape® can get you out of almost any difficult situation.

Please Note: Kraken Tape does fuse permanently however due to conditions and usage being beyond our control, we recommend you do not use if leakage/breakage would cause harm or damage of any kind. If in doubt speak to a professional. Do not use on Gas pipes of any kind.

Order Code	Mod: 227649	Price each exc. VAT 1+	inc. VAT each 5+
N24GN	Silicone Repair Tape	£9.99	£8.99 £11.99

Fragile Parcel Tape 50mm x 66m



A strong white tape with red wording, ideal for sealing parcels and warning about the fragility of the contents. Supplied on a 50mm x 66m roll.

Order Code	Mod: 047202	Price each exc. VAT 1+	inc. VAT each 5+
N47CF	Fragile Parcel Tape	£2.07	£2.07 £2.49

All Weather Repair Tape 10m



- Ideal for outdoor repairs
- Suitable for temporary repairs on greenhouses, windows and car headlights, etc.
- 50mm wide by 10m length

A self-adhesive polythene repair tape which is especially suited to outdoor applications, due to its UV resistant construction. Ideal for temporary repairs to greenhouses, windows, car headlights and the like.

Order Code	Mod: 036119	Price each exc. VAT 1+	inc. VAT each 5+
N89BA	All Weather Tape	£2.49	£2.24 £2.99

Over 200 stores nationwide

Parcel and Packaging Tape 40m

- A strong, brown polypropylene film with a good strength adhesive
- Ideal packing tape for carton sealing
- Supplied on a 48mm x 40m roll



Order Code	Mod: 033771	Price each exc. VAT 1+	inc. VAT each
N98AL	Parcel Tape	£1.32	£1.59

Double Sided Paper Tape 10m

A double sided adhesive tissue tape suitable for general purpose craft applications such as sticking photos into albums, etc. It is supplied on a 15mm x 10m roll.



Order Code	Mod: 033781	Price each exc. VAT 1+	5+	inc. VAT each
N99AL	Double Sided Tape	£1.65	£1.34	£1.99

Twin Pack of Clear Tape 40m

- Two 40m rolls of clear tape
- Ideal for repairing tears, wrapping presents and removing bits from clothing



Two rolls of cello tape. Ideal for repairing tears, wrapping presents, and removing bits from clothing.

Order Code	Mod: 036480	Price each exc. VAT 1+	5+	inc. VAT each
R088V	Twin Pack Clear Tape	£0.82	£0.74	£0.99

3+ Multi-Purpose Magnetic Tape 19mm x 5m

- Magnetic on one side, adhesive on the other
- 19mm x 5m long
- Tear line also doubles as a ruler
- Soft and very flexible
- Special adhesive can be removed without leaving sticky residue
- Magnetic pairing can be used on card, plastics, glass wood any non-ferrous surfaces



Typical applications include: Refrigerators pictures filing cabinets, menus, school lockers, calendars, children's artwork, arts and crafts, DIY educational cards, classroom white boards and To Do Lists plus much, much more.

Order Code	Mod: 224248	Price each exc. VAT 1+	inc. VAT each
N77GB	3+ Magi Mags Silver	£3.32	£3.99

Gaffer Hi Vis Flour Tape 50mm x 10m Fluorescent Yellow

- High quality cloth tape
- Optical high visibility yellow
- Waterproof
- High strength

High quality easy to see cloth tape suitable for multiple applications and a good general purpose



tape. Strong, very tough, waterproof, easy to tear by hand and suitable for both indoor and outdoor use

Mould-resistant	No
Water-resistant	Yes
Double-Sided	No
Product Width	950mm
Product Depth	50mm
Product Height	950mm
Product Weight	112g

Order Code	Mod: 1001364	Price each exc. VAT 1+	inc. VAT each
N49DL	High Vis Yellow Tape	£2.49	£2.99

Gaffer Hi Vis Tape 50mm x 10m Fluorescent Orange

- High quality cloth tape
- Optical high visibility orange
- Waterproof
- High strength

High quality easy to see cloth tape suitable for multiple applications and a good general purpose tape.



Strong, very tough, waterproof, easy to tear by hand and suitable for both indoor and outdoor use

Mould-resistant	No
Water-resistant	Yes
Double-Sided	No
Product Width	950mm
Product Depth	50mm
Product Height	950mm
Product Weight	112g

Order Code	Mod: 1001366	Price each exc. VAT 1+	inc. VAT each
N50DL	Orange Gaffer Tape	£2.49	£2.99

Shurtape Duck® Tape Original 50mm x 25m Silver



- Cloth tape ideal for hundreds of uses around the home, garage and garden
- High strength adhesive that sticks firmly to most surfaces
- Strong, waterproof*, seals, reinforces, protects, binds and identifies
- Suitable for indoors and outdoors
- 50mm wide, 25m in length

Order Code	Mod: 1029110	Price each exc. VAT 1+	inc. VAT each
A55RH	Duc Tape 50mmx25m Si	£5.82	£6.99

Shurtape Duck® Tape Original 50mm x 25m White



- Cloth tape ideal for hundreds of uses around the home, garage and garden

- High strength adhesive that sticks firmly to most surfaces
- Strong, waterproof*, seals, reinforces, protects, binds and identifies
- Suitable for indoors and outdoors
- 50mm wide, 25m in length

Order Code	Mod: 1029111	Price each exc. VAT 1+	inc. VAT each
A53RH	DuckTape 50mmx25m Wh	£5.82	£6.99

Shurtape Duck® Tape Original 50mm x 25m Black

- Cloth tape ideal for hundreds of uses around the home, garage and garden
- High strength adhesive that sticks firmly to most surfaces
- Strong, waterproof*, seals, reinforces, protects, binds and identifies
- Suitable for indoors and outdoors
- 50mm wide, 25m in length



Order Code	Mod: 1029107	Price each exc. VAT 1+	inc. VAT each
A54RH	DuckTape 50mmx25m Bl	£5.82	£6.99

Shurtape Duck® Tape Ultimate 50mm x 25m White

- Heavy duty triple layered cloth tape
- Suitable for 1000's of uses both regular or extreme
- Unique adhesive is 50% stronger than most other cloth tapes
- For use both indoors and outdoors
- Just like a real duck its 100% waterproof



Order Code	Mod: 1032415	Price each exc. VAT 1+	inc. VAT each
A57RH	DuckTape 50mmx25m Wh	£7.49	£8.99

Shurtape Duck® Tape Ultimate 50mm x 25m Silver

- Heavy duty triple layered cloth tape
- Suitable for 1000's of uses both regular or extreme
- Unique adhesive is 50% stronger than most other cloth tapes
- For use both indoors and outdoors
- Just like a real duck its 100% waterproof



Order Code	Mod: 1032416	Price each exc. VAT 1+	inc. VAT each
A56RH	DuckTape 50mmx25m Wh	£7.49	£8.99

Shurtape Duck® Tape Ultimate 50mm x 25m Black

- Heavy duty triple layered cloth tape
- Suitable for 1000's of uses both regular or extreme
- Unique adhesive is 50% stronger than most other cloth tapes
- For use both indoors and outdoors



- Just like a real duck its 100% waterproof

Order Code	Mod:	Price each exc. VAT	inc. VAT each
A51RH	DuckTape 50mmx25m Bl	£7.49	£8.99

Denso Tape 50mm x 10m Roll

- For the protection of buried or exposed pipes, rods and cables
- Remains plastic over a wide temperature range
- Non-hardening and non-cracking
- Resistant to acids, alkalis, salts and micro-organisms
- Highly impermeable to water



Weight: 1.5kg

Order Code	Mod:	Price each exc. VAT	inc. VAT each
A17RG	Denso Tape 50x10m	£9.99	£11.99

Everbuild Powergrip Double Sided Tape 50mm x 2.5m



- Powerful synthetic rubber resin adhesive designed to bond to any material
- Reinforced double sided Polyester fabric tape
- Completely weatherproof - suitable for outdoor and indoor use
- Strong initial bond strength
- Will stick to porous and non porous surfaces

Order Code	Mod:	Price each exc. VAT	inc. VAT each
A51RG	DSidedTape 50mmx2.5m	£9.15	£10.99

Everbuild Powergrip Double Sided Tape 25mm x 2.5m

- Powerful synthetic rubber resin adhesive designed to bond to any material
- Reinforced double sided Polyester fabric tape
- Completely weatherproof - suitable for outdoor and indoor use
- Strong initial bond strength
- Will stick to porous and non porous surfaces



Order Code	Mod:	Price each exc. VAT	inc. VAT each
A48RG	DSidedTape 25mmx2.5m	£4.99	£5.99

Gorilla Glue Gorilla Tape 48mm x 32m

- Ultra tough cloth tape
- Made from 3 layers
- Tough all weather shell
- Double thick adhesive layer
- Strong webbed backing



Order Code	Mod:	Price each exc. VAT	inc. VAT each
A22RH	Gorilla 48mm x 32m	£9.15	£10.99

Gorilla Glue Gorilla Tape 48mm x 11m

- Ultra tough cloth tape
- Made from 3 layers
- Tough all weather shell
- Double thick adhesive layer
- Strong webbed backing



Order Code	Mod:	Price each exc. VAT	inc. VAT each
A19RH	GorillaTape 48mmx11m	£4.99	£5.99

Unibond Duct Tape Silver 50mm x 25m

- Heavy-duty, fabric reinforced tape
- High strength adhesive with a lasting hold
- Water resistant
- Ideal for binding, repairing and reinforcing
- Suitable for hundreds of uses around the home



Order Code	Mod:	Price each exc. VAT	inc. VAT each
A69RH	DuctTape Sl 50mmx25m	£6.24	£7.49

VELCRO® Heavy-Duty Stick On Tape Black 50mm x 1m

- Extra strong heavy duty stick on tape
- Weather resistant
- The adhesive reaches maximum strength after 24 hours
- Cuts to size & easy to use



Order Code	Mod:	Price each exc. VAT	inc. VAT each
A73RH	VELCRO 50mmx1m Bl	£8.32	£9.99

Glue & Spray Glue

Unibond No More Nails Roll Interior / Exterior 19mm x 1.5m

- Strong, double sided tape
- Eliminates the need for nails and screws in many applications
- Safe and easy to use
- Sticks to most building materials
- For interior and exterior use



Order Code	Mod:	Price each exc. VAT	inc. VAT each
A71RH	NoMoreNails19mmx1.5m	£5.82	£6.99

Unibond General Purpose Silicone Translucent 300ml



- Silicone sealant
- Forms a permanent, flexible seal
- Weatherproof
- Excellent adhesion
- Also suitable for draught proofing

Order Code	Mod:	Price each exc. VAT	inc. VAT each
A72RH	Silicone.Trans.300ml	£4.99	£5.99

Maplin Spray Adhesive 500ml

- Quick and convenient high strength bond
- Wide range of uses
- Ideal to use on furniture, flooring and for bonding foam to a wide range of surfaces
- Do not use on surfaces where temperatures may exceed 50°C
- Supplied in a 500ml can



Order Code	Mod:	Price each exc. VAT	inc. VAT each
N66AN	Spray Adhesive 500ml	£3.74	£4.49

Ultratape Spray Adhesive 500ml

- Bonds fabric, foam, wood, concrete, plastic, metal, etc.
 - Supplied in a 500ml can
- This spray adhesive produces a permanent bond between a wide variety of materials including fabrics, foams, wood, concrete, metals, plastics, rubber and polythene.



Order Code	Mod:	Price each exc. VAT	inc. VAT each
N42AQ	Spray Adhesive	£4.57	£5.49

Servisol Silicone Adhesive Sealant 75ml

- Ready to use, one part
- Neutral cure, non-corrosive
- Suitable for use on metals and plastics
- Excellent insulating and sealing properties
- Prevents arcing on EHT connections
- Tack free in 40 minutes
- Operational from -50°C to +230°C
- Ideal for potting electronic components and keeping gaskets in place
- Supplied in a 75ml tube



Order Code	Mod:	Price each exc. VAT	inc. VAT each
RE89W	Silicone Adhesive	£4.99	£5.99

Find out more in-store

Our staff can offer friendly and expert advice; we're here to help



Tetrion Fillers All Purpose Powder Filler Standard 500g

- For internal and external use
- Can be used on plaster, brick, wood, stone, concrete, render, plasterboard
- 2 hour drying time for sanding
- 24 hour drying time for painting



Order Code	Mod:	Price each exc. VAT 1+	inc. VAT each
A65RH	1032444	£2.49	£2.99

Tetrion Fillers All Purpose Powder Filler Decor 1.5kg

- For internal and external use
- Can be used on plaster, brick, wood, stone, concrete, render, plasterboard
- 2 hour drying time for sanding
- 24 hour drying time for painting



Order Code	Mod:	Price each exc. VAT 1+	inc. VAT each
A64RH	1032441	£6.65	£7.99

Mxbon Superglue with Brush 5g

- High performance adhesive in handy 5g bottle
- Integral brush top for easy application
- High strength
- Bonds a wide range of materials
- Cures in seconds



Excellent performance cyanoacrylate adhesive in 5g bottle with easy to use brush-on application. Mxbon cyanoacrylate will give excellent bonds on rubbers, porcelain, most plastics and metals with rapid cure times. **Please note:** We are not allowed to sell butane or solvent based products to persons under the age of 18

Mould-resistant Yes
Water-resistant No
Colour Clear

Order Code	Mod:	Price each exc. VAT 1+	inc. VAT each
N36DL	1001338	£3.57	£4.29

Mxbon Superglue Liquid 2 Pack 3g

- High performance adhesive 2 x 3g tubes
- Easy to use precision application
- Cost effective
- Bonds a wide range of materials
- Cures in seconds



Excellent performance cyanoacrylate adhesive in 2 x 3g easy to use tubes for precision application. Mxbon cyanoacrylate will give excellent bonds on rubbers, porcelain, most plastics and metals. **Please note:** We are not allowed to sell butane or solvent based products to persons under the age of 18

Mould-resistant Yes
Water-resistant No
Colour Clear

Order Code	Mod:	Price each exc. VAT 1+	inc. VAT each
N34DL	1001334	£2.90	£3.49

Mxbon Superglue Gel 2 Pack 3g

- High performance adhesive gel 2 x 3g tubes
- Easy to use precision application
- Gap filling
- Bonds a wide range of materials
- Cures in seconds



Excellent performance cyanoacrylate adhesive gel in 2 x 3g easy to use tubes for precision application. Mxbon cyanoacrylate gel will give excellent flexible bonds on rubbers, porcelain, most plastics and metals and has good gap filling properties. **Please note:** We are not allowed to sell butane or solvent based products to persons under the age of 18.

Mould-resistant Yes
Water-resistant No
Colour Clear

Order Code	Mod:	Price each exc. VAT 1+	inc. VAT each
N35DL	1001336	£2.90	£3.49

Mxbon Superglue Bottle 20g

- Cyanoacrylate adhesive 20g bottle
- Easy to use nozzle application
- High strength
- Bonds a wide range of materials
- Cures in seconds



Excellent performance cyanoacrylate adhesive with easy to use nozzle application. Mxbon cyanoacrylate will give excellent bonds on rubbers, porcelain, most plastics and metals. **Please note:** We are not allowed to sell butane or solvent based products to persons under the age of 18.

Mould-resistant Yes
Water-resistant No
Colour Clear

Order Code	Mod:	Price each exc. VAT 1+	inc. VAT each
N37DL	1001340	£3.57	£4.29

Mxbon Glass Glue 3g

- Glass adhesive 3g tube
- Easy to use precision application
- Dries clear
- Bonds glass to glass
- Cures in seconds



Excellent performance glass adhesive in 3g easy to use tubes for precision application. Mxbon glass adhesive will give excellent bonds to glass to glass or glass to metal. **Please note:** We are not allowed to sell butane or solvent based products to persons under the age of 18

Mould-resistant Yes
Water-resistant Yes
Colour Clear

Order Code	Mod:	Price each exc. VAT 1+	inc. VAT each
N39DL	1001342	£2.90	£3.49

Send direct

If any product is not in stock, we will order it for you and send it with free delivery

Terms and conditions apply



Mxbon Superglue Pen 4g

- Cyanoacrylate adhesive 4g pen
- Easy to use precision application
- High strength
- Bonds a wide range of materials
- Cures in seconds



Excellent performance cyanoacrylate adhesive in 4g pen for precision application. Mxbon cyanoacrylate will give excellent bonds on rubbers, porcelain, most plastics and metals.

Please note: We are not allowed to sell butane or solvent based products to persons under the age of 18

Mould-resistant Yes
Water-resistant No
Colour Clear

Order Code	Mod:	Price each exc. VAT 1+	inc. VAT each
N38DL	1001344	£3.57	£4.29

Mxbon Plastic Glue 20ml

- Dries clear
- Ideal for rigid plastics
- Resistant to household chemicals
- Fast curing
- Supplied in 20ml tube



A solvent based adhesive suitable for bonding most hard plastics such as PVC, polystyrene and acrylics. Can also be used for bonding ceramic, textiles and paper.

Please note: We are not allowed to sell butane or solvent based products to persons under the age of 18

Mould-resistant Yes
Water-resistant Yes
Colour Clear

Order Code	Mod:	Price each exc. VAT 1+	inc. VAT each
N41DL	1001346	£2.90	£3.49

Mxbon Fabric Glue 20ml

- Dries clear
- Water based
- Flexible bond
- Suitable for most fabrics



Solvent free fabric glue suitable for bonding most fabrics such as cotton, linen, synthetics, jute, felt and leather. Ideal for hemming clothes, applying name tags and repairing holes and tears. Provides strong adhesion which withstands dry cleaning and washing.

Please note: We are not allowed to sell butane or solvent based products to persons under the age of 18

Mould-resistant Yes
Water-resistant Yes
Colour White

Order Code	Mod:	Price each exc. VAT 1+	inc. VAT each
N42DL	1001348	£2.90	£3.49

Mxbon Multipurpose Glue 50ml

- Dries clear
- Solvent based
- Flexible bond



All purpose solvent based adhesive suitable for bonding a wide range of materials such as ceramics, fabric, wood, rubber and most plastics. Provides a flexible bond

Please note: We are not allowed to sell butane or solvent based products to persons under the age of 18.

Mould-resistant Yes
Water-resistant Yes
Colour Clear

Order Code	Mod:	Price each exc. VAT 1+	inc. VAT each
N43DL	50ml MultiPurp Glue	£3.57	£4.29

Mxbon Quickset Epoxy 5 Minute 28g

- Easy syringe application
- 1200psi bonding strength
- Bonds a wide range of products
- Supplied in 28g hand syringe

Quick setting epoxy which automatically dispenses into equal parts with one push. Suitable for bonding glass, metal, china, wood, fibreglass or for any project requiring a 5-min cure time. No mess, no spillage and no wastage.

Please note: We are not allowed to sell butane or solvent based products to persons under the age of 18.

Mould-resistant Yes
Water-resistant Yes
Colour Amber

Order Code	Mod:	Price each exc. VAT 1+	inc. VAT each
N44DL	5Min QuickSet Epoxy	£4.57	£5.49

Mxbon Plastic Weld Epoxy 10 Minute 28g

- Easy syringe application
- 4000psi bonding strength
- Bonds a wide range of plastics
- Supplied in 28g hand syringe

Instant setting epoxy which automatically dispenses into equal parts with one push. Suitable for bonding a wide range of plastics. No mess, no spillage and no wastage.

Please note: We are not allowed to sell butane or solvent based products to persons under the age of 18.

Mould-resistant Yes
Water-resistant Yes
Colour Amber

Order Code	Mod:	Price each exc. VAT 1+	inc. VAT each
N45DL	10MinPlasticWeldEpoxy	£5.82	£6.99

Mxbon Metal Epoxy 5 Minute 28g

- Easy syringe application
- 2500psi bonding strength
- Bonds a wide range of metals
- Supplied in 28g hand syringe

Quick setting metal epoxy which automatically dispenses into equal parts with one push. Suitable for bonding most metals including copper, steel, stainless steel, aluminium, brass and iron. No mess, no spillage and no wastage.

Please note: We are not allowed to sell butane or solvent based products to persons under the age of 18.

Mould-resistant Yes
Water-resistant Yes
Colour Light grey

Order Code	Mod:	Price each exc. VAT 1+	inc. VAT each
N46DL	5Min Metal Epoxy	£4.57	£5.49

Mxbon Waterproof Epoxy 4 Hour 28g

- Easy syringe application
- 2000psi bonding strength
- Bonds a wide range of materials
- Bonds and cures underwater
- Supplied in 28g hand syringe

Quick setting epoxy which automatically dispenses into equal parts with one push. This product is an advanced industrial strength 2-part system which is strong and flexible when cured. Formulated to repair, seal and bond various materials. Works underwater or in the presence of water and remains waterproof. No mess, no spillage and no wastage.

Please note: We are not allowed to sell butane or solvent based products to persons under the age of 18.

Mould-resistant Yes
Water-resistant Yes
Colour White / Light Yellow

Order Code	Mod:	Price each exc. VAT 1+	inc. VAT each
N47DL	4Hr Waterproof Epoxy	£5.82	£6.99

Mxbon Metal Epoxy Putty 4 minutes 50g

- For repairing cracks and holes
- Emergency repair for pipes and tanks
- Can be drilled, sanded, filled and painted

A dark grey epoxy putty for repairing metals, wood, concrete, ceramics and some plastics.

Can be easily kneaded by hand and moulded into required shape.

Can be drilled, sanded, filled and painted once cured. Sets in 4 minutes.

Please note: We are not allowed to sell butane or solvent based products to persons under the age of 18.

Mould-resistant Yes
Water-resistant Yes
Colour Dark Grey

Order Code	Mod:	Price each exc. VAT 1+	inc. VAT each
N48DL	50g Metal EpoxyPutty	£4.57	£5.49

Araldite® Rapid Tubes 15ml 2 Part

- Strong, long lasting solvent-free adhesive
- The 2-component epoxy is fast setting
- Parts repositionable for 4 minutes
- High temperature resistance -30° C to 65° C
- Water, oil, chemical and impact resistant

Order Code	Mod:	Price each exc. VAT 1+	inc. VAT each
A05RG	Rapid Tubes 15ml 2	£6.65	£7.99

Brummer Yellow Label Interior Stopping Small Light Oak

- Interior grade wood filler
- Ideal for repairing furniture, doors, skirting boards and wooden floors, picture frames and mouldings

- Heat proof up to 90°C
- Works equally well on most metals
- Use under all decorative finishes, including polish, lacquer, varnish and paint
- Suitable for outside use if varnished or painted over

Order Code	Mod:	Price each exc. VAT 1+	inc. VAT each
A11RG	Ylw Label Int Oak SM	£4.15	£4.99

Brummer Yellow Label Interior Stopping Small Pine

- Interior grade wood filler
- Ideal for repairing furniture, doors, skirting boards and wooden floors, picture frames and mouldings
- Heat proof up to 90°C
- Works equally well on most metals
- Use under all decorative finishes, including polish, lacquer, varnish and paint
- Suitable for outside use if varnished or painted over

Order Code	Mod:	Price each exc. VAT 1+	inc. VAT each
A13RG	Ylw Label Int Pine M	£4.15	£4.99

Evo-Stik 528 Instant Contact Adhesive 500m^l

- General purpose contact adhesive
- Suitable for bonding laminates, wall boards, plywood, hard board panels and leather goods
- High initial grab bond upon contact
- Excellent final bond strength with low odour

Order Code	Mod:	Price each exc. VAT 1+	inc. VAT each
A97RG	Cont Adhesive 500ml	£13.32	£15.99

Polyvine Cascamite One Shot Structural Wood Adhesive Tub 220g

- Specially formulated for exterior joinery exposed to weather elements
- Extremely good gap filling properties with fast bonding strength
- Use internally and externally where high bond strength, gap filling and water resistant is required

Order Code	Mod:	Price each exc. VAT 1+	inc. VAT each
A40RH	Wood Adhes.Tub 220g	£4.99	£5.99

Technical Helpline

0333 400 9500

For technical information and assistance relating to any Maplin purchase, contact our team of experts

Brummer Yellow Label Interior Stopping Small Medium Oak

- Interior grade wood filler
- Ideal for repairing furniture, doors, skirting boards and wooden floors, picture frames and mouldings
- Heat proof up to 90°C
- Works equally well on most metals
- Use under all decorative finishes, including polish, lacquer, varnish and paint
- Suitable for outside use if varnished or painted over



Order Code	Mod:	Price each exc. VAT	inc. VAT each
A12RG	Ylw Label Int Oak M	£4.15	£4.99

Everbuild Bath & Sanitary Silicone Sealant Clear 310ml 500

- Fungicidal formula to prevent mould growth - designed for sanitary applications
- Permanently flexible and provide a good sound seal for professional finish
- Will not discolour on aging
- Quick curing low dirt pick up
- Waterproof seal
- Fits most common mastic or sealant guns

Colour: Clear
Size: 310ml

Order Code	Mod:	Price each exc. VAT	inc. VAT each
A38RG	Sealant Clear 310ml	£6.65	£7.99

Everbuild Bath & Sanitary Silicone Sealant White 310ml 500

- Fungicidal formula to prevent mould growth - designed for sanitary applications
- Permanently flexible and provide a good sound seal for professional finish
- Will not discolour on aging
- Quick curing low dirt pick up
- Waterproof seal
- Fits most common mastic or sealant guns

Colour: White
Size: 310ml

Order Code	Mod:	Price each exc. VAT	inc. VAT each
A26RG	Sealant White 310ml	£6.65	£7.99

Everbuild Clean Room Silicone C3 565

- Advanced neutral curing, hygienic sealant
- Contains SteriTouch® a powerful antibacterial compound
- FDA approved food compatibility
- Stops black mould growth
- Outstanding adhesion to most substrates

- Virtually odourless in application
- Remains permanently flexible with a movement capability of ± 25%

Weight 364g
Size 300ml

Order Code	Mod:	Price each exc. VAT	inc. VAT each
A66RG	Silicone C3 565	£5.82	£6.99

Everbuild Acoustic Sealant & Adhesive C4 AC50

- Permanently flexible with high grab rate
- Adheres to most surfaces whilst being mould resistant
- Forms an acoustic and intumescent barrier by sealing gaps between plasterboard walls, floors and ceilings and dry lining applications
- Non flammable properties
- When cured can be painted over and is easy to clean up

Order Code	Mod:	Price each exc. VAT	inc. VAT each
A69RG	Sealant & Adhesive	£4.15	£4.99

Everbuild Caulk Once White 310ml C3

- Premium acrylic caulk formulated to outperform all other conventional decorating caulks and flexible fillers
- Manufactured using an advanced high quality polymer
- Offers superior adhesion, minimal shrinkage and outstanding flexibility as well as tooling down smoothly
- Durable, longer lasting product that will cope with joint movement over time
- Can be painted over with most paint types within 60 minutes

Size 310ml

Order Code	Mod:	Price each exc. VAT	inc. VAT each
A34RG	Caulk OnceWhite310ml	£2.49	£2.99

Everbuild Fix & Fill Expanding Foam Filler 750ml

- Designed to fill gaps, fix frames and insulate walls or boards
- Quick setting polyurethane foams in aerosol form
- Foam expands on application up to 50 times its original volume and expands on application by 150%
- Supplied with attachable nozzles
- Designed to fill gaps, fix frames and insulate walls or boards

Size 750ml

Order Code	Mod:	Price each exc. VAT	inc. VAT each
A22RG	Foam Filler 750ml	£14.99	£17.99

Everbuild Fill & Fix Expanding Foam Filler 500ml

- Designed to fill gaps, fix frames and insulate walls or boards
- Quick setting polyurethane foams in aerosol form
- Foam expands on application up to 50 times its original volume and expands on application by 150%
- Supplied with attachable nozzles
- Designed to fill gaps, fix frames and insulate walls or boards

Size: 500ml

Order Code	Mod:	Price each exc. VAT	inc. VAT each
A60RG	Expand Foam 500ml	£12.49	£14.99

Everbuild Caulk Once White 400ml C4

- Premium acrylic caulk formulated to outperform all other conventional decorating caulks and flexible fillers
- Manufactured using an advanced high quality polymer
- Offers superior adhesion, minimal shrinkage and outstanding flexibility as well as tooling down smoothly
- Durable, longer lasting product that will cope with joint movement over time
- Can be painted over with most paint types within 60 minutes

Size: 400ml

Order Code	Mod:	Price each exc. VAT	inc. VAT each
A64RG	Caulk White 400ml	£2.49	£2.99

Everbuild Roof & Gutter Sealant Black 310ml

- Premium quality butyl based sealant and adhesive
- Provides instant, permanent weather-proofing to a wide variety of roofing applications
- Adheres to most common roofing materials such as bitumen, asphalt, felt, metals and wood
- Can be applied in wet conditions, even under heavy rain
- Excellent gap filling properties without shrinkage

Order Code	Mod:	Price each exc. VAT	inc. VAT each
A66RG	Sealant Black 310ml	£2.90	£3.49

Faithfull Mastic Gun 425ml



- Suitable for all trades and home use
- Accepts cartridge sizes up to 425ml
- Solid metal frame
- Rounded shaped trigger mechanism for comfort
- Handy nozzle cleaning pin

Order Code	Mod:	Price each exc. VAT	inc. VAT each
A03RH	1032311	£4.15	£4.99

Faithfull Foam Spurt Gun



- Designed for use with standard 500/750ml gun foam canisters
- Complete with sprung trigger mechanism
- Flow adjusting knob to ensure fine control over the foam output
- Features a non stick coated needle, canisters fitting valve and a stainless steel barrel
- Ideal for filling and sealing of cavities, joints and more

Order Code	Mod:	Price each exc. VAT	inc. VAT each
A09RH	1031723	£20.82	£24.99

Evo-Stik Sticks Like All Weather Adhesive 290ml



- One of the strongest adhesives you can buy
- Will bond most surfaces, even if both are impervious
- Will bond damp surfaces and may even be used under water
- Can be used in any weather, however extreme
- May be over painted

Size: 290ml
Colour: White

Order Code	Mod:	Price each exc. VAT	inc. VAT each
A84RG	1031700	£9.15	£10.99

Everbuild Stick 2 All Purpose Contact Adhesive Tube 30ml



- Premium grade rubber based contact adhesive
- Suitable for internal and external use

- One minute instant bond

Order Code	Mod:	Price each exc. VAT	inc. VAT each
A81RG	1031681	£2.49	£2.99

Evo-Stik Impact Adhesive 250ml Tin



- A one part contact adhesive
- Ideal for numerous jobs around the home and in the workshop
- Provides a strong bond
- No need for jigs, clamps or weights
- Suitable for bonding many types of substrates

Order Code	Mod:	Price each exc. VAT	inc. VAT each
A87RG	1031706	£7.49	£8.99

Evo-Stik Impact Adhesive Small Tube



- A one part contact adhesive
- Ideal for numerous jobs around the home and in the workshop
- Provides a strong bond
- No need for jigs, clamps or weights
- Suitable for bonding many types of substrates

Order Code	Mod:	Price each exc. VAT	inc. VAT each
A85RG	1031707	£3.32	£3.99

Evo-Stik Impact Adhesive Large Tube



- A one part contact adhesive
- Ideal for numerous jobs around the home and in the workshop
- Provides a strong bond
- No need for jigs, clamps or weights
- Suitable for bonding many types of substrates

Order Code	Mod:	Price each exc. VAT	inc. VAT each
A86RG	1031709	£5.82	£6.99

Evo-Stik 715011 Wood Adhesive Resin W Mini 50ml

- Fast setting, extra strong wood adhesive for interior use
- Dries to a clear finish that can be sanded, painted or stained
- Suitable for all types of wood
- No mess, clog-free nozzle and twist to seal cap
- Anti-roll bottle

Size: 50ml

Order Code	Mod:	Price each exc. VAT	inc. VAT each
A89RG	1031717	£2.90	£3.49

Evo-Stik 715219 Wood Adhesive Resin W 250ml

- Fast setting, extra strong wood adhesive for interior use
- Dries to a clear finish that can be sanded, painted or stained
- Suitable for all types of wood
- No mess, clog-free nozzle and twist to seal cap
- Anti-roll bottle

Size: 250ml

Order Code	Mod:	Price each exc. VAT	inc. VAT each
A96RG	1031716	£7.49	£8.99

Evo-Stik 715615 Wood Adhesive Resin W 1 Li

- Fast setting, extra strong wood adhesive for interior use
- Dries to a clear finish that can be sanded, painted or stained
- Suitable for all types of wood
- No mess, clog-free nozzle and twist to seal cap
- Anti-roll bottle

Size: 1 Litre

Order Code	Mod:	Price each exc. VAT	inc. VAT each
A98RG	1031712	£19.15	£22.99

Evo-Stik 715110 Wood Adhesive Resin W 125

- Fast setting, extra strong wood adhesive for interior use
- Dries to a clear finish that can be sanded, painted or stained
- Suitable for all types of wood
- No mess, clog-free nozzle and twist to seal cap
- Anti-roll bottle

Size: 125ml

Order Code	Mod:	Price each exc. VAT	inc. VAT each
A93RG	1031715	£4.99	£5.99

Evo-Stik 715417 Wood Adhesive Resin W 500ml

- Fast setting, extra strong wood adhesive for interior use
- Dries to a clear finish that can be sanded, painted or stained
- Suitable for all types of wood
- No mess, clog-free nozzle and twist to seal cap
- Anti-roll bottle

Size: 500ml

Order Code	Mod:	Price each exc. VAT	inc. VAT each
A92RG	1031711	£9.99	£11.99

**Buy it on the web at
maplin.co.uk**

Shop for all Maplin products online at our website and check out our latest products and special offers!



Evo-Stik 716063 Wood Adhesive Weatherproof 125ml

- Fast setting
- Extra strong
- Weatherproof water resistant wood adhesive
- For interior or exterior use
- Can be sanded, painted or stained



Size: 125ml

Order Code	Mod: 1031720	Price each exc. VAT 1+	inc. VAT each
A02RH	Adhesive 125ml	£4.99	£5.99

Evo-Stik 717916 Wood Adhesive Weatherproof 1litre

- Fast setting
- Extra strong
- Weatherproof water resistant wood adhesive
- For interior or exterior use
- Can be sanded, painted or stained



Size: 1 Litre

Order Code	Mod: 1031722	Price each exc. VAT 1+	inc. VAT each
A94RG	Wood Adhesive 1litre	£20.82	£24.99

Evo-Stik 717411 Wood Adhesive Weatherproof 500ml

- Fast setting
- Extra strong
- Weatherproof water resistant wood adhesive
- For interior or exterior use
- Can be sanded, painted or stained



Size: 500ml

Order Code	Mod: 1031718	Price each exc. VAT 1+	inc. VAT each
A95RG	Wood Adhesive 500ml	£10.82	£12.99

Evo-Stik 717015 Wood Adhesive Weatherproof 250ml

- Fast setting
- Extra strong
- Weatherproof water resistant wood adhesive
- For interior or exterior use
- Can be sanded, painted or stained



Size: 250ml

Order Code	Mod: 1031721	Price each exc. VAT 1+	inc. VAT each
A01RH	Adhesive 250ml	£8.32	£9.99

Evo-Stik Impact Adhesive 500ml Tin

- A one part contact adhesive
- Ideal for numerous jobs around the home and in the workshop
- Provides a strong bond
- No need for jigs, clamps or weights
- Suitable for bonding many types of substrates



Order Code	Mod: 1031705	Price each exc. VAT 1+	inc. VAT each
A91RG	Adhesive 500ml Tin	£12.49	£14.99

Unibond No More Nails Original Tube 200ml

- High strength grab adhesive
- Eliminates the need for nails and screws in many application
- Safe and easy to use
- Adheres to most building materials
- Dries white



Order Code	Mod: 1032423	Price each exc. VAT 1+	inc. VAT each
A70RH	No More Nails 200ml	£5.82	£6.99

Unibond No More Nails Original Cartridge 300ml

- High strength grab adhesive
- Eliminates the need for nails and screws in many applications
- Safe and easy to use
- Adheres to most building materials
- Dries white



Size: 300ml
Colour: White

Order Code	Mod: 1031795	Price each exc. VAT 1+	inc. VAT each
A68RH	NoMore Nails 300ml	£7.49	£8.99

Gorilla Glue Gorilla Polyurethane Glue 250ml

- Incredibly strong, bonding all types of wood, stone, metal, ceramics, glass, foam, etc.
- Waterproof and temperature resistant
- Polyurethane based glue
- Foaming action that fills whilst it sticks
- Sandable, stainable, paintable and can also take a varnish



Order Code	Mod: 1032345	Price each exc. VAT 1+	inc. VAT each
A21RH	Gorilla Glue 250ml	£10.82	£12.99

Gorilla Glue Gorilla Polyurethane Glue 60ml

- Incredibly strong, bonding all types of wood, stone, metal, ceramics, glass, foam, etc.
- Waterproof and temperature resistant
- Polyurethane based glue
- Foaming action that fills whilst it sticks
- Sandable, stainable, paintable and can also take a varnish



Order Code	Mod: 1032348	Price each exc. VAT 1+	inc. VAT each
A18RH	Gorilla Glue 60ml	£4.99	£5.99

Gorilla Glue Gorilla Polyurethane Glue 115ml

- Incredibly strong, bonding all types of wood, stone, metal, ceramics, glass, foam, etc.
- Waterproof and temperature resistant
- Polyurethane based glue
- Foaming action that fills whilst it sticks
- Sandable, stainable, paintable and can also take a varnish



Order Code	Mod: 1032344	Price each exc. VAT 1+	inc. VAT each
A20RH	Gorilla Glue 115ml	£7.49	£8.99

Loctite Lock N Seal Tube 3ml

- Fast acting thread lock and sealant
- Vibration proof
- Seals against leaks and corrosion



Loctite Lock N Seal is fast acting thread lock and sealant which is vibration proof and seals against leaks and corrosion. Ideal for carburettor screws, alternator housings, seals, oil pressure switches and threaded pipe joints.

Size: 3ml
More than 75 years of success has made Henkel Loctite the world leader in the development and manufacture of high-performance adhesives, sealants and chemical products. Success based on experience, leadership and technical innovation. Henkel's leading brands can be found all over the world and enjoy high levels of awareness and trust.

The commitment of Henkel Loctite to research and development has resulted in the most technically advanced range of products available today. Products that speed manufacturing processes, reduce costs and improve quality throughout industry. Products for global use that comfortably exceed national and international standards.

This huge product range offers unchallenged performance and consistency for even the most demanding applications in the automotive, microelectronics, aerospace and medical industries, in over 80 countries world-wide.

Order Code	Mod: 1032366	Price each exc. VAT 1+	inc. VAT each
A26RH	Lock N Seal Tube 3ml	£3.74	£4.49

Polycell Sealant Strip Kitchen/Bathroom White 41mm

- Perfect alternative to gun and tube sealants
- Ideal for covering imperfections
- Can easily be wiped clean
- Produces a neat, watertight result
- Suitable for many different surfaces



Order Code	Mod: 1032368	Price each exc. VAT 1+	inc. VAT each
A37RH	Sealant White 41mm	£7.49	£8.99

Ronseal High Performance Wood Filler Natural 550g



- Can be drilled, screwed or planed
- Rebuilds rotten wood
- Cures wet rot and prevents recurrence
- No shrinking or cracking
- For interior and exterior use

Few things are beyond repair with Ronseal High Performance Wood filler. It is a chemically bonded filler and catalyst that provides extremely tough repairs to virtually any wood damage without shrinking or cracking. Fills to any depth and can be drilled, screwed or planed. Ideal for use in interior or exterior wood repairs more than 5mm deep. Typical areas include window frames, sills, doors and door frames. For minor and surface wood repairs use Ronseal Multi Purpose Wood Filler.

Areas of use: Interior / Exterior wood
Application: Filling Knife

Drying time approx: 30 mins

Protection level: Very High

Available in Various Sizes.

Available in: Natural, Dark or White.

This Ronseal product is supplied in a tub with re-saleable lid.

Colour: Natural.

Size: 275g.

It does what it says on the tin.

Their aim at Ronseal is always to provide products that meet exactly your requirements; that is why they spend a lot of time listening to what you have to say. They then take that feedback into their R & D Laboratories, and using the very latest technological advancements, they can then deliver innovative new products and the quality service for your DIY and project needs.

This is an ongoing process and, coupled with their no-nonsense advertising and marketing, and their extensive consumer education, these innovative new product developments will continue to help them lead in their product categories, meeting and exceeding your requirements in the future.

Order Code	Mod: 1032398	Price each exc. VAT 1+	inc. VAT each
A45RH	Filler Natural 550g	£12.49	£14.99

Ronseal High Performance Wood Filler Natural 275g



- Can be drilled, screwed or planed
- Rebuilds rotten wood
- Cures wet rot and prevents recurrence
- No shrinking or cracking
- For interior and exterior use

Few things are beyond repair with Ronseal High Performance Wood filler. It is a chemically bonded filler and catalyst that provides extremely tough repairs to virtually any wood damage without shrinking or cracking. Fills to any depth and can be drilled, screwed or planed. Ideal for use in interior or exterior wood repairs more than 5mm deep. Typical areas include window frames, sills, doors and door frames. For minor and surface wood repairs use Ronseal Multi Purpose Wood Filler.

Areas of use: Interior / Exterior wood

Application: Filling Knife

Drying time approx: 30 mins

Protection level: Very High

Available in Various Sizes.

Available in: Natural, Dark or White

This Ronseal product is supplied in a tub with re-saleable lid.

Colour: Natural

Size: 275g.

It does what it says on the tin.

Their aim at Ronseal is always to provide products that meet exactly your requirements; that is why they spend a lot of time listening to what you have to say. They then take that feedback into their R & D Laboratories, and using the very latest technological advancements, they can then deliver innovative new products and the quality service for your DIY and project needs.

This is an ongoing process and, coupled with their no-nonsense advertising and marketing, and their extensive consumer education, these innovative new product developments will continue to help them lead in their product categories, meeting and exceeding your requirements in the future.

Order Code	Mod: 1032397	Price each exc. VAT 1+	inc. VAT each
A46RH	Filler Natural 275g	£9.15	£10.99

Ronseal Smooth Finish Multi Purpose Interior Wall Filler Ready Mixed 1.2kg



- Strong repairs to plaster, stone, concrete and wood
- Reduced sanding
- Super smooth finish
- Fills gaps up to 20mm deep
- Touch dry in 1-2 hours

The Ronseal Multi Purpose Interior Wall Filler is a general purpose filler, based on Acrylic Polymer and fine Dolomite fillers, for interior and exterior use, and Surface dry in 1 to 2 hours.

Ronseal multi-purpose produces an extremely smooth finish and has excellent application properties coupled with strength and flexibility. Ideal for making repairs to plaster, stone, concrete or wood.

It is easy to sand and gives excellent adhesion, also gives a long lasting repairs that won't shrink or crack.

Available in Tub or Tube format.

Ronseal applicator included.

Can be drilled once dried hard.

Areas of use: Interior walls and ceilings

Application: Filling Knife

Drying time approx: 2 hours.

Protection level: High

Available in various sizes

The Ronseal RSLMPRMF12VP is supplied in a Plastic tub with re-sealable lid.

Weight: 1.2kg

It does what it says on the tin.

Their aim at Ronseal is always to provide products that meet exactly your requirements; that is why they spend a lot of time listening to what you have to say. They then take that feedback into their R & D Laboratories, and using the very latest technological advancements, they can then deliver innovative new

products and the quality service for your DIY and project needs.

This is an ongoing process and, coupled with their no-nonsense advertising and marketing, and their extensive consumer education, these innovative new product developments will continue to help them lead in their product categories, meeting and exceeding your requirements in the future.

Order Code	Mod: 1032400	Price each exc. VAT 1+	inc. VAT each
A44RH	Filler Ready Mix 1.2kg	£4.99	£5.99

Today's Tools EP200 Epoxy Putty Refill - Single



- Reinforced epoxy putty stick
- Cures steel hard within 15 to 20 minutes
- Extremely tough and durable with exceptional adhesion
- Can be used on a wide range of surfaces
- Can be drilled, tapped, sanded, painted, filed or machined within 1 hour
- Capable of withstanding temperatures up to 350°F

Epoxy Putty is a pre-measured kneadable reinforced epoxy putty stick that cures steel hard within 15 to 20 minutes of mixing at room temperature (77°F).

The epoxy is extremely tough and durable with exceptional adhesion to a wide range of surfaces.

Within an hour it can be drilled, tapped, sanded, painted, filed or machined. It can be used to bond, seal, plug, mould or rebuild many different surfaces.

The epoxy is capable of withstanding temperatures up to 350°F and will even harden under water.

Applications:

Plumbing, Air Conditioning, Electrical, Industrial,

Automotive, Marine, Farming, Home

Order Code	Mod: 1032443	Price each exc. VAT 1+	inc. VAT each
A66RH	Putty Refill Single	£4.99	£5.99

Hook & Loop

Hook and Loop Fasteners



A versatile self-adhesive mounting and fixing system consisting of two nylon tapes, one covered in thousands of tiny loops, and the other in thousands of tiny hooks. When pressed together, the hooks grip the loops forming a tight secure closure capable of resisting very strong lateral pulls. Yet to separate the strips, you simply peel them apart. The strips have a strong pressure-sensitive adhesive backing and are ideal for securing the grille in front-loading loudspeaker cabinets, for example. The strips are 25mm (1in. approx) wide and are sold in separate 1m lengths of hooks and loops, or in four pairs of 25mm squares. Colour of both parts is black.

QE95D - 4prs 1 inch hook/loop adhesive
UV18U - 1m hooks adhesive
UV83E - 1m loops adhesive

Order Code	Mod: 026810	Price each exc. VAT 1+	inc. VAT each 5+
QE95D	4prs 1in Hook & Loop	£1.65	£1.99
UV18U	1m Nylon Hooks	£2.49	£2.99
UV83E	1m Nylon Loops	£2.49	£2.99

Adhesive 60cm Hook & Loop



- Quick and easy to use fixing system
- 2.5cm wide and 60cm long
- Press and seals in seconds

A versatile self-adhesive mounting and fixing system consisting of two nylon tapes, one covered in thousands of tiny loops, and the other in thousands of tiny hooks. When pressed together, the hooks grip the loops forming a tight secure closure capable of resisting very strong lateral pulls. Yet to separate the strips, you simply peel them apart. The strips have a strong pressure-sensitive adhesive backing and are ideal for securing the grille in front-loading loudspeaker cabinets, for example. Available in black [N22GN] and white [N23GN].

Order Code	Mod: 227647	Price each exc. VAT		inc. VAT each
		1+	5+	
N22GN	60cm Hook & Loop Blk	£3.32	£2.99	£3.99
N23GN	60cm Hook & Loop Wht	£3.32	£2.99	£3.99

12 Hook & Loop 2.5cm Dots



- Twelve circular 2.5mm diameter adhesive pads
- Self-attaching hook and loop material
- Ideal quick fix solution
- Use at home, at work or on the road

Order Code	Mod: 227646	Price each exc. VAT		inc. VAT each
		1+	5+	
N21GN	12 Hook & Loop Dots	£3.32	£2.99	£3.99

Cleaning & Aerosols

Computer Cleaning

Durable 50 Low Lint Cleaning Cloths



- 50 low-lint absorbent cloths for use on screens, computers, printers and all office equipment
- Ideal for use with Durable branded cleaning fluids and foams
- Size: 145x170mm

- Long-lasting pack of 50

Order Code	Mod: 531612	Price each exc. VAT		inc. VAT each
		1+	5+	
A97KT	Lint Free Cloths x50	£7.07	£6.36	£8.49

Durable Laptop Cleaning Kit 25ml



- Handy cleaning kit ideal for safe and gentle cleaning of all laptops and notebooks
- Fluid leaves a protective film on the surface of the laptop screen which dramatically reduces static charge, protects the screen and prolongs cleanliness
- Housing and keyboard are easily cleaned with the Superclean wipes, which contain BACT-O-CLEAN, an anti-microbial additive that kills 99.9% of germs and viruses including the common cold, flu virus, E-coli, Salmonella, MRSA, Listeria, H5N1 Bird-Flu and the H1N1 Swine Flu virus
- Contents: 25ml Screenclean Pro fluid, 1 micro-fibre cloth and 6 individually packed Superclean wipes, supplied in a handy protective case

Order Code	Mod: 531614	Price each exc. VAT		inc. VAT each
		1+	5+	
A99KT	Laptop Cleaning Kit	£9.15	£8.24	£10.99

Monitor Cleaning

Durable 50 Individually Wrapped Screen Cleaning Sachets



- 50 individually packed, moist low lint wipes pre-saturated with alcohol free cleaning fluid
- For gentle and streak-free cleaning of monitor screens, screen filters, laptop screens and PDAs
- Also suitable for glass surfaces on scanners and photocopiers
- Long lasting anti-static effect

Order Code	Mod: 531618	Price each exc. VAT		inc. VAT each
		1+	5+	
A19KU	Screenclean 50 Wipes	£9.15	£8.24	£10.99



Over 200 stores nationwide

Durable Screen Protector and Cleaner 25ml



- Cleaning fluid for all screens including laptop, TFT, Palm, PDA, plasma, satellite navigation and smartphones
- Cleaning leaves a protective film on the screen, dramatically reducing static charge and prolongs cleanliness
- Supplied in a handy carry case
- Anti-static, alcohol free, non toxic and hypoallergenic
- Contents: 25ml cleaning fluid in pump spray bottle and 1 micro fibre cloth

Order Code	Mod: 531617	Price each exc. VAT		inc. VAT each
		1+	5+	
A98KT	Screenclean Pro Set	£7.49	£6.74	£8.99

Durable Wet and Dry Screenclean Sachets 10



- 10 individually packed sets of wet and dry cleaning wipes for gentle and streak-free cleaning of monitor screens, screen filters and PDAs
- Also suitable for glass surfaces on photocopiers and scanners
- Alcohol-free and anti-static
- 10 sets per pack

Order Code	Mod: 531615	Price each exc. VAT		inc. VAT each
		1+	5+	
A14KU	Screenclean DuoWipes	£2.90		£3.49

Durable Screenclean Set 125ml



- Anti-static, alcohol-free fluid for gentle and streak-free cleaning of monitors, screen filters and laptop screens
- Ideal for use on glass surfaces on photocopiers and scanners
- Contents: 1 bottle Screenclean fluid 125ml and 20 low-lint cloths

Order Code	Mod: 531616	Price each exc. VAT 1+	inc. VAT each 5+
A15KU	Screenclean Set	£4.57	£5.49

100 Anti Static Screen Cleaning Wipes



- Designed for use on computer screens to enhance clarity
- Anti-static formula prevents dust build-up
- 100 wipes in a handy resealable tub

Order Code	Mod: 218498	Price each exc. VAT 1+	inc. VAT each 5+
N74CX	PC Screen Cleaners	£4.99	£5.99

12 Wet and Dry Screen Cleaning Wipes



- Specially formulated for all glass screens, plastic and polarised filters
- Maximise image clarity with special non-streak formula
- Contains 12 sets, each with one wet and one dry wipe

Order Code	Mod: 218506	Price each exc. VAT 1+	inc. VAT each 5+
N77CX	Wet/Dry Screen Wipes	£1.24	£1.49

Handheld LCD Cleaner



- Portable screen cleaning kit
- Soft micro-fiber cleaning wipe protects against scratches
- Cleaning liquid is stored in the handle for portability
- Soft micro-fiber cleaning wipe, CDs and DVDs

Order Code	Mod: 385098	Price each exc. VAT 1+	inc. VAT each 5+
A37JR	Handheld LCD Cleaner	£4.15	£4.99

Portable Screen Cleaning Kit



- Self-contained cloth and cleaning solution
- Removes dust, germs, lint and smudges
- Ideal for small TVs, mobile phones or gaming devices
- Anti-bacterial formula
- Anti-static
- High quality microfiber cloth
- 100ml capacity

Order Code	Mod: 634701	Price each exc. VAT 1+	inc. VAT each 5+
A99KW	Portable Screen Clean	£2.50	£3.00

Squeezy Anti Bacterial Screen Cleaner



- Removes dust and fingerprints without streaks or stains
- Anti-bacterial formula
- 150ml capacity
- Trigger action bottle for ease of use
- Microfibre cleaning cloth

Follow these steps to safely clean your flat screen in just a few minutes

1. Turn off your monitor or TV set and if it's warm, allow to cool down. Areas of dirt or oil are easier to spot when the screen is off.
2. Use the microfibre cloth provided to gently wipe any loose dust from the surface
3. Apply a few sprays of cleaning solution to the cloth (not the screen) and gently wipe until clean

Order Code	Mod: 531226	Price each exc. VAT 1+	inc. VAT each 5+
A42KL	Squeezy ScreenClean	£4.15	£4.99

Anti Bacterial Screen Cleaner

- Removes dust and fingerprints without streaks or stains
- Anti-bacterial formula
- 60ml capacity
- Microfibre cleaning cloth

Follow these steps to safely clean your flat screen in just a few minutes

1. Turn off your monitor or TV set and if it's warm, allow to cool down. Areas of dirt or oil are easier to spot when the screen is off.
2. Use the microfibre cloth provided to gently wipe any loose dust from the surface
3. Apply a few sprays of cleaning solution to the cloth (not



the screen) and gently wipe until clean

Order Code	Mod: 531228	Price each exc. VAT 1+	inc. VAT each 5+
A43KL	Mini ScreenClean Kit	£3.32	£3.99

LCD/Plasma Screen Cleaning Kit



- Removes dust and fingerprints without streaks or stains
- Ideal for LCD, computer screens, plasma displays, compact discs and keyboards
- Includes 200ml cleaning fluid
- Microfibre cloth
- Dust brush, ideal for tricky corners and crevasses
- Please consult your LCD/Plasma screen manual prior to using this product to ensure compatibility

Order Code	Mod: 454483	Price each exc. VAT 1+	inc. VAT each 5+
A35JY	Screen Cleaning Kit	£4.15	£4.99

Screen Cleaning Pack



- Lint free screen cleaning cloth quickly and safely removes greasy marks, dirt, dust and bacteria
- Conductive honeycomb carbon fibres dissipate static and reduce attraction of airborne dust
- 100% non-conductive, solvent and alcohol free, deionised water spray
- Safer for modern flat screens and touch screens
- Cloth guaranteed for 300 washes

With its large, antistatic screen cloth and 100% natural Screen Spray, this new Screen Cleaning Pack offers exceptional and safe cleaning for all types of modern screens.

Pack includes: 1 x Antistatic Screen Cleaning Cloth (35 x 35 cm) & 1 x Screen Cleaning Spray (32 ml)

Order Code	Mod: 988531	Price each exc. VAT 1+	inc. VAT each 5+
N58DF	Screen Cleaning Pack	£8.32	£9.99

Other Home & Office Cleaning

Durable Hard Surface Foam Cleaner 400ml

- Highly effective anti-static foam cleaner for use on hard surfaces
- Non-drip formula gently lifts stains and ingrained dirt from computer housings, printers and other office equipment
- Foam has a pleasant apple aroma
- Non-flammable
- 400ml can

Please note: We are not allowed to sell butane or solvent based products to persons under the age of 18.

Order Code	Mod: 531608	Price each exc. VAT 1+	inc. VAT each 5+
A07KU	SupercleanFoam 400ml	£4.57	£5.49



Durable Moist Telephone Cleaning Wipes in Dispenser Tub 100

- 100 moist low-lint wipes, pre-saturated in alcohol free cleaning fluid
- Ideal for cleaning mobile phones, telephones and headsets
- Contains BACT-O-CLEAN, an anti-microbial additive that kills 99.9% of germs and viruses including the common cold and influenza viruses, E-coli, salmonella, MRSA, listeria and H5N1 bird-flu
- Also effective against the H1N1 Swine Flu virus
- Supplied in a handy dispenser tub



Order Code	Mod: 531609	Price each exc. VAT	inc. VAT each
A08KU	Phone Clean Tub x100	£2.74	£2.46 £3.29

Durable Moist Hard Surface Cleaning Wipes in Dispenser Tub 100

- 100 moist low-lint wipes, pre-saturated in alcohol free cleaning fluid
- For cleaning computer housings, printers, mice and other office equipment
- Anti-static and long lasting disinfectant
- Contains BACT-O-CLEAN, an anti-microbial additive that kills 99.9% of germs and viruses including the common cold and influenza viruses, E-coli, salmonella, MRSA, listeria and H5N1 bird-flu
- Also effective against the H1N1 Swine Flu virus
- Supplied in a handy dispenser tub



Order Code	Mod: 531610	Price each exc. VAT	inc. VAT each
A09KU	Superclean Tub x100	£2.90	£3.49

Durable Moist Hard Surface Cleaning Wipes Individually Wrapped Sachets 50



- 50 individually wrapped, moist low-lint wipes, pre-saturated in alcohol free cleaning fluid
- For cleaning hard surfaces such as computer housings, printers, mice and other office equipment
- Anti-static and long lasting disinfectant
- Contains BACT-O-CLEAN, an anti-microbial additive that kills 99.9% of germs and viruses including the common cold and influenza viruses, E-coli, salmonella, MRSA, listeria and H5N1 bird-flu
- Also effective against the H1N1 Swine Flu virus

Order Code	Mod: 531611	Price each exc. VAT	inc. VAT each
A13KU	Superclean 50 Wipes	£8.32	£7.49 £9.99

Durable Hard Surface Cleaning Fluid Pump Spray 250ml

- General purpose alcohol-free liquid for cleaning computer housings, printers and other office equipment
- Contains BACT-O-CLEAN, an anti-microbial additive that kills 99.9% of germs and viruses including the common cold and influenza viruses, E-coli, salmonella, MRSA, listeria and H5N1 bird-flu
- Also effective against the H1N1 swine flu virus
- Antistatic and disinfectant
- For best results, use with dry clean cloths, Order Code: A97KT
- Convenient 250ml pump-action spray bottle



Order Code	Mod: 531613	Price each exc. VAT	inc. VAT each
A17KU	SupercleanFluid250ml	£3.74	£3.36 £4.49

Servisol Label Remover 200ml

- Quickly neutralises the adhesion of labels
- Cleans sticky residue left by previous labels
- Ideal for use on photocopiers, fax machines, computers, printers, etc.
- Is also an effective cleaning solvent for some inks and dyes
- Pleasant citrus smell
- Supplied in a 200ml aerosol can



Order Code	Mod: 004173	Price each exc. VAT	inc. VAT each
AP98G	Label Remover Spray	£5.82	£5.24 £6.99

Servisol Antistatic Foam Cleanser 400ml

- Unique anti static foam cleanser
- Unrivalled in performance
- Removes dirt, grease and stains
- Prevents accumulation of dust
- Safe on plastic, metal and most other materials
- Supplied in a 400ml aerosol can



Order Code	Mod: 004151	Price each exc. VAT	inc. VAT each
JP18U	Foam Cleaner 400ml	£4.15	£3.74 £4.99

Isopropanol Cleaning Wipes



- An isopropanol injected tissue
- Ideal for use as a cleaning wipe on surfaces prior to applying adhesive tape.

Supplied in a sachet.

Order Code	Mod: 033787	Price each exc. VAT	inc. VAT each
N08AN	Cleaning Wipes	£0.82	£0.74 £0.99

Maplin Label Remover 200ml

- For the removal of adhesive labels
- A non-CFC spray
- Cleans sticky residues
- Supplied in a 200ml can



Order Code	Mod: 025350	Price each exc. VAT	inc. VAT each
N63AN	Label Remover 200ml	£4.15	£3.36 £4.99

Maplin Foam Cleanser 400ml

- Advanced multipurpose foam cleanser
- Fast acting aqueous based cleaner
- Ideal for automotive upholstery
- Specially formulated for cleaning hard surfaces
- Use for cleaning and degreasing both vertical and horizontal surfaces
- Controlled break foam allows for fast application without excessive run off
- Antistatic properties to repel the attraction of dust
- Supplied in a 400ml can



Order Code	Mod: 025343	Price each exc. VAT	inc. VAT each
N65AN	Foam Cleaner 400ml	£3.32	£2.99 £3.99

Anti-Static General Office 100 Wipes



- 100 wipes in a resealable, self-dispensing tub
- Anti-static formula - ideal for general office use

Order Code	Mod: 218495	Price each exc. VAT	inc. VAT each
N73CX	Surface Wipes 100 Pk	£2.49	£2.99

Servisol Anti Static Spray 200ml

- Protects electrical equipment by preventing static build-up
- Stops the attraction of airborne dust
- For use on television screens, monitors, cabinets and fluorescent lights
- Safe on plastics, polished metal and wooden surfaces
- Supplied in a 200ml aerosol can



Order Code	Mod: 029000	Price each exc. VAT	inc. VAT each
RE73Q	Antistatic Spray	£4.15	£3.74 £4.99

 We can deliver to your home or office (UK only)

Air Dusters

Maplin Air Duster

- Quickly removes dust and debris
- High pressure jet or air cleans effectively
- Can reduce computer failure from blocked or dirty fans
- Available in both 200ml and 400ml aerosol cans with tube
- Ideal for use on keyboards, laptops, fans, printers, PCBs and photographic equipment



18

Order Code	Mod:	Price each exc. VAT	inc. VAT each
N57JX	Airduster 200ml	£8.32	£9.99
N60AN	Airduster 400ml	£12.49	£14.99

Servisol Dust and Dirt Remover 400ml

- Quickly removes dirt, dust and loose particles from delicate equipment and inaccessible areas
- Ideal for use on computers, cameras, watches and other electronic components and equipment
- Non-flammable formulation
- Extension tube to reach inaccessible areas



18

Order Code	Mod:	Price each exc. VAT	inc. VAT each
RE72P	Airduster 400ml	£14.15	£16.99

Servisol Invertible Dust and Dirt Remover 110ml

- Quickly removes dirt, dust and loose particles from delicate equipment and inaccessible areas
- Ideal for use on computers, cameras, watches and other electronic components and equipment
- Non-flammable formulation
- Extension tube to reach inaccessible areas



18

Order Code	Mod:	Price each exc. VAT	inc. VAT each
RE78K	Invertible Airduster	£7.49	£8.99

Durable Invertible Airduster 200ml

- Air duster for removing dirt from sensitive equipment and hard to reach areas
- Can be used on laptops, keyboards, printers, photographic and video equipment
- Invertible - can be used upside-down



18

- HFC free - ozone friendly
 - Flammable - not to be used on live equipment
 - Supplied with extension tube
- PLEASE NOTE: By law we are not allowed to sell butane or solvent based products to persons under the age of 18.

Order Code	Mod:	Price each exc. VAT	inc. VAT each
A10KU	Inv. Airduster 200ml	£9.15	£10.99

Durable Non-Flammable Airduster 150ml

- Air duster for removing dirt from sensitive equipment and hard to reach areas
- Non flammable and CFC free - ozone friendly
- Can be used on laptops, keyboards, printers, photographic and video equipment
- Supplied with extension tube
- Supplied in a 150ml can



18

Order Code	Mod:	Price each exc. VAT	inc. VAT each
A16KU	Non-FlamDuster 150ml	£8.32	£9.99

Durable Non-Flammable Airduster 400ml

- Air duster for removing dirt from sensitive equipment and hard to reach areas
- Non flammable and CFC free - ozone friendly
- Can be used on laptops, keyboards, printers, photographic and video equipment
- Supplied with extension tube
- Supplied in a 400ml can



18

Order Code	Mod:	Price each exc. VAT	inc. VAT each
A12KU	Non-FlamDuster 400ml	£14.15	£16.99

Falcon Dust Off Airduster 530ml

- 530ml of high quality compressed gas
 - Easy to use trigger, allowing precise control
 - Includes a straw for careful application.
 - High pressure jet of clean airduster
- PLEASE NOTE: By law we are not allowed to sell butane or solvent based products to persons under the age of 18



18

The newest and most economical duster delivers more cleaning power per can. Designed for larger cleaning applications and frequent users. Plenty of value per ml. Same efficient blasting power as other disposable products. The unique trigger discharge system allows the user to have precise, comfortable and accurate application. 100% ozone safe. This product contains Bitterant to help discourage inhalant abuse. **This product is flammable and must not be used on live electrical parts**

Order Code	Mod:	Price each exc. VAT	inc. VAT each
N86HJ	Falcon Air Duster	345490	

Electronic Cleaners

Maplin Switch Cleaner 200ml

- A highly efficient general purpose cleaning solvent
- Cleans and protects
- Ideal for the removal of stains, coatings, printing inks, oil, grease and dirt
- Does not cause corrosion
- Safe to use on most plastics or fibres
- Suitable for cleaning most electrical apparatus, installations and delicate instruments
- Supplied in a 200ml aerosol



18

Order Code	Mod:	Price each exc. VAT	inc. VAT each
N62AN	Switch Cleaner 200ml	£3.32	£3.99

Maplin Contact Cleaner 200ml

- Ideal for removing grease, oil, dirt and coatings
- Does not cause corrosion, leaves no residue
- Low toxicity



18

Order Code	Mod:	Price each exc. VAT	inc. VAT each
N61AN	Contact Clean 200ml	£3.32	£3.99

Servisol Contact Cleaner 200ml

- Provides electrical cleaning and mechanical lubrication for contacts, switches and relays
- Removes tarnish, dirt, grease, dust, oil and other deposits
- Prevents arcing between dry contacts
- Inaccessible areas are accessed by the extension nozzle supplied with the can
- Supplied in a 200ml aerosol can



18

Order Code	Mod:	Price each exc. VAT	inc. VAT each
JP17T	Switch Cleaner	£4.15	£4.99

WD 40 Specialist Contact Cleaner 400ml

- Cleans oil, dirt, flux residue and condensation from sensitive electrical equipment
- Rapidly penetrates
- Leaves no residue
- Can be used on electrical equipment, contacts, plastics and rubber
- Smart-straw feature - built-in straw that cannot be lost - use with straw folded down for a wide-angle spray from the can, or folded up for a precision spray through the straw



Order Code	Mod.	Price each	exc. VAT	inc. VAT each
N94LJ	WD-40 Contact Cleanr	1+	5+	
		€6.65	€6.39	€7.99

Maplin PCB Cleaner 200ml

- Highly efficient cleaning solvent
- Cleans and protects
- Ideal for the removal of stains, coatings, printing inks, oil, grease and dirt
- Also ideal for removal of flux residues
- Low toxicity, leaves no residue
- Does not cause corrosion of metal
- Safe to use on most plastics or fibres
- Suitable for cleaning most electrical equipment
- Supplied in a 200ml can



Order Code	Mod.	Price each	exc. VAT	inc. VAT each
N64AN	PCB Cleaner 200ml	1+	5+	
		€3.32	€2.99	€3.99

Maplin Electronic Cleaning Solvent 200ml

- Ideal for use on video and audio heads
- Evaporates in seconds
- Removes flux, grease, oil and other common contaminants
- Leaves no residue
- Safe for use on most surfaces and materials
- Supplied in a 200ml can



Order Code	Mod.	Price each	exc. VAT	inc. VAT each
N69AN	Electr.Solvent Clean	1+	5+	
		€3.32	€2.99	€3.99

Servisol Electronic Cleaning Solvent 200ml

- Safe and effective cleaning of electronic and electrical components
- Safe on plastics and rubber
- Rapid evaporation
- Ideal for PCBs, tape heads, kits, business machines and all electronic components
- Supplied in a 200ml aerosol can



Order Code	Mod.	Price each	exc. VAT	inc. VAT each
RE70M	Electr.Clean Solvent	1+	5+	
		€4.57	€4.11	€5.49

Isopropyl Alcohol 400ml

- Universal electronic cleaning solvent
- Evaporates after use
- For use on tape heads, disc drives, PCBs and other instruments and delicate components
- Safe on plastics
- Supplied in a 400ml aerosol



Order Code	Mod.	Price each	exc. VAT	inc. VAT each
RE79L	IFA 170 400ml	1+	5+	
		€8.32	€7.49	€9.99

Isopropyl Alcohol 1 Litre

- Universal electronic cleaning solvent
- Evaporates after use
- For use on tape heads, disc drives, PCBs and other instruments and delicate components
- Safe on plastics
- Supplied in a 1 litre can



Order Code	Mod.	Price each	exc. VAT	inc. VAT each
RE71N	IFA 170 1ltr	1+	5+	
		€12.49	€11.24	€14.99

Industrial Cleaners & Wipes

Big Wipes Black Top Multi-Purpose Wipes Tub of 80

- Industrial strength cleaning wipes
- Advanced cleaning formula gives unique ability to clean a vast range substances
- Great for cleaning hands, tools and surfaces
- Full size heavy-duty wipes in a handy tub for easy dispensing



Order Code	Mod.	Price each	exc. VAT	inc. VAT each
A09RG	Black Multi-P.Wipes	1+		
		€8.32		€9.99

Everbuild Wonder Wipes Trade Tub of 100

- Specially formulated to clean hands, tools and surfaces
- Particularly useful when there is no water on site
- Anti bacterial additive for killing bacteria on dirty surfaces and hands
- Resistant to MRSA, Salmonella, Listeria and E.Coli



Order Code	Mod.	Price each	exc. VAT	inc. VAT each
A25RG	Wonder Wipes Tub	1+		
		€12.49		€14.99

Evo-Stik 191 Adhe Cleaner 250ml

- Fast and effective
- Able to tackle wet or dry adhesives
- Old adhesive can be removed
- Removes grease, wax and similar stains
- Easy to use



Order Code	Mod.	Price each	exc. VAT	inc. VAT each
A99RG	Cleaner 250ml	1+		
		€5.82		€6.99

Swarfega Original Classic Hand Cleaner 500ml

- Smooth green gel formula which removes ingrained oil, grease and general grime
- Added conditioner maintains the skins natural moisture level
- Easy to apply and quick rinsing



Order Code	Mod.	Price each	exc. VAT	inc. VAT each
A61RH	Hand Cleaner 500ml	1+		
		€4.99		€5.99

Swarfega Red Box Heavy-Duty Trade Hand Wipes 150 Pack

- A mobile washroom in a box
- Tough, large wipes are impregnated with a heavy-duty cleaner
- Ideal for mobile repair and maintenance vans and use around the workshop
- 150 wipes per box



Order Code	Mod.	Price each	exc. VAT	inc. VAT each
A60RH	HD Trade Hand Wipes	1+		
		€18.32		€21.99

Swarfega Orange Hand Cleaner Pump Top Bottle 4 Litre

- Advanced formulation hand cleaner with polygrains
- Natural citrus oil removes oil, grease and general soilings quickly and efficiently
- Contains moisturiser to help care for the skin



Order Code	Mod.	Price each	exc. VAT	inc. VAT each
A62RH	Org Cln Pump Pack 4L	1+		
		€23.32		€27.99

Lubricants

Multi Purpose Silicone Grease

- Lubricates, waterproofs, insulates and preserves electrical and electronic equipment
- High surface resistivity
- Ideal for switch contacts, ignition systems and EHT connections
- Operational from -5°C to +200°C
- Available in 200ml (RE81C) aerosol and 50g tube (RE90X)



Order Code	Mod.	Price each	exc. VAT	inc. VAT each
RE81C	Silicone Grease 70	1+	5+	
RE90X	Silicone Grease 50g	€5.40	€4.11	€6.49
		€4.15	€3.83	€4.99

WD-40 Smart Straw 400ml

- No more lost straws
- Dual action spray pattern for outstanding versatility and performance
- Quick and simple one handed operation
- Sleek contemporary design
- Now in a larger 400ml can
- Cleans and protects, drives out moisture, stops squeaks, loosens rusted parts and frees sticky mechanisms



Order Code	Mod.	Price each	exc. VAT	inc. VAT each
A25LJ	WD-40 Smart Straw	1+	5+	
		€4.99	€4.79	€5.99

WD-40 Specialist High Performance Silicone 400ml

- Withstands temperatures of -35 to +200 degrees
- Prevents parts from sticking
- Waterproof and protects against moisture
- For use on Rubber, Plastic, Metal and Wood



Order Code	Mod: 687233	Price each exc. VAT	inc. VAT each
N35NW	WD-40 Silicone 400ml	£6.65	£7.99

WD-40 Specialist Anti Friction PTFE Dry Lubricant 400ml

- Withstands temperatures of -20 to + 250 degrees
- Enhanced lubrication and protection
- Dry clear film that resists dirt, dust and oil
- For use on plastic, metals and glass



Order Code	Mod: 687234	Price each exc. VAT	inc. VAT each
N39NZ	WD-40 Dry PTFE	£6.65	£7.99

3 in 1 Oil 100ml

- Lubricates, cleans and prevents rust
- Supplied in a convenient drip can with cap
- 100's of jobs around the place
- In the car, office, workshop or garden the uses are endless



3-IN-ONE's unique set of ingredients enable it to lubricate, clean and protect metal surfaces. 3-IN-ONE's easy-to-use drip spout allows you to apply the product right where it's needed most. 3-IN-ONE oil also offers you different application solutions to treat your tools and home, office and sports equipment.

Order Code	Mod: 385507	Price each exc. VAT	inc. VAT each
N43HT	3 in One Oil 100ml	£2.49	£2.99

WD40 Multi Spray 100ml

- Top quality multi use spray, 1000's of uses
- Stop squeaks, loosens rusted parts
- Frees sticky mechanisms
- Drives out moisture on electrical, tools, garden equipment etc

Introducing this handy size can of WD40, this world famous aerosol is truly a wonder product. Boasting 1000's of uses in all kinds of roles from in the garden, in the tool shed to jobs around the house and car.



WD-40 protects metal from rust and corrosion, penetrates stuck or jammed parts, displaces moisture, and lubricates just about anything. WD-40 is also great when it comes to cleaning grease, grime, and other marks from most surfaces.

Order Code	Mod: 351529	Price each exc. VAT	inc. VAT each
N60HQ	WD40 100ml	£2.49	£2.99

Ambersil Graphite Lock Lubricant

- Extends the life of locks and padlock
- Long lasting lubrication, no oils to attract dirt and grime
- Dry film repels water
- Works even when lock has mild corrosion
- Ideal for corrosive or saline conditions
- Helps prevent snapped keys
- Padlocks open first time – even after extended inspection times
- Ideal for locks on remote equipment, buildings, and cabinets

Whether its for routine maintenance or long-term shut-down this Graphite Lock Lube will help to prevent your locks and padlocks from becoming seized or corroded. Just put the nozzle into the lock cylinder and press to fire a jet of high quality graphite lubricant into the lock to coat the moving parts. Because the graphite forms a dry powder it is ideal for indoors or outside, hot or cold conditions and it will prevent sticking from a build up of contaminants.



Order Code	Mod: 444745	Price each exc. VAT	inc. VAT each
N68JB	Graphite Lock Lube	£2.50	£3.00

Maplin Silicone Grease with PTFE 200ml

- Water resistant
- High quality insulator
- Prevents arcing
- Excellent lubricating properties
- Supplied with extension tube
- Supplied in a 200ml can



Order Code	Mod: 030030	Price each exc. VAT	inc. VAT each
N71AN	Silicone Grease/PTFE	£4.57	£5.49

Contralube 770 Connector Lubricant 8g Sachet



- Synthetic clear gel designed to protect power & data connections
- Use on all metals – prevents oxidation, corrosion and rust
- Extends life of contacts and connectors - halts vibration/fretting corrosion
- Water and salt water resistant
- Does not evaporate, go hard or contain silicone
- Dielectric product (up to 10kV) so does not cause faults if mis-applied
- More permanent solution than WD40/spray lubricants
- UV dye included

Use Contralube 770 on all your electronic, electrical and signal, data connections.

It will protect your equipment from moisture, corrosion, oxidation, dust vibration etc. Amazingly it doesn't affect the flow or quality of signal.

Apply generously to the connector or contact surface you wish to protect. In the case of multi pin connectors, squirt directly into the male and female pins/holes of the connector you wish to safeguard. Administer to any spade, bullet or any other type of push fit connector. Contralube is good for any metal to metal contact – for instance an external antenna and RF connections. It can be used to protect CCTV connections and is particularly useful for radio controlled model enthusiasts.

Because of its composition it can be used on many other applications where metal meets metal; including trailer rollers, winches, shackles, slides, motor pivot points, speed logs, sliding doors, window hinges, domestic appliances, garden equipment, garage door tracks and general annoying squeaks/noises - Contralube is more permanent than any general solvent spray lubricant. (Due to the variability of plastics and elastomer materials, it is advisable to perform a compatibility test).

Dispenser Type:	Sachet
Invertible:	N/A
Operating Temperature:	-40°C to 130°C
Colour:	Clear
Product Width:	50mm
Product Depth:	5mm
Product Height:	140mm
Product Weight:	9g

Order Code	Mod: 866754	Price each exc. VAT	inc. VAT each
N78DD	Contralube 770 8g	£2.49	£2.99

Shopping with us is easy...

In-store

7 days a week, check store listings at the back of the catalogue for address details

Online

maplin.co.uk

24hrs a day, 7 days a week, 365 days a year

Phone

0333 400 9500

Phone lines open 7 days a week

Buying for business?

0333 400 9740

Aerosol Pocket Rocket Lubricant Repellent 400ml

- High specification moisture repellent
- Instantly displaces water using dispersing agents and corrosion inhibitors
- Leaves a light silicone free protective lubricating film behind
- Suitable for 100's of application
- Protecting car ignition systems and electrics
- Penetrating and releasing seized nuts, hinges
- Protecting metal components against rust
- Cleaning grease and grime from threads and components



Pocket Rocket is a high specification penetrating moisture repellent. The special blend of water dispersing agents and corrosion inhibitors instantly displaces water leaving a light 'Silicone Free' protective lubricating film. Uses: Penetrates and Lubricates, Repels Moisture, Helps Prevent Re-seizure, Cleans, Protects Against Corrosion. Suitable for 100's of applications including Protecting car ignition systems and electrics, Penetrating and releasing seized nuts, hinges etc. Protecting metal components against rust. Cleaning grease and grime from threads and components.

The Aerosol company provide a varied range of aerosols and applicators manufactured to exacting standards for quality and safety, and specialise in line marking paint ideal for a wide range of applications for playing fields, car parks, warehouses, golf courses and road marking, specially formulated for stencil, line or freehand marking.

Order Code	Mod: 1031647	Price each exc. VAT 1+	inc. VAT each
A04RG	Lub. Repellent 400ml	£2.90	£3.49

3-IN-ONE Aerosol with PTFE 250ml

- Superior lubricant that offers long lasting protection
- Ideal for chains, cables and gear mechanisms
- Features six inch telescopic spout



3-IN-ONE Multi-Purpose Oil Aerosol with PTFE is a superior lubricant that offers long lasting protection. Ideal for chains, cables and gear mechanisms.

Size: 250ml. The world's number one multi-purpose lubricant, with hundreds of uses around the home, garage or work place.

3-IN-ONE is a precise drip oil, and the new telescopic spout reaches even the most hard to get to places. With a radical new appearance reminiscent of a traditional old style oil can, the telespout incorporates a six-inch flexible extendable spout.

Order Code	Mod: 1032360	Price each exc. VAT 1+	inc. VAT each
A00RG	3-IN-ONE 250ml	£4.15	£4.99

3-IN-ONE Silicone Spray 400ml

- Provides a long lasting and quick drying silicone coating
- Formulated for use on metal, rubber, wood and vinyl
- Protects electrical parts and is perfect for wet environments and marine use
- Features six inch telescopic spout



3-IN-ONE Silicone Spray provides a long lasting and quick drying silicone coating which is formulated for use on metal, rubber, wood and vinyl. It protects electrical parts

and is perfect for wet environments and marine use. Size: 400ml. The world's number one multi-purpose lubricant, with hundreds of uses around the home, garage or work place. 3-IN-ONE is a precise drip oil, and the new telescopic spout reaches even the most hard to get to places. With a radical new appearance reminiscent of a traditional old style oil can, the telespout incorporates a six-inch flexible extendable spout.

Order Code	Mod: 1032362	Price each exc. VAT 1+	inc. VAT each
A01RG	3-IN-ONE 400ml	£5.82	£6.99

3-IN-ONE Anti-Seize Copper Grease 300ml

- High temperature lubricant capable of withstanding -18°C to 1,100°C
- Anti-seize compound that protects metal components from corrosion, rust, water, heat and acid
- Forms a protective coating which will not wash off or burn
- Features six inch telescopic spout



3-IN-ONE Anti-seize Copper Grease is a high temperature lubricant and anti-seize compound that protects metal components from corrosion, rust, water, heat and acid. Capable of withstanding temperatures ranging from -18°C to +1,100°C, this grease is also enhanced with graphite for even better lubrication. Once applied, a protective coating is formed which will not wash off or burn, therefore reducing metal to metal friction. 3-IN-ONE professional anti-seize copper grease also assists with the assembly and future dismantling of all threaded metal parts.

Applications: Prevents seizure from high temperature and corrosion. Assists dismantling of threaded fastenings. Prevents disc brake squeal.

Size: 300ml Spray Can. The world's number one multi-purpose lubricant, with hundreds of uses around the home, garage or work place. 3-IN-ONE is a precise drip oil, and the new telescopic spout reaches even the most hard to get to places. With a radical new appearance reminiscent of a traditional old style oil can, the telespout incorporates a six-inch flexible extendable spout.

Order Code	Mod: 1032364	Price each exc. VAT 1+	inc. VAT each
A02RG	3-IN-ONE Cpr Grease	£5.82	£6.99

Plusgas 802-10 Plusgas Aerosol 400ml

- Lubricant to aid screw and bolt assembly
- Penetrating oil used by mechanics, engineers, builders, plumbers, locksmiths and handymen
- Tool cleaner, lawn mower cleaner
- Rust and corrosion prevention agent
- Cleans grease build-up and leaves protective film
- Displaces moisture



PlusGas Formula A is no ordinary penetrating oil. It is faster, safer and more powerful than any other dismantling lubricant. PlusGas is the penetrating oil used by mechanics, engineers, builders, plumbers, locksmiths and home handymen. Tool Cleaner/Maintainer. Lawn Mower Cleaner. Rust/Corrosion Prevention agent. Lubricant to aid screw and bolt assembly. Cleans grease build-up and leaves protective film. Temporary lubricant (oil rather than grease). Reduces squeaks and rattles on machinery.

Displaces Moisture. Helps prevent re-seizing of treated parts. Pre treatment of equipment to be stored [will need degreasing prior to use]. Size 400ml Aerosol. Plusgas lubricant is produced by Saint-Gobain Abrasives, a sector of Compagnie de Saint-Gobain which is a multinational corporation headquartered in Paris, France. Saint-Gobain is a leading producer of construction products, high-performance materials (abrasives, ceramics, high-performance plastics, and reinforcements), flat glass, and glass containers. The company is also a leading distributor of building products.

Their research and development teams are continually upgrading the product offering based on market needs and new technologies to solve cutting, grinding, and finishing problems, increase productivity, and provide the best option for the application in performance and/or total cost.

Order Code	Mod: 1032370	Price each exc. VAT 1+	inc. VAT each
A34RH	Plusgas Aero 400ml	£10.82	£12.99

Swarfega Jizer Degreaser 500ml

- Parts degreaser which quickly dissolves heavy deposits of mineral oil, grease, tar, bitumen and waxes
- Can be used for removing oil and grease marks from floor surfaces, tar spots and oil from body work
- Also suitable for cleaning paint brushes



Parts degreaser which quickly dissolves heavy deposits of mineral oil, grease, tar, bitumen and waxes. Can be used for removing oil and grease marks from many floor surfaces, tar spots and oil from body work and cleaning paint brushes.

Water rinsable. Size 500ml Aerosol. Not many people know that when the Swarfega product was first invented by AB Williamson, it actually started out as Deo Silkware Protector, a mild solution for hand-washing silk stockings, intended to prevent them from laddering. The war diverted silk to parachute production, and the Americans arrived in Britain with nylon, destroying the silk stocking market — and the need for Deo Silkware Protector.

In 1947, Swarfega was born; it was the first hand cleaner of its type in the world. The name derives from 'swarf', being the old Derbyshire engineering term for oil and grease and 'eager', as in 'eager to clean'. In its early days, Swarfega was available in places frequented by men such as motorbike shops, chemists and even barbers. Now, with a range of over 40 specialist cleaning products from hand cleansers to surface cleaners, Swarfega is as popular as ever.

Throughout industry, Swarfega has researched and developed the solution to your cleaning problem. They also have a service to match; if you're not sure which products meet your requirements, one of Deo's Technical Service team will analyse the problem and suggest the correct solution.

Order Code	Mod: 1032448	Price each exc. VAT 1+	inc. VAT each
A63RH	Jizer Degr 500ml	£5.82	£6.99

Swarfega Duck Oil 500ml

- Multi-purpose service spray
- Silicone-free and non-conductive
- Easily penetrates, lubricates and protects



Swarfega Duck Oil is a silicone-free, non-conductive, multi-purpose service spray which has an exceptionally low surface tension, meaning it can easily

penetrate, lubricate and protect. No need to dismantle machinery and parts. Size: 500ml

Not many people know that when the Swarfega product was first invented by AB Williamson, it actually started out as Deb Silkware Protector, a mild solution for hand-washing silk stockings, intended to prevent them from laddering. The war diverted silk to parachute production, and the Americans arrived in Britain with nylons destroying the silk stocking market — and the need for Deb Silkware Protector.

In 1947, Swarfega was born, it was the first hand cleaner of its type in the world. The name derives from ‘swarf’, being the old Derbyshire engineering term for oil and grease and ‘ega’, as in ‘eager to clean’. In its early days, Swarfega was available in places frequented by men such as motorbike shops, chemists and even barbers. Now, with a range of over 40 specialist cleaning products from hand cleansers to surface cleaners, Swarfega is as popular as ever.

Throughout industry, Swarfega has researched and developed the solution to your cleaning problem. They also have a service to match; if you’re not sure which products meet your requirements, one of Deb’s Technical Service team will analyse the problem and suggest the correct solution

Order Code	Mod:	Price each exc. VAT	inc. VAT each
A59RH	1032446	1+	£5.99
Duck Oil 500ml			

WD-40 Specialist Silicone Aerosol 400ml

- Withstands temperatures of -35 to +200 degrees
- Prevents parts from sticking
- Waterproof and protects against moisture
- For use on rubber, plastic, metal and wood

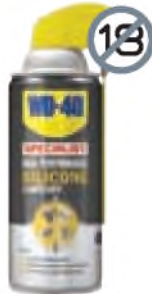

Order Code	Mod:	Price each exc. VAT	inc. VAT each
A81RH	1032458	1+	£7.77
WD-40 Aerosol 400ml			

Butane Gas

Butane Gas Refill 200ml

- CFC-free
- For use with butane powered soldering irons, lighters etc
- High-quality refined butane gas
- Contains no contaminants
- Supplied in a 200ml aerosol can

Ideal for refilling portable gas powered soldering irons, butane powered lighters, etc.

WARNING: Flammable contents, this product should be used in a well ventilated area
PLEASE NOTE: By law we are not allowed to sell butane or solvent based products to persons under the age of 18
N.B. A 200ml Servisol branded equivalent may be supplied as an alternative



Order Code	Mod:	Price each exc. VAT	inc. VAT each
N59AN	025349	1+	£4.99
Butane Refill 200ml			

Buying for business?
0333 400 9740



Freezer & Defrost Spray

Maplin Freezer Spray 400ml

- Reduces surface temperature of electrical components to aid detection of overheating and similar faults
- Quick and effective
- Easy to use
- Rapid evaporation
- Can be used to freeze water in small bore pipes to effect a repair avoiding the necessity of system drainage
- Supplied in 400ml cans

Please note: We are not allowed to sell butane or solvent based products to persons under the age of 18

Order Code	Mod:	Price each exc. VAT	inc. VAT each
N68AN	026296	1+	£9.99
Freezer Spray 400ml			



Servisol Freezer Spray 200ml

- Rapid cooling agent for locating faults in PCBs, electronic components and equipment
- Reduces component temperature to -50°C
- Non-flammable
- Safe on plastics including polystyrene
- Can be used to cool thermally sensitive parts during soldering or calibration, to shrink fit metal assemblies
- Great for the removal of chewing gum
- Supplied in a 200ml can

7% by mass is flammable - but product is totally non-flammable in use.

Order Code	Mod:	Price each exc. VAT	inc. VAT each
RE77J	029004	1+	£6.99
Freezer Spray 200ml			



Servisol Fridge and Freezer Defroster 200ml

- Removes the need to scrape or chip ice from your freezer therefore simplifies defrosting
- Saves time
- Also suitable for use on frozen car door locks
- Supplied in a 200ml aerosol can

Please note: We are not allowed to sell butane or solvent based products to persons under the age of 18

Order Code	Mod:	Price each exc. VAT	inc. VAT each
RE88V	029012	1+	£4.99
Easy Thaw/Defroster			



Tool Storage

Tools Storage

Raaco Small Toolbox

- Lightweight
- Removable tote tray
- Weatherproof
- Made from durable polypropylene
- Dimensions: 170 x 290 x 127mm



Order Code	Mod:	Price each exc. VAT	inc. VAT each
RE23A	032822	1+	£4.99
Small Toolbox			

Stanley Sortmaster Organiser

- Unique angled corners accommodate angled tools such as hammers
- Removable dividers allowing a combination of tools and small parts storage
- Special lid structure with upper ribs interlocking with inner dividers
- Top lid lock to keep contents secure
- Allows personal customisation
- Dimensions: 430 x 90 x 330mm



Order Code	Mod:	Price each exc. VAT	inc. VAT each
N05DW	1031182	1+	£13.99
Stanley Sortmaster			

Raaco Medium Sized Toolbox

- Practical and strong
- Removable tote tray
- Carrying handle and lock
- 2 storage sections in lid
- Dimensions: 217x400x166mm



Order Code	Mod:	Price each exc. VAT	inc. VAT each
N10AC	032830	1+	£8.99
Medium Toolbox			

Maplin 2-In-1 Plastic Tool Box

- Two plastic tool boxes in one
- Each box has an internal tray and two detachable organisers
- Ideal for tools, hobbies and general storage
- 18.5" Tool Box Dimensions: 473 x 250 x 223mm
- 11.8" Tool Box Dimensions: 300 x 154 x 124mm



Order Code	Mod:	Price each exc. VAT	inc. VAT each
N82DF	997986	1+	£19.99
2-in-1 Plus Tool Box			

Raaco Solid 1 Storage Box

- Small sized transport box
- Made of polypropylene (PP)
- Two click locks and integrated handle
- Can be secured with a padlock
- Dimensions: 275 x 175 x 125mm



Order Code	Mod:	Price each exc. VAT	inc. VAT each
N60DD	997994	1+	£9.99
Raaco Solid1 Toolbox			

Raaco Solid 2 Storage Box

- Medium sized transport box
- Made of polypropylene (PP)
- Two click locks and integrated handle
- Can be secured with a padlock
- Dimensions: 370 x 275 x 170mm



Order Code	Mod:	Price each exc. VAT	inc. VAT each
N61DH	997996	1+	£14.99
Raaco Solid2 Toolbox			

Raaco T31 Toolbox With Removable Tray and Assorter Box

ORDER IN STORE OR ONLINE

- Practical and robust 18" Toolbox
- With removable tote tray and assorter box for smaller items
- Full length carrying handle
- Two secure 'click' locks
- Dimensions: 235 x 445 x 230mm



Order Code	Mod.	Price each exc. VAT 1+	inc. VAT each
N96NX	T31 Toolbox	£13.32	£15.99

Raaco T33 Toolbox With Removable Tray

ORDER IN STORE OR ONLINE

- Toolbox with removable tote tray and assorter box
- Full length handle for easy carrying
- Has safety locking mechanism
- Robust polypropylene construction
- Multi purpose tray stored within lid, helps selection of tools and other items
- Dimensions: 258 x 480 x 255mm



Order Code	Mod.	Price each exc. VAT 1+	inc. VAT each
N97NX	T33 Toolbox	£16.65	£19.99

Raaco T35 Toolbox With Two Removable Trays and Assorter Box

ORDER IN STORE OR ONLINE

- Toolbox with two removable trays and an assorter box
- Full length handle for easy carrying
- Robust polypropylene construction
- Locking handle mechanism ensures lid remains closed
- Multi purpose tote trays stored within lid helps to section tools and other items
- Dimensions: 285 x 580 x 290mm



Order Code	Mod.	Price each exc. VAT 1+	inc. VAT each
N98NX	T35 Toolbox	£24.99	£29.99

Maplin Aluminium Tool Box with 2 Sliding Drawers

- Large tool box with sturdy aluminium clad finish
- Lockable main compartment with hinged lid and two sliding drawers both with soft felt interior
- Great addition to any garage or shed for keeping your tools organised and tidy



- Each case supplied with lockable latches and two keys
- Base of the tool box has four feet fitted to prevent surface damage and the underside getting scratched
- Tough handle with chrome finish
- Dimensions: 544 x 238 x 267mm

Order Code	Mod.	Price each exc. VAT 1+	inc. VAT each
N80DF	Alu Tool Case with 2	£41.65	£49.99

Maplin Premium Trolley Tool Case with Compartments

- Rugged corrugated exterior with aluminium cornering and lockable latches
- Compete with extendable carry handle and two trolley style wheels for easy transport
- Includes two tool panels with elastic straps for up to 30 tools
- Base is split into three vertical sections with dividers for loose storage
- Interior is has a soft felt finish for less scratching and movement in transit
- Comes with six rubber feet for mounting horizontally or vertically
- Latched hinged lid for easy open or close
- Dimensions: 465 x 345 x 142mm



This trolley style tool case is perfect for service engineers, general DIY and hobbyists alike. Keep all your valuable tools organised and tidy inside this clever tool case. It comes complete with two internal tool panels and elastic straps for holding up to 30 individual tools and measuring devices. Completely secure with its two lockable latches, and very easy to transport using the trolley wheels and extendable handle. Base is split into three vertical sections with dividers and a soft felt finish for less scratching and movement whilst in transit.

Order Code	Mod.	Price each exc. VAT 1+	inc. VAT each
N81DF	Alu Tool Case with T	£41.65	£37.49

Stanley Jumbo Tool Box 22in with Tray

ORDER IN STORE OR ONLINE

- Ideal for transporting and storing multiple tools
- 2 removable organisers for storing small parts
- Metal latches ensure secure locking
- Fixed organiser ideal for screwdriver bits
- Complete with removable tote tray
- Easy grip handle folds flat when not in use
- Dimensions: 562 x 314 x 300mm



The Jumbo organiser tool box is ideal for transporting and storing multiple tools and has 2 removable organisers for storing small parts. Metal latches provide secure locking of the tool box. There is a fixed organiser for screwdriver bits in the lid along with a removable tote tray. The easy grip handle folds flat when not in use. Dimensions: 562 x 314 x 300mm.

Order Code	Mod.	Price each exc. VAT 1+	inc. VAT each
N50DW	StanJ ToolBox22In	£24.99	£29.99

Heavy Duty Multi Purpose Tool Bag

- Heavy duty tool bag with hard-wearing plastic feet
- The perfect organizer for the contractor



- and DIYer
- Complete with strong aluminium handle with foam grip
- Includes 10 internal and 13 external pockets
- Dimensions: 420mm (w) x 210mm (d) x 250mm (h)
- Complete with shoulder strap

Order Code	Mod.	Price each exc. VAT 1+	inc. VAT each
N08JF	Professional ToolBag	£12.49	£14.99

Maplin Heavy Duty Multi Purpose Tool Holdall

- Heavy duty tool holdall with hard-wearing plastic feet
- The perfect organiser for the contractor and DIYer
- Complete with strong aluminium handle with foam grip
- Handle can be folded down to give better access
- Includes a multitude of pockets
- Dimensions: 390mm (w) x 230mm (d) x 265mm (h)
- Complete with shoulder strap



Order Code	Mod.	Price each exc. VAT 1+	inc. VAT each
N69HL	Heavy Duty Tool Bag	£19.15	£22.99

Stanley Multi Pocket Tool Apron

ORDER IN STORE OR ONLINE



- Multiple pockets for maximum organisation
- Complete with tape pocket and hammer loop for convenient reach
- Ergonomic back padding for safety and comfort
- Hard wearing durable fabric

Order Code	Mod.	Price each exc. VAT 1+	inc. VAT each
N40DW	Stan Tool Apron	£16.65	£19.99

Raaco Tool Belt 80-130cm Black / Silver

ORDER IN STORE OR ONLINE



- 14 pocket tool belt with quick release buckle
- Adjustable waist size 31-51inch (80-130cm)
- Keep your tools and favourite accessories around your waist
- Padded for extra comfort
- Made from tear-resistant polyester

Order Code	Mod.	Price each exc. VAT 1+	inc. VAT each
N92DF	RaacoToolBelt	£17.49	£15.74

Stanley FatMax Tool Backpack

ORDER IN STORE OR ONLINE

- Padded with zip fastening design
- Backpack can open in two halves
- Back support system with air mesh shoulder straps for ergonomic, convenient carriage
- Large storage area with compartmented pockets to secure tools
- Waterproof plastic bottom protects against moisture and dirt
- Reinforced canvas
- Two side pockets
- Dimensions: 360 x 460 x 270mm



Order Code	Mod: 1032433	Price each exc. VAT 1+	inc. VAT each
N46DW	Stan Fat Backpack	£41.65	£49.99

Stanley FatMax Backpack on Wheels

ORDER IN STORE OR ONLINE

- Made from heavy-duty 600 denier fabric
- Features extendable metal handle for easy transportation
- Removable internal divider with multiple pockets for a variety of tools
- Contains a laptop compartment and multiple loop and external pockets for additional storage
- Dimensions: 360 x 230 x 540mm



Order Code	Mod: 1032435	Price each exc. VAT 1+	inc. VAT each
N47DW	Stan Fat Bag w/Wheel	£49.99	£59.99

Raaco Toolbag Trolley

ORDER IN STORE OR ONLINE

- Toolbag mounted on a trolley
- Retractable telescopic handle
- Pockets in different sizes for storing tools, parts and accessories
- Two carry straps
- Made from tear-resistant polyester
- Dimensions: 520 x 310 x 445mm



Order Code	Mod: 999776	Price each exc. VAT 1+	inc. VAT each
N91DF	RaacoToolTrolley	£70.82	£84.99

Raaco BinKit12 1 Wall Panel

ORDER IN STORE OR ONLINE

- 1 perforated steel wall panel
- Includes 12 bins made from polypropylene
- Mount on the wall and store your nuts, bolts screw, nails or other small parts
- Space saving solution
- Ideal for a garage or warehouse
- Dimensions: 520 x 11 x 440mm



Order Code	Mod: 999782	Price each exc. VAT 1+	inc. VAT each
N89DF	BinKit12 1WallPanel	£16.65	£19.99

Raaco Clipkit22 2 Wall Panels

ORDER IN STORE OR ONLINE

- 2 perforated steel wall panels
- Peg and clip hand and power tools to these wall mountable panels
- Ideal storage solution to mount on your garage, shed or warehouse wall
- Includes 22 clips and hooks
- Space saving solution with customisable configuration



Order Code	Mod: 999784	Price each exc. VAT 1+	inc. VAT each
N88DF	Clipkit22 2WallPanel	£26.99	£29.99

Raaco StartSet6 3 Wall Panels

ORDER IN STORE OR ONLINE

- 3 perforated steel wall panels
- Peg and clip hand tools, power tools and small parts to these wall mountable panels
- Space saving solution
- Includes 33 clips and 12 bins made from polypropylene
- Customisable configuration
- Easy to mount
- Dimensions: 1560 x 11 x 440mm



3 perforated steel wall panels with an assortment of 33 clips and hooks on which to store all types of tools and 12 storage bins. Ideal for mounting on your garage or warehouse wall.

Order Code	Mod: 999778	Price each exc. VAT 1+	inc. VAT each
N90DF	StartSet6 3WallPanel	£41.65	£49.99

Send direct

If any product is not in stock, we will order it for you and send it with free delivery

Terms and conditions apply.



Raaco Shelving System S450-31 4 shelves

ORDER IN STORE OR ONLINE



- Shelving system with 4 shelves
- Each shelf with a 31cm depth
- Made from galvanized steel
- Carrying capacity 100kg per shelf
- Ideal addition to a garage, utility room or warehouse
- Easy to assemble

Please note tools, boxes and equipment not included

Material Type	Steel
Number of Shelves	4
Shelf Depth	310mm
Colour	Silver
Product Width	920mm
Product Depth	340mm
Product Height	2000mm
Product Weight	15000g

Order Code	Mod: 999804	Price each exc. VAT 1+	inc. VAT each
N84DF	S450-31(4+8)Shelving	£49.99	£59.99

Raaco Shelving System S450-31 6 shelves

ORDER IN STORE OR ONLINE



- Shelving system with 6 shelves
- Each shelf with a 31cm depth
- Made from galvanized steel
- Carrying capacity 100kg per shelf
- Ideal addition to a garage, utility room or warehouse
- Easy to assemble

Please note that tools, boxes and equipment are not included

Material Type	Steel
Number of Shelves	6
Shelf Depth	310mm
Colour	Silver
Product Width	920mm
Product Depth	340mm
Product Height	2000mm
Product Weight	18400g

Order Code	Mod: 999798	Price each exc. VAT 1+	inc. VAT each
N85DF	S450-31(6+8)Shelving	£56.65	£67.99

Buy it on the web at maplin.co.uk

Shop for all Maplin products online at our website and check out our latest products and special offers!



CLICK + COLLECT - Reserve your items online and pick up at your local store

Raaco Shelving System S450-40 4 shelves

ORDER IN STORE OR ONLINE

- Shelving system with 4 shelves
- Each shelf with a 40cm depth
- Made from galvanized steel
- Carrying capacity 100kg per shelf
- Ideal addition to a garage, utility room or warehouse
- Easy to assemble



Please note that tools, boxes and equipment are not included

Material Type	Steel
Number of Shelves	4
Shelf Depth	400mm
Colour	Silver
Product Width	920mm
Product Depth	430mm
Product Height	2000mm
Product Weight	17000g

Order Code	Mod.	Price each exc. VAT 1+	inc. VAT each 10+	inc. VAT each
N86DF	S450-40(4-8)Shelving	£54.15	£48.74	£64.99

Raaco Shelving System S450-40 6 shelves

ORDER IN STORE OR ONLINE

- Shelving system with 6 shelves
- Each shelf with a 40cm depth
- Made from galvanized steel
- Carrying capacity 100kg per shelf
- Ideal addition to a garage, utility room or warehouse
- Easy to assemble



Please note that tools, boxes and equipment are not included.

Material Type	Steel
Number of Shelves	6
Shelf Depth	400mm
Colour	Silver
Product Width	920mm
Product Depth	430mm
Product Height	2000mm
Product Weight	21000g

Order Code	Mod.	Price each exc. VAT 1+	inc. VAT each 10+	inc. VAT each
N87DF	S450-40(6-8)Shelving	£66.65	£59.99	£79.99

Flight Cases

Small Flight Case with Foam Interior

- Compressible foam interior can be cut out to fit equipment for protection
- Secured with two lockable clasp-action catches
- Tough black plastic handle with attractive chrome trimmings
- Bottom and the back of the case have 4 feet fitted to help prevent scratches



Great for securing those small valuable items such as cameras, sat navs, PDAs and much more. Keeps them under lock and key and protected from damage.

Specifications

External dimensions	(inc. feet and handle): 330(w) x 290(d) x 140(h)mm
Internal dimensions:	315(w) x 250(d) x 110(h)mm
Weight:	1.6kg

Order Code	Mod.	Price each exc. VAT 1+	inc. VAT each
N50FU	Small Flight Case	£20.82	£24.99

Aluminium Flight Case With Tool Compartments and Dividers

- Perfect for transporting your tools in a stylish way
- Dividers in the bottom and pockets in the lid ensure you'll never lose your tools
- Tough black plastic handle with attractive chrome trimmings
- Two lockable catches ensure concealed valuables don't go missing
- Includes a shoulder carrying strap which hooks on to buckles mounted on either side of the case
- The bottom and the back of the case have four feet fitted to prevent the underside getting scratched.



Specifications:

External dimensions	(inc. feet & handle): 460 x 350 x 160 mm
Internal dimensions:	440 x 315 x 120 mm
Weight:	2.6 kg

Order Code	Mod.	Price each exc. VAT 1+	inc. VAT each
GL34M	Metal Flight Case	£20.82	£24.99

Rugged Case with Foam Interior

- Rugged grey exterior with a corrugated finish
- Ideal for transporting your optics and various equipment safely
- Compressible foam interior can be cut out to fit equipment for protection
- Secured with two lockable clasp-action catches
- Tough grey plastic handle with rugged extrusions
- Bottom and the back of the case have 4 feet fitted to help prevent scratches



Technical Specification

External dimensions:	(inc. feet & handle): 336(w) x 260(d) x 133(h) mm
Internal dimensions	314(w) x 214(d) x 110(h) mm

Order Code	Mod.	Price each exc. VAT 1+	inc. VAT each
N78GG	Rugged Case (med)	£23.32	£27.99

Rugged Tackle Box with Cantilever Tray

- A rugged corrugated case with cantilever trays
- The handle is made from tough grey plastic with rugged extrusions
- Secured with two lockable clasp-action catches
- The bottom of the case have four feet fitted which help to prevent the underside of the case from getting scratched
- Cantilever trays are separated by dividers which can be positioned as desired
- The base of the case is split up by padded dividers
- External dimensions: (inc. feet & handle) 306(w) x 230(d) x 250(h)mm



This secure rugged box can be used to store your tools, components, cables or beauty products. Its cantilever trays open up and make it easy to organise and select your stuff

Order Code	Mod.	Price each exc. VAT 1+	inc. VAT each
N81GG	Rugged Tackle Box	£24.99	£29.99

Aluminium Case with Cantilever Trays



- A quality aluminium type case with four cantilever trays
- The cantilever trays are separated by dividers which can be positioned as desired
- Secured with two lockable clasp-action catches
- The base of the case is split up by padded dividers
- The handle is made from tough black plastic with attractive chrome trimmings
- The bottom and the back of the case have four feet to prevent scratches

Specifications:

Dimensions	360 x 230 x 250mm
------------	-------------------

Order Code	Mod.	Price each exc. VAT 1+	inc. VAT each
N42BJ	Alu Case with Trays	£27.49	£32.99

Flight Case with Foam

- Foam interior can be cut out to fit equipment for protection
- Secured with two lockable clasp-action catches
- Tough black plastic handle with attractive chrome trimmings
- Shoulder carrying strap hooks on to buckles mounted on either side of the case
- Bottom and the back of the case has four feet fitted to help to prevent scratches
- Dimensions including feet and handle - 460 mm width x 350 mm height x 160 mm depth
- Internal dimensions - 440 mm width x 315 mm height x 120 mm depth
- Weight - 2.6 kg



You wouldn't want your valuable tools and equipment to bear the brunt of damage during transit, would you? Then you need to invest in Maplin's tough and rugged flight case equipped with foam. Manufactured using hi-quality materials, Maplin's portable flight cases are tough and rugged, guaranteeing safe transportation and storage of your valuable and fragile equipment.

Maplin's flight case is ideal for tools, cameras, laptops, sat navs, as well for fragile personal accessories like hair dryers and such like.

External dimensions	460 (l) x 350 (w) x 160 (d) mm
Internal dimensions:	440 (l) x 315 (w) x 120 (d) mm
Weight:	2.6 kg

Order Code	Mod.	Price each exc. VAT 1+	inc. VAT each
N70AP	Metal Case with Foam	£29.15	£34.99

Large Rugged Case

- A grey rugged corrugated case
- Foam interior can be cut out to fit equipment for protection



- Suitable for keeping optics and various equipment safe

- Secured with two lockable clasp-action catches
- Tough grey plastic handle with rugged extrusions

External dimensions:

[inc. feet & handle]: 450(w) x 330(d) x 145(h)mm

Internal dimensions: 434(w) x 314(d) x 133(h)mm

Order Code	Mod:	Price each exc. VAT	inc. VAT each
N79GG	225744 Rugged Case (lrg)	£31.65	£37.99

Flight Case Triple Pack with Dividers



- Three metal flight cases in one convenient pack - ideal for service engineers, tool storage or general use
- Small and medium cases can be split in to three vertical sections, large case can be split in to four sections using supplied dividers
- Internal pocket in lid of each case, ideal for storing paperwork or manuals
- Each case supplied with locking latches and two keys for each case

Dimensions (W x H x D in mm)	External	Internal
Small case:	325 x 205 x 85	311 x 191 x 74
Medium case:	375 x 255 x 115	360 x 240 x 100
Large case:	460 x 330 x 160	440 x 310 x 144

Order Code	Mod:	Price each exc. VAT	inc. VAT each
N50JU	513879 Flight Case 3-Pack	£33.32	£39.99

Maplin Flight Case Coloured Triple Pack

- Three coloured flight cases in one pack
- Silver aluminium frame with a red, blue or black diamond PVC surface
- Ideal for service engineers, tools or general storage
- Case interior lined with grey foam padding
- Each case is fitted with rubber feet, plastic handle and lockable latches



Large Case	460 x 335 x 150mm [w x h x d]
Medium Case	430 x 290 x 120 [w x h x d]
Small Case:	400 x 250 x 92 [w x h x d]

Order Code	Mod:	Price each exc. VAT	inc. VAT each
N31DE	999982 Alu 3 in 1 Case	£33.32	£39.99

Large High Impact Case With Pre Cut Foam Interior

- Keep your valuables safe in this robust, water resistant case
- Two pieces of pre-cut foam enable you to customise the interior to suit your specific needs
- Tough exterior that ensures contents are protected



With our Large High Impact Case you can safely store and transport your valuable equipment or parts. Its tough exterior and airtight valve keep the case completely water resistant, meaning you'll never worry about them getting damaged or wet. Its inside contains two pieces of foam which you can easily mould around the shape of your valuables, so you can completely customise the inside to suit your needs!

Top lid: 1 piece of wave foam
 Bottom lid: 2 pieces of pre-cut foam and 1 piece of wave foam
 External - 515 x 415 x 200
 Internal - 485 x 355 x 186

Order Code	Mod:	Price each exc. VAT	inc. VAT each
N14GR	228650 High Impact Lrg Case	£41.65	£49.99

Household Storage

Really Useful 0.2L Box 5 Pack

ORDER IN STORE OR ONLINE

- A multi-purpose, strong and durable stacking box
- Designed to meet many storage needs



Dimensions:	External	Internal
	120 x 85 x 45	90 x 65 x 32

Order Code	Mod:	Price each exc. VAT	inc. VAT each
N65FL	810317 0.2 litre pack of 5	£4.99	£5.99

Really Useful 0.3L Box 6 Pack

ORDER IN STORE OR ONLINE

- A multi-purpose, strong and durable stacking box
- Designed to meet many storage needs



Dimensions	External	Internal
	120 x 85 x 65	90 x 65 x 55

Order Code	Mod:	Price each exc. VAT	inc. VAT each
N66FL	810319 0.3 litre pack of 6	£6.65	£7.99

Really Useful Organiser Set 0.14L 16 Pack

- 16 x 0.14 litre boxes ideal for storing small items
 - Wall mountable for ease of location
 - Lids push-lock down for secure storage avoiding spillages
 - Transparent boxes so that contents can be viewed
- Ideal for batteries, nuts and bolts, washers, pins, small items of stationery or craft hobbyist bits and bobs. Get your workshop or garage organised using this wall-mountable storage system. Each box measures 64mm (L) x 50mm (W) x 43mm (H) and has flip up side handles that secure the lid and the contents to avoid frustrating spillages. Overall dimensions: 280mm (W) x 202mm (H) x 90mm (D - including box extrusions).
- NB: Contents not included.



Order Code	Mod:	Price each exc. VAT	inc. VAT each
N60JW	513733 16 Box Organiser Set	£13.32	£15.99

Really Useful 3L Box

- A multi-purpose, strong and durable stacking box
- Designed to meet many storage needs



	External	Internal
Dimensions:	245 x 180 x 160	190 x 143 x 120

Order Code	Mod:	Price each exc. VAT	inc. VAT each
N35BG	810320 3L Mini Box	£3.32	£3.99

Really Useful 4L Box with Divider Trays

ORDER IN STORE OR ONLINE



- Handy storage box with lockable lid
 - Stacks with or without lid
 - Extremely tough
 - 2 removable divider trays to organise items
 - Dimensions: 395 x 255 x 85mm
 - Made from food grade polypropylene -15°C to 80°C
- NB: Contents not included

Order Code	Mod:	Price each exc. VAT	inc. VAT each
N52CX	115321 4L Hobby Box	£9.15	£10.99

Really Useful 9L A4 Box



- A multi-purpose, strong and durable stacking box
- Designed to meet many storage needs

Dimensions:	External	Internal
	395 x 255 x 155	335 x 210 x 140

Order Code	Mod:	Price each exc. VAT	inc. VAT each
L40BL	810322 9L A4 Storage Box	£5.82	£6.99

Really Useful Box 9L 5 pack

- 5 storage boxes from the Really Useful Box Company:
 - 9 litre (holds 24 DVDs), 3 litre (holds 18 CDs or 10 DVDs), 2 litre (holds 50 floppy disks), 1 litre and 0.3 litre
 - Food grade polypropylene -15°C to 80°C
- NB: Contents not included



Dimensions and Weight	
9 Litre:	External: 395 x 255 x 155mm Internal: 335 x 210 x 140mm
3 Litre:	External: 245 x 180 x 160mm Internal: 190 x 143 x 120mm
2 Litre:	External: 240 x 130 x 125mm Internal: 190 x 100 x 104mm
1 Litre:	External: 195 x 100 x 70mm Internal: 185 x 80 x 60mm
0.3 Litre	External: 120 x 85 x 65mm Internal: 90 x 65 x 55mm

Order Code	Mod:	Price each exc. VAT	inc. VAT each
L39BL	048173 5 in 1 Storage Box	£12.49	£14.99

Really Useful 9L XL Box

ORDER IN STORE OR ONLINE

- A multi-purpose, strong and durable stacking box
- Designed to meet many storage needs



External Dimensions	Internal Dimensions	Order Code	Mod.	Price each exc. VAT 1+	inc. VAT each
395 x 255 x 205	335 x 210 x 180	N67FL	810323	£6.65	£7.99

Really Useful 18L Box

ORDER IN STORE OR ONLINE

- A multi-purpose, strong and durable stacking box
- Designed to meet many storage needs



External Dimensions	Internal Dimensions	Order Code	Mod.	Price each exc. VAT 1+	inc. VAT each
480 x 390 x 200	380 x 310 x 170	N37BG	810324	£9.15	£10.99

Really Useful 19L XL Box

ORDER IN STORE OR ONLINE

- A multi-purpose, strong and durable stacking box
- Designed to meet many storage needs



External Dimensions	Internal Dimensions	Order Code	Mod.	Price each exc. VAT 1+	inc. VAT each
395 x 255 x 330	315 x 205 x 310	N68FL	810325	£9.15	£10.99

Really Useful 35L Box

ORDER IN STORE OR ONLINE

- A multi-purpose, strong and durable stacking box
- Designed to meet many storage needs



External Dimensions	Internal Dimensions	Order Code	Mod.	Price each exc. VAT 1+	inc. VAT each
430 x 490 x 310	370 x 310 x 280	N39BG	810326	£14.15	£16.99

Small Items Storage

Self-Seal Bags 57mm x 76mm 100 Pack

- Polythene bags with grip tops
- Ideal for storing small components
- The bags have a white panel on one side which can be written on
- Bags are supplied in packs



of 100
• Dimensions: 57 (w) x 76 (h)

Order Code	Mod.	Price each exc. VAT 1+	inc. VAT each
JK77J	003980	£2.49	£2.99

Self-Seal Bags 89mm x 114mm 100 Pack

- Polythene bags with grip tops
- Ideal for storing small components
- The bags have a white panel on one side which can be written on
- Supplied in packs of 100
- Dimensions: 89 (w) x 114 (h) mm



Order Code	Mod.	Price each exc. VAT 1+	inc. VAT each
JK78K	857234	£3.32	£3.99

8 Compartment Component Storage Box

- Ideal for storage of small items like screws, washers and electrical components
- 8 separate compartments
- Individual snap shut lids
- Made from transparent plastic to easily identify what is in each compartment
- Dimensions: 87 x 21 x 61mm



A clear plastic box with 8 separate compartments, each with a snap shut lid. Ideal for storage of small screws, washers and any small item that can be easily lost.

Order Code	Mod.	Price each exc. VAT 1+	inc. VAT each
SF04E	026133	£1.90	£2.29

Raaco 21 Compartment A45 Assorter Box

- Assorter box with 21 fixed compartments
- Ideal for keeping your components and spare parts organised
- Transparent plastic lid, for easy viewing
- Multiple boxes are stackable
- Made of robust polypropylene plastic
- Fitted with a sliding latch



Order Code	Mod.	Price each exc. VAT 1+	inc. VAT each
N59DD	999768	£7.49	£8.99

Maplin 18 Compartment Component Storage Box

- 18 compartments each with a snap-shut lid
- Ideal for small electronics components, screws, washers
- Transparent plastic for easy viewing
- Dimensions: 215 x 37 x 125mm



A clear, plastic storage box for electronic/electrical components and similar small items. It has 18 compartments and the snap-shut lid allows safe transport of contents.

Order Code	Mod.	Price each exc. VAT 1+	inc. VAT each
AN83E	012842	£2.49	£2.99

Raaco 5 Compartment Pocketbox

- Pocketbox with 5 fixed compartments
- Includes removable insert tray
- Ideal for keeping your components and spare parts organised
- Transparent plastic lid, for easy viewing
- Small handy size
- Made of robust polypropylene plastic
- Dimensions: 119 x 95 x 27mm



This Pocketbox has 5 compartments built into a removable tray and is fitted with a latch that keeps the lid securely closed. The base is made of robust polypropylene plastic, while the lid is of transparent plastic, allowing the contents to be easily identified.

Order Code	Mod.	Price each exc. VAT 1+	inc. VAT each
N04AC	032807	£2.90	£3.49

Raaco 7 Compartment A6 Assorter Box

- A6 Assorter box with 7 fixed compartments
- Ideal for keeping your components and spare parts organised
- Transparent plastic lid, for easy viewing
- Multiple boxes are stackable
- Made of robust polypropylene plastic
- Fitted with a sliding latch
- Dimensions: 175 x 143 x 32mm



The Raaco Assorter series are a range of handy component storage boxes that are easy to take with you anywhere.

This A6 sized box has 7 fixed compartments and is fitted with sliding latch that keep the lid securely closed. The base is made of robust polypropylene plastic, while the lid is of transparent plastic, allowing the contents to be easily identified.

Product Width	175mm
Product Depth	143mm
Product Height	32mm
Product Weight	9g

Order Code	Mod.	Price each exc. VAT 1+	inc. VAT each
N14AC	810331	£3.32	£3.99

Raaco 12 Compartment A6 Assorter Box

ORDER IN STORE OR ONLINE

- A6 Assorter box with 12 fixed compartments
- Ideal for keeping your components and spare parts organised
- Transparent plastic lid, for easy viewing
- Made of robust polypropylene plastic
- Multiple boxes are stackable
- Fitted with a sliding latch
- Dimensions: 175 x 143 x 32mm



This A6 sized box has 12 fixed compartments and is fitted with sliding latch that keeps the lid securely closed. The base is made of robust polypropylene plastic, while the lid is of transparent plastic, allowing the contents to be easily identified.

Order Code	Mod.	Price each exc. VAT 1+	inc. VAT each
N15AC	784852	£3.32	£3.99

Maplin 20 Compartment Component Storage Box with Removable Inserts

- Made from clear plastic to easily identify the contents
- Use for storing small components, screws, nails, washers, nuts or buttons!
- Customisable layout using the supplied 15 removable inserts
- Snap-shut lid to secure the contents
- Dimensions: 275 x 180 x 45mm



A clear, plastic box with 15 removable dividers for storage of components, hardware and other similar small items. The supplied dividers allow various size compartments to be configured. Resize to suit your component size. The easy snap-shut lid allows safe transport of contents ensuring they do not spill out.

Need spare dividers for this box? See Maplin Order Code: N776Q

Order Code	Mod:	Price each exc. VAT	inc. VAT each
SF05F	026150 Large Storage Box	1+ £5.24	£6.29

Raaco 32 Compartment A4 Assorter Box

ORDER IN STORE OR ONLINE

- A4 Assorter box with 32 fixed compartments
- Ideal for keeping your components and spare parts organised
- Transparent plastic lid, for easy viewing
- Multiple boxes are stackable
- Made of robust polypropylene plastic
- Fitted with sliding latches
- Dimensions: 338 x 260 x 57mm



This A4 sized box has 32 fixed compartments and is fitted with sliding latches that keep the lid securely closed. The base is made of robust polypropylene plastic, while the lid is of transparent plastic, allowing the contents to be easily identified.

Order Code	Mod:	Price each exc. VAT	inc. VAT each
N18AC	810332 A4 Assorter Box 32	1+ £7.49	£8.99

Raaco 13 Compartment Assorter Box with Removable Inserts

- Assorter box with up to 13 compartments
- Removable inserts provide great flexibility for different box layouts
- Supplied with two sliding latches and an ergonomic handle
- Made of robust polypropylene plastic
- Transparent plastic lid, for easy viewing
- Multiple boxes are stackable
- Dimensions: 338 x 261 x 57mm



This 13 compartment box has removable inserts for creating different box layouts, giving great flexibility. This box comes with a handle and is fitted with two sliding latches that keeps the lid securely closed. The base is made of a robust polypropylene plastic, while the lid is of transparent plastic, allowing the contents to be easily

identified.

Order Code	Mod:	Price each exc. VAT	inc. VAT each
QP43W	029166 Service Case 13	1+ £8.32	£9.99

Stanley FatMax Professional Organiser

ORDER IN STORE OR ONLINE



- Ideal for storing and organising small parts and accessories
- Supplied with 10 removable storage cups for easy access
- Transparent polycarbonate lid allows easy location of contents
- Side latches allow multiple organisers to be clipped together for easy transportation
- Dimensions: 360 x 440 x 60mm

This Stanley FatMax Professional Organiser is ideal for storing and organising small parts and accessories, such as fixings, nuts, bolts etc. It is supplied with 10 removable storage cups for easy access, allowing individual cups to be conveniently moved to where needed, without having to have the whole organiser near by - ideal for situations where space is limited.

The transparent polycarbonate lid allows easy location of contents and locks components in position, to stop the cups sliding around. Side latches allow multiple organisers to be clipped together for easy transportation.

Order Code	Mod:	Price each exc. VAT	inc. VAT each
N51DW	1032439 Stan Fat Pro Organ	1+ £20.82	£24.99

Raaco Portable Storage Unit including Four 13 Compartment Assorter Boxes



- The HandyBox is a lightweight, robust, portable storage unit
- Contains four assorter boxes with 13 removable inserts
- Can be stacked, stand alone, hung or grouped together
- Smart lock retains the boxes in place while in transit
- Made of robust polypropylene plastic
- Dimension: 375 x 265 x 310mm

The HandyBox portable storage unit comes complete with four Assorter boxes with 13 compartments. It is an easy matter to transport all four Assorters at once, they can be carried in one hand. Multiple HandyBox's can be stacked, hung, grouped together or used as stand alone storage. The smart lock feature ensures the Assorter boxes remain in place whilst in transit.

Each 13 compartment box has removable inserts for creating different box layouts, giving great flexibility. The boxes come with a handle and are fitted with two sliding latches that keeps the lid securely closed. The base is made of a robust polypropylene plastic, while the lid is of transparent plastic, allowing the contents to be easily identified.

Order Code	Mod:	Price each exc. VAT	inc. VAT each
RF35Q	029041 Assorter13 Handy Box	1+ £37.49	£44.99

Raaco 18 Drawer Cabinet Dimensions Height 417mm Width 306mm Depth 150mm



- Robust Steel Cabinet
- With 18 drawers made from impact proof plastic
- Can stand alone or be hung on a wall
- Height 417mm Width 306mm Depth 150mm

Order Code	Mod:	Price each exc. VAT	inc. VAT each
N94NX	784855 18 Drawer Cabinet	1+ £14.99	£17.99

44 Drawer Organiser Storage Cabinet Dimensions 510 x 307 x 147mm



- Stand alone or wall mount
- 40 small drawers, 3 medium drawers and 1 large drawer
- Impact resistant drawers
- Multiple drawers can be stacked together
- Ideal for storing nuts, bolts, odds and ends and even sewing accessories
- Pack of 15 dividers to split the smaller drawers in half for additional storage available separately, Order Code: N09AX

Order Code	Mod:	Price each exc. VAT	inc. VAT each
ND82D	810333 44 Drawer Cabinet	1+ £20.82	£24.99

Spare Drawer Dividers for 44 Drawer Cabinet



- 15 assorted draw dividers for use with the 44 Drawer Cabinet (Order Code: ND82D)
- Contains two dividers for the large drawer at the base, three dividers for the medium drawers above and ten dividers for the small drawers

Order Code	Mod:	Price each exc. VAT	inc. VAT each
N09AX	78538 ND82 Dividers 15pk	1+ £3.32	£3.99

Reserve online, collect in-store in 30 minutes





Buying for business?

Here at Maplin we have a dedicated Business to Business team who are passionate about helping your business grow.

Enjoy the following benefits as a Maplin business to business customer:

ONE-TO-ONE ACCOUNT MANAGEMENT

You have a dedicated account manager so that we really know you and your business, ensuring the best levels of service every time you call.

CREDIT ACCOUNT

Order your products and pay on invoice, with 30 day terms helping your cash flow.

VOLUME PRICING

Need an item in bulk? No problem, we can satisfy the most demanding orders and also provide you with special prices on volume purchases.

SCHEDULED ORDERS

Save time, for the consumables and equipment that you need on a regular basis, with scheduled orders despatched to you automatically.

BESPOKE PRODUCT SOURCING

Our close contacts in manufacturers around the world mean we can source many hundreds of items that we don't regularly sell.

CUSTOM BRANDING

We understand your brand is one of the most important aspects of your business and can supply most of our range custom branded with your logo, slogan or sales message.

The B2B team are committed to providing a first class business partnership with unrivalled customer service and free technical support.

Our Account Managers work closely with businesses throughout the UK and work hard to ensure that each client receives the products and services best suited to their needs.

Contact our B2B Team to discuss your own business requirements. You can then explore the possibilities of how Maplin can use its wealth of experience and expertise to help grow your business.

Call us now on **0333 400 9740**
or email business@maplin.co.uk

Volume Discounts

Easy ways to pay

Free Delivery on orders over £10

Choose your delivery slot

Buying for education?

Here at Maplin, we're always looking for innovative technology that can make learning more inspiring.

We work closely with schools, colleges and universities to help with their technology requirements and support their curricular objectives.

As a part of our strong commitment to education, we offer a discount across our entire product range to both students and educational establishments.

Our dedicated business team and special services available only to business customers are all easily accessible. You can find our electronics and technology solutions through our wide network of over 200 stores, our website with more than 20,000 products or through your personal account manager over the phone.

YOUR BENEFITS

- Education discount
- 30 day end-of-month Credit Accounts*
- Volume quotes available upon request
- Online and in-store use of account
- One-to-one account management
- Bespoke product sourcing and branding
- Free delivery on orders over £10
- Scheduled and forward ordering service

Call our Business Team to apply for an account and discuss your business needs on 0333 400 9740

*Subject to credit approval



Proud to sponsor and support

TEENTECH
awards/2015

UK Inland Orders

CONTACT US

Should you wish to contact our fully trained and friendly staff, whatever your enquiry, please use the options below.

SALES AND CUSTOMER CARE ENQUIRIES:

0333 400 9500

[Calls are recorded and monitored for security and training purposes]

Opening Hours:

Monday to Friday: 8:30am to 8:00pm

Saturday: 9:00am to 5:00pm and

Sunday: 10:00am to 4:00pm

TECHNICAL ENQUIRIES:

0333 400 9500 [Calls are recorded and monitored for security and training purposes]

Opening Hours:

Monday to Friday: 9am to 6:00pm

FAX ENQUIRIES:

0333 400 9501

EMAIL:

customercare@maplin.co.uk

technical@maplin.co.uk

WRITE TO:

Maplin, PO Box 534,

Manvers, Rotherham, United Kingdom, S63 3DH

HOW TO ORDER

To purchase any of the goods contained within our Catalogue, please select one of the following options below.

Telephone

We welcome your order by telephone, however to help speed up the process; please quote your customer number if known. You may pay for your order by credit/debit card or a business account. We shall require your card number, the expiry date and the cardholder's full name, address and security code.

If you are an account customer, always quote your account number.

Please call on: 0333 400 9500

Maplin Stores

You can view a list of our stores in the Catalogue or visit our website for the latest on our proposed new store openings as we are sure there will be one opening near you.

Order Online

Our fully interactive and secure internet site is available 24 hours a day, 365 days per year to place your order and provide information on all our products. Please visit us at: www.maplin.co.uk

Post

We will accept your orders by post. Wherever possible, please use the dedicated Maplin order form to notify us of your requirements. We also suggest you keep a copy of your order for your own records. Once this is complete, please post to: Maplin, PO Box 534, Manvers, Rotherham, United Kingdom, S63 3DH

Fax

Simply complete an order form and then fax this to: 0333 400 9501

Please note:

Should you have any queries about our products or you are unsure whether we stock a particular item, please contact our customer care team via telephone, email, or post.

HOW TO PAY

Paying for your order could not be simpler. The information below provides the payment options we accept.

For Internet orders we only accept credit and debit cards, PayPal or Maplin gift cards.

Credit/Direct Debit Cards:

We are pleased to accept orders with payment by any of the following credit/direct debit cards: American Express, Connect, Eurocard, Mastercard, Visa, Maestro, Solo.

We also accept most company procurement cards (please enquire for details). NEVER send your card to us, simply write the number, expiry date, issue number (where applicable) and security number of your credit/debit card on your order, sign it and post it to us.

Cheque or Postal Order

Cheques and postal orders should be made payable to "Maplin Electronics Ltd". In your own interest, cross all cheques or postal orders sent in the post with two straight lines across the centre and marked payee only. Please add your guarantee card number and expiry date on the back of the cheque.

Credit Accounts

For bona fide Business, Educational or Government Establishments a credit account may be opened subject to status. Application forms are available upon request, please contact customer care on 0333 400 9500 or visit www.maplin.co.uk.

PayPal

This option is only available for Internet orders.

CHAPS or BACS Transfer

Should you wish to pay via bank transfer through BACS or CHAPS, please contact us for further details.

Maplin Gift Card

Can be used in-store, online or over the phone.

Please Note:

Do remember to add the £2.99 Inc. VAT postage and packing charge on orders below £10.00.

For your own security, do not send cash.

DELIVERY

Delivery of your order can take place in one of the following options.

Service	Price	Delivered
Standard delivery:	£2.99	3-5 working days
Free on orders above	£10	

For vital consignments, Maplin offer a guaranteed delivery service.

Service	Price	Delivered
Next Working Day:	£5.99	(anytime 7:30am-8pm)
Next Working Day:	£10.00	(before noon)
Saturday Delivery:	£6.99	(anytime 9am-5pm)
Saturday Delivery (AM):	£12.99	(before noon)
*Next Working Day (AM):	£13.50	(before 10.30am)

*This service is only open to Trade Customers. We do endeavour to despatch all orders, that we receive before 5pm (Monday-Friday), the same day and goods are normally delivered within three working days.

Service	Price
Shuttl Delivery:	POA
Shuttl Now (within 90mins):	POA
Shuttl When (delivery slot):	POA

Check our website for more details

Method of Despatch

We will despatch your goods the method selected by you when you place your order. Our current couriers are Royal Mail, Parcel Force, Yodel and Shuttl.

If you are aware that you may not be able to accept delivery of your order, please make suitable, alternate arrangements. Alternatively please contact us at your earliest opportunity to prevent any possible delay in the receipt of your order.

Delivery Discrepancies

Should you have any query regarding the delivery of your order, this should be made to Maplin within 14 calendar days after your order/despatch or from receiving a credit account statement.

RETURNS and REFUNDS

We understand that there may be times you need to return a product to us. We set out below your legal right to return items to us together with information about our separate "Satisfaction Guarantee".

SATISFACTION GUARANTEE

We offer a 30 day money-back policy on all of our products except those set out in "Exclusions" below. If you wish to return an item that is not required please refer to the steps below. This is separate and in addition to any of the Consumer's legal rights to cancel including the right set out in section 6.1 of the Conditions of Sale below.

The item must be in its original "as new" condition including instructions and accessories and also accompanied by a valid proof of purchase.

This may be returned to one of our many stores nationwide or you may call or email our customer care team to receive a returns authorisation number.

Return postage charges must be met by the Customer.

EXCLUSIONS FROM THE SATISFACTION GUARANTEE

Products that are not included within the 30 day satisfaction guarantee are:

- Goods that have had their manufacturer's warranty revoked by the breaking of the seal of the product, or registration or activation of software or SIM cards
- If the silver strip on the back of your Product Activation Key Card has been partially or completely damaged or removed.
- The seal has been broken on any DVD's, CD's or software including games.
- Gift Cards

If you consent to a digital download starting within the 14 day cancellation period and acknowledge the right to cancel will be lost, you will not be able to request a refund. This does not affect the legal rights of a consumer.

FAULTY GOODS

We do appreciate that sometimes a problem with a product may occur. If this does arise you may contact our helpful staff who can assist in resolving these issues. However should you have cause to return a product to us because the item is faulty, please see below for guidelines.

Please either return the item to a Maplin store or call our customer care team to obtain a returns authorisation number.

We do request the returned unit is accompanied with any accessories and a valid proof of purchase. A return address is stated on the reverse of the despatch note or can be found in the Contact Us section on our website. We may offer a courier collection service for larger items.

Any returns authorisation number must be clearly displayed on the return packaging and we ask all reasonable care is taken to ensure the goods are suitably packaged. We also would suggest a proof of postage is obtained when returning goods to us.

Maplin may refuse the return of an item if it is not accompanied by a returns authorisation number. Please contact our customer care team to obtain this before the products return.

Any defects in goods that appear within 12 months (or as previously stated) and are due to faulty materials, workmanship or design will be made good by Maplin, either by repair or, at the sole discretion of Maplin, replacement or refund.

Maplin do reserve the right to inspect returned goods at our central returns centre, prior to a replacement or refund being completed.

Damage to Goods by the Customer

Should products purchased from Maplin be damaged by the Customer after their purchase, Maplin offer a service to evaluate and repair goods. There is an initial diagnostic fee of £15.00 to be paid and, upon completion of our investigations, an invoice outlining the full costs of the repair. Our current charge for this service is £30.00 per hour or part thereof. The diagnostic fee would be deducted if the repair is completed, however if

you decide against the offer of the repair, the fee is non-refundable. All repairs are guaranteed for 3 months. The legal rights of a Consumer are not affected.

DOCUMENTATION

Maplin standard documentation comprises of an invoice and despatch note.

Other documentation which, from time to time, may be required to accompany or support entry of orders into certain countries, will be charged at cost unless previously specified. Maplin will quote such charges, if requested to do so, at the time of any quotation. All such charges will be detailed separately.

Certificates of Origin

Maplin undertakes, as necessary, to obtain, complete and submit Certificates of Origin to Chambers of Commerce and overseas consulates for certification and legislation. Maplin cannot arrange for certification or obtain other documentation from outside the UK. Additional Documentation - Charges

If the following additional documentation is required a handling charge will be incurred:

- Confirmed Irrevocable Letter of Credit
- Certificate of Origin
- Hazardous Goods Document: Charges on application

BFPO ORDERS

How To Order From BFPO Addresses:

If your BFPO address is in Northern Ireland you must use the ordinary inland prices, but if your BFPO address is elsewhere in the world you do not have to pay VAT but small order charges will be applied.

However if any item is too large or heavy for despatch by BFPO you must supply a civilian address and pay extra for carriage at cost. Should the rules pertaining to VAT change due to government legislation, VAT will be charged at whatever rate is in force at the date we despatch your order. Please refer to our general

Conditions of Sale Terms & Conditions

1 Definitions

In these Terms and Conditions the following words shall have attributed to them the meanings specified

- 1.1 'Maplin' shall mean Maplin Electronics Ltd. whose principal place of business and registered office is at Brookfields Way, Manvers, Wath Upon Dearne, Rotherham S63 5DL.
- 1.2 'Customer' shall mean the person, company or any other body that purchases or agrees to purchase Goods whether a Consumer Trade Customer or Credit Customer.
- 1.3 'Consumer' shall mean an individual acting for purposes which are wholly or mainly outside that individual's trade, business, craft or profession.
- 1.4 'Trade Customer' shall mean a Customer who buys Goods for the purpose of a business and not as a Consumer.
- 1.5 'Credit Customer' shall mean a Trade

Customer to whom Maplin allows credit in respect of Goods purchased or agreed to be purchased.

- 1.6 'Goods' shall mean all goods and services which the Customer agrees to buy from Maplin including replacements for defective Goods, hardware documentation and software products licensed for use by the Customer.
- 1.7 'Contract' shall mean the Contract between Maplin and the Customer for the sale of Goods by Maplin to the Customer.
- 1.8 'Catalogue' shall mean any published promotional material produced by Maplin.
- 1.9 'Working Days' shall mean Monday to Friday inclusive but exclusive of Bank Holidays.
- 1.10 'Customer's Registered Address' shall mean the address of the Customer that is already registered with Maplin or the address registered with the issuing company of any debit or credit card which is used as a means of payment for Goods.
- 1.11 'Goods' shall mean the relevant goods which are the subject of the Contract;
- 1.12 'B Grade Products' The B Grade Products are all clearance items; there are various product conditions for example:- New, boxed and end of line Scratch and dent to product or packaging or both Refurbished Used and returned All of the B Grade products are tested, in full working order and carry a twelve-month warranty.
- 1.13 'Distance Selling' shall mean a non face-to-face purchase, therefore an item purchased via the Internet, over the telephone or mail order.

Maplin Electronics Registration Number : 1264385
Maplin Electronics VAT number : GB 772 312 444

2 General

- 2.1 All orders for Goods are accepted by Maplin subject to these terms and conditions of sale which supersede any other terms and conditions previously published. These constitute the entire understanding between Maplin and the Customer for the sale of Goods. Maplin accepts responsibility under these terms and conditions for its commitments to the Customer. Maplin also accepts responsibility by its duly authorized agents.
- 2.2 Any substitute products that are supplied, and found not to be suitable will be collected at Maplin's expense. Contact Customer Service to arrange for the goods to be returned.
- 2.2.1 Goods will be supplied based on any information provided by the Customer.
- 2.3 Any Catalogue published by Maplin is an invitation to treat and not an offer to supply.
- 2.4 Subject to condition 2.5 any advice or recommendation given by Maplin or its employees or agents to a Trade Customer as to the storage, application or use of the Goods is followed or acted upon entirely at the Trade Customer's own risk.

- 2.5 Condition 2.4 shall not apply to any Customer purchasing Goods as a Consumer.
- 2.6 All descriptions and illustrations contained in the Catalogue or any price list or otherwise communicated to the Customer are correct at the time of publication.
- 2.7 If the description of any Goods, which are not directly manufactured by Maplin, contained in any correspondence, invoice or the current Catalogue varies from that of the manufacturer's description, then the manufacturer's description will be deemed to be the correct description and shall take precedence over the description assigned by Maplin. The updated and complete manufacturer's description is available from Maplin on request before any order is placed.
- 2.8 In the event of any material change to any description of goods since the date of publication of the last Catalogue by Maplin, Maplin will advise the Customer of the revised description at the time of delivery of the goods or before where possible.
- 2.9 Maplin reserves the right without prior notice to discontinue any Goods or to make design changes as part of a continuous programme of improvement or to assist availability. All mail order Goods detailed in the Catalogue have been processed in strict accordance with standard quality procedures approved to ISO 9001:2008.
- Goods listed in any Maplin Catalogue may originate from a Non-EU source. Any published information by Maplin as to the country of origin of Goods is an indicator only of the source of supply to Maplin and does not constitute a warranty or representation. All contracts between Maplin and the Customer shall be governed by and interpreted in accordance with English Law and both Maplin and the Customer submits to the exclusive jurisdiction of any competent Court in the United Kingdom. Nothing contained herein shall affect a Consumer's legal rights in connection with the purchase of the Goods. Further information can be obtained from your local Trading Standards office or Citizens Advice Bureau.
- 2.10 All prices for the Goods are in pounds Sterling and subject to Value Added Tax ("VAT") at the relevant rate ruling on the date of despatch and do not include the cost of carriage, packaging or other charges which becomes payable under any contract with Maplin. Prior to the conclusion of the contract Maplin will inform the Customer the total amount to be debited.
- 2.11 Whilst every endeavour will be made to maintain the prices in the Catalogue Maplin reserves the right to alter prices at any time. Prior to the conclusion of the contract Maplin will inform the Customer the total amount to be debited.
- 2.12 Any change in price will be communicated to

the Customer at the time of ordering. Prior to the conclusion of the contract Maplin will inform the customer the total amount to be debited.

- ### 3 Order Processing
- 3.1 Where possible orders should be made using Maplin order codes and a Customer number.
- 3.2 Written confirmation is not required for a Trade Customer telephone order, but if the Trade Customer sends written confirmation such confirmation must be marked 'Confirmation Only' so as to avoid liability for a duplicated delivery. Any resulting duplication of delivery shall be the responsibility of the Trade Customer.
- 3.3 Maplin reserves the right to deliver part orders, or hold orders until all items are available, as required. Credit cards are only charged for written and telephone orders when Goods are despatched for delivery or collected from a Maplin Store. The exceptions to this being when Maplin has been requested to custom build Goods to special order and Internet orders which will be charged at the point of order confirmation. Only one mail order handling charge will be levied (if applicable) in respect of the total order. If any goods are not available within 30 days of the order being placed the Customer will be informed and will be offered the option to continue to await delivery, accept an alternative product or cancel the order and receive a refund where funds have been taken.
- 3.4 When dealing as a Trade Customer authorisation for the return of goods must be obtained from the Customer Care Department by telephoning 0333 400 9500.
- 3.5.1 Acceptance of an internet order placed by a Customer and the completion of the contract between the Customer and Maplin will take place when the Customer receives an email from Maplin that confirms that the Goods have been dispatched "Dispatch Confirmation". The Contract between us will only be formed when Maplin sends the Customer the Dispatch Confirmation.
- 3.5.2 If Maplin is unable to supply the Customer with a Good, for example, because that Good is no longer available, or because of an error in the price on Maplin's website or catalogue, or Maplin is unable to obtain authorisation for the Customer's payment, or where the Customer does not accept Maplin's terms and conditions of sale, Maplin will inform the Customer of this by e-mail, for internet orders, or by post for mail and telephone orders, and Maplin will not process the Customer's order. If the Customer has already paid for the Goods, Maplin will refund the Customer the full amount as soon as possible and in any event within 14 days.

- 3.5.3 ACCEPTANCE BY MAPLIN OF ANY PAYMENT MADE BY THE CUSTOMER IN CONNECTION WITH ANY GOODS DOES NOT CONSTITUTE MAPLIN'S ACCEPTANCE OF THE CUSTOMER'S ORDER AND A LEGALLY BINDING CONTRACT IS NOT FORMED UNTIL THE CUSTOMER RECEIVES MAPLIN DISPATCH CONFIRMATION E-MAIL AND MAPLIN WILL NOT BE OBLIGED TO SUPPLY GOODS TO THE CUSTOMER UNTIL THEN.
- 3.6 Telephone orders to be charged to a Credit Account held by a Trade Customer with Maplin will only be accepted with an official purchase order number.
- 3.7 Trade Customers wishing to purchase Goods on account at a Maplin store will be required to provide a written purchase order containing the Maplin trade account number. This procedure is also required when a 'call to collect' product reservation is made at a Customer's local Maplin store.
- 3.8 Products reserved in accordance with condition 3.7 must be collected within 5 working days from notification of goods arriving in Store, failing which Maplin will charge the Customer a restocking fee.
- 3.9 In the event of cancellation of part of an order by a Trade Customer Maplin reserves the right to invoice for any difference between the selling price applicable for the final quantity despatched and the total price of the original order plus a restocking charge. Orders where goods have been specifically ordered for Trade Customer requirements (schedule and non-stock items) cannot be cancelled.
- ### 4 Payments
- 4.1 Payment shall be made by the Customer for all monies owed to Maplin in respect of orders placed for Goods.
- 4.2 Under normal circumstances payment shall be made at the time that the order is placed. Payment may be made by, and is accepted by, cash, cheque or major credit and debit cards: [Maestro, MasterCard, Visa and American Express]. PayPal (online only). Cheques must be made payable to "Maplin Electronics Ltd" and crossed "payee only".
- 4.3 Credit terms are available to Trade Customers on request and subject to status, satisfactory references and acceptable trading history with Maplin. Payment is due by the end of the month following the month of despatch without any deductions. If the Credit Customer fails to make any payment on the due date, then, without prejudice to any other right or remedy available to Maplin, Maplin shall be entitled to:
- i) Cancel the order and suspend further deliveries of Goods.
 - ii) Allocate any payments made by the Customer to such of the Goods (or Goods supplied under any other order) as Maplin may think fit.

- iii) Charge an administration fee for any legal or other collection processes required to recover all monies due.
 - iv) Charge interest on the unpaid amount from the due date in accordance with the Late Payment of Commercial Debts (Interest) Act 1998.
- 4.4 If the Customer fails to make payment for the Goods in accordance with these Terms and Conditions or permits any other breach of any contract for sale or if any distress or execution shall be levied upon any of the Customer's goods or if the Customer offers to make any arrangement with its creditors or if any petition in bankruptcy is presented against the Customer or the Customer is unable to pay its debts as they fall due or if being a limited company any resolution or petition to wind up the Customer (other than for the purpose of amalgamation or reconstruction without insolvency) shall be passed or presented or if a Receiver, Administrative Receiver or Manager shall be appointed over the whole or any part of the Customer's business or assets or if any petition for the appointment of any administrator is presented against the Customer or if the Customer shall suffer any actions or proceedings under foreign law all sums outstanding in respect of the Goods shall become payable immediately.
- 4.5 Maplin may in its absolute discretion and without prejudice to any other rights which it may have, suspend all future deliveries of Goods to the Trade Customer and/or terminate any contract without liability upon its part, in the event of any breach of these Terms and Conditions by the Trade Customer.
- 5 Delivery
- 5.1 Delivery is free (within the UK mainland) for all orders over £10 inclusive of VAT. Other delivery methods are available at additional cost. The current charge can be ascertained by contacting Maplin. Prior to the conclusion of the contract Maplin will inform the Customer the total amount to be debited.
- 5.2 The risk of damage to or loss of Goods ordered from Maplin will pass to the Customer when the goods are delivered.
- 5.3 Same day despatch is normally achieved but not guaranteed, provided the order has been received by Maplin before 5.00 pm during Working Days. This provision does not apply to Goods requiring special modification (e.g. calibration, kits etc.) and orders which are too large to be despatched by Maplin contracted carrier. Delivery will normally only be made to the Customer's registered address unless notified to Maplin in writing beforehand. All orders will be despatched where reasonably practicable the same working day as the order is received by Maplin and normally delivered within three to five working days. For vital consignments, Maplin offers a guaranteed delivery service, weekdays before 10.30 am and Saturday before 12.00 noon. All orders for guaranteed deliveries must be received by 5.00pm on a working day and will be subject to extra charges. Details of the charges are available from Maplin prior to the placing of any order.
- 5.4 Carriage will be charged on orders involving Export at the appropriate rate prevailing at the date of despatch. Prior to the conclusion of the contract Maplin will inform the Customer the total amount to be debited.
- 5.5 The Customer is responsible at their own expense to obtain any import or export license or any other documentation deemed necessary by any compliant authority.
- 5.6 The Customer must inspect the Goods as soon as reasonably practicable after delivery or upon purchase from a store and shall within 14 days of such delivery or receipt give notice to the Customer Care Department of Maplin of any apparent physical or delivery damage in the Goods.
- 5.7 Queries regarding shortages of Goods must be made within 14 days of delivery date and must be accompanied by the despatch note. Queries regarding Goods invoiced but not delivered must be made to the Customer Care Department of Maplin within 14 days of invoice date and the invoice number must be quoted.
- 5.8 Maplin shall not be liable to compensate the Trade Customer by way of damages or otherwise for non-delivery or late delivery of the Goods or for any loss consequential or otherwise arising from non-delivery or late delivery.
- 5.9 The Customer is responsible at their own expense to obtain any import or export license or any other documentation deemed necessary by any compliant authority.
- 5.10 The Customer must inspect the Goods as soon as reasonably practicable after delivery or upon purchase from a store and shall within 14 days of such delivery or receipt give notice to the Customer Care Department of Maplin of any apparent physical or delivery damage in the Goods.
- 5.11 Queries regarding shortages of Goods must be made within 14 days of delivery date and must be accompanied by the despatch note. Queries regarding Goods invoiced but not delivered must be made to the Customer Care Department of Maplin within 14 days of invoice date and the invoice number must be quoted.
- 5.12 Maplin shall not be liable to compensate the Trade Customer by way of damages or otherwise for non-delivery or late delivery of the Goods or for any loss consequential or otherwise arising from non-delivery or late delivery.
- 5.13 NOTHING IN THIS SECTION AFFECTS THE LEGAL RIGHTS OF THE CONSUMER.
- FURTHER INFORMATION ABOUT YOUR CONSUMER RIGHTS ARE AVAILABLE FROM YOUR LOCAL TRADING STANDARDS OFFICE OR CITIZENS ADVICE BUREAU.
- 6 Returns
- 6.1 Consumer's legal right to return unwanted goods: This is separate and in addition to Maplin's satisfaction guarantee set out at section 6.2 below.
- 6.1.1 Notwithstanding any other provisions of these Conditions of Sale, the Customer has the right to change their mind and to cancel an order within 14 calendar days without giving any reason (in accordance with the Consumer Contracts (Information, Cancellation and Additional Charges) Regulations 2013). The cancellation period will expire after 14 days from the day on which the Customer acquires, or a third party other than Maplin's carrier and indicated by you acquires, physical possession of the Goods.
- 6.1.2 To exercise this right to cancel the Customer must inform Maplin of its decision to cancel the order by a clear statement (e.g. a letter sent by post, fax or e-mail). The Customer may use the model cancellation form included at Annex 1 below, but it is not obligatory. To meet the cancellation deadline, it is sufficient for the Customer to send its communication concerning its exercise of the right to cancel before the cancellation period has expired.
- 6.1.3 Reasonable care should be taken by the Customer whilst the goods remain in their possession and goods must be adequately packaged when being returned back to Maplin.
- 6.1.4 If the Customer cancels this Contract in accordance with this section 6.1, Maplin will reimburse to the Customer all payments received from the Customer, including the costs of delivery (except for the supplementary costs arising if the Customer chose a type of delivery other than the least expensive type of standard delivery offered by Maplin). Maplin may make a deduction from the reimbursement for loss in value of any Goods supplied, if the loss is the result of unnecessary handling by the Customer. The Customer is only liable for any diminished value of the Goods resulting from the handling other than what is necessary to establish the nature, characteristics and functioning of the Goods the Customer has received.
- 6.1.5 Maplin will make the reimbursement without undue delay, and not later than:
 - (a) 14 days after the day Maplin receives back from the Customer any Goods supplied; or
 - (b) (if earlier) 14 days after the day the Customer provides evidence that it has returned the Goods; or
 - (c) if there were no Goods supplied, 14 days after the day on which Maplin is informed

about the Customer's decision to cancel this Contract.

- 6.1.6 Maplin will make the reimbursement using the same means of payment as the Customer used for the initial transaction unless the Customer has expressly agreed otherwise, and in any event, the Customer will not incur any fees as a result of the reimbursement.
- 6.1.7 The Customer shall send back the Goods to Maplin without undue delay and in any event not later than 14 days from the day on which the Customer cancelled the order. The deadline is met if the Customer sends back the Goods before the period of 14 days has expired.
- 6.2 Satisfaction guarantee - Maplin offers 30-day return policy. To return a product under this policy the Customer should:
- Return the product to one of Maplin stores within 30 days or
 - Follow the returns instructions on the delivery paperwork or
 - Email Maplin at customer-care@maplin.co.uk or
 - Telephone Customer Service on 0330 400 9500
 - Write to Maplin at the address in Condition 1.1.
- A Returns Number will be issued and this must be clearly identified on a returns label or the external packaging, and internal documentation when the Goods are returned, no markings should be made on the product or product packaging. The internal documentation should include proof of purchase, the returned product must be complete, and in re-saleable condition with original packaging. Maplin will not accept the return under the 30-day return policy of any Goods that have had a manufacturer's or supplier's warranty or registration invoked. Software is excluded from the Maplin Satisfaction Guarantee. Maplin will deem such registration by the Customer as acceptance of the Goods. Maplin must receive all returns within 30 days of the Returns Number being issued and any Goods received after that period will be dealt with on an individual basis. The Customer must take all reasonable care to ensure that all returned items be suitably packaged, and that the Goods are protected when being returned. The Customer must provide to Maplin proof of despatch to Maplin. In the event of Goods being returned without a previously allocated Return Number the processing of any claim by the Customer is likely to be delayed.
- 6.3 Where unwanted Goods are returned to Maplin after the expiry of the 30-day return period but within a reasonable period of time Maplin reserves the right to levy a handling charge of 20% of the invoice value, with a minimum charge of £10 will be levied on goods 'not wanted' or 'incorrectly ordered' or due to duplication resulting from a confirmation order not being endorsed to

that effect. The Customer must bear all the costs of returning any unwanted Goods to Maplin and provide proof of postage. Maplin reserve the right to recover reasonable direct costs where collection of goods from a Customer has been requested. Maplin reserves the right not to accept the return of unwanted, non-defective goods after the 30 day period at its absolute discretion.

- 6.4 Faulty goods - Any defects in the Goods which under proper use appear within a reasonable period after delivery and which are due to faulty materials, workmanship or design will be made good by Maplin either by repair or, at the sole discretion of Maplin, by replacement or refund. Any claim for Goods or the defective parts should be returned together with proof of purchase and (if relevant), all complete accessories, instruction manuals and software and, wherever possible, in the original packaging. Any claim for defective Goods or parts must be made in writing (specifying the date of purchase and invoice number) within a reasonable period of time after delivery.
- 6.5 All warranties and conditions which are capable of being excluded by statute or otherwise are excluded from any contract provided that nothing in the contract shall affect the statutory rights of the Consumer or liability for death or personal injury caused by the negligence of Maplin.
- 6.6 Maplin Reserve the right to inspect at the National Distribution Centre in Manvers any Goods returned prior to issuing credit for those Goods.
- 6.7 Warranty seals applied to any Goods supplied by Maplin must not be removed or broken and any product without the warranty seals intact will be deemed to have had any warranty invalidated and the Goods will be deemed to have been accepted by the Customer.
- 6.8 The warranty period as stated in 6.4 is from the date of purchase if goods are replaced within this warranty period, the warranty will continue from the original date of purchase unless specifically agreed otherwise by Maplin in writing.
- 6.9 Conditions 6.1 to 6.7 inclusive do not affect a Consumer's legal rights in connection with the purchase of the Goods. Further information about your consumer rights can be obtained from your local Trading Standards office or Citizens Advice Bureau.
- 6.9.1 Where the Customer purchases software from Maplin which is downloaded using an activation key the Customer gives its express consent to Maplin supplying such software immediately following completion of the Customer's order. If the Customer begins the download of the software the Customer acknowledges that the Customer will lose its legal right to cancel the order as described in clauses 6.1.1 to 6.1.7 above

- 6.10 The responsibility for ensuring that Goods are sufficient and suitable for the Customer's requirements rests with the Customer save insofar as Maplin have specifically advised the Customer that the Goods are sufficient and suitable for the Customer's purposes.
- 7 Intellectual Property
- 7.1 Goods referred to in any Maplin Catalogue, correspondence or invoice may be subject to a patent, trade mark, registered design, copyright, topography right or other right of a third party. Maplin owns full copyright in respect of any Catalogue whether published in paper or electronic form. The reproduction, storage in a retrieval system, or transmission, in any form or by any means, electronic, mechanical, photocopying, recording or otherwise, in part or in whole, is prohibited without the prior written consent of Maplin. Notwithstanding any other term of these conditions of sale, title in any software program that forms part of the Goods purchased is retained by Maplin and will not pass to the Customer. Such software programs may only be used by the Customer and a revocable non-exclusive licence is hereby granted for the sole use of the Customer (so far as Maplin are able to grant such licence) and any software must not be copied or altered or otherwise modified in any way.
- 7.2 Where any designs or specifications have been supplied by the Customer for manufacture of Goods by Maplin the Customer warrants that the use of such designs or specifications for the manufacture, processing, assembly or supply of the Goods shall not infringe the rights of any third party and the Customer shall indemnify Maplin against all costs claims and demands of whatsoever nature arising out of the use of such designs or specifications.
- 8 Data Protection
- 8.1 By placing an order with Maplin the Customer agrees to data relating to the transaction being retained and processed by Maplin in accordance with the Data Protection Act or any statutory modification thereof. The data so retained will be used by Maplin for the purpose of accounting and marketing and will not be disclosed to any third party without the previous consent in writing of the Customer.
- 8.2 Maplin may send to the Customer details of other Goods and services offered by Maplin that Maplin may consider to be of interest to the Customer. If the Customer does not wish to receive details of these offers then they should contact Maplin either in writing at Brookfields Way, Manvers, Wath Upon Dearne, Rotherham S63 5DL, by facsimile on 0333 400 9501 by telephone on 0333 400 9500 or by e-mail at customer-care@maplin.co.uk requesting that data is removed from the marketing database. Maplin subscribes

to the data protection principles as laid down by the Information Commissioner and all data is held securely. The Customer may, by writing to the Customer Care Department of Maplin, request that all data relating to them be deleted from its records. Customers may also, in accordance with the provisions of the Data Protection Act, obtain copies of such data that is held in respect of them by Maplin. For Trade Customers Maplin will also retain and process information in its capacity of a credit reference agency. Telephone calls and e-mails to Maplin may be recorded or monitored for the purposes of security training and quality assurance. For further details See Privacy policy.

9A MAPLIN'S LIABILITY IF YOU ARE A CONSUMER CUSTOMER

This clause [9A] only applies if you are a Consumer.

- 9A.1 If Maplin fails to comply with these [terms and conditions of sale or our website terms of use], Maplin is responsible for loss or damage the Customer suffers that is a foreseeable result of Maplin's breach of these [terms and conditions of sale or our website terms of use] or Maplin's negligence, but Maplin is not responsible for any loss or damage that is not foreseeable. Loss or damage is foreseeable if it was an obvious consequence of Maplin's breach or if it was contemplated by the Customer and Maplin at the time we entered into the Contract.
- 9A.2 Maplin only supply the Goods to Consumers for domestic and private use. The Customer agrees not to use the Goods for any commercial, business or re-sale purposes, and Maplin has no liability to the Customer for any loss of profit, loss of business, business interruption, or loss of business opportunity.
- 9A.3 Maplin does not in any way exclude or limit its liability for:
- 9A.3.1 death or personal injury caused by Maplin's negligence;
- 9A.3.2 fraud or fraudulent misrepresentation;
- 9A.3.3 any breach of the terms implied by section 12 of the Sale of Goods Act 1979 (title and quiet possession);
- 9A.3.4 any breach of the terms implied by section 13 to 15 of the Sale of Goods Act 1979 [description, satisfactory quality, fitness for purpose and samples];
- 9A.3.5 arising under Section 2(3) Consumer Protection Act 1987; or
- 9A.3.6 for any matter which it is not permitted by law to limit or exclude, or attempt to limit or exclude, Maplin's liability.

10 Force Majeure

- 10.1 Maplin shall not be liable to the Customer or deemed to be in breach of Contract by reason of any delay in performing, or any failure to perform, any obligations of Maplin in relation to the Goods, provided that the delay or failure was due to any cause beyond reasonable control of Maplin. Without prejudice to the generality of the foregoing, the following shall be regarded as causes

beyond reasonable control of Maplin: Act of God, explosion, flood, tempest, fire or accident; war or threat of war, sabotage, insurrection, civil disturbance or requisition; acts, restrictions, regulations bye-laws, prohibitions or measures of any kind on the part of any governmental, parliamentary or local authority; import or export regulations or embargoes; strikes, lock-outs or other industrial actions or trade disputes [whether involving employees of Maplin or of a third party]; difficulties in obtaining raw materials, labour, fuel, parts or machinery; power failure or breakdown in machinery.

11 Ownership and Risk

- 11.1 The risk of damage to or the loss of Goods supplied by Maplin will pass to the Trade Customer when the goods are loaded on to the delivery vehicles at Maplin premises. However the title of the goods will not pass to the Trade Customer until payment in full of all sums due from the Trade Customer to Maplin has been made. Risk in the Goods will not transfer to the Consumer until the Goods are in the physical possession of the Consumer.
- 11.2 Delivery having been made, the property in the goods shall not pass from Maplin until
- (i) The Customer shall have paid the price plus VAT in full; and
- (ii) No other sums whatever shall remain owing to Maplin.
- 11.3 Until property in the goods passes to the Trade Customer. The Trade Customer shall hold the products and each of them on a fiduciary basis as bailee for Maplin. The Trade Customer shall store the products [at no cost to Maplin] separately from all other Products in its possession and marked in such a way that they are clearly identified as Maplin property. Notwithstanding that the Products [or any part of them] remain the property of Maplin, the Trade Customer may sell or use the Products in the ordinary course of the Trade Customer's business at full market value for the account of Maplin. Any such sale or dealing shall be a sale or use of Maplin property by the Trade Customer on the Trade Customer's own behalf and the Trade Customer shall deal as principal when making such sales or dealings. Until property of the Goods passes from Maplin the entire proceeds of sale or otherwise of the Products shall be held in trust for Maplin and shall not be mixed with other money or paid into any overdrawn bank account and shall be at all material times identified as Maplin money. Maplin shall be entitled to recover the price [plus VAT] notwithstanding that property in any of the Goods has not passed from Maplin.
- 11.4 Until such time as the property in the Goods passes from Maplin, the Trade Customer shall upon request deliver up such of the Goods as have not ceased to be in existence or resold to Maplin. If the Trade Customer fails to return Goods, Maplin may enter any

premises owned occupied or controlled by the Trade Customer where the Goods are situated and repossess the Goods. On the making of such repossession the rights of the Trade Customer shall cease.

- 11.5 The Trade Customer shall not pledge or in any way charge by way of security for any indebtedness any of the Goods that are the property of Maplin. Without prejudice to the other rights of Maplin, if the Trade Customer does so all sums whatever owing by the Trade Customer shall forthwith become due and payable.
- 11.6 The Trade Customer shall insure and keep insured the Goods to the full value against 'all-risks' to the reasonable satisfaction of Maplin until the date that property in the Goods passes from Maplin and shall, whenever requested by Maplin, produce a copy of the policy of insurance and evidence of payment of premium. Without prejudice to the other rights of Maplin, if the Trade Customer fails to pay any sums whatever owing by the Trade Customer on the due date, all sums due to Maplin shall forthwith become due and payable.

12 Miscellaneous

- 12.1 All headings in these Terms and Conditions are for ease of reference only and shall not affect the construction of any contract between Maplin and a Customer. Any provision of any contract with Maplin which is or may be void or unenforceable shall to the extent of such invalidity or unenforceability be deemed severable and shall not affect any other provision of any Contract. No waiver or forbearance by Maplin [whether expressed or implied] in enforcing any of its rights under any contract shall prejudice its right to do so in the future. For the purposes of the Contracts [Rights of Third Parties] Act 1999 it is agreed by Maplin and the Customer that nothing in any contract shall confer on any third party any right to enforce or any benefit of any term of any contract that may be concluded by them.

Annex 1 – Model Cancellation Form

To Maplin Electronics Ltd, Brookfields Way, Manvers, Wath Upon Dearne, Rotherham S63 5DL or Email to Customercare@maplin.co.uk

I/We [Customer name] _____ hereby give notice that I/We [Customer name] _____ cancel my/our contract of sale of the following goods:

Ordered on: _____
 Received on: _____
 Order reference number: _____
 Name of Customer: _____

Address of Customer: _____

[Signature of Customer:] _____

Date: _____



A - Z Index

Useful Information

A - Z Index

a

ADSL Accessories	48
Aerial Cables	19
Air Dusters	377
Alarm Cable	57
Alkaline Batteries	230
Amorphous Solar Panel Kits	220
Analogue Audio	09
Angle Grinders	331
Antistatic	158
Apple 30pin Cables	36
Appliance Bulbs	289
Audio	155
Audio Banana Terminals	84
Audio Connectors	76
Audio Grade	125
Audio Transformers	176
Auto Transformers	176
Automotive Cable	51
Automotive Relays	169
Automotive RF Connectors	98
AV Cables - Know your cables	07
AV Cables	06
AV Converters	27
AV Switches	21

b

Back-up Batteries	251
Bar & Segment Displays	140
Batteries - Alkaline Cross Reference Chart	231
Batteries - Lithium Cross Reference Chart	237
Batteries - Silver Oxide Cross Reference Chart	239
Batteries	230
Battery & Gas Irons	332
Battery Boxes	252
Battery Chargers	233
Battery Clips	253
Battery Connectors	104
Battery Size Convertors	252
Battery Testers	252
Battery Testers	357
Belden Cables	50
Bench Power Supplies	281
Blade Crimps	108
Blanking Plates	255
Blow Torches	336
BNC Adapters	96
BNC Connectors	95
BNC Leads	19
Breadboard	180
Bulbs	285
Bullet Crimps	107
Business to Business	388
Butane Gas	381
Button Cells	238
Buzzers & Sounders	203

c

Cable Clips	71
Cable Management	69
Cable Protector	69
Cable Ties	72

Cable Wrap	69
Cables - Guarantees	05
Camera & Camcorder Batteries	246
Capacitance Conversion Table	120
Capacitor Packs and Kits	120
Capacitors	120
Car Fuses	188
Cat 5e Network Cables	40
Cat 6 Network Cables	40
Cat 6a Network Cables	40
Cat 7 Network Cables	41
Ceramic	122
Ceramic Fuses	188
Charge Regulators	225
Chassis Fuseholders	190
Chassis Transformers	172
Chisels	317
Circuit Breakers	189
Clamp Meters	346
Cleaning & Aerosols	374
Click & Collect	02
Clips	348
Coin Cells	236
Component Loudspeakers	202
Component Testers	356
Computer Cables - Know your cables	31
Computer Cables	28
Computer Cleaning	374
Computer Connectors	89
Computer Power Connectors	90
Conduit & Trunking	70
Control Stations	159
Corded Drills	328
Cordless Drills	327
Cordless Phone Batteries	248
Cordless Screwdrivers	327
Crimp Connectors	107
Crocodile Clips	105
Crystalline Solar Panel Kits	220
Crystals	128
Cut Cable	49
Cut Cables: Shopping for cut cable at maplin	51

d

D-Sub Connectors	89
D-Type Enclosures	194
DC Power Cable	54
DC Power Connectors	102
De-soldering Tools	341
Development Equipment	183
Development Software	180
Diecast Enclosures	200
Digital Audio	15
DIN & Mini-Din	88
DIN & Multiway Connectors	88
Diodes	144
DisplayPort Cables	34
Double Layer	127
Drill Accessories	328
Dual In-line Switches	166
DVI Cables	34

e

Eco Halogen Bulbs	285
Education	389
Electrical & Wiring Books	259
Electrical Cables	207

Electrolytic	125
Electronic Cleaners	377
Enamelled Copper Wire	57
Encapsulated Transformers	176
Enclosure Accessories	201
Enclosures	194
Energy Saving Bulbs	285
Energy Saving Monitors	256
Environmental Testers	351
Equipment Wire	49
Extension Cables & Reels	207
Eyelets & Fork Crimps	107

f

Ferrites	179
Ferrule Crimps	109
FireWire Cables	32
Fixing Clips	363
Fixings	359
Flexible Solar Panel Kits	223
Flight Cases	384
Float Switches	167
Floodlighting & PIR Lighting	296
Fluorescent Lighting	291
Folding Solar Panels	224
Freezer & Defrost Spray	381
Fuse Kit	188
Fuse Wire	186
Fuses	186

g

Gears & Pulleys	193
Gel Connectors	107
General Purpose Relays	169
Glass Fuses	187
Glue & Spray Glue	367
Glue Guns	332

h

Halogen Bulbs	290
Hammers	317
Hand Tools	299
HDMI	06
HDMI Connectors	95
HDMI Converters	26
HDMI Splitters	24
HDMI Switches	21
Heatsinks	156
Hex & Utility Keys	308
High Power LEDs	130
High Power Wirewound	117
Hobbyist Tools	324
Hook & Loop	373
Hooks	364
Household Fuses	186
Household Storage	385
Household Wiring	253
Hydrogen	229

i

IC Sockets	155
------------------	-----

IDC Connectors	91
IEC & Mains Connectors	99
Incandescent Bulbs	287
Industrial Cleaners & Wipes	378
Infrared Devices	143
Instrument Cases	199
Inverters 12V	274
IP Rated Cable Glands	199
IP Rated Enclosures	198
IP Rated Mains Connectors	104

j

Jack (6.35mm) Cables	27
Jacks 3.5mm 4-Pole	81

k

Key Switches	165
Keyfob Batteries	250
Kits & Tools	109
Knives & Cutting Tools	319
Knobs	168

l

Lantern Batteries	250
Laptop Power Supplies	262
Laser Diode Module	143
LCD and OLED Displays	141
LED - Calculating the Series Resistor	131
LED Clips and Covers	140
LED Clusters	140
LED Driver	155
LED Facts	128
LED Kits and Tester	129
LED Light Strips	128
LEDs 10mm	137
LEDs 3mm	131
LEDs 5mm	133
LEDs 8mm	136
Light Dependent Resistors	118
Light Switches	255
Lighting Fittings	258
Lighting Transformers & Accessories	295
Lightning Cables	36
Lithium High Power Batteries	232
Logic Devices	152
Loudspeaker Connectors	84
Loudspeaker Terminals	85
Lubricants	378

m

Magnets	167
Magnifier Lamps	297
Magnifiers & Microscopes	325
Mains Conditioners	210
Mains Lampholders	294
Mains Plugs	253
Mains Soldering Irons	336
Mains Voltage Converters	279
Mains Wall Plates	254
Mains Wiring Cable	68





Measurement Hand Tools	321
Measurement Hand Tools	358
Metal Film	116
MHL Cables	37
Micro Switches	165
Microchip PIC Micro Controllers	154
Microchip Programming Tools	154
Microphone & Stage Cable	67
Microphone Cables	27
Modular Wall Accessories	41
Monitor Cleaning	374
Mono Jack Adaptors 2.5mm	79
Mono Jack Adaptors 3.5mm	80
Mono Jack Adaptors 6.35mm [1/4 Inch]	82
Mono Jacks 2.5mm	78
Mono Jacks 3.5mm	79
Mono Jacks 6.35mm [1/4 Inch]	81
Motor Run	127
Motors & Gearboxes	192
Motors & Servos	191
Multi Function Tools	318
Multi-Function Tool	332
Multi-Plugs	207
Multicoloured LED	138
Multimeter Features	434
Multimeter Fuses	191
Multimeters	342
Multiway Connectors	88
Mylar & Paper Speakers	202
Mylar	123

n

N-Type Adaptors	97
N-Type Connectors	97
Nails	359
Neon Lamps	294
Network & Telecoms	90
Network Cables	40
Network Testing	358
Networking & Data Cable	54
Nuts, Bolts & Washers	362

o

Online Ordering	02
Op-Amps	150
Optical / Audio Switches	25
Optocouplers	142
Optoelectronics	128
Oscilloscopes & Function Generators	352
Other Home & Office Cleaning	375
Outdoor & Underwater Lighting	297

p

Panel Fuseholders	189
Panel Meters	143
Panel Mount LEDs	139
Parallel, Serial & PS/2 Cables	38
PCB Compounds	186
PCB Connectors	110
PCB Development	180
PCB Fuseholders	191
PCB Terminal Block	110
PCB Terminal Connectors	110
PCB Terminal Connectors	91

PCB Transformers	175
Phono Adaptors	77
Phono Connectors	76
Photodiodes	142
Picture Hanging	363
Pin Jumpers	90
Plastic Enclosures	195
Pliers, Cutters & Forceps	312
Polyester	123
Polypropylene	124
Portable Power	240
Potentiometers	119
Power Amps	153
Power Cables	210
Power Connectors	99
Power Relays	170
Power Supplies	260
Power Supply Adapters	267
Power Supply Cases	199
Power Tools	327
Powered Saws	331
Printed Circuit Boards	182
Probes	347
Proximity Switches	166
Push Switches	162

r

Rack Mounting Cases	200
RCD	215
Rechargeable Batteries	232
Reed Relays	171
Reflector Bulbs	288
Relays	169
Renewable Energy	215
Resistance Wire	120
Resistor Packs and Kits	116
Resistors - Understanding Resistors and Reading Rating Codes	115
Resistors	115
RF Cables	52
RF Encoders/Decoders	155
RFI Class	124
Rocker Switches	161
Rotary Switches	166
Rotary Tool Accessories	331
Rotary Tools	330
RS232/233/422	153

s

Samsung 30pin Cables	37
Sander	331
Satellite & Cable Adapters	94
Satellite & Cable Connectors	93
Saws	320
SCART & AV Leads	16
SCART	95
SCART Cable	50
SCART Switches	26
Screwdriver Accessories	305
Screwdrivers	299
Screws	359
Sealed Lead-Acid Batteries	249
Security Lighting	296
Semiconductor Accessories	156
Semiconductor Packs and Kits	144
Semiconductors	144
Servos	191



Shaped LED 138
 Sleeving 54
 Slide Switches 164
 SMA Connectors 98
 Small Bulb Lampholders 293
 Small Bulbs & Lamps 292
 Small Items Storage 386
 Socket Sets 310
 Solar Accessories 227
 Solar Batteries 228
 Solar Batteries 250
 Solar Briefcase Generator 219
 Solar Gadgets 217
 Solar Grid Tie Invertors 228
 Solar Motorhome Kits 225
 Solar PIR Security Lights 218
 Solar Power Stations 222
 Solar Shed Lights 217
 Solar Trickle Chargers 219
 Solder 340
 Solder Tags 183
Soldering 332
 Soldering Accessories 340
 Soldering Irons 12V 340
 Soldering Stations 338
 Soldering: The Art of Soldering 334
 Spanners & Wrenches 311
 Speaker Cable 64
 Speaker Cables 28
 Speakon Connectors 84
 Specialist Rechargeable Batteries 251
 Splicer Crimps 109
 Springs 364
Stage Cables 27
 Stage/Instrument 20
 Staplers, Nail Guns & Tackers 316
 Stereo Jack Adaptors 2.5mm 79
 Stereo Jack Adaptors 3.5mm 80
 Stereo Jack Adaptors 6.35mm [1/4 Inch] 83
 Stereo Jacks 2.5mm 79
 Stereo Jacks 3.5mm 80
 Stereo Jacks 6.35mm [1/4 Inch] 83
 Store Locations 400
 Stripboard 182
 Super Capacitor 124
 Suppression 179
Surge Protection & RCD 213
 Surge Protection 213
 Switch Packs 161
Switches 159

t

Tantalum 125
Tape & Glues 364
 Tape 364
 Telephone Cables & Extension Reels 44
Telephone Cables 44
 Telephone Couplers & Adapters 46
 Telescopic/Retrieval Tools 324
 Temperature Measurement 350
 Terms & Conditions 390
Test & Measurement 342
 Test Connectors 105
 Test Lead Kits 346
 TFT Display Module 142
 Thermal Fuses 189
 Thermistors 118
 Thermocouples 352
 Thumbwheel Switch 166
 Thunderbolt Cables 36

Tilt & Vibration 167
 Timers 152
 Tips, Cables & Testing 265
 Toggle Switches 160
 Tool Kits 306
Tool Storage 381
 Toroidal Transformers 173
Transformers, Ferrites & EMC 172
 Transistors 146
 Trigger Transformers 177
TV & Satellite Connectors 92
 TV Aerial Adapters 92
 TV Aerial Connectors 92
 TV, Satellite & Coax Cable 58
 Tweezers, Probes, Forceps and Clamps 318

u

UHF [PL259] Adapters 98
 UHF [PL259] Connectors 97
 Ultrasonics 205
 Ultraviolet Blacklight Lighting 292
 US Style Mains Connectors 102
 USB 2.0 Cables 28
 USB 3.0 Cables 31
 USB Connectors 89
 USB OTG Cables 37
 USB Power Supplies 260

v

Van Damme Instrument Cable Neutrik Mono Jack-XLR F 28
 Van Damme Mono 6.35mm Cables 28
 Van Damme SC DMX Cable, Neutrik 3 Pin XLR M-F 28
 Vandal Resistant Switches 164
 VanDamme Instrument Cable Neutrik Stereo Jack-Jack 27
 Variable 127
 VGA Cables 33
 Vices, Workbenches & Trolleys 321
Video & RF Connectors 95
 Video Leads 18
 Video Switches 26
 Voltage Comparator 153
 Voltage Regulators 147
 Voltage Testers 349

w

Wall Plugs 361
 Watch & Jewellery Tools 323
 Weatherproof Wiring 258
 Wind Turbines 215
 Wire Strippers & Crimpers 315
 Wireless Telephone Extenders 45

x

Xenon Lamps 294
 XLR Adaptors 87
XLR Audio 86
 XLR Connectors 86

Store Locations



ENGLAND

Andover - SP10 4DU
Aylesbury - HP20 1DG
Banbury - OX16 1LX
Barnsley - S71 1JE
Barnstaple - EX31 1JB
Barrow-in-Furness - LA14 2NE
Basildon - SS14 1WP
Basingstoke - RG22 6HL
Bath - BA1 1EB
Bedford - MK42 0DJ
Birmingham:
 Temple St - B2 5BN
 Erdington - B23 6TH
 Selly Oak - B29 6SJ
Blackburn - BB1 1BB
Blackpool - FY4 3AW
Bolton - BL2 1HQ
Boston - PE21 7NN
Bournemouth - BH2 5LR
Bracknell - RG12 1EN
Bradford - BD1 4RH
Brentwood - CM14 4AN
Brierley Hill - DY5 1SY
Brighton - BN1 4JE
Bristol:
 Brislington - BS4 5NG
 Cribbs Causeway - BS34 5TS
 Gloucester Rd - BS7 8AA
Cambridge:
 Cambridge Beehive - CB1 3ET
 Cambridge Central - CB2 3AH
Cannock - WS11 8XP
Canterbury - CT1 1ZG
Carlisle - CA1 2PD
Chatham - ME4 5AA
Chelmsford - CM2 6JX
Cheltenham - GL52 2ND
Cheshire Oaks - CH65 9HD
Chester - CH1 4RY
Chesterfield - S40 1TB
Christchurch - BH23 2BN
Colchester - CO3 3GT
Coventry - CV6 5QQ
Cramlington - NE23 6UY
Crawley - RH10 1DY
Crewe - CW1 2RP
Derby - DE21 6NZ
Doncaster - DN5 9TP
Eastbourne - BN23 6QU
Exeter - EX2 8BT
Farnborough - GU14 7QJ
Folkestone - CT19 5FG
Gateshead - NE11 9YS
Gloucester - GL4 4LP
Grimby - DN31 1TY
Guildford - GU1 3BJ
Harlow - CM20 2AB
Harrogate - HG1 1BJ
Hemel Hempstead - HP1 1BJ
Hereford - HR4 9SB
Huddersfield - HD1 6PF
Hull - HU1 2PS
Ipswich - IP4 1HA
 Kettering - NN16 9TS
 Kidderminster - DY11 6DY
King's Lynn - PE30 4YN
Leeds:
 Junction 1 - LS11 0BD
 Regent St - LS2 7QN
Leicester - LE1 1SG 
Lincoln - LN6 7TP
Liverpool:
 Aintree - L9 5AY
 Central - L1 1QR
 Edge Lane - L7 9LG
Loughborough - LE11 5HG
Lowestoft - NR32 2ED
Luton - LU1 2TE
Maidenhead - SL6 1AY
Maidstone - ME14 1QX
Manchester:
 Fort Retail Park - M8 8EP

Oxford Rd - M1 5QA
Mansfield - NG18 1HA
Middlesbrough - TS1 5BU
Milton Keynes - MK6 1BH
Newbury - RG14 1DJ
Newcastle - NE1 5JQ
Newport Isle of Wight - PO30 2TA
Northampton - NN5 5JW
Norwich:
 Castle Meadow - NR1 3BY
 Sweet Briar Retail Park - NR6 5DH
Nottingham:
 Castle Retail Park - NG7 5QJ
 Parliament St - NG1 1EH
Nuneaton - CV11 4EG
Oldham - OL2 5HX
Oxford - OX2 0HA
Perry Barr - B42 1AA
Peterborough - PE1 1PZ
Plymouth - PL1 1LP
Poole - BH15 3TF
Portsmouth - PO1 5ET
Preston - PR5 4AW
Reading - RG2 0HS
Redditch - B98 7AH
Rotherham - S60 1TG
Rugby - CV21 1RW
Salford - M5 3TP
Salisbury - SP1 2TJ
Scunthorpe - DN15 8NN
Sheffield:
 Pinstone St - S1 2HN
 Drake House Retail Park - S20 7JJ
 Hillsborough - S6 2LL
Shrewsbury - SY1 1LE
Slough - SL1 3TA
Solihull - B91 3SJ
Southampton:
 Bevois Valley Rd - SO14 0JR
 East Bargate - SO14 2DL
Southend - SS2 4DQ
St Helens - WA9 1JJ
Stafford - ST17 4LL
Stevenage - SG1 1XU
Stockport - SK1 2ED
Stoke on Trent - ST4 1NB
Stratford-upon-Avon - CV37 0BT
Sunderland - SR1 3HW
Swindon - SN3 3SQ
Tamworth - B78 3HB
Taunton - TA1 3TZ
Teesside - TS17 7BW
Telford - TF3 4PB
Thanet - CT10 2QU
Thurrock Lakeside - RM20 1WN
Truro - TR3 6AZ
Tunbridge Wells - TN1 2AH
Wakefield - WF2 9SD
Walsall - WS2 8LL
Warrington - WA1 2QQ
Westcliff - SS0 7BP
Wigan - WN5 0UH
Woking - GU21 6XX
Wolverhampton - WV1 3ER
Worcester - WR3 8HP
Worthing - BN11 1BE
Yeovil - BA22 8YQ
York - YO30 4XU

LONDON - CENTRAL

Camden - NW1 7PG
Canary Wharf - E14 4QT
Great Portland St - W1W 8QL
Hammersmith - W6 0QU
Holborn - WC1V 6RL
Kensington - W8 5ED
Liverpool St - EC2M 7LA
Marble Arch - W2 2DS
Monument - EC3M 1EB
Queensway - W2 6LY
St Paul's - EC2V 6ET
Strand - WC2R 0AP
Tottenham Court Road - W1T 7PX

LONDON - INSIDE M25

Beckton - E6 6LG
Bromley - BR1 1EG
Charlton - SE7 7SR
Clapham Junction - SW11 1PX
Crayford - DA1 4ER
Croydon - CR9 1SE
Ealing - W5 2NH
Edmonton - N18 3HA
Enfield - EN2 6BE
Epsom - KT19 8AH
Forest Hill - SE23 1HH
Harrow - HA1 2DR
Hounslow - TW3 1NA
Ilford - IG1 1XT
Kingston Upon Thames - KT1 1BS
New Malden - KT3 4LU
Orpington - BR5 3RP
Putney - SW15 1SR
Romford - RM1 1JU
Staines - TW18 4BL
Staples Corner - NW2 6LW
Stratford - E15 1NG
Streatham - SW16 1BJ
Sutton - SM1 1DU
Tottenham Hale - N17 9FR
Uxbridge - UB8 1JY
Watford - WD17 2EN
Wembley - HA9 8TS
Wimbledon - SW19 1PS
Wood Green - N22 6BH

SCOTLAND

Aberdeen - AB24 2BQ
Ayr - KA8 9BF
Cumbernauld - G68 0FR
Dundee - DD3 8RX
East Kilbride - G74 1LJ
Edinburgh - EH11 2EZ
Falkirk - FK1 1LW
Glasgow:
Airport
 St Enoch - G1 4DB
 Forge Retail Park - G31 4BW
 Great Western Rd - G4 9EJ
Hamilton - ML3 6AD
Inverness - IV2 7GD
Livingston - EH54 6RQ
Perth - PH1 5XA
Paisley - PA3 4EP
Stirling - FK7 7NZ

WALES

Cardiff:
 Capital Retail Park - CF11 8AZ
 Newport Rd - CF24 1PQ
Llandudno - LL30 1RY
Llanelli - SA14 9UZ
Swansea - SA6 8QL
Wrexham - LL13 7LW

NORTHERN IRELAND

Belfast:
 Boucher - BT12 6HR
 Connswater - BT5 5DL
Coleraine - BT51 3QQ
Londonderry - BT47 6SA

REPUBLIC OF IRELAND

Cork - Blackpool Retail Park
Dublin:
 Blanchardstown Retail Park
 Jervis St
Dundalk - Dundalk Retail Park
Galway - Well Park Retail Park
Limerick - Childers Rd Retail Park



Love innovation and technology?

Head to Maplin... To explore our huge range of exciting products then visit our stores or head to Maplin.co.uk



HARD DRIVES



<http://goo.gl/4xil4p>



COMPUTING & OFFICE



<http://goo.gl/t0sV2n>



CAR SECURITY & NAVIGATION



<http://goo.gl/cWkloQ>



GADGETS, TOYS & HOBBIES



<http://goo.gl/LajQIA>



NETWORKING



<http://goo.gl/v6w8v3>



PERSONAL HEALTH



<http://goo.gl/MAAjJE>



DRONES



<http://goo.gl/BYqD7m>



HOME ELECTRICALS



<http://goo.gl/CmXnpl>

maplin.co.uk

0333 400 9500

@maplintweet

PRICE MATCH*

we will **never be beaten on price**

365 DAY

product quality **no quibble guarantee**

ITEM NOT IN STOCK?

we will order and send it with **free delivery****

CLICK + COLLECT

maplin.co.uk

OVER 20,000

more products online → maplin.co.uk

* see maplin.co.uk for full terms and conditions

** see in-store for details



CABLES



COMPONENTS



POWER



TOOLS

maplin.co.uk 0333 400 9500



5 026686 175370

Code: CA375



E & OE. All trademarks acknowledged. All prices include VAT. All prices correct at time of going to press. All prices are subject to change without notice, all offers are subject to availability. All prices are in Sterling. Not all products are available in all stores, please check availability. 0333 phone numbers will be charged at standard rate (please refer to your service provider for call charges). Please note there is a **£2.99** postage on orders under **£10**.

We also accept written orders at:

Maplin Electronics, PO BOX 534, Manvers, Rotherham S63 3DH,
and the following cards on phone orders:

