

INDUSTRIAL ELECTRONICS

JULY 1966

5s 0d

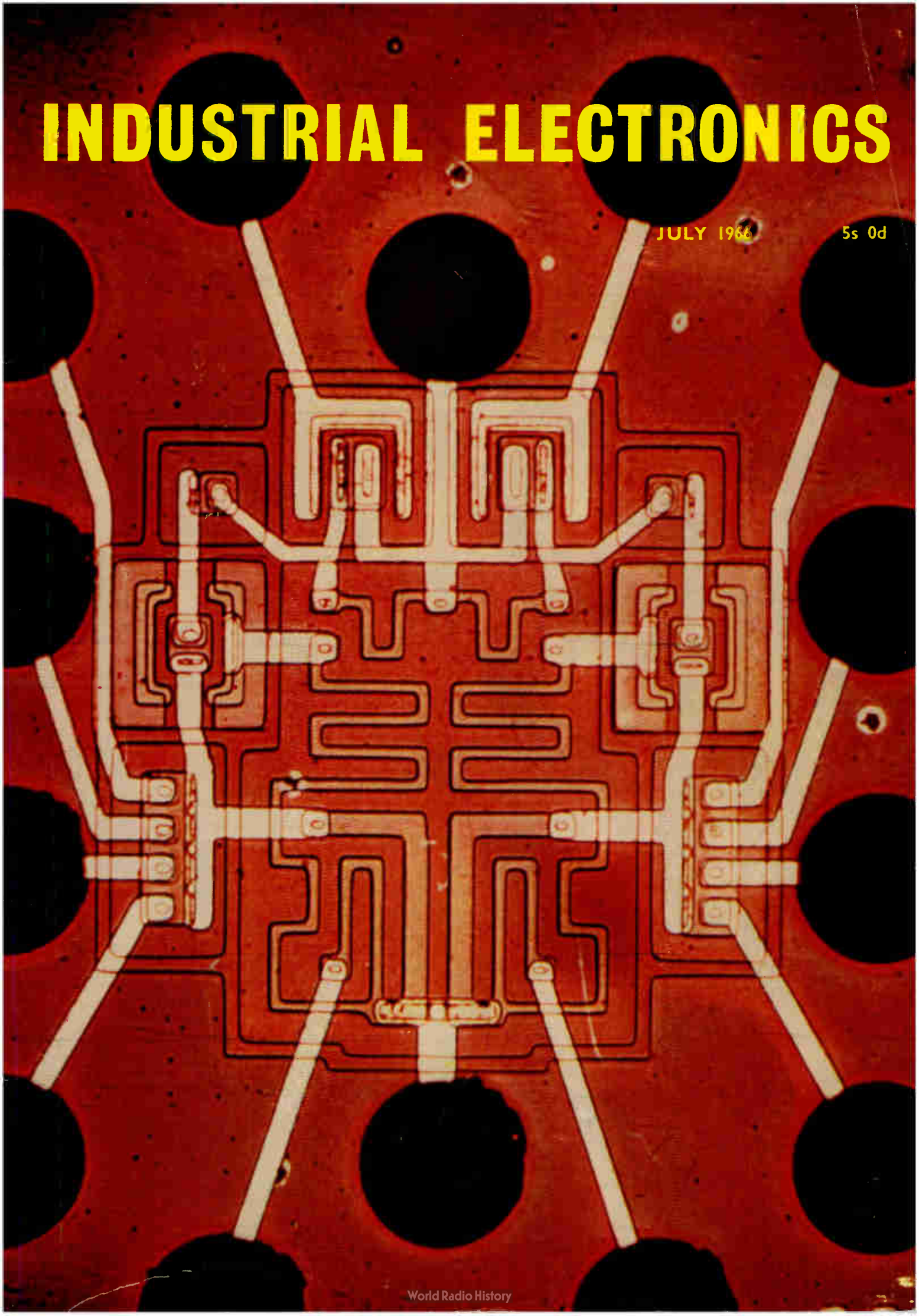

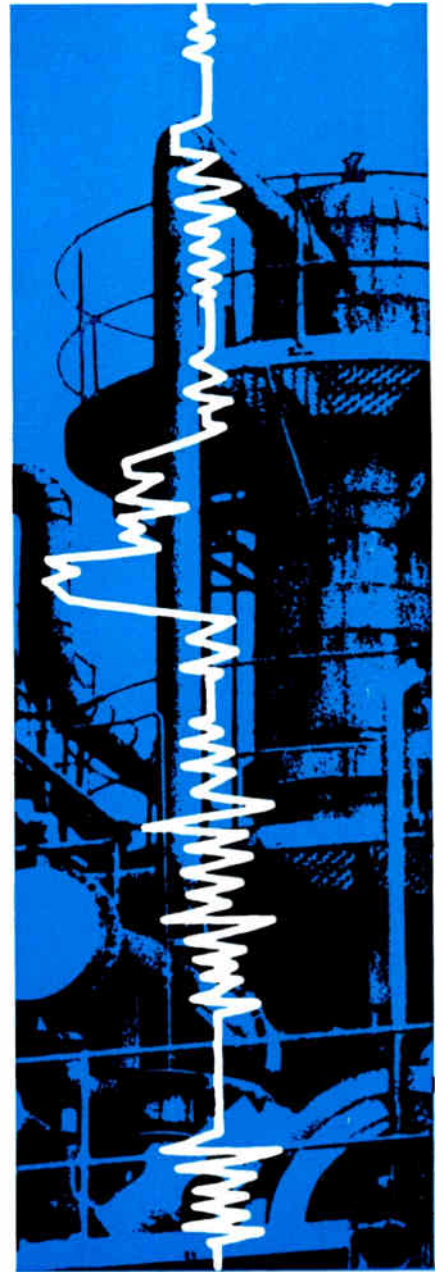
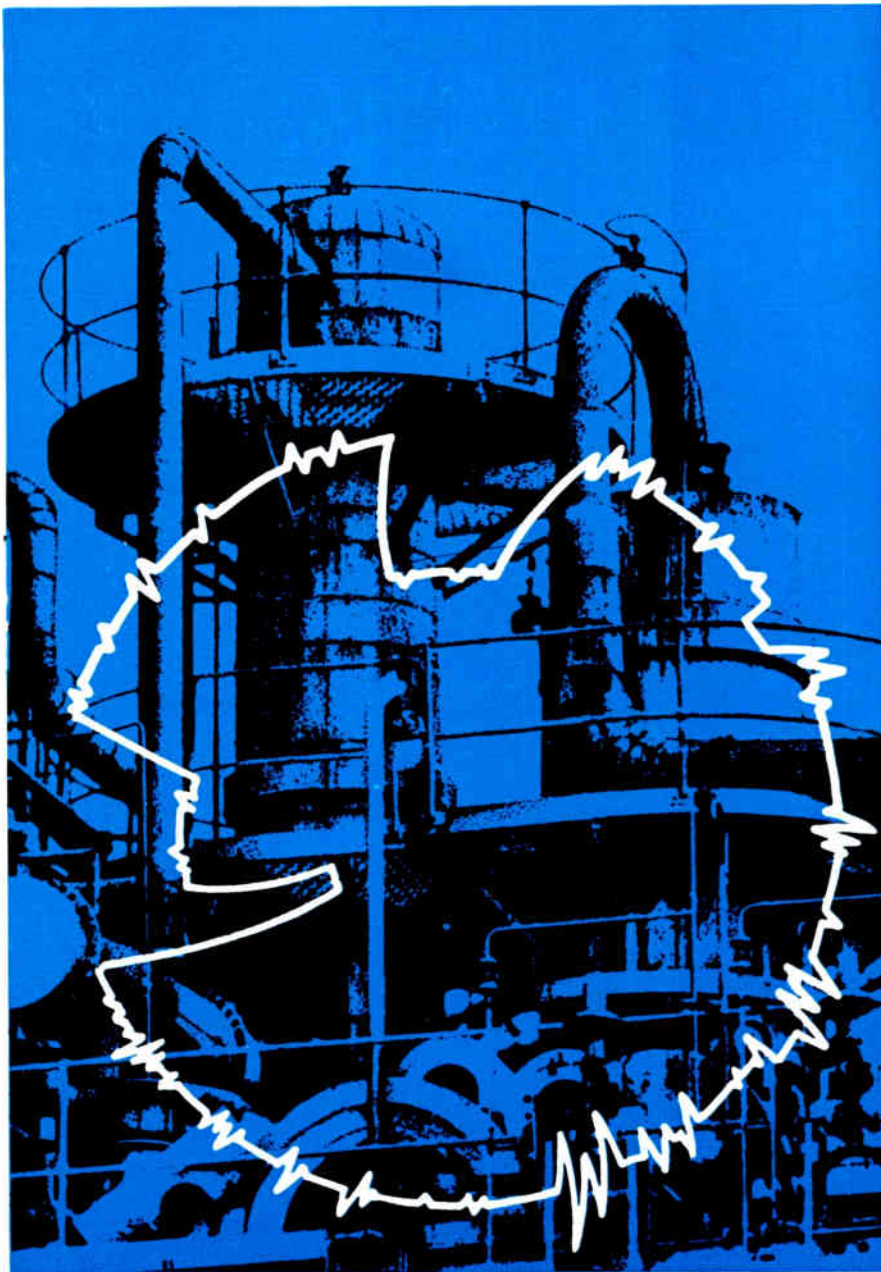

Circular- or strip-chart recorders for accurate process measurement

Wherever variables are measured, Kent KE and Mark 3 recorders offer the finest value available today. Their versatility fits them for all kinds of applications.

Accuracy? You can rely absolutely on any Kent instrument to do exactly what the specification states it will do.

Whether you prefer the strip-chart or circular form of these instruments, the full-size charts ensure easy and reliable reading. All the electronic units are identical and interchangeable.

Kent Mark 3 and KE instruments will measure *any* variable which can be expressed in terms of an electric signal — prices and delivery times competitive.

Kent KE — easy to install and maintain

Available as circular-chart recorders and three different types of circular-scale indicator. Wide range of optional control, transmission and alarm functions. Minimum lubrication. All-mains operation. Interchangeable-unit construction.

Kent Mark 3 — for single- or multi-point measurement

Mark 3 instruments will print out data from up to 16 different points, in dots, numbers or colour coding. It has a wide range of optional control, transmission and alarm functions — pneumatic, electric or electronic actuation. A 36-range version is available for research and similar applications.



Detailed literature by return from:

KENT **KENT INDUSTRIAL INSTRUMENTS LIMITED**

Biscot Road, Luton, Bedfordshire, England
Telephone: Luton 21151

*Industrial Instrument Division
of George Kent Limited*

INDUSTRIAL ELECTRONICS

Incorporating British Communications and Electronics

Communications Automation Instrumentation Control

Contents July 1966

Editor-in-Chief **W. T. COCKING, M.I.E.E.**
Editor **T. J. BURTON**
Editorial: **K. G. HOLMES**
 T. A. KELLY
Production **D. R. BRAY**
Drawing Office **H. J. COOKE**
Advertisement Controller **G. H. GALLOWAY**
Advertisement Manager **R. H. C. DOHERTY**

311 **Comment**

312 **Transistor and Diode Chip Development**

by J. G. Scott, B.Sc.

Today, the development of the two most prominent forms of microelectronics (thin-film circuits and semiconductor integrated circuits) relies mainly on packaging techniques. This article describes some of the advances in the packaging of semiconductor devices and circuits achieved by Hughes International (U.K.) Ltd. and now being applied at their Glenrothes factory.

318 **Colour Analysis by Computer**

by A. Maple-Brown

Colour matching has long been an art based on the judgement of humans. While this has been satisfactory in the past, it is now proving to be inefficient with modern production methods. Computing systems have been developed for colour analysis and this article describes their application in this sphere.

323 **An Industrial C.R.T. Data Display**

by R. Mosley

Data-display equipment can offer industrial-plant designers, engineers and operators a flexible, economic and centralized instrumentation and control system, able to meet the most exacting demands of reliability and high-speed presentation. This article describes the operation and capabilities of one such display system, using cathode-ray tubes.

328 **Radio Telemetry in Industry**

by C. H. Hoepfner

Several uses of radio telemetry in industry are described in this article. Following a brief presentation of what radio telemetry is, the article continues by discussing its applications to automotive conveyors, gear trains, ship-propeller shafts, power-generating stations, chain drives, cable tensions and earth-moving equipment. Uses of telemetry for the design of new equipment and the safe operation of production systems are also given.

VOLUME 4

NUMBER 7

continued overleaf

© Iiffe Electrical Publications Ltd., 1966

Permission in writing from the Editor must first be obtained before letterpress or illustrations are reproduced from this journal. Brief abstracts or comments are allowed provided acknowledgment to the journal is given.

Published on the last Thursday of the preceding month by

Iiffe Electrical Publications Ltd., Dorset House, Stamford Street, London, S.E.1

Managing Director: W. E. Miller, M.A., M.I.E.R.E.

Telephone: Waterloo 3333. *Telegrams/Telex:* Electronics Iiffepres 25137 London

**ANNUAL SUBSCRIPTION, HOME £3 0s. 0d. OVERSEAS £3 10s. 0d.
CANADA and U.S.A. \$10.00.**

INDUSTRIAL ELECTRONICS

Incorporating British Communications and Electronics

Communications Automation Instrumentation Control

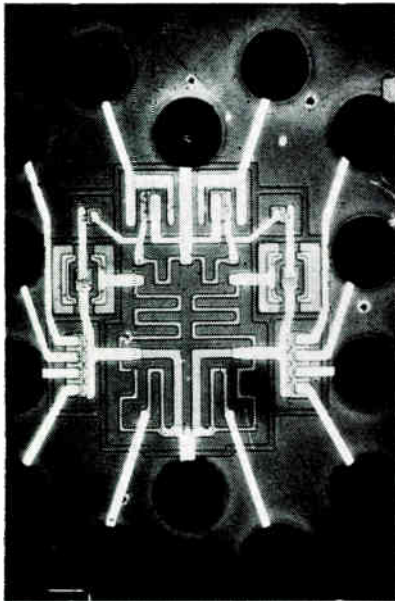

OUR COVER

This micro-photograph shows in magnified form a flip-chip version of a 14-contact microelectronic circuit (a monolithic, dual 4-input DTL gate). Although this has been produced in experimental quantities only, it demonstrates the concept is by no means limited to direct diode and transistor chips. This latest development in microelectronics is described and discussed in an article starting on page 312.

● INDEX TO PRODUCTS

For the convenience of the reader who requires rapid access to information on specific products, an 'index to products' is provided on the same sheet as the reader enquiry cards.

Contents *continued*

331 **Talkabout by Nexus**

The Instruments, Electronics and Automation Exhibition in retrospect and some outspoken views on the British telephone system are but two of the topics dealt with this month by Nexus. Comments on Bill Hewlett and Dave Packard (of Hewlett Packard) and Ray Brown (late of Racal Electronics) are also included by Nexus.

334 **Analogue-to-Digital Converters—1**

by Richard Graham

Digital methods of data presentation have several advantages over the established analogue methods. They are widely used for such applications as machine control and are finding increasing use in voltmeters and similar instruments. These uses require that an analogue signal should be transformed to a digital form and this function is performed by an analogue-to-digital converter or digitizer. There are two types of these, physical and electronic. This opening article of the series describes the first.

What's On and Where?

A regular feature which lists forthcoming events. Professional meetings, symposia, conferences and exhibitions are included. For easy reference this item is positioned facing the inside back cover.

Features

- | | | | |
|-----|---|-----|------------------------------------|
| 317 | National Industrial-Film Awards 1966 | 339 | New Apparatus |
| 327 | Industrial Communication | 351 | Industrial News |
| 332 | Manufacturers' Literature | 354 | Applications and Techniques |
| 333 | Sputtering Insulating Materials | 356 | New Books |
| 338 | General-Purpose Translator for Digital Computers | 52 | <i>Classified Advertisements</i> |
| | | 57 | <i>Index to Advertisers</i> |

Next Month

Direct digital control in industry is the title of a short series of articles which starts in the August issue. This series deals with the application of direct digital control to industrial processes. The treatment is in an easy-to-understand manner and will interest both experts and non-experts. Another main article is Analogue-to-Digital Converters—2.

This booklet is available to all interested in printed circuits . . .

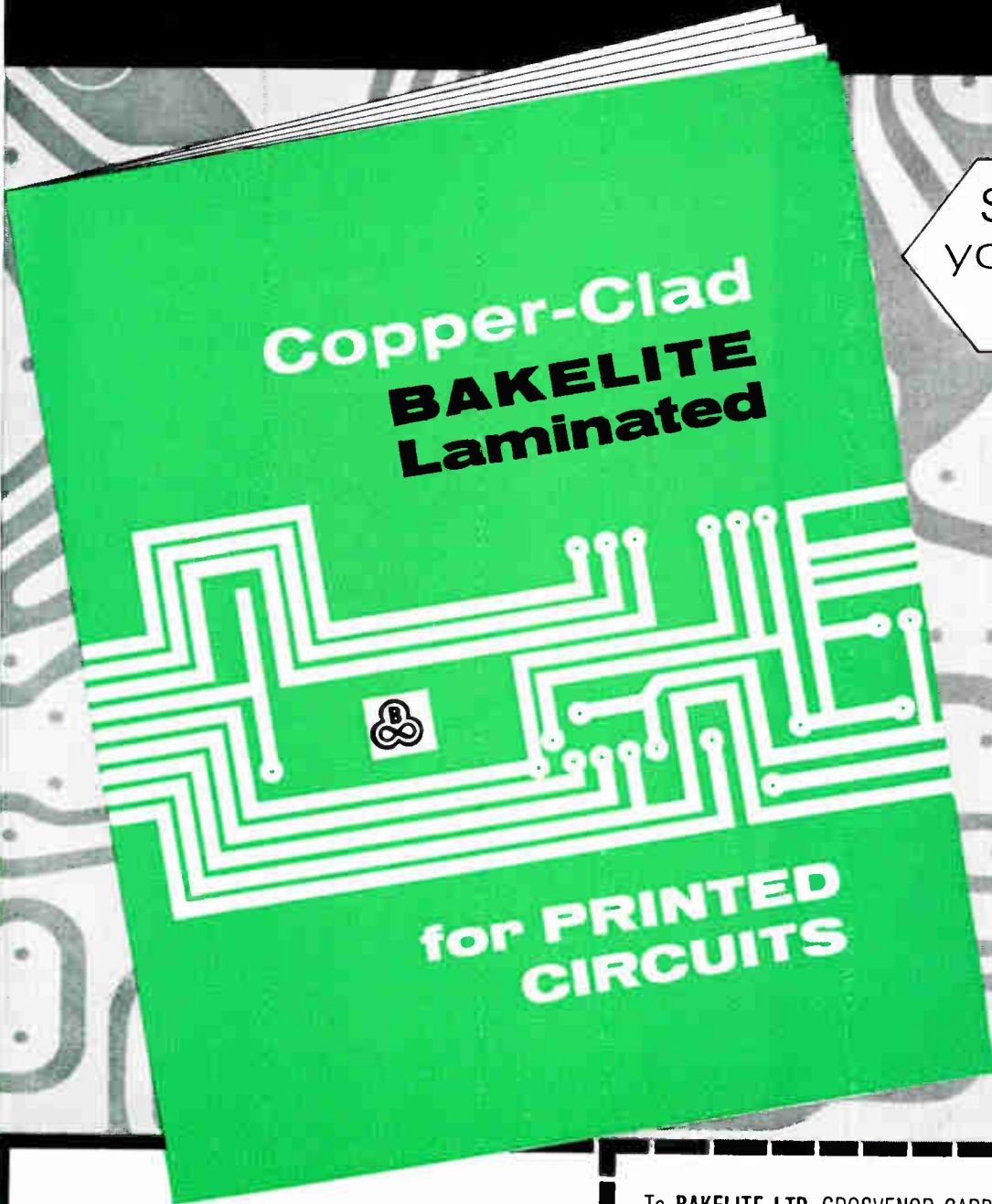

Send for
your copy
TODAY

Bakelite Limited

A **BXL** COMPANY

12-18 Grosvenor Gardens, London SW1. Tel: SLOane 0898

Sales Offices at: Birmingham Tel: Central 5011
Manchester Tel: Blackfriars 2861. Glasgow Tel: City 6825

The trefoil symbol and the word BAKELITE are registered trade marks of Bakelite Limited

To **BAKELITE LTD, GROSVENOR GARDENS, LONDON SW1**
Please send me, free of charge, a copy of "Copper-Clad
BAKELITE Laminated for Printed Circuits".

NAME _____

ADDRESS _____

SPECIAL INTEREST _____ IE7

POTENTIOMETER PROBLEM?

THEN COLVERN IS THE ANSWER!

Only one of our wirewound potentiometers is illustrated, but with over 50 different types in constant production there is one to suit most applications. Send us details of your requirements.

SEE YOUR ELECTRONIC ENGINEERING INDEX LIBRARY, FOR FULL TECHNICAL DATA

COLVERN
LIMITED



Spring Gardens, Romford, Essex, England.

Telephone: ROMFORD 62222 (PBX) Telex: 23984



they turn up everywhere . . .

the many brands of TUFNOL laminates—the well-known phenolics, tried, tested and in use throughout industry both in the U.K. and overseas—the new, unique epoxides. They turn up everywhere in ships, in cars, in planes and trains; in switchgear, in machine tools—in fact wherever engineers and designers need top quality laminates. Each one has its own unique combination of mechanical, electrical and chemical properties. A range of engineering materials that is invaluable for a multitude of industrial applications—that is what TUFNOL means.

Full technical specifications of all brands are immediately available from TUFNOL LTD.

TUFNOL IS MANY MATERIALS

TUFNOL TUFNOL LTD. PERRY BARR · BIRMINGHAM 22B · Tel: Birchfields 4554

(Regd. trade mark)

Branches: LONDON · BIRMINGHAM · BRISTOL · MANCHESTER · NEWCASTLE-UPON-TYNE · GLASGOW · BELFAST

so our
design engineers
went broody...

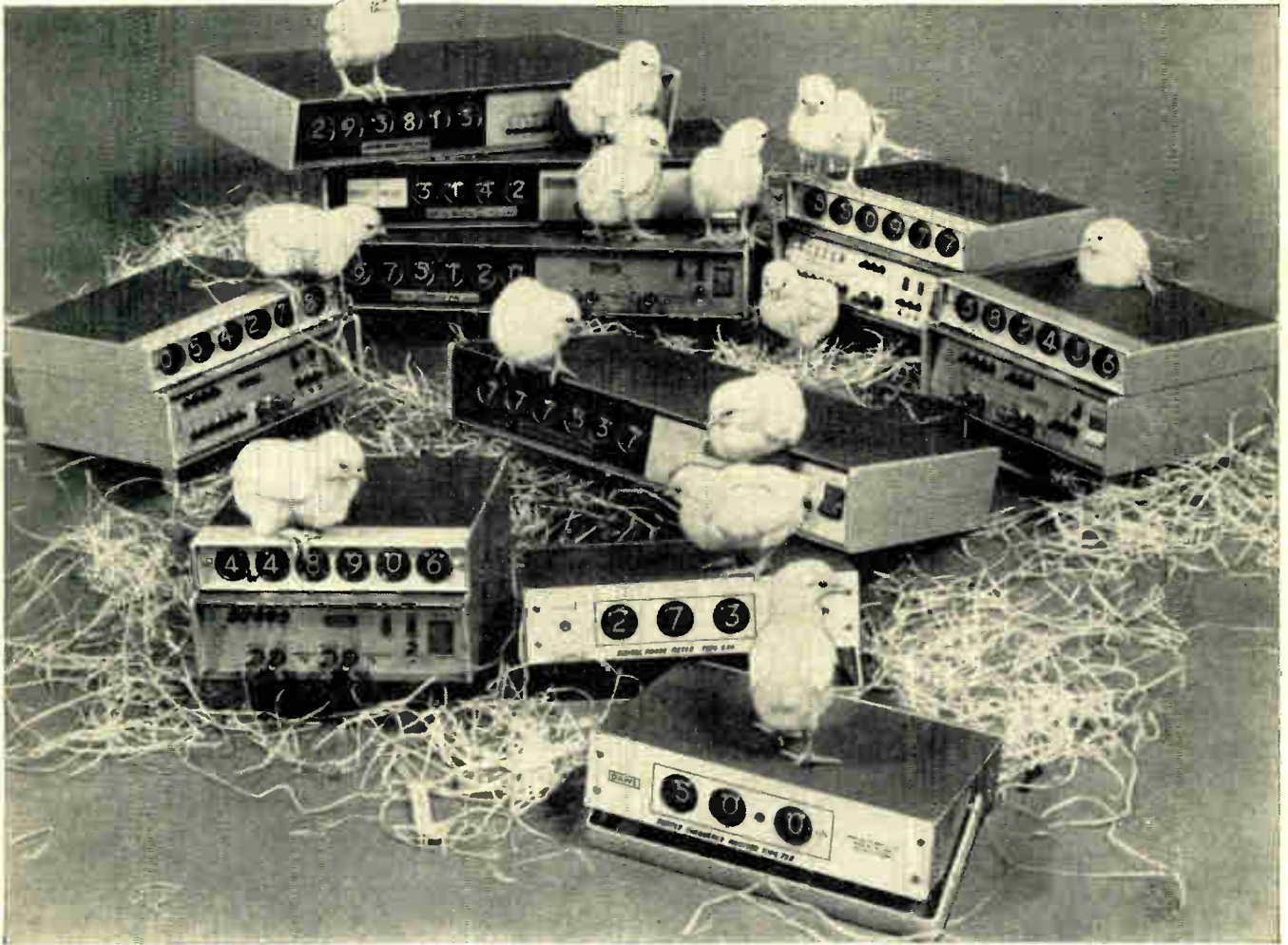

and
hatched out
a whole new family
of DAWE
digital instruments!

Tall ones, short ones, fat ones, slim ones—modular construction explains the family resemblance, those elegant good looks, those frank, open, easy to read faces. It also explains the remarkably low cost (for example, the Type 920A 4 digit, 1Mc/s, Frequency Meter and Counter, £113) and the ease with which modified versions can be made up to meet your individual requirements. For a start the range consists of seventeen of the little beauties—counters, timers, tachometers, ratio meters, frequency meters and multiple function units—but like all proud parents we hope to add to our family from time to time!

Full details available from:—

INSTRUMENT
and digital measurement

division of **DAWE** INSTRUMENTS LTD.,

WESTERN AVE., LONDON, W3 Tel: ACOrn 6751 A member of the *Simms* group of companies

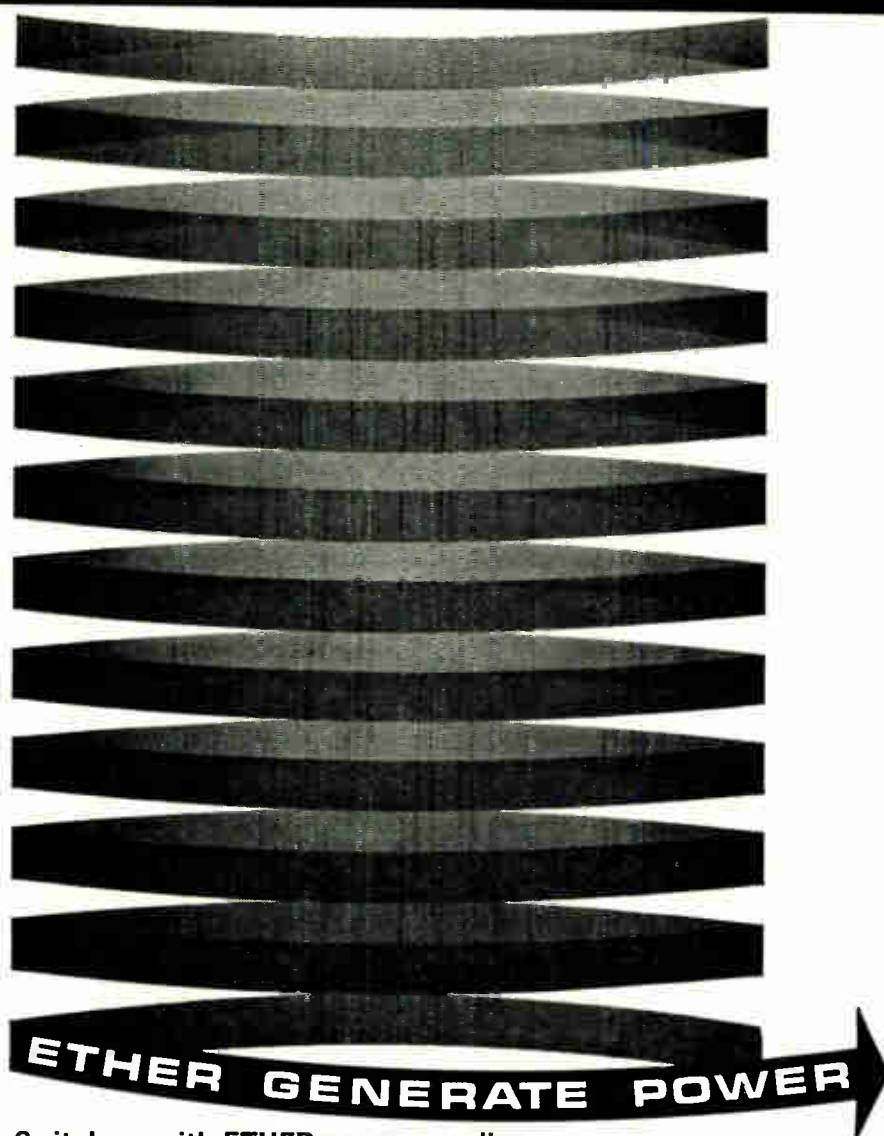

Switch-on with ETHER power supplies

Power supplies—an integral part of any electronic design—can be a headache. Consult Ether at the design stage of any project. Specialist designs available in addition to a wide range of off-the-shelf equipment, all with power-in-reserve including: High-stability units (single and multi-output) variable, plug-in and programmed equipment with wide choice of current and voltage ranges, a.c. voltage regulators, silicon or germanium units.

“ TALK POWER WITH ETHER ”

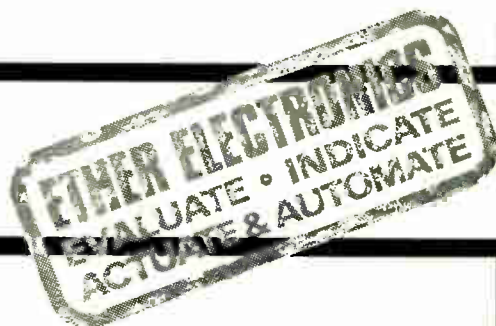

ETHER

ETHER LIMITED, General Products Division, Caxton Way, Stevenage, Herts. Telephone Stevenage 4422.

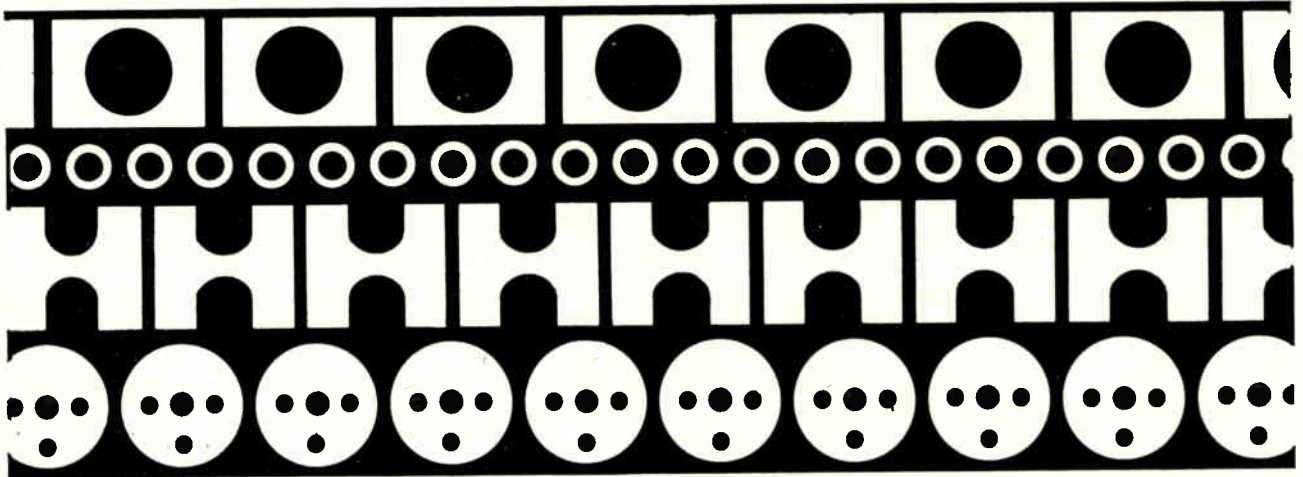

controlled soldering starts with an Enthoven preform

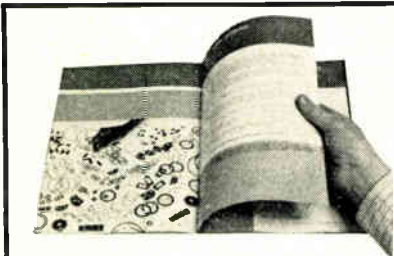

New free booklet describes the complete range of Enthoven Solder products... preforms among them. Ask now for your copy of 'Soldering with Enthoven'.

The right amount of solder, in the right place, every time. The right alloy to suit the surfaces to be joined. The right flux for effective wetting. The right heat-source. Enthoven know about this kind of thing, will give advice, supply preforms—cored or solid. Controlled soldering means economical soldering. Soldering with Enthoven preforms saves solder, time and wastage. Cuts costs. Produces a stronger, cleaner job. Enthoven supply washers, rings, shims and strips in a wide variety of alloys, cored and solid, and design to meet special requirements.

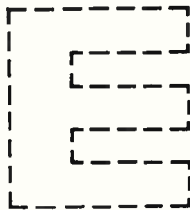

ENTHOVEN SOLDERS LIMITED

Sales Office & Works · Upper Ordnance Wharf · Rotherhithe St · London SE16 · Bermondsey 2014 · Head Office · Dominion Buildings · South Place · London EC2 · Monarch 0391

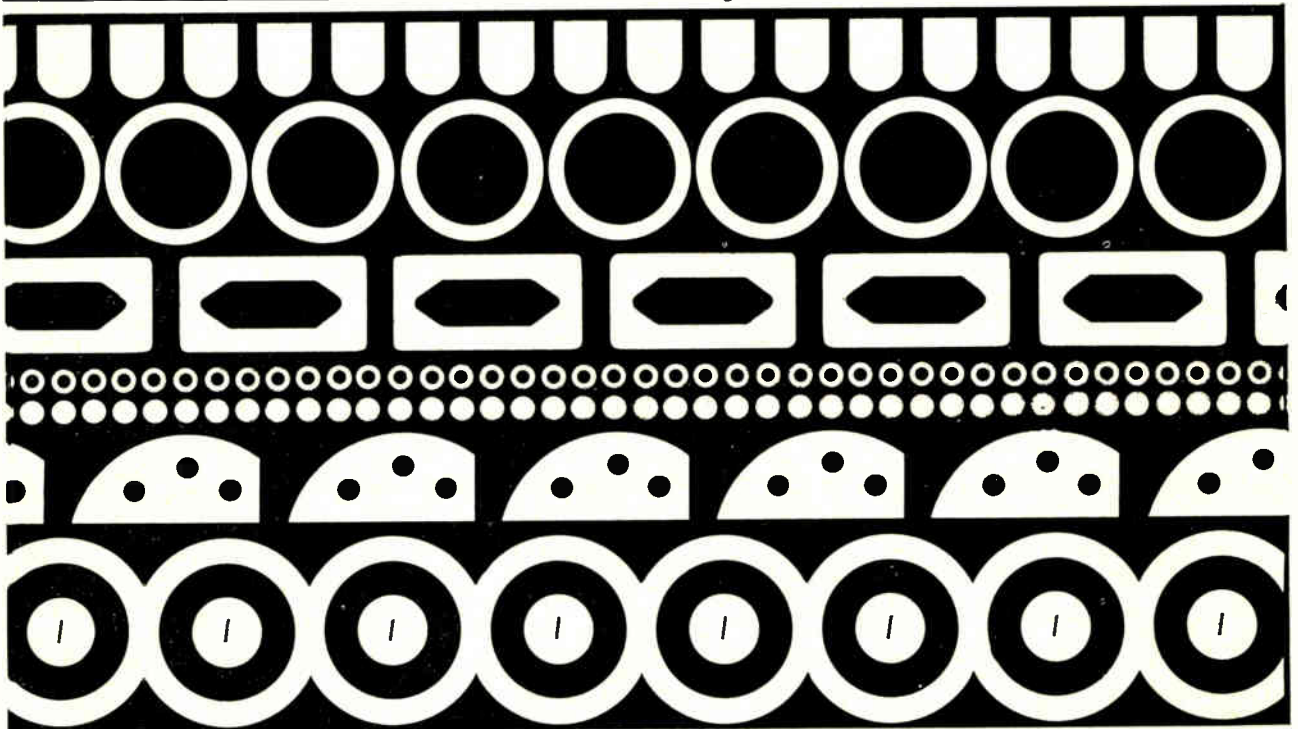

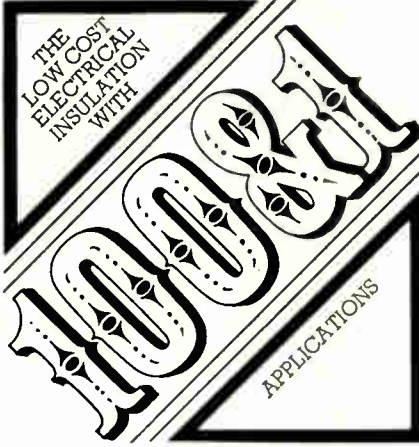

ROLL OR SHEET!

Immediately available in roll- or sheet form, and just a few days service for coils cut to any width up to 36".

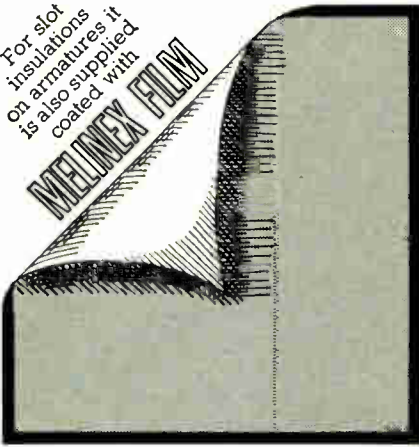

YOUR OWN STAMPED COMPONENTS

For users wishing to make their own stamped components, it can be supplied in strip, or continuous coil for roll fed operation. Or our own fully equipped works can supply the components machined to your drawings.

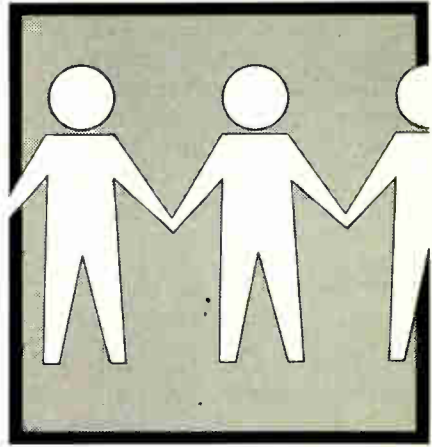

Thickness range from

.004"
to
3/64"

for coils, or up to 1" in sheet or strip.

SQUARE OR RECTANGULAR TUBE

For transformer bobbin formers in calendered or matt finish.

A sample piece for testing, and price details will be sent to you upon application (see coupon below).

You can save time and money by using Delanco Presspahn send now for full information.

To: Anglo-American Vulcanized Fibre Co. Ltd. Cayton Works, Bath Street, London, E.C.1. CLE 8484.

Please send me a sample of Delanco Presspahn and price details

Name

Company

Position

Address

I.E.I



New Mullard Positive Temperature Coefficient Thermistors

... provide cheap and effective motor protection

Three new positive temperature coefficient thermistors, types VA8601, VA8602 and VA8603 in the Mullard VA8600 series are designed specifically for use as detectors in motor overload and overheat protection circuits (the VA8602 joins an earlier device of this type, P80/110/33/01). These p.t.c. thermistors are resistors which, below a certain temperature (90 to 110°C according to type), have a nominal resistance less than 250Ω. Above this temperature, the resistance increases by approximately 15% per deg C. At the designed operating point, 110, 120 or 130°C for types VA8601, VA8602 and VA8603 respectively, the resistance is 1kΩ.

The major advantage of thermistors over conventional protection devices (usually bi-metal thermostats) is that they are extremely small, about the size of a match head, and that consequently they can be inserted directly into the 'hot-spot' of the item to be protected, for example in the winding of a motor field. Thermistors can thus immediately sense the actual temperature of the winding; something that, due to thermal lag, a conventional device mounted on the outside of the winding cannot do. This of course is most important under stalled-start conditions when the winding may heat up very quickly, and under start-stop conditions when, after cut-out, the external protection device may cool off more rapidly than the motor and thus allow the motor to be restarted even though its field is still overheated.

The most important application for these thermistors lies in 3-phase motor protection. In this application, three thermistors are required, one imbedded in each field winding. Connected in series, these thermistors can, via a relay or solid-state switching device such as a thyristor, immediately detect 3-phase fault conditions: single-phasing, unbalanced or incorrect voltage operation, faulty ventilation, stalled rotor or sustained overload.

The use of thermistors allows considerable economies to be made in equipment costs, not only in the protection circuits—thermistors cost only a few shillings—but also in the expensive overrating used in the past to compensate for anticipated misuse of industrial motors.

The three types of p.t.c. thermistor available in the motor protection range are designed for operation at 110,

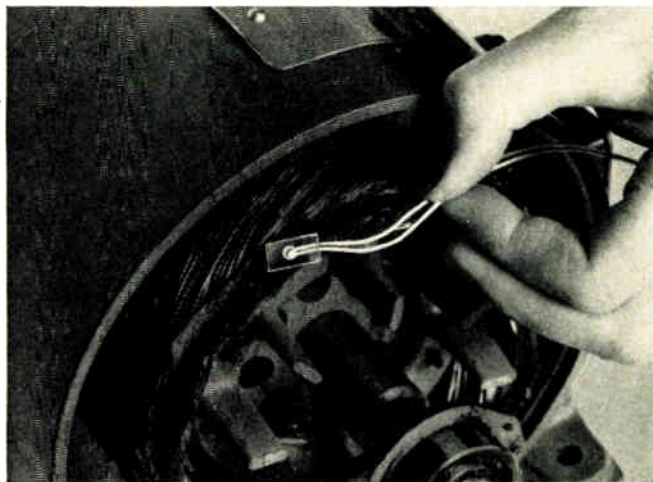

P.T.C. thermistor for motor protection.

120 and 130°C. The 120 and 130°C types are specifically intended for use in the protection circuits of motors with windings insulated to B.S.2757, Classes E and B respectively. The 110°C type is normally used as an early warning device for the 120°C thermistor: the latter may be used to perform a similar service for the 130°C type.

Although this particular group of thermistors is designed for motor and other winding protection, many other types are available from Mullard which are suitable for an extensive variety of applications, such as electro-mechanical control systems, excess current protection and stabilisation in power units, and to make up extremely reliable delay circuits for relays. The method and accuracy of control by thermistors is limited only by the ingenuity of the designer.

Each device in the VA8600 series is 4.8mm × 3.5mm. Leads are p.t.f.e. covered, a specialised material which will tolerate, without damage, temperatures up to 250°C. Preferred lead length is 8in, but other lengths can be supplied for quantity orders.

For further details of positive temperature coefficient thermistors in the VA8600 series, please use the reply card of this journal (see reference opposite).

What's new from Mullard

Faster 'D' Stores

new cost-reducing design

Faster operation at a more competitive price is the most attractive feature of the new improved 'D' stores now available from Mullard. The new models supersede the earlier version introduced last year which had a 2µs cycle time with a capacity of up to 16 384 50-bit words. The earlier version has, however, proved the reliability of the basic 'D' store design in a number of varied applications in Britain and on the Continent: full service facilities are, of course, provided in both of these areas.

Before quoting any figures for the cycle and access time of the new model, it must be appreciated that speed is a function of store size. The most commonly used size - a 16 384 26-bit word store - is used as a basis for discussion here. A 'D' store of this size coupled direct to the control equipment, i.e., with the omission of store staticisers, is capable of operating with wide margins at a speed of only 1.6µs. The same store, operating with its own staticisers, has a cycle time of 1.7µs and an access time of 0.75µs. A similar store for 16 384 50-bit words has a cycle time of 1.9µs and an access time of 0.85µs.

'D' stores can be supplied to individual customer requirements. Optional features include sequential addressing, the provision of separate input and output registers as opposed to the standard input/output register, power supplies, power supply control units and a memory tester. For all

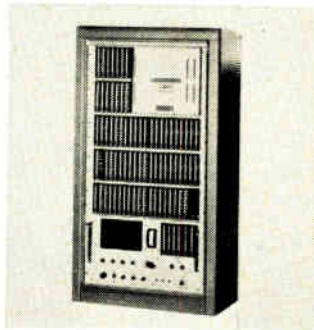

of these features standard boards or units are available.

The majority of these boards are based on a circuit block concept in which encapsulated component blocks replace discrete components. In the complete 'D' store system, only ten different circuit blocks are used - ten to twelve of these blocks being mounted on a typical 7x5in board.

Silicon Planar Transistors for U.H.F. and V.H.F. Amplifiers and Oscillators

A low noise factor at frequencies up to 1Gc/s and a high f_T are the major attractions of the new Mullard n-p-n silicon planar epitaxial transistors 2N3570, 2N3571 and 2N3572. These devices are thus particularly suitable for use as low noise amplifiers or oscillators at frequencies up to 1Gc/s. Typical applications are:

Brief data:	2N3570	2N3571	2N3572
V_{CE0}	15V	15V	13V
$f_T(I_C=5mA, V_{CE}=6V)$	1.5Gc/s min.	1.2Gc/s min.	1.0Gc/s min.
$C_{ob}(V_{CB}=6V, I_E=0)$	0.75pF max.	0.85pF max.	0.85pF max.
$N_F(I_E=2mA, V_{CB}=6V)$	7dB max.	—	—
$f=1Gc/s, R_S=50\Omega$	—	4dB max.	6dB max.
$f=450Mc/s, R_S=100\Omega$	—	—	—
$r_b C_c(I_E=-5mA, V_{CB}=6V, f=79.8Mc/s)$	8ps max.	10ps max.	13ps max.

pre-amplifiers in wideband oscilloscope deflection amplifiers, oscillators in 470Mc/s communication receivers, wideband video amplifiers for carrier telephony repeaters, and wideband v.h.f. amplifiers for microwave links.

TO-72 encapsulation has been used with the fourth lead connected to the envelope.

New Small Signal Transistors

Two new n-p-n silicon planar transistors, types 2N2483 and 2N2484, have now been added to the Mullard range of low-level, low-noise, high performance industrial transistors. Both devices have extremely low noise figures, a feature which makes them eminently suitable for use in low drift d.c. amplifiers, differential amplifiers and high-gain, low-level amplifiers, of the types used in strain gauges, pick-offs and control systems. In addition, their high f_T enables these transistors to give excellent service in h.f. oscillators and frequency multi-

pliers. From the performance data given it will be seen that these new transistors operate as high gain supplements to earlier Mullard types 2N929 and 2N930 which were designed for use in similar applications.

Although these are relatively inexpensive devices, comprehensive data sheets have been prepared for both types which give full h-parameter coverage and specify their h_{FE} between 10µA and 10mA. Both devices are in TO-18 encapsulation with the collector connected to the envelope.

Brief data:

	2N929	2N930	2N2843	2N2484
V_{CE0}	45V	45V	60V	60V
$h_{FE}(I_C=10\mu A, V_{CE}=5V)$	40-120	100-300	40-120	100-500
P_{tot}	300mW	300mW	360mW	360mW
$N_F \text{ max. } (I_{CE}=10\mu A, V_{CE}=5V, R_S=10k\Omega)$	4dB	3dB	4dB	3dB
Bandwidth 0 to 15.7kc/s	4dB	3dB	4dB	3dB
$f_{Tmin}(I_C=0.5mA, V_{CE}=5V)$	50Mc/s	50Mc/s	60Mc/s	60Mc/s
$T_{jmax.}$	175°C	175°C	200°C	200°C

A single detector to cover all the major microwave bands

AEY17 Backward Diode

Using Mullard's new AEY17 backward diode, designers of crystal video receivers and doppler radar receivers can now, for the first time, use a single detector or mixer diode to cover all the major microwave frequency bands. The AEY17 possesses the high tangential sensitivity, -54dBm from 1Gc/s to 18Gc/s. Its r.f. admittance is closely controlled so that the v.s.w.r. in a 50Ω transmission line does not exceed 5:1 over this frequency range. This performance, together with a video impedance of 300Ω, is achieved without the use of the d.c. bias normally required with conventional detector diodes.

An additional advantage of the AEY17 is its low flicker noise which enables receivers to be designed with i.f.'s in the audio range and noise figures some 15dB lower than those obtainable from conventional mixer diodes. When used as a mixer, the AEY17 requires only 200µW local oscillator drive.

FURTHER DETAILS of the Mullard products described in this advertisement can be obtained from the address below or through the Reader Information Service of Industrial Electronics using the appropriate code number shown below.

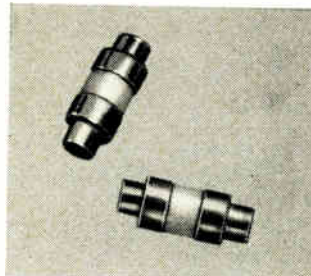

P.T.C. Thermistors	IE 335
Improved 'D' Stores	IE 336
2N3570, 2N3571, 2N3572 Silicon Planar Epitaxials	IE 337
Small Signal Transistors	IE 338
AEY17 Backward Diode	IE 339



Mullard Limited, Mullard House, Torrington Place, London, WC1. Telephone: LANgham 6633

CAM 37

**An
illustration
of
G.P.
-upmanship**

TMC

General Purpose (G.P.) Relay

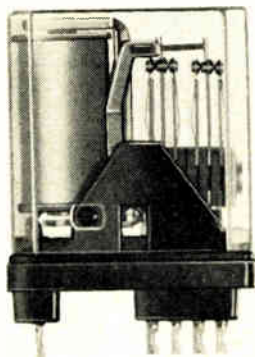

Q *G.P. upmanship.
What's that?

A Going one (or maybe
two or three) better
than others.

To find out how this is
done write to TMC for
details of their new
*General Purpose Relay.
If you feel you know then
write, telephone or telex
for a quotation.

TMC

**TELEPHONE
MANUFACTURING
COMPANY LIMITED**

Components Division
Roper Road
Canterbury
Kent

Telephone: 66577
Telex: 28115

TMC is a registered Trade Mark

A MEMBER OF THE  GROUP OF COMPANIES



TRANSISTOR TESTING DOWN TO NANO AMPS with the Type TT164

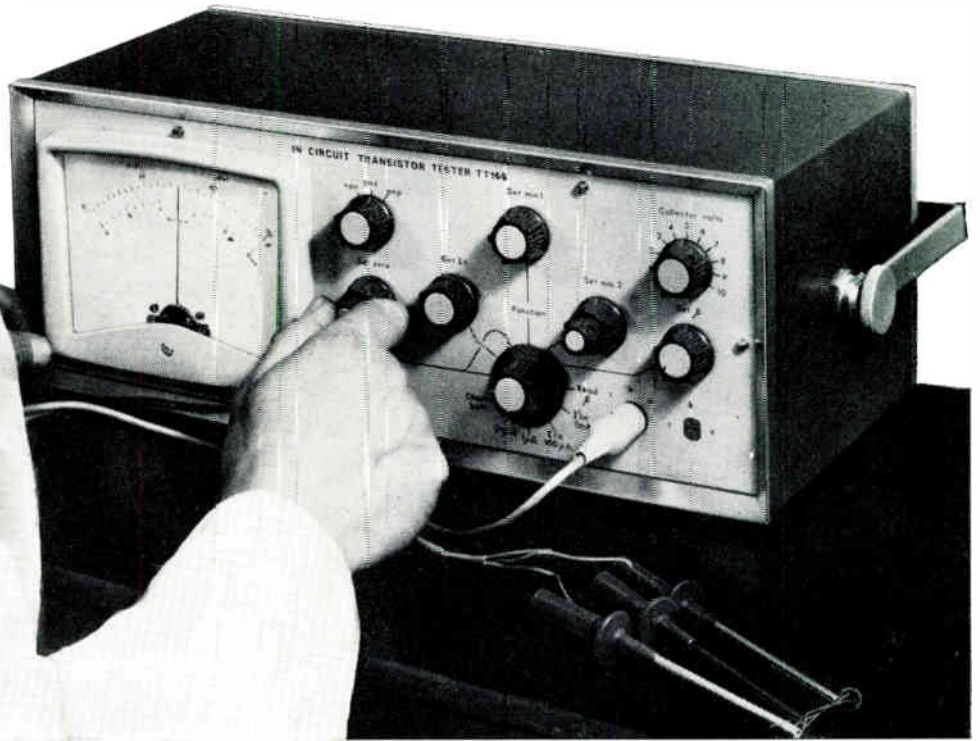

The new Avo In-Circuit Transistor Tester Type TT 164 enables medium power p.n.p. or n.p.n. transistors to be tested simply and quickly. There is no involved setting up, and carefully designed circuits balance out the shunting effect of components connected to the transistor under test.

Introduced to meet the requirements for a direct-reading instrument that is simple to operate, the Type TT 164 — replacing its successful predecessor, the Type TT 162 — is also able to measure (out of circuit) very small leakage currents down to a first indication of 10 nano Amps (300nA f.s.d.).

A battery check facility ensures that supply voltages do not fall below the limit required for satisfactory operation. Overload protection is provided by an internal circuit limitation.

COLLECTOR VOLTAGE:

(In-circuit and Out-of-circuit)

0—10V continuously variable.

COLLECTOR CURRENT:

(In-circuit and Out-of-circuit)

0—10mA continuously variable, and in additive steps of 10mA up to approx. 30mA.

CURRENT GAIN (Beta):

(In-circuit and Out-of-circuit)

0—150 and 0—300 \pm 5% between $\frac{1}{3}$ f.s.d. where external base loading is above 400 Ω .

LEAKAGE CURRENT I'co:

(Out-of-circuit only)

0—300nA, 0—3 μ A.
0—100 μ A and 0—1mA f.s.d.

New descriptive literature now available on request.

AVO LTD

AVOCET HOUSE, ARCHCLIFFE ROAD · DOVER · KENT

Telephone: Dover 2626





3 POLE POWER CONNECTOR L1722 P&S

finger-proof shrouds on plug and
socket contacts. Rating 7amp AC
5 amp DC 250 volts.
Send for Leaflet P703

STACKING PLUGS

4 mm. 'DZ' contacts – single L1708 double L1706.
provide fully shrouded tap-off points for cable
and plug-in connections on all types of instruments
Send for Leaflet P676



YOU SHOULD
KNOW ABOUT
THESE **NEW**

BELLING-LEE components

Write for leaflets mentioned above or telephone Miss Woolgar at Enfield 5393 Ext. 27
Belling & Lee Limited · Great Cambridge Road · Enfield · Middlesex · Telephone: Enfield 5393 · Telex: 263265

The resources of AEI Electronics
Temperature Control Bulletin No. 7.

A new high accuracy solid state Thermocouple temperature controller

62012

AEI has further extended its range of solid state temperature controllers to include a new thermocouple unit Type TC3—yet another moderately-priced high-performance instrument.

Like the RTR3/2 controller—recently announced and already very successful—the TC3 is fully proportional and is designed to work with the established

range of AEI thyristor power regulators. Standard regulators are available in 4, 6 and 10kW ratings, but by using distribution amplifiers, the power which can be controlled is unlimited.

The TC3 is fully transistorised, including the "chopper" and can accept signals in the 0.2 millivolt and 0.40 millivolt ranges from any thermocouple.

TEMPERATURE CONTROL

For further information please write to: Associated Electrical Industries Ltd., Industrial Components Department, P.O. Box 1, Harlow, Essex. Tel: Harlow 26761 (STD 085 96); Telex: 81291—ASSOSELECT HRLW, or your nearest AEI office.



AEI ELECTRONICS

THE TRANSFORMER THAT TAKES TO THE AIR—



SERIES 20 REGAVOLT

although only 2¼" x 1·7/8" dia this variable transformer will dim lighting up to 120 watts on 400 cycle supplies. It is particularly useful in transistor circuits when used on 50 cycle supplies as a 25 watt 1 amp voltage regulator. Full details are given in list 635/OS available on request



Specialists in Current and Voltage Control
The British Electric Resistance Co. Ltd.
QUEENSWAY ENFIELD MDDX. HOWARD 2411 Grams: Vitrohm Enfield 49 R

mackie

Mackie take particular pride in being able to offer a unique service to industry, not only with their standard range of power conversion and generating equipment but also in the development of prototype and special purpose machines.

here

Mackie power units are applied to all types of communication and navigational aids such as Radar, Echo Sounders, Gyro-compasses, Telephone Systems, Computers and Aircraft Ground Power Supplies. Of particular interest is the fact that over 50% of the world's shipping utilizes Mackie power supplies for marine radar. Mackie produce to A.I.D., A.R.B., G.P.O. or Admiralty standards covering a wide range of applications.

there

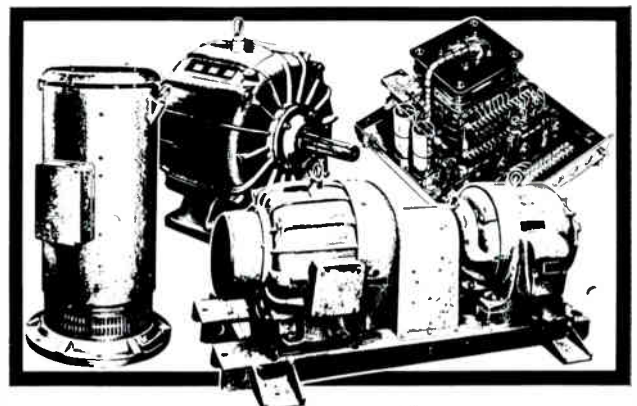

everywhere

Rotary Convertors and Transformers: Self-exciting Generators and Alternators: Motor Generators and Motor Alternators: Pole Amplitude Modulation Motors: Transistorised Static Inverters: Post Office Type Pulsing and Ringing Machines: Dynamotors: Automatic Voltage Regulators—Magnetic Amplifier and Fully Transistorised Types.

W. MACKIE & CO. LTD., WILLOW LANE, MITCHAM, SURREY
Telephone: Mitcham 0951-6 Telegrams: Mackie Croydon Surrey Telex. 264041

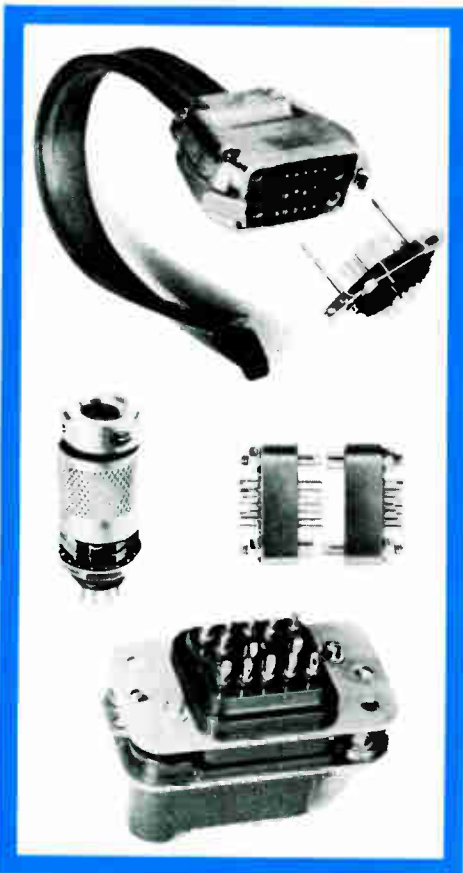
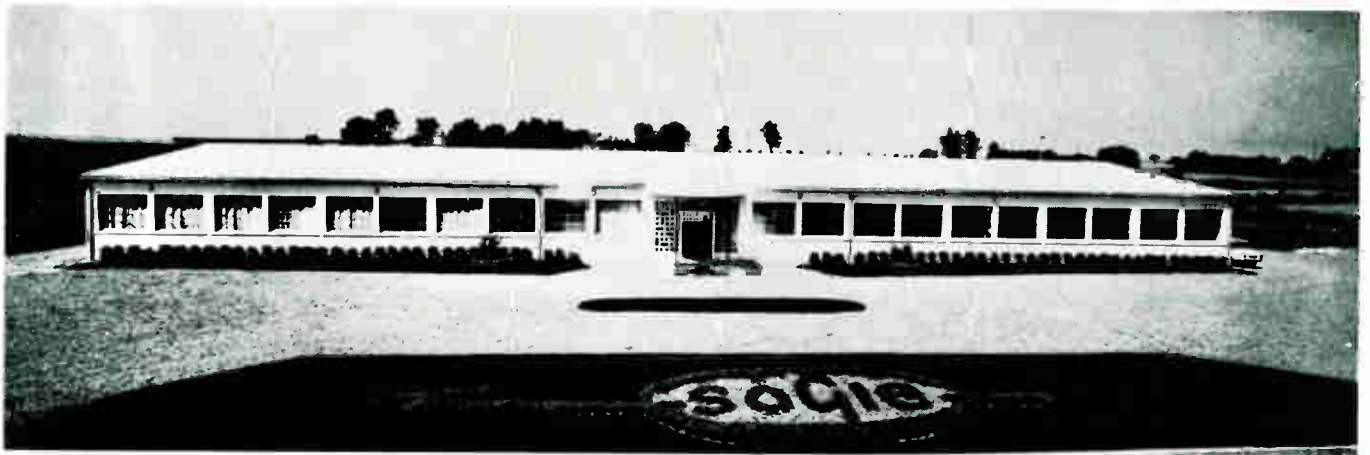

AN
ULTRA-MODERN
FACTORY PRODUCING
ELECTRICAL
CONNECTORS

CUSTOM DESIGN WORK

● SOCIÉTÉ GÉNÉRALE
POUR L'INDUSTRIE
ÉLECTRONIQUE

CELDIS LIMITED
4 Trafford Road
RICHEFIELD ESTATE
READING BERKSHIRE

PLANT LOCATED AT CHATEAURENAULT

If you use INTERFERENCE FILTERS

you should have a copy
of this booklet



GRUBB PARSONS

GRUBB PARSONS · WALKERGATE
NEWCASTLE UPON TYNE 6
TELEPHONE 650411 TELEX 53109

ELECTRO-MECHANICAL

COUNTING & BATCHING



- Counting speed 2400 per min.
 - Batching speed 1500 per min.
 - Complete with photocell input
 - Counting continues without hindrance to products
- Prices from £27-10-0

'BINADIC' SOLID STATE



- Printed Circuit plug-in modules
- Counting speed 3000 per sec.
- With or without Digitron display
- Suitable for variety of inputs

Prices from £55

Photain Controls Ltd. can offer a variety of Counting and Batching units and systems for almost every type of product—give Photain your counting, batching and associated control problems today!

PHOTAIN CONTROLS LTD
Randalls Road, Leatherhead, Surrey.
Telephone: Leatherhead 2776 & 5517.

Give it the works!

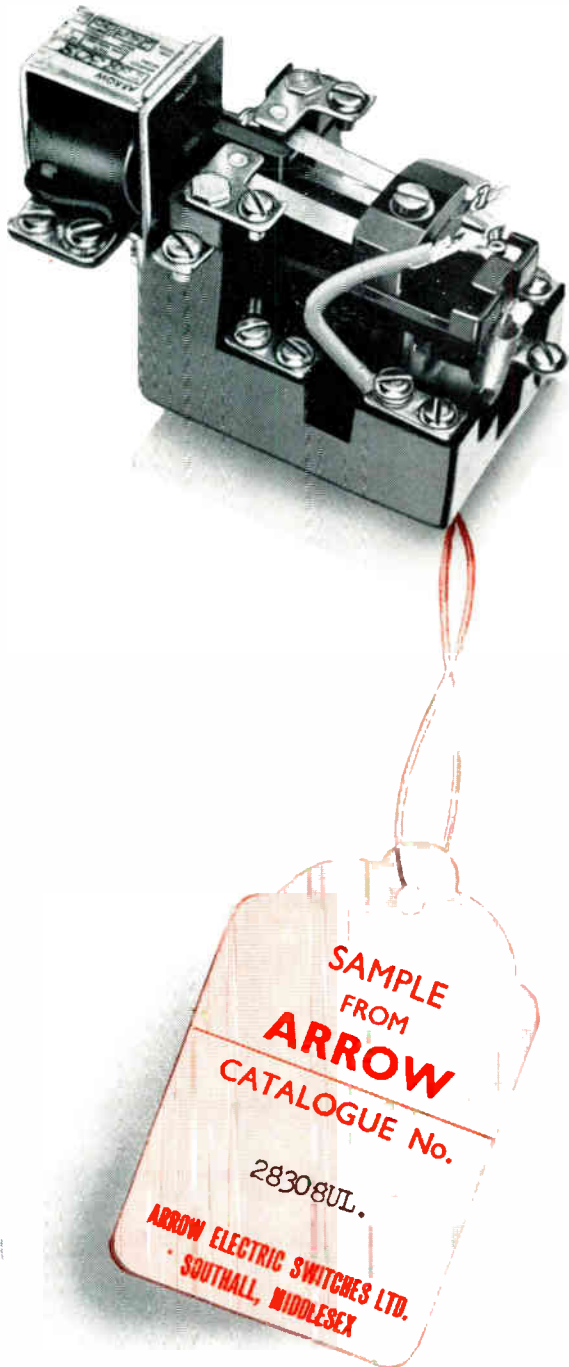

We, at ARROW, understand the responsibility which rests on any Engineer's shoulders whose job it is to specify relays. Therefore, knowing our products as we do, we welcome every opportunity to send samples, as we are confident of the results.

Illustrated is a small Latching Relay particularly suitable for fast cycling latching functions.

The standard circuit is d.p. changeover.

Why not 'give it the works'— you'll get good value for money!

ARROW ELECTRIC SWITCHES LTD

BRENT ROAD · SOUTHALL · MIDDX

Telephone: SOUthall 2442

A53

NEW from KELVIN

DigiKelvo

A multi-purpose instrument with Digital read-out, printed circuit boards and printed circuit connections and extreme portability (10½" x 5¼" x 9¼") for measuring voltage, current and resistance.

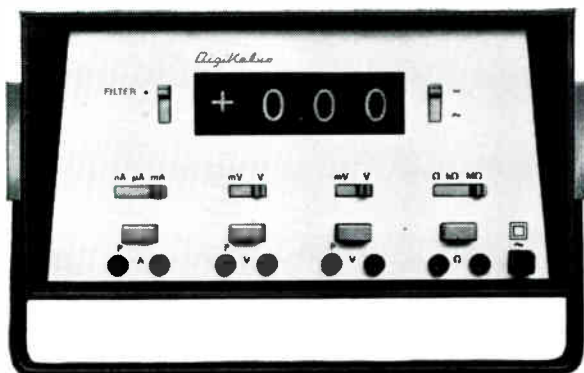

ACCURACY ±0.5% for D.C. ± 1 digit
±1% for A.C. ± 1 digit

RANGES

A.C. and D.C. current 1nA.....999mA
A.C. and D.C. voltage 0.01mV.....999V
resistance 0.01Ω.....99.9MΩ

- * Digital indication of A.C. and D.C. voltage, current and resistance with polarity sign
- * Auto range changing and comma position
- * 4 highly insulated input channels. Input channel selection by push button
- * Instrument protected by fuses
- * Bright character digit tubes for wide angle viewing

Price: £260 nett ex-works. U.K. only.

KELVIN KELVIN ELECTRONICS COMPANY
A DIVISION OF SMITHS INDUSTRIES LIMITED

Kelvin House, Wembley Park Drive, Wembley, Middlesex.
Telephone: Wembley 8888. Grams: Keeco Wembley
Telex: 25366.

KEC 2741



D.C. Motors for electronic speed control

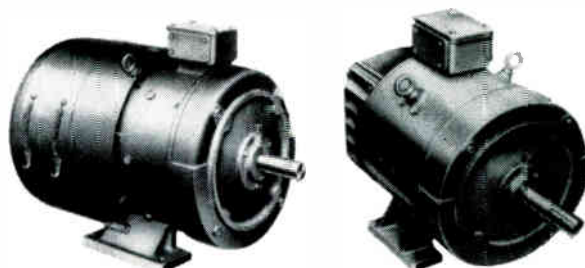

¼-1.00 h.p.



**THE ELECTRICAL POWER ENGINEERING CO. (B'HAM) LTD.,
EPE WORKS 558, BROMFORD LANE BIRMINGHAM 8.**

Telephone: STEchford 2261.

Grams: Torque Phone, Birmingham.



**Complex steel and
non-ferrous investment castings
straight-from-the-mould**

**CUT MACHINING COSTS
— SAVE SKILLED
MAN HOURS!**

PICASTINGS emerge as accurate components straight from the mould. Minimise machining costs and save valuable time. Bring a new design freedom to the shape and complexity of parts ranging from fractions of an ounce to a few pounds in weight. Fine detail, small holes, cavities with high length-to-bore ratios, and thin wall sections are faithfully reproduced in virtually every grade of cast steel, and in a wide range of non-ferrous alloys. For a typical component and full details of what PICASTINGS can offer you, fill in the coupon.

Send for leaflet IE.1



PICASTINGS

Send to
P.I. CASTINGS (Altrincham) LTD., Davenport Lane, Atlantic Street,
Altrincham, Cheshire. Tel: Altrincham 5811 Telex: 66-105

NAME.....
COMPANY.....

P.I. CASTINGS ALTRINCHAM LIMITED.
DAVENPORT LANE • ATLANTIC STREET • ALTRINCHAM • CHES.
Tel: Altrincham 5811 Telex: 66-105

P125

**NOW! Ranges of up to
100,000 Ω per volt, with**

**Kelvo
MULTI-RANGE
TEST METERS**

Measuring AC/DC volts, amps, resistance, capacitance, decibels, temperature.

A comfortable handful of high precision test equipment, covering the widest needs of electrical and electronic measurement. Built-in safeguards against overload and mechanical shock. Wide, shadowless scales, and up to 48 measuring ranges without accessories. The Kelvo range of instruments has been developed to combine reliability, precision, versatility, ease of operation and to be of a convenient and handy size. Send for literature.

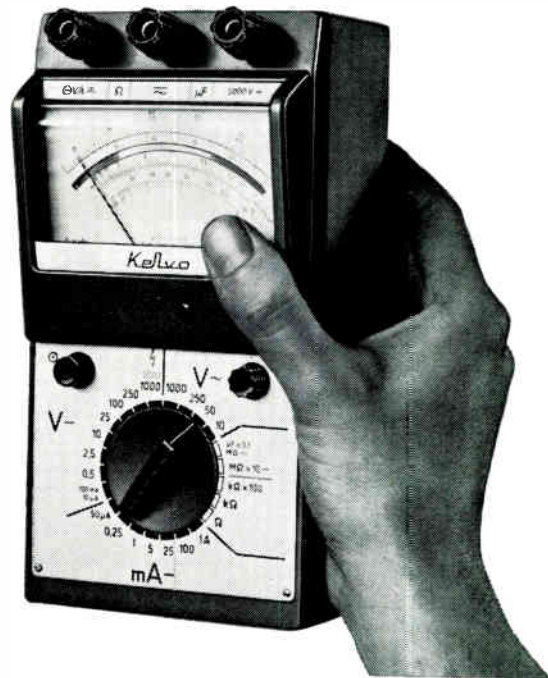

- * High accuracy
- * Friction-free ligament suspension movement
- * Continental symbols
- * Single selection knob
- * Automatic electrical cut-out
- * Modern styling

KELVIN

KELVIN ELECTRONICS COMPANY

A DIVISION OF SMITHS INDUSTRIES LIMITED

Kelvin House, Wembley Park Drive, Wembley, Middlesex.
Telephone: Wembley 8888. Grams: Keeco Wembley
Telex: 25366.

KEC 2323



VANGUARD

25 WATT TRANSISTORISED

Mobile Radiotelephone



ONLY the VANGUARD has ALL these qualities

- 25/30 & 50/60Kc/s channels ■ Extensively Transistorised ■ Sealed Block I.F. Filters ■ Printed Circuitry ■ Very low Battery Drain ■ All Aluminium Construction ■ Dust-proof and splash-proof
- One-Six Channels ■ 25 Watts Output ■ Very low-noise Receiver ■ High Stability Mute ■ 4 Watts Audio Output ■ Meets British, American, Canadian and Continental Specifications

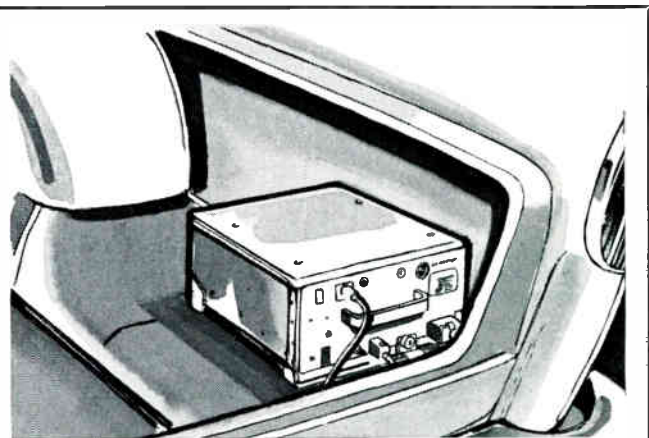

PYE TELECOMMUNICATIONS LIMITED

CAMBRIDGE • ENGLAND • TEL.: CAMBRIDGE 61222 • TELEX NO. 81166

THE **PYE** **Bantam** TWO-WAY RADIOTELEPHONE

a Fully Transistorised Walkie-Talkie!

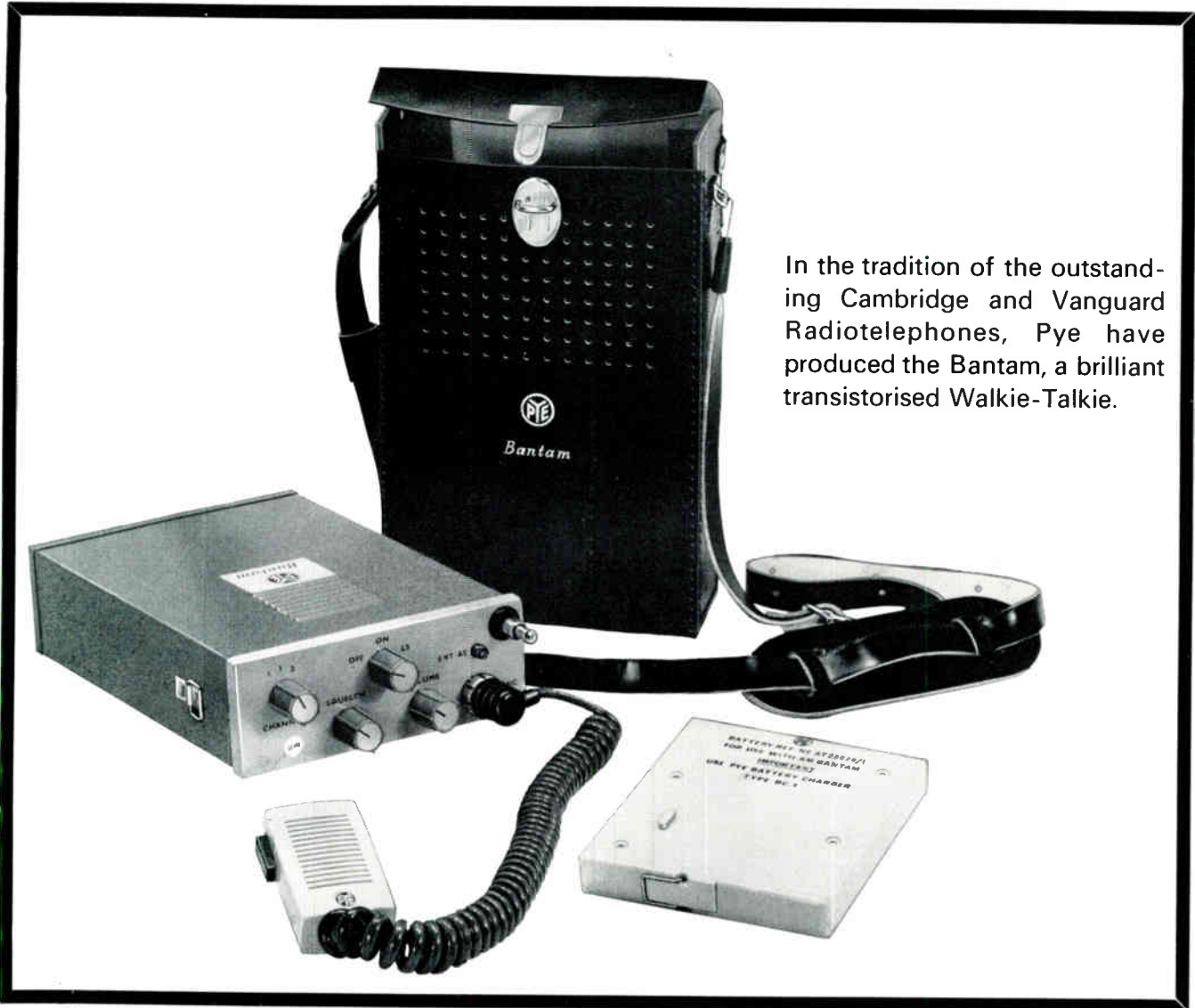

In the tradition of the outstanding Cambridge and Vanguard Radiotelephones, Pye have produced the Bantam, a brilliant transistorised Walkie-Talkie.

- Fully transistorised Transmitter and Receiver
- Long endurance with Rechargeable or Dry Batteries
- Crystal Filter selectivity
- Reliability and accessibility of components
- Very high performance Receiver
- Lightweight 4 lbs. (1.82 kg.)
- Frequency Band 25-174 Mc/s.
- Weatherproof
- Air Registration Board approved for light aircraft category III.
- Approved by G.P.O. to Spec. W6345.
- Intrinsically safe version available

PYE TELECOMMUNICATIONS LTD. CAMBRIDGE ENGLAND. Tel.: Cambridge 61222
Telex No. 81166

ELECTRO PLATING

**ELECTROPLATING
to SPECIFICATION**

Specialist electroplaters of small parts
in quantity

**SILVER, HARD GOLD, NICKEL,
CHROME, CADMIUM, TIN/ZINC,
SPECULUM, RHODIUM, VACUUM
COATING, BARREL POLISHING**

Fully approved War Office, M.O.A. and A.R.B.

N.T. FROST LTD.

HARFORD STREET, BIRMINGHAM 19
Tel.: CENTRAL 4135

For further information circle 232 on Service Card

NOTHING CLEARER THAN WESTON

Your logical choice is Weston for quality of design, for accuracy and for reliability. In the range of Clear Front moving coil instruments, rectangular, square and fan shaped models are available, all with cover masks in a choice of 7 colours. The range is completed by the new space saving Edgewise Instrument. Leaflet W.E.2/2 gives full details.

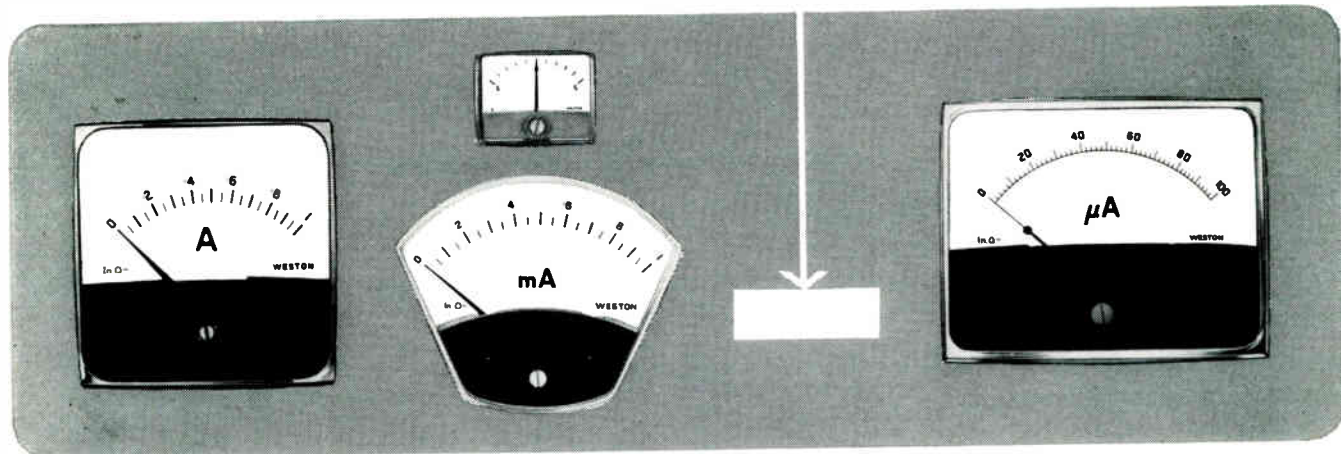

SANGAMO WESTON LIMITED • ENFIELD • MIDDLESEX

Telephone: Keats 1100. Grams: Sanwest, Enfield. Telex: 24724

A WESTINGHOUSE DATA LOGGING AND ALARM SCANNING SYSTEM IS VITAL FOR THE EFFICIENT RUNNING OF MOST INDUSTRIAL PLANTS!

Saves time and manpower. Records automatically, pressures, temperature flows, electrical quantities and on/offs, revolutions, fire detectors, tank/hopper levels.

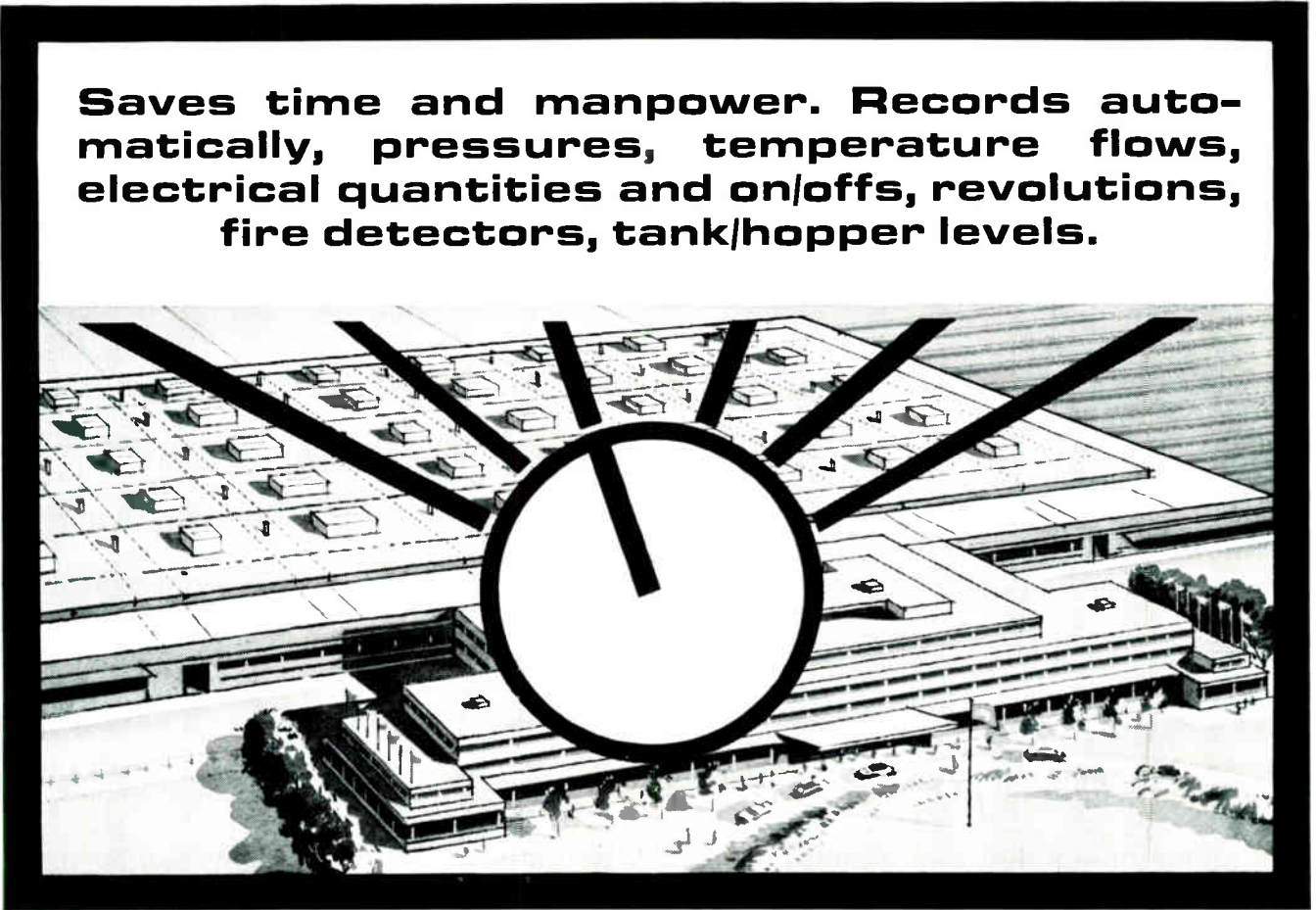

'Phone Chippenham 2881
Automation Division for further details

 **WESTINGHOUSE** 

BRAKE AND SIGNAL CO. LTD.
AUTOMATION DIVISION · CHIPPENHAM · WILTS.

For further information circle 234 on Service Card

ROTAX-BALDWIN PHOTO-ELECTRIC 200 SERIES ENCODERS



Low-cost Photo-electric encoders are more accurate than mechanical types. They achieve high resolution without the use of gears and so avoid backlash, hysteresis and vibration problems. Of their type the 200 series are the smallest and most compact. ■ Low cost ■ Trouble free ■ Long periods between maintenance. Readily available from stock. We offer you the important economic advantage of being able to choose from a wide range of codes (Gray, B.C.D., Sine etc). Why not contact Rotax?

ROTAX

INSTRUMENTATION DIVISION

ROTAX LIMITED, INSTRUMENTATION DIVISION
WILLESDEN JUNCTION, LONDON, N.W.10. TELEPHONE: ELGAR 7777

For further information circle 235 on Service Card

SERVISCOPE MINOR



Extend the range of your present test instrumentation with this versatile Teleequipment oscilloscope. Simplified operation—minimum controls, automatic time base synchronisation—but top quality construction.

2.75" tube with graticule, contrast filter and rubber light hood. Bandwidth DC-30Kc/s (-3dB); maximum sensitivity 100mV/0.5 cm division. Time base continuously variable from 100µsecs to 100msecs per 0.5cm division. Mains operated, fully portable. Instruction manual supplied.

Descriptive leaflet on request.

Obtainable only direct from the country's largest specialist manufacturer of portable oscilloscopes for science and industry.

Serviscope is a registered trade mark

TELEEQUIPMENT





Teleequipment Ltd., 313 Chase Rd., Southgate, London N.14
Tel: Fox Lane 1166

Please send me, without obligation, the descriptive leaflet on the Serviscope Minor.

NAME

ADDRESS

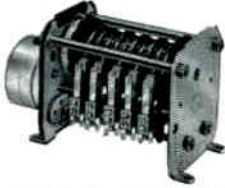
IE/7

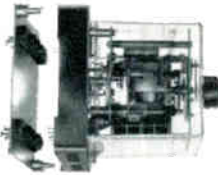
	TIMERS	SERIES 934 TIMER base mounting
	TIMERS	SERIES 807 TIMER base mounting, micro switches
	TIMERS	SERIES 934 TIMER flush mounting
	TIMERS	SERIES 809 TIMER base mounting, snap action switches
	TIMERS	SERIES 812 TIMER panel mounting, snap action switches
	TIMERS	SERIES 932 TIMER base mounting, plug in base

The 800 Series of sequence timers—the timers with the spring held cams and the single clamp screw for simplicity of adjustment—can accommodate up to 24 cams with snap action switches or a lesser number of micro-switches. The 900 Series of reset timers is available with time ranges between seconds and 30 hours. Both series are available as base or flush mounting types. The base mounting version of the 900 Series can be offered with a plug-in base. For full details of these competitively priced timers, make contact with Magnetic Devices now.



M.O.A.-A.R.R.E.-A.R.B. Approved Inspection
G.P.O. & C.E.G.B. Approved Suppliers

MAGNETIC DEVICES LIMITED
NEWMARKET · SUFFOLK · ENGLAND
TEL: NEWMARKET 3451 (10 LINES)

Grams Magnetic Newmarket Telex 81245
 MANUFACTURERS OF RELAYS, SOLENOIDS, & CONNECTORS

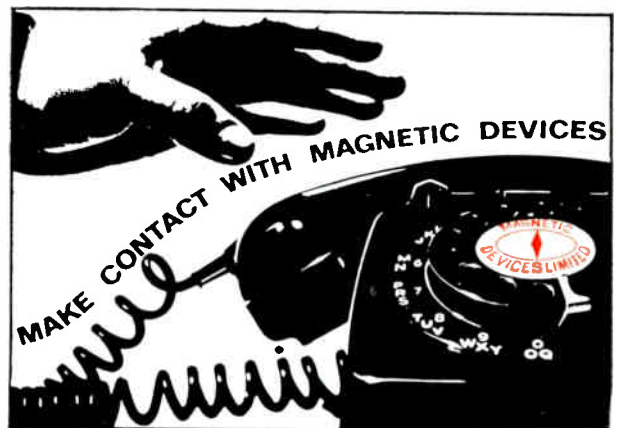

Industry chooses TRANSITRON HLTTL

why?

because HLTTL offers:



The most advanced range of universal logic circuits available



Combined performance not possible in any other form of monolithic digital circuit—

High Noise Immunity	800mV
High Fan Out	15 min
High counting speed	20 Mc/s Min
Low propagation delay	10 nSec max
High capacitive line driving capability	300 pF



A completely compatible and full comprehensive range of integrated logic circuits including—

- Gates: Single and Multiple NAND/NOR and NAND-OR plus expanders
- Flip Flops: Gated 2 phase, Charge Storage and Master Slave types
- Also Line, Lamp and Clock Drivers



Package versatility—

- 14 or 22 lead ceramic-glass flat packs
- 14 lead ceramic-glass dual in-line plug-in packs
- 8 or 12 lead low height TO-5 packages



TRANSITRON ELECTRONIC LIMITED

Gardner Road · Maidenhead · Berkshire · Telephone: 26371 STD OMA-8 Telex: 84335

ASSOCIATE COMPANIES IN PARIS AND MUNICH

Representatives in: Amsterdam · Copenhagen · Milan · Oslo · Stockholm · Vienna · West Berlin · Zurich

INDUSTRIAL ELECTRONICS

Incorporating British Communications and Electronics

Designing by Computer

Recently one of the production artists of *Industrial Electronics* asked: Can a computer do our job? About an hour later, the questioner and two other production men went about their work happy in the thought that computers are not about to usurp their jobs—it is also possible that their knowledge of computers was increased!

This topic is now one of general interest, but fortunately we are beginning to think along lines: 'how can a computer help me in my work' rather than 'will it replace me'. In particular, designers are considering the latest computing techniques as having very great potential in the design stage of almost any product or problem.

For a number of years digital computers have been used for data processing and by now we accept that they are necessary tools for bankers, cashiers and statisticians. With the development of simpler program languages and improved accessories, however, it is now possible for the designer to 'converse' with machines directly without communicating through a programmer. This 'conversational mode' makes it possible for the designer to proceed with his problem step-by-step and it also makes it possible for him to use the computer as a well-informed assistant who has all of the relevant textbook information available on request. Another significant change is the development of means of making a single large machine available, apparently simultaneously, to a number of subscribers. Already machines offering multi-access of up to 100 subscribers are available—one was recently installed at the Ministry of Technology's National Engineering Laboratory, East Kilbride.

Perhaps the most significant developments, however, are the units which have been produced for conveying information about geometric shapes to and from the computer in the designer's natural language—a sketch. Unique among these is the graphic console with a light pen. This looks like a television screen but as well as displaying information it allows the designer to draw with the light pen on the face of the tube and so put information directly into the computer. Equipment has also been developed which allows the computer to read and memorize drawings. The organization or software of these computing processes is even more remarkable and may require tens or hundreds of man-years to write.

All this seems to indicate that only aesthetic designers belonging to large companies will be able to use the computer for design. This is far from true. During a recent visit to Racal Electronics we had the opportunity to design a video amplifier using a computer. Having specified the bandwidth, gain, etc., the machine computed and printed out in 15 min, the value of each component and the frequency response of the amplifier. Admittedly the first attempt, purposely conceived outside the limits to catch-out the computer, resulted in one capacitor being 30,000 μF . The second attempt within limits produced realistic values for the components. And the cost of this machine? According to Racal, it is costing the equivalent of 2½ engineers a year !

Today, the development of the two most prominent forms of microelectronics (thin-film circuits and semiconductor integrated circuits) relies mainly on packaging techniques. This article describes some of the advances in the packaging of semiconductor devices and circuits achieved by Hughes International (U.K.) Ltd. and now being applied at their Glenrothes factory.

PACKAGING means many things. It means the packing case used to transfer the complete equipment from the manufacturer to the customer, the cabinet in which the complete assembly is fitted, the shape and design of the functional modules comprising the equipment, the form of the components and sub-assemblies used to manufacture the functional modules, and so on. In other words the business of electronics hardware is the business of packaging; if all the problems which could be classed as packaging problems were solved, electronics would be completely changed in character. Take the case of the simple transistor, which is normally specified as shown in Fig. 1. As can be seen, practically all parameters are affected by the packaging concept and performance, and the same applies to all components, sub-assemblies, modules and systems.

Microelectronics

With this in mind, let us look at the present-day microelectronics situation. The silicon monolithic circuit has revolutionized the design of electronics systems over the past few years, and we are now beginning to see the effects in terms of hardware. Computers, military systems, and even commercial instruments are appearing with a considerable portion of their circuitry in integrated form. This is a packaging achievement, since no circuit functions have been developed in integrated-circuit form that are not available in discrete-component form, and these equipments do not, in general, have a performance superior to their conventional counterparts. They do, however, have smaller

size, greater reliability and lower cost; and sometimes, in order to achieve the same performance when using integrated circuits, they are more complex.

This topic of performance comparison is a convenient point at which to introduce the monolithic versus hybrid controversy, which is really the subject of this article. Without going into too much detail about the comparison of single-chip and multi-chip construction, the basic philosophy of the monolithic school is that most requirements can be met by circuits fabricated in silicon, using planar techniques. However, while a great deal of work is going on to extend the range and capability of these circuits, a very sizeable fraction of circuit requirements cannot yet be met by them. This applies particularly to high-performance circuits, mostly linear or analogue.

The recognized alternative to the monolithic-circuit approach is the thin-film hybrid approach. Miniaturization, reliability and economy are achieved by thin-film deposition of such passive components as can be fabricated in this way. Other components, including active components, are soldered or welded in position. Until now, this approach has been favoured only for high-performance circuitry or for low production quantities, where suitable off-the-shelf monolithic circuits are not available.

One of the main disadvantages of hybrid circuits has been the rather unsatisfactory diodes and transistors available. The penalties of small size include handling difficulties and inferior environmental performance.

This clear division of capability between hybrid and monolithic circuits has resulted in the concept of a

situation implying that a clear decision must be made whether to go monolithic or to go hybrid. Now, however, advances in semiconductor packaging have made possible a unified microelectronics system, drawing on both hybrid and monolithic techniques (see Fig. 2).

'Flip-Chip' Components

In essence, these advances consist of two main improvements, resulting for the first time in viable semiconductor devices in chip form. First, the surface is protected by a glass layer so that the chips can be tested, handled and mounted without deterioration. Secondly, contacts have been provided so that the chips can be mounted face down, directly onto the thin-film circuit. These technological breakthroughs have been accompanied by a great deal of work on handling techniques and equipment, providing the back-up necessary to make flip-chip circuits a sound economic proposition.

Let us look briefly at the design and construction of these flip-chip components. Fig. 3(a) shows a typical transistor built on a 0.025-in. square chip. This chip looks different from a conventional transistor chip mainly in respect of its contact configuration. The emitter and base diffusions are made in the usual manner but, instead of forming contacts over (or immediately adjacent to) the emitter and base, thin-

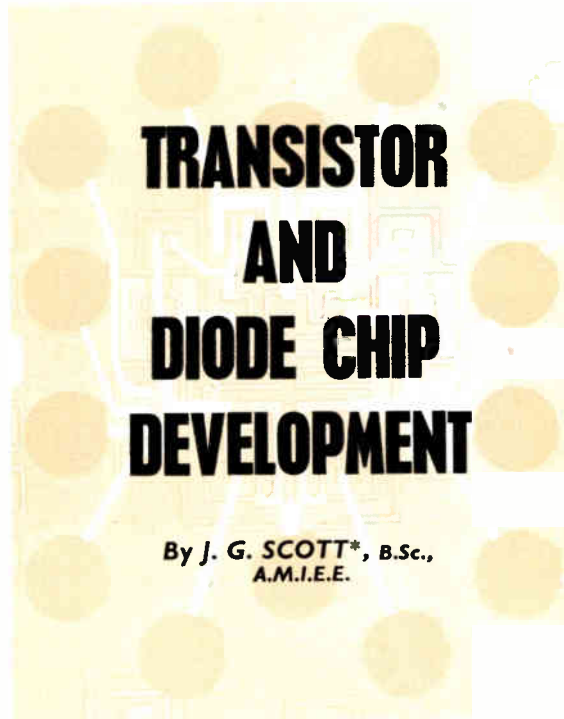

* Formerly with Hughes International (U.K.) Ltd.

Fig. 1. This table shows how practically all the parameters of a simple transistor are affected by the packaging concept and performance. Parameters marked with asterisks are those dependent upon package design

Electrical Characteristics	Package	Environmental Capability
Voltage Rating* Current Rating* Power Rating* Leakage Current* Saturation Voltages* Transient Performance Current Gain Capacitance*	Dimensions* Materials* Marking* Finish* Packing*	Hermeticity* Shock Resistance* Corrosion Resistance* Operating Reliability*

Fig. 2. These two diagrams indicate how in the past (a) microelectronics implied a clear distinction between hybrid and monolithic circuits. Now (b), a unified microelectronics system can be envisaged, drawing on both hybrid and monolithic techniques

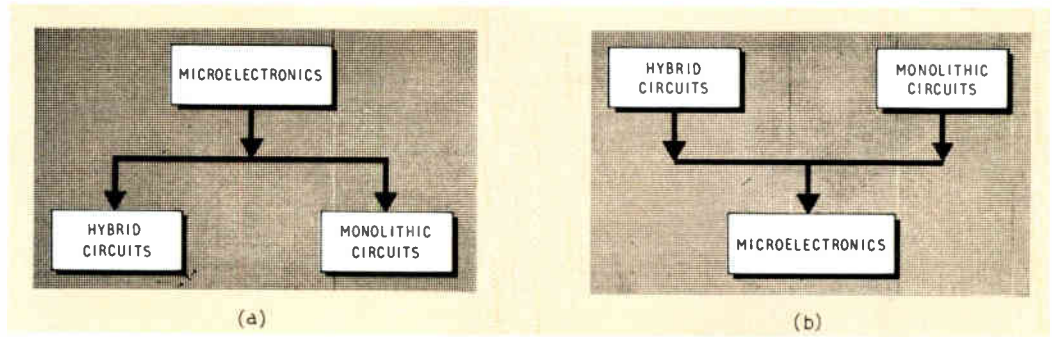

film conductors are laid down and the contacts are then built up well clear of the active structure. This is purely for mechanical convenience (i.e., the chip design is dictated by the packaging concept), for by moving the emitter and base contacts towards the corners of the chip, a broader mounting base is obtained and positioning and tolerancing problems are eased.

The collector contact to a planar transistor chip is usually formed by the back surface of the chip, which is mounted either directly into the header or on to a mounting tab. In the case of the face-mounted transistor chip, the collector must be brought to the top surface, and this is done by penetrating the n-epitaxial layer by means of an n+ diffusion. Although this involves an additional operation, it does not add significantly to the cost, since it is a non-critical step.

Contact metallurgy and form are key factors in making usable flip-chip components. The contacts must be uniform and compatible with both the thin-film conductor which serves as their foundation and the protective glass layer covering the active surface of the chip. The contacts must also be of a material which will bond satisfactorily to the thin-film circuit. There must be just sufficient give to ensure that, where there are more than three 'bumps', satisfactory contact will be achieved at all points. Mounting methods will be discussed later, and it need only be said at the moment that the alloy at present in use adequately satisfies all of these requirements.

Glass surface passivation has been mentioned above, and it is worth noting that this probably represents as significant a step forward in surface protection as did the introduc-

tion of planar processes. Oxide passivation is reasonably effective under controlled conditions, and it is well known that transistor chips will work under water. However, anyone who has assembled planar transistors knows that to obtain a reliable product, even planar devices must be meticulously clean and dry before encapsulation. The 'glass-ambient' concept puts the sensitive junction area one step further away from harmful contaminants. While overall circuit encapsulation or protection is still highly recommended, this is mostly to protect the parts from mechanical damage. Fig. 3(b) shows very effectively the uniform contact 'bump' structure and the high quality of the glass layer. Note the two collector positions available, only one of which is fully formed. The second makes it possible to offer a left-handed version, which can often simplify a circuit layout and reduce the number of cross-overs required.

Thin-Film Circuits

Before moving on to describe the range of flip-chip components, it is relevant to comment on suitable thin-film substrate systems. With regard to the substrate itself, either glass or glazed ceramic can be used. However, besides meeting standard thin-film process requirements, the substrate must have an acceptable expansion coefficient. Glass or alumina with an expansion coefficient close to that of the silicon-chip material is recommended for high reliability, and materials in the range from 4 to 6.5×10^{-6} per $^{\circ}\text{C}$ are adequate. Alumina, with its higher conductivity, is particularly appropriate to higher-power situations.

Many thin-film metallurgies are available, but variants of

Fig. 3. (a) This cross-section of a typical flip-chip transistor illustrates the difference between flip-chip and conventional-chip contact configurations. Here, contacts are built up well clear of the active structure. (b) The uniform contact 'bump' structure of a transistor chip, and the high quality of its glass layer, are clearly shown in this enlargement. Two collector positions are available, only one of which is fully formed; the second allows for 'left-handed' versions to be made

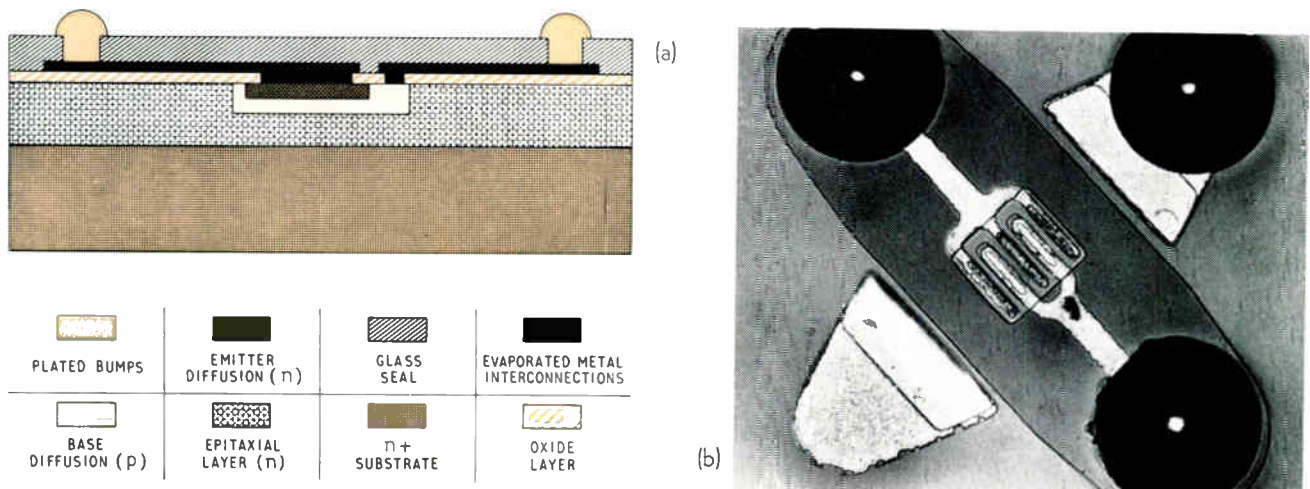

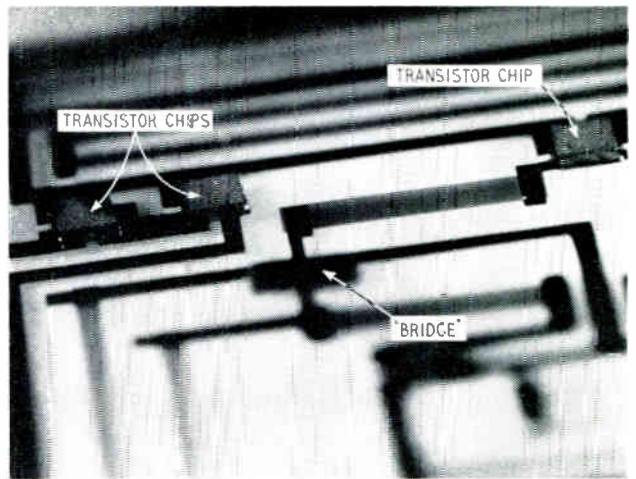
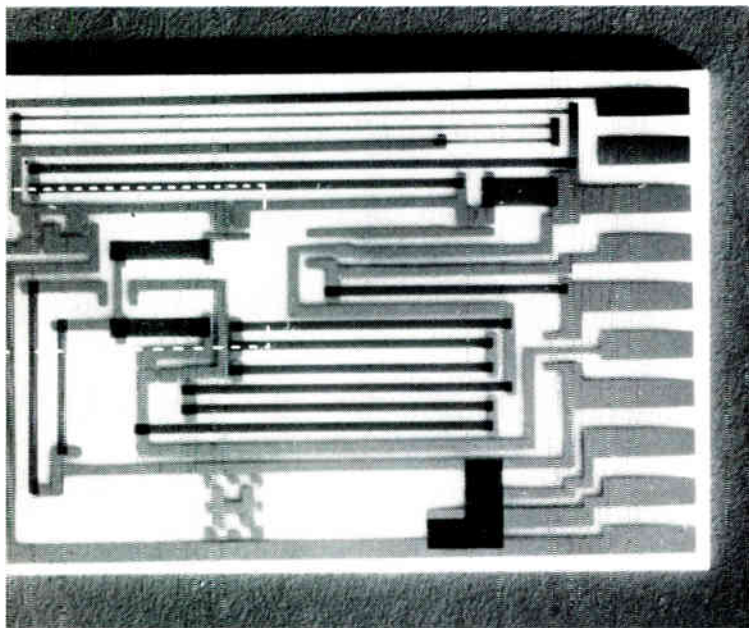

Fig. 4. (a) (left) a greatly magnified view of a thin-film circuit (using flip-chip transistors) for a hybrid operational amplifier. Near the left-hand side can be seen the mounting pads (within the dotted rectangle) for three transistors and one 'bridge'. (b) (above) the three transistor chips and the bridge are here shown (arrowed) mounted in position on their pads

the chrome/gold system are most frequently met. Work at Hughes has been centred on the chrome/copper/gold system, and this is well suited to the flip-chip contact system.

Mention should be made at this stage of the supreme practical example of flip-chip hybrid circuits—those used by IBM in their 360-System computers. These are not, strictly speaking, thin-film circuits, for they are deposited by screen-printing processes and so are more appropriately called thick films. This process is receiving more and more attention nowadays, since it offers simplicity, easy tooling

for new designs or modifications, and relatively-low capital investment. Its main disadvantage is that the resolution of the screen-printing process is inferior to that obtained using thin-film techniques (particularly wet process ones).

There has been some criticism of the hybrid approach on the grounds of the limited capability of the technology, especially in the light of advances in solid-circuit design; but there is no reason why this system need be obsolete for many years to come, if the same substrate system is used to mount and interconnect more complex chips.

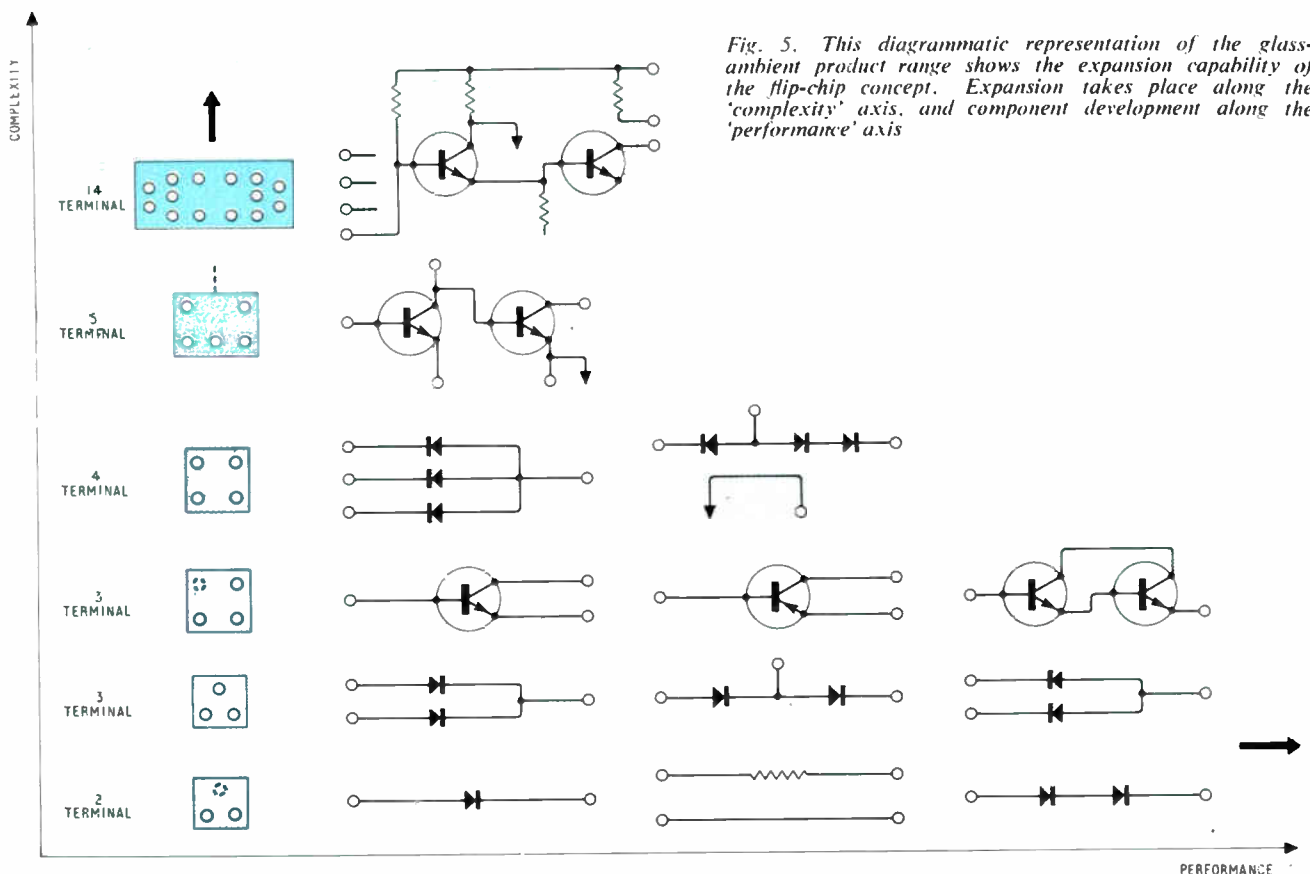

Fig. 5. This diagrammatic representation of the glass-ambient product range shows the expansion capability of the flip-chip concept. Expansion takes place along the 'complexity' axis, and component development along the 'performance' axis

Fig. 6. Four photographs of various component and circuit slices now being produced at Hughes' Glenrothes factory (a)—a triple common-anode diode; (b)—a slice containing quad-emitter transistors; (c)—a slice containing DTL gate circuits; (d)—an enlargement of a DTL circuit

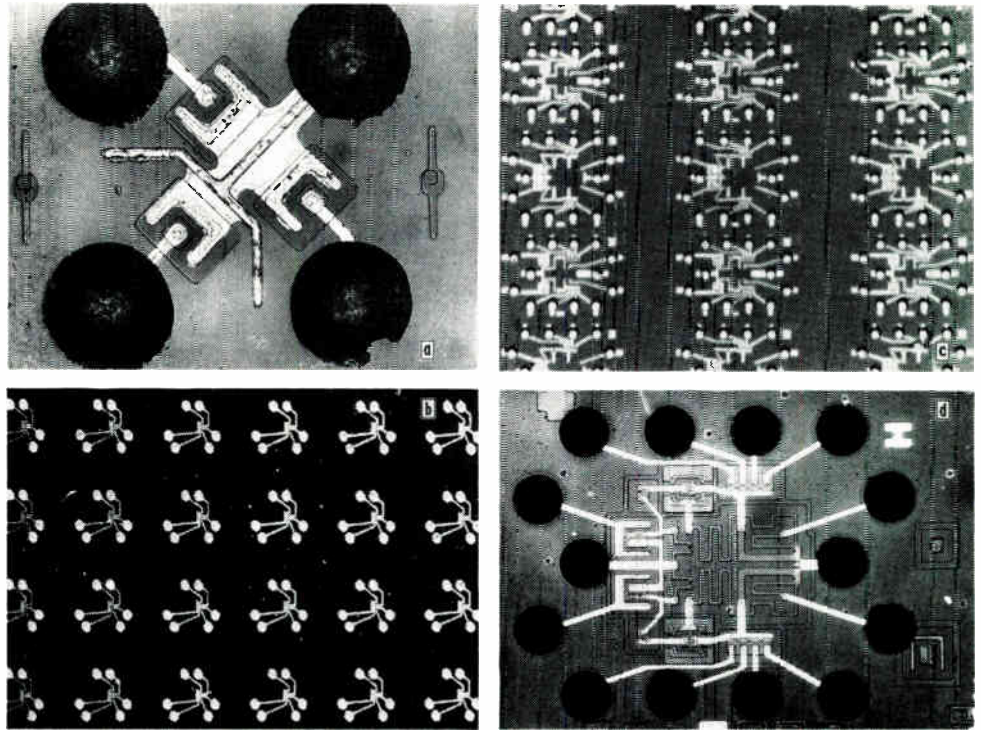

Fig. 4(a) shows the thin-film circuit for a hybrid operational amplifier using flip-chip transistors; near the left-hand side of this circuit can be seen mounting pads for three transistors and one bridge, which are shown (mounted) in close-up in Fig. 4(b). Flip-chip short circuits are used to provide a cross-over function and are undoubtedly an attractive proposition if only a few cross-overs are required. (They correspond to cross-over links on conventional printed circuit boards.) On complex circuits with high chip and wiring densities, there may be many cross-overs, and the additional steps necessary to make thin-film cross-overs could well be justified. The resulting thin-film circuit would then be topographically equivalent to a multi-layer printed-circuit board.

Range of Flip-Chip Components

Fig. 5 shows diagrammatically the expansion capability of the chip concept. Starting from the simplest component (a diode), expansion can take place along the complexity axis. As an indication of expansion potential, development quantities of a 14-bump dual 4-input DTL gate have been produced. Along what might be termed the performance axis, a wide range of components is under development, but the emphasis so far has been on evaluation of the chip concept. On the diode side, for example, attention has been concentrated on one specification basis, namely a 30-V 50-mA switching diode, which can satisfy a very wide range of requirements. Transistor work is centred on an n-p-n transistor (with characteristics very similar to the 2N2369) and on a complementary p-n-p type. We have already examined the n-p-n transistor, and Fig. 6 shows various other component and circuit slices now being produced.

Mounting Techniques

Several methods have been studied to establish the most reliable and efficient method of mounting flip chips, and the problem can be divided in two parts: handling and fixing. The simplest way to fix the chip to the substrate is to solder

it down. This can be done (a) by heating the substrate to the required temperature, or (b) by preheating the substrate to near its soldering temperature and then temporarily raising the chip temperature from the back. Method (a) has the disadvantage that the chips will not freeze in position until they are all fitted and the substrate is cooled. Method (b) is quite feasible, either by the use of a hot-gas gun or by applying a temperature boost via the vacuum pick-up which is generally used to manipulate the chip. Alternatively, the chip may be ultrasonically bonded, and from tests so far carried out, this ultrasonic welding appears the most satisfactory method. (Units have also been centrifuged successfully at 25,000 g.)

One obvious advantage of the ultrasonic method is that both the substrate and the chip are at room temperature during the bonding operation; there is thus minimum stress between the two parts at this temperature. In the other systems described, zero stress temperature (if there is one) is likely to be above 200 °C. If there is a close matching of temperature coefficients between the two parts, and if the chip and substrate are near the same temperature when the solder freezes, this problem is less important, but it should not be overlooked. Another advantage of the room-temperature ultrasonic-welding process is that it is unnecessary to shroud the substrate in an inert atmosphere.

On the mechanical handling side, automatic and semi-automatic equipments are under development, and a manually-operated ultrasonic moulder is now on the market (see Fig. 7), which is capable of mounting 250–350 chips per hour. The chips are placed (contact-side down) on a separate moving mirror plate, positioned and orientated by moving the mirror plate, and then picked up by the vacuum tip of the ultrasonic transducer. The substrate is then



ELECTRONIC
COMMUNICATIONS
INSTRUMENTATION
CONTROL



Fig. 7. This manually-operated ultrasonic chip mouter, capable of mounting 250-350 chips per hour. The chips are placed on a mirror plate, orientated, and then picked up by the vacuum tip of an ultrasonic transducer. The substrate is positioned under the transducer, and the chip is then placed on the circuit and bonded into position

moved into position under the transducer (a graticule in the microscope is used to facilitate this), and the chip is then placed on the circuit and bonded into position.

We have mentioned the importance of contact design and have described devices with up to 14 contacts per chip. It is obvious that the technical problems involved in mounting a 14-bump chip are much greater than those encountered in providing a sound method of mounting 3-bump devices. This problem area is currently receiving a great deal of attention, and the indications are that the present contact system and mounting method will be satisfactory for all chip designs.

Reliability Tests

Reliability is becoming more and more important as equipment gets more complex, and flip-chip techniques are still too new to offer very much reliability data. However, thin-film circuits are known to be extremely reliable, and the overall system reliability revolves around the active devices and the method of mounting. A technique has been developed using special glass headers for evaluating flip-chip transistors and other components. The chip is mounted on the header as if on to a thin-film circuit, and

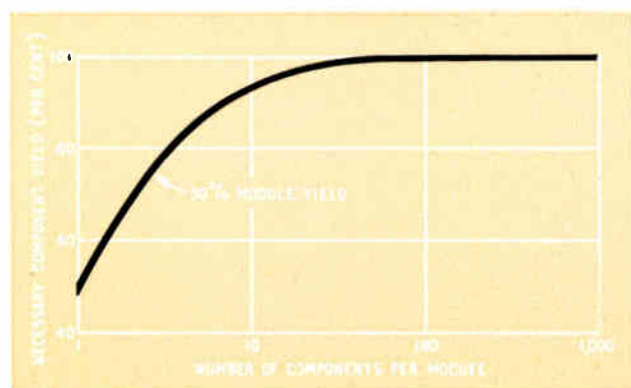

Fig. 8. One of a family of curves which shows the relationship between component yield, complexity and module yield. If there exists the facility to replace one faulty component per module, then the yield values are improved considerably

the assembly can then be treated like a conventional TO-18 transistor for measurement, life testing and environmental testing. In a similar way, the mounting method is also being evaluated.

The 'repairability' of flip-chip hybrid circuits is worthy of comment. Although they are not so easy to repair as certain other forms of hybrid circuit, repair is possible, and this leads to additional advantages of hybrid systems over equivalent monolithic circuits, both in the factory and the field.

Fig. 8 shows the relationship between component yield, complexity and module yield. This is one of a family of curves, from which it can be shown that a 10-component module may be made with a yield of 60% if 95%-yield components are used, and with 82% yield if 98%-yield components are used. If the facility is available to replace one faulty component per module, these yields immediately rise to 97.5%, and 99.6%, respectively. In more complex modules the benefits of repairability are even more spectacular.

Encapsulation and Interconnection

The techniques so far discussed permit the design of compact, economic, high-performance modules. As can be seen from Fig. 9, one complete level of interconnection is removed, and a second level is simplified to one step instead of fourteen. Furthermore, the area taken up by active chips is drastically reduced, from 0.093 sq. in. (for the normal technique) to 0.005 sq. in. (for the flip-chip method).

To take full advantage of this improvement, interconnection at the module level must be critically examined. A

Fig. 9. This table compares the assembly characteristics for normal and flip-chip 14-lead circuits. The normal (flat-pack) technique requires a lead area, whereas the glass-ambient flip-chip method does not

Assembly Stages	Die Mounting	Bonding	Capping	Welding or Soldering	Total
Number of Assembly Steps Required—					
(a) Normal (flat-pack) Method	1	28	1	14	44
(b) Flip-Chip Method	0	0	0	1	1

wide choice of techniques is available, including hand wiring, single or multi-layer printed-circuit boards, modules mounted on printed-circuit connectors and so on. The choice of encapsulation techniques at the module level is also extremely wide, ranging from no encapsulation at all through to large 'flat packs' or hermetically-sealed transistor-like cans. It is beyond the scope of this article to discuss in detail any of these problems, and only one further point will be made. At the substrate level, if it is found desirable to protect the substrate and chips from mechanical damage, it is of vital importance to adjust the expansion coefficient of the encapsulant by using appropriate fillers. The encapsulant should also be used as sparingly as possible.

Power Levels

One disadvantage of this new degree of miniaturization is the problem of power dissipation, which is to some extent accentuated by the method of mounting chips. Nearly all the heat must be conducted to the substrate from the contact bumps. The use of alumina substrates and thermally-conductive encapsulants improves the situation somewhat, but the main improvement will come from circuits and component design. The use of micropower techniques is simplified by the low capacitance and compactness of the substrate and complete system.

Conclusion

The glass ambient flip chip is basically a silicon chip, containing simple or complex functions, connected to the outside world through uniform and standard conducting bump contacts. The sensitive regions on the chip are protected from the outside world by a glass coating. The chip is flexible in function, but standard in mechanical and electrical mounting, and this offers flexibility in design together with uniformity in mounting techniques.

The advantages of the flip-chip hybrid concept are many. (1) They have a lower cost per function, as can be seen at system, sub-system, circuit and device levels. (2) They are flexible for design work, because minimum tooling and development expense is incurred, and the development response time is faster. Also, proprietary circuits can be designed, optimum design being achieved through the use of a wide range of standard or special components. (3) The concept of 'expansion capability' will not become dated,

since total active thin-film systems could be made in flip-chip form and interconnected using these techniques. (All present devices and circuit functions are reducible to this form.) (4) System improvement is achieved, through size reduction, increased reliability and the removal of one complete level of interconnection. (5) The concept of production suitability is maintained, since it has sufficient power, potential and length of technical life to justify capital investment; this is of supreme importance where a guarantee of useful life is necessary. Also, yield at the module stage is inherently high (being improved by the availability of pre-tested dice and the repair capability) and modifications can be carried out easily.

Finally, engineers can now stop debating whether to use hybrid or monolithic techniques and can get on with the job. The two systems have become one, and the term hybrid can now be defined as 'doing the job using the best available means'.

National Industrial-Film Awards 1966

THE Annual National Industrial-Film Awards Competition was held this year in the Shell Centre Theatre, London. Organized by the British Industrial Film Association under the auspices of the Confederation of British Industry, this competition aims, through the medium of film, to provide an opportunity for viewing industrial activities and the progress made in production, research and management; to explain the position of industry and its social problems in a free society; to stimulate the production of industrial films of the highest standard; and to select those British films to be entered in the Annual International Industrial Film Festival (the seventh of which will be held in Venice from 13th-18th September, under the auspices of the Council of European Industrial Federations).

For the purposes of the competition, the subjects covered by the films are divided into seven categories: A, films about industrial questions of general interest (economic, social, technical or scientific). B, films about specific industrial products, materials or projects. C, films which aim less at information than those in categories A and B, but which have the purpose of contributing to the prestige of the industry concerned, or of a firm. (These three categories are for films intended for showing primarily to the general public.) D, films about specific industrial products, materials or projects intended primarily for specialist audiences. E, films on the industrial applications of scientific principles and research, intended primarily for special audiences, including educational establishments. F, films on management and manpower training (e.g., management methods, measures for increasing productivity, rationalization, automation, human relations within a firm, vocational guidance and training etc.). And G, films on accident prevention, occupational diseases, health, re-education and measures of social security. (These last two categories are for films intended for an industrial audience rather than the general public.)

The growing importance of the industrial film as a medium for education, training and communication of information was borne out by the number of films (152) entered for the competition, and by the number of delegates (over 300) enrolled for the screenings of the short-listed films. The days are now past when the industrial film was considered to be appropriate only for an unimaginative and therefore dull presentation of facts and figures. The facilities and advice available from independent and often small film-production companies (such as those belonging to

the Film Producers Guild) can now rival the best in the world, and besides the actual production of a sponsored film will be offered full distribution services on a world-wide scale. For those more interested in screening industrial films rather than sponsoring and producing them, distribution and advisory organizations abound, and the B.I.F.A. (30 Queen Anne's Gate, London, S.W.1, Phone: Whitehall 9971) provides a regular information service and the opportunity to view new films as they become available.

The competition's special export prize—given to the film best calculated to promote British exports—was awarded to *Design for Today* (Category C), and other awards for 1966 were as follows:

Category A. *Horizons Unlimited*: Foreign Office, Commonwealth Relations Office, Colonial Office and the Association of British Aerospace Constructors. (World Wide Pictures Ltd.).

Category B. *The Tortoise and the Hare*: Pirelli Tyre Co. (G.B.) Ltd. (Cammell Hudson & Brownjohn Ltd.).

Category D. *Spat System*: GKN Screws & Fasteners Ltd. (Rayant Pictures Ltd.); *Vauxhall Bedford England*: Vauxhall Motors Ltd. (Arthur Wooster Ltd., Production Consultants: Anthony Gilkison Associates).

Category E. *Distillation*: Shell International Petroleum Co. Ltd. (Shell Film Unit); *Power From Fusion Part 2—The Problem of Containment*: United Kingdom Atomic Energy Authority (G. Buckland Smith, in association with the Film Producers Guild); *Forward to First Principles*: British Railways Board. (British Transport Films); *Physics And Chemistry Of Water*: Unilever Ltd. (World Wide Pictures Ltd.).

Category F. *Work Study in Printing*: British Productivity Council, British Federation of Master Printers and Kindred Trades Federation. (Basic Films Ltd.); *Instructional Technique: Part D—Visual Aids*: Ministry of Defence (Navy). (Stewart Films Ltd.).

Category G. *The Nature of Fire*: Fire Protection Association. (Kinocrat Films Ltd.); *And Then There Was One*: Allen & Hanbury Ltd. (Verity Films Ltd., in association with the Film Producers Guild).

Of those films on electronic subjects, which were entered for the competition but which were not among the 29 short listed, special mention might be made of *Thin-Film Microcircuits* and *Electrons In Harness*, both made for Mullard Ltd., and *The Radio Sky*, made for A.E.I. Ltd.

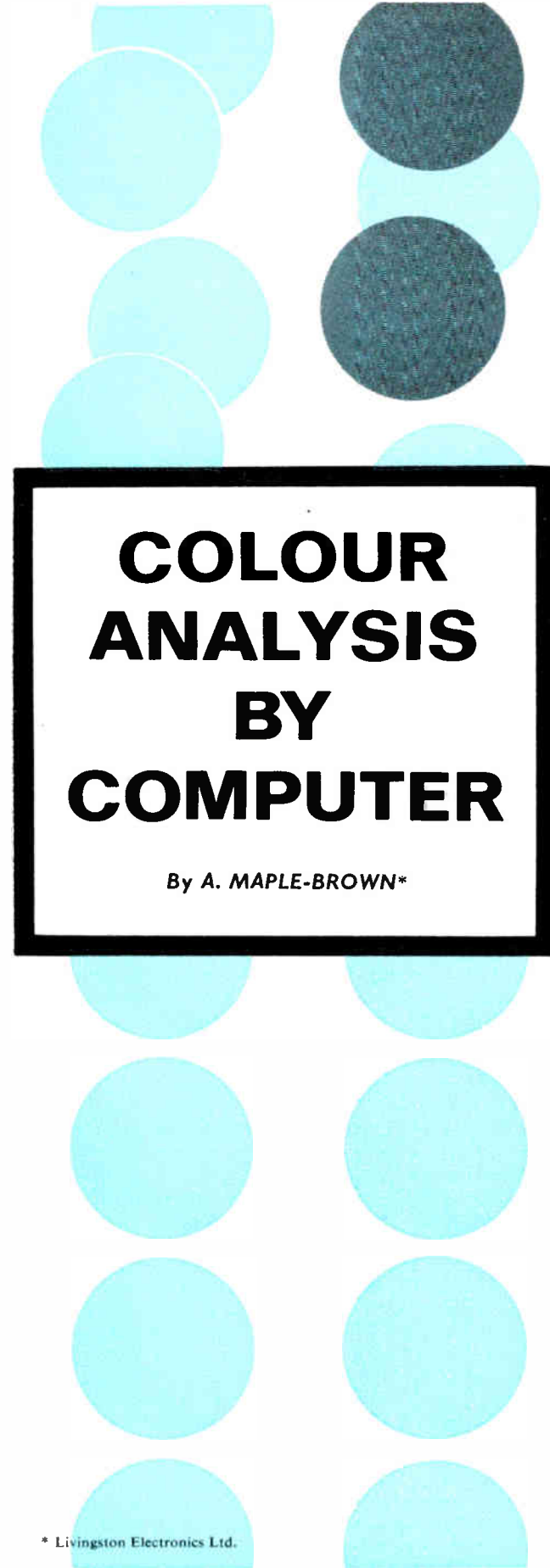

COLOUR ANALYSIS BY COMPUTER

By A. MAPLE-BROWN*

* Livingston Electronics Ltd.

Colour matching has long been an art based on human judgement. While this has been satisfactory in the past, it is now proving to be inefficient with modern production methods. Computing systems have been developed for colour analysis, and this article describes their application in this sphere.

WE become aware of light or colour when the retina of the eye is stimulated by electromagnetic radiation having a wavelength in the range of approximately 400 m μ to 700 m μ (1 m μ = 10⁻⁹ metre = 10 Å). The wavelengths of the various different colours we see vary from violet (400–430 m μ), through blue (430–485 m μ), green (485–570 m μ) and orange (586–610 m μ), to red (above 610 m μ).

Colour Perception

The first important fact about colour is that it is a sensation generated by the brain as a result of visible light entering the eye; thus a given colour light will not necessarily provide the same sensation to different observers. While the eye is very sensitive to small colour differences of samples viewed together, it has a very poor memory; thus if two slightly different colours are observed one at a time, the eye is not nearly as sensitive to differences between them as it would be if they were seen side by side.

The large number of experiments which have been undertaken in the study of colour vision all point to the fact that the eye reacts to visible electromagnetic radiation in a three-dimensional manner. In other words, it appears that the retina of the eye is equipped with three types of detector, each with maximum sensitivity in different regions of the visible spectrum. The perception of colour is thus determined in the brain by the relative magnitudes of the signals from the three different detectors. Hence we can say that every colour can be accurately described numerically by three factors, or co-ordinates. Dyers, for instance, often describe a colour qualitatively in terms of the three factors: hue, depth and brightness (or brilliance).

The actual sensitivity of each of the detectors at different wavelengths has been determined by averaging the results of actual tests made with numbers of different observers, each having normal colour vision. These average characteristics have been standardized and describe the vision of a hypothetical 'standard observer'. This 'standard observer' came into being in 1931 at the C.I.E. (Commission International de l'Eclairage) conference and has remained in use ever since, despite some limitations. The spectral sensitivity of the three detectors is shown in Fig. 1 and they are known as the C.I.E. x, y and z spectral-distribution curves for normal colour vision. It will be seen that x represents the detector most sensitive to red light, while y is most sensitive in the yellow/green region and z is most sensitive in the blue region.

Light Sources

What has been said so far takes no account of where the light stimulating the retina has originated. In nearly every instance where colour is present, light (usually white) has been reflected from a surface. It is obvious that the colour of the light illuminating a surface will greatly affect the colour of the light reflected by that surface, and this is clearly evident if an object is alternately illuminated with different, strongly-coloured spot lights. Similarly, it is not possible for a surface (unless it is fluorescent) to reflect a colour that is not present in the illuminating light. For the purpose of measuring colour, it is essential to know the

relative amounts of light that are present in the source at different wavelengths.

To establish internationally-comparable values for colour measurement, it has become international usage to work with only two standardized sources of light. These are: (1) source A, an incandescent lamp operated at a colour temperature of 2,854 °K, and (2) source C, representative of average daylight as from a completely overcast sky. Fig. 2 shows the relative energy distribution of these sources.

Part of the light falling on an object is reflected, while the rest is either absorbed or transmitted. The reflected portion of the radiation is measured as the reflectance, and is defined (at a particular wavelength) as the ratio of the light reflected by the surface to the light reflected by a perfect white surface at the same wavelength and under the same conditions of illumination. The ideal white surface is such that all incident light is diffusely reflected from it. Since reflectance is a ratio measurement, it is independent of the energy distribution of the illuminating light; and the reflectance of a surface at various wavelengths is measured with a spectrophotometer. The colour of a reflecting surface is thus determined by the product of three separate factors: the reflectance of the surface, the energy distribution of the incident light falling on it, and the effect of the observer.

Colour Measurement

To measure colour, rather than reflectance, we have to return to our standard observer and the three-detector system in order to measure the response of the different detectors when viewing the object under consideration. In practice, this can be done by making an instrument with three (or four) filters and an associated photosensor, which have the same spectral sensitivity as the x, y and z detectors of our standard observer.

With one particular instrument (the Color Eye), the new 'Signature' model has four filters (two x, one y and one z), because of the secondary response of the standardized red detector in the blue end of the spectrum. In either case, the colour is measured by comparison with a standard—usually barium sulphate or white vitrolite glass. The three, or four, readings are then multiplied by calibration factors to give the C.I.E. X, Y and Z tristimulus values of that particular colour when illuminated with a given light source (usually source C). These three figures are expressed in percentages, and the instrument designed to make these measurements is called a 'colorimeter'. By plotting these C.I.E. tristimulus values it would be possible to construct a three-dimensional colour solid defining all possible colours. Since this would be somewhat difficult to work with, it is common practice to project the 'colour solid' on to a 'colour plane', and to indicate all colours in this plane, which has two orthogonal axes: x and y.

The projection of a particular colour on to this plane is done by calculating the 'chromaticity co-ordinates' (x and y) using the equations

$$x = \frac{X}{X + Y + Z} \text{ and } y = \frac{Y}{X + Y + Z}$$

Hence x represents the ratio of the red tristimulus value in terms of the total of tristimulus values, while y represents the proportion of yellow/green. These co-ordinates then describe the chromaticity of a colour by defining the hue and saturation (purity). The brightness (or luminosity), on the other hand, does not affect x and y in any way; for example, if all the tristimulus values are doubled, x and y do not change. It is this separation of 'chromaticity'

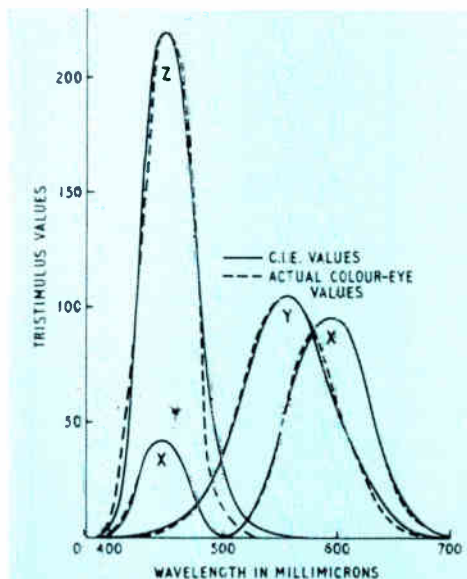

Fig. 1. Comparison tristimulus curves (for illuminant C)

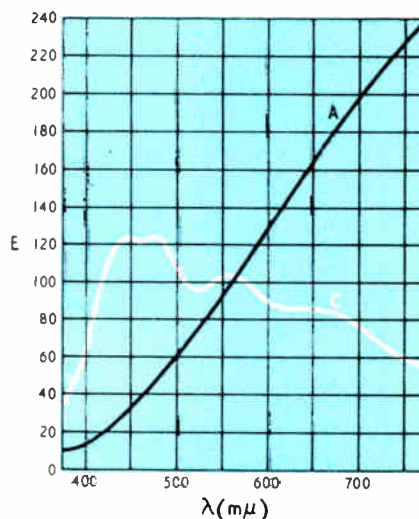

Fig. 2. Relative energy distribution curves of standard sources A (incandescent light) and C (overcast-sky daylight)

and 'luminosity' which makes computation of the chromaticity co-ordinates useful in practice. Colour as described by the C.I.E. system can thus be plotted on a chromaticity or tristimulus diagram (see Fig. 3).

If we were to plot the chromaticity co-ordinates of all pure spectrum colours, starting with blue and finishing at red, we would cover a horseshoe-shaped path starting at point P and finishing at point Q; all possible colours are located within the area between the curve and the line joining P and Q. The chromaticity co-ordinates of equal-energy light are (0.333, 0.333), while those of illuminants C and A are (0.310, 0.316) and (0.4476, 0.4074) respectively. In most practical cases, however, we are concerned with measuring colour as it would appear under daylight view-

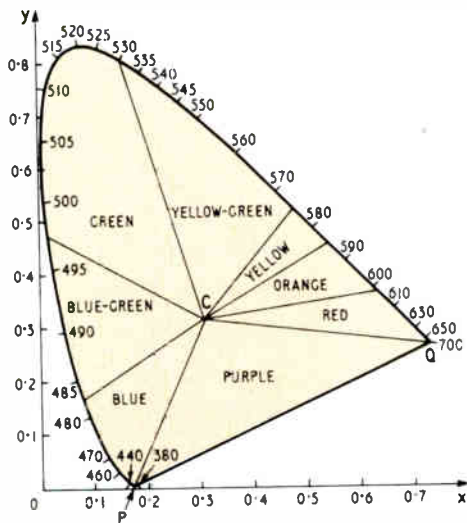

Fig. 3. A C.I.E. chromaticity diagram. The point C in the centre is the 'achromatic', 'neutral', 'white' or 'illuminant-C' point

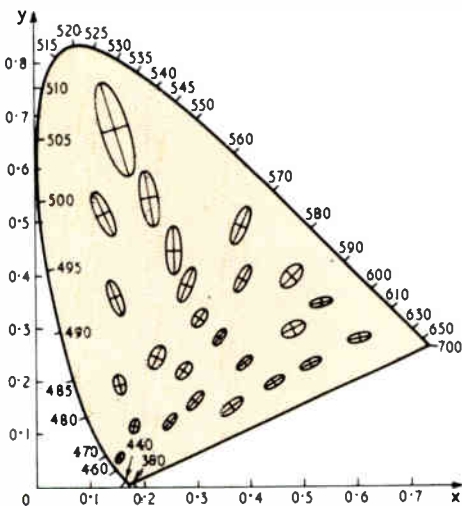

Fig. 4. MacAdam ellipses representing the visual colour-difference threshold (tenfold magnification)

ing conditions; i.e. under illuminant C. For a perfectly white reflecting surface, the energy distribution of the reflected light will be the same as that of the incident light, so the chromaticity co-ordinates of a perfect white surface illuminated by illuminant C are the same as the chromaticity co-ordinates of illuminant C itself, viz. (0.310, 0.316). Colours of the same hue but of different saturation have chromaticity co-ordinates along straight lines starting at (0.310, 0.316), the so called 'achromatic' or 'neutral' point, and finishing at any point on the spectrum locus. The further away the chromaticity point is from the neutral point, the greater the purity of the colour.

While the co-ordinates (x, y) define the chromaticity of a dyeing, a measure of the brightness is also required to define exactly the colour. This is supplied by one of the C.I.E. tristimulus values, the so called 'luminosity' (or Y) value.

This is because the Y spectral sensitivity coincides with the relative-luminosity sensitivity of the eye. The full three co-ordinates of the C.I.E. system can, therefore, be plotted in space in such a manner that the Y axis (luminosity) rises vertically from the plane of the chromaticity diagram and passes through the neutral point. It is interesting to note that, for higher values of brightness, the colour solid thus defined in terms of x, y and Y co-ordinates is not cylindrical in shape but becomes pointed, rather like a mountain. Thus, at 100% brightness the only colour existing is pure white.

Colour Difference

When we come to the question of colour difference, it might be reasonable to assume that two pairs of colours, located in different parts of the chromaticity diagram and with the same chromaticity co-ordinate and luminosity differences (i.e., the same Δx , Δy and ΔY), might exhibit similar degrees of colour difference to an observer. Regrettably, this is not true, and so if one wishes to determine small chromaticity differences by an objective method, it is necessary to transform the C.I.E. system into another system where distance corresponds to colour difference as seen visually, so that the spacing of two colours is a measure of their visual colour difference (ΔE). In other words we require a uniform colour-difference scale.

Many people have looked into this problem and have developed various methods of evaluating colour difference. Judd¹ was one of the earliest workers in this field, and his colour difference formula (1939) is used as a basis for defining the N.B.S. (U.S. National Bureau of Standards) unit of colour difference. Another formula which is of importance was given in 1944 by Nickerson and Stultz²; but the particular investigations that we wish to discuss here have been done by MacAdam³.

After conducting experiments on the magnitude of the minimum detectable visual colour difference, MacAdam deduced that colour differences which can just be distinguished from a given standard are located in the C.I.E. chromaticity diagram on an elliptical locus around the chromaticity point of the standard. The elliptical curves, which have different axes, orientation and size depending upon which part of the chromaticity diagram they occupy, are shown magnified 10 times in Fig. 4. If luminosity differences are also considered, we obtain 'tolerance ellipsoids' in colour space.

Simon and Goodwin of the Union Carbide Corporation⁴ have taken this information a stage further and produced special charts which enable colour differences, based on MacAdam's work, to be determined graphically. (MacAdam's work was carried out using light sources and, as a result, is based on chromaticity differences only; Simon and Goodwin, however, have taken into account differences in brightness (Y) as well.) With this chart system, the area enclosed by the pure spectrum locus on the chromaticity diagram is divided into 89 different zones, each with a standard characteristic tolerance ellipse. Obviously, at any point within any of these zones, the standard ellipse will differ from the theoretically-determined ellipse, but the zones have been chosen so that this error is never more than 12½%.

To make the use of these charts as simple as possible, the x and y axes within a given zone are rotated relative to each other to transform the MacAdam ellipses into circles. This means that a given distance in any direction on these charts corresponds to a constant chromaticity difference (ΔC). Thus, having plotted the standard in the centre of the chart, Δx and Δy determine the location of the sample point, and the distance between the two gives ΔC , or the

Fig. 5. The two display modules for the colour-analysis computer system. The one on the left is for chromaticity, and that on the right is for colour analysis

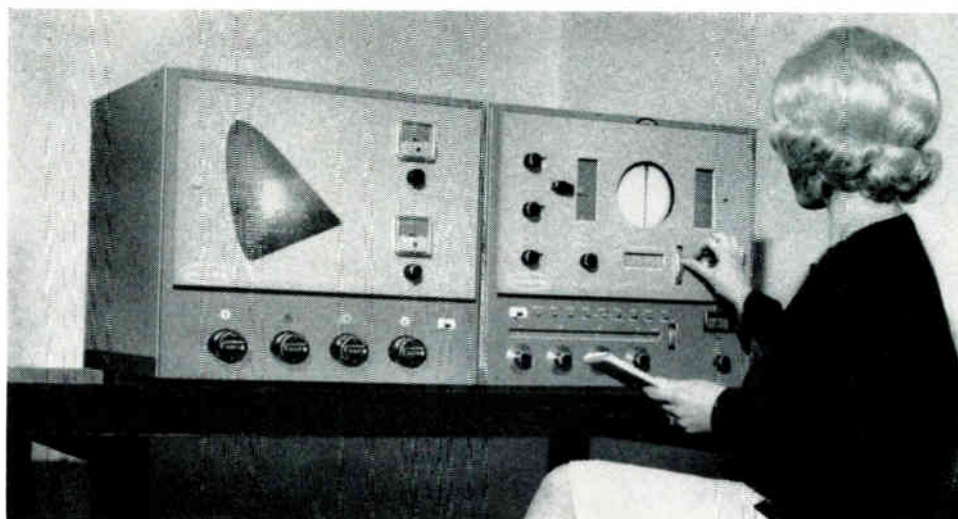

chromaticity difference (uncorrected for brightness) between the two.

Now it is known that the size of any given ellipse varies for different levels of brightness, while its shape and orientation remain constant. As a result, all of the chromaticity charts used by Simon and Goodwin were prepared for one level of brightness, and a second chart was introduced to correct for brightness. This second chart also gives the difference in brightness (ΔL) and the total colour difference (ΔE) in MacAdam's units; ΔE is given by the equation $\Delta E = \sqrt{\Delta C^2 + \Delta L^2}$.

Colour-Difference Computers

Practical experience with all these colour-difference formulae described here has shown that there is no formula for which the same ΔE values at different parts of colour space correspond exactly with visually-apparent colour differences. The colour differences calculated using the Simon and Goodwin method, however, appear to be the closest existing approximations to visual observations. It is for this reason that the colour-difference computers recently introduced by Instrument Development Laboratories are programmed in terms of the MacAdam system of analysis, and work in much the same way as the Simon and Goodwin charts. There is one important difference between these computers and the Simon and Goodwin charts though. With the computers, no correction is required for brightness, as the Y value is automatically fed into the calculation to give the correct value of ΔC immediately.

As Fig. 5 shows, a set of colour-analysis display computers consists of two modules, the first of which is called the chromaticity-display computer (C.D.C.) and the second the colour-analysis display computer (C.A.D.C.). The C.D.C. provides a quick and simple method of converting the readings of a colorimeter directly into the chromaticity co-ordinates x and y. This eliminates the multiplication and addition processes necessary when doing the job manually.

From the point of view of analysing small colour differences, the absolute-chromaticity co-ordinates can only tell us into which of the Simon and Goodwin zones our standard

colour falls. This can be read directly from the actual C.I.E. chromaticity diagram display on the C.D.C. Knowing this zone, we can then programme the C.A.D.C. section so that the MacAdam ellipse drawn on the oscilloscope tube corresponds to the uniform colour-difference ellipse for that particular zone. To do this, we rotate a roll-chart, giving four constants for each zone, until the zone number required is selected; the four potentiometers under the roll chart are then adjusted to give the settings indicated on the roll chart. We then have displayed on the C.A.D.C. oscilloscope the MacAdam tolerance ellipse centred on our particular standard colour.

There is a control on the C.A.D.C. for selecting the size of ellipse required for a particular analysis job, and this is variable from 0 to 15 MacAdam chromaticity-difference units (ΔC). If we wish to check a sample relative to our standard, we go back to the colorimeter and measure the reflectance of the sample relative to the standard itself. With the I.D.C. Colour Eye this is particularly easy, since it only means using the standard colour as the standard and reading directly from the meter the percentage reflectance through the X, Y and Z filters of our sample relative to this standard.

These ΔX , ΔY and ΔZ readings are then fed into the C.A.D.C. via three potentiometers, which affect the position of a spot on the oscilloscope display. If $\Delta X = \Delta Y = \Delta Z = 100\%$, the sample is a perfect match with our standard colour and the spot falls in the middle of the tolerance ellipse. If any of these readings are not 100% the location of the spot representing the chromaticity co-ordinates of the sample will be somewhere else, either inside or outside the established tolerance ellipse. Thus, once the C.A.D.C. has been set up for a particular standard, in a matter of minutes it can be seen whether or not a sample is inside or outside tolerance. Alternatively, by adjusting the size of the ellipse until it intersects the spot, the ΔC of the sample can be directly read from the computer. Simultaneously, another meter indicates brightness difference between sample and standard, so that $\Delta E = \sqrt{\Delta C^2 + \Delta Y^2}$ can be computed using a simple drum-analogue device mounted in the front of the C.A.D.C. Colour differences in terms of dominant wavelength and purity are also clearly shown.

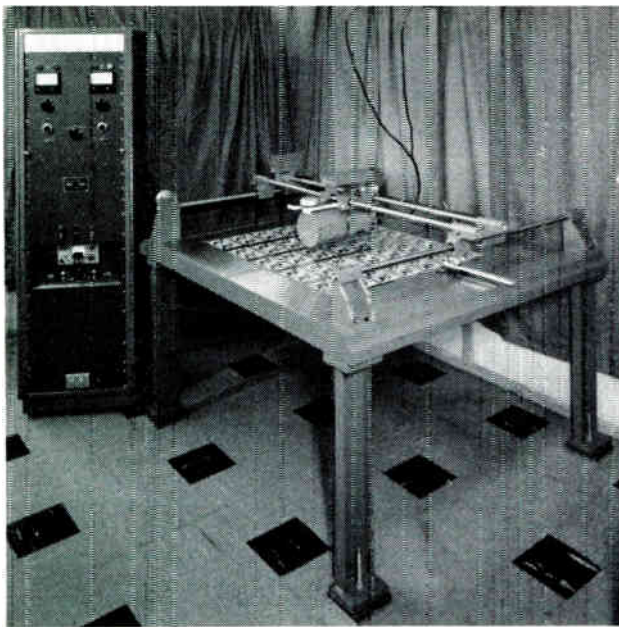
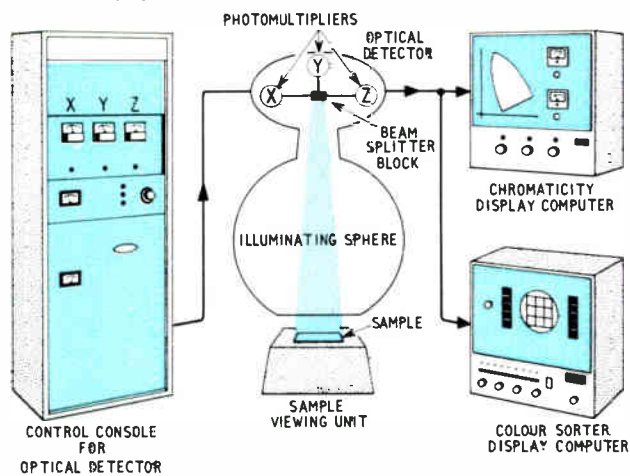

Fig. 6. The 'Colorede' continuous colour-measuring system. It consists of three principal sub-assemblies: an optical detector, a control unit (left) and an illuminator

Fig. 7. A schematic showing the basic units used for a colour shade-sorting system in the textile industry



With these computers it is thus possible to obtain quickly a decision as to whether or not a production batch of coloured material is suitable for further processing, packaging or dispatching to a customer. In most industries this is now done visually, with results depending on such factors as the time of day, how an observer feels and, of course, how many observers are used.

One of the main objectives in developing these special-purpose computers has been to make them as simple as possible, so that people completely unfamiliar with colour physics can operate them easily. In industry, at the moment, nearly all decisions on colour matching are made by highly-skilled and experienced colourists and/or chemists. Such people are unfortunately very difficult to obtain and train, so the need for aids such as these new computers becomes greater all the time. It is for this reason, too, that the computers have been made so simple to use, completely eliminating the need for complicated charts and detailed calculations.

Colour Monitoring

A further extension of the use of these units occurs when it is important to monitor and control the colour of materials processed on a continuous basis. By feeding ΔX , ΔY and ΔZ values directly into the C.A.D.C. in the

form of electrical signals from a continuous colour-measuring device such as the I.D.L. 'Colorede' (Fig. 6), it is possible to observe the movements of the spot on the C.A.D.C. which corresponds to the colour of the passing material; it is then immediately apparent when the colour has drifted outside tolerance. An even more sophisticated approach would be to use the outputs of the Colorede as the inputs to a special-purpose computer (either analogue or digital) to control variables affecting colour, so that the process can be varied to keep the output colour within a certain tolerance.

Another off-line application, which has proved of great importance in the U.S.A., is the use of these computers for sorting large batches of material, produced on a continuous basis, into various shade groupings within which there is no perceptible colour difference. A complete shade-sorting system for the textile industry is shown in Fig. 7. Here the C.D.C. unit is used as before, but the C.A.D.C. is modified to have a display similar to the Simon and Goodwin charts, in that an equal distance in any direction from the centre of the oscilloscope display corresponds to a constant chromaticity difference. Instead of the MacAdam ellipse we get a circle, which for simplicity is replaced by a fixed graticule. This is divided into various squares, each with a diagonal dimension corresponding to a certain number of MacAdam units of chromaticity difference. Thus, when a piece of material cut from a production batch is placed under the viewing system, the display spot will move to a certain point on the oscilloscope which corresponds to a particular shade zone.

There is also a meter, as before, showing brightness difference. Assuming we have a 3×3 graticule on the oscilloscope display and three different brightness groupings (light, normal and dark), this gives 27 different shade categories into which production can be sorted. The contents of any given category can then be confidently shipped to a customer, knowing that there is very little colour difference between materials within this group. Actual experience has shown that the variations in most mills are so great that $9 \times 9 \times 9$ groups are needed; the type of display used with this system permits the user to select whichever is best for his particular application.

All of this more sophisticated colour-analysis equipment has been developed in the last few years because of the impossibility of obtaining sufficiently-qualified staff to do this type of work. This manpower shortage has been felt earlier in the U.S.A. than here, but there is no reason to suppose that our experience will not be the same as production increases and skilled people become harder and harder to obtain.

Acknowledgement

I am most indebted to Mr C. H. Harris, of Instrument Development Laboratories, who was kind enough to read the manuscript and make helpful suggestions.

References

- Judd, D. B., 'Specification of Uniform Color Tolerances for Textiles', *Textile Research*, pages 253-263, 1939. 'Specification of Color Tolerances at the National Bureau of Standards', *Amer. J. Psychol.*, Vol. 52, page 418, 1939.
- Nickerson, D., and Stultz, K. F., 'Color Tolerance Specification', *J. Opt. Soc. Amer.*, Vol. 34, pages 550-570, 1944.
- MacAdam, D. L., 'The Graphical Representation of Small Color Differences', *J. Opt. Soc. Amer.*, Vol. 33, page 675, 1943.
- Simon, F. T., and Goodwin, W. J., *American Dyestuff Reporter*, Vol. 47, page 105, 1958.

Bibliography

- 'Colour in Business, Science and Industry', by D. B. Judd and G. Wyszecki. John Wiley and Sons Inc., 1963.
 'Colour Measurement in the Textile Industry', by Anni Berger and Andreas Brockes, *Bayer Farben Revue (Special Edition No. 3E)*, 1964. Farbenfabriken Bayer A.G., Leverkusen.

Data-display equipment can offer industrial-plant designers, engineers and operators a flexible, economic and centralized instrumentation and control system, able to meet the most exacting demands of reliability and high-speed presentation. This article describes the operation and capabilities of one such display system, using cathode-ray tubes.

By R. MOSLEY*

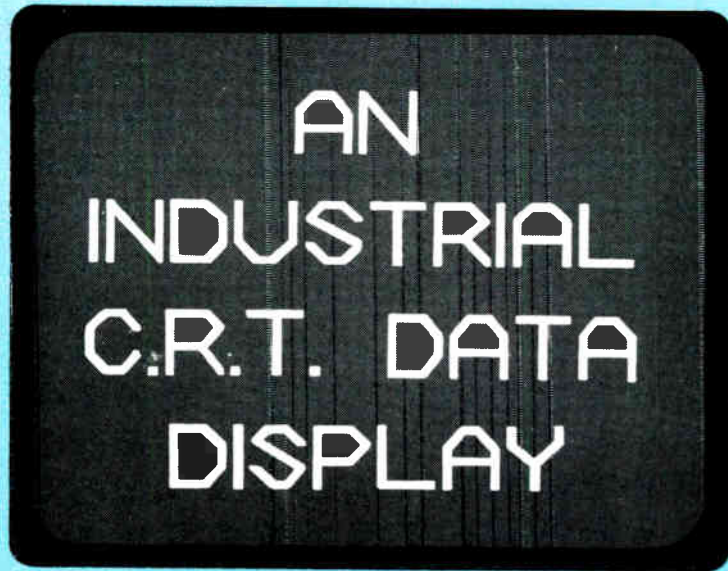

IN every field of industry or commerce, one of the first steps to attaining efficient management and operation is the acquisition of accurate and comprehensive information, at high speed and on demand, in a form easily assimilated. The present trend towards the use of centralized digital processors indicates the growing need for high-speed data presentation for the supervision and control of complex industrial plant processes. Data from the various sections of the plant and stages of manufacture is needed on demand to provide management with immediate information on yield, progress and efficiency. Control staff require immediate access to all salient plant-operating parameters, and research staff must have speedy information for experimental and statistical research.

The prompt availability of information on these factors results in increased productivity and more accurate predictions of quality and quantity, in addition to the more efficient utilization of plant and personnel. Essential also is the necessity to provide the means of scanning potentially dangerous conditions at a rate determined by the exigency of the situation. Maximum safety is therefore more easily attained and operating staff can be relieved of routine monitoring tasks entailing a large array of diversified instrumentation.

Cathode-Ray Tube Displays

The demand for centralized control and instrumentation in industry has led to the formation, in various companies, of research groups specializing in the data-display field. Many paths have been explored, but development in the last few years has narrowed to the utilization of the cathode-ray tube as a display output device, using symbols capable of being designed to the user's requirements.

Many types of c.r.t. display equipment are available, with their own inherent technical and economic attractions. The Series-20 display system manufactured by Elliott Automation was, however, designed specifically for advanced industrial and military data-presentation applications. The

appropriate type of character generation was carefully considered before a line of development was pursued, and physiological, ergonomic and economic factors were instrumental in the choice of an incremental beam-deflection method. The display itself has been designed to present information in the most satisfactory form to the operator, the legibility, contrast and size of the characters being arranged so that data can be read equally clearly in daylight and artificial-light conditions.

Character Generation

Characters, which can be in the form of almost any letter or number, are produced on the screen of a c.r.t. by causing the tube's electron beam to trace out the required pattern. The control of this scanning process is provided by a character generator.

In the Elliott system, a character generator (see Fig. 1) is mounted in a rack and consists of a number of logic-function boards which measure 8 in. by 5 in.; these contain standard logic elements made with silicon planar passivated

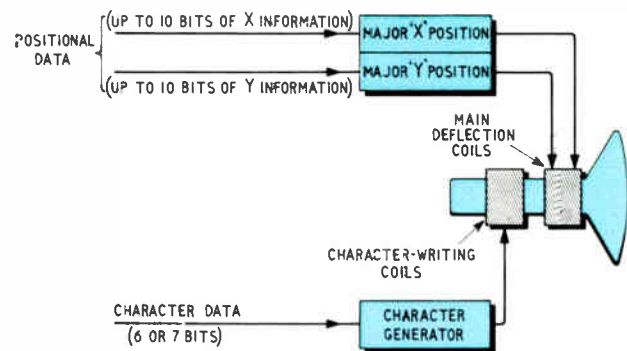

Fig. 1. A simplified representation of an Elliott character generator/positioner. Modular in concept, its electronic design incorporates a number of logic-function boards (for character shaping, circuit timing, etc.) that may be easily replaced to change the monitoring conditions

*Elliott Brothers (London) Ltd.

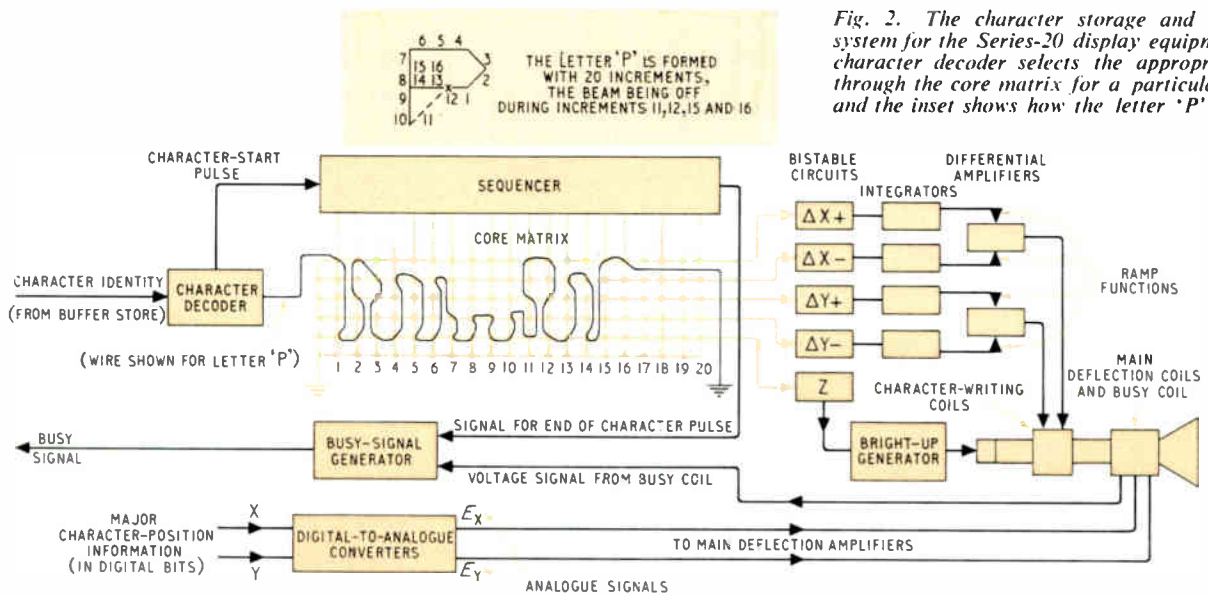

Fig. 2. The character storage and generation system for the Series-20 display equipment. The character decoder selects the appropriate route through the core matrix for a particular symbol, and the inset shows how the letter 'P' is formed



Fig. 3. The table version of the Series-20 display. Using a light pen, information can be fed directly from the c.r.t. face into a computer, where it can be stored, processed or used for on-line applications. Alpha-numeric information on the tube can also be handled in this manner for process control

transistors and diodes with metal-oxide film resistors. One board contains a specially-wired core store to develop the character shapes (which are specified by the customer within a permissible format) and the character set may be changed by substituting a new core board. Other boards provide the drive and timing circuits, as well as the digital-to-analogue converters needed to drive the c.r.t. scan coils.

Each character or symbol is composed of twenty equal increments in the X and Y directions. The character sub-origin point is the centre of a given character cell, the possible matrix for each character consisting of a grid composed of 5 lines by 5 lines. The character to be displayed is generated by increasing or decreasing, by fixed equal amounts, either the X or Y co-ordinates of a beam position (or both together), within definite sequential time notches. During these incremental periods, a 'bright-up' signal is applied for character formation, this bright-up signal increasing the intensity of the trace on the c.r.t.

Storage

The character storage is contained in a matrix consisting of five horizontal rows of twenty cores (see Fig. 2). The first row designates a positive increment in X, the second

Fig. 4. Two typical display formats that may be specified using the Series-20 system

REACTOR _ _ STATE			
NEUTRON FLUX	N/SO CM	2×10^{13}	
THERMAL POWER	MW	570	
GAS INLET TEMP	DEG C	203	
GAS OUTLET TEMP	DEG C	398	
GAS PRESSURE	LBS/SO IN	204	
GAS FLOW	LBS/SEC	6000	
STATION			
ELECTRICAL OUTPUT MW 158			

AMMONIA PLANT PRODUCTION					
METHANE	FEED	15.1	ATA	7900	CMH 25 C
PR I	REF	13.1	ATA	6530	CMH 710 C
SEC	REF	12.8	ATA	16725	CMH 950 C
HT	CONV	12.4	ATA	18210	CMH 430 C
LT	CONV	12.3	ATA	18535	CMH 153 C
COMP 330 ATA 14150 CMH 35 C					
NH3 41.3 TONNES PER HOUR					

a negative increment in X. The third and fourth rows designate similar positive and negative increments in Y, and the fifth row presents bright-up information (Z). Each character wire passes through the appropriate cores in the matrix, a choice of up to 63 characters being possible.

When the character identity is retrieved from the buffer store, it is presented as a 6-bit binary number to the character decoder, which then selects the appropriate wire and sends a 'half-current' through that wire to thread all those cores in the core matrix which the character design requires. A 'character-start' pulse is then applied to a sequencer, which passes a 'half-current' sequentially down each vertical row of five cores for a 1- μ sec period. The pre-wired selected cores thus turn over, one vertical column at a time, from left to right. The outputs from the horizontal rows operate their respective incremental or bright-up bistable circuits, the outputs of which are integrated to form ramp functions. Two differential amplifiers accept the ramp functions and their outputs pass to the auxiliary deflection amplifiers of the displays.

Outputs

Two digital-to-analogue converters give output voltages which are a function of the digital bits defining the character position. These voltages are fed to the main deflection amplifiers of the displays, positioning the c.r.t. beam at the sub-origin point of a character cell. The character-generator outputs consist of two main X and Y deflection signals, two auxiliary X and Y deflection signals and a bright-up (character or symbol) signal. The inset to Fig. 2 shows how the character 'P' is formed.

Inputs

The character generator requires the following inputs from the computer or buffer store: character positioning (up to ten bits of information for both X and Y directions); character decoding (six or seven bits, for 64 or 128 different character shapes); character-size control (two bits, if required); and brightness selections (two bits, if required, plus additional bits as required for selection of any display arrangement; e.g., three bits for selecting one from eight,



Fig. 5. (a) The basic display system, including storage facilities; (b) An expanded display system, showing the range of output facilities available

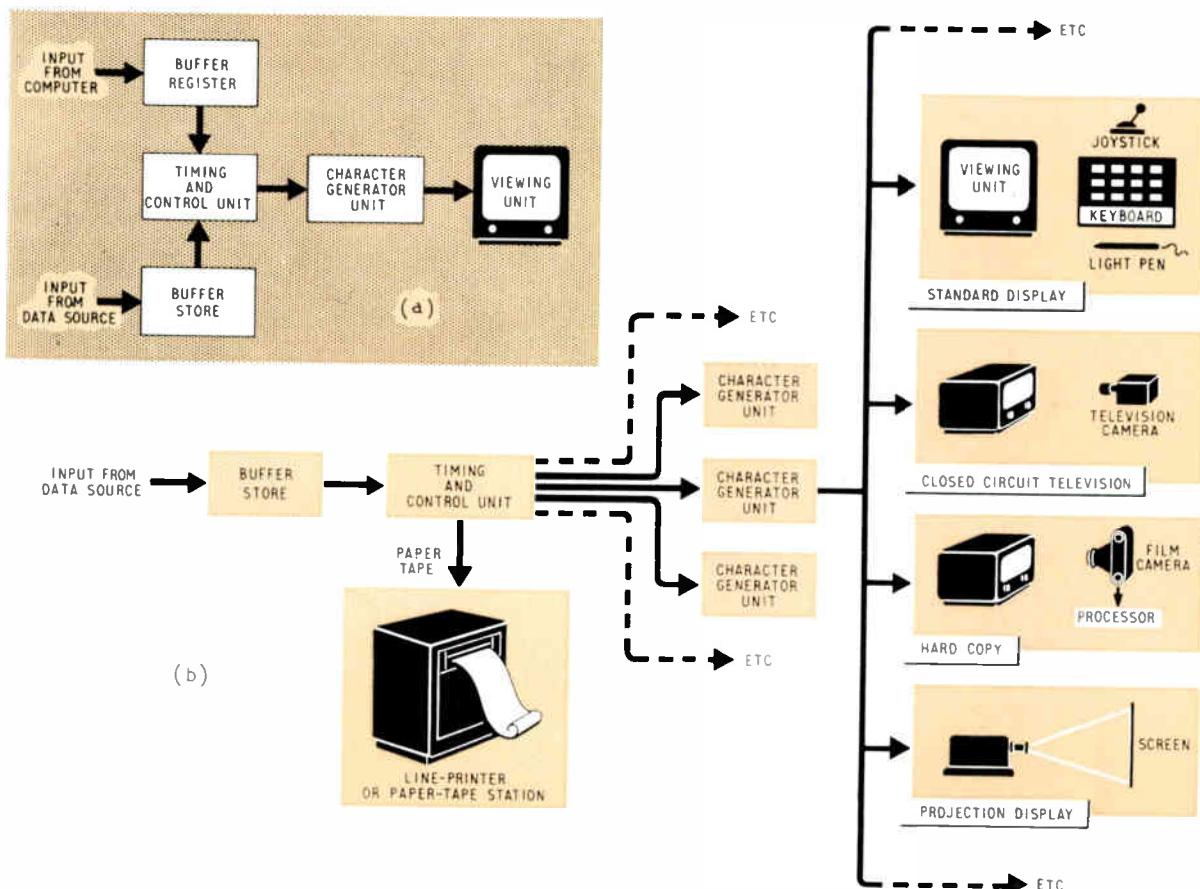

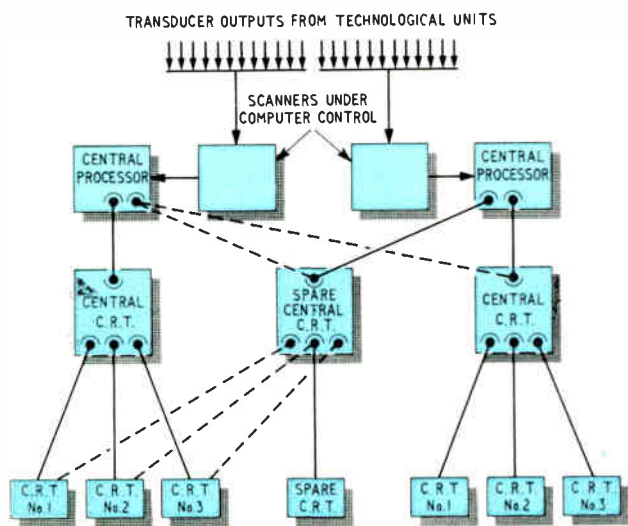

Fig. 6. A block diagram of the data-acquisition and display system designed for a gas-coking plant. On-line computer control is employed, and some 6,000 points in the plant are monitored

and eight bits for any arbitrary pattern of eight displays). An output of one bit is available from the character generator as a busy signal.

Display-Regeneration Rate

The critical frequency at which the 'flicker' (due to the sequential painting of the display on the c.r.t. screen) appears as a steady picture to the human eye is dependent upon many variables, including the mark-space ratio of writing to non-writing periods, the wavelength of the light emitted from the screen phosphor, the frequency, the colour and intensity of the ambient lighting, the brightness of the display, and viewer fatigue. In order to allow for these factors, the frequency of the display timer may be pre-set to a suitable frequency for the conditions under which the

display is to be used. From experience in this field, it has been found that only in dim, amber-free lighting can a frequency as low as 6 c/s be used, but a frequency of 10 c/s is satisfactory under normal conditions. Two typical display formats are given in Fig. 4.

Applications

The Series-20 display system is modular in concept, thus allowing basic units to be built up into configurations required by the customer. Fig. 5 gives an indication of how the system may be expanded.

In their simplest form, c.r.t. display systems can be used for a multitude of applications in industry where high-speed data dissemination is of importance; in this case, they are used in conjunction with a buffer store to maintain the regeneration rate. A keyboard is used to up-date addresses in the store and a series of buttons is arranged to facilitate interrogation of the system for data required. Information or instructions can be transmitted to and from areas of plants where noise levels are intense and a high degree of integrity is needed.

Display System for a Gas-Coking Plant

Although invaluable as autonomous systems, c.r.t. display configurations exhibit maximum flexibility when integrated with a computer. Fig. 6 shows the block diagram of a c.r.t. instrumentation system proposed for a gas-coking plant in Eastern Europe. The specifications for it demanded that a large amount of data was to be handled and a high reliability was to be achieved. Both requirements were met by the utilization of on-line computer control and by the absence of the large arrays of conventional instruments normally required to indicate the behaviour of such a plant. The maximum close-down time of the system was not to exceed more than ten minutes per month, and so, since this was insufficient to carry out major repairs, two computers and display systems were specified to increase the overall reliability.

Each of the two display systems consists of three 17-in. viewing units, having a viewing area 10 in. high and 13 in.

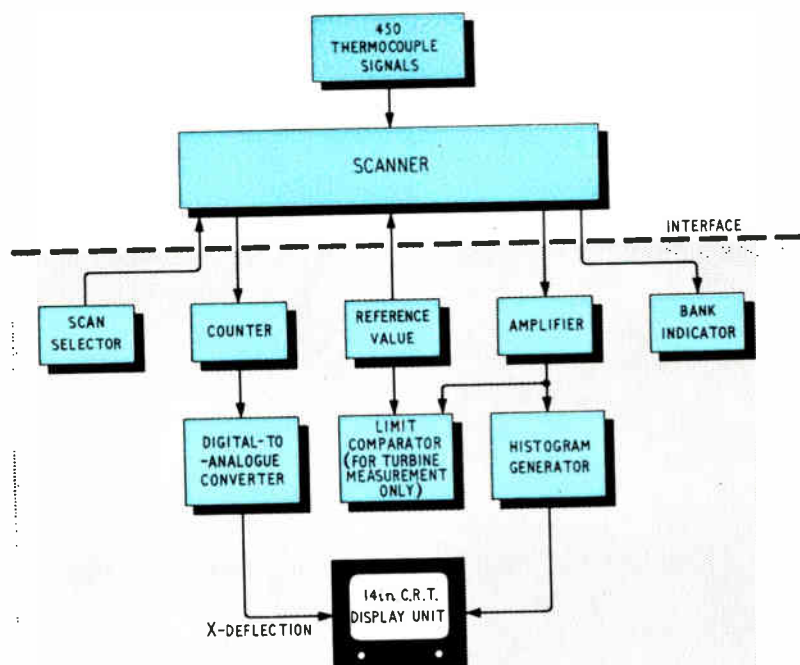

Fig. 7. This block diagram shows a c.r.t. display system for monitoring thermocouples in a power-generating station. Each display/monitor used can handle up to 50 boiler-tube and turbo-generator temperature measurements

wide. The formats are arranged so that the whole of each screen is utilized and the characters are as large as possible. The system is capable of displaying characters on a matrix of 64 columns and 64 lines, these characters being the capital letters of the alphabet, the numbers 0 to 9, and a selection of special symbols and punctuation marks.

The system uses two levels of brightness on two of the displays to emphasize the alarm points. The two levels are 'normal' and 'increased', thus allowing emphasis to be placed on any character or block of characters by 'bright-up'. In addition, each display has a brightness control and a focus control to allow adjustments to be made for the ambient-lighting conditions and the operator's requirements. The three displays of each system are driven from one character generator, but each display can be programmed to cover certain conditions only.

The processing calculations are simple, and the plant transducers are scanned by hardware under computer control so that the frequency of reading a particular point is related to its importance. Altogether some 6,000 points (valve positions, flow rates, frequencies, temperatures, etc.) are monitored, and the values obtained are composed with pre-set top and bottom limits; if the readings are outside the correct range, a fault message is fed to the display equipment. Some of the variable set points are automatically calculated from other transducer readings.

Two alarm conditions are catered for: a first-class alarm indicates a fault condition that will jeopardize the safety of the plant and necessitate immediate shut down unless effective remedial action is taken; and a second-class alarm indicates a fault condition that requires investigation or denotes a failure of a less serious nature.

The C.R.T. Displays

Referring to Fig. 6, c.r.t. No. 1 will normally display the numbers of those transducers from which an alarm has been signalled, so that no complex programming or formatting is necessary. All transducer units are allocated a fixed location on the screen and the number of the unit will be illuminated in the same position each time an alarm arises; in addition, it is possible to indicate some brief information about the unit. Normally, c.r.t. No. 1, will remain blank until an alarm arises, but other formats can be displayed on it, if necessary, by the use of a display-selection rotary switch on the control panel. The software can be arranged so that, if an alarm is initiated, all the information displayed on the tube will disappear, only the alarm condition remaining.

C.R.T. No. 2 will display, on request from the display-control panel, detailed information on the first-class alarms of a selected unit. This alarm information will cover a maximum of some 40 or so points (with, say, 20 characters per point) to give their instantaneous values, rates of change, numbers and spaces; again, plenty of spare capacity is provided. C.R.T. No. 3 will display, on request, detailed information on the second-class alarms, and Nos. 2 and 3 display systems can also be used for scanning data in selected areas of the plant when required by the plant operator.

The centralized instrumentation described above gives the operator immediate access to data at any time, with the assurance that all other areas are still being automatically scrutinized for alarm states. Plant operating parameters can be changed on-line easily and with minimum effort according to the rapidity with which set points can be recalled to the c.r.t. screen and changed by keyboard. No action takes place before the new point has been checked visually and 'entered' into the computer with an 'accept key'.



Display System for a Power-Generating Station

As already stated, display systems are more effectively utilized when coupled to a central computing system. They can, however, provide a most effective means of centralized instrumentation in other ways.

Fig. 7 depicts a typical c.r.t. display/instrumentation system for a power-generating station. The monitoring complex was designed to reduce the work load as well as the overall number of mechanical recorders used for boiler-tube and turbo-generator temperature measurement. A single 14-in. tube is employed, upon which are displayed (in sequence) 20 banks of up to 50 thermocouple measurements to give a histogram temperature profile; the thermocouples for the boilers are in this case attached to the superheater, reheater and drum.

The optimum scanning rate for this application was found to be one reading every five minutes for the boiler-start cycle, but a selective scanning speed of one reading every three minutes is possible for emergencies. Some 450 thermocouples are employed, each monitor being capable of handling up to 50 measurements with ease, scanning these measurements and giving an indication of the highest value in each scan. It was found that a time dwell of 30 sec per 50 points was more than adequate, and an identification of the scan area was also displayed.

Facilities are provided on a manual console for a lower rate of scan, if this is required, with each measurement indicated in turn; a 'hold' facility for a longer display is also available, for use at the operator's discretion. This system for the boiler tubes is also used in a similar fashion for the turbo-generators, and can be utilized in any areas of industry where centralized high-speed data scanning is of vital importance.

Industrial Communication

The introduction of a system of industrial communication, using microfilms for information storage and retrieval, has been announced by Kelly-Illiffe Ltd. and the National Trade Press Ltd. In collaboration with the American firm Information Handling Services Inc., a new company, Information Handling Ltd., has been formed which will make available to British industry the 'Visual Search Microfilm File' (VSMF), a high-speed storage and retrieval system for specifications and product information on components and materials.

With VSMF, the information is indexed by multiple terms which describe the parts, materials and sub-systems that a manufacturer needs. The subscriber is given a complete service (including the data on film, an updating service and the installation of a semi-automatic reader/printer and film-storage console) and data on a given product can be located in less than 1 min. The average time for a complete search, including a review of all suppliers' data available and the printing of the necessary copies, averages 5½ minutes as compared with one hour when using conventional methods.

For further information circle 51 on Service Card

RADIO TELEMETRY IN INDUSTRY

By C. H. HOEPPNER*

Several uses of radio telemetry in industry are described in this article. Following a brief presentation of what radio telemetry is, the article continues by discussing its applications to automotive conveyors, gear trains, ship-propeller shafts, power-generating stations, chain drives, cable tensions and earth-moving equipment. Uses of telemetry for the design of new equipment and the safe operation of production systems are also given.

RADIO telemetry provides a method for transmitting data by radio, and may be most advantageously employed where wired connections are impossible, unsafe or technically undesirable.

Although there are many forms of radio telemetry, they all operate according to the same basic principle of a transducer converting the measured parameter to an electrical signal, which in turn modulates a radio transmitter (see Fig. 1). At a point remote from the area where the measurement is being made, a receiver is tuned to pick-up the transmitted modulated radio signal, which it then converts to an electrical signal that is proportional to the parameter being measured. The measured signal can be presented in many ways, but usually it is fed to a meter or a recorder. Fig. 2 illustrates, in schematic form, a typical dual-channel telemetry system which provides facilities for the remote measurement of two parameters.

Range of Applications

In this decade, the technologies of automation and telemetry have emerged from highly intricate and expensive hardware to less elaborate and less costly systems, easily adaptable to the needs of any size of plant. As computers lighten the burden for man, so do telemeters lighten the burden for expensive machinery and equipment. Costly fatigue failures are now avoidable through the installation

of reliable, rugged, accurate, and miniature telemetry components in hitherto inaccessible locations and environments.

Their industrial uses are virtually limitless; systems can be built to specifications and encapsulated to withstand the most adverse conditions; low-cost measurement and telemetry systems have been applied to read internal vibration and strain in rotating equipment, chains, vehicles, and projectiles, thus eliminating slip rings and wires. Measurements may be made—under actual operating conditions—of vibration, acceleration, strain, temperature, pressure, magnetic fields, electrical current and voltage, all under adverse conditions such as in a field of high electrical potential, in fluids, steam or high-velocity gases.

Conveyor-Chain Monitoring

An IEC conveyor-chain telemetry system was recently installed at the Pontiac, Michigan, plant of General Motors. Consisting of a chain link, telemetry transmitter and telemetry receiver, it was designed and constructed to operate in the 600-°F environment of the paint ovens for one hour. The receiver was located near the conveyor chain, and the transmitter was equipped with a tuned dipole aerial to give sufficient radiation and thus eliminate the need for receiver aerials in locations such as ovens, spray booths and similar chambers.

The need for telemetry measurement on an automobile-conveyor chain is two-fold: to stop link breakage, and to

* Industrial Electronics Corporation, U.S.A.

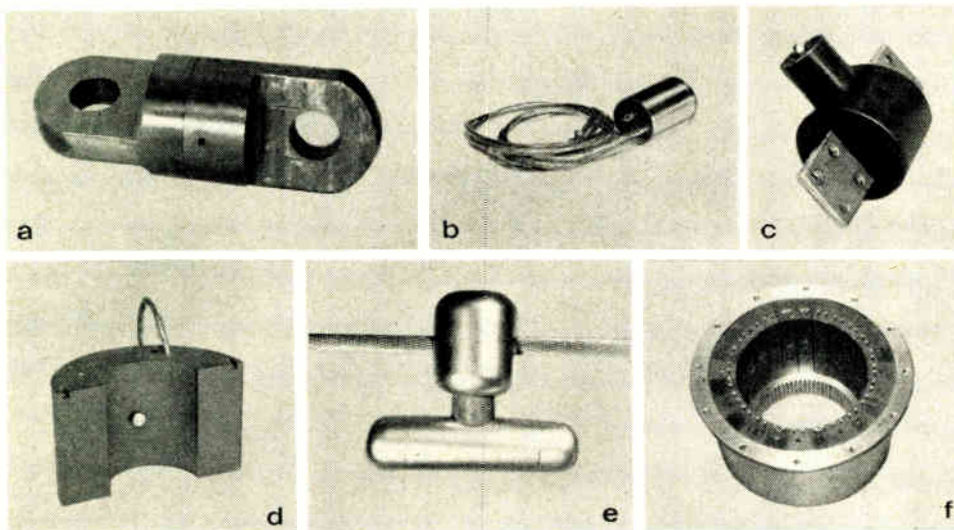

Fig. 1. A range of radio telemetry transmitters for measuring: (a) the pulling tension in underground conduits; (b) strain; (c) the current in a power busbar; (d) the torque in a rotating shaft; (e) the vibration in a high-voltage transmission line; and (f) the vibration in jet-engine blades (this transmitter has 24 channels)

adjust the drive torques. Other incidental advantages have also become apparent since the equipment was first installed: the location of any point on the chain can be accurately determined; the speed of the chain and variations in that speed are easily noted; and the measurement of temperature in the ovens can be obtained, in addition to the strain measurement.

Chain-link breakage was the problem to which telemetry was first applied in this plant, the links apparently breaking due to fatigue by cyclic over-stressing. The conveyor chains run from one floor level to another as well as around drive pulleys, the torques of which can be varied. Inasmuch as the point of highest tension is at the top level, which is always the 600 °F baking oven, it was necessary to develop a unit which could withstand such a temperature.

Drive Pulleys and Torques

Other points suspected of causing overstrain were the drive pulleys, which were located at many points throughout the 8,000-ft conveyor chain. The links bore against the pulleys on one side, and it was necessary to instrument the link on the inside with a strain-gauge bridge. Consequently, the surface strains on the outside of the link were not measured, but the inner-surface reading could be extrapolated to give the outer surface strain by means of laboratory measurements. Bending strain was reduced by inserting supporting blocks at appropriate points on the inside of the link, the results of tests showing quite definitely that the strain at the drive pulleys was excessive and that the strain at the top of the conveyor ramps in the baking ovens was within limits. Consequently, in the design of the new conveyor systems, larger drive pulleys will be used and telemetry will assist in setting the drives on all pulleys to minimize the added strain at the drive point.

A frequent problem with the conveyor chain is the lack of tension at points along the line, particularly at the lower end of descending ramps, where the tension becomes zero and the links pile up. This condition, if it is observed, can be corrected by changing the drive torques. The approach of pile-up cannot usually be observed, however, and without strain measurement the pile-ups occur regularly and can become serious enough to cause the conveyor to jump the track. The presence of loose chain links in the system also indicates that the other links are being over-strained, and so it is desirable to make measurements in order to set the torques on the drive pulleys correctly. Telemetry has become a great aid in setting drives, for the speed of the chain (as well as the drive torque) can be observed remotely at any particular point on the chain. This gives the operator the required measurement to prevent variations in torque and destructive pile up.

The measurement system is portable, so that a measuring chain link can be inserted during a period of time when the line is stopped, and the telemetry transmitter (complete with batteries and aerial) can be hung on the supports which reach from the conveyor chain to the automobile bodies. Since the size restrictions on the telemetry equipment are not severe, batteries may be used for any desired operating time. The batteries are rechargeable, a cycle of ten hours' daytime use and fourteen hours' overnight charge being provided.

Gear-Train Power Loss

To measure the efficiency of a gear-train speed reducer, operating between a high-speed power source (such as an electric motor) and a low-speed load (such as a ball-crushing mill), IEC designed radio telemetry transmitters to operate simultaneously from strain gauges on the input and output shafts, and to transmit torque readings to stationary indica-

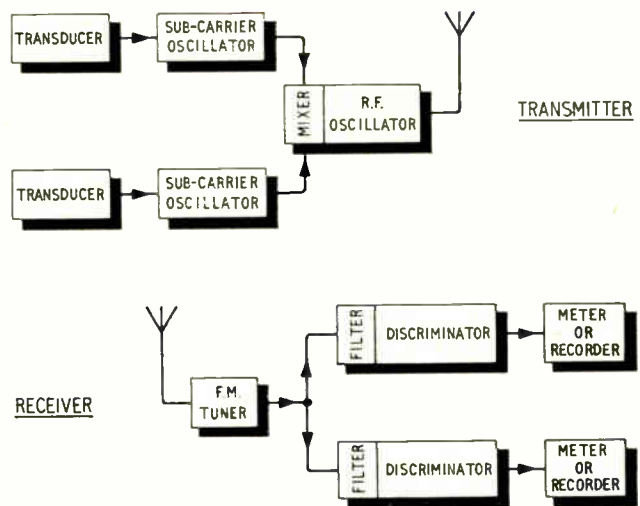

Fig. 2. This block diagram depicts a typical dual-channel f.m. telemetry system

tors. From the reading of the tachometer on the input shaft and a knowledge of the gear ratio, the r.p.m. of both the input and output shafts can be determined. From these figures input and output horsepower can be calculated and hence the gear train efficiency is obtained. The telemetry transmitters can be installed and removed quickly and may be used in areas where dirty and corrosive environments prevail.

Marine Industry Applications

To operate a ship efficiently, it is essential to have an accurate measurement of its shaft horsepower. At the boilers and turbines, horsepower measurement can be inaccurate because of the power lost in the speed-reducing drive. Ship speed may be affected by the condition of the hull or propeller, and so horsepower measurement (correlated with speed measurement) can provide many useful facts. The Sun Ship Company has applied an IEC radio telemetry system to measure the torque and horsepower on the drive shaft of one of its ships. The equipment operates without slip rings and is attached to strain gauges which are properly mounted on the shaft to measure torque; a telemetry receiver is located remotely and displays torque and r.p.m. readings. Torque is thus observed directly, and horsepower is obtained by simple computation.

Power Plants

In power-generating plants, coal is fed by conveyor belt to a number of hoppers, a tripper on the conveyor belt diverting the coal into a particular hopper until it is full. Either manual or automatic sensing determines whether the hopper is full, at which moment a signal is transmitted to the conveyor to move the hopper on to the next bin. Should manual control lapse, or the automatic sensor fail to function, as much as six tons of powdered coal can be dumped on to the power-station floor each minute. Such a mishap was experienced frequently at one plant before the installation of IEC remote control equipment.

To eliminate such costly waste, a pressure switch was installed in the tripper chute in order to activate a radio transmitter if coal backed up into the tripper. The signal is then radioed to a receiver located at the conveyor belt's controller, stops the belt and sounds an alarm. This type of control is difficult to accomplish by wire connections.

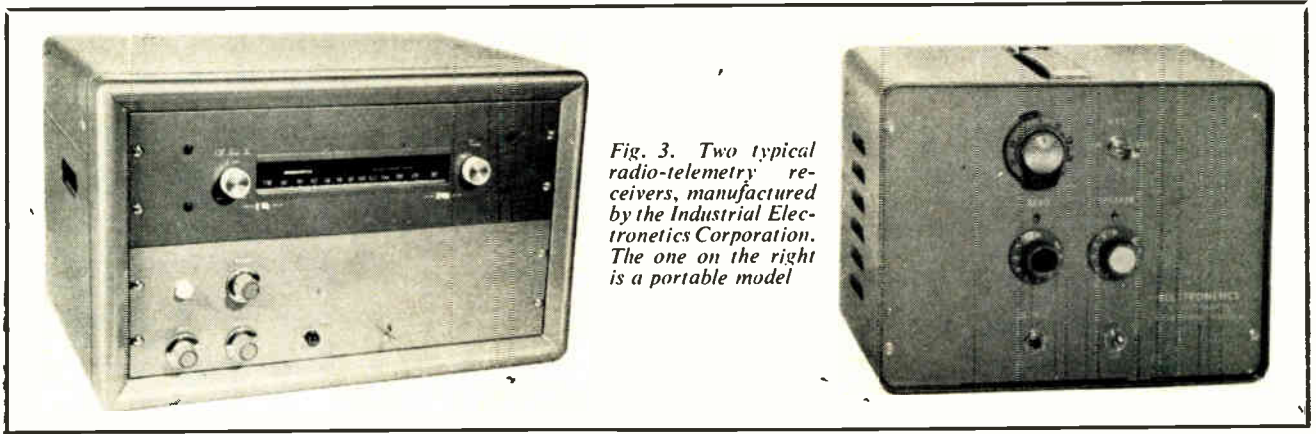

Fig. 3. Two typical radio-telemetry receivers, manufactured by the Industrial Electronics Corporation. The one on the right is a portable model

because of the movement of the tripper in the corrosive coal-dust atmosphere; most trippers are not electrically powered for this reason. A radio transmitter with long-life batteries fitted to the tripper, together with the a.c.-powered receiver at the control end, eliminates such problems as wire abrasion, short circuits and breakage. Subcarrier tone-frequency coding is used to eliminate the effects of interference and noise, giving positive protection at all times.

Chain-Drive Breakage

If a conveyor chain that has been carefully tested by the manufacturer before delivery breaks on the job, and the user is certain that he did not exceed the manufacturer's strain rating, then a dilemma arises which radio telemetry can solve. A strain gauge can be bonded to one link of the chain and connected to a radio telemeter fastened to the side of the chain; the telemeter goes round with the chain over pulleys and past gears, measuring the strain at every point under actual operating loads. It thus determines whether or not the chain is overloaded and, furthermore, gives the user an indication of when and how the loads occur. The manufacturer also acquires operating histories which enable him to build a better chain, for (if the overload cannot be eliminated) he can use the data to design a stronger chain.

Cable-Tension Telemetering

In many applications, radio cannot be used to transmit strain information from the measuring transducer to the receiver and recorder, and the telemeter developed by IEC for measuring tension in underground cables is an example of how to overcome this condition. When radio cannot be used, it is usually possible to employ the pulling cable (or the conductors) to bring the telemetered information to a location at which it can be recorded.

To measure the tension in each of three cables being pulled through an underground conduit, washer-type load cells are placed under the heads of each of the three pulling bolts; these load cells are then connected to the telemetry transmitters located inside the pulling head. The transmitters include batteries to power the units for a period of up to ten hours, each telemetry subcarrier being of a different frequency so that it may be multiplexed with the other subcarriers on a single line.

The centre conductor and the outer braid of all the cables are connected electrically, making a complete short circuit; this feature is used to conduct current through the entire length of the electrical conductors. A small iron-core toroid, with a high-impedance winding, is installed around the centre conductor beneath the outer shield, and two

small wires are brought out through the insulation and the outer shield to the telemetry transmitter. In this manner, currents of several amps are induced in the large centre conductor, circulating along the length of the line and returning through the outer shield. At the drum end of the conductor, another current transformer is used to sense the flowing current and produce a voltage which is then coupled to a radio transmitter.

The radio transmitter is located on the side of the drum, and produces a very low-power radio signal; this permits the subcarriers, which are coupled from the conductor, to be transmitted (without the use of slip rings or rotating joints) a few feet to a receiving aerial, which is connected to an ordinary telemetry receiver and recorder. The three signals, which are transmitted simultaneously, are separated by filters in the receiver so that they can be discriminated and plotted separately.

The entire system is calibrated electrically by placing a known resistor across one of the arms of the strain-gauge resistance bridge in each load cell. The shift in frequency produced by the resistor is referenced directly to the load in pounds, by knowing the square-inch cross-section of the load cell. In the very first tests of this unit, an unexpected phenomenon—large alternating stresses of a 'violin-string effect'—was noted. These stresses varied greatly with the free length of the pulling cable and the rate of pull.

Other applications of such a system include measurements of strain in metallic belts, chains, tram-ways, loading cranes, conveyor cables, mine-shaft cables, underground conduits and oil wells.

Earth-Moving Equipment

A crane-hoist operator may over-turn his crane or damage his hoist by picking up too great a load. Measurements along the crane boom or hoist bed are inaccurate at best and connecting wires are easily broken.

IEC have designed a system in which a radio-telemetry transmitter (located in the hook which picks up the load) is used to radio the magnitude of the load to the operator in his cab, a red line on the load meter indicating the danger point. Simple scale markings show the effect of the boom angle, and the telemetry transmitter in the hook is equipped with rechargeable batteries which will operate many days between chargings. Provision is made to recharge the batteries overnight from the main battery of the crane, and current requirements are negligible.

Zero or tare adjustment is made by simple screwdriver control at the receiver, and recalibration or scale change is also provided as an additional receiver adjustment.

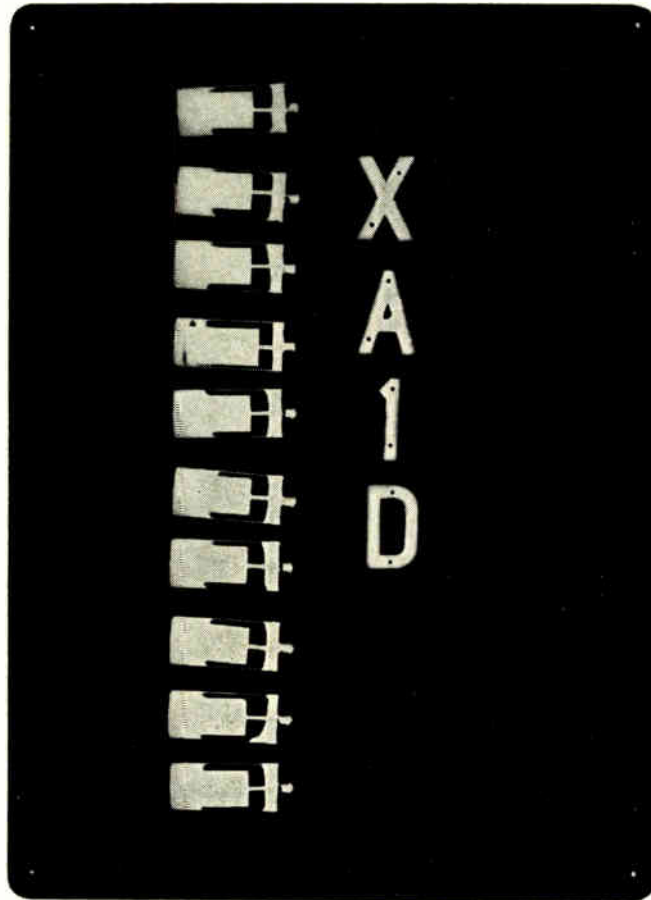

One of these Kemet Capacitors never left the factory



— which one and why not?

Most people would find it difficult to say. In fact, it was the fourth from the top. And the reason? A flaw so small that it took special X-ray equipment to detect it. Now such a flaw does not affect normal operational performance, and this particular capacitor would have proved perfectly satisfactory in a conventional circuit. But Union Carbide scrapped it without hesitation because all Kemet capacitors must meet the criteria laid down in Aerospace and

Defence specifications. How does Union Carbide impose this rule inflexibly, yet keep prices down? The answer is stringent quality control throughout the manufacturing process. By obtaining all raw materials from approved sources and by constant attention to detail throughout production, Union Carbide ensure that reliability is "built-in" not "tested-in". This means the scrap rate is negligible and prices remain among the most competitive on the market.

If you would like to know more about Kemet solid tantalum capacitors and the advanced manufacturing and test methods which ensure their operational reliability, contact Union Carbide now!

Kemet Capacitors
another practical product of



UNION CARBIDE LIMITED, KEMET DEPARTMENT, ENGINEERING PRODUCTS DIVISION, 8 GRAFTON STREET, LONDON W1. MAYFAIR 8100
Sales and Enquiries: Aycliffe Industrial Estate, Co. Durham. Aycliffe 2601.
UK Distributors for 'J' Series Capacitors: SASCO Gatwick Rd., Crawley, Sussex.

CHEMICALS · CRYOGENICS · DYNEL FIBRE · ELECTRIC WELDING · ELECTRONICS · FERRO-ALLOYS · FLAME PLATING · PRESTONE CAR POLISH · SILICONES · SUPERALLOYS · UCON LUBRICANTS
The terms Kemet, Dynel, Prestone, Ucon and Union Carbide are registered trade marks of Union Carbide Corporation EC 90

in the heart of fire control

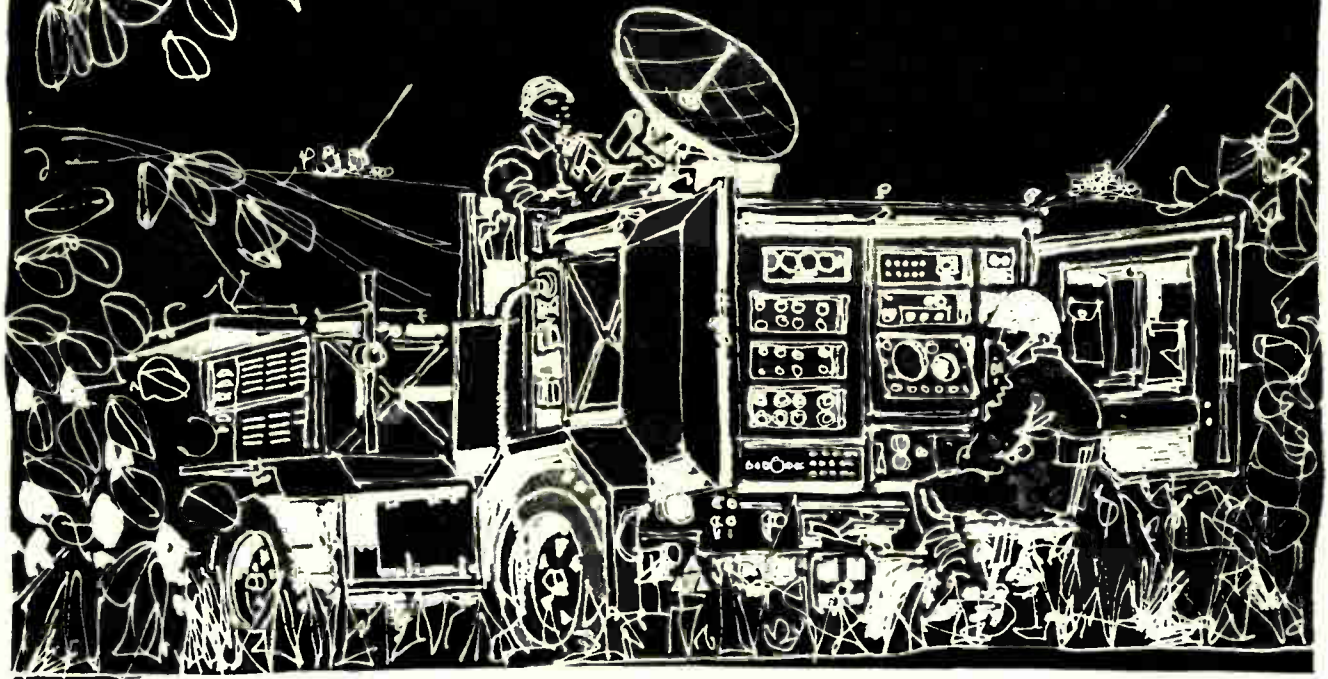

Muirhead size 23 synchros



Data transmission requirements for military and industrial purposes are met increasingly by the highly accurate Muirhead size 23 synchro. Developed primarily to meet the requirements of Def.148 and Mil-S-20708, the 23 synchro is now available from stock and can be produced to meet your own programme requirements.

Its features include:

- ★ accuracy to Mil specifications or 3' of arc
- ★ stainless steel housing
- ★ "thru'-bore" ruggedized construction
- ★ nickel iron laminations
- ★ -55°C to +125°C temperature range
- ★ maintains accuracy under adverse conditions
- ★ complete range of 400 c/s and 60 c/s instruments available.

Please send me full information on size 23 synchros
 and your extensive range of servo components
 Please ask an applications engineer to contact me

NAME

POSITION

ADDRESS

MUIRHEAD TECHNIQUE
MUIRHEAD & CO. LIMITED
 BECKENHAM, KENT, ENGLAND. BECKENHAM 4888

SD 1195174

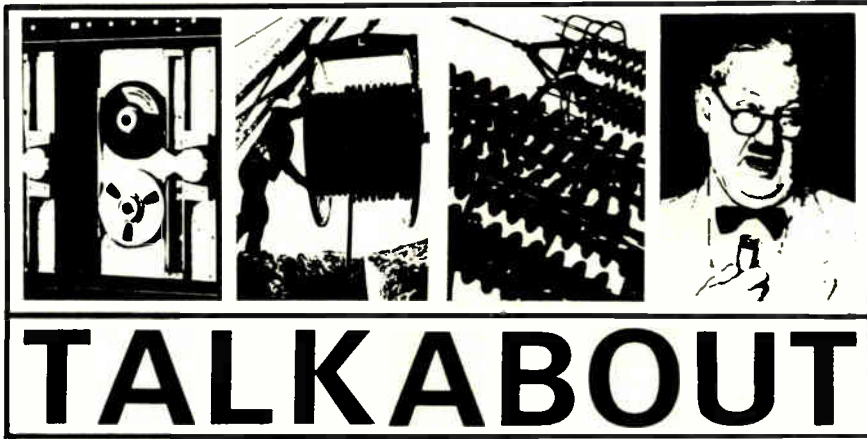

TALK ABOUT

Now that the IEA Exhibition is over the time has come to assess the results. Unquestionably it was the best ever. It was the biggest ever, the best attended and the most international. And also the most costly. Off-the-record chats with a number of company exhibition managers and PROs revealed that an expenditure of £10,000 for the six days was nothing exceptional. But many companies spent far less than this.

Only one company told me that things were 'a bit slow'. The great majority were enthusiastic. One company not exhibiting this year told me afterwards that they had perhaps made a mistake.

The mini-IEA's mushrooming in various hotel suites and lounges in the area appeared uniformly happy. They were attracting good attendances with serious enquiries at a fraction of the cost and far less restriction than would have been the case in Olympia itself.

Contrary to expectation the huge joint American stand failed to dominate the show. This was probably due to having no central set-piece to catch the eye. Each of the exhibiting U.S. companies had a uniform booth which gave the appearance of a number of rather insignificant side-shows when compared with the lavish mass displays of the leading British companies in the same hall. The American stands were packed on only one occasion—at the king-size cocktail party on the Monday evening. But there was plenty of A-OK comment from U.S. exhibitors after the show. Business, apparently, was sure-fire.

Happiest man of the show was Mr. T. E. Rees, Chairman of Industrial Exhibitions Ltd. It was certainly his week. Not only had he staged the biggest ever IEA but on Derby Day he had the additional satisfaction of leading his horse Polymint into the winner's enclosure at Epsom. He had won the

Edmont Handicap Stakes with an outsider (100-7) by a handsome 2½ lengths.

The oldest exhibit at the show—the Crompton-Kapp current indicator made in 1881—on the Crompton Parkinson stand. The biggest instrument—the giant Cossor oscilloscope housing a lounge and bar.

The most reluctant visitor—Mr. Frank Cousins, Minister of Technology, who didn't turn up until the Thursday, although he was sharply enough off the mark when it came to looking at Soviet developments a couple of weeks earlier.

It is strange to reflect that the generation of young engineers now entering our laboratories were born

By NEXUS

into the age of guided weapons. In fact, that the GW industry which has made such an impact on control techniques in other disciplines and fathered micro-min and the integrated circuit is already over 20-years old.

I wonder how many readers will remember, or will have even heard of, some of the early attempts recalled by T. L. Smith in a recent issue of the *Journal of The Royal Aeronautical Society*. In 1942, for example, when a team at Cossor worked on 'Brakemine', an anti-aircraft ground-launched radar beam-rider. Or a year later, 'Ben', another ground-to-air missile designed to ride on a searchlight beam. Or 'Longshot', an air launched radar beam rider. Yet another was 'LOP/GAP' (Liquid Oxygen and Petrol/Guided Anti-aircraft Projectile). None of these came to anything but they were the foundation of significant later developments.

It is equally strange to reflect that

while guided weapons have made such extraordinary advances in a mere 20 years, the Post Office telephone monopoly with somewhat simpler problems and far greater experience to draw on, provides a progressively worsening service. I was reminded of this by a GPO press statement which proudly announced that Warsaw telephone operators can now directly dial subscribers in the U.K. And that an operator at the London Continental Exchange can dial directly to subscribers in Warsaw. Splendid! But how on earth do you get connected on a routine call from Central London to, say, the suburbs or the home counties?

The man-hours wasted on abortive dialling during an average day must be astronomical. Mr. D. A. Barron, the GPO's Engineer-in-Chief admitted in a recent press interview that the situation is grim. Congestion, he says, is the difficulty. Too many people on the lines. This frightens me. Remember the congestion-on-the-roads problem and how it was alleviated (but not solved) by making it too expensive to park in London. Meter charges have soared from 6d. per hour to 2s. per hour in busy areas. Shall we have a proportional increase in telephone charges to force us off the lines?

Mr. Barron quotes figures for local telephone calls. Only 75% of calls made are connected at the first attempt, 20% fail because the called subscriber isn't there or is otherwise busy, and only 5%, he claims, are due to exchange or line faults or incorrect dialling. My own experience suggests an overall success rate of about 30%. And that, according to some of my colleagues, is generous.

A letter to the press has reported a typical 45-minute wait to be connected to the Continental Service after dialling 100. This subscriber says he can dial direct to his office in the home counties from any telephone in Germany. But, of course, he can't do this in reverse.

Quite obviously, we could pick up a few tips from the Continent. But all is not well even there. Disturbing reports come from Paris. One subscriber has waited two years for the telephone, has paid £32 for the installation, and reports his house value to have risen by at least £200 as a result. But worth the wait if you want to sell your house.

Even so, I shan't order the new STC Deltaphone with its warbler and tritium dial light unless our own service improves. My home line was recently out of order on two occasions for a total of seven days. When I asked for a week's rebate on my quarterly

rental I was told firmly "we don't guarantee a service"—and that was that. On overcharging I have been more fortunate having had two admissions with appropriate refunds. When STD first came into service, a journalist colleague reported a reduction of £19 on his STD bill after a dispute.

Mr. Barron and his Post Office teams have their difficulties. Nobody denies this, but the attempt to leapfrog one stage in the technology by shifting to electronic exchanges has surely misfired. After 9 years of effort it is not seriously off the ground except for small exchanges and the crossbar exchange has had to be ordered after all.

And the GPO image is not improved by notices such as this one in a telephone booth quoted recently. 'In some telephone numbers figures now replace exchange names, e.g. 061-273-1234. To call one of these numbers, dial O for the operator'. No wonder Mr. T. A. O'Brien, Chief PRO of the GPO, and ipso facto chief apologist, has more letters published in the correspondence columns than anyone else I can think of. His name seems to appear in the daily press almost as often as the Prime Minister's and certainly more often than his chief, Anthony Wedgwood Benn.

Sadly missed from the electronics scene is Mr. Ray Brown who was appointed British arms super-

salesman after a week or so of frantic rumours—or controlled leaks by the powers-that-be. I was fortunate to meet Ray Brown again during this period but restrained myself from congratulating him prematurely. I can hardly bring myself to congratulate him now that the appointment has been made public—but I wish him luck.

For this is the sort of job where you can't win. At least not while a political lunatic fringe shouts 'SHAME' every time you score a bullseye. But whatever the trials and tribulations that lie ahead, Ray Brown will certainly remember the day he left Racal. At an evening party he was presented with an oversized bowler and a trick rolled umbrella to mark his transition from successful industrialist to temporary civil servant. A thoroughly good time was had by all.

He leaves Racal at an interesting moment in the company's technical development. At the new Tewkesbury laboratories of Racal Research Ltd. an Elliott 4120 computer has entered service as a circuit design tool. And more humbly, Racal have taken the plunge by using Hz engravings on their new instrument range.

Frank (Boff diode) Boff, Chief Engineer of Racal Instruments, told me he had mastered the art of writing Hz instead of c/s but I noticed the traditional British designation still slipping into his conversation. These changes certainly challenge our ability

to break long standing habits. Wireless is still a common term among the elderly and has stubbornly remained in the title of our contemporary *Wireless World*, one of the oldest if not the most senior of all radio/electronic journals.

No instrument company has rocketed into the big league so effectively as that formed in 1939 by Bill Hewlett and Dave Packard in the shadow of their old University, Stanford.

Acknowledging the great part played by Stanford University in the growth of Hewlett-Packard, Ray Smelek of H-P Ltd., the U.K. subsidiary, recently suggested that a strong Company/University relationship could develop from the close proximity of their new site at South Queensferry to the Universities of Edinburgh and Glasgow.

Taking the Stanford University history as a pattern such a development could yield interesting results. In 1939 in the San Francisco area there were five electronic firms employing about 300 people. To-day, in the Stanford area alone, there are 70 firms employing 20,000. According to Ray Smelek, most of these firms were started by University graduates.

Our electronics companies are certainly becoming more education-minded. A recent advertisement for staff carried the heading 'McMichael Ltd.—A Member of the G.C.E. Group of Companies'.

Manufacturers' Literature

The Digital Logic Handbook 1966-67 Edition. A comprehensive 352-page publication on flip-chip modules has been released for free distribution by the Digital Equipment Corporation (U.K.) Ltd. It incorporates material from their catalogues and computer brochures, and contains fourteen application notes. Specifications and prices for more than 150 flip-chip modules and accessories for them are given, and extensive notes on analogue-to-digital conversion theory and techniques are included.

Digital Equipment Corporation (U.K.) Ltd., 11 Castle Street, Reading, Berks.

For further information circle 52 on Service Card

Transitron Catalogue. A 72-page short-form catalogue (SF66) is now available from Transitron Electronic Ltd. and contains all device parameters and specifications for the company's range of semiconductors, special products, wire and cable products and precision connectors. It is fully cross-referenced and includes selection charts and outline drawings for all the devices.

Transitron Electronic Ltd., Gardner Road, Maidenhead, Berks.

For further information circle 53 on Service Card

Fluidic Devices Systems. The developing technology of fluidics is arousing much interest amongst electronic engineers. This 12-page illustrated booklet from Corning explains the principles

of the use of fluid amplifiers, and gives typical examples of how they can be used for binary logic, computing, timing, switching, controlling and amplifying. It also includes definitions of terms and a list of symbols currently used by designers.

Corning Glass Works, Corning, New York, U.S.A.

For further information circle 54 on Service Card

'Duraform' Reinforced Thermoplastics. A new trend in thermoplastic sheeting, of special interest to laminators and fabricators, is described in this six-page publication (D.21A) from Turner Brothers Asbestos. The materials discussed are asbestos-reinforced rigid vinyl thermoplastic laminating sheets and laminates, particularly suitable for building, engineering and chemical applications.

Turner Brothers Asbestos Co. Ltd., P.O. Box 40, Rochdale.

For further information circle 55 on Service Card

Valves and Picture Tubes. The 1966 edition of Mazda's 160-page valve-data booklet has just been published. It contains abridged data (selected for maintenance work) on 264 current and obsolescent valves and picture tubes, and its equivalents list has 1,250 fully cross-indexed types. Transistor data will be given in a separate booklet to appear later this year.

Thorn-AEI Radio Valves & Tubes Ltd., 7 Soho Square, London, W.1.

For further information circle 56 on Service Card

8 types



THERMOFIT
HEAT SHRINKABLE TUBING

of heat-shrinkable tubing available in standard lengths and short sleeves, marked if required.



RAYCHEM
L I M I T E D

RNF-100 Type 1	Flexible-Flame-retarded-Irradiated Polyolefin
RNF-100 Type 2	Flexible-Clear-Cross-linked Polyolefin
CRN	Semi-rigid-High strength-Opaque or clear Polyolefin
SCL	Dual wall-inner wall meltable-Polyolefin
KYNAR	Tough-High temperature-Clear Polyvinylidene fluoride
PVC	Flexible-Flame-retarded-Irradiated Polyvinyl chloride
NT	Flexible-Robust-Solvent-resistant Neoprene
TFE	High temperature-Clear-Non-burning Fluorocarbon

BRANTHAM NEAR MANNINGTREE ESSEX · TELEPHONE MANNINGTREE 2401 · TELEX 18201

1/IE 7/6



WINSTER PRODUCTS (engineering)LTD

SIGNALLING·CONTROL·COMMUNICATIONS

introduce their

INDUSTRIAL COMMUNICATION SYSTEMS

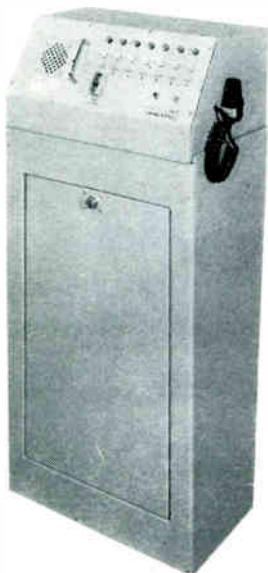

7 STATION CENTRAL CONSOLE FOR SELECTIVE SPEECH SYSTEM.

The WINSTER Industrial Communication Systems have been designed to cover a wide range of industrial and commercial applications, from a simple two-station system to the complex multi-station systems required for large works or plant. OF PARTICULAR IMPORTANCE IS THE FACT THAT THE EQUIPMENT CAN BE SUPPLIED FOR USE IN HAZARDOUS AREAS IF REQUIRED.

With a choice of selective or 'ring' speech and a range of different types of remote stations, the system can, in one form or another, meet the communication requirements of most industries. (For underground communications the Winster S.L.1. system is recommended).

An alarm signal, which is automatically broadcast from all remote stations, can be incorporated for use in connection with fire protection equipment, or for use in the event of any emergency.

Although designed to stand up to rugged conditions and corrosive atmospheres, the appearance of the equipment is such that it can be installed in an office, or by a switchboard, and blend with its surroundings.

The range of remote stations available include weatherproof types for outside installations, 'loud-hailer' types of up to 20 watts output and those of intrinsically safe design for use in hazardous areas.



STANDARD REMOTE STATION WITH CALL BUTTON, INDICATOR LIGHT AND PRESS-TO-SPEAK MICROPHONE.



'LOUD HAILER' TYPE STATION WITH SEPARATE MICROPHONE, PRESS-TO-SPEAK SWITCH AND CALL BUTTON, BUILT ON THE BLOCK PRINCIPLE THE SAME SIZE UNIT CAN PROVIDE 5, 10, 15 OR 20 WATTS OUTPUT.



WINSTER PRODUCTS (engineering)LTD

BATH STREET, ILKESTON, DERBYSHIRE. Telephone: ILKESTON 3187-8-9 Telex 37138

London Office: 18-24 MALTRAVERS STREET, W.C.2. Telephone Temple Bar 1008-9

SPUTTERING INSULATING MATERIALS

SPUTTERING is a technique which is finding more and more application in the manufacture of micro-electronic circuits. The basic principle, known and used for a number of years, is one of depositing one material in the form of a very thin layer on to a workpiece or substrate, all within a vacuum. In the past d.c. sputtering systems have been available but these can be used only for the sputtering or deposition of metals on to a substrate.

Now the world's first radio-frequency sputtering system for the vacuum deposition of insulating materials has been introduced into the U.K. by the Consolidated Vacuum Division of Bell & Howell.

The equipment, known as the PlasmaVac 'AST-200 R. F. Sputtering System', will enable the microelectronics manufacturer to deposit the dielectric in thin-film capacitors, encapsulate thin-film and integrated circuits, or undertake surface passivation of semiconductors.

Other applications include the fabrication of cermet resistors, multi-layer interconnection of monolithic circuits and optical coating.

The r.f. sputtering system uses the same vacuum chamber as is used for d.c. (or metal-only) sputtering. As a result both systems can be combined in a single vacuum chamber to deposit conductors and dielectrics simultaneously or sequentially, without breaking the vacuum.

Fig. 1 illustrates schematically the basic component parts of the sputtering chamber. When depositing or sputtering metal only, the chamber is first evacuated and a high potential is then applied between the anode and filament. Later a gas discharge occurs when a gas such as argon is introduced into the chamber. The low-energy positive ions produced in this discharge will bombard the substrate and

serve to remove most loosely-bonded surface contaminants by a combination of heating and 'ion scrubbing'.

When the system has reached stability, a negative potential is applied to the source material, commonly called the ion target. This negative potential attracts the positive ions in the plasma causing them to impinge on the target with sufficient energy to sputter the target atoms. The ejected atoms are deposited on to the substrate to form a thin film.

D.C. sputtering will not work with non-conducting materials because a surface charge collects on the target surface and blocks the ions. Applying r.f. power to the target (or a metal plate on which the target material is mounted) alternates the target potential rapidly between negative and positive, and electrons from the plasma break up the surface charge each time the target becomes positive.

The triode system offers many advantages over deposition equipment utilizing diode sputtering or conventional evaporation. It may be operated at pressures as low as 10^{-3} torr and guarantees precision control over factors most directly affecting yields and costs.

Deposition rate is constant throughout the fabrication period, thickness uniformity is held to within 1% over a 1-in. square substrate, and film-hardness and adherence are greatly improved. PlasmaVac has through-hole plating capabilities and can also coat curved surfaces. The system also requires less argon. Argon pressure is about 1 millitorr, compared to 20 to 50 millitorr in a typical diode system. There are fewer collisions between atoms and ions or gas molecules, with the result that more atoms reach the substrate, and less energy is dissipated.

For further information circle 57 on Service Card

Illustrated here is a complete three-unit system for sputtering both metals and non-conducting materials

Fig. 1. This shows, in simple schematic form, the basic component parts of the vacuum chamber

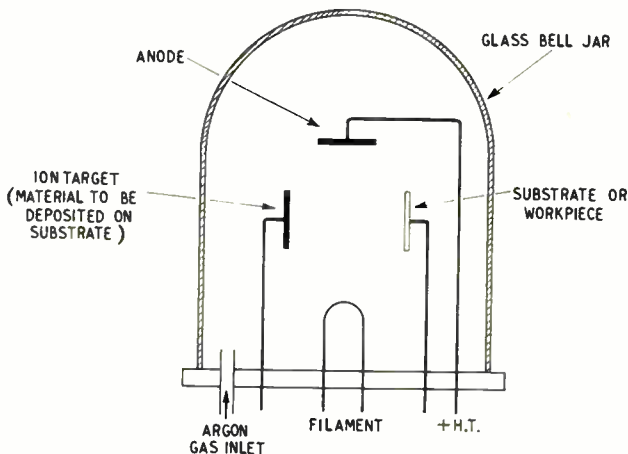

ANALOGUE

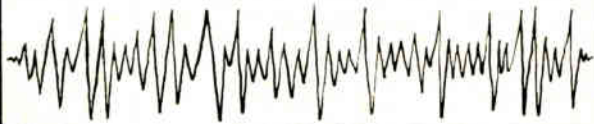

TO DIGITAL



CONVERTERS-1

By RICHARD GRAHAM

Digital methods of data presentation have several advantages over the established analogue methods. They are widely used for such applications as machine control and are finding increasing use in voltmeters and similar instruments. These uses require that an analogue signal should be transformed to a digital form and this function is performed by an analogue-to-digital converter or digitizer. There are two types of these, physical and electronic. This opening article of the series describes the first.

It has been well established for some years now that digital methods of extracting and presenting information have a number of definite advantages over the traditional analogue systems used until recently.

A pointer instrument is an analogue device, and it may fairly be said that there is not very much wrong with the one that is found in every laboratory. And, of course, there isn't; but consider the way in which it is used. Suppose the small variation in the output voltage of a power supply is being observed when loaded and unloaded. The better the power supply, the more difficult is the measurement. The procedure is to align the pointer and its reflection in the anti-parallax mirror, trying to avoid getting one's head between the meter and the light, and (blinking back the tears) to keep watching while the pointer moves.

This is fine if it is being done in a laboratory by someone who has plenty of time and who really wants to know. But what if the measurement is being done on an inspection bench on a piece-work basis? There will be neither the time nor the inclination to make a production out of it, and it is obviously desirable to evolve a quick, accurate, and easy-to-read way of doing the job.

It is possible that the result of a measurement must be fed to a computer or transmitted over cables to an information centre. If this is the case, then a signal that is either present or absent, which is another way of saying digital, stands a much better chance of being received without distortion than an analogue, or continuously-varying signal.

Often, it is required to control the movement of a device such as a machine tool to very fine limits. To recognize the exact position of the tool bed, a signal must be obtained from it, and a digital signal is much easier to handle than the analogue variety.

Again, it may be required to have the reading of, say, a weighing machine presented in-line to prevent reading errors. ('In-line' simply means that the reading is indicated by a row of numbers rather than a pointer on a scale.)

For all these applications, a device must be used to convert continuous or analogue signals into discrete bits of signal which represent information by being either present or absent; i.e., digital.

There are two classes of 'digitizer', as the jargon has it, which can be labelled 'physical' and 'electronic'. The physical class, which it is proposed to treat first, is used for machine control, position measurement, and indication of displacement and rotation. Electronic digitizers are used for voltage and frequency measurement, and any parameter which can be turned into a voltage or frequency by means of an appropriate transducer.

Physical A-D Converter

Here again, a broad division can be made between coded-scale and counting converters, and the coded type will be described first.

A very simple and, at first sight, logical system would be to have a scale with ten tracks and ten contacts. Holes would be punched in the ten tracks so that, for instance, if the scale moved to the left by seven positions, the seventh contact would be made, as shown in Fig 1. Photocells and lamps, or an insulating board with contact fingers could also be used. This principle has, in fact, been used for simple read-out systems.

Binary Codes. If, however, the information is to be fed to a computer or other types of data-handling equipment, the signal is not used in decimal form, but in one of the binary codes. Another reason for using binary codes is that only four tracks are needed instead of ten to show a ten-position movement.

It is entirely possible that just after the mention of the word 'binary' several readers remembered pressing engagements elsewhere. The situation can, perhaps, be retrieved

Fig. 1. An elementary form of digitizing system, which could be used for simple read-outs

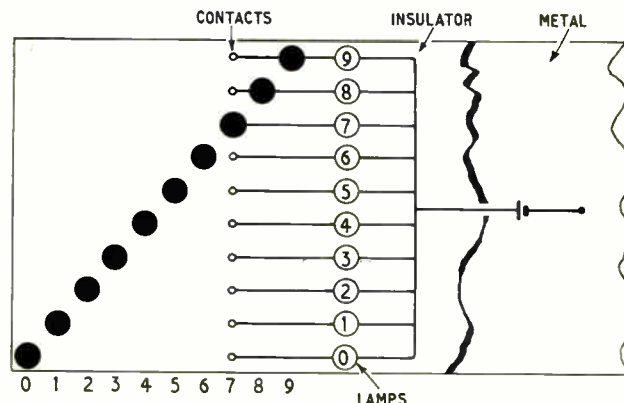

by saying that if a signal is present it is counted as '1' and if absent, as '0'. The numbers 0 to 9 can be made up of signals representing 4, 2, 2, and 1. If these are on tracks A, B, C and D of a scale, and A is present, B is present, C is absent, and D is present, the output would contain signals representing $4 + 2 + 0 + 1 = 7$. There is no need to go into binary arithmetic and Boolean algebra to understand the principles of digitizers. For instance, if in Fig. 2, the black areas represent conducting parts of a scale and the little circles contacts, then with no movement the contacts would pick up signals representing $0 + 0 + 0 + 0 = 0$. If the scale moved five paces to the left, the contacts would have $0 + 2 + 2 + 1 = 5$.

If the signals are intended to be used by a computer to position a tool or press, then they would be used as they are and not decoded at all. On the other hand, if the device is simply to operate a read-out, then the four signals must be decoded in a binary-to-decimal decoder.

A typical circuit is shown in Fig. 3. Relays are operated, via amplifiers, by the signals from the digitizer, and for any combination of relay operations a path exists from the 'root' of the relay 'tree' to one of its branches. For instance in Fig. 2, position 4 corresponds to the state where tracks B and C have signals and A and D have not. Therefore, in Fig. 3 branch 4 will be connected to the root as shown by the dotted line. A common form of display consists of sets of lamps, one for each branch, each being associated with a number from 0 to 9.

Ambiguities. Several difficulties exist with the binary code used in the above description, which for obvious reasons is known as a 4221 code. Consider Fig. 4, in which the reading line is not exactly normal to the direction of motion, due perhaps to errors in assembly. If the movement of the scale is such that the reading line is in the position shown, the reading should be either '1' or '2'. As it is, the reading will be '0'.

Different codes have therefore been evolved to overcome this problem, one of them being shown in Fig. 5. In this type of code, which is known as Watts Reflected Decimal, only one digit changes at each transition, and ambiguities are not a problem. Translating the code to decimal form is slightly more complicated because of the fact that the signal on A affects that on B, that on B the signal on C and so on. The presence of a signal on track A means that B must be inverted, whilst the absence of a signal on A dictates that B stays as it is. This process entails the use of additional decoding relays. Types of code in which this state of affairs exists are said to be 'cyclic', because subsections repeat themselves throughout the scale. The B, C, and D tracks in Fig 5, for instance, are symmetrical about the 4/5 transition.

If it is desired, in spite of the difficulties mentioned above, to use an ordinary non-cyclic code, then an alternative way of avoiding ambiguities is the 'V-scan' or double-brush method, shown in Fig. 6. Without this, there would be an area of uncertainty as sensors 1 and 2 in Fig 6(a) crossed the edges of the segments shown. It would be possible for both to read '0' or '1'. With V-scan, Fig. 6(b), two sensors inspect the coarser track, and the one to be used is decided by the signal from sensor 1, so that there is no doubt whether sensors 2 or 3 are near an edge. In fact, they could be considerably misaligned without affecting the result. Once again, elimination of ambiguities is obtained for the price of a little more complication.

Detection

The words 'sensor' and 'contact' have been used so far. To be more specific, the type of sensor in common use is the photocell. For high resolution systems, it is almost

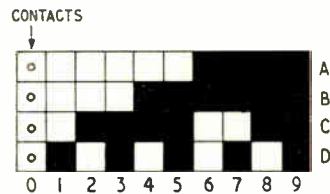

Fig. 2. One form of binary-coded scale

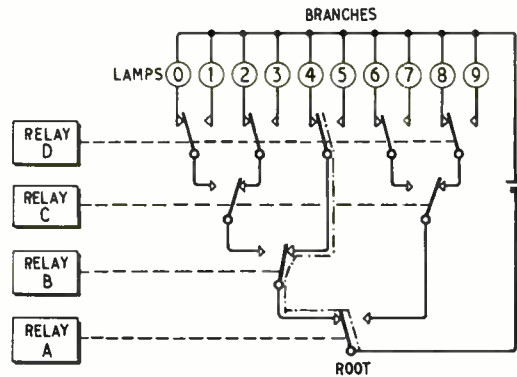

Fig. 3. A circuit for decoding from 4221 binary to decimal. The output, in this case, operates read-out lamps, but could be used to drive other devices, such as a printer or card punch

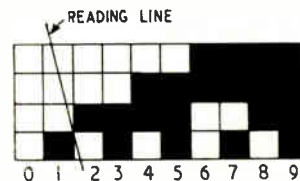

Fig. 4. The result of reading-line misalignment

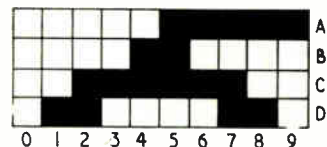

Fig. 5. Watts Reflected Decimal binary code for readings up to 9

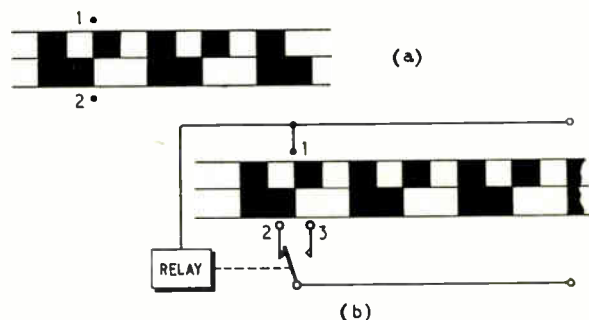

Fig. 6. (a) Using two photocells, doubt exists as to whether the reading is '1' or '2'. In (b) the use of V-scan eliminates this ambiguity

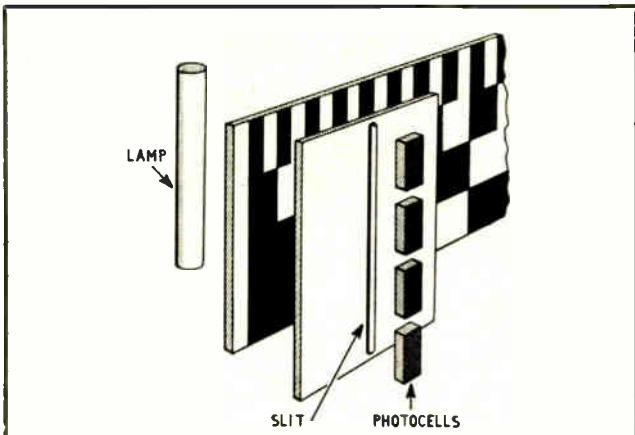

Fig. 7. The general arrangement of an optical digitizer

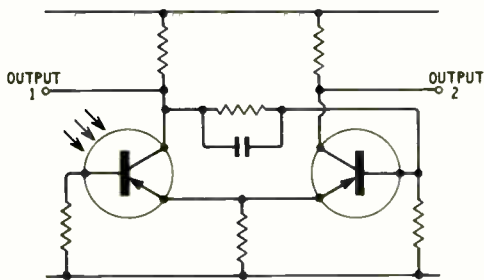

Fig. 8. Circuit diagram showing a phototransistor being used as one half of a Schmitt-trigger pulse generator

essential. In practice, the coded scale (or disc if used for rotation measurements) is a transparency made by photographic methods, with small photocells or phototransistors illuminated through the transparency by lamps. A typical arrangement is indicated in Fig. 7.

With the scale in motion, the waveform from the photocells is a trapezoidal wave, or roughly square with sloping sides and rounded corners. To form this into a suitable input to data-processing system it is necessary to define the 'top' and 'bottom' and to reduce the rise and decay times. The usual method is to use a Schmitt trigger to square the output from the cell, or, if a phototransistor is used, it can form one half of the Schmitt, as in Fig. 8. Anti-phase outputs are obtained from the two collectors, a facility which can be useful, as will be seen later.

It will be appreciated that for each multiple of ten positions to be recognized, there will be four tracks on the scale. The resolution of a scale is the size of the smallest division, and, as an example, circular scales have been made with 10,000 minor divisions on a radius of 2.5 in.

Scales are in use with mechanical sensors. That is, in which the coding pattern is of conductive material on an insulating substrate, the scale being scanned by spring-loaded contact fingers. This type is used in applications where driving torque is of little consequence. When excess torque is a problem, for instance when the position of a pointer instrument is to be digitized, the optical type is in general use.

Counting Digitizers

The second main division of 'physical' digitizers is the counting type, which allows considerable simplification of the scale or disc.

(Continued on page 337)

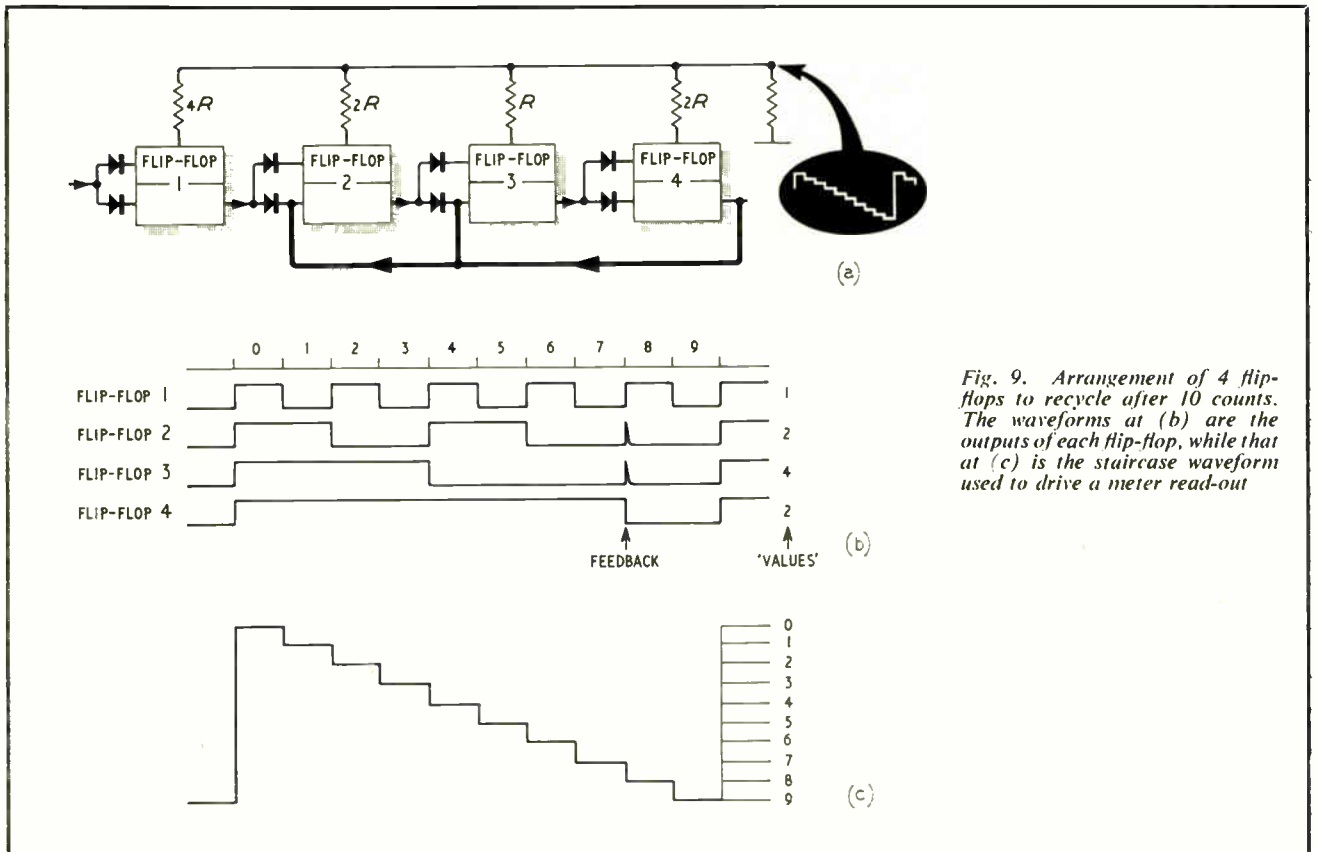
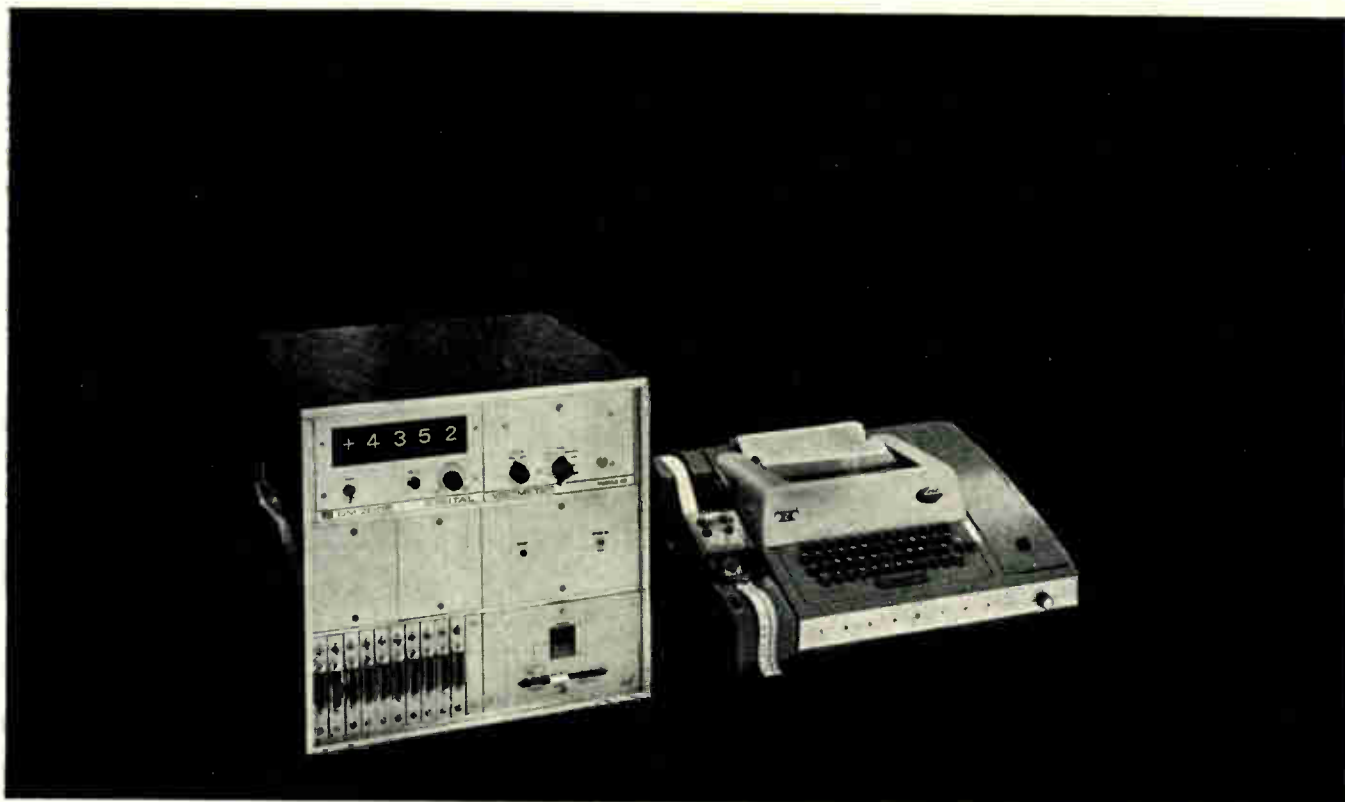

Fig. 9. Arrangement of 4 flip-flops to recycle after 10 counts. The waveforms at (b) are the outputs of each flip-flop, while that at (c) is the staircase waveform used to drive a meter read-out



microscan data loggers pack more data handling ability into three and a half cubic feet than most other systems squeeze into twenty

with silicon transistor reliability too!

Compactness apart, performance is impeccable; ambient temperature range is extended to 60°C. Series mode rejection up to 60dB and common mode rejection to 120dB—without filters! A specification without equal today because the system is guarded throughout, including the Reed Relay Low Level Scanner. MICROSCAN costs depend on your requirements, ranging from £1,500 + £5 per channel.

- * *Dynamco Integrating Digital Voltmeter, DM.2006.*
- * *Scale 9999—sensitivity 10uV.*
- * *Noise rejection—Series mode: 60dB at 50c/s · Common mode: 180dB at D.C. and 50c/s.*
- * *System rejection—100 channels series mode 60dB without filter. Common mode 120dB 1 K ohms unbalance.*
- * *Temperature range: 0–60°C.*

Ask for more details of
Dynamco MICROSCAN Data Loggers.



DYNAMCO SYSTEMS LTD
Govett Avenue · Shepperton · Middx
Tel : Walton-on-Thames 26321/8



MORE NEW PRODUCTS

Genevac's policy of continuous expansion now extends the standard product range to include the following:—

- ★ GRS1.—1 c.f.m. SINGLE STAGE ROTARY PUMP
- ★ GRD1.—1 c.f.m. DOUBLE STAGE ROTARY PUMP
- ★ ODPI.—1" AIR OR WATER COOLED DIFFUSION PUMP
- ★ PL44.—1" COMBINED PUMPING UNIT
- ★ TCG. 5 & 6—MAINS OR BATTERY OPERATED THERMOCOUPLE GAUGE
- ★ PRV.—AIR OPERATED RIGHT-ANGLE VALVE
- ★ HVG.—HIGH VOLTAGE GENERATOR & PROBE
- ★ SV20.— $\frac{1}{2}$ " AIR ADMITTANCE VALVE
- ★ SV15.— $\frac{1}{4}$ " MAGNETIC ISOLATION VALVE



FOR ADVANCED INFORMATION SHEETS
ON THESE NEW ITEMS CONTACT—



GENEVAC LTD.

Subsidiary of General Engineering Co. (Radcliffe) Ltd.

PIONEER MILL · RADCLIFFE · MANCHESTER
Tel: RADCLIFFE 3041-2

LONDON OFFICE: 5th Floor, 6 Lambeth Road, London, S.E.1.

MIDLAND OFFICE: 283 Stratford Road, Shirley, Solihull Warwickshire.

SCOTTISH OFFICE: 15 Moray Place, Edinburgh, 3.

MANCHESTER OFFICE: Heap & Ptrs. Ltd, Royal London House, 196 Deansgate, Manchester, 3. Tel: BLACKFRIARS 0185

LIVERPOOL OFFICE: Heap & Ptrs. Ltd, Empire Buildings, Fazakerley Street, Liverpool, 3.

Tel: WATERLOO 2248

Tel: SHIRLEY 4508

Tel: CALEDONIAN 5597

Tel: BLACKFRIARS 0185

Tel: CENTRAL 9532/3

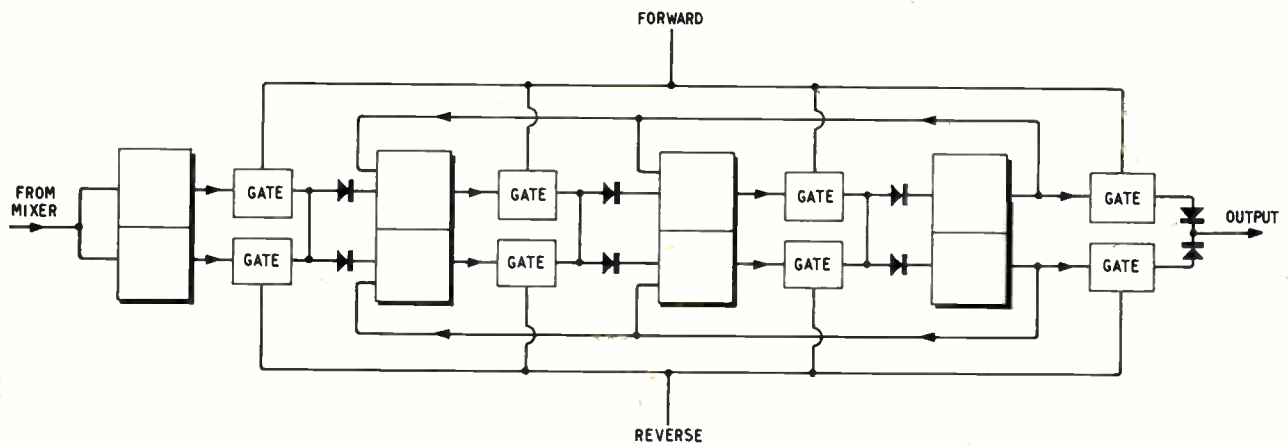

Fig. 10. The same counter as in Fig. 9 arranged to count in both directions by the addition of gates to select the output from the appropriate collector of each flip-flop. The extra feedback loop is also shown

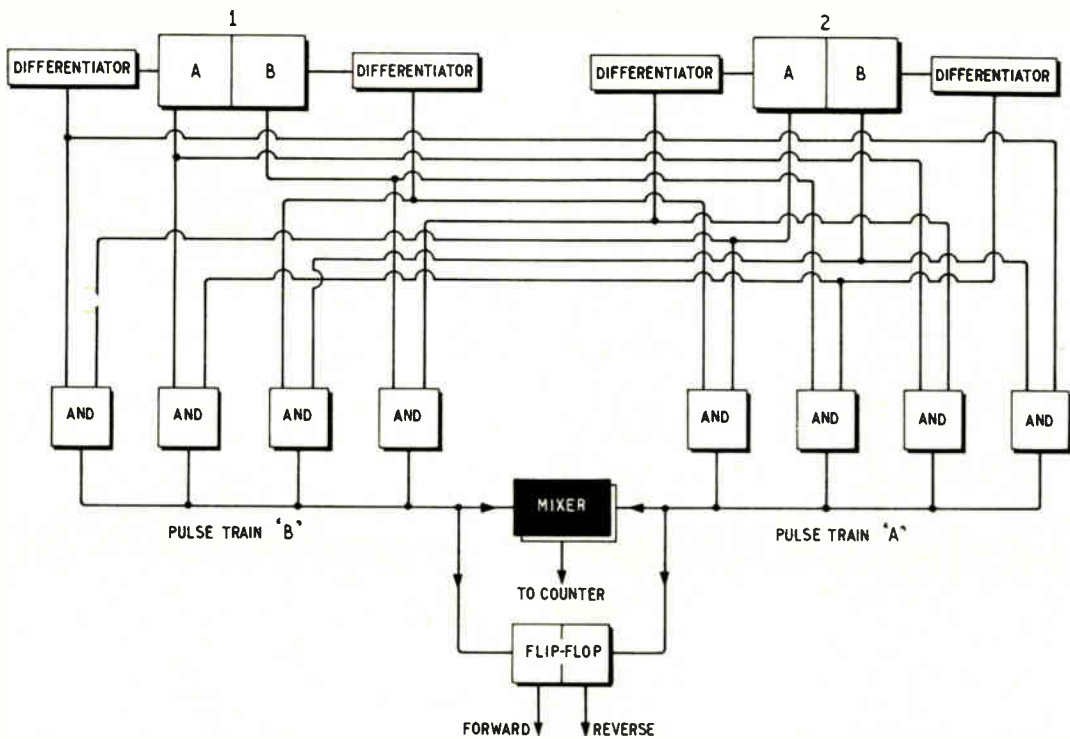

Fig. 11. The block diagram of the control unit. The blocks marked 'differentiator' convert the square wave output into spikes

Instead of a complicated pattern on the disc and a fairly extensive set of lamps and, possibly, V-scan choosing logic, the counting digitizer uses a scale with simple identical lines marked on it and, at the most, two photocells and lamps. To be sure, the ensuing circuitry is still a little on the sophisticated side, but finely divided scales tend to be expensive and any saving is useful, particularly in low-cost industrial equipment.

One important difference exists, which is a drawback in some applications. With the coded type, by recognition of the pattern, the decoding circuitry 'knows' where it is at any point. In the counting, or incremental, variety, it is only by reference to an arbitrary zero that this is possible, and if one mark is missed, or if a noise transient simulates a mark, accuracy is lost.

The principle is simple. As each mark passes the photocell/lamp combination, a pulse is produced which, after shaping, is passed to a counter. The counter display then reads movement directly. This, of course, is highly simplified, and the process is complicated by many factors, notable among which being the problem of reverse movement. The solution to this affords as a by-product an effective increase by a factor of four in the resolution of the scale.

To describe the process it is first of all necessary to consider briefly the operation of a reversible counter. The type of counter commonly used consists of a chain of bistable flip-flops. Each flip-flop triggers the next, and the total count is 2^n input pulses, where n is the number of flip-flops. By feeding back pulses from the outputs of some flip-flops to the inputs of earlier ones, the count is reduced.

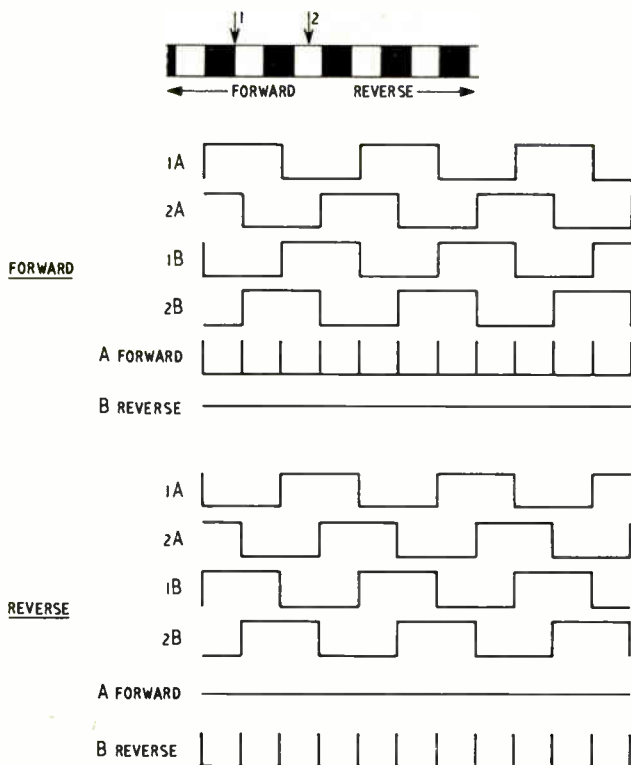

Fig. 12. The waveforms from the phototransistor flip-flops. Pulse trains marked A and B refer to those in Fig. 11

For instance, in Fig. 9, without the feedback (shown in heavy lines) the set of four flip-flops would re-cycle after sixteen input pulses. The feedback reduces this to ten. The number of pulses counted is recognized by examining the states of the flip-flops. With appropriate resistors connected to each output, a staircase waveform is obtained and can be used to drive a meter. From Fig. 9, the output of each flip-flop is taken from one side. To make the counter reverse, it is only necessary to take the output from the other side. The staircase waveform will now 'descend' instead of 'ascending'. A new feedback loop will be re-

quired as the existing one is inoperative in the new counting mode.

To select the counting mode required, it is necessary to pass the triggering pulses from one flip-flop to the next through gates which can be controlled by voltage levels. The control unit is concerned with the production of these levels and also of the pulses for counting. The full block diagram of the unit is shown in Fig. 10 with a block diagram of the control unit in Fig. 11 (waveforms in Fig. 12).

The blocks A¹, A² and B¹, B² are two circuits of the type shown in Fig. 8, with outputs taken from each transistor. From the waveforms in Fig 12, it can be seen that the photocells are separated by a multiple of half a division. From A¹, A² and B¹, B², the signal is taken to differentiators, which produce spikes from the original rectangular waves. The outputs of the differentiators, together with the undifferentiated waves, are applied to gates in the order shown. From Fig. 12, it can be seen that only one of the lines, Outputs 1 & 2 (Fig. 8), bear spikes for either direction of movement. These spikes can therefore be used to trigger the flip-flop, which in turn operates the direction control lines in Fig. 10. The spikes from each line are combined and used to drive the counter, and Fig. 12 shows that there are four spikes to each cycle of the waveform, so that the resolution is effectively increased.

For finer resolutions, say, down to 0.001-in. increments, it is common practice to use Moiré fringes rather than marks on a scale. Fringes are optical effects obtained by placing face-to-face transparent plates ruled with a series of parallel lines. If the plates are placed so that the lines on one plate are at a slight angle to those on the other, a slight movement of one plate relative to the other in a direction normal to the lines will result in a large movement of the fringe. A movement of one line-spacing, which can be much less than 0.001 in., will cause the fringe to move a distance which depends on the angle of the two plates, and which can be any amount—a matter of inches.

With variants of these techniques, most mechanical information can be converted into digital form and displayed or used in control processing systems.

The second class of digitizers, to be dealt with in the second part of this article, comprises those which are electronic in principle—no moving parts in fact.

General Purpose Program Translator for Digital Computers

The Ministry of Technology has placed a contract with the Imperial College of Science and Technology for a three-year programme of work on a general-purpose program translator (or compiler) for digital computers. The problem to be tackled is of common concern to all computer users, especially those in industry, for the contract aims at providing a general tool for the translation of any 'language' (the form in which instructions to a computer are given) into any other language for subsequent use by a computer.

Most programs today are written in a 'high-level' language (i.e., in a notation such as plain English or mathematics) and programs thus encoded must be translated (by the compiler) in order to run on a particular computer. Not every existing or planned computer has a range of compilers for the translation of every existing language in use into every other one, and so a user may be thwarted should he wish to use a particular program on several different computers. Again, the user of a particular computer may wish to use programs written in a wide variety of languages

on it, but the number of available compilers may be capable of translating only a few of these languages.

Unfortunately, with the present techniques for writing programs, it is not possible to provide every type of computer with a compiler for every language, for there are just not enough programmers available who are skilled in the art of designing the compilers. The project will thus entail the investigation of methods of describing, in computer terms, both computer languages and computer systems; arising out of these descriptive methods will be the construction of compilers that will operate with a given pair of descriptions (of a language and of a machine) to translate programs written in that language to the code of the specified machine.

A related goal of the project is to allow a choice between alternative translations of the source program to machine code, so as to select the coding that will be most efficient. The criteria of efficiency in this context may be several, and their choice and relative importance will be under the control of the user of the translator.

BSY38 – BSY39 ***practical, economical*** ***silicon planar epitaxials*** ***for high speed logic***

Mullard BSY38 and BSY39 silicon planar epitaxial transistors are designed to meet *economically* and *practically* the needs of high speed logic, of 20ns typical propagation delay. Features of these two n-p-n transistors are low saturation voltage, small desaturation time, high f_T at low voltage, small depletion capacitance and narrow spreads on current gain and input voltage. Encapsulation is TO-18. Both types are in large quantity production and are available for immediate delivery.

Further details of these and other devices can be obtained from:

Mullard Limited, Industrial Markets Division, Mullard House, Torrington Place, London WC1.

Here are brief specifications:
 TYPES BSY38, BSY39

V_{CB} (max)	($I_E = 0\text{mA}$)	+ 20	V
V_{CE} (max)	(cut-off)	+ 15	V
I_{CM} (max)		200	mA
P_{tot} (max)	($T_{amb} = 25^\circ\text{C}$)	300	mW
h_{FE}	($I_C = 10\text{mA}$) BSY38 BSY39	39 to 60 40 to 120	
f_T (typ)	($V_{CB} = 2\text{V}, I_C = 10\text{mA}$)	350	Mc/s
t_s	($I_C = I_B = I_{BM} = 10\text{mA}$)	8	ns
V_{CE} (sat)	($I_C = 10\text{mA}, I_B = 1\text{mA}$)	<250	mV
C_{tc}	($V_{CB} = 5\text{V}, I_E = 0, f = 1\text{Mc/s}$)	<5	pF

LANgham 6633. Telex : 22281.

Mullard

Si

planar

Continuing fine: outlook, bright

BD-H superfine resistance wires are not just fair-weather friends. They are materials whose proved performance and reliability enable manufactures of precision resistors and potentiometers to forecast a bright outlook for their products in service. □ Why do so many manufacturers specify BD-H? The straight answer is because we give them what they want. A choice of four different types of nickel alloy—'Nichrome', 'Nichrome' V, 'Karma' and 'Advance'. A complete range of sizes, from .002 in. downwards. A choice of finish—bright, oxidised, enamelled, or enamelled and silk-covered. □ We manufacture, test and inspect to standards which make for rare uniformity of resistance over the operating range. Commercially, we price competitively and deliver promptly. And we provide conscientious technical service to back up the goods. □ Tapping the barometer won't change the weather. But tap us for technical Data Sheet No.1, "Superfine Wires", and you'll be set fair for the future.

'Nichrome', 'Karma' and 'Advance' are all Registered Trade Marks

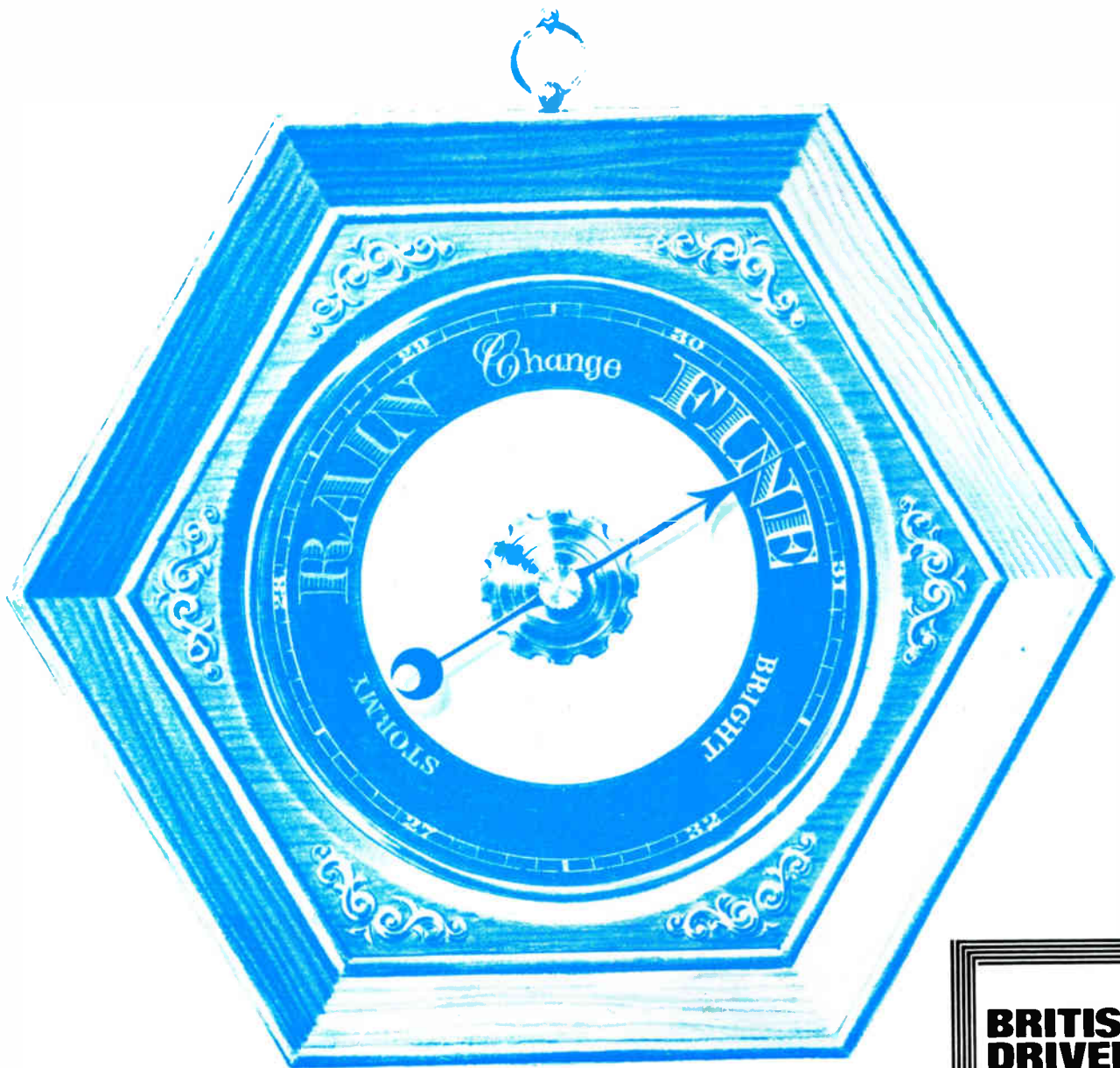

NICHROME BRITISH DRIVER-HARRIS CO LTD CHEADLE HEATH CHESHIRE GATLEY 6661

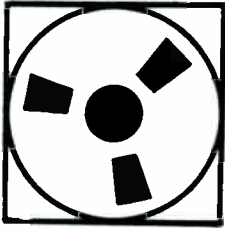

NEW APPARATUS

ELECTRONICS COMMUNICATIONS INSTRUMENTATION CONTROL

1. Language Laboratory

Language tuition for the business executive has been aided by the introduction of the Aveley Electric language laboratory. This consists of a self-contained tape recorder, complete with headphones and a microphone, which the executive can keep in his office for use at any convenient time. The phrases to be learned are pre-recorded on the top track of the twin-track tape and each one lasts for about 3 sec. After hearing this the person using the machine repeats the phrase and records it on the bottom track. This recording is played back immediately and then the original phrase is replayed. In this way the person can hear and compare his own rendering of the phrase with the pre-recorded version without having to rewind the

tape. Push-button operation is included for ease of use and the noise-excluding headphones and the directional microphone eliminate unwanted sounds.—*Aveley Electric Ltd., South Ockendon, Essex.*

For further information circle 1 on Service Card

2. Crane Drives

Herbert Morris Ltd. have applied the principle of the linear motor to the drive units of overhead underslung cranes. Their 'Morrispac' range of linear-thrust units eliminate gears, clutches and couplings and incorporate no moving parts. Each unit comprises a series of three-phase windings on a laminated magnet core, the arrangement acting as a stator. The joist or track on which the crane travels acts as the rotor.

When a current is applied to the windings, the horizontal component of the resulting magnetic force acts on the joist to drive the stator, and the crane, along. The vertical component of the force attracts the stator to the joist and reduces the wheel loading of the crane. A simple forward-reverse push-button control unit is supplied. Electronic control gear, giving controlled acceleration and deceleration and enabling the thrust unit to be run from a d.c. supply, is available.—*Herbert Morris Ltd., P.O. Box 7, Loughborough, Leicester.*

For further information circle 2 on Service Card

3. Universal Coupling

Perfection Parts has announced the 'Perfection' flexible nylon shaft

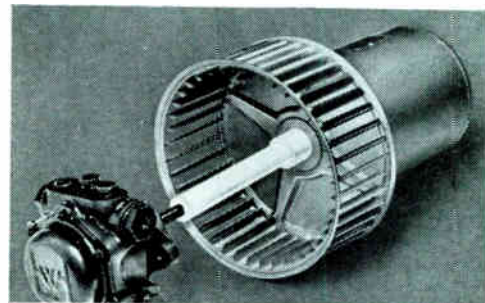
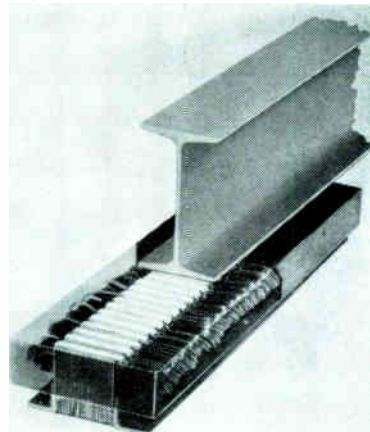



4

NEW

**ELECTRONICS
COMMUNICATIONS
INSTRUMENTATION
CONTROL**

5

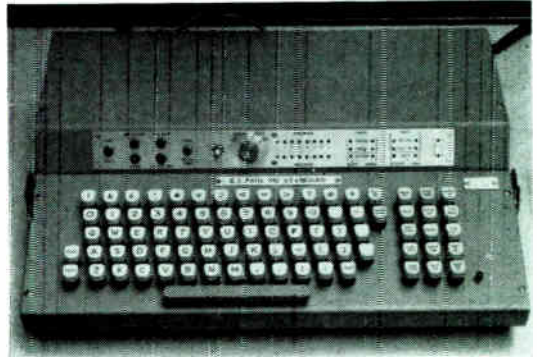

6

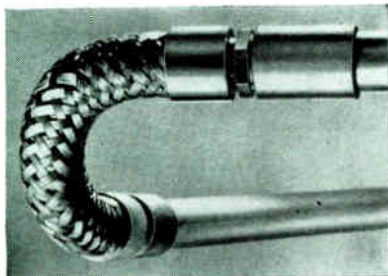

7

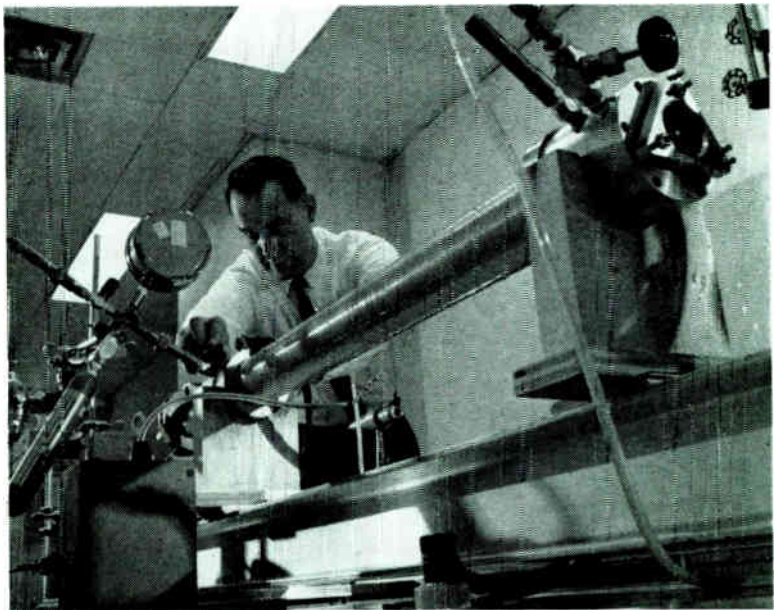

coupling for electric motors. This coupling is very light and has in practice proved virtually indestructible. Three basic lengths of coupling are available, 2 $\frac{1}{4}$, 4 $\frac{3}{8}$ and 6 $\frac{1}{2}$ in., but these can be cut to any intermediate lengths. An interchangeable pump shaft fits into the coupling so that it may be adapted to fit any shaft by a simple push-fit operation. Prices vary according to size and quantity from 3s. 3d. to 5s. 5d.—*Perfection Parts Ltd., 59, Union Street, London, S.E.1.*

For further information circle 3 on Service Card

4. Power-Cable Alarm for Cranes

Following an increase in the number of accidents caused by crane jibs touching overhead high-voltage cables, Siebe Gorman, in conjunction with Bon Automation Ltd., have developed the 'Electrowarn'

alarm system. This consists of a probe fitted to the jib and connected to a control unit in the driver's cab. When the probe comes within the vicinity of a high-voltage cable a bell in the control unit is sounded. An external alarm can also be operated. The distances of operation from the probe to the cable are preset before delivery of the control unit and cannot be altered without the unit being dismantled. The minimum distances range from 2 ft 6 in. for 3-3-kV cables to 27 ft 6 in. for 400-kV cables. Operating from 12 or 24-V d.c., the system incorporates fail-safe protection.—*Siebe Gorman and Co. Ltd., Davis Road, Chessington, Surrey.*

For further information circle 4 on Service Card

5. Tape Keyboard

K. S. Paul and Associates have announced the PM general-purpose

punched-paper tape keyboard. This works in conjunction with a tape punch and a tape reader to prepare, verify, edit and duplicate punched tapes in any code. Odd or even parity can be generated or parity can be omitted. The keyboard can be supplied with a conventional layout or with a specified layout of 64 (or more) keys. The punch and reader have been designed to reduce noise and vibration. Backspacing of the tape is controlled from the keyboard.—*K. S. Paul and Associates Ltd., Kingsbury Works, Kingsbury Road, London, N.W.9.*

For further information circle 5 on Service Card

6. Electrical Conduits

Two types of conduits for the electrical wiring of buildings have been produced by the Simplex Electric Co. One of these is made of steel in sizes of $\frac{3}{8}$, $\frac{1}{2}$ and 1 in. A range of

flexible joints (illustrated), made of woven tinned-steel wire and having good crushing strength, can be obtained. The other type of conduit is of p.v.c. It is suitable for use in narrow cavities and plasters as thin as $\frac{1}{2}$ in. Both systems can be re-wired and are prepared by Simplex from the building drawings. Complete kits for each building, with all parts ready for installation, are supplied. With the use of this system, building-site labour costs can be cut by 40%.—*The Simplex Electric Co. Ltd., Creda Works, Blythe Bridge, Stoke-on-Trent, Staffs.*

For further information circle 6 on Service Card

ELECTRONICS

7. Laser Pump

A high-energy laser pump which is capable of energizing a 3-ft laser rod has been developed by Westinghouse Research Laboratories. This pump, or flash lamp, differs from earlier types in that it is of a coaxial design. Two quartz tubes fitted one inside the other and fixed at each end with an electrode form the flash lamp. The annular gap between the tubes is filled with a gas to provide a discharge path between the electrodes. The laser rod fits inside the transparent inner tube and the outer tube is coated to act as a reflector. When the flash lamp is fired, the laser rod is completely surrounded by a cylinder of light and a laser beam is produced. The efficiency of this pump (i.e. the ratio of the laser output to the electrical input to the pump) is 5.1% compared with 4.6% for other types of pump. Having a good mechanical strength, a typical 3-ft pump can repeatedly handle 70,000 joules of electrical energy or about 10^6 W.—*The Westinghouse Electric Corporation, 200 Park Avenue, New York 10017, U.S.A.*

For further information circle 7 on Service Card

8. Marine Radars

The 17, 19 and 21 series of transistorized marine radars produced by Kelvin Hughes are built from a range of standard basic units. The versatility of this construction system enables radars ranging from simple relative-motion displays to sophisticated computerized true-motion displays to be supplied. The three series offer choices of a 6-ft, a 7.5-ft or a 10-ft scanner, a 3-kW or a

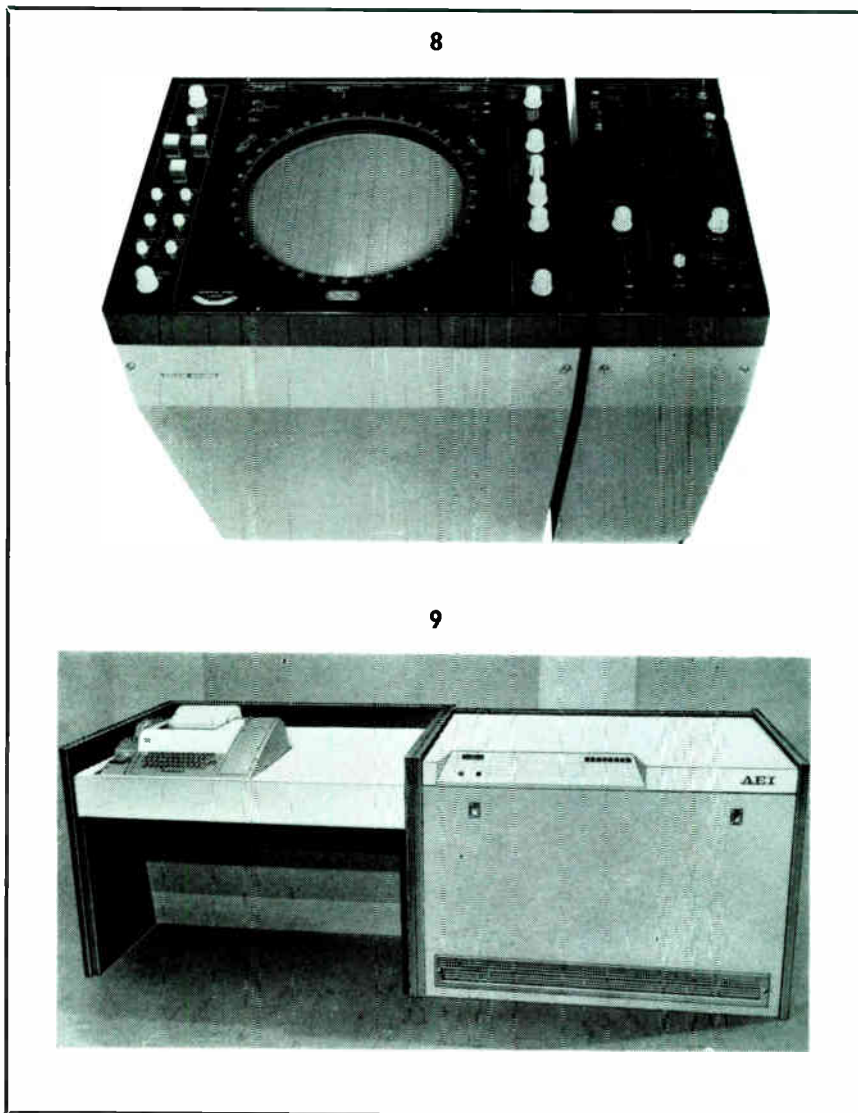

25-kW transmitter-receiver, and a 9-in., 12-in. or 14-in. display. Ranges up to 24 miles with the 17 series and 48 miles with the 19 and 21 series can be obtained and the series 21 incorporates off-centering which provides an extended range of 64 miles in any direction. Range markers and calibration rings are included on all units. Illustrated is the type 21/14 display.—*Kelvin Hughes, New North Road, Hainault, Ilford, Essex.*

For further information circle 8 on Service Card

9. Process Computer

A microminiature process computer, the CON/PAC 4020, is now available from A.E.I. This uses monolithic silicon integrated circuitry to provide a good reliability and an insensitivity to electrical noise. The core memory has a cycle time of $1.6 \mu\text{sec}$ and can be supplied with a capacity of 4,000 words of 24-bit

length. The memory capacity can be expanded to 32,000 words. A full range of peripheral equipment is available. A wide variety of programming routines can be used to ensure rapid and economical commissioning of systems.—*Associated Electrical Industries Ltd., New Parks, Leicester.*

For further information circle 9 on Service Card

10. Digital Stop-Clock

The type 661D is one of a range of 'Digicron' digital stop-clocks recently introduced by Darang Electronics. The maximum timing period is 59 min 59.9 sec, the time being indicated on a five-digit display. The timing source is derived from the mains or an external timing source can be used. The clock is stopped and started by push buttons on the front panel or by remote external contacts. Power requirements are

NEW

**ELECTRONICS
COMMUNICATIONS
INSTRUMENTATION
CONTROL**

95-130 or 190-260 V a.c. at 50 c/s.—
*Darang Electronics Ltd., Restmore
Way, Hackbridge Road, Hackbridge,
Surrey.*

For further information circle 10 on Service Card

COMMUNICATIONS

11. D.S.B./S.S.B. Transmitter

The G.341 marine transmitter from Redifon gives coverage of the three marine frequency bands of 400-535 kc/s, 1.6-3.8 Mc/s and 4-26 Mc/s, providing 195 channels. As well as being suitable for telegraphy, it is capable of double-sideband and single-sideband operation. Because nowadays ships tend to spend less time in port than before, maintenance is required to be speedy and the modular construction of the G.341 permits this. Designed for use as a ship's main transmitter, the unit provides outputs of up to 1.2 kW peak-envelope-power at the higher frequencies for long-distance working, the output being less at the lower frequencies. The input power requirements are 440 V at 50 or 60 c/s, three-phase. A motor-alternator set for operation from 110-220 V d.c. is available.—*Redifon Ltd., Broomhill Road, Wandsworth, London, S.W.18.*

For further information circle 11 on Service Card

12. Transistorized Radars

Four transistorized radars have been added to the Decca 'Transar' series and will be known as the 'Transar Group 7'. Each of these relative-motion radars has a 16-in. diameter display and the group offers a choice of a 6-ft or a 9-ft slotted-waveguide aerial and of powers of 10 or 25 kW. Eight range scales from $\frac{1}{2}$ -48 nautical miles are provided. The two 25-kW models can be supplied with a scale of 64 nautical miles as an alternative to the 48-nautical mile scale. Models with statute mile ranges are available for use in the U.S.A. Other features include a variable range marker and a reflection plotter for direct, parallax-free plotting over the radar picture.—*Decca Radar Ltd., Decca House, Albert Embankment, London, S.E.1.*

For further information circle 12 on Service Card

13. Industrial Communication

The industrial communication systems introduced by Winster Products offer a choice of equipment to fulfill many industrial and commercial communication needs. The systems range from simple two-station wired links to complex multi-station internal communication networks. An alarm can be incorporated to sound from all extensions for fire protection and other purposes. The equipment is of a rugged design and will withstand corrosive atmospheres. The range of remote stations includes weather-proof types, loudhailers with outputs of 5-20 W, and intrinsically-safe

types for use in hazardous areas.—
*Winster Products (engineering) Ltd.,
Bath Street, Ilkeston, Derbyshire.*
For further information circle 13 on Service Card

14. Public Address System

The 'Verbaflex', a portable public-address system manufactured by Paul Bouyer et Cie. of France is now available in the U.K. from Douglas A. Lyons and Associates. It consists of a 5-ft column speaker unit incorporating a transistorized amplifier and two standard 6-V dry batteries. The microphone is of the cardioid type and is supplied complete with a

10

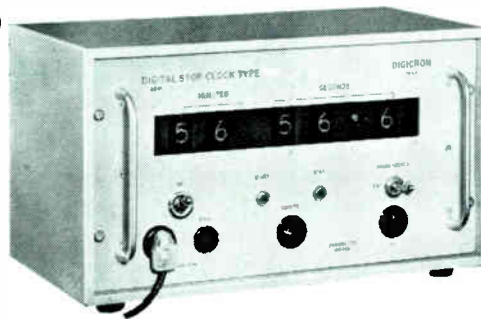

11



12



3



stand and a 30-ft cable. An output of 7-8 W is provided.—*Douglas A. Lyons and Associates Ltd., 32 Grenville Court, Dulwich, London, S.E.19.*

For further information circle 14 on Service Card

15. Portable Walkie-Talkie

A completely self-contained radio walkie-talkie has been introduced by Burndept Electronics. Known as the B.E.347, it is housed in a single aluminium case. The rechargeable battery pack is contained in the lower half of the case and the whole unit can be dropped in to a special charger without the need to re-

move the batteries for recharging. The amplitude-modulated system operates on up to three channels in the 80-106 Mc/s frequency band with a channel spacing of 25 or 50 kc/s. The range between portables is about three to five miles over a clear optical path.—*Burndept Electronics Ltd., West Street, Erith, Kent.*

For further information circle 15 on Service Card

16. Television Monitors

E.M.I. now have available a range of six transistorized monochrome television monitors. All of these operate on 525- and 625-line standards and a

405-line version of each can be obtained. Display-tube sizes of 14 in., 19 in. and 23 in. are included. Three monitors in the range feature local or remote selection of two alternative inputs and of internal or external synchronization, and remote control of brightness, contrast and cueing indication. Local or remote selection of line standards can be optionally supplied.—*E.M.I. Electronics Ltd., Hayes, Middlesex.*

For further information circle 16 on Service Card

17. V.H.F. and U.H.F. Receivers

Two low-cost solid-state receivers for ground/air communications systems are now available from Motorola. Designated CM610 and CM620, these single-channel receivers operate in the v.h.f. (108-180 Mc/s) and u.h.f. (225-400 Mc/s) frequency bands respectively. A sensitivity of 1.5 mV, a minimum 100-dB image rejection, and good intermodulation and cross modulation characteristics are claimed. A sealed, pre-tuned crystal filter has a channel bandwidth of 36 kc/s at 6 dB and 80 kc/s at 80 dB. Audio outputs are 1 W at 600 Ω with 5% distortion, and 10 mW for headset use. The unit fits a 19-in. rack and operates from any 115-V a.c. (50 to 400 c/s) or 28-V d.c. source.—*Motorola Inc., Military Electronics Division, 8201 E. McDowell Road, Scottsdale, Arizona, U.S.A.*

For further information circle 17 on Service Card

18. Closed-Circuit Television

G.E.C. Electronics have introduced a compact closed-circuit television system. Two types of monitor are available, a 19-in. model and a transistorized 11-in. monitor. The camera is the type VCT 1, a transistorized 625-line unit employing a standard 1-in. vidicon camera tube (illustrated). It features automatic control of sensitivity and the only two manual controls are the optical-focus adjustment and an on/off switch. Optional extras include remote control of pan, tilt, iris, focus and zoom. Other ancillaries include synchronizing-pulse generators, distribution amplifiers, video mixers, etc.—*G.E.C. Electronics Ltd., East Lane, Wembley, Middlesex.*

For further information circle 18 on Service Card

19. Push-Button Dialling

The Siemens repertory telephone dialler contains 30 labelled push-

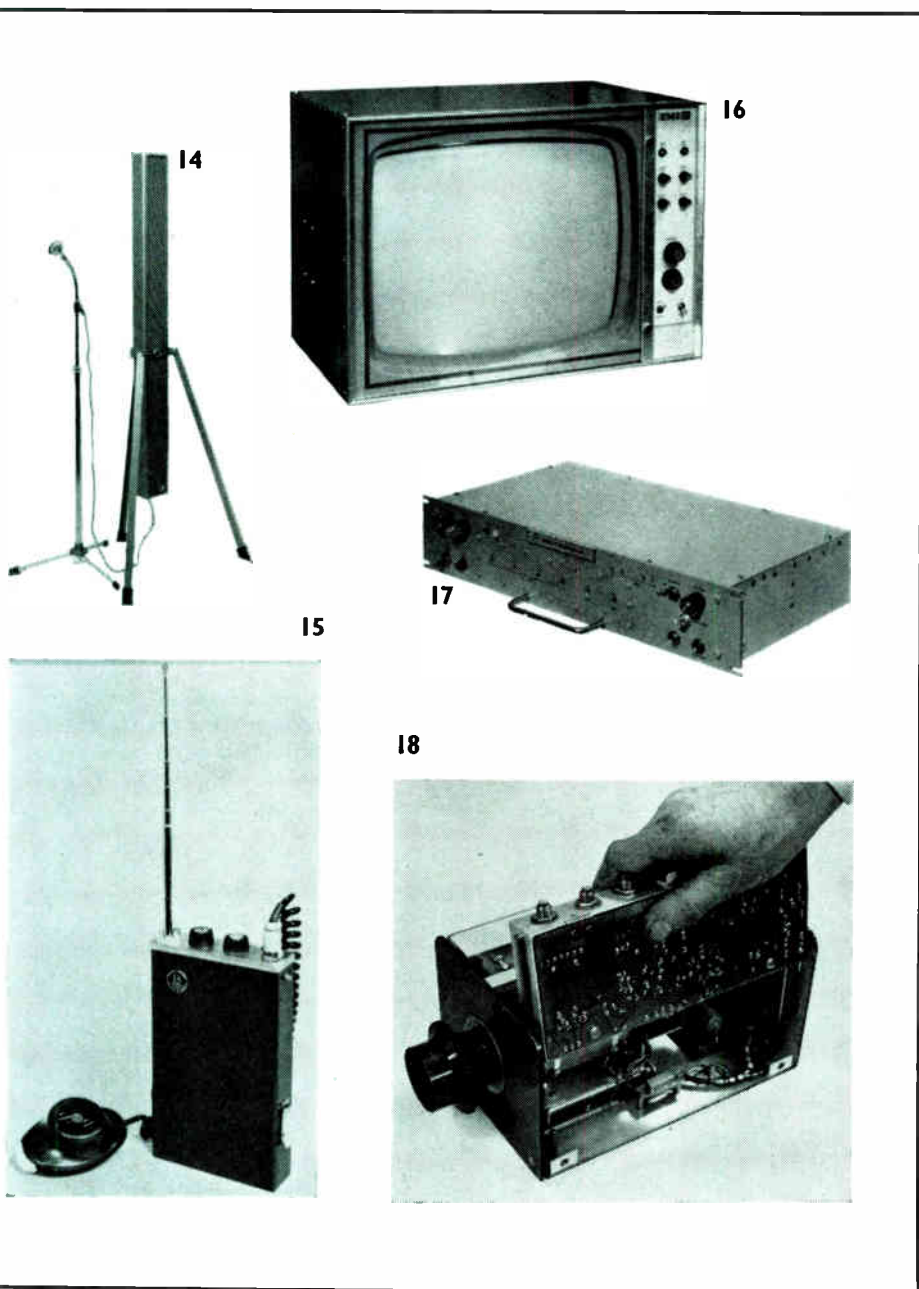

NEW

ELECTRONICS
COMMUNICATIONS
INSTRUMENTATION
CONTROL



19

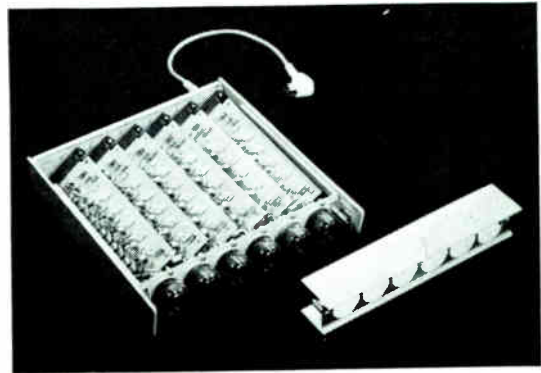

21

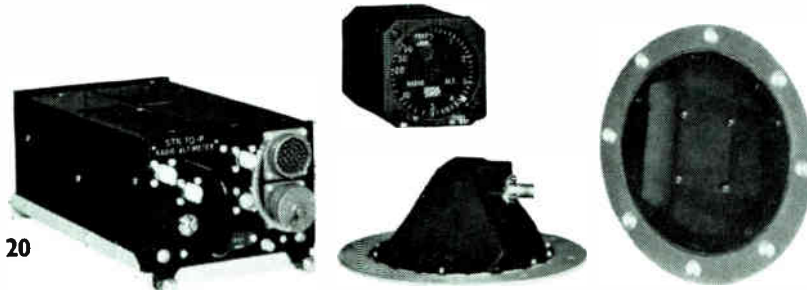

20

22



buttons. Each of these corresponds to a complete telephone number which can have up to 16 digits. When a button is pressed, the number is dialled automatically. The numbers for each button can be easily altered with the use of a bank of 10 numbered buttons. An automatic re-dialler is included which is operated by a single button to re-dial engaged numbers.—*Siemens-Schuckertwerke AG, 8520 Erlangen, Germany.*

For further information circle 19 on Service Card

INSTRUMENTATION

20. Radio-Altitude

An accurate solid-state radio altimeter, the STR 70-P, has been produced by S.T.C. It meets all the requirements for low-level flight-control systems including automatic

landing, terrain following, low approach, low-level strike and helicopter auto-hover. The height measuring range is 0-5,000 ft. Low-altitude warning and self-checking facilities are included and in the event of a failure the indicator needle is hidden or, for the terrain-following mode, the output is clamped to zero. The monolithic circuitry used produces a high standard of reliability, the mean time between failures being 5,000 hr.—*Standard Telephones and Cables Ltd., S.T.C. House, 190 Strand, London, W.C.2.*

For further information circle 20 on Service Card

21. Digital Instrumentation

A range of digital modules, or standard assemblies type 720, has been introduced by Dawe Instruments. It includes power supplies, display counters, clock-pulse generators, double-decade dividers, snaping-and-limiting amplifiers, control units and binary displays. These can be built up into a range of units

known as the 900 series for many different instrumentation applications. This series includes frequency meters, ratiometers, tachometers, counters and timers. The standard assemblies are mounted on plug-in printed circuit boards. Illustrated is a typical six-decade display counter.—*Dawe Instruments Ltd., Western Avenue, Acton, London, W.3.*

For further information circle 21 on Service Card

22. Intrinsically-Safe Voltmeter

John Davis and Son have developed a voltmeter, type 9105, for use in testing intrinsically-safe circuits in hazardous atmospheres. It is capable of metering both a.c. and d.c. voltages and is calibrated for 0-30 V. The needle is fully damped and readings can be taken with the meter held at any angle. A toughened glass window protects the scale and the unit is fully enclosed.—*John Davis and Son (Derby) Ltd., All Saints Works, Derby.*

For further information circle 22 on Service Card

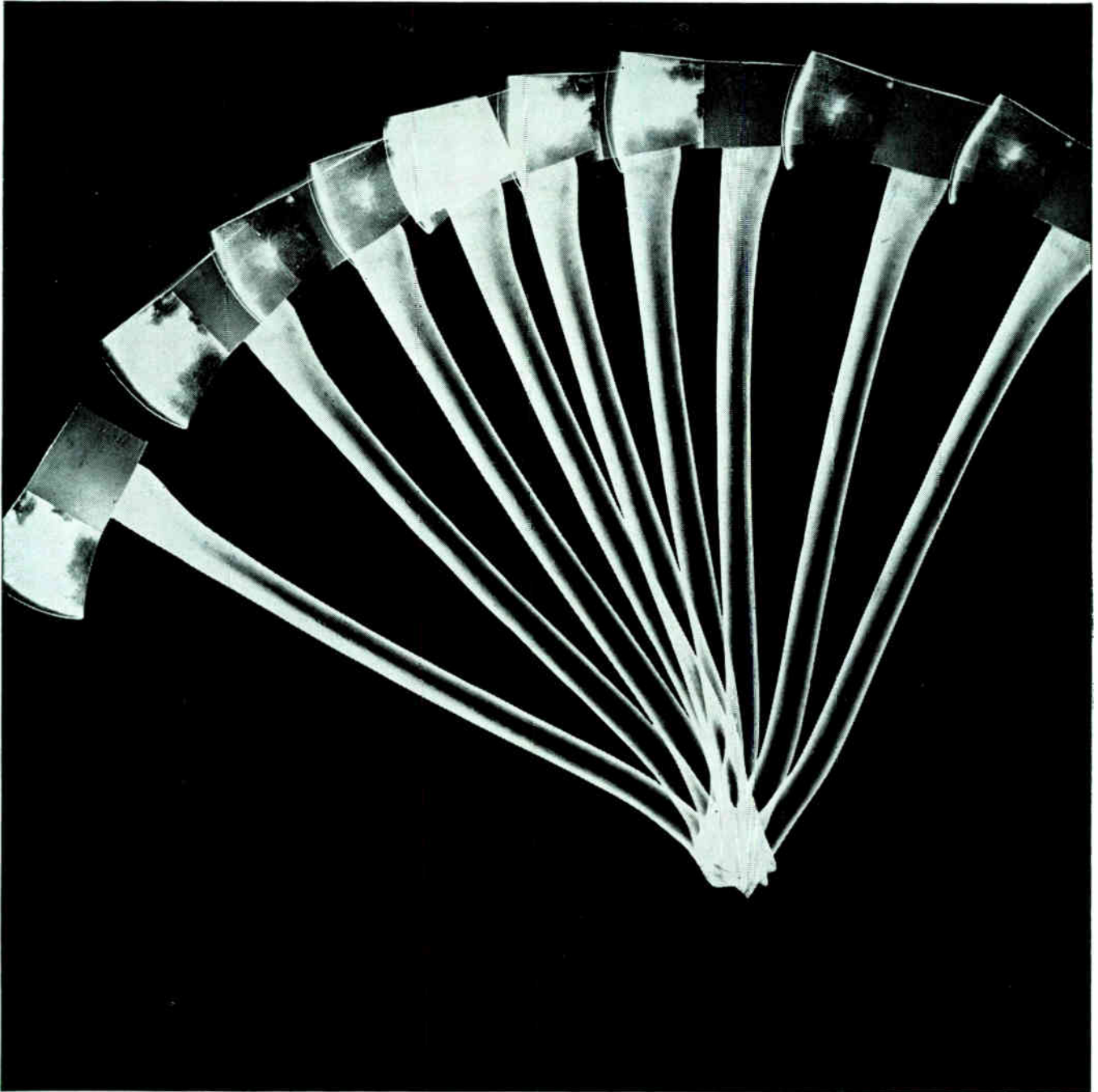

Cheapest way to chop

DC-to AC with an AEI Synchronous Chopper. It fits a standard B9A 9-pin thermionic valve holder, is suitable for feeding both high resistance and transformer-coupled low impedance circuits, its low noise level allows a 1 microvolt signal to be detected. Typical applications are: recording thermo-couple and ionisation chamber outputs; drift correction in analogue computer amplifiers; general instrumentation. Stability is high, operational life is long. Available in two models: CK3 for 50 c/s; CK4 for 100 c/s.

CK3 AND CK4 SYNCHRONOUS CHOPPER

Write to: Power Protection and Meter Department, AEI Switchgear Division, Trafford Park, Manchester 17, or your nearest AEI office.

AEI
SWITCHGEAR

ASSOCIATED ELECTRICAL INDUSTRIES LIMITED SWITCHGEAR DIVISION TRAFFORD PARK MANCHESTER 17

SM 302/1

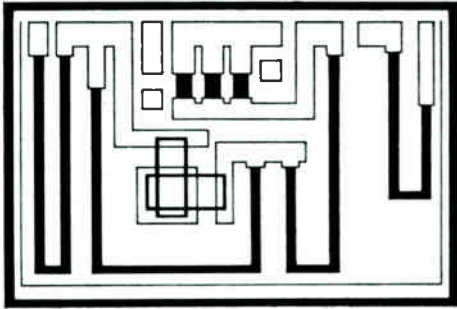

englass

ceramic and glass
substrates

presenting the most advanced
range of substrates

high alumina ceramic

Vacuum tight
High alumina (94% 97.6% 99.5%)
High strength and thermal conductivity
Good abrasion resistance
Uniform matt finish

or high quality glaze manufactured by
Wade (Ulster) Limited under licence from
Western Gold and Platinum Inc USA

glass

Moulded
Borosilicate
Optically Ground and Polished
(CLA 1 microinch or better)
Fire Polished Edges
Quality Controlled

a substrate service

to suit the requirements of the
electronics industry

send for technical literature to



English Glass Company Limited
Scudamore Road Leicester
Telephone Leicester 871371



**HIGH EFFICIENCY
SOLDERING INSTRUMENTS**

FOR
BENCH LINE PRODUCTION

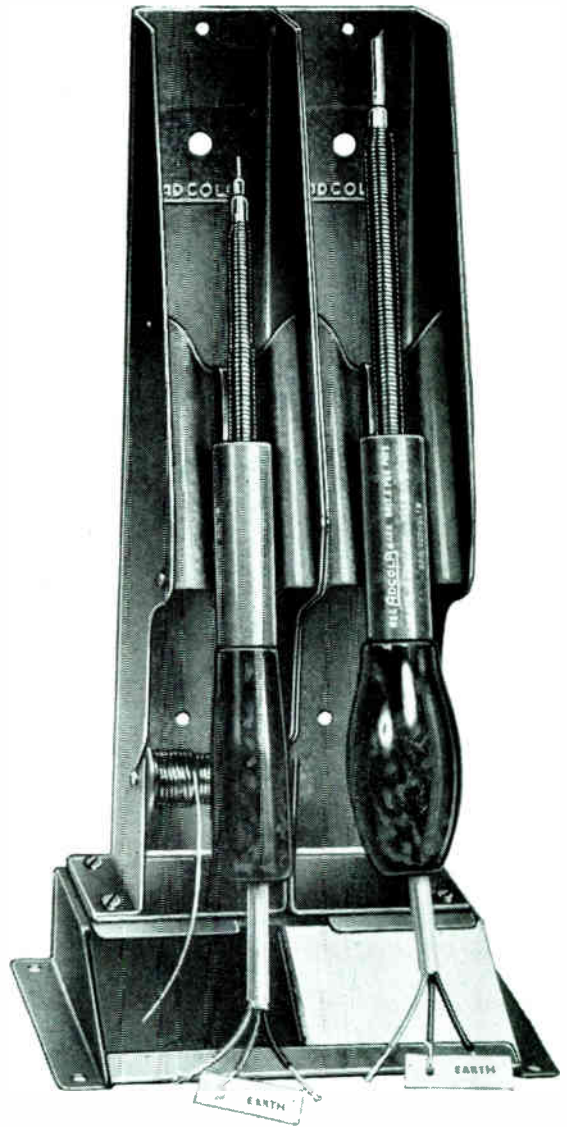

Apply direct to
Head Office Sales and Service

ADCOLA PRODUCTS LTD.
ADCOLA HOUSE
GAUDEN ROAD
LONDON S.W.4

Telephone
MACaulay
0291/3

Telegrams
SOLJOINT, LONDON S.W.4

INDEX TO PRODUCTS

Please refer to appropriate pages to obtain code number for marking enquiry card

A—Advertising pages E—Editorial pages

Aircraft altitude displays	E345	Oscilloscopes	24A
Alarm scanning systems	23A	Paint electrodeposition	E349
Altimeters, radio	E344	Pendants, push-button	E346
		Photo-electric letter-sorting machines	E355
Cabinets, boxes, chassis, racks, etc.	44A	Plastics mouldings and extrusions	50A
Cable stropping, bands	48A	Plastics tubing	29A
Capacitors	27A, 58A	Position indicators, machine tool	E350
Castings	19A	Potentiometers	2A
Chart readers	47A	Power cable alarms	E340
Choppers, electronic	35A	Power supplies	5A, 14A
Circuits logic	26A	Printed circuits	1A, 56A
Coil winding machines	46A	Programming boards	E348
Communication systems, industrial	E342	Public address systems	E342
Components, electronic	46A, 51A		
Computers, process	E341	Radars, marine	E341
Conduits	E350	Radars, transistorized	E342
Connectors, plugs, sockets	12A, 15A, 43A, 50A	Radio frequency sputtering systems	E333
Controllers, level	E355	Radioactivity measurements	E346
Controllers, temperature	13A	Radiotelephones	20A, 21A
Counters	49A	Receivers, V.H.F. and U.H.F.	E343
Counting and batching units	16A, E350	Recorders, chart	Cover 2, 39A
Couplers	E339	Regulators, pressure	E346
		Relays	Cover 4, 10A, 17A, 50A, 56A, E348
Data logging systems	23A, 31A	Resistors	48A
Dialling, push-button	E343		
Digital modules	E344	Sensors	E349
Digital stop-clocks	E341	Solder and soldering tools	6A
Diodes	9A	Springs and connectors	51A
Diodes, Zener	42A	Stores 'D'	9A
		Stroboscopes	E345
Electro plating	22A	Substrates	36A
Encoders	24A, 49A	Synchros	28A
Exciters, static	E347		
		Tape keyboards	E340
Filters, interference	16A	Tape recorders/reproducers, magnetic	E339
		Television, closed circuit	E343
Galolinium	E355	Thermistors	8A
		Timers	27A
High voltage monitoring	E354	Transducers	E347
		Transformers, variable	14A
Industrial communication	E327	Transistor testers	11A
Industrial processes, computer simulation	E355	Transistors	9A, 33A, 38A, 45A
Instruments, general	4A, 18A, 19A, 22A	Transmitters, D.S.B./S.S.B.	E342
Insulation materials	3A, 7A, 41A	Trucks, electric	E346
Laser pumps	E341	Ultrasonic cleaners	40A, E354
Magnetrons	E348	Vacuum equipment, high	32A
Magnets and magnetic materials	44A	Valves, water thermostatic	E347
Meters	55A	Voltmeters	E344, E345
Monitors, television	E343		
Monitors, voltage drift	E345	Walkie-talkies, portable	E343
Motors	18A, 44A	Weighing equipment	E349
Motors, linear	E339	Weighing units, hydrostatic	49A
Mouldings, porcelain steatite	51A	Wire, general	48A
		Wire, resistance	34A

MANUFACTURERS' LITERATURE

Page E332

E**

37

Let the

INDUSTRIAL ELECTRONICS

READER ENQUIRY SERVICE

help you to obtain more information

To obtain further details of any of the coded items mentioned in the Editorial or Advertisement pages of this issue, please complete one or more of the attached cards circling the appropriate reference number(s). Your enquiries will be passed on to the manufacturers concerned and you can expect to hear from them direct in due course. Cards posted from abroad require a stamp. These Service Cards are valid for six months from date of publication.

PLEASE USE CAPITAL LETTERS

Pour obtenir tous renseignements sur les produits codés mentionnés dans les articles ou dans les pages publicitaires de ce numéro nous vous prions de remplir une ou plusieurs des cartes ci-jointes en encerclant le ou les numéros de référence appropriés. Vos demandes de renseignement seront transmises aux fabricants intéressés qui, en temps voulu, vous feront parvenir leur réponse. Il est nécessaire d'affranchir les cartes postées à l'étranger. Ces cartes de service sont valides pendant six mois à partir de la date de publication.

PRIÈRE D'UTILISER DES CARACTÈRES D'IMPRIMERIE

Weitere Einzelheiten über irgendwelche Artikel, die auf redaktionellen oder Anzeigenseiten erscheinen, erhalten Sie, indem Sie eine oder mehrere der beigefügten Karten ausfüllen und die entsprechende(n) Kennnummer(n) eintragen. Ihre Anfrage wird an den Hersteller weitergeleitet, und Sie werden dann direkt von ihm hören, Karten, die im Ausland aufgegeben werden, müssen frankiert werden. Diese Service-Karten sind für sechs Monate vom Ausgabebetrag gültig.

BITTE IN BLOCKSCHRIFT AUSFÜLLEN

Per ulteriori particolari in merito agli articoli menzionati nel testo o nelle pagine pubblicitarie di questo numero, Vi preghiamo di completare una o più delle schede allegate chiudendo in un cerchietto il numero o i numeri di riferimento. La Vostra richiesta sarà inoltrata ai fabbricanti interessati che Vi risponderanno direttamente. Le schede dall'estero devono essere regolarmente affrancate. Questo scontrino di servizio è valido per sei mesi dalla data di pubblicazione.

SI PREGA DI COMPILARE LE SCHEDE IN STAMPATELLO

Con objeto de obtener más detalles de cualquiera de los artículos mencionados en las páginas editorial es o de anuncios de este número, sírvase rellenar una o más de las unidas tarjetas poniendo un círculo al número o números de referencia. Sus consultas serán transmitidas a los fabricantes interesados de quienes tendrán noticias directamente a su debido tiempo. Las tarjetas enviadas desde el extranjero requieren franqueo. Estas tarjetas de servicio son válidas durante 6 meses a partir de la fecha de publicación.

SÍRVASE ESCRIBIR CON LETRAS MAYUSCULAS

RCA SEMI CONDUCTORS 24 hour delivery

Production Quantities

POWER	2N 1480	2N 1487	2N 3055	2N 3442	2N 3771
	2N 1481	2N 1488	2N 3439	2N 3583	2N 3772
	2N 1484	2N 1490	2N 3440	2N 3584	40 264V1
	2N 1485	2N 2148	2N 3441	2N 3585	
INDUSTRIAL	1N 3196	2N 3529	2N 3872	40111	40348
	1N 3253	2N 3668	2N 398A	40209	40349
	1N 3254	2N 3669	40108	40266	
	1N 3754	2N 3870	40109	40267	
	2N 1225	2N 3871	40110	40347	
SWITCHING	2N 1091	2N 3241	40231	40233	
	2N 1301	2N 3242	40232	40234	
COMMUNICATIONS	2N 3375	2N 3866	40405	40281	40291
	2N 3553	2N 3932	40280	40290	40292
	2N 3632	2N 3933			

PERFORMANCE WITH SILICON

Engineering Prototype Quantities

POWER	2N 1479	2N 1487	2N 2148		
	2N 1480	2N 1488	2N 3055	2N 3442	2N 3771
	2N 1481	2N 1489	2N 3439	2N 3583	2N 3772
	2N 1484	2N 1490	2N 3440	2N 3584	40 264V1
	2N 1485	2N 1702	2N 3441	2N 3585	
	2N 1486	2N 1905			
INDUSTRIAL	1N 3196	2N 3228	2N 3871		
	1N 3253	2N 3053	2N 3872	40111	40348
	1N 3254	2N 3529	2N 398A	40209	40349
	1N 3754	2N 3668	40108	40266	
	2N 1225	2N 3669	40109	40267	
	2N 3870	40110	40347		
SWITCHING	2N 1091	2N 3241	40231	40233	
	2N 1301	2N 3242	40232	40234	2N 2938
COMMUNICATIONS	2N 3375	2N 3866	40405	40281	40291
	2N 3478	2N 3932	40280	40290	40292
	2N 3553	2N 3933	40282		
	2N 3632				



THE MOST TRUSTED NAME IN ELECTRONICS.

RCA GREAT BRITAIN LIMITED, Electronic Components & Devices Sales
LINCOLN WAY · WINDMILL ROAD · SUNBURY-ON-THAMES · PHONE: SUNBURY 5511

ASSOCIATE COMPANY OF RADIO CORPORATION OF AMERICA

23. Voltage Drift Monitor

A drift monitor which is capable of recording drifts of a few p.p.m. over several days is available from J. and P. Engineering. It is intended for monitoring power supplies of voltages from 0.1 V to 5 kV and currents of 100 μ A to 5 A. The circuit consists of a zener-diode regulated reference voltage source, a divider network and an amplifier. Temperature control results in an overall temperature coefficient better than 0.2 p.p.m. for a temperature change of 1 °C. The stability for a 10% mains-supply variation is better than 1 p.p.m. An output for a pen recorder is provided.—*J. and P. Engineering (Reading) Ltd., Portman House, Cardiff Road, Reading, Berks.*

For further information circle 23 on Service Card

24. Stroboscope

Lunatron Electronics have added the model 1209 to their range of

stroboscopes. This has three ranges of flashing frequency, these being 60–6,000, 600–6,000 and 3,000–15,000 flashes per min. The frequency of operation is shown on a meter on the top face of the unit. The flash duration is 5–10 μ sec. Transistorized circuitry is used throughout and this is stabilized against mains-supply fluctuations. External triggering with a shorting circuit can be used and an external lamp can be operated.—*Lunatron Electronics Ltd., Chester Works, Chester Avenue, Luton, Beds.*

For further information circle 24 on Service Card

25. Voltmeter

The Advance VM76 voltmeter has a frequency range for a.c. measurements which exceeds 1 Gc/s. The f.s.d. values of the a.c. voltage ranges are from 300 mV to 300 V r.m.s. while those of the d.c. range extend from 300 mV to 1 kV. On both a.c. and d.c. measurements,

accuracies of $\pm 2\%$ of f.s.d. up to 100 V and $\pm 3\%$ of f.s.d. above 100 V are provided. The accuracy of resistance measurements is $\pm 5\%$ at mid-scale which, depending on the range, corresponds to 1 Ω to 10 M Ω , with eight ranges covering 0.02 Ω to 500 M Ω overall. Push-button selection of the various functions is featured.—*Advance Electronics Ltd., Roebuck Road, Hainault, Ilford, Essex.*

For further information circle 25 on Service Card

26. Aircraft Attitude Display

An artificial horizon known as the type FH 14 has been developed by Ferranti to meet the need for a standby unit of this type in high-flying high-performance aircraft. It contains its own vertical gyro and an electrically-driven spherical attitude display. This provides a linear display of pitch attitude within $\pm 85^\circ$ and full freedom in roll. A per-

NEW

ELECTRONICS
COMMUNICATIONS
INSTRUMENTATION
CONTROL

23



24



25

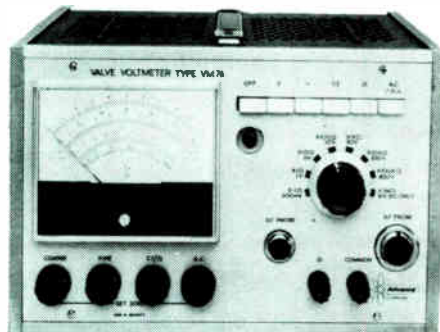

26

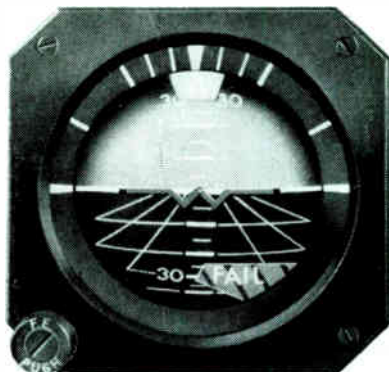

spective pattern on the two-colour display gives the appearance of depth. A pattern of pitch lines indicates the horizon direction and gives additional roll guidance at high pitch angles.—*Ferranti Ltd., Aircraft Equipment Department, South Hill Park, Easthampstead, Bracknell, Herts.*
For further information circle 26 on Service Card

27. Radioactivity Measurements

The Cary model 3810 vibrating-reed electrometer available from V. A. Howe is a sensitive recording instrument for radioactivity measurements. It is intended to be used with special attachments for radio respirometry (respiration pattern analysis), tritium air monitoring or the radioactivity analysis of gas chromatograph effluents. For respiration pattern analysis, the unit's high sensitivity and stability permit measurements of carbon-14 to 10^{-6} microcuries per c.c. of air. A variety of chamber sizes and types is available for a wide range of radioactivity measuring applications. The unit can be used to detect the maximum permissible concentration of tritium in air. Argon-41, krypton-85, and other radioactive isotopes in the gas phase will also be detected. For high-temperature radioactivity chromatography, a special oven can be obtained and the system provides a wide range of operating conditions.—*V. A. Howe and Co. Ltd., 46 Pembridge Road, London, W.11.*
For further information circle 27 on Service Card

CONTROL

28. Electric Truck

Electronic control has been applied to the Hyster-Ransome 'L' series of battery-powered 'SpaceSaver' lift trucks. Known as 'Solectronic', this control system uses one pedal for control of speed and direction. Pressure on the left side of this pedal initiates forward drive while pressure on the right side is for reverse. Depression of the pedal actuates a thyristor control circuit to deliver steplessly-variable current to the drive motor. Less power is wasted with this system than with resistance-controlled systems so that an increased amount of work can be obtained from one battery charge.—*Hyster Overseas, Turriff Building, Great West Road, Brentford, Middlesex.*
For further information circle 28 on Service Card

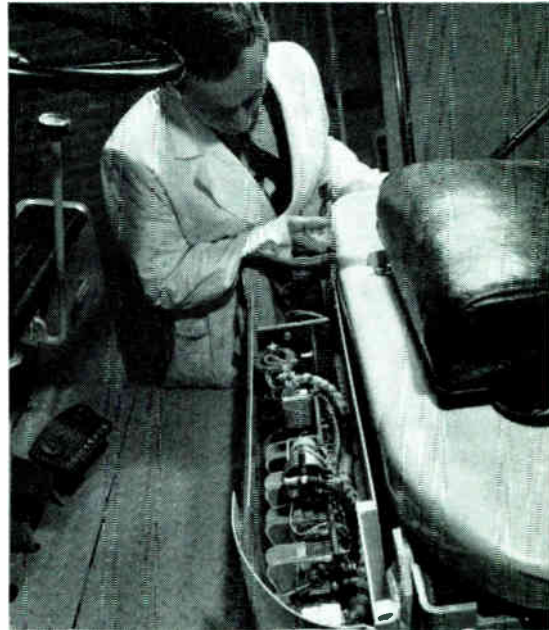

28

NEW

ELECTRONICS
COMMUNICATIONS
INSTRUMENTATION
CONTROL

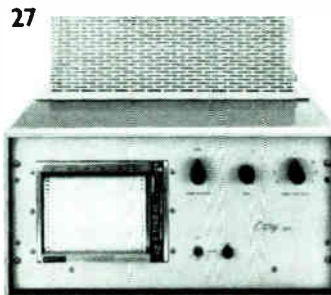

27



29

29. Push-Button Pendant

A rugged pendant push-button control station has been introduced by Brookhirst Igranic. It has a resilient neoprene body which is weather proof and resistant to most oils, greases and cutting fluids. Each pendant is supplied as a kit of parts which can be easily assembled by the user. A complete station consists of a top and a bottom moulding and one to eight intermediate sections. Two buttons, each actuating a normally-open, a normally-closed or a change-over contact, are housed on each inter-

mediate section.—*Brookhirst Igranic, Elstow Road, Bedford.*

For further information circle 29 on Service Card

30. Pressure Regulators

The Series RO 4 piston-operated miniature pressure regulators produced by C. A. Norgren Ltd. are suitable for use with air and non-corrosive gases. Operating on a maximum line pressure of 400 p.s.i., the output pressure of the standard models can be adjusted from 5-100 p.s.i. Models with output ranges of 5-50 p.s.i. can be obtained. The

30

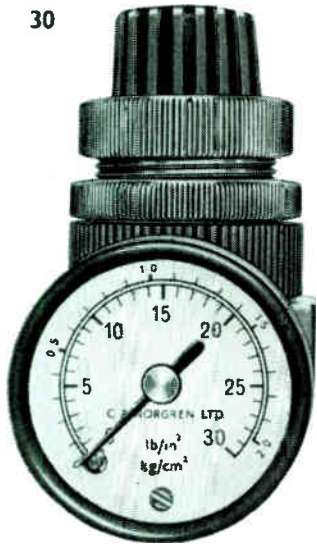

31



standard models incorporate a relieving feature which permits the regulated pressure to be reduced by an adjustment of the control knob. Non-relieving types can also be supplied. The picture shows an RO 4 fitted with a Series 304M pressure gauge.—*C. A. Norgren Ltd., Shipston-on-Stour, Warwickshire.*

For further information circle 30 on Service Card

31. Transducers

The transducers in the range produced by Smith Hobson consist of two similar toroidal transformer cores

32

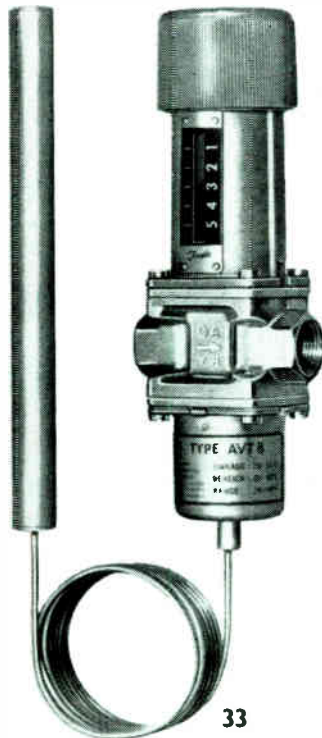
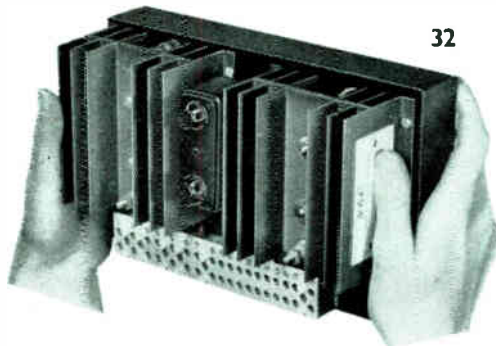

33

core so that it can be put in position without any disturbance of the cable being metered.—*Smith Hobson Ltd., Hersham Trading Estate, Walton-on-Thames, Surrey.*

For further information circle 31 on Service Card

32. Static Exciter

The 'Gecostat 16/80', recently introduced by G.E.C., is a static exciter for the automatic control of alternators. It can be used with 400–440-V three-phase alternators or 230–250-V single- or three-phase alternators with output frequencies of 50 or 60 c/s. Under normal conditions, an output of 16 A at 80 V is produced, the maximum continuous output being 2 kW in an ambient temperature of 55 °C. The unit provides direct excitation of alternators with outputs up to 75 kVA and automatic control of brushless and conventional exciter-controlled alternators up to 500 kVA.—*The General Electric Co. Ltd., Birmingham, 6.*

For further information circle 32 on Service Card

33. Thermostatic Water Valve

Danfoss have introduced a thermostatic water valve, designated the type AVTB, which automatically controls liquid temperatures. It is particularly suitable for use with heat exchangers. The unit comprises a bellows-actuated valve and a sensing bulb containing liquid and saturated liquid vapour. An increase in temperature at the bulb causes a pressure increase at the bellows to close the valve. Three models are produced having temperature ranges of 32–85 °F, 70–140 °F and 125–190 °F. The sensing units are interchangeable so that the temperature range of a valve can be readily altered.—*Danfoss (London) Ltd., 6 Wadsworth Road, Perivale, Greenford, Middlesex.*

For further information circle 33 on Service Card

each with an a.c. winding. As such they are suitable for non-contact measurement of currents in cables. Units with a d.c. control winding for control applications can be supplied. The outputs of the units are reduced to a value suitable for moving-coil meters by a rectifier and current transformer. Auxiliary rectifier units with outputs up to 100 VA can be obtained. The picture shows the type DC/TR/HC which has a current range of 2,000–20,000 A. Other models are the type DC/TR/LC, with a current range of 200–1,500 A, and the type DC/TR/SC which has a split

34. Indicating Controller

An indicating controller which can be supplied as either an electronic or a pneumatic unit is available from Fischer and Porter Ltd. Known as the 'Scan-Line', it has a number of control capabilities and gives a clear indication of the state of the equipment being controlled. In operation, a movable scale is adjusted so that the required set value corresponds to a line on the face of the instrument. Any deviation of the measured value

of voltage or pressure is shown by a pointer. The calibrated accuracy is $\frac{1}{2}\%$ of the scale span.—*Fischer and Porter Ltd., Salterbeck Trading Estate, Workington, Cumberland.*

For further information circle 34 on Service Card

35. Patchboard Programming

A range of patchboard programming units for use in process control, data processing and other applications has been introduced by AMP. These are manually-operated switches which provide a large number of switching combinations. Six standard sizes are available offering from 240–5,120 holes per board. Programs in the form of ready-plugged boards can be held for immediate use and readily inserted into the rear frame. The equipment being programmed is wired to the contacts on this frame, the contacts corresponding exactly to the holes in the board. A roller cam movement ensures that all contacts are wiped during closing.—*Aircraft-Marine Products (G.B.) Ltd., Terminal House, Stanmore, Middlesex.*

For further information circle 35 on Service Card

COMPONENTS

36. Magnetron

A 4-mm magnetron, type 4MA6, is now being produced by Elliott-Automation. This magnetron can maintain stable frequency and efficiency characteristics for operating periods in excess of 200 hr. The useful life is expected to be 500 hr. A power rating of 5 kW is offered as well as a pulse duration of 5 nsec and a rise time of 1 nsec. The output from this magnetron is obtained through size 26 waveguide.—*Elliott Electronic Tubes Ltd., Elstree Way, Borehamwood, Herts.*

For further information circle 36 on Service Card

37. Mercury Relay

Techna (Sales) Ltd. are distributing a relay known as the 'Euroswitch-M'. This employs mercury contacts instead of the traditional type and these have a life expectancy of over ten million operations. Operation is by a plunger action instead of tilting and there are therefore no external moving parts. The mercury container is stainless steel which

enables severe shocks due to current surges, arcing, etc., to be withstood. A current of 25 A at 440 V a.c. can be disconnected at an operating frequency of up to 2,000 per hour. A full range of standard coil voltages are available and the operating power required is only 4 W on d.c. voltages and 6 VA on a.c. voltages. This relay, measuring 1.5 in. in diameter and 3.25 in. long, is hermetically sealed and is suitable for use in dangerous or contaminated atmospheres.—*Techna (Sales) Ltd., 47 Whitehall, London, S.W.1.*

For further information circle 37 on Service Card

NEW

**ELECTRONICS
COMMUNICATIONS
INSTRUMENTATION
CONTROL**

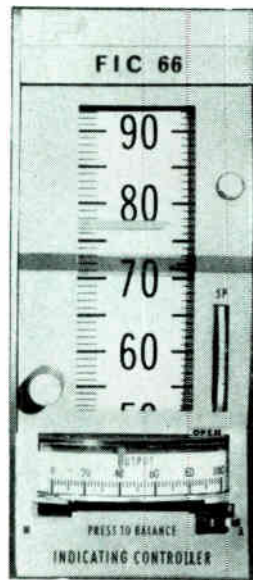

34

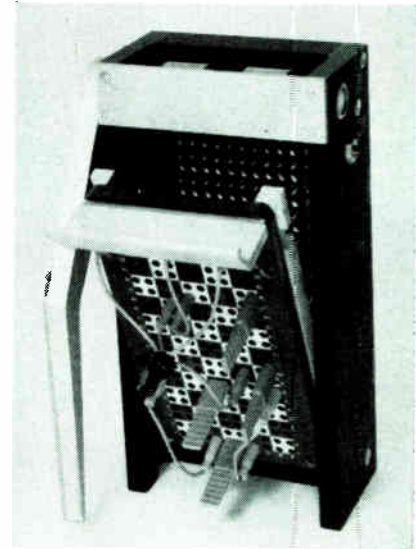

35

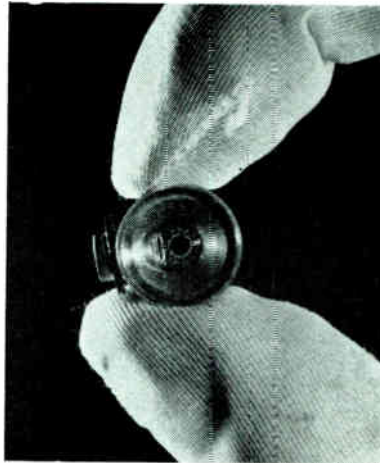

36

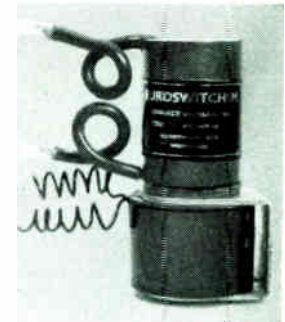

37

38. Pressure Transducers

The VT series of miniature bonded strain-gauge pressure transducers introduced by Intersonde Ltd. are intended for applications where high static or dynamic pressures are to be measured in confined spaces. The transducers are based on a precision-machined steel tube. On this, four strain-gauge elements are wound and connected in a Wheatstone-bridge configuration. The gaseous or liquid pressure media entering the interior of the tube induce stresses in the tube wall. These are sensed by the two active

ETHER LOW-COST RECORDERS

Xactline Transistorised Indicating Recorders

- Self-contained transistorised potentiometric indicating recorders; operating from thermo-couples or resistance bulbs to indicate and record temperature—or any variable which can be converted to a d.c. millivolt signal
- Up to six point operation
- Calibration accuracy: $\pm 1\%$ of span
- Sensitivity: $15 \mu\text{V}$
- Wide temperature range: up to 1750°C
- Minimum span 5.0mV (nocold junction compensation) 7.5mV (for thermo-couples)
- 10Ω (25°C —resistance bulbs)

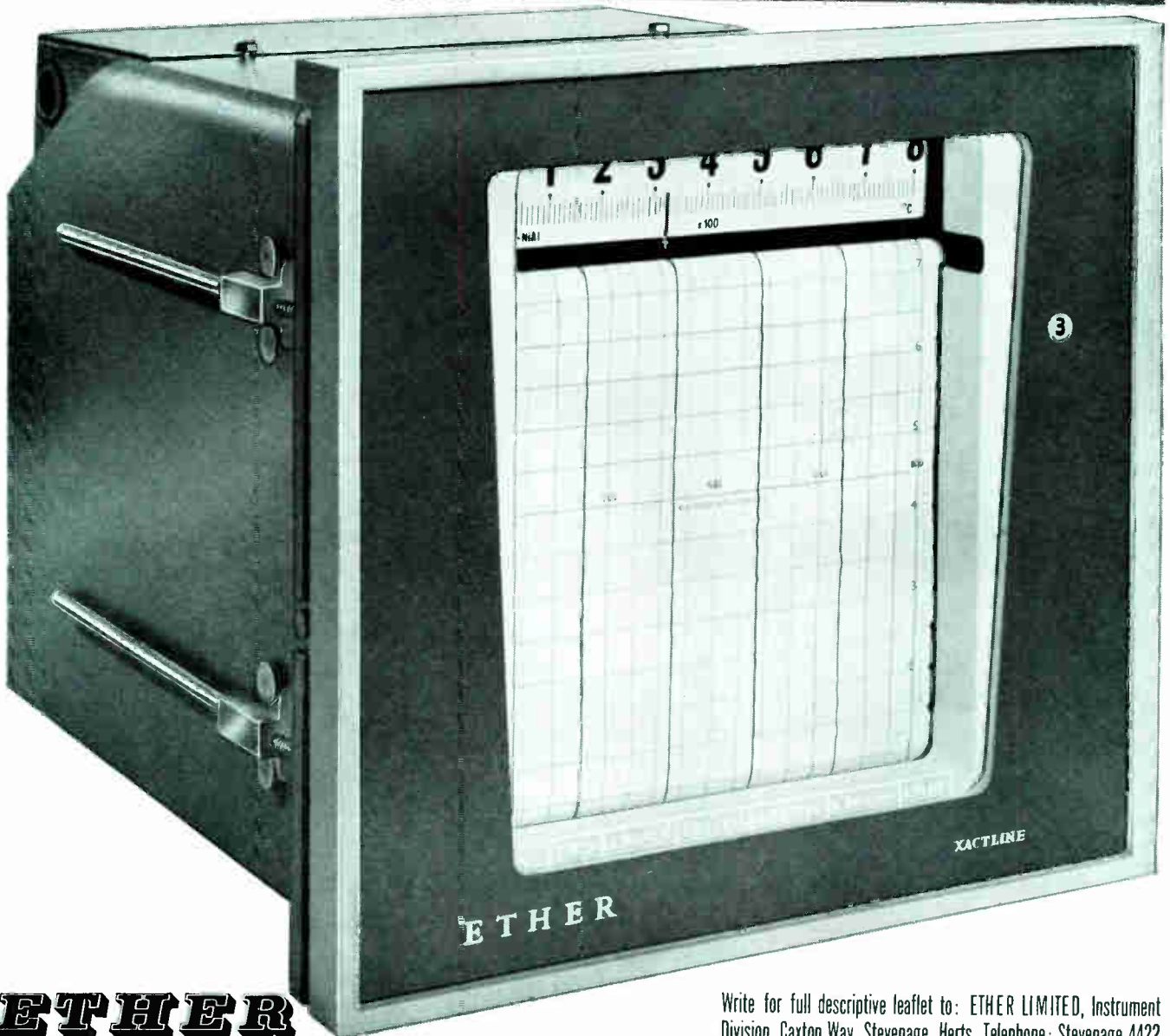

ETHER

Industrial Electronics July 1966

Write for full descriptive leaflet to: ETHER LIMITED, Instrument Division, Caxton Way, Stevenage, Herts. Telephone: Stevenage 4422

for those **BIG** cleaning problems..



Large? Smallish Large? Largish? largish small? tiny?—worry not. Dawe can/will supply the ultrasonic cleaning plant most appropriate to your present/future needs. There is a standard plant for most cleaning requirements; if however your cleaning problems need a specialised answer Dawe are equipped to advise, design, and build plant for your specific requirements.

DAWE POWER ULTRASONICS

For example, the large ultrasonic cleaning plant seen above is a Dawe custom built unit of a type being supplied to H.M. Dockyards in the U.K. and abroad for the cleaning of electrical and electronic equipment. On the other hand, if your cleaning can be handled by the Dawe Transistorised Soniclean 1141B from the Standard range you too will be amazed at the lengths to which we go to ensure speedy delivery/satisfaction/the best answer to your requirements.

Drop a line to Dawe—the experts.

small ones too!



POWER ultrasonics division of **DAWE INSTRUMENTS LTD.,**

WESTERN AVE., LONDON, W.3 Tel: ACO rn 6751

A member of the *Simms* group of companies

Industrial Electronics July 1966

strain-gauge elements. With an applied excitation of 24 V the output produced is 3.6 mV per 1,000 p.s.i.g. The transducers may be used up to 10,000 p.s.i.g. A hysteresis error of less than 1% of f.s.d. is quoted.—*Intersonde Ltd., The Forum, High Street, Edware, Middlesex.*

For further information circle 38 on Service Card

39. Nickel Temperature Sensors

Precision etched-foil nickel-resistance temperature sensors produced by the Budd Co. of the U.S.A. are now available from Westland Aircraft. These elements are suitable for surface mounting to measure temperatures up to 300 °C. Their resistance at 24 °C is 50 Ω and the temperature sensitivity is approximately 0.5% per °C. A linearization network is available to give a linear output over the temperature range.—*Westland Aircraft Ltd., Saunders-Roe Division, East Cowes, Isle of Wight.*

For further information circle 39 on Service Card

PRODUCTION AIDS

40. Weighing Equipment

The weighing equipment type M7550 produced by Ekco can be used for many purposes involving accurate weighing, lifting or stress measurement. It consists of a load-cell and a transistorized amplifier and indicator. In the illustration, the equipment is being used to estimate the safe load for a crane. The hook of the crane is attached to a shackle on a buried concrete block and a load cell is placed between the two. The indicator is connected to the load cell and the required load is preset on the indicator. The meter on the indicator can be viewed by the driver while hoisting to the required load level and it indicates when the required load has been met. Other applications include chain and sling testing, check-weighing of goods vehicles, testing draw-bar pull and

axle loads and similar uses. The unit has an accuracy of $\pm\frac{1}{2}\%$ of full load.—*Ekco Electronics Ltd., Southend-on-Sea, Essex.*

For further information circle 40 on Service Card

41. Electrodeposition of Paint

The electrodeposition of paint is a recent development which offers several advantages over the traditional methods of painting. It consists of a metal object being immersed in a tank of a special paint. A d.c. current is passed from a negative electrode, which may be the tank wall, to the metal object being painted which acts as the positive electrode. An even film of paint is formed on the object and this film is free from runs, penetrates cavities and will not wash off. K. Welters Ltd. have produced equipment which will simulate production conditions. It consists of a rotary transporter which will hold six articles. The articles are passed through a deposition tank and then

38

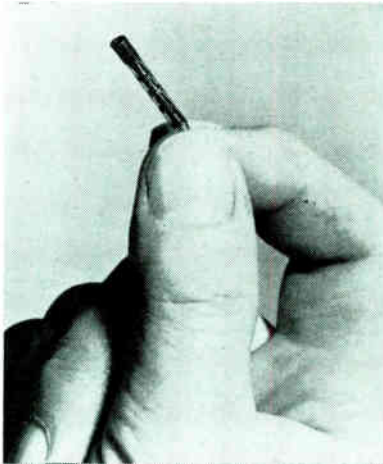

39

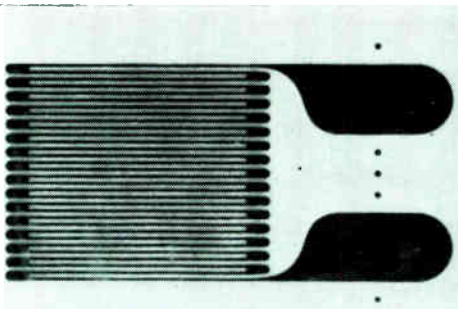

NEW

ELECTRONICS
COMMUNICATIONS
INSTRUMENTATION
CONTROL

40



NEW

ELECTRONICS
COMMUNICATIONS
INSTRUMENTATION
CONTROL

41

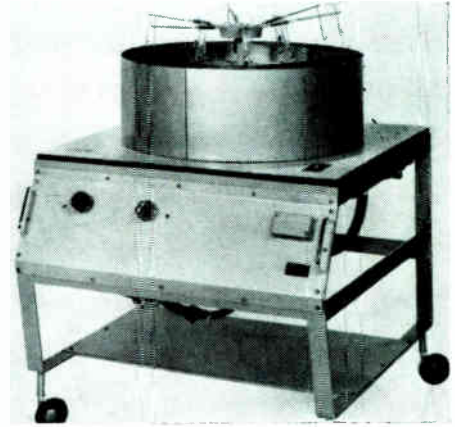
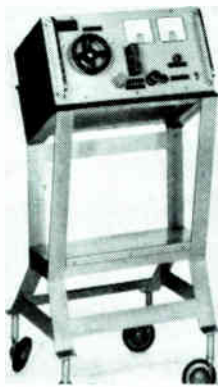

42

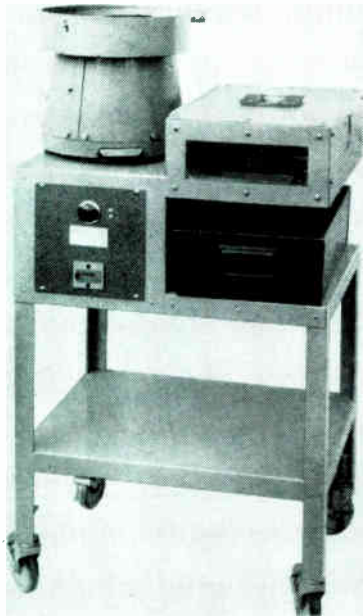

43

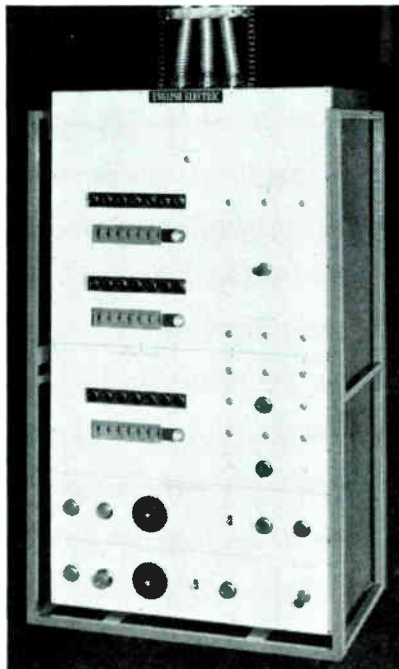

through a stripping tank where surplus paint is removed. For tests the transporter is connected, as shown, to a three-tank system.—*K. Welters Ltd., 23a West Wycombe Road, High Wycombe, Bucks.*

For further information circle 41 on Service Card

42. Counter and Batcher

Photain's recently-introduced 'Auto-count' counts and batches articles regardless of their shape and weight. The detecting element used is a 'light curtain' consisting of a light source and a row of photocells. If an article falls through the light beam to obscure at least one photocell a signal will be produced. The range

of three light curtains covers article diameters of $\frac{1}{8}$ –6 in. Complementary electromagnetic counters and batch counters are available. These count up to 999,999 at a speed of up to 2,400 per min and count batches at 1,500 articles per min. Transistorized counters operating at speeds up to 3,000 articles per sec and having a total count of 9,999 are also produced.—*Photain Controls Ltd., Rاندalls Road, Leatherhead, Surrey.*

For further information circle 42 on Service Card

43. Machine-Tool Position Indicator

Automatic position-indicating equipment for single- or multi-axis

machine tools is now in production by English Electric. This provides a direct digital readout of linear mechanical movement with a resolution of 0.0005 in. In operation, the linear movement is converted to a rotary motion which is transmitted, via a gear-box, to a 'Rotapulse' unit. This produces 1,000 electrical pulses for one revolution of its shaft. The pulses are amplified and counted, the count being displayed on a readout of six digits plus a sign indicator. The counter adds as the tool moves away from a datum point and subtracts as it moves towards it.—*Control Gear Division, The English Electric Co. Ltd., Kidsgrove, Stoke-on-Trent.*

For further information circle 43 on Service Card

Planning your next move?

ASK ABOUT "SELLOTAPE" ELECTRICAL TAPES

because you'll find the solution to many problems in the manufacture of electrical components in the versatile "Sellotape" electrical range—a range tailor-made for a wide variety of taping jobs—insulating, securing, protecting, holding, identifying (by printed tape) and many others. Whether the job calls for an extra-thin insulating material or for an extra-tough tape for heavy duty work . . . whether a component has to withstand freezing conditions or operate at very high temperatures you can be sure that "Sellotape" have a tape for it.

- 1 "Sellotape" electrical tape is a neat, secure replacement for the usual metal lamination clamp on printed circuit components and in double-sided form it secures the component to the circuit board.
- 2 Electrical grade 1609 used as an insulating film and holding medium for the copper electrostatic screen in transformer windings.
- 3 "Sellotape" Polyester Thermosetting 1607 for security on stick-wound coils.
- 4 "Sellotape" electrical grade tape is an inexpensive, easy-to-apply insulating and protective medium for flexible printed wiring systems.
- 5 "Sellotape" electrical tape wound on a mandrel adhesive outermost makes inexpensive insulating formers.

There is a team of "Sellotape" specialists constantly at work in this field. The benefit of their experience and advice is always freely at your disposal.

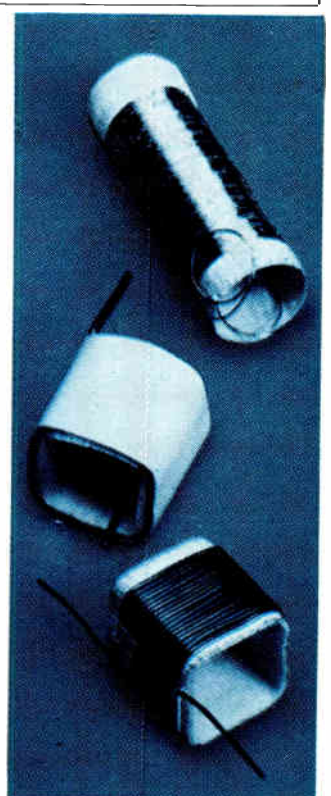
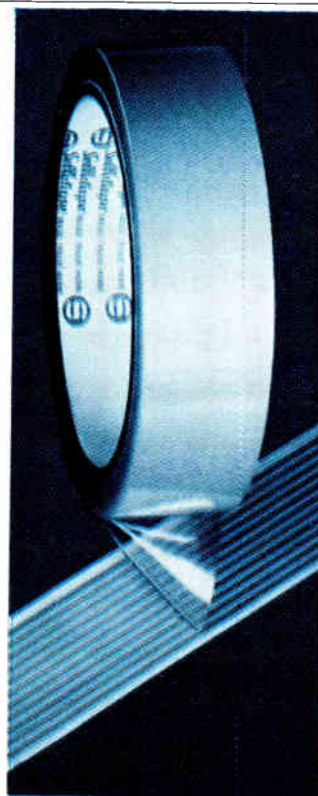
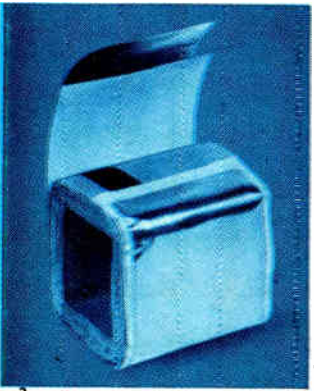

Sellotape products—a plus on every production line

SELLOTAPE PRODUCTS LIMITED, INDUSTRIAL DIVISION, SELLOTAPE HOUSE
54-58 HIGH STREET, EDGWARE, MIDDLESEX. Telephone: EDGware 2345. Telex: 262462
DUBLIN OFFICE: 1/2 LOWER MOUNT STREET, DUBLIN 2. Telephone: 61108/9
Associated Manufacturing Companies in Australia, Canada, Eire, New Zealand and South Africa

"SELLOTAPE" is the registered trade mark of Adhesive Tapes Limited

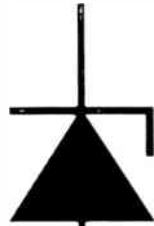

163 different Mullard Zener Diodes



† 3.3 to 75V... 0.28 to 75W

† 5% tolerance

† new low prices

Mullard silicon voltage regulator (Zener) diodes give you $\pm 5\%$ voltage tolerances at prices normally associated with tolerances of $\pm 10\%$ or 20% .

In the wide Mullard range there are 163 different voltage/power ratings—from 3.3 to 75V (E24 log-series values) and 280mW to 75W. They exhibit sharp knee characteristics, low dynamic resistance and low leakage currents.

MULLARD RANGE OF SILICON VOLTAGE REGULATOR (ZENER) DIODES

	Voltage Range	Power Rating	Encapsulation
*BZY91	10 to 75V	75W	DO-5
*BZY93	6.8 to 75V	20W	DO-4
OAZ222 - OAZ223	5.6 and 6.2V	10W	DO-4
BZY96	4.7 to 9.1V	1.5W	DO-1
BZY95	10 to 75V	1.5W	DO-1
BZY88	3.3 to 9.1V	0.4W	DO-7
† BZY94	10 to 75V	0.4W	DO-7
BZY78	5.3 typical	0.28W	DO-7

BZY91 series is capable of withstanding peak surges of 4.4kW for a 100μs.

**Available with either normal or reverse polarities. † To be released shortly.*

A New Publication Every designer should have his own copy of Mullard's new publication 'Voltage Regulator (Zener) Diodes' which includes detailed considerations of voltage-stabilising, voltage-shifting, voltage-clipping and other circuits. It's free... just write to Mullard for your copy.

Mullard

Mullard Limited, Industrial Markets Division,
Mullard House, Torrington Place, London, W.C.1. LANgham 6633.

a powerful electronic computer has been announced by **NCR** and **Elliott-Automation**. A jointly-owned company, **NCR Elliott Computer Workshops Ltd.**, has been formed to operate the service.

A firm of engineering design consultants, **J. Maplesden and Partners**, has recently been formed. The service being offered to small and medium-sized manufacturers covers all aspects of the design of products.

The M.L. Group has announced the formation of **M.L. Industrial Products Ltd.** The company will manufacture and market a wide range of electrical components and testing instruments.

Meter-Flow Ltd. are now manufacturing, under licence to **Instruments Inc.** of the U.S.A., the B.S. and W. monitor primarily for use in the oil industry. This instrument will monitor and control the quantities of solid and water contamination in oils.

SGS-Fairchild is to build two more factories adjacent to its existing plant at Agrate, near Milan, Italy. One of these factories will manufacture a full range of silicon semiconductors while the other will provide mechanical components for these devices.

The Coors Porcelain Co. of America have confirmed the appointment of **Andermann and Ryder Ltd.** as their sole selling agents in the U.K. Two

types of ceramic materials are offered, alumina and beryllia.

The **Avo** instrument sales division has moved its premises to **Avocet House**, **Archcliffe Road**, **Dover, Kent**. The instrument service and spares departments and the coil-winding division remain at **92-96 Vauxhall Bridge Road**, **London, S.W.1**, until further notice.

Shipton Automation (Manufacturing) Ltd. has become **Shipton Electronics Ltd.** The company's products include language laboratories, touch-dial telephones, repertory diallers, loudspeaking telephones and the 'Tel-Stor' telephone answering machine.

Continuous production of a non-radioactive isotope, carbon-13, is now under way at **20th Century Electronics**. The company is the only one in the world to produce this isotope.

AEI and **Grundig** of Western Germany have concluded an agreement making **AEI Electronics** the sole distributors for **Grundig** closed-circuit television systems in the U.K. **AEI Electronics** will also have non-exclusive marketing rights throughout the world except in some European countries.

Decca Radar has entered the field of marine automation equipment and is to introduce a range of standard products designed to meet the requirements of various classes of merchant

ships. This extension to the company's range of products follows the recent acquisition of **Setpoint**, manufacturers of marine and industrial control engineering equipment.

The formation of **Computer Technology Ltd.**, a British company specializing in the development and application of advanced computing equipment, has been announced. Included in the range of activities is the development of low cost store systems with 200 nsec access time, the design of multi-access organizations for small computers, studies in graphical processing and the development of new production and assembly techniques.

Waycom have announced their appointment as U.K. representatives for the **National Semiconductor Corp.** of the U.S.A. The products of the American company include silicon amplifier switches, chopper transistors and integrated circuits.

C-E-I-R Ltd. have taken further office space at **164/182 Oxford Street**. Much of this space is to be allocated to the training division to allow the division to accommodate its programme of courses in management technology and computer techniques.

The automation division of **The M.E.L. Equipment Co. Ltd.** has moved from **Waddon Factory Estate**, **Croydon**, to **Manor Royal**, **Crawley**, **Sussex**. The move follows a year's temporary residence at **Waddon** during construction of extensions to the company's main factory and offices at **Crawley**.

Plessey Radar has signed an agreement with **CSF**, **Compagnie générale de télégraphique Sans Fil** of France, for the manufacture and sale of the **CSF TI 450** scan-conversion bright display and its peripheral equipment. The agreement gives **Plessey** exclusive rights in the U.K., together with non-exclusive rights in certain other parts of the world.

Microwave and Electronic Systems Ltd. (M.E.S.L.) have formed an agreement with **Sanders Associates** of the U.S.A., whereby an interchange of microwave technology between the two companies will take place. Under the agreement, **M.E.S.L.** will manufacture exclusively in the U.K., and non-exclusively in Europe, the entire microwave product line of **Sanders Associates** for a period of seven years.

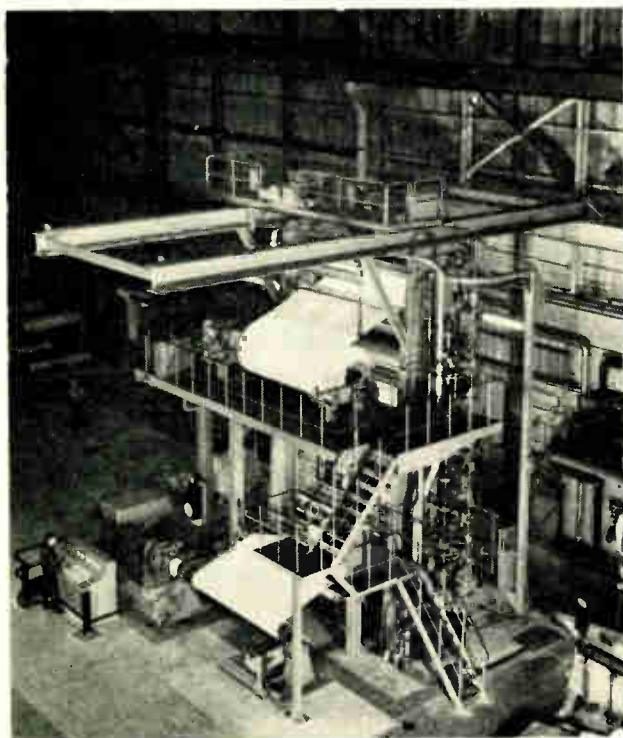

A STARDRIVE CONTROLLED SUPER CALENDER, installed at the **Rutherglen (Glasgow)** works of the **Clyde Paper Co.**, incorporates a 500-h.p. **Stardrive** adjustable-speed main drive and controls supplied by **Lancashire Dynamo Electronic Products**, of the **M1 Group**. It forms part of the production flow line, and provides additional facilities for the fine finishing of machine-coated printing papers. A vertical stack of fourteen 130-in. wide rolls is used on the machine, being driven by friction contact from the bottom roll. Maximum running speed of the motor is 1,500 ft per min and this can be reached within 45 sec from a dead start.

Automation in the Gas Industry

The East Midlands Gas Board is to apply advanced automation to a process for making town gas from light petroleum distillate at a new plant being built in Northampton. The project, which is being undertaken jointly by the E.M.G.B. and Elliott-Automation, involves the application of an on-line computer system for the optimization and control of the gas-making process. An ARCH 9000 industrial-control computer will be used, to improve the reliability of plant operation, ensure that safe working conditions are maintained at all times, and increase the efficiency of the gas-making process.

The project is being submitted to the N.R.D.C. for consideration under the terms of the collaborative arrangement which was approved by the Ministry of Technology in November last. Under this arrangement, financial support can be granted to pioneering projects in a wide range of industries.

Computer System for 200 Subscribers

English Electric-Leo-Marconi have announced that design studies have been successfully completed for a new type of large central computer which can be used by up to 200 people at the same time. It has been designed for use by universities, research centres, Government departments and commercial firms.

The user feeds to the computer, through a terminal or console in his own office, the data which he wants processed; the computer instantly accepts the job, does the calculations and sends the answer back in a few seconds. Distance between the terminal and the computer is not critical—they can be hundreds of miles apart or in adjoining rooms.

The BIMCAM Association

At the recent Annual General Meeting of BIMCAM, J. Tham (George Kent Ltd.) took over the office of Chairman of the Council for 1966/67 and H. G. Oughton (Foster Instrument Co. Ltd.) was elected deputy Chairman. E. W. Wilson (The Leeds Meter Co. Ltd.) and L. S. Yoxall (Foxboro-Yoxall Ltd.) continue in office as President and Immediate Past President of the Association for 1966/67,

W. T. Flower (Bailey Meters & Controls Ltd.) was re-elected and W. H. Medcalf (Leeds & Northrup Ltd.) was elected to the Council. Other members of the Council who continue are: W. J. A. Copeland (Immediate Past Chairman), K. West (Crosby

ELECTRONIC MODULE CIRCUIT-CONNECTION PATTERNS are being automatically produced in small batches by this machine at the East Kilbride factory of Standard Telephones and Cables Ltd. The 'Ministac' patterns are made from 0.01-in. thick nickel-silver stock strip, and the machine is controlled by the traversing program card at the top left of the machine baseplate. The card, which carries nine lines of holes along its length, is scanned by a row of nine photodiodes arranged underneath it; the photocells send signals to solenoid-operated punches at the centre of the baseplate, and material is punched out according to the program. The program card itself is produced from a standard paper template blank

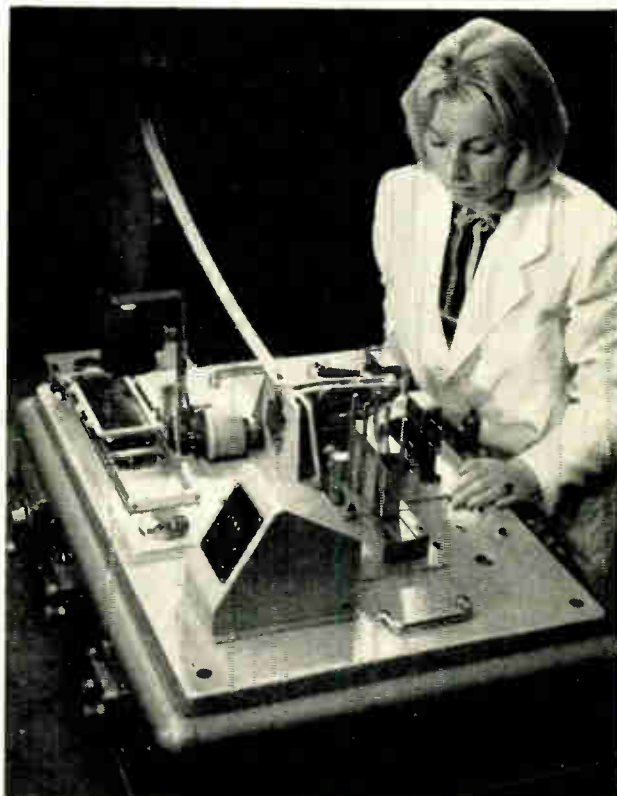

Valve & Eng. Co. Ltd.), J. C. Page (Teddington Autocontrols Ltd.), B. H. C. Budenberg (Budenberg Gauge Co. Ltd.), G. A. G. Ive (Radiovisor Parent Ltd.), and R. Postle (Honeywell Controls Ltd.).

Holography

A new corporation to develop basic inventions in the field of holography (three-dimensional photography without lenses) has been formed by Scientific Advances Inc. and the Du Pont Company. The new company, to be known as the Holotron Corporation, holds exclusive rights to inventions growing out of research on holography at the University of Michigan and at the Columbus and Pacific Northwest Laboratories of the Battelle Memorial Institute, parent corporation of SAI.

Holography involves the use of a laser beam to record patterns on photographic film that can subsequently be reconstructed as a three-dimensional image. Early work indicates that holograms in colour are practicable, and holograms in moving picture form may eventually be developed.

Drive and Control Equipment for Tinplate Mill

The Steel Company of Wales has awarded a £900,000 contract to Associated Electrical Industries Ltd. for the electrical drives and control equip-

ment in their new three-stand double-reduction tinplate mill at Trostre Works, Llanelly. The main drive motors, which total 19,000 h.p., will be supplied from thyristor converters, and the control system will incorporate automatic control of strip thickness.

A computer for data logging and automatic slowing down of the mill will be supplied, and this will be suitable for modification, if required, to provide complete automatic control of the mill.

Electronic Automation in Britain, 1966

The benefits to be derived from automation, and the economic need to use the techniques arising out of it, are just two of the points stressed by Mr. Cousins in his foreword to a new booklet 'Electronic Automation in Britain, 1966', prepared by the Ministry of Technology and the Central Office of Information.

The 42-page publication describes the progress of automation in a broad cross-section of British industry, highlighting specific achievements and pointing to future advances. The text has been made available for wider publication by the Electronic Engineering Association, for whom it was originally prepared, and it will be distributed by the Ministry of Technology to industry both at home and overseas.

Applications and Techniques

Ultrasonic Cleaning

An ultrasonic cleaner employing a technique that significantly reduces cleaning costs has been introduced by the Westinghouse industrial equipment division.

Manufactured parts usually pick up two different kinds of contaminants: some (such as salts) are soluble in water, while others (such as shop oils) are soluble only in solvents. Conventional cleaning equipment cannot handle the two types of cleaning chemical required at the same time, and so two different cleaning units must be used.

A Freon water-in-oil emulsion (TWD-602) has now been developed by DuPont to remove simultaneously both types of contaminants, and Westinghouse's TWD-TF ultrasonic degreaser has been developed to use this new all-purpose cleaner. Both types of contaminants are removed by the one piece of equipment, parts coming out clean, dry, and cool enough to be handled safely without protective clothing. The contaminants are first removed ultrasonically, by dipping the parts in the Freon emulsion, and the parts are then cold-dried in a conventional TF Freon, being rinsed by vapour.

For further information circle 58 on Service Card

High-Voltage Monitoring

An acoustic method of transmitting to earth measurements of the movements of equipment energized at 25 kV has been developed by the research department of British Railways. It can be applied both to overhead power-supply systems and to pantographs mounted on a moving vehicle, and is suitable for measuring such parameters as forces, displacements and accelerations; under all normal atmospheric conditions, signals with frequencies from d.c. to 50 c/s can be recorded with an accuracy of $\pm 5\%$. The acoustic technique avoids the difficulties of accommodating heavily-insulated signal transformers or of obtaining a licence to use f.m. radio.

The instrument can transmit six channels of information simultaneously (using frequency-multiplexing techniques whereby each of the measuring transducers is energized at a different audio-frequency between 3.9 and 7.2 kc/s), and

produces an a.m. output signal. This signal is amplified, mixed with others, and then fed into a piezoelectric device which imparts it (in the form of sound waves) to a glass rod 11 in. long. The sound waves are reconverted into electric signals by piezoelectric transducers, and after amplification and filtering, each signal is detected in a phase-sensitive detector, using the appropriate reference voltage for comparison.

Nuclear Power Station Protection from Earthquakes

In Japan, the problem of ensuring the safety of atomic plants is increased by the threat of earthquakes. To overcome such hazards, many special features have been incorporated into the design of the Tokai Mura atomic power station built for the Japan Atomic Power Co. by the British General Electric Co. of Japan Ltd.

The installation in question is a graphite-moderated gas-cooled reactor, in which carbon dioxide is used for the cooling gas, and natural uranium for the fuel; the reactor core is of conventional design, comprising a honeycomb of graphite blocks laid one upon the other. Control of the nuclear reaction is exercised by lowering and raising boron-steel rods in the vertical channels of the core, thereby altering the neutron flux.

Two sets of rods are provided—'fine' rods for precise control of the reaction, and 'coarse' rods to shut down the reactor completely; in an emergency, the nuclear reaction can be

Looking down on one of the 44 hoppers, which contain some four million boron-steel balls. At the throat of each hopper is a powerful electromagnet, whose field supports a loose ring which retains the balls in the hopper. When the circuit to the electromagnet is broken (on receipt of a control signal from the safety equipment), the balls are free to fall out of the unobstructed throat into the reactor



damped down immediately by dropping the coarse rods into the core. In the event of an earthquake, however, it is possible that the graphite blocks of the core could be displaced, and hence it would be impossible to lower the rods into the core.

As a safeguard, therefore, 44 hoppers (see picture), filled with boron-steel balls manufactured by the Hoffmann Manufacturing Co. Ltd., are located within the pressure vessel above the core. In the event of an emergency, the balls are released automatically and drop into the vertical channels of the core, thereby damping down the nuclear reaction.

Computer Simulation of Industrial Processes

An industrial-simulation technique has been developed by General Electric Company (U.S.A.), with which entire automation systems for cement, steel, mining, petroleum or chemical processes can be simulated by combining analogue and digital computers. The instrumentation allows the actual instrument readings to be viewed under simulated conditions, and the effect of automatic control on a particular process can be observed.

Simulation studies can reduce the time that it takes for process automation systems to begin operation, and can also improve the understanding of particular industrial-process needs. In one study (of a blast furnace) heat balances were developed that would have taken 15 years using manual calculations; in three minutes, the computers ran a series of simulations that represented 24 years of testing on a real furnace. The results showed that production could be boosted as much as 30% by a particular combination of oxygen and fuel mixes, pressures and coke rates.

For further information circle 59 on Service Card

Photoelectric Letter-Sorting Machine

A new letter-sorting machine, built by Thrissell Engineering in co-operation with the G.P.O. engineering department, has been installed at the G.P.O. Norwich Sorting Office and is at present undergoing trials. Extensive use is made of sub-miniature photoelectric head units on the machine, and a number of these have been supplied by Lancashire Dynamo Electronic Products, of the M.I. Group.

The first operation in the sorting process is the stamping of each letter in an encoding machine with a coded series of invisible phosphorescent dots; the letters are then transferred in batches to a sorting machine, after which the operation is entirely automatic.

The letters entering the machine are detected by a photoelectric head (see picture) and a system of belts then takes each letter past another set of photoelectric heads, which picks up the information from the phosphorescent dots. The information obtained is gated into the logic circuit of the machine by a further set

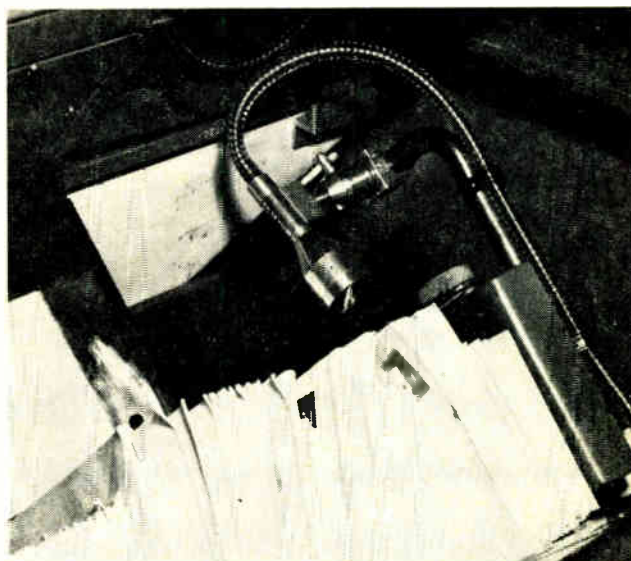

Letters entering the sorting machine are detected by an LDEP sub-miniature photoelectric head type OCP 71

of photoelectric heads and is stored until each letter reaches the correct pigeon-hole. The machine can handle about 7,000 letters an hour.

Level Control in Boreholes

A recent adaptation of the standard 'Aquatrol' level controller manufactured by Fielden Electronics Ltd. now allows the pump in a borehole to be controlled automatically in sympathy with the rise and fall of water.

A specially-designed electrode, lowered down a borehole to the required working level, connects the low-voltage low-current electrical-input circuit of the Aquatrol unit (essentially an electronic switch which activates a relay) to earth, whenever the water level rises and touches the electrode. Normally, two electrodes are used at two distinct levels above the pump, so that it can be switched on and off at the high and low levels respectively. Many switching arrangements can be provided (with or without manual/automatic and stop/start switches) for three-phase or single-phase pumps.

For further information circle 60 on Service Card

Gadolinium Ingots

Johnson, Matthey & Co. Ltd. have announced their production of a 3.7-kg ingot of gadolinium, believed to be the largest single quantity of this rare element ever produced. Gadolinium has the highest thermal neutron absorption cross-section (46,000 barns) of any known element, and has been used for the control rods in atomic reactors (to regulate the rate of fission by absorbing neutrons), as thin light-weight nuclear shielding in aircraft, and in protective clothing.

Being ferromagnetic, gadolinium may well have a promising future in electronics—in the form of new magnetic alloys—since the metal has unusual superconductive properties and so may find uses in cryotrons.

NEW BOOKS



The Thyristor and its Applications

By A. W. J. GRIFFIN and R. S. RAMSHAW. Pp. 175 + viii. Chapman and Hall Ltd., 11 New Fetter Lane, London, E.C.4. Price 30s.

The thyristor—a three-terminal semiconductor device—can be used in a variety of inverter arrangements to supply a.c. power over a wide range of frequencies. One fully-established use of the thyristor is that of controlling the speed of both a.c. and d.c. motors, and devices already exist that can handle 0.5 MW.

In this volume, written for electronic, power and control engineers, the construction of the device is described and clear explanations are given of its operation and usage.

Non-Destructive High Potential Testing

By HAROLD N. MILLER. Pp. 148. Iliffe Books Ltd., Dorset House, Stamford Street, London, S.E.1. Price 30s.

This book covers the whole field of non-destructive high-voltage testing (from general principles to specific operational instruments), particular emphasis being laid upon insulation theory and practice.

Separate chapters are devoted to the generation of high potentials and test equipment available, and the book concludes by describing testing techniques. A glossary of special terms peculiar to the field is included, as well as a bibliography of current articles and books on the subject.

Heating with Microwaves

By H. PÜSCHNER. Pp. 320 + xvii. Cleaver-Hume Press Ltd., Little Essex Street, London, W.C.2. Price 72s.

This book has been prepared for those engineers concerned with the introduction of the new types of microwave heating devices and installations used for the dielectric heating of non-conducting substances. It aims not only to describe the present state of the art, but also to give useful hints to stimulate further developments in this field.

High-frequency circuits for short wavelengths take different forms (co-axial connectors, waveguides, cavity resonators etc.) and use different kinds of tubes (e.g., continuous-wave magnetrons), and the practical manipulation of these tubes, together with their h.f. circuits and the necessary measuring techniques, are discussed in detail.

Electronics, A Bibliographic Guide - 2

By C. K. MOORE, B.Sc. and K. J. SPENCER, F.L.A. Pp. 369 + xvi. Macdonald and Co. (Publishers) Ltd., Gulf House, 2 Portman Street, London, W.1. Price 85s.

This volume has been published as a guide to the literature on electronics subjects which has appeared in the years 1959 to 1964.

Semiconductor Devices

By JAMES J. BROPHY. Pp. 130 + viii. George Allen and Unwin Ltd., Ruskin House, 40 Museum Street, London, W.C.1. Price 18s.

The principles of operation, the structure and character-

istics of the most important of the semiconductor devices are outlined in this book. The treatment of the subject is non-mathematical, making it easy to read for those who are not familiar with electronics.

Code for Temperature Measurement: Part 4. Thermocouples

B.S. 1041: Part 4. 1966. Pp. 37. British Standards Institution, 2 Park Street, London, W.1. Price 10s.

Developments and improvements in temperature measurement techniques are being included in this revised edition of B.S. 1041. This section gives guidance on the selection of the most appropriate thermocouple for any particular application. The possible sources of error and inherent limitations of the various thermocouple systems are described and precautions which should be observed are detailed.

An appendix contains a survey of instruments for use with thermocouples and gives a short description of each type.

Proceedings of the First Microelectronics Lecture Course, Oxford, 1965

Edited by G. W. A. DUMMER. Pp. 197 + iv. United Trade Press Ltd., 9 Gough Square, Fleet Street, London, E.C.4. Price 63s.

In July 1965, a lecture course was held at the Clarendon Laboratory, Oxford, on the subject of integrated circuits. The twenty-one papers given during the course are contained in this book.

Multi-Lingual Glossary of Industrial Diamond Terms

Industrial Diamond Information Bureau, Arundel House, 36-43 Kirby Street, London, E.C.1. Price £1.

This glossary contains 912 terms in English, German, French, Dutch, Italian, Spanish, Swedish and Japanese.

Electrical Instruments in Hazardous Locations

By ERNEST C. MAGISON. Pp. 225 + ix. Plenum Press, 272 W. 17th Street, New York 10011, U.S.A. Price \$22.50.

Calculus of Finite Differences (Third Edition)

By CHARLES JORDAN. Pp. 655 + xxi. Chelsea Publishing Co., 50 E. Fordham Road, New York 10468, U.S.A. Price \$7.50.

Wave and Oscillatory Phenomena in Electron Beams at Microwave Frequencies

By V. N. SHEVCHIK, G. N. SHVEDOV and A. V. SOBOLEVA. Pp. 362 + xviii. The Pergamon Press Ltd., 4 Fitzroy Square, London, W.1. Price £5.

Linear Automatic Control Systems with Varying Parameters

By A. V. SOLODOV. Pp. 270 + xvii. Blackie and Son Ltd., 5 Fitzhardinge Street, London, W.1. Price 75s.

PAINTON RELIABILITY

at the right price for these

FIVE NEW CONNECTORS

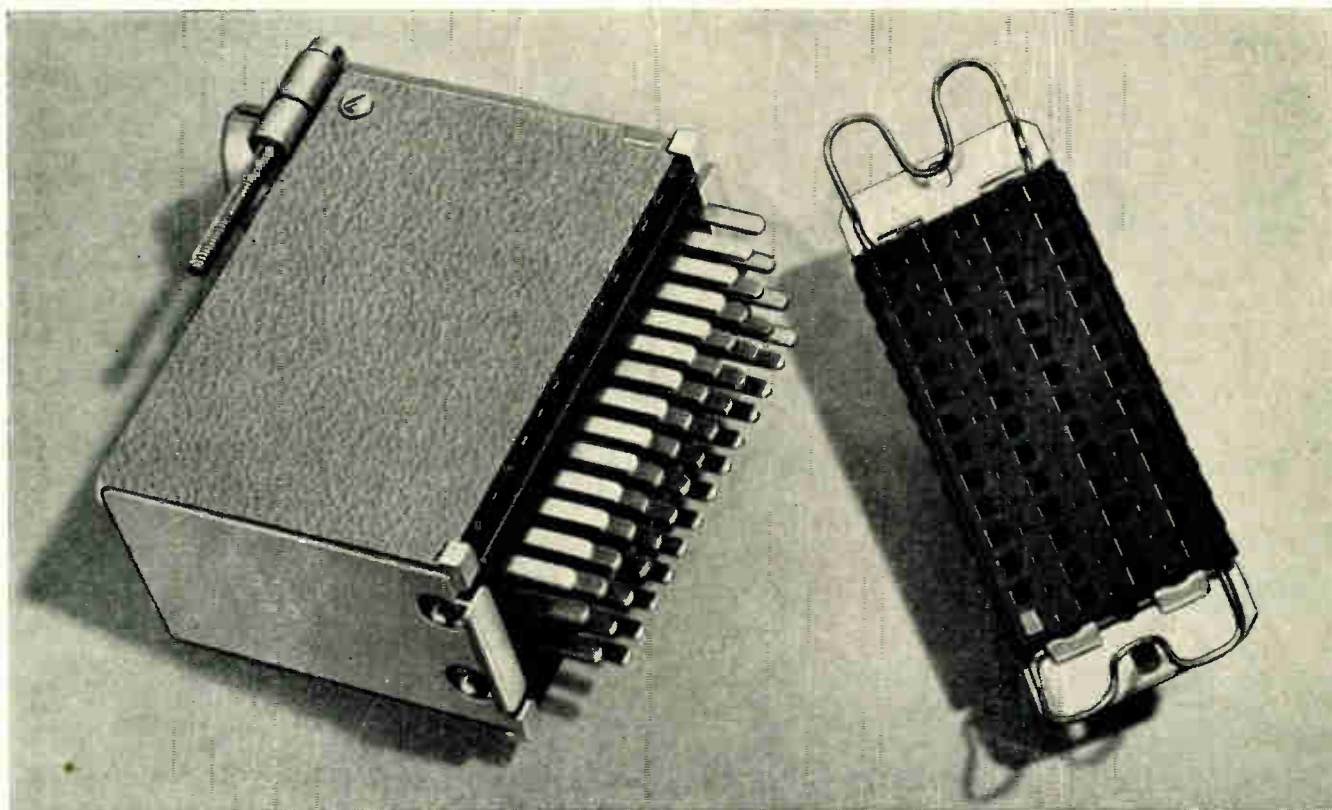

35 WAY

47 WAY

55 WAY

59 WAY

71 WAY

These new additions to the Painton **159 Series** Connectors embody the space-saving configuration and high standards of reliability already well established for this range of components, and are offered at sensible prices. Send for leaflet P.S.10

*Delivered
ex-stock!*

These Types specially developed for the G.P.O. & approved by them as P0203.



Painton & Co. Limited

KINGSTHORPE • NORTHAMPTON

Tel: 34251 (10 lines). Grams: 'Ceil' Northampton. Telex 31576

Overseas Associated Companies Australia Painton Australia Pty. Ltd. • Benelux Painton S.A. • Germany Painton G.m.b.H. Italy Painton Italiana • Sweden Svenska Painton A.B. • U.S.A. Painton Inc.

Murex offer two new catalogues to users of sintered permanent magnets

Two new catalogues for users of sintered permanent magnets and magnet alloys are now available from Murex Limited

CATALOGUE P26 for TECHNICAL DATA

This is a comprehensive publication describing Murex magnet alloys and dealing with their applications and design considerations. The Murex Sincomax technique is fully described and particular reference is made to internal magnet systems. Please write for catalogue P.26.

CATALOGUE P27 for STANDARD SHAPES

This useful brochure gives details of over 500 different Murex magnet designs for which dies are available. The delivery times of these standard Murex magnets are good and their use avoids the expense and delay which is often involved in special tooling. Please write for Catalogue P.27.



MUREX LIMITED · RAINHAM · ESSEX

Powder Metallurgy Division
Rainham, Essex 53322 Telex 28632 Telegrams: Murex, Rainham-Dagenham Telex

M37/A

For further information circle 254 on Service Card

McGEOCH

INDICATOR PANELS

and

DESKS

designed and manufactured to your requirements



WILLIAM McGEOCH & CO. (BIRMINGHAM) LTD.
(now on Telex 338346 McGEOCH B'HAM)
B O R D E S L E Y , B I R M I N G H A M 1 0
A member of the McGEOCH group

For further information circle 255 on Service Card

4^d will answer all your miniature motor problems



B.V.C. Electronic Developments Ltd. have specialised in the design, development and manufacture of electric motors, for operation from high frequency down to 50 cycles frequency, or D.C. supplies.

If you have a requirement for small electric motors, servo motors or small mechanisms either of standard types or built to your specification, then a 4d. stamp will bring the answer. Write to:—

B.V.C. ELECTRONIC DEVELOPMENTS LTD.
Dept. 1E/E.5, GOBLIN WORKS, LEATHERHEAD, SURREY

Tel.: Ashted 6121

SL521-B



the
unique SL521
a complete

LOGARITHMIC

VERY BRIEFLY

VOLTAGE GAIN
12 dB

I.F. stage
on a single
silicon chip

CUT OFF
FREQUENCY
170 Mc/s

MAX RECTIFIED
OUTPUT
1.0 mA

The SL521 has integral supply line decoupling and is designed for direct coupling. It is available now, ex-stock, from Semiconductors Ltd.

a completely British product originated by the Allen Clark Research Centre, Caswell.

*Write for full details of this and other
amplifier ranges*

PLESSEY Components Group

SEMICONDUCTORS LIMITED
Cheney Manor, Swindon, Wilts. Telephone: Swindon 6251

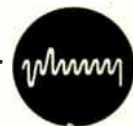

WHITELEY

ELECTRICAL RADIO CO. LTD.

ELECTRONIC COMPONENTS & EQUIPMENT

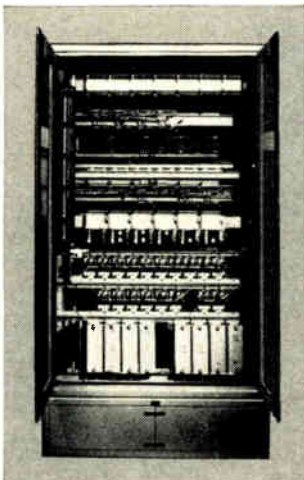
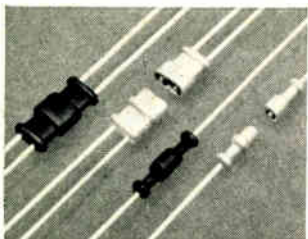
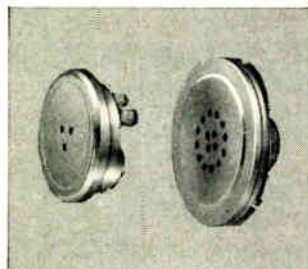
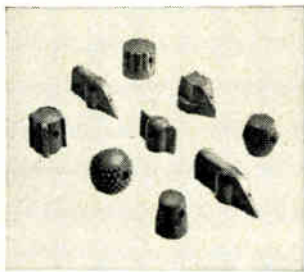
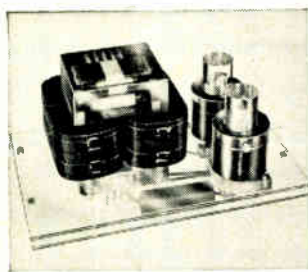

Whiteley Electronic Components are designed and precision-built in the Company's own factories. Every operation is strictly controlled, every part is vigorously inspected and tested. Nothing is left to chance—hence Whiteley's enviable reputation.

WHITELEY ELECTRICAL RADIO CO. LTD

MANSFIELD · NOTTS · ENGLAND
London Office: 109 KINGSWAY, W.C.2

Tel: Mansfield 1762/5
Tel: HOLborn 3074

WB186

COIL WINDING

If you buy, design or manufacture coils it is worth knowing about

KOLECTRIC in 1966

8 NEW MACHINES

★ The world famous American Coil Winding Equipment Company of New York have appointed Kolectric as their U.K. sales distributors for their sophisticated turret transfer coil winders. Automation is the keynote and high production rates are guaranteed.

★ Brand new is a programmed counter unit for accurately controlling complete winding sequences particularly for coil windings having a number of tappings.

★ Kolectric's own versatile small and medium size layer winders are now available with this device and are unbeatable for reliability, ease of operation and price.

★ For medium and heavy duty work, Kolectric now market a wider range of R.M.T. coil and strip winders.

**A COMPLETE RANGE
AT THE RIGHT PRICE
AT THE RIGHT TIME**

Write now for details
or a demonstration

KOLECTRIC LTD

SINCLAIR HOUSE, THE AVENUE, EALING
LONDON, W.13. Tel.: PERIVALE 9066

SIEMENS

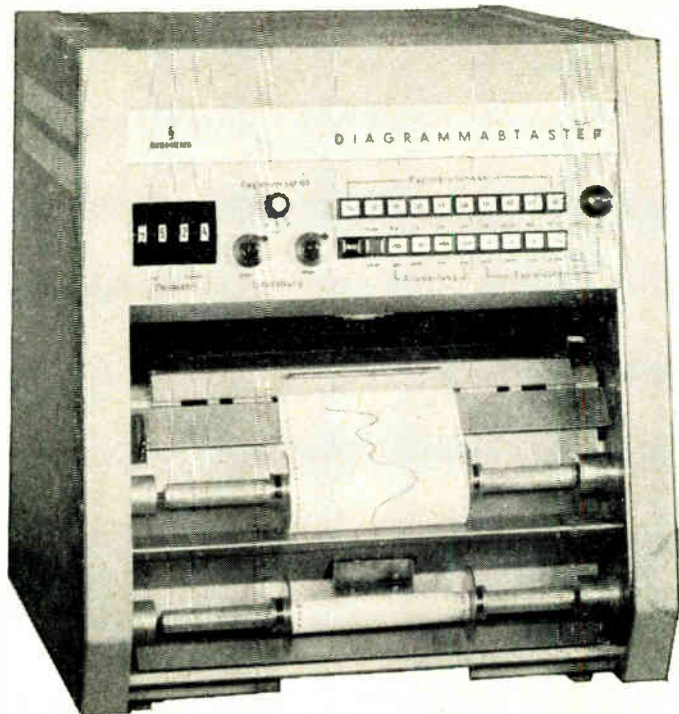

ELECTRONIC CHART READER

fully automatic

- INTEGRATION
- STATISTICAL EVALUATION
- EVALUATION ACCORDING TO PRESET FUNCTIONS
- PROVISION FOR PUNCHED TAPE OUTPUT, COMPUTER OR TELEPRINTER

This unique instrument has been designed for the rapid and accurate evaluation of chart recordings. The normal display unit has provision for ten statistical registers and facilities for determining in advance (up to 99 days if required) the time selected for the evaluation of continuous recordings.

The use of the Standard Teleprinter Code in the digital output permits the connexion of a wide range of ancillary equipment.

*Suitable for Paper width 70 to 290 mm
paper speeds 5, 10, 20, 40 mm/sec.*

FULL DETAILS
FROM
U.K. AGENTS

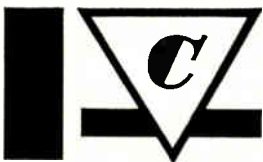

R.H. COLE ELECTRONICS LTD.

CROYDON SURREY MUNICIPAL 4411

For further information circle 260 on Service Card



·024" to ·080"

LEWMEX AND ENAMEL WIRES for superior windings

The wide range of tests applied before, during and after manufacture ensures that L.E.W. enamelled wires achieve the quality and balance of properties best suited to the customer's needs.

THE LONDON ELECTRIC WIRE COMPANY & SMITHS LTD · CHURCH ROAD · LEYTON · LONDON · E10

For further information circle 261 on Service Card

CABLE STRAPPING AND BANDS BY METWAY PRODUCTS

**"STUDWAY"
BLACK PVC STRAPPING**
2 widths—5/16" and 1/4"
Cartons of 25 yard coils with studs

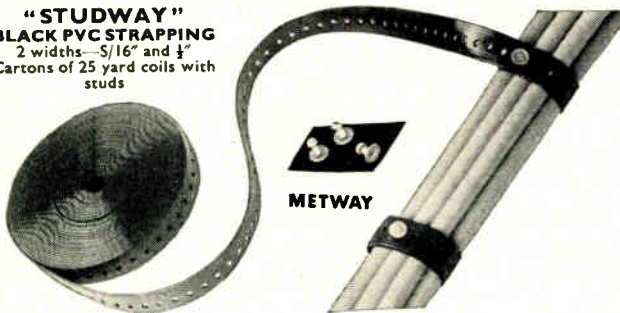

"NEATWAY" PLASTIC BANDS
4 sizes—2 1/2, 5 1/2, 6 1/2, 7 1/2. Self Locking



● FOR FULL DETAILS OF THESE AND OTHER PLASTIC CLIPS, SADDLES AND CLEATS—ASK FOR CAT. No. OHS/10/11E.

METWAY · KEMP TOWN · BRIGHTON 7 · SUSSEX

For further information circle 262 on Service Card

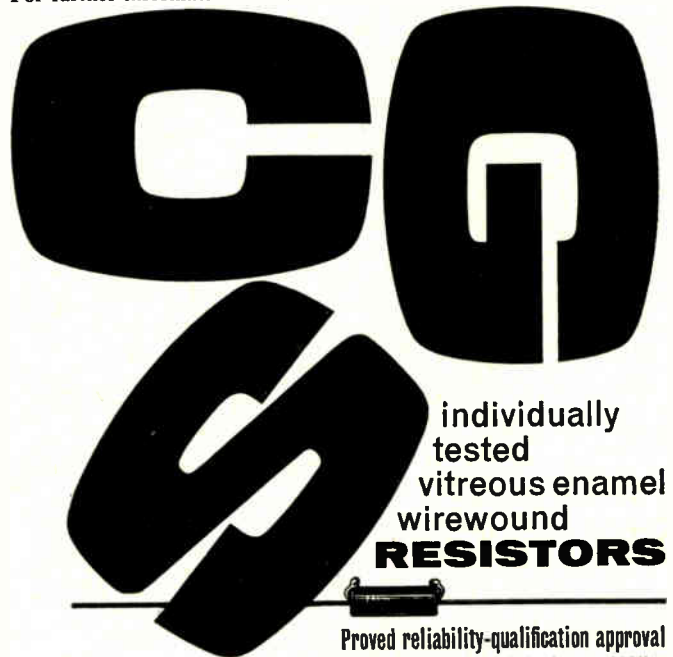

individually tested vitreous enamel wirewound **RESISTORS**

Proved reliability-qualification approval embraces RCSC types RWV4J-K & L, Ω to $100K\Omega$

CGS resistors offer you highest standard of quality and performance at extremely competitive prices, due to specialisation, an efficient production organisation and selective buying of raw materials. Up to 100 of any RCSC type resistors are available from stock. Leading manufacturers, GPO, Ministry of Aviation, Admiralty, and NATO are among the many users of CGS resistors. RCSC type approved to DEF 5111-1, manufactured under EID and ARB approved inspection conditions.

For price list, catalogue and stock list write or phone: **THE C.G.S. RESISTANCE CO. LTD.**
Marsh Lane, Gosport St., Lymington, Hants. [Tel.: Lymington 2811 & 3282
Telex: 47691

Your questions answered

WEIGHT?

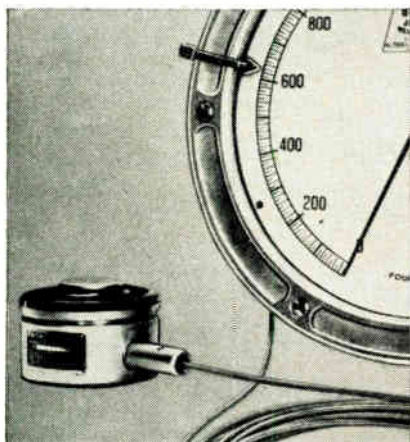

Hydrostatic Weighing Unit

This unit has been developed to cover a wide field of industrial weighing applications.

The basic unit consists of a completely sealed hydrostatic load cell connected to a Bourdon tube load indicating gauge by means of a flexible metallic capillary. Loads of 100 lbs. to 100 tons may be displayed on gauges ranging in size from 4" to 24" diameter. The gauge may be located up to a maximum distance of 200 ft. away from the load cell. Accuracy is better than 0.5% of scale capacity.

ANGLE?

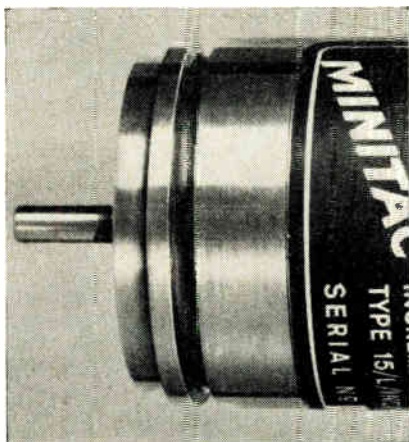

Minitac Optical Shaft Encoder

The Minitac incremental encoder provides the means of determining precisely the angular position of a shaft, its angular velocity and acceleration.

The output from the encoder is sinusoidal corresponding to discrete angular increments of shaft position. Direction of rotation is also sensed enabling the encoder to be used in digital control systems. Various resolutions are available to suit specific applications.

TOTAL?



Bi-directional Electronic Counter

Designed principally for use with shaft encoders this counter is equally applicable to any linear device giving a serial output. A bank of numerical display tubes are arranged to provide any number of decades. The instrument counts up to any pre-arranged maximum after which the next positive pulse resets the display to zero. A similar sequence follows when negative pulses are applied. A zero setting button enables the counter to operate with the encoder in any selected position.

Any of these individual units may be incorporated in the users system or combined to form the basis of a digital control system in a wide field of applications.

Don't hesitate to send for the technical data sheets, or ask us about your particular needs—that's what we are here for.

Brown

S. G. Brown Limited Chiswick Division : Devonshire Works, Dukes Avenue, Chiswick, London, W.4. Tel : CHI 7494.

 A HAWKER SIDDELEY COMPANY IN ASSOCIATION WITH AMERICAN BOSCH ARMA CORPORATION

For further information circle 264 on Service Card

only one . . .

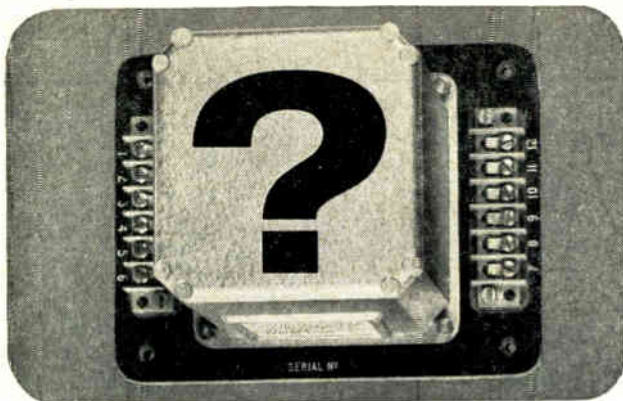

of these is a . . .

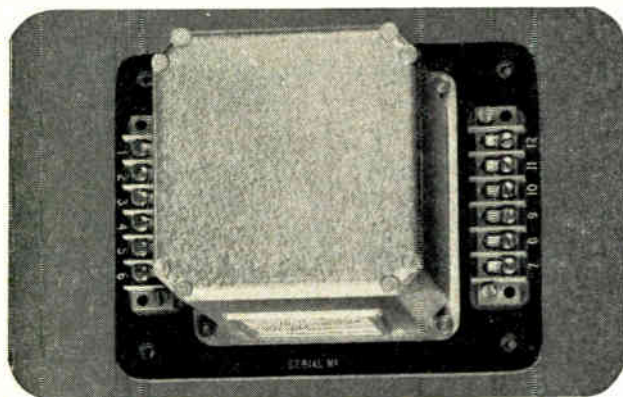

Frequency Marginal Relay *

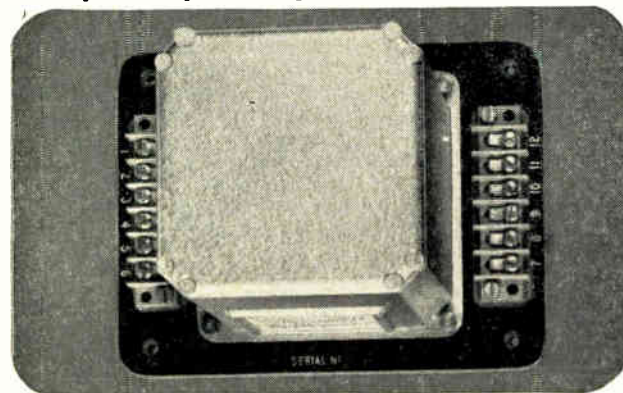

Marstat Frequency Marginal Relays are solid state silicon transistor relays which are impervious to harmonic distortion of waveform and wide changes of voltage. Rugged construction allows mounting in any position, in dust-laden or bad atmospheres, without routine maintenance. Three models are available: FM-1 to GPO specification PT 1085 Clause 16; FM-2 and FM-3 for industrial applications. Ask for full details.

* The one at the top. At the bottom is an A.C. voltage marginal relay and in the middle an automatic check synchroniser. All three are Marstat units—as used in the Marstat system of solid state controls.



Pickersleigh Rd
Malvern
Worcestershire
Malvern 61786
Telex: 33267

London Office: Wingate House • 83-107 Shaftesbury Avenue • London W.1. Tel: GER 1738 • Telex: 282242

For further information circle 265 on Service Card

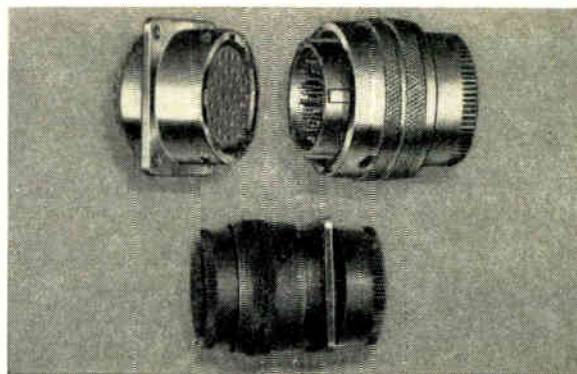

KPT/KPTM PLUGS

Miniature circular plugs designed to MIL-C-26482. KPT's are supplied with solder contacts, KPTM's with crimp contacts.

Cannon Electric
(Great Britain) Ltd.,
Lister Road,
Basingstoke, Hants.
Tel: Basingstoke 3171



CANNON

For further information circle 266 on Service Card

PLASTIC MOULDINGS

THERMO-SETTING THERMO-PLASTIC

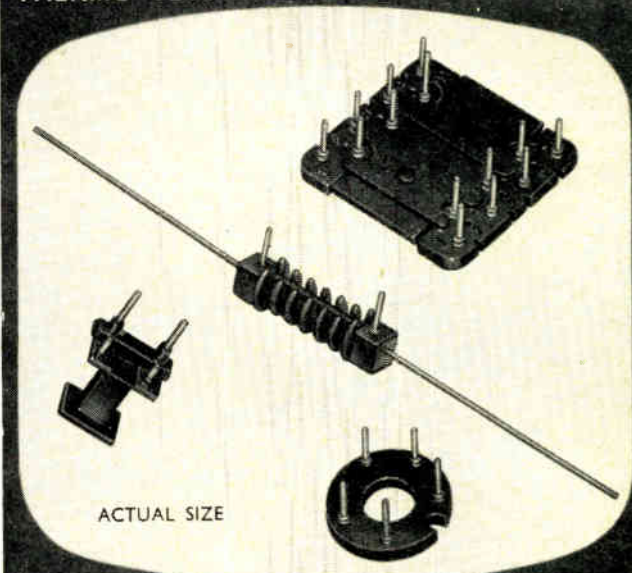

FREDERICK W. EVANS LTD.
Plastic Works, Long Acre, Birmingham 7.
Telephone: STD. 021 EASt 3071 (4 Lines)

For further information circle 267 on Service Card

springs and pressings for the electronic industry

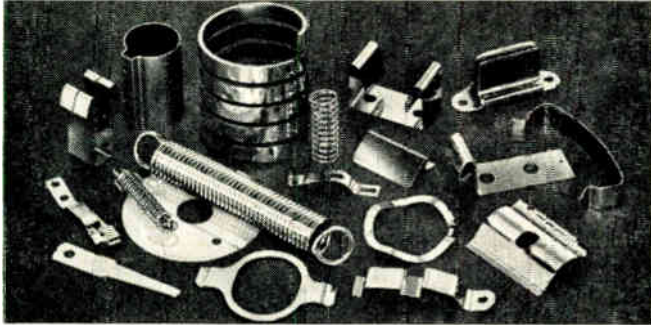

Made to your individual requirements from Beryllium Copper, Nickel Silver, Stainless Steel, Phosphor Bronze, Tantalum, Spring Steel etc.

Write or phone for further details to:

LITCHFIELD BROTHERS LTD.

Heage Firs, Nether Heage, Derby
Telephone: Ambergate 435/6/7

For further information circle 268 on Service Card

For further information circle 269 on Service Card

Porcelain

Steatite

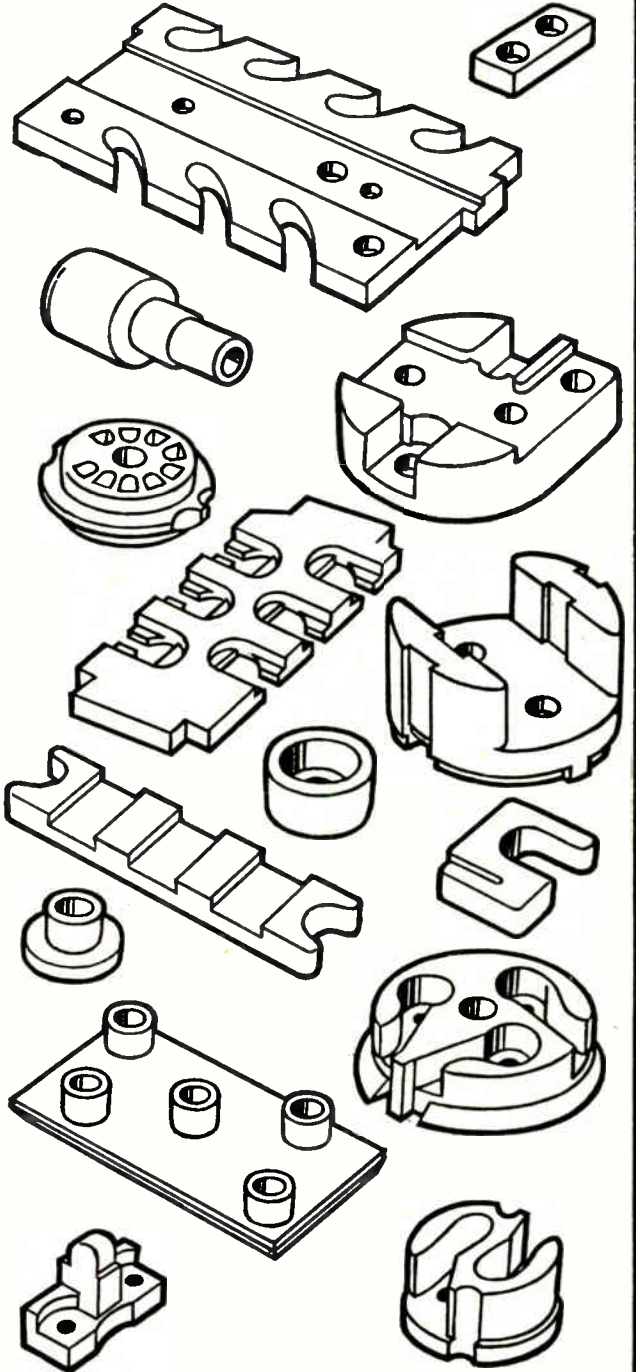
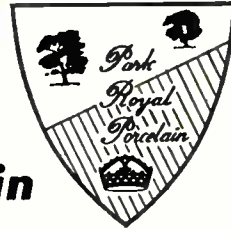

PARK ROYAL PORCELAIN CO LTD INCORPORATING V.G. PORCELAIN CO LTD

GORST ROAD
PARK ROYAL
LONDON, N.W.10

Telephones:
ELGAR 1411/7
Telex:
London 25589

POLAR

STAND OFF
INSULATORS

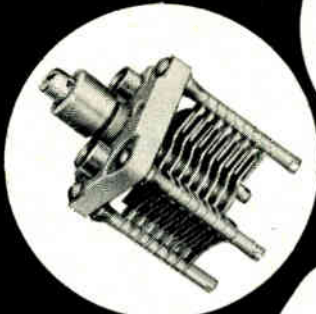
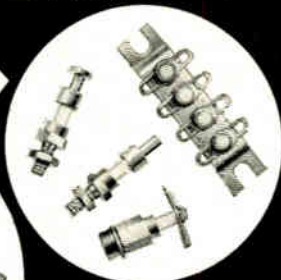

TRIMMERS



Photographs actual size



AND
P.T.F.E. LEADTHROUGHS



WINGROVE & ROGERS LTD

DOMVILLE ROAD · LIVERPOOL 13
Telephone: Stonycroft 2265
LONDON OFFICE: 75 Usbridge Road · Ealing W.5. Tel: EALIng 7046/7

Industrial Electronics July 1966

CLASSIFIED ADVERTISEMENTS

FULLY DISPLAYED: £3 per single column inch.
RUN-ON: 5/6 per line of approximately 7 words.
Where an advertisement includes a Box Number 1s. extra.
SERIES DISCOUNTS: 12 insertions, 15%.
Remittances payable to "Industrial Electronics".

Copy is required by 11th of the month for insertion in the following month's issue, by 6th of the month if proofs are required.

Address to:
Classified Advertisement Dept.
Industrial Electronics
Dorset House, Stamford St., London, S.E.1.

SITUATIONS VACANT

microwave devices

An expanding development programme offers a number of challenging opportunities for work on the following projects:

MICROWAVE TUNNEL DIODES AND AMPLIFIERS HIGH POWER C.W.
T.W.T. AMPLIFIERS MICROWAVE INTEGRATED CIRCUITS LOW
NOISE T.W.T. AMPLIFIERS VARACTOR DIODES

Vacancies exist for

SENIOR ENGINEERS, ENGINEERS and ASSISTANT ENGINEERS

at attractive starting salaries. A Contributory Pension Scheme is in operation. Assistance with housing and removals will be available for successful candidates. Local interviews can be arranged.

Apply in confidence to:-

R. P. Smith, Personnel Officer,
Standard Telephones and Cables Limited
Brixham Road, Paignton, DEVON.

STC

Valve Division.

[625]

ELECTRONICS INSTRUCTOR

required for students at the Company's own Engineering College in Cornwall.

Employment is to be offered on a two-year contract with a possible option of extension. Applicants should have an appropriate degree or professional qualification, and have a broad basic knowledge of communications and the ability to instruct generally to O.N.C. level. However, specialised practical and theoretical instruction to H.N.C. level would be required on electronics as applied to telecommunication systems, together with detailed knowledge of associated test equipment techniques.

Students are not prepared for external examinations. The aim is to produce practical engineers capable of handling the Company's own varied communications systems. Classes are normally limited to eight students whose range of experience may vary considerably.

Please write giving details of age, experience and qualifications, to Staff manager:

CABLE AND WIRELESS LTD. Mercury House, Theobalds Road, London, W.C.1

[633]

EXPERIMENTAL OFFICERS



**applied
physics,
electronics**

There are two vacancies for men up to 30 years of age preferably with qualifications at the H.N.C. level (or the equivalent) in applied Physics or Electronics for appointment as Experimental Officers with the Physics Group of Research Department at Billingham, Co. Durham.

Applied Physics

The group is engaged in the development of radioisotope and ultrasonic techniques and their application to a wide range of problems arising in production and research. Other aspects of work require the measurement of a variety of physical properties and the application of physical methods to chemical analysis. Applicants should have a sound knowledge of basic physics and good practical ability.

Electronics

The group is also responsible for the electronic equipment in use in the Department which includes ESR, NMR, optical and mass spectrometers, nuclear radiation counting and analytical instruments. Candidates for the post of Experimental Officer (Electronics) should have some experience in the maintenance of complex equipment and will be expected to contribute to development topics which involve electronic design and constructional work.

Profit Sharing [and Pension Fund Schemes are in operation and assistance will be offered to married men for house purchase, removal expenses and temporary lodging allowance.

Applications in writing stating briefly age, qualifications and experience to :—

**Mr. H. Williamson,
Personnel Officer,
Imperial Chemical Industries Ltd.,
Heavy Organic Chemicals Division,
Organic House, Billingham,
Co. Durham.**

Please quote ref. IE.

[620



THE BAHRAIN PETROLEUM
CO. LTD.
ALAWI, BAHRAIN

The following vacancy has arisen on the teaching staff of the Company's Vocation Training Centre:—

ELECTRICAL TEACHER/INSTRUCTOR

to teach apprentice and selected adult employees craft contents/practices to the level of City & Guilds Electrical Craft Practice and eventually to the Electrical Technician Course Levels.

Applicants should possess as a minimum requirement, full Technological Certificate in Electrical Engineering, have appropriate craft experience and have instructed in and offered entrants to these examinations either in industry or in a technical institute for at least three years.

This position offers a unique opportunity to participate in the Company's comprehensive programme for the advancement of Bahraini Nationals. The work entailed calls for professional skill allied to patience, and sympathetic understanding, and successful applicants will find the work rewarding.

The salary offered for each position will not be less than £1,800 per annum. A cost-of-living allowance is payable, together with free air-conditioned accommodation. Medical treatment for staff is free, paid home leave is given as well as a substantial allowance for local leave, and there is provision for participation in the Company's Pension and Provident Fund Schemes.

Fully qualified men (under 45) should apply to Caltex Services Limited, Caltex House, Knightsbridge Green, London, S.W.1, quoting INST/IE.

[626

The British Division
of a Progressive American Company of International Repute
is expanding the engineering section of its

ELECTRONIC DIVISION.

There are vacancies for

SYSTEM DESIGNERS

with experience in servo or Digital Data handling systems.

The project offers exceptional

OPPORTUNITIES

to join at an early stage a team from which future

EXPERTS AND LEADERS

in Numerical Control of Machine tools will be selected.

Applications in writing to:

Personnel Officer
Cincinnati Milling Machines Ltd.
(Cimtrol Division)
Dells Lane, Biggleswade, Bedfordshire



[630

BOOKS

'TELEVISION Engineering: Principles and Practice.' Vol. III: Waveform Generation. By S. W. Amos, B.Sc.(Hons.), A.M.I.E.E., and D. C. Birkinshaw, M.B.E., M.A., M.I.E.E. The third volume of a comprehensive work on the fundamentals of television theory and practice, written primarily for the instruction of B.B.C. Engineering Staff. This volume gives the application in television of sinusoidal, rectangular, sawtooth and parabolic waves and shows the mathematical relationship between them. The main body of the text is devoted to the fundamental principles of the circuits commonly used to generate such signals, the treatment being largely descriptive in nature and therefore less mathematical than that of the previous volume. The work is intended to provide a comprehensive survey of modern television principles and practice. 30s net from all booksellers. By post 31s 3d from Iliffe Books Ltd., Dorset House, Stamford Street, London, S.E.1.

LET US
SETTLE YOUR
STAFF PROBLEMS
PLACE AN ADVERTISEMENT
IN THE
AUGUST ISSUE
OF
INDUSTRIAL ELECTRONICS
NOW

COVENTRY TECHNICAL COLLEGE DEPARTMENT OF ELECTRICAL ENGINEERING

Second Advertisement

Applications are invited for the following post, duties to commence 1st September (1966) or as soon as possible thereafter.

Senior Lecturer in Telephony

The engineer appointed will be required to lead the development of a revised approach in teaching this special subject as new systems are developed and introduced. In addition he must be competent to teach Telephony at all stages (but especially at Advanced level) in existing City and Guilds Courses 49 and 300. Adequate teaching experience and qualifications of professional status are essential.

Salary scale Senior Lecturer £2,140 x 60 (4)—£2,380 per annum. Application forms and further particulars available from the Principal, Coventry Technical College, Butts, Coventry, to be returned not later than 12th August, 1966. [621

BUSINESS OPPORTUNITIES

LOOKING FOR PROFITABLE NEW LINES? OPPORTUNITIES — ONTARIO STYLE

Manufacturers from Ontario, Canada, wish to contact successful established sales organisation covering the U.K. Please send full particulars of your Company and product interest to:

Government of Ontario
Trade and Industry Branch
Ontario House, 13 Charles II Street
London, S.W.1 [622

ARTICLES FOR SALE

PHOTO-ELECTRIC CONTROLS for industry

Quick delivery Send for Catalogues

Hird-Brown Limited
Flash Street, Bolton, Lancs.
Tel. 27311 [629

FRY'S Flowsolder Machine Model III, complete with Flowfluxer, extractor hood quantity solder, flux thinners. £750 o.n. Phone: PROSPECT 4463. [627

CAPACITY AVAILABLE

AIRTRONICS LTD.

for coil winding, assembly and wiring of electronic equipment, transistorised sub-units, sheet metal work. 3a, Walerand Road, London, S.E.13.

Telephone: LEE Green 1706. [628

Technical Courses This Autumn

For further information circle 275 on Service Card

BOROUGH POLYTECHNIC
Borough Road, London, S.E.1
WATERLOO 7654

Full time sandwich courses for B.Sc. (C.N.A.A.) in Electronic Engineering.
Full time and part time Courses for Part III, I.E.E. Examination.
Part time day and evening courses for H.N.C. in Electronic Subjects.
Endorsements for I.E.R.E. Parts IV and V examinations.
Special courses in field effects, transistors, Digital systems, Control systems, Microwave Television, and Illumination Engineering.

Application forms and further details of this course are available from the Secretary

[632]

For further information circle 276 on Service Card

UNIVERSITY COLLEGE OF NORTH WALES, BANGOR
School of Engineering Science
Post Graduate Courses for the Degree of M.Sc.

MATERIALS SCIENCE
CONTROL ENGINEERING AND INSTRUMENTATION
PHYSICAL ELECTRONICS AND INTEGRATED CIRCUITS

All these Courses are S.R.C.—Approved

Further particulars may be obtained from the Registrar, The University College of North Wales, Bangor.

[634]

For further information circle 277 on Service Card

MEDWAY COLLEGE OF TECHNOLOGY
Department of Electrical Engineering

A FULL-TIME COURSE
for the
Part III IEE Examination
Session: 1966/67

Next course, offering choice of both heavy or light current subjects, starts in September for examinations in June 1967. This course usually qualifies for a Major County Award.

Applications and further details from the Principal, Medway College of Technology, Horsted, Maidstone Road, Chatham, Kent.

[624]

For further information circle 278 on Service Card

PLYMOUTH COLLEGE OF TECHNOLOGY
Electrical Engineering Department

1. Part-time and Full-time Courses for B.Sc.(Eng.) University of London (External) I.E.E. and I.E.R.E. Examinations

2. Special Courses arranged for Session 1966-67.

Basic Microwave Theory T.V. Engineering
Electronic Computers Colour T.V.
Industrial Electronics
Logic and Switching Circuits
Semiconductor Theory
The Cathodray Oscilloscope—Theory and Application
33-kV/132-kV Underground Cable Practice
T.V. Production Courses for Teachers

3. One-day Courses.

Micro Electronics
Principles of Digital Computers
The Generalised Machine
Data Processing and Transmission

Full details on all courses may be obtained from:-

The Head of Electrical Engineering Department,
B. R. Webster, B.Sc.(Eng.), M.I.E.E., M.I.E.R.E., A.M.I.Mar.E.

[635]

For further information circle 279 on Service Card

NORTHERN POLYTECHNIC
Holloway Road, London, N.7.

Principal:
J. LEICESTER, M.Sc., M.Sc.Tech., Ph.D., F.R.I.C.
Department of Electronic and Telecommunications Engineering
Head of Department:
J. C. G. GILBERT, M.I.E.R.E., Assoc. I.E.E., F.T.S.

Full-time 3-year course in preparation for the Northern Polytechnic Diploma in Electronics and Telecommunications. This course is recognised by the Institution of Electronic and Radio Engineers and gives full exemption from the Graduatehip examination.

Part-time day release and evening courses for the external Graduatehip examination of the Institution of Radio Engineers covering:-

Applied Electronics
Computer Engineering
Television Engineering
Advanced Telecommunication Principles
Communication Radio

Advanced Short Courses on:
Colour Television Engineering
Modern Network Theory
Pulse Techniques
Basic Microwave Techniques
Transistor Engineering
Audio Engineering Measurements

Full-time, 2-year course in Radio and Television Servicing in preparation for the City & Guilds of London Institute and the Radio Trades' Examination Board's Certificates. Part-time day release and Evening classes in Electronic Servicing for the Electronic Servicing Certificate of the City & Guilds of London Institute (Subject 47).

All the above courses include practical laboratory and workshop experience (where applicable). London fees: £36 per year, plus £5 10s. registration fee, for all full-time courses. (No fee for students under 18 years of age.)

Evening class fees range from 50s. to 90s. per session.

Enrolment for Day classes by appointment.

Enrolment for part-time day release and evening classes: 20th, 21st, 22nd September, 1966, between 6.30 and 7.30 p.m.

New session commences 26th September, 1966. Prospectus free on application to Secretary.

[631]

For further information circle 280 on Service Card

Postgraduate Courses at

CRANFIELD

(designated to be brought within the university grants system)

Electronic
and Control
Engineering

The Department of Electrical and Control Engineering offers one-year and two-year residential postgraduate courses which provide for specialisation in any of the following subjects:

Electronics Design
Linear Electrical Network Theory
Control Engineering
Flight Control
Aviation Electronics
Aircraft Power Systems

The courses emphasise the "systems engineering" concept and are specially designed to suit the graduate engineer or scientist in industry. Great importance is given to advanced experimental work and to design practice. Analogue and digital computing facilities are available.

Advice given on financial aid. Further information from:

The Registrar, The College of Aeronautics,
Cranfield, Bedford.

[623]

change of name

•
•
•



•
•
•

Our range of products has grown so much in recent years that the name Hendrey Relays Ltd. no longer conveys an adequate impression of our activities. So... from 1st June, 1966, we are changing our name to **HENDREY RELAYS & ELECTRICAL EQUIPMENT LTD.** It's the same Company, with the same high technical standards and the same service... only the name has changed!

•
•
•
•
•
•
•

- Industrial and Aircraft Relays.
- Flameproof and Special Purpose Switches.
- Tissue Processing Apparatus.
- Laboratory and Test Equipment.
- Borehole Logging Apparatus and Spark Recorders.
- Mercury Vapour Concentration Meters.
- Consoles and Control Units.
- etc., etc.

HENDREY RELAYS & ELECTRICAL EQUIPMENT LTD.

390-394 BATH ROAD, SLOUGH, BUCKS.

Telephone: Burnham 609/612

Grams: Hendrelay, Slough

MANUFACTURING ELECTRICAL ENGINEERS, CONTROL AND LABORATORY APPARATUS

On Admiralty, Principal Ministries and Post Office Lists, A.R.B. and M.O.A. Approved Design and Inspection.

DO YOU NEED TO MEASURE

- * A. C. VOLTAGE
- * CURRENT or
- * POWER

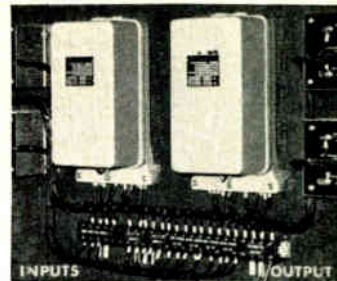

POWER TELEMETERS

for indicating, recording or control?
**...THEN A LANDIS & GYR
TELEMETER WILL HELP YOU**



- reduced burden on CT's and VT's
- avoids expensive multiple pilot cables
- fully adjustable
- 5 or 10 mA D.C. output permits use of ordinary moving coil indicators of any size
- independent of temperature effects, supply variations and load resistance up to 5000 ohms
- can summate several separate circuits
- accuracy classes 1.0 or 0.5
- C.E.G.B. approved

Similar advantages with LG Auxiliary Instrument Transformer Telemeters for Current or Voltage.

Other LG telemeters measure low power D.C. values, Position, Pressure, Temperature, Rotational displacement, Level, Pulse rate. Outputs either D.C. analogue or digital pulse frequency.

When Quality Counts... **LANDIS & GYR**

LANDIS & GYR LTD · VICTORIA RD · ACTON · W3 · ACORN 5311
LGT 11

For further information circle 272 on Service Card

ELECTRONICS PRINTED CIRCUITS

An extremely comprehensive service is available to industry which is unique in its scope and unprecedented in its quality of workmanship and speed of service while at the same time giving that all important individual attention and very competitive price terms that every buyer seeks.

The service consists of inclusive facilities for the design, development, and large scale production of all types of electronic equipment, instruments, etc., together with all processes involved in the design, development and production of printed circuit boards.

The unique location of T.E.S. Ltd., allows this first class service, which is to be found nowhere else, to be brought to your doorstep by an almost daily transportation service to 100 miles all for the price of a telephone call. **Shanklin 3096.**

Special attention will be given to very welcomed enquiries from customers outside the U.K.

TRANSMETRIX ELECTRONIC SYSTEMS LTD.
Hyde Works, Shanklin, Isle of Wight, Hants

For further information circle 273 on Service Card

**KEEP UP-TO-DATE EVERY MONTH
MAIL THIS ORDER NOW**

To: **Hiffe Electrical Publications Ltd., Dorset House, Stamford Street, London, S.E.1, England.**

Subscription rates: 12 months Home £3. 0. 0. Overseas £3. 10. 0.
Canada and U.S.A. \$10.00.

ORDERS MAY ALSO BE PLACED WITH THE LOCAL AGENT IN YOUR AREA

Please enter my subscription to *Industrial Electronics* for the next 12 months. Remittance for enclosed.

NAME.....

FIRM.....

ADDRESS.....

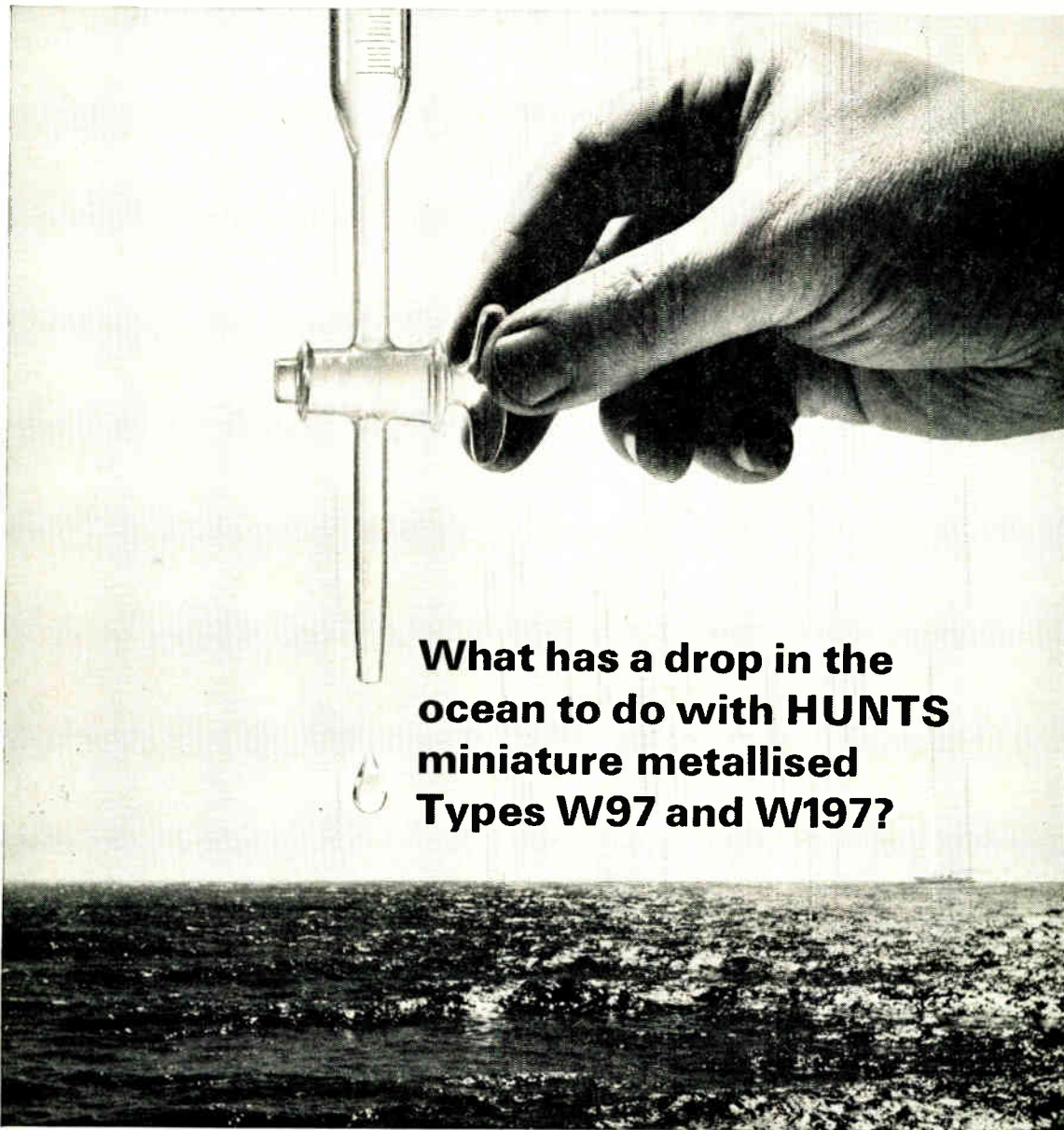

What has a drop in the ocean to do with HUNTS miniature metallised Types W97 and W197?

A lot—when it comes to the ratings of their renowned range of Miniature Metallised Dielectric Capacitors. Investigation of a period in which sales amounted to 24,000,000 types W97 and W197 shows returns of less than 500 . . . and even these few renegades suffered only from mechanical faults such as damage in transit or mis-registered print. Literally a drop in the ocean ! And both W97 and W197 incorporate Hunts patented features such as castellated pattern winding, double metal tubing sealed with Thermetic compound, and Hunts famous termination techniques. The results give wide temperature and voltage ranges, and high resistance to vibration and shock. Contact Hunts by letter or phone for full details of W97 and W197.

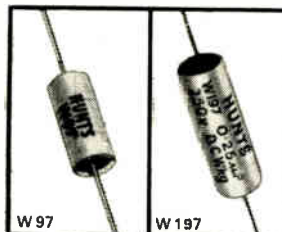

Hunts (Capacitors) Ltd
Wandsworth, London SW18
Telephone: VANdyke 6454 Telex: 25640
Factories also in Surrey and North Wales



Conferences, Symposia and Colloquia

3rd-8th July. International Measurement Conference (IMEKO IV), to be held in Warsaw. Details from the Secretariat, Budapest 5, P.O.B. 457, Poland.

4th-6th July. Conference on 'Automation in Materials Inspection', to be held at Imperial College, London, S.W.7. Details from the Institute of Physics and The Physical Society, 47 Belgrave Square, London, S.W.1. (Phone: Belgravia 6111).

6th July. One-day Symposium on the 'Applications of Computers in Medicine'. To be held at the Enfield College of Technology, Queensway, Enfield. (Phone: Howard 1126).

6th-12th July. Symposium on the 'Future Technical Pattern of Control Engineering Equipment in Ships'. Further information from Municipal and Industrial Exhibitions Ltd., 3 Clement's Inn, London, W.C.2. (Phone: Chancery 1200).

7th-8th July. Conference on 'Spectroscopy and Automation', to be held at the University of Bristol. Organized by the Institute of Physics and The Physical Society, 47 Belgrave Square, London, S.W.1. (Phone: Belgravia 6111).

7th-8th July. Conference on 'Chemically-Grown Surface Films', to be held at the University of Strathclyde. Organized by the Institute of Physics and The Physical Society, 47 Belgrave Square, London, S.W.1. (Phone: Belgravia 6111).

10th-22nd July. The Institution of Electrical Engineers Summer School on 'Microwave Techniques', to be held at the University of Leeds. Registration forms from the Secretary, Savoy Place, London, W.C.2. (Phone: Covent Garden 1871).

11th-14th July. Conference on Aerospace Systems, to be held in Seattle, Washington. Details from the Institute of Electrical and Electronics Engineers Inc., 345 East 47th Street, New York 10017, U.S.A.

11th-15th July. Joint I.E.R.E./I.E.E. Conference on 'Applications of Thin Films in Electronic Engineering', to be held at Imperial College of Science and Technology, Exhibition Road, London, S.W.7. Details from the Institution of Electronic and Radio Engineers, 8-9 Bedford Square, London, W.C.1. (Phone: Museum 1901).

8th-20th August. Seminar on Optimal Control and Hybrid Computation, to be held in Dubrovnik, Yugoslavia. Organized by the Yugoslav Committee for Electronics and Automation, P.O.B. 356, Belgrade, Yugoslavia.

17th-19th August. Seventh Annual Joint Automatic Control Conference (JACC), to be held at the University of Washington, Seattle, Washington. Further information from Prof. A. E. Bryson, A.I.A.A. Headquarters, 1290 6th Avenue, New York 10019, U.S.A.

29th Aug.-2nd Sept. Symposium on Neutron Monitoring for Radiological Protection, to be held in Vienna. Further information from Mr. D. J. W. Dawes, Ministry of Technology, Millbank Tower, London, S.W.1. (Phone: Victoria 2255).

12th-15th September. Conference on 'Electronic Engineering in Oceanography'. Organized by the Institution of Electronic and Radio Engineers (Phone: Museum 1901) and to be held at the University of Southampton.

12th-16th September. Conference on 'Radiation Methods in Nuclear Power', to be held at Berkeley, Glos. Further details from the Meetings Officer, The Institute of Physics and The Physical Society, 47 Belgrave Square, London, S.W.1. (Phone: Belgravia 6111).

12th-16th September. The Sixth International Conference on 'Microwave and Optical Generation and Amplification'. To be held at Cambridge University and organized by The Institution of Electrical Engineers, Savoy Place, London, W.C.1. (Phone: Covent Garden 1871).

12th-16th September. The Seventh International Machine-Tool Design and Research Conference, to be held at the University of Birmingham. Details from the Organizing Secretary, Department of Mechanical Engineering, Birmingham University.

13th-15th September. Conference on Electrical Network Theory and Design, to be held at the University of Newcastle-upon-Tyne. Further information from Dr. A. G. J. Holt, Electrical Engineering Dept., The University, Newcastle-upon-Tyne 1.

19th-23rd September. Conference on High-Voltage D.C. Transmission. To be held at the Manchester College of Science and Technology, and organized by the Institution of Electrical Engineers, Savoy Place, London, W.C.2. (Phone: Covent Garden 1871).

21st-23rd September. Conference on the Physics of Semiconducting Compounds. To be held in London and organized by the Institute of Physics and The Physical Society, 47 Belgrave Square, S.W.1. (Phone: Belgravia 6111).

26th-29th September. Residential Conference on 'Integrated Process-Control Applications in Industry'. Organized by the Institution of Electrical Engineers, Savoy Place, London, W.C.2. (Phone: Covent Garden 1871).

26th-29th September. Sixth National Inspection Conference on Quality, Reliability and Marketing, to be held at New College, Oxford. Organized by the Institution of Engineering Inspection, 616 Grand Buildings, Trafalgar Square, London, W.C.2. (Phone: Whitehall 0818).

28th-30th September. Conference on 'Energy Beams and their Uses', to be held at the University of York. Further

WHAT'S ON AND WHERE

Continued

details from the organizers, the Institute of Physics and The Physical Society, 47 Belgrave Square, London, S.W.1. (Phone: Belgravia 6111).

3rd-5th October. Aerospace and Electronic Systems Convention, to be held at the Sheraton Park Hotel, Washington D.C. Programme details from Harold Schutz, Westinghouse Elec., Box 746, Baltimore, Maryland, U.S.A.

3rd-5th October. National Electronics Conference, to be held at the Conrad Hilton Hotel, Chicago, Illinois. Programme details from Dr. J. C. Hancock, Purdue University, Lafayette, Indiana, U.S.A.

9th-11th October. International Conference on the Automatic Operation and Control of Broadcasting Equipment. To be held in London and organized by the Institution of Electrical Engineers, Savoy Place, London, W.C.2. (Phone: Covent Garden 1871).

13th-14th October. Fourth Canadian Symposium on Communications, to be held at the Queen Elizabeth Hotel, Montreal. Further information from Prof. G. W. Farnel, McGill University, 805 Sherbrooke Street, W. Montreal, Canada.

24th-26th October. Second International Convention on 'Microelectronics', to be held in the Congress Hall of the Munich exhibition grounds during the Electronica 66 Exhibition. Organized by the International Electronics Association, Theresienhohe 15, 8 Munchen 12, W. Germany.

Courses

Fluid Logic Systems

Maxam Power Ltd. have arranged a series of one-day lecture programmes on the design, function and application of the Maxalog system of fluid logic. Held every Friday (from 10 a.m. to 3.30 p.m.), the programmes form an introduction to industrial fluid-logic systems and include practical demonstrations. Further information may be obtained from Mr. B. Hoyle, 36 Brunel Road, East Acton, London, W.3. (Phone: Shepherds Bush 9312).

Exhibitions

8th-24th July. Moscow

2nd British Industrial Exhibition to be held in Sokolniki Park, Moscow. Organized, with the support of the Board of Trade and under the joint sponsorship of the Association of British Chambers of Commerce and the Russo-British Chamber of Commerce, by Industrial and Trade Fairs Ltd., Commonwealth House, 1-19 New Oxford Street, London, W.C.1. (Phone: Chancery 9011).

20th-21st July. Southampton

Exhibition of Ultrasonic Equipment manufactured by the power ultrasonics and non-destructive testing divisions of Dawe Instruments Ltd., Western Avenue, Acton, London, W.3. To be held at the Skyway Hotel, Southampton.

22nd-26th August. London

The 1966 Television & Radio Show, to be held at Earls Court. Organized by Industrial and Trade Fairs Ltd., Commonwealth House, New Oxford Street, London, W.1. (Phone: Chancery 9011).

23rd-26th August. Los Angeles

Western Electronic Show and Convention (Wescon), to be held in Los Angeles, California. Further information from Don Larson, Wescon, 3600 Wilshire Boulevard, Los Angeles, California, U.S.A.

24th-31st August. Johannesburg

Electra '66, the annual South African Electrical, Electronic and Nucleonic Exhibition. Organized by Scientific, Electronic and Engineering Exhibitions Ltd., P.O. Box 2900, Johannesburg, South Africa.

8th-14th September. Basel

First International Nuclear Industries Fair and Technical Meetings (Nuclex 66), to be held in Basel, Switzerland. Details from the Secretary, Nuclex 66, 4000 Basel 21, Switzerland.

4th-9th October. Ljubljana

The Thirtieth International Exhibition of 'Modern Electronics', organized by the Yugoslav Committee for electronics, telecommunications, automation and nucleonics (ETAN). Details from Gospodarsko Razstavisce (Ljubljana Fair), Ljubljana, Titova 50, Yugoslavia.

10th-14th October. Amsterdam

Fairex '66, an exhibition of electronic components and testing equipment and professional electro-acoustic equipment. Further information from the Secretariat, Fairex Committee, Amsterdam, Minervalaan 82 hs.

11th-13th October. Melton Mowbray

Exhibition and Conference on Inspection and Testing Equipment. Organized by the Production Engineering Research Association, Melton Mowbray, Leicestershire, and to be held in Melton Mowbray.

17th-22nd October. Basel

Third International Exhibition and Congress of Laboratory, Measurement and Automation Techniques in Chemistry (ILMAC), to be held in the halls of the Swiss Industries Fair. Details from the Secretariat, Schweizer Mustermesse, 4000 Basel 21, Switzerland.

20th-26th October. Munich

Electronica 66, an international trade exhibition of electronic components and related measuring and production equipment. Details from Exhibition Consultants Ltd., 11 Manchester Square, London, W.1. (Phone: Hunter 1951).

24th-27th October. New York

Twenty-first Annual International I.S.A. Exhibition and Conference on Instrumentation, Systems and Automatic Control. To be held at the New York Coliseum, and organized by the Instrument Society of America, 500 William Penn Place, Pittsburg, Pennsylvania 15219, U.S.A.

24th-28th October. Antwerp

Exhibition and Congress on Instrumentation and Automation in the Paper, Rubber and Plastics Industries. Further information from P.R.P. Automation, Jan van Rijswijkklaan 58, Antwerp, Belgium.



just a hint of interesting developments which are on the way...

For further information circle 202 on Service Card

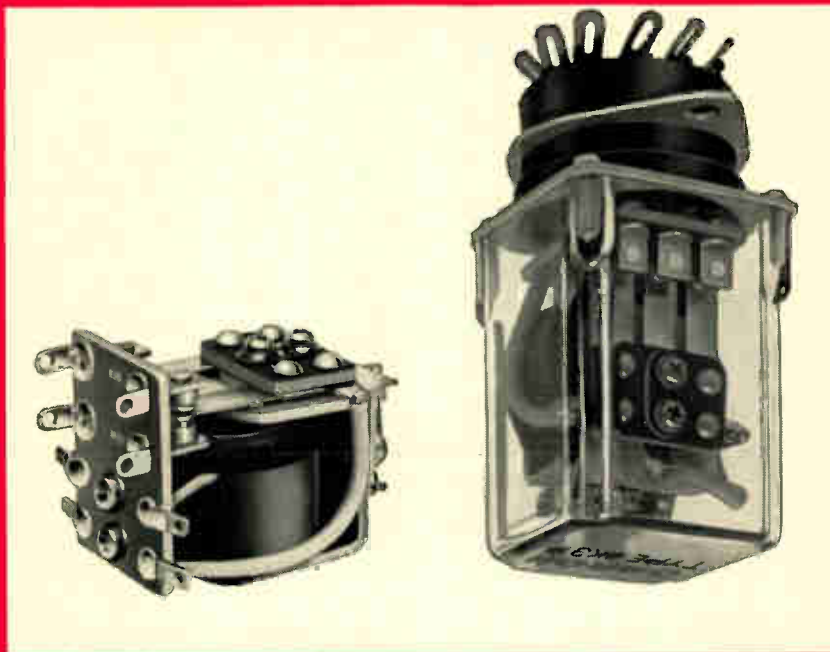
KEYSWITCH**RELAYS****why say Keyswitch?**

It's a difference of quality, often not visible until you look at performance data. Keyswitch miniature and sub-miniature relays are exhaustively tested... each one individually. All conform precisely to a very fine specification. Their reliability is proven. They have all the benefits of Keyswitch delivery—and that's quick, every time.

TYPE MK2 Illustrated approx. actual size. Inexpensive double-pole double-throw midget power relay. 99.9% pure silver contacts switch to 7.5A or 250V d.c./300V a.c. Operation and release 15-30 milliseconds. Universal coil range to 250V a.c./d.c. This relay can cost as little as 11/6.

TYPE MK3P Illustrated approx. actual size. 3-pole plug-in version with clear cover, and complete with socket. Contacts de-rated. This relay can cost as little as 17/6.

always to price \boxtimes **always to specification** \boxtimes **always on time**

KEYSWITCH RELAYS LIMITED • CHICKLEWOOD LANE • LONDON • NW2 • TELEPHONE: GLADSTONE 1182 • TELEX: 282724