

INDUSTRIAL ELECTRONICS

MARCH 1966

5s 0d

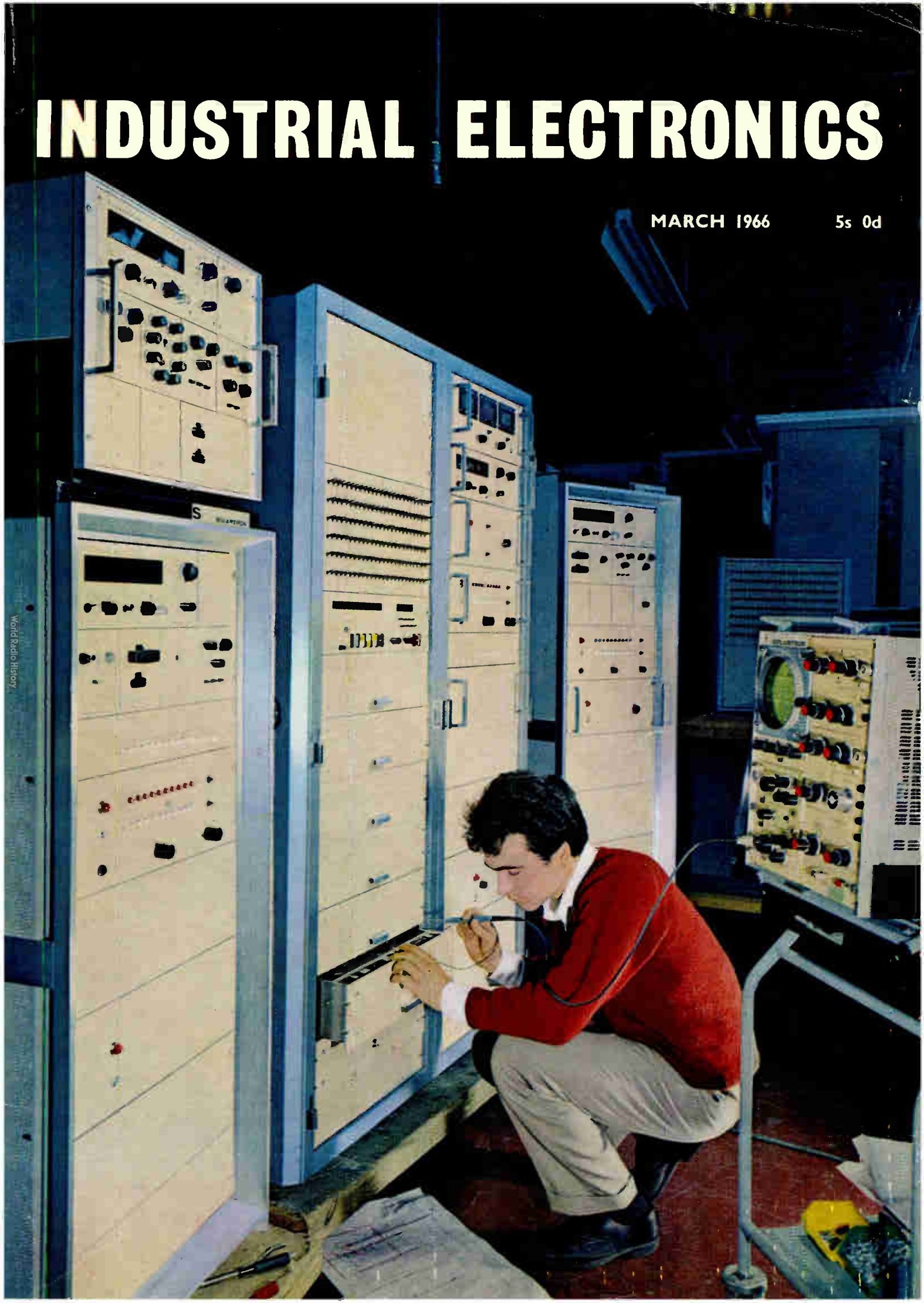

World Radio History



food for thought

must be served to every computer before it can start thinking and drawing conclusions. And, as every epicure knows, the secret of a successful meal is in the preparation of the ingredients.

The on-line process computer can thrive only on a diet of data, measured, transduced and transmitted with accuracy. In this sphere the Kent cuisine is supreme.

Write now for details of the extensive range of detecting elements, measuring instruments, converters, controllers, transmitters, transducers, actuators, and interlocks - and, of course, the vital interface equipment - that is being recommended in many of the top establishments.

An aperitif? The technical support is everything that one pleasantly anticipates from a company so long matured in all forms of industrial measurement and control.

George Kent Limited, Luton, Bedfordshire, England.



INDUSTRIAL ELECTRONICS

Incorporating British Communications and Electronics

Communications Automation Instrumentation Control

Contents March 1966

Editor-in-Chief **W. T. COCKING, M.I.E.E.**

Editor **T. J. BURTON**

Editorial: **K. G. HOLMES**
T. A. KELLY

Production **D. R. BRAY**

Drawing Office **H. J. COOKE**

Advertisement Controller **G. H. GALLOWAY**

Advertisement Manager **R. H. C. DOHERTY**

99 **Comment**

100 **Data Logging Applications in Industry** *by G. A. Rigby, B.Sc.(Eng.)*

The uses of data-logging techniques in industrial process and control systems are becoming much more widespread as their capabilities are appreciated. This article provides an introduction to the basic principles of such techniques and includes several examples of their applications.

105 **Thermoelectricity and Thermoelectric Applications** *by A. R. Sheard*

Thermoelectric devices are being used on an increasing scale for refrigeration, air-conditioning and many other applications. They are a commercial proposition and are becoming more and more competitive. The advantages, principles of operation and diverse uses of thermoelectric cooling and heating modules are described in this article.

112 **The 'Rotenoid'—A True Rotary Solenoid** *by G. W. Cullen*

The 'Rotenoid' is a true rotary solenoid, the rotor of which is urged round by a perfect magnetic couple. This article explains the operation of this device and outlines its use with wafer switches and as a circuit selector for a variety of applications.

123 **Analytical Instruments for Process Plants, Pt. I** *by R. Millership, Ph.D., B.Sc.*

The progress and increasing complexity of industrial process plants have led to the need for very rapid chemical analysis of their products. Such requirements have been met by the design of a wide range of analytical instruments for both laboratory and on-stream use. This article deals with some of the general aspects of various types of apparatus, and discusses their principles of operation and methods of application.

continued overleaf

VOLUME 4

NUMBER 3

© Iliffe Electrical Publications Ltd., 1966

Permission in writing from the Editor must first be obtained before letterpress or illustrations are reproduced from this journal. Brief abstracts or comments are allowed provided acknowledgment to the journal is given.

Published by

Iliffe Electrical Publications Ltd., Dorset House, Stamford Street, London, S.E.1

Managing Director: W. E. Miller, M.A., M.I.E.R.E.

Telephone: Waterloo 3333. *Telegrams/Telex:* Electronics Iliffepres 25137 London

ANNUAL SUBSCRIPTION, HOME £3 0s. 0d. OVERSEAS £3 10s. 0d.
CANADA and U.S.A. \$10.00.

INDUSTRIAL ELECTRONICS

Incorporating British Communications and Electronics

Communications Automation Instrumentation Control



OUR COVER

The subject of this month's cover picture is data loggers. It shows a modern data-logging system, which is made up from a range of modules, on final test at Solartron's plant. Elsewhere in the issue data logging in industry is discussed.

● INDEX TO PRODUCTS

For the convenience of the reader who requires rapid access to information on specific products, an 'index to products' is provided on the same sheet as the reader enquiry cards.

Contents *continued*

127 **Talkabout by Nexus**

Instrumentation and control for hovercraft, some contribution that the aviation industry has made to other industries and drink and driving are three of the topics tackled by Nexus this month.

What's On and Where?

A regular feature which lists forthcoming events. Professional meetings, symposia, conferences and exhibitions are included. For easy reference this item is positioned facing the inside back cover.

Features

104 **Computers in the Hospital**

116 **A.T.C. Radar for R.A.F.**

117 **New Communication System for Hotels**

118 **Applications and Techniques**

122 **New Electronic Telephone Exchange**

128 **Refinery Control Systems at Fawley**

129 **New Apparatus**

141 **Datafair 66—Real-Time Computing Symposium**

143 **Magnetic Recording Symposium in Brussels**

145 **Industrial News**

149 **New Books**

150 **Manufacturers' Literature**

83 *Classified Advertisements*

89 *Index to Advertisers*

Next Month

Automatic control systems are finding many applications in industry. One unusual application of fully-automatic control to a diesel-engine test-bed dynamometer installation at Vauxhall Motors is the topic of one of the main articles in the April issue. Another article will deal with the latest developments in electric fog signalling.

This booklet is available to all interested in printed circuits . . .

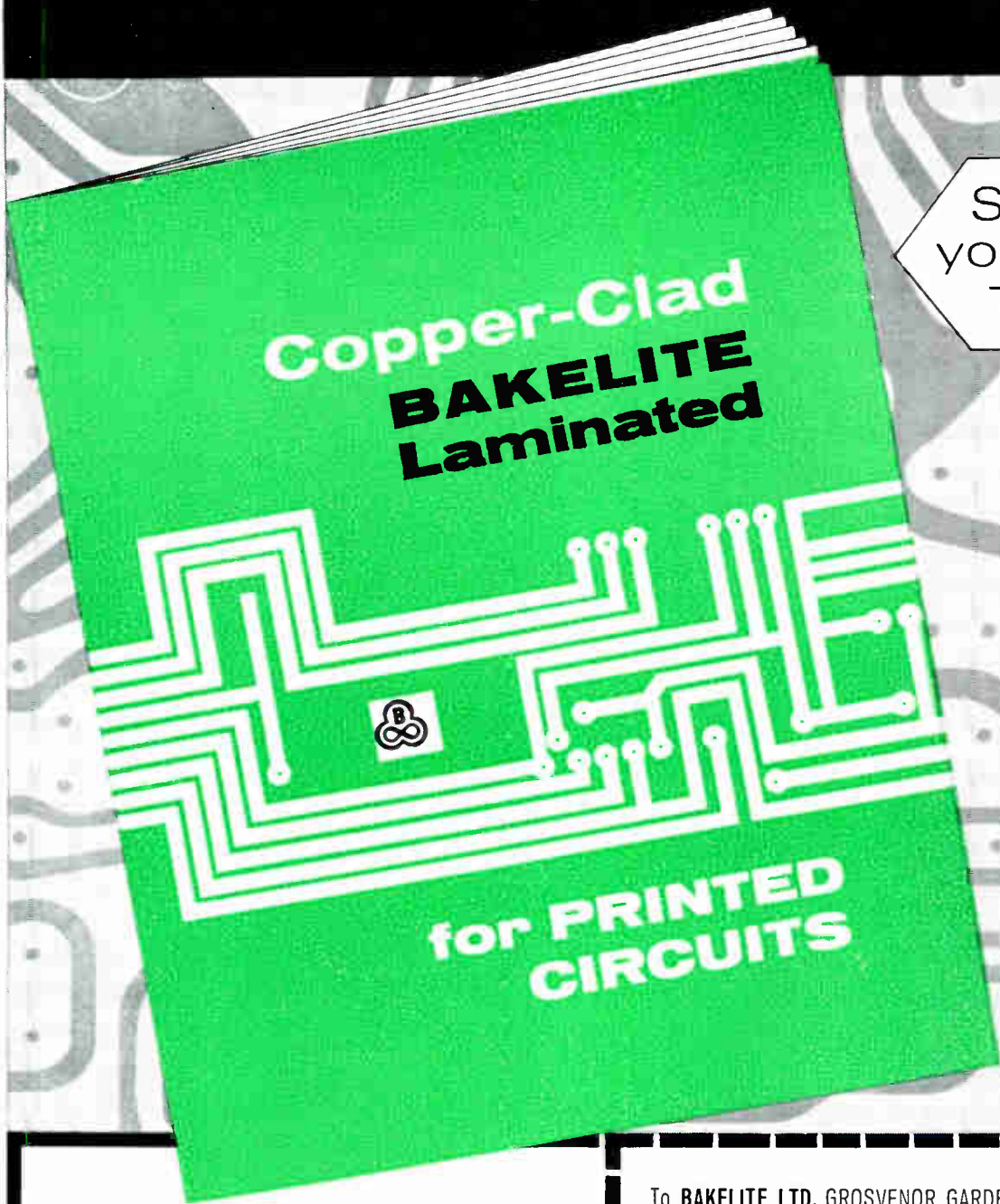

Send for your copy TODAY

Bakelite Limited

A BAKELITE XYLONITE COMPANY

12-18 Grosvenor Gardens, London SW1. Tel: SLOane 0898

Sales Offices at: Birmingham Tel: Central 5011
Manchester Tel: Blackfriars 2861. Glasgow Tel: City 6325

The trefoil symbol and the word BAKELITE are registered trade marks of Bakelite Limited

To BAKELITE LTD, GROSVENOR GARDENS, LONDON SW1

Please send me, free of charge, a copy of "Copper-Clad BAKELITE Laminated for Printed Circuits".

NAME _____

ADDRESS _____

SPECIAL INTEREST _____

IE.3

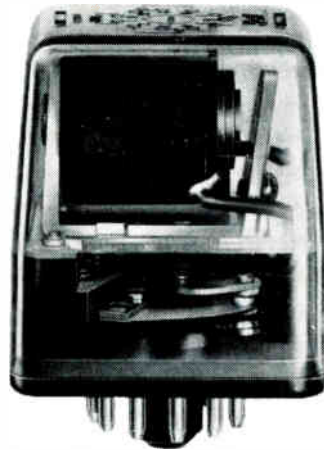

Good design
is often a question of what you cut out. In designing
this D55 plug-in relay we cut out
9 wires
18 soldered connections
 $\frac{1}{2}$ inch off the height
and quite a bit off the price

by means of the unique system of peripheral contacts each fixed directly to its base pin.

The D55 is one of four relays in which these soldered connections have been eliminated.

Delivery is Ex Stock
for the following versions:—

D03 2 changeover contacts,
coil voltages 12, 24, 48-50 or 110 DC
D53 2 changeover contacts,
coil voltages 24, 110 or 210-250 AC
D05 3 changeover contacts,
coil voltages 12, 24, or 48 DC
D55 3 changeover contacts,
coil voltages 110 or 220-250 AC

All contacts are rated at 6 amps
250 volts AC. All relays have
very strong Makrolon dust
covers with the pin connection
diagram on top. All are
available with tag or screw
terminal sockets.

Other coil voltages available
up to 150 volts DC or 330 volts
50 cycles.

Full details from
B & R Relays Limited
Temple Fields Harlow Essex
Telephone Harlow 25231/4
Telex 81140

BR.10

B&R

We've counted them!

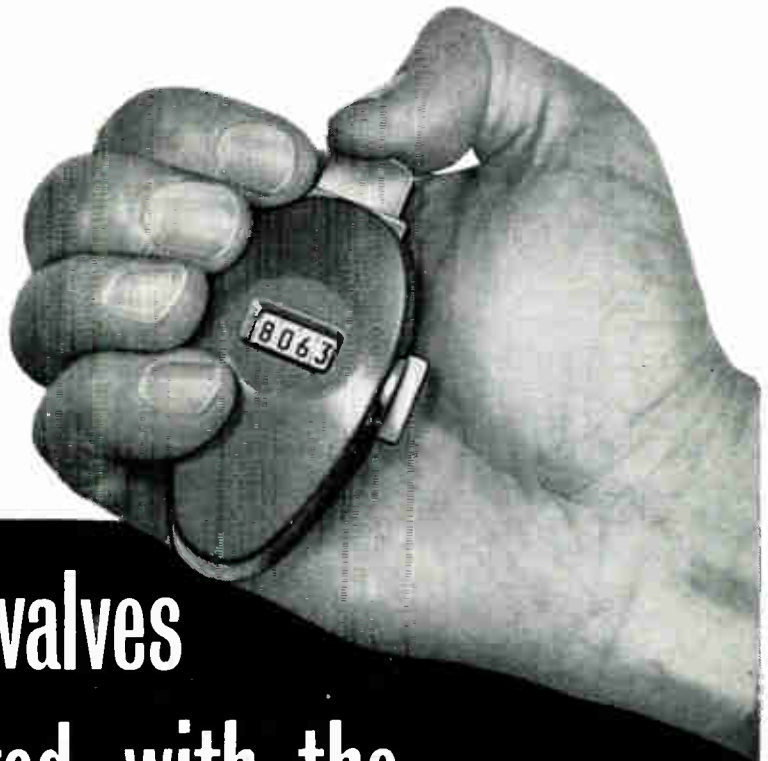

Over 8,000 valves can be tested with the

Valve Characteristic Meter *Mk 4*



The Avo Valve Characteristic Meter Mk 4 can test, accurately and simply, any type of standard receiving or small transmitting valve having up to a maximum anode dissipation of 25 W.

The construction of the instrument combines modern streamlined appearance with mechanical strength. All controls are protected by 'roll-round' handles, and the fold-away lid safeguards valve holders.

Tests that can be carried out include:

- Inter-electrode insulation
- Anode current
- Mutual conductance
- 'Gas' current

Families of curves can also be plotted.

The Avo Valve Characteristic Meter is supplied complete with a current copy of the Avo Valve Data Manual* which gives in-line testing information without the necessity of referring to individual manufacturers' literature.

Write for V.C.M. Mk 4 leaflet

** The 17th edition is now available. Extra copies available from Avo Spares Dept. at 35/-, post free.*

AVO LTD

AVOCET HOUSE · 92-96 VAUXHALL BRIDGE ROAD · LONDON S.W.1

Telephone: VICtoria 3404



VC9

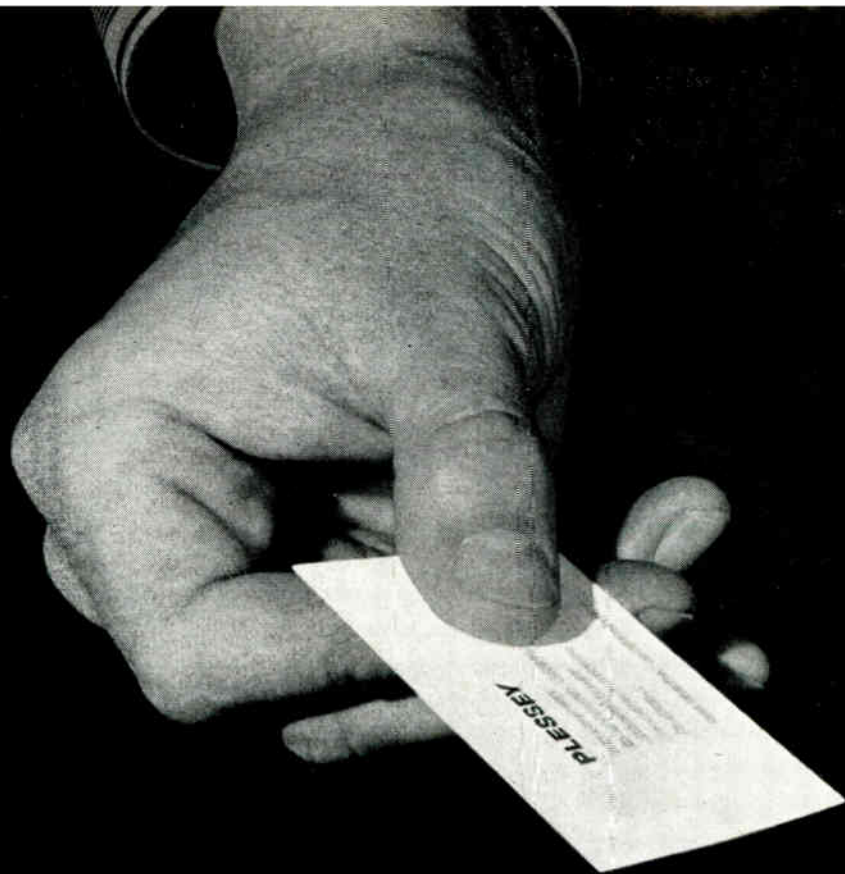

The Plessey man who hands you this card

Behind every Plessey representative stands the most comprehensive electronic-component capability in the world. In the new Plessey Components Group there are specialised Divisions, modern production plants, development laboratories, 16,000 skilled employees, and more than 40 years of experience. Plessey can meet practically every component requirement for commercial, industrial and military electronic equipment. As well as producing one of the widest ranges of electronic components available, Plessey also offers you the highest

possible component reliability. Incomparable Plessey test facilities include one of Europe's most extensive and up-to-date environmental laboratories. A separate research centre, among the most advanced in Europe, has originated many new components and materials. The expert from Plessey will be happy to tell you about Plessey components the next time he visits you. If there is a particular problem you would like to discuss, or particular components on which you want advance information, just fill out the coupon below, and post it to Plessey.

For more information fill in and post this coupon

Please send me data on the Plessey components ticked below/I would like a Plessey specialist to visit and tell me about them

- | | | | |
|---|---|--|--|
| <input type="checkbox"/> air & plastic dielectric variable capacitors | <input type="checkbox"/> infra-red detectors | <input type="checkbox"/> silicon alloys | <input type="checkbox"/> subminiature valves & neon lamps |
| <input type="checkbox"/> cast permanent magnets | <input type="checkbox"/> loudspeakers | <input type="checkbox"/> solar cells | <input type="checkbox"/> valveholders & ceramic components |
| <input type="checkbox"/> ceramic capacitors | <input type="checkbox"/> new subminiature rotary switch | <input type="checkbox"/> new rotary solenoid | <input type="checkbox"/> new printed circuit connectors |
| <input type="checkbox"/> coil assemblies | <input type="checkbox"/> micro-alloy & micro-alloy diffused transistors | <input type="checkbox"/> solid circuits | Name _____ |
| <input type="checkbox"/> cold cathode tubes | <input type="checkbox"/> miniature silicon rectifiers | <input type="checkbox"/> switches | Title _____ |
| <input type="checkbox"/> diffused silicon rectifiers | <input type="checkbox"/> number tubes | <input type="checkbox"/> tantalum capacitors | Company _____ |
| <input type="checkbox"/> dry reed relay inserts | <input type="checkbox"/> planar switching diodes | <input type="checkbox"/> tape decks | Address _____ |
| <input type="checkbox"/> electrical connectors | <input type="checkbox"/> preformed wiring | <input type="checkbox"/> timing & regulating devices | _____ |
| <input type="checkbox"/> electroluminescent devices & mimic diagrams | <input type="checkbox"/> pick-up cartridges | <input type="checkbox"/> transducers | _____ |
| <input type="checkbox"/> electrolytic capacitors | <input type="checkbox"/> rectifier stacks | <input type="checkbox"/> transformers & inductors | Telephone _____ |
| <input type="checkbox"/> ferrite memory cores & matrices | <input type="checkbox"/> relays | <input type="checkbox"/> transistors | |
| <input type="checkbox"/> filters | <input type="checkbox"/> resistors & potentiometers | <input type="checkbox"/> wound components | |

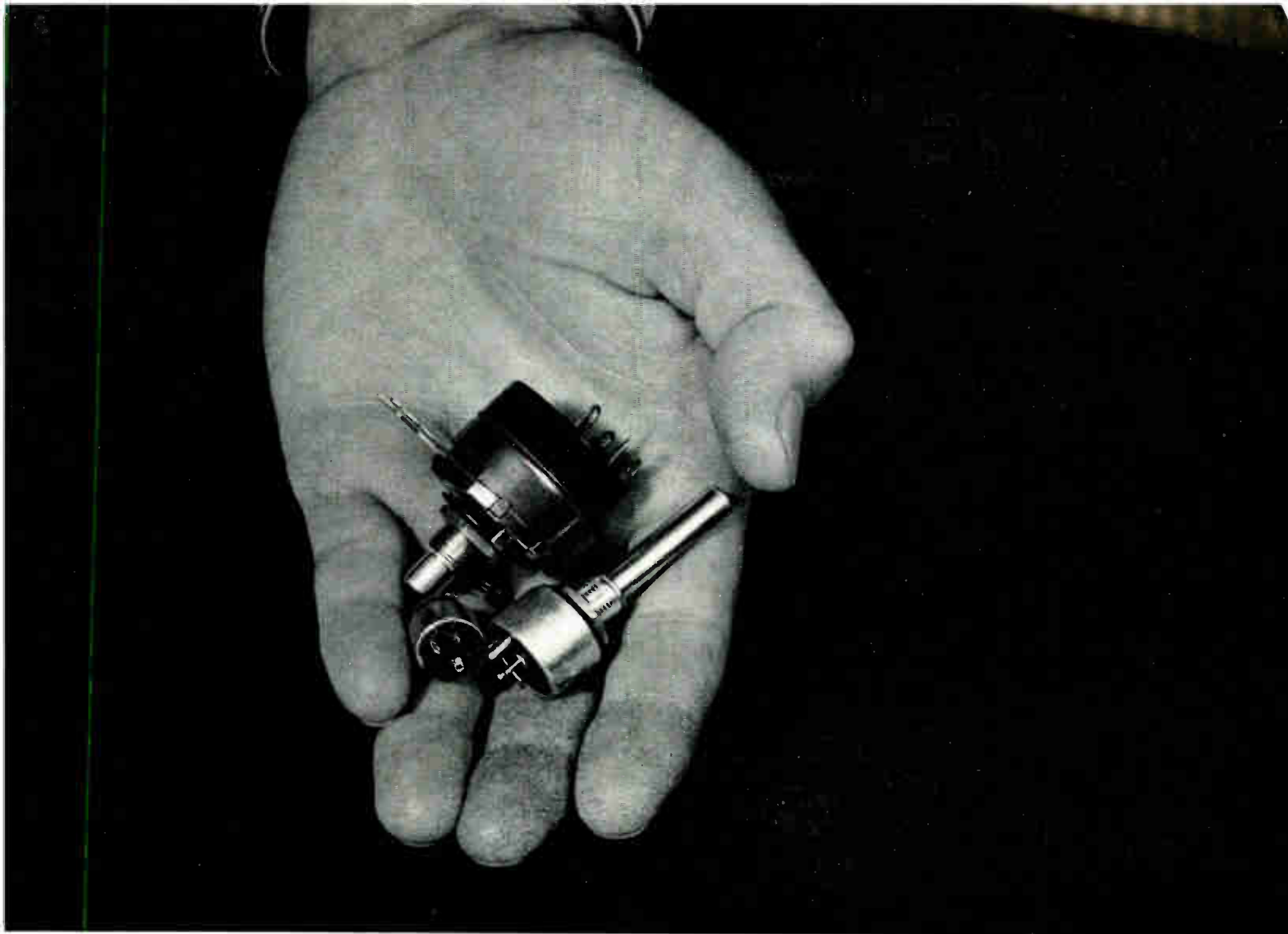

...offers you 39 different categories of electronic components. Here are three of the newest:

New Subminiature Rotary Switch



This subminiature 12-position switch uses a printed-circuit rotor and hard gold plated contacts. Operating range: -50°C to $+85^{\circ}\text{C}$. Contact rating: 50V, 100mA resistive for 20,000 cycles. Contact resistance: 15 milliohms (max). Diameter: 17.463mm.

New Printed-Circuit Connectors



These are manufactured in strips and can carry up to 80 contact positions. They can be cut to customers' exact requirements with a variety of combinations to suit individual printed-circuit connector applications. Rating: 750V a.c. rms at sea level, 5A continuous, -40°C to $+85^{\circ}\text{C}$, contact resistance less than 15 milliohms.

New Rotary Solenoid



Designed for reliability and long life, this Rotenoid is particularly suited to the operation of multi-bank wafer switches where extra force is often required to overcome initial loads due to high static friction and indexing mechanisms. It will operate at a temperature of 180°C . DC operating range: 2V to 440V dissipation 12W continuous or up to 100W, according to function.

PLESSEY Components Group



The Plessey Company Limited, Kembrey Street, Swindon, Wiltshire. Telephone: Swindon 6211. Telex: 44180

For further information circle 207 on Service Card

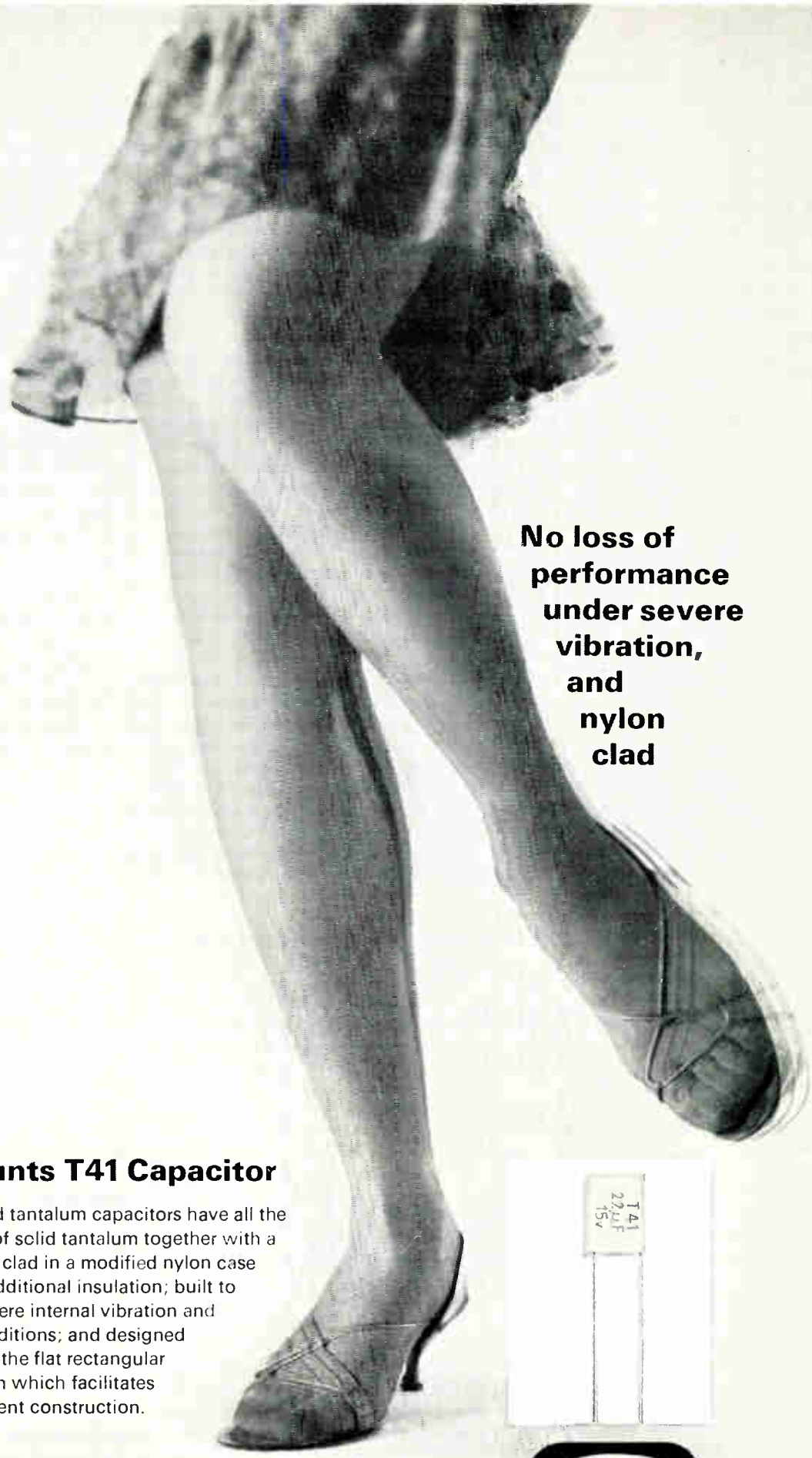

**No loss of
performance
under severe
vibration,
and
nylon
clad**

—That's Hunts T41 Capacitor

Hunts T41 solid tantalum capacitors have all the supreme advantages of solid tantalum together with a unique construction — clad in a modified nylon case which requires no additional insulation; built to withstand the most severe internal vibration and acceleration conditions; and designed to take advantage of the flat rectangular package form which facilitates high density component construction.

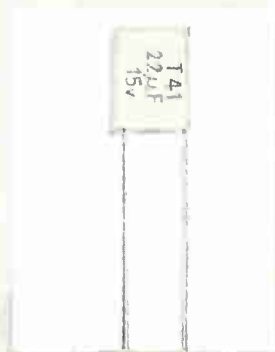

Full details freely available on request from
A. H. Hunt (Capacitors) Limited
Bendon Valley, Garratt Lane, London SW18
Telephone VANdyke 6454, Telex 25640
Factories also in Surrey and North Wales



Why is this trademark important to you?

For 30 years one principle has guided us in meeting our responsibility to provide you with equipment of the highest performance standards. That principle is *integrity*.

<i>integrity in design</i>	25% of our people are in Research and Development.
<i>integrity in manufacturing</i>	The best facilities, the best materials, the industry's finest craftsman.
<i>integrity in sales</i>	Honest claims, backed up by a seldom used but always dependable guarantee.
<i>integrity in service</i>	Around the world, around the clock to <i>insure</i> Collins performance.

Our trademark is a symbol of Collins integrity. You can depend on it.



COLLINS RADIO CO., Dallas, Texas, U.S.A. □ Europe, Middle East and Africa Headquarters, Heathrow House, Bath Rd. Cranford, Hounslow, Middlesex, England,
MELBOURNE · PARIS · FRANKFURT · ROME · MEXICO CITY · BEIRUT · TORONTO · HONG KONG

**An
illustration
of
G.P.
-upmanship**

TMC

General Purpose (G.P.) Relay

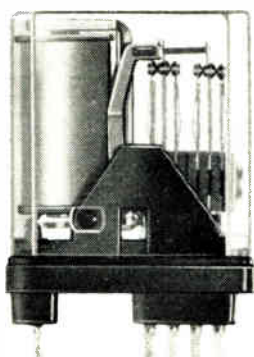

Q *G.P. upmanship.
What's that?

A Going one (or maybe
two or three) better
than others.

To find out how this is
done write to TMC for
details of their new
*General Purpose Relay.
If you feel you know then
write, telephone or telex
for a quotation.

TMC

**TELEPHONE
MANUFACTURING
COMPANY LIMITED**

Components Division
Roper Road
Canterbury
Kent

Telephone : 66577
Telex : 28115

TMC is a registered Trade Mark

A MEMBER OF THE  GROUP OF COMPANIES

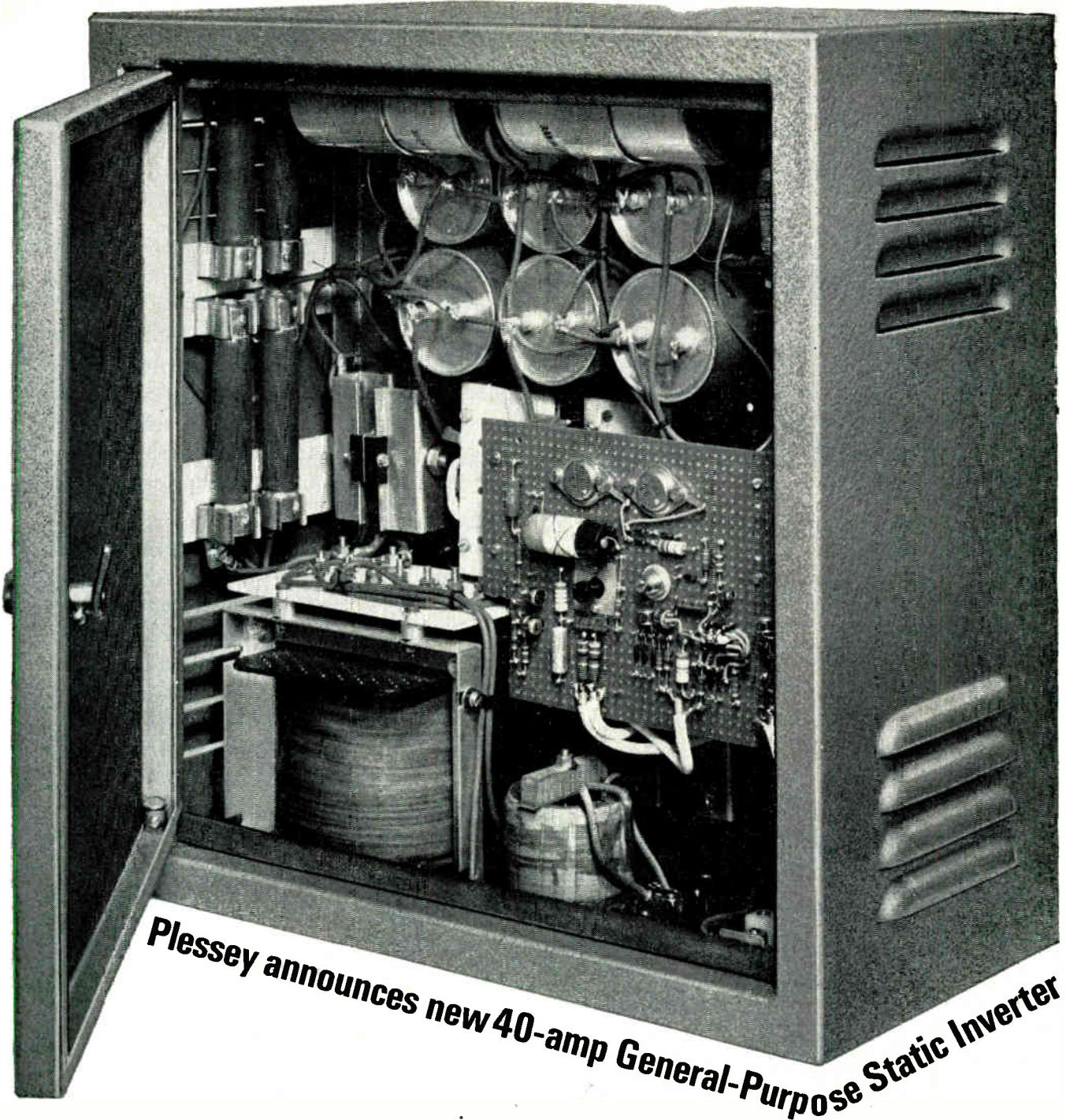

Plessey announces new 40-amp General-Purpose Static Inverter

The new Plessey 40-amp Static Inverter combines, for the first time, the many advantages of static-inverter power supplies with reasonable price and delivery. Basically a 40-amp unit, it produces a maximum of 10 kva, 230-volt, 50 or 60 c/s output from a nominal 220-vdc input, with other input-output combinations to meet individual requirements. This general-purpose unit is readily adaptable to a wide variety of applications, wherever you want maximum reliability and immediate start-up, without maintenance. Typical applications include motor supply, fluorescent lighting, commercial air conditioning and marine purposes.

This 40-amp Static Inverter brings you major collateral benefits from long Plessey experience in developing and producing ultra-high-performance static inverters

for the aircraft industry. To find out all about this versatile new dc-to-ac conversion equipment, contact Plessey today, indicating your required input and output as specifically as possible.

PLESSEY

Dynamics



The Plessey Company Limited
Electrical Equipment Division
Eastern Avenue West, Romford, Essex
Telephone: Ilford 3040

looking for LEAKS

Listening will be more productive since leaks, however fine, generate ultrasonic energy. The Dawe Type 1873 "hears" and locates the escape of leaking gas even through minute apertures. It will locate low pressure leaks but is quite insensitive to all audible sounds. The 1873 will detect a leak through a 0.010in. hole under 10 p.s.i. at distances up to 45ft.

Typical applications are the detection of gas leaks in pressure vessels, evacuated system leaks, turbulence in pneumatic and hydraulic systems, corona discharge, friction and worn bearings in mechanical systems and leaks from many other sources. The 1873 is no larger than a torch and almost as easily operated.

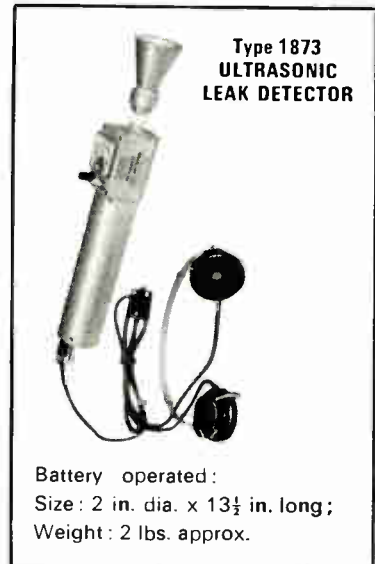
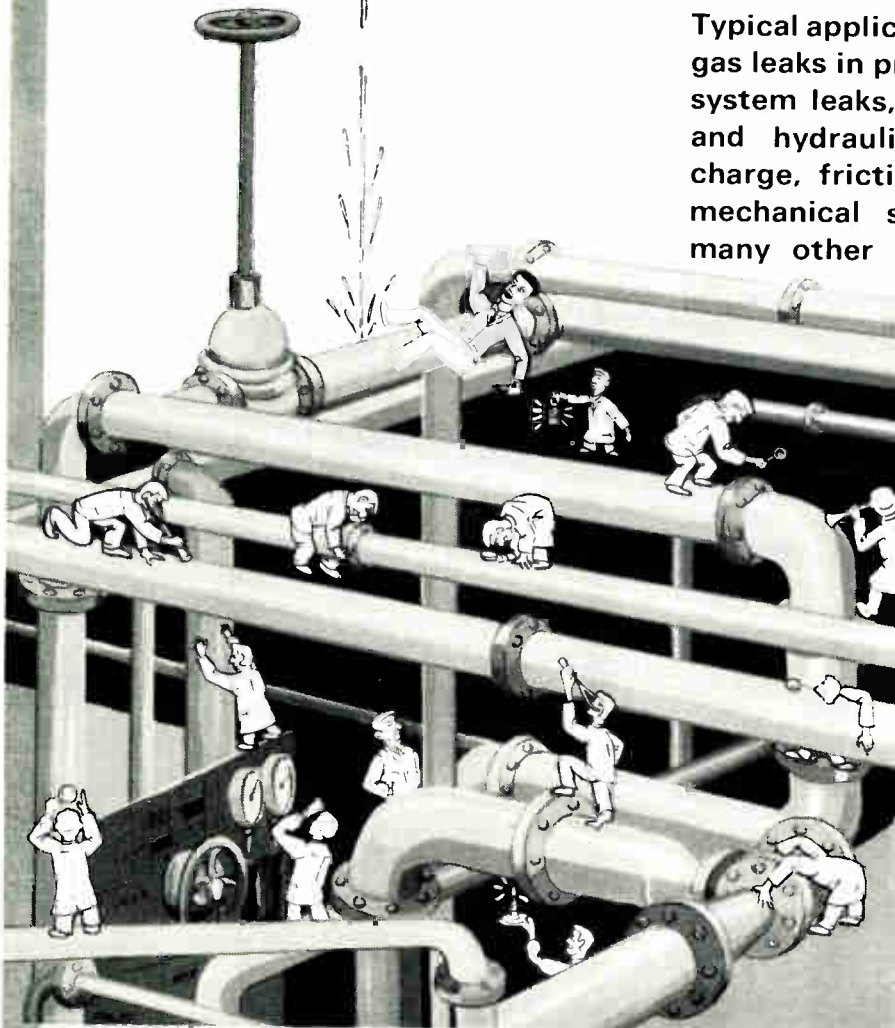

Type 1873
ULTRASONIC
LEAK DETECTOR

Battery operated:
Size: 2 in. dia. x 13½ in. long;
Weight: 2 lbs. approx.

NON DESTRUCTIVE testing

division of **DAWE** INSTRUMENTS LTD.,

WESTERN AVE., LONDON, W3 Tel: ACOrn 6751

A member of the *Synn* group of companies

MUIRHEAD **TECHNIQUE 1**

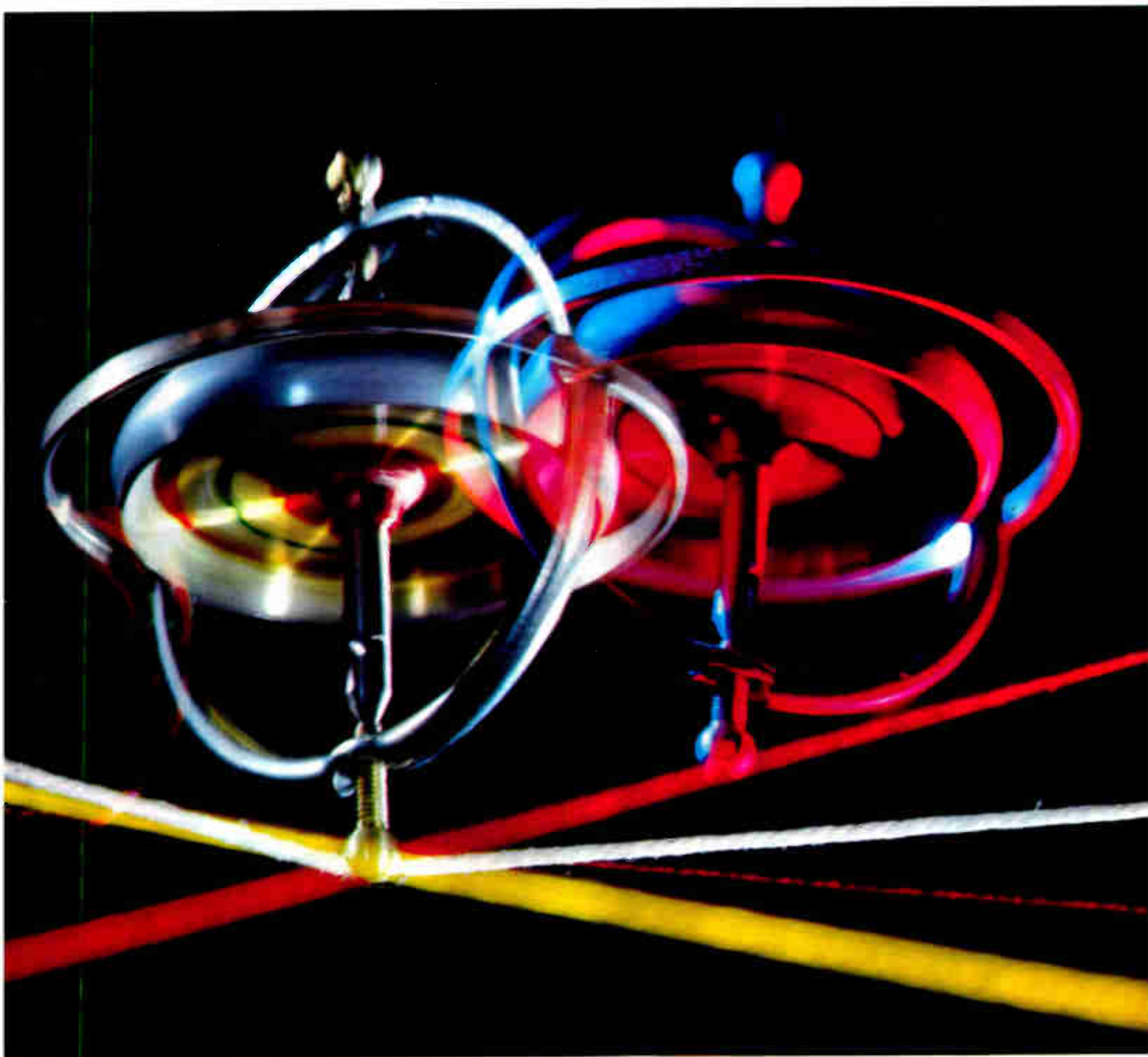

SYNCHROS AND SERVOS *-the willing slaves*

Today, the marriage of electronic brain with mechanical muscle offers exciting new techniques to almost any industry.

These remarkable devices, which automatically stabilise big ships or remotely control reactor rods in nuclear power plants, may also help to make a better biscuit or automate a coal mine.

Every business man owes it to himself to know the basic principles. For example consider the simple gyro . . .

SYNCHROS and SERVOS -

Gyroscopic constancy is only one of many physical laws which can be harnessed by synchros and servos.

For synchros and servos are the willing slaves, the former the nerves and the latter the muscles, that make automation practical. In outward appearance like small electric motors, they measure and assess movement, convert it into electrical signals, read the signals and turn them back into movement, magnifying or reducing it as required. They can feed back a description of the task performed to verify whether it has been done accurately and apply any correction. They give to electro-mechanical equipment the sort of response the human body obtains from the interaction of eye, ear, brain, nerve and muscle.

Taming the storm

Fitting stabilisers to ocean going vessels has earned the gratitude even of hardened sea travellers. In almost all ships afloat fitted with stabilisers, Muirhead stabiliser control is used. Even ships of a mere 80 tons displacement can have them. There are systems designed to be effective from standstill to maximum speed—a new development particularly appropriate for vessels such as weather ships, light ships and fishing trawlers.

A high precision version of our familiar friend the gyroscope keeps its constant station within the ship. The relative movement between the gyro and the ship as it responds to the rolling of the sea, is 'felt' by the highly sensitive 'automatic nerve' of a Muirhead synchro transmitter. It translates its reading into an electrical signal and with it passes continuous instruction to the Muirhead servo 'muscles'. These in turn control a variety of stabilising systems according to the type and size of ship.

This same principle enables our latest armoured fighting

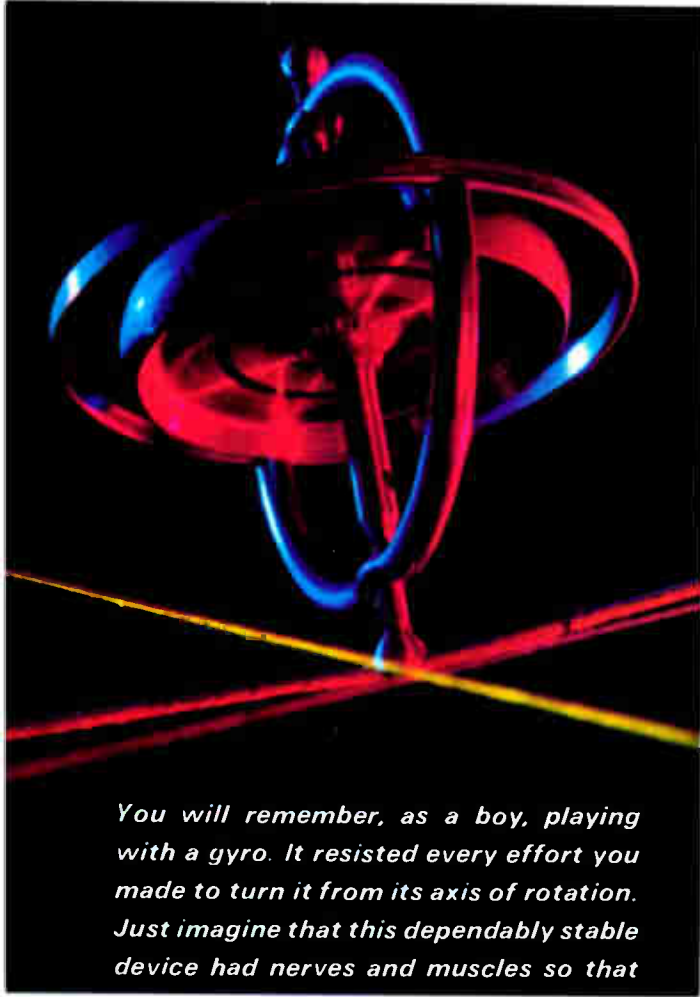

You will remember, as a boy, playing with a gyro. It resisted every effort you made to turn it from its axis of rotation. Just imagine that this dependably stable device had nerves and muscles so that

it could hold constant the environment which contained it. Then you could hold a big ship steady in a stormy sea. You could aim a space vehicle at Venus with a predictable expectation of its arrival. You do not need us to tell you that these things are already possible. But better still, you could automate intricate factory operations. You could revolutionise your industry.



vehicles to fire guns as from a 'stable platform' even while bucketing over the roughest terrain. It has made possible, too, the moving map which shows a driver exactly where he is on the road he is travelling—a synchro senses changes in direction relative to a gyro, and a miniature computer calculates distance travelled.

The ship of the future will be even more efficient and automated, probably to the extent of providing the captain with full remote control from the bridge.



Automated steel strip rolling mill

your willing slaves in automation

Data Logging

New standards of efficiency and economy are being contributed by 'data-logging'. The Muirhead Powermeter using electro magnetic pickups continuously records shaft horsepower hours, and indicates instantaneous shaft speed and power. From data such as this specific fuel consumption can be calculated. A large ship may use as much as 100 tons of fuel in 24 hours, so that even 1% saving is vital.

Besides these 'brains' for ships, Muirhead synchros are part of their 'eyes', for all leading makers use them in shipborne and shore radar.

Controlling the atom

A nuclear power station makes heat and electricity from the uranium atom's chain re-action. To control this tiger so that its power is harnessed without its bite, first demands positive continuous knowledge, and then precise control, of the conditions in the inaccessible interior of the reactor. Control rods, of which there may be more than a hundred, regulate the heat. It is vital to know their exact position at all times and to have them adjust automatically. In all British reactors except one, so far, designers have chosen to rely on Muirhead. The Muirhead units have to be installed in positions that can only be accessible at rare intervals, where they must withstand very dry carbon dioxide gas at high pressure, and temperatures around 150°C. A Muirhead transmitter takes all this together with constant exposure to radiation for up to five years. With it, a new range of instrumentation gives pointer and digital indication to an accuracy of 0.1%.

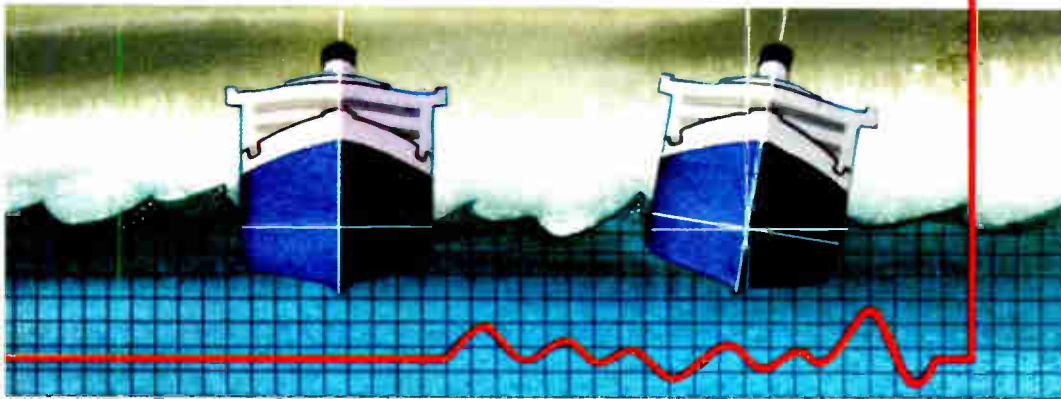
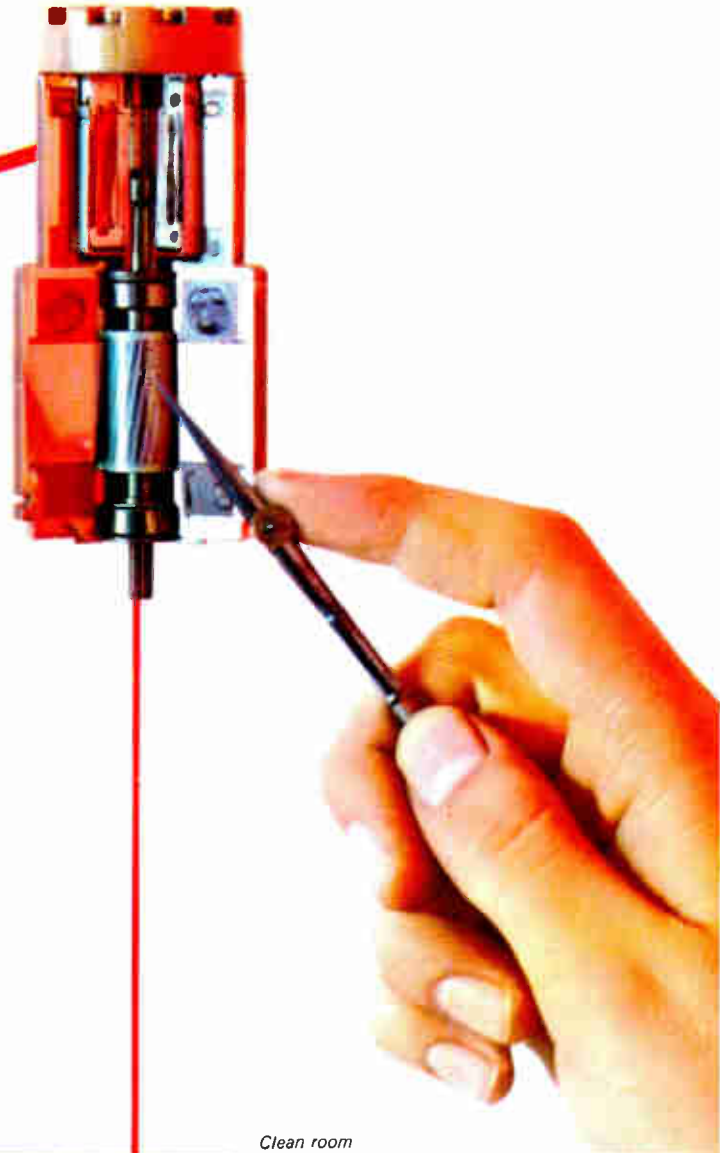

Clean room



Giving new meaning to accuracy

We need quite new ways of expressing accuracy. Traditional references simply no longer apply. The most carefully built synchros can sense minute changes relative to gyro position caused by deviations in direction, which if not corrected by ultra accurate servo systems could result in a planetary probe missing its target by millions of miles. Muirhead synchros, having an accuracy of better than 30 seconds of arc, are used in inertial navigation systems now being developed for aircraft, submarines and missiles.

The significance of '30 seconds of arc' may not be easy to appreciate. To bring it down to earth: if a navigation system of this accuracy were used to guide an airliner flying, say, 6,000 miles from Los Angeles to London, it would arrive within the perimeter of the airport without any additional correction.

Accuracy of this order cannot be achieved with mass produced and batch tested gadgets.

I am interested, without obligation, in knowing how my business would benefit from:

1 (tick box)

Synchros and Servo-mechanisms:
The nerves and muscles that make automation practical.

2

Facsimile Transmission:
Transmits pictures and visual data for reproduction as though distance did not exist.

3

Electronic Instrumentation:
The most accurate and versatile means of measurement.

Muirhead TECHNIQUE is the title of a quarterly technical house journal which we will be pleased to send to you.

I would like a consultation, without obligation, with Muirhead engineering advisers on the subject(s) I have ticked.

Please send me explanatory literature on the subject(s) I have ticked.

Name of organisation:

Nature of business:

Please address reply to me personally:

Mr.

Title or position held:

Address:



Accuracy: Synchros and servos keep space vehicles on course—and they also keep Guinness time in this giant neon clock in Piccadilly Circus.



This is why at Muirhead the vital stages of manufacture take place under conditions more exacting than most operating theatres. A 'clean room' at the factory has its air circulation so thoroughly filtered that it will entrap dust particles down to a hundred millionth of a millimetre in diameter. Air temperature is strictly controlled, special cosmetics and dress are supplied for operatives, and all equipment is 'scrubbed' in a sonic energy tank. Some synchros and servos undergo as many as 300 separate tests before delivery, and an 'identity card' is kept on each component for five years.

Automation for Industry

This extreme accuracy and sensitive response opens new vistas in every field, particularly when harnessed to the computer.

A typical system designed by Muirhead automatically controls production to very fine limits at a number of steel strip rolling mills. Here, metal passing through a train of six hot rolling stands enters the first stand an inch thick, travelling at 250 feet per minute. It leaves the final stand at 2,500 feet per minute reduced in thickness to 0.1 inch. Controlling the gap of the heavy metal rollers, the cooling of the metal and its acceleration posed technical problems that could only be solved by this phenomenal new order of accuracy and automatic response.

From machine tool control to regulating the accuracy of the Guinness clock at Piccadilly Circus . . . the next logical step is to automate our hypothetical biscuit factory or coal mine.

Ask yourself if your profits, your products or your expansion can be bettered by using synchros and servos. Only the opportunity is needed to set a design study in motion. Write now for a consultation with Muirhead engineering advisers.

MUIRHEAD & CO. LIMITED

BECKENHAM KENT ENGLAND

BECKENHAM 4888

LETRASET INSTANT LETTERING ON TAPE

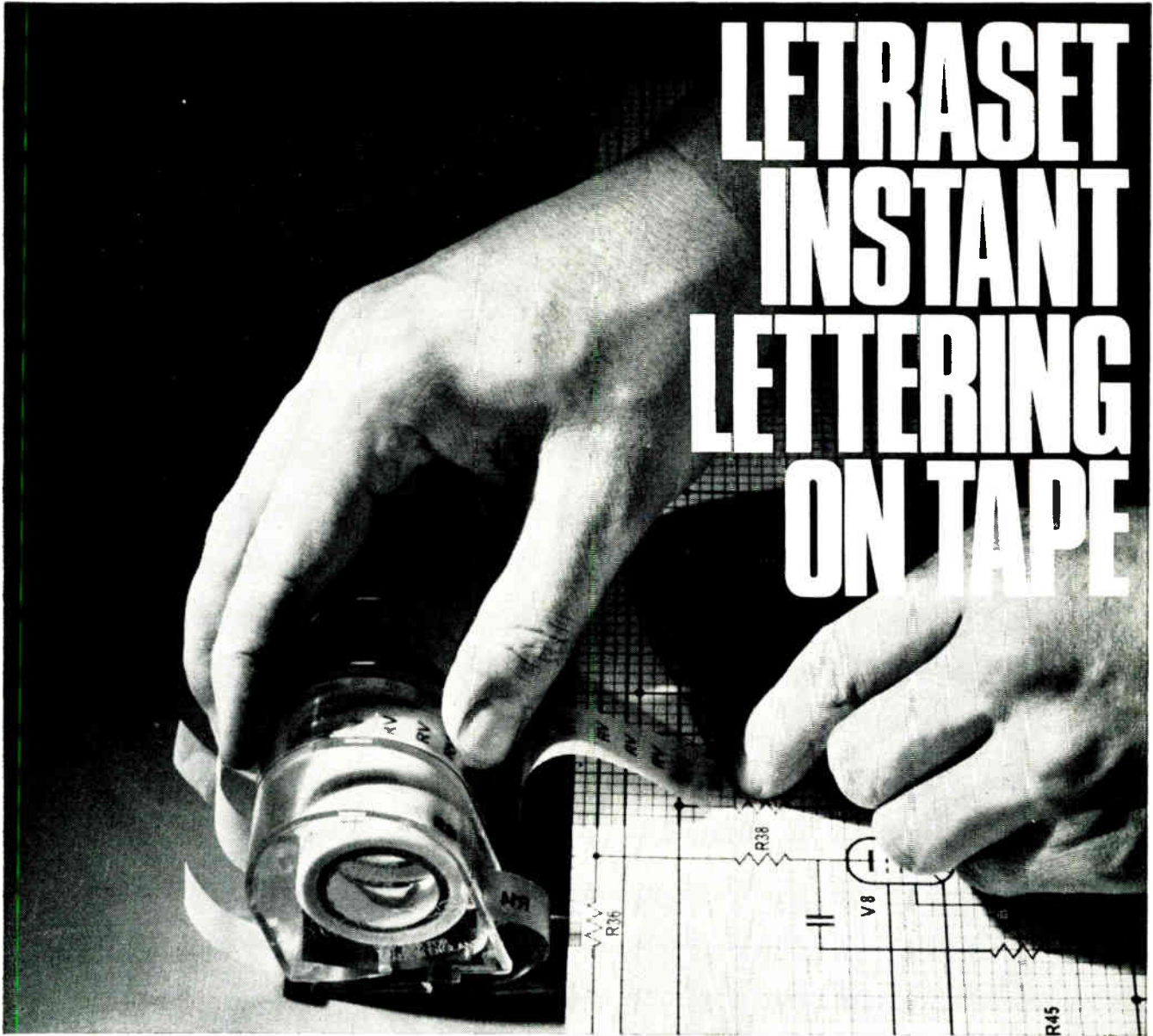

Letratapes reduce the application of dry transfer lettering to a new pull and press technique. The transfer can be applied without rubbing. Simply pull from the special Letratapes dispenser; the symbols are automatically "released" and only light finger tip pressure is required to ensure complete adhesion to any surface.

The Letratapes technique vastly increases the speed of application which makes it particularly suitable for repetitive coding.

The first range consists of a comprehensive component reference system for electronic circuit systems. The range of 120 tapes includes all common reference codes, numeral sequences and frequently used set words.

Comprehensive code symbol range

Dyeline Resistant

Two letter sizes

Up to 500 codes on one tape

Stocked by major Letraset dealers

Also for direct marking of components

Letratape Coding System is a product of Letraset Limited, St. George's House, 195/203 Waterloo Road, London, S.E.1. Telephone Waterloo 1401.

Detailed brochure now available; please return coupon

name _____

company _____

address _____

I.E. 5/66

Letratapes

For further information circle 218 on Service Card

desks, chassis, cubicles, consoles, cabinets, in fact any and every sort of sheet metal work used in the electronics and electrical industries, looks better with Lundsmanship—the art of producing superbly finished, infinitely accurate craftsmanship right through a job, from sketch to finished equipment housing. If you require one off or a hundred off; one foot or a hundred feet; one rack or a roomful; for top quality at competitive prices you can rely on Lundsmanship.

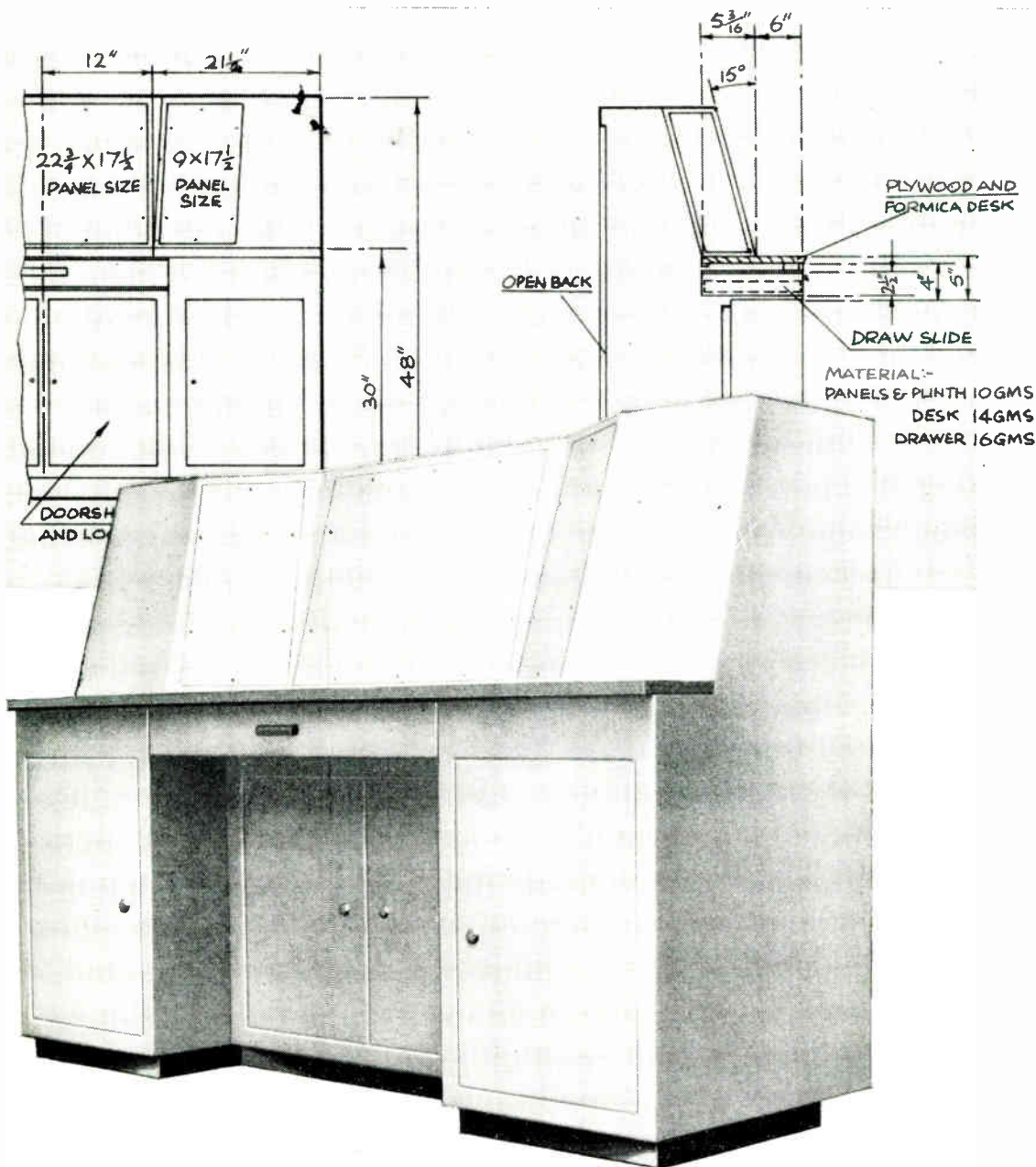

SEE YOUR
ELECTRONIC ENGINEERING INDEX
LIBRARY
FOR FULL TECHNICAL DATA

another example of **LUNDSMANSHIP** SETTING NEW STANDARDS

LUNDS of Wandsworth BENDON VALLEY LONDON S.W.18 Tel: VANdyke 7676/8

A NEW WAY OF MEASURING TORQUE

achieving accuracies within 0.25%

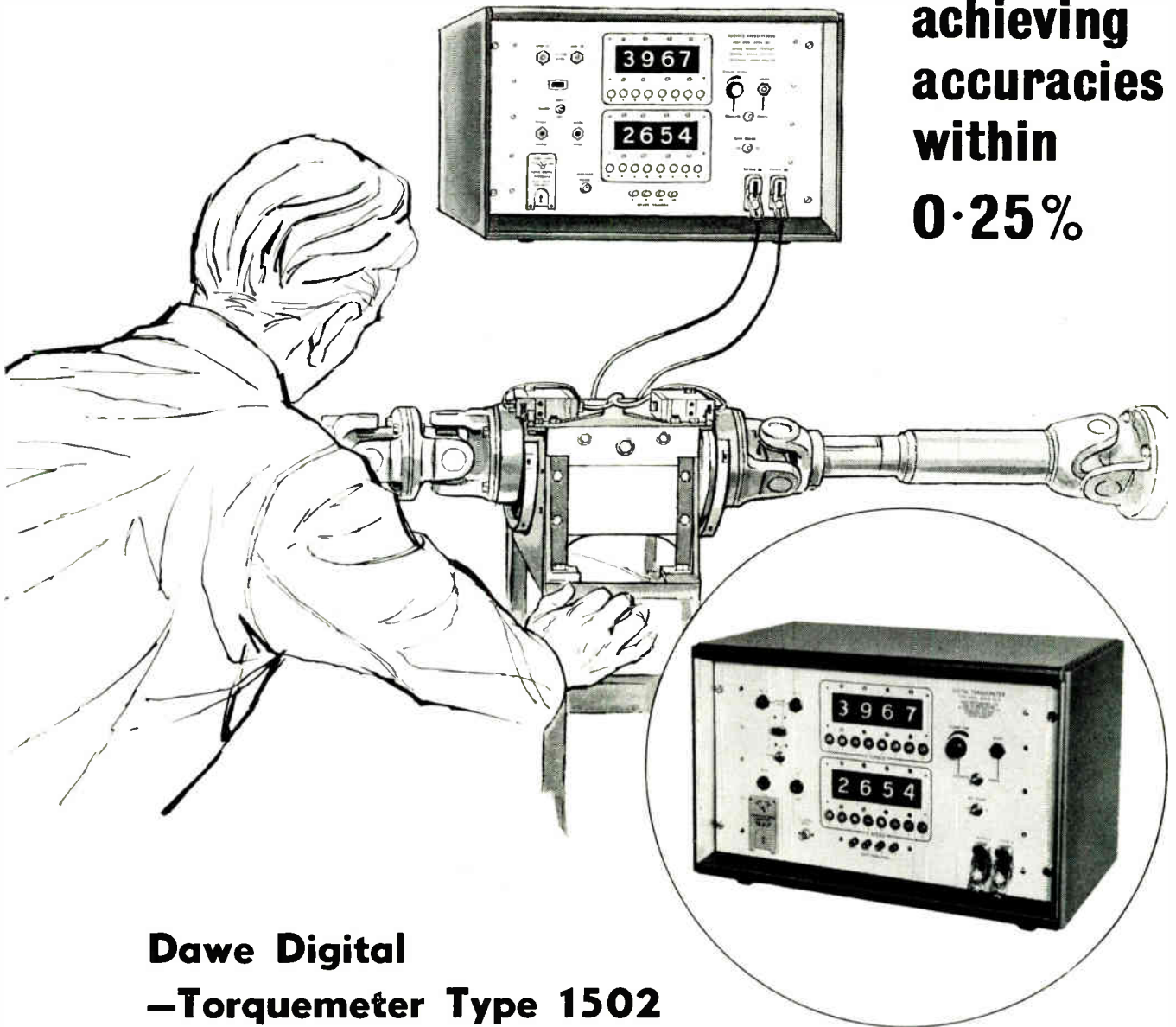

Dawe Digital —Torquemeter Type 1502

A MARKED ADVANCE ON EXISTING EQUIPMENT—

It takes 20 readings per shaft revolution and displays the average (obtained electronically). Under high-torque, low-speed conditions, it has distinct advantages over costly and bulky swinging dynamometer equipment.

- * Fully transistorised
- * Displays two 4-figure readings
- * Very high accuracy and resolution—typically 0.25% for a 3° twist at 500 r.p.m.
- * Simultaneous readings of speed and torque
- * Errors through torsional vibrations minimised by averaging techniques

- * Unique torque setting facility
- * Two instruments may be synchronised to give simultaneous readings

Send for leaflet of this latest contribution by DAWE to measuring techniques in the marine, automotive and aeronautical industries

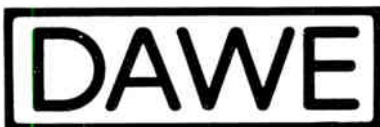

Full technical data from:—

DAWE INSTRUMENTS LTD., WESTERN AVE., LONDON, W.3 Tel: AC0rn 6751

A member of the *Simms* group of companies

If air displacement must be audible



you don't need AIRSCREW FANS

Aircrew pay particular attention to quiet vibrationless running

AIRSCREW-WEYROC LIMITED WEYBRIDGE SURREY TELEPHONE WEYBRIDGE 45599

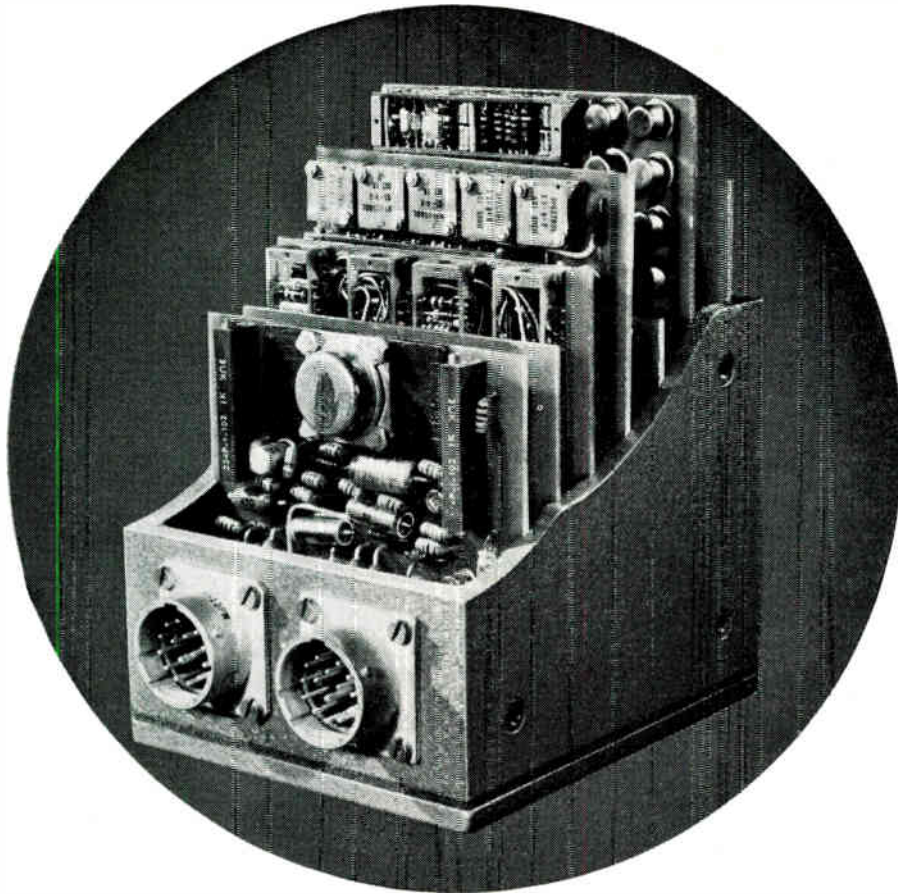

THE HEART OF A DATA HANDLING SYSTEM

The A/D Converter (type IL 6170/2) has been proved under operating conditions—in aerospace applications—as severe as any it will be expected to meet in industry.

High performance and long-term reliability are therefore assured when it is used for less demanding applications such as data logging, computer and general scientific systems.

Fast conversion rates make the A/D Converter especially suitable for computer and high-speed data acquisition work; its sealed unit and rugged construction for industrial use e.g. in steelworks and process control.

- * fast conversion rate
- * rugged sealed unit
- * increased production costs of the past two years have been absorbed: price unchanged at £795 ex. works
- * excellent delivery time: small quantities off the shelf
- * demonstrations arranged in customer's works

Input	Analogue range 0 to -6v d.c. Centre zero available on request Impedance 10 k.ohms Read Pulse A pulse going from earth to a positive level
Conversion	Minimum conversion time 140 micro-secs Maximum conversion rate 7000 words/sec Resolution 1 part in 1024 Accuracy $\pm 0.1\%$ full scale $\pm \frac{1}{2}$ least significant digit
Output	Pure binary 10 bit parallel words, stored until succeeding read command Digital representation '0' by 0 volts '1' by +10 volts Impedance 5 k ohms for a logical '1' 1 k ohms for '0' Internal 100 Kc/s clock available for synchronising
Supplies	-12 v ± 0.25 v at 170 mA +12 v ± 0.25 v at 300 mA
Temperature range	-20°C to +55°C Full accuracy over range 0°C to 40°C
Size/weight	4 x 3½ x 3½ ins. approx. 2½ lbs.

BRITISH AIRCRAFT CORPORATION

GW DIVISION
BRISTOL WORKS FILTON BRISTOL
Telephone: 693831

IPC2

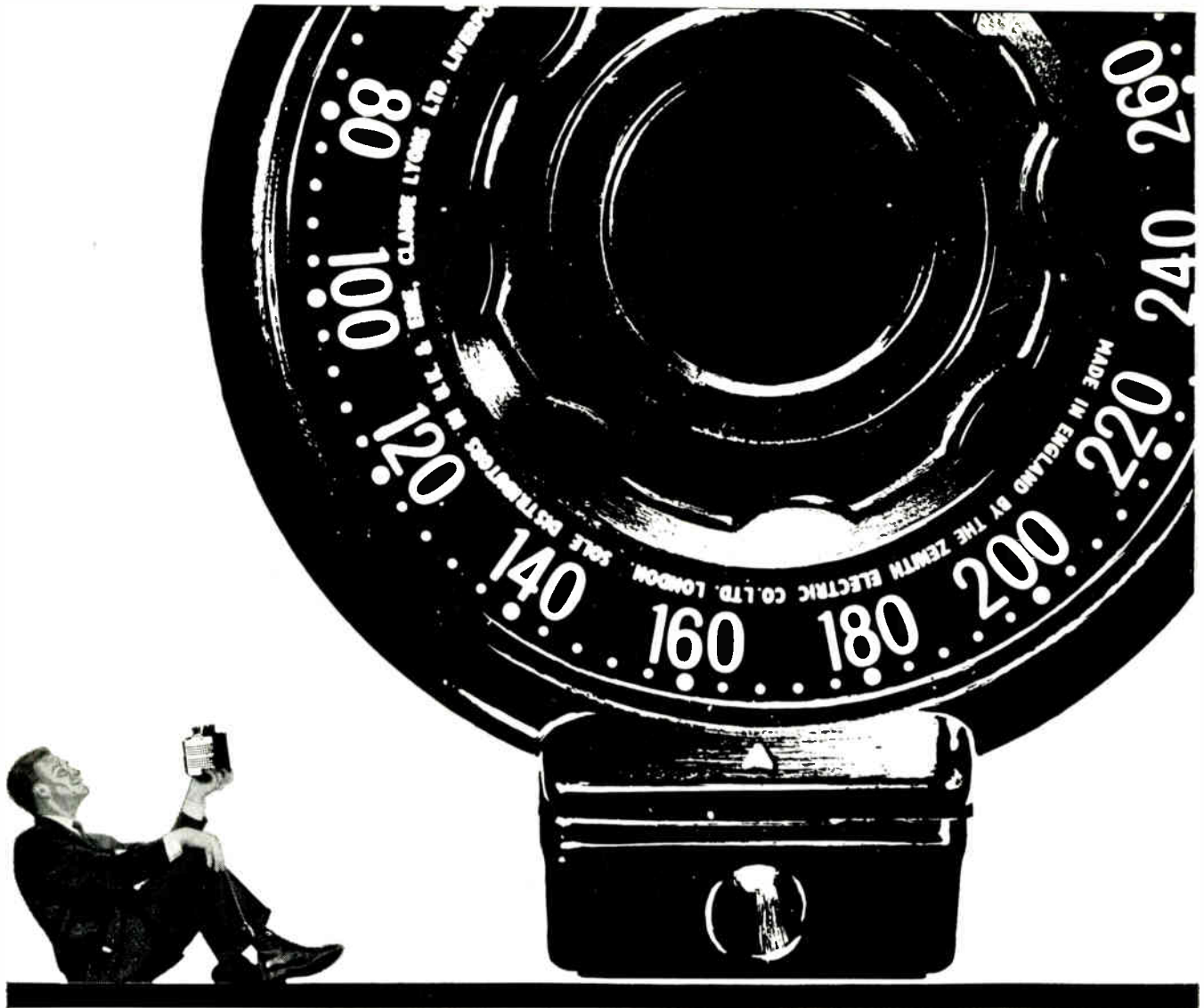

THE VARIAC* variable transformer is the most useful and versatile device ever developed for the control of a.c. voltage, or of current, power, heat, light, speed. It provides smooth continuous adjustment of output voltage from zero to line voltage and above, either hand-operated or motor-driven.

Only Variac has Duratrak*—a patented track surface giving longer life, increased overload and surge capacity and maximum economy in maintenance.

There are over 600 Variac models and assemblies to suit virtually every possible requirement, ranging from small units for laboratory or instrument use to large ganged assemblies for high power 3-phase operation. The range includes low-voltage, high-frequency, dual-output and narrow-range types, open, covered, portable, metalclad and oil-immersed constructions, plus many special models. This is the largest range of variable transformers available today.

The technical superiority and dependability of Variac are the result of over 30 years of development and refinement since the introduction of the first Variac models—the *original* variable transformers.

*'Variac' and 'Duratrak' are registered trade marks

Variac^{REGD}

variable transformers

for infinitely variable voltage control

Variacs are made in England by the Zenith Electric Co. Ltd. London, and exclusively distributed in the U.K. Eire and British Colonies by Claude Lyons Ltd.

Write for comprehensive catalogue to Publicity Department, Hoddesdon

CLAUDE LYONS LTD

Valley Works, Hoddesdon, Herts Hoddesdon 4541 Telex 22724
76 Old Hall Street, Liverpool 3 MARitime 1761 Telex 62181

CL47/408

WHAT'S THE NEW DELANCO M.F. TUBE GOT THAT OTHERS HAVEN'T?

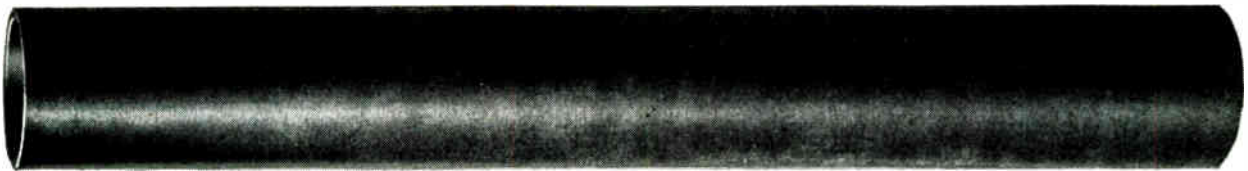

(EVERYTHING!)

Developed by our Technical Staff, M.F. (Melamine Impregnated Fibre) was designed to produce a tube with outstandingly improved electrical properties and high non-arcing properties.

The list of properties achieved by the material are compared opposite with similar properties listed by BSS.934 which cover this field.

Average Values obtained on 'Delanco' Impregnated Vulcanized Fibre Tube.

Values as laid down in BSS.934

Water Absorption	(2-3)%	(20-55)%
Surface Breakdown <i>without</i> pre-drying	18 K.V.	10 K.V. (dry)
Electric strength <i>without</i> pre-drying	9 K.V.	5 K.V. (dry)
Cohesion (BSS.1314) between layers.		
A proof list value of 78 lbs., withstood 250 lbs. easily.		
Density	1.35	1.35
Machineability	Excellent	

ANGLO-AMERICAN VULCANIZED FIBRE CO. LTD • CAYTON WORKS • BATH STREET • LONDON EC1 • CLE 8484

M-O V REED CAPSULES FOR ENVIRONMENTAL VERSATILITY

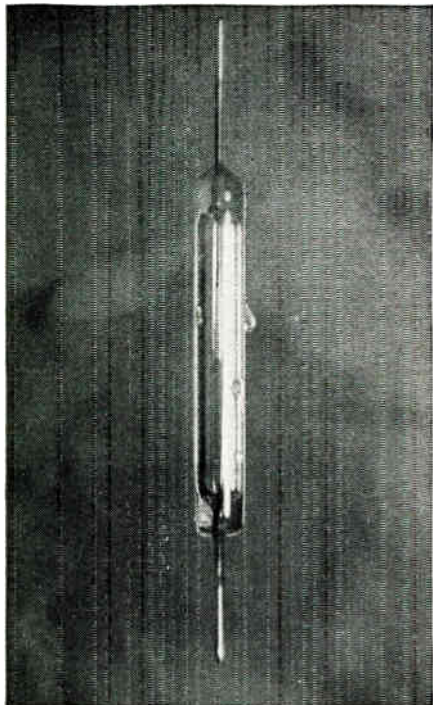

HUMIDITY

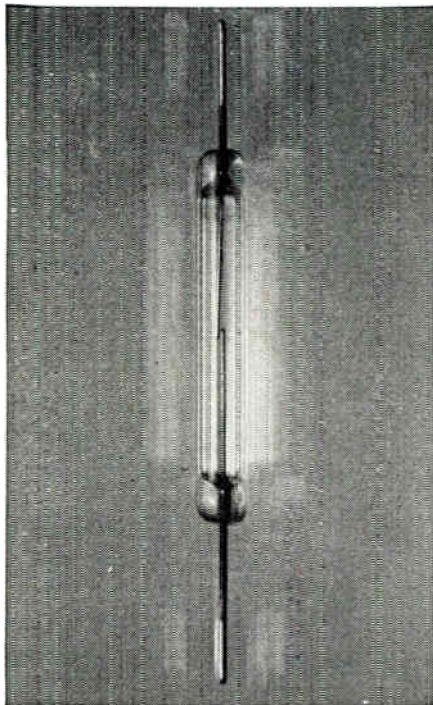

VIBRATION



DUST

The recently introduced RCI Reed Capsule for fast low-level switching has a multitude of applications in the communications and electronics industries. Its hermetic sealing makes it ideal for use in industrial atmospheres, where humidity,

dirt and corrosion quickly affect other kinds of switch. Its high resistance to shock and vibration widens the range of applications to all kinds of equipment that call for rugged components. M-O V Reed Capsules are to B.P.O. specifications.

To start you thinking on uses for these Capsules, here are some applications:

- Telephone exchanges
- Communication networks
- Data links
- Computer controlled machine tools
- Automatic switches on rotating equipment
- Automatic traffic control systems
- Switching

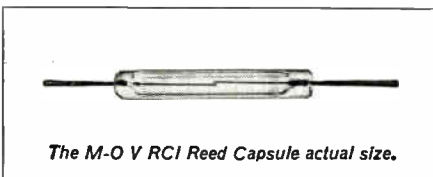

The M-O V RCI Reed Capsule actual size.

in industrial atmospheres Exhibition models and displays Multi-contact switches Rev. counters.

If you are currently specifying other kinds of fast low-level switch, perhaps you could benefit from changing over to Reeds. So why not call us in now? We would welcome the opportunity of helping you.

Maximum overall length of Capsule.....	46.1 mm
Maximum switched voltage, resistive load.....	50 V a.c. or d.c.
Maximum switched current, resistive load.....	100 mA a.c. or d.c.
Maximum current through closed contact.....	1 A a.c. or d.c.
Capacitance.....	less than 0.2 pF
Operating time (including bounce).....	less than 2 milli secs.

Release time.....	less than 0.5 milli secs.
Contact resistance.....	less than 100 milli ohms.
Field strength to operate switch.....	73 gauss
Life expectancy when operated by a solenoid.....	10 ⁷ -10 ⁸ operations
Coil to operate switch.....	58 A turns

Our technical information centre is ready to help with your application problems.



Write for full data sheets on these or other M-O V products, or telephone RIVerside 3431. Telex 23435.

THE M-O VALVE CO LTD
BROOK GREEN WORKS • HAMMERSMITH • LONDON W6 • RIVERSIDE 3431



electrosil contribution to **VC10** reliability

175,000,000 RESISTOR HOURS WITHOUT FAILURE!

Electrosil TR glass-tin-oxide resistors of which about 50,000 are used in the various electronic equipments of the VC10, have now completed 175 x 10⁶ hours without a single failure. A 60% confidence failure rate of 0.0005% per 1000 hours. In the words of BOAC—"easily the most reliable component in these equipments".

Remember, Electrosil resistors have full Qualification Approval, and only Electrosil TR resistors give you Triple Rating. Approval to DEF 5115 Pattern RFG5 fully supports this. Over 50 million resistors produced by Electrosil to this standard are your guarantee of service. Send today for full details.

equipment reliability begins with

Electrosil



P.O. BOX 37 · PALLION · SUNDERLAND · CO. DURHAM
Telephone: Sunderland 71480 Telex 53273

For further information circle 226 on Service Card
 Both X and Y units plug in, enabling the user to make a wide variety of measurements hitherto only possible with expensive instruments. To date, 2Y+2X operational plug-in amplifiers are available.

THE CD 1400 'SCOPE SYSTEM VERSATILE 5" PORTABLE DOUBLE BEAM

The CD 1400 from Solartron is a truly flexible low cost oscilloscope system — backed by the best in modern production techniques. The X and Y plug-in units currently available allow the instrument to be used for the widest range of applications and other plug-ins now under development will extend the system even further. A 5" double gun CRT operating at 4 kV provides bright, high resolution displays at all sweep speeds. Proprietary oscilloscope cameras can be attached, and trolleys are available for maximum mobility.

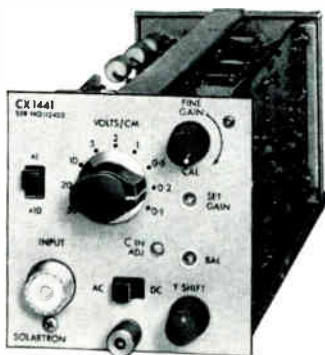

* CX 1441 DC - 15 Mc/s approximately, 100mV/cm, general purpose amplifier suitable for pulse work. Additional $\times 10$ provides 10mV/cm from DC - 750 Kc/s.

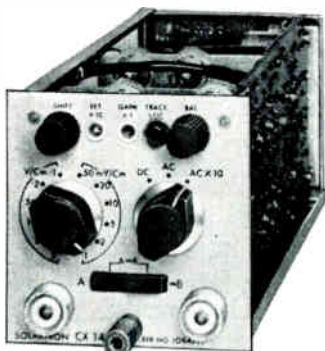

* CX 1442 1 mV/cm DC differential amplifier with a common mode rejection of 60dB. For use with transducers and servo systems etc. An AC $\times 10$ position gives a sensitivity of 100 μ V/cm for low level noise investigation.

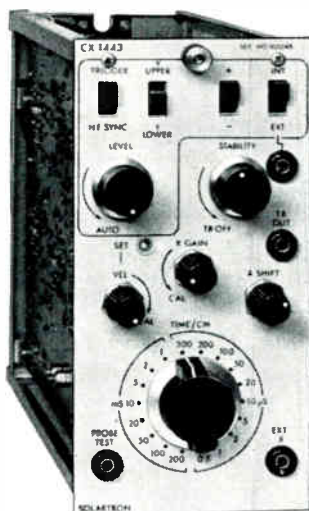

* CX 1443 Basic time-base unit. 18 ranges from 0.5 μ sec/cm - 0.5sec/cm. Suitable for use with all Y units. "Normal", "Auto" and "HF sync".

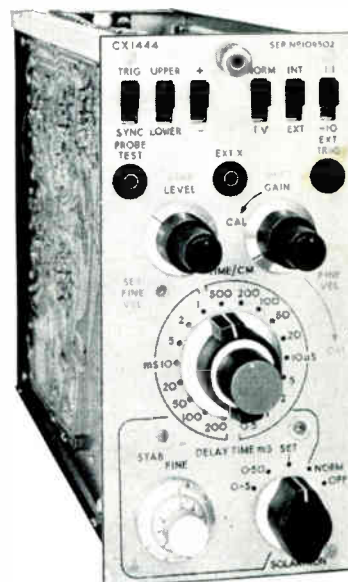

* CX 1444 Time base and sweep delay generator. Performance similar to CX 1443. Delays up to 100m/sec. Suitable for digital computer and television waveform investigation.

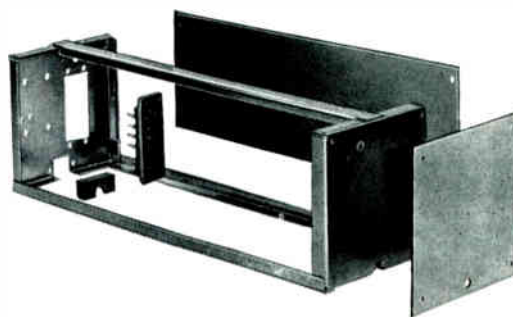

CX 1445-6 Blank X and Y plug-in units available enabling the customer to construct his own units to suit specialized applications.

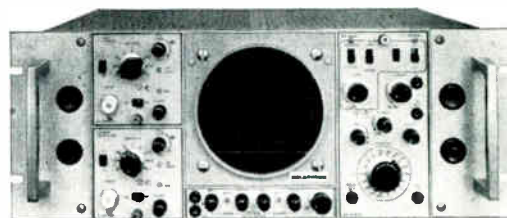

* CX 1447 A rack-mounting case is available as an alternative for use in standard 19" racks. Side panel design permits simple signal connections from rear of instrument.

* Measurement Accuracy 5%

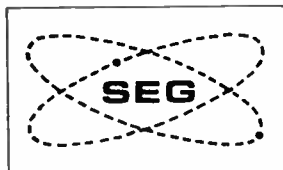

THE SOLARTRON ELECTRONIC GROUP LIMITED
 Farnborough, Hants, England. Telephone: Farnborough (Hants) 44433
 Telex: 85245 Solartron Fnbro. Cables: Solartron Farnborough.
 A MEMBER OF THE SCHLUMBERGER GROUP



**SO MUCH
MORE BEHIND
A SOLARTRON
'SCOPE**

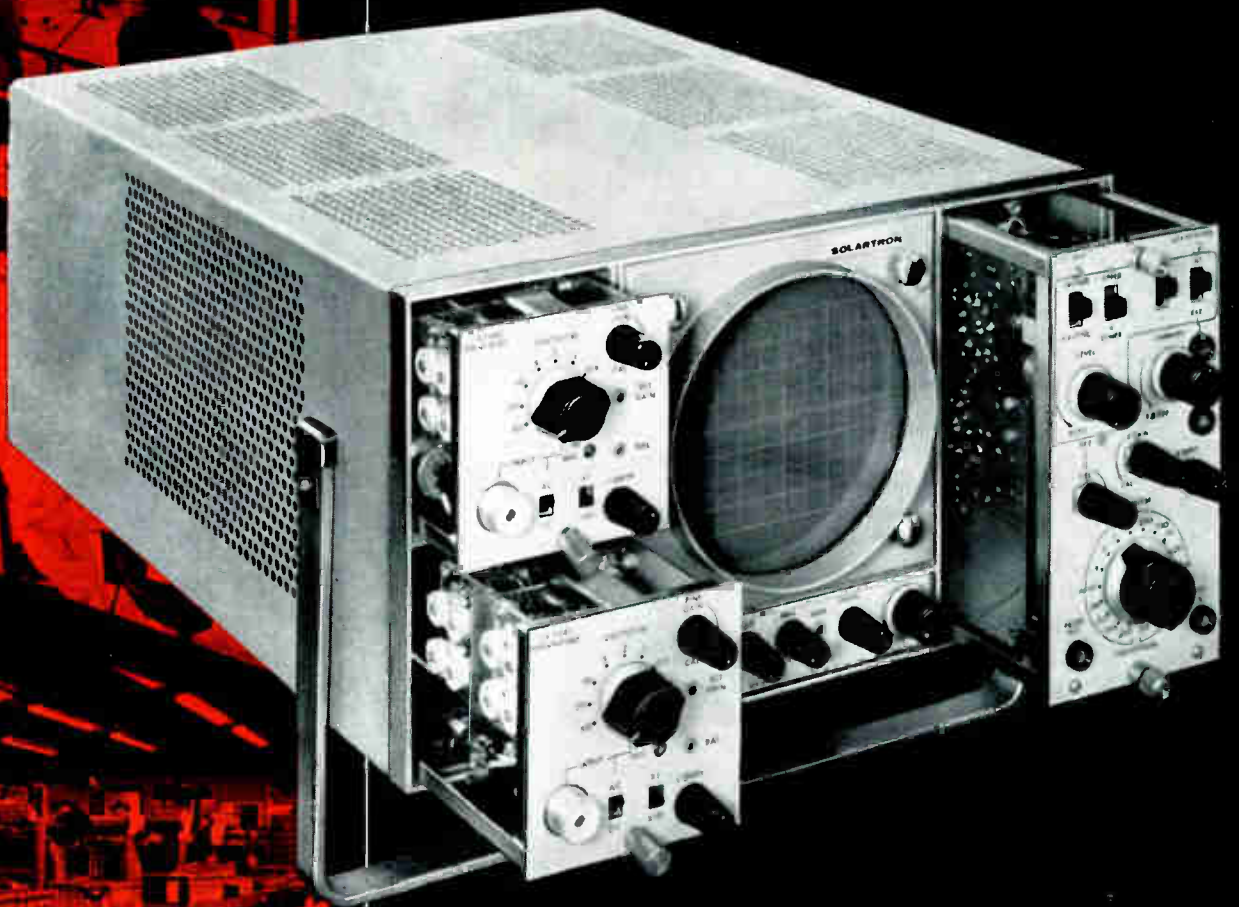

SOLARTRON
For Data Systems · Transducers · Computers
Military Systems · Electronic Instrumentation

RAPID AND SIMPLE CHEMICAL ANALYSIS

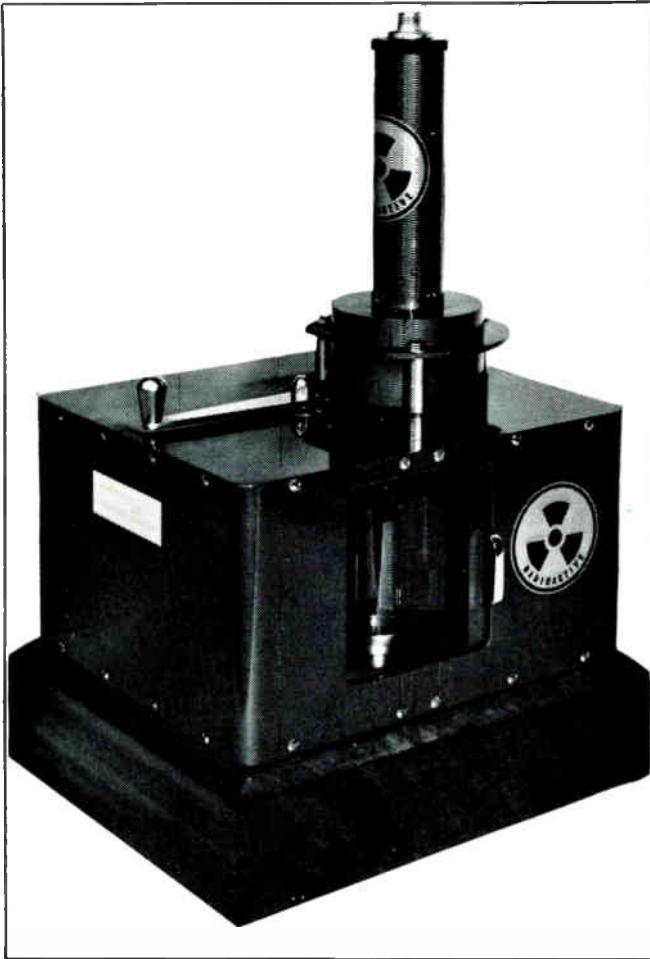

WITH THE TYPE 147L LABORATORY ANALYSER

Specify 147L Mk.1 for the determination of any high atomic number element in a low atomic number carrier—for Sulphur in oil—for TEL in petrol—for Chlorine in water—for Clay in paper. This laboratory analyser, which uses a radioactive source (promethium 147 or tritium bremsstrahlung), a sample cell and a Geiger-Müller radiation detector, is in production and has had proven success throughout the oil industry in the rapid and simple determination of the sulphur and tetra ethyl lead content of petroleum products. It is now being adopted for numerous other measurements which basically involve a relatively high atomic number element in a low atomic number carrier.

For further particulars please write to:

SAUNDERS-ROE & NUCLEAR ENTERPRISES LIMITED
 Owned by Westland Aircraft Limited and Nuclear Enterprises (G.B.) Limited
 North Hyde Road Hayes Middlesex. Telephone Hayes 3800

- Please send full details
- Please arrange for your technical consultant to call

Name.....
 Address..... IE/1



now add **GOSSEN**
 control equipment
 to their range

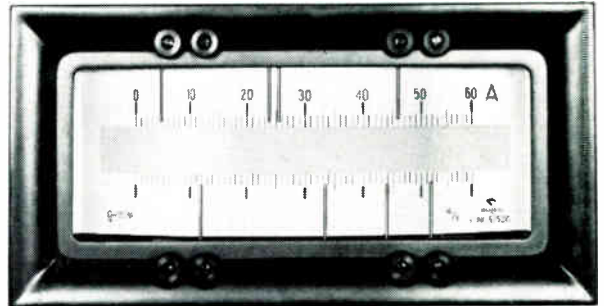

PANTAM light spot indicating instrument with photoelectric alarm contacts.

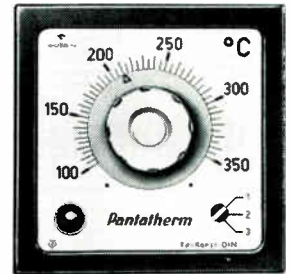

Left: **PANTAM** pointer indicator with photoelectric contacts.
 Right: **PANTATHERM** electronic temperature controller.

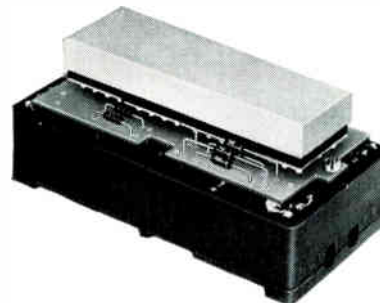

PANTACOMP
 compact solid state
 D.C. amplifiers.

With modern compact styling and economic prices, these instruments will provide close control for your process.

Write for details to:—



Evershed & Vignoles Limited
 A member of the Kent group of companies

ACTON LANE WORKS, CHISWICK, LONDON, W.4
 Telephone: CHiswick 3670 EV13

POTENTIOMETER PROBLEM?

THEN COLVERN IS THE ANSWER!

Only one of our wirewound potentiometers is illustrated, but with over 50 different types in constant production there is one to suit most applications. Send us details of your requirements.

SEE YOUR ELECTRONIC ENGINEERING
INDEX LIBRARY, FOR FULL TECHNICAL
DATA

COLVERN
LIMITED

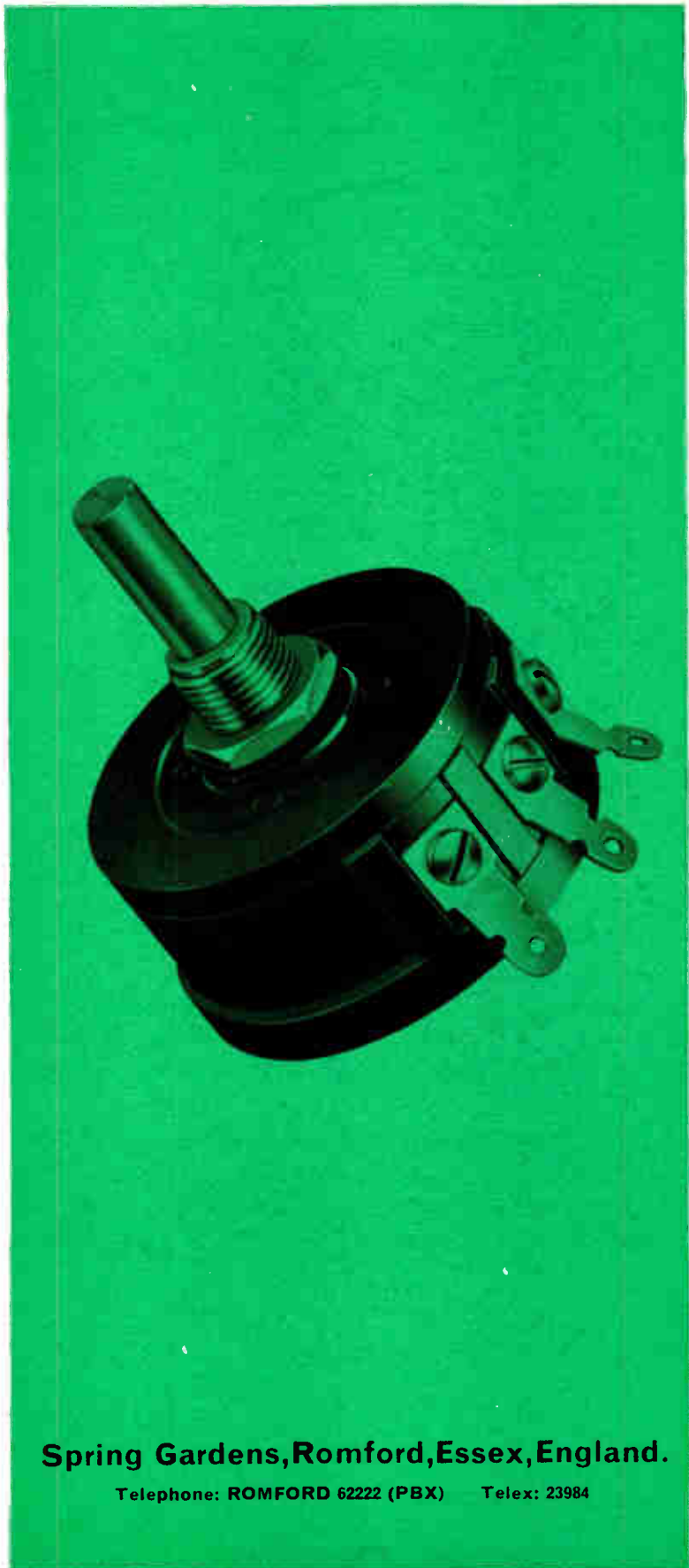

Spring Gardens, Romford, Essex, England.

Telephone: ROMFORD 62222 (PBX) Telex: 23984

Sensitivity $40\mu\text{V}(1^\circ\text{C})$

Multi-Million Operational life

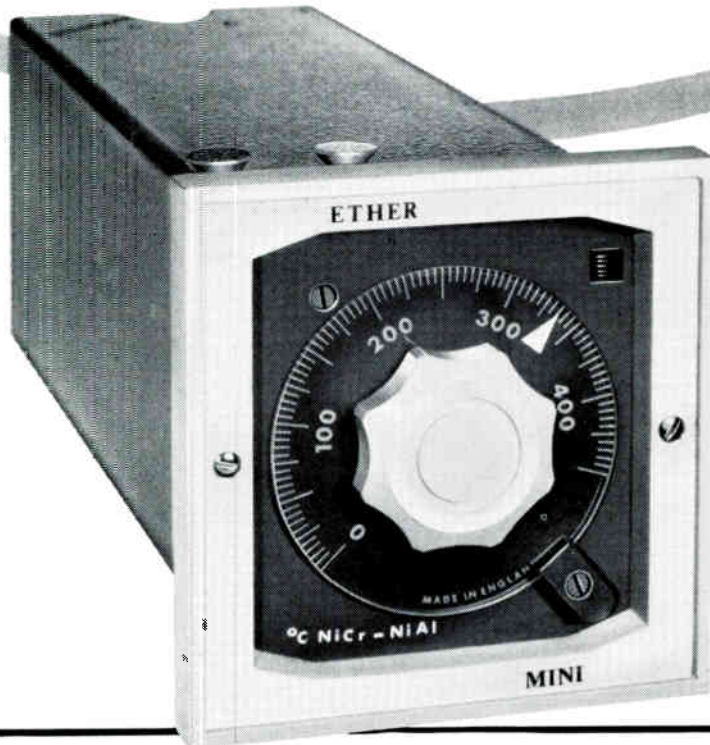

ETHER

TRANSISTORISED TEMPERATURE REGULATOR

MINI TYPE 17-90

Accurate, Reliable Temperature Control up to 2000°C

The difference signal between the output of a thermocouple and an internal reference voltage is fed to a transistorised amplifier to operate a relay. The relay will operate on an input signal differential of less than 40 microvolts, equivalent to less than 1°C , with base metal thermocouples, and less than 2°C with precious metal types. Provision is made for increasing this differential by a factor of 10 where very close control is not required.

The relay has a life expectancy of several million operations at maximum load rating. Set point is adjusted by a precision potentiometer, and read by the position of an illuminated cursor on a calibrated scale. A signal lamp is provided to show the control condition. Standard ranges from £27-10-0.

ETHER
LIMITED

Send for full details to:—

CAXTON WAY, STEVENAGE, HERTFORDSHIRE

Telephone: Stevenage 3040-55

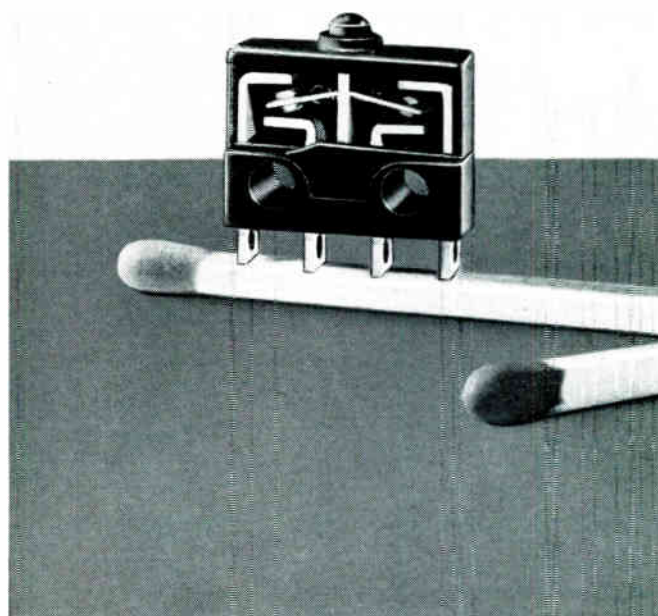

Brilliant... and ultra-small microswitches

New illuminated pushbutton
and sub-subminiature switches
in the Plessey/Licon range

LIGHTED PUSHBUTTON SWITCHES

Illustrated above is the Plessey/Licon Type '44' Sealed, 4 bulb, Illuminated Pushbutton Switch. This is one of the new Plessey/Licon Switches combining indicating and manual switching functions in a single compact sealed unit. The Pushbutton provides colour, a legend-coding, and actuates single pole or two circuit microswitches. Standard models utilise one or two-pole switch units, but multipole versions can be made to special order. Momentary or maintained contact, solenoid-held and indicator-only are all standard. A wide variety of lens cap combinations, such as horizontal optical or quad split, solid colour, or projected colours is available; the Types 04 and 44 (sealed) provide as many as four separate indicators in one compact pushbutton.

SUB-SUBMINIATURE SWITCHES

With unrivalled vibration and shock resistance and mechanical life in excess of 10 million operations, the new Plessey/Licon Type 18 sub-subminiature microswitch is designed for use in aircraft, missiles and other applications where space is valuable and reliability essential. A two-circuit switch, the Type 18 has the high contact-rating of 8 amps at 250 V a.c. or 30 V d.c. Overall dimensions are 0.51" (13 mm) long x 0.2" (5 mm) wide x 0.36" (9mm) high (excluding tags and plunger). The narrow width permits mounting a number of switches in a small space.

PLESSEY/LICON microswitches—with more than 10,000 to choose from—cover the whole spectrum of precision-switch requirements. Write today for complete details of Type 18 Sub-subminiatures, Types 01, 04 and 44 illuminated pushbuttons, or other versions of the most robust, reliable and versatile microswitches you can buy.

The Plessey Company Limited
Electromechanical Division
New Lane, Havant, Hants.
Telephone: Havant 6344 Telex: 86296

PLESSEY
Components Group



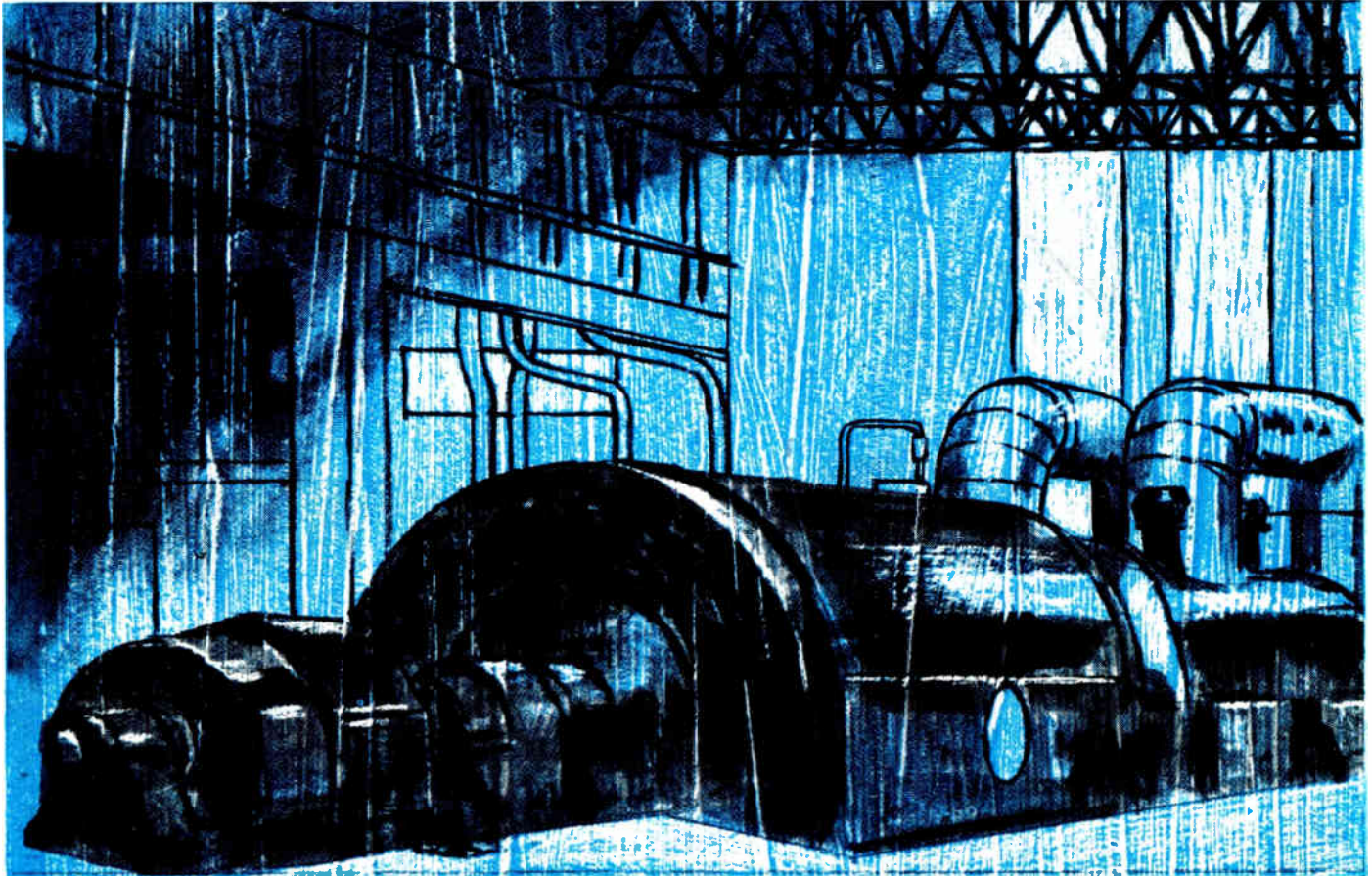

When it's a question of **SEMICONDUCTORS**

 **WESTINGHOUSE** 
IS THE POWER BEHIND THEM!

WESTINGHOUSE not only make very good semiconductors—they also make the widest range. That's why such a variety of industries use them. The Westinghouse range includes devices for the smallest electronic application to the largest industrial plant.

A special compression bonding technique in manufacture eliminates thermal fatigue to give improved performance and greater reliability. Trouble-free, instant in action—that's Westinghouse Semiconductors. And they're backed by over 40 years experience in rectifier design and development. What more could you ask?

Write for a copy of our abridged SEMICONDUCTOR brochure showing the Westinghouse range of Silicon Diodes, Thyristors and Rectifier Assemblies.

Dept. IE/3/66 **WESTINGHOUSE BRAKE AND SIGNAL COMPANY LIMITED**
82, York Way, King's Cross, London N.1
Terminus 6432 Telex 2-3225

Stand No. G10
Electrical Engineers (ASEE) Exhibition
Earls Court
23-30 March 1966

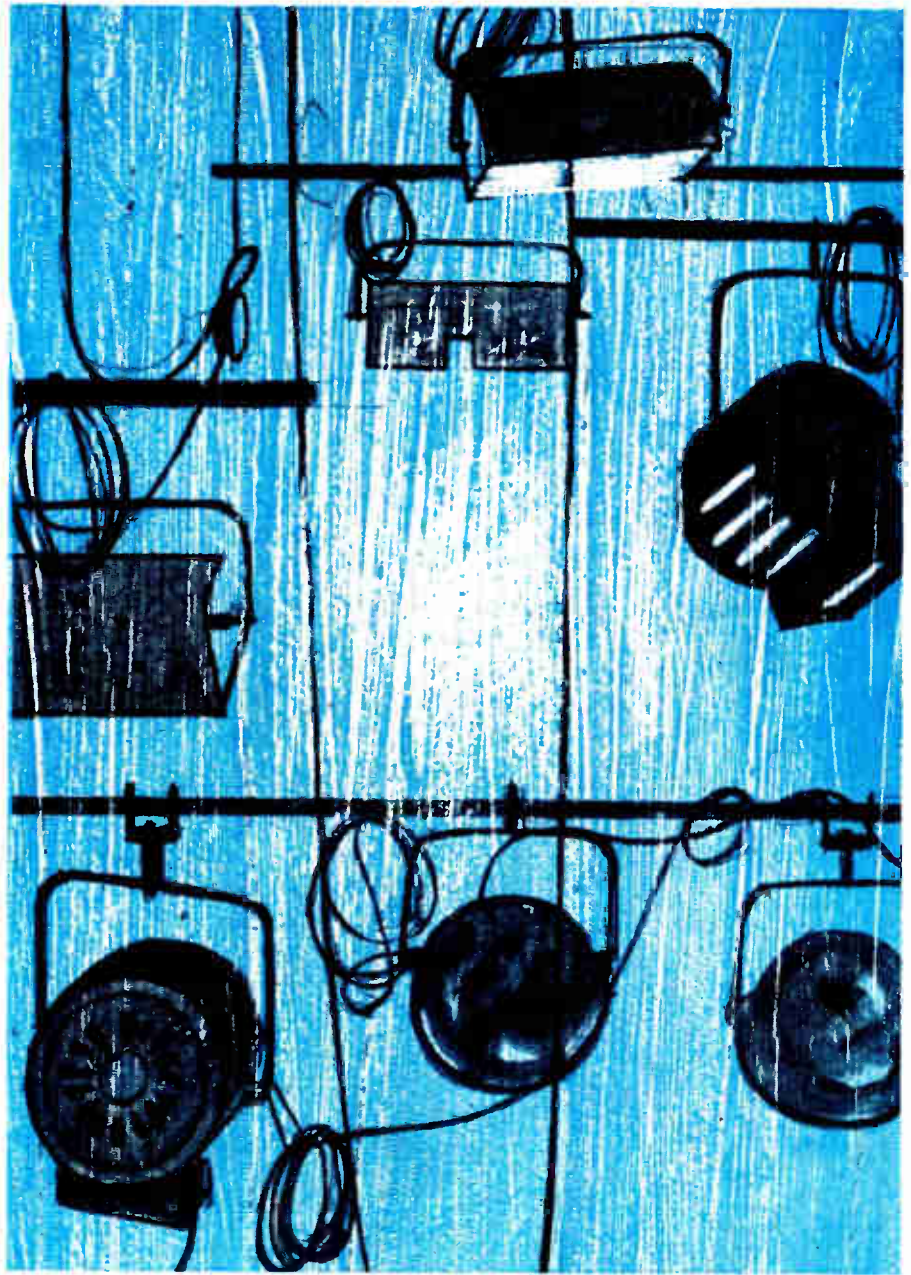

* **The Westinghouse brochure** gives abridged information about: Silicon Diodes ranging from 200mA to 300A at 100 to 1800V and Thyristors from 500mA to 250A, 25V to 1200V according to type.

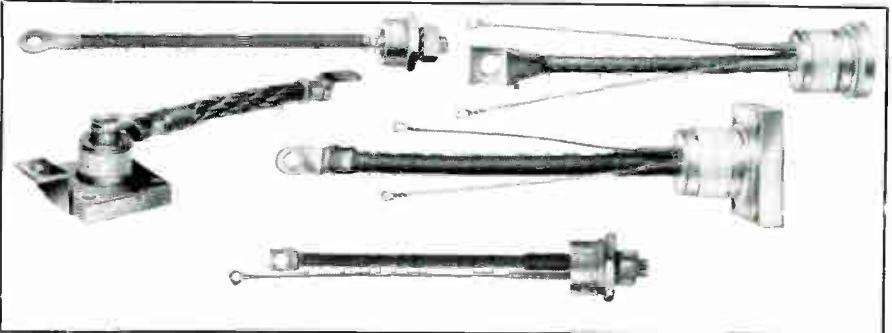

Mullard capacitors – 14 quality ranges



Miniature Foil
C280 Series

Metallised polyester foil construction designed for printed circuit applications. Working Voltage (d.c.) 250V
Capacitance Range 0.01 to 0.22 μ F
Capacitance Tolerance $\pm 20\%$
Temperature Range -45° to $+85^{\circ}$ C

Metallised Polyester
C281 Series

Flat rectangular shape affords maximum component density. Post Office approved type. Working Voltages (d.c.) 250V and 400V
Capacitance Ranges 0.01 to 2.2 μ F and 0.01 to 0.47 μ F
Capacitance Tolerance $\pm 10\%$
Temperature Range -55 to $+85$ C

Tubular Polyester
C296 Series

Interleaved layers of aluminium and polyester foil wound in extended foil configuration. Working Voltages (d.c.) 160V and 400V
Capacitance Ranges 0.01 to 1 μ F and 0.001 to 0.47 μ F
Capacitance Tolerance $\pm 10\%$
Temperature Range -40° to $+85^{\circ}$ C

Miniature Electrolytic
C426 Series

A range of general purpose aluminium capacitors of conventional construction. Working Voltages (d.c.) 2.5V to 64V
Capacitance Range 0.64 to 500 μ F
Capacitance Tolerance -10 to $+50\%$
Temperature Range -40° to $+70^{\circ}$ C

Small Electrolytic
C437 Series

An extension of the C426 Series with large capacitance values in a small physical size. Working Voltages (d.c.) 2.5V to 64V
Capacitance Range 64 to 4,000 μ F
Capacitance Tolerance -10 to $+50\%$
Temperature Range -40 to $+70^{\circ}$ C

Large Electrolytic
C431 Series

A single-ended range of high value electrolytic capacitors of conventional construction. Working Voltages (d.c.) 10V to 64V
Capacitance Range 320 to 16,000 μ F
Capacitance Tolerance -10 to $+50\%$
Temperature Range -40° to $+70^{\circ}$ C

Miniature Long Life Electrolytic
C428 Series

Specially developed for professional applications where long service life and high reliability are essential. Working Voltages (d.c.) 4V to 64V
Capacitance Range 2.5 to 320 μ F
Capacitance Tolerance -10 to $+50\%$
Temperature Range -40° to $+70$ C

Mullard

Industrial Markets Division
Mullard Limited
Mullard House
Torrington Place London WC1 L ANgham 6633

to meet the needs of industrial users

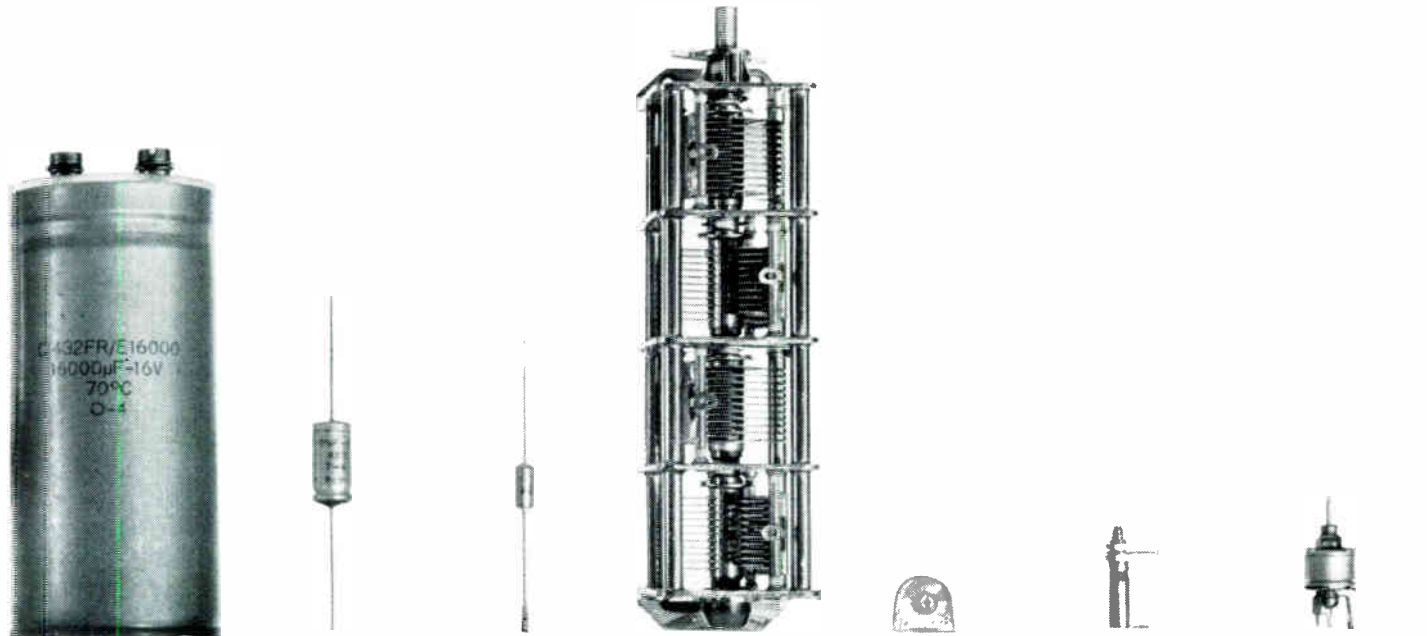

Large Long Life Electrolytic
C432 Series

Designed for use in professional equipment power supply units where service life and reliability are of the utmost importance. Working Voltages (d.c.) 6.4V to 100V
Capacitance Range 900 to 31,500 μ F
Capacitance Tolerance -10 to +50%
Temperature Range -40° to +70°C

Solid Aluminium Electrolytic
C415 Series

For use in extreme environmental conditions this unique range employs a semiconductor material in place of the conventional liquid electrolyte. Working Voltages (d.c.) 4V to 40V
Capacitance Range 2 to 100 μ F
Capacitance Tolerance -10 to +50%
Temperature Range -80 to +85°C

Solid Tantalum Electrolytic
C421 Series

Offer advantages over wet aluminium types in terms of size and operation under severe environmental conditions. Working Voltages (d.c.) 6V to 35V
Capacitance Range 0.33 to 330 μ F
Capacitance Tolerance \pm 20%
Temperature Range -55 to +65°C

Precision Tuning
C001|C002 Series

The two series include single, double, triple and quadruple gangs with capacitances ranging from 16 pF (single) to 4 x 640 pF. They are available with an insulated or non-insulated rotor and with a linear or logarithmic grading.

Foil Dielectric Trimmers
C010 Series

Type C010AA/60E for printed circuit mounting has a variable capacitance of 60 pF. A professional version is also available having a closely controlled temperature coefficient and a capacitance swing of 45 pF.

Tubular Ceramic Trimmers
C004 Series

For general industrial applications, an invar rotor is guided by a phosphor-bronze spring within the internally ground ceramic tube. For use in more arduous environmental conditions the rotor is guided by a cut thread and a locking device is incorporated. Capacitance swings of 3, 6, 12 and 18 pF are available.

Concentric Air-dielectric Trimmers E Series

A series of 9 trimmers with capacitance swings of 2 to 8, 3 to 30 and 4 to 60 pF and voltage ratings of 300V at 760 mmHg, and 100V at 70 mmHg. Six of the series are fitted with a PTFE friction collar which makes further locking unnecessary.



JUST PUBLISHED — A new booklet describing the full range of Mullard industrial capacitors is now ready. Send for your copy :-

Name _____

Position _____

Company _____

Address _____



IN RESEARCH AND INDUSTRY

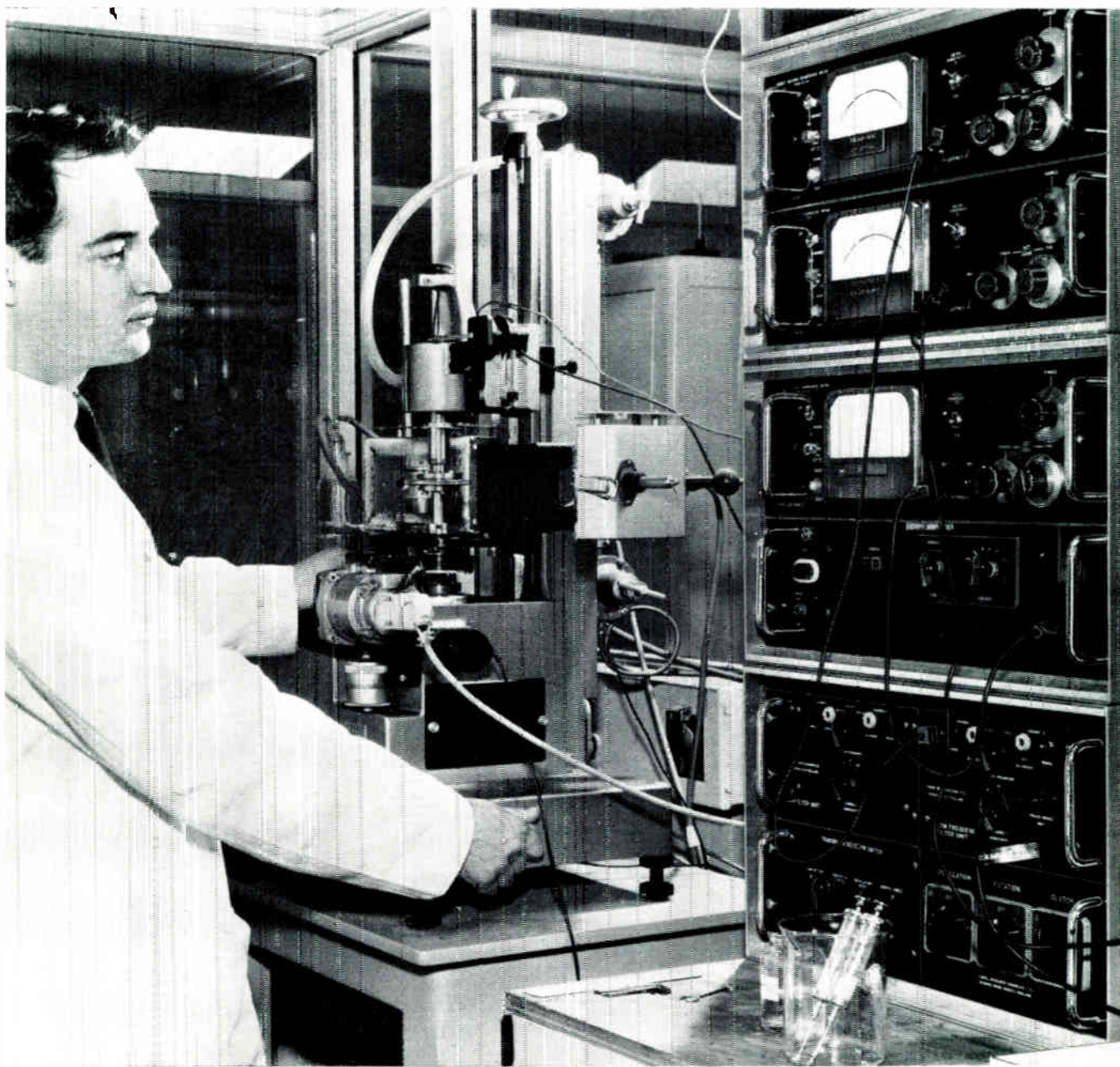

B.P.A. TRANSDUCER METERS in use in conjunction with the 'Weissenberg' Rheogoniometer—in the Research and Development Laboratories of the International Synthetic Rubber Company Limited.

"After exhaustive testing, we standardised on BPA electronic displacement measuring equipment for our Weissenberg Rheogoniometers, because of their range and sensitivity"

—Sangamo Controls Limited.

Equipment for measuring or recording force, load, displacement or fluid pressure.



BOULTON PAUL AIRCRAFT LIMITED · ELECTRONICS DIVISION · WOLVERHAMPTON

Member of the DOWTY Group

between

5pF and 250,000pF

your choice is easy...

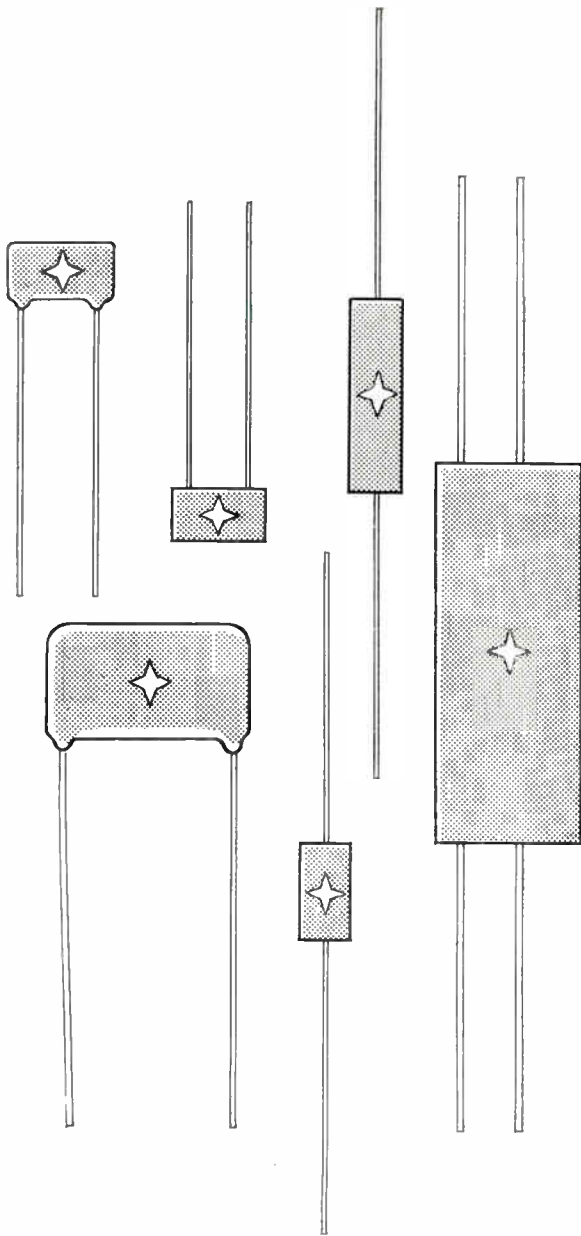

SILVER STAR CAPACITORS

cover all your needs

The standard range of Silver Star® capacitors contains a wide variety of sizes in encapsulated or dipped finishes. Your needs are covered, for any nominal capacitance value between 5 and 250,000 pF can be supplied—generally with a tolerance as close as $\pm 0.5\%$.

All Silver Star capacitors are of fired construction giving them unrivalled stability. A rigid system of process control throughout manufacture ensures that their outstanding electrical properties are consistently maintained.

In addition, every Silver Star capacitor is checked before we send it to you for four critical characteristics—capacitance, power factor, proof voltage and insulation resistance. Only components that meet the stringent Silver Star standards are supplied.



You can choose your requirements with these free data sheets. Just ask for them.

Johnson Matthey

JOHNSON, MATTHEY & CO., LIMITED
73-83 HATTON GARDEN, LONDON, E.C.1
Telephone: Holborn 6989 Telex: 21465

Vittoria Street, Birmingham, 1 Telephone: Central 8004
75-79 Eyre Street, Sheffield, 1 Telephone: 29212

GD 131

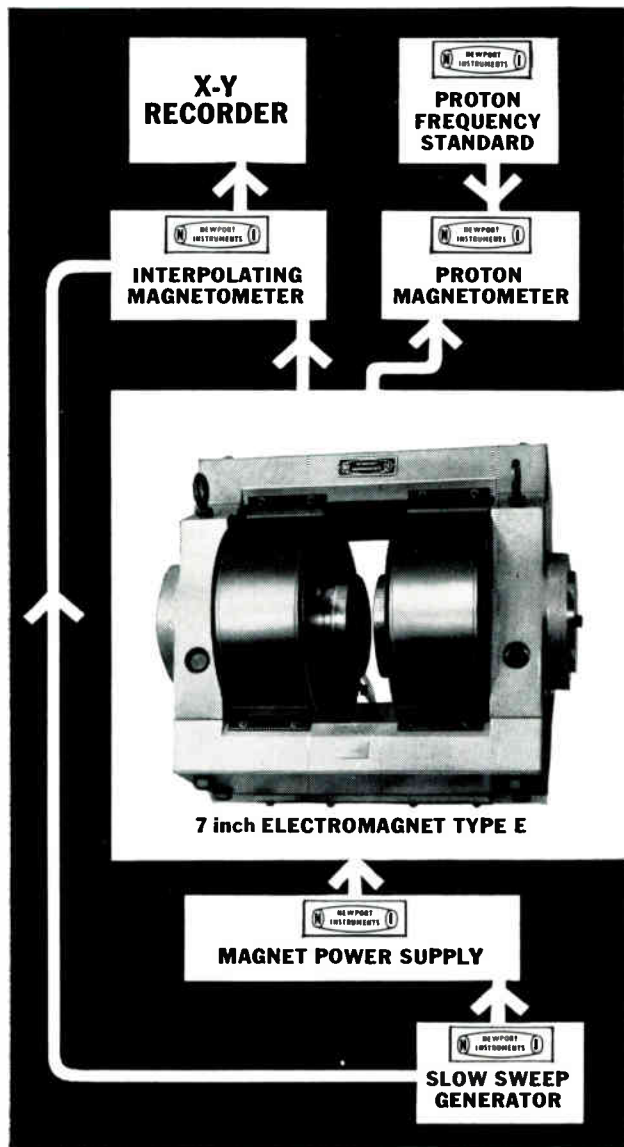

LEADERSHIP with a system

Within the wide range of NEWPORT electromagnet systems, we can offer magnets for every laboratory application. NEWPORT leadership in the field of electromagnet technology is 'leadership with a system'—with any of the special systems designed and built by NEWPORT.

We at NEWPORT offer a service to match our reputation as the best-known name in the field of electromagnets, magnet power supplies and magnetometers. Standard or custom-built, our magnets and magnet systems represent not only accuracy and dependability—but economy of price.

Let us send you a copy of the NEWPORT Catalogue—now.

Newport Instruments

LTD

Newport Pagnell, Bucks, England, Tel: Newport Pagnell 401

BERCOTROL[®]

A NEW ALL SOLID STATE SPEED REGULATOR AND STARTER



Bercotrol motor speed regulators for closed loop control

The smallest, most accurate, combined starter and speed regulator, allowing commutator motors of up to 5 h.p. to be direct on line started and controlled accurately over the speed range of up to 100:1, with no load to full load regulation better than 1% of base speed.

- * all solid state
- * no moving parts
- * facilities for remote control, dynamic braking and reversing
- * standard models for ½, 1½, 2, 3½, and 5 h.p.
- * simple to install
- * requires only nominal 200/250V 50 cycle A.C. supply.

Ask Mr. Radford to send you a list IED 103 OS and arrange a practical demonstration.



Industrial Electronics Division,
**THE BRITISH ELECTRIC
RESISTANCE CO. LTD.**
Queensway, Enfield, Middlesex.
Tel: HOWard 2411

See us at the A.S.E.E. Exhibition
23rd-30th March · STAND No. K.3

39B

SILICON PLANAR n-p-n TRANSISTORS ZT190 SERIES

GENERAL PURPOSE TRANSISTORS
COMBINING LOW COST AND VERSATILE
PERFORMANCE

ZT191 has Qualification Approval to Specification CV8615

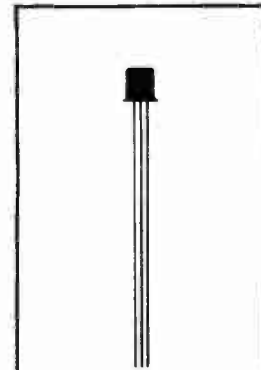

ACTUAL SIZE
BS3934
SO-12A/SB3-6B
JEDEC TO-18

FERRANTI

First into the Future

RATINGS AND CHARACTERISTICS	ZT190	ZT191	ZT192	ZT193	Unit	Test Conditions
Max. Collector-Base Voltage	20	20	40	40	V	
Max. Collector-Emitter Voltage	15	20	20	20	V	
Max. Dissipation	300	300	300	300	mW	at 25°C
Max. Collector-Base Leakage Current	200	50	50	50	nA	at 25°C V _{CB} = 20V I _B = 0
Max. Collector-Emitter Saturation Voltage	350	200	200	200	mV	I _C = 10mA
D.C. Current Gain	50-190	35 min	38-120	75-200		I _C = 10mA V _{CE} = 0-4V
Min. Transition Frequency	200	300	300	300	MHz	I _C = 10mA V _{CE} = 10V f = 100 MHz
Max. Storage Time	150	300	200	200	nS	I _C = 10mA I _{BE} = 10mA

Write now for full details to: FERRANTI LTD · GEM MILL · CHADDERTON · OLDHAM · LANCS. Telephone (061) MAIN 6661

FE272/2

THE **Bantam** TWO-WAY RADIOTELEPHONE

a Fully Transistorised Walkie-Talkie!



In the tradition of the outstanding Cambridge and Vanguard Radiotelephones, Pye have produced the Bantam, a brilliant transistorised Walkie-Talkie.

- Fully transistorised Transmitter and Receiver
- Long endurance with Rechargeable or Dry Batteries
- Crystal Filter selectivity
- Reliability and accessibility of components
- Very high performance Receiver
- Lightweight 4 lbs. (1.82 kg.)
- Frequency Band 25-174 Mc/s.
- Weatherproof
- Air Registration Board approved for light aircraft category III.
- Approved by G.P.O. to Spec. W6345.
- Intrinsically safe version available

PYE TELECOMMUNICATIONS LTD. CAMBRIDGE ENGLAND.

Tel: Teversham 3131
Telex No. 81166

BY APPOINTMENT TO
H.R.H. THE DUKE OF EDINBURGH



SUPPLIERS OF MOBILE
RADIOTELEPHONE EQUIPMENT



'CAMBRIDGE' transistor Mobile Radiotelephone

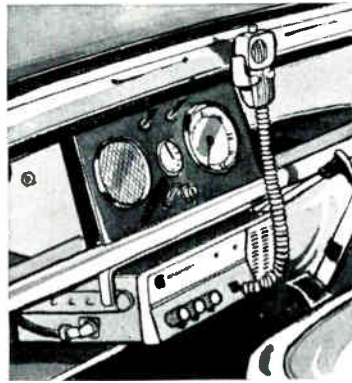

A new high standard in Mobile Radiotelephone design

- Fully transistorised receiver
- Printed circuit sub-assemblies
- Sealed I.F. block filters
- Dustproof and splashproof
- GPO approved and meeting American and European specifications
- 100 Milliamps receiver drain
- A.M. or F.M. versions
- 25 Kc/s or 50 Kc/s channelling
- Single or six channel

PYE TELECOMMUNICATIONS LIMITED

CAMBRIDGE • ENGLAND • TELEPHONE: TEVERSHAM (CAMBRIDGE) 3131 • TELEX No. 81166

For controlled delay ...

Use **ETHER**

Pneumatic time delay switches



These delay units comprise a push-button operating a snap-action switch via a self-contained pneumatic assembly. The delay time can be varied by adjustment of the air bleed.

- * Ex Stock Delivery
- * Low Cost
- * Reliable Operation
- * Variable Delay 0.2 secs—60 secs
- * Switching Capacity to 440 V. 3 A.
- * Standard mushroom head or full guard push-button
- * Solenoid types also available

For full technical specifications write to:

ETHER LTD., General Products Division
CAXTON WAY · STEVENAGE · HERTS.
Stevenage 3040-55



D.C. Motors

for electronic speed control

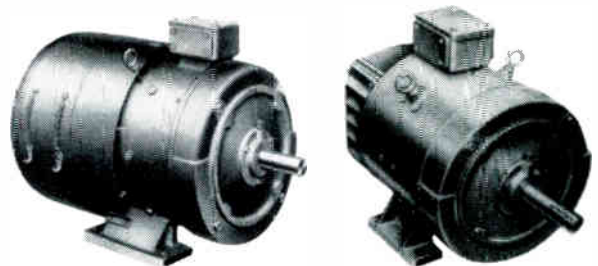





1/4—100 h.p.

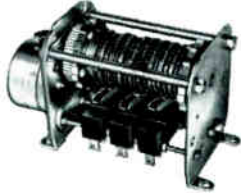

THE ELECTRICAL POWER ENGINEERING CO. (B'HAM) LTD.,
EPE WORKS 558, BROMFORD LANE BIRMINGHAM 8.

Telephone: STEchford 2261.

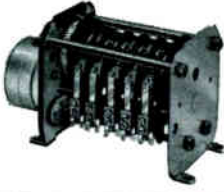
Grams: Torque Phone, Birmingham.

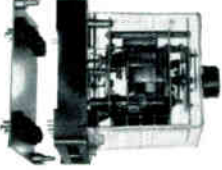
	TIMERS	SERIES 934 TIMER base mounting
	TIMERS	SERIES 807 TIMER base mounting, micro switches
	TIMERS	SERIES 934 TIMER flush mounting
	TIMERS	SERIES 809 TIMER base mounting, snap action switches
	TIMERS	SERIES 812 TIMER panel mounting, snap action switches
	TIMERS	SERIES 932 TIMER base mounting, plug in base

The 800 Series of sequence timers—the timers with the spring held cams and the single clamp screw for simplicity of adjustment — can accommodate up to 24 cams with snap action switches or a lesser number of micro-switches. The 900 Series of reset timers is available with time ranges between seconds and 30 hours. Both series are available as base or flush mounting types. The base mounting version of the 900 Series can be offered with a plug-in base. For full details of these competitively priced timers, make contact with Magnetic Devices now.



M.O.A.-A.R.R.E.-A.R.B. Approved Inspection
G.P.O. & C.E.G.B. Approved Suppliers

MAGNETIC DEVICES LIMITED
NEWMARKET · SUFFOLK · ENGLAND
TEL: NEWMARKET 3451 (10 LINES)

Grams Magnetic Newmarket Telex 81245
MANUFACTURERS OF RELAYS, SOLENOIDS, & CONNECTORS



ELECTRO PLATING

**ELECTROPLATING
to SPECIFICATION**

Specialist electroplaters of small parts
in quantity
**SILVER, HARD GOLD, NICKEL
CHROME, CADMIUM, TIN/ZINC
SPECULUM, RHODIUM, VACUUM
COATING, BARREL POLISHING**
Fully approved War Office, M.O.A. and A.R.B.

N.T.FROST LTD.

HARFORD STREET, BIRMINGHAM 19
Tel.: CENTral 4135

For further information circle 248 on Service Card

UNDERWATER RESEARCH HIGH-INTEGRITY EQUIPMENT FOR

**OFF-SHORE OIL-PROSPECTING
OCEANOGRAPHIC SURVEYS
OCEANOGRAPHIC SEISMOLOGY**

Pressure-tight housings for electronic apparatus; Cable and Cable-glands; Hydrophones; Polythene-sealed switches, magnets, thermometers and other components. Winches for oil rigs, hydrography, coring, sounding, trawling etc.

Left.

- * 1. Cable-gland with 8 independent cables entering the high-pressure side.
- * 2. Assembly of five independent interconnecting cables with five single-way glands and one five-way gland.
- 3. Polythene-sealed magnetic reed switch.
- 4, 7. Polythene-sealed hydrophones.
- 5. Polythene-sealed magnet.
- 6. Polythene-sealed pressure-tight housing.

Below. 10-ton winch for oil-drilling rig.

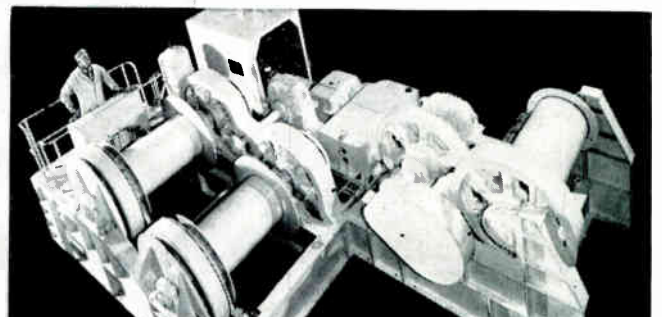
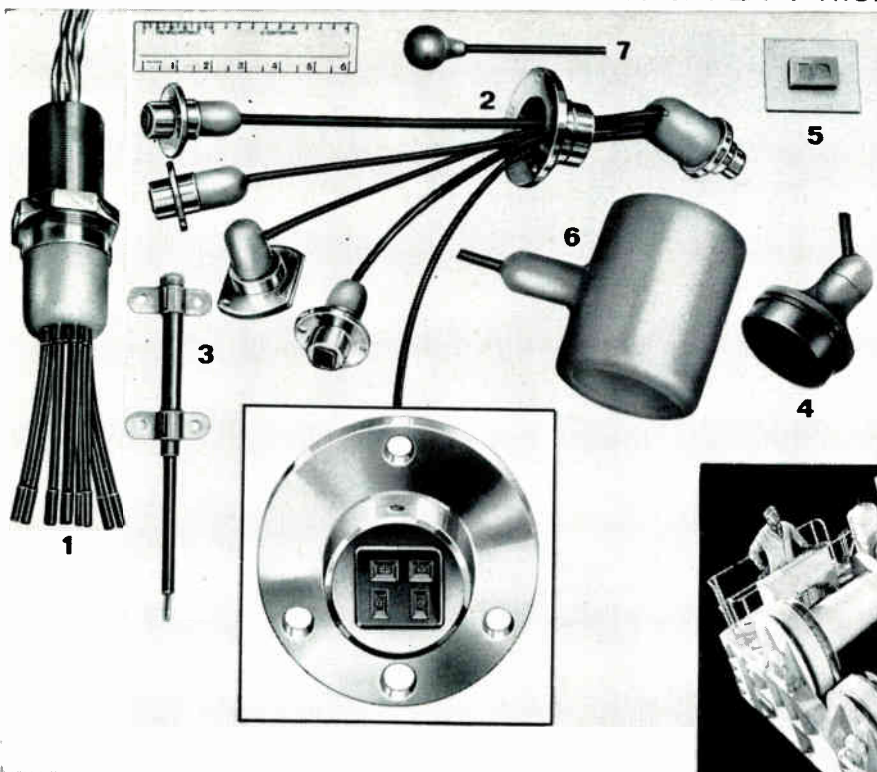

Submarine Cables Ltd

owned jointly by AEI and BICC. Greenwich, London, S.E.10, England.

* Cable glands are made with either screw or flange-type stems for fitting to underwater housings or vessels to provide cable entries capable of withstanding hydraulic pressure for long periods.

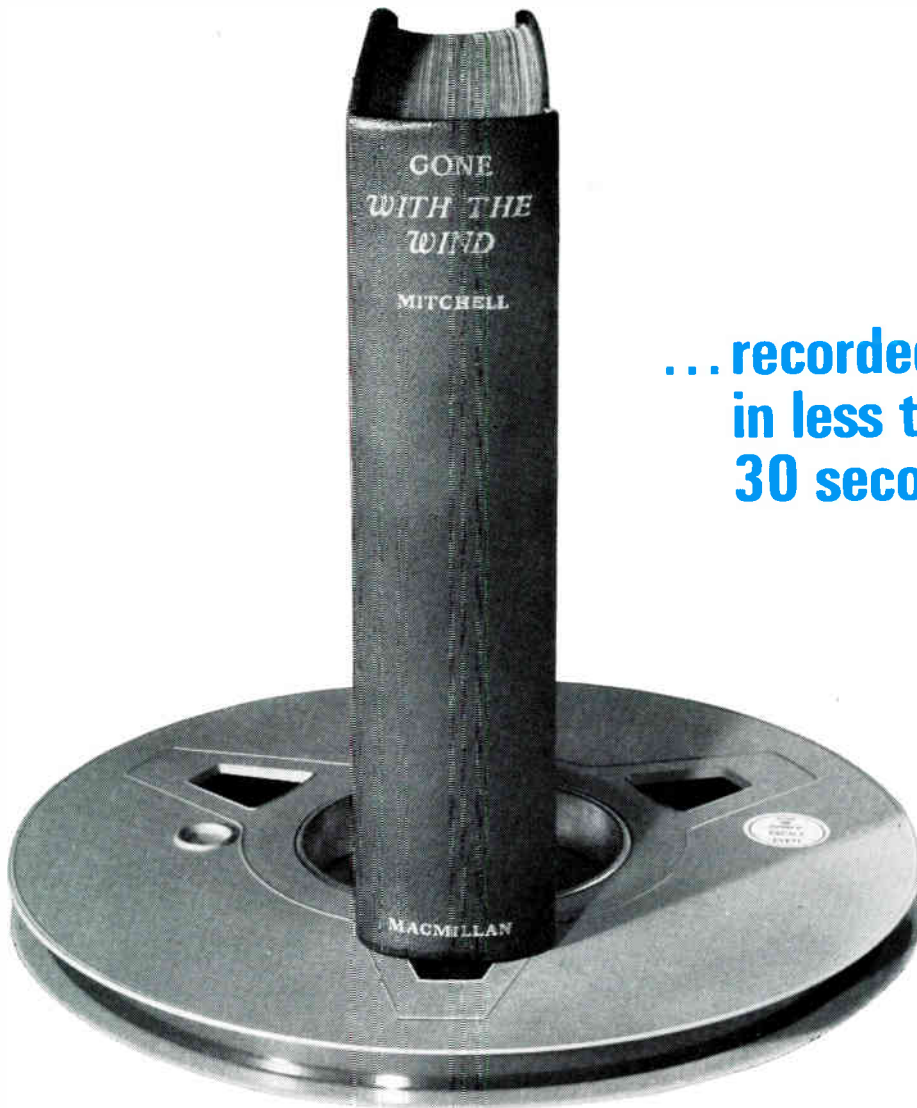

... recorded
in less than
30 seconds

The new made-in-Britain PLESSEY 5500 can handle from 12,000 to 120,000 characters per second

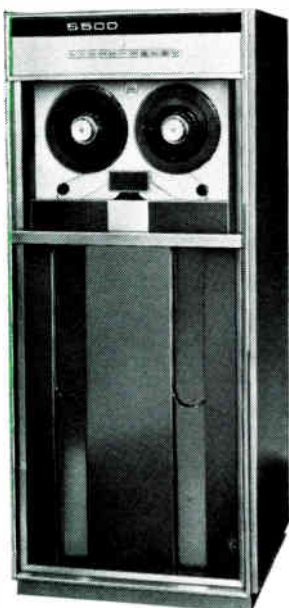

The Plessey 5500 is the only digital tape transport with that kind of performance which is wholly manufactured in the United Kingdom. With tape speeds up to 150 in/sec, the versatile, low-cost Plessey 5500 is fully 7- or 9-track IBM — compatible.

Now Plessey announces the 5500 Data Acquisition System

This system accepts data at widely variable rates into a Plessey 6- μ sec buffer core store and feeds data for storage in IBM block format to the 5500 transport at 200, 556, or 800 b.p.i. The core-store capacity can be varied to suit customer requirements, and data checks are performed as specified by the customer. Full system controls are provided internally; either 7- or 9-channel data inputs can be accepted.

Write today for full details of the new Plessey 5500 and advice from our system design experts on your data acquisition problems.

PLESSEY Automation



The Plessey Company Limited
Data Equipment Division
Martin Rd., West Leigh, Havant, Hants.
Telephone: Havant 6391. Telex: 86227
Telegrams: Pleslee Havant

PA(DE)1

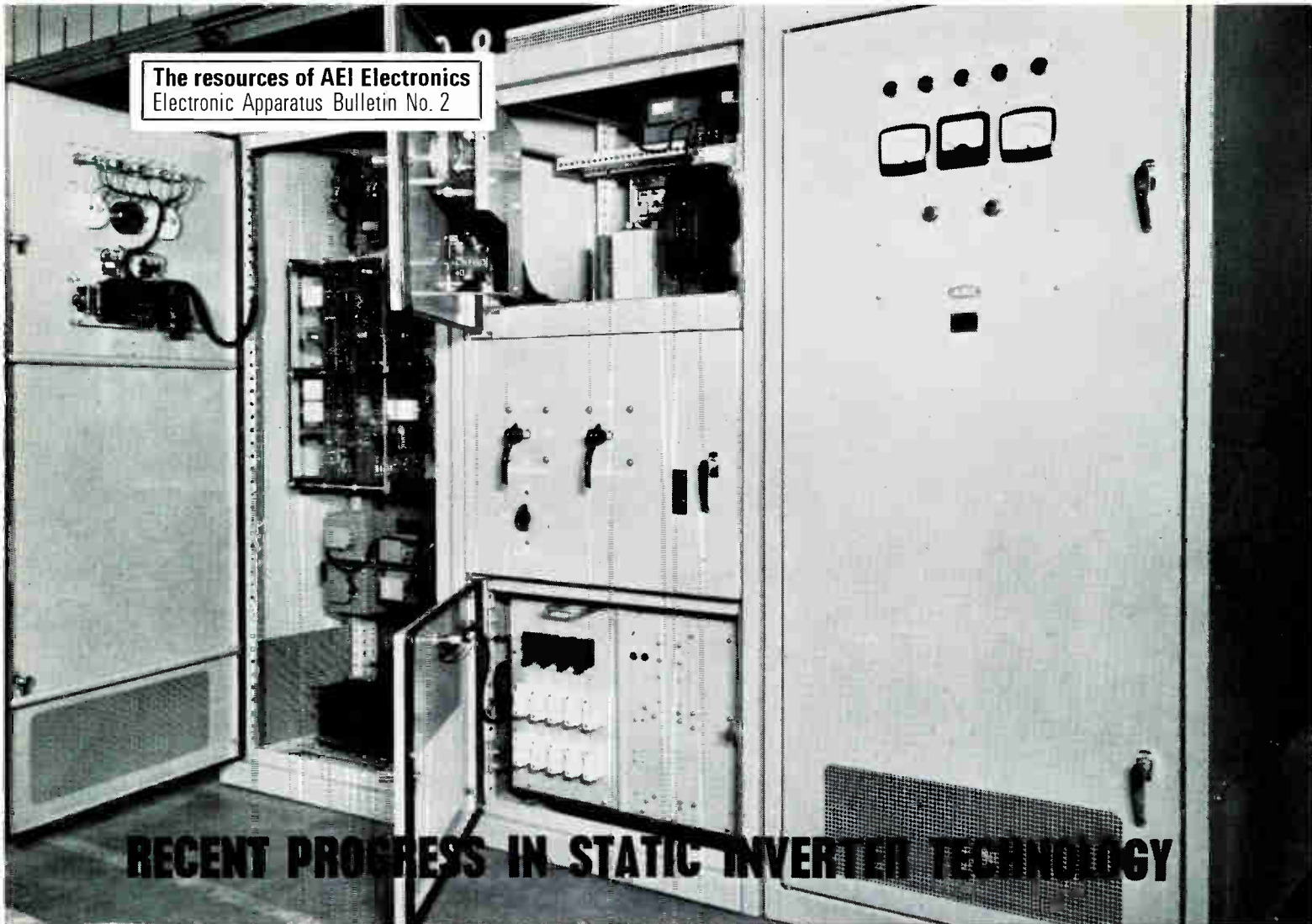

RECENT PROGRESS IN STATIC INVERTER TECHNOLOGY

Advertiser's Announcement

Cubicle housing a complete 'no-break' system. Such systems provide an unbroken supply of power. The cubicle shown houses 2 kVA 'no-break' inverter sets and one static changeover equipment.

For the past four years AEI Electronics has been engaged upon an intensive programme of research into the application of thyristors to D.C.-A.C. conversion. The details of this programme are of interest both intrinsically and because they exemplify the way in which the advent of economically priced but efficient semiconductor devices has obviated many of the difficulties hitherto associated with this particular field of electrical engineering.

No-break and Stand-by power supplies

Once the reliability of the static inverter had been established on service it was logical to apply it to emergency power supply systems—and in particular to "No-break" supply systems, which, like those customarily specified for communications, power stations, hospitals and air traffic control equipment, must completely eliminate the possibility of a power break or interruption during a mains failure.

Prior to the introduction of static inverters the nearest anyone had come to a true no-break system was one in which the mains supplied an A.C. motor which drove an alternator and a heavy flywheel. The load was permanently connected to the alternator,

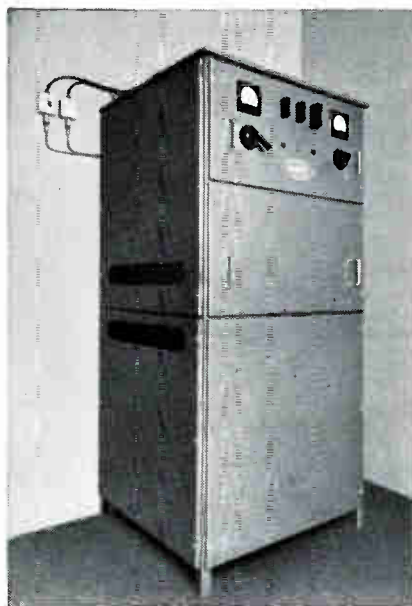

An AEI stand-by power supply static inverter, type FQ43, is housed in this cubicle supplied to the Stockport Corporation.

For further information circle 250 on Service Card

and, in the event of a mains failure, the flywheel kept the alternator revolving until a diesel engine could be started up and connected to the generator.

The first true no-break system evolved by AEI works in the following manner: the mains supply is rectified and then inverted to A.C. before supplying the load; a battery is connected to the D.C. circuit ahead of the inverter and is thus permanently on charge. When a supply failure occurs the battery takes over as soon as there is a voltage drop—no matter how small. A diesel-alternator can then be started up and connected to the rectifier input; this in turn will take up the load from the battery. Where only breaks of short duration occur the diesel-alternator is not required. The battery is then rated to produce full power during such breaks. For applications where a break of a few milliseconds is permissible AEI manufactures a complete range of "Stand-by" power supplies.

A.C. motor control and frequency changers

A more recent, and in some respects more important, application of static inverters is the control of A.C. motors. Owing to the difficulty of doing this by any conventional technique many engineers have hitherto preferred to use D.C. motors which, though less convenient, are at least relatively easy to control. For certain equipment, however,

D.C. motors simply will not do. A case in point is a high speed grinding machine manufactured by one of AEI's customers in the machine tool industry. This machine has to be driven at speeds of up to 60,000 rpm, and the power unit must withstand widely varying loads. Control is required over a 4.1 speed range, and to achieve this a bulky (and noisy) motor generator had been used. This leviathan has now been replaced by an AEI unit consisting of a rectifier feeding D.C. into an inverter with a variable frequency control oscillator. The advantages of this system—which is small enough and quiet enough to be mounted on the side of the grinder console—are accuracy of control and negligible maintenance. And together these more than compensate for the slightly higher cost which has, in any case, been offset by increased sales of the machine tool to which it is fitted.

A complete range of A.C. Motor Control and Frequency Changers Units will be manufactured.

D.C. transformers

An application has now arisen for static inverter voltage changing on D.C. supplies. This involves feeding the D.C. supply into an inverter with an output transformer wound to give the required voltage, then rectifying the output. Of course this is specialised equipment, and the present demand would scarcely warrant the production of a standard range of the kind now being developed for A.C. motor control. However, AEI are building units to individual orders and batch production may eventually be justified.

General Purpose Low Power Unit

General purpose low power static inverters have a variety of applications. In one case, for instance, a manufacturer specialising in marine air conditioning equipment, became interested in static inverters because one of his products—a compressor which had to be run immersed in refrigerant fluid—had to be driven by a D.C. motor located outside the sealed compressor unit, when installed in ships with no A.C. supplies. This arrangement involved the use of a complicated system of glands which had never proved entirely satisfactory. It was obvious that with an efficient static inverter to convert the ship's supply, the unit could be driven by the integral A.C. induction motor normally supplied when the unit was installed on A.C.

vessels. The inverters developed for this purpose amply fulfilled expectations and, like the lighting inverters referred to below, subsequently proved of value in other applications.

Transport lighting

AEI's work on static inverters for transport lighting began with a request from British Lighting Industries Limited for a means of converting the D.C. supply from a 24 volt battery to A.C. to power fluorescent lighting in buses. To meet this requirement, AEI Electronics developed what subsequently became their first commercially available static inverter—the type FQ24. This is a transistorised unit capable of supplying two 20 watt fluorescent tubes (or one 40 watt tube) from the 24 volt battery.



AEI Static inverter, type FQ44. This inverter is housed in a special dust and waterproof box designed for British Railways coaches.

Shortly afterwards British Rail ordered an inverter for use in passenger carriages. The input and output requirements were similar to those specified for the FQ24, but since the unit was to be installed in the roof of the carriage it had to be capable of withstanding higher ambient temperatures. Once this problem had been surmounted it proved possible to design units with outputs of up to 2,500 watts.

The success of these early static inverters engendered considerable interest among manufacturers in industries outside the transport field, many of whom saw in the new equipment the possibility of substantially improving the performance of their products. Today the principle of static inversion is widely accepted throughout modern industry. Indeed, it is no exaggeration to say that the static inverter is now firmly established as one of the electrical engineer's fundamental components. Its status is, in fact, roughly analogous to that of the semiconductor rectifier a few years ago. And from this it may reasonably be inferred that applications will multiply rapidly in the years ahead.

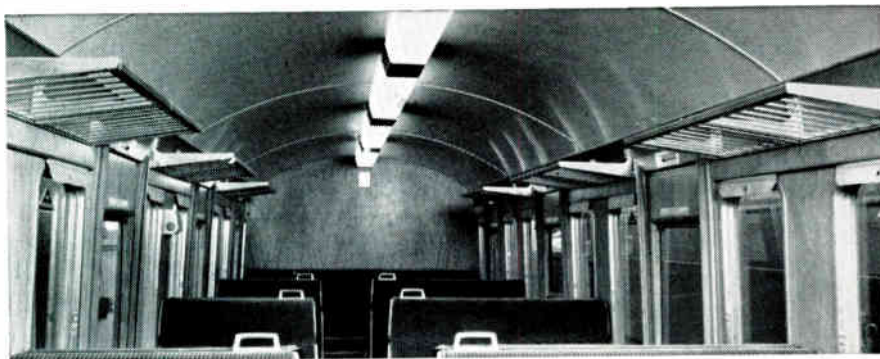

Interior of a British Railways coach. The fluorescent lighting is operated from an AEI static inverter.

AEI STATIC INVERTERS

FROM A STANDARD RANGE

- General Purpose Low Power Inverters
- Lighting Inverters
- No-break and Stand-by Inverters
- AC Motor Control and Frequency Changer Inverters

UNITS ALSO BUILT TO ORDER

For special applications both industrial and scientific

For further information contact—Associated Electrical Industries Limited, Industrial Electronics Sales, New Parks, Leicester or your nearest AEI office.





PLESSEY PROFESSIONAL COMPONENTS

Individual Requirement Specialists —A Unique Service

Each component range produced by Plessey Professional Components Division requires a high degree of specialisation and experience—the result of years of development and production. Products of this Division include miniature and sub-miniature relays, rotary solenoids, printed circuit switches, filters, individually built precision variable capacitors, crystal ovens, vibrators, trimmer capacitors and thermostats, and many more. These are products which require manufacture to exacting specifications, and call for an exceptionally high degree of skill. Plessey Professional Components Division occupies a modern, 125,000 sq. ft. plant at Titchfield, Hampshire, and offers unparalleled experience and 'know-how' in the field of high-precision components. In addition, the resources of the whole Plessey Company are available to give unique service to equipment designers and manufacturers. Nearly every component from the Professional Components Division has Qualification Approval or is approved to equivalent standard. The highest standards of quality control are ensured through the facilities of the Plessey Environmental Laboratory.

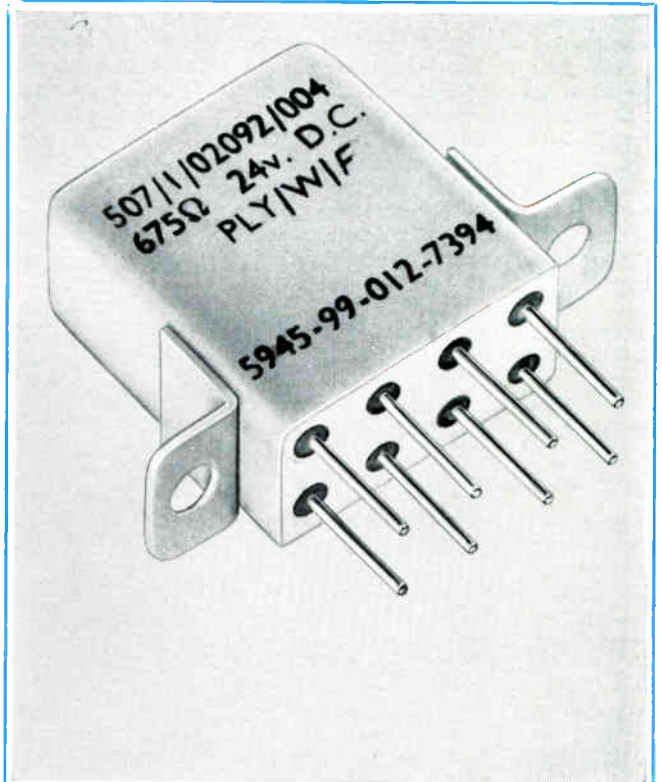

This relay works from -65°C to $+125^{\circ}\text{C}$

Relays: A typical item is the SUB-MINIATURE RELAY TYPE CF (NATO ref. 5945-99-012-7392 to 7396), approved to Ministry R.C.S.C. Specification DEF. 5165—SM5L. Fully sealed, and with a balanced armature and high contact pressures, it gives a particularly good performance under conditions of severe shock. Twin gold-plated contacts make it specially suitable for switching in low-level circuits.
Contact action: 2-pole changeover.
Contact rating: 3 Amps at 28 volts d.c. or 115 volts a.c. 400 c/s. 10^5 ops at 3 amps.
Standard coil values: 6, 12, 24, 48 and 110 volts d.c.
Voltage proof: 1000 volts r.m.s. a.c. at 50 c/s between terminals and case; 750 volts between open contacts.
Temperature range: -65° to $+125^{\circ}\text{C}$.
Shock: 100g for 8 milliseconds.
Weight: 0.52 oz (14.8 gm) max.

For further information on how Plessey Professional Components Division can help you, write today.

PERFORMANCE FIRST

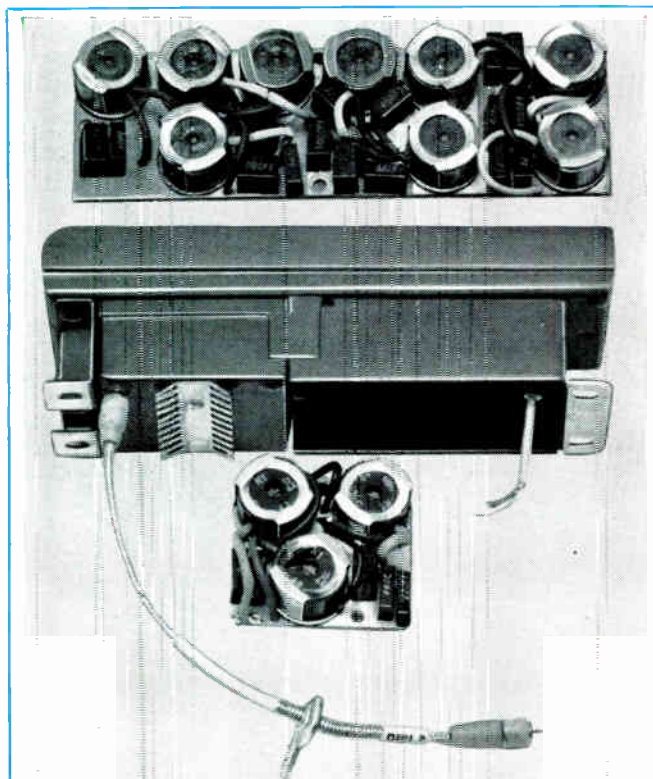

This filter works from -55°C to $+100^{\circ}\text{C}$

Filters: An example of a filter designed, engineered and manufactured to customer specification, is this 1st and 2nd I.F. Filter Unit (NATO ref. 5915-99-951-4140 and 5915-99-951-4141).

	1st I.F. Filter	2nd I.F. Filter
Centre Frequency	1.825 mc/s	500 kc/s
Pass Band	1.77-1.88 mc/s (1db)	477.5-522.5 Kc/s (6db)
Pass Band Loss Spread	1db	1db
Discrimination, Upper	55db @ 2.8 mc/s	60db @ 545 Kc/s
Discrimination, Lower	55db @ 1.3 mc/s	60db @ 455 Kc/s
Input Impedance	50 ohms u/bal	5000 ohms u/bal
Output Impedance	5000 ohms u/bal	5000 ohms u/bal
Temp. Range	-55° to 100 C	
Environmental Spec.	MIL-STD-202B	

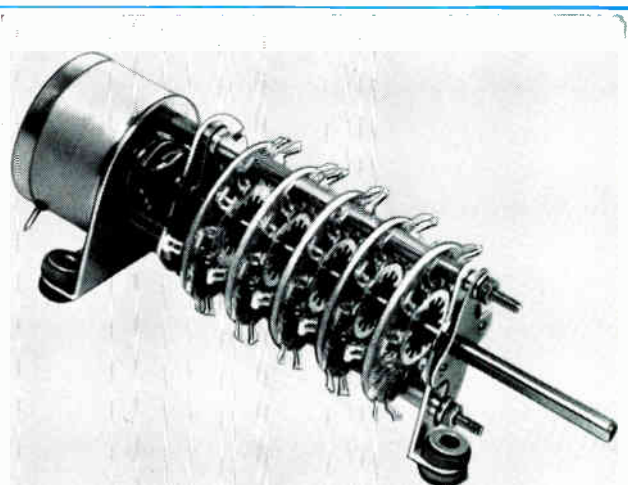

This solenoid works from -65°C to $+180^{\circ}\text{C}$

Switches and Allied Equipment: The Division offers an extensive service to equipment designers on switching problems, and it manufactures printed-circuit assemblies ranging from the 10- and 16-way edge switches to the miniature rotary type.

The Rotary Solenoid Size 14 is the first of a series in which torque is produced by a perfect magnetic couple, achieved by the rotation of a segmented armature in an annular gap. The absence of axial movement permits direct mechanical coupling to the load. Low inertia of the armature makes for rapid cycling at a given power. It is shown here driving a 6 wafer switch, making a complete circuit selector.

Operating voltage range: from 2 volts to 440 volts d.c.

Power rating: 100 watts maximum, within duty-cycle limits; 12 watts continuous.

Temperature range: -65°C to $+180^{\circ}\text{C}$ (the latter on minimum duty cycle).

Repetition rate: 50 cycles per second typical.

Stroke angles: ranging between 15° and 80° .

PLESSEY

Components Group



The Plessey Company Limited
Professional Components Division
Abbey Works, Titchfield
Fareham, Hampshire
Telephone: Titchfield 3031
Telegrams: Plessey Fareham Telex

Melabs

**STRIPLINE
SOCKET
CIRCULATORS**

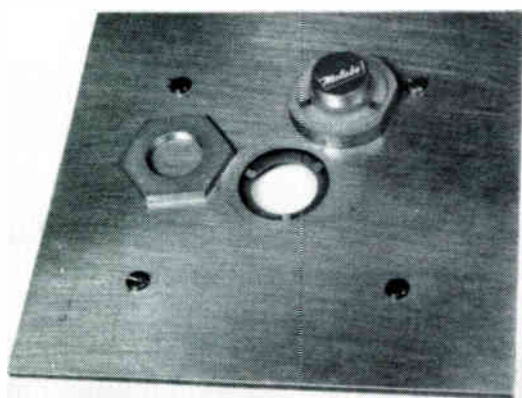

Melabs have introduced a range of microwave ferrite 3-port circulators designed for use in standard semi-rigid striplines where the ground planes are 2 mil, thick copper with no rigid back-up plate. The socket for the circulator is made by cutting two concentric holes at the appropriate location in the stripline package. The circulator is then fitted by inserting it in the socket and tightening the locking nut. Circulators of this type are now available for any frequency from 2 to 12 Gc/s and have an electrical performance comparable to conventional circulators with coaxial connectors.

A similar range of circulators is available suitable for use in rigid striplines having $\frac{1}{4}$ " thick aluminium ground planes. The standard dielectric used is Rexolite 2,200 but other dielectric materials can be provided.

**WALMORE
ELECTRONICS LTD**

11-15 BETTERTON ST DRURY LANE, LONDON, WC2 Tel: TEMple Bar 0201-5

**Contactor
Type C.2839**
(Patent applied for)

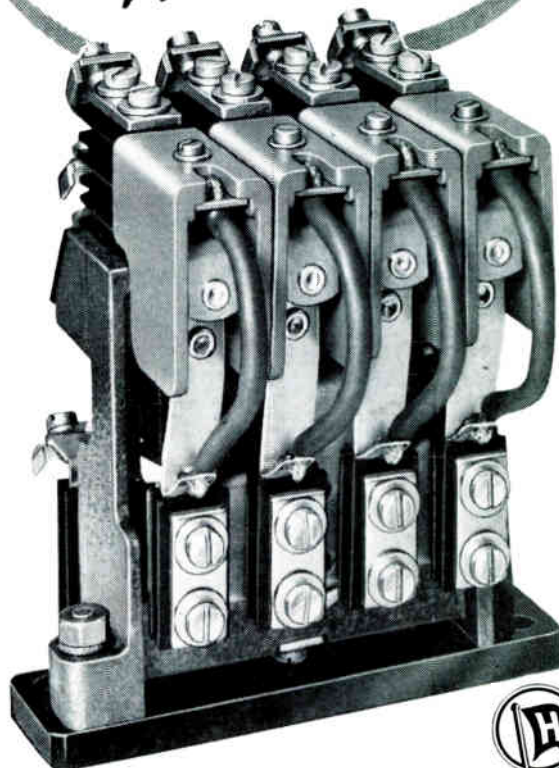

- Produced with four important features in mind:
1. Maximum life and reliability
 2. Low cost
 3. Silent operation
 4. Minimum overall size

Intended for use in applications where space is at a premium and for the control of medium power circuits up to 440v. A.C.

Hendrey Relays

HENDREY RELAYS LIMITED
390-394 BATH ROAD, SLOUGH, BUCKS.

Tel.: Burnham 609/612

Telegrams: Hendrelay, Slough

MANUFACTURING ELECTRICAL ENGINEERS
CONTROL AND LABORATORY APPARATUS
A.R.B. and M.O.A. APPROVED DESIGN & INSPECTION

many variations with modular units

service penetration panel

filters for power line

standard module
screening panel, walls
ceiling & floor

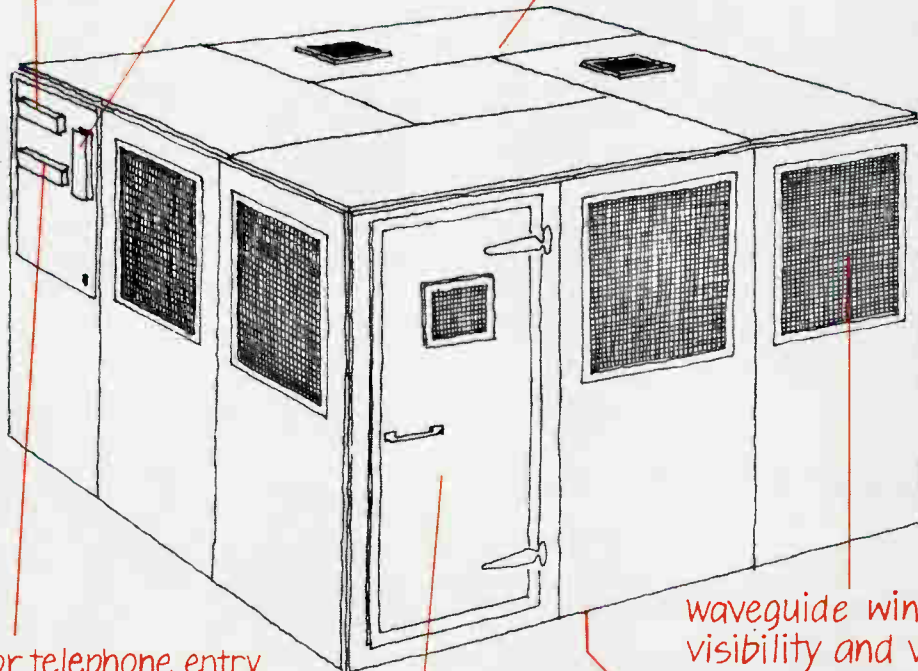

filters for telephone entry

waveguide windows for
visibility and ventilation
in same size panel

door-frame unit
to modular dimensions

screened panel with
timbered and covered
floor optional

Belling-Lee are official consultants on radio frequency interference suppression and shielded enclosures to the British and Overseas Defence Services.

easily assembled room provides high r.f. attenuation over a wide frequency range. Typical performance: -100dB , 100 kc/s to 10 Gc/s .

BELLING-LEE r.f. shielded enclosures

Write for leaflets F11-16 or telephone Miss Woolgar at Enfield 5393 Ext. 27

Belling & Lee Limited · Great Cambridge Road · Enfield · Middlesex · Telephone: Enfield 5393 · Telex: 263265

For further information circle 257 on Service Card

Any type or make of **ENAMELLED WIRE** copper or resistance alloy can be incorporated in our **TEXTILE COVERED WINDING WIRES**



STANDARD-BS 156
(oleo-resinous)

VINYL-ACETAL-BS 1844
(Synthetic)

Bicalex
Conymel
Polyanite
Lewmex
Simvar

POLYURETHANE-BS 3188
(Easy solder 'F' or 'M')

Bicelflux
Conysol
Polysol
Lewcosol
Sims Quick Solder

Also **POLYFLUX**
(Epoxy-resin, easy solder)

DIAMEL
(Epoxy-resin on resistance wire only)

A complete and comprehensive range from one single source plus a service which it is our constant aim to maintain.

Textile covered wires in enamelled copper, plain copper, tinned copper or resistance alloys. Single, twisted pair, bifilar.

T.N.A. Wires for easy soldering and bonding.

Tinsellated conductors, bunched conductors, textile covered or waxed.

Wave-winding Wires a speciality

If you have any development problem which involves winding wires remember that textiles are versatile and if a suitable wire does not exist we are always ready to elaborate new types.

A complete range from one source **FINE WIRES LIMITED**

P.O. BOX 78, NOTTINGHAM TELEPHONE: 44301 TELEGRAMS: STRENGTH, NOTTINGHAM
LONDON SALES OFFICE: 6/10 GT. PORTLAND STREET, W.1 PHONE: LANGHAM 1071

For further information circle 258 on Service Card

for variable speed

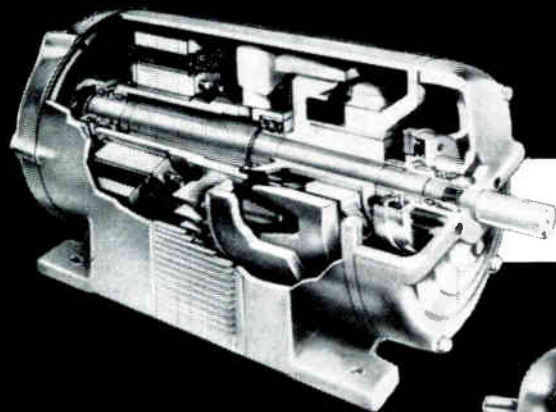

drives

and automation

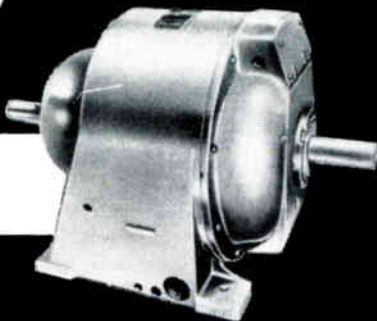

Heenan Dynamic, Ajusto-Spede and Dynaspede drives, with electronic control gear, to suit almost any system.

- ★ Speed Control
- ★ Torque Control
- ★ Torque Limiting
- ★ Controlled Acceleration
- ★ Synchronisation
- ★ Tension Control
- ★ Load Sharing of Multiple Drives



HEENAN & FROUDE LTD.
WORCESTER · ENGLAND

see us on **STAND No. N.N. 16** (First Floor)
ELECTRICAL ENGINEERS (A.S.E.E.) EXHIBITION 1966

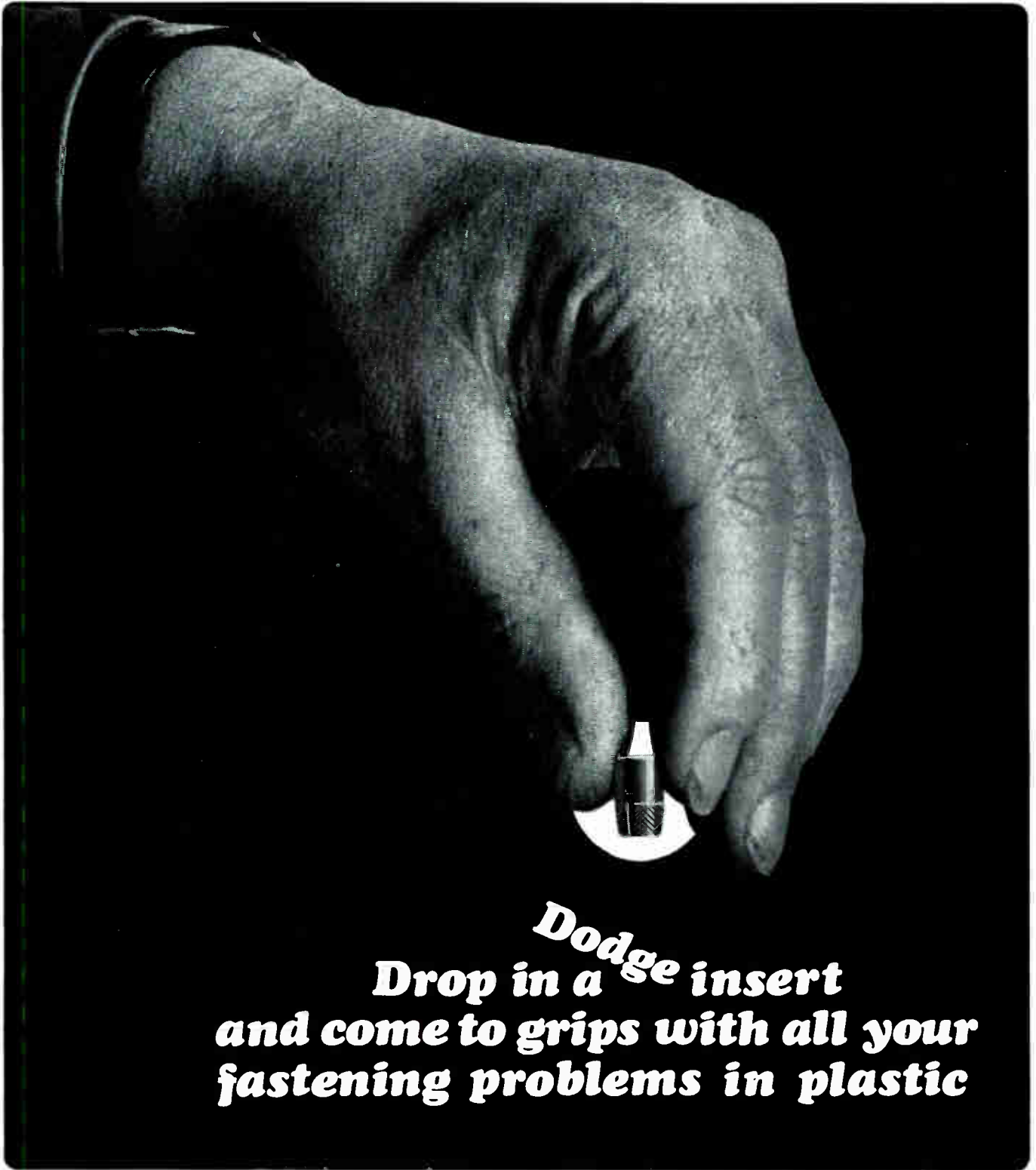

Dodge insert
Drop in a
and come to grips with all your
fastening problems in plastic



UNBRAKO 'DODGE'
inserts are
manufactured under
licence to British
Patent No. 886997

There are countless opportunities for you to use inserts, send for our latest literature and actual samples on the subject—you'll find them interesting!

Unbrako

fasteners for industry

UNBRAKO LIMITED
Burnaby Road, Coventry
Telephone 88722 Telex 31-626

Ovens - Quartz Crystals - Quartz Crystals - C Filters - Crystal Ovens Crystal Ovens - Crysta al - Crystal Filters - Cry Ovens - Crystal Filters - Quartz Crystals - Cryst

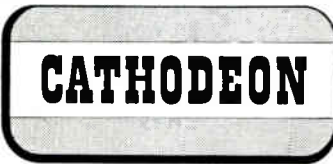

CATHODEON CRYSTALS LIMITED
LINTON • CAMBRIDGE • TELEPHONE: LINTON 501 • TELEX: 81212 • CABLES: "QUARTZ" CAMBRIDGE

AUSTRIA: WERKSVERTRETUNG HANS KOCUREK, LINKE WIENZEILE 58, VIENNA 8. **BELGIUM:** PYE TELECOMMUNICATIONS S.A.B., 127 RUE EDUARD FAES, JETTE, BRUSSELS 5. **DENMARK:** OSKAR PADE, 1 EMILIEVEJ, CHARLOTTEBLUND, COPENHAGEN. **FINLAND:** OY HEDENGREN AB, LÖNNROTSGATAN 18, HELSINKI. **FRANCE:** CONTINENTALE ET GARNIER, 17 RUE D'ASTORG, PARIS 8e. **WEST GERMANY:** ING. ERICH SOMMER, ELEKTRONIK GmbH & Co. KG, JAHNSTRASSE 43, 8 FRANKFURT AM MAIN 1. **HOLLAND:** VANANDEL N.V., NIEUW MATHENESSERSTRAAT 33, ROTTERDAM-N. **NORWAY:** J. M. FEIRING A/S, LILLETORVET, 1, OSLO. **PORTUGAL:** TURBOMAR, LARGO DO MASTRO 29, 2°, LISBON. **SWEDEN:** GUNNAR WIKLUND AKTIEBOLAG, KUNGSATAN 38, STOCKHOLM C. **SWITZERLAND:** TRONICAIR S.A., RAMPE DE LA TREILLE 3, CASE POSTALE 222 GENEVA.

Insuloid Cradleclip

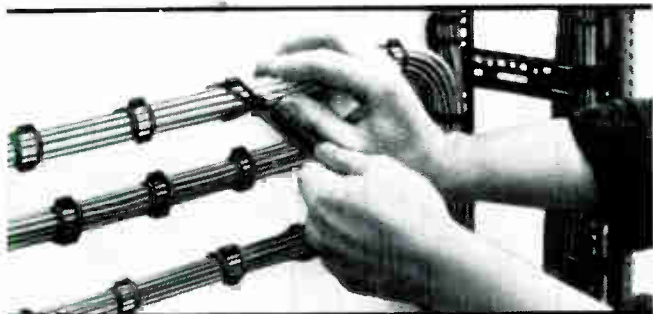

**THIS MOST ADVANCED
WIRING SYSTEM CUTS
INSTALLATION TIME
TO SECONDS**

- ▶ A new high speed simplified form of wiring—takes only 5 seconds per fixing point
- ▶ Neater, more compact wiring
- ▶ Full insulation, suitable for all climates
- ▶ Quick and easy wiring amendments
- ▶ Electrical and mechanical security under all conditions
- ▶ Substantial savings in wiring costs

The system consists of binders and clips for unsupported wiring and cradles with clips for anchored wiring. Binders and cradles are moulded in tough nylon and are virtually unbreakable.

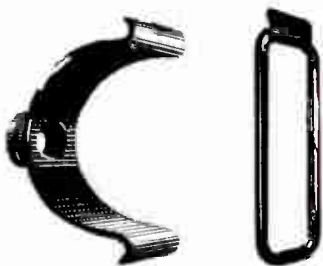

Insuloid

**WIRING SYSTEM
SPECIALISTS**

▶ For full details of the Insuloid Cradleclip and many other cable fixing devices write for the Insuloid Catalogue available on request from

INSULOID MANUFACTURING CO. LIMITED

Sharston Works, Leestone Road, Wythenshawe, Manchester, England.
Tel : WYThenshawe 5115-6-7 Grams : Insuloid Manchester Telex : 66657

**ISOLA-
base-materials:**
for printed circuits for all purposes.

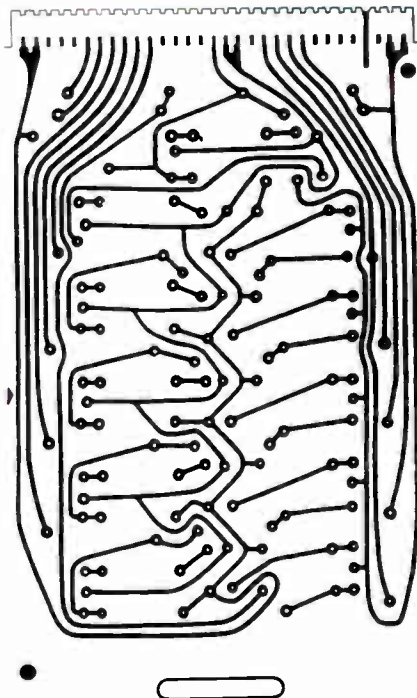

**SUPRA-CARTA-Cu
quality 96**

Supporting-material: laminated paper on phenolic resin base, top quality for radio and television industries and for other commercial applications, corrosion-proof, non-burning according to ASTM D 635-56 T, cold-punchable.

SUPRA-CARTA-E-Cu

Supporting-material: laminated paper on epoxy resin base, low dielectric-loss factor for all frequencies, high resistance values, track resistant, good mechanical strength.

VERRODUR-E-Cu

Supporting-material: fibre glass laminate on epoxy resin base with highest electrical and mechanical characteristics in extreme climates, quality 100, corresponding to NEMA-Part 10, G 10 quality 110, corresponding to NEMA-Part 10, G 11 Ask for our technical information-bulletins and samples.

**ISOLA
DÜREN**

**Isola Werke A. G.
5160 Düren**

Federal Republic of Germany
U. K. agent: J. M. Harding Assoc. J. E. E.
12 Olfington Gardens, Worthing, Sussex

400V $V_{CER(sus)}$

5A $I_C(peak)$

10 Mc $f_T(min)$

For the first time
at Economy Prices

2N3583
 $V_{CER(sus)} min = 250 V$

2N3584
 $V_{CER(sus)} min = 300 V$

2N3585
 $V_{CER(sus)} min = 400 V$

40255
 $V_{CEO(sus)} min = 350 V$
 $I_C max = 1 amp$
 $\theta_{j-c} = 15^\circ C/W$

40256
 $V_{CEO(sus)} min = 250 V$
 $I_C max = 1 amp$
 $\theta_{j-c} = 15^\circ C/W$

2N3439
 $V_{CEO(sus)} min = 350 V$
 $I_C max = 1 amp$
 $\theta_{j-c} = 30^\circ C/W$

2N3440
 $V_{CEO(sus)} min = 250 V$
 $I_C max = 1 amp$
 $\theta_{j-c} = 30^\circ C/W$

RCA ADDS THREE NEW "SMALL TO-3" (TO-66) HIGH-CURRENT TRANSISTORS TO THE LOW-COST, HIGH-VOLTAGE SILICON LINE

For further information please write or telephone:-

		2N3583	2N3584	2N3585
h_{FE}	@ $I_C = 100 ma, V_{CE} = 10 V$	40 min	40 min	40 min
	@ $I_C = 1 amp, V_{CE} = 10 V$	10 min	25-100	25-100
$h_{FE} @ 5 Mc$	@ $I_C = 200 ma, V_{CE} = 10 V$	2 min	2 min	2 min
$I_{S b}$	@ $V_{CE} = 100 V$	250 ma min	250 ma min	250 ma min
$V_{CEO(sus)}$	@ $I_C = 200 ma$	175 V min	250 V min	300 V min
$V_{CE(sat)}$	@ $I_B = 125 ma, I_C = 1A$		0.75 V max	0.75 V max
I_C		5 amp peak 2 A continuous	5 amp peak 2 A continuous	5 amp peak 2 A continuous



THE MOST TRUSTED NAME IN ELECTRONICS

RCA GREAT BRITAIN LIMITED Sales Division, Lincoln Way, Windmill Road, Sunbury-on-Thames.
Associate Company of Radio Corporation of America. Telephone: Sunbury 5511.

INDUSTRIAL ELECTRONICS

Incorporating British Communications and Electronics

Automated Machine Tools

One of the favourite topics of the Minister of Technology is machine tools. We assume that when he presses for greater use of machine tools he means the kind in which automatic control is effected by some form of computer rather than the simple kind of 'automatic' to be found in every factory. We assume, in fact, that he is pressing for more automation.

His problem seems to be to persuade industrialists to invest capital in automated machine tools. This is not a new problem. Such tools have been available for ten years or more and all their manufacturers have tried hard to sell them. Ten years of talk by tough professionals had had little effect and ten years more is unlikely to produce a landslide of orders for automated tools.

Why are they not more widely used? There is only one answer to this. They are not more widely used because the manufacturing industries are not yet convinced that the use of automatic machine tools will result in an adequate return on the capital outlay required. The assessment of the performance is not an easy matter for requirements differ greatly according to the nature of a company's business.

One of the greatest advantages of the electronic control of a machine tool is the ease with which the programme can be altered. A change of paper or magnetic tape carrying the instructions will turn over the machine from one job to another. Consequently this form of control is especially suitable for a firm which specializes in making small batches of a great many different products. At the other extreme, the firm which makes the same item in very large quantities may well find that more mundane automatic control is as suitable, or even more suitable. We ourselves naturally favour the more widespread use of automatic techniques in the control of machine tools, but we do recognize that it is not suitable for every purpose. In our view there are two things which are hindering its wider adoption. The first is the difficulty a company finds in making a reasonably accurate assessment of the value of automation techniques to that company. Talk will accomplish nothing, what are wanted are facts and figures. The other is a suspicion about the reliability of automated apparatus. The more that a single machine will do, the more is a firm putting all its eggs in one basket and the more costly is even a single breakdown.

It is our view that if the Minister of Technology wishes to promote the wider use of automated tools he should tackle these two problems. Surely such tools are used in Ordnance factories and other Government-controlled establishments. Figures should be available to him, therefore, on the savings to be effected by their use and also on their reliability. We suggest that they should be collected and published.

233	4.3.66	09.30	DATA LOGGING APPLICATIONS IN INDUSTRY
234	4.3.66	09.30	DATA LOGGING APPLICATIONS IN INDUSTRY
235	4.3.66	09.30	DATA LOGGING APPLICATIONS IN INDUSTRY
236	4.3.66	09.30	DATA LOGGING APPLICATIONS IN INDUSTRY
237	4.3.66	09.30	DATA LOGGING APPLICATIONS IN INDUSTRY
238	4.3.66	09.30	DATA LOGGING APPLICATIONS IN INDUSTRY
239	4.3.66	09.30	DATA LOGGING APPLICATIONS IN INDUSTRY
240	4.3.66	09.30	DATA LOGGING APPLICATIONS IN INDUSTRY *
241	4.3.66	09.30	DATA LOGGING APPLICATIONS IN INDUSTRY
242	4.3.66	09.30	DATA LOGGING APPLICATIONS IN INDUSTRY
243	4.3.66	09.30	DATA LOGGING APPLICATIONS IN INDUSTRY

By G. A. RIGBY, B.Sc.(Eng.), A.M.I.E.E.*

The uses of data-logging techniques in industrial process and control systems are becoming much more widespread as their capabilities are appreciated. This article provides an introduction to the basic principles of such techniques and includes several examples of their applications.

MODERN electronic data-logging techniques are being increasingly employed in industry for the monitoring and ultimate control of industrial processes and equipment. The basic operation of data logging is relatively simple and can start with the remote measurement of a single physical quantity, such as temperature, flow, pressure, etc., and be expanded up to many hundreds of parameters.

In data logging, the physical quantity to be monitored is first sensed by a transducer, which produces an electrical output signal, the amplitude of which is proportional to the quantity being measured. For data-logging purposes, there is a need for a unit which converts this analogue signal to a digital (pulse) form corresponding to the value of the measured quantity.

The Digitizer

Such a unit is called a digitizer, digital voltmeter or analogue-to-digital converter, and it is upon this instru-

* Data Systems Division, Solartron Electronic Group Ltd.

ment that the whole operation of data logging is based. Digitizers are complex devices and must, therefore, offer compensating advantages, which they do principally by increasing accuracy and speed.

An analogue device is capable of measuring with an error of $\frac{1}{2}$ to 1%, whereas a digital device quite ordinarily has an error of 0.1% and can be obtained with errors of only 0.01%. An analogue instrument responds to a change in input level in times of the order of $\frac{1}{4}$ to 1 second, but a digital instrument will give an accurate reading in a few hundredths of a second, and often many times faster.

A digital instrument is thus vastly superior to its analogue counterpart, although more expensive. Because of their high operating speeds, however, digital measuring devices can be shared among many inputs, so that the cost per input can actually be less with a digital system. A further advantage of the digital instrument is that its reading can be recorded by a suitable printer.

System Operation

A basic data-logging system, such as that shown in Fig. 1, comprises an input scanner, which acts as a multi-way switch to connect each input in turn to the digitizer, the digitizer itself and a printer. The operating sequence is as follows: the scanner selects the next input and gives a digitize command signal to the digitizer, thus causing it to make a measurement; when conversion is complete, the digitizer gives a print command to the printer, which prints out the voltmeter reading. An identifying number is also printed out alongside the reading, from data supplied by the scanner.

Outputs

A line or strip printer is only one of several output devices which can be used, and is probably the most common one. A punched-tape output is almost as frequently used and enables the recorded data to be computer-processed at a later time, or to be stored. A typewriter provides a conventional log sheet with tabulated results and can print in two colours.

The speed capabilities of existing equipment allow printed and punched outputs to be obtained at about ten readings per second, while typed outputs are normally restricted to only one reading per second.

Fig. 1. A basic data-logging system

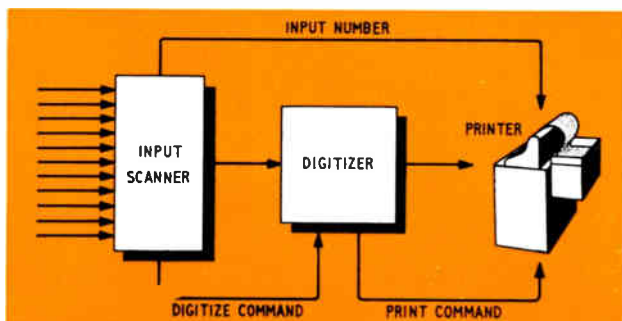

System Inputs

Inputs are d.c. voltages representing physical quantities such as temperature, pressure, flow, force, power, etc., and these quantities are converted to voltages by transducers, of which the best known is the thermocouple. The voltages produced by transducers are usually of the order of a few tens of millivolts, and are thus subject to electrical interference. The data logger must, therefore, have the ability to measure the signal voltage accurately in the presence of interference voltages; i.e., it must have 'common-mode rejection'. The problem of interference is aggravated by greater physical separation of transducer and logger, necessitating special precautions such as the use of screened leads.

A data logger does not require special transducers and many of those used industrially for control and measurement are quite suitable. The only requirement is that the transducer should produce a d.c. voltage output, or an output which is readily converted to that form, such as a d.c. current.

Transducers producing pulse outputs, such as some types of flowmeters, can still be handled by data loggers, but as their outputs are already in digital form the digitizer is by-passed.

In the basic system of Fig. 1 only two modes of operation are possible: continuous scanning with a record of all values, or a single scan on demand—again with a print-out of all values. Such a system is perfectly adequate for investigational or routine test work, but has little application to a continuous manufacturing process. For this application other facilities must be added, such as the ability to give warning of alarm conditions.

Alarm Scanning

For monitoring a continuous process, it is not necessary or desirable to give a continuous record of parameter values. What is required is a record of points in alarm only, combined with a routine log of all points at regular intervals, and these functions are provided by the more elaborate data-logging system shown in Fig. 2.

The basic system of scanner, digitizer and printer has been augmented by a typewriter, alarm limits and a digital clock (the input conditioning and the linearizer will be referred to later). With this system all inputs can be scanned continuously, digitized and compared with alarm limits. When an alarm is detected, the printer operates to give a record of the point number, measured value and time. In addition, there may be a symbol to indicate whether the alarm was for a high or a low limit. The system may be further modified so that when a point has



been detected as being in alarm and a print-out has been obtained, no further print-out will occur of that point until it has returned to normal; a second print-out will then indicate this condition. Furthermore, this system can produce an alarm summary on manual demand; i.e., at a particular time a print-out (usually in red) can be obtained of all points in alarm, together with their values.

Alarm annunciation can also be made by sounding klaxons or flashing lights, and at pre-set time intervals (such as every one or two hours, or once per shift) the typewriter can produce a complete log of all inputs, with time.

Input Conditioning

So far, the system has only measured and recorded voltage levels, which require translating into physical units before their significance can be fully appreciated. In the case of a system with several hundred inputs, it is impossible for the operator to memorize the calibrations of all transducers, and it is impractical for him to refer to tables and graphs. It is convenient, therefore, for the read-out to be in the units concerned and, in general, there are two requirements: scaling linear transducers and correcting the curvature of a non-linear transducer characteristic such as that of a thermocouple.

Linear inputs can be dealt with in two ways. The simpler is to provide individual resistive attenuators on each input in order to reduce the transducer output to a level where the scale factor is an integral power of ten. For instance, if a particular transducer has a full scale output of 20 mV for a pressure of 500 p.s.i. we may use an input attenuator to reduce the voltage to one quarter of its value, so that 500 p.s.i. will be represented by 5 mV. If the system is to have a resolution of 1 p.s.i., the digitizer must have a resolution of 10 μ V; this technique is limited only by the sensitivity of the digitizer.

The second method consists of changing the digitizer's sensitivity; but, as each input may require a different scale factor, this is clearly not as convenient as the input-attenuator technique.

Linearizing

Linearization raises its own problems, to which there are three possible solutions. Firstly, the signal can be linearized

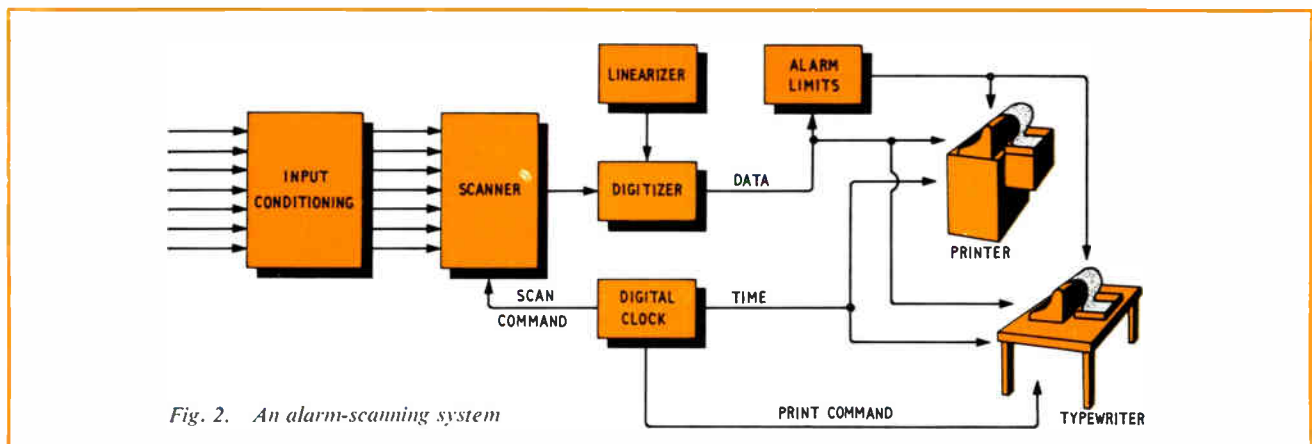

Fig. 2. An alarm-scanning system

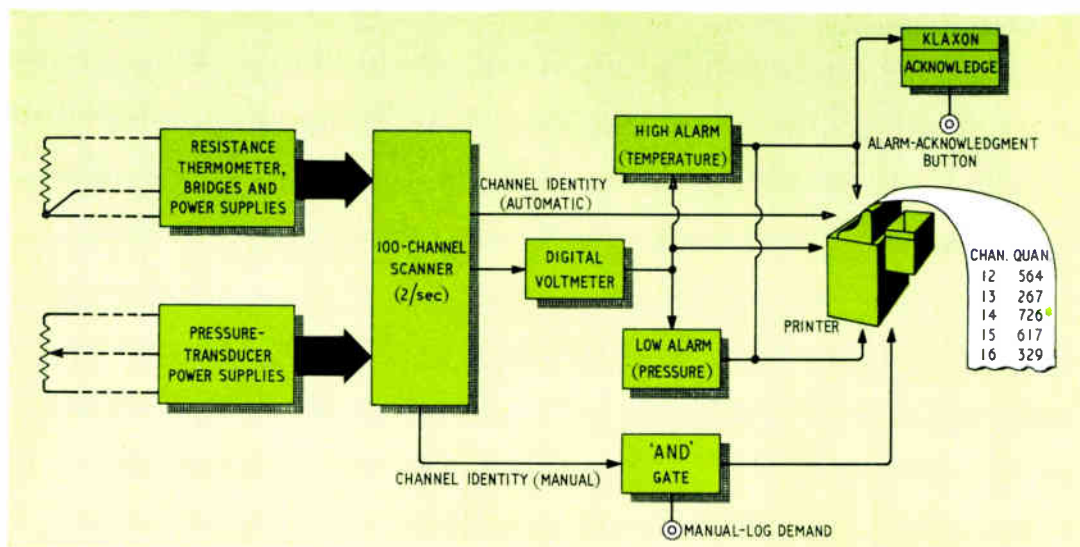

Fig. 3. A data-logging system for turbo-alternator protection

in the analogue stage, prior to digitization; secondly, it can be incorporated into the digitization process; and thirdly, it can be done digitally after the digitizer.

The first method is not suited to low-level voltages, as it requires some form of amplification. This may be placed between the scanner and digitizer, but individual linearizers are required for each type of transducer. The third method requires a digital store, in which the linearizing law is held, and requires computer-type techniques. It is not therefore an economic method.

The most satisfactory method is the second one, whereby linearization is built into the digitizing process. Details will not be discussed here, but most digitizing techniques, in particular the sequential-approximation and counter-integrator ones, are suitable. Linearizing circuits are easily added and it is not difficult to provide for a number of linearizer laws.

Industrial Uses

Before proceeding to specific examples, the capabilities of data-logging systems may be summarized as follows:

- Speed: 10 points per second typical, 100 points per second and faster available
- Accuracy: 0.1% commonplace, 0.01% available
- Unambiguous display
- No reading errors
- Alarm facilities
- Digital setting means no loss in accuracy
- Automatic print-out
- Routine log production

Also, very significantly with regard to future developments, data-logging systems are able to communicate directly with digital computers, so that the installation of a data logger is very often the first step towards digital-computer control. It is a very necessary first step, since a plant cannot be controlled until sufficient data has been collected to enable the control system to be designed.



Here, we are principally concerned with the application of data loggers to continuous processes. They have applications in industrial research and development and test laboratories, but, in principle, these do not differ from applications in other research establishments and these are outside the scope of this article.

Turbo-Alternator Protection

Many industrial plants operate their own generators, which have high capital costs and whose failure can mean expensive down-time and lost production. Fig. 3 represents a data-logging system, installed in a large chemical manufacturing plant to monitor the temperature and pressure of the lubricating oil supplied to the main bearings of a turbo-alternator.

Resistance thermometers are used to sense temperature, and pressure signals are obtained from potentiometric transducers, with a d.c. excitation. The resistance thermometers are of the three-terminal type, to obtain first-order temperature compensation of the connecting leads. A constant-current power supply reduces the effects of bridge non-linearities and each element is connected to an individual bridge circuit which has zero balance and sensitivity controls. Over small temperature ranges the bridge output can be taken as linear.

The inputs total one hundred and are identified on the print-out by the two-digit numbers from 00 to 99. They are sampled continuously at the rate of two per second and are digitized by a digital voltmeter. All temperature measurements are referred to a single high limit, and the pressure measurements are referred to a single low limit. If an alarm condition is detected, a print command is given so that a print-out of that channel will occur and give the channel number, value, and alarm signal. A klaxon is also sounded and continues to operate until silenced by the operator pressing an 'alarm-acknowledgement' button for that channel. The klaxon cannot sound again on that channel until the acknowledgement button has been returned to normal. A print-out of all channels can be demanded manually at any time, the print-out starting at the beginning of the next scan after the print button is pressed. Any channel in alarm is indicated by an asterisk.

A second data logger is now being installed to monitor a new installation. It will provide comprehensive coverage of the plant and the monitored parameters will include steam conditions, winding temperatures, output voltage and feed-water temperature.

The alarm system has also been extended, independent high and low limits being applied to each input, and the alarm panel has a three-position switch for each channel. The central position indicates the normal condition, the switch is lowered for 'alarm acknowledgement', when a red lamp glows, and is raised for 'out of commission', when an amber light glows. As previously, a line printer gives both a permanent record of points in alarm and a print-out of all points on demand.

Electrolytic-Plant Monitoring

When monitoring an electrolytic bath for alarm levels, it is not sufficient to set fixed voltage levels since the voltage across the bath varies with the current passing through it. Variations in current may be quite acceptable and should not cause an alarm to be raised; the alarm level must therefore vary in sympathy with current magnitude.

To provide for this the system shown in Fig. 4 has been devised. The voltage across the cell can be represented by $E = E_0 + KI$, where E_0 is a constant and I is the current passing through the cell. The factor K is a parameter of the cell and depends on the strength of solution, temperature, etc.; it serves to define the condition of the cell and an alarm must be raised if its value goes beyond pre-set limits.

A transducer produces a voltage proportional to the cell current, and this is applied to a potentiometer so that, by adjustment, a voltage V can be obtained equal in magnitude to KI . The cell voltage is backed off by V and by a voltage equal to E_0 . Consequently the voltage e presented to the voltmeter is zero so long as the set-point conditions of KI are maintained. Also it remains zero for any value of I provided K remains constant. However, should K change, an alarm will be raised if the change in K is sufficient to raise e to the alarm level.

Gas Chromatography

A subject which is claiming increased attention is the automatic recording and processing of the outputs of gas chromatographs. The conventional method of recording is by chart recorder, from which the analysis is made manually. The output of a gas chromatograph is a series of voltage peaks, the magnitude and spacing of which represent the amount and nature of the gases present in the sample under test.

Clearly a data logger can digitize the output from the chromatograph, but ideally digitization should only occur

during the time when an output peak is present, and the peak must be identified in time to enable the gas to be identified.

The problem is one of time control—how to arrange to start and stop digitizing at the time when a peak is expected, and how to relate that to a particular gas.

A subsidiary decision (and fortunately the data logger is quite capable of providing the data whichever decision is made) is whether to operate on the actual value of the peak, or whether to operate on the area under the curve. In the former case the digitizer itself can be peak-reading, and in the latter the area is proportional to the sum of equidistant ordinates and therefore requires only simple adding arrangements. It is anticipated that on-line operation will be achieved to provide an automatic, continuous quality-control check.

Working-Space Monitoring

Modern office blocks are equipped with air conditioning equipment whose performance must be monitored for efficient operation. This requires measurement of air temperatures, humidity and the working-fluid conditions such as temperature and flow.

In general terms this is another example of plant monitoring requiring a continuous alarm scan with a routine log taken at specified intervals. However, in the case of an office block, the plant is sited either in the basement or on the roof, and displays on intermediate floors are required.

A typical installation consists of the main logger sited adjacent to the air-conditioning plant. All points are monitored and the routine log is produced at this location. At one or more locations spaced throughout the building, local stations display the conditions within their area and the operator or maintenance technician thus has available to him data at a position not too far removed from the corresponding space.

In designing such a system, interconnecting cables must be kept to a minimum, as they can become the major cost item. It is not economic, for example, to run individual leads from 200 thermocouples spaced throughout a building to a logger sited in the basement. The logger may only cost £2,000–3,000 and the cost of supplying and installing cable could equal this. If two or three local stations are now added, necessitating further wiring, the overall costs are quite prohibitive.

There are a number of techniques and arrangements to keep cable costs down, and these are invariably based on a 'tree' scheme, as shown in Fig. 5. Each sub-scanner may have a local digitizer and display, but the cost of these is less than that of running multi-core cable back from the central logger to the local station.

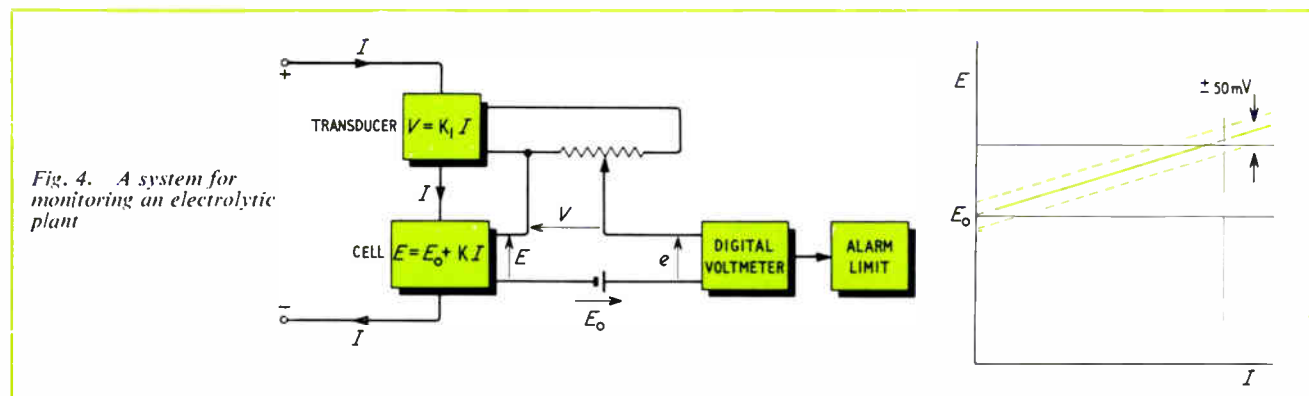
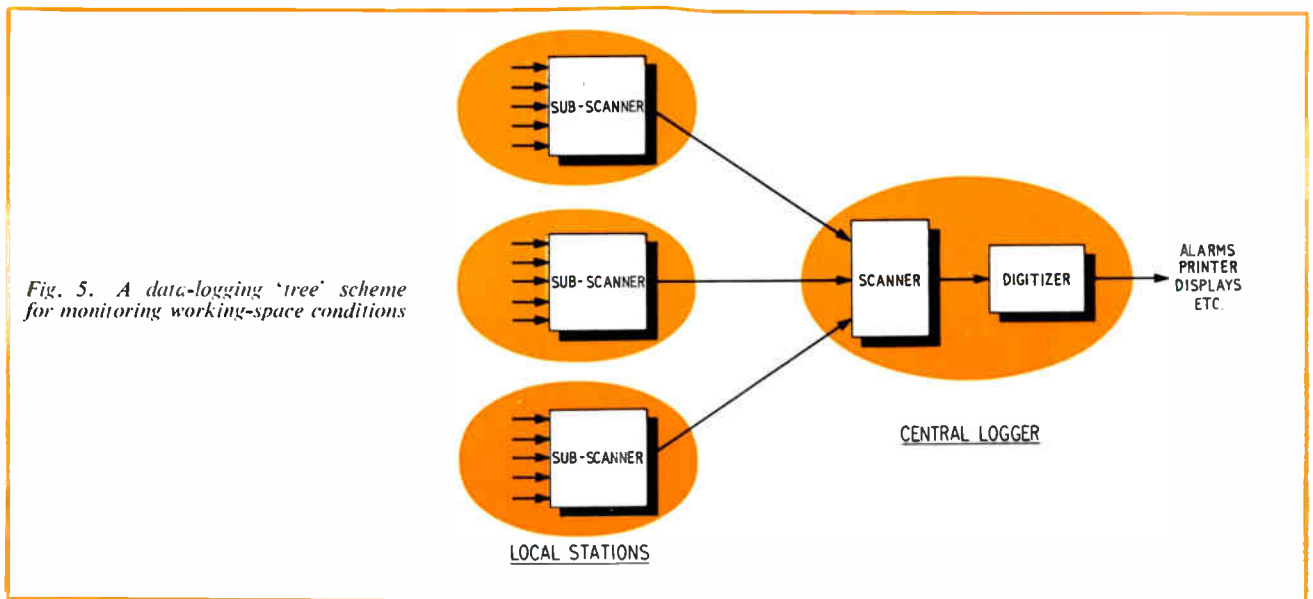

Fig. 4. A system for monitoring an electrolytic plant



Strain-Gauging of Large Structures

The technique of strain-gauging, which has long been applied to aircraft and other structures, is being increasingly applied to large structures of a civil engineering nature such as bridges and dams.

It is desirable to have a knowledge of the strain existing in a structure during erection and under load for two reasons: it enables the design figures to be checked against actual values, and thus assists in future design work, and, for safety reasons, it is necessary to know the strain values. The need for this in the case of dams and nuclear-reactor pressure vessels is obvious. In those applications where strains are measured over periods of time extending into years, it is essential to reduce drift in the gauging and measuring system to an absolute minimum.

Strain measurement in pre-stressed concrete structures has attracted particular attention, and for this purpose special strain-gauging techniques have been evolved. The bonded-resistance strain gauge is not suitable as it is subject to drift; there are difficulties in bonding the gauge to the concrete, and the gauge length must be such that the presence of aggregate in the concrete does not invalidate the measurement.

It is now generally accepted that the vibrating-wire gauge

is the most suitable. This consists of a tensioned wire, secured between two anchor points, which when plucked will vibrate at a frequency related to the tension. This arrangement is virtually drift free under the constant-temperature conditions that prevail in large structures and has the further advantage that the electrical connections are made by two wires only.

The measurement is made by counting the vibration frequency after an initial disturbance by a pulse, and the frequency may be transmitted over distance without loss of accuracy.

The technique does not lend itself to dynamic measurements, so that high scanning speeds are not required; a speed of one or two points per second is quite adequate and allows ample time for each gauge to be individually plucked and counted.

Conclusion

Data logging is supplanting older techniques in many industrial applications and enables measurements to be made which would be impossible or uneconomical by other means. It forms the essential first step towards supplying data for the control of continuous-processing plants and enables data to be acquired for future design studies.

Computers in the Hospital

A department of English Electric-Leo-Marconi Computers Ltd. has been set up to investigate the use of computers in hospitals so that the number of nurses required in intensive-care wards may be reduced; at the moment one nurse is needed for each patient.

At a recent symposium a consultant from the company described how computers can be used for the everyday control of hospital functions, for staff allocation and for patient monitoring. A patient-monitoring computer is envisaged which will be able to respond to changes in a patient's condition faster than a nurse is able to and would instantly inform the ward sister or the duty doctor of any deterioration or improvement in the patient's health. A computer could also be used for the allocation of hospital

facilities so that patients could be admitted at the most convenient time without their having to wait in hospital beds until the necessary equipment becomes available.

The recording of reports is another use of the computer. Reports could be generated of each patient's progress so that consultants can discharge patients when they are ready without having to wait to see them on the next regular visiting day. The keeping of records is a further task which can be carried out more efficiently with the use of a computer. Every significant medical event in a person's life could be recorded and held in a random access file to be up-dated as new information becomes available.

Other tasks under consideration include purchase and stores accounting and laundry control.

Thermoelectric devices are being used on an increasing scale for refrigeration, air-conditioning and many other applications. They are a commercial proposition and are becoming more and more competitive. The advantages, principles of operation and diverse uses of thermoelectric cooling and heating modules are described in this article.

THERMOELECTRICITY & THERMOELECTRIC APPLICATIONS

By A. R. SHEARD*

THERMOELECTRICITY is not new. T. J. Seebeck discovered thermoelectric generation in 1821—though he misinterpreted his own discovery. J. Peltier observed that heat was generated across the junction of two dissimilar conductors in 1834 and E. Lenz, in 1838, showed that the effect was reversible. Simply, the Peltier effect is the absorption or rejection of heat at the junctions of two dissimilar conductors through which current is flowing.

Following the initial discovery of thermoelectricity, little progress was made, and thermoelectric cooling, for example, was regarded as a scientific curiosity. A revival of interest in thermoelectric generation during the 1930s led to the development of semiconductor thermoelectric materials: the practicability of the Peltier effect was then realized and consequently interest and development work has increased, particularly during the last decade. Thermoelectricity is a commercial proposition for many instrument applications and is becoming increasingly competitive for air conditioning and refrigeration. Some of the possible advantages of thermoelectricity are listed below: (1) heating or cooling according to the direction of the current; (2) immediate function when power is supplied; (3) no moving parts; (4) no vibration and silent in operation; (5) function with the same efficiency under the same conditions irrespective of size; (6) spot or 'pin-point' cooling is possible; (7) accurate capacity matching compared with vapour cycle equipment and performance is more predictable; and (8) infinitely variable temperature control, etc.

Unlike vapour-cycle systems, thermoelectric systems perform with the same efficiency under the same conditions irrespective of the system size. A d.c. source is essential and the coefficient of performance (C.O.P. = Q_c/W), the ratio of heat absorbed, Q_c , to electrical power input, W , is dependent on the operating conditions. For example, the C.O.P. for a maximum cooling demand can be as low as 0.1 in practice or even zero when the heat absorbed is zero. On the other hand, for minimum demand the coefficient of performance increases to infinity as the current applied is reduced to zero.

Thermoelectric cooling is now in practical use in such diverse fields as air conditioning, electronics, general instrumentation, refrigeration, medicine, vapour control and computers.

Principle of Operation and Structure of the Thermoelectric Module

Materials

All thermoelectric cooling and heating materials fall under the general classification of semiconductors. A good thermoelectric material has a low thermal conductivity, κ W/cm²/°C, a high electrical conductivity, σ Ω/cm, and a high Seebeck coefficient, α V/°C. Neither electrical insulators nor electrical conductors satisfy these requirements hence the choice of semiconductor materials. A measure of material suitability is given by the figure of merit Z where

$$Z = \frac{\alpha^2 \sigma}{\kappa} \text{ } ^\circ\text{K}^{-1}$$

All three parameters in this expression are temperature dependent and Z is frequently expressed as the dimensionless figure of merit ZT where T is the mean of the hot and cold junction temperatures in °K.

For cooling applications, the best dimensionless figure of merit at room temperature or below is approximately 0.9. Mass-produced material probably averages around 0.8. Material for generation purposes designed to operate at 1,000 °C may have ZT values of 1.0 at 1,000 °C.

Values of ZT significantly greater than unity have only been observed for material measured under special conditions, such as low temperature combined with a transverse magnetic field.

Materials For Cooling Applications

The best materials currently known are alloys of bismuth telluride Bi₂Te₃. Although similar in appearance, the two branches of a cooling thermocouple are dissimilar in that they have Seebeck coefficients of opposite sign with respect to copper. One branch is positive (termed p-type), and the other negative (termed n-type). Usually, the parameters (α , σ , κ) of both branches are of similar magnitude when matched for optimum performance.



ELECTRONICS
COMMUNICATIONS
INSTRUMENTATION
CONTROL

*De La Rue Frigistor Ltd.

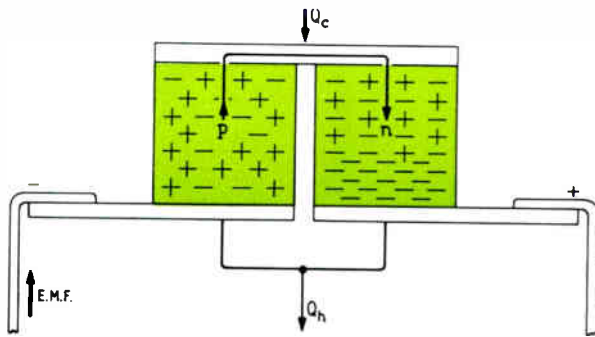

Fig. 1. Two semiconductor blocks joined together by a conducting strap to form a couple

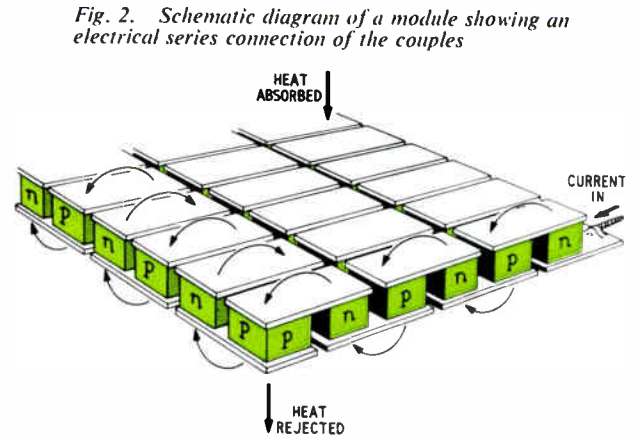

Fig. 2. Schematic diagram of a module showing an electrical series connection of the couples

The p-type material is an alloy of bismuth telluride (Bi_2Te_3) with antimony telluride (Sb_2Te_3) whereas the n-type material is an alloy of bismuth telluride with bismuth selenide (Bi_2Se_3).

The materials can be manufactured by an orientated crystal-growing process or, more recently, by powder metallurgy techniques. The relative advantages of these processes has been discussed elsewhere, but powder metallurgy methods have already facilitated considerable price reductions, and further reductions can be forecast with confidence.

Operation

Fig. 1 shows p- and n-type semiconductor blocks joined together by a conducting strap to form a couple. A similar conducting strap is joined to the remote end of each block, and the straps at both sides are arranged to provide good thermal contact surfaces. The blocks have similar thermal and electrical conductivities and complementary Seebeck coefficients of similar magnitude.

The p-type material has a deficiency of electrons, illustrated by positive signs and n-type material has an excess of electrons illustrated by negative signs. On the application of a direct current potential to the couple, with negative source polarity connected to the p-type block, migration of charges occurs as illustrated. Another way of considering this is that adjacent to the connecting strap, the p-block becomes more negative and the n-block more positive. Under the influence of the applied potential, electrons flow from the p block across the strap and into the n block. In doing so, they are forced from a comparatively low energy state to a high energy state, and obtain this energy by extracting heat from the junctions across which they are forced to flow.

If the direct-current polarity is reversed, it follows that electrons must flow in the opposite direction; i.e., from a high energy state to a low energy state. The surplus energy is given off as heat at the connecting junctions.

One can readily appreciate why it is possible to change from a cooling to a heating cycle merely by reversing the direction of current flow. If this reversal is carried out rapidly, for example by applying an alternating current, the thermal inertia is such that no Peltier cooling effect would be apparent, and both junctions would heat up owing to resistive Joule heating throughout the couple. A direct-current supply must therefore always be used.

Heat Transfer Relationships

So far only the junction (or Peltier) effect has been mentioned. If this was the only consideration, the bulk of the semiconductor blocks would not be important. However, as

in all electrical conductors, Joule resistive heating occurs. This detracts from the cooling effect and complements the heating effect.

The 'optimization' of block size with regard to required cooling conditions is necessary in order to achieve a compromise between conflicting effects.

The distance between heat-absorbing and heat-rejecting surfaces is comparatively small, and flow of heat from one to the other is inevitable. If κ is the thermal conductance of the material and ΔT is the temperature differential across the junctions, heat flows from the hot to the cold junction at the rate $\kappa\Delta T$. The Joule heating takes place in the bulk of the material and is proportional to the square of the current I . The rate of Joule heat generation is I^2R where R is the resistance of the material.

It is assumed that half the Joule heat flows to the cold junction to operate against the Peltier cooling effect. Therefore the quantity of heat Q_c absorbed at the cold junction can be expressed by

$$Q_c = \alpha IT_c - \frac{1}{2}I^2R - \kappa\Delta T \quad \dots (1)$$

T_c is the temperature of the cold junction in °K and αT_c is a convenient way of expressing the Peltier coefficient where, in this case, α is the Seebeck coefficient of the couple. αIT_c is the rate of Peltier heat absorption at the cold junction.

From the equation it can be appreciated that there are limiting combination values of I and ΔT when

$$\alpha IT_c = I^2R + \kappa\Delta T,$$

and Q_c is then zero. This illustrates why it is not possible to obtain an increased performance by indefinite increase of the power supplied. Power surplus to the optimum requirement of a system is not only wasteful but also reduces the performance.

Heat generated at the hot junction is expressed by

$$Q_h = \alpha IT_h + \frac{1}{2}I^2R - \kappa\Delta T \quad \dots (2)$$

where T_h is the temperature of the hot junction in degrees Kelvin. The electrical power to operate the thermocouple is

$$Q_h - Q_c = I^2R + \alpha I\Delta T = W \quad \dots (3)$$

which is the sum of the Joule heating loss plus the power loss to overcome the opposing potential generated by ΔT . Alternatively expression (3) can be written $W = I(IR + \alpha\Delta T)$; i.e., $W = IV$ watts where V is the potential drop across the couple or module.

The total heat production rate Q_h which must be dissipated

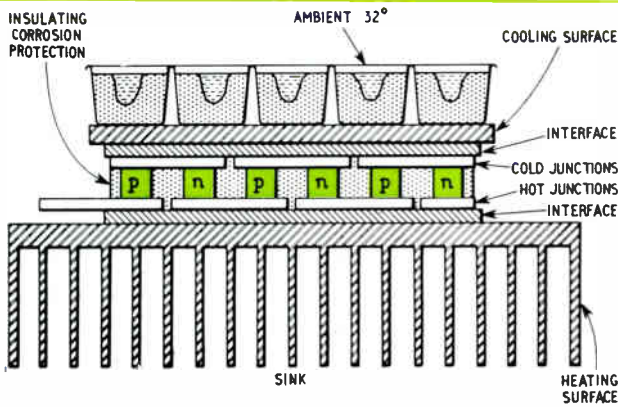

Fig. 3. A thermoelectric heat-transfer system for ice making

into the heat sink from the hot junctions, is the total power input W , plus the heat absorbed at the cold junction and pumped through the module; i.e.,

$$Q_h = W + Q_c \quad \dots (4)$$

Consideration must be given to the temperature dependence of basic parameters α , σ and κ . The temperature variability assumes considerable importance by its effect on the above expressions when transferring heat over a large temperature-differential or over a wide range of different temperatures.

Modules

Module Construction

Normal practice is to make up a number of couples into an electrically series-connected unit or module (Fig. 2). The construction is in fact a bent strip and as such is mechanically weak. For this reason, arrays of more than 12 couples are uncommon unless some mechanical support is provided to prevent damage during handling.

Frequently, the copper conducting straps forming the 'hot' surface are resin-bonded to impart strength and rigidity. Mechanical strength and ease of application are also improved by supplying the module sandwiched between anodized aluminium plates or high thermal conductivity ceramic plates such as alumina and beryllia.

An important aspect of all modules is that they are supplied flat and parallel to very close tolerances. It is equally important that they are mounted on surfaces prepared to the same tolerances otherwise module-to-surface heat transfer would suffer.

Mounting

A general mounting arrangement is illustrated in Fig. 3. The module can be fixed in place by epoxy resin or solder or preferably it can be mechanically clamped under firm pressure.

The interfaces merit special attention. The copper connecting straps in the module not only form the electrical current path but are also the surfaces by which heat is transmitted through the module. Clamping these connectors directly to metallic surfaces would cause electrical short circuiting and an insulating interface is necessary. This interface must obviously be a good thermal conductor otherwise an intolerable heat flow barrier would be built into the system. Because a good electrical insulator is not compatible with a good thermal conductor, much development work has been carried out to find the best compromise solution.

*Frigistor and Delacoat are registered trade marks.

Interfaces in general use are:—

- (1) hard anodized aluminium plates attached either by epoxy resins, or by mechanical clamping using silicone grease or oil for a good thermal contact;
- (2) films of materials such as mica, 'Mylar' and 'Teflon' usually in conjunction with a clamping arrangement;
- (3) spraying the copper straps with alumina to provide an insulating film with attachment as in (1) above or by metallizing and soldering;
- (4) building a module on to an alumina plate having attached conducting straps on the module side and a conducting surface on the other. The module is then soldered to the heat exchange surfaces. This latter technique has the advantages of eliminating poor conducting films of materials such as epoxy resin, high mechanical strength, and it eliminates the necessity to prepare accurate mounting surfaces as the solder film flows to take up discrepancies.
- (5) Frigistor modules which are now available with Delacoat insulated surfaces. These modules can be clamped to any conducting surface without fear of creating a short circuit.*

The importance of good thermal contacts cannot be over-emphasized. Every degree lost across a thermal barrier has to be deducted from the module performance when considering system capabilities. In the past it was common to have combined interface losses of 10 °C to 15 °C. With the latest techniques these can be reduced to as little as 2 °C.

It is inadvisable to use modules as structural members of any system. Tensile and shear forces can be particularly damaging.

Performance

Thermoelectric module performance is subject to a number of variables such as the operating current and its relationship with the designed optimum current, the temperature differential and the actual temperature of one of the junctions. When considering a system rather than a basic module, the temperature differential across interfaces must be known also.

Fig. 4 refers to a single couple designed to give a maximum temperature difference ΔT °C at 60 A. The relationship between ΔT °C and cooling capacity Q_c is shown for a series of different current ratings. The cold junction temperature T_c is maintained at 0 °C and a correction factor can be applied for different cold junction temperatures. Alternatively, a different set of curves could be used for each cold junction temperature.

Fig. 5 shows the variation of coefficient of performance with temperature difference for the same current values and under the same conditions as in Fig. 4. The current for highest coefficient of performance can then be selected.

When the current necessary to obtain the required temperature difference at the highest coefficient of performance is known, the voltage drop per couple is obtained from Fig. 6. Again, this voltage can be corrected for different values of T_c as the curves apply to $T_c = 0$ °C only.

The performance characteristics above refer only to the normal refrigeration mode of operation where current $I > 0$ and the temperature of the hot junction T_h is greater than that of the cold junction T_c ; i.e., $T_h > T_c$. For some applications, particularly air conditioning, other modes of operation must be considered.





When current flow is reversed (I negative), the modules operate as heaters. All the electrical power appears at the heated face together with heat pumped across the module. The total power Q_h was shown in expressions (3) and (4) previously. Comparison with vapour-cycle heat pumps shows that thermoelectric heat-pumping systems will develop coefficients of performance greater than unity at much higher temperature differences. Fig. 7 is a composite graph for a module operating in the heating mode. The information given is analogous to that of Figs. 4 and 5 and the cold junction is assumed static at 0°C for comparison. Correction factors for other values of T_c can be used as previously.

Also to be considered, and this applies particularly for air-conditioning projects, is the situation where the 'cold' junction T_c is in fact hotter than the 'hot' junction T_h , the current flow being normal (I positive). This mode of operation is referred to as the Q_c overload mode and can frequently occur, for example in winter, when, say, the outside ambient-air cooling the hot junction is at a much lower temperature than that of a room overheated by sunlight, and/or personnel or machines. It can most frequently happen in marine applications where sea water is used for cooling hot junctions at any season of the year. When $T_h < T_c$ expression (1) becomes

$$Q_c = \alpha IT_c - \frac{1}{2}I^2R + \kappa\Delta T \quad \dots (5)$$

where the heat flow by conduction aids the Peltier heat absorption instead of working against it.

When operating in the 'overload mode' condition, very high coefficients of performance are possible particularly under low current and low temperature differential conditions which can frequently occur in practice.

It is not generally realized, but because of the heating and

Q_c overload modes of operation, the annual running costs of thermoelectric air-conditioning systems are lower than costs of a vapour-cycle system working under the same conditions.

Module Limitations

Figure of merit Z is used to characterize a material since the maximum theoretical temperature difference ΔT obtainable from a material is $ZT_c^2/2$. Unfortunately the parameters (α , σ and κ) which define Z cannot be varied independently, and the temperature variation of Z is consequently governed by the temperature variation of these parameters. The present values of Z (i.e., of the order of $3 \times 10^{-3} \text{ }^\circ\text{K}^{-1}$) give temperature differences of approximately 75°C , the hot junction temperature T_h being 27°C , while $5 \cdot 10^{-3} \text{ }^\circ\text{K}^{-1}$, the maximum foreseeable value, represents a temperature difference of 90°C with T_h 27°C .

The present Frigistor modules are designed to give the optimum ΔT at 300°K , and although the temperature difference may rise as the temperature rises, it will nevertheless be less than the optimum. Fall-off in performance, which is due to the onset of intrinsic conduction, is small, amounting to about 15% at 200°C . This is approximately 70°C above the limit set at present by the low temperature solder used to produce the junctions. The lower operating temperature of a module is indefinite and is governed almost entirely by what the user considers to be an acceptable performance. ΔT , for example, at 200°K is 0.27 of that at 300°K .

Strains introduced into a module by differential thermal expansion do not limit the operational temperatures in the present modules, although in certain circumstances the life of a module which is rigidly fixed to either the heat sink or source can be affected. Strains introduced by temperature differentials produce bending of the module in the same manner as a bimetallic spring bends. Where plates are rigidly attached to several bridges both shear and tension exist. These strains are the reason for limiting the maximum size of a couple of the present design to a rating of approximately 100 A.

The maximum size of a rigidly-fixed aluminium plate on any module should not exceed approximately one in. square.

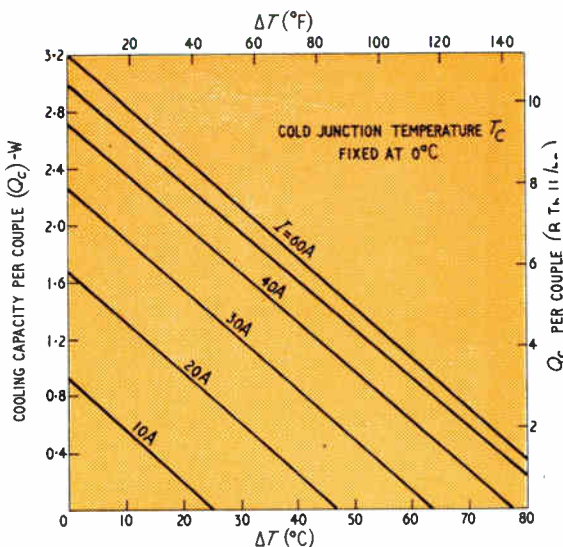
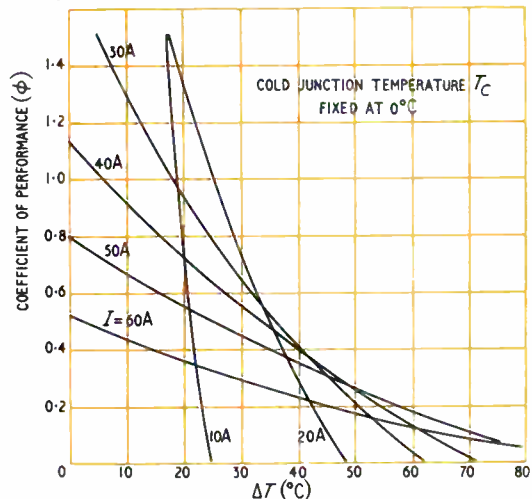

Fig. 4. Graph of cooling capacity per couple plotted against temperature differential for various current ratings

Fig. 5. Coefficient of performance plotted against temperature differential for various current ratings



The size of a module, mounted non-rigidly, is not restricted by these strains. However, modules become increasingly difficult to manufacture and use as the size increases. It should be remembered that effective heat transfer is only possible when surfaces are in good thermal contact and unless suitable provision is made for thermal distortion, poorer performance will result.

The lower limit of module size is fixed only by manufacturing difficulties. Module performance must be expected to fall as size is reduced because radiation losses and thermal shunting by the air and surrounding insulation material will proportionately increase.

The response time (i.e., the time taken to approach operating conditions after switching on) is governed by the thermal diffusivity of the material, the lengths of the p and n couples, the operating current, the conductance to the environment and, to a lesser extent, the thermal capacity of the junctions. For 'reasonable' values of these quantities, a response time of about 30 sec might be observed. This refers, of course, to a module or couple surface. The response time for the contents of, for example, a refrigerator or any other application will be much greater.

New Materials

New materials are assessed after preparation by measuring the parameters making up the figure of merit Z together with the more basic parameters of numbers of carriers and scattering mechanism. The latter are obtained from a measure of the voltage which appears mutually perpendicular to both an applied current and a magnetic field (i.e., the Hall voltage). These values enable the potentialities of the material to be assessed without the need for very large numbers of samples. The Hall measurements also allow the selection of the most effective doping agents. The latter are small and carefully-controlled additions are made to the basic semiconductor alloy to carefully balance the relationships between the parameters.

Practical Applications

In the field of instrumentation an osmometer has been developed to determine the osmolarity of biological and other

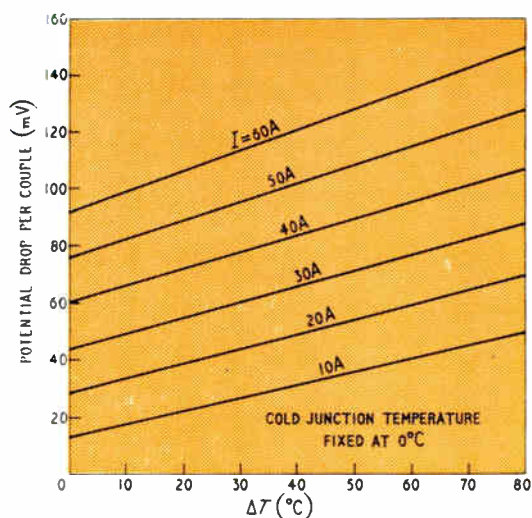

Fig. 6. The relationship between the applied potential and the temperature difference

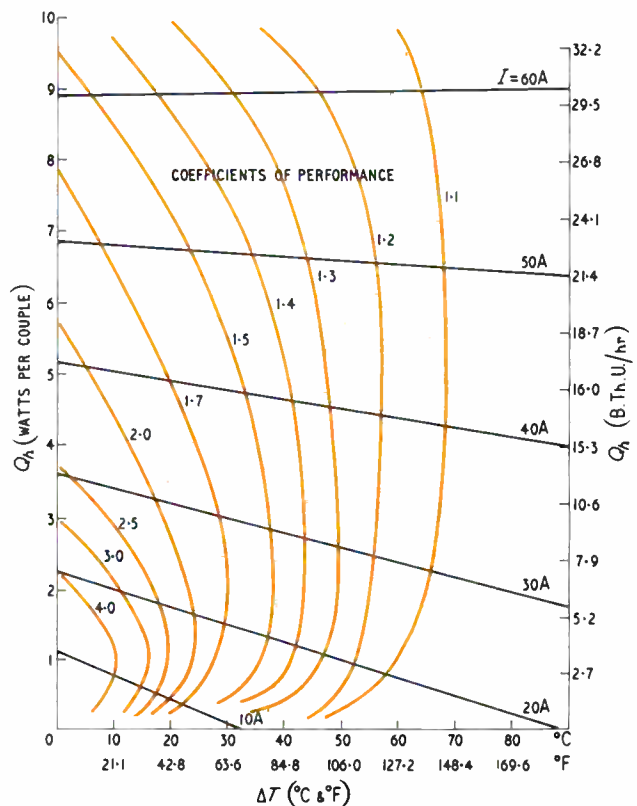

Fig. 7. The relationships between Q_h , I , T , and C.O.P. for a couple operated in the heating mode. The cold-junction temperature $T_c = 0^\circ\text{C}$

fluids by measuring the depression of freezing point. The equipment is fully automatic. A 1-2 ml sample of fluid is cooled in a chilled bath maintained by a Frigistor module and heat-sink assembly. At a pre-determined degree of supercooling (approximately 3°C), the sample is automatically raised from the bath and freezing is initiated by an electro-mechanical vibrator. The latter switches off as the temperature rises and then stabilizes at the freezing point due to latent heat. Temperature is observed on a readout meter or can be continuously monitored on a pen recorder. The primary sensing element is a thermistor connected in a bridge circuit.

The instrument was originally developed to monitor body fluids and to work in conjunction with an artificial kidney machine. Other models are being developed and will find application in the milk, chemical and oil industries.

Cold Platforms and Mounting Trays

Cold platforms or mounting trays are used to freeze down irregular, fragile or non-magnetic materials for processing. Frigistor trays up to 25 cm by 6 cm have been supplied to the jewellery trade for holding gold watch straps, expanding bracelets and tie pins during engine turning and engraving processes. The items are rapidly frozen in place using water, polyglycol or other suitable media, and they can be easily removed and cleaned. The semiconductor industry uses small mounting trays for freezing down very thin slices of silicon prior to scribing for the production of the very small pieces required for transistor manufacture.

Photomultiplier Coolers

Photomultiplier coolers have been supplied to manufacturers of particle counting equipment. Versions of this device are made to individual manufacturer's requirements.

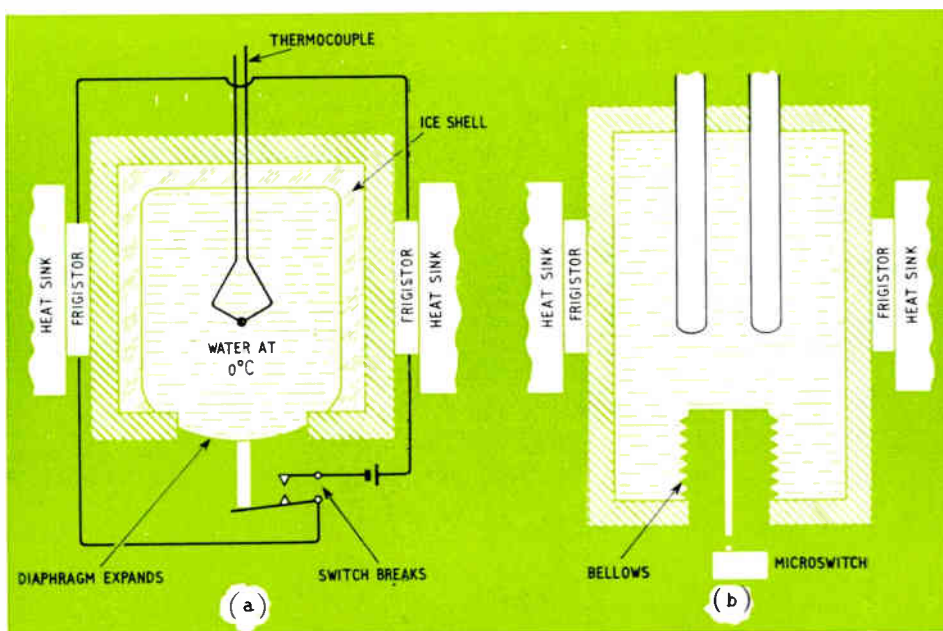

Fig. 8. (a) The Frigistor thermocouple reference chamber in schematic form; (b) The reference chamber in its final developed form

Two types have been developed; one cools the cathode region of the photomultiplier tube by direct contact with a metal block attached to the Frigistor modules; the other uses an oil as the heat transfer medium between the tube and the Frigistor modules. Measurements on the first type show two orders of magnitude reduction of dark current. Two stage thermoelectric cooling is being applied to improve performance still further.

Transistor Cooling

Some applications require close control of the transistor temperature whereas others only require the temperature to be maintained below a certain level. In either case it is generally possible to use an equipment chassis or cabinet as a heat sink for the Frigistor modules. An actual example concerns some transistors which had to be maintained below 50 °C and preferably below 30 °C in an enclosure the ambient temperature of which could rise to 70 °C. A special 2-couple assembly of the 15-A type operating at 8 A maintained the transistors below 25 °C even though the chassis temperature rose to 70 °C.

Television

Thermoelectric cooling is used to improve performance of the vidicon tube in a closed-circuit television-monitor system in a steel mill (*Electronic Design* July 5th, 1961). Operating in an ambient temperature of 60 °C, and with a cooling capacity of 5 W, the vidicon is maintained at 32 °C. The rest of the camera is cooled by forced air at 60 °C and operates at 71 °C. Reliable operation despite elevated temperatures is particularly important because the camera is inaccessibly located at the end of a travelling crane which is in use 24 hr a day.

Other applications are known to exist and new ones are suggested daily. The following are of general interest: the cooling of small hoppers feeding dies with granulated plastic material which previously tended to coalesce at the works ambient temperature; the extension of resin pot-life by cooling the mixture containers; the cooling of machine tool tips; the provision of small specialized test chambers for purposes such as creep tests, strength of materials; and the

testing of electronic components and assemblies down to -55 °C or even lower.

Laboratory and General Applications

Water/Ice Thermocouple Reference Chamber

This Frigistor instrument has been developed to take up to 180 fine-gauge (0.2 mm) thermocouple reference junctions. The junctions are maintained at 0 °C to an accuracy better than -0.009 °C to +0.05 °C and this temperature is stable to ±0.01 °C. The ambient range is +2 °C to 32 °C. Fig. 8 shows a working sketch of the instrument which comprises a water-filled hermetically-sealed copper chamber. Six stainless-steel tubes of 5-mm bore protrude through one end of the chamber and a flexible metal bellows forms the other end. Two Frigistor modules cool the copper chamber until a suitable lining of ice forms inside. The stainless-steel tube ends are then in a pocket of water completely surrounded by ice. As the ice forms, the metal bellows expand and operate a microswitch thereby opening the electrical circuit to the modules. The ice then melts and the bellows contract causing the module circuit to close and the cycle of operations to commence again and continue indefinitely. Thermocouples are simply pushed down the stainless steel tubes which should contain a little oil for good thermal contact. The instrument is cooled by natural convection and is completely self-contained requiring only an a.c. power source. Fig. 9 is a general view of the instrument.

The instrument described above can only be used in ambient temperatures above freezing point. Another version which also operates in ambients below freezing point is available. Non-standard forms of both types of instrument can be supplied to order; for example with thermocouples already wired in place.

The reference chamber is already used by the Electricity Industry, by the Atomic Energy Authority and by computer manufacturers, in addition to general laboratory use.

Temperature Controlled Chambers

These can be built for almost any purpose requiring a small chamber operating at temperatures as low as -55 °C. Of

particular interest are small chambers or ovens which provide a temperature-stabilized environment for quartz crystals used as electronic frequency standards. Without the ovens it would be impossible to use the crystals as the frequency varies with temperature.

In use, the crystals age and the process is accelerated at higher temperatures. Thermoelectric crystal ovens are used either to reduce the oven temperature, thereby increasing the crystal life, or to facilitate use of the oven in ambient temperature extremes.

Dew-Point Measurement

This is one of the simplest thermoelectric applications requiring a single couple for temperatures as low as -35°C . Two- or three-stage assemblies provide small surfaces which can be cooled to approximately -70°C and -100°C respectively to provide a good water-cooled heat sink. The dew point can be detected by means of a light beam reflected to a photocell by a mirror on the cold junction. As dew forms, the reflected light scatters and a signal is obtained from the photocell. Alternatively, two conducting films separated by a hair-line insulation gap can be used instead of a mirror and photocell. As dew forms, the insulation gap is bridged and a signal is obtained as current flows between the two films. The dew-point temperature can be measured by a thermocouple or possibly a thermistor.

These devices are commercially available, and it is interesting to note that their use is proposed for automatic weather stations because they can continuously monitor an environment for long periods without attention.

Infra-Red Detectors

A range of devices has been built to special order for cooling infra-red detectors and thereby improving their sensitivity. Fig. 10 is a general view of a three-stage device which cools the small detector element to almost -100°C in vacuo. The instrument is water cooled and the minimum temperature is slightly dependent on the water temperature. The first and second stages, which operate inside a vacuum cover, can be seen but the first stage and water-cooled heat sinks are hidden by the instrument case.

Pour-Point Determination

A Russian instrument has been described¹ for determining the pour point of petroleum products. The equipment is automatic and operates by passing ultrasonic pulses through an oil sample which is being gradually cooled by a thermoelectric system. When the pour point is reached, the pulses begin to be attenuated. The oil temperature, which is monitored by a thermistor, is rapidly increased to 10°C by reversing current through the thermoelectric modules. The sample is then automatically poured out and replaced by another.

Cloud-Point Determination

This is another test carried out by oil laboratories for determining the temperature at which component crystallization commences. A two-stage Frigistor system has been supplied for prototype development. The control system will more conveniently depend on an optical technique.

Melting-Point Apparatus

Progressive chilling and reheating of samples is simple and easily controlled by thermoelectric cooling. Materials which are liquids at normal ambient temperature can now be identified by their melting points; the determination being simpler and requiring much smaller samples than a boiling-point determination.

Industrial Electronics March 1966



Fig. 9. The Frigistor thermocouple reference chamber



Fig. 10. A three-stage thermoelectric cooler for infra-red detectors

Conclusion

The list of applications is by no means exhaustive and could be extended into specialized fields such as preferential absorption of samples in gas chromatography on a micro scale. However, the range of applications and developments in different fields has been chosen to indicate devices of more general interest and which are either readily available or in an advanced state of development at the present time.

Acknowledgement

It is a pleasure to acknowledge assistance received from many colleagues, in particular Mr. A. Penn, for the section on module limitations. The York Division of the Borg-Warner Corp., Pennsylvania, supplied Fig. 3.

Reference

¹ Kolenko, 'Thermoelectric Cooling Devices'.

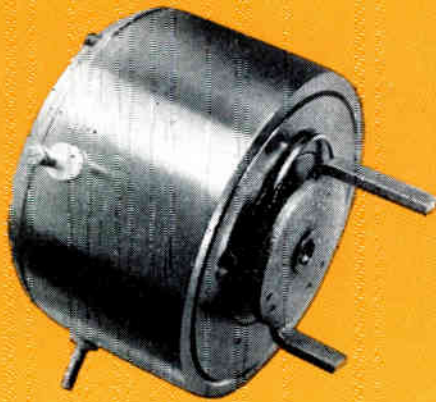

General view of complete Rotenoid actuator

THE 'ROTENOID'

a true rotary solenoid

By G. W. CULLEN*

The Rotenoid is a true rotary solenoid, the rotor of which is urged round by a perfect magnetic couple. This article explains the operation of this device and outlines its use with wafer switches and as a circuit selector for a variety of applications.

ROTARY solenoids have been used since World War II as cheap, compact but powerful snap-action actuators where a limited angular stroke is required. Normally a return spring resets the shaft to the 'start' position when power is removed. In electronic equipment they often appear as circuit selectors, in which the solenoid is used to drive a rotary switch shaft in discrete uni-directional steps with the aid of a ratchet and indexing mechanism. Thus the switch shaft is advanced by one position each time a pulse is received. Alternatively the circuit selector will function as a remote homing device in a manner similar to that of a uni-selector.

Until now the majority of rotary solenoids available in the U.K., U.S. and Europe have been basically plunger-type electro-magnets whose linear motion is converted to rotation by balls or rollers travelling on inclined or spiral tracks. Attempts by many designers to produce rotary motion by direct magnetic action appear to have failed to achieve an efficiency comparable with that of the spiralling plunger.

This article shows how a modern approach to design involving a thorough understanding of the problem being attempted has resulted in the development of a true rotary solenoid (called the 'Rotenoid')† whose output for a given power input compares well with other rotary solenoids of similar size and which offers a number of advantages.

Advantages of the Rotenoid

Designers of electronic systems have sometimes criticized existing quasi-rotary solenoids, particularly on grounds of reliability. A true rotary solenoid has the advantage of ultimate simplicity in the action of its moving part, reducing friction to a minimum. In the Rotenoid the armature is light and balanced, providing immunity from vibration, shock and high levels of linear acceleration. Moreover, the armature is urged round by a perfect magnetic couple which itself imposes virtually no radial or axial load on the bearing

system. The result is a smooth action with a minimum of self-generated vibration to induce failure in itself or surrounding components.

A further advantage is that the stroke can be limited by the user to suit his particular requirements without risk of deranging the solenoid mechanism.

Arrangement of the magnetic circuit has permitted the inclusion of two widely-spaced bearings which can be made substantial. As no linear motion is involved, coupling of the output shaft to the load can be made simple and free from wear.

In its standard form the Rotenoid is dustproof, but it can be fully sealed for use in particularly severe environments.

The torque characteristic of the magnetic gap system is constant, obviating the need for mechanical distribution of the work content of the stroke—the limited rise in end torque at high powers due to saturation of the iron is peculiar to all solenoids.

This new solenoid also has an excellent temperature capability which reduces the risk of inadvertent 'burn-out'.

To sum up, the Rotenoid has a number of attributes to commend it to designers of new-generation military and industrial equipment.

Development History

The initiating directive was simply to develop for production a reliable but competitive tractive rotary solenoid in a

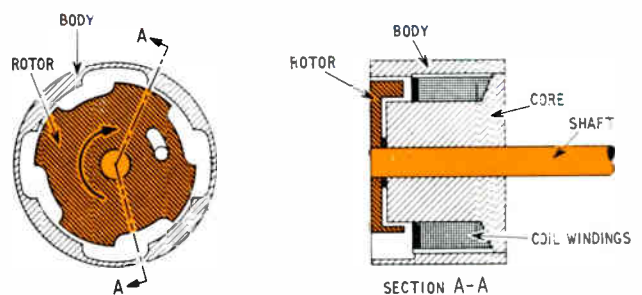

Fig. 1. Prototype design to system 1. Note that the magnetic gap length is constant but the adjacent face areas are increased as the stroke progresses

*Plessey Components Group.
†Registered trade mark.

popular size. As the project was to be undertaken for the Professional Components Division, considerable accent was placed on reliability.

A market survey showed that a device about 1.4 in. in diameter and under 1 in. long was the most acceptable. Thus the maximum dimensions were set. It was noted, however, that units 1.9 in. in diameter were also popular and that the design chosen should be suitable for adaptation to a larger size. Examination of relevant sales literature revealed that existing rotary solenoids were of the flat-faced plunger type, axial force on the plunger being converted to torque by various forms of inclined plane. With this arrangement it is necessary, and fortuitously possible, to distribute the work content to the inverse-square force-stroke characteristic of a flat-faced plunger more evenly through the angular stroke by 'shaping' of the inclined plane.

The salient question was: if an angular stroke is so desirable, why not produce it directly with a magnetic couple? Patents, ancient and modern, disclosed much work in this direction, but there was no evidence of a true rotary solenoid currently in production. Hence an efficient magnetic couple became the goal and the prospect of doing something that had not been done successfully before lent incentive and challenge to the project.

Two ideas were put forward for consideration. We will identify them as:—

System 1: constant magnetic gap, increasing area of pole face (Fig. 1)

System 2: constant area of pole face, decreasing magnetic gap (Fig. 2)

Of the first prototypes neither gave a particularly impressive performance. Nor was it clear which arrangement should be pursued and, since different gap systems were being considered, the need for a general tractive force formula, which could be applied to either, became apparent.

In an electro-magnet of the angular form it can be shown that:

$$\text{Torque } (T) = 4.43M^2 \frac{dP}{d\theta} \text{ lb in.} \quad \dots (1)$$

where M = m.m.f. across active air gap in ampere turns

$P = uA/L$ = permeance

A = Gap face area in sq in.

L = Gap length in in.

u = Magnetic Space Constant = 3.192×10^{-8}
Weber/Ampere-Turn per Inch

and θ is in radians.

In words, we can say that traction is proportional to the rate of change of active gap permeance.



Applying Equ. (1) to System 1 (annotated in Fig. 3) we have:

$$T = \frac{4.43M^2 \cdot u \cdot h \cdot r \cdot N}{L} \text{ lb in.} \quad \dots (2)$$

where h = Depth of outer gap in inches

L = Outer gap length in inches

r = Mean radius of L in inches

N = Number of teeth

For a given power (and neglecting saturation of the iron) all the terms of Equ. (2) are constant, giving a constant torque characteristic. In words, we can say that torque is proportional to the depth and number of teeth and inversely proportional to the gap length (not the *square* of gap length as in plunger systems).

Equation (1) was also applied to System 2. It will suffice here to say that the torque characteristic takes the form of the inverse square law.

The Final Design

With the understanding provided by the general tractive force formula, it was clear that the work content of the torque/stroke characteristic of System 1 (constant gap, increasing area) would always be biased towards the beginning of the stroke. In System 2 (constant area, decreasing gap) the work would tend to appear later in the stroke. Thus, there was some difficulty in deciding which of the two systems to develop. That which started well might start an operation it could not finish, while the system which gave out most work at the centre of the stroke might not start at all!

System 1 was chosen for the following reasons:—

- (a) Practically all loads have static friction, and maximum torque at the beginning of the stroke would be useful in overcoming this factor. Moreover, this type of torque/stroke characteristic seemed ideally suited to the operation of multiple wafer switches where a high initial torque is desirable to overcome the switch detent mechanism. Torque above that required to turn the load would accelerate the load during the initial part of the stroke and emerge as kinetic energy at the end of the stroke—but this was not to say that kinetic energy should be relied on to complete the stroke. At least the work was being obtained from the solenoid, however, and any acceleration achieved could be beneficial in producing a rapid action.

Fig. 2. Prototype design to system 2. In this case the adjacent tooth face areas are constant but the mean gap length decreases as the stroke progresses. Note that axial thrust tends to be severe

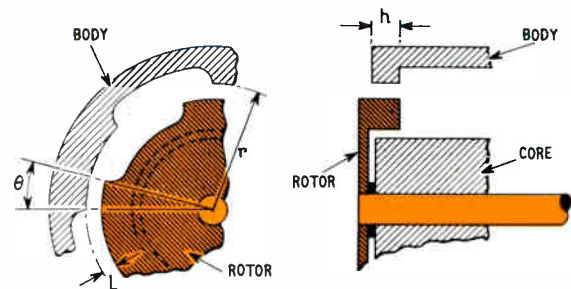
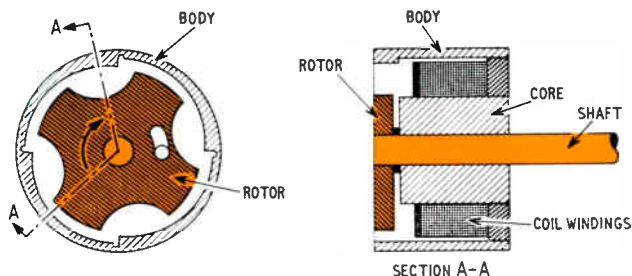

Fig. 3. Annotation of the active gap of system 1 for use in Equ. (2)

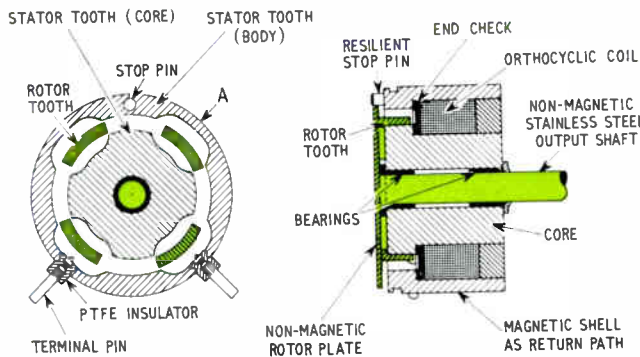
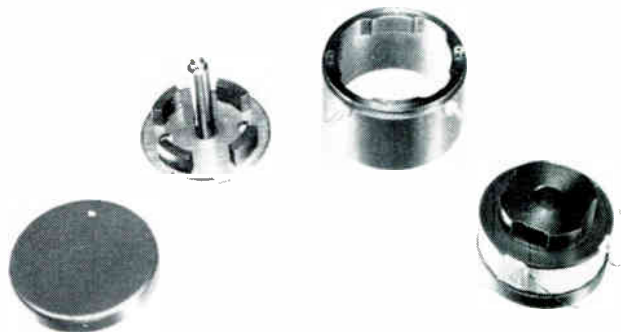

Fig. 4. Form of the final design. The drawing clearly shows how the permeance of the inner gap changes as the stroke progresses, contributing to the work output. It also shows that radial movement of the rotor teeth produces no overall change in active air gap permeance and hence there are no radial forces present. Moreover, as the rotor plate is non-magnetic, axial thrust is minimal

Fig. 5. An exploded view of the Rotenoid components



- (b) There remained a further improvement that could be introduced into the final form. At the beginning of the stroke practically all the magnetizing force of the coil acts across the active outer gap of System 1, since it is by far the greatest reluctance in the system. As the stroke progresses, however, the reluctance of the outer gap reduces to a value not much greater than that of the inner gap. The m.m.f. acting on air is now divided between the two gaps, that portion magnetizing the inner gap being wasted. By introducing teeth on the core and completely isolating individual teeth on the rotor, the inner gap would be made active too with a notable increase in end torque.
- (c) The magnetic efficiency of System 1 would always be very high in that nearly all the available stroke is useful. In systems having an inverse square law characteristic, the work content of the initial part of the stroke tends to be lost, due to the very low starting force or torque.
- (d) System 1 was relatively easy to produce, easy to design and permitted both directions of rotation with common piece parts. The concept was also flexible in the range of stroke angles that could be provided. Reference to Equ. (2) will

show that torque is proportional to the number of rotor teeth. However, an increased number of segments would only permit a shorter angle of rotation. It was clear that a given size of solenoid could be used to produce a high torque over a short stroke or a low torque over a long stroke—the work content would be approximately the same. Stroke angles in the range of 15° to 80° were planned employing between 8 and 2 teeth.

- (e) If desired, a certain amount of torque shaping could be achieved by varying the depth of and/or angle subtended by the teeth.

The form of the final design is shown in Fig. 4 and Fig. 5. The rotor plate which carries the rotor segments is made of austenitic (non-magnetic) stainless steel so that the inner gap is not shunted and there is minimum axial thrust. As the rotor segments can move radially in the gap without producing any overall change in permeance, and therefore no change in flux, there is no radial force upon them. We may say that the design produces a perfect magnetic couple. It is clear that this arrangement is not conducive to wear and, in fact, a life of 1.5×10^6 operations has already been exceeded.

Fig. 6. The Rotenoid as a 12-position, 5-pole, circuit selector showing below it a suitable commutating switch

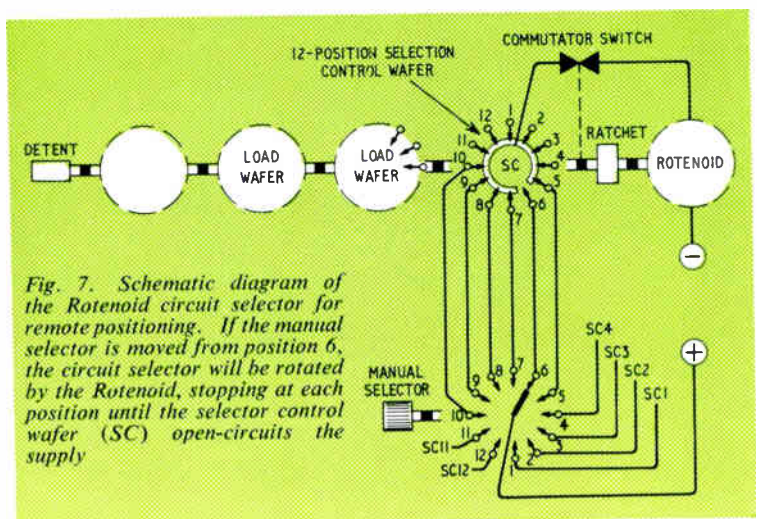
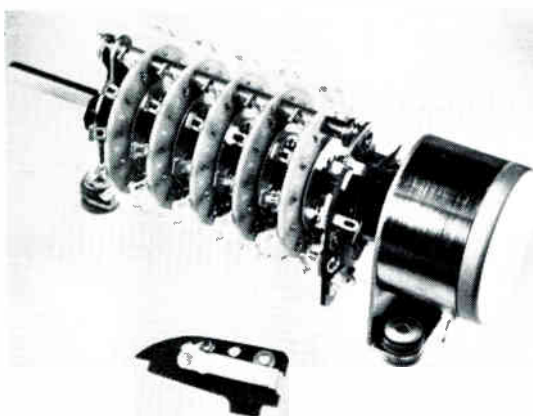

Fig. 7. Schematic diagram of the Rotenoid circuit selector for remote positioning. If the manual selector is moved from position 6, the circuit selector will be rotated by the Rotenoid, stopping at each position until the selector control wafer (SC) open-circuits the supply

Great care was taken to ensure an even cross-section of iron throughout the stator, the thick section between the body teeth (arrow A on Fig. 4) being essential in feeding flux to the outer teeth. The distance between body and core teeth and the depth of the scallops are an optimized compromise to keep leakage to a minimum. It will be noted that the scallops on the body provide a convenient place for terminals. Flying leads were avoided as they are invariably too long for some applications and too short for others. Leads could also help to introduce moisture to the inside of the solenoid.

Certain other aspects of the design are discussed in greater detail in the paragraphs which follow.

It must be mentioned that combinations of Systems 1 and 2 are possible but, generally speaking, starting torque will be low, particularly as, with a direct rotary action, there is no mechanical inclined plane that may be 'shaped' to amplify the starting torque. It was felt that devices similar to System 2 would be more expensive and would not permit the use of common piece parts for both directions of rotation.

Materials, Construction and Manufacture

Examination of the exploded view of the Rotenoid (Fig. 5) in conjunction with Fig. 4, will give an understanding of the construction.

The static magnetic circuit comprises purified iron to minimize the energy lost in magnetizing the system. Each part is individually electroless* plated with nickel, which is of low porosity and not prone to galvanic corrosion. Moreover, nickel is ferro-magnetic. It will be noted that the orthocyclic and free-standing coil is trapped at one end by the iron collar which is forced on to the core. Subsequently the collar (carrying the core and coil) is forced in to the body to form a complete stator assembly, and to obviate the risk of movement between core and body the outer joint is brazed.

The orthocyclic coil warrants special mention. In an ordinary coil the wires of adjacent layers do not lie parallel to each other. In an orthocyclic coil all the turns are kept at right angles to the coil axis and the wires of succeeding layers can be caused to fall in the grooves produced by adjacent wires of the preceding layer to give an increase in space factor of 10%. This is an important contribution when obtaining the maximum work from a solenoid of limited size. In addition, mechanical and electrical stresses on the wire are reduced and thermal conductivity is improved.

The magnetic circuit is completed by the mild steel segments that are welded to the non-magnetic stainless steel rotor plate. The segments are cut from extruded section and, without modern electronically-controlled welding equipment, it is difficult to see how this assembly could have been made an

*Electroless refers to a solution which is not an electrolyte.

economic proposition. Incidentally, the shaft is also welded to the rotor plate to complete a strong and rigid rotor assembly. Readers will see that the rotor is light and balanced, rendering it free from the effects of vibration.

Where there is no great radial load on the shaft, it is carried by oil-impregnated bushes. When the load to be driven imposes great side thrust on the solenoid shaft, roller bearings are provided.

Stroke angle is controlled to $\pm \frac{3}{4}^\circ$ by a 'cut-away' in the rotor plate. Movement is limited by a heavy duty curled pin which, being resilient, absorbs shock and reduces noise. At the time of writing, a test piece has completed 10^6 cycles at high power with no significant wear of pin or rotor plate.

The terminal pins are silver plated for good solderability and are held in position by p.t.f.e. insulators which are extruded into the holes provided. Cross-wire welding is used to join the coil lead-out and the terminal pin.

At the rotor end the coil is contained by an end check moulded in diallyl phthalate (d.a.p.), a high-temperature thermosetting material. The use of d.a.p., p.t.f.e. and high-temperature wire makes it possible to operate the Rotenoid at 180°C . For the same reason, it may be run at 15 W continuously and without a heat sink in an ambient temperature of 35°C , and a life of 20,000 hr can then be expected.

Finally, on the topic of construction, it remains to explain that the cover is clenched in position to exclude foreign particles and complete an assembly which is virtually unaffected by environment.

Coil resistances in the range 0.84–5,000 Ω are provided, and the general performance characteristics of a typical version are summarized in Table 1.

Applications

It has been mentioned previously that the Rotenoid is highly suitable for remote control of multiple wafer switches, and it is shown in the role of a circuit selector in Fig. 6. When such a device is used as a stepping switch, the commutating switch is wired in series with the Rotenoid coil. A cam, operated by the Rotenoid, opens the commutating switch just before the end of the forward stroke, which is completed by the inertia of the armature and the 'snatch' of the indexing mechanism. The return spring drives the armature backwards, closing the commutating switch about the same time as the next tooth on the ratchet is engaged. Thus the Rotenoid is made to reciprocate rapidly (each cycle taking 20–45 msec to complete, depending on load and power) causing the switch to rotate in discrete unidirectional steps.

As a stepping switch the circuit selector can be made to home remotely on to any one of twelve positions by wiring a 'selection control' wafer, the commutating switch and coil all in series (Fig. 7).

Table 1: Torque chart of Size 14 Rotenoid

Duty Cycle (See Note 1)			$F = 1$	$F = 0.83$	$F = 0.42$	$F = 0.21$	$F = 0.16$
			Unlimited Continuous Duty	$a = 60$ sec	$a = 20$ sec	$a = 6$ sec	$a = 5$ sec
			$F \rightarrow 0$	$F \rightarrow 0$	$F \rightarrow 0$	$F \rightarrow 0$	$F \rightarrow 0$
			$a = 17$ min	$a = 4$ min	$a = 1$ min	$a = 35$ sec	
Amp-turns at 20°C			576	630	890	1,240	1,410
Maximum watts in free air at 35°C (See Note 2)			15	18	36	70	90
Torque in lb-in. and, in brackets, gm-cm at 20°C	35° Rotary Stroke	Start	0.9 (1039)	1.1 (1269)	1.8 (2075)	2.4 (2770)	2.5 (2882)
		End	0.65 (750)	0.7 (807)	0.8 (924)	1.1 (1269)	1.2 (1384)

Note 1.— F = Fraction of time 'on' in one duty cycle. $F \rightarrow 0$ is applicable when the solenoid cools to ambient temperature during 'off' periods. a = max. length of energized period 'on' in one duty cycle.

Note 2.—'Maximum watts' is the initial dissipation of a solenoid which is at ambient temperature when the supply is first switched on.



If the circuit selector is driven by pulses of indeterminate length the commutator switch can be used to insert a resistance in series with the coil at the end of the stroke. This will prevent overheating when the pulses are very long and also conserve power.

Often a designer wishes to introduce a manual setting knob on the free end of the switch shaft. To facilitate freedom of movement in each direction, a ratchet that disengages completely can be supplied.

To achieve remote bi-directional operation, a solenoid can be placed at each end of the switch shaft; the disengaging ratchet is necessary here too.

S.R.B.P. or ceramic wafer switches similar to the Plessey 'GA' Range are normally used in selectors, but there is now a trend to replace the wafer switches with easily-replaceable printed switch cards for certain low-power applications.

For higher power switching, the Rotenoid can be used to operate banks of micro-switches simultaneously through a cam shaft.

As a form of remote position control, the Rotenoid will often provide a modestly-priced alternative to a position servo comprising synchro (or potentiometer), amplifier, small motor and gearbox.

Hitherto, a large part of the demand for devices of this type has been for military application, but, with the increase of automation and computation, industrial outlets for the Rotenoid are increasing. Moreover, the new industrial applications require a unit-life expectancy previously specified for military applications only.

The Rotenoid should also be thought of as a general-purpose actuator. Its rotary action will often obviate the need for a crank lever and contribute to a compact assembly. Normally a return spring suited to the mode of operation is provided. In this form the solenoid can provide a 'fail safe' device, cutting off fuel, say, when electrical power fails. Where it is necessary to conserve electrical power two Rotenoids may be used 'back to back' to give dual position control, current only being consumed in the few msec required to get from one position to the other. In this case the return spring is omitted.

A simple form of telegraph giving from two to twelve signals can be obtained by replacing the load wafers of the circuit selector with an indicator. Again no power is consumed once the pointer has been positioned.

A few of the possible applications are: hydraulic and pneumatic valve control; waveguide control; wave change mechanism; automatic machine-tool control; automatic check-out of cable looms; computer peripheral equipment; counting; ticket issuing machines; vending machines; automobile transmission control; carburettor control; remotely-controlled safe locks; and camera actuation.

A.T.C. Radar for R.A.F.

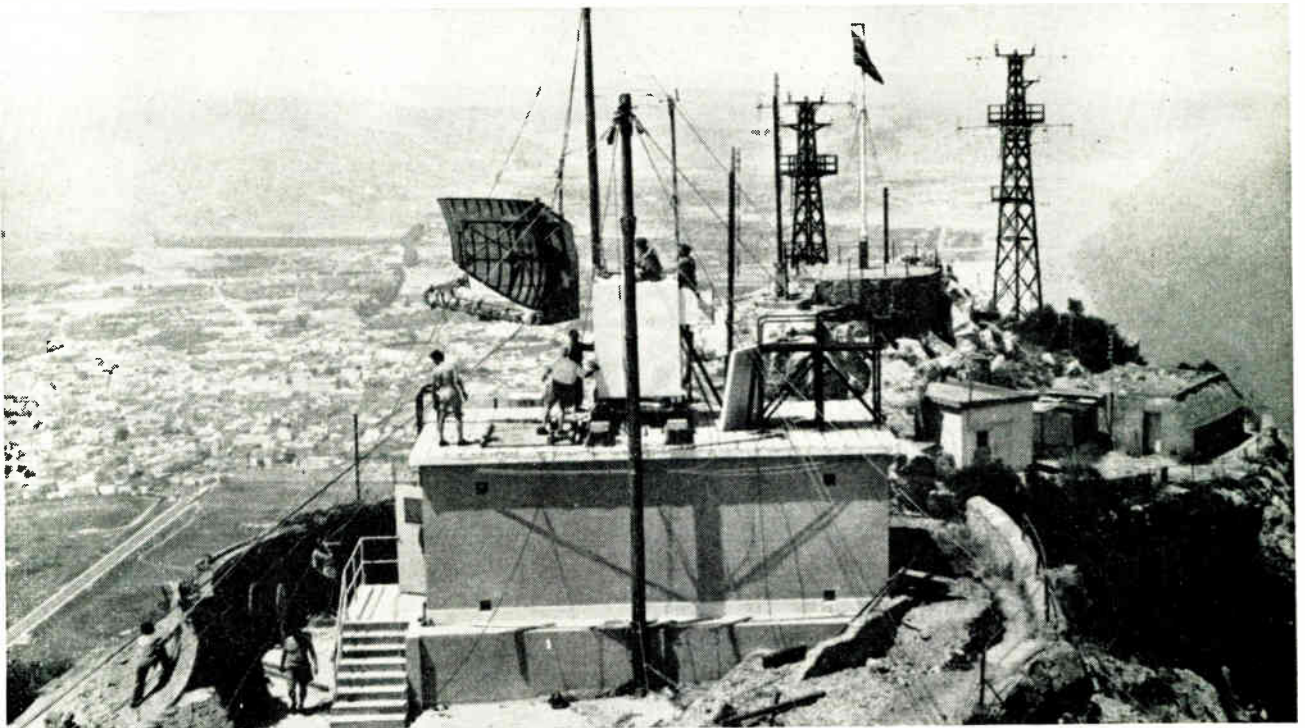

A total of thirty Plessey AR-1 radar installations has now been ordered by the Ministry of Aviation for air-traffic control at R.A.F. home and overseas stations. These high-definition, general-purpose systems fulfil all air-traffic control functions within 75 miles of a terminal, and one such system will soon be providing London (Heathrow) Airport with additions to its terminal-approach and intermediate-range surveillance facilities.

Due to their compact design, these radar systems can be fitted with comparative ease, even when the site presents installation difficulties, and the picture shows an AR-1 aerial (one of thirteen recently ordered) being installed by the R.A.F. at Gibraltar, where more detailed control information from existing radar installations will be provided.

For further information circle 47 on Service Card



This shows the 'room status' display panel at the receptionist's desk

New Communication System for Hotels

The world's first fully transistorized 'room status' and 'maid location' system has been installed by the British Relay organization in London's new Royal Garden Hotel.

This system indicates which rooms are vacant, let, or vacant but not ready for letting. A display panel with indicators for each room is situated at the reception desk, the cashier's desk, and the housekeeper's office.

How it Operates

Each vacant room is indicated by a green light on the panel. When a room is let the receptionist presses a button to cancel the appropriate light. A 'no light' indicates that the room is let. Therefore, the receptionist acts only on green lights. When a client vacates a room and clears his account at the cashier's desk the cashier depresses the appropriate button adjacent to the room number and sets up a red indication light on the receptionist's and housekeeper's panels.

The housekeeper directs the maid by intercom to the vacated room indicated by the red light on the panel. When the maid enters the room she inserts a key into a panel which sets up a winking white light beside the red light on the housekeeper's panel. Meanwhile the red light remains on the receptionist's and cashier's panels. When the maid has finished she withdraws the key and the white light ceases to blink and remains constant. The housekeeper then directs the floor assistant housekeeper to the room which is checked and cleared by inserting a clearing key into a socket to set all lights to green to indicate that the room is available for letting.

The location of the maid is always shown by a corridor indicator on each floor working in parallel with a flashing indicator on the housekeeper's panel. Maintenance of the system is simple—each room has a module on a centrally-housed printed circuit board and a faulty module can be removed and replaced by a spare within seconds.



Each bedroom has a bedside panel carrying the push-button controls for the 6-channel relay television system; the controls for the closed-circuit television system linking all major parts of the hotel; the controls for the 4-programme radio service; the background music controls; the indicator for the 'message waiting' system which is combined with the key rack and ensures that a client proceeding straight to the room will see the visual indication and telephone the enquiry desk for the message; the cancel button for the labour-saving 'morning call' system whereby guests book their calls through an automatic storage unit; and light switches

Applications and Techniques

'Talking' Computers for Phone-Call Charges

Computers that 'talk' are now being used to give long-distance telephone operators split-second information on the cost of calling over 30,000 exchanges in the U.S.A. and Canada.

The system, which has been installed by the Northwestern Bell Telephone Co. in Omaha, U.S.A., and employs a matched pair of Honeywell 200 computers, saves operators 45 sec or more in determining rates on many long-distance calls. It takes only 15 sec for the relevant details of the call to be keyed into the computer, an 'audible voice' reply being made almost instantaneously. Spoken words are recorded on a small magnetic drum and the computer 'talks' by picking out those it requires to give the correct call cost; the drum unit also contains pre-recorded phrases, which may be automatically selected as appropriate.

Aircraft Refuelling Control

Manchester Airport has been fitted with an aircraft bulk-refuelling installation commissioned by the Esso Petroleum Co.

The system provides 20 refuelling positions

which are supplied from nine underground tanks. Three 50-h.p. pumps feed the fuel through two underground pipelines to the outlet hydrants.

Transistorized level-control equipment manufactured by Lancashire Dynamo Electronic Products and installed by B. French Ltd. controls the pumps. It maintains the required flow in the output line and ensures that excessive pressures do not develop when all the outlets are closed. The flow rate is measured on a proportional flow transducer and is controlled by a pressure switch. The transducer output is a train of pulses, the pulse rate being proportional to flow. It is passed through a frequency converter to provide an input for a disc chart recorder. This is fitted with two adjustable limit switches and the complete arrangement provides three contacts which energize star-delta starters for the pumps.

The equipment senses the rate of feed required and initiates one, two or all three of the pumps accordingly. A control station provides an indication of the extreme levels in the fuel tanks. High- and low-level probes in the tanks provide the signals for this.

Data Loggers for Aircraft Testing

Four data loggers, specially designed by English Electric-Leo-Marconi Ltd., have been delivered to the Royal Aircraft Establishment at Farnborough, Hants., and will be used to record the results of structural tests on aircraft during 'torture' tests in a ground testing rig.

The four loggers can together continuously record the strain and temperature measurements (represented by millivolt signals derived from thermocouples and strain gauges) at 3,072 separate points on an airframe under test, at a rate of 32 points per second per logger. The signals are converted into digital values, which are punched out on paper tape ready for feeding to a computer for analysis.

Each logger has to operate in an area of heavy electrical interference, and particular attention



This shows a BAC 111 aircraft being refuelled by the controlled equipment at Manchester Airport

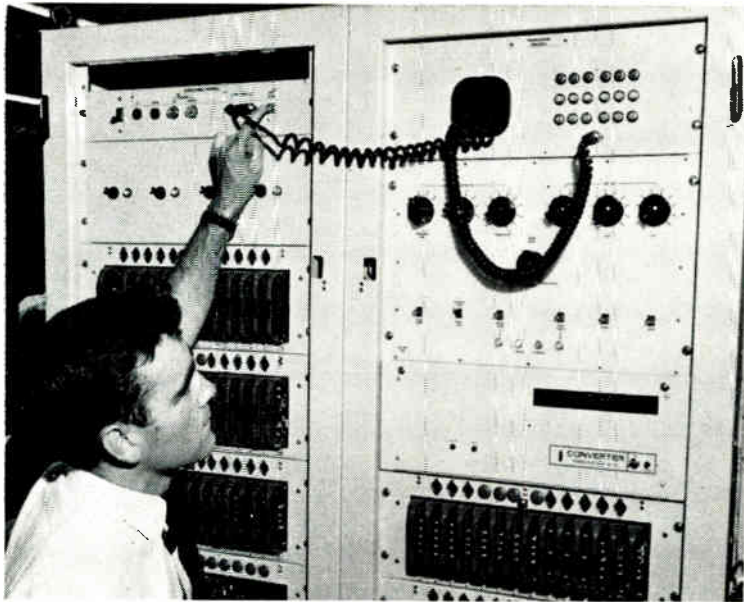

The data loggers are now completing their commissioning stage, and one is shown here, prior to delivery, on final test at Marconi Instruments' Kidsgrove factory

has consequently been paid to the sampling system and the removal of induced noise by a combination of continuous and numerical filtering.

The scanning system of the equipment is manufactured in modular form, thus providing a high degree of flexibility—particularly convenient for experimental work—and reducing the extent of transducer cabling.

For further information circle 48 on Service Card

P.C.M. Telemetry for the Concorde

It is essential to record as much data as possible during one test flight of an aircraft under development. Telemetry equipment is often used for this but the existing systems are limited in the number of channels they can accommodate. Several test flights have to be made before adequate information about all the factors affecting the aircraft's performance can be recorded.

For the Concorde project, a pulse code modulation (p.c.m.) telemetry system will be used. It is being developed by the British Aircraft Corp. in collaboration with Radiation Inc. of the U.S.A.

In this 2,500-channel system, the output signals from a number of transducers in the aircraft are sampled in turn and passed to an analogue-to-digital converter. The digital output from this is in a binary form and is transmitted over a radio link to a ground station to be recorded on magnetic tape. This data relates to such parameters as oil pressures, vibration, etc.

The use of p.c.m. allows for many more channels of information than do other types of telemetry. Also, more noise can be tolerated as the receiver has to distinguish between 'on' and 'off' states only. This is not the case with systems

which depend on varying amplitudes or frequencies. A further advantage is the higher accuracy of measurement.

P.C.M. telemetry is versatile and is suitable for any applications in industry where large amounts of accurate measurements are needed.

X-Ray Recording on Television Film for Hospitals

X-Ray pictures of patients are now being recorded on television film to assist doctors in their diagnosis and teaching at two of London's teaching hospitals—Guy's and St. Bartholomew's.

The pictures are taken with a Sony 'Videocorder' (Type PV-120 VE) in conjunction with a Marconi television X-ray image intensifier, and are recorded on magnetic tape in the form of a television signal. The picture can be played back at any time, thus obviating the need to expose a patient to further radiation during a second examination.

The X-ray image intensifier, by increasing electronically the brightness of the screen image, gives more information and uses less radiation than normal X-ray methods, and the Videocorder replaces the conventional cine-film technique that requires larger X-ray doses to expose the film and has a longer processing time.

The instant availability of television tape recordings (which can be re-used repeatedly), together with the facility to show pictures in slow motion, either forwards or in reverse, is proving of great value for examinations of processes such as heart action or swallowing, which are too fast for observation at normal speed. A single frame can be held stationary for many minutes, and no operating adjustments are needed on replay, only one being required to record. Two audio channels are also available, one of which can be used for dubbing commentary on to an existing video recording.

For further information circle 49 on Service Card

The equipment used for recording X-ray pictures on television film. On the right is the Videocorder, on the left the X-ray image intensifier, and in the centre is a monitor screen

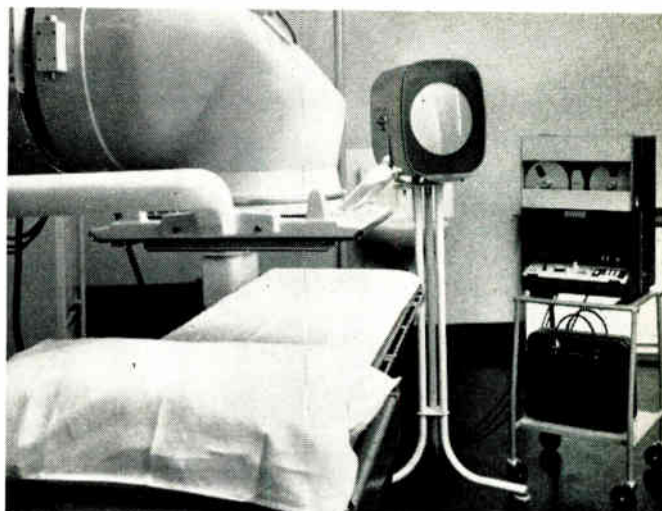

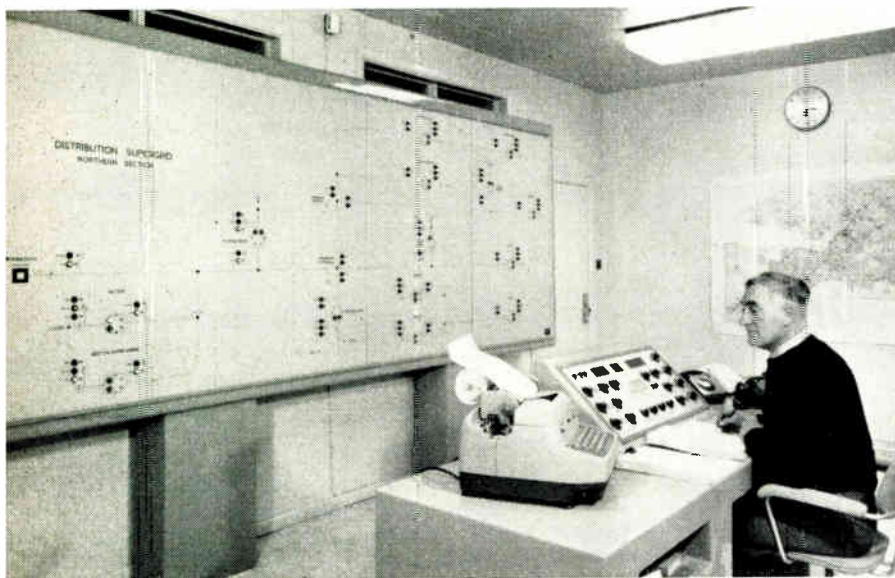

The Seabank control centre, whose mimic panel indicates points of the 'supergrid' in alarm and which contains a two-way telephone link with each outstation

High-Speed Control for High-Speed Gas

Gas distribution by the high-pressure 'supergrid' which is fed from the South Western Gas Board's plant near Avonmouth is being controlled by a supervisory and remote-control telemetering system ('Westronic') manufactured by Westinghouse Automation.

The telemetry equipment enables information to be transmitted in digital form between five unmanned outstations and the control centre (at Seabank), and eventually sixteen outstations at different points on the pipeline will be linked to the centre.

A total of 98 indications and 27 control functions (relating to gas pressures, rates of flow and governor and valve positions) are dealt with by the system, and these are logged at pre-set time intervals by an automatic typewriter in the control centre.

Alarm equipment continuously scans 90 points over the entire 'supergrid' every eight seconds, any alarm state being immediately indicated on a mimic panel and giving rise to an audible warning.

For further information circle 50 on Service Card

Finger-Print Identification by Computer

In order to combat the modern scientific criminal, I.B.M. computers are being used by police forces for the identification of finger-prints. The aid that the computers can offer to crime detection is now increased by the introduction of new methods of finger-print coding.

The conventional method is to feed the finger-prints into the computer in a coded form as a series of points. Treated photographs of the prints are read by an optical reader and the computer compares the prints with those in its file until matching prints are found. The suspect's name is then printed out.

Finger-prints on police files are taken under perfect conditions. Those found at the scene of

the crime are often distorted or left on rough surfaces. This makes the matching process difficult and a long list of suspects with similar prints has to be produced. The list is then narrowed down by normal police methods.

It has now been discovered that if the prints are coded by the angular values of their families of curves (i.e. sines and cosines) the values remain fairly constant if the prints are distorted. With the use of this method of coding, the computer produces a much shorter list of suspects, as many of the similarities between prints due to distortion are eliminated. The computer can produce the list even when working on a fragment of a print.

Microswitch Control for Fermenting Vessels

To cope with an increased demand for beer, Ind Coope Ltd. are commissioning a giant new 432,000-gallon capacity fermenting block at their Burton-on-Trent Brewery.

Close temperature supervision of the fermenting process is a feature of the installation, which consists of 27 vessels capable of holding 400 barrels and six holding 200 barrels. When the beer is transferred from the collection vessels to the tanks, its temperature is raised by two-degree stages (up to a mean 70 degrees) under the surveillance of Honeywell circular-chart recorders. These record temperature continuously for the period the beer is in the vessel, any temperature adjustments required being made from a point adjacent to the recorder.

Cleaning the vessels is automatically carried out by a detergent ball situated in the centre of the roof of each vessel. Safe operation of this cleaning process is ensured by Honeywell microswitches fitted to the hatch of each tank; the switches only allow the cleaning mechanism to operate if the door to the vessel concerned is open (indicating that the tank is empty).

A Honeywell microswitch, fitted to the hatch of a fermenting vessel, eliminates the possibility of automatic cleaning operations being initiated while beer is present in the tank

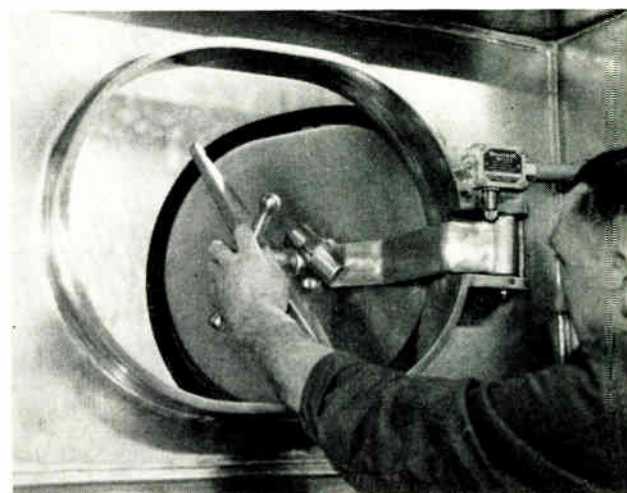

Computer-Derived Manufacturing Instructions

A new computer technique (called automated manufacturing planning or 'Amp', for short) has been introduced by I.B.M. and allows a manufacturer to convert engineering design data automatically into precise manufacturing instructions. The technique uses the basic cause-and-effect logic of the manufacturing process to identify the operations necessary to produce a part, or assembly, and then calculates the exact sequence in which these operations must be performed.

It may be used with any I.B.M. computer and specifies the raw material form to be used, the methods and time standards involved and, by extending these, gives detailed estimates of total production costs. It is a logical extension to I.B.M.'s 'automated design engineering'—a technique using a computer to convert customer requirements into product designs—and the first company to use the technique was the Rollway Bearing Co. Inc., of Syracuse, New York, a manufacturer of cylindrical roller bearings.

Internal Teleprinter Network

In order to speed up the distribution of Telex messages to the nine floors of the Stewarts and Lloyds' London premises, Creed and Co. Ltd. have installed an internal teleprinter communications system.

The system links six of the departments and a post room to a Telex receiving room. In the Telex room, messages from the G.P.O. network are received in the form of punched tape accompanied with printed pages. Messages from a private teleprinter network linking other Stewarts and Lloyds' premises are received on punched tape and the characters corresponding to the codes are printed against the perforations.

When a message is complete, it is fed to one of the heads of a three-channel transmitter in the Telex room. This transmits the message to one of the model 75 receivers in the six departments. Here it is automatically printed out on a page which can be passed to the staff member concerned. Messages for the departments without receivers are transmitted to the post room where they are printed out as before and distributed through the internal mail service.

A system such as this is suitable for any large building where departments are a long way from the Telex room.

For further information circle 51 on Service Card

Oil-Cooled Vibrator for Electro-Mechanical Components

Components fitted to supersonic aero-engines have to withstand high operating temperatures and vibration conditions when in service and must, therefore, be tested under equivalent conditions. For this reason Vactric Control Equipment Ltd. has installed an oil-cooled vibrator in its environmental test laboratory at Morden, in Surrey, for resonance search and endurance testing of servo and other electro-mechanical components.

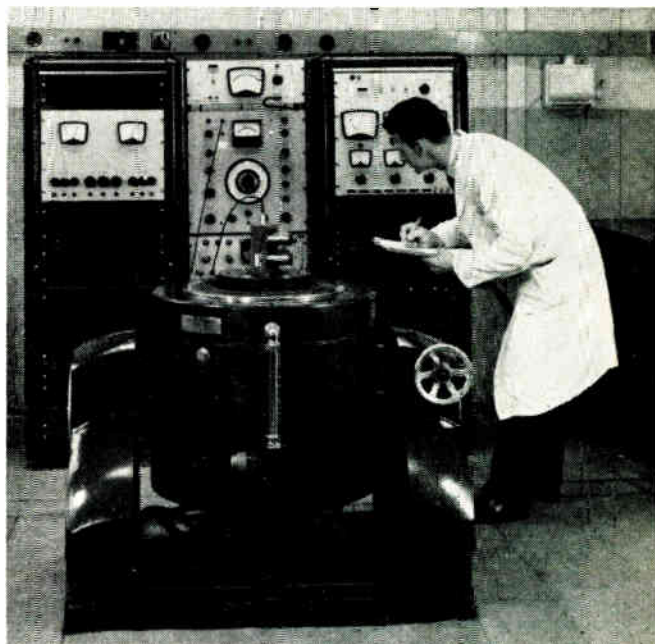

The oil-cooled vibrator, which has a vector thrust of 1,950 lb, installed in Vactric's environmental test laboratory. It is available for testing other companies' products by negotiation

Made by Derritron Electronic Vibrators Ltd., the vibrator can test components at elevated temperatures with an amplitude of $\frac{1}{2}$ in. at the lower end of the frequency range, which is 5 c/s to 7 kc/s. The unit is driven by a 10-kVA amplifier, and controlled by an oscillator giving 132 ranges of sweep frequency.

Circuit Breaker for Low Currents

Conventional fuses and circuit breakers incorporating bi-metallic strips cannot operate on low currents. Nevertheless, fast-acting circuit breakers which will do so are essential, for it has been found that even currents as low as 50 mA can have fatal effects and fire can be caused by currents of 300 mA.

The French firm of Société Bresson-Faille-Marchand has introduced a device which will operate on low-earth-leakage currents to break a circuit almost immediately. It contains a toroidal transformer wound on a core of a high-permeability 'Mumetal' alloy containing 74% nickel and developed by Telcon Metals Ltd. The transformer detects the leakage current and has an operating power of only 500 μ VA which is sufficient to actuate the contact release mechanism. This mechanism consists of a permanent magnet made of 'Ticonal', which is a high-energy magnetic alloy containing 14% nickel and was developed by Mullard Ltd. The magnet attracts a blade against the opposition of a spring. When a current is detected, a de-magnetizing force is applied to the magnet. The magnet releases its hold on the blade which springs away with sufficient force to trip a cut-out switch.

This device is compact and low priced and is therefore suitable for both industrial and domestic use.

New Electronic Telephone Exchange

A REED electronic telephone exchange system, claimed to be the most advanced automatic telephone exchange system in the world, has been announced by AEI.

The system, known as 'Rex,' is compatible with all existing automatic telephone exchange networks. It can be supplied for new exchanges, as a direct extension of electro-mechanical exchanges, or used to 'turn round' telephone exchanges nearing the end of their operational service.

Among the important technical advances incorporated in the new system is an entirely new apparatus practice enabling 20,000 to 30,000 lines of Rex equipment to be accommodated in the space normally required for a 10,000-line electro-mechanical exchange, with a saving of up to 70% of floor space. The sensitivity of the system enables the subscriber/exchange link to cover a geographical area greater than that of a conventional exchange.

The electronic control is high-speed and embodies a stored programme technique; control is simple and has been designed for unattended operation; all service requirements can be automatically reported to a distant maintenance control centre.

The basic design permits all future switching facilities likely to be required by a modern telecommunications network, such as abbreviated dialling and subscribers' automatic transfer, together with all current standard features, such as data for automatic message accounting, to be provided. All facilities are available as standard features of the system, and could be omitted or modified as required.

Design and Operation

The design of a successful telephone exchange system depends on the solving of two major problems. The first is concerned with switching thousands of sources to thousands of destinations and providing a discrete path for each. The second is the detection, interpretation and

This shows an engineer working on the field trial reed electronic exchange which will come into operation at Leighton Buzzard later this year

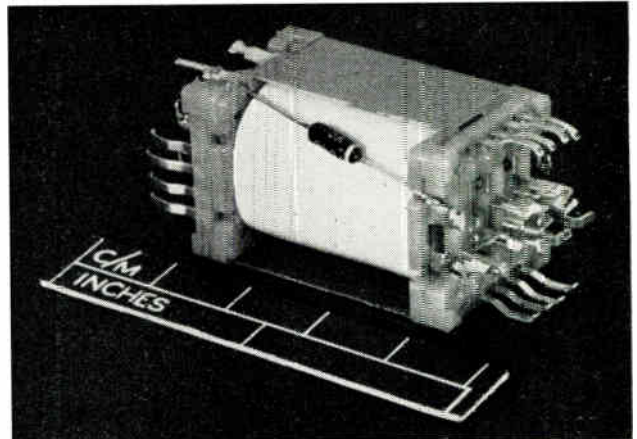

One of the standard crosspoint relays used in the telephone system

manipulation of millions of 'bits' of information to ensure that the correct discrete paths are chosen and set up.

The Rex system employs reed relay crosspoint switching combined with electronic control—a smooth integration of both physical and electronic functions.

Each reed relay provides a discrete route from a source to a destination. The energization of a particular coil, to close the reed contacts and set the route, is the function of a separate control equipment and the reed, being simpler than any other contact, is very reliable and requires no routine maintenance. In addition, the matrix or array of reed switches may be enlarged in any ordinate, simply by the addition of rows or columns of reed-relay crosspoints, to cater for any switching requirements.

The other half of the problem, the control and derivation of switching paths in response to information, can be solved electronically by reducing control to a preset sequence of actions in response to appropriate information. There are two main types of information required to set a call through any telephone exchange. Primary information comes from the exchange itself and covers the identity of the source and the identity of the destination. Secondary information derived from the system concerns the availability of paths and equipment to satisfy the needs of the source. Control is the selection and implementation of the sequence of activities appropriate to the combination of primary and secondary information.

In the Rex system, the scanner detects the calling source and offers its identity to the translator where it is converted into the control language. Information is then added to enable the right kind of service to be provided.

The electronic control is high-speed and embodies the advanced stored programme technique. Complete system security (to whatever degree may be required) has been achieved by circuit design and testing during the development period and by the duplication of important equipment items. The control is simple in operation and offers complete self-checking and fault recording facilities for maintenance purposes. The only moving parts in the system are the reed switch contacts. Reed switches can operate 50-100 million times which in this telephone application represents an average working life of 30-40 years.

For further information circle 52 on Service Card

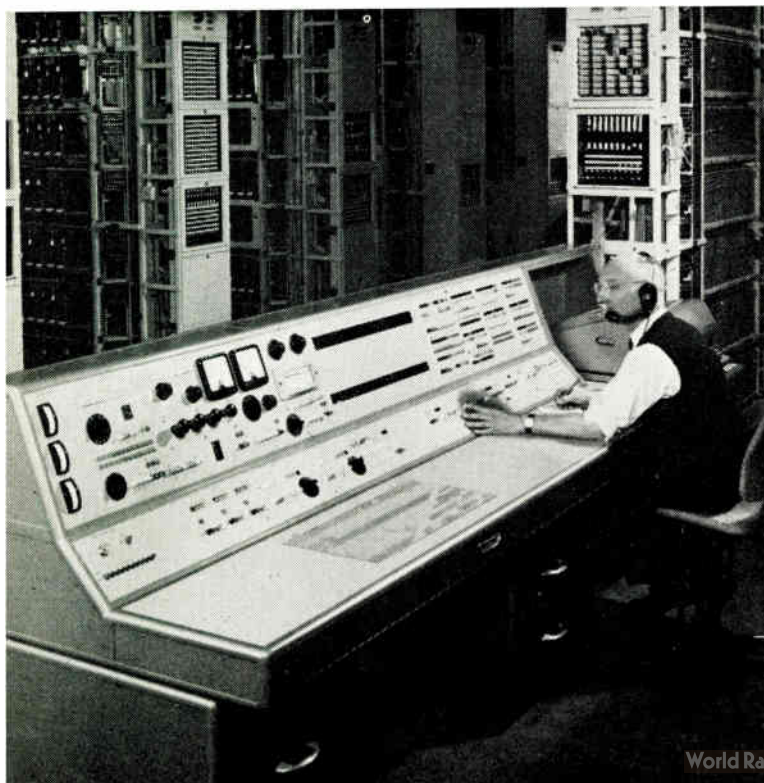

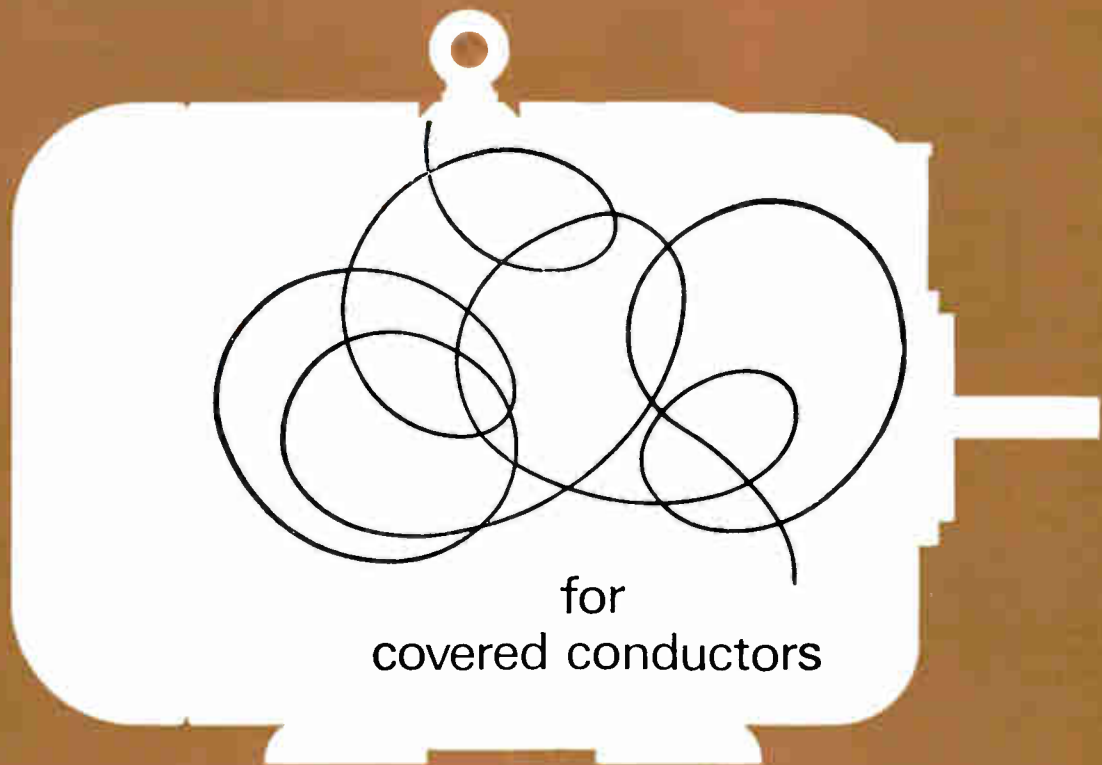

for
covered conductors

**PIRELLI
GENERAL**

of course



PIRELLI GENERAL CABLE WORKS LIMITED SOUTHAMPTON

Does this solve your problem?

These symbols are a visual demonstration of the principle on which LEDEX Rotary Solenoids operate. A linear movement (such as the operation of a push-button or an on/off switch) is—by the movement of three balls around and down inclined races—ingeniously converted into a rotary movement of from 25° to 95°, either clockwise or anti-clockwise.

This is a simple, frictionless, method of remote control switching, which, in conjunction with NSF-Oak rotary wafer-type switches, makes a most efficient circuit selector or stepping relay.

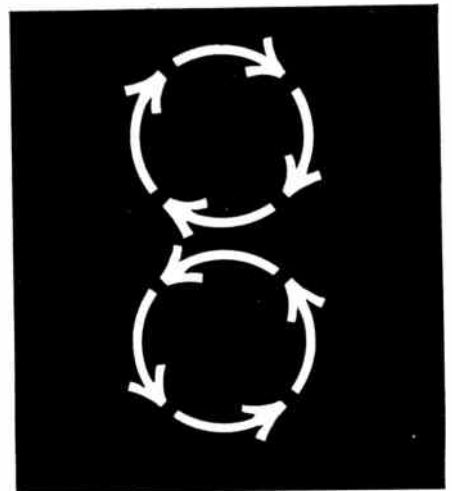
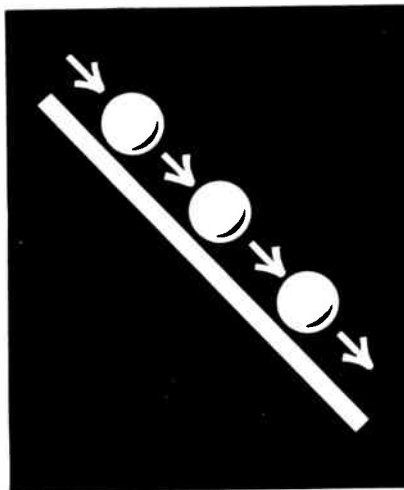
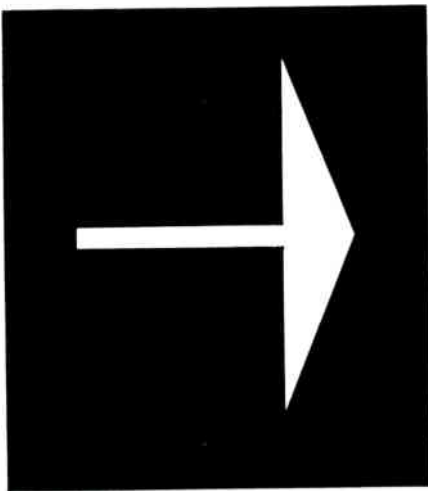

The LEDEX principle provides a high torque, snap-action, rotary movement that has many advantages over other methods of remote control. Compactness, reduction in weight, lower cost and complete reliability are some of the factors which have influenced designers in many industries to specify LEDEX. It may well be the answer to some of your current problems.



LEDEX



NSF LIMITED

Sole Licensees of LEDEX Inc., Dayton, U.S.A.

A MEMBER OF THE *Simms* GROUP OF COMPANIES

Other NSF products:—

- Rotary Wafer Switches
- Push Button and Slide Switches
- Lever Switches
- Miniature sealed Relays

SALES OFFICE:

31-32 Alfred Place, London, W.C.1

Telephone: LAngham 9561 Telex: 21907

Telegrams: ENESEF TELEX LONDON

WORKS: KEIGHLEY, YORKSHIRE

THE process industries are those which produce materials, and include petroleum, petrochemical and chemical plants, metals and mineral producing plants and so on. The products produced in these industries are specified in terms of their chemical composition, or physical properties, and the process used generally involves changing the composition of physical state of the input material to produce the specified end product.

The Problem of Quality Control

Instrumental control of such processes has evolved using parameters such as temperature, pressure, flow, level, etc., as control variables, and correlating the composition of the product and the process performance to these variables by laboratory measurements.

The exact relationship between these controlled variables and the final product specification is usually neither completely understood nor readily amenable to calculation. Nevertheless, as a result of prior experience, experiment with pilot plants or a period of trial and error in the running up of the actual plant, it is possible to establish initial control values which result in the production of end products within the required specification and at satisfactory yield. These suitable operating conditions can then be maintained using pneumatic or electronic instruments in simple or complex closed-loop control systems.

During operation, changes in feed composition, composition of reagents and impurities, etc., take place, which require the controlled parameters to be reset. The existence and magnitude of these changes in process conditions was, until fairly recently, largely determined by either:—

(1) Inference from the secondary changes produced in the continuously measured parameters, e.g. temperature, pressure, etc., or (2) taking samples from various points in the plant and analysing these in a control laboratory.

Purely inferential control has a number of obvious disadvantages. The physical control parameters respond in a non-specific manner to changes in composition and, because of their insensitivity, may not respond at all or only to a degree which is not accurately measurable. These parameters are also in general inter-related in a complex manner, so that considerable judgement is required in interpreting the changes which do occur and taking appropriate action.

It is therefore essential to augment this method of control by taking actual measurements of composition or specified properties as frequently as possible, and this is a requirement which continues to increase as more critical processes appear and as product specifications increase in severity.

The Laboratory Approach

Some of the disadvantages of providing this essential control information by the classical laboratory approach are as follows:—

(1) Information is available only after considerable delay and at infrequent intervals, unless special arrangements are made.

(2) Even the provision of this information often requires elaborate facilities and relatively large numbers of personnel. If special arrangements are made to give more frequent readings at one part of the plant, the routine measurements invariably suffer at some other part.

(3) When classical methods of analysis are used, the delays involved may be almost independent of the number of laboratory personnel, since an individual determination may take several hours.

(4) The accuracy of the measurements provided depends on the skill of the laboratory staff, the experimental and sampling methods and the variable delays between sampling and measurement.

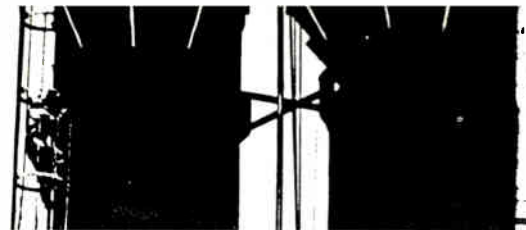

The progress and increasing complexity of industrial process plants have led to the need for very rapid chemical analysis of their products. Such requirements have been met by the design of a wide range of analytical instruments for both laboratory and on-stream use. This article deals with some of the general aspects of various types of apparatus, and discusses their principles of operation and methods of application.

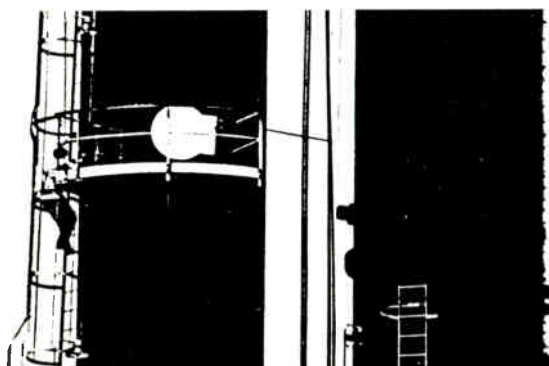

ANALYTICAL INSTRUMENTS FOR PROCESS PLANTS. PART 1

By R. MILLERSHIP, Ph.D., B.Sc.*

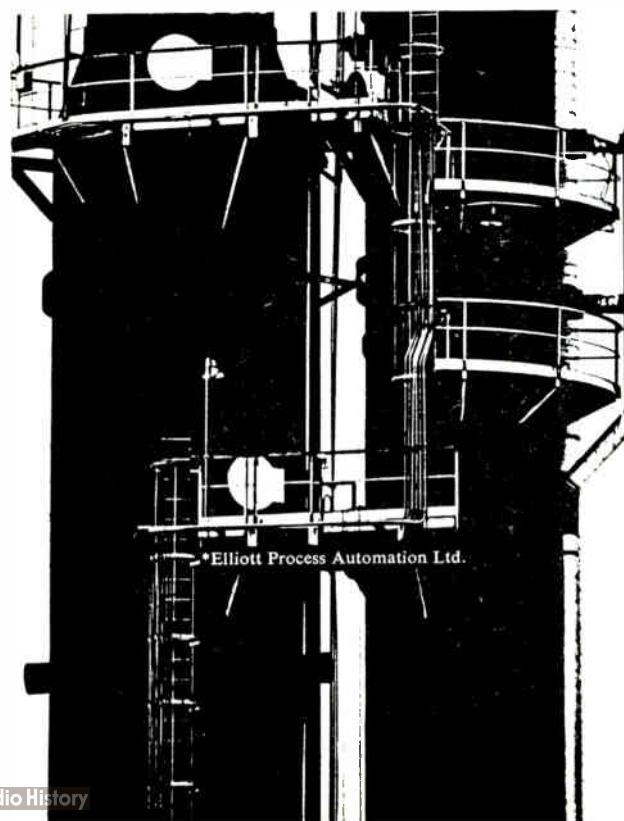

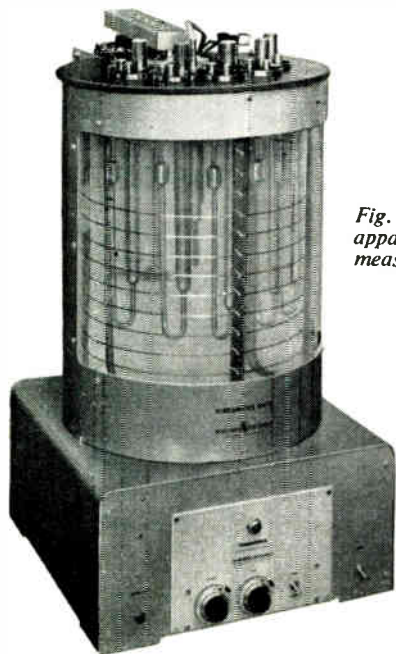
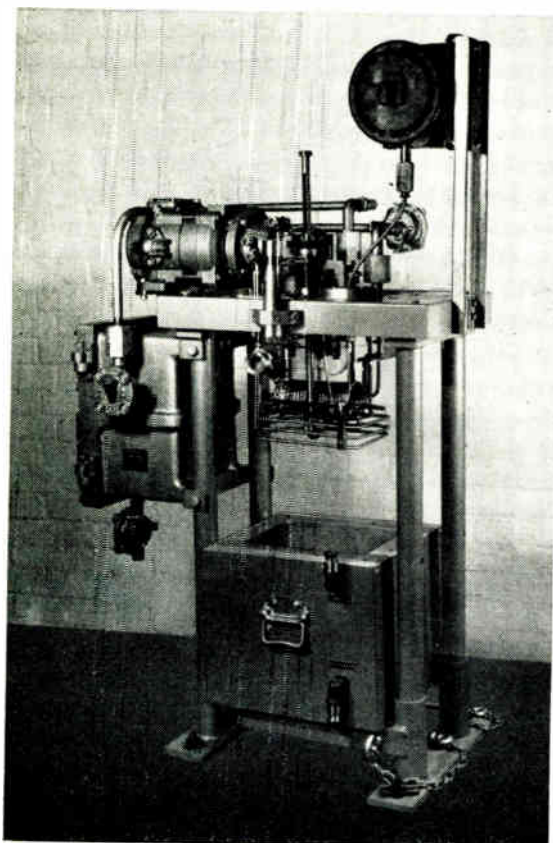

Fig. 1. Laboratory apparatus for measuring viscosity

Fig. 2. A process viscometer, which carries out the same measurements on-stream as those made manually in the laboratory by the apparatus shown in Fig. 1



Even at its best, off-line laboratory control only provides general trend information and the action taken to alter the controlled conditions between the occasions when laboratory information is available is still at the discretion of operators or supervisors, who may take wrong or imprecise action. The existing state of the plant can only be derived by extrapolation from data which is often several hours out of date and the exact result of specific action can only be determined after a similar delay.

Instrument Requirements

Considerable research and development has therefore been devoted by the process industries and instrument manufacturers, with the object of producing analytical instruments which will:—

- (1) Operate on-stream in the plant and provide as nearly as possible continuous composition information to operators.
- (2) Provide control signals which can be used directly in individual closed loops to control plant operation without intermediary operator decision.
- (3) Provide values of dependent, constrained variables in more complex control systems.
- (4) Provide more rapid and sometimes more accurate methods of carrying out those measurements which are essentially confined to the laboratory.

Apart from their use in direct control or monitoring of processes, on-stream analysers can also fulfil highly important safety functions. These include, naturally, the protection of personnel by the detection of leakage of toxic or explosive material. A further important safety function is the detection of materials which may be harmful to the plant itself, thereby, for example, prolonging the life of catalysts or allowing longer periods of operation between scheduled preventative maintenance.

So far we have only considered the more or less steady-state operation of a process. In many cases the feed stock of a process may come from different sources which differ greatly in character. Some of the most spectacular increases in operational efficiency have been achieved by using on-stream analytical instruments to speed up the process of getting a plant back on specification after a complete change in feed material.

On-Stream Analysers

In designing analytical instruments for on-stream applications, and actually applying them on process plants, there are a number of general requirements which must be met; for example:—

- (1) The instrument must be robust and capable of operating over long periods with its specified accuracy and with a minimum of maintenance.
- (2) When maintenance is required, the design should allow this to be done with the greatest ease and preferably without requiring special skills from maintenance staff.
- (3) The materials of construction, particularly those in contact with the plant stream, must be chosen to minimize corrosion and chemical reaction with the stream.
- (4) The instrument must conform to the appropriate safety regulations.
- (5) Wherever possible, means should be provided to enable calibration and functional checks to be carried out in situ.
- (6) A sampling and sample preparation system is required to provide a representative sample to the analyser in a form which the instrument can accept and measure over long periods of time.
- (7) A technique must be used in which the composition measurement is readily converted into a form compatible

with the overall control system, or such that it can be assimilated by the operator.

(8) Where a measurement derived from a standard test forms part of the specification, the analyser output must be expressible in standard test units even though a measurement involves fundamental physical or chemical units.

Conversion from Laboratory to Process Form

An example of the evolution of a process instrument from a well-known laboratory experimental form can be seen in Figs. 1, 2, 3 and 4. In this case the laboratory equipment in Fig. 1 is used to measure the viscosity of Newtonian fluids, by measuring the time taken for a fixed volume of the fluid to flow through a capillary of known dimensions, under fixed temperature and pressure conditions. The same basic method is used in the process instrument (Fig. 2), except that it is made continuous by, as it were, inverting the procedures. The fluid is pumped through the capillary at a constant rate and the pressure differential across the capillary is then measured to give the viscosity.

This conversion of measuring method achieves two objectives. Firstly, the method is made continuous; secondly, the variable measured is now a differential pressure, a parameter for which control instrumentation exists. By choosing the appropriate geometry in the analyser one can install a pressure transmitter and controller of a type that is compatible with the overall plant control system.

With this general type of instrument, the measurement is usually displayed on a chart recorder which is often in a control room. The instrument is installed as close to the sampling point as possible, a typical installation being shown in Fig. 3, where the sampling system is plumbed in situ and includes filters, pressure regulators and so on. All the instrument variables are pre-set on the instrument; there is only the recorder/controller in the control room.

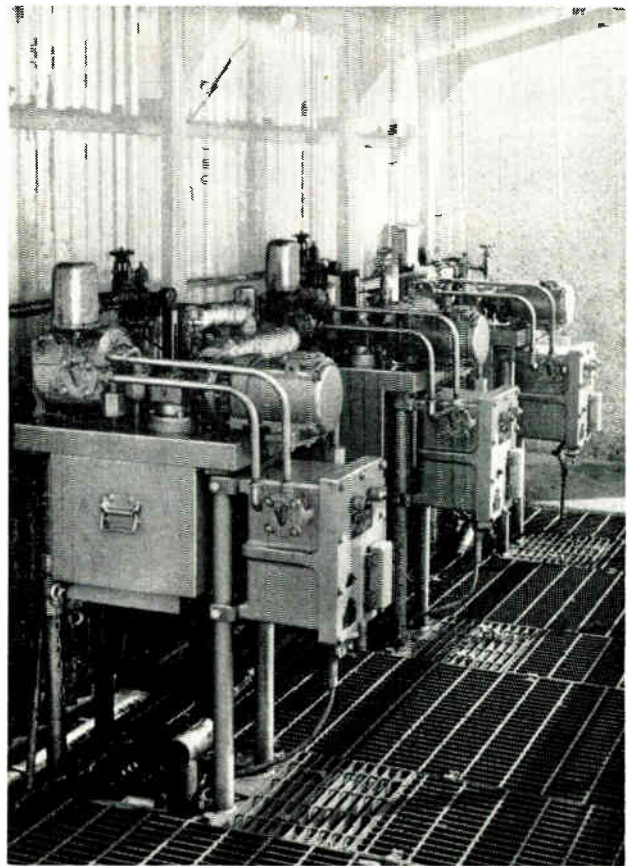

Fig. 3. Process viscometers, of the kind shown in Fig. 2, in a process plant, together with a sampling system and control signal transmitters

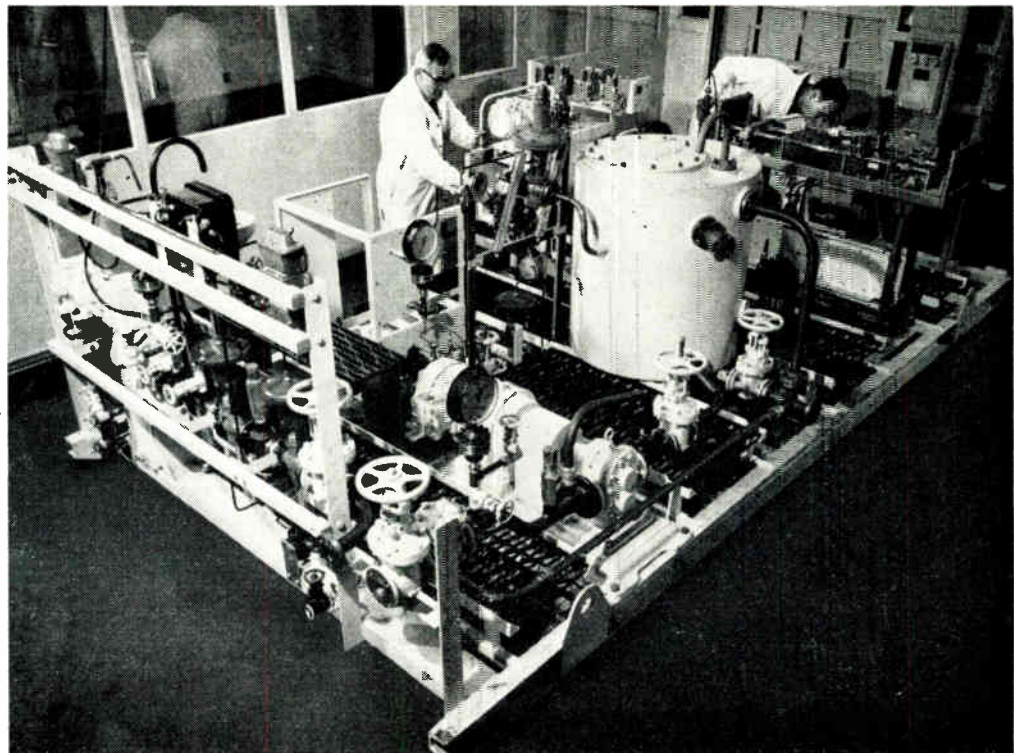

Fig. 4. A process viscometer, with other analysers, sampling systems and controllers, mounted in unitized form. This shows a complete unit for analytical control of a blending process, entirely prefabricated and tested before shipping

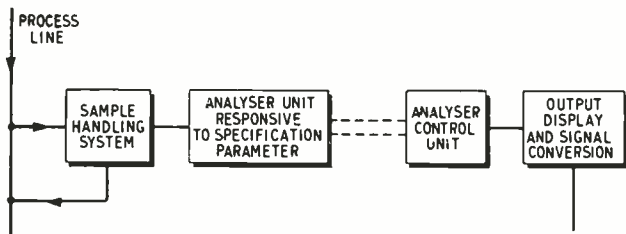

Fig. 5. A generalized block diagram of a process analyser



Fig. 6. An on-stream automatic titrator, which contains an analyser (comprising titration vessel, sample and reagent burettes), titration sequence-control units, pH-point indicator and output recorder, all mounted together at the sample point

There are many self-contained instruments of this general kind giving a continuous output. When this type of instrument is used in conjunction with a data logger, or in a computer control system, the measurement can be scanned exactly as can other transducers—in this particular example in the same way as any other pressure.

There are other types of instrument in which some sequence of action in the instrument is determined by an electro-mechanical or electronic control unit. Considering these, one can loosely represent a process analyser by the diagram shown in Fig. 5; it consists of a sampling system, an analyser unit, a control unit for the analyser, and a unit to produce an output display or control signal.

Included in this category are analysers which produce non-continuous outputs, e.g. automatic titrators, chromatographs, some forms of X-ray and spectrometers, etc.

In these cases the control unit and display unit (a meter, graphic recorder or typewriter) are often mounted together in a control room or a location remote from the analyser proper, which may be mounted close to the sampling point.

Two examples are shown in Figs. 6 and 7. The first of these is an automatic titrator which performs 'wet chemical' analyses—in this case volumetric titration of sample and reagents to a pH end-point. The analytical procedure is identical to that which would be performed manually in a laboratory, but the sequence of events is in this case controlled automatically. This particular installation has an analyser unit, an analyser control unit and a recorder, all mounted in one location. Fig. 7 shows a chromatograph used for analysing complex gas or liquid mixtures; the analyser unit is mounted in the plant at the sampling point and the control unit is installed with the recorder in the control room. This particular instrument, which is simple and robust, also illustrates one of the two trends in analytical instrumentation particularly as applied to chromatographs. On the one hand, the chromatograph becomes more and more complex as it is required to perform more difficult analyses, and it is often necessary to analyse samples from many different parts of the plant in the one instrument in order to justify the cost of installation. On the other hand, there are many analyses which can be performed with an instrument which is designed to be simple, rugged and inexpensive. The one illustrated is of the second kind.

To be concluded

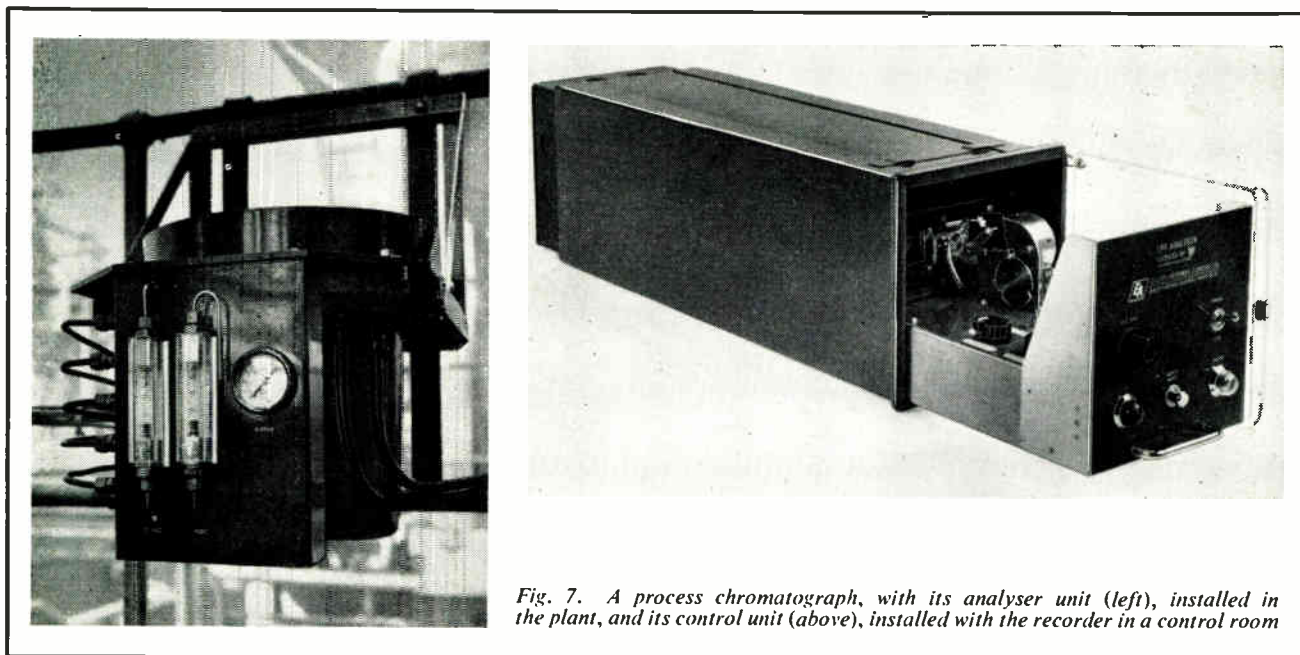
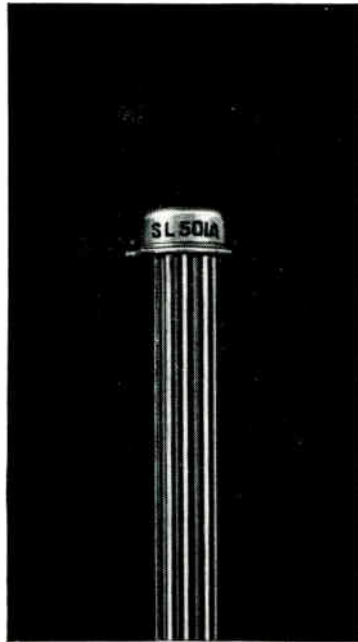

Fig. 7. A process chromatograph, with its analyser unit (left), installed in the plant, and its control unit (above), installed with the recorder in a control room



the
SL500 series
is the
most advanced
solid circuit
wideband
amplifier series
in the world

VERY BRIEFLY

CURRENT GAIN
26dB

BANDWIDTH
100 Mc/s

INTERNAL AGC
40dB.RANGE

INTERNAL
SUPPLY LINE
DECOUPLING

a completely British product originated by the Allen Clark Research Centre, Caswell.

*Write for full details of this and other
amplifier ranges*

PLESSEY Components Group

Semiconductors Limited



Cheney Manor, Swindon, Wilts. Tel: Semiconductors Sales, Swindon 6251

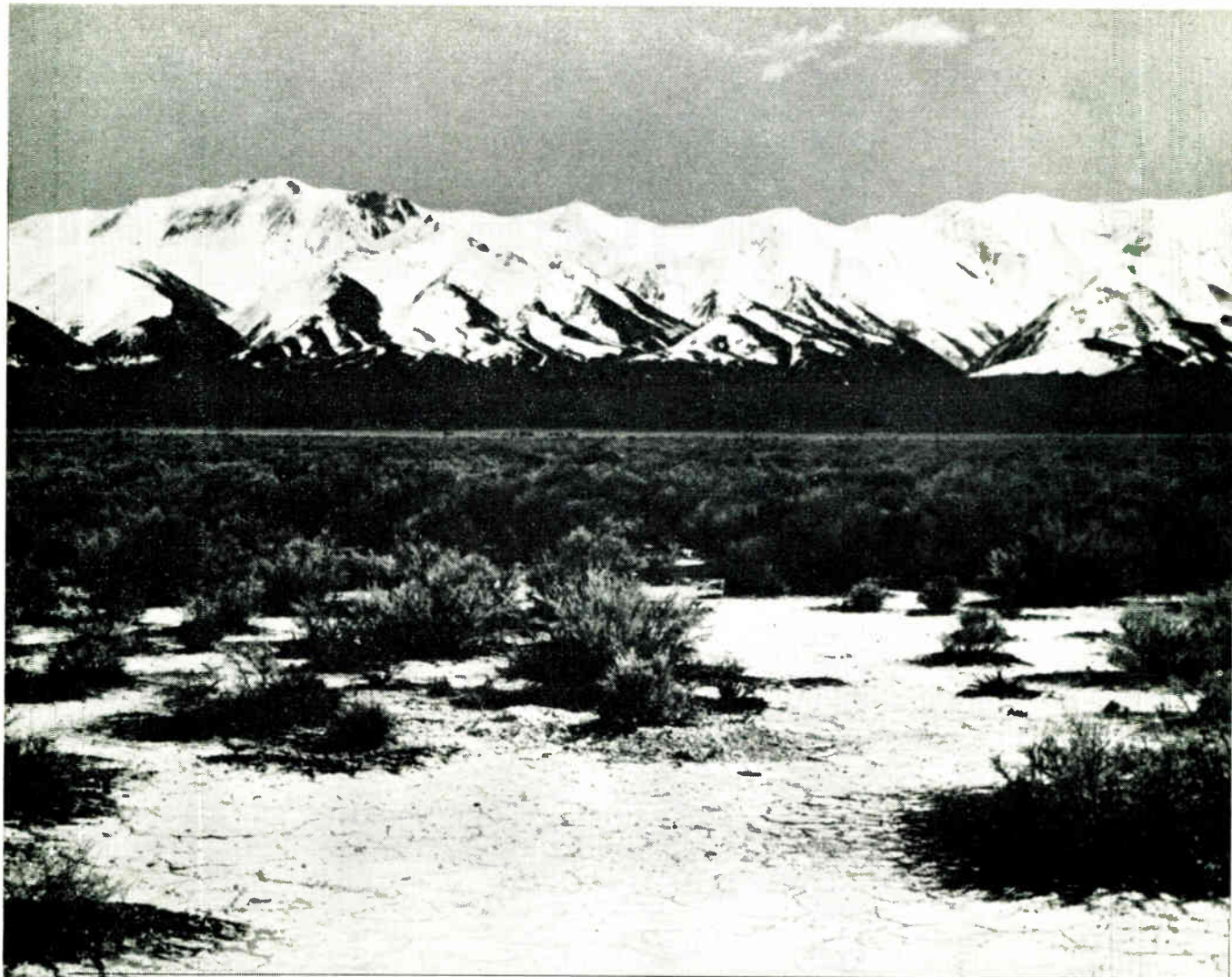

Species: Associated Aerials arrays

Habitat: Remote rugged
(hot or cold, wet or windy)

Behaviour: Dependable

Associated Aerials make a huge range of communications aeri- als. Compact, reliable RT aeri- als to stand up to taxis, fire-brigades and police forces; omnidirectional and directional aeri- als that work dependably for many years on end in remote and tough territories; marine and ship-to-shore aeri- als; TV transmitting aeri- als. VHF, UHF—you name it, Associated Aerials almost certainly already make it. Use still higher frequencies, and Associated Aerials will keep ahead of you. Think of a requirement that nobody's yet heard of, and Associated Aerials will develop an array to meet it. Get in touch

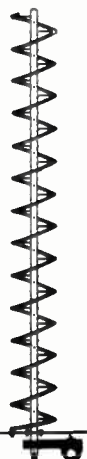

with Associated Aerials. Let them make an array for you, and then forget all about it. That's the way with Associated Aerials—the most easily forgotten aeri- als in the world.

ASSOCIATED AERIALS LTD

Knight Road Strood Kent England Telephone: Medway 78255 Telex : 89146

Members of the Associated Aerials Group of Companies:
G. S. V. (Marine & Commercial) Limited
Radio Telephone Aerial Systems Limited
R. T. Masts Limited





TALK ABOUT

So you think you have an instrumentation and control problem? To those readers bowed down with the weight of their industrial control problems I commend a brief study of the hovercraft. This remarkable British invention, which has now literally and figuratively got off the ground in a big way, has brought a crop of problems all its own. And I don't mean only the old Ministry dilemma of not knowing whether it's a ship or an aircraft, or even a bus in its cross-country role, and whether the chap in charge is a mariner, an aviator or a bus driver.

Lt.-Cmdr. G. Hammond, R.N., writing in the *Journal of the Institute of Navigation* reveals a few of the problems and some of the sophisticated instrumentation required to overcome them. To begin with a rough sea gives a rough ride 'not unlike that of a car going over a series of hump bridges with vertical accelerations of the order of $1\frac{1}{2}g$ '. Because airscrews are the most efficient form of propulsion and are basically noisy the crew must work through the intercom. Because the controls are aerodynamic the best response is obtained at speed. Because the craft is free of water drag it is virtually wind borne and in moderate beam winds can track with as much as 45° of drift angle. Because the economics of hovercraft operation are based on speed they must travel fast with possible closing speeds, hovercraft to hovercraft, of 140 knots. And because of their aerodynamic shape they have low superstructures with poor visibility.

To know where you have been, where you are now, where you are going and to avoid collisions on the way, the navigational set-up on the N.3 combines marine radar with a Decca flight log, the two linked by Omnitrac computer. There is also a doppler system.

In addition, proposed for evaluation are an Elliott inertial platform and a VLF navaid receiver. One finishes up with two PPI displays, a roller chart and optical plotter (for which the Hydrographer has produced special plastic navigational charts scaled to match the PPI scales), a Decca flight log and Decometers, read-outs of Lat., Long., Track, Speed, and Distance-to-go, and a driver's steering/track indicator which tells him when he is

By NEXUS

off track and shows him how to get back on it.

As Lt.-Comdr. Hammond says, 'The problem falls between marine and air navigation with the disadvantages of both'. And please note I have only mentioned the navigational problem. There are all the others concerned with engines, fuel management, control surfaces and the like. Quite an exercise in instrumentation and control in a number of engineering disciplines.

The centenary year of the Royal Aeronautical Society has revived, for me, many nostalgic memories and given cause for much reflection on the present run-down of the UK aviation industry. There are those who claim that the aircraft industry is essential if only for the so-called spin-off of technology which can be used elsewhere. There are others who pooh-pooh the whole idea.

An unusual example of spin-off is the fully-automated coal face. According to Sir George Dowty the first hydraulic roof support used in 1947 resembled an aircraft shock-absorber and was not dissimilar to a Lancaster bomber undercarriage leg. By 1949 a walking support had been tested underground and by 1957 fully

advancing roof supports were in production. By 1964 the first fully automated face had come into operation.

This, of course, is a fairly long time scale, overall, but, without the impetus towards greater knowledge of hydraulics brought about by aviation the first stage of producing a workable hydraulic pit-prop might have been considerably delayed.

Aviation has always been a good customer of the electronics industry for all types of equipment. It has also injected ideas as well as orders into the industry. A prime example is the analogue computer. With a history going back to 'do-it-yourself' exercises in the aircraft industry, the analogue computer was soon taken up by the electronic industry for development into the precision design and engineering tool it is today. Solartron, one of those doing nicely in the analogue business took £250,000 of orders for these machines (half for export) in the final quarter of last year.

Critical path analysis systems, now widely used in all manner of engineering and production projects had their baptism in aviation. Now I note that Marconi used PERT in planning Ghana's television network. Aviation has, indeed, been a pacemaker in so many fields.

And, as spenders, the aircraft industry does us all a lot of good. British Aircraft Corporation is currently spending £800,000 on three ICT 1900 series computers including a 1905 for scientific work.

The question remains, can we afford to run down the aircraft industry any more? Regrettably, time is not on our side. Chatting casually with a travel agent recently, I suggested he must be pretty slack at this time of year. I was hopelessly wrong. He told me he was handling the biggest contract he'd had for many a long day—shipping 300 aircraft engineers, their furniture and their families to the United States. The whole bill would be settled by Boeing. It's good to hear of somebody making some money from the brain drain, but we shall pay dearly in the long run.

Enormous attention is being given to the proposed legislation on drink and driving. There is much talk of loss of liberty to the individual, much technical argument on the uptake, distribution and elimination of alcohol in the body, some doubt on the efficiency of the simpler testing methods and a whole range of opinion on the point at which the presence of alcohol degrades driving ability.

Rightly or wrongly, the courts often

show a distrust of some scientific aids. This has been quite marked in many cases of speeding where doppler equipment has been used as the measuring device.

The police, well aware of the necessity of accuracy, have now been studying methods of analysing micro-litre samples of capillary blood. At a recent international conference on 'Alcohol and Traffic Safety' in the United States, Dr. H. Walls of the Metropolitan Police Laboratory presented a paper on the work in this field by the Forensic Science Laboratory, Nottingham. A Pye gas chromatograph was used to measure peak heights and it was found that for any particular operator reproducibility of results was good but not so good between operators. By using a Chromolog electronic integrator made by George Kent Ltd. to measure peak area, results were greatly improved.

It is pleasant to know that electronics is helping along this type of work designed to protect the borderline suspect as well as convict the gross offender.

Incidentally I have been amused by the BBC's ready acceptance of the word Breathalyzer as a generic term when they are still sensitive about using old favourites such as Hoover or Thermos flask. For some reason Breathalyzer has caught on though it is by no means the only device of its type on the market. But I agree it is nicely and neatly descriptive and much less vulgar than two other American devices, the Intoximeter and the call-a-spade-a-spade Drunkometer.

In a world seemingly dedicated to the formation of bigger and bigger, though not necessarily better, industrial units it is interesting to speculate on the optimum size of an electronics

company for efficiency, profitability and ability to support R and D. Many of the larger companies, having tried central administration, have reverted to divisional structures having a fair measure of autonomy.

But how small can you get? The classic one man and a boy of the thirties may be gone forever. The age of opportunity has not, however, completely gone. One of the exhibitors at IEA started in business two years ago with little more. Setpoint Ltd. claim to have started with two men and a typewriter and are now expanding into the USA in the data logger and other automation fields.

Publicity managers groaning under the burden of advertising costs may be interested to know that the advertising office of the recently published *Électronique Actualités* in Paris is in rue des Martyrs.

Refinery Control System at Fawley

Virtually all the primary refining processes in Britain's largest petroleum refinery will be controlled from a single room when a project now being undertaken at Esso's plant at Fawley is completed next October.

The installation has been designed and manufactured by the digital systems division of Foxboro-Yoxall Ltd., of Redhill, and will control more than a dozen complex refining processes (previously requiring nine control centres) which produce such products as petrol, paraffin, diesel oils, industrial fuel oil and jet fuels. Radio and other specialized communications methods will be used to overcome the problems arising from the distances involved in the scheme at Fawley.

The system (PCP 88) employs parallel cascade processing, whereby one master computer is used to supervise a number of subordinate (or slave) computers, which in turn send digital instructions directly to over 400 control valves. Should a slave computer fail, another will automatically assume its critical functions of identifying and correcting upsets of process flow rates, temperatures and pressures.

Two features of the installation are of special significance in process control: high reliability is assured by means of digital back-up of the critical control functions; and facilities are available for a plant programmer to change supervisory programmes without accidentally erasing or affecting the direct digital control programme.

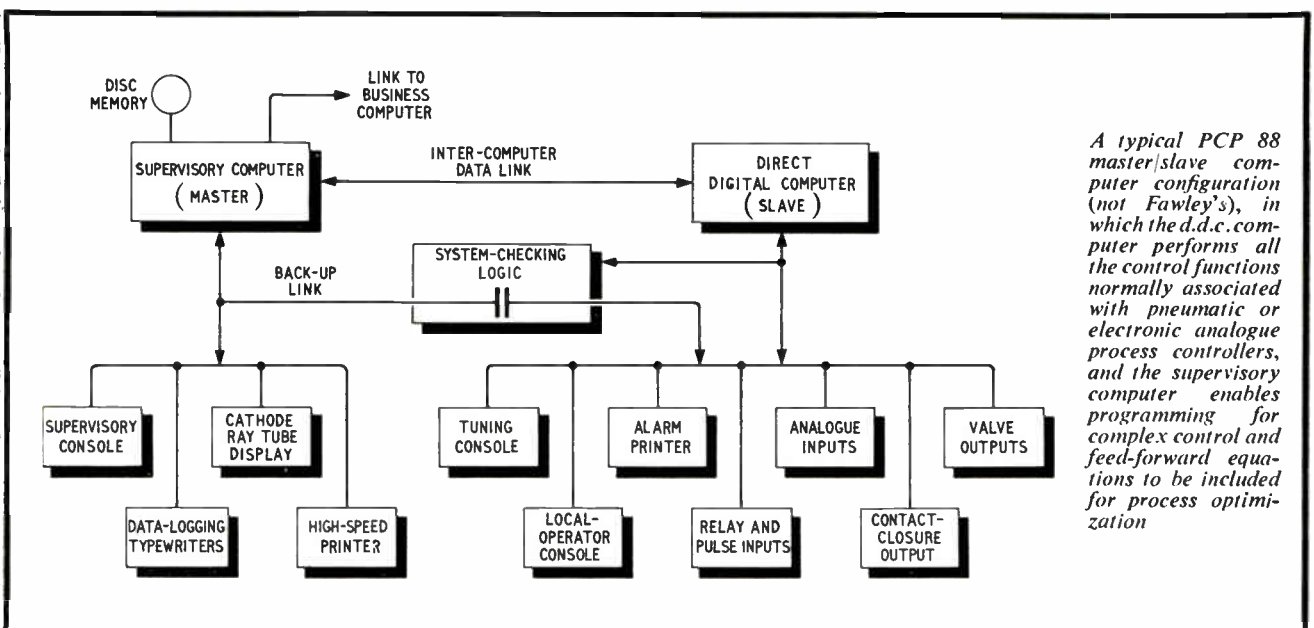

A typical PCP 88 master/slave computer configuration (not Fawley's), in which the d.d.c. computer performs all the control functions normally associated with pneumatic or electronic analogue process controllers, and the supervisory computer enables programming for complex control and feed-forward equations to be included for process optimization

WHY BE A HEAD HUNTER ?



up-grade your equipment with Emidata series E2 Multi Track Heads

Let's face it, recording durations are short enough and tape is expensive. Now with Emidata E2 Heads for instrumentation you can double the existing recording time. Replace your heads with Emidata E2s and upgrade your equipment immediately.

These heads have gap lengths of 200 micro-inches and 90 micro-inches for record and playback respectively, to enable a recording density of 4 kilocycles per inch per second to be used. You get D.R. Bandwidth to 120 Kc/s at 30 i.p.s. or FM bandwidth to 20 Kc/s at 60 i.p.s.

Advanced construction methods ensure that all gaps are precisely in line to a degree of accuracy unobtainable by other methods.

No other heads in Europe offer you consistent performance to compare with E2s which are available ex-stock. The reply-paid card will bring you full details by return.



**PLEASE SEND ME FULL DETAILS OF
EMIDATA SERIES E2 MULTITRACK HEADS**

NAME AND POSITION (BLOCK LETTERS PLEASE)

COMPANY

ADDRESS

TELEPHONE

EXTENSION



- Similarity of performance between identical and paired assemblies.
- Profiled face ensures intimate contact with the tape at all speeds up to 120 inches per second.
- Precise gap alignment—accurate track location between machines without amplitude variation.
- Precise azimuth ensures complete interchangeability of heads.
- Available in all IRIG and SBAC track configurations for 1/2-inch and 1-inch tape.



EMIDATA INSTRUMENTATION RECORDING SYSTEMS

are based on reliable proven Emidata Instrumentation Tape Deck TD5/6 and custom built electronic equipment using direct, frequency modulation and digital modes of recording.

The wide range of applications includes mechanical and electrical research, medical, biological and general research, nucleonics, seismic studies, radio communications and use with analogue and hybrid computers.

Postage
will be
paid by
Licensee

No postage
stamp necessary
if posted in
Great Britain or
Northern Ireland

BUSINESS REPLY CARD
Licence No. SOX 64

EMI ELECTRONICS LTD
AUTOMATION DIVISION · DEPT. EC5
HAYES · MIDDLESEX · ENGLAND



EMI ELECTRONICS LIMITED

AUTOMATION DIVISION · HAYES · MIDDX · ENGLAND
TELEPHONE: HAYES 3888 · EXTENSION 2126

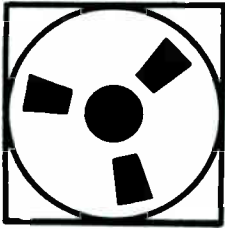

NEW APPARATUS

ELECTRONICS COMMUNICATIONS INSTRUMENTATION CONTROL

1. Listening Device

A listening device, manufactured by Minear Holdings and known as the Minearscope, is now available from R. S. Stokvis and Sons. It has been designed for the detection of vibration which is sensed by a transducer and transmitted via an amplifier and the stethoscope-type headset to reach the ear as sound waves. The sensitivity is such that even the break-up of the molecular structure in a piece of steel under stress can be heard. Other applications include the detection of wear in machinery, checking the precision fit of moving parts and the detection of irregularities in liquid flow. An output for a tape recorder is provided with the more sophisticated Minear Audiometer and this unit gives both an audible indication, through a similar type of headset, and a visual indication, on a meter, of vibration

and noise in machinery.—*R. S. Stokvis & Sons Ltd., 12-16 High Street, Walton-on-Thames, Surrey.*

For further information circle 1 on Service Card

2. Fire-Alarm System

Associated Electrical Industries Ltd. have announced the A.E.I. 'Fire-Man', a manually-operated fire-alarm system. It consists of three basic units: a 'break glass' call point, an indicator panel and an audible alarm (siren or bell). Large areas can be zoned and fitted with separate indicator panels for each zone, the alarm being common to all zones. For small systems a unit comprising a relay and a buzzer can be installed, in place of the indicator panel. Where a general audible alarm is not required, for example where it might cause dangerous panic, a lamp and buzzer unit can be used as a primary

alarm. This would be supervised by one person who would initiate secondary alarms with switches on the indicator panel. The system is suitable for 12-V battery operation.—*Private Telephone Department, A.E.I. Telecommunications Group, Worsley Bridge Road, Lower Sydenham, London, S.E.26.*

For further information circle 2 on Service Card

3. Mild-Steel Cases

A range of mild-steel cases, type 22B, is being marketed by Danfoss (London) Ltd. These are suitable for housing contactors, motor starters, electronic circuitry and similar equipment, and they can be fitted together to build up complete systems. Sections can be knocked out of the panels and the hinged cover for the insertion of terminals and cable entries. These knockouts are flush

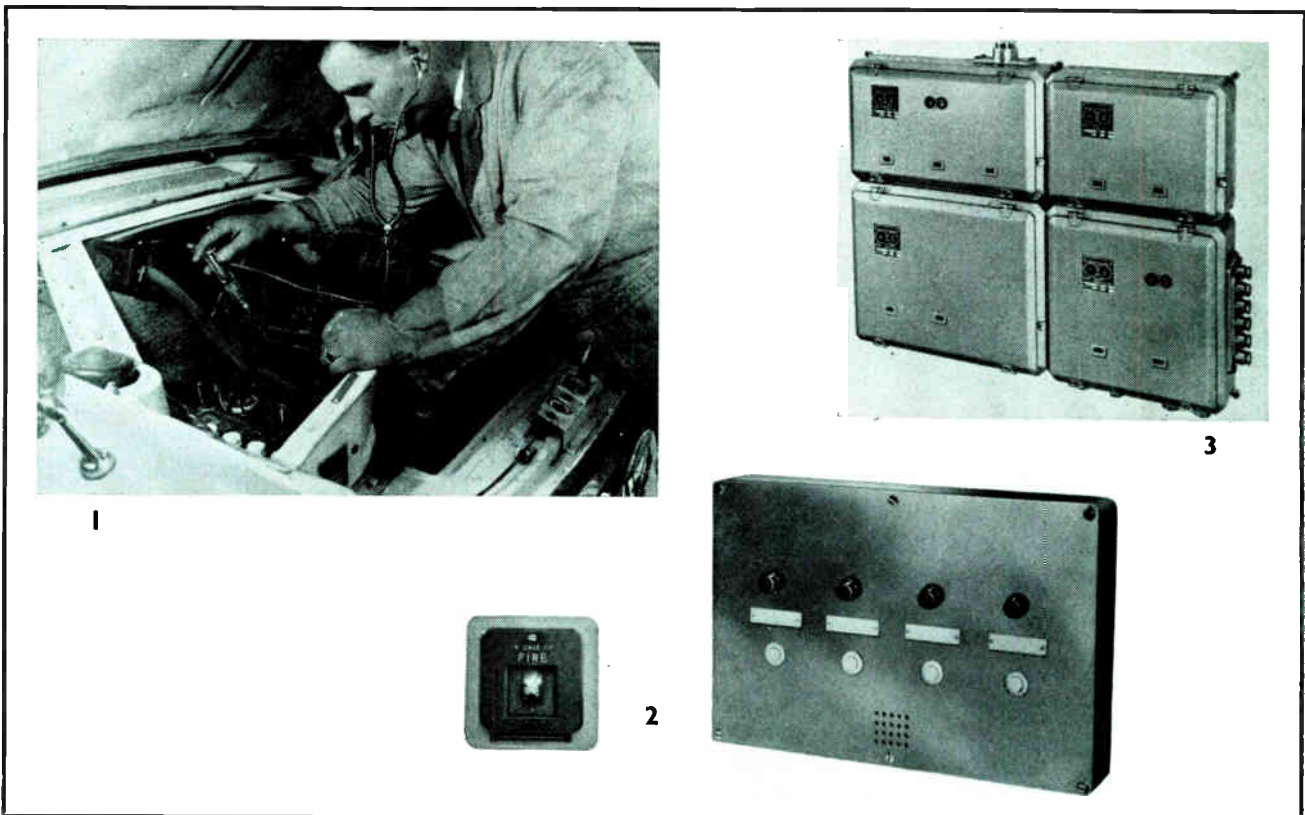

NEW

ELECTRONICS
COMMUNICATIONS
INSTRUMENTATION
CONTROL

with the casing and do not impair the smoothness of the surface. The cases are splash-proof and can be used in installations where frequent hosing down of equipment is necessary.—*Danfoss (London) Ltd., 6 Wadsworth Road, Perivale, Greenford, Middlesex.*

For further information circle 3 on Service Card

4. Fault-Alarm Equipment

The Clifford and Snell fault-alarm systems are now available from D. Robinson and Co. Ltd. These have been used in power stations, ships, etc. for many years and were supplied as tailor-made systems for particular applications. Now the equipment is being offered in a modular form suitable for diverse applications. Various fascia sizes are available for different mounting arrangements and miniature fascias are supplied as standard 144-way units. Alarm and lamp-test relays for a 6-way alarm system will plug into modules suitable for 19-in. rack mounting. Alarm is given by a 'klaxon' relay and a flashing light system.—*D. Robinson & Co. Ltd., Victoria House, 44 Park Street, Camberley, Surrey.*

For further information circle 4 on Service Card

5. Semiconductor Heat Sink

A heat sink which can accommodate up to 32 or more semiconductors has been introduced by Wakefield Engineering Inc. Known as the Series FCA-820 Cooling Package, it incorporates a motor-driven fan to increase the air flow around the fins. It is made in four quadrants which are electrically insulated from each other. Each unit is built to the customer's requirements to provide the correct cooling for particular circuits. The use of these efficient heat sinks, with their low thermal resistance, will enhance circuit performance and will reduce the amount of regulating circuitry required. Available in the U.K. from—*Walmore Electronics Ltd., 11-15 Betterton Street, Drury Lane, London, W.C.2.*

For further information circle 5 on Service Card

6. Contactors

The Electrical Remote Control Co. Ltd. (Elremco) have added the types DL 16, DL 20, DL 25 and DL 32 to their range of SBIK contactors and starters. It is claimed that the

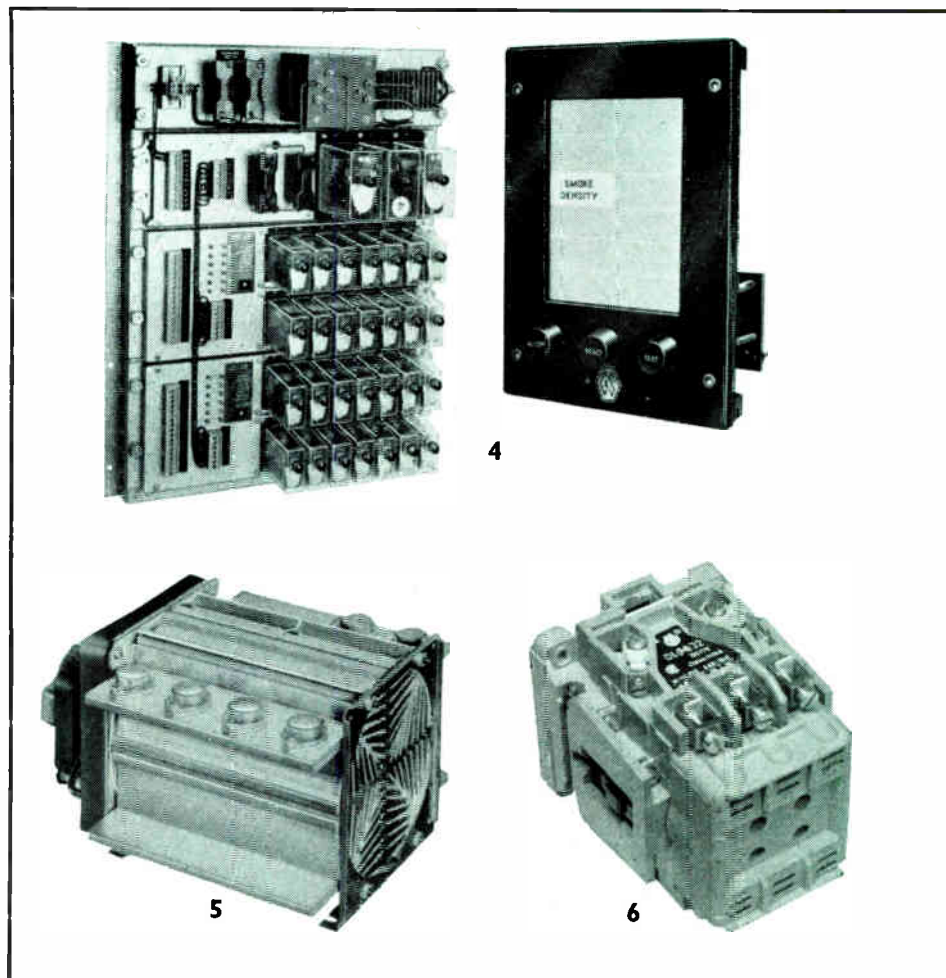

electrical life of the contacts has been increased to 6 times that of other contactors in the range. The contact rating has also been increased. As contactors they can control inductive loads taking up to 42 kW at 500 V a.c. When used as motor starters loads up to 30 h.p. at 500 V, 3-phase a.c. can be accommodated. Other units are available for approximately 400 h.p.—*The Electrical Remote Control Co. Ltd., Bush Fair, Harlow, Essex.*

For further information circle 6 on Service Card

ELECTRONICS

7. Precise Sine-Wave Sources

The Model 100 System manufactured by Radio Frequency Laboratories Inc. of the U.S.A. provides sine waves of precise amplitude and having a frequency stability of $\pm 0.25\%$ with a total harmonic distortion within $\pm 0.035\%$. There are two models of this equipment, the V100 which is a

voltage source of 1 mV to 1 kV at 50 c/s to 10 kc/s, and the A101 which is a current source of 1 mA to 50 A at frequencies between 50 c/s and 3 kc/s. The uses of the equipment include calibration of meters and digital voltmeters and facilities for obtaining a direct reading of the percentage error of a meter are incorporated. Accessory panels can be added to both units for particular purposes and the two can be connected together for calibration of wattmeters. Available in the U.K. from—*Wessex Electronics Ltd., Royal London Buildings, Baldwin Street, Bristol 1.*

For further information circle 7 on Service Card

8. Demonstration Computer

A computer which can be used either as a teaching aid or as a design tool has been announced by System Computers Ltd. Known as the logic tutor, it can be used to demonstrate the elements of combinational logic and the operational principles of digital computers. By using patch panels one unit can serve a number

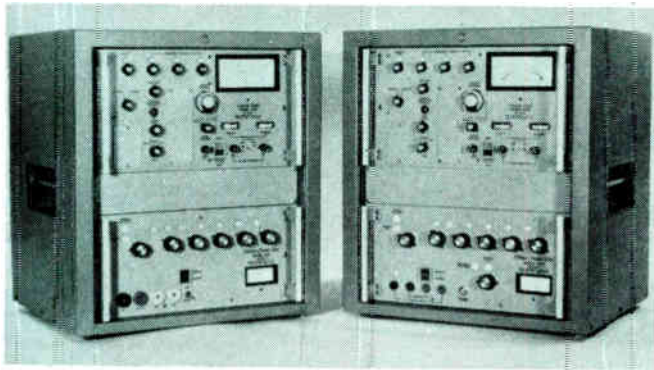

7

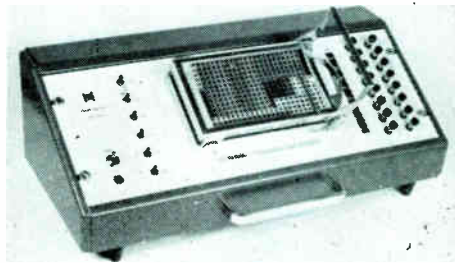

8

9

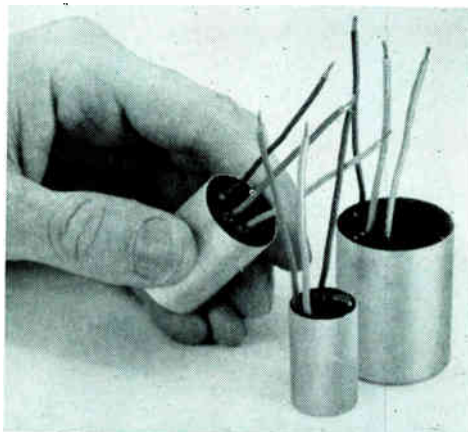
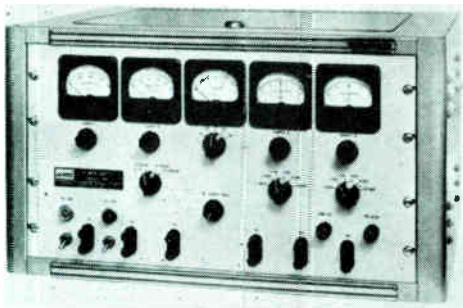

10

of students. Logic circuits can be prepared on the panels and checked before being brought to the machine. This offers fuller participation by the students and protects the logic elements by allowing errors to be rectified before the elements are put on the machine. As a design tool, the Logic Tutor can aid the design and development of logic control systems. It allows for rapid and easy interconnection of the elements of a system so that it can be verified without the need to wire up circuits or connect power supplies.—*System Computers Ltd., Fossway, Newcastle upon Tyne, 6.*

For further information circle 8 on Service Card

9. Multiple-Output Power Supply

A power supply has been designed by Advanced Measurement Instruments of America which will give simultaneous supplies of all the necessary voltages for the operation of vacuum-tube circuits. It is being marketed in the U.K. by Microwave Systems Ltd. Regulated adjustable d.c. voltages up to 300 V at up to

200 mA can be obtained and the non-regulated adjustable a.c. ranges give a maximum of 150 V. A separate 6.3-V a.c. output is provided. The d.c. voltages are positive or negative and all d.c. external load currents are monitored simultaneously on front-panel meters. All voltage sources can be checked on a built-in voltmeter.—*Microwave Systems Ltd., Enfield, Middlesex.*

For further information circle 9 on Service Card

10. Charger Modules

A range of miniature constant-current charger modules for use with nickel-cadmium rechargeable batteries is now available from the Kynmore Engineering Co. Ltd. These are no larger than the batteries themselves and have little reverse (leakage) current so that they may be left permanently connected to the batteries. The batteries are recharged simply by plugging the modules into the mains. The circuitry of the modules consists of a semiconductor rectifying arrangement using gold-bonded diodes. A tubular

can houses the Araldite-encapsulated components. The circuit ensures that the impedance, and therefore the charging rate, remain constant irrespective of the state of the accumulator being charged. This means that even completely-exhausted cells can be charged. The modules are suitable for forming composite power units for torches, hearing aids, transistor radios, r.f. paging systems and other equipment.—*The Kynmore Engineering Co. Ltd., 19 Buckingham Street, London, W.C.2.*

For further information circle 10 on Service Card

11. Signal Generator

The G.2. low-frequency signal generator produced by Linstead Electronics is a versatile source of audio and ultrasonic signals for circuit testing, vibration testing, etc. The frequency range of 10 c/s to 100 kc/s is covered in four decades with continuously-variable adjustment throughout each range. Sine-wave outputs from 0.6 V r.m.s. are available as well as square waves of 0.9 V peak-to-peak. The rise time on

NEW

ELECTRONICS
COMMUNICATIONS
INSTRUMENTATION
CONTROL

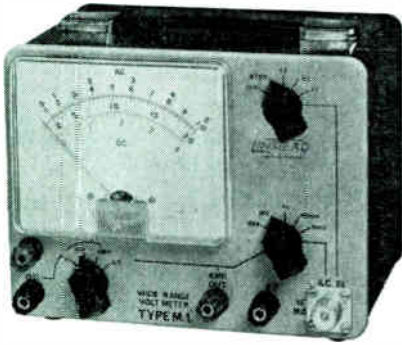

11

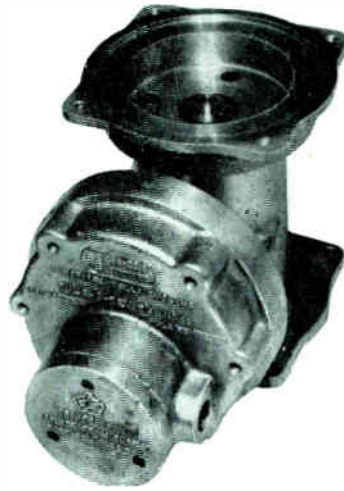

12



13

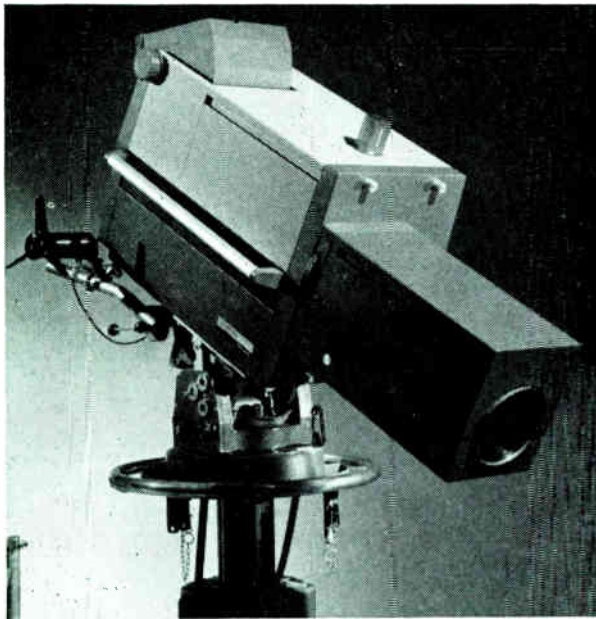

14

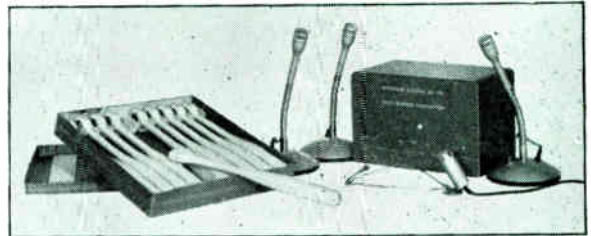

15

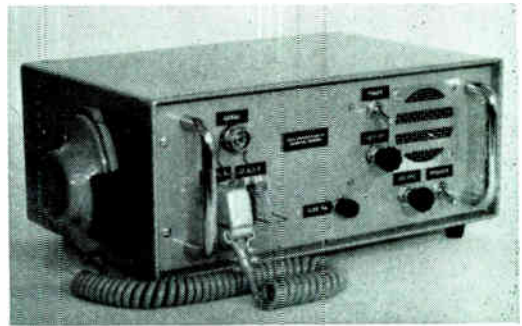

16

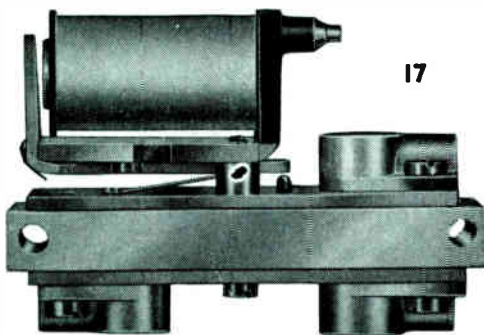

17

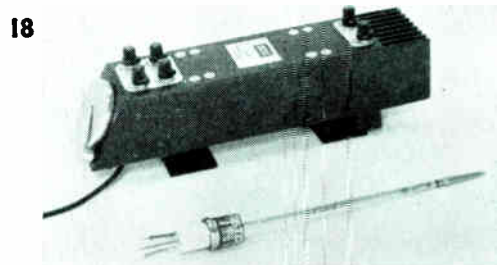

18

square waves is better than 1 μ sec and d.c. coupling eliminates loss of amplitude at low frequencies. The output amplitude control consists of a step attenuator and continuous control over each step. An output of 0.1 W into 3 Ω is provided for loudspeaker testing and other applications.—*Linstead Electronics Ltd., 35c Newington Green, London, N.16.*

For further information circle 11 on Service Card

12. Rotary Pulse Generator

The series RS Mark 3 Puls-O-Rev unit is now under production by Jiskoot Autocontrols Ltd. This unit is suitable for many applications where a digital electrical output is required from any mechanical rotary motion. It has been designed so that it can be adapted to fit all types of rotary meters. Basically it consists of a number of magnets fitted to a rotatable resin disc. A reed switch is located near to the disc to be actuated by the magnets as they are driven past the switch by the rotating disc. The switch is a dry or a mercury-wetted type and up to 100 operations per sec can be achieved. The unit is housed in an aluminium weather-proof and flame-proof case.—*Jiskoot Autocontrols Ltd., Goods Station Road, Tunbridge Wells, Kent.*

For further information circle 12 on Service Card

13. Shaft Encoder

A digital shaft encoder which features up to 10,000-ft separation from the encoding transmitter to the digital readout has been announced by the Theta Instrument Corp. This encoder, series 10, will directly drive several parallel readouts and printers without the need for code conversion or power amplification. It interfaces with readouts and printers rather than digital computers and its applications include analogue-to-digital conversion. With a life of 25,000,000 revolutions, the unit can run continuously at a speed of 1,000 r.p.m. or intermittently at 1,500 r.p.m.—*The Theta Instrument Corp., Saddle Brook, New Jersey 07663, U.S.A.*

For further information circle 13 on Service Card

COMMUNICATIONS

14. Colour Television Camera

Using 4 plumbicon tubes, 3 for the chrominance channels and the other for the luminance channel, Marconi's

recently-introduced Mark 7 colour television camera is fully solid-state with the exception of four Nuvistor valves. The 4-tube arrangement means that the accurate registration of the 3 colour tubes is not so critical and better monochrome pictures can be produced than with 3-tube cameras. Thin-film circuitry is employed and this contributes to the stability of the unit, which is such that once initial setting-up has been completed the camera can be controlled from a single control panel containing the iris, master black level, master gain, on/off and capping controls. A relay optical system is employed which enables the same lenses to be used as are at present used for image orthicon cameras. The system also ensures that the correct amount of light enters the luminance tube at all times and it can be easily adjusted for monochrome operation, in which case all the light is passed to the luminance tube and none to the chrominance tubes. Both 525 and 625-line standards are accommodated and signals suitable for NTSC, PAL and SECAM are generated. A version with 4 vidicon tubes can be obtained for telecine use.—*The Marconi Co. Ltd., Chelmsford, Essex.*

For further information circle 14 on Service Card

15. Radio Interpretation System

The Multitone Electric Co. Ltd. have introduced a compact radio interpretation system for small conferences of about 50 delegates. It consists of a transistorized 4-channel transmitter with either desk or halter microphones of the noise-cancelling type for the interpreters, and 4-channel lorgnette receivers for the delegates. The speakers' voices are heard directly by the interpreters and those delegates who understand the speakers' language. The interpreted languages are heard through the receivers. As 4 languages can be transmitted simultaneously, this system is suitable for conferences using up to 5 languages. The transmitter can be mains or battery operated.—*The Multitone Electric Co. Ltd., 12-20 Underwood Street, London, N.1.*

For further information circle 15 on Service Card

16. V.H.F. Radio-Telephone

The Radio Communications Co. have introduced the type TRT/6 radio-telephone into the 'Telecomm' range of products. This is suitable for mobile use or for use as a fixed

station in remote areas where a mains supply is not available. It operates from a 12-V battery and, being all solid-state, it draws a standby current of only 26 mA and a current during transmission of 1 $\frac{1}{2}$ A. Despite these low figures, a power output of approximately 5 W is produced by the transmitter. The receiver power output is 1 W. The unit is intended for a.m. speech operation in the 40-100 Mc/s band of frequencies. Between 1 and 12 channels are provided with spacings of 25 or 50 kc/s. A unit for repeater operation, type TRT/6R, is also available.—*The Radio Communications Co., 16 Abbey Street, Crewkerne, Somerset.*

For further information circle 16 on Service Card

17. Aerial Changeover Relay

A changeover relay for use with coaxial aerial leads is now available from Magnetic Devices Ltd. This d.c.-operated series 951 relay is for aerial switching at frequencies around 450 Mc/s but can be used for applications requiring low inter-contact capacitance. It is fast operating and has a single changeover contact rated at 1 A or 30 W maximum. The coaxial cables are easily solder-connected without disturbing the adjustment of the relay and the elimination of coaxial plugs and sockets in the relay body has reduced the size and the cost. A v.s.w.r. of approximately 1.1:1 at 450 Mc/s is quoted and the cross-talk is 39 dB.—*Magnetic Devices Ltd., Newmarket, Suffolk.*

For further information circle 17 on Service Card

18. T.W.T. for 4-Gc/s Band

Standard Telephones and Cables have introduced a low-voltage travelling wave amplifier, Type W7/5G, which has been designed for use in 1,800-channel radio communication links. It operates in the 3.6 to 4.2-Gc/s band. The gain with an output of 20 W is 43 dB and the saturated output is 30 W. This means that this amplifier can be substituted in an existing system for a tube with a gain of 40 dB and an output of 10 W to produce, with the same drive power, twice the output of the 40-dB tube. The tube is housed in a robust permanent-magnet mount which incorporates r.f. input and output waveguide connections. Also incorporated are mechanical alignment, deflection and matching adjustments.—*Standard Telephones and Cables Ltd., Footscray, Sidcup, Kent.*

For further information circle 18 on Service Card

NEW

ELECTRONICS
COMMUNICATIONS
INSTRUMENTATION
CONTROL

19. 10-Button Internal Telephone

Associated Telephones Ltd. are now marketing an intercommunication system consisting of one 10-button central station and up to 10 single-button extension telephones. It is suitable for customer-installation and the distance to each extension from the central station can be up to 1,000 yards. The quality of speech is to G.P.O. standards and G.P.O. style handsets are used. The system is flexible so that it can be built up from one 10-button station and one extension to a full network of 10 extensions. A 21-day free trial with one extension and a central station is offered.—*Associated Telephones Ltd., 156 Camden High Street, London, N.W.1.*

For further information circle 19 on Service Card

20. F.M. Test Set

A battery-operated test set manufactured by Amalgamated Wireless (Australasia) Ltd. is being marketed in this country by Livingston Laboratories Ltd. This unit, type A410, is compact and solid-state and has been designed for field service and maintenance of f.m. two-way radio equipment. It consists of an f.m. signal generator operating in both the u.h.f. and the v.h.f. frequency bands, an i.f. calibrator, an f.m. deviation meter, and an a.f. and r.f. power meter. Both receiver and transmitter measurements in the frequency range of 30–520 Mc/s are possible.—*Livingston Laboratories Ltd., Greycaines Estate, Bushey Mill Lane, North Watford, Herts.*

For further information circle 20 on Service Card

21. Mono/Stereo Headset

S. G. Brown Ltd., a Hawker Siddeley Company, have developed a noise excluding headset, the Dynamic (3C 1100), which will give high-

quality mono or stereo reproduction. The frequency response is ± 6 dB over the range of 20 c/s to 8 kc/s although reproduction is good up to 20 kc/s. Distortion is less than 1% with an average input power to each earpiece of 1 mW, and the maximum input power to each earpiece is 0.5 W for less than 6% distortion with a 120-dB sound level. The lightweight cable (the complete headset including the 6-ft cable weighs 18 oz) has the conductors individually screened and the connections to each earpiece are taken via a conductor and the screen so that the possibility of interference between stereo channels is reduced.—*The Hawker Siddeley Group Ltd., Duke's Court, 32 Duke Street St. James's, London, S.W.1.*

For further information circle 21 on Service Card

INSTRUMENTATION

22. Infrared Spectrophotometer

Perkin-Elmer have introduced a high-speed infrared spectrophotometer, the Model 257. This presents each spectrum being investigated as a continuous record on a strip chart of linear transmittance against linear wavenumber. Three abscissa scales and three recording speeds are incorporated. The unit is of the double-beam optical-null type. It utilizes a filter-grating monochromator and scans at wavelengths from 4,000–625 cm^{-1} . The chart is synchronized with the monochromator and at the end of each run the monochromator automatically returns to the start position. Precise calibration of the chart is maintained independently of chart stretch and it is also maintained through the automatic scale change of 2:1 at a wavelength of 2,000 cm^{-1} . Abscissa expansion of $2\frac{1}{2}$ times and 10 times is available and records of transmission against time at any set wavenumber are possible. A range of accessories for sampling solids, liquids and gases can be obtained.—*Perkin-Elmer Ltd., Beaconsfield, Buckinghamshire.*

For further information circle 22 on Service Card

23. Bridge Oscillator and Attenuator

The type 5720 bridge unit from H. Tinsley and Co. Ltd. consists of a square-wave generator, giving two
(Continued on page 135)



You want components that are sound

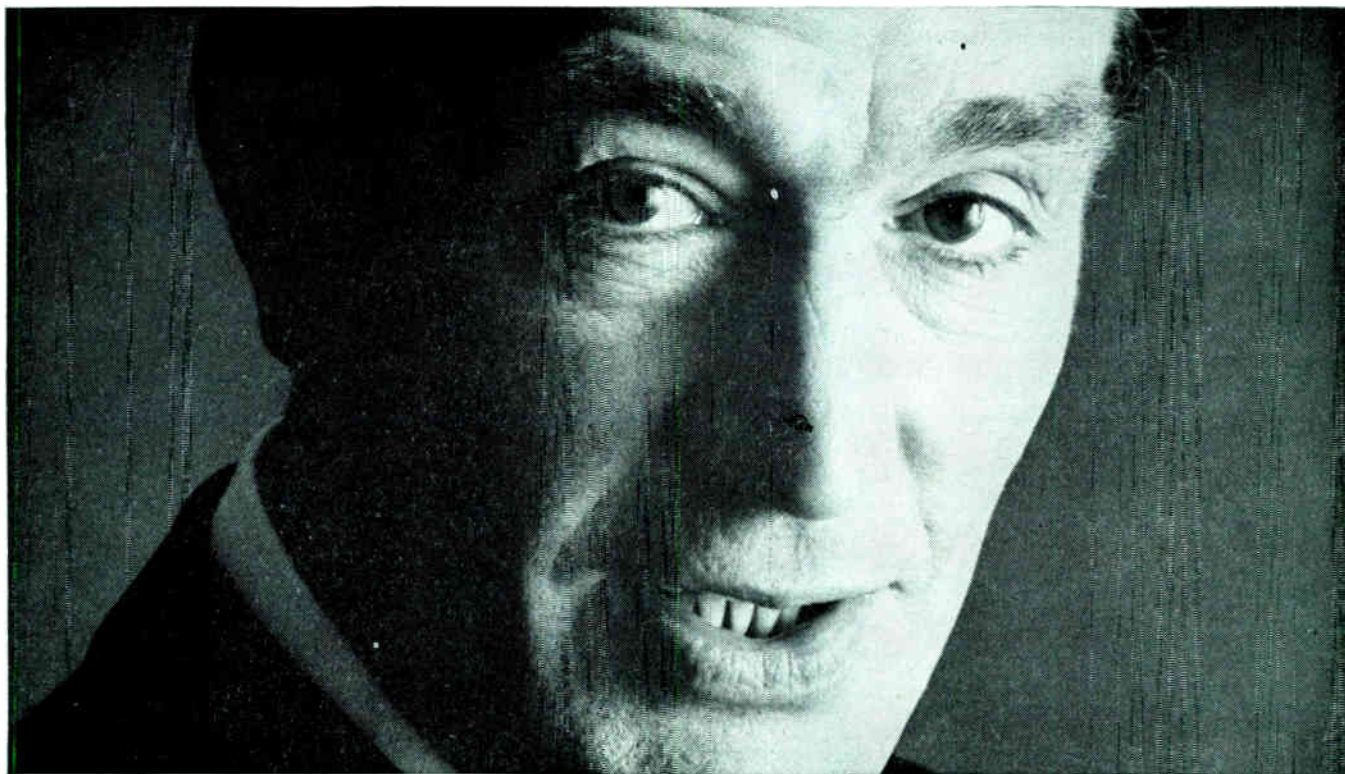

Amplivox make sound components

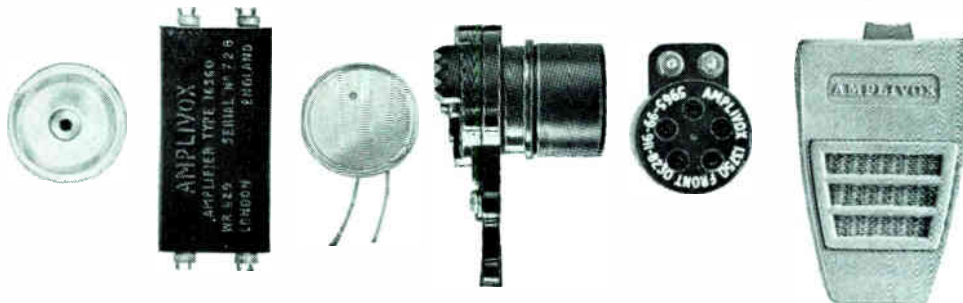

Don't risk your reputation! Enhance it! When your products incorporate Amplivox components you are backing your own good name with the Amplivox reputation.

Constant research and development have established and maintained Amplivox as leaders in the field of sound transmission and reception. Hand Microphones * Stethoscope Listening Units * Miniature Microphones * Noise Excluding Headsets * Tropicalised Microphone Inserts * Earphones * Miniature Amplifiers * Lightweight Headsets.



WRITE OR PHONE FOR FULL DETAILS: AMPLIVOX INDUSTRIAL DIVISION, BERESFORD AVE., WEMBLEY, MIDDLESEX. TEL: WEMBLEY 8991

WODEN for ALL these system components

TORQUE MOTORS—
for precise torque and angular positioning under load. Range—up to 12,000 gm. cm. $\pm 7^\circ$.



SERVO VALVES—Electro-hydraulic—
for accurate oil flow control in response to any input signal. Single-stage design. Immune to dirt. Max: 4 gpm at 1000 psi.

PROGRAMMERS—
stepping drum types with inbuilt logic, available for interlocking sequential operations. The heart of process control systems. Max: 93 switches, 100 steps.

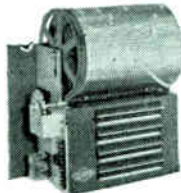

MATRIX BOARDS—
for optimum switch/space ratio. Highly versatile, yet inexpensive. Max: 10,000 way, up to 5 decks.

PATCHBOARDS—
for circuits demanding many small changes or a few complex ones. Several major programmes can be stored and reintroduced as required. Range—normally up to 1,600 way.



PATCHCORDS—
over 20 varieties provide slick patch-board programming.

CARD READERS—
for repetitive programmes. Numerous complex circuits may be stored as punched-cards. Range—up to 1,600 way.



80 COLUMN CARD READER—
for static reading of 1 to 960 circuits through the standard 80 column TAB card.

CROSS BAR SWITCHES
for simple effective operations. Easily set up at minimum cost. Any number of 10 x 20 way units may be linked.



WODEN AUTOMATION LTD
OXFORD STREET • BILSTON • STAFFS • ENGLAND

ADCOLA

PRODUCTS LIMITED
(Registered Trade Mark)

**HIGH EFFICIENCY
SOLDERING INSTRUMENTS**
FOR
BENCH LINE PRODUCTION

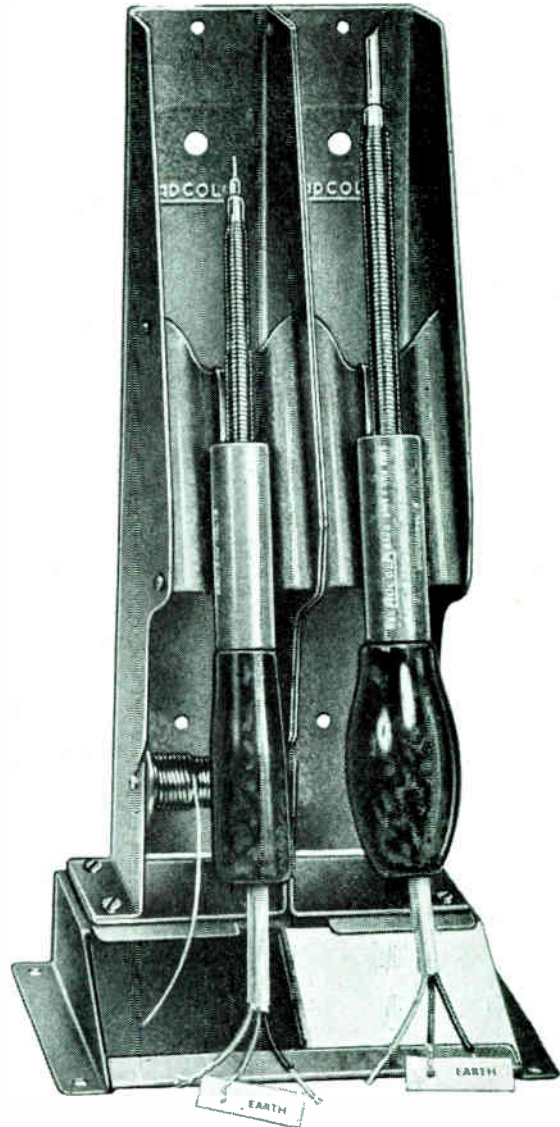

Apply direct to
Head Office Sales and Service

ADCOLA PRODUCTS LTD.
ADCOLA HOUSE
GAUDEN ROAD
LONDON S.W.4

Telephones
MACaulay
4272
and
3101

Telegrams
SOLJOINT, LONDON S.W.4

INDEX TO PRODUCTS

Please refer to appropriate pages to obtain code number for marking enquiry card

A—Advertising pages E—editorial pages

	page		page
Aerials	58A	Potentiometers	E139, 27A
Alarm systems	E129, E130	Potentiometric recorders, d.c.	E135
Amplifiers	57A, E136	Power supplies	E131
Analyzer, chemical	26A	Printed circuits	53A, 88A, E146
Analyzers, process-stream	71A	Printed circuits, edge connectors	73A
Bridge oscillators	E134	Printers, teletype	E147
Bulbs	82A	Public address (multi-channel)	E133
Cabinets, boxes, chassis, racks, etc.	16A, E29	Pulse generators/amplifiers	Cover 3
Cables, fixing devices	53A, E140	Radar	E116, E145
Cables, reeling units	E140	Radiation thermometry	E136
Calibrators, portable	81A	Radiotelephones	38A, 39A, E133
Capacitors	6A, 33A, 35A, 72A	Recorders, chart	89A
Casting system (resin)	65A	Recorders, data	E136
Castings	74A	Regulators, power and speed	36A
Charger modules	E131	Regulators, temperature	28A
Chronometer, digital	E80	Relays	2A, 8A, 46A, 48A, 64A, 76A, Cover 4, E133
Circuit breakers	E139	Resistors	80A
Circulators, stripline	48A	Semiconductors	30A, 31A
Communications systems	E134	Shielding enclosures r.f.	49A
Components, electronic	4A, 5A, 61A, 62A, 64A, 74A	Signal generators (a.f.)	E130
Components, submarine	42A	Solder and soldering tools	62A
Computer components	Cover 2	Solenoids	47A, 56A
Computers, digital	E130, 67A	Spectrophotometer	E134
Conductors covered	55A	Speed drive	50A
Connectors	81A	Springs and connectors	80A
Contactors	E130	Submarine components	42A
Controllers, liquid level/flow	E148	Switches, micro	29A
Controllers, load and strain	E136	Switches, pneumatic	40A
Controllers, time/temperature	E136	Switches, proximity	E136
Converters, analogue-digital	19A	Switches, reed	E138, 22A
Crystals, quartz	52A	Tape recorders, television	E119
Cutters, veroboard	E140	Tape transports, digital	43A
Data, logger/recorder	66A	Telemetry equipment	E120
Diodes, Zener	E139	Teleprinters	E121
Electrical equipment, general	76A	Television cameras, colour	E133
Electronic equipment, general	7A	Terminal and terminal blocks	82A
Electroplating	42A	Test sets	E134
Encapsulants	E138	Testers, ferrite-core	E139
Encoders	E133	Timers, sequence	41A
Fans	18A	Transformers, variable	20A, E138
Filters	47A	Transistors	37A, 54A, E139
Generator, sweep	79A	Travelling wave amplifiers	E133
Generators, pulse	E133	Tubing	76A
Generators, tachometer	E136	Typewriters, input/output	82A
Headsets, mono/stereo	E134	Ultrasonic leak detectors	10A
Heatsinks	E130	Vacuum gauges	E134
Indicators, 3-colour	77A	Valve testers	3A
Inserts	51A	Wire	50A, 80A
Instrumentation, electronic	17A, 26A		
Insulation materials	21A		
Inverters, static	9A, 44A, 45A		
Laminates, plastics metals	1A		
Lasers	78A		
Lettering tape	15A		
Listening devices	E129		
Magnets and magnetic materials	36A		
Meters	E135, 34A		
Motors	40A, 78A		
Oscillators	40A, 90A		
Oscilloscopes	24A, 25A, 75A, 81A		
Photoconductors, germanium	68A, 69A		
Plastics, mouldings and extrusions	70A, 82A, 88A		

MANUFACTURERS' LITERATURE Page E150

Carlyle Air Conditioning Co. Inc.
E.M.I. Electronics Ltd.
English-Electric-Leo-Marconi Computers Ltd.
Hilger—I.R.D. Ltd.
I.I.T. Research Institute
Marconi Instruments Ltd.
Mullard Ltd.
Rank Audio Visual Division
Spencers Joinery Ltd.
S.T.C. Components Marketing Division
Westool Ltd.

Let the

INDUSTRIAL ELECTRONICS

READER ENQUIRY SERVICE help you to obtain more information

To obtain further details of any of the coded items mentioned in the Editorial or Advertisement pages of this issue, please complete one or more of the attached cards circling the appropriate reference number(s). Your enquiries will be passed on to the manufacturers concerned and you can expect to hear from them direct in due course. Cards posted from abroad require a stamp. These Service Cards are valid for six months from date of publication.

PLEASE USE CAPITAL LETTERS

Pour obtenir tous renseignements sur les produits codés mentionnés dans les articles ou dans les pages publicitaires de ce numéro nous vous prions de remplir une ou plusieurs des cartes ci-jointes en encerclant le ou les numéros de référence appropriés. Vos demandes de renseignement seront transmises aux fabricants intéressés qui, en temps voulu, vous feront parvenir leur réponse. Il est nécessaire d'affranchir les cartes postées à l'étranger. Ces cartes de service sont valides pendant six mois à partir de la date de publication.

PIÈRE D'UTILISER DES CARACTÈRES D'IMPRIMERIE

Weitere Einzelheiten über irgendwelche Artikel, die auf redaktionellen oder Anzeigenseiten erscheinen, erhalten Sie, indem Sie eine oder mehrere der beigefügten Karten ausfüllen und die entsprechende(n) Kennnummer(n) einrahmen. Ihre Anfrage wird an den Hersteller weitergeleitet, und Sie werden dann direkt von ihm hören, Karten, die im Ausland aufgegeben werden, müssen frankiert werden. Diese Service-Karten sind für sechs Monate vom Ausgabebetrag gültig.

BITTE IN BLOCKSCHRIFT AUSFÜLLEN

Per ulteriori particolari in merito agli articoli menzionati nel testo o nelle pagine pubblicitarie di questo numero, Vi preghiamo di completare una o più delle schede allegate chiudendo in un cerchietto il numero o i numeri di riferimento. La Vostra richiesta sarà inoltrata ai fabbricanti interessati che Vi risponderanno direttamente. Le schede dall'estero devono essere regolarmente affrancate. Questo scontrino di servizio è valido per sei mesi dalla data di pubblicazione.

SI PREGA DI COMPILARE LE SCHEDE IN STAMPATELLO

Con objeto de obtener más detalles de cualquiera de los artículos mencionados en las páginas editoriales o de anuncios de este número, sírvase rellenar una o más de las unidas tarjetas poniendo un círculo al número o números de referencia. Sus consultas serán transmitidas a los fabricantes interesados de quienes tendrán noticias directamente a su debido tiempo. Las tarjetas enviadas desde el extranjero requieren franqueo. Estas tarjetas de servicio son válidas durante 6 meses a partir de la fecha de publicación.

SÍRVASE ESCRIBIR CON LETRAS MAYUSCULAS

Three outstanding Relays from DUPAR

DUPAR Phase Failure and Reversal Relay Type PFS

Prevents motor rotation being reversed when phases of supply become reversed and prevents re-start under phase failure. 3 phase up to 500V 25 or 50 c.p.s.

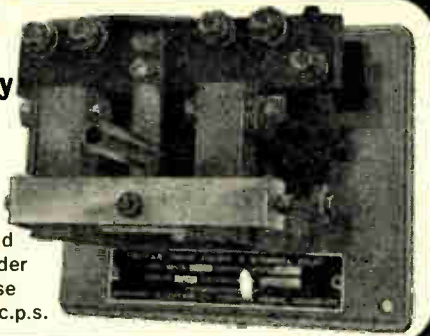

DUPAR Miniature Plug-in Relay Type EB

With international octal base. 3,600 operations per hour. 12 to 240V a.c. 50 cycles. Switching capacity 6A at 240V a.c.



DUPAR Type ET Protector

Gives complete motor protection against overload and single phasing. Range 0.25 to 60 amp.

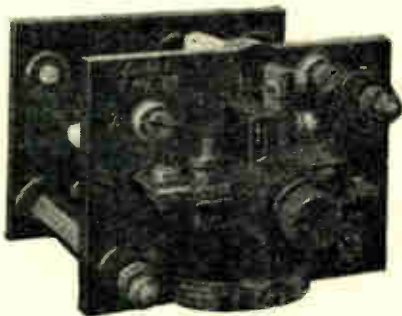

DUPAR for dependability

Please send for leaflets on these products



DEWHURST

& PARTNER LIMITED

HOUNSLOW · MIDDLESEX

and

BIRMINGHAM · CARDIFF · GLASGOW

LEEDS · MANCHESTER

NEWCASTLE · NOTTINGHAM

WHITELEY

miniature



ELECTRONIC COMPONENTS

Reduce your problems & equipment size to a minimum

The Whiteley organisation has tackled and solved many big problems in the past and in the last decade have developed quite a technique for solving many miniaturisation problems.



Whiteley miniature components cover a very wide range, but we show as examples a transformer, a potentiometer mounting, a small iron cored choke and a mu-metal core encapsulated in epoxy resin. Modern research and development techniques are available to you by simply writing or telephoning us at Mansfield giving details of your particular big problem regarding small components.

WHITELEY ELECTRICAL RADIO CO. LTD.

MANSFIELD · NOTTS · Telephone: Mansfield 1762/5

WB 177

isolated and balanced outputs of 2.5 V each, and a detector which is synchronized with the generator. It is suitable for strain-gauge bridges or resistance thermometer bridges where a combined oscillator and detector is required. The sensitivity can be controlled to make each division of the meter correspond to an exact amount of strain or temperature according to the way the unit is used. Accessories include strain gauges, expendable thermometer elements, a strain-gauge slide-wire unit and a thermometer bridge.—*H. Tinsley & Co. Ltd., Werndee Hall, South Norwood, S.E.25.*

For further information circle 23 on Service Card

24. D.C. Potentiometric Recorder

Fielden Electronics Ltd. have produced a true d.c. potentiometric recorder at a price which is claimed to be lower than that for any comparable instrument. It can function from various thermocouples, when automatic cold-junction compensation is included, and it also operates from d.c. voltage signals in ranges from 0-10 mV up to 0-100 mV, or d.c. current signals in ranges from 0-50 μ A up to 0-10 mA. With this instrument, the measurement of such parameters as temperature, pressure,

flow, pH, weight, smoke density, level, etc., is possible. Instruments are available with two control arms each of which can be adjusted to any set value in the scale range to provide 3-step controller action for control and alarm.—*Fielden Electronics Limited, Wythenshawe, Manchester.*

For further information circle 24 on Service Card

25. Dewpoint Meter

A special lamp, fitted with a gap over which conduction takes place when condensation forms, is the basis of an instrument known as the 'Lampighter' which has been announced by Shaw Moisture Meters. This is a simple automatic unit which will indicate dewpoint temperatures in the range 0-100 °C. The lamp lights up in the presence of condensation and heats until the condensation disappears. A thermistor senses the temperature of the lamp and this is indicated on a dial.—*Shaw Moisture Meters, Rawson Road, Westgate, Bradford.*

For further information circle 25 on Service Card

26. Vacuum Gauge

The Model 5 ionization gauge from Edwards High Vacuum Ltd. is suitable for use with most ionization gauge heads and plate-type heads.

Direct indication of pressure is given in the range 10^{-3} to 10^{-10} torr without the need for the time-consuming procedures normally required for measurement with ionization gauges. The pressure range is covered by a selector switch and continuous indication without range selection on an alternative logarithmic scale is provided for pressures between 10^{-4} and 10^{-9} torr. Filament and grid currents are continuously indicated on separate meters and the grid current is controlled to within 1% for a $\pm 10\%$ supply voltage variation. A variable power supply of up to 100 W is included for gauge-head electrode degassing and zero suppression enables the sensitivity to be increased for leak-detection purposes.—*Edwards High Vacuum Ltd., Manor Royal, Crawley, Sussex.*

For further information circle 26 on Service Card

27. Dissolved Oxygen Meter

A portable battery-operated oxygen meter, model SM. 121, has been added to the Pro-Tech Advisory Services Ltd. range of instrumentation. This incorporates a waterproof transistorized amplifier module, an automatic temperature compensator with a range of 2-35 °C,

23



NEW

ELECTRONICS
COMMUNICATIONS
INSTRUMENTATION
CONTROL

24

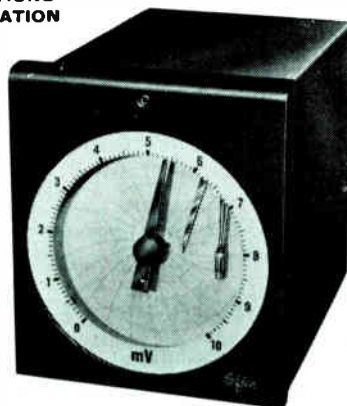

25



26

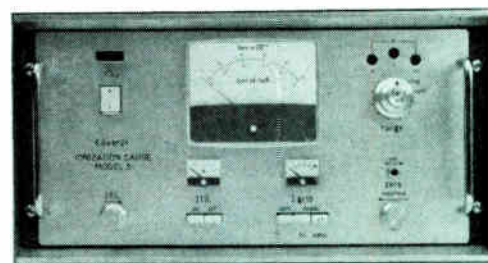

NEW

ELECTRONICS COMMUNICATIONS INSTRUMENTATION CONTROL

and an electronic thermometer. Dissolved oxygen within 0–15 p.p.m. is indicated on the dial to an accuracy of ± 0.1 p.p.m. and direct readings of temperature accurate to $\pm 0.5^\circ\text{C}$ between 0 and 40°C are also provided on this dial. A check button is featured which affords a simple means of checking the electrode calibration without the need for comparative calibration. Accessories include a traverse unit for measurements to a depth of 400 ft and a miniature strip chart recorder.—*Pro-Tech Advisory Services Ltd., 21 High Street, Rickmansworth, Hertfordshire.*

For further information circle 27 on Service Card

28. Chart Recorder

Telsec Instruments have produced a low-cost potentiometric chart recorder for laboratory use. It has been designed to fill the gap between the single-purpose instruments and the more costly elaborate models while exhibiting reliability of circuitry and precision of operation. A 10-speed gear-box is incorporated for ease of change in chart speeds and the pen-response time is 0.6 sec. The maximum sensitivity is 10 mV f.s.d. with a deadband of only 0.1% and the potentiometer linearity is 0.25%. It is portable and mains or battery powered.—*Telsec Instruments Ltd., Sandy Lane West, Eastern By-Pass, Littlemore, Oxford.*

For further information circle 28 on Service Card

CONTROL

29. Load and Strain Control for Materials Testing

A system for the control of the load and strain applied to a specimen under test has been developed by Instron Ltd. It enables the applied strain or load to be automatically and precisely controlled and to follow various modes such as sawtooth or sinusoidal cycling. With the use of this system, the capabilities of the Instron model ITT (floor model) universal testing instruments can be extended and the equipment has been designed as an accessory to these. Conditions of load and stress that would occur in practice can be simulated and the system can be

used to control the load while the strain is measured and vice-versa. For crystal studies, the strain rate can be varied for the investigation of dislocations through pure crystals.—*Instron Ltd., Halifax Road, High Wycombe, Buckinghamshire.*

For further information circle 29 on Service Card

30. Servo Amplifier

A microelectronic amplifier, model TMS-501, which will deliver up to 5 W to a servo load has been announced by Solitron Devices Inc. The operating frequency of this unit is $400\text{ c/s} \pm 20\text{ c/s}$ and the gain can be adjusted from 100 to 1,000 by suitable selection of the external input resistor. Thin-film circuitry and silicon power transistors are used and reliability and ruggedness are enhanced by the epoxy compound which forms a hermetic seal.—*Solitron Devices Inc., 256 Oak Tree Road, Tappan, New York 10983, U.S.A.*

For further information circle 30 on Service Card

31. Temperature Controller

The laboratory circulator developed by the Churchill Instrument Co. has been designed to pump temperature-controlled water, or any other medium, continuously around or through external apparatus. Consisting of a cylindrical tank with a heater, pump, temperature indicator and controller, and facilities for cooling, this instrument circulates water at a rate of up to 30 gal per hr. The unit may be used in photographic and general-purpose laboratory applications, and temperatures near to ambient can be maintained precisely by passage of mains water or refrigerant through the cooling coil. Employing a minimum volume closed-loop principle, temperature control of water jackets, apparatus and small machinery can be maintained. The packaged unit can also be used to give complete mixing in a constant-temperature water bath.—*The Churchill Instrument Co. Ltd., Walmgate Road, Perivale, Greenford, Middlesex.*

For further information circle 31 on Service Card

32. Pneumatic Controller

An inexpensive pneumatic controller has been introduced by Foxboro-Yoxall Ltd. Known as the model 43A controller, it can accommodate mechanical elements for measurement of pressure, vacuum, flow, temperature, relative humidity, dew point and level. A choice of 4 control modes is offered: on/off, full pro-

portional (the band is adjustable between $\frac{1}{2}$ and 400%), proportional plus reset, and differential gap. The steel cover is weather and dust-proof so that the unit can be installed in the open. It is suitable for surface, pipe, yoke or panel mounting. Exhaust air from the controller purges the interior of the instrument case to protect it against corrosive plant atmospheres.—*Foxboro-Yoxall Ltd., Redhill, Surrey.*

For further information circle 32 on Service Card

33. Tachometer Generator

Muirhead & Co. Ltd. now have in production a size-11 servomotor tachometer generator, model 11M10X1, which has been designed for use in precision integrating and velocity servos. The linearity of the output voltage with speed is 0.07% and the maximum variation of the output voltage with temperature is only 0.25% over a temperature range of -15°C to $+75^\circ\text{C}$. By the adoption of the 'inverted' tachometer design, the output voltage has been increased to 2.75 V per 1,000 r.p.m. which is nearly 5 times higher than that of the earlier types of size-11 tachometers. Various motor windings are available to suit customers' requirements.—*Muirhead and Co. Ltd., Beckenham, Kent.*

For further information circle 33 on Service Card

34. Inductive Proximity Switch

Mec-Test Ltd. have developed an inductive proximity switch, type LDS.04, which eliminates failure due to wear, fatigue, seizure, corrosion or liquid penetration. It consists of a coil assembly potted in an epoxy resin and housed in a heavy-duty metal sheath. When the unit is connected to a suitable solid-state control module, also produced by this company, the presence of metal over the face of the switch will cause the current through the switch to vary. This will produce a change in the output voltage from the control module for the operation of a relay or other controlling device. A special form of control module for machine-tool applications is produced which will not be actuated by small swarf chips.—*Mec-Test Ltd., Copse Road, St. Johns, Woking, Surrey.*

For further information circle 34 on Service Card

35. Radiation Thermometry

The 600 series of radiation thermometry equipment manufactured by Ircan Inc. is now available in the U.K. through Ad. Auriema Ltd. The

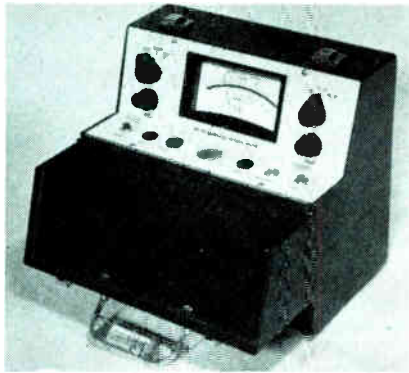

27

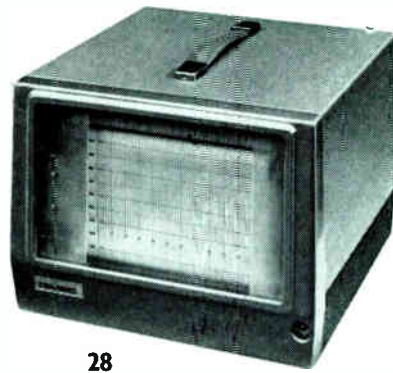

28

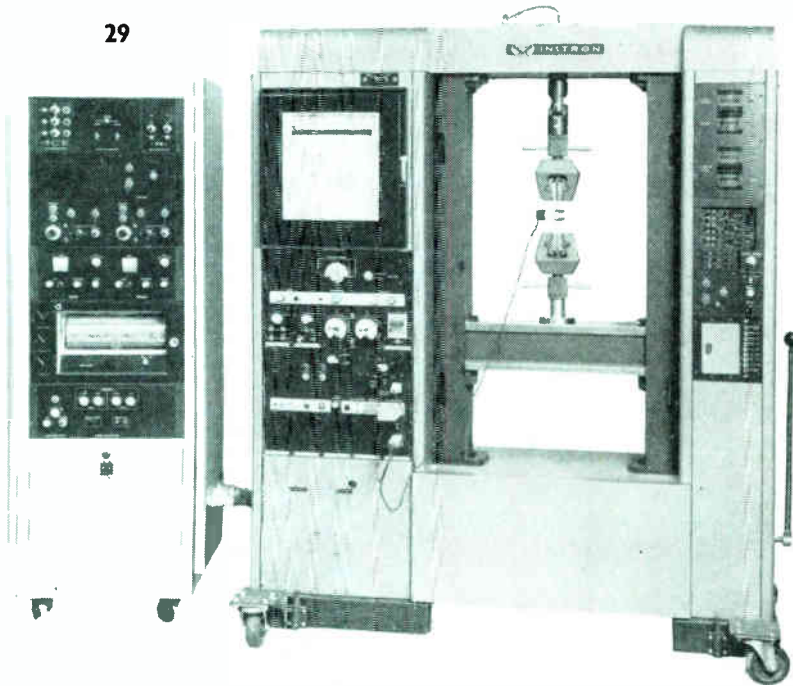

29

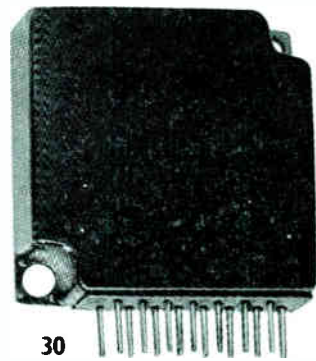

30

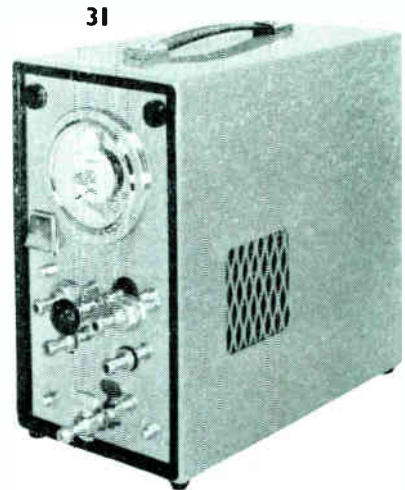

31

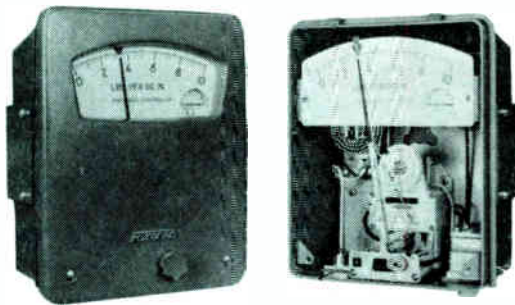

32



33

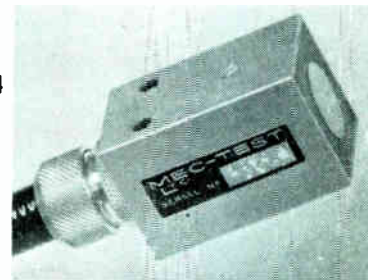

34

NEW

ELECTRONICS
COMMUNICATIONS
INSTRUMENTATION
CONTROL

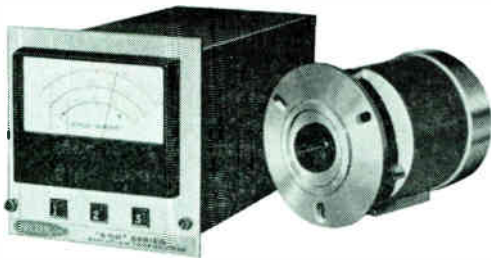

35

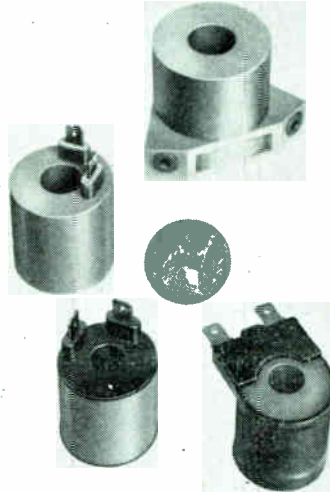

36



38



37

series includes a radiation pyrometer, indicators, on/off controllers and proportional controllers which are all compatible with each other and various existing recording and control systems. It is suitable for industrial monitoring and control in applications where the objects concerned are inaccessible, moving or being heated quickly or where the objects are fragile or in corrosive atmospheres. In operation, the infrared radiation emitted from the object is picked up by an optical system and focused on to an infrared detector. It is converted into an electrical signal which is amplified and displayed as temperature on a meter. A narrow band only of short-wavelength infrared radiation (2.0-2.6 microns) is detected as this allows reliable temperature measurements down to 80 °C. —Ad. Auriema Ltd., 125 Gunnersbury Lane, London, W.3.

For further information circle 35 on Service Card

COMPONENTS

36. Encapsulated Coils

Westool Ltd. have entered into limited production of encapsulated coils for relays and other electromagnetic devices. The encapsula-

tion is waterproof to a high degree, so that the coils will operate effectively in conditions of high humidity. They are also more robust and consequently possess improved electrical and mechanical characteristics. Two methods of encapsulation are currently being employed using either epoxy resins or polypropylene. Polypropylene is lower in cost, therefore Westool have decided to concentrate on this at the present time.—Westool Ltd., Bishop Auckland, Co. Durham.

For further information circle 36 on Service Card

37. Variable Transformer

The Series 30 Regavolt variable transformers are now available from the British Electric Resistance Co. Ltd. With a former diameter of only 3-in., the units can be supplied in a ventilated case for bench mounting or as rigid assemblies of ganged units for 2- or 3-phase operation. They will accept a maximum of 250 V a.c. to produce an output of 0-250 V and versions for 50 c/s and 400 c/s are available. Current ratings are 0.5 A for unmounted units and 0.7 A for units mounted on a heat sink. The series includes units for other outputs. Motor drive can be obtained together with cam and microswitch assemblies which will switch the output on or off for any angle of rotation.—The British Electric

Resistance Co. Ltd., Queensway, Enfield, Middlesex.

For further information circle 37 on Service Card

38. Dry Reed Switch

A dry reed switch, the MR990, from Gordos is being marketed by B. and R. Relays. It has been designed for loads rated at 100 W and is rated at 3 A, 250 V d.c. maximum. This switch has two contacts on each blade, the first set closing before the second when the switch is energized. The first contact is of tungsten and takes all of the inrush and most of the bounce portion of the total operating time. The main contacts, which are of di-met, provide a low-resistance path in parallel with the tungsten contacts. When the main contact closes, the tungsten reed is lifted a few thousandths of an inch from the back surface of the main contact on which it normally rests. On opening, the main contact has these few thousandths of an inch to travel in which it builds up momentum. Therefore, when the main contact strikes the tungsten blade, the breaking of the tungsten contact is rapid and very little arcing can take place. Typically, on energization, the tungsten contact closes 5-10 ampere-turns ahead of the main contact. There is some reclosure present but the reclosure period is only of

(Continued on page 139)

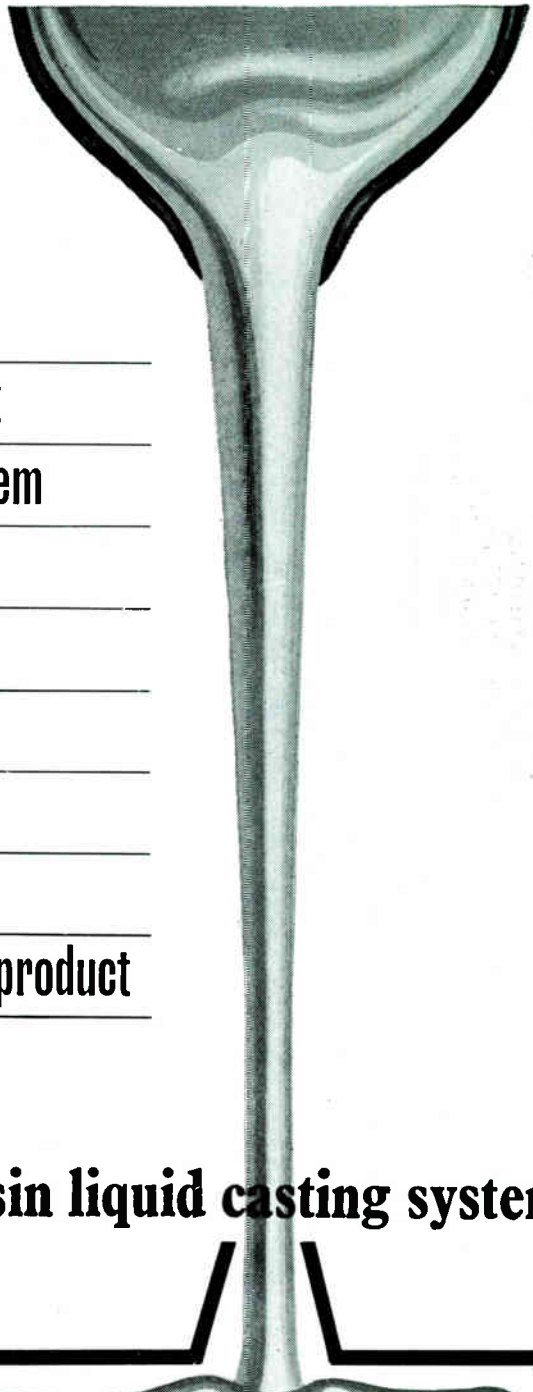

What is **RXE 11**?

An important new Shell development

A completely new resin casting system

A **liquid** resin system

Overcomes curing-agent problems

Easy to handle

Has outstanding crack resistance

Cuts casting costs

Provides a better-performance end product

RXE 11 is the new EPIKOTE resin liquid casting system for the electrical industry

write for details now:

The Information Officer
Shell Chemical Company Limited
Shell Centre, Downstream Building, London, SE1

Please send me literature on the
RXE 11 EPIKOTE RESIN LIQUID CASTING SYSTEM

Name _____

Position _____

Company _____

Address _____

End-use requirement _____



Shell Chemical Company Limited
Shell Centre, Downstream Building, London, SE1

SHELL and *EPIKOTE* are trade marks



dear diary...

This is a Dynamco Data Logger, a fanatical recorder of detail. It is a machine for accumulating facts—and for operating warning or control systems, where appropriate. Dynamco Systems will build you just as much data logger as you need—from standard single or multi-channel equipment, virtually off-the-shelf, to a series of matched units such as the National Physical Laboratory has recently installed for recording of data from wind-tunnel experiments. *Ask for literature*; we have 'Digital Data Logging', which describes principles and applications, and a Short Catalogue, which describes the equipment we use to put our ideas into action.



DYNAMCO SYSTEMS LTD
Govett Avenue · Shepperton · Middx
Tel: Walton-on-Thames 26321/8

μ sec duration and, for the type of loads that this switch is intended, should present no problems.—*B. and R. Relays Ltd., Temple Fields, Harlow, Essex.*

For further information circle 38 on Service Card

39. Miniature Lever Keys

Now available from Keyswitch Relays for light-current switching applications is a range of P.O. 1000 type miniature double-throw lever keys with a mechanical life in excess of 750,000 operations per switching cycle. The contact action provided is a changeover, and is available in combinations of locking, non-locking and stop action, with a maximum of sixteen changeovers (eight per action). Contact ratings are 100 V at 300 mA d.c. or 1 A a.c. and 12 V at 1 A d.c. The overall length is 2.78 in., depth including handle 2.19 in. and width 0.62 in.—*Keyswitch Relays Ltd., Cricklewood Lane, London, N.W.2.*

For further information circle 39 on Service Card

40. Circuit Breakers

The SB-600 series of Thermo-Break circuit breakers manufactured by Sylvania of the U.S.A. are being marketed in this country by Thorn Special Products Ltd. They consist of two silver contacts and a bimetal strip housed in a gas-filled glass envelope. The contacts are normally closed until either the ambient temperature or the current flowing through the circuit breaker exceeds the rated value. When actuated by the ambient temperature, the contacts remain open until the temperature falls to below the rated value

so that the bimetal strip can cool to close the contacts. When actuated by an overload current, the bimetal strip is heated to open the contacts and cools while the contacts are open to close them once more. It continues to heat and cool until the overload is removed. The units are available with any one of 21 contact opening temperatures ranging from 80 to 180 °C in 5 °C steps. They are rated to take continuous currents of 10 A at 120–240 V and fault currents of 28 A, 120 V and 13 A, 240 V.—*Thorn Special Products Ltd., Great Cambridge Road, Enfield, Middlesex.*

For further information circle 40 on Service Card

41. Zener Diodes

A series of miniature zener diodes, designated IN4728–64, manufactured by Motorola Semiconductor Products Inc., is now being offered in the U.K. by Celdis Ltd. These diodes are rated at 3 W maximum when used with suitable heat sinks, and 1 W can be delivered continuously at an ambient temperature of 50 °C. Voltage ratings range from 3.3–100 V and 5% and 10% standard tolerances are available. Each component is encapsulated in a plastic-based silicone polymer and reliability is enhanced by the use of silver leads.—*Celdis Ltd., Trafford Road, Richfield Estate, Reading, Berkshire.*

For further information circle 41 on Service Card

42. Trimming Potentiometers

The Helipot Division of Beckman Instruments have produced two trimming potentiometers, the 61SG and

NEW

**ELECTRONICS
COMMUNICATIONS
INSTRUMENTATION
CONTROL**

the 61SB, which have been designed for panel mounting. The 61SG mounts from the front of the panel while the 61SB is mounted from the back. Seventeen standard resistance values are available from 10 Ω to 1 M Ω . The hard-surfaced resistive element is composed of glass and precious metals fired at high temperatures and fused to a Steatite base. This offers high stability with infinite resolution. Power dissipation is $\frac{1}{2}$ W at 85 °C and the components operate at temperatures between –65 and +150 °C. A total resistance tolerance of +20% is quoted with a minimum practical resistance tolerance of +5%. The travel of the wiper is continuous with no stop. The one-piece housing of the potentiometers is of stainless steel and both models are fitted with solder lugs.—*Beckman Instruments Ltd., Queensway, Glenrothes, Fife, Scotland.*

For further information circle 42 on Service Card

PRODUCTION AIDS

43. Ferrite-Core Tester

Automatic testing of coincident-current memory core mats in production-line quantities and at realistic switching speeds has been made possible with the introduction by the Digital Equipment Corp. (U.K.) Ltd. of a ferrite tester. This

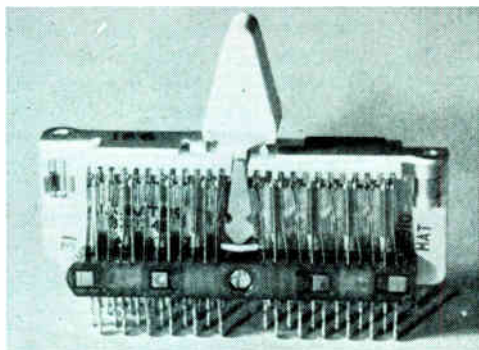

39



40



41

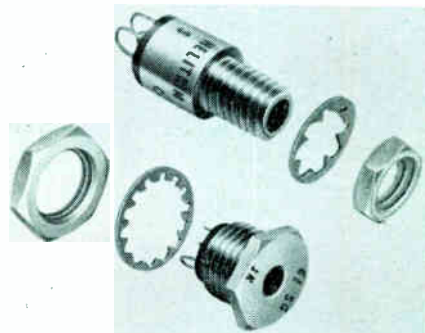

42

NEW

ELECTRONICS COMMUNICATIONS INSTRUMENTATION CONTROL

machine, type 1527, can also test word-organized and coincident current stacks. In operation, pulses are fed from high-speed current drivers to read and write the contents of each address in the mat being tested. The responses are fed to a difference amplifier and are evaluated by a 4-channel discriminator. Error detection circuitry evaluates the discriminator outputs and failures

are identified. All standard test patterns can be programmed and optional pattern generators can be added for special requirements. The front panel controls include a diode programming board and an error co-ordinates display.—*The Digital Equipment Corp. (U.K.) Ltd., 11 Castle Street, Reading, Berkshire.*

For further information circle 43 on Service Card

44. Cable-Reeling Unit

A ceiling-fitted cable-reeling unit in the Marcaddy series is now being

marketed by the manufacturers, V. L. Martin and Co. Ltd. This is for use with portable electric tools in workshops and factory areas. Constant cable tension regardless of the amount of cable in use is ensured by a spring mechanism and the cable automatically rewinds after use. The unit will swivel and tilt to follow the direction of pull and cable twisting is eliminated by a stop which prevents rotation of more than 350°. Electrical continuity between the fixed and moving parts of the unit is maintained by a slip ring at the centre of the drum. Both 5-A and 13-A cable can be accommodated and the two models offer a choice of 30 or 60-ft cable lengths.—*V. L. Martin & Co. Ltd., Witley Works, Southall, Middlesex.*

For further information circle 44 on Service Card

45. Veroboard Cutters

Two spot face cutters have been introduced by Vero Electronics Ltd. Both tools have special application for Veroboards, and have been designed to cut the copper strips cleanly and with the minimum effort on the part of the operator. The first of the new spot face cutters (part no. 2022), shown at top of the picture, is for use on Veroboards of 0.1, 0.15, 0.156 and 0.2-in. hole matrix. The other one (part no. 2023) is for use on the 0.050-in. pitch Micro-Veroboard.—*Vero Electronics Ltd., South Mill Road, Regent's Park, Southampton.*

For further information circle 45 on Service Card

46. Encapsulation of Cable Splices

A range of hyseal epoxy cable-splice kits is being marketed in the U.K. by Hysol International, a division of the Hysol Corp. of America. Each kit contains a flexible case which will fit a variety of cable sizes. The ends of the case are self-sealing to the cable contours and obviate the need for taping. With the case fitted to the cable, an epoxy resin is poured in through a filling spout. A ventilating spout ensures that the case is completely filled without voids or air pockets. The low-viscosity resin is not damaging to thin walls of polyethylene insulation and a special primer can be obtained which will improve the adhesion of the epoxy to the polyethylene. This method of encapsulation is fast and reliable and can be carried out by untrained personnel. It is suitable for cables carrying up to 50 kV.—*Hysol International, Corney Road, Chiswick, London, W.4.*

For further information circle 46 on Service Card

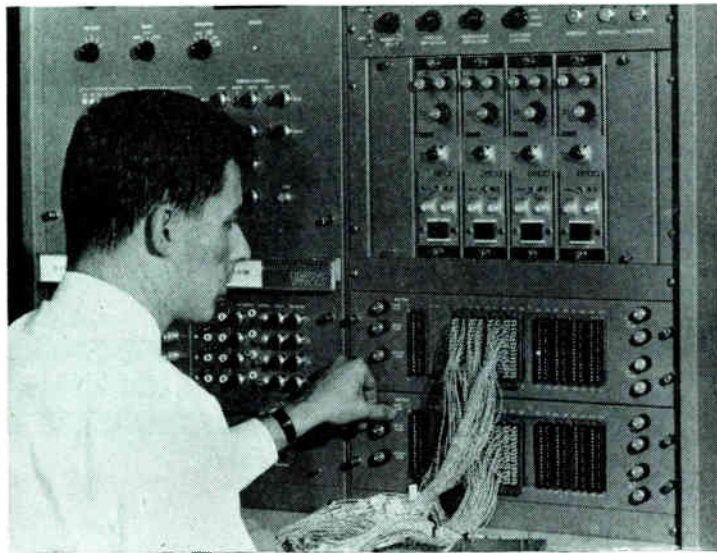

43

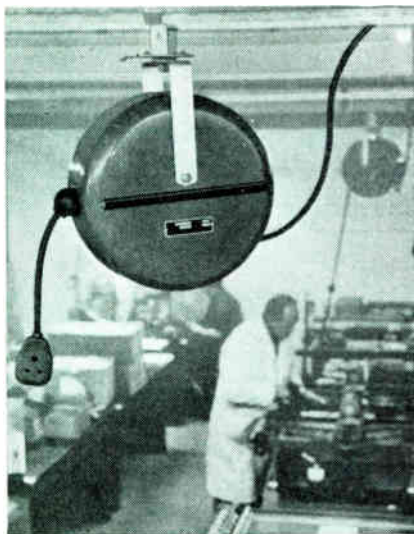

44

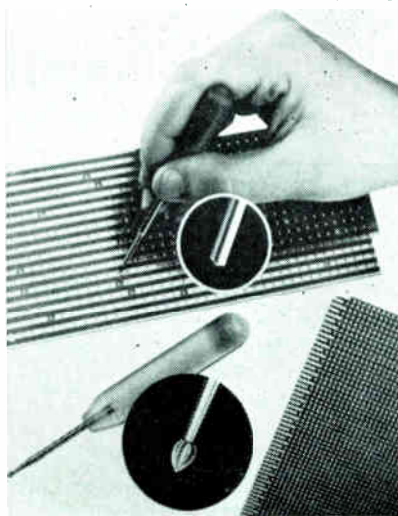

45



46

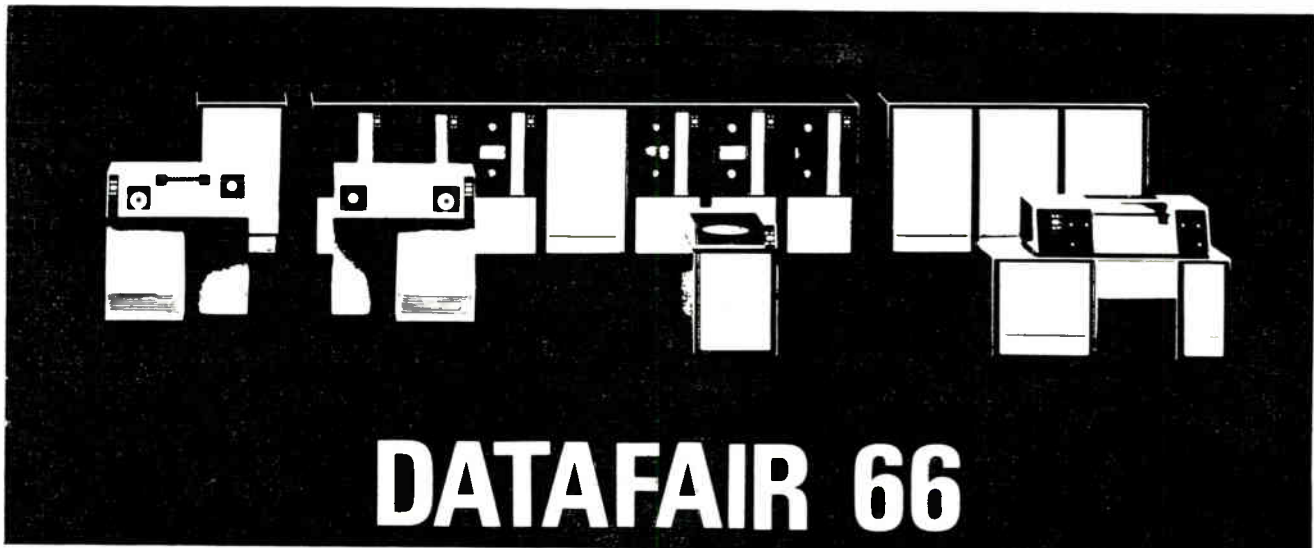

Real-Time Computing Symposium

THE possibility of a network of multi-access time-sharing computer systems, on a regional or even national scale, was discussed by Professor S. Gill during last January's 'Datafair' at Imperial College, London. In his paper, the first presented at the symposium organized by the British Computer Society, Prof. Gill outlined the development of real-time computing techniques (from their early applications in predicting ballistic trajectories during the last war, to their more recent incorporation into large time-sharing systems) and stressed the need for bold planning and enlightened government support in the future.

The establishment of a national computer 'grid' would enable subscribers, using appropriate terminal equipment, to enjoy the facilities of a very powerful central processor which would be prohibitively expensive to buy for all but the largest organizations. Operating on a multi-access time-sharing basis, the system would be entirely automatic and self-checking, and with its vast store (including a library of standard programmes) would be capable of transmitting and processing data virtually instantaneously.

Other papers presented at the symposium were on 'The implications of real-time systems for management control', by Mr. F. C. de Paula; 'Planning for real-time wagon progress control on a computer', by Mr. W. H. Sargent (of British Rail); 'A working real-time system in the textile industry', by Mr. A. Grebert (of Univac); 'Systems principles and range of applications', by Mr. J. R. Sheard (of I.C.T.); and 'Real-time systems design

techniques', by Mr. M. J. Beaver (of I.B.M.).

Three papers from representatives of universities were also presented during Datafair, and these served to remind us all that, although a spirit of co-operation does exist between the academic and industrial worlds, sponsorship for university research and development work should be further stimulated.

Real-Time Computing

Datafair was principally concerned with real-time computing, which implies the feeding of a computer with information about events as they occur and having it processed fast enough for almost simultaneous results or instructions to be obtained; these may then, if required, be used to control the events while they are actually happening. In fact, a certain amount of

confusion arose among the delegates (of whom there were over 2,000, far exceeding the anticipated response) as to exactly what real-time meant or implied, and this emphasized one of the problems which seems to exist in the field of computer science—that of terminology. The average potential user knows little of how a computer works, and in any case does not need to know; his concern is to make sure that any system he is offered will undertake efficiently all the services he requires, and may well be bewildered by the mass of technical jargon in which the package he is contemplating buying is wrapped. Unless a computer is working at its full potential twenty-four hours a day, it is not being used economically and may well be a waste of money; consequently, many users prefer to hire computer time according to their needs, and it is



A view of an I.C.T. 1905 computer configuration, for scientific applications. The central processor offers multi-programming facilities and can handle up to four main programmes (each with two sub-programmes) at the same time

possibly in this direction that future facilities will be developed for the majority of users.

Manufacturers' Presentations

Datafair gave plenty of opportunity for discussing future prospects, as well as existing systems, and represented a major and welcome co-operative effort between the manufacturing industry and a professional organization such as the British Computer Society. The series of lectures and presentations by manufacturers, though clashing somewhat in timing and being not unnaturally sales-orientated, covered most aspects of real-time computing applications. These ranged from management-information systems to on-line industrial control; from data-transmission techniques to stock-market predicting. If the emphasis tended to be on commercial applications of computers, there were, nevertheless, several papers presented and systems demonstrated which were of great interest from an industrial point of view.

Control Data Ltd. (53) described the problems of man/machine communication which arise out of the development of larger computers and the resulting complexity of peripheral devices, and went on to discuss the need for factory data-collection systems to improve industrial organization; the uses of digital computers in industrial process control, data logging and plant simulation formed the subject of another of their lectures. In contrast, I.B.M. (U.K.) Ltd. (54) concentrated mainly on their commercial and business systems, but even so many of their lectures were of a general nature, describing the capabilities of their hardware for multi-plant organizations, communication systems and time-sharing 'conversational' systems.

De la Rue Bull Machines Ltd. (55)

demonstrated a multi-access time-sharing scheme by linking up terminal equipment (over standard telephone lines) with the New York computer service bureau that General Electric Company (U.S.A.) inaugurated last year; the advantages of such an on-line system, where no knowledge of the remote hardware and software is required and in which commands are typed in plain English rather than in code, were very apparent. Also stressing the capabilities of real-time computer sharing were I.C.T. Ltd. (56) whose lectures and demonstrations included aspects of computer control for message switching, information retrieval, data communication and the public services.

Elliott Brothers (London) Ltd. (57) were showing a c.r.t. display unit which, when linked to a computer, can give an immediate numerical or graphical display of stored or scanned data on demand, thus providing facilities for centralized monitoring and control of manufacturing processes. English Electric - Leo - Marconi Ltd. (58) were likewise concerned with the prospects of real-time control of industrial processes, and presented papers on the uses of computers in industrial design, data transmission and multi-console applications in research.

Honeywell Controls Ltd. (59) described their data-acquisition, display and control systems suitable for a range of industrial control applications, including a warehouse-supervision scheme and nuclear power station monitoring. In conjunction with Standard Telephones & Cables Ltd. (60), they demonstrated high-speed send/receive terminal equipment suitable for real-time communication. Univac Ltd. (61) and the National Cash Register Co. Ltd. (62) both presented films describing actual uses and potential capabilities of real-time

operations, but these tended to be more commercial than industrial in nature.

It was encouraging also to note the participation of the National Physical Laboratory (63), who gave a demonstration of the flexibility of equipment fitted with an NPL 'standard interface'. This comprises a set of connections and control circuits for joining together data-processing equipment and was devised originally for use with a system of data-processing modules developed at the laboratory.

Future Trends

An emphasis on business applications was characteristic of most of the presentations, though this does not mean that industry was neglected. Nearly every field in which computers can be applied to some economic advantage were mentioned, but many of the industrial systems described were either of use only to the very large organization or were rather general and speculative in nature.

Industry must bear a measure of the responsibility for this, for it was the greater interest that business took in the early stages of computer science that encouraged a commercial-applications bias. Of course, the standard nature of much routine commercial work lent itself to easier exploitation by computer techniques, but industry's initial slowness to recognize and seize upon the potentialities of computers has meant that much of what was available in the past was in reality only an adaptation of a system designed for some other purpose. Only during the last five years or so have custom-built systems been developed which are economically interesting, but often these are too large and comprehensive for the more modest requirements of smaller industries, who will either turn to hiring computer time or perhaps look to the development of some kind of modular system from which small and specialized configurations can be built up.

Many manufacturers already provide schemes for hiring computer time, together with short courses of instruction in programming techniques, and it is while using such facilities that many engineers have discovered, perhaps to their surprise, that the difficulties and complications they anticipated did not materialize. It may be that computer hire, on a multi-access time-sharing basis, is the temporary answer to many industrial problems, for it involves a comparatively small capital outlay and during off-peak hours can be quite cheap. However, we must presumably wait for some years before we can expect to see on the market a range of small, powerful,



Control Data's remote input/output device (the 6090), a multi-station data-entry and retrieval unit combining an electronic typewriter and c.r.t. display

**This advertisement
is for people who think**

- they don't need ...
 - can't afford ...
 - can't operate ...
 - haven't the room ...
- for a computer.**

**Elliott's new 903 computer
proves them wrong by being**

- indispensable ...
- costing only £12,750 ...
- easy to operate ...
- 2' 2" x 3' 1" x 3' 7"

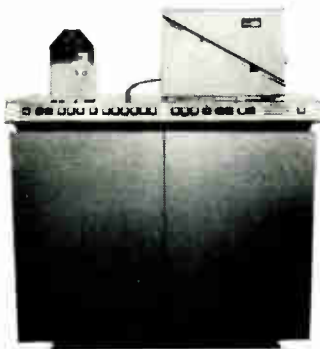

Elliott 903 is a computer priced to fit neatly into the tightest departmental or small-organisation budget, sized right for classroom, laboratory or design office. But unobtrusiveness ends where performance begins . . . High speed arithmetic store; comprehensive instruction code; full hardware arithmetic facilities - all backed by a library of effective software. A range of peripherals enables the 903 to be tailored to *your* particular requirements. 903 has a great range of applications, yet is so simple to operate that a layman can be trained to write and run programs in just three days. Simple . . . and *reliable*: 903 is built on the know-how developed by Elliotts over 15 years in the computer industry. Elliott 903 the new small computer which cuts data processing problems down to size.

Elliott-Automation Computers Limited

Elstree Way, Borehamwood, Hertfordshire. Telephone: ELStree 2040.

 A Member of the Elliott-Automation Group.

Mullard introduces first U.K. Copper-doped Germanium Photoconductors

HIGH DETECTIVITY AND RAPID RESPONSE IN 2 TO 25 μ m WAVEBAND

Mullard's latest development—two high detectivity, fast-response detectors for pulsed or modulated radiation in the 2 to 25 μ m waveband—will be of great interest to physicists and spectroscopists in universities and research establishments. The new detectors, types RPY37 and RPY40, are copper-doped germanium photoconductive cells cooled to 4.2°K in liquid helium cryostats. Their introduction complements the spectral coverage already provided by Mullard's lead sulphide and indium antimonide detectors.

The RPY37 and RPY40, as well as the other detectors mentioned, are, of course, superior to thermal detectors in detectivity and response; the intrinsic response time of the sensitive element in both of the new devices is less than 1 μ s.

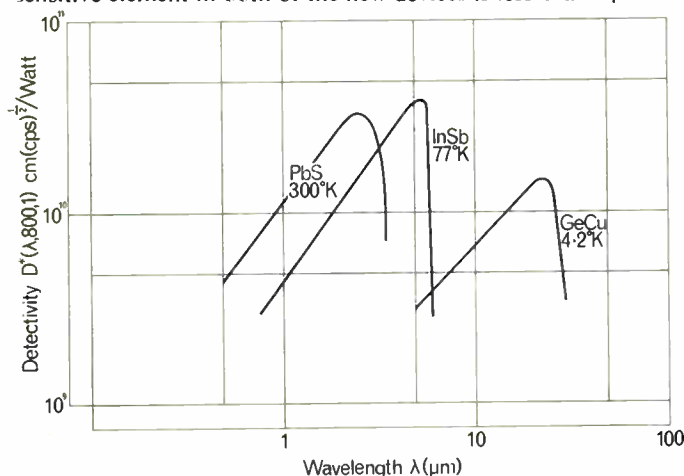

Infra-red detector performance

The rapid response of both detectors is most valuable in the study of transient phenomena. The RPY37, which has a sensitive area of 6 mm \times 1 mm, provides the spectroscopist



Filling the RPY37 with liquid helium

with an ideal tool for obtaining high resolution at wavelengths up to 25 μ m. The larger sensitive area of the RPY40 makes this device suitable for the examination of transient phenomena such as pulsed or modulated emission from long-wavelength gas and solid-state lasers. In this work there may be only a few milliseconds in which a particular effect can be observed, for example, while a large pulsed magnetic field is applied to the specimen under test. Other applications for these detectors will be the examination of radiation phenomena encountered in shock tube studies, plasma studies and solid-state research.

The detectors are constructed of stainless steel and, once they have been filled, no further attention is required for at least seven hours.

For further details of infra-red detectors RPY37 and RPY40, please use the reader reply card of this journal (see reference number opposite).

What's new . . . from Mullard

Ferroxcube H-cores introduced

New shape for Miniature Transformer Cores

Two high permeability Ferroxcube H-cores have recently been released by Mullard. Using these cores, truly miniature wide-band transformers can now be constructed for communication and audio systems.

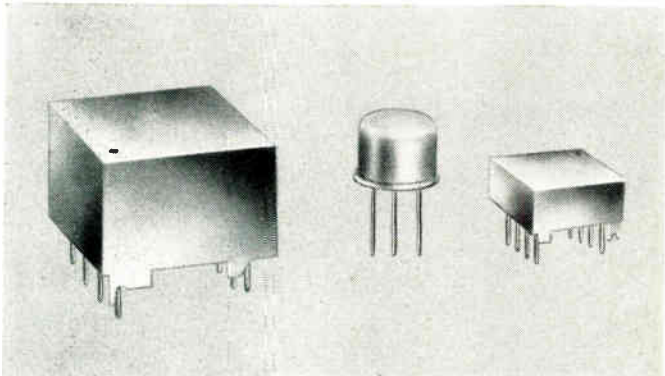

H10 (right) and H20 cores, shown with a transistor in TO-5 encapsulation

One of the main problems encountered in miniature transformer design using cores of conventional construction is that the air gaps greatly reduce the high initial permeability. With Mullard H-cores, however, air gap effects are reduced to a minimum by presenting closely mating polished surfaces at the gap. The high A_L value achieved by this technique, when combined with modern winding methods, enables stray capacitance and inductance to be reduced to a minimum. As a result, trans-

formers using Mullard H-cores provide optimum bandwidth within a given volume.

The complete core assembly consists of an H-core piece and either a rectangular window (H10) or a U-shaped piece (H20) which completes the magnetic circuit. Winding is simplified and coil former size reduced by moulding the latter on the bar of the H-shaped piece. Pin connections on an extension of the coil former enable the completed assembly to be mounted directly on to a printed circuit.

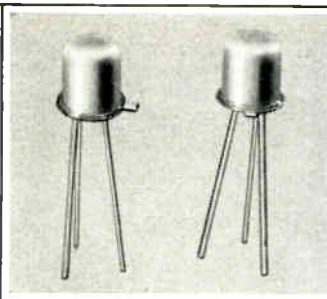

Upgrading and extension of 18kW range of Avalanche Power Rectifiers

As a result of rigorous and extensive life testing, the forward current ratings of rectifiers in the Mullard BYX25 series have been upgraded to 20A at a stud temperature of 125°C. As this new current rating is achieved without any increase in price, the cost of devices in this series has been effectively reduced by 40% when considered on a volt/amp basis.

The BYX25 series has also been extended to include a 1000V crest working rectifier, type BYX25-1000 (and type BYX25-1000R—reverse polarity version). The increased avalanche voltage of this new rectifier will allow considerable savings to be made in the construction of higher voltage stacks because fewer diodes will be required to provide a given safety factor.

All devices have an 18kW avalanche power rating and can also accommodate a 360A peak one-cycle surge (50c/s). These factors make this series particularly suitable for high-voltage power supply applications in transmitters and similar equipment.

Further release of N-P-N Silicon Planar Epitaxial Transistors

Mullard's latest n-p-n silicon planar epitaxial transistors, types BSX19 and BSX20, have been designed for use in either high-speed logic switching circuits or h.f. amplifiers. These new transistors have the high performance, reliability and ruggedness associated with planar epitaxial construction. Both devices have extremely short switching times, 10ns (max) and 13ns (max) respectively.

In switching circuits optimised for high-speed operation, propagation times of 5 to 10ns can be obtained. However, the voltage ratings of these transistors enable slower speed (50 to 100ns), high noise margin (2V), DTL circuits to be designed to work from a 12V supply.

The versatility of these transistors is such that they are also suitable for use in h.f. amplifiers. Their high gain and high cut-off frequency make them particularly suitable for roles in transistorised mobile and portable h.f. and v.h.f. telecommunication equipment where an output power of 500mW with a gain greater than 10dB can be readily realised.

The BSX19 and BSX20 fully meet JEDEC specifications 2N2368 and 2N2369 and, if required, can be supplied with these JEDEC references marked on the can. Both transistors are in TO-18 encapsulation.

In production at the moment, small quantities are already available for immediate delivery.

FURTHER DETAILS of the Mullard products described in this advertisement can be obtained from the address below or through the Reader Information Service of Industrial Electronics using the appropriate code number shown below.

- Germanium Photoconductors IE 334
- Ferroxcube H-cores IE 335
- Industrial Magnetrons IE 336
- Avalanche Power Rectifiers IE 337
- N-P-N Silicon Planar Epitaxial Transistors IE 338

INDUSTRIAL MAGNETRONS FROM 200W TO 5kW

Mullard industrial magnetrons are now available with power outputs ranging from 0.2 to 5kW and, for special applications, quick-heating versions of most types are also available. Designed for use in r.f. heating and diathermy equipment, all of these magnetrons operate in the 2.45Gc/s \pm 25Mc/s band allocated for microwave heating.

The lowest powered magnetron in the range is the 200 watt JP2-0.2. This valve has been specially developed for use in diathermy equipment, and can be used without forced cooling when mounted on an adequate heat sink.

All the magnetrons in this range are rated for continuous operation. Under non-continuous operating conditions, standard

magnetrons do have the disadvantage that power is consumed by the filament during standby periods. This wastage can be overcome by switching off filament supplies during these periods, although, when switching on again, 2 to 4 minutes are required to reach full working temperature. Mullard has overcome this particular difficulty by including a selection of quick-heating magne-

trons in the range offered. These magnetrons reach operating temperature within 7 to 10 seconds.

At present, quick heating magnetrons are in greatest demand for use in self-service 'hot meal' vending machines in which waiting time must be kept to a minimum. Use of these magnetrons in this application also ensures maximum efficiency and minimum running costs.

	f (\pm 25 Mc/s)	P _{out} (cw)	Delay before applying h.t.	Cooling	Applications
JP2-0.2	2.45 Gc/s	0.2 kW	3 min	Heat sink	Diathermy Catering, industrial processing and heating
JP2-1A	2.45 Gc/s	1 kW	7 sec	Air	
JP2-2.5A	2.45 Gc/s	2.5 kW	2 min	Air	
JP2-2.5W	2.45 Gc/s	2.5 kW	2 min	Water	
YJ1080	2.45 Gc/s	2.5 kW	10 sec	Water	
JP2-5W	2.45 Gc/s	5 kW	4 min	Water	



Mullard Limited, Mullard House, Torrington Place, London, WC1. Telephone: LANgham 6633



ask the
men at
Hellermann



... to talk
about plastics

They will tell you about —

... the qualified design engineers who will develop your project for economical production; the comprehensive mould and die-making division; the modern machinery which enables each job to be produced by the most up-to-date method; the experienced and qualified technicians and trained production personnel, and maintained delivery dates.

This fully co-ordinated service, together with a nation-wide sales force, is available to every Hellermann customer, because Hellermann know that the most important job to any customer is his own. **If you want a practical demonstration of our ability to serve you, talk plastics with Hellermann today or write for brochures "Hellermann Mouldings" and "Hellermann Extrusions".**

HELLERMANN



Largest independent injection moulders and extruders of thermoplastics in the United Kingdom

Hellermann Plastics Limited,
Crawley, Sussex. Telephone: Crawley 28888
Offices in Birmingham, Manchester, Glasgow
(A member of the Bowthorpe Holdings Limited group of companies)

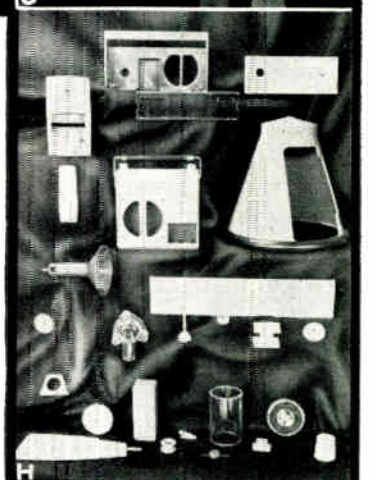

A Doug Green, A.M.I.E.D., A.M. Inst B.E., Design Manager, designs and styles components from customers' brief.

B Ron Strevett, A.M.I.E.I., Chief Inspector, discusses a new formula technique with Chief Chemist, Norman McCombie, A.I.R.I.

C Fred Wickens, tool room superintendent, and his assistant Alf Bridges supervise a team of 37 qualified and experienced tool makers.

D Jim Payne, Technical Services Manager, giving personal attention to a customer with an engineering query.

E Tim Hayes, Extrusions Production Supervisor, discussing method of coiling and final packaging to meet customers' specification.

F David Burt, Sales Director, maintaining close liaison with customers' executives and technicians.

G Peter Hollands, Stores Supervisor, and Les Munro, Transport Manager, working together routing consignments to ensure speedy delivery.

H A small selection of plastic mouldings and extrusions produced by Hellermann Plastics.

inexpensive processors and peripheral equipment, which has been designed on a modular basis and which may eventually become as common and simple to operate as an office typewriter.

Symposium Discussion

During a discussion session held towards the end of Datafair, delegates had an opportunity to hear the points of view of and challenge a panel representing computer users, manufacturers and consultants, as well as those concerned with government policy, the universities and the press. Questions and answers were lively, and certain beliefs and attitudes did emerge quite forcibly: unless there is a considerable increase in the appreciation of and education in computer techniques (by both management and engineers at all levels), then the growth of computer usage and the removal of much wrong thinking about its effect will be slow and wasteful of talent. Just who is to organize comprehensive training courses (those which are available at the moment are oversubscribed several times over) was not clear; the government may be able to set up a nationwide scheme once the National Computing Centre has been established, and the manufacturers will undoubtedly continue to provide facilities to potential computer buyers or hirers.

But perhaps it is time for the user industries themselves to take over some of the responsibility for arranging a scheme, and they might start by encouraging the introduction of com-

puter techniques into school and university curricula.

We were assured that the sociological as well as educational implications of the spread of computer science should not be overlooked either, for until we can learn to regard computers as tools to be used rather than threats to be feared, then we shall never take full advantage of their capabilities. Study is necessary to resolve the human problems of adapting to man/machine communications and interaction, and a major reorganization of industrial practices, from board room to shop floor, may well be indicated.

The common belief that the Americans lead the world in computer science was another topic which stimulated some strong exchanges. While admitting the enormous advantages they derive from space research projects and generous finance, perhaps we are not adventurous enough in our experimental and development work. There is no reason to suppose our technologists are inferior in quality to the Americans, and so can it be that the right attitude or spirit is lacking?

To sum up, Datafair 66 can justifiably be judged a success if the enthusiasm and response of the delegates is any guide. It was perhaps over comprehensive and too technical for everything that it offered to be properly assimilated, even if it did concern itself solely with real-time computing. What must have struck most who attended it was the range and diversity of applications to which computers can or will be put, and the consequent danger of assuming that, because most



The Control Data 6060 remote calculator, designed for the scientist and engineer, and enabling immediate data entry and visual response to be achieved in a "conversational" mode with the central processor

commercial and industrial activities can be computerized, they should be.

The real question is where do we go from here? Will the enthusiasm and interest generated lose its impetus, as it tended to do after the 1958 computer conference and exhibition, or can we maintain not only a desire to explore the possibilities of this growing technology, but also infuse a more imaginative approach to it? The answer lies as much in the attitude of actual and potential users as in the research and development of the manufacturers.

Magnetic Recording Symposium in Brussels

A TWO-DAY symposium on magnetic recording technology, held by Ampex International last January at the Palais de Congrès in Brussels, provided a useful opportunity not only to examine and discuss the present state-of-the-art of magnetic recording techniques, but also to see demonstrated some of the latest equipment available in this expanding field.

Over two hundred delegates (from more than a dozen nations) attended the symposium and they represented a broad range of industrial and scientific interests. A large proportion of those present came from Britain and France, principally from research and aerospace organizations, and this was not altogether surprising, for high-precision recorders have tended to be applied primarily in military and space development projects and scientific research. However, engineers from the electronics and electronics-user industries were present too, as well as representatives from hospitals, government bodies, professional institutions, the universities and the manufacturing, automotive and communications industries.

A team of Ampex technical staff presented a series of papers which reviewed the development of magnetic recording techniques—concentrating particularly on the design philosophy underlying the research work Ampex are at present engaged upon—and discussed the desirability and practicability of wide-bandwidth recording systems. Instruments incorporating magnetic-recording facilities now range from very precise telemetry and airborne reconnaissance units to low-cost domestic audio appliances; from large video recorders and reproducers (especially in their closed-circuit television applications) to digital-tape handlers for computer configurations. Industrial uses of instrumentation recording systems are becoming more widespread as more reliable checking, monitoring and recording equipment becomes available, and they may be expected to expand even further as lower-cost units for data logging, numerical control and communications are developed.

Several of the design and operational concepts discussed were illustrated by an exhibition and demonstration of Ampex's new range of equipment, which will be shown

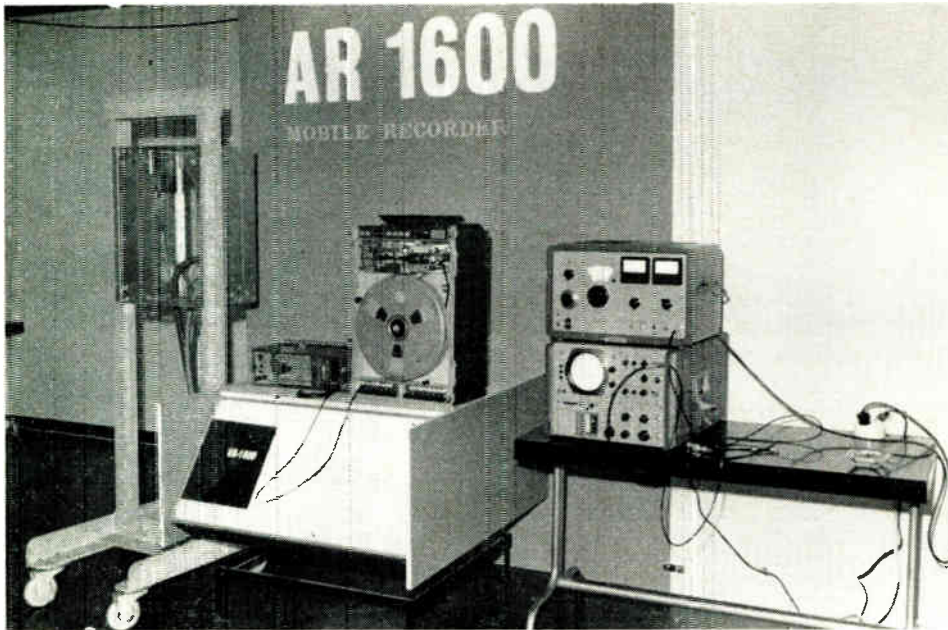

Fig. 1. One of the exhibits at the Ampex Magnetic Recording Symposium in Brussels—the AR-1600. This is the airborne version of the 1600 series of instrumentation recorders

again at the forthcoming International Aerospace Instrumentation Symposium at Cranfield next month.

The 1600 series of instrumentation recorders which was presented is available in three models: the FR type, for ground station, industrial and laboratory use; the PR type, for field, vehicular and shipboard applications; and the AR type (see Fig. 1), for airborne use. This range of instruments has a 2-Mc's bandwidth and a 14-channel record/reproduce capability, and with its fast-response capstan servo system provides a near-absolute time base accuracy. The FR model (taking up to 16-in. reels) has a time base error of $\pm 0.5 \mu\text{sec}$ at 120 in./sec, the other types (taking up to 14-in. reels) having one of $\pm 2.0 \mu\text{sec}$ at the same tape speed.

Also of interest was the introduction to the European market of a compact digital-tape transport, the ATM-13 (see Fig. 2), which weighs only 110 lb. Besides recording more than twice the amount of data per unit area of tape than has hitherto been possible, it generates data which is appropriate for direct tape input to several computer pro-

Fig. 2. The ATM-13 digital-tape transport, which produces tape suitable for direct inputting to several computer processing systems



cessing systems. A buffer storage unit is available to plug in to the ATM-13, thus allowing the economic recording of variable digital-data rates or data bursts; blocks of data are stored only $\frac{1}{4}$ in. apart on the tape, and this short gap—made possible by the transport's stop/start time of 6 msec—offers savings in tape and processing time.

Finally, a short film was shown on the technique of film scanning and recording by electron beams. The predicted advantages of such a recording method have now been realized, and a reliable electron/optical system has been developed by Ampex Research Laboratories. A suitably focused electron beam is directed on to a tape, which is coated with a silver-halide film, and is zig-zagged across the full tape width by suitable X and Y deflection plates. After one line sweep in the Y direction, the beam executes a short line jump in the X direction and is swept back across the film. The information is recorded in the Z direction (i.e., into the depth of the tape), the rate of electron incidence (and thus its penetration) being proportional to the signal to be recorded. Following the electron bombardment, the tape contains merely a latent image which must be processed to provide a transparency, in which suitably modulated lines have been laid down rather like a television picture raster. The recorded lines have a width of about $\frac{1}{4}$ mil or less, and so may be used either to obtain a high-resolution pictorial image or simply to represent data like an ordinary magnetic tape; in either case the recording frequency can be as high as 100 Mc/s, with a signal-to-noise ratio of at least 30 dB.

The playback process requires coating the tape surface with a plastic scintillator, which is then bombarded by a one-mil electron beam, the light being collected on the reverse side of the tape by a photomultiplier. This system is much more efficient than a conventional flying-spot scanner, for it uses no lens and so collects nearly all the generated light.

At present one of the main users of magnetic recording equipment is the computer industry, where techniques for more efficient data inputting and outputting are being developed and where the need for small-size large-capacity storage facilities are urgent. One may reasonably expect to see a considerable improvement in the performance and range of equipment in this field, and industry can hardly fail to benefit from such developments.

**staff-saving
automatic
quality control
you can afford**

The rationalised design of the Elliott I.S.C. Type 1129 Process-Stream Analyser now makes automatic, continuous process stream analysis an economical proposition where it did not seem justified before. This rugged, yet sensitive single-stream instrument, with the wide adaptability of expansive multi-stage chromatographs, brings down operating costs and increases productivity and quality standards at greatly reduced prime costs. Now you can release qualified laboratory staff for more important work.

The 1129 automatically and reliably controls sample introduction, zero and attenuation adjustment, peak presentation and timing cycle. By remote control it provides continuous, variable attenuation programming of four stream components, according to pre-set cycles. The unique carrier-gas system minimises base-line shift. The instrument is immediately adaptable for integration of component peaks, digital readout and closed-loop control. The types of columns, detectors, carrier gas and utilities depend on the application.

Send for fully descriptive booklet 11A

ELLIOTT I.S.C. LOW-COST PROCESS- STREAM ANALYSER

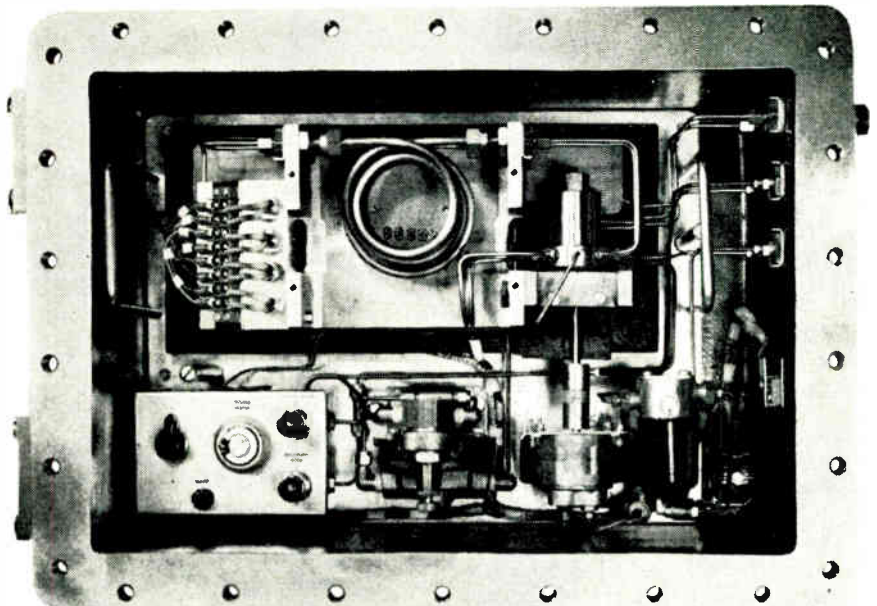

The analyser unit which replaces individual specialised analysers, features a simplified design, increased reliability and reduced cost.



PROMPT NATION-WIDE SERVICE FACILITIES

ELLIOTT PROCESS AUTOMATION LTD.

Quality Control Division

Blackwall Lane, Greenwich, London SE10. Greenwich 6441



A member of the Elliott Automation Group

NEW CAPACITORS



METALLIZED MYLAR (DUPONT)

The smallest in the world in the range 1000 to 39000 pF—utterly reliable—tropicalized—waterproof—conform to international military specifications. $\pm 1\%$, 3% , 5% , 10% . 63V-400V.

STABILIZED POLYCARBONATE

High stability of frequency and temperature—exceptionally low power factor—high dielectric insulation resistance—safe operation at high temperatures (125°C)—big space saver. $\pm 1\%$, 3% , 5% , 10% . 63V-400V.

* METALLIZED POLYESTER

Rugged reliability—small size for sub-miniature assemblies—high performance and quality—competitive cost for production runs. 1000 pF 4.7 m/d $\pm 10\%$; 20% . 250V-400V.

Write for technical literature.
Specific samples on request from

RADIO RESISTOR COMPANY LTD
9-11 Palmerston Road, Wealdstone, Harrow, Middlesex.
Telephone: HARrow 6347 Telex: 25573 HISTAB HARROW



* EX STOCK

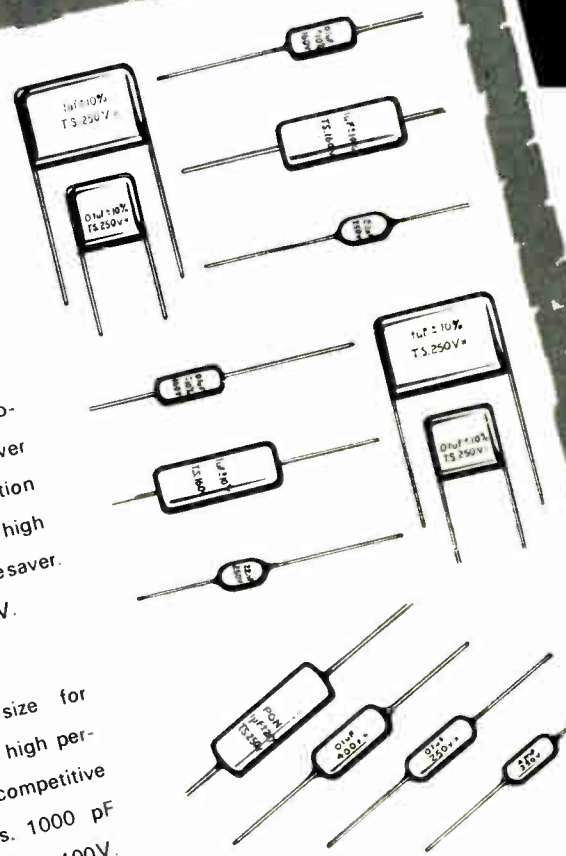



Personal News

Two senior appointments have been made in the radio division of Standard Telephones and Cables Ltd. **W. Philip Rowley, M.B.E., M.I.E.R.E.**, has joined the division as marketing manager (communications) and **Clifford E. Harris, M.I.E.E.**, has been appointed technical manager (communications).

Chilton Electric Products Ltd. have announced the appointment of **E. Coleman, A.M.I.E.E.**, as technical director. Mr. Coleman joined Chilton as chief engineer and was subsequently appointed chief technical executive when he assumed responsibility for the works in addition to handling development matters.

Viscount Caldecote has been elected to the board of directors of English Electric-Leo-Marconi Computers Ltd. He is also deputy managing director of British Aircraft Corp. and a director of The English Electric Co.

W. Mackie & Co. Ltd. have appointed two new directors. These are **C. H. Maddock, B.Sc.**, who becomes sales director, and **F. S. E. Street** who is now works director.

A. G. Smith, A.M.I.E.E., F.I.E.S., has been appointed chief lighting engineer of The Benjamin Electric Ltd. He joined the company in 1937 as sales engineer.

Two board changes have been announced by British Insulated Callender's Cables Ltd. **W. J. J. Curry, B.Sc., Ph.D., M.I.E.E.**, has become an executive director and he will be concerned with the operation of certain B.I.C.C. Group companies overseas. **C. O. Boyse, B.Sc.(Eng.), M.I.C.E., M.I.E.E.**, who has been a director since 1956, is retiring.

D. D. Jones, B.Sc., M.Sc., D.I.C., has been appointed head of the laboratories of Associated Semiconductor Manufacturers Ltd. Associated Semiconductor Manufacturers Ltd. is the joint Mullard-G.E.C. company developing and manufacturing Mullard semiconductor devices.

D. E. Taylor has been appointed general sales manager for Dynamco Instruments Ltd. **B. C. D. Wood** and **P. F. Taylor** have become U.K. sales manager and export sales manager respectively.

The British Electrical and Allied Manufacturers' Association (BEAMA) have appointed **Harold Bradshaw, C.Eng., A.M.I.Prod.E.**, as secretary to the power generation and industrial mechanical plant divisions of the association. Formerly he was sales manager of Adamson and Hatchett Ltd.

Lyn T. Davies, managing director of Royal Worcester Industrial Ceramics Ltd., has been appointed a member of the Welsh Committee of the Central Training Council. This council was established by the Minister of Labour to advise him on industrial training.

Jack Brown is now marketing services manager for SGS-Fairchild Ltd. He is being assisted in this position by **Stuart Cook** who is the European editor of the company's house journal *Planar News*.

The manager of the recently-formed education and training division of Friden Ltd. is **A. R. Rider**. The division is responsible for staff training and for education courses for users of Friden products.

H. W. Taylor, B.Sc., A.Inst.P., has assumed the post of sales manager for the Kelvin Electronics Co. He will be concerned with the sales of non-destructive testing equipment.

British Insulated Callender's Cables Ltd. have announced that **W. I. B. Shankland** is now general manager of the wiring and general cables division. This is in succession to **P. W. Clephan**.

Robert Greenwood, B.Sc., has joined the board of T.M.M. (Research) Ltd., the major research unit in the Textile Machinery division of Stone-Platt Industries. He joined T.M.M. (Research) in 1958 to set up an aerodynamic and automatic control section.

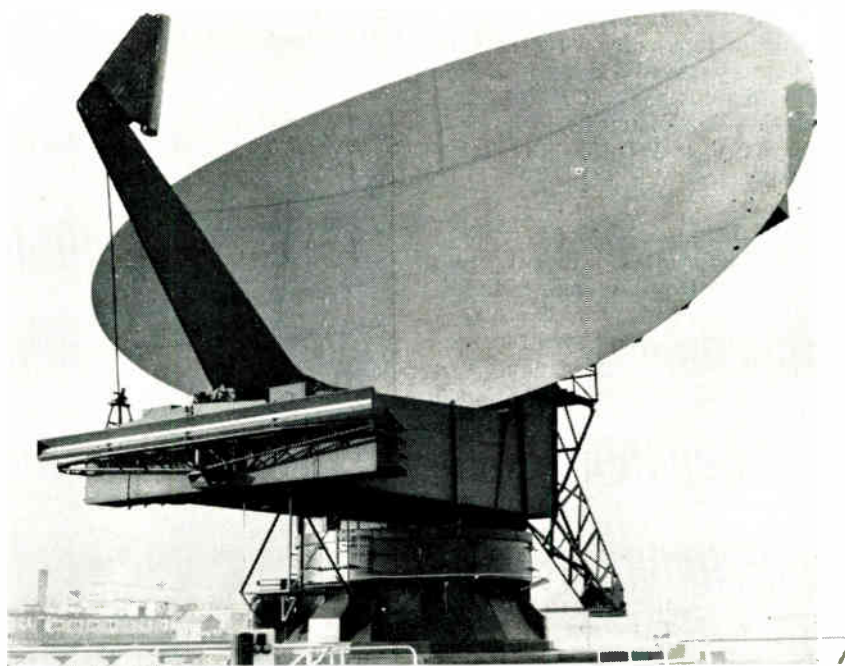

A GROUND-ENVIRONMENT RADAR DEFENCE SYSTEM, which includes radar stations, data-handling computers and communications networks, has been developed by A.E.I. Electronics and supplied to the Saudi Arabian Government. The £25 million system (using the type-40 series) provides instantaneous three-dimensional position data on all aircraft within the extensive radar cover and is suitable for civil and military air-traffic control. Designed for high reliability in all climatic conditions, it enables precise flight paths for interceptors to be calculated, and an automatic testing system gives instantaneous fault indication and automatic switching to standby equipment in the event of failure.

For further information circle 64 on Service Card

Ralph D. Haxby has been appointed to the board of the Solartron Electronic Group. He has been with the company since 1959 and, as systems director, is responsible for Solartron's computer, data and simulation activities.

It has been announced by the board of Bendix Electronics Ltd. that **W. S. Blake, A.B.I.M., F.I.I.S.**, the company's general manager, has joined the M.P.J. Gauge & Tool Co. Ltd. as director and general manager. His move will ensure closer liaison between the two Bendix companies

Belling and Lee Ltd. have announced changes in their sales department. **L. R. Dunlop** has taken over the position of contracts manager and **J. D. Harrison** has received the appointment of sales administration manager.

C. R. Longman, A.M.I.E.R.E., has become engineer-in-charge, television studios, London, for the B.B.C. He has been with the B.B.C. since 1943.

The new-products manager at the Greenock manufacturing plant of I.B.M. United Kingdom Ltd. is now **D. G. Ashton Davies**. Previously he was a divisional manager at E.M.I. Electronics Ltd.

W. N. Richardson, marketing manager of Hughes International (U.K.) Ltd., has been appointed a director. Before joining the company in 1960 he had marketing appointments with the Plessey Co. and Salford Technical Instruments.

Craig M. Houston, M.A., has received the appointment of export sales manager for Royal Worcester Industrial Ceramics Ltd. Mr. Houston is an expert in the Anglo-Soviet Bloc sector of international trade and was previously a consultant in international marketing.

Maxam Power Ltd. now have as their works manager **T. A. Clarke, A.M.I.Prod.E., A.B.I.M.** This company, a member of the Holman Group, is to be detached from the Group's centralization scheme and re-sited at the Carn Brea works.

Company News

The Plessey Co. Ltd. have opened a special apprentice training school. The intention is to train apprentices so that they may become the supervisors and managers of the future.

The sales office for the television distribution systems division of **Thorn Electronics Ltd.** is now located at Thorn Electronics Ltd., Great Cambridge Road, Enfield, Middlesex.

A London office and demonstration centre has been opened by **d-mac Ltd.** at 260 Gray's Inn Road, London, W.C.1. The company's data-logging and graphic-data handling equipment will be demonstrated at the centre.

Honeywell Controls Ltd. have extended their factory space at the Newhouse, Lanarkshire, plant. The main expansion is in the micro-switch division and other additions are being made to the computer and manufacturing facilities.

The American company of **Eaton Yale and Towne Inc.** have appointed **Hyltern Controls Ltd.** as their sole licensee in the U.K. and Eire. This will increase the availability of the American company's range of electromagnetic clutches and brakes in this country.

T. J. Sas and Son Ltd. have been appointed the U.K. representative for the **Chomerics Co.** of America. They will be marketing the range of gaskets for electronic use, including waveguide gaskets, resins, plastic fillers and similar products, manufactured by the Chomerics Co.

R. H. Cole Ltd. have formed a plastics service division. This will supply a complete range of heating and temperature control equipment to the plastics industry. The equipment will be that manufactured by several companies throughout the world.

The **British Xylonite Co. Ltd.** has ceased to function as a separate concern and has been split into three divisions of the parent company, **British Xylonite Ltd.**

A.E.C.-Hartons Ltd. has changed its name to **Automatic Control Engineering Ltd.** This name is thought to be more descriptive of the work of the company.

S. E. Laboratories (Engineering) Ltd. have appointed additional continental agents. These are **A/S Danbridge**, of Denmark, **Insko Elektronik AB**, of Sweden, and **Avtotehna**, of Yugoslavia.

Livingston Laboratories Ltd. has been appointed the sole U.K. representatives for the range of telecommunication test equipment manufactured by **Amalgamated Wireless (Australasia) Ltd.**, of Sydney. Included in the range are a number of portable modular solid-state test sets covering the frequency range 10 c/s to 520 Mc/s.

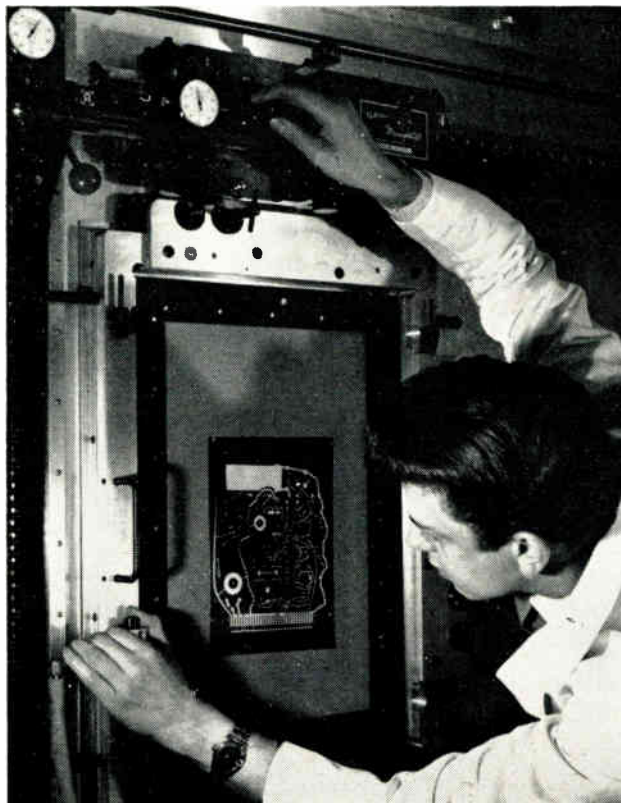

PRECISION MULTI-IMPRESSION PHOTOGRAPHY

is a technique being used increasingly by printed-circuit manufacturers and other industries where extreme image accuracy is required. By linking optical readout with their latest equipment for producing multiple-images, **P. T. Barclay & Partners Ltd.**, of Leatherhead, have been making advances in 'stop and repeat' photography so that, using their reader, steps can be read from a datum line to an accuracy of 0.0005 in. over 12 in., with a repeatability of 0.00025 in. The picture shows an operator setting up the camera to produce printed-circuit photo-negatives

For further information circle 65 on Service Card



THE AUTOMATIC SEAT-RESERVATION SYSTEM

being used by B.E.A. at their West London Air Terminal is to be supplemented by 225 Westrex teletype model-35 printers (see picture) during the second stage of its development.

The system is based on twin Univac-490 real-time computers, and the printers will enable the telephone sales clerks to interrogate the computer system as to seat availability on any of BEA's European flights. The required information can subsequently be inserted into the system.

For further information circle 66 on Service Card

The Marconi International Marine Co. Ltd. have announced that their Manchester servicing base has moved to new premises. The new address is: The Marconi International Marine Co. Ltd., Manchester Dry Docks, Mode Wheel, Manchester 17.

Waycom Ltd. have acquired larger premises as part of their expansion programme. Their address is now: Wokingham Road, Bracknell, Berkshire.

School of Ultrasonic Testing

The Ultrasonoscope Co. (London) Ltd. have announced the formation of a school of ultrasonics.

The aim of this is to instruct inspectors, engineers and users of ultrasonic instruments on the use of ultrasonics for the detection of defects in a wide range of products. Models, slides and films will be used to illustrate the basic principles and the latest ultrasonic equipment will be used for practical demonstrations.

The applications of ultrasonics in such industries as the metal, gas, electricity, petroleum, transport, and agricultural industries will be discussed.

A detailed syllabus can be obtained on request from the Ultrasonoscope Co. (London) Ltd., Sudbourne Road, Brixton Hill, London, S.W.2.

Mass Spectrometry Data Centre

A mass spectrometry data centre is to be established at the Atomic Weapons Research Establishment, Aldermaston. It is being set up by the U.K. Atomic Energy Authority with support from the Office of Scientific and Technical Information.

One of the tasks to be undertaken at the centre will be an investigation into the use of computers for chemical analysis. This type of analysis would consist of computerized matching and evaluation of mass spectra. Different matching techniques will be tried in conjunction with the relevant computer programmes to find the most suitable system.

Another project will be research into methods of classification and handling of information. The aim is to produce a spectra reference and retrieval system so that compounds can be quickly recognized from their spectra.

A world-wide index of compounds which have already been examined by mass spectrometry will be drawn up and data for an information service is to be accumulated. The index and the information service will become available in due course to all users of mass spectrometers.

The Marconi Co. and Ferranti Ltd. have signed a licensing agreement whereby Marconi will manufacture and market the range of silicon micro-circuits designed and sold by Ferranti under the name of Micronor II. The agreement will increase the production capacity of this range of integrated circuits and will provide users with a second source of supply.

A. Schrader's Son have established a separate organization for the manufacture of industrial fluid power products. The address of this organization is A. Schrader's Son, Division of Scovill Manufacturing Co., Walkmill Lane, Bridgton, Cannock, Staffordshire.

The London office of Whessoe Ltd. has the new telephone number of Whitehall 3201.

The Raytheon Europe International Co. has established an office at 32 Avenue Matignon in Paris. This office will represent the divisions which deal with missile control and weapons systems, radar, microwave communications equipment, satellite and space vehicle systems and submarine equipment.

Electrosil Ltd. are to commence manufacturing micro-integrated circuits. Also, automatic integrated-circuit testers will be made available. These will be of interest to purchasers requiring rapid automatic testing and inspection of integrated circuit packages whether monolithic, thin-film or containing discrete components.

The office equipment division of Remington Rand Ltd. and the Univac computer division have formed a joint publicity department. This will service both divisions in advertising, sales promotion and public relations and will be headed by Ann S. Whiting.

The Charterhouse Group has acquired a 30% interest in Inertia Switch Ltd. The Group is putting up loan capital to finance expansion of the Inertia Switch premises so that the company will be able to extend their activities in instrumentation.

Hewlett-Packard Ltd. have taken over the sales and services responsibilities for the products of the Mechrolab Division of Hewlett-Packard of California. This division was recently integrated with the F. and M. Scientific Division.

Stanland Photography Ltd. have commenced a component and delivery service for manufacturers in the South East. Components to be photographed at the firm's studio are collected by a staff member from the manufacturers together with details of any special requirements. Manufacturers or agencies wishing to use the service should ring Little Waltham 376.

The Epta Engineering Co. have moved their head office to Macroom Road, Maida Hill, London, W.9. The electronic assembly department is also located at this new address.

Electronic Telephone Exchanges

The Post Office has ordered another four electronic telephone exchanges, which will be installed at Brampton (Cumberland), Bishopton (Renfrewshire), Llanwern (Monmouth) and Odiham (Hants). The Bishopton exchange will have a capacity for 1,000 subscribers, the other for 800.

These orders follow the successful trials of electronic equipment at Leamington Spa and Peterborough, and the equipment (particularly suitable for exchanges serving up to 2,000 lines) has been developed by the Post Office and the five principal British manufacturers of telephone switching equipment: Associated Electrical Industries Ltd., Automatic Telephone and Electric Co. Ltd., Ericsson Telephones Ltd., General Electric Co. Ltd. and Standard Telephones and Cables Ltd.

Increased Exports of Valves and Semiconductors

Exports of valves, tubes and semiconductor devices during the third quarter of 1965 reached a total of £3,165,115 according to figures based on Customs and Excise returns and issued by the Electronic Valve and Semi-Conductor Manufacturers' Association (VASCA) and the British Radio Valve Manufacturers' Association (BVA).

The totals for the nine months to 30th September 1965, show that the exports of semiconductor devices have increased by 46% over the corresponding period of 1964 and the exports of valves and tubes have increased by 11%. (Export figures for the first nine months of 1964 were, for semiconductor devices: £1,369,956; and for valves and tubes: £6,636,268.)

Solid-State Microwave Link

A completely solid-state microwave radio system is being supplied by G.E.C. (Telecommunications) Ltd. to Chile. It will link the capital, Santiago, with Arica over a distance of about 1,120 miles.

Solid-state equipment was chosen for its reliability and low power requirements. These factors are of great importance where the unattended repeater stations are in remote locations. The system will accommodate monochrome and colour television or up to 960 telephone channels. In addition to the link between the two main cities, 21 other towns will be provided with telephone communication over the system.

Similar equipment is also being supplied by G.E.C. to Zambia to link Lusaka with Kitwe. This is also fully solid-state and provides three broadband channels. One of these channels will carry 625-line television and the

other will carry 960 telephone channels. The third acts as a protection channel, automatically coming into operation if either of the other two fails.

Joint Computer Purchase by City and County Councils

The Norwich City Council and the Norfolk County Council have agreed to establish a joint computer centre.

An English Electric-Leo-Marconi System 4/30 computer will be used. It will process most of the clerical work of the two councils for such purposes as accounting, quantity surveying, education and police statistics.

The combined venture will permit both councils to use a more powerful computer than either of them would be able to afford alone. Overheads and staff costs will also be reduced. In addition, they will be able to process more advanced work than would otherwise be possible.

The system is planned so that the 27 district councils in the county will also be able to process their work on the computer. It is scheduled for installation in about two years' time.

This agreement follows the modern trend in this country for various concerns to share a computer. Not only do those concerns gain the benefits described here, but also the computer is used more efficiently. Often a computer can handle more work than is required of it by a single firm or company.

Instrument Leasing

Dynamo Instruments are introducing a leasing scheme for their range of a.c. and d.c. measuring equipment. The instruments are being offered at reasonable rental terms for a minimum period of 5 years.

This scheme will enable small concerns operating on a tight budget to be able to use instrumentation which they cannot afford to buy. Details, including typical rental terms, can be obtained from *Dynamco Instruments Ltd., Salisbury Grove, Mychett, Aldershot, Hants.*

For further information circle 68 on Service Card

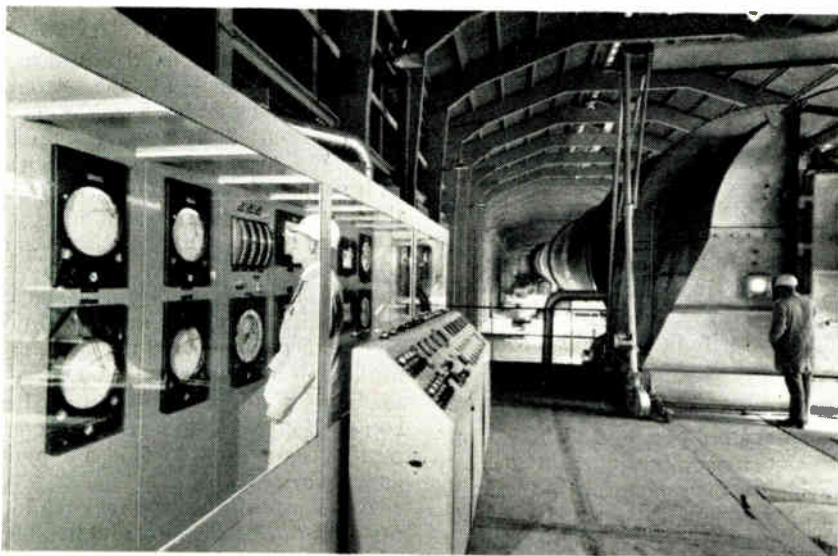

NOW FULLY OPERATIONAL in the Blue Circle works at Westbury, Wilts, of Associated Portland Cement Manufacturers Ltd., is a new 500-ft kiln—one of the largest and most fully automated in Europe.

Instrumentation to control the kiln (the firing end of which is shown on the right of the picture) includes a Honeywell centralized panel (on the left), which provides the means for recording indicating and controlling at optimum values the kiln variables, thus ensuring a continuous flow of high-quality product and keeping fuel costs to a minimum. The variables include air temperatures in several positions, temperatures of grate and kiln exit, pressure within the cooler and back-end draught.

The flow of pulverized fuel to the kiln burner pipe is also controlled, as is the clinker feed to the cement mills, and for maximum combustion efficiency the fuel/air ratio is trimmed by reference to the oxygen content of the exit gases.

For further information circle 67 on Service Card

Correction

In a past issue (p. 539, November 1965) reference was made to the programming of the Ruf 'Praetor' computer. The nylon tags are not used for programming, as suggested in the report, but are part of a filing system. Programming for this computer is carried out in a conventional manner.

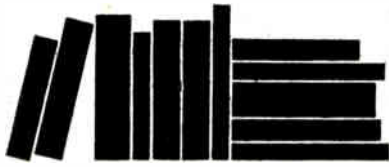

NEW BOOKS

Oscilloscope Measuring Technique

By C. CZECH. Translated from the German by A. Smith Hardy. Pp. 620 + xviii. Cleaver-Hume Press Ltd., 10-15 St. Martin's Street, London, W.C.2. Price 105s.

This publication (in the Philips technical library series) is a revised and extended replacement for the author's previous *Cathode Ray Oscilloscope*. The technique of the c.r.o. has advanced considerably over the last few years (fields of application having broadened considerably as a result) and this handbook aims to be a complete guide to the uses of the modern oscilloscope in research, development and control.

The text, which is supported by copious circuit diagrams and oscillograms, covers theory and design techniques, and gives ample information on the uses of the instrument. Eighteen chapters are devoted to detailed descriptions of measuring techniques in different fields, including several of non-electrical values.

The contents are divided into four main parts: the cathode-ray oscilloscope; general measuring technique; practical examples; and photographic recording and large-picture projection of oscillograms. This book should prove a valuable work of reference for all electronic engineers.

Microelectronic Circuits and Applications

By JOHN M. CARROLL. Pp. 360 + viii. McGraw-Hill Publishing Co. Ltd., McGraw-Hill House, Shoppenhangers Road, Maidenhead, Berks. Price 78s.

This book, by the former managing editor of the American journal *Electronics*, contains seventy-eight articles from the magazine, assembled so that they offer a complete description and analysis of all the recent advances in the microelectronics field.

It provides not only an historical review of micro-miniaturization, but also gives a wealth of technical data on new circuit devices, the materials used in their development, the guide-lines for choosing and adapting the most appropriate circuit for any particular electrical system.

Such topics as fabricating circuits on or within silicon blocks, designing integrated circuits for pulse-type circuits, adapting circuits involving internally-generated light and creating circuits that function at near-absolute zero are included, and applications of all the important micro-electronic techniques, theorems and methods are discussed.

Hundreds of reference sources and circuit diagrams are given, the whole collection of articles providing an important concentration of facts, figures and design procedures that every engineer needs to help him understand and apply modern microelectronic practice.

Circuits Using Direct Current Relays

By A. H. BRUINSMA. Pp. 86 + x. Iliffe Books Ltd., Dorset House, Stamford Street, London, S.E.1. Price 13s 6d.

Despite the development of many new devices which can replace relays, there still exist problems—particularly in the design of simple and reliable circuits for switching and amplifying—where relays have an important role to play. This book (a Philips paperback) explains the principles of

applying direct-current relays in commanded or programmed sequence circuits and gives a useful insight into a number of uncommon circuits which have been well proved in practice.

The author has avoided the use of complicated mathematics in his discussion of the circuits, thus enabling the properties of the relay to be clearly understood. By combining the basic circuits covered in the book, many variations are possible, and a large number of solutions are thus provided to problems in automatic or commanded sequence circuits (with either fixed or variable programmes).

Introduction to Variational Methods in Control Engineering

By A. R. M. NOTON. Pp. 122 + x. Pergamon Press Ltd., 4 & 5 Fitzroy Square, London, W.1. Price 30s.

Variational methods and dynamic programming are potentially powerful tools not only for improving the design of automatic controls, but also in applying computers to control industrial processes. This monograph aims to provide an introduction to the subject for research workers and students engaged in control engineering, its treatment being predominantly mathematical.

Transistors in Logical Circuits

By J. PH. KORTHALS ALTES. Pp. 117 + viii. Iliffe Books Ltd., Dorset House, Stamford Street, London, S.E.1. Price 16s.

This is a Philips paperback which discusses the uses and advantages of commercially-available semiconductor components for digital-circuit design. Comparisons are made with already-known analogue relay circuits and examples of industrial applications are given.

Reliability of Electronic Components

By C. E. JOWETT. Pp. 165 + viii. Iliffe Books Ltd., Dorset House, Stamford Street, London, S.E.1. Price 42s.

A presentation of all the relevant facts concerning the properties and stabilities of various classes of components and materials used in electronics is given in this publication. It will be of benefit to all concerned in the electronic industry, from the designer to the production worker.

Network Analysis for Telecommunications and Electronics

By R. A. LAMPITT. Pp. 269 + viii. Iliffe Books Ltd., Dorset House, Stamford Street, London, S.E.1. Price 63s.

This book has been written to make the inherently-complicated subject of network analysis easy to understand. A logical approach has been adopted throughout, using mathematics as a tool, and the problems of tuned networks, wave filters, transmission lines and waveforms are discussed.

Electrical Phenomena in Gases

By R. PAPOULAR. Pp. 198 + iv. Iliffe Books Ltd., Dorset House, Stamford Street, London, S.E.1. Price 45s.

First published in France, and now translated by B. Jeffrey, this illustrated monograph on the nature and importance of electrical discharges through gases approaches its subject from both a theoretical and experimental stand-

point. It should prove of value to those engaged in research in the fields of basic plasma physics and gaseous discharge, as also to specialists in electrical and electronic engineering.

New Materials and Processes in Instrument Manufacture

Proceedings of the S.I.R.A. Conference at Eastbourne, May 1965. Pp. 108. British Scientific Instrument Research Association, South Hill, Chislehurst, Kent. Price 80s.

These proceedings contain all twenty-four papers presented at the conference, together with factual material abstracted from the resulting discussions. The papers discuss those new materials and techniques which are of special interest in the production of precision measuring and controlling instruments.

British Miniature Electronic Components Data, 1965-1966

Edited by G. W. A. DUMMER and J. MACKENZIE-ROBERTSON. Pp. 984 + xvi. Pergamon Press Ltd., 4 & 5 Fitzroy Square, London, W.1. Price £9.

In this fourth edition of British Miniature Components Data, over 90% of the items described are appearing for the first time in the series. The parameters of compactness, quality and potential usefulness have governed the selection, and many line drawings, design and applications data and photographs are included. This reference book also contains much advance data which has been provided by the manufacturers concerned.

Manufacturers' Literature

Modular Laboratory Furniture. Tables, benches, fume cupboards, storage cupboards and other laboratory furniture produced by Spencers Joinery Ltd. are described in this 32-page brochure. It is illustrated with line drawings and photographs and dimensional details of some of the furniture are included. *Spencers Joinery Ltd., Laboratory Furniture Division, Southbury Road, Enfield, Middlesex.*

For further information circle 69 on Service Card

Ultrasonic Controls in Mining. Of 8 pages, this illustrated brochure, publication No. USM2, outlines the ultrasonic control equipment manufactured by Westool Ltd. for use in coal mines. The equipment includes underground traffic controllers, hopper level controllers and wagon tippers. *Westool Ltd., St. Helen's Auckland, Bishop Auckland, Co. Durham.*

For further information circle 70 on Service Card

Measuretest. A new technical publication—*Measuretest*—has been published by Marconi Instruments Ltd. It will be mainly devoted to the applications of electronic measuring instruments and will appear six times a year. Each issue will be devoted to one main theme, with application notes, and the first one deals with counters. In addition, the journal provides solutions to measurement problems and gives details of modifications to the company's instruments.

Marconi Instruments Ltd., St. Albans, Herts.

For further information circle 71 on Service Card

Application Note. This is a six-page booklet (MK/185X) covering the use of STC's BCY42 transistors in a 10-Mc/s wide-band amplifier and an audio amplifier delivering 1 mW into a 600-Ω load. Circuit diagrams and components lists are given, together with typical performance characteristics. *S.T.C. Components Marketing Division, Footscray, Sidcup, Kent.*

For further information circle 72 on Service Card

Guides to Industrial and Commercial Air-Conditioning. Two publications are being offered by the Carlyle Air Conditioning Co. on air-conditioning installations. One discusses the different types of air-conditioning systems appropriate to a variety of locations (computer rooms, testing laboratories, manufacturing areas, machine shops, etc.), and the other describes and lists the range of equipment available for such applications.

Carlyle Air Conditioning Co. Inc., 1 King Street, St. James's, London, S.W.1.

For further information circle 73 on Service Card

16-mm Sponsored Films. More than 350 films, covering technical and general interest subjects, are listed in this 52-page publication and are available from the Rank film library. The films are classified into 17 major categories, including building construction, civil engineering, the food industry, industrial Britain, manufacturing processes and the motor industry.

Rank Audio Visual Division, Woodger Road, Shepherds Bush, London, W.12.

For further information circle 74 on Service Card

4½-in. Image Orthicon Television Camera Tubes. This 12-page brochure (V/ORT) contains detailed information on EMI's 4½-in. image orthicon camera tubes, including performance data, operating conditions, design characteristics, setting-up procedures and guaranteed specifications. A wide range of vidicon camera tubes is also referred to briefly.

E.M.I. Electronics Ltd., Hayes, Middlesex.

For further information circle 75 on Service Card

Frontier. The I.I.T. Research Institute of Chicago publishes this 32-page journal quarterly, and the Autumn 1965 issue had as its main topic computer technology. Articles on computers for machine control, data-communications, structural engineering and research are included, and the significance of recent advances in hardware and software design is discussed.

I.I.T. Research Institute, 10 West 35th Street, Chicago, Illinois, U.S.A.

For further information circle 76 on Service Card

Quick Heating V.H.F. Tetrodes and Double Tetrodes. This data and applications booklet (TP 601) from Mullard includes in its 26 pages a description of quick-heating valves for mobile transmitters, and provides designers with information on the techniques associated with their use. Abridged data is given on each type of valve, performance and reliability are described, and a selection of practical circuits and recommended valve line-ups for different types of transmitter are suggested.

Mullard Ltd., Mullard House, Torrington Place, London, W.C.1.

For further information circle 77 on Service Card

Automation in the Generating Station. Supervisory and control techniques developed by English Electric-Leo-Marconi for power-station automation are described in this 14-page publication (DP/234), which is now available. The requirements of a generating station are discussed and are followed by an introduction to the concept of computer-based automatic control systems.

English Electric-Leo-Marconi Computers Ltd., Portland House, Stag Place, London, S.W.1.

For further information circle 78 on Service Card

Process Instruments. Three 8-page catalogues from Hilger-I.R.D. Ltd. describe their latest range of infra-red gas analysers. The instruments may be used for top-gas analysis in steel furnaces, control of carbon in steels and cast irons, carburizing control and leak detection in pipe lines; each illustrated brochure contains diagrams, performance characteristics and operational specifications.

Hilger-I.R.D. Ltd., 98 St. Pancras Way, Camden Road, London, N.W.1.

For further information circle 79 on Service Card

0.15" CONTACT PITCH

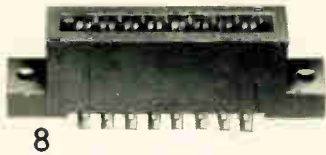
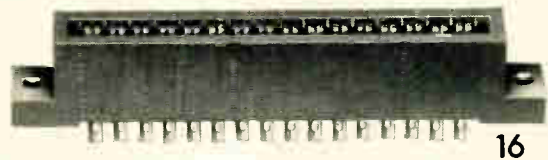

PRINTED CIRCUIT EDGE CONNECTORS

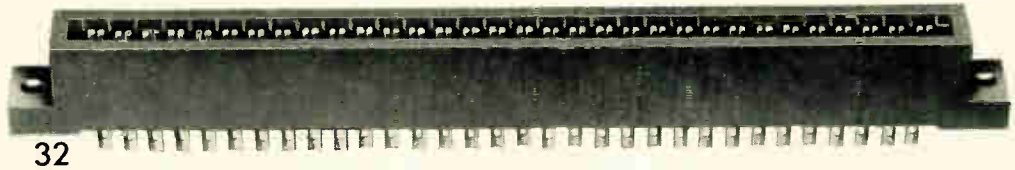

FROM 8 TO 32 CONTACTS
DESIGNED FOR USE WITH 1/16" BOARDS

AND

MADE BY

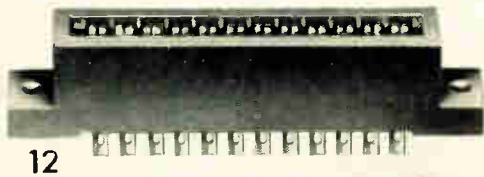

PAINTON

*By the way -
quick delivery!*



SEND FOR FULL DETAILS

Painton & Co. Limited

KINGSTHORPE, NORTHAMPTON

Tel: 34251 (10 lines) Grams: Ceil. Northampton. Telex 31576

AUSTRALIA Painton (Australia) Pty. Ltd. U.S.A. Painton Inc. ITALY Painton Italiana. SWEDEN Svenska Painton A.B. BENELUX Painton S.A.
GERMANY Painton G.m.b.H.

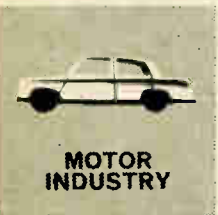
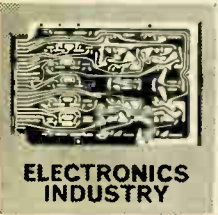

10,000,000

*SKILLED
MAN HOURS
SAVED
WITH*

PICASTINGS

CENTRIFUGAL INVESTMENT CASTINGS

This is probably the understatement of the year. Taking all aspects into consideration:- the elimination of machining operations the freeing of production capacity the utilisation of the optimum material for the job in hand the removal of design restrictions, the use of the potential advantages inherent in PICASTINGS cannot be assessed in numbers of man hours alone.

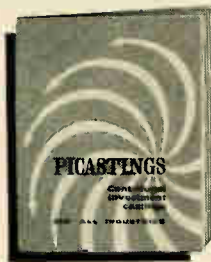

Please send for leaflet F.1 for full details

P.I. CASTINGS (Altrincham) LTD.

DAVENPORT LANE, ATLANTIC STREET
ALTRINCHAM

Tel.: Altrincham 5811

Telex 66/105
P.I.17

**AVOID
EXPENSIVE
DELAYS IN
RESEARCH &
PRODUCTION**



**ORDER
EX-STOCK*
FROM
LIND-AIR**

**At lower than cost*

Yes, direct from our vast stocks we can supply immediately: Sefram 5 channel **PEN RECORDERS** at a mere £270 (Net list price £690), 4 channel fully Portable Systems £139. 10. 0, an extensive range of **TRANSDUCERS** and **ACCELEROMETERS** for industrial control, Hydraulic equipment including **MOOG SERVO VALVES** by Dowty for only £70. We also hold at least a hundred thousand British and American **PLUGS, SOCKETS** and **CONNECTORS** including Cannon, Thorn, Amphenol, Bendix, Pye, Plessey, Belling-Lee, McMurdo, SCF, Painton, etc. 400 **CYCLE** components, **SYNCHROS, SERVOS, MAGSLIPS, TACHOGENERATORS, RESOLVERS**, etc. **TRANSISTORS, DIODES, RECTIFIERS** and **VALVES**. Stantelum **CAPACITORS**, metal oxide **RESISTORS**. Our **MICRO-WAVE** stock includes **WAVEGUIDE** plumbing in all configurations, **KLYSTRONS** and **MAGNETRONS**, TR cells and **TWTs**. **RELAYS** of all types, Panel **METERS**, Pressure **GAUGES**. All at less than manufacturers' prices.

SEND AT ONCE FOR ILLUSTRATED LITERATURE:

LIND-AIR ELECTRONICS LTD

53 Tottenham Court Road · London · W.1

Telephone: LAngham 3653 (10 lines)

DOUBLE BEAM COSSORSCOPE 2300

Model 2300 is a compact, precision calibrated oscilloscope designed specifically for high-sensitivity, low-frequency applications in electrical engineering, servo analysis, electro-mechanical transducer displays, electro-myography and electro-cardiography. A double-gun cathode-ray tube is employed. Two identical amplifiers are provided with a choice of either single-ended or differential inputs.

The triggering system provides four modes of operation: Auto, A.C. Slow, A.C. Fast, and D.C., and the sweep may be triggered from any selected point on the positive or negative slope of the signal. Mechanical triggering is available, whereby an external contact closure, developed across the MECH and COMMON terminals of the oscilloscope by the apparatus under test, will trigger the time-base, an external voltage source being unnecessary. Single-stroke operation can be primed or triggered by a push-button.

- Frequency response d.c. to 200 kc/s (-3 dB)
- Identical Y amplifiers 1 mV/cm to 50 V/cm
- 19 calibrated timebase ranges 5 sec/cm to 5 μ sec/cm
- Voltage calibration $\pm 3\%$ and time calibration $\pm 3\%$
- Mechanical triggering Z modulation and equal X-Y facilities



COSSOR
A Member of the Raytheon International Group

COSSOR INSTRUMENTS LTD.
The Pinnacles, Elizabeth Way,
Harlow, Essex, England.
Tel: Harlow 26862 Cables: Cossor Harlow

WESTON—FOREMOST FOR MOVING COIL RELAYS

MODEL S 170 for control applications

The Model S 170, permanent magnet moving coil relay. Combines extreme sensitivity with high precision. It is eminently suitable for control applications when a relay operating within close tolerances is necessary. The minimum signal current is 5 mic A. d.c.; shunts and series resistors can be incorporated for currents and voltages up to 5 A and 250 V d.c.



MODELS S 124 a miniature alarm relay with "hold-on" contacts

The Model S 124 is of the permanent magnet moving coil type and can be supplied to operate on currents as low as 2 mic A. d.c. High contact pressure is ensured by magnetic attraction between the contacts; these will "hold-on" until reset manually or by remote electrical control. Front-of-panel and flush mounting relays are available.



MODEL S 115 a miniature switching relay

The Model S 115 functions as an "on-off" switching relay and is supplied for operating currents down to 50 mic A. d.c. Single and double coil windings are available. The relay can be mounted in any position and is magnetically self-shielding. The space occupied on the chassis is only 1½ in. x ¾ in.; weight, 1¼ oz.

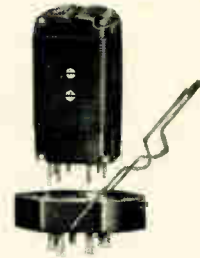

For full details of the Weston range of relays, please write to:—

SANGAMO WESTON LIMITED • ENFIELD • MIDDLESEX

Telephone: Keats 1100. Grams: Sanwest, Enfield. Telex: 24724

For further information circle 288 on Service Card

LN

PRECISION SEAMLESS TUBING

Specialists in :

Capillary tubing for controls (thermostats, thermostatic valves, thermometers, etc.)

Bourdon tubing for pressure gauges.

Tubing for measuring pointers in aluminium and aluminium alloys.

LA NATIONALE S.A.
GENÈVE ET CHAMPAGNE, SUISSE

GENEVA (Switzerland)

For further information circle 289 on Service Card

M^cGEOCH



manufacturers of

- SWITCH and FUSE GEAR
- WATERTIGHT SOCKETS and PLUGS
- INDICATOR LIGHTS and UNITS
- LIGHTING FITTINGS and SIGNS, etc.

WILLIAM McGEOCH & CO. (BIRMINGHAM) LTD.

(Dept. E.I.)

BORDESLEY, BIRMINGHAM 10

See us on
**STAND
E10**
A.S.E.E.
EXHIBITION
EARLS COURT
23-30 MARCH

*this is all the
space you need to
mount the*
**THORN 3-COLOUR
INDICATOR**

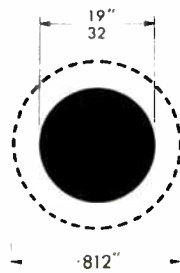

This very compact unit has an overall length of approximately 2.230" and an outside diameter of approximately .812". It can be installed into a single panel hole measuring only 19/32" using a simple fixing ring and lock nut, both of which are supplied. This makes it suitable for a wide variety of signalling applications where space is at a premium.

The Thorn Three Colour Indicator contains three internal coloured filters optically positioned to project the selected colour through an external front lens. Both lens and filter are of glass, not plastic, and there is, therefore, no discoloration.



The unit is designed for use with a variety of Atlas Midget Panel Lamps (6, 12 or 28V) and is supplied with either a black anodised or bright chrome front nut, and solder or screw terminals. The standard filter colours are red, orange and green.

Please write for full details to:

Thorn Special Products Ltd



Great Cambridge Road, Enfield, Middlesex.
(Howard 2477)

A member of the Thorn Electrical Industries Ltd
group of companies.

TSP3

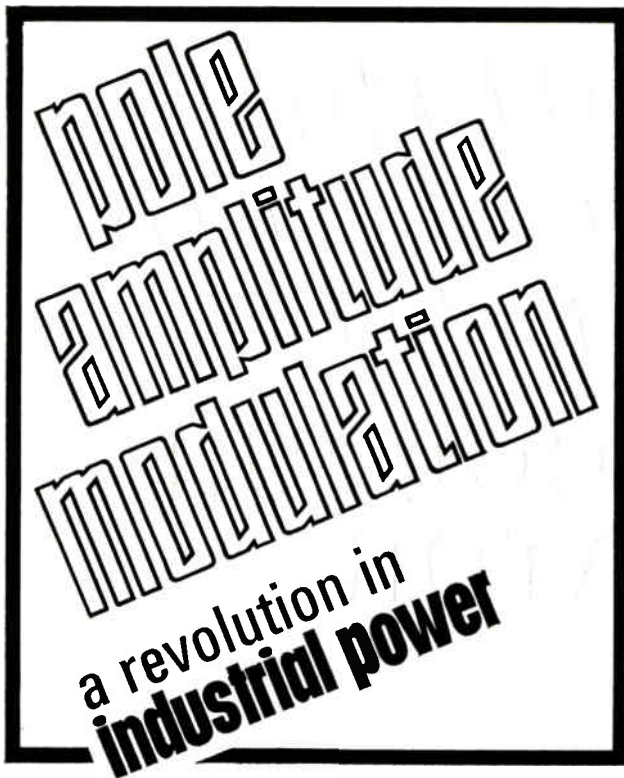

This patented, multi-speed a.c. motor has been specifically designed for use in situations demanding either falling or practically constant torque. This variable speed characteristic allows the P.A.M. motor to be used economically in systems related to the machine tool, air conditioning, printing and textile industries as well as in the marine and electrical engineering fields generally.

Mackie Pole Amplitude Modulation motors can be seen
on Stand No. KK1
at the A.S.E.E. Exhibition.

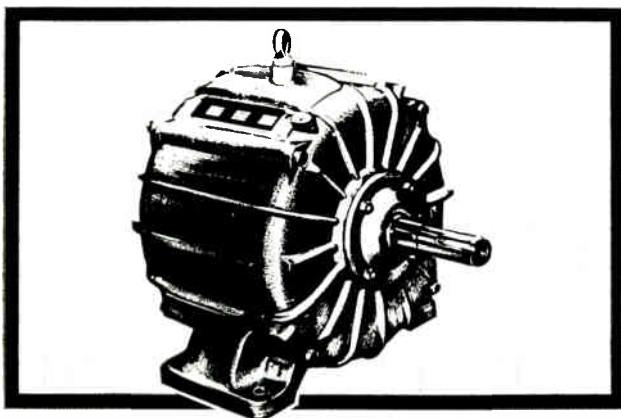

mackie

W. MACKIE & CO. LTD., WILLOW LANE, MITCHAM, SURREY
Telephone: Mitcham 0951-6. Grams: Mackie Croydon Surrey. Telex: 264041

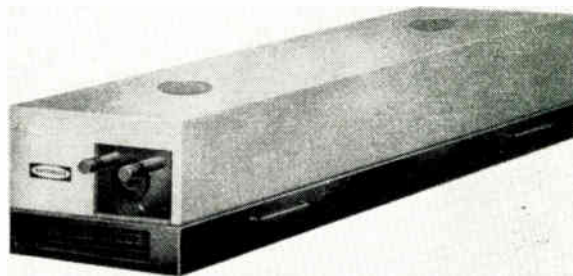

Raytheon now offers the Model LG12, a CW Argon Ion Laser producing a minimum of 1 watt in the single transverse mode (TEM_{0,0}). The one-watt power output of the LG12 is over the range of 4545 to 5145 angstroms in the blue-green portion of the visible spectrum with the principal lines at 4880 and 5145 angstroms. Beam diameter is 2 mm at the exit aperture and less than 3 milliradians divergence. The water-cooled laser head measures 40" long, 12" wide, 10" high and weighs less than 100 pounds.

WALMORE
ELECTRONICS LTD
11-15 BETTERTON ST., ORURY LANE, LONDON, WC2 Tel: TEMple Bar 0201-5

televisione

テレビ

Television

télévision

Fernseher

ТЕЛЕВИЗИЯ



The Universal Telonic SV-13 Sweep Generator "Speaks Television" in any Language

A truly International Test Instrument, Telonic's SV-13 Sweep/Signal Generator is used for alignment and adjustment of TV receivers and tuners world over. Its unique capacity of 13 plug-in channels permits comprehensive coverage of the entire 20-225 MHz frequency range in a single instrument.

Simply by changing these channel plug-in "strips" the user can adapt the SV-13 to check out RF and IF channels and other VHF circuits from Bangor to Bangkok. The instrument may be specified originally with American, European, Italian, Australian, or Japanese channels plus any number of plug-in strips. Channels may even be varied to suit a particular test set-up, e.g. 8 TV channels plus 4 RF bands plus one IF. The instrument's selection dial is engraved according to the standards furnished.

To simplify production application of the SV-13, pulse-type, crystal-calibrated, built-in markers supply frequency indication above and below center frequency at standard 4.5 MHz and 5.5 MHz separation between video and sound carriers.

Other Specifications: RF channels adjustable from 5 to 20 MHz, IF channels from 10 to 40% of center frequency; output is 1 VRMS into 75 ohms; Flatness between markers, $\pm 1\%$, over each channel, $\pm 2.5\%$,

overall, $\pm 5\%$; Attenuation is 99 db in steps from 3 db.

And look at these options available with the SV-13

- Additional RF Output System
- Additional IF Markers
- Local Oscillator Adjustment
- Remote Control Channel

Telonic also produces the SD-3, SD-3M and SN-3 sweep generators for Testing UHF circuits, as well as the SV-14 for FM work. Other Telonic sweep generators cover audio to 3000 MHz in a variety of convenient models. A full product line catalog is yours on request.

Telonic[®]

INDUSTRIES, U.K.

A DIVISION OF
TELONIC INDUSTRIES INC.
"THE SUMMIT", 2 CASTLE HILL TERRACE
MAIDENHEAD, BERKS
TEL.: MAIDENHEAD 23057

Representatives in all major cities in the U.S., Canada, South America, Europe, Great Britain, Scandinavia, and the Far East.

SWEEP GENERATORS

RF ATTENUATORS

DETECTORS

COAXIAL SWITCHES



*Fine
Craftsmanship*

... the skill needed to produce hand carved furniture is only acquired by experience and practice. The art of making fine wire of high quality is equally a matter of skill and precision gained through over 80 years of unrivalled 'know-how' applied to modern production methods and techniques.

Fine Wire by
L·E·W

WIRESMITHS TO THE WORLD

**THE LONDON ELECTRIC WIRE CO.
AND SMITHS LIMITED**
CHURCH ROAD • LEYTON • LONDON E10



Proved reliability-qualification approval embraces RCSC types RWV4J-K & L, 1.Ω to 100KΩ

CGS resistors offer you highest standard of quality and performance at extremely competitive prices, due to specialisation, an efficient production organisation and selective buying of raw materials. Up to 100 of any RCSC type resistors are available from stock. Leading manufacturers, GPO, Ministry of Aviation, Admiralty, and NATO are among the many users of CGS resistors. RCSC type approved to DEF 5111-1, manufactured under EID and ARB approved inspection conditions.

For price list, catalogue and stock list write or phone: **THE C.G.S. RESISTANCE CO. LTD.**
Marsh Lane, Gosport Street, Lymington, Hants. Tel: Lymington 2811

For further information circle 296 on Service Card

**springs and
pressings for the
electronic industry**



Made to your individual requirements from Beryllium Copper, Nickel Silver, Stainless Steel, Phosphor Bronze, Tantalum, Spring Steel etc.

Write or phone for further details to:
LITCHFIELD BROTHERS LTD.

Heage Firs, Nether Heage, Derby
Telephone: Ambergate 435/6/7

The B.V.C design and development service can answer your miniature motor problems for only 4d.



B.V.C. Electronic Developments Ltd. have specialised in the design, development and manufacture of electric motors, for operation from high frequency down to 50 cycles frequency, or D.C. supplies.

If you have a requirement for small electric motors, servo motors or small mechanisms either of standard types or built to your specification, then a 4d. stamp will bring the answer. Write to:—

B.V.C. ELECTRONIC DEVELOPMENTS LTD.
Dept. I.E./3, GOBLIN WORKS, LEATHERHEAD, SURREY
Tel.: A shtead 6121

For further information circle 298 on Service Card

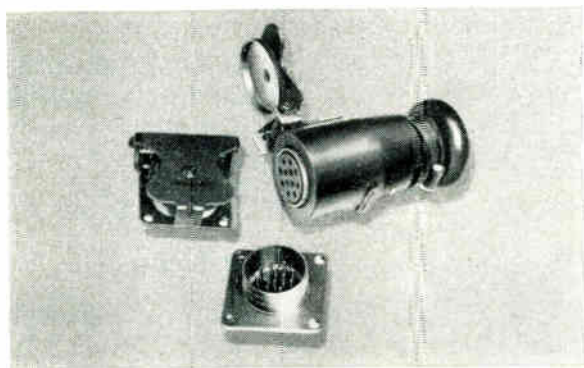

NATO TRAILER CONNECTORS

Rugged Steel/Neoprene Housings,
F.V.R.D.E. Approved. Up to 37 Contacts.

Cannon Electric
(Great Britain) Ltd.,
Lister Road,
Basingstoke, Hants.
Tel: Basingstoke 3171



CANNON

crystal controlled portable, multi-range calibrator



Tequipment type C1 Calibrator provides a comprehensive selection of accurate calibration waveforms for the complete alignment of Tequipment and other oscilloscopes, signal generators, counters, etc. The Calibrator incorporates a crystal source and a number of accurate frequency dividers which produce all the relevant waveforms, thus ensuring a timing accuracy of a very high order.

Brief Specification

The following signals are available:—

- 1 A square wave at either 100 Kc/s or 1 Mc/s repetition rate.
Rise time approx. 5 nSecs.
Amplitude continuously variable 0-5v.
- 2 A square wave at either 10 Kc/s, 1 Kc/s and single shot repetition rate.
Rise time approx. 0.5 μ Secs.
Amplitude adjustable from 100v to 5mV.
- 3 Time marker pulses and timing comb.
Pulses at repetition rates of 1 Mc/s, 100 Kc/s, 10 Kc/s, 1 Kc/s, 50 c/s.
The individual marker frequencies are also separately available. Marker accuracy crystal controlled. (.02%)
- 4 Television waveform (*non-interlaced*).
Power consumption approx. 90 watts.
(*Rated for continuous operation*).
 - Size only 13" x 13" x 6½", weight 24 lb.
 - Price £120 0s 0d.



Tequipment Ltd, 313 Chase Rd., Southgate, London, N.14. Fox Lane 1166
Scottish Office: 30 Castle Street, Edinburgh. Tel. Balerno 3120

“What do you mean, you didn't know Imperial Datalog made input/output typewriters?”

Sorry to sound so aggressive, but if you're in the market for Input/Output Typewriters, we think it's about time you found out. And we can give reasons that are as sound as our machines. We make Input/Output Typewriters *and* Contacts Only and Solenoids Only Machines to suit every conceivable kind of electronic equipment.

Strong robust machines all of them—and perfectly happy to work for 24 hours a day if need be. Flexible too. When you order an Imperial Datalog Typewriter, we'll build it to your particular requirements at little or no extra cost.

You can specify special symbols, types of feed-back switches, solenoid voltages and so on. And because our machines are 100% British, we can offer you a fast and comprehensive technical service that's second-to-none.

Our prices aren't exorbitant either—a standard, full keyboard Solenoids Only Machine costs about £335.



Let's face it, can you afford *not* to know about Imperial Datalog Input/Output Typewriters? Write for details, or ring us at:—

Datalog Ltd

81 Kingsway, London, WC2 Tel: HOLborn 9662 (a subsidiary of Imperial Typewriter Co. Ltd.)

For further information circle 301 on Service Card

SHROUDED TERMINAL BLOCKS

**METWAY
PRODUCTS**

“BAKELITE”

10 amp. 500 volt.
In 2 or 3 way



“COVEREDWAY”

P.V.C. Flexible with
Press-on Polystyrol Cover
10 amp. 380 volt.
12 way — May be cut to requirements



“BARRIERWAY”

moulded phenolic with
POLYSTYRENE COVER
20 amp. 500 volt.
2, 4, 6, 8, 10 or 12 way

See us at our Stand G19
A.S.E.E. Exhibition

• FOR FULL DETAILS ASK FOR LIST No. NBQ/181R

METWAY • KEMP TOWN • BRIGHTON 7

For further information circle 302 on Service Card

TECHNICAL MOULDINGS

POLYSTYRENE-POLYTHENE
POLYPROPYLENE
CELLULOSE-ACETATE
ABS-DELTRIN
AND NYLON ETC.
DESIGN TOOLMAKING
HOT FOIL STAMPING
MOULDING



Henley Plastics Ltd. HENLEY-ON-THAMES TELEPHONE 3861

For further information circle 303 on Service Card

VITALITY BULBS

Tested and proven
A.I.D. and A.R.B.
Miniature and Sub-miniature
indicator bulbs, from 1 to 50v,
in sizes from 4.0 mm.

Catalogue from:—Vitality Bulbs
Ltd., Neville House, Wood Green,
N. 22. MULberry 1931.

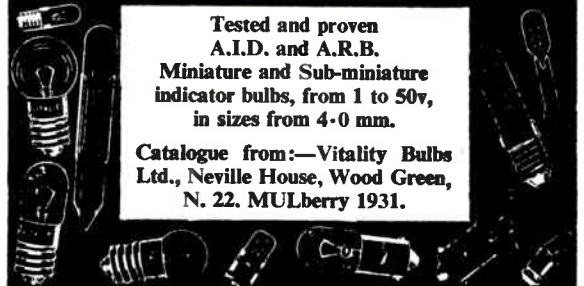

CLASSIFIED ADVERTISEMENTS

FULLY DISPLAYED : 55/- per single column inch.
SEMI-DISPLAYED : 45/- per single column inch.
RUN-ON : 4/6 per line of approximately 7 words.
Where an advertisement includes a Box Number Is. extra.
SERIES DISCOUNTS : 12 insertions, 15%.
Remittances payable to "Industrial Electronics".

Copy is required by 16th of the month for insertion in the following month's issue, by 12th of the month if proofs are required.

Address to :
Classified Advertisement Dept.
Industrial Electronics
Dorset House, Stamford St., London, S.E.1.

SITUATIONS VACANT

STC TELEPHONE SWITCHING DIVISION



Engineers— join in the rapid growth of STC

Standard Telephones and Cables Limited has a growing share in the steadily increasing use of telecommunications throughout the world. This above-average expansion in both production and techniques has created opportunities for qualified Engineers on Telephone Exchange Design and Development in either the electronic or electro-mechanical fields.

We need

CONTRACT ENGINEERS · DESIGN ENGINEERS · ELECTRONIC SYSTEMS DEVELOPMENT ENGINEERS · MECHANICAL DESIGN ENGINEERS · ELECTRO-ACOUSTIC ENGINEERS

Vacancies exist at all levels. Starting salaries will be attractive and negotiated according to qualifications and relevant experience.

For comprehensive details about the work, salary and prospects—as well as information on the company itself—write or telephone for our new booklet.

The Staff Personnel Officer (IN/2), Standard Telephones and Cables Limited, Oakleigh Road, New Southgate, London, N.11. (Telephone ENTERprise 1234, Extn. 601) [531]

NEW TELECOMMUNICATIONS DEVELOPMENTS

Involving some of the most advanced equipment in the world, offer careers of outstanding interest, secure and well paid, to science and engineering graduates.

A Royal Signals Officer is trained to command men. He leads a full and satisfying life, much of it out of doors. During his career he has ample opportunity to obtain professional qualifications and to use them in tackling interesting problems in many different countries.

The Royal Corps of Signals is responsible for the Army's modern telecommunications network, and also for a world-wide static communications system. It needs graduates as officers, and offers immediate commissions to suitable candidates.

PAY AND ALLOWANCES now compare very favourably with anything a young graduate could earn in civilian life.

APPLICANTS should be under 25 and should hold (or be studying for) a degree or a diploma recognised by the National Council for Technological Awards, preferably in Mathematics, Physics, Applied Science, Natural Science, Electrical Engineering, or a diploma acceptable to the Institution of Electrical Engineers or the Institution of Electrical and Radio Engineers, as giving exemption from these Institutions' examinations.

SERVICE can be either for a short period (minimum three years, with tax-free gratuity) or as Limited Service Regular Officer (initially for 16 years with a pension and gratuity at the end) or for a full career up to at least 55.

FOR FURTHER DETAILS write stating age and educational qualifications held (or for which studying) to Lt.-Col. D. L. Pounds, Room 045, Ministry of Defence, Dept. 47, Old War Office Building, Whitehall, London S.W.1. [540]

ASSISTANT CONTROLLERS

Posts and Telecommunications Department, Sarawak

DUTIES: To undertake the installation and maintenance of all types of modern telecommunications equipment, including multi-channel radio and automatic exchanges. A knowledge of associated line plant is desirable. To train staff in the practical aspects of their duties and be responsible for running a small zone centre.

Candidates, who should normally be nationals of the United Kingdom or the Republic of Ireland, must not be over 45 years and should possess Graduate or A.M.I.E.E. or equivalent qualifications.

Salary in scale £1,627-£2,905 p.a. plus approximately 25% terminal gratuity. 2-3-year contract. Free family passages and medical attention. Child and education allowances. Generous leave.

Please apply for further details giving your full name and age, together with brief details of your qualifications and experience, and quoting RC.292/155/01. to:—

Appointments Officer
MINISTRY OF OVERSEAS DEVELOPMENT
Room 301, Eland House, Stag Place
Victoria, London S.W.1 [546]



The Engineer who lands a job with us is off to a great start

(and his family knows it!)

Life takes on a very different meaning with the Anglo American Corporation. You and your family live in South Africa where the climate is healthy and sunny and the scenery often spectacular; you work with the foremost mining group in a country that's developing rapidly and becoming increasingly prosperous. If you are under 35, ambitious, and have the right qualifications you can look forward to a full and rewarding life, and to a career with great prospects.

THE PEOPLE YOU WORK FOR

Anglo American—the progressive international corporation whose engineers design, install and maintain a wide range of sophisticated mining equipment.

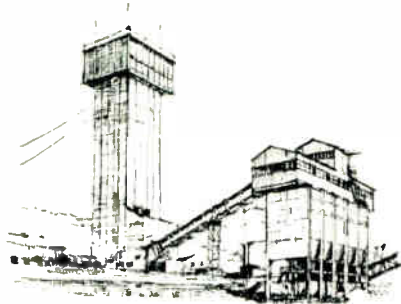

THE SALARY YOU EARN

Your gross salary with Anglo American is almost bound to be higher than your present earnings in Britain. Certainly you'll notice a difference in net income because tax is much lower. A married man with two children, earning £1,500, pays a mere £68.

A single man pays only £153. (The exchange rate is 'pound for pound').

THE HOME YOU MAKE

For as little as £5 a month rent you will get a modern flat or 3-bedroomed detached house if you are married; and there is excellent furnished accommodation if you are single.



THE SOCIAL SECURITY YOU ARE OFFERED

The mining industry offers excellent pension and provident funds, very generous sick leave privileges and comprehensive medical coverage.

THE HOLIDAYS YOU ARE GIVEN

30 days annual holiday on full pay plus a holiday allowance of £35, and every 5 years long leave of at least 70 days.

THE THINGS YOU DO

Social clubs and all sorts of sporting activities flourish—subscriptions are very low. The main cities are modern and bustling; there are many beautiful beaches and several great game reserves—all within reasonable driving distance.

THE QUALIFICATIONS YOU NEED

Mechanical and Heavy Current Electrical Engineers should hold either a B.Sc. (Eng.) or a Higher National Diploma or Higher National Certificate.

A minimum of 2 years' experience in heavy industry is desirable, though vacancies also exist for recently qualified Engineers with a degree or H.N.D and B.Sc.

Draughtsmen should have served an approved apprenticeship, hold the Higher National Certificate (Mechanical) and have had at least 3 years' experience in the design of structural steelwork.

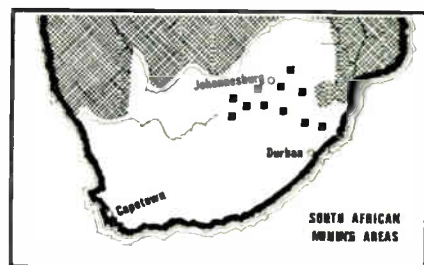

NOW WHAT?

You apply for more information and an application form. You may have an interview. You may land the job. If you do there are free air passages waiting for you and your family. Take the first step to Anglo American and South Africa now.

Write to: The Appointments Officer, Dept. SA 6623, 7 Rolls Buildings, London E.C.4.

ANGLO AMERICAN CORPORATION OF SOUTH AFRICA

545

planned growth for the 70's

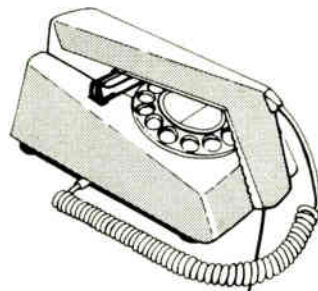

STC

The expansion of our team preparing for the mass production of ELECTRONIC EXCHANGES for world markets has created vacancies for the following staff:

**METHODS ENGINEERS
PRODUCTION PLANNING ENGINEERS
AUTOMATION ENGINEERS**

Applicants should be well qualified and have experience in the latest production and control techniques. Suitable candidates will be offered attractive salaries and assistance with housing.

Apply: **Staff Personnel Officer (PG/6)**
Standard Telephones and Cables Limited,
Oakleigh Road, New Southgate,
London, N.11

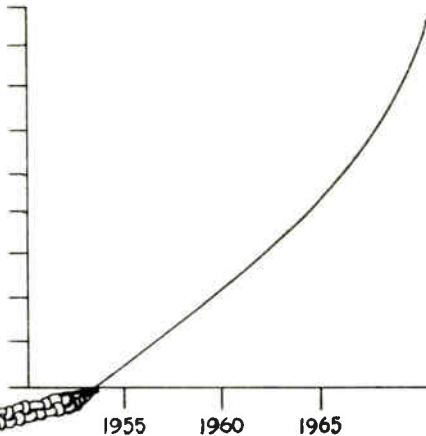
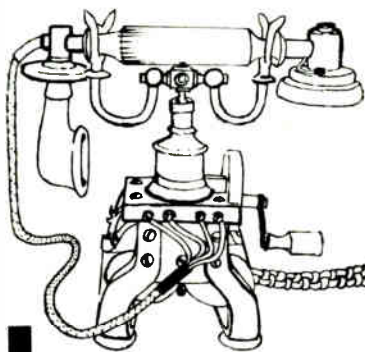

[543]

SENIOR EXECUTIVE ENGINEERS

EAST AFRICAN POSTS AND TELECOMMUNICATIONS ADMINISTRATION

Duties include:—

1. The design and planning of (a) automatic telephone exchanges or (b) trunk network and transmission systems, using v.h.f. and u.h.f. radio and line circuits, or (c) local line schemes and junction cables.
2. Responsibility for the installation and maintenance of overhead and underground telegraph and telephone lines; telephone/telegraph apparatus including teleprinters, automatic and manual exchanges; carrier telephone apparatus and VF telegraph apparatus; railway block signalling and control apparatus; transport; small petrol and diesel generators.

Applicants, not over 50, must (a) have a degree in engineering, with 7 years' experience as a telecommunications professional engineer, or (b) be a Corporate Member of I.E.E. or I.E.R.E., with 5 years' experience.

Salary in scale £2,097-£2,448 p.a. (including overseas allowance) plus 25% terminal gratuity (an increase of the order of 12½% of existing gross salaries has been approved). Free passages and medical attention. Accommodation at reasonable rental. Generous education allowances. Disturbance allowance payable on first appointment. Home leave on full pay at end of tour. Two-year contract.

Applicants, who should be nationals of the United Kingdom or Republic of Ireland, should apply for further details, giving full name, qualifications, experience, and quoting Reference RC.292/54/01, to:—

Appointments Officer
MINISTRY OF OVERSEAS DEVELOPMENT
Room 301, Eland House, Stag Place, London S.W.1

[541]

COURSES

**THE UNIVERSITY OF ASTON
IN BIRMINGHAM**
(designate)

The College of Advanced Technology
Birmingham

**DEPARTMENT OF
ELECTRICAL ENGINEERING**

**ONE-YEAR GRADUATE COURSE
LEADING TO A MASTER'S DEGREE
IN ELECTRICAL ENGINEERING.**

OCTOBER, 1966, to SEPTEMBER, 1967

A graduate course leading to a Master's degree is being offered in electrical engineering. The course will be of one year duration. It will consist of six months of lectures, tutorials and laboratory work, followed by six months of project work in a chosen specialist field. One-third of the lecture work will consist of mathematics and electrical engineering materials. The remaining time will be devoted to one specialist option selected from the following:—

1. Communication Systems.
2. Design of Pulse and Digital Circuits and Systems.
3. Control Systems.
4. Electrical Machines.
5. Electrical Power Systems Engineering.

Application forms and further particulars may be obtained from the Head of the Department of Electrical Engineering (ref. M.Sc.), The College of Advanced Technology, Gosta Green, Birmingham 4.

[545]

EXPERIMENTAL OFFICERS

applied physics electronics

There are two vacancies for men up to 30 years of age preferably with qualifications at the H.N.C. level (or the equivalent) in applied Physics or Electronics for appointment as Experimental Officers with the Physics Group of Research Department at Billingham, Co. Durham.

Applied Physics

The group is engaged in the development of radioisotope and ultrasonic techniques and their application to a wide range of problems arising in production and research. Other aspects of work require the measurement of a variety of physical properties and the application of physical methods to chemical analysis. Applicants should have a sound knowledge of basic physics and good practical ability.

Electronics

The group is also responsible for the electronic equipment in use in the Department which includes ESR, NMR, optical and mass spectrometers, nuclear radiation counting and analytical instruments. Candidates for the post of Experimental Officer (Electronics) should have some experience in the maintenance of complex equipment and will be expected to contribute to development topics which involve electronic design and constructional work.

Profit Sharing and Pension Fund Schemes are in operation and assistance will be offered to married men for house purchase, removal expenses and temporary lodging allowance.

Applications in writing stating briefly age, qualifications and experience to:—

Mr. H. Williamson, Personnel Officer

Imperial Chemical Industries Limited

Heavy Organic Chemicals Division

Organic House, Billingham Co. Durham

Please quote Ref. No. I.E.

1544

2 SENIOR APPOINTMENTS IN MARKETING

We need 2 original thinkers, conversant with current marketing thought, who are able to make a significant contribution to our marketing effort, and who are looking for an opportunity to develop their talents. They will be encouraged to take responsibility and become authorities in their own fields, and they will operate in the stimulating idea climate of a company which is vigorously expanding in the electrical and electronic fields.

Don't waste our time if you are an average man looking for an average return. But if you are able to make an above average contribution, for which you can reasonably expect an above average return, write now for an application form. Assistance will be given with legal fees and removal expenses.

MARKET RESEARCH & ANALYSIS

REF. MRA/IE

This man will investigate new and existing products, markets, marketing methods and competition, and provide the intelligence upon which company marketing policy is based.

Candidates should have experience in market research, preferably with an electrical or electronic company — the ideal man would probably have gained experience with the Marketing Services or Market Research unit of a marketing orientated electronics company or agency.

SALES PROMOTION — PUBLICITY & ADVERTISING

REF. SP/IE

Given the marketing policy and suggested strategy, this man will develop the total promotion and communication of products to markets. He should have the experience and breadth of vision to develop a comprehensive plan for the promotion of products and services through press advertising and direct mail, exhibitions, lectures, stockists, etc. He should have a background in publicity work in the electrical or electronics industry, together with the experience to take responsibility for the overall planning, execution and evaluation of complete campaigns from the original brief.

He will be responsible for the promotional budget, existing staff, and liaison with our Advertising Agency and P.R. Consultants.



MARKETING MANAGER
MTE CONTROL GEAR LIMITED
LEIGH-ON-SEA, ESSEX
Telephone: Southend 524281

1549

SALFORD ELECTRICAL INSTRUMENTS LIMITED



Electronic Electromechanical and Mechanical Engineers

We offer excellent opportunities for work on interesting long term development projects in our new laboratories in Eccles. If you are interested in any of the above positions and you have a degree and at least five years' post graduate experience, please apply to the Personnel Manager,

Salford Electrical Instruments Ltd.
PEEL WORKS, BARTON LANE, ECCLES, Nr. MANCHESTER

[551]



TURNER, OGILVY & PARTNERS LTD.

MANAGEMENT AND MARKETING CONSULTANTS

26 GILBERT STREET, LONDON, W.1

APPOINTMENTS DIVISION

ANNOUNCE ON BEHALF OF

ONE OF THE WORLD'S LARGEST MAKERS OF TV RECEIVERS WITH ANNUAL SALES OVER 150 MILLION DOLLARS

EXCEPTIONAL VACANCIES FOR ELECTRONIC ENGINEERS IN THEIR MONOCHROME AND COLOUR TV DESIGN GROUP

SENIOR PROJECT ENGINEERS

£5,500 p.a.

(Plus Fringe Benefits
worth at least £2,000 p.a.)

Exciting permanent prospects requiring at least 3 years' experience in design of CHROMA and COLOUR CIRCUITRY with or without knowledge of SCANNING and CONVERGENCE. Able to direct activities of additional engineers.

SENIOR ENGINEERS

£4,000 p.a.

(Plus Fringe Benefits
worth at least £2,000 p.a.)

With min. 3 years' colour processing circuit experience/scanning and convergence circuits. Well versed in horizontal output circuit.

These appointments carry continuous free hospital benefits and insurance including family. Free travel to the U.S.A. 2,000 dollars furniture allowance. Cash profit sharing. Deferred profit sharing. Splendid chances of advancement. Attractive residential areas close to factory near Chicago. Friendly co-operation and help throughout.

PLEASE REPLY GIVING
FULL PERSONAL DETAILS TO:

Mr. J. M. BOWDEN
TURNER, OGILVY & PARTNERS LTD.
26 GILBERT STREET, LONDON, W.1. MAYfair 7131

[552]

WESTINGHOUSE AUTOMATION

If you are looking for an exciting position in one of the loveliest parts of England, then come and join a rapidly expanding team of engineers handling Control and Automation systems for an International Company. We have the following vacancies:

SALES ENGINEERS

with previous experience of selling to generate the sale of electronic systems and engineering in the London, Midlands and North West of England areas. Applicants should preferably have knowledge of electronics and/or instrumentation and control practice.

APPLICATIONS, PROJECT AND EQUIPMENT ENGINEERS

based at Chippenham, to quote for and design schemes to customers' specifications and handle orders obtained by the sales engineers. These engineers will have a strong electronics logic design and/or instrumentation and control background together with suitable academic qualifications, i.e., degree, H.N.D., H.N.C., etc.

Please write quoting ref. S.A.1166/1E or phone to:

The Personnel Manager

WESTINGHOUSE BRAKE & SIGNAL CO. LTD.

Chippenham, Wiltshire (Chippenham 2881, ext. 148) (Reverse charges)

[550]

PATENTS

EXPLOITATION OF PATENTS

THE proprietors of British Patent No. 905606 relating to "Improvements in measuring systems" desire commercial working of the patent in the United Kingdom by licence or otherwise. Replies to—Box I.E.530, Industrial Electronics.

EXPLOITATION OF PATENTS

THE proprietors of British Patent Nos. 851177 and 851178, relating to "Electrical read-out devices" and "Weighing systems," desire commercial working of these patents in the United Kingdom by licence or otherwise. Replies to—Box I.E.547.

SERVICES OFFERED

ELECTRICAL engineer with experienced staff offers assistance to manufacturers requiring installation and maintenance for their equipment used in the West Country.—Gladwell, Roborough, Plymouth. [542]

BUSINESS OPPORTUNITIES

STRATFORD JOHNS STUDIO
12, NEW QUEBEC STREET
MARBLE ARCH, LONDON W.1

TECHNICAL PHOTOGRAPHY

INTERIORS OR EXHIBITIONS, INDUSTRIAL OR TECHNICAL. PIECES OF SPECIFIED EQUIPMENT WHICH NEED TO BE CLEARLY MARKED AND REPRODUCED. TO BE USED FOR TRADE AND TECHNICAL PUBLICATIONS, NATIONAL OR PROVINCIAL PRESS OR GLOSSY MAGAZINE. EXECUTED TO VERY HIGH STANDARD.

MR. EDMUND HELLER, A.R.P.S.
will be pleased to give full information
AMBassador 1818

[481]

QUALITY MANUFACTURED PRODUCTS FROM ONTARIO, CANADA

Looking for new lines to sell? Manufacturers from Ontario, Canada, are seeking established successful sales organisations covering the United Kingdom. Send full particulars of your company and product interest to:

Trade and Industry Department
Ontario House, 13 Charles II Street
London, S.W.1

[460]

For further information circle 304 on Service Card

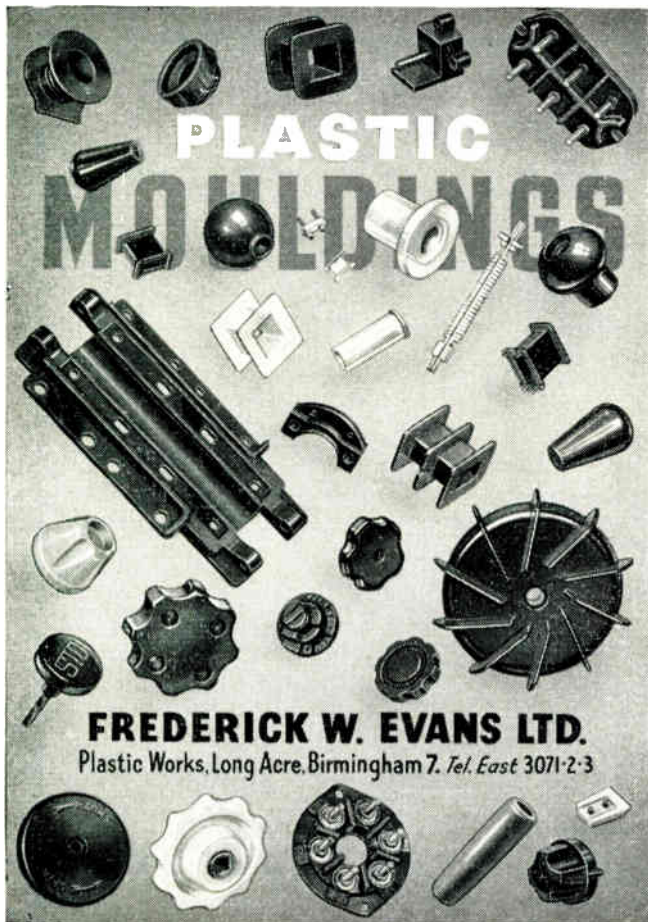

PLASTIC MOULDINGS

FREDERICK W. EVANS LTD.
Plastic Works, Long Acre, Birmingham 7. Tel. East 3071-2-3

For further information circle 305 on Service Card

ELECTRONICS PRINTED CIRCUITS

An extremely comprehensive service is available to industry which is unique in its scope and unprecedented in its quality of workmanship and speed of service while at the same time giving that all important individual attention and very competitive price terms that every buyer seeks.

The service consists of inclusive facilities for the design, development, and large scale production of all types of electronic equipment, instruments, etc., together with all processes involved in the design, development and production of printed circuit boards.

The unique location of T.E.S. Ltd., allows this first class service, which is to be found nowhere else, to be brought to your doorstep by an almost daily transportation service to 100 miles all for the price of a telephone call. Shanklin 3096.

Special attention will be given to very welcomed enquiries from customers outside the U.K.

TRANSMETRIX ELECTRONIC SYSTEMS LTD.
Hyde Works, Shanklin, Isle of Wight, Hants

For further information circle 306 on Service Card

THE ONLY

SUB-MINIATURE

"3000 TYPE" RELAY

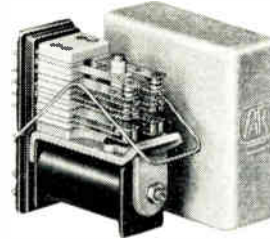

The Hopwood-Par Type P3 relay, although miniature, retains every possible feature of the "3000 Type" plus ceramic insulation

It can have up to 6 poles; twin or HD contacts and tags for PRINTED CIRCUITS

Made in England



SIMMONDS & ROBINSON LTD.

VICTORIA HOUSE, 44 PARK STREET
CAMBERLEY SURREY

Telegrams: ROBRELAYS · Telephone: Camberley 25501 · Telex 85141

Adcola Products Ltd.	62
Airscrew-Weyroc Ltd.	18
Amplivox Ltd.	61
Anglo-American Vulcanized Fibre Co. Ltd.	21
Appointments Vacant	83
Associated Aerials Ltd.	58
Associated Electrical Industries Ltd.	44, 45
Avo Ltd.	3
B & R Relays Ltd.	2
B.V.C. Electronic Developments Ltd.	81
Bakelite Ltd.	1
Bell & Howell Ltd.	89
Belling & Lee Ltd.	49
Boulton Paul Aircraft Ltd.	34
British Aircraft Corporation Ltd.	19
British Electric Resistance Co.	36
C.G.S. Resistance Co. Ltd.	80
Cannon Electric (Great Britain) Ltd.	81
Cathodeon Crystals Ltd.	52
Classified Advertisements	83
Collins Radio Co.	7
Colvern Ltd.	27
Cossor Instruments Ltd.	75
Datalog Ltd.	82
Dawe Instruments Ltd.	10, 17
Dewhurst & Partner Ltd.	64
Dynamco Systems Ltd.	66
E.M.I. Electronics Ltd.	59, 60
Electrical Power Engineering Co. (Birmingham) Ltd.	40
Electrosil Ltd.	23
Elliott Process Automation Ltd.	71
Elliott-Automation Computers Ltd.	67
Ether Ltd.	28, 40

Evans, F. W., Ltd.	88
Evershed Vignoles Ltd.	26
Ferranti Ltd.	37
Fine Wires Ltd.	50
Frost, N. T., Ltd.	42
Heenan & Froude Ltd.	50
Hellerman Ltd.	70
Hendry Relays Ltd.	48
Henley Plastics Ltd.	82
Hewlett Packard Ltd.	Cover iii
Hunt, A. H. (Capacitors) Ltd.	6
Imperial Typewriter Co. Ltd.	82
Index to Products	63
Insuloid Manufacturing Co. Ltd.	53
Isola Werke, A. G.	53
Johnson Matthey & Co. Ltd.	35
Kent, Geo., Ltd.	Cover ii
Keyswitch Ltd.	Cover iv
La Nationale S.A.	76
Letraset Ltd.	15
Levell Electronics Ltd.	50
Lind-Air Electronics Ltd.	74
Litchfield Bros. Ltd.	80
London Electric Wire Co. & Smiths Ltd.	80
Lund Bros. Ltd.	16
Lyons, Claude, Ltd.	20
M-O Valve Co. Ltd.	22
McGeoch, William, & Co. (B'ham) Ltd.	76
Mackie, W., & Co. Ltd.	78
Magnetic Devices Ltd.	41
Metway Electrical Industries Ltd.	82
Muirhead & Co. Ltd. 11, 12, 13, 14	
Mullard Ltd.	32, 33, 68, 69

N.S.F. Ltd.	56
Newport Instruments Ltd.	36
P.I. Castings (Altrincham) Ltd.	74
Painton & Co. Ltd.	73
Pirelli General Cable Works Ltd.	55
Plessey Co. Ltd.	4, 5, 9, 29, 43, 46, 47
Products Index	63
Pye Telecommunications Ltd.	38, 39
RCA Great Britain Ltd.	54
Radio Resistor Co. Ltd.	72
Reader Enquiry Service	63
Ross Catto & Co. Ltd.	82
Sangamo Weston Ltd.	76
Saunders Roe & Nuclear Enterprises Ltd.	26
Semiconductors Ltd.	57
Shell Chemical Co. Ltd.	65
Simmonds & Robinson Ltd.	88
Solartron Electronic Group Ltd.	24, 25
Submarine Cables Ltd.	42
Thorn Special Products Ltd.	77
Telephone Manufacturing Co.	8
Telequipment Ltd.	81
Telonic Industries U.K.	79
Transmetrix Electronic Systems Ltd.	88
Unbrako Ltd.	51
Vitality Bulbs Ltd.	82
Walmore Electronics Ltd.	48, 78
Westinghouse Brake and Signal Co. Ltd.	30, 31
Whiteley Electrical Radio Co. Ltd.	64
Woden Automation Ltd.	62

For further information circle 307 on Service Card

NEW

the DG 5511 low-cost, portable, two-channel thermal writing recorder

The DG 5511 will provide two channels of analogue and three channels of event information on one chart of record, each channel being 50 millimetres wide. Two plug-in modules are available, the Type 1-150 Attenuator and the Type 1-511 Medium Gain DC Pre-Amplifier Module. Utilising these two plug-in modules, signals with voltage levels as low as 0.5 millivolts and up to 500 volts, in the frequency range DC to 125 cycles per second, can be recorded. Mechanical stops prevent overlapping of traces and provide stylus protection. The DG 5511 can be used for a wide range of applications including the measurement of strain, torque, pressure, force, attenuation, flow, vibration, velocity, temperature, acceleration, displacement.



FEATURES

- * PORTABLE, COMPACT, RUGGED — Just plug in and record.
- * VERSATILE — Incorporates a 3 in 1 modular concept whereby two plug-in signal conditioners accept a wide range of voltage inputs — and no pre-amplifier is needed for telemetry or other high-level signals. * SNAP-IN CHART LOADING — Loads from the front with no threading required. * THERMAL WRITING — True rectilinear trace presentation. * EXCELLENT FREQUENCY RESPONSE — d-c to 70 cps ± 1.5 db at full amplitude (50mm); d-c to 125 cps ± 2.0 db at 10mm amplitude. * PUSH-BUTTON SELECTABLE CHART SPEEDS — 1, 5, 25 and 125 mm/sec automatic trace density correction provided. * ALL SOLID STATE.

Consolidated Electrodynamics

a division of BELL & HOWELL LIMITED
14 Commercial Road, Woking, Surrey. Tel: Woking 5633

Covers the very wide Frequency Range 0.2c/s to 1.22Mc/s

TRANSISTOR DECADE OSCILLATOR TYPE TG 66A

Frequency is selected by means of four in-line additive decade controls and a five position multiplier switch. The last of the additive controls is continuously variable so that any frequency may be selected with a discrimination better than $\pm 0.03\%$ or $\frac{1}{10}$ th of the specified frequency accuracy, whichever is the greater. The output source voltage of the oscillator is monitored by a meter with an expanded scale, and a continuous control is fitted so that the output may be set with a discrimination better than $\pm 0.05\text{dB}$.

SPECIFICATION

ACCURACY

$\pm 0.02\text{c/s}$ below 6c/s .
 $\pm 0.3\%$ from 6c/s to 100kc/s .
 $\pm 1\%$ from 100kc/s to 300kc/s .
 $\pm 3\%$ above 300kc/s .
 all measured at 25°C .

STABILITY

$\pm 6\%$ mains voltage change produces less than $\pm 0.005\%$ frequency change up to 100kc/s .
 Change of frequency with temperature is less than $\pm 0.025\%$ per $^\circ\text{C}$ above 100c/s .

DISTORTION

Less than 0.15% from 15c/s to 15kc/s .
 Less than 0.5% at 1.5c/s and 150kc/s .

OUTPUT

Continuously variable from -94dBm to $+10\text{dBm}$ into 600 ohms . Source voltage variable from $30\mu\text{V}$ to 5V . Output impedance 600 ohms at all settings. Meter fitted with dBm and V scales.

TEMPERATURE RANGE

-10°C to $+45^\circ\text{C}$.

POWER SUPPLY

"Mains" — $100/125\text{V}$,
 $200/250\text{V}$; $50/60\text{c/s}$; 6VA ,
 or "Batteries" — 4 Self-contained type PP9, life 300 hours.

SIZE

$6\frac{1}{2}$ " high \times $10\frac{1}{2}$ " wide \times 7 " deep.

WEIGHT

12 pounds.



LEVELL
PORTABLE INSTRUMENTS

Price complete with batteries

£150 Leather case
 £5 extra.

Fully detailed leaflets are available on our complete range of portable instruments.

LEVELL ELECTRONICS LTD.

Park Road, High Barnet, Herts.
 Telephone: BARnet 5028.



Meetings

The Institution of Electrical Engineers

Savoy Place, London, W.C.2. (Phone: Covent Garden 1871).

All meetings are held at Savoy Place and begin at 5.30 p.m. (tea at 5 p.m.) unless otherwise stated.

25th Feb. Electronics Division lecture on 'Distributed Network Synthesis'.

28th Feb. Electronics Division lecture on 'Scanning Electron Microscopy—its use in the evaluation of semiconductor materials and devices'.

1st March. Control and Automation Division lecture on 'The Analysis and Design of Model Reference Adaptive Control Systems'.

1st March, 2 p.m. Electronics Division discussion on 'Gamma and Infra-Red Camera Techniques'. A joint meeting with the I.E.R.E. Medical and Biological Group.

2nd March, 9.30 a.m. and 2.15 p.m. Electronics Division Colloquium on Microphones.

3rd March. Lecture on 'The Generation of Cloud Electricity'.

8th March. Control and Automation Division lecture on 'Future Instrumentation for Control Systems'. A joint meeting with the Society for Instrument Technology.

The Institution of Electronic and Radio Engineers

8-9 Bedford Square, London, W.C.1. (Phone: Museum 1901-3).

All meetings will be held in the Institution's Lecture Room, 9 Bedford Square, unless otherwise stated. Tickets are required for these meetings.

23rd March, 6 p.m. Electro-Acoustics Group lecture on 'The Propagation of Sound through Liquid'.

28th March, 5.30 p.m. Joint meeting of the I.E.R.E. Television Group, the I.E.E. and the Television Society on 'Semiconductors and Television Receivers'.

29th March, 2.30 p.m. and 5.30 p.m. Joint I.E.R.E./I.E.E. Computer Groups' colloquium on 'Computer Control in Industry—Equipment Design and Application Engineering'. To be held at the London School of Hygiene and Tropical Medicine, Keppel Street, Gower Street, London, W.C.1.

31st March, 2.30 p.m. and 5.30 p.m. Radar Group symposium of short papers on the 'Monitoring of Ground and Airborne I.L.S. Equipment for Automatic Landing'. To be held at the London School of Hygiene and Tropical Medicine, London, W.C.1.

18th April. Joint I.E.R.E./I.E.E. Computer Groups' discussion on 'Computer Bulk Storage'. To be held at the I.E.E., Savoy Place, London, W.C.2.

Society of Environmental Engineers

Radnor House, London Road, Norbury, London, S.W.16. (Phone: Pollards 0011).

Meetings are held at 6 p.m. at Imperial College (Mechanical Engineering Department), Exhibition Road, London, S.W.7.

23rd March. Discussion on the 'Specification of an Instrumentation System for Packaging'.

The Institute of Physics and The Physical Society

47 Belgrave Square, London, S.W.1. (Phone: Belgravia 6111).

Advance registration is necessary for all meetings. Details may be obtained from the Meetings Officer.

28th March, 8.15 p.m. The 1965 Guthrie lecture on Nuclear Fusion Research, to be held at the Oxford College of Technology.

Society of Electronic and Radio Technicians

33 Bedford Street, London, W.C.2.

2nd March, 7.15 p.m. Lecture on 'Industrial Electronics', at the Charles Trevelyan Technical College, Maple Terrace, Newcastle 4.

9th March, 7 p.m. Lecture on 'Electronic Organs', at the London School of Hygiene and Tropical Medicine, Gower Street, London, W.C.1.

29th March, 7.30 p.m. Lecture on 'Current Trends in Transistor Radio Design and Servicing', at the East Midlands Gas Board, Lower Parliament Street, Nottingham.

The Institution of Electrical and Electronics Technicians Engineers

26 Bloomsbury Square, London, W.C.1. (Phone: Langham 5927).

The following meetings will be held in the I.E.E. Lecture Theatre, Savoy Place, London, W.C.2, at 6 p.m. Details from the Secretary of the I.E.E.T.E.

7th March. Lecture on 'Control by Computer'.

4th April. Lecture on 'Microelectronics'.

The Television Society

166 Shaftesbury Avenue, London, W.C.2. (Phone: Temple Bar 3330).

All meetings, unless otherwise stated, are held in the Conference Suite, I.T.A., 70 Brompton Road, London, S.W.3, and commence at 7 p.m.

25th Feb. Lecture on 'The Use of Test Line Signals for Remote Monitoring of Picture Quality at Unattended Transmitters'.

WHAT'S ON AND WHERE

Continued

24th March. Discussion on 'The Impact of Semiconductors on Television Receiver Design'.

15th April. Lecture on 'Domestic Video Recording'.

21st April. The Fleming Memorial Lecture on 'The Implications for Television of Modern Thinking on the Visual Process'. To be held at the Royal Institution.

Conferences, Symposia and Colloquia

2nd-4th March. Tenth Scintillation and Semiconductor Counter Symposium, to be held at the Shoreham Hotel, Washington, D.C. Organized by the Institute of Electrical and Electronics Engineers Inc., 345 East 47th Street, New York 10017.

21st-24th March. Fourth International Aerospace Instrumentation Symposium, to be held at the College of Aeronautics, Cranfield, Bedford. Details from the Symposium Organizer.

29th-31st March. Symposium on 'Automatic Control in Electricity Supply', to be held in Manchester. Organized by the Transformer Division of Ferranti Ltd., Chadderton, Lancashire.

30th March-1st April. Conference on 'Nuclear Structure and Elementary Particles', to be held at the University of Oxford and organized by the Nuclear Physics Sub-Committee of The Institute of Physics and The Physical Society.

4th-7th April. Conference on 'Scattering, Non-Linear Optics and Electromagneto Optics'. Organized by the Optical Group of the Institute of Physics and The Physical Society and to be held at the University of York. Advance registration will be necessary.

12th-15th April. Symposium on 'Electronics, Measurement and Control in Ships and Shipbuilding', to be held at the University of Strathclyde. Organized jointly by the Electronics and Control Section of the I.E.E. Scottish Centre and the Scottish Section of the I.E.R.E.

19th-21st April. Conference on 'The Performance Assessment of High-Vacuum Pumps', to be held at the University of Sussex and organized by The Institute of Physics and The Physical Society, 47 Belgrave Square, London, S.W.1. (Phone: Belgravia 6111).

19th-21st April. Symposium on 'Environmental Engineering and its Role in Society'. Organized by The Society of Environmental Engineers, Radnor House, London Road, Norbury, London, S.W.16. (Phone: Pollards 0011). To be held at Imperial College, Exhibition Road, London, S.W.7.

19th-22nd April. Colloquium on 'Microwave Communication', to be held in Budapest. Organized by the Hungarian Academy of Sciences and the Scientific Society of Telecommunication. Details from Valkó Péterné, Budapest V, Szabadság Tér 17, Hungary.

3rd-5th May, 1966. British Joint Computer Conference, to be held in Eastbourne, Sussex, and sponsored under the aegis of the United Kingdom Automation Council. Details and registration forms from the Conference Secretariat, Institution of Electrical Engineers, Savoy Place, London, W.C.2. (Phone: Covent Garden 1871).

6th May. Conference on the 'Fatigue of Metals'. Held by The Institute of Physics and The Physical Society at 47 Belgrave Square, S.W.1.

15th-19th May. Annual conference of the Radio and Television Retailers Association and the Electrical Appliance Association, 19-21 Conway Street, London, W.1. (Phone: Euston 6046). To be held at the Metropole Hotel, Brighton.

25th May. Conference on 'Recent Advances in Semiconductor Strain Gauges'. Held by The Institute of Physics and The Physical Society at 47 Belgrave Square, S.W.1.

Exhibitions

21st-25th March, New York

International Convention and Exhibition on the latest developments in the electrical and electronics field. Organized by the Institute of Electrical and Electronics Engineers Inc., 345 East 47th Street, New York 10017, and to be held at the New York Hilton Hotel and the Coliseum.

22nd-24th March, Melton Mowbray

Exhibition and conference on 'Modern Production Techniques and Equipment'. Organized by the Production Engineering Research Association, Melton Mowbray, Leicester. (Phone: Melton Mowbray 4133).

28th-31st March, London

The Physics Exhibition of the latest instruments and apparatus of use and interest to professional physicists. To be held at Alexandra Palace and organized by the Institute of Physics and The Physical Society. Tickets will be required and full details may be obtained from the Exhibitions Officer, 47 Belgrave Square, S.W.1. (Phone: Belgravia 6111).

28th-31st March, London

The First Bio-Medical Engineering Exhibition and Symposium, to be held at the Royal Horticultural Society's New Hall. Details from the organizers: U.T.P. Exhibitions Ltd., Racquet Court, Fleet Street, London, W.C.4. (Phone: Fleet Street 6444).

18th-22nd April, London

The Fourth International Industrial Finishes Exhibition, to be held at Earls Court. Organized by Technical Exhibitions Ltd., 3 Clements Inn, London, W.C.2. (Phone: Chancery 1200).

30th April-8th May, Hanover

The Hanover Fair, to be held in Hanover-Messegeleunde. Details from Schenkers Ltd., Royal London House, 13 Finsbury Square, E.C.2. (Phone: Metropolitan 9711).

23rd-28th May, London

International Instruments, Electronics and Automation Exhibition. Organized by Industrial Exhibitions Ltd., 9 Argyll Street, London, W.1. (Phone: Gerrard 1622) and to be held at Olympia.

**Less than 2% overshoot
or pulse height variations
in output*
8000A pulser from
Hewlett-Packard**

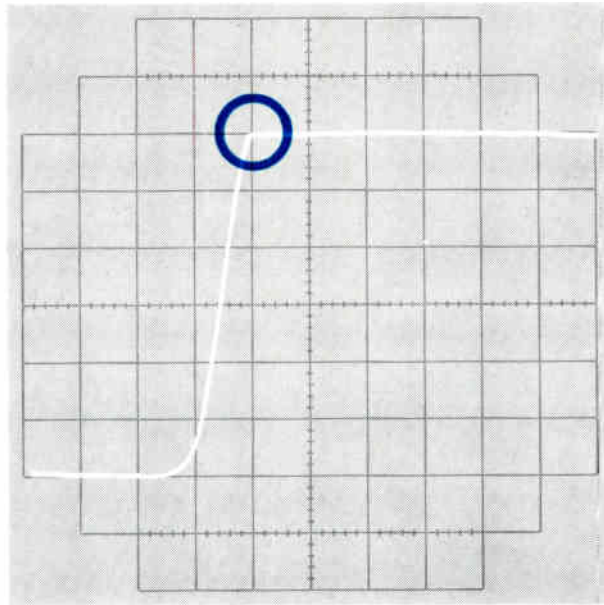

**10 V_{peak} output pulse from hp 8000A;
Time base is 1 nsec/cm. Note clean pulsetop profile.**



*Unusually well controlled pulse shape is inherent in this new pulser from Hewlett-Packard. Confusing output pulse irregularities such as pre-shoot, ringing and overshoot are minimized in first 100 nsec of pulse duration for easier, more accurate interpretation of test results. The hp 8000A rise time is < 1 nsec., repetition rate is 100 KHz and maximum output is 10 V_{peak}.

Also constant 50 Ohm source impedance, positive or negative polarity and advanced triggering are included. All these characteristics make the 8000A an excellent low cost pulse source for precise rise-time testing of circuits, components and other instruments.

Price: £ 113
Data and prices are subject to change without notice.

HEWLETT  **PACKARD**
LIMITED

DALLAS ROAD, BEDFORD. Tel: BEDFORD 68052

Headquarters in USA: Palo Alto (Calif.)
European Headquarters:
Geneva (Switzerland)
European Plants: Bedford (England),
Böblingen (Germany)

For further information circle 202 on Service Card

KEYSWITCH

RELAYS

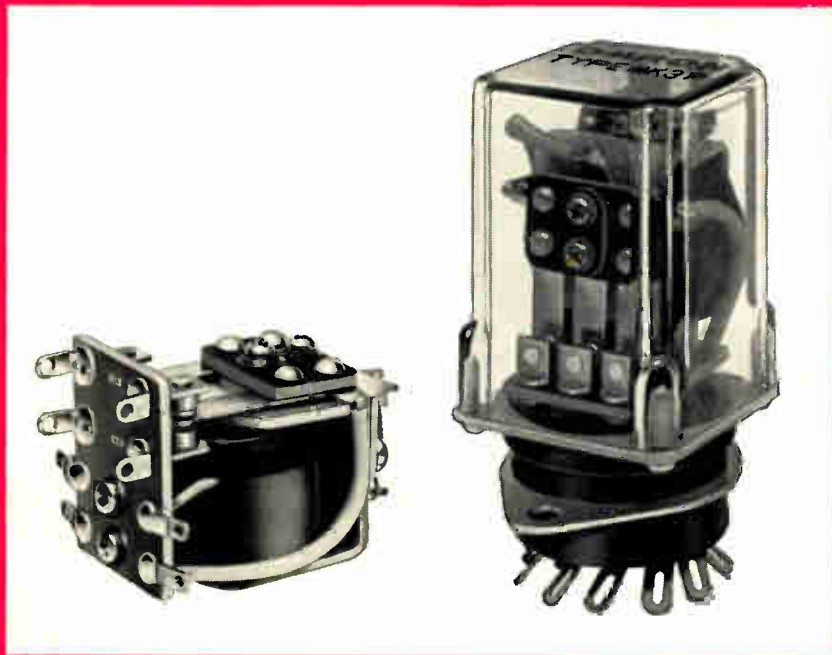

why say Keyswitch?

It's a difference of quality, often not visible until you look at performance data. Keyswitch miniature and sub-miniature relays are exhaustively tested... each one individually. All conform precisely to a very fine specification. Their reliability is proven. They have all the benefits of Keyswitch delivery — and that's quick, every time.

TYPE MK2 Illustrated approx. actual size. Inexpensive double-pole double-throw midget power relay. 99.9% pure silver contacts switch to 7.5A or 250V a.c./500V d.c. Operation and release 15-30 milliseconds. Universal coil range to 250V a.c./d.c. This relay can cost as little as 11/0.

TYPE MK3P Illustrated approx. actual size. 3-pole plug-in version with clear cover, and complete with socket. Contacts de-rated. This relay can cost as little as 17/6.

always to price  **always to specification**  **always on time**

KEYSWITCH RELAYS LIMITED · CRICKLEWOOD LANE · LONDON · NW2 · TELEPHONE: GLADSTONE 1162 · TELEX: 262764