

INDUSTRIAL ELECTRONICS

FEBRUARY 1966 5s 0d



Speedrace

install it RAPIDLY
change frequency over the full H.F. range RAPIDLY
change mode or operational state RAPIDLY
adapt to new requirements RAPIDLY

TA 184 10 kW linear amplifier



RTA 191 Receiver terminal

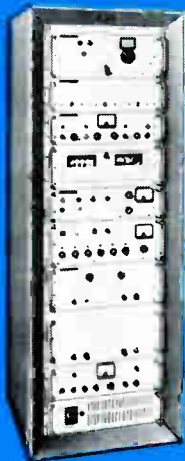

MA 228 Exciter Unit

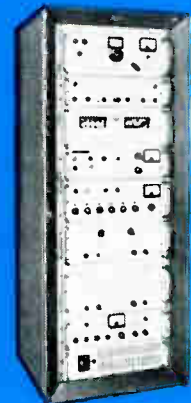

LA 304 Remote Control Console



"Speedrace" satisfies nearly all HF communications requirements, being assembled from standard sub-units into remotely-controlled, automatically-tuned reliable systems. Static or transportable installations. Available with output powers 1 kW to 10 kW. Incorporating most modes of operation. 280,000 synthesiser-controlled operating frequencies of unsurpassed accuracy and stability.

RACAL

RACAL COMMUNICATIONS LTD

Western Road, Bracknell, Berks. Tel: Bracknell 3244.
Telex: 84166. Cables: Racal Bracknell.

INDUSTRIAL ELECTRONICS

Incorporating British Communications and Electronics

Communications Automation Instrumentation Control

Contents February 1966

Editor-in-Chief **W. T. COCKING, M.I.E.E.**

Editor **T. J. BURTON**

Editorial: **K. G. HOLMES**
 T. A. KELLY

Production **D. R. BRAY**

Drawing Office **H. J. COOKE**

Advertisement Controller **G. H. GALLOWAY**

Advertisement Manager **R. H. C. DOHERTY**

49 **Comment**

50 **On-Line Computer Alarm Analysis**

by P. C. M. Kay

An on-line computer alarm-analysis system has recently been supplied to the C.E.G.B. Nuclear Power Station at Oldbury-on-Severn. This article discusses the monitoring requirements of such a plant, and describes the various operating techniques of the alarm scanning, checking and indicating equipment being used.

56 **Coal Ash Determination by Cendrex**

by R. E. Milner

In some processes, such as the reduction of coal to smokeless fuel, the pulverization of coal for generating station boilers, or the manufacture of gas, the ash content of the burnt fuel must be continuously known. A method using X-rays for coal-ash determination is described here.

59 **Process Dynamics, Pt. 2**

by J. W. Wumack, D.Eng.Sc., M.Sc., B.Sc.

In the second part of this article the author describes the technique of model-building for the description of processes requiring automatic control.

65 **Velocity Measurement Using Doppler Radar Techniques**

by E. M. Wells, B.Sc.

The theory of doppler radar techniques for velocity measurement is explained in this article and military and industrial applications are described.

VOLUME 4

NUMBER 2

continued overleaf

© Iliffe Electrical Publications Ltd., 1966

Permission in writing from the Editor must first be obtained before letterpress or illustrations are reproduced from this journal. Brief abstracts or comments are allowed provided acknowledgment to the journal is given.

Published by

Iliffe Electrical Publications Ltd., Dorset House, Stamford Street, London, S.E.1

Managing Director: W. E. Miller, M.A., M.I.E.R.E.

Telephone: Waterloo 3333. Telegrams/Telex: Electronics Iliffepres 25137 London

**ANNUAL SUBSCRIPTION, HOME £3 0s. 0d. OVERSEAS £3 10s. 0d.
CANADA and U.S.A. \$10.00.**

INDUSTRIAL ELECTRONICS

Incorporating British Communications and Electronics

Communications Automation Instrumentation Control

Contents *continued*

69 **Talkabout by Nexus**

This new and regular feature is a commentary about the electronics manufacturing and user industries. How to get cracking on an electronics project and a brief and amusing reference to keeping automation in its place are but two of the topics which have attracted the attention of Nexus this month.

What's On and Where?

A regular feature which lists forthcoming events. Professional meetings, symposia, conferences and exhibitions are included. For easy reference this item is positioned facing the inside back cover.



OUR COVER

The front-cover picture this month shows the Oldbury nuclear power station which is scheduled to come into operation later this year. When operational, it will be the largest nuclear power station in England, with an electrical output of 600 MW. It will be the most efficient nuclear station and it is the first to use concrete pressure vessels. Many of the design features are unique. The computer alarm analysis system for Oldbury is one of a number of the latest electronic systems which contribute to the operation of the plant. This is described in an article in this issue.

● **INDEX TO PRODUCTS**

For the convenience of the reader who requires rapid access to information on specific products, an 'index to products' is provided on the same sheet as the reader enquiry cards.

Features

- | | | | |
|----|--|----|---|
| 53 | Optical Character Recognition System for Reading Machines | 77 | New Apparatus |
| 54 | Computer Time Sharing | 89 | Radiation Monitoring for Nuclear Power Station |
| 58 | Automatic Landing by Super VCI0 | 89 | New Airborne Automatic Direction Finder |
| 63 | Automatic Volumetric Dispensing System | 90 | Illustrated Reports |
| 64 | Fluid Amplification | 92 | Electronic Control for Concrete Laying |
| 68 | Range Finding by Laser | 93 | Industrial News |
| 70 | Broadband Coaxial Cable Communications Link | 97 | New Books |
| 71 | Searching by Television | 98 | Manufacturers' Literature |
| 72 | Applications and Techniques | 72 | <i>Classified Advertisements</i> |
| 76 | U.S. Exhibition in London | 77 | <i>Index to Advertisers</i> |

Next Month

Data logging is being used more and more in all industries. Various forms of equipment are available for the collection and presentation of information for process plants, ships' engine rooms, etc. One of the main articles in the March issue deals with data logging and describes a versatile system which can be built up from a number of standard units. Thermoelectricity and the application of some thermoelectric devices is the subject of another article.

This booklet is available to all interested in printed circuits . . .

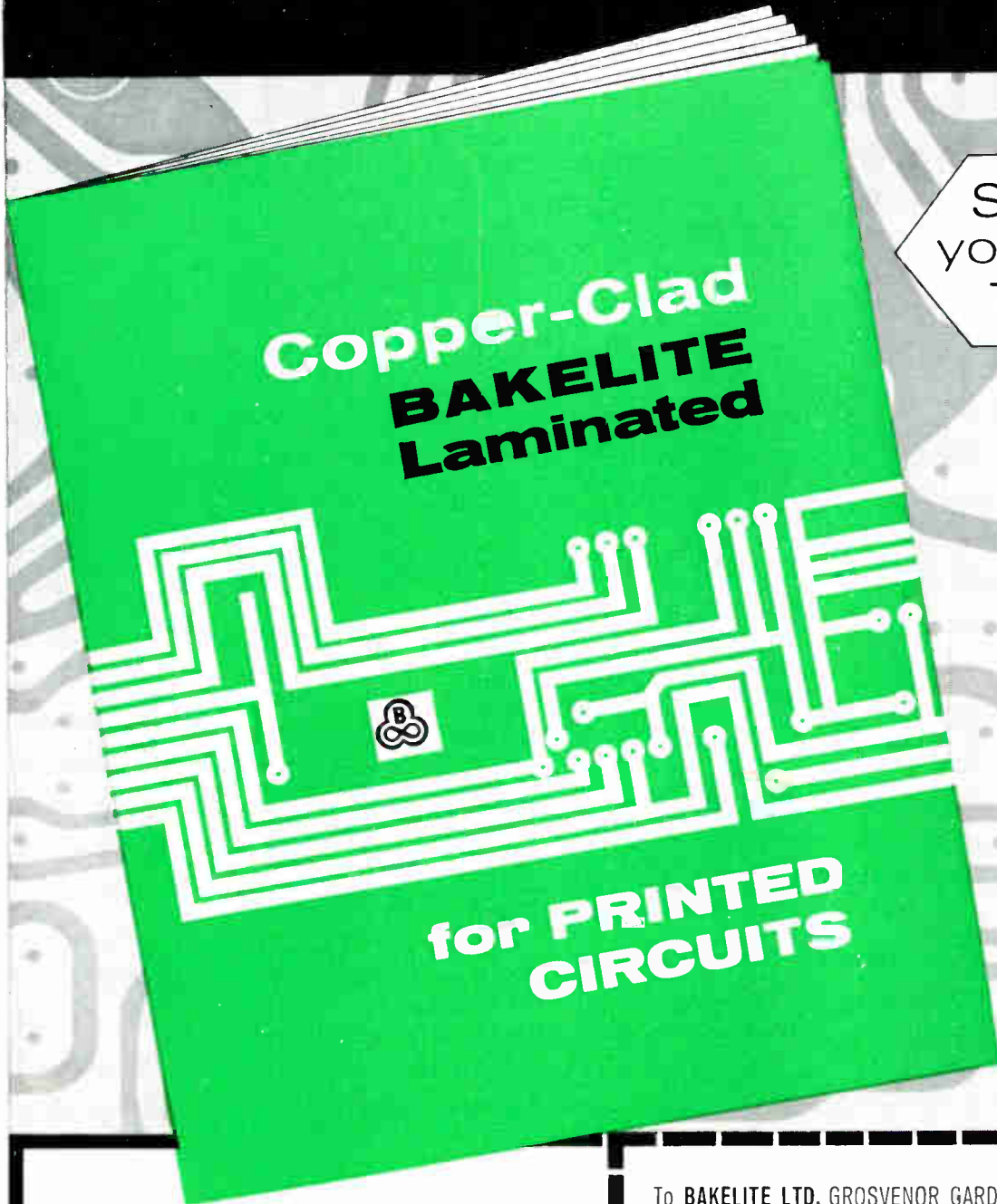

Send for your copy TODAY

Bakelite Limited

A BAKELITE XYLONITE COMPANY

12-18 Grosvenor Gardens, London SW1. Tel: SLOane 0898

Sales Offices at: Birmingham Tel: Central 5011
Manchester Tel: Blackfrars 2861. Glasgow Tel: City 6825

The trefoil symbol and the word BAKELITE are registered trade marks of Bakelite Limited

To BAKELITE LTD, GROSVENOR GARDENS, LONDON SW1
Please send me, free of charge, a copy of "Copper-Clad BAKELITE Laminated for Printed Circuits".

NAME _____

ADDRESS _____

SPECIAL INTEREST _____

IE.2

COLVERN

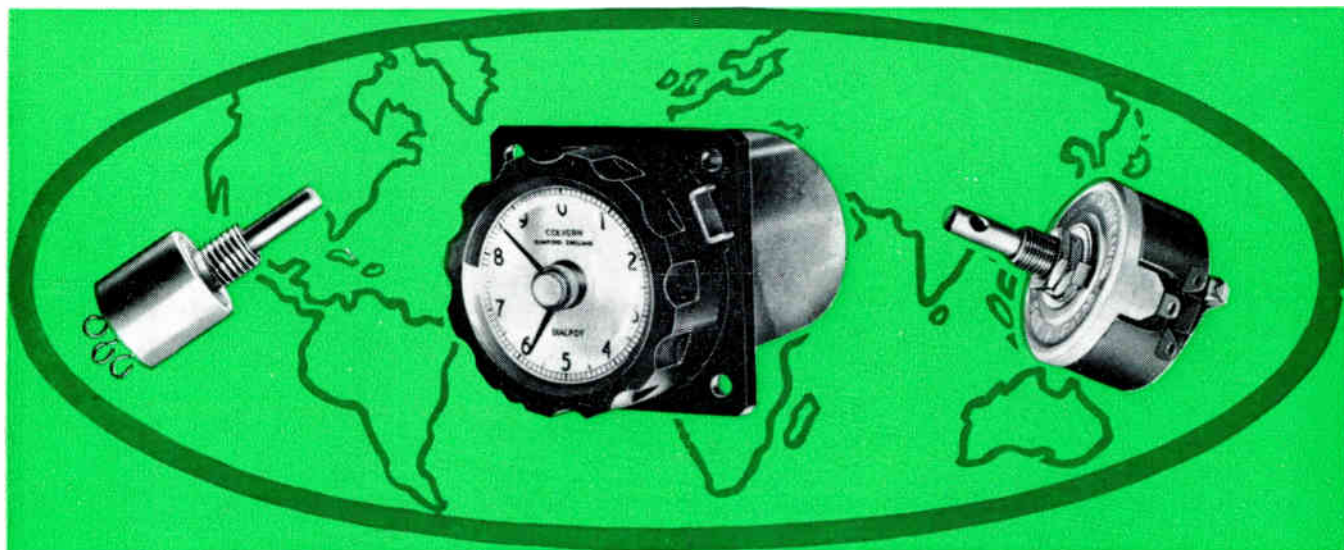

WORLD RENOWNED

for wire wound **POTENTIOMETERS**

- ★ STANDARD TYPES 1-25 WATT.
- ★ SEALED TROPICAL TYPES.
- ★ HELICAL, STANDARD AND PRECISION.
- ★ PRECISION LINEAR AND FUNCTION.

With over 50 types in production. This comprehensive range covers most of the requirements of a wirewound potentiometer, but if you have a special problem contact our advisory engineering service. Literature also available.

COLVERN
LIMITED

Spring Gardens, Romford,
Essex, England

TEL. ROMFORD 62222 (PBX) TELEX 23984

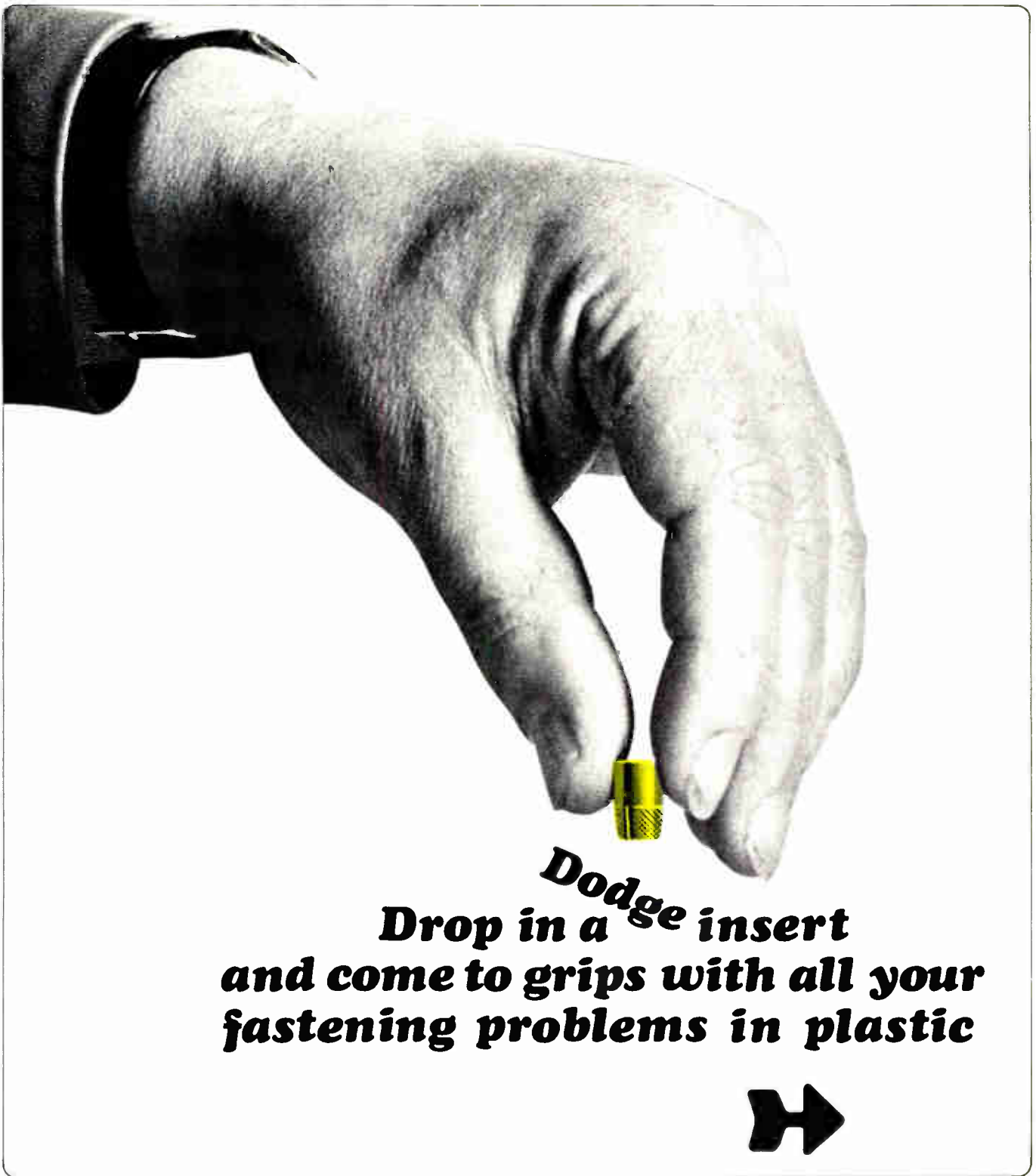

Dodge insert
Drop in a
and come to grips with all your
fastening problems in plastic



a neat 'Dodge' these inserts

Unbrako	UNBRAKO LTD. BURNABY ROAD COVENTRY ENGLAND
	Telephone No.88722 Telex No. 31626
<i>Please send me samples and literature</i>	
NAME & POSITION _____	
COMPANY _____	
ADDRESS _____	
TELEPHONE _____	EXT. _____

'Dodge' in action

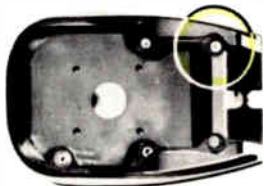

LIQUOR DISPENSOR

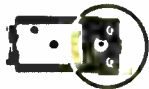

SWITCH COMPONENT

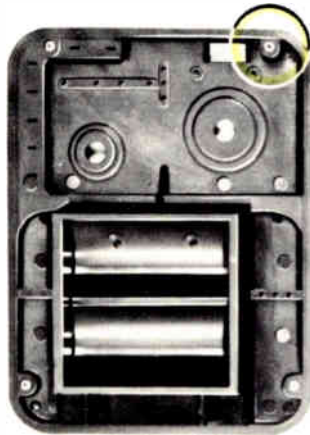

FRONT OF INSTRUMENT CASE



FRONT OF TRANSISTOR RADIO

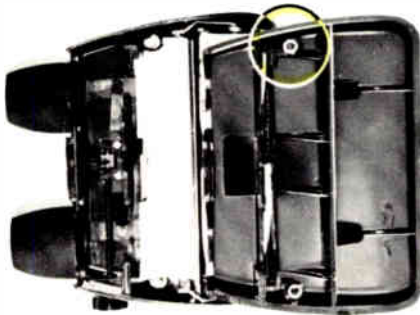

STEREO VIEWER



MINIATURE SWITCH



ELECTRIC WIRE SOCKET

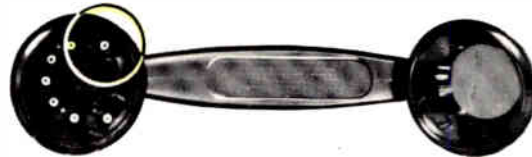

TELEPHONE HANDSET

Postage
will be paid
by
Licensee

No postage
stamp
necessary
if posted in
Great Britain
or
Northern Ireland



Unbrako

UNBRAKO LTD.
BURNABY ROAD
COVENTRY
ENGLAND

Business Reply Card Licence No.CV-79

UNBRAKO LTD
BURNABY RD
COVENTRY
WARWICKSHIRE
ENGLAND

Unbrako Dodge Expansion Inserts are manufactured
under licence to British patent No. 886997

MT 20 **First dust proof** **humidity-proof** **wire wound trimmer** **at anything like this price**

MT20 is a simple, proved, all-British design of TO5 transistor size, ideal for printed-circuit use, with single-turn top end adjustment, positive mechanical end stops, self-locking shaft.

Dust-proof, moisture-proof, shock-resistant and reliable over temperatures -20 to $+125^{\circ}\text{C}$.

50 to 2K 16/6, 5K to 10K 17/6 for 500's. Smaller quantities a shilling or two more. Delivery 3/4 weeks. Many values ex-stock.

For full data write to Miniature Electronic Components Ltd
St. Johns Woking Surrey Woking 63621

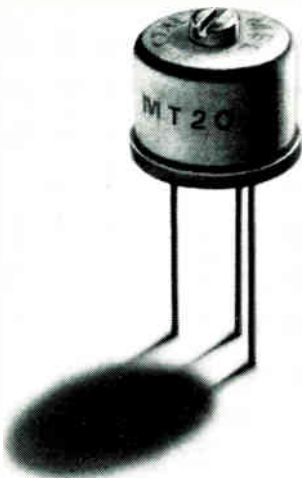

m-e-c

Trimmer Potentiometers
Wire-wound Resistors
Miniature Switches
Elapsed Time Meters

ME22

Both X and Y units plug in, enabling the user to make a wide variety of measurements hitherto only possible with expensive instruments. To date, 2Y+2X operational plug-in amplifiers are available.

THE CD 1400 'SCOPE SYSTEM VERSATILE 5" PORTABLE DOUBLE BEAM

The CD 1400 from Solartron is a truly flexible low cost oscilloscope system — backed by the best in modern production techniques. The X and Y plug-in units currently available allow the instrument to be used for the widest range of applications and other plug-ins now under development will extend the system even further. A 5" double gun CRT operating at 4 kV provides bright, high resolution displays at all sweep speeds. Proprietary oscilloscope cameras can be attached, and trolleys are available for maximum mobility.

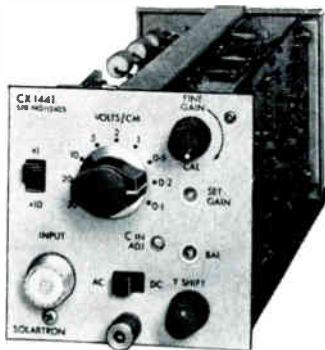

* CX 1441 DC - 15 Mc/s approximately, 100mV/cm, general purpose amplifier suitable for pulse work. Additional $\times 10$ provides 10mV/cm from DC - 750 Kc/s.



* CX 1442 1 mV/cm DC differential amplifier with a common mode rejection of 60dB. For use with transducers and servo systems etc. An AC $\times 10$ position gives a sensitivity of 100 μ V/cm for low level noise investigation.



* CX 1443 Basic time-base unit. 18 ranges from 0.5 μ sec/cm - 0.5sec/cm. Suitable for use with all Y units. "Normal", "Auto" and "HF sync".



* CX 1444 Time base and sweep delay generator. Performance similar to CX 1443. Delays up to 100m/sec. Suitable for digital computer and television waveform investigation.

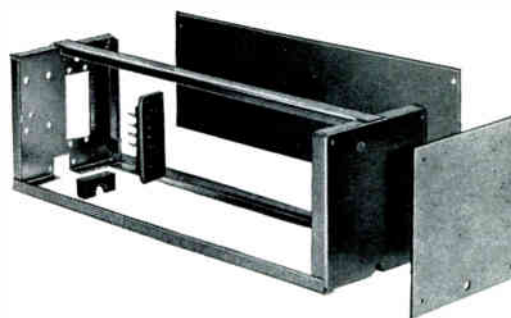

CX 1445-6 Blank X and Y plug-in units available enabling the customer to construct his own units to suit specialized applications.

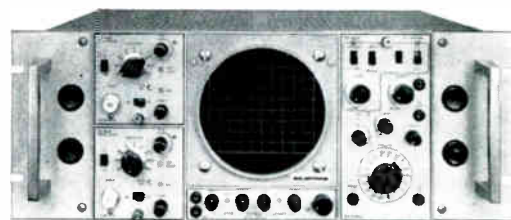

* CX 1447 A rack-mounting case is available as an alternative for use in standard 19" racks. Side panel design permits simple signal connections from rear of instrument.

* Measurement Accuracy 5%

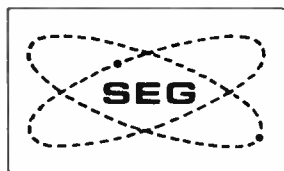

THE SOLARTRON ELECTRONIC GROUP LIMITED
Farnborough, Hants, England. Telephone: Farnborough (Hants) 44433
Telex: 85245 Solartron Fnbro. Cables: Solartron Farnborough.
A MEMBER OF THE SCHLUMBERGER GROUP



**SO MUCH
MORE BEHIND
A SOLARTRON
'SCOPE**

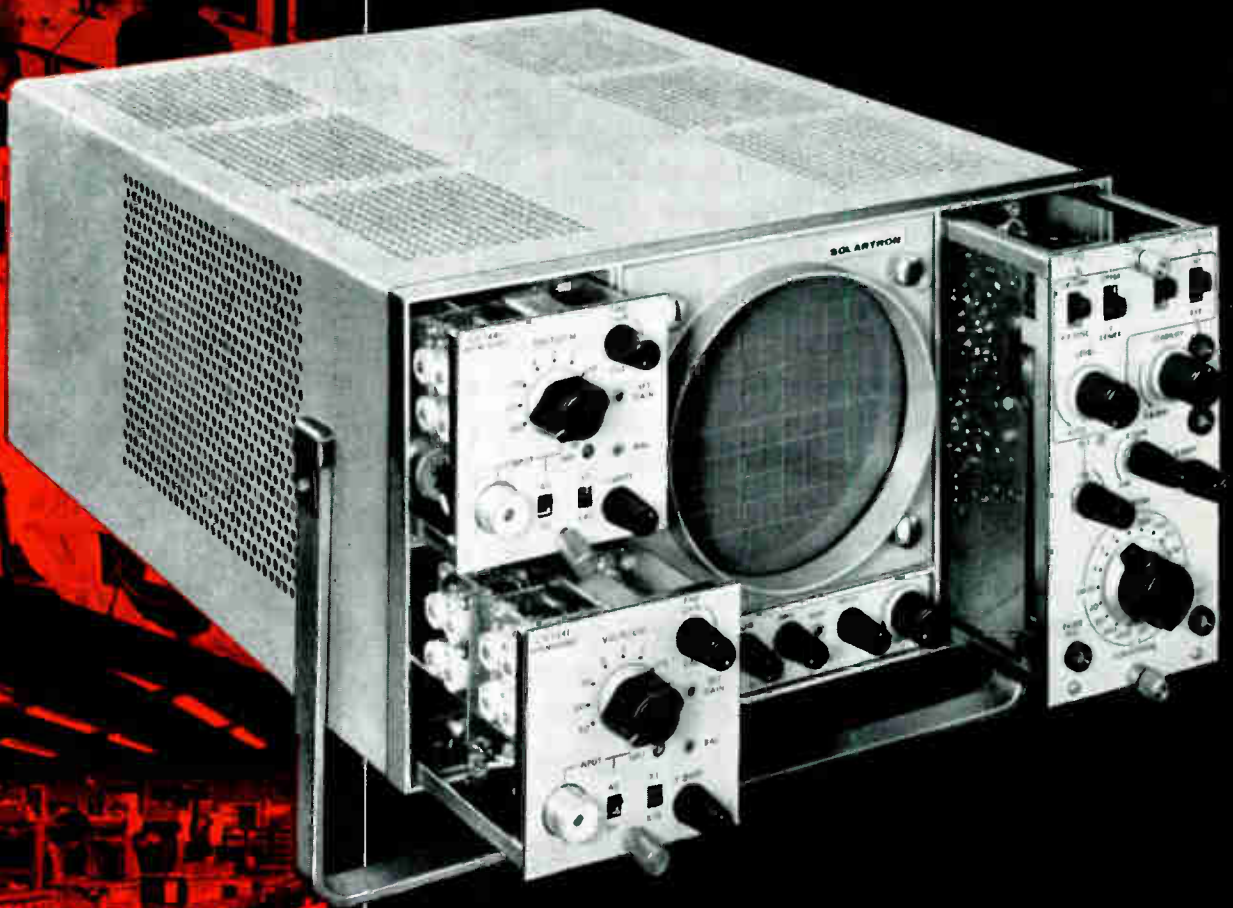

SOLARTRON

For Data Systems · Transducers · Computers
Military Systems · Electronic Instrumentation

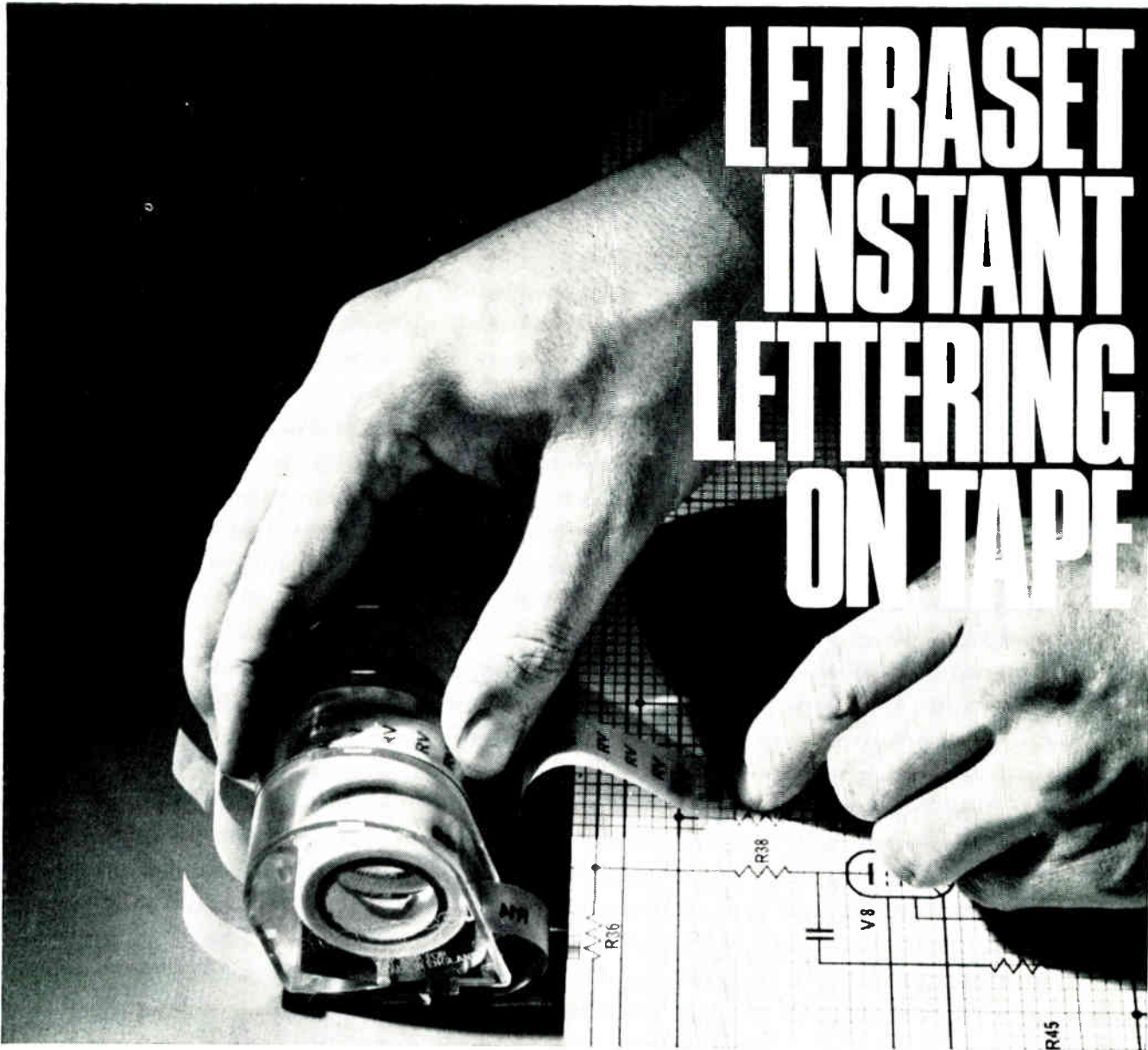

Letratapes reduce the application of dry transfer lettering to a new pull and press technique. The transfer can be applied without rubbing. Simply pull from the special Letratapes dispenser; the symbols are automatically "released" and only light finger tip pressure is required to ensure complete adhesion to any surface.

The Letratapes technique vastly increases the speed of application which makes it particularly suitable for repetitive coding.

The first range consists of a comprehensive component reference system for electronic circuit systems. The range of 120 tapes includes all common reference codes, numeral sequences and frequently used set words.

Comprehensive code symbol range

Dyeline Resistant

Two letter sizes

Up to 500 codes on one tape

Stocked by major Letraset dealers

Also for direct marking of components

Letratape Coding System is a product of Letraset Limited, St. George's House, 195/203 Waterloo Road, London, S.E.1. Telephone Waterloo 1401.

Detailed brochure now available; please return coupon

name _____

company _____

address _____

I.E. 4/66 **Letratapes**

T A K E S I X

to measure a megacycle



STOP PRESS

- * Variable sensitivity control on A.C. input.
- * Variable display timer (0.5-5 secs).
- * Period measurement over 1, 10 & 100 cycles
- * Provision for external ref.
- * Binary coded decimal output (optional extra).

Six big digits, clear and unambiguous, to measure frequency and time up to one megacycle and down to one microsecond—clearly, without flicker.

Six into one only just goes

Not much spare space on the panel of this instrument—the digits are big and the unit is small, compact, portable. Makes for convenience and easy reading, with an adjustable support that holds firm at any convenient angle.

Smaller and smaller!

Design of the Venner TSA 3436 Mark 2 is based on solid experience of applying transistorised digital techniques to measuring instruments. Small as it is, the TSA 3436 Mark 2 will give precise readings up to a megacycle and down to a microsecond.

ONLY £215 (Price applicable to U.K. only)

Laboratories and technical colleges welcome the compactness, strength and simplicity-in-use of the TSA 3436 Mark 2. In industry, its dependability, and the clarity of its display, make it uniquely suitable for inspection and quality control applications.

Full technical details will be sent on request.

VENNER TSA 3436 MARK 2 TIME/FREQUENCY METER

VENNER ELECTRONICS LIMITED

KINGSTON BY-PASS · NEW MALDEN · SURREY. MALDEN 2442

Overseas subsidiaries

VENNER A. G. BURGERNZIELWEG 16-3006 BERNE-SWITZERLAND · VENNER N. V. HELMSTRAAT 3-DEN HAAG-HOLLAND



MORE
FACILITIES
EASIER
TO USE

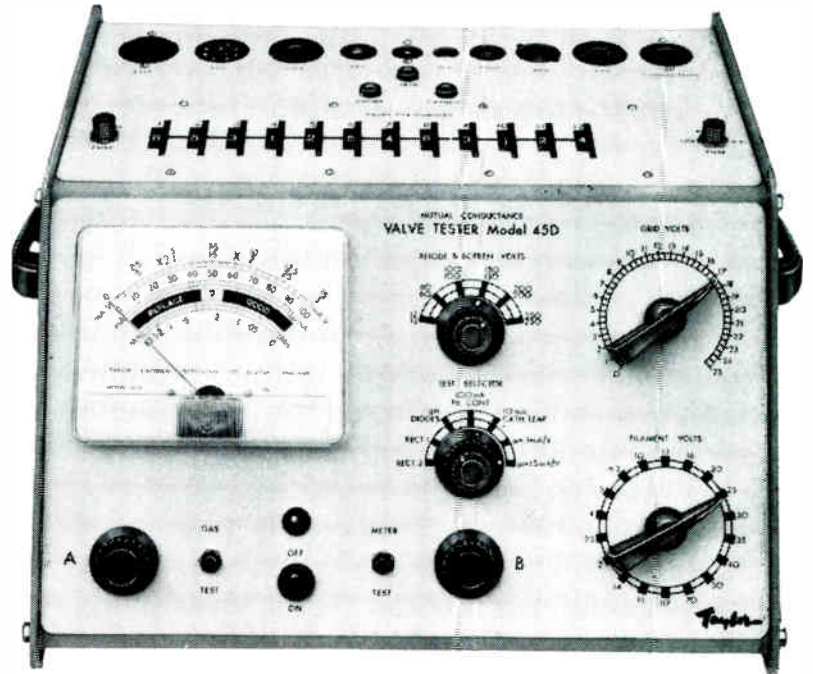

Taylor

Provides rapid mutual conductance measurement on more than 7,000 valves, British, American and Continental, with up to 12 pins and with a maximum power dissipation of 25 watts. Also tests CRTs (including colour TV tubes). *New edge control circuit selector switch connects any valve pin to any electrode.* Checks diodes and rectifiers for emission under normal working conditions with a load test for high current rectifiers. *Tests each section of frequency changer and other multiple valves separately for mutual conductance and emission.* Ten valve bases, including Compactron and Nuvistor types; a B14E base accepts a range of adaptors to cover any obsolete or new base not already incorporated. *Tests most CRTs without removing tube from receiver with adaptor which can be supplied.*

45D
TESTS
OVER
7,
TYPES

VALVE TESTER

7,000

The pace of new techniques in electronic equipment implies constant re-appraisal of test capability. In the new 45D Valve Tester, Taylor research and continued development offers an instrument as advanced as the industry it serves, with more facilities, improved design and easier operation. Write or telephone now for complete information.

IF IT'S **TAYLOR** MADE, IT'S CLEARLY BETTER



TAYLOR ELECTRICAL INSTRUMENTS LTD. Montrose Avenue, Slough, Bucks.
Phone: Slough 21381 - Grams: Taylins, Slough.



965/5/1



CONSIDER MAGNETIC DEVICES FOR RELAYS

For the simple reason that we have a very extensive range of relays that covers many requirements of circuit design. If however our wide basic range does not offer a solution to your problem then our Design and Applications Departments are at your service. If you require our Catalogue — a sample — a quotation — our help in any way, make contact with Magnetic Devices Now.



M.O.A.-A.R.R.E.-A.R.B. Approved Inspection
G.P.O. & C.E.G.B. Approved Suppliers

MAGNETIC DEVICES LIMITED
NEWMARKET · SUFFOLK · ENGLAND
TEL: NEWMARKET 3451 (10 LINES)

Grams Magnetic Newmarket Telex 81245
MANUFACTURERS OF SOLENOIDS, CONNECTORS & TIMERS
R.S. 1006

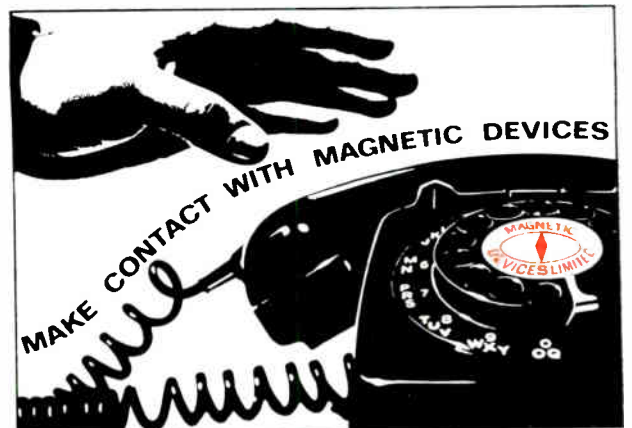

CHOOSING A TRANSFORMER?

Make it your business to know our business

Our business is *making* transformers — mains transformers to 10 kVA, audio transformers, voltage transformers, current transformers and pulse transformers as well as smoothing and swinging chokes and saturable core and A.C. linear reactors. It's a business that we know *all* the ins and outs of . . . which is why we can produce *exactly* the instrument you want at a really competitive price. It's a business that we've been perfecting for over 35 years — and in that time we've built up a reputation for a second-to-none advisory service that covers every aspect of design and application. It's a business that's good enough to get M.O.A. and A.R.B. approval as well as delegated Admiralty Inspection facilities. Yet it's a business that's not grown too large for close *personal* attention to all customers' needs. Our name is Redcliffe Industries Limited and next time you're choosing a transformer keep the name



right in the forefront of your mind

REDCLIFFE INDUSTRIES (BRISTOL) LIMITED
Emery Road, Brislington, Bristol 4 Tel: Bristol 77431-4

“You need to get on well together when you're tied together like this. It's a good thing Neco made all five of us!”



**“Hear!”
“Hear!”**

A unique package deal Not just gears and motor, but speed control unit, tachogenerator and indicator as well, are all in one matched Neco team. They are made together and tested together to make sure they will work well together. Nothing is left to chance. And everything is Neco. Just one place to go if there should be a query.

Adjustable Speed D.C. Motor Systems The range is considerable. Motors are available with output from $\frac{1}{8}$ to 2 h.p. There is a full selection of standard gearboxes for various torque ratings. There is even a meter with 240° deflection if required.

Extremely Flexible These systems provide a wide useful speed range at rated torque, have exceptional smoothness at low speeds and gradual acceleration under full control of the operator. Operation is immediate — there is no warm up time — the rectifiers are highly efficient solid state silicon. The systems are made by Servo-Tek & Neco Ltd. For further details please write or telephone: —



Normand Electrical Company Limited
North Street · Clapham Common · London SW4
Macaulay 3211/5 · Telex 264400
Walton Road · Eastern Road · Cosham · Hants.



all roads lead to IR...

Thyristors, zeners, power diodes, silicon and selenium rectifiers—all over the world designers and engineers turn to IR for semiconductors. Why? Because IR have the experience which puts IR components ahead of the field—not only in design, but in trustworthiness too. May we help you with your application problems?



INTERNATIONAL RECTIFIER

Immediate off-the-shelf delivery from IR distributors—phone
ENGLAND Crawley 28700, Gipsy Hill 6166, Heywood 60640 & 69390, Hitchin 2242, Leeds 35111, Leicester 68561, Museum 3261/9, Portsmouth 20465, Todmorden 2601, Skyport 1314 & Slough 26367/8. **SCOTLAND** Douglas 2711 & Cumbernauld 23687 & 25601. **N. IRELAND** Belfast 26222

INTERNATIONAL RECTIFIER

HURST GREEN · OXTED · SURREY · TELEPHONE OXTED 3215
TELEX RECTIFIER OXTED 8819



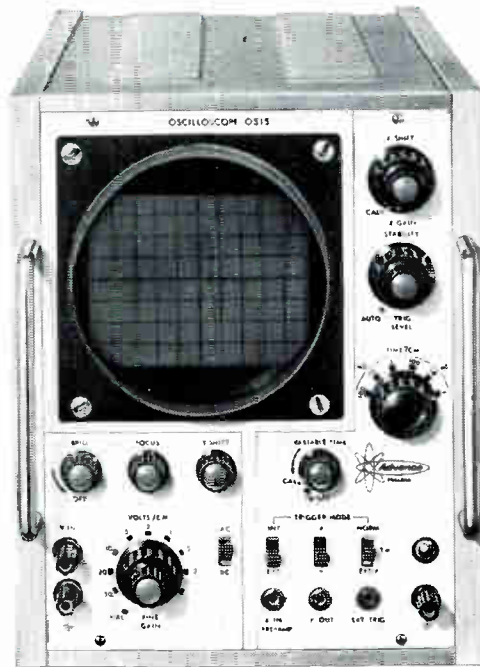

*and now an
oscilloscope
from Advance*

The Advance OS15 is an attractively styled, low cost oscilloscope which has a wide application in industry.

Designed and built to the traditional Advance concept of reliable general purpose instrumentation, the OS15 has a specially designed CRT giving a clearer and brighter display. The horizontal amplifier incorporates a pre-amplifier, while both sensitivity and timebase have switched and continuous controls.

Simple to use and easy to service—most of the components are mounted on a single printed circuit board and only one type of valve is used throughout.

You will wish to know more about this new oscilloscope from Advance. Write now for full specification and/or a demonstration.

For further information circle 217 on Service Card

*you need an
oscilloscope,
have the
best available
for £55*



- * DC—3Mc/s Bandwidth
- * 100mV/cm Sensitivity
- * 1 Sec/cm to 0.5 μ Sec/cm Timebase
- * Continuous control of Sensitivity and Timebase
- * DC—coupled X amplifier for X-Y Display
- * TV Frame Sync.
- * 5in. Helical PDA Tube

Price £55 (special terms to educational authorities)

ADVANCE ELECTRONICS LIMITED
Instrument Division,
Roebuck Road, Hainault, Ilford, Essex
Telephone: Hainault 4444
Telegrams: Attenuate, Ilford



Only one-fifth of the story!

Yes, STC Components Group is able to supply you with about five times the number of different types of components shown—*off the shelf*. And the range of components is being extended all the time. If your requirements are urgent, STC Electronic Services Division offers *same day despatch*.

Each STC Division maintains an Applications Department with Engineers ready to help you choose the most suitable and most economic components and circuits for your equipments or systems.

Wherever your location on the map, STC Components Group, made up of nine successful Divisions and a single mobilized field force, can put the finest components service right on your

doorstep. The Group is represented in practically every country through ITT (International Telephone and Telegraph Corporation).

To obtain your copy of the STC 'Designers Digest' write, 'phone or telex STC Components Group, Footscray, Sidcup, Kent. Telephone: FOOtscray 3333. Telex: 21836.

high-grade components by **STC**
COMPONENTS GROUP

FIXED RESISTORS AND THERMISTORS

GENERAL PURPOSE FIXED RESISTORS (actual size)

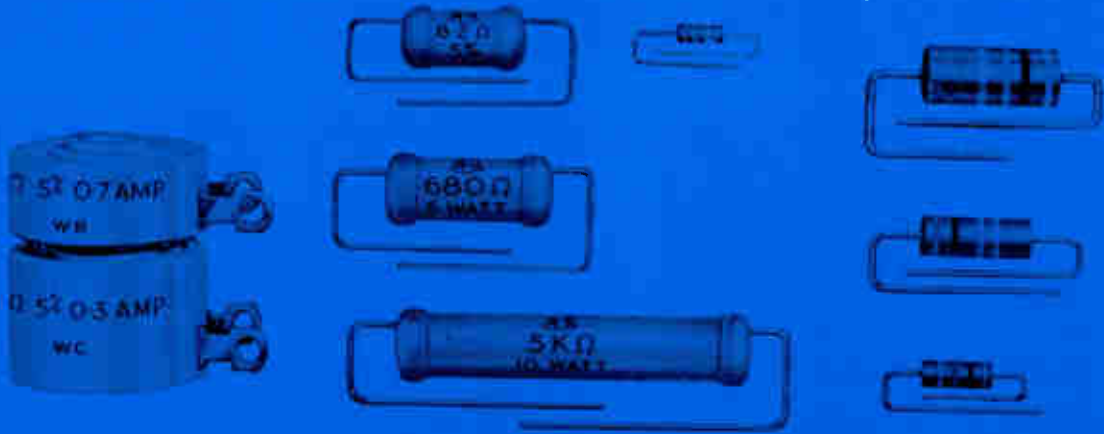

THERMISTORS (actual size)



HIGH STABILITY RESISTORS (actual size)



A wide range for delivery "by-return" of:

WIRE-WOUND RESISTORS — ratings 3W. (0.5-10 Ω), 5W. (15 Ω -8.2K Ω), 10W. (15 Ω -25K Ω) and 30W. (33 Ω -1.5K Ω), all at 5% tolerance.

POWER SECTIONS — for "build up" wire-wound resistors in units from 10 Ω (-7A) to 2.2K Ω (-065A), all at 5% tolerance.

CARBON COMPOSITION RESISTORS — $\frac{1}{10}$ W. (10 Ω -1M Ω) $\frac{1}{2}$ W. and 1W. (4.7 Ω -22M Ω) or 2W. (10 Ω -22M Ω), all at 10% tolerance.

HIGH STABILITY RESISTORS — Carbon Film rated at $\frac{1}{2}$ W. (10 Ω -22M Ω) at 5% tolerance and Oxide Film rated at 1W. (10 Ω -1M Ω) at 2% tolerance.

THERMISTORS for current surge limiting and temperature compensation.



Radiospares Ltd.

4-8 MAPLE STREET · LONDON W.1 · ENGLAND

Telephone: EUSton 7232 (8 lines). Telegrams and Cables: RADOSPERES, LONDON, W.1

RS14

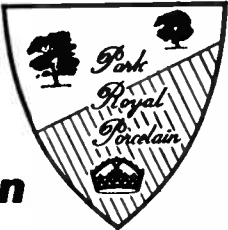

Porcelain
Steatite

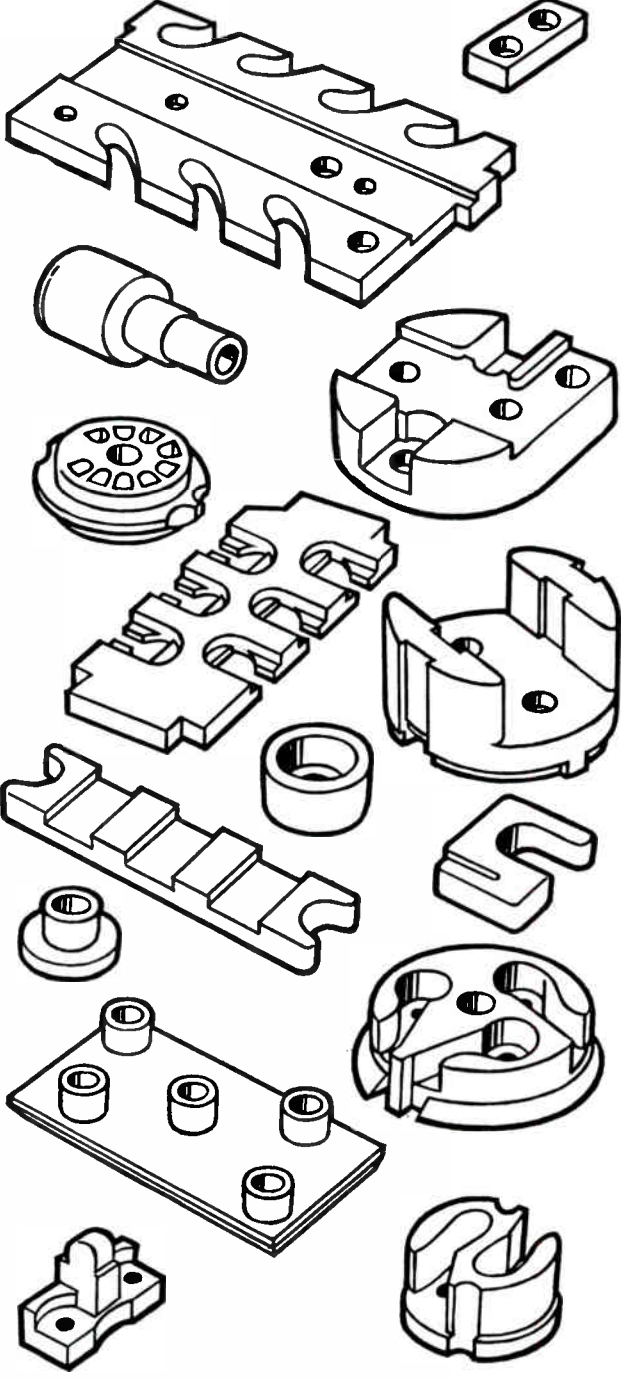

V. G. PORCELAIN CO LTD

GORST ROAD
PARK ROYAL
LONDON, N.W.10

Telephones:
ELGAR 1411/7
Telex:
London 25589

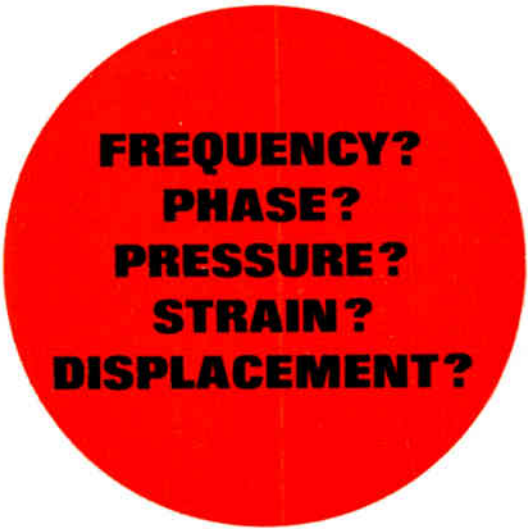

Getting permanent records of test, experimental and research data could be a problem for the laboratory operating on a limited budget. Could be . . . unless they've heard about the Honeywell 1706 Visicorder. By careful design and exclusion of unnecessary frills, Honeywell can offer in the 1706 a compact, *low cost* instrument with big-machine performance. Check its features—6 independent channels, d.c. to 13000 c.p.s. 2 reference lines, 8 chart speeds from 6 to 800mm/sec ($\frac{1}{4}$ to 32in/sec), photo flash timer intervals of 0.1 and 1 sec., a writing speed greater than 75cm/msec, and recording paper size of 12cm x 30m. So easy to operate too, with only four simple controls and drop in paper loading. And all at a price that puts it well within the means of any laboratory budget. The 1706 is just one in a wide range of recording oscillographs . . . themselves just one range in many ranges of instrumentation produced by Honeywell's Industrial Products Group for research and industry. **For further information write to Honeywell Controls Limited, Industrial Products Group, Great West Road, Brentford, Middlesex. Atlas 9191.**

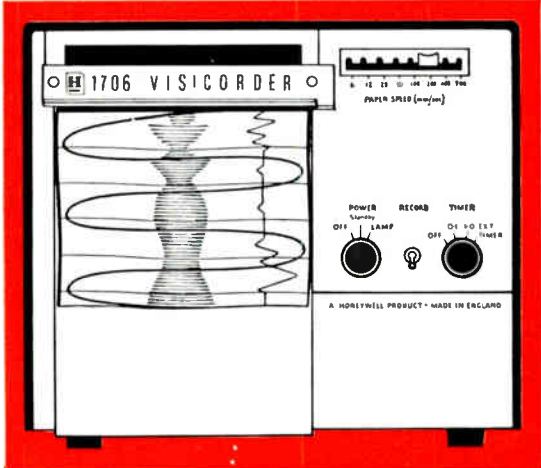

Honeywell

Honeywell International Sales and service offices in all principal cities of the world. Manufacturing in United Kingdom, U.S.A., Canada, Netherlands, Germany, France, Japan.

DERRITRON INSTRUMENTS SERVE INDUSTRY.....

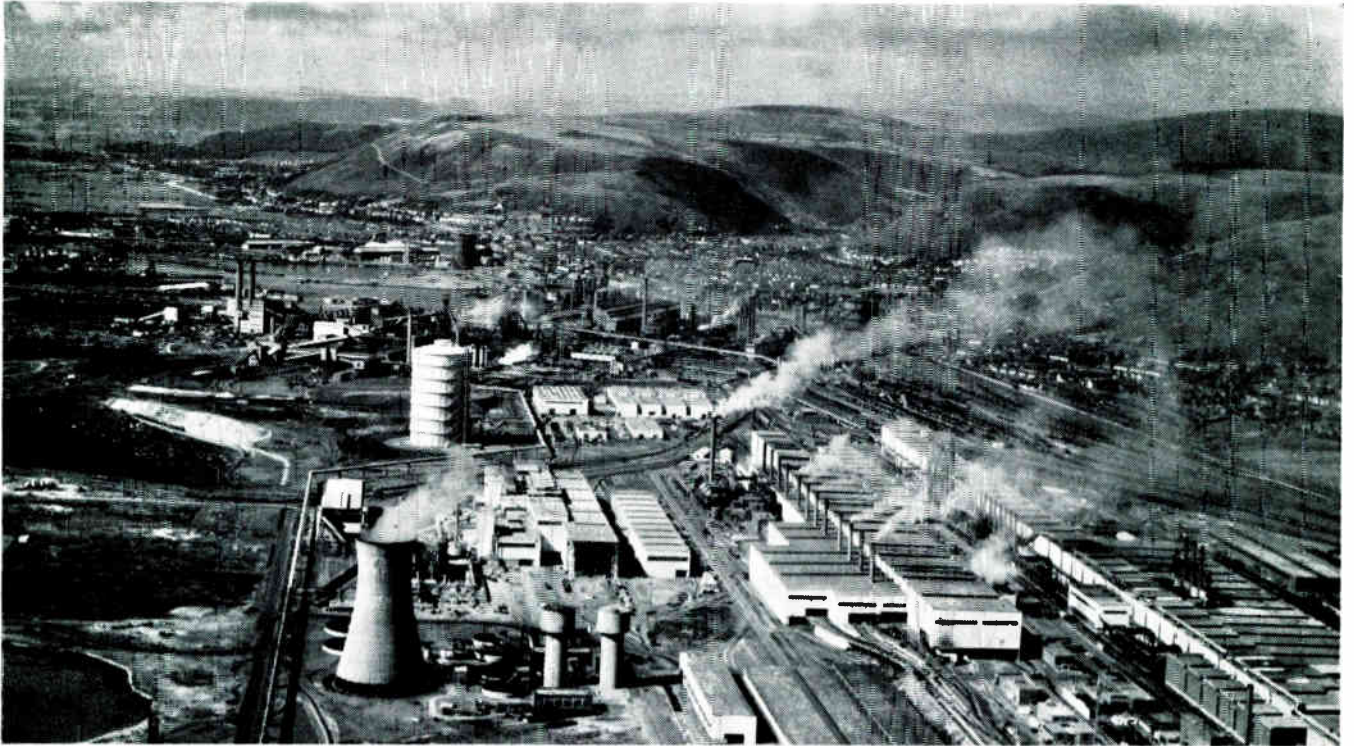

DERRITRON INSTRUMENTS LTD., leading manufacturers of high grade laboratory and field test equipment, have numerous products in the following categories:—

D.C. and Thermocouple Potentiometers · D.C. Resistance Standards · pH Measuring Instruments · pH Electrodes and Accessories · Titrometers · Conductivity Bridge Weston Standard Cells · Taut Suspension Galvanometers · Corrosion Test Meter Stabilised D.C. Power Supplies, E.H.T. & L.T. · Transistorised Portable Oscilloscope.

The standard of accuracy and reliability of DERRITRON INSTRUMENTS LTD. products is such that normal industrial tests can be made to laboratory standards and a large number of these instruments have been designed for on-site tests and are fully portable. Transistors have been used wherever practicable thus ensuring extremely high reliability.

If you have a measuring problem in any of the above categories, please write or telephone for our catalogues, prices and if required, assistance from our advisory department. Our sales engineers will be pleased to demonstrate any of our products.



DERRITRON INSTRUMENTS LTD. 24 UPPER BROOK STREET, LONDON, W.1. HYDe Park 2291

Give it the works!



We, at ARROW, understand the responsibility which rests on any Engineer's shoulders whose job it is to specify relays. Therefore, knowing our products as we do, we welcome every opportunity to send samples to be given 'the works', as we are confident of the results. Illustrated is a small 5-amp Plug-in Relay ideal for high performance automation equipment. The standard circuit is d.p. changeover.

ARROW ELECTRIC SWITCHES LTD

BRENT ROAD · SOUTHALL · MIDDX

Telephone: SOUthall 2442

A54

For further information circle 224 on Service Card

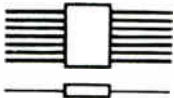

ACTUAL SIZE

TO-88

ZSS70-ZSS90 SERIES

available MARCH 1966

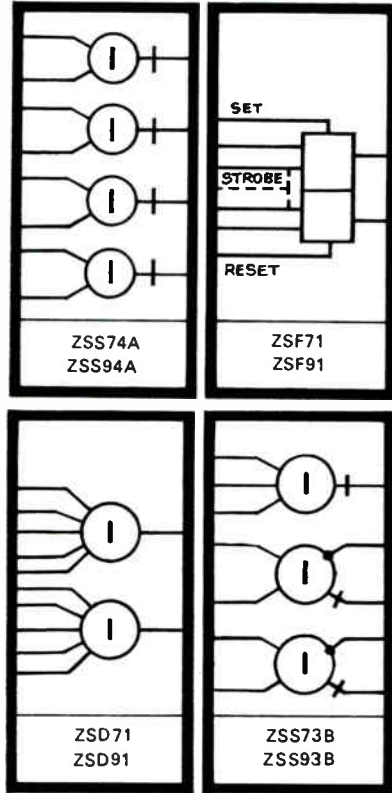

ACTUAL SIZE

TO-78

ZSS50-ZSS80 SERIES

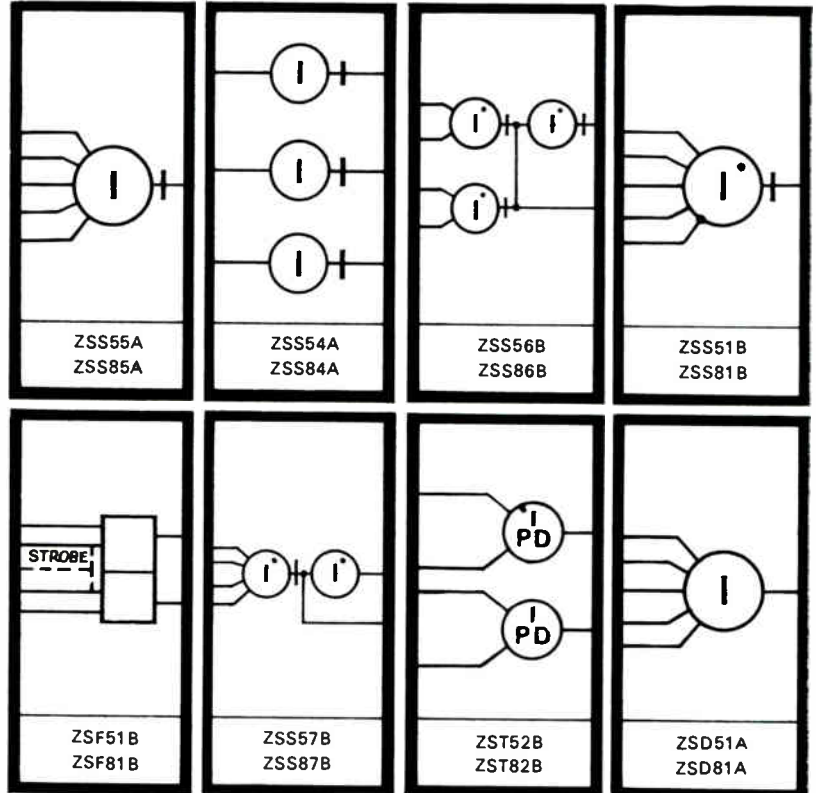

There are over **50 MICRONOR II** digital integrated circuits

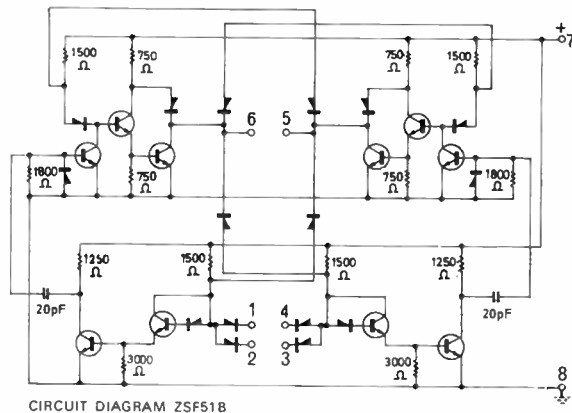

Features

- Diode Transistor Logic
- Very Low Propagation Delay Times
- High Noise Immunity
- J-K Flip-Flop Noise Immunity equal to that of basic gate
- High Fan OUT

Basic Ratings and Characteristics

- Typical Propagation Delay Time 8.0 nSec
- Maximum Fan OUT—Basic Gate 8
- Typical Noise Immunity 1.0 Volt
- Maximum Temperature Range:
ZSS50 Series, ZSS70 Series -55 to +125 °C
ZSS80 Series, ZSS90 Series 0 to +70 °C

FERRANTI has the largest microcircuit production unit in Europe

FERRANTI

First into the Future

Write now for more details to: Ferranti Ltd · Gem Mill · Chadderton · Oldham · Lancs · Tel: (061) MAIn 6661

FE276/2



IN RESEARCH AND INDUSTRY

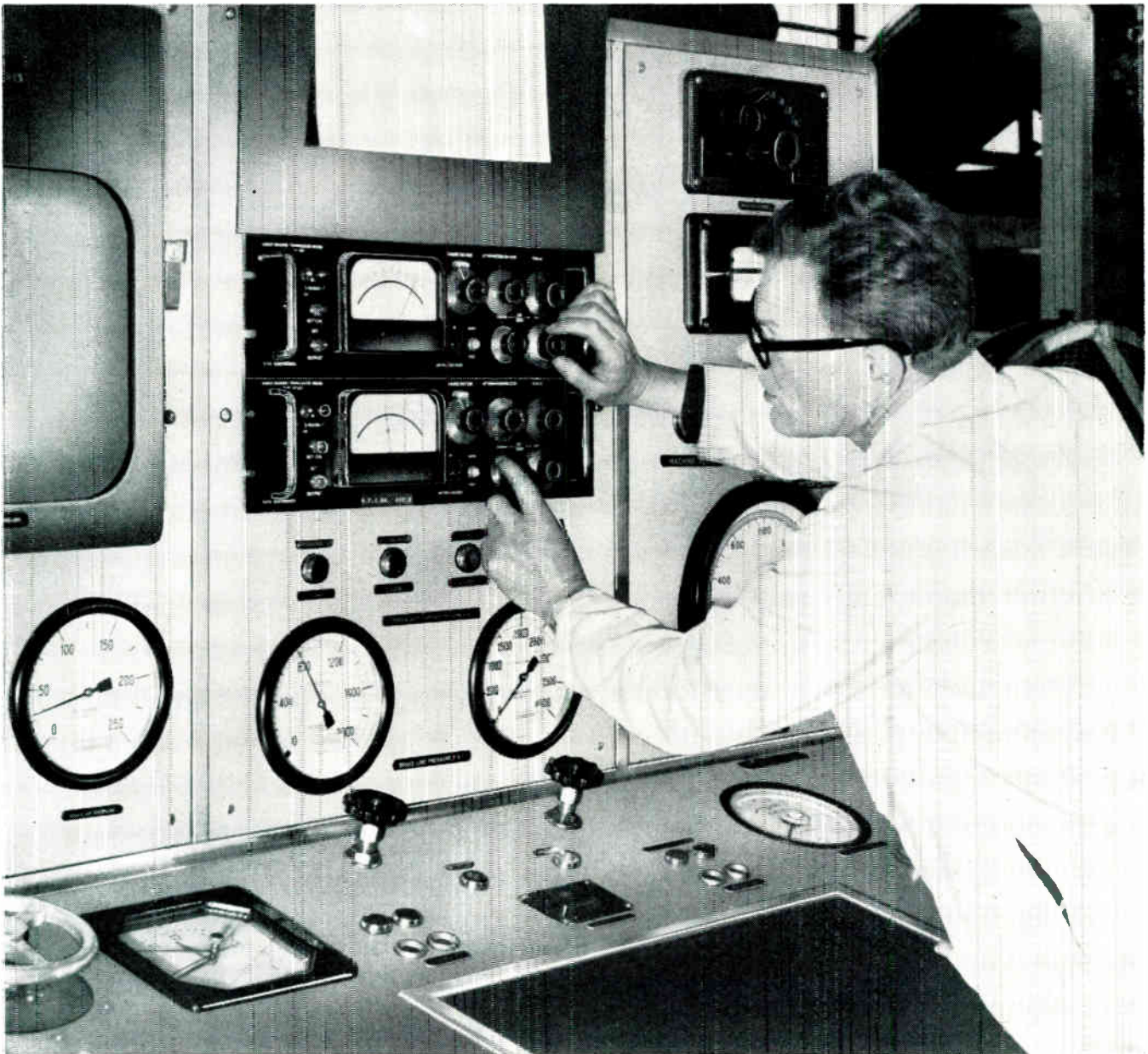

B.P.A. TRANSDUCER METERS in use on the dynamometer test rigs of the Girling Brake Company Limited

"Boulton Paul electronic displacement measuring equipment has been found invaluable in our research and development programme" – Chief Development Engineer, Girlings

Equipment for measuring or recording force, load, displacement or fluid pressure



BOULTON PAUL AIRCRAFT LIMITED · ELECTRONICS DIVISION · WOLVERHAMPTON

Member of the DOWTY Group



JUST LIKE THE OTHER 800 MILLION— UNIQUE

Erie have made approximately 800 million of the Type 9 insulated carbon composition resistor since they were first put into production as far back as the early thirties. Every one is identical, yet every one is unique.

The care and attention to detail in their manufacture, and the rigorous inspection checks at every stage, ensure that not only does every component operate efficiently, but is in itself an example of Erie's unique manufacturing skill.

The same care and attention that goes

into quality control applies throughout all the company's activities; your orders and enquiries for instance. Every order, whether it be for a million, or for a strictly limited number for a highly specialist purpose, receives the same quiet efficient attention.

Every enquiry, too, no matter how apparently simple or difficult is dealt with in the same enthusiastic manner by our technical and sales staff.

Erie take a pride in performance



Write for catalogue to:

ERIE RESISTOR LIMITED,

Great Yarmouth, Norfolk, England.

Telephone: Great Yarmouth 4911.

Cables: Resistor Great Yarmouth Telex: 97421

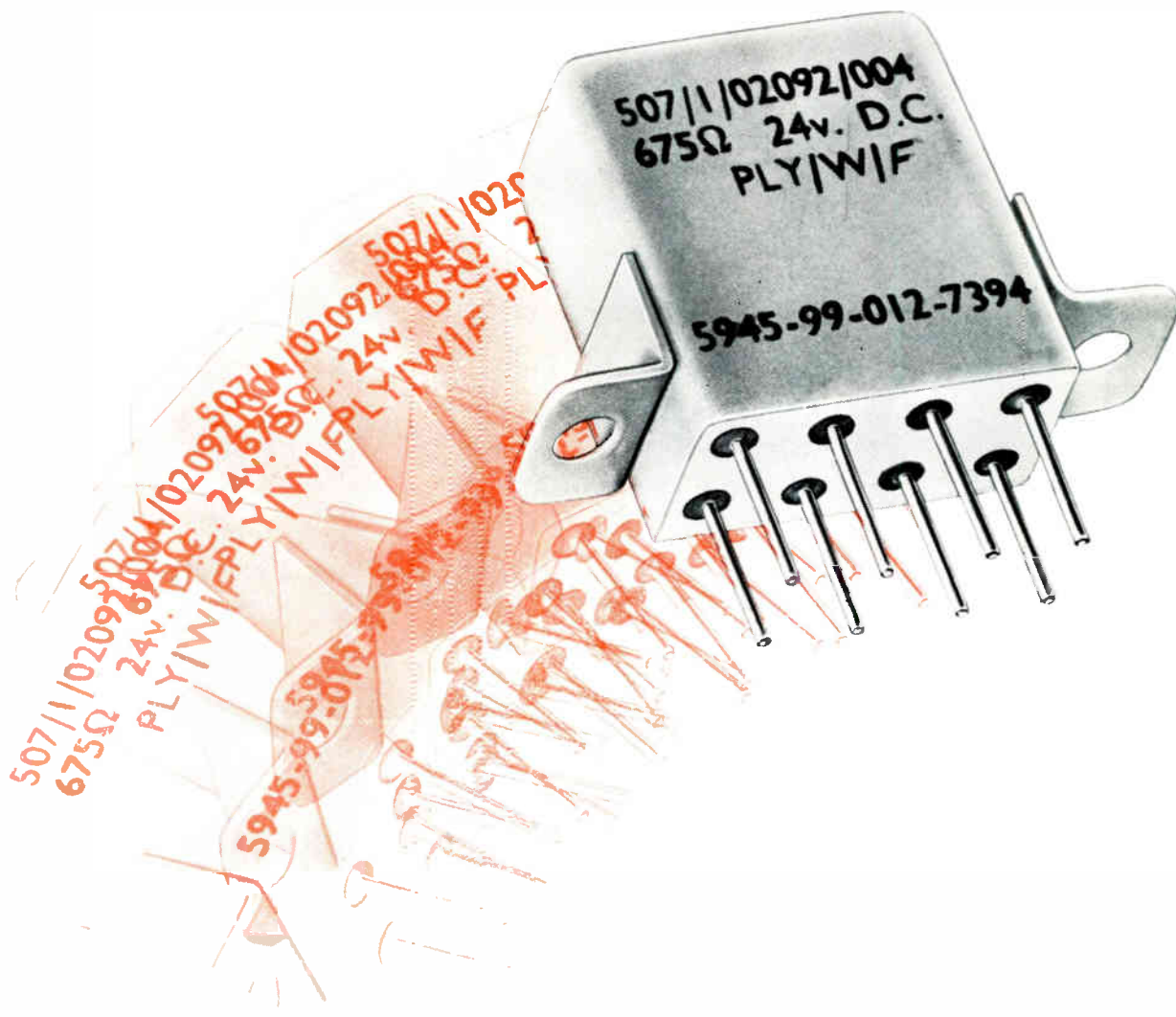

Shock is no hazard to this relay

PLESSEY makes it

Hazardous environments present no problems to the new Plessey type CF sub-miniature relays. They meet all DEF 5165 requirements such as humidity (HI); and vibration, and MIL-R-5757 for shock up to 100g for 8 milliseconds. The twin gold-plated contacts are rated for a million 1-amp (or 100,000 3-amp) operations at 28V D.C. or 115V A.C. (400 c/s). Both operate and release times are never more than 5 milliseconds, and the operating temperature range is -65°C to +125°C.

For complete technical details of the extensive range of coils, and mountings available, please fill out and post the coupon below.

I would like further information on the Type CF relay.

NAME _____

COMPANY _____

ADDRESS _____

PC 18

PLESSEY



Components Group

The Plessey Company Limited Titchfield, Fareham, Hants
Professional Components Division Telephone: Titchfield 3031

Why do we insist on manufacturing thermocouple alloys which are sub-standard ?

Because that's how our customers insist on having them. Let us explain. □ British Driver-Harris thermocouple wires 'T1' and 'T2' have been specified for temperature measurement in British nuclear submarines. For 'sub-standard' read 'best possible' and you have the answer. □ Our customers well know that in terms of long life, stability and a constant EMF, there's no more exacting standard than our own. □ 'T1' and 'T2' nickel-chromium/nickel-aluminium thermocouple alloys are intended for general use at temperatures up to 1100°C. The wires conform to British Standard 1827:1952, and they also meet the requirements laid down in the relevant Air Ministry Specifications covering extension leads. □ Data Sheet No. 2 is a useful introduction to the range of B D-H base metal thermocouple alloys. Could you do with a free copy?

'T1' and 'T2' are Registered Trade Marks



NICHROME

BRITISH DRIVER-HARRIS CO LTD CHEADLE HEATH CHESHIRE GATLEY 6661



In installations where control of pumps and water levels is critical, **NOFLOTE** control can take complete command. Simple and robust in construction and completely automatic in operation, **NOFLOTE** controls are currently saving manpower and worry in installations throughout the World. **NOFLOTE** is one of the many measuring and control instruments for industry made by Kent-Evershed Limited.

For full details and specification of **NOFLOTE** control, write for leaflet No. SS.66/15

The term NOFLOTE is a trade mark of Kent-Evershed Limited.

KENT-EVERSHED

Kent-Evershed Limited Acton Lane Works · Chiswick · London W4 · Telephone : Chiswick 3670 EV 11

A member of the Kent group of companies



The man who carries this brief case . . .

Behind every Plessey representative stands the most comprehensive electronic-component capability in the world. In the new Plessey Components Group there are specialised Divisions, modern production plants, development laboratories, 16,000 skilled employees, and more than 40 years of experience. Plessey can meet practically every component requirement for commercial, industrial and military electronic equipment.

As well as producing one of the widest ranges of electronic components available, Plessey also offers you the highest

possible component reliability. Incomparable Plessey test facilities include one of Europe's most extensive and up-to-date environmental laboratories. A separate research centre, among the most advanced in Europe, has originated many new components and materials. The expert from Plessey will be happy to tell you about Plessey components the next time he visits you. If there is a particular problem you would like to discuss, or particular components on which you want advance information, just fill out the coupon below, and post it to Plessey.

For more information fill in and post this coupon

Please send me data on the Plessey components ticked below/I would like a Plessey specialist to visit and tell me about them

- | | | | |
|---|---|--|--|
| <input type="checkbox"/> air & plastic dielectric variable capacitors | <input type="checkbox"/> infra-red detectors | <input type="checkbox"/> silicon alloys | <input type="checkbox"/> subminiature valves & neon lamps |
| <input type="checkbox"/> cast permanent magnets | <input type="checkbox"/> loudspeakers | <input type="checkbox"/> solar cells | <input type="checkbox"/> valveholders & ceramic components |
| <input type="checkbox"/> ceramic capacitors | <input type="checkbox"/> new subminiature rotary switch | <input type="checkbox"/> new rotary solenoid | <input type="checkbox"/> new printed-circuit connectors |
| <input type="checkbox"/> coil assemblies | <input type="checkbox"/> micro-alloy & micro-alloy diffused transistors | <input type="checkbox"/> solid circuits | |
| <input type="checkbox"/> cold cathode tubes | <input type="checkbox"/> miniature silicon rectifiers | <input type="checkbox"/> switches | Name _____ |
| <input type="checkbox"/> diffused silicon rectifiers | <input type="checkbox"/> number tubes | <input type="checkbox"/> tantalum capacitors | Title _____ |
| <input type="checkbox"/> dry reed relay inserts | <input type="checkbox"/> planar switching diodes | <input type="checkbox"/> tape decks | Company _____ |
| <input type="checkbox"/> electrical connectors | <input type="checkbox"/> preformed wiring | <input type="checkbox"/> timing & regulating devices | Address _____ |
| <input type="checkbox"/> electroluminescent devices & mimic diagrams | <input type="checkbox"/> pick-up cartridges | <input type="checkbox"/> transducers | _____ |
| <input type="checkbox"/> electrolytic capacitors | <input type="checkbox"/> rectifier stacks | <input type="checkbox"/> transformers & inductors | _____ |
| <input type="checkbox"/> ferrite memory cores & matrices | <input type="checkbox"/> relays | <input type="checkbox"/> transistors | _____ |
| <input type="checkbox"/> filters | <input type="checkbox"/> resistors & potentiometers | <input type="checkbox"/> wound components | Telephone _____ |

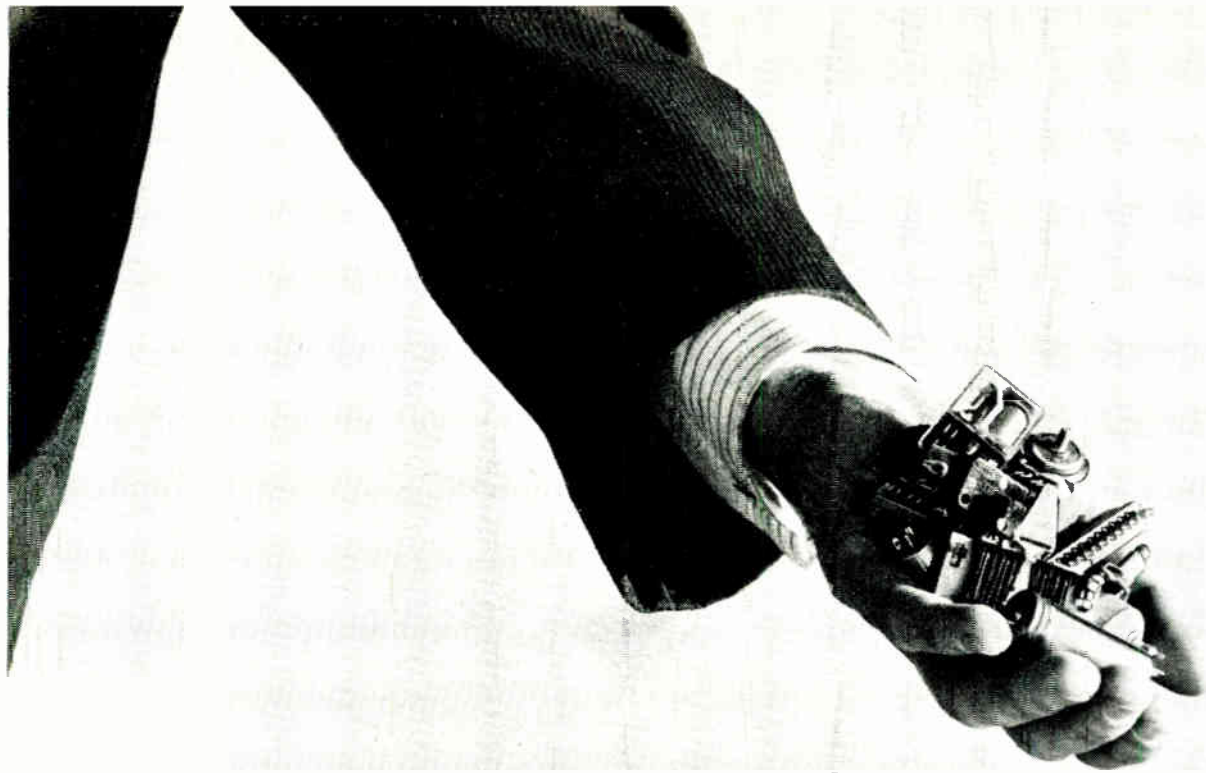

offers you 39 different categories of electronic components. Here are three of the newest:

New Subminiature Rotary Switch



This subminiature 12-position switch uses a printed-circuit rotor and hard gold plated contacts. Operating range: -50°C to $+85^{\circ}\text{C}$. Contact rating: 50V, 100mA resistive for 20,000 cycles. Contact resistance: 15 milliohms (max). Diameter: 17.463mm.

New Printed-Circuit Connectors

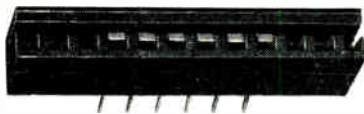

These are manufactured in strips and can carry up to 80 contact positions. They can be cut to customers' exact requirements with a variety of combinations to suit individual printed-circuit connector applications. Rating: 750V a.c. rms at sea level, 5A continuous, -40°C to $+85^{\circ}\text{C}$, contact resistance less than 15 milliohms.

New Rotary Solenoid



Designed for reliability and long life, this Rotenoid is particularly suited to the operation of multi-bank wafer switches where extra force is often required to overcome initial loads due to high static friction and indexing mechanisms. It will operate at a temperature of 180°C . DC operating range: 2V to 440V dissipation 12W continuous or up to 100W, according to function.

PLESSEY Components Group



The Plessey Company Limited, Kembrey Street, Swindon, Wiltshire. Telephone: Swindon 6211. Telex: 44180

For further information circle 231 on Service Card

RCA

SILICON-CONTROLLED RECTIFIERS

*Cover your Most Important
Current Requirements*

3 TYPES PRICED FOR HIGH VOLUME USE



2N3529
2 Amp I_{FRMS}
400 $V_{RM(rep)}$



2N3525
5 Amp I_{FRMS}
400 $V_{RM(rep)}$



2N3670
12.5 Amp I_{FRMS}
400 $V_{RM(rep)}$

...AND 3 TYPES FOR HIGH-RELIABILITY USE



2N1770-78
7.4 Amp I_{FRMS}
25-500 $V_{RM(rep)}$



2N1842A-50A
16 Amp I_{FRMS}
25-500 $V_{RM(rep)}$



2N681-90
25 Amp I_{FRMS}
25-600 $V_{RM(rep)}$

Whether your design has application in stepless control, in mass-produced mains operated appliances, or in commercial and industrial power control, relaying, or other switching functions, RCA SCR's offer the extra design features for operation at full ratings. Optimize your designs with RCA SCR's.



The Most Trusted Name in Electronics

RCA GREAT BRITAIN LIMITED, Sales Division, Lincoln Way, Windmill Road, Sunbury-on-Thames
ASSOCIATE COMPANY OF RADIO CORPORATION OF AMERICA. Telephone: Sunbury 5511

SQUARE FORM IMRAKS at no extra cost

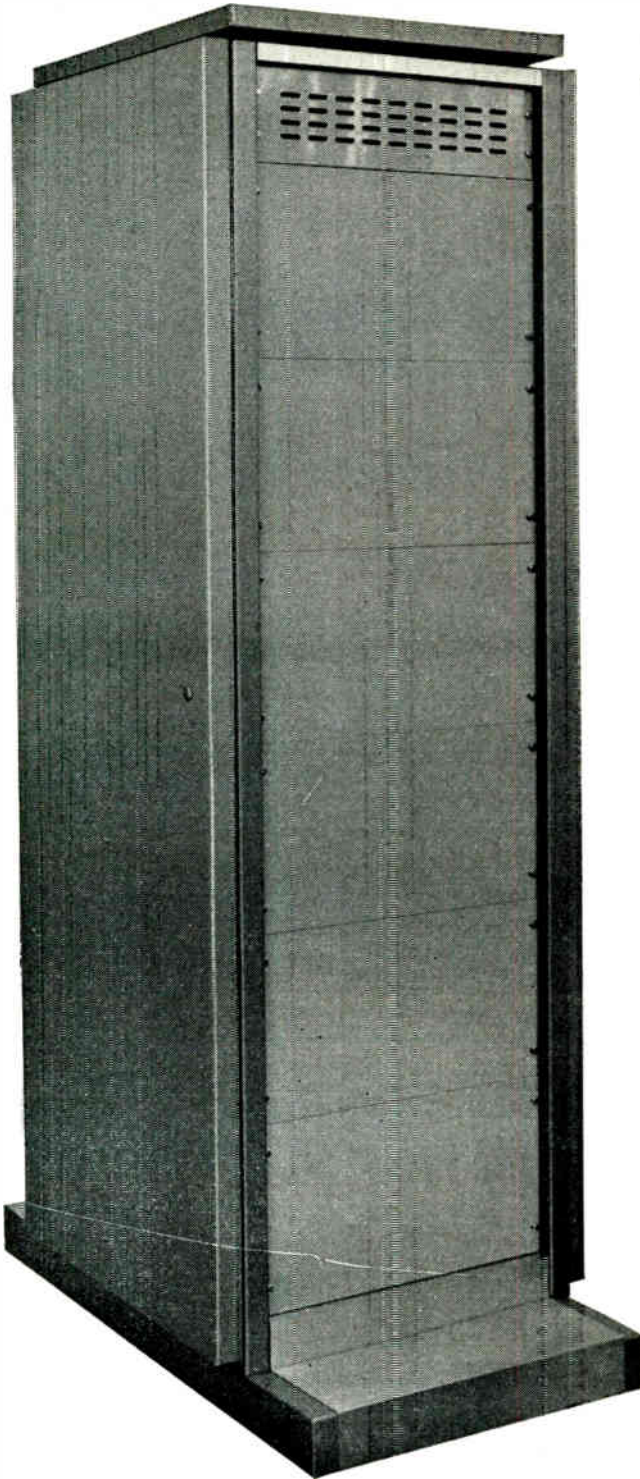

This new "square" form of styling is now available, as an optional alternative to the existing "radiused" design, on 95 models in the International Series of Imraks. These include all sizes of cubicle, enclosed, totally enclosed, induced ventilation and forced ventilation racks. When you buy any of these Imraks, you can choose the type of styling you prefer . . . at no extra cost!

On all but induced ventilation racks, these new square form racks have an attractive raised "mushroom" top to allow adequate ventilation (on induced ventilation racks the top is fitted in direct contact with the rack). These new style Imraks do, of course, still provide all the facilities offered by this versatile racking system, such as: choice of panel mountings, shortened doors, meter panel units, castors, lifting eyes, desk and drawer units, blowers, etc

A new range of low cost mobile bases and fixed plinths, designed to match the styling of the square form Imraks, has also been introduced with a model to suit each plan size of rack

Send today for full details and information on other new Imhof products

other new products include

new Imrak withdrawable desk units mounted on ball bearing telescopic slides, new small cases including carrying cases, new sizes of 600 series cases, new sizes of 1520 and 1550 cases, new induced ventilation fan units, new chassis runners, 18 new handles and paper protected aluminium panels



Alfred Imhof Limited

Dept. No. IE/2 Ashley Works
Cowley Mill Road Uxbridge Middlesex
Telephone Uxbridge 37123 Telex 24177
Telegrams IMCASE-UXBRIDGE-TELEX

Agents in Algeria Australia Belgium Brunei Canada Denmark Finland
France Germany Holland Iraq Israel Italy Lebanon Mexico
New Zealand Nicaragua Norway Portugal Saudi Arabia Singapore
South Africa Sudan Sweden Switzerland Syria Thailand Tunisia
U.S.A. Zambia

w.7



VANGUARD

25 WATT TRANSISTORISED

Mobile Radiotelephone



ONLY the VANGUARD has ALL these qualities

- 25/30 & 50/60Kc/s channels
- Extensively Transistorised
- Sealed Block I.F. Filters
- Printed Circuitry
- Very low Battery Drain
- All Aluminium Construction
- Dust-proof and splash-proof
- One-Six Channels
- 25 Watts Output
- Very low-noise Receiver
- High Stability Mute
- 4 Watts Audio Output
- *Meets British, American, Canadian and Continental Specifications*

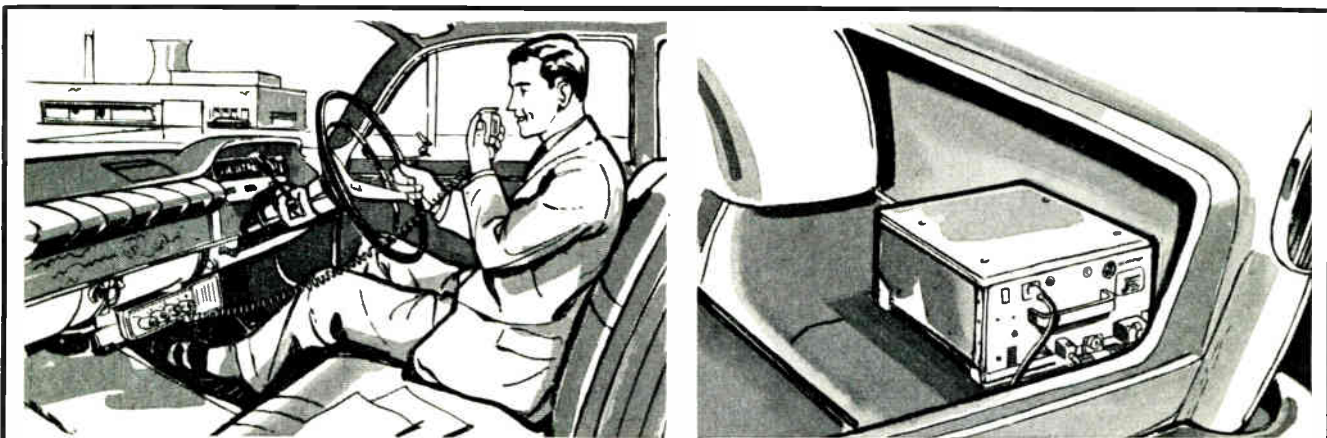

PYE TELECOMMUNICATIONS LIMITED

CAMBRIDGE · ENGLAND · TEL. TEVERSHAM (CAMBRIDGE) 3131 · TELEX NO. 81166

THE **PYE** Linesman FULLY TRANSISTORISED PORTABLE TWO WAY RADIOTELEPHONE



Based on the now famous Pye Bantam solid-state Walkie/Talkie, the Pye Linesman with many additional features, makes it suitable for use in all types of weather, the Pye Linesman is proving invaluable in cable laying, road construction, building sites etc.

Important features are that it is free-standing, incorporates large capacity batteries, is weatherproof and has a voltage indicator to show the state of the battery.

The 'Linesman' is designed never to let you down in the field. It is available for AM and FM in frequency bands from 25–174 Mc/s. It is used by the British Post Office.

PYE TELECOMMUNICATIONS LIMITED

CAMBRIDGE · ENGLAND · TELEPHONE: TEVERSHAM (CAMBRIDGE) 3131 · TELEX No. 81166

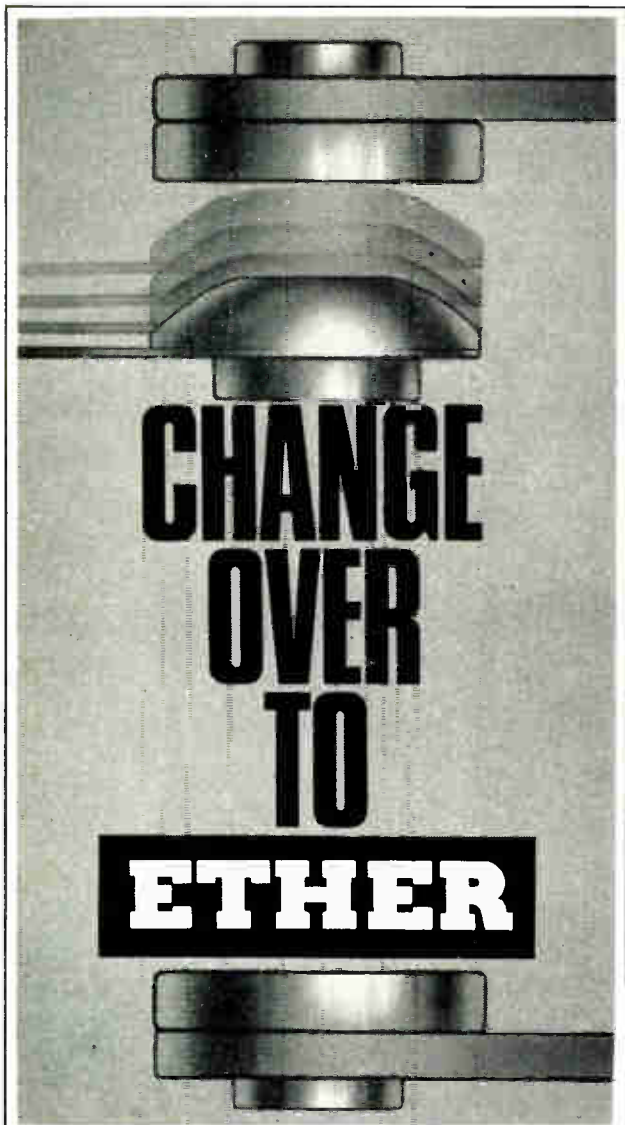

Two new general purpose miniature relays have been added to the Ether range. Designed for printed circuit or chassis mounting, they are compact, reliable and inexpensive.

Two-pole changeover types are rated at 2 amps; single pole double make-and-break types at 3 amps (240V a.c. or 24V d.c.)

Standard coil voltage: 6, 12, 18 and 24V d.c.

Maximum operating power: 1 watt.

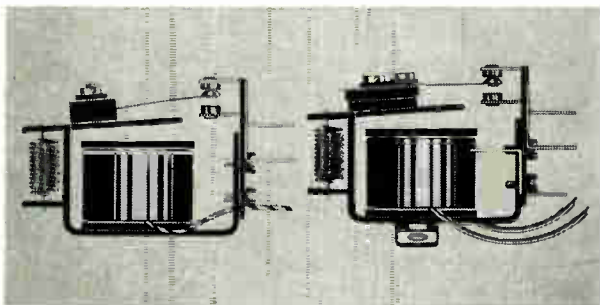

Write for full details to:

ETHER LIMITED
GENERAL PRODUCTS DIVISION
 CAXTON WAY · STEVENAGE · HERTS
 Telephone: Stevenage 3040-55

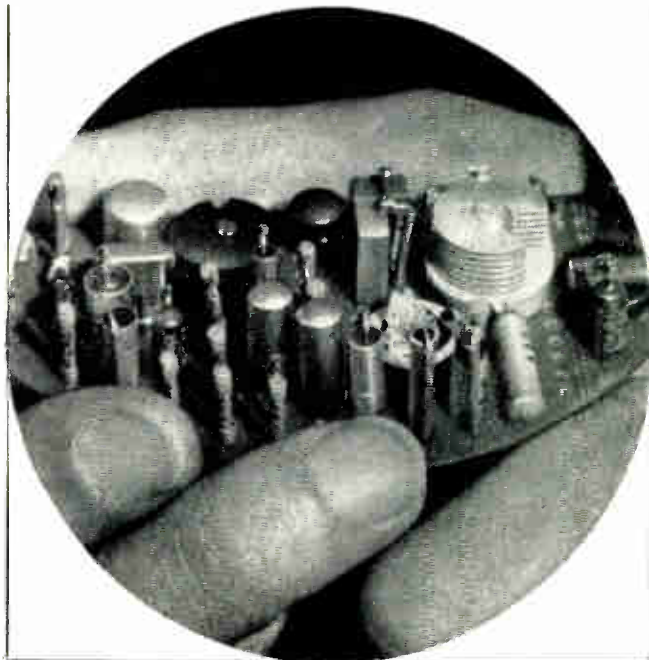

AIR DIELECTRIC
 TRIMMER CAPACITORS

The extensive range of Oxley Air and Solid Dielectric Trimmer Capacitors have proved over the years their ability to withstand and fulfill the requirements of manufacturers of high quality Electronic Instruments and telecommunication equipment.

The range includes:

- ★ Air Dielectric Trimmer Capacitors from 3 to 100 pF.
- ★ Temperature compensating Trimmer Capacitors.
- ★ Tubular Capacitors with P.T.F.E. and Quartz as the dielectric media.
- ★ Differential and Butterfly type Capacitors.

Most types are available for printed Circuit and Module board applications.

Write for technical details of Oxley products.

Longlasting Precision

OXLEY

**DEVELOPMENTS
 COMPANY LIMITED**

ULVERSTON
 LANCASHIRE, ENGLAND
 TELEPHONE: ULVERSTON 2567
 CABLES: OXLEY ULVERSTON

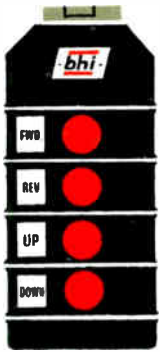

91,000 Type pendant
one or more standard
contact blocks for
pushbutton operation
in hard rubber case.



91,000 Type
Joystick control
multi-directional
control by small
positive-action
joystick.

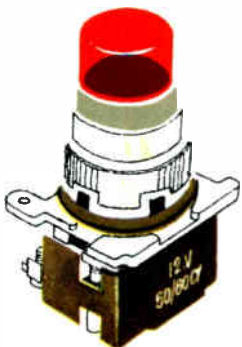

91,000 Type
Illuminated pushbutton
combined indicator
lamp and pushbutton
for panel mounting.



91,000 Type Key-
operated switch
cylinder-lock
switching with
usual choice of
contact arrangements.



Brookhirst Igranite Ltd
Elstow Road · Bedford

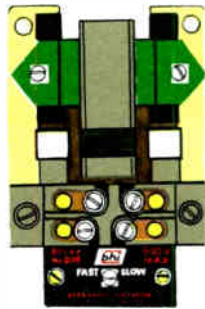

Single-contact
pneumatic timer
delayed contact
operation or
resetting.



Double-contact
pneumatic timer
any combination of
instantaneous contact,
delay after
energisation or after
de-energisation



Oil-tight limit switch
adjustable roller lever.



Oil-tight limit switch
forked operating lever.



Oil-tight limit switch
wobble stick operator.

Ring the changes in control with BHI 91,000 Series Heavy Duty Oil-Tight Units

Basis of the 91,000 range is a standard contact block which can be used singly or ganged Pushbuttons multi-directional joystick, lever, knob or key operation are available, all occupying the same amount of panel space. Indicator lamps, illuminated pushbuttons and press test buttons which light up when pressed complete a truly versatile range.



Ganged contact blocks

Up to four contact blocks per gang. Two contact sets per block, either N.O., N.C. or Changeover. Silver contacts. External screw connections. Put them together in any combination.

Pushbuttons

Positive action pushbuttons: choice of five colours, five operators – standard, long, mushroom, jumbo, staydown mushroom. One-hole panel fitting to standard 91,000 series size.

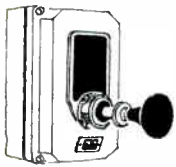

Joystick master controller

Up to eight switching positions about a central off position. Up to 12 N.O., N.C., or C/O circuits. 91,000 series one-hole mounting. Positive latching if required.

Rotary versions

Rotary versions add versatility by plunger operation from cam. Seven different cams give seven different contact sequences . . . with further variation according to the arrangement of contact blocks. Operation by key, lever or knob. Complete unit takes same space, same fixing hole as pushbuttons.

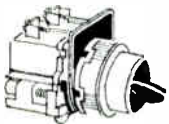

Brookhirst Igranic Limited
Elstow Road · Bedford
Telephone : 67433 · Telex : 82261

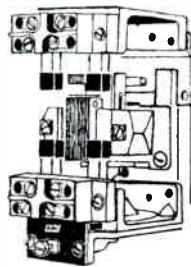

Pneumatic Timing Relay with 0.2 to 60 sec. delay – screwdriver changeover of mode of operation

One or two timing heads can be used with a single coil, each set separately to provide delay after energisation or de-energisation. One timing head and one instantaneous contact can be used. Setting up is quick, and timing then remains consistent. Contacts will make 8A or break 5A at 600V ac over a long, reliable life. Two-screw fixing, choice of operating voltages, backlash-free timing adjustment make this a simple yet versatile unit with many uses. It's the BHI type 906 pneumatic timer.

Oil-tight, and positive in action, one basic switch can be fitted for operation dozens of different ways

A standard moulded block enclosing contacts of the single-pole, changeover, twin-break type is mounted in a die-cast housing. Oil-tight cover, operation is through an oil-tight diaphragm. The contact block can be replaced by contactless switching if required. Two tapped and two through holes in the housing are provided for mounting. Action is so designed that contact is fully positive even at minimal operating speeds. Spring-return or stayput operation available on most versions.

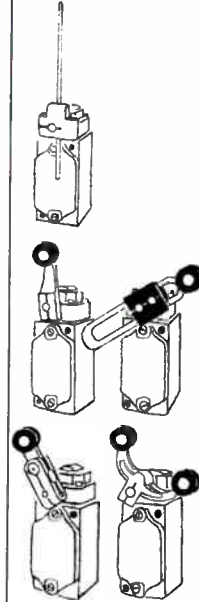

... Rotary Operators

In which the operating lever can be clamped at any angle on a rotating shaft. Also available with bare shaft for your operator.

- Adjustable rod
- Roller lever
- Adjustable roller lever
- Precision roller lever
- Forked lever
- rollers in line or offset

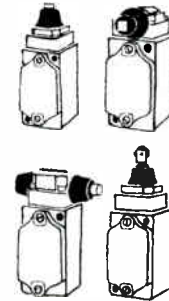

... Linear Operators

- Top push button
- Side push button
- Side push rod
- Top push roller
- Side push roller
- vertical or horizontal
- Cats whisker
- Wobble stick

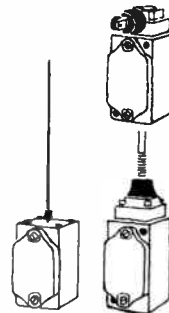

Full technical data is available from BHI. Ask for: full details of the 91,000 range

Publication ZB88
Type 906 pneumatic timer

Publication ZB56
Oil-tight Limit
Switches



DOUBLE BEAM COSSORSCOPE 2300

Model 2300 is a compact, precision calibrated oscilloscope designed specifically for high-sensitivity, low-frequency applications in electrical engineering, servo analysis, electro-mechanical transducer displays, electro-myography and electro-cardiography. A double-gun cathode-ray tube is employed. Two identical amplifiers are provided with a choice of either single-ended or differential inputs.

The triggering system provides four modes of operation: Auto, A.C. Slow, A.C. Fast, and D.C., and the sweep may be triggered from any selected point on the positive or negative slope of the signal. Mechanical triggering is available, whereby an external contact closure, developed across the MECH and COMMON terminals of the oscilloscope by the apparatus under test, will trigger the time-base, an external voltage source being unnecessary. Single-stroke operation can be primed or triggered by a push-button.

- Frequency response d.c. to 200 kc/s (-3 dB) ■ Identical Y amplifiers 1 mV/cm to 50 V/cm
- 19 calibrated timebase ranges 5 sec/cm to 5 μ sec/cm ■ Voltage calibration $\pm 3\%$ and time calibration $\pm 3\%$ ■ Mechanical triggering Z modulation and equal X-Y facilities



COSSOR
A Member of the Raytheon International Group

COSSOR INSTRUMENTS LTD.
The Pinnacles, Elizabeth Way,
Harlow, Essex, England.
Tel: Harlow 26862 Cables: Cossor Harlow

Exceptionally accurate & stable Ekco miniature tuning forks

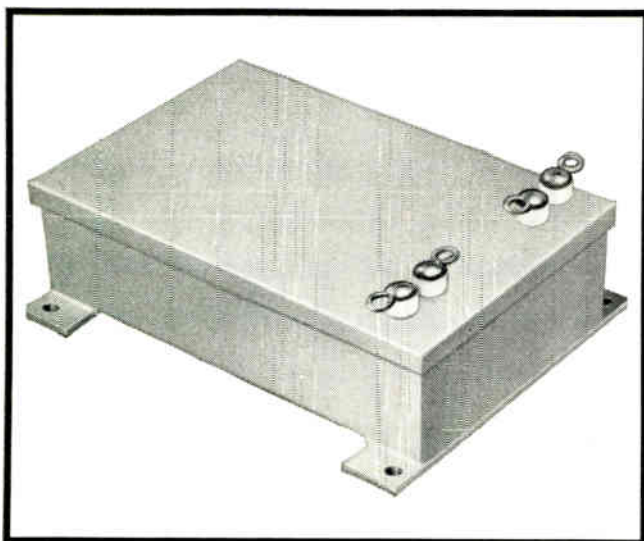

The Ekco Miniature Tuning Fork type E228 is designed for frequency control applications where high accuracy and stability are required. Of rugged construction, it is available in a range of seven standard frequencies.

The tuning fork is intended to be used with a transistorised maintaining amplifier to produce a sinusoidal signal of low distortion and stable frequency. Circuit details of a suitable amplifier can be supplied.

Typical applications include frequency control in static inverter power supplies, repetition rate control in radar systems and as laboratory sub-standards.



EKCO ELECTRONICS LTD.
AVIATION DIVISION
SOUTHEND-ON-SEA · ESSEX

WHITELEY Epoxy Resin Mouldings

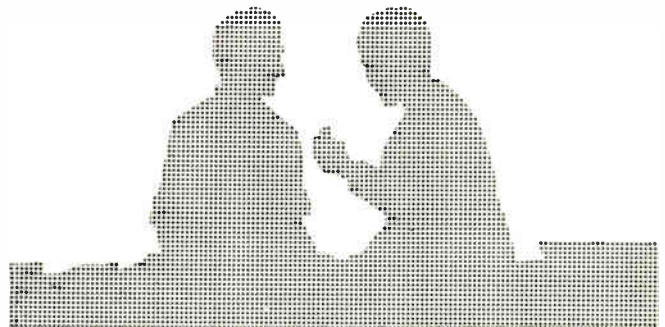

Great mechanical strength, excellent electrical insulation and complete climatic protection are ensured in Whiteley Epoxy Resin mouldings. Low shrinkage and strong adhesion to components and leads renders these Resins particularly suitable for encapsulation. Full details will be gladly sent on request.

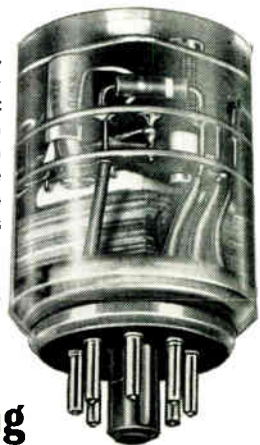

Line Isolating Transformer

Transformer Y.17525 is a low loss audio frequency transformer, for use as an isolating transformer on circuits employing 17 c/s signalling, i.e. Post Office telephones. The insulation of the 'line' winding provides isolation against voltage surges of up to 25 KV rms. and continuously applied voltages of 14 KV rms. Please write for full details.

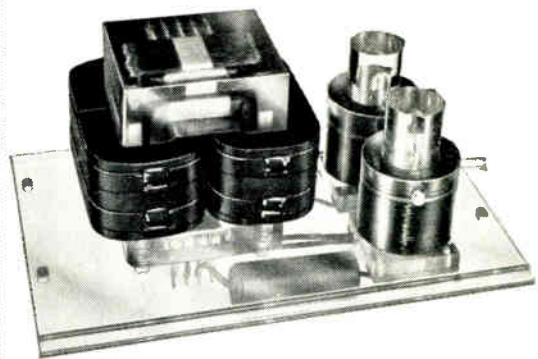

WHITELEY ELECTRICAL RADIO CO LTD
MANSFIELD · NOTTS Tel: Mansfield 1762/5

WB171A

ETHER

POTENTIOMETRIC TIME/TEMPERATURE PROGRAMME CONTROLLER TYPE 12-94

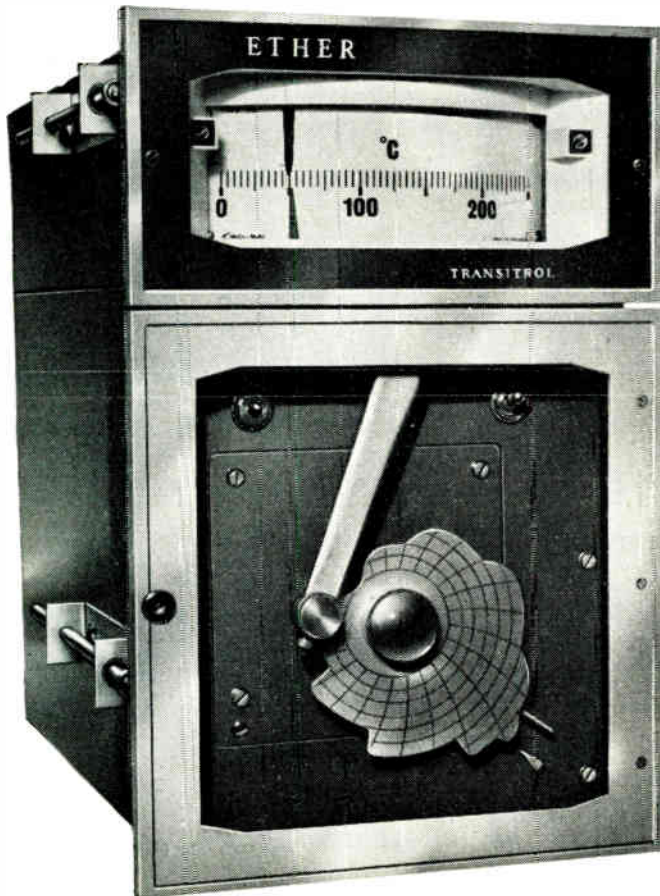

The *Ether Transitrol* 12-94, available in a variety of types, combines potentiometric control and indication with a cam-operated Time/Temperature Programme Unit. Housed in a welded steel case the equipment is fully sealed against dust and moisture. Solid state construction throughout ensures high reliability under widely varying conditions over a long working life.

In the Programme Unit a cam is driven by a synchronous motor, at a selected speed, and a gear train permits various time cycles to be chosen. Standard equipment includes two uncut cams scribed in time and temperature scales, which can be supplied cut to a tolerance of 1% of the instrument scale range. One involute-curve cam for fixed temperature control is

also supplied. Fine adjustment is provided on the control arm to correct small errors in cam cutting.

Though mainly used to control the heating and cooling cycles of furnace loads, the Transitrol can control any process in which a signal can be converted into a d.c. current or voltage.

Full specification and details of range and prices on application to

ETHER LIMITED CAXTON WAY STEVENAGE HERTS TEL: STEVENAGE 3040-55

**WE ARE
LOOKING TO
THE FUTURE**

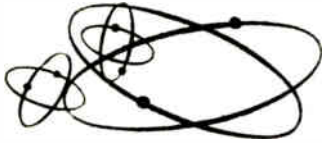

YOURS

OR TO BE MORE PRECISE, YOUR COMPANY'S AND WE HAVE FORSEEN AUTOMATION PROBLEMS ARISING IN THE GENERAL FIELD OF SEQUENTIAL CONTROL, DATA PROCESSING & LOGIC CIRCUITRY, WHICH WILL REQUIRE AN ECONOMICAL SOLUTION THAT'S WHERE WE COME IN!

Whatever the size of your company automation of your operations can take you straight into the 70's. C. & N. and their electronics 'know-how' are already thrusting forward the production systems in other companies by a decade, bringing greater efficiency, reducing expensive labour costs and increasing production.

Why lag behind when automation can do the same for you. C. & N. can provide economical answers to your particular problems. They can be analysed, converted into practical propositions, manufactured and installed as a complete system.

Our specialist team of engineers was formed to carry out such projects on behalf of the U.K. Atomic Energy Authority and we are now in a position to extend this expertise into industrial fields.

Why not make your problem our problem and see how quickly we can solve it.



**C. & N. (ELECTRICAL) LTD.,
THE GREEN, GOSPORT, HAMPSHIRE.
TEL: GOSPORT 82391/9 TELEX: 86121**



For further information circle 245 on Service Card

EVERYTHING FOR WIRING

is made by

ROSS, COURTNEY



In addition to their well known clamp washers, wire end terminals, and clips etc. they also make buckles connectors, eyelets, sockets, crimped tags, solder tags, cable straps in metal or nylon, machine attached terminal male tabs etc.

EVERYTHING in fact. So if you have a problem why not ask them for details of the particular products in which you are interested?



ROSS, COURTNEY & CO., LTD.

Terminal House, Elthorne Road, London, N.19

Telephone: ARChway 0551

U.K. LICENSEES OF
**THE THOMAS
& BETTS CO.**
INCORPORATED
U.S.A.

Look at M-O V's wide range of solid-state microwave components for Communication, Industrial and Defence Projects

M-O V have now increased their range of microwave components with the addition of no less than *seventeen* devices. The commercial introduction of so many microwave products at one time is due to the vast experience of M-O V's 600 engineers, and their extensive R & D facilities devoted to microwave technology.

Modern quality-control methods ensure repeatability of characteristics over long and short production runs.

6 Waveguide-to-coaxial transitions: S-, C- and X-bands, side and rear entry; 2.5-4.1/4.1-7.0/7.0-11.5 Gc/s; VSWR 0.8; Waveguide connectors WG10/13/16; Coaxial connectors C or N (50 ohm).

3 Waveguide isolators: 5925-6425/5925-6175/6175-6425 Mc/s; Power handling capacity 10W; Forward loss 0.35/0.5 dB; Reverse loss 25/35 dB; VSWR 1.02/1.06; Connectors WG14.

2 Coaxial isolators: 2500-4000/4000-7000 Mc/s; Power handling capacity 3W; Forward loss 1-2 dB; Reverse loss 20-35 dB; VSWR 1.2-1.5; Connectors C (50 ohm).

2 High-performance hybrid mixers: Transmitter 5925-6425 Mc/s; R.F. power level 30-40 mW; Capacitance 20 pF (modulation input); Connector WG14. Receiver 5925-6425 Mc/s; R.F. power

level 1-2 mW; Capacitance 20 pF (I.F. output); Connector WG14.

1 X-band source: 7.0-12.4 Gc/s; Electronic tuning range 100 Mc/s at 7.0 Gc/s, 150 Mc/s at 12.4 Gc/s; Power output 30 mW at 7.0 Gc/s, 10 mW at 12.4 Gc/s. Input 30 V d.c. 250 mA; Connector WG16.

2 Fast X-band diode switches: Two-way 7.0-12.4 Gc/s; Insertion loss 2 dB; Isolation 20 dB; Switching time 1 ns; Connector WG16. One-way 7.0-12.4 Gc/s; Insertion loss 2.5 dB; Isolation 25 dB; Switching time 1 ns; Connector WG16.

1 X-band diode attenuator: 7.0-12.4 Gc/s; Insertion loss 1 dB; Attenuation 30 dB; VSWR 1.5 at minimum attenuation, 2.0 at maximum attenuation; Connector WG16.

NO OTHER EUROPEAN MANUFACTURER CAN MATCH THE CAPABILITY OF M-O V IN THE FIELD OF MICROWAVE TECHNOLOGY



For full data and application sheets please write to, or telephone:

THE M-O VALVE CO LTD

Brook Green Works, Hammersmith, London W6

Telephone: RIVerside 3431 Telex: 23435

RAYTHEON

**1 WATT CW
ARGON ION LASER**

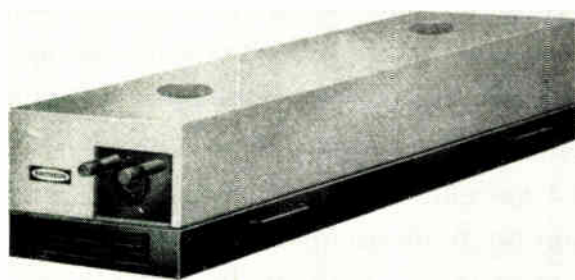

Raytheon now offers the Model LG12, a CW Argon Ion Laser producing a minimum of 1 watt in the single transverse mode (TEM_{0,0}). The one-watt power output of the LG12 is over the range of 4545 to 5145 angstroms in the blue-green portion of the visible spectrum with the principal lines at 4880 and 5145 angstroms. Beam diameter is 2 mm at the exit aperture and less than 3 milliradians divergence. The water-cooled laser head measures 40" long, 12" wide, 10" high and weighs less than 100 pounds.

WALMORE
ELECTRONICS LTD
11-15 BETTERTON ST., DRURY LANE, LONDON, WC2 Tel: TEMple Bar 0201-5

**SERVISCOPE
MINOR**



Extend the range of your present test instrumentation with this versatile Telequipment oscilloscope. Simplified operation—minimum controls, automatic time base synchronisation—but top quality construction.

2.75" tube with graticule, contrast filter and rubber light hood. Bandwidth 30Kc/s (-3dB); maximum sensitivity 100mV/0.5cm division. Time base continuously variable from 100usecs to 100msecs per 0.5cm division. Mains operated, fully portable. Instruction manual supplied.

Descriptive leaflet on request.

Obtainable only direct from the country's largest specialist manufacturer of portable oscilloscopes for science and industry.

Serviscope is a registered trade mark

TELEEQUIPMENT

Telequipment Ltd., 313 Chase Rd., Southgate, London N.14
Tel: Fox Lane 1166

Please send me, without obligation, the descriptive leaflet on the Serviscope Minor.

NAME

ADDRESS

IE/2

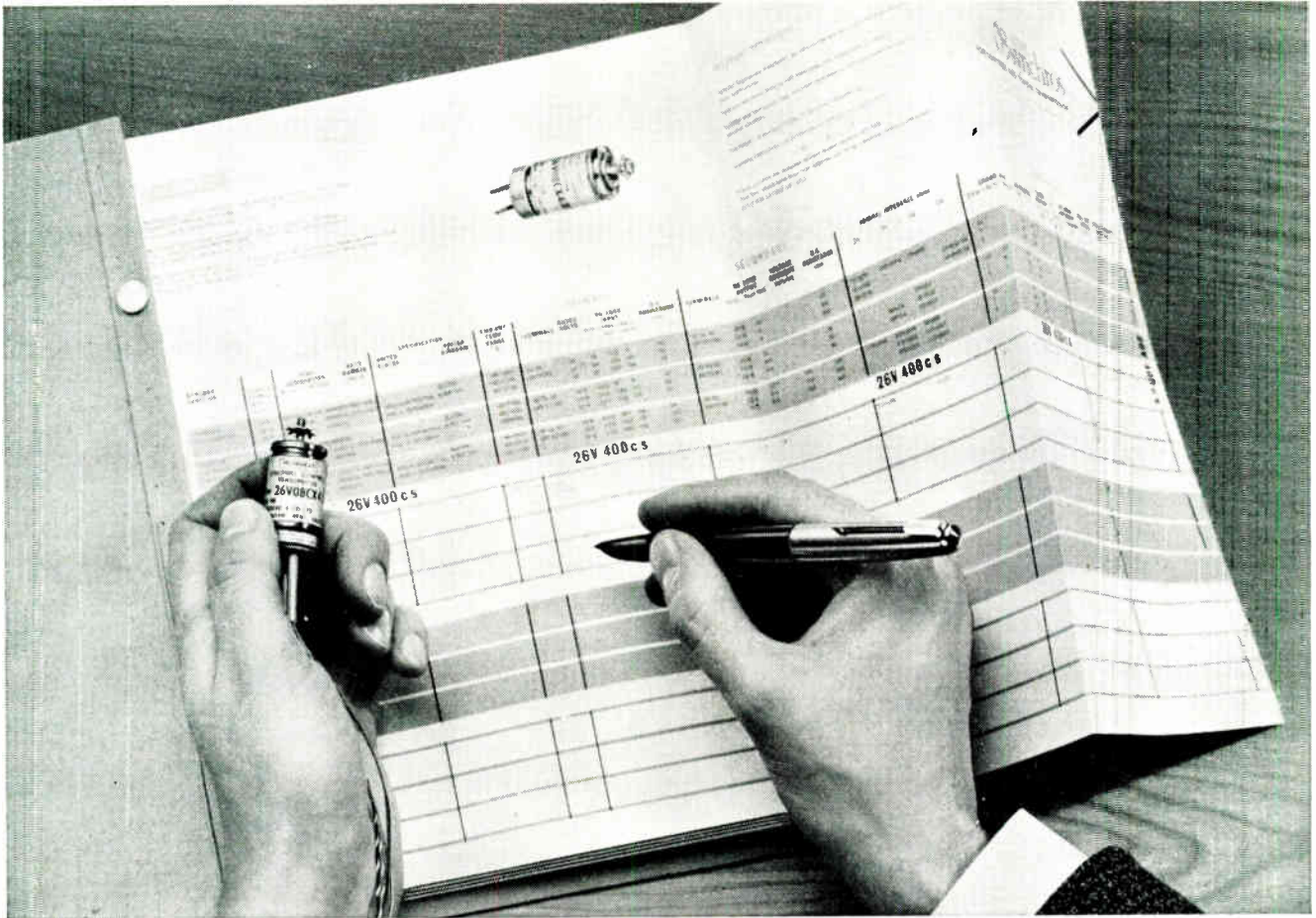

NEW, COMPREHENSIVE DATA

- SYNCHROS AND SERVO MOTORS

Just published, and available *free* on request, is the new Muirhead Synchro and Servomotor data binder. It contains the most comprehensive information available anywhere, and includes special details on Mounting and Zeroing. It is an essential 'working tool' for every designer. Data sheets have a new, easy-to-read design. There is, for example, a fully detailed sheet for each synchro from size 08 to 23, giving NATO stock

numbers where applicable. Synchros qualified to British Specification DEF.148 are now included. It is disposable. The newest idea yet is to avoid the need for amendments—none will be issued, for you will get a new and complete binder the instant major changes occur. Send for your free copy, today! And remember, there is a Muirhead Synchro for every synchro function.

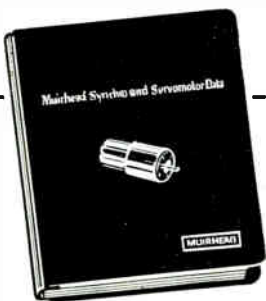

Muirhead & Co. Limited
Beckenham · Kent
Beckenham 4888

MUIRHEAD

Please send me, free of charge, a copy of the new Muirhead Synchro and Servomotor Data Binder:

NAME POSITION

COMPANY

ADDRESS

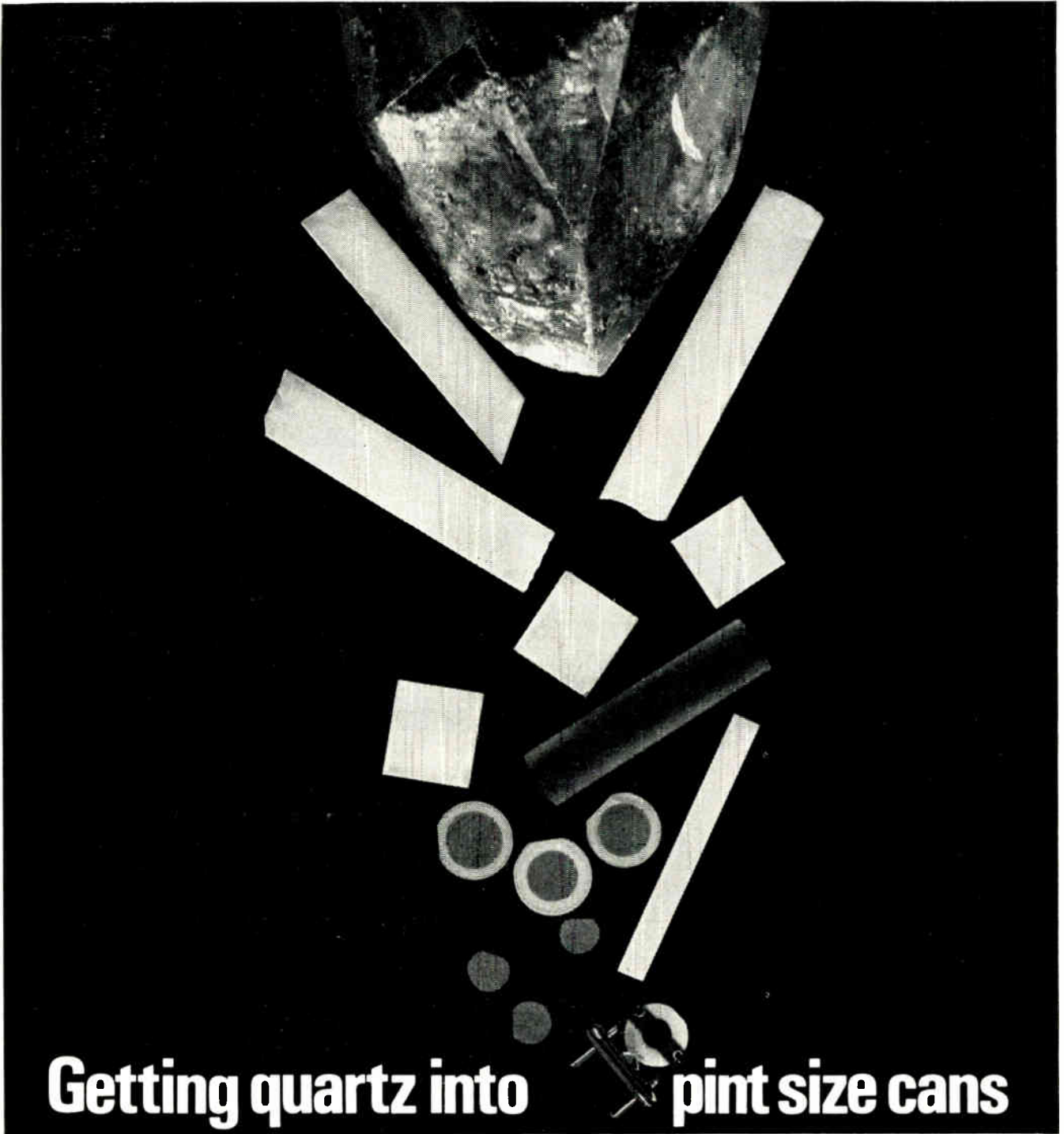

Getting quartz into pint size cans

SUB-MINIATURE HOLDERS SAVE SPACE

To meet the increasing demand for lightweight compact components in advanced equipment, Brush are now selling a range of sub-miniature styles. Styles Q12 and Q13 (covering the frequency range 4—100 Mc/s) permit a sixfold increase in packing density, with



no loss of stability. Other alternatives in metal and glass encapsulation are also available covering the frequency range 50kc/s to 100 Mc/s. Crystals can be supplied to meet current British and American service specifications.



KEEP YOUR EYE ON BRUSH

BC  **BRUSH CLEVITE**

BRUSH CLEVITE COMPANY LTD HYTHE SOUTHAMPTON PHONE HYTHE 3031 GRAMS BRUDEV HYTHE SOUTHAMPTON TELEX 47687

INDUSTRIAL ELECTRONICS

Incorporating British Communications and Electronics

N.E.R.C.'s First Year

The National Electronics Research Council (N.E.R.C.) has now been operating for about one year and last month they held their first Annual General Meeting of the Council.

The first annual report reminds one that N.E.R.C. was founded from an idea put forward in 1961 by Admiral of the Fleet the Earl Mountbatten of Burma. At that time, Earl Mountbatten drew attention to the lack of co-ordination in the electronics research carried on by the universities, by government establishments and by industry and he suggested that consideration should be given to the formation of a co-ordinating body, or research council.

Following a number of preparatory meetings and a lot of groundwork, N.E.R.C. was formed and the Council was duly incorporated on 20th July 1964, with Earl Mountbatten as the Chairman and a General Committee comprising 5 representatives from the educational field, 6 representatives from governmental bodies and 12 representatives from industry. The voting power of the industry group is further increased by the fact that the governmental-body representatives have chosen to be representatives without voting rights. This means that the N.E.R.C. tripartite partnership in the field of electronics research between government, industry, and the academic world in Britain favours industry—which most people in industry will agree is as it should be.

Most of the work in the first year of existence of any co-ordinating body is of an organizational nature. N.E.R.C. is no exception in this respect and it has formed links with other bodies and created one or two smaller committees. In addition two major projects have been initiated by the Council. The first deals with the selective dissemination of information (S.D.I.) to electronics research workers. The Department of Education and Science has awarded £6,000 for support of the first five months of the S.D.I. project. During this period the work included the preparation of the detailed specification of the S.D.I. system and compilation of tenders from computer bureaux so that a definitive figure for the cost of the whole project is available. The second project, now successfully under way, concerns the publication of *N.E.R.C. Review*, which is produced quarterly and aims to review the progress in electronics research.

In spite of the general approval which has greeted the whole concept of N.E.R.C., the fear has been expressed that the Council will be just another body of laudable intentions and high resolves whose promises outrun its performance. At this early stage one cannot be positive about the future usefulness of N.E.R.C., but one can see that a firm foundation has been laid for what could be a vitally important body.

All agree that Britain cannot afford the money and manpower effort spent and effectively lost in research which is duplicated by the lack of co-ordination. Given the opportunity and co-operation N.E.R.C. can reduce this wastage and thereby bring benefits to all.

ON-LINE COMPUTER ALARM ANALYSIS

By P. C. M. KAY*

*A.E.I. Automation Ltd.

An on-line computer alarm-analysis system has recently been supplied to the CEGB Nuclear Power Station at Oldbury-on-Severn. This article discusses the monitoring requirements of such a plant, and describes the various operating techniques of the alarm scanning, checking and indicating equipment being used.

ONE of the main characteristics of modern industry is the constantly-increasing size of manufacturing plant. Larger plants frequently become highly complex as the economic and technical possibilities of adding refinements to increase their efficiency arise.

From the operators' point of view, however, the great complexity of these plants makes them difficult to control, and their size and cost makes the results of incorrect operation correspondingly expensive.

Power stations are no exception to this trend, and have led to the introduction of large numbers of alarm warning devices (ranging from pressure switches to large limit-checking data loggers) to assist the operators in preventing plant damage.

Alarm Scanning Requirements

All new power stations are operated remotely by a small staff in a central control room, where all warning devices must, therefore, be indicated. The usual method of displaying large numbers of alarm indications uses small glass panels inscribed with messages which are illuminated when the appropriate warning device is operated. The appearance of new alarms usually causes an audible warning to sound and a message to flash until an acceptance button is pressed.

When the number of alarm indications rise into the thousands, however, the necessary banks of alarm panels become very large, increasing the size of the control room and making proper surveillance by one man difficult. Furthermore, in these highly-instrumented and heavily-interconnected plants, one plant fault can trigger off a large number of alarm indications simultaneously, and the operator will then have difficulty in deciding quickly what has happened and what action he should take.

At the 600-MW two-reactor nuclear power station which is at present being constructed at Oldbury-on-Severn by the Nuclear Power Group, 3,000 alarms have to be displayed in the control room and a new type of alarm-handling system is being introduced.

All alarm signals are scanned by an AEI 1040 process-control computer, which suppresses unimportant signals and displays the remainder as a set of plain English messages on four c.r.t. display units.

The Alarm System

The complete alarm system is shown diagrammatically in Fig. 1. In addition to the monitoring of the 3,000 alarm contacts on the plant, two Burst Cartridge Detection (B.C.D.) computers and two temperature scanners are used to feed alarm data to the central computer for transmission to the display screens.

The B.C.D. computers have magnetic drum stores and plug-in wired programmes. They operate in conjunction with 16 precipitators, which measure the radio-activity of gas samples from 450 groups of fuel channels. Radio-activity in the coolant gas emerging from a fuel channel indicates that radio-active fission products are escaping from a leaking or burst fuel cartridge. The B.C.D. computers check the activity levels against high limits, check the rate of change of activity, and calculate averages over a period of time. All readings are transmitted to the computer but

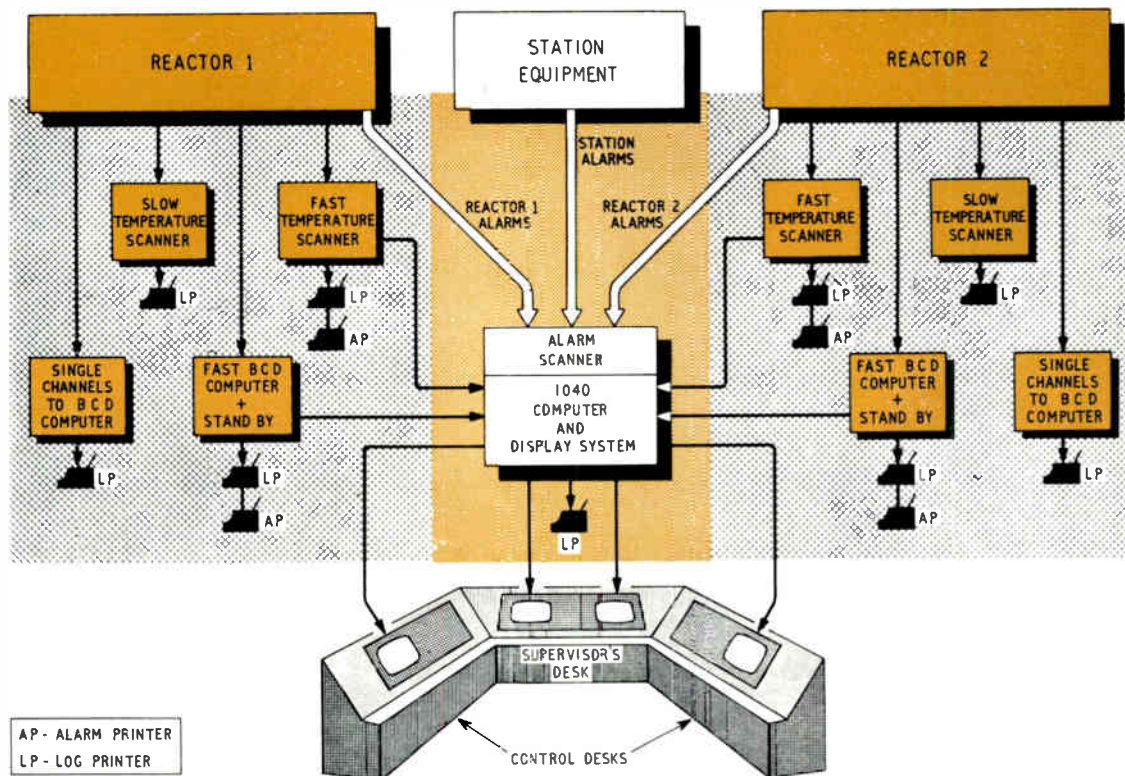

Fig. 1. A block diagram of the computer scanning and display system

only those outside the limits are displayed on the c.r.t. screens.

The temperature scanners are data loggers, each of which scans 150 thermocouples, checking each one against a limit. As with B.C.D. information, all values are transmitted to the computer, those outside the limits being marked for retransmission to the displays.

In addition to passing them to the main computer, the B.C.D. computers and the temperature scanners both record their results on teleprinters. A regular log of all points is produced on one printer, while alarms are recorded on another. These printers are normally kept in a logging area outside the control room, but the alarm printers are mounted on trolleys and can be moved into the control room if either the main computer or the display system should fail.

The Computer

The main computer performs an average of 50,000 instructions per second, and has a core store of 4,096 44-bit words and 2 drum stores of 8,192 words each. The instructions and data necessary to enable the computer to analyse the alarm patterns and to assemble the appropriate messages are read into the computer on punched paper tape. They are then transferred to the drum stores, whose writing heads may be isolated to prevent accidental destruction of the information by a momentary computer failure.

The computer has a fully-interleaved transfer system, which enables blocks of information to be transferred to or from all the input/output peripheral devices virtually simultaneously and in parallel with the operation of the arithmetic unit.

The alarm computer reads the state of the 3,000 alarm contacts on the plant via the alarm scanner, and all points are scanned four times per second. The contacts are typically oil-pressure switches in the many lubricating

Fig. 2. A view of one of the two reactor control desks, showing the display screen on the right

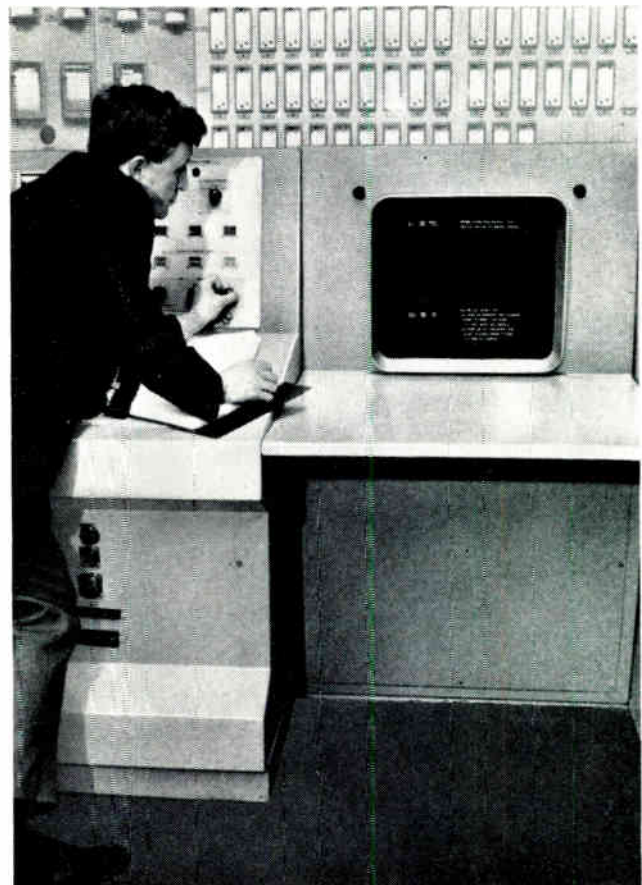



Fig. 3. A close-up of one of the display screens on the control desks, indicating an alarm message

systems, differential-pressure switches across seals and strainers, travel-limit switches for reactor control rods, and overcurrent relays for motors, circuit breakers and vital nuclear-instrument faults. The alarm scanner is essentially a 40-pole 80-way electronic switch connecting 40 alarm contacts at a time to one of the computer input channels.

Alarm Analysis

The main function of the computer is the analysis (based on the cause-and-effect relationship between many of the alarms) of the alarm patterns. It must: determine the basic cause of the appearance of a group of related alarms; determine which alarm indications are giving unnecessary information and can therefore be suppressed; select the appropriate messages of advice or warning to be transmitted to the operator; and deduce (from the appearance of others) faults such as leaks, bursts, etc., which cannot be instrumented.

One word (44 bits) of data associated with each alarm condition gives information on all the faults that can cause it and all the faults that can arise as a result of it. A second word contains details of the alarm.

This information allows the computer to pick out groups of related alarms and to establish the basic cause and the latest and most urgent effects in the cause-and-effect chains. (All intermediate alarms are suppressed.)

A typical cause-and-effect chain might be formed by a choked strainer causing a lack of cooling-water flow to an oil cooler. This would result in hot oil flowing to a pump or blower bearing, thus causing the bearing to over-heat and the pump to trip. Under these circumstances the computer would display the choked strainer fault and the pump trip, indicating that the two were related. It might also display advice to the operator to check that the standby pump starts, or alternatively, if a standby pump were not available, a warning of the consequences.



LECT NI
MM IN ATION
NT LMENTA ON
N L

These messages of advice or warning can be associated either with a single alarm or can be caused to appear only when certain combinations of alarm signals occur.

Computer Self-Checking Facilities

Apart from the analysis procedure, a large number of instructions, taking up a significant proportion of the computer's time, are required simply to assemble the alarm messages from coded data and to organize their transmission to both display screens and the teleprinter.

A further group of instructions is used to check continually that the whole system is operating correctly. Every $\frac{1}{4}$ second, before requesting a transfer of information from the scanner, the computer performs a routine to check its own operational devices. If a fault is found, or if the computer fails completely, no request for information is made and a timing circuit in the scanner immediately indicates a computer failure.

As well as causing messages to be displayed on the c.r.t. screens, the computer records the appearance of all alarms on a teleprinter, together with the time. The log is printed in such a way that it is possible to see which alarms were suppressed and which displayed to the operator.

Alpha-Numeric C.R.T. Display

In the control room there are four 21-in. c.r.t. screens—one on each of the two reactor control desks and two on the supervisor's desk. How the information is displayed on the reactor desks is shown in Figs. 2 and 3, and it is divided into three parts:

The left-hand side of the screen is reserved for B.C.D. and temperature information, above and below respectively. Three numbers are displayed for each point outside the limits, the first being the point identification code, the second the actual value, and the third the limit which has been exceeded.

On the right-hand side are displayed the alarm messages derived from alarm contacts on each reactor unit. Sets of messages that are derived from the same basic plant fault are grouped together (between rows of hyphens) with the basic fault marked by an asterisk. Thirty-two lines of 39-character messages can be displayed, but if more alarms than this occur at one time, they are simply held in a queue in the computer store. The operator is warned of the existence of a queue of undisplayed alarms by a lamp on the control desk, and he can examine the queue by means of a switch which causes existing messages to be moved up and off the screen while new information from the queue is inserted at the bottom. The queue lamp is extinguished when the end of the queue is reached.

All the information on the reactor-desk screens is repeated on the screens on the supervisor's desk, with the addition of 16 lines of station alarm messages at the bottom right-hand corner. The station alarms appear on both these screens so that the failure of a tube does not prevent any messages reaching the operator.

The operator's attention is drawn to the new alarms by an audible warning and a flashing light which indicates which section of the display is affected. He cancels these by pressing buttons on the desk. The appearance of new alarms also freezes the display, to allow the operator to read messages which would otherwise appear for only a short time, and the display is unfrozen by a reset button.

The characters on the c.r.t. screens are produced by causing electron beams to trace out the appropriate shapes rather like a pencil writing on paper—a method quite different from that used to produce a normal television picture. These writing movements naturally take place at very high speed (4,000 characters can be traced out in about 100 msec), thus allowing a complete display of information to be

regenerated 10 times per second, which is enough to give a virtually flicker-free display.

The display system at Oldbury has its own core store, although a later version can share a computer's store. Six-bit character codes are read into the display store by instructions from the computer and the appropriate characters are then displayed until they are over-written by further computer instructions.

The display units are mounted on trolleys which roll into the backs of the control desks, spare trolleys being provided so that faulty display units can be quickly replaced.

The Oldbury Reactor

This equipment is now being commissioned at Oldbury and will shortly go into service. It is the first of a series of computer-based information-handling systems using c.r.t. displays which is being planned for future power stations.

The gas-cooled reactor, with natural uranium fuel in Magnox cans, is one of the most highly-instrumented plants in the world and there are good reasons for this. The fuel cans are working close to their temperature limits and a few can failures are therefore to be expected. Faulty cans in any of the 3,300 fuel channels will release radioactive fission products into the coolant stream and must therefore be detected and removed; fuel and coolant gas temperatures must also be carefully monitored. Furthermore, in common with all reactors, correct operation of the control rods is vital and large numbers of alarm indications arise from the rod-control equipment and its associated instrumentation. It is not surprising that the problem of handling large numbers of alarm indications has arisen first in these plants, though with the trend to large plants and increasing use of remote control, the problem can be expected to spread to other areas particularly in the chemical-process industries.

Purely-Logical Computer Operation

Another feature of the Oldbury equipment is that the main computer is not required to perform any mathematical functions—it is being used purely for logical operations. Most computers in on-line applications perform many more purely-logical operations than is perhaps generally appreciated. An application with no mathematics at all does,

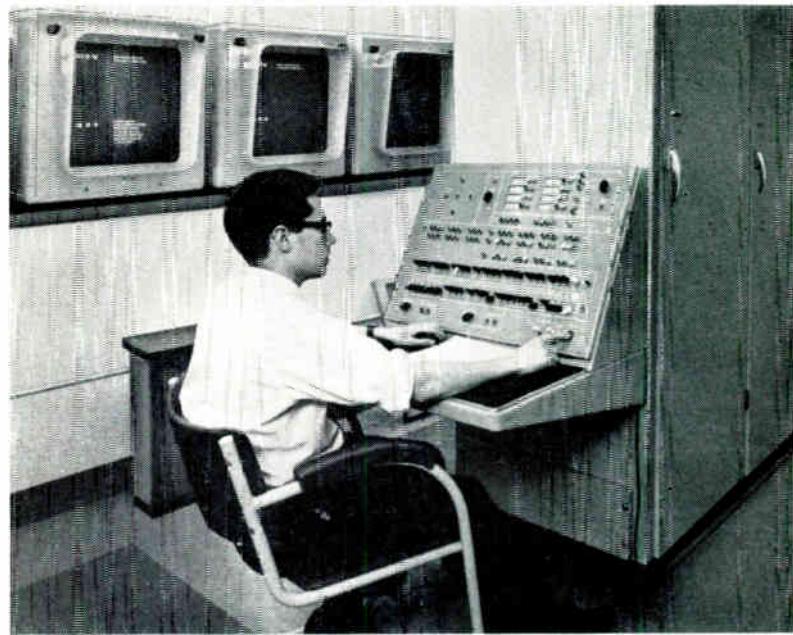

Fig. 4. The computer at the Oldbury Nuclear Power Station being tested

however, drive home the point that computers can earn their living on logical operations alone. The cost of process computers is still decreasing and it is likely that they will find increasing application in the field of logical decision taking, as they have a number of advantages over large assemblies of relay or solid-state logic circuits.

Their ability to time-share their circuits between a large number of different jobs can reduce the total number of components in a system, with the consequent reduction in cost and improvement in reliability. Even more important is the fact that one hardware design can be used for many different applications and the development cost can therefore be spread. Finally, the hardware can often be ordered and manufactured before the function of the equipment is known exactly.

Optical

Machines which 'read' printed alphanumerical characters by an optical process are often used in data processors and advantages can be gained if data is fed into the processor in a printed form which can be read by human operators, such as on invoices or data sheets, rather than in a coded form on punched tape, punched cards or magnetic tape. Existing optical character-reading machines rely on specially-shaped characters for their recognition of them. They recognize the character by comparing the entire character being read with standard characters programmed into the machine or by inspecting parts of the characters (i.e. the individual strokes) and comparing the combinations of the vertical and horizontal strokes with combinations for standard characters also programmed into the machine. (See *Industrial Electronics*, Volume 2, numbers 8, 9 and 10, the August, September and October 1964 issues, pages 397, 410 and 475: *Developments in Electronic Reading Machines* by John B. Rudkin.)

A team at the Mullard Research Laboratories has been devising a system for the recognition of imperfect printed and handwritten block capitals. The system consists of

Optical Reading

defining characters by the relative positions of a set of points corresponding to certain features of the characters. It was found that this method provides the least ambiguity and tests on a computer programme showed it to be adequate. The features chosen are the ends of lines, angles between lines, curves and loops. A point will define the end of a line or an angle between two lines and curves can be specified by the point at the centre of the arc of the curve. Loops cannot be specified by single points and therefore they are combined with ends, angles and curves to form other features such as an angle-on-a-loop. In all there are six defining features.

The features for each character are written down in order and form codewords and these can be entered into a store in the reading machine. Each character may have more than one codeword depending on the different ways in which the character can be written but, as this is a flexible system, the store may be added to as a new codeword for each letter or figure occurs. The machine can then compare the features of the character it is reading with the codewords in the store and thereby identify the read character.



ONE of the world's largest computer systems, the GE-645, has been developed by General Electric Company (U.S.A.) and is to be delivered to the Massachusetts Institute of Technology this year. It has been designed specifically for large-scale time-sharing operations, and should not only reduce considerably the costs of computing but also spread more widely its availability and use.

Time-sharing is a term that describes the technique of allowing many people to use, simultaneously, the full services of a computer, and the GE-645 system will enable as many as 300 out of over 1,000 possible subscribers to share the central computer at the same time.

The concept of a number of users sharing the time and services of a computer is not especially new, and arose originally out of the economic necessity for spreading the operating costs of a large powerful installation. The machine still treats its work load in sequence, but moves back and forth between its various jobs in such a way that results are provided to each user to suit his requirements.

A time-sharing computer system, besides processing complete programmes in batches lasting minutes or hours, can also meet the demands of subscribers who need 'conversational' answers (to problems requiring a step-by-step solution) within seconds, or 'real-time' answers (to actual computing problems) within milliseconds.

TIME-SHARING

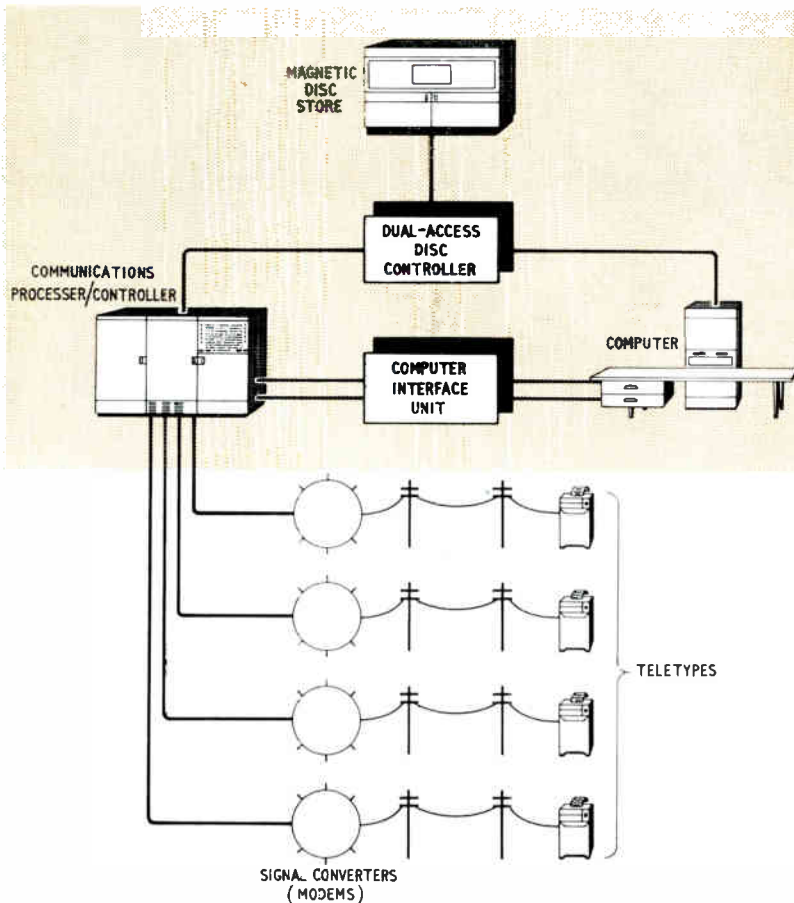

A block diagram giving a general impression of a computer time-sharing system

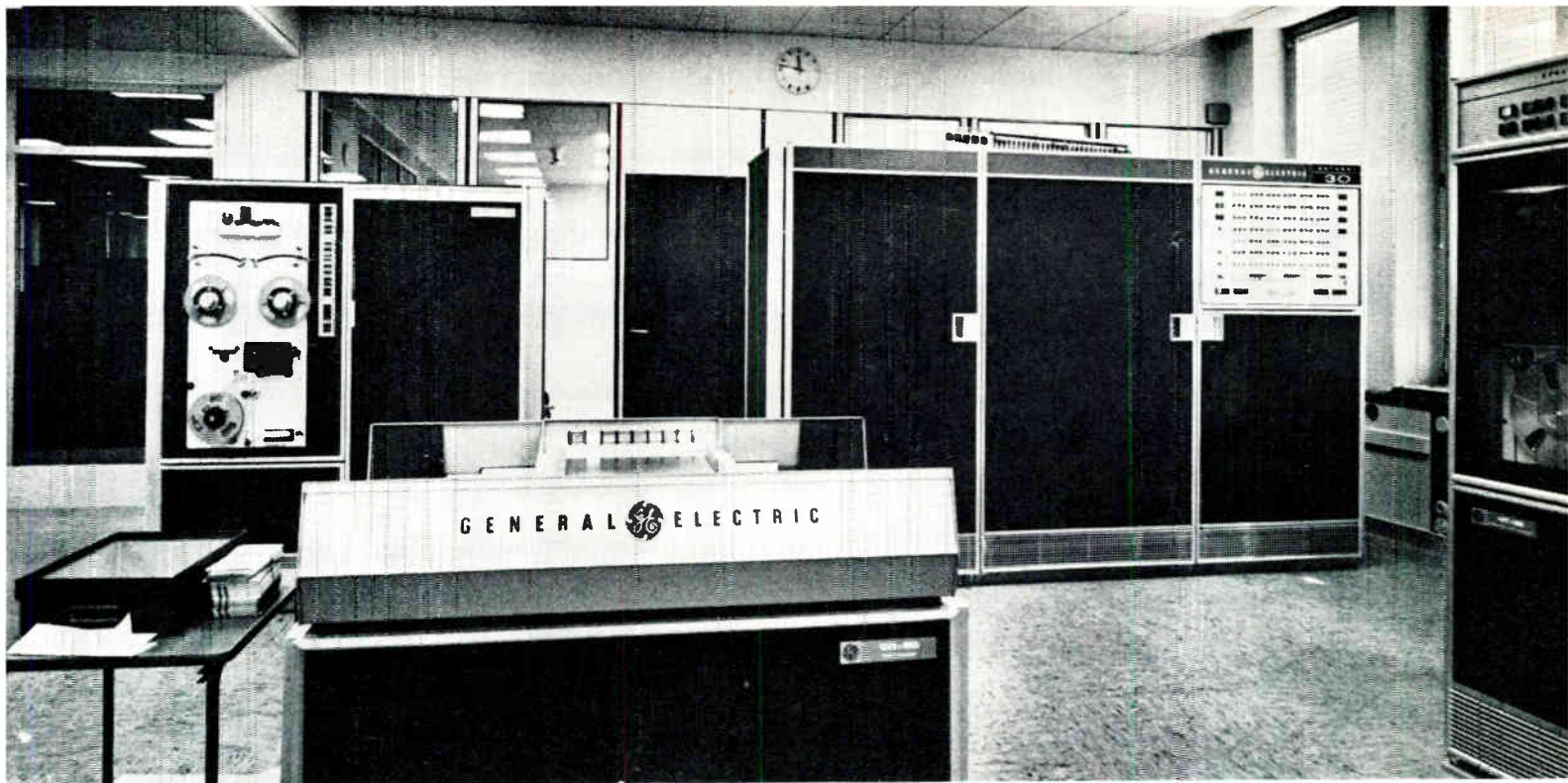

One of the time-sharing computer systems (the compatibles/600) manufactured by General Electric Company (U.S.A.), whose computers are marketed in the United Kingdom by De La Rue Bull Machines Ltd.

COMPUTER SYSTEMS

It accomplishes all these jobs automatically, without compromising the needs of any of them, and in effect acts for each subscriber as if he were the only one using the system. It will also accommodate a variety of plug-in communications devices (operating at various speeds), such as small-scale digital computers, analogue computers, teletypewriters and visual-display devices.

The first generation of time-sharing systems consisted of research and experimental computing systems, which used existing computer equipment modified to work conversationally on a limited scale; most systems being operated during the past two years fall into this group.

The second generation appears to fall into two classes: (1) limited systems, which are those which represent improvements on and modifications to the first generation; they carry out lower-cost operations and have a capacity limited to 30 or 40 simultaneous users, with up to 100 connected terminals; (2) extensive systems (those of the present day) which employ equipment and software specifically designed to handle simultaneously the problems of hundreds of users from over a thousand subscribers. The GE-645 is an example of such a system.

Several technical developments in recent years have resulted in the production of much cheaper time-sharing systems. The cost per electronic logic function has continued to fall rapidly, while the speed of the logic has increased; this means that large quantities of electronic logic can be devoted to making more efficient use of other portions of the computer system, including electro-mechanical devices, communications equipment and mass storage. Also, large-volume random-access storage (the type which makes time-sharing systems possible) has recently become commercially available at greatly reduced costs; as the total available volume of storage per device has grown, the cost per bit of storage has decreased. The result is that present-day computers can store economically

large volumes of information and provide it to users at random—something which has never been feasible with sequential storage equipment using punched cards or magnetic tapes.

As a result of the experience gained from experimental and limited time-sharing systems, several significant benefits to computer users are apparent. Many new problems have been solved which, in the past, have been too large to be handled by slide rule or desk calculator, yet too small to be submitted to the extensive and time-consuming programming step necessary to gain solutions from traditional computers. As a result, mathematicians, design engineers, business planners and statisticians have turned to time-sharing systems in increasing numbers.

An increased accessibility of computers to business and geographic communities is another advantage; through the use of teletypewriter terminals in homes, offices, class-rooms, production plants and laboratories, users have quick and convenient access to a computer which may be located many miles away.

Future development of time-sharing computer systems appears to be moving in two principal directions. First, towards the growth in business and industrial-management information systems, where executives will have direct access to most of the information necessary to run their businesses. And secondly, towards the development of information utilities within individual companies, industries, professions, universities, government institutions and localities. Local time-sharing systems may eventually be interconnected between geographic regions, thus completing a nation-wide network of information systems.

INDEX TO PRODUCTS

For the convenience of the reader who requires rapid access to information on specific products, an 'index to products' is provided on the same sheet as the reader enquiry cards

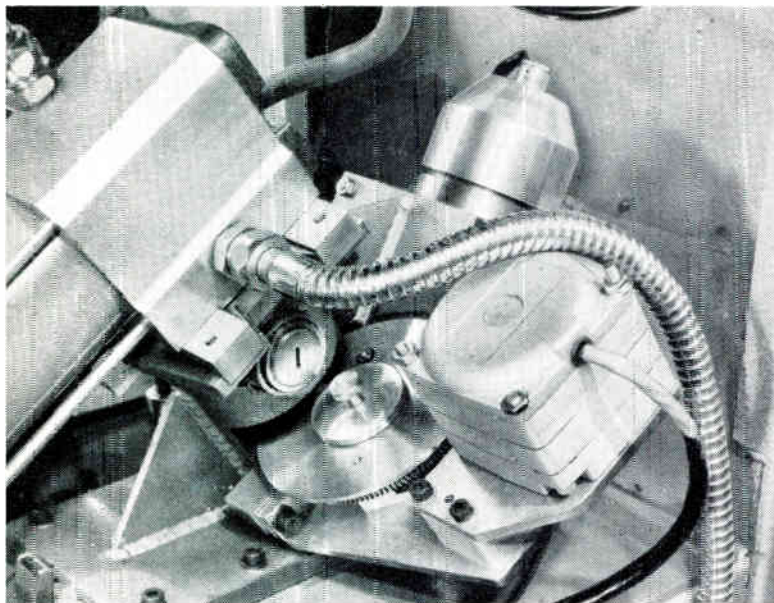

In this picture the X-ray tube can be seen on the left with the servo motor on the right and the photomultiplier above the motor

A typical Cendrex installation at the Bevercotes Colliery

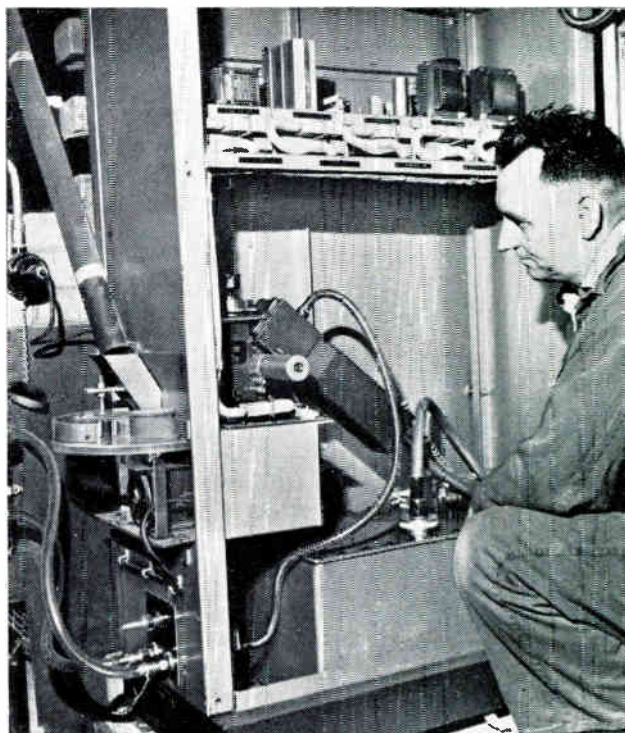

potentiometer are a d.c. power supply acting as a resolver unit, and the output circuit. Current in this circuit varies from zero to 5 mA but this of course can easily be converted to other signal standards if required.

Process Control Features

A strip-chart recorder and an indicator are normally mounted in the front door of the cabinet. Although these are sufficient to give immediate indication and a permanent record, it is usual to take advantage of the automatic control facility by using the output current to operate current-sensitive relays. In typical systems the relays are used to regulate the coal-washing machinery, or to re-cycle the coal through the washery. Another form of operation uses several bunkers containing coals of different ash contents, the feed from the bunkers being controlled to give a mix of constant quality.

A rather different type of application, found in power-stations that use pulverized coal, entails the adjustment of the boiler controls, such as fan speed etc., to optimize the combustion conditions according to the varying quality of the coal.

Economy and Practical Advantages

Apart from the fact of having a continuous and accurate sample measurement, a big advantage of the Cendrex apparatus lies in the time saved between analysis and appropriate action—the distance-velocity lag. By pyrolysis, the time taken to read a sample is at least fifteen minutes, and in practice the time taken to act on this in passing on readings and adjusting manual controls can be up to one hour.

The Cendrex method, however, by reducing sample time

and providing automatic control, reduces the lag to the order of 3 to 6 minutes, with the additional advantage of reducing the number of operatives required per shift. Quality consistency is also, of course, vastly improved by the automatic technique.

Economy of operation is another important factor, although not necessarily obvious from an examination of the operating principles. This has been shown in several cases overseas, and again recently in this country following a careful cost analysis, to amount to a saving of the complete cost of the equipment within the first year of operation. The necessary capital cost of elaborate X-ray and electronic equipment is, on this basis, completely justified within a comparatively short period by the reduction of plant running costs alone, and is an example of the service that electronic engineering can perform for industry.

Automatic Landing by Super VC10

A successful fully-automatic landing has been made at Gatwick airport by a Super VC10 which was fitted with a duplicate monitored autopilot manufactured by Elliott-Automation. The landing was performed as part of the current series of proving trials being carried out on an aircraft made available by the British Aircraft Corporation.

All VC10s and Super VC10s are fitted with the autopilot equipment which is the only system capable of continuous operation at full accuracy and performance after any failure. More than 70,000 airline flying hours have been accumulated and the present trials will extend its use into landing in poor weather conditions.

This is the most advanced equipment in the world to fly in airline service and Britain is now ahead of any other country in the application of new flight safety techniques.



In the second part of this article, the author describes the technique of model-building for the description of processes requiring automatic control.

IN the first part of this article the several experimental methods used for measuring process frequency response functions were reviewed. All these methods require considerable effort to perform, so that the usefulness of the results needs to be well established.

All process plants are (mathematically) non-linear, and thus the principle of superposition does not apply. Neither do the transfer function techniques of servo theory, since these all depend on the property of linearity. In practice the majority of processes can be successfully regarded as linear when small perturbations about a steady state are being considered. Fortunately this is usually the case in control studies, and linear design methods are used. If the process is to operate at steady states covering a wide range of conditions (e.g. from 20% to 100% of full capacity) the frequency response function must be measured at several different levels within the range. If non-linearities are severe the controller gain settings may need to be varied according to the process operating level.

Non-linearity complicates the design of control systems for full-scale plant which are based on the measured dynamic characteristics of pilot plants. To scale-up process time constants correctly they must be analytically related to physical measurements of the plant.

Multivariable Processes

All real processes have more than one significant input and output. A transfer function expresses the relationship between one input-output pair, and a complete description of a process requires measurement of a matrix of transfer functions relating all the possible input-output pairs. Multivariable processes often show interaction between variables; that is, one input affects several outputs.

This greatly complicates the control design problem. Suppose that a process is steady with all outputs at their desired values, and then one output is disturbed. If the control scheme alters one input to counteract the change, then several other outputs will alter from their set points because of the process interactions. In general an error in one output requires a simultaneous change in all input variables if the disturbance is to be removed rapidly. As a specific example consider a man taking a showerbath: he demands a constant water flowrate at a particular temperature. If the hot water supply temperature falls he must adjust both the hot and cold taps in order to maintain the desired conditions.

Mesarovic¹ has discussed the extension of linear design methods to multivariable processes. The feedback control matrices required for best control of a strongly-interacting process probably require a computer for their implementation. What is more important is that in most cases, although computer control may not be used, the analysis of proposed control systems becomes very difficult.

When dealing with very non-linear processes, or those in which the variables interact strongly, the empirical approach

of describing process dynamics by measurement becomes very tedious.

Model Building

If knowledge of the physical nature of the process is such that its transient behaviour can be predicted from the solution of the describing equations, then a different type of solution to complex control design problems is possible.

The major difficulty lies in establishing the relevant equations. In doing this the basic approach is to postulate a mechanistic model of the whole process. Then fundamental physical laws are applied to reach a mathematical description of this mechanism. At this stage experimental evidence, if available, is used to reinforce the assumptions made in proposing the particular mechanism. The physical laws used usually include unsteady-state mass, heat, and momentum balances. Some terms in the equations may be evaluated using empirical steady-state relationships, e.g. for frictional pressure drop.

To illustrate the technique suppose the chemical reaction $A \rightarrow B$ takes place in an isothermal, bench scale, batch reactor. If the molecular weights of A and B are known, a reasonable guess at the order of the reaction can be made. A possible describing equation is thus established . . . e.g. $dA/dt = k_1.A^2 - k_2.B$. The experiment is performed and the composition-time history is recorded. This permits the evaluation of coefficients (chosen to minimize error) in the expected equation. Comparison with results may now show that this equation is incapable of predicting the results. Then the proposed mechanism is altered, and fresh kinetic equations written and fitted to the data, until satisfactory describing equations are found.

It should be noted that this procedure does *not* establish the mechanism of the reaction $A \rightarrow B$. It merely proves that the describing equations can predict the future course of the reaction in time.

This is exactly what is needed by the engineer in the dynamic description of a process for the purpose of control system design.

This method has been applied to a wide variety of process plant units by D. Campbell in his book 'Process Dynamics'.² The book focuses attention on the formulation of equations rather than their verification, but is required reading for those new to dynamic studies. Most of the published data on process dynamics³ is concerned with experimentally verifying the describing equations for some small sub-process. This is very useful, since the engineer dealing with a large process has simply to lump together all the 'known' mechanisms of its component parts—being careful to include the effects of interaction between one part of the process and the next part of the process.

Continuous Flow Chemical Reactor

To give a detailed example of the application of this technique we shall consider the description of a chemical reactor.

The reactor, which is shown here in a very much simplified form in Fig. 1, is well stirred, and is cooled by water flowing through a central coil. Reactants A and B are continuously fed to the reactor; they react to form C and then D by exothermic reactions . . . C is the desired product.

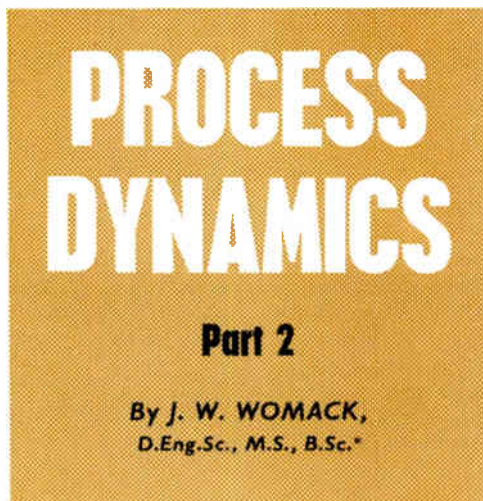

* Electronic Associates Ltd.

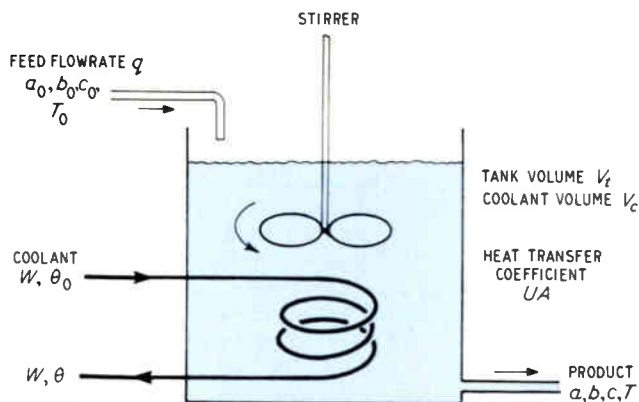
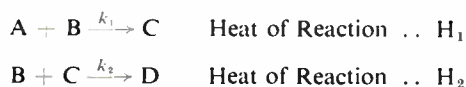

Fig. 1. Schematic diagram of a chemical flow reactor

Equations describing the reaction kinetics have been established by laboratory work, and agree with the 'mechanism'



The rate constants are both temperature dependent, and can be expressed as

$$k_1 = k_{1,0} \exp(-E_1/RT) \quad \dots (1)$$

$$k_2 = k_{2,0} \exp(-E_2/RT) \quad \dots (2)$$

Numerical values have also been established, and $E_2 > E_1$.

The steady-state design calculations will size the reactor and fix the reactant flow rates and reactor temperature in order to achieve some economic optimum. An increase in temperature or reduction of feed flow rate would adversely affect the percentage yield of C, so that an efficient control scheme is necessary. We shall regard temperature as the most important variable to be controlled. It has been proposed that control be achieved by varying the flow rate of

coolant through the coils. The whole system is highly non-linear, but can be represented analytically.

The unsteady mass balance equations are just the kinetic equations modified by inflow and outflow of reactants. An equation is needed for each component. Thus:

$$\frac{da}{dt} = -k_1ab + (a_0 - a)q/V_t \quad \dots (3)$$

$$\frac{db}{dt} = -k_1ab - k_2bc + (b_0 - b)q/V_t \quad \dots (4)$$

$$\frac{dc}{dt} = +k_1ab - k_2bc - cq/V_t \quad \dots (5)$$

Here lower case letters denote concentrations, subscript 0 indicating inlet conditions and the unsubscripted concentrations pertain to both the reactor and the product stream (it is a well stirred reactor). V_t is the reactant volume and q the volumetric feed rate.

The temperature of the reactants, T , is found as the solution of the unsteady heat balance equation,

$$\left(\text{Rate of accumulation of enthalpy} \right) = \left(\text{Rate of generation of heat by reaction} \right) - \left(\text{Rate of removal of heat in cooling coils} \right) - \left(\text{Rate of removal of enthalpy in product} \right)$$

from which,

$$V_t c_p \frac{dT}{dt} = +k_1 H_1 ab V_t + k_2 H_2 bc V_t - UA(T - \theta) + qc_p(T_0 - T) \quad \dots (6)$$

Specific heat, c_p , is expressed on a volumetric basis; the mean coolant temperature, θ , is established by taking an unsteady heat balance on the flowing coolant.

$$V_c c_{pc} \frac{d\theta}{dt} = + UA(T - \theta) + Wc_{pc}(\theta_0 - \theta) \quad \dots (7)$$

V_c is the coolant volume and c_{pc} is the coolant specific heat.

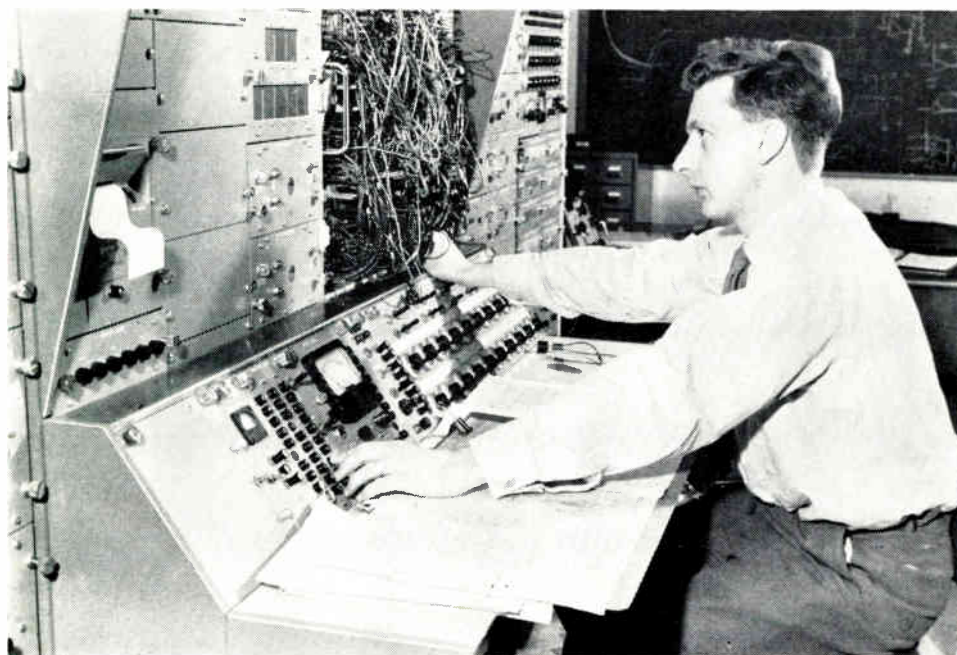

Here a simple simulation study can be seen in progress at the Analogue Computing Laboratory of the Central Electricity Generating Board

A simple simulation study being carried out at E.A.I., New Jersey, with the use of a desk-top computer and an oscilloscope display of the results

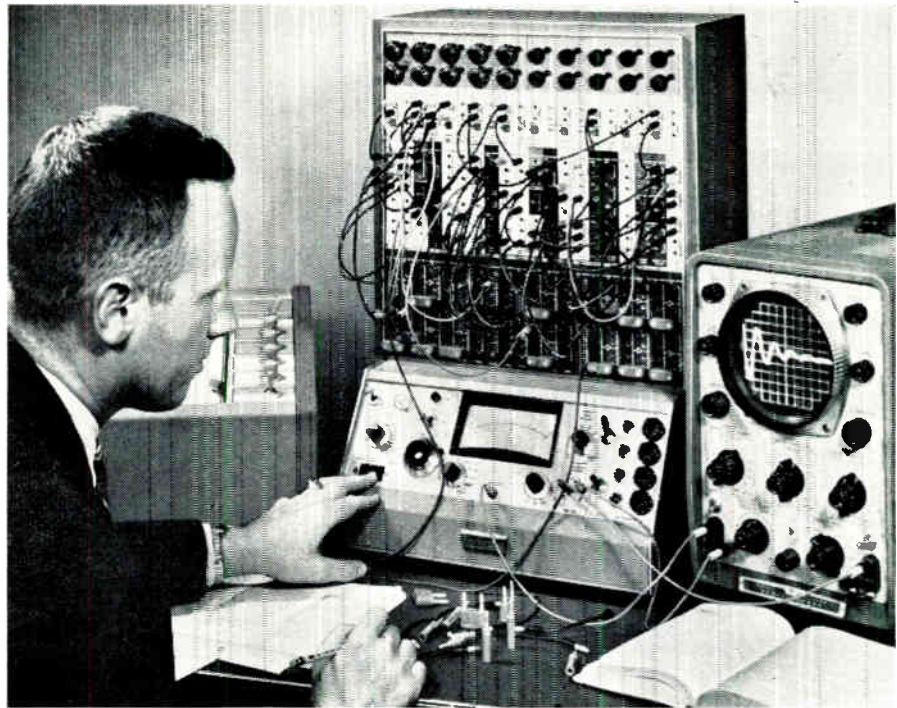

One further complication is that the heat transfer group, UA , is dependent on the coolant flowrate, W . Standard chemical engineering heat transfer correlations suggest that

$$UA = k_3 + k_4 W^{0.8} \quad \dots (8)$$

and allow evaluation of the coefficients.

The reactor temperature is to be maintained constant, so the control system will act on the error

$$E = T - T_{\text{set point}} \quad \dots (9)$$

The proposed control equation,

$$W = K_p E + K_i \int E dt \quad \dots (10)$$

completes the mathematical description of the process.

Use of the Process Model

The average control engineer might balk at the idea of solving the set of ten simultaneous equations which have been derived to describe the flow reactor. This set is not particularly complicated, but an analytical solution is clearly impossible. In practise the process description can be used in two ways.

The transfer matrix of frequency-response functions can be derived from the describing equations. First the equations are linearized² by rewriting them in terms of perturbations about a steady operating point. The transfer functions are then found directly by taking the Laplace transforms of the linearized equations. This method is far easier than experimentally measuring the frequency-response function, since most of the describing equations can be established without the need for experiments. For very non-linear processes the frequency-response functions can quickly be evaluated at different operating levels.

However in the case of multivariable processes with interaction the limitations of servo control systems design become apparent. In these situations the process describing equations are used in their second way, for process simulation.

Here simulation is taken to mean the solution of the

describing equations (by computer) in such a way that the designer can observe the transient response of any variable in the process to any process input. The essence of good simulation is that the engineer must be in a position to perform 'experiments' on the process in order to test the various possible control schemes. He must, therefore, be able to change coefficients rapidly—and even to change the form of the equations (probably those of the control system).

Control system design via simulation has advantages over the direct experimental approach. Firstly in speed: the simulated experiments will take about twenty seconds each—process time constants are often measured in hours. Secondly in safety: if a control system does not work at the simulation stage there is no chance of the physical plant being damaged. A simulation is much more flexible as experiments can be performed over a wider range of variables than can be covered by an operating plant. It is usually very much cheaper: in-plant experiments are often expensive in terms of lost production and wasted raw materials.

Finally, a simulation study produces a very clear understanding of the meaning of a complex set of equations. This results from the very close man/computer information feedback loop which is essential to successful simulation.

Simulation by Analogue Computer

Over the past decade analogue computers have proved themselves to be uniquely suitable for simulation purposes.

On an analogue computer physical variables such as temperature or flowrate are represented by voltages. That is, voltage is the electrical analogue of the process variables. Specific scale factors relate voltages in the computer to the variables in the problem being solved.

The computer itself contains a number of modules which can perform mathematical operations such as summation, integration (with respect to time), and multiplication on the voltages presented at their inputs. These computing modules are interconnected so that voltages in the computer are related by the same mathematical equations as the original physical variables. The computer circuit is then directly *analogous* to the physical system.

If the input variables on the computer can be made to

Fig. 2. This schematic diagram shows the analogue computer circuit required to simulate the 10 describing equations of the flow reactor

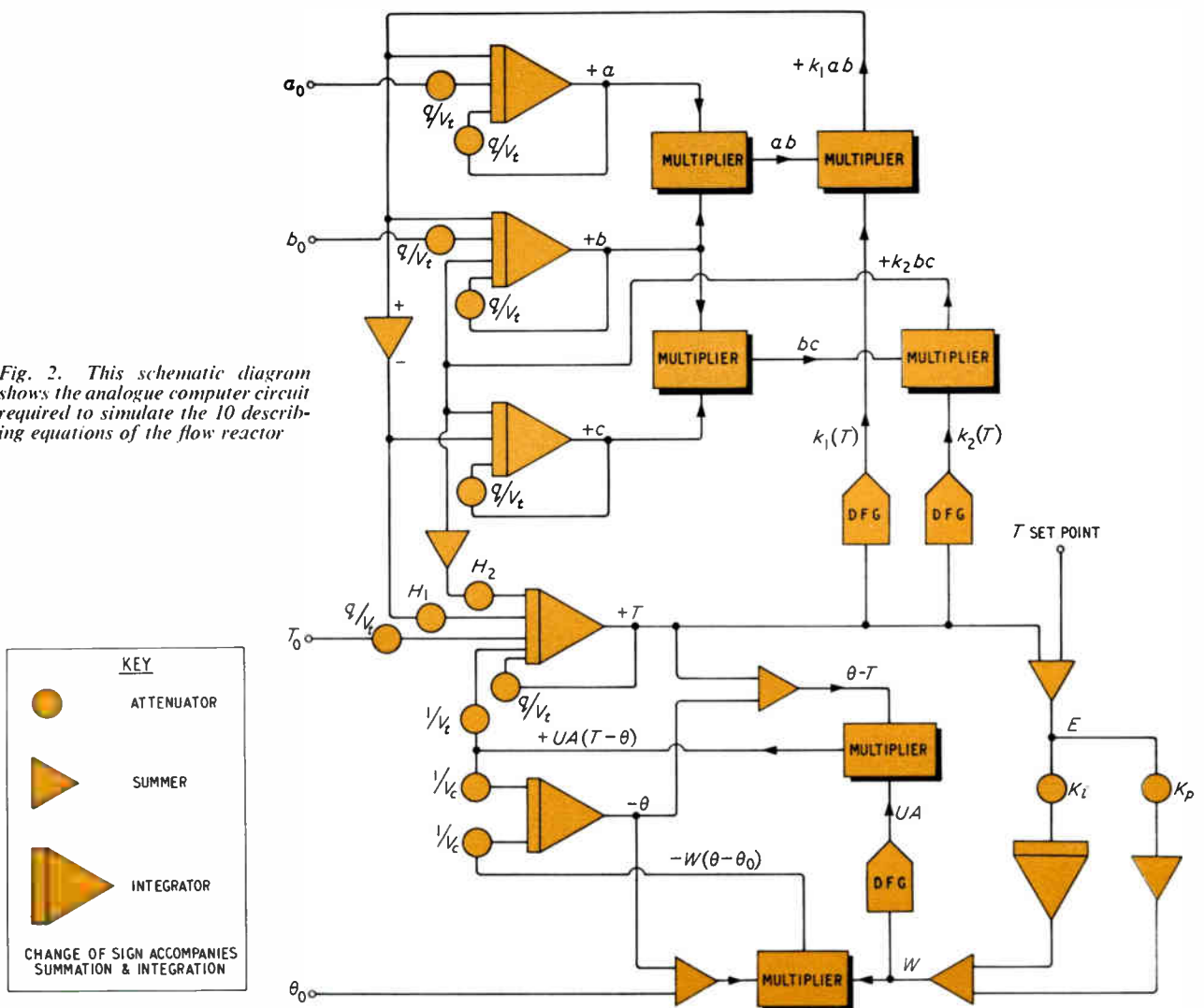

change in the same way that the physical input quantities change, then the responses of the computer circuit *simulate* those of the physical system.

The simulation of process dynamics usually requires the solution of sets of ordinary differential equations. Such problems are the strong point of the analogue computer, which finds non-linear equations almost as easy to solve as linear equations.

The analogue circuit required for the simulation of the flow reactor equations derived above is shown in Fig. 2. A medium-sized analogue computer would be needed for their solution. During the simulation changing a coefficient simply requires the resetting of an attenuator, and changes in the control scheme are dealt with by 're-patching' the computer to suit the new equations.

In some cases the analogue computer finds a use in the model-building process during the verification of the equations. One experiment may be performed, and the response recorded . . . the model is then refined until its analogue simulation reproduces the experimental response.

Conclusion

Simulation has been widely used for studies of process dynamics in the chemical and allied industries in the last five years. It is especially useful for control studies on complex, interacting systems—a distillation column with pump-arounds

in which heat economy is achieved by heat exchange between streams is a good example of such a system. Simulated plants have also been used to train process operators to respond correctly to dynamic upsets of their plants.

Getting the original equations is the key step. It is not difficult to formulate equations, as illustrated above, which are likely to represent the plant well. Of course Parkinson's Law applies . . . 'problems expand to the limit of the available computers'. Its corollary is often true: useful results can be obtained from a simplified model on a smaller computer. In formulating the simplest useful set of equations, engineering judgement plays the critical part.

Experimental methods of measuring the frequency response relationships between input-output pairs are important to the study of process dynamics. Their chief usefulness lies in verifying models suggested to represent small process units. Models of large plants which comprise sets of small units then become more reliable. Of course, the design of many simple one-loop control systems uses the measured frequency response function directly.

References

- ¹ Mesarovic, 'Control of Multivariable Linear Systems', M.I.T. Press (1962).
- ² Campbell, D. P. 'Process Dynamics', J. Wiley, N.Y. (1960).
- ³ Butcher, K. L. *British Chemical Engineering*, 7, 28 (1962).

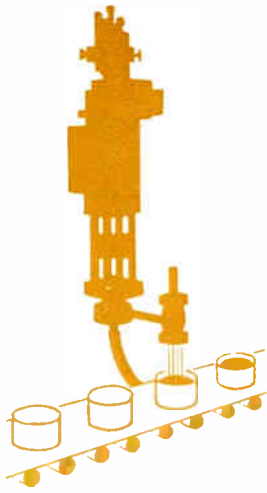

Automatic Volumetric Dispensing System

Neumo Ltd., of Peacehaven in Sussex, have developed a volumetric dispensing system which can be fitted to an existing conveyor belt and, by the addition of standard filling heads and controls, convert it into a fully-automatic filling machine.

The filling system, which incorporates Neumo volumetric dispensing units, is mounted on a free-standing frame which can be placed in a convenient position alongside the conveyor [see Figs. 1(a) and (b)]. The standard frame will take one, two or three filling heads and these are adjustable as to height and spacing (to allow for different container sizes) and are locked into position by spring-loaded plungers. The frame is so constructed that the dispensers can be situated beneath the conveyor, while the filling heads are immediately above the moving belt.

The adjacent control console, which is also free-standing, contains electric controls, timers, programmers, indicator lights and an air regulator. The only component to be

fixed to the conveyor is that incorporating the supporting platform, on which are mounted dispensing-station container guides (which incorporate a clamp and which carry an arresting gate and its operating mechanism) and various electrical capacitance-type sensors. These guides and sensors are also independently adjustable and the supporting platform is bolted to the conveyor frame by twelve bolts; these are the only mechanical connections to be made, for all linkages between components are electrical or pneumatic, as shown in Fig. 2.

The unit shown in Fig. 1(a) is designed to fill containers of capacities from $\frac{1}{2}$ pint to 1 gallon (though any measuring system can be adopted) and the triple-head unit will fill the containers at rates of 100 to 24 per min respectively. Liquids of greatly varying viscosities can be handled by the dispensers and a change in viscosity during a run will have no effect on the volume filled. Partial blockage of the filling nozzles has no effect on volume filled either, and an accuracy of $\pm 1\%$ is guaranteed.

The setting-up and operation of the system is extremely simple, and to change from one container size to another takes less than five minutes. Once the system has been set-up, an initial run can be made under manual control before putting the automatic sequence into operation; coloured warning lights are displayed on the control console to ensure that short stroking or any other fault is immediately indicated.

The operating cycle is as follows (referring to Fig. 2): provided the gate is initially closed and in its rest position, when the first container reaches its sensor (S_2 , under the first filling head) this sensor will initiate the filling programme after closing the clamp. It is necessary for containers to be under each of the other two filling heads for these to fill, since each has its own sensor which cannot alone initiate a programme. Thus, if at the end of a run only one or two containers are in position, only the

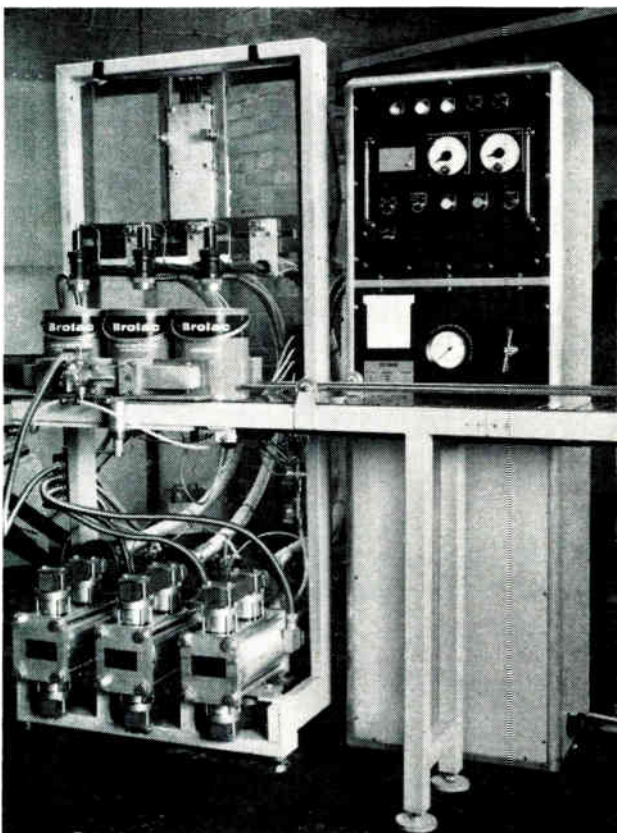
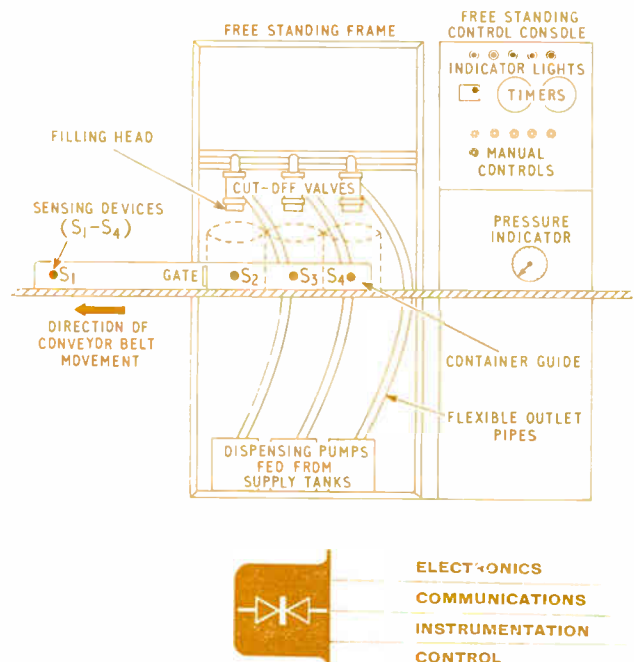

Fig. 1 (a). (Left) A view of the Neumo automatic volumetric dispensing equipment fitted to a conveyor belt

Fig. 1 (b). (Below) A diagrammatic representation of the sensing, dispensing and filling equipment



ELECTRONICS
COMMUNICATIONS
INSTRUMENTATION
CONTROL

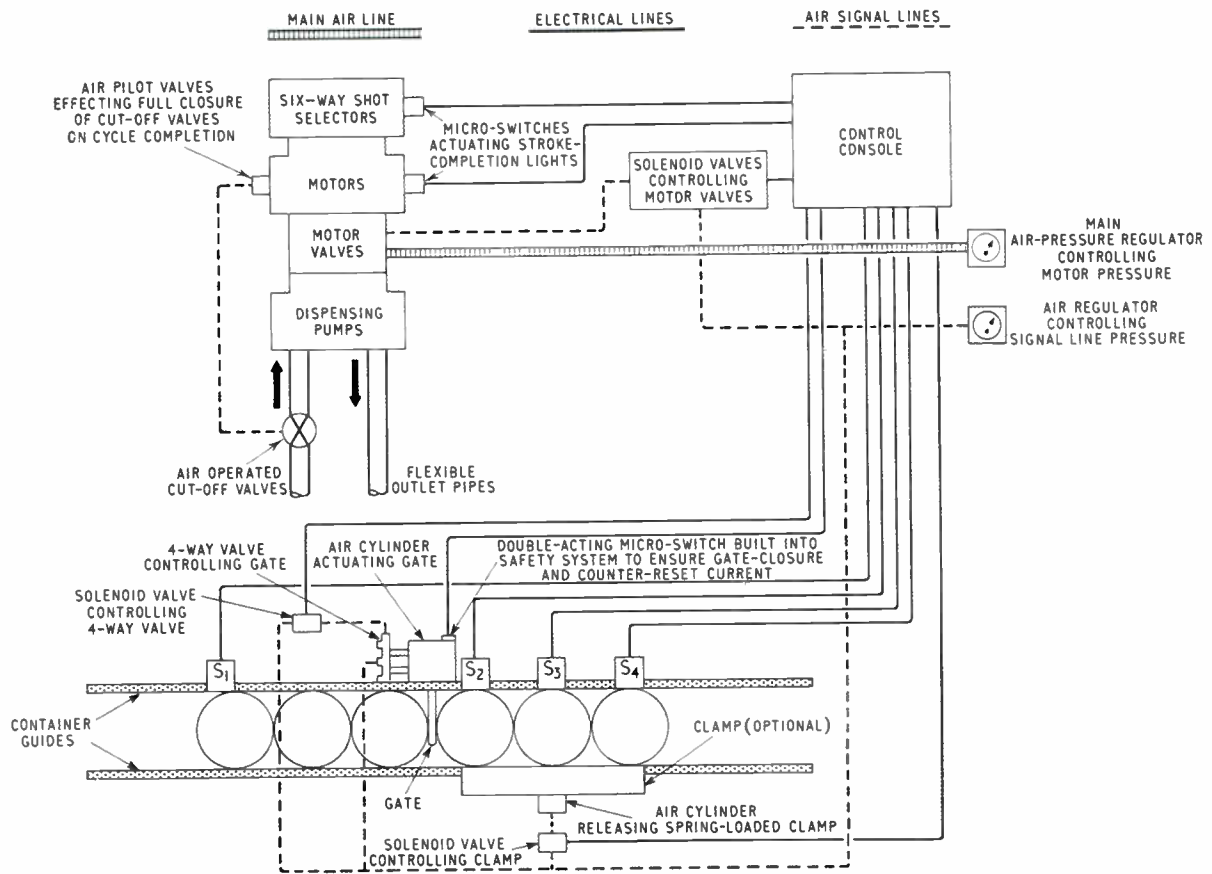

Fig. 2. A schematic diagram showing the air and electrical linkages of the automatic volumetric dispensing system. The upper left-hand part of the diagram represents all three motor/pump assemblies, and the lower part of the diagram represents the conveyor belt installation viewed from above

appropriate heads will fill. When the containers have been filled, the gate and clamp open and the three containers pass along the conveyor. The first of these passes the sensor S_1 , which is so placed as to ensure that all three containers will by then be clear of the gate, which is then closed by this sensor; the cycle then recommences.

The system comprises standard units and can be custom

built to precise requirements; Neumo claim that besides developing this economical method of adapting a conveyor system for automatic volumetric dispensing (the basic system costs from as little as £2,500) they are also offering a solution to some of the problems posed by the requirements laid down in the Weights and Measures Act of 1963, concerning dispensing by volume.

Fluid Amplification

Corning Glass Works, of New York, has formed a fluidic products department to develop its research into fluid amplification. The company made its first fluid amplifiers (devices that use the flow of fluids in much the same way that electrical circuits use the flow of electricity) in 1960, and now makes integrated fluid devices and systems to customer specifications, besides manufacturing a range of fifteen standard products.

In fluidics, standard products are used to build up systems much as electrical components are used in electronics to form circuits. Fluid devices utilize the flow of fluids—usually air—to recognize and act upon instruction signals, to count and to switch, and their chief uses are in binary logic and industrial control applications. The fluid amplifiers usually have no moving parts and are not affected by temperature, vibration or environment; being simple in form, they are cheap, tough, reliable and stable. Designs

using fluid amplifiers range from locomotive controls and drying systems, to missile-guidance units and low-speed computers (low speed because fluids cannot move as fast as electrons).

The amplifiers work on the principle that a low-pressure fluid stream, if controlled correctly, can redirect, start or stop the flow of a much stronger stream. Thus not only can they sense, count and switch, but they can also amplify signals much as do electron tubes and transistors and fluid units can be built up to perform logic functions.

Channels to carry the fluid are made in strong photo-sensitive glass by imposing an image of the required network on to the glass. When the image is developed, acid is used to etch away the network to the desired depth, thus forming open channels. The network is then sealed by putting one or more additional channelled layers over it and finally a cover layer.



VELOCITY MEASUREMENT USING DOPPLER RADAR TECHNIQUES

By E. M. WELLS, B.Sc.*

The theory of doppler radar techniques for velocity measurement is explained in this article and military and industrial applications are described.

THE fact that doppler radar can be used to measure velocity is well-known. What is not so well-known is the variety of problems to which this technique provides a solution, the common feature of all of them being that velocity must be measured without physical contact. It is the object of this article to discuss the main features of radars designed purely to perform this function.

A doppler radar is shown in its simplest form in Fig. 1. The c.w. transmission at frequency f_0 is reflected from the target with a frequency shift which, if measured by a receiver stationary with respect to the transmitter and at the same place, will be given by

$$f_d = f_0 \frac{2v}{c} \quad \dots \dots \dots (1)$$

where v is the radial velocity of the target and c the velocity of light. For normal terrestrial velocities the ratio $2v/c$ is very small, being approximately 3×10^{-9} for $v = 1$ m.p.h. However, the frequency shift may be extracted directly by mixing the received signal with a sample of the transmitted wave, as shown in Fig. 1, and amplifying in a selective amplifier. Any instrument which measures this beat frequency, such as an analogue converter from frequency to proportional current or a digital counter, can thus be calibrated directly in velocity. There are two restrictions, namely only the radial component of target velocity is measured and the simple mixing process does not differentiate between approaching and receding targets.

Now Eq. (1) may be re-written as

$$f_d = \frac{v}{\lambda_0/2} \quad \dots \dots \dots (2)$$

from which we may deduce that the doppler frequency in cycles/second is equal to the velocity of the target in half carrier wavelengths per second. Thus, distance run may be measured by integrating the velocity, which in practice becomes simply counting cycles of the beat-note.

An equipment which has appeared in two versions for different applications is the Marconi Electronic Velocity Analyser (E.V.A.). In its first version the intention was to monitor the approach velocity of naval aircraft as seen from the deck of an aircraft carrier during the landing

phase. The equipment is mounted in a fixed position on the deck of the carrier looking along the expected flight path, and is required to present an instantaneous meter indication of velocity and also a permanent record of velocity against time. In order to meet this requirement the equipment has separate transmitting and receiving aerials with beamwidths of 6° in elevation and 20° in azimuth. (These magnitudes take account of all possible variations in flight path.) The transmitter delivers 100 mW at 10,000 Mc/s. and the receiver develops doppler frequencies at the first mixer as shown in Fig. 1. Amplification at doppler frequency is followed by a frequency-to-proportional-current converter which feeds both a meter and a pen recorder.

The main design problems are centred around the difficulty of maintaining adequate receiver sensitivity in the environment of an aircraft carrier. Modern microwave video mixer crystals can give a noise factor of the order of 18 dB for this type of receiver and it is possible greatly to reduce the level of thermal noise in the receiver by a narrow-band tracking filter which limits the noise bandwidth of the receiver to about 50 c/s. The alternative is a fixed filter which is wide enough to include all variations of aircraft speed. Such an equipment, if its sensitivity is not degraded by the environment, should be capable of monitoring the speed of an aircraft over the last mile of the approach path.

However, several factors can degrade this sensitivity unless provision is made to remove their effect. If the jump-over of power from the transmitting to the receiving aerial either directly or via fixed objects at short range is too high, the noise factor of the receiver can be degraded. With the transmitter power involved in this equipment and in the comparatively uncluttered environment of a carrier

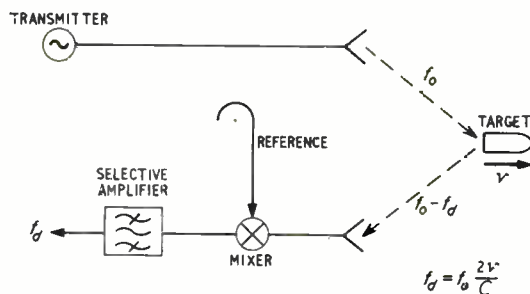

Fig. 1. Doppler radar in its simplest form

*The Marconi Co. Ltd.

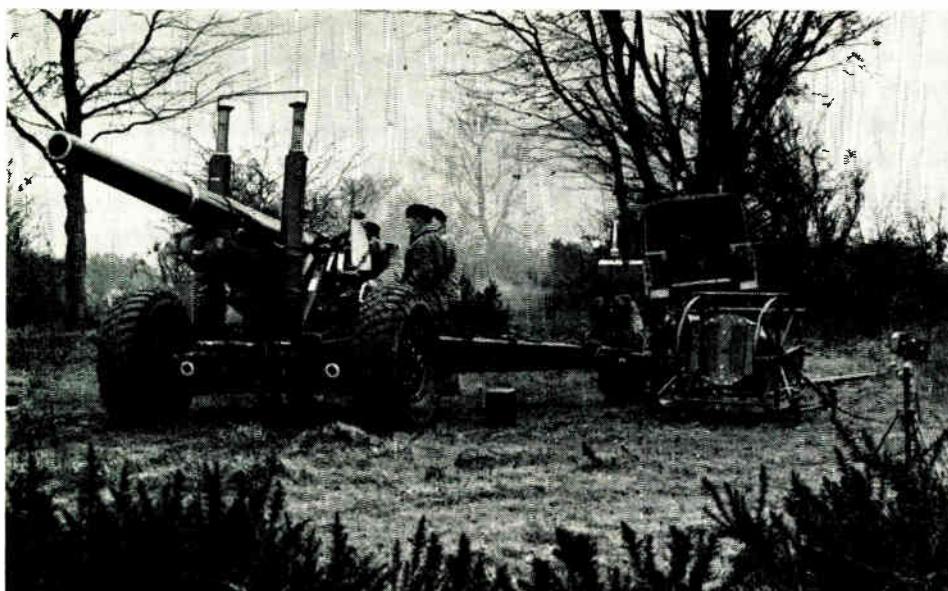

Fig. 2. Army Electronic Velocity Analyser (E.V.A.) in operation

deck this type of trouble is not experienced. Rain can also provide doppler-shifted signals in the receiver, but these differ from wanted signals in as much as they are of lower velocity and also of the opposite sign if the carrier is steaming into wind. A receiver can, if necessary, be designed to reject the unwanted sign of doppler but in this case it is adequate to reject low velocities with a band-pass filter. Interference effects between the direct signal and indirect signals reflected from part of the ship's structure can lead to signal fading. During such time, doppler signals associated with propeller or turbine blades may become predominant. The tracking filter has a time constant long enough to provide a memory during these fades which would otherwise confuse the visual meter presentation. Such fading does not confuse the velocity/time graph provided by the pen recorder because the short term drop-outs and displacements of the smooth curve can be ignored. The most significant source of receiver degradation is jamming by other radar and radio equipment. In early equipment, which employed CV2154 mixer crystals and was therefore comparatively insensitive, this was not found to be a worry, but the employment of a more sensitive receiver in order to get more range showed the need for re-design to reject impulsive jamming.

Another version of the E.V.A. equipment has been employed to measure the muzzle velocity of artillery shells and the equipment is illustrated in operation in Fig. 2. Apart from the difference in mechanical design, which had to be rugged to withstand use by the Army in the field, the main difference between this Army version of E.V.A. and the Navy version is in the wide range of velocities with which the former equipment must cope. Also, neither the tracking filter nor meter presentation are required or applicable to the short duration of this measurement. The equipment can cater for any muzzle velocity in the range 500 to 5,000 f.p.s. In order to do this and still retain a low enough noise threshold, a ladder of crystal-controlled local oscillator frequencies is provided, from which one may be selected to shift the doppler frequency associated with any type of shell into a narrow band-pass analysing circuit. The bandwidth normally chosen corresponds to a velocity bracket of 100 f.p.s. which is adequate to cover the variation in velocity over the few hundred feet covered by the measurement. This may be replaced by 250 or 500 f.p.s.

if warranted by special circumstances. This exercise has been extremely successful, and the technique is now accepted by the British Army as the standard method of calibrating guns. It has useful performance for all calibres from 0.303 upwards.

In these and other applications, such as monitoring the speed, acceleration, and braking performance of motor cars, the radar target is substantially a point. In another class of application the radar target is a surface moving with respect to the radar. The aircraft Doppler Navigator is an example of this in its most sophisticated form, but the description will be given in terms of the more recent Hovercraft installations.

If we examine the situation in which the microwave source obliquely illuminates a patch of a moving surface (see Fig. 3), there will be at any one instant a large number of scattering points each contributing to the total signal received by the radar. If the surface is moving with respect to the radar each of these scattering points will be in the beam only for a restricted time, thus the total signal received is the sum of a train of overlapping bursts. The amplitude and phases of these bursts vary in a random manner so that the sum is amplitude and phase modulated. Also, the conversion factor from frequency to velocity is a function of the angle of incidence, and this angle will vary over the illuminated patch between limits set by the beamwidth of

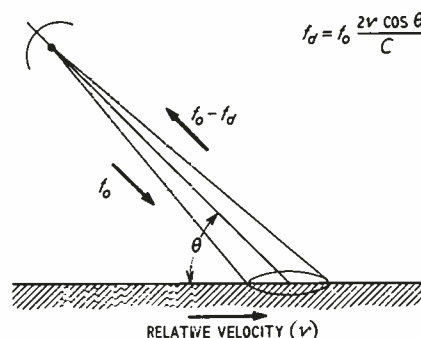

Fig. 3. Showing how velocity information is derived from a microwave source obliquely aimed at a moving surface (as in the case of a Hovercraft installation)

Fig. 4. A development model of the Marconi Hovercraft doppler equipment

the aerial. Thus for two reasons the doppler spectrum will not be a single frequency but will be spread over a finite bandwidth, and the detection means must take the mean frequency of the spectrum as the measure of velocity. A tracking filter can be designed to perform this function.

The Hovercraft has unique problems of speed measurement in that contact with the surface over which it is travelling would introduce a large drag effect and attempts to measure air speed by conventional means are foiled by positional errors due to the pressure pattern round the craft. Microwave doppler techniques have so far been the only successful approach to this problem. A radar illuminating any small patch of water surface near the craft will, in principle, meet the requirement, but there appear to be good reasons for using the wake as the radar target, for if the sea is smooth the passage of the craft will provide a rough surface which gives sufficient back-scatter to give adequate signal, and if the sea is rough the passage of the craft will keep the scattering coefficient reasonably constant, since the structure of the wake will be governed more by the passage of the craft than by the general state of the sea surface. The normal mounting position for a simple speed measurement is therefore in the stern with a 45° depression angle in a vertical plane parallel to the fore-and-aft axis. Allowance is made for this depression angle, of course, in the calibration of the instrument. The choice is fairly arbitrary, but the angle must not be too steep or the measurement becomes too sensitive to changes in pitch, nor too shallow so that either the signal varies with sea-state or the signal-to-noise ratio is not consistent with accuracy. Measurement shows that the wake behaves as though it were being dragged along at about 5% of the water speed, and allowance must be made for this in calibration.

This equipment is shown in Fig. 4; the aerial is a 1-ft diameter centre-fed paraboloid, and the transmitter is a reflex klystron generating 40 mW at 14,000 Mc/s. A 3-port ferrite circulator is used as a duplexer, the third port of which carries a mixer crystal. A reference signal is reflected into this mixer by a controlled mismatch on the aerial arm. Also mounted on the aerial is an audio amplifier, with a bandwidth adequate to cover all expected speeds, and circuits which provide a remote-monitoring facility since the aerial is mounted inaccessibly at the back of the craft. The two other units are mounted as convenient in the craft and are cable-connected to the aerial unit. The so-called tracking filter is in fact a voltage-controlled oscillator which is caused to track the incoming doppler signal with a constant displacement frequency, this frequency being the centre frequency of a discriminator in the control loop. The bandwidth of the discriminator is such as to include all components of the spectrum. A signal at doppler frequency is regained by displacing the frequency of the tracking oscillator by the (known) centre frequency of the discriminator. Presentation is on a calibrated meter on the pilot's instrument panel.

A further development of this same exercise involves using two heads, measuring velocity components in two orthogonal directions, and thereby providing information for drift and along-track velocity. Two speedmeters are mounted so that they both illuminate the same patch of the wake and measure the velocity of the components respectively 45° to port and 45° to starboard of the fore-and-aft axis of the craft. Use of the 45° components rather than fore-and-aft and thwartships components allows the measurement of drift angles up to 45° without the

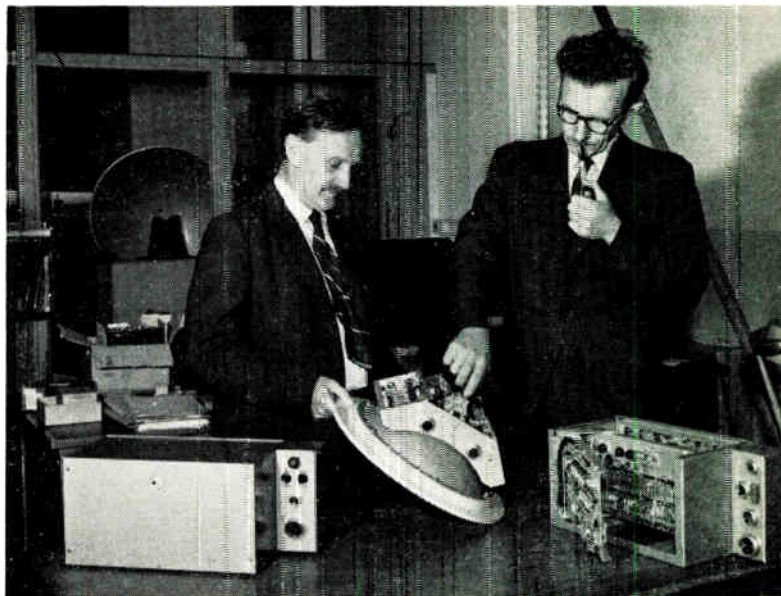

necessity of tracking through zero doppler. Use of the same part of the sea surface for the two measurements means that any bias effect acts equally on the two heads. The output from the two heads can be combined to provide true velocity and drift angle. We note of course that these will be measured with respect to the surface of the sea and in order to relate them to absolute displacements it may be necessary to apply tidal corrections. It is normal in an aircraft Doppler Navigator to provide three beams at least, thus allowing pitch and roll compensation. In this case, with two beams, pitch compensation is not attempted.

The use of such a doppler drift-cum-speedmeter in a Hovercraft offers two facilities. Firstly, the pilot needs the indication of forward speed and drift on his instrument panel. If the mechanical design of the craft is such that it is possible and desirable to provide an off-centred thrust-line in order to off-set excessive drift it can be envisaged that by closing the loop round the drift measurement this could be automatic. Secondly, in combination with compass information, the drift and speed measurements can be used to drive a true-motion navigational radar. A combination of Doppler Navigator and the Marconi 'Argus' display is particularly attractive. The latter provides a true-motion display which could be stabilised with respect to the track made good, thus not only giving a navigational system which is independent of outside aids, but also giving the navigator a display which he can relate to the outside world without having mentally to convert displayed bearings to bearings relative to ship's head.

Another velocity measurement problem has been posed by the steel industry. In rolling processes a knowledge of the speed with which the work-piece goes through the rolling mill is of importance, and is difficult to measure with sufficient accuracy by any means involving physical contact. This interest in velocity is found in both cold-rolling and hot-rolling processes.

It is in the nature of any rolling process that the work-piece will emerge from the mill at a faster velocity than it

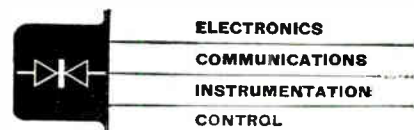

goes in, since the cross section has been reduced. In the so-called temper mill, which is a cold process, sheet steel is reduced in thickness by an amount which affects the temper of the material and, to effect adequate control, there is a need to monitor the difference in speed between the input and the output sides of the mill to an accuracy of 1 part in 2,000. Initial experiments with microwave doppler have shown that the technique is capable of achieving this accuracy. Specially designed means are required to launch the power as a surface wave on the steel sheet, and it is found that there is sufficient back scatter from even nominally polished surfaces to give an adequate signal. It has been shown that there is distinct advantage in using 30,000 Mc/s rather than 14,000 and it is probable that the optimum wavelength would be related to the size of surface irregularities.

In hot-rolling processes less accurate velocity measurement is required, but some automated mills have gone to considerable expense to provide instrumentation based on

photo-cells. In assessing the applicability of microwave doppler techniques there was obvious difficulty in allowing the launching means to approach closely to the hot metal. However, a substantial signal can be obtained from work-pieces as small as a few inches in diameter by illuminating them with a narrow beam with equipment similar to the Hovercraft speedmeter. Unfortunately, a major disadvantage when using an unconfined beam in this environment is that there is no range discrimination; that is to say, doppler echoes are received from other machinery moving in the field of the radar at other ranges. F.m. or a.m. (pulse) modulation techniques are available which are capable of range discrimination for a few yards, but these have not so far been tried in this environment.

Acknowledgment

The author wishes to thank the Director of Engineering & Research, The Marconi Company Limited, for permission to publish this article.

Range Finding by Laser

One of the many possible applications of the laser is the measurement of distances, and equipment for this has been developed by R.C.A.

Their laser range finder, available in the U.K. and Europe from Rank Pullin Controls, measures distances by metering the time taken for an emitted pulse of light, the laser beam, to be reflected off a particular object and returned to the unit to be received on a photomultiplier receiver. The distance is given directly in metres on a dial. The short-duration laser beam is produced by introducing light into a rod of ruby and the 1-milliradian beam width which results from this allows distances to objects as small as a flag-pole to be measured. On a day of fair visibility, this instrument has been used to measure the distance to a television aerial mast some ten or twelve miles away. Accurate sighting is by means of a telescope with a magnification of seven times.

The range of the instrument is 200–9,990 m and a model for 19,990 m can be obtained. The accuracy is ± 10 m over about 19 m and the resolution is 5 m. Reflections from unwanted objects closer than the one being sighted can be excluded by selection of the minimum distance required and the operator can select any one of four closely-spaced objects.

Each measurement requires a 10-sec warm-up period and the pulsing and metering take a further 0.5 sec. The unit is portable, weighing 25 lb, and is battery powered.

Applications of this and all laser equipment are necessarily limited by visibility, but include military use as well as land-surveying and marine work. Cloud height can be measured for meteorological studies and the system can also provide an aid to aircraft pilots, especially on approach to runways.

For further information circle 45 on Service Card

The picture on the left shows the rear panel and the controls. A fifth digit on the right of the dial indicates which object or target in a group of up to four is being ranged. The target selector switch is above this. On the right an operator is sighting the range finder on to a distant object





TALK ABOUT

We British are fond of recalling that our splendid institutions were not built in a day. That, for example, our democratic form of government has been painlessly developed over a span of 900 years of history.

In comparison, how vulgarly hasty is the mere 350 years it will take our engineering industry to achieve the full manpower-saving benefits made possible by numerical control. It has been estimated that some 250,000 jobs could be saved by the intelligent introduction on a wide scale of this by-no-means-new aid to industry. Yet the 1965 saving in manpower was a modest 700. I quote no less an authority than Sir John Toothill of Ferranti.

Mr. Frank Cousins, Minister of Technology, has asked rhetorically, 'Can we get out of the atmosphere that all we think we have to do about automation and productivity is talk about it'.

I suggest that Sir John and his colleagues in the electronics industry have done much more than talk about it. They have long since made the tools and the techniques available for general engineering itself to do more than talk about it. The trade associations led by BEAMA and EEA have also done much to overcome fear and prejudice. But the engineering industry still drags its heels.

We are all living a little longer these days. We are justly proud of our stately nation and are accustomed to stately progress. But 350 years is a mighty long time and gives the Ministry of Technology enormous scope for a really breathtaking advance this year in giving a lead to the ignorant, the over-cautious and the restrictive practitioners.

How to get cracking on a project was demonstrated by Marconi when they unveiled the Mk VII colour television camera. This product is interesting as

an example because it not only had its full complement of electronic problems but also embodies a great deal of precision mechanical engineering and a sophisticated optical system. Yet, despite the technical problems of design and integration of the systems and sub-systems which make up the Mk VII, the development time of the whole project up to demonstration of a fully engineered prototype was only ten months.

During these ten months the sales engineers were not, as might be expected, nervously wondering if the Mk VII

By NEXUS

would ever get out of the labs. They were too busy booking no less than 76 orders for the new camera, mostly from across the Atlantic.

At the other end of the scale is the five years development time the Engineering Research Department of British Rail is to take on a comparatively simple system to override driver-error on trains. The system will automatically apply the brakes if drivers exceed a pre-set speed over restricted sections of track.

With all its implications of the need for a greater measure of protection of the travelling public against the irresponsibilities of the servants of B.R. I should have thought this project would have enjoyed a much less leisurely approach.

Discussing this with a friend in industry, well experienced in dealing with contracts from similar public bodies, I was told that it was nothing unusual. My friend explained that the most recent meeting at his company involved no less than fifteen experts who arrived in fifteen separate cars. The particular project under consideration had been in being for something

over two years and the specification had not yet been agreed. 'You can't really blame them—it's the paper work and all the committees they have to contend with' he said, sadly shaking his head.

I'm all for automation in principle, but I occasionally suffer from an overwhelming revulsion against the whole concept. This is largely a cyclic phenomenon which occurs soon after the first day of each month. In fact just as soon as I realize that once again ERNIE has let me down.

I have never been able to fully trust this Electronic Random Number Indicator Equipment with its random noise source and its chattering print-out of numbers which never, even remotely, have correspondence with those on the ageing and fast depreciating Premium Bonds registered in my name. And, believe me, no numbers could be more random than my lot.

It was in such a moment of depression that I attended the Connaught Rooms to witness the ballot for stands for the forthcoming International Instruments, Electronics and Automation Exhibition. Here were gathered the high priests of automation from whom one could reasonably expect an example to be set. Not a bit of it!

Absent indeed were all those random noise generators, flip-flops, ring counters, flashing lights, logic circuits, automatic print-outs and the rest of the paraphernalia we shall be obliged to examine professionally and be encouraged to buy when we visit the exhibition in May.

To my delight, I found the assembled high priests in the ornate Crown Room having no truck whatever with electronics when it came to a serious matter like balloting for stands.

Under the supervision of the Hon. John Geddes, chairman of the Exhibition Committee and chief spokesman of Elliott Automation, the draw took place from a good honest old-fashioned manually-operated revolving drum with good honest human fingers lifting out the seen-to-be-fair results. And I may add that the print-out of the results was achieved by a pretty girl using an old-fashioned pencil at a civilized writing speed on non-continuous stationery.

Did I say something about the IEA Committee not setting an example? Well, I was wrong. The ballot for stands was a perfect example of keeping automation in its proper place. In fact a lesson to us all. Automation should be applied selectively to specific processes where some advantage is to be obtained from speed, accuracy or economy, and preferably from all three. The ballot may have been over more quickly (but not more accurately or

economically) by applied automation but that may well have spoilt what was something of a social as well as a business occasion.

In a grim world it was with real pleasure that I received, and with even greater pleasure read, 'No Fancy Waistcoats', a collection of 'remini-

scences' by Pat Smallman, Manager, Publicity Services, Sperry Gyroscope Company.

Illustrated by Douglas Bisgood, each of the thirteen pieces which make up this little booklet has a Sperry message well embroidered with odd items of information, wry humour, broad comedy and honest horse-sense.

The collection is a re-print of a series of advertisements which appeared originally in the Journal of Commerce. Whether they sold any data loggers, inertial navigation systems, or Gyrosyn compasses I don't know. But I'm sure that they did a first-class job of creating goodwill—and will continue to do so in booklet form.

Broadband Coaxial-Cable Communications Link

A new coaxial-cable system for speech and data transmission has been produced that will provide routes thousands of miles long and carry 32,400 channels.

This is the L-4 of the Bell Telephone Laboratories which supersedes the L-1 and L-3 systems at present in use. A major installation is scheduled for completion in 1968 which will link Boston to Florida via Washington D.C. A 114-mile field trial is now under way.

The cable consists of 20 coaxial conductors, each pair carrying 3,600 speech channels. Other conductors in the cable are to carry control and alarm signals and some are for maintenance purposes.

Repeaters, using specially designed, high-frequency silicon transistors, are placed at 2-mile intervals. These have better reliability and longer life than their valve counterparts and, as they are designed as plug-in units, maintenance costs are reduced. They are installed in pre-cast manholes of standard sizes.

In addition regulating networks at about every 14 miles

automatically adjust repeater gain to compensate for changes in cable losses caused by changes in temperature. Equalizing networks at every 50 miles and at the main repeater stations, which are up to 160 miles apart, compensate for changes in gain caused by unpredictable effects occurring in the cables and equipment under normal operating conditions. They can be adjusted by remote control while the system is operating. Without interruption of the service, the performance of each repeater can be checked and a faulty unit detected by a test signal being inserted at the repeater input. The test-signal output level is measured at the receiving terminal or main station.

The large cable, the close spacing of the repeaters and the high frequencies used, which are from 564 kc/s to 17,548 Mc/s, give the system its increased capacity, for the L-4 will carry nearly twice as many channels as any long distance system in use at the present time including microwave radio links.

For further information circle 46 on Service Card

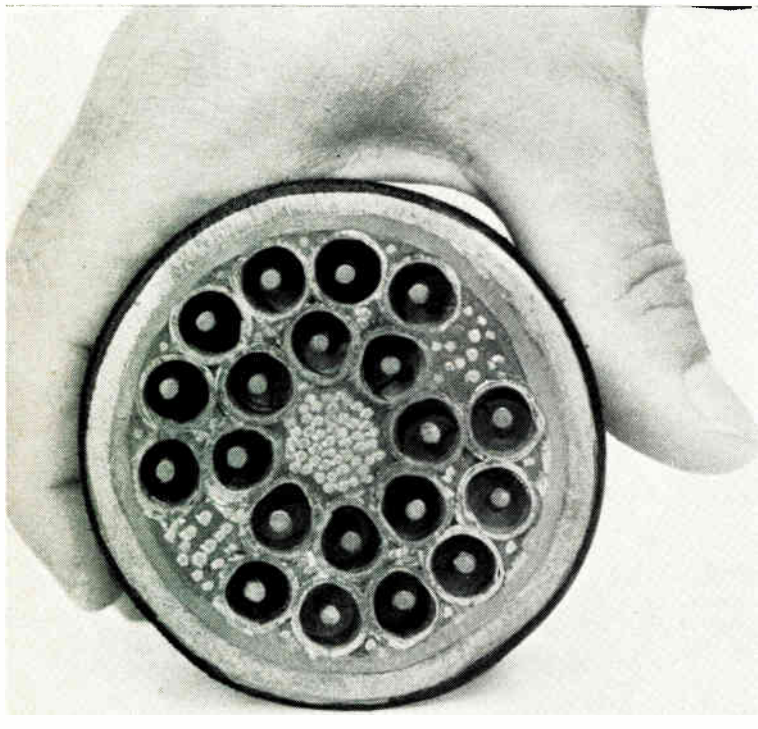

(A) A cross-sectional view of the 3-in diameter cable showing the 20 coaxial conductors

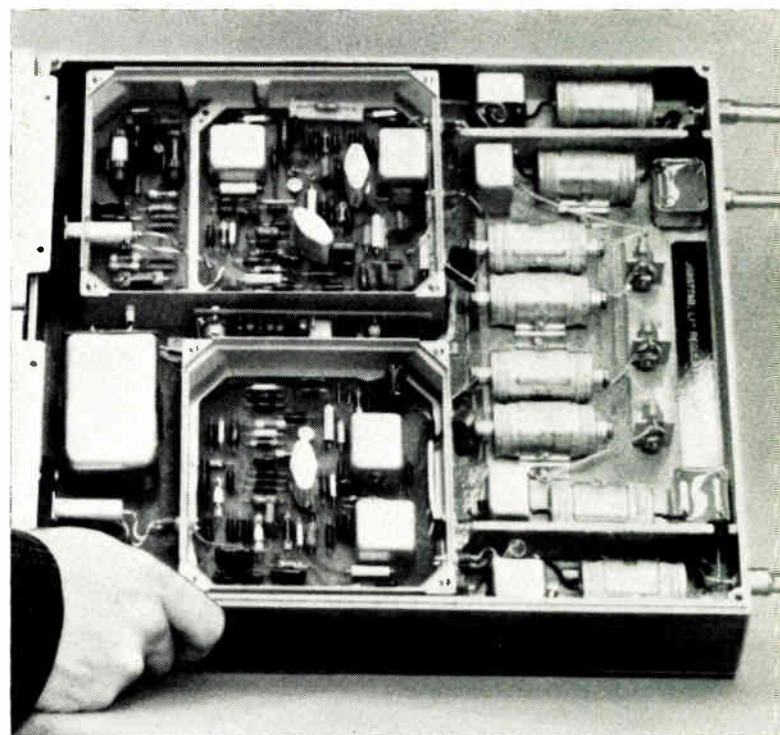

(B) A repeater of the regulating type which compensates for changes in cable losses

**This advertisement
is for people who think**

- they don't need ...
 - can't afford ...
 - can't operate ...
 - haven't the room ...
- for a computer.**

**Elliott's new 903 computer
proves them wrong by being**

- indispensable ...
- costing only £12,750 ...
- easy to operate ...
- 2' 2" x 3' 1" x 3' 7"

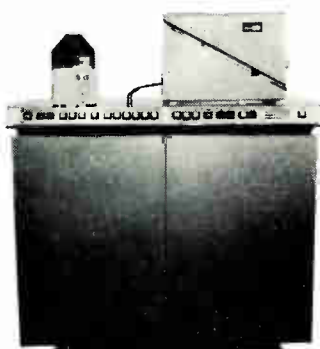

Elliott 903 is a computer priced to fit neatly into the tightest departmental or small-organisation budget, sized right for classroom, laboratory or design office. But unobtrusiveness ends where performance begins ...

High speed arithmetic store; comprehensive instruction code; full hardware arithmetic facilities - all backed by a library of effective software. A range of peripherals enables the 903 to be tailored to *your* particular requirements. 903 has a great range of applications, yet is so simple to operate that a layman can be trained to write and run programs in just three days. Simple ... and *reliable*; 903 is built on the know-how developed by Elliotts over 15 years in the computer industry. Elliott 903 the new small computer which cuts data processing problems down to size.

Elliott-Automation Computers Limited

Elstree Way, Borehamwood, Hertfordshire. Telephone: ELStree 2040.

 A Member of the Elliott-Automation Group.

First U.K. Manufacturer to offer Ferrite Magnetic Heads

Consistent performance over greatly
extended operational life

Mullard offers a comprehensive range of professional standard audio heads with consistent high quality performance over a greatly extended operational life.

Using the new range of Mullard low impedance record and replay heads for $\frac{1}{4}$ -inch tape, designers of specialised equipment for professional recording studios will now be able to obtain performance which is virtually unaltered or limited by head wear. Minimal wear and unchanging electrical properties throughout the working life of a ferrite head mean that it can be used on a 'fit-and-forget' basis; amplifier circuits associated with ferrite heads do not need the frequent compensatory adjustments which have to be made throughout the much shorter life of a metal head. Tests showed that after 1000 hours running time at a tape speed of $7\frac{1}{2}$ in/s, the output of a ferrite head measured at 8 kc/s was only reduced by 1.5dB and that after a further 5000 hours the output was substantially unaltered.

Head noise is reduced to a minimum by the low h.f. core loss and low eddy current loss of the ferrite core material. The signal currents are approximately the same as those associated with metal heads; the bias current required by a ferrite head is much lower. Precise control of the properties of the ceramic material, combined with advanced mechanical techniques, ensures a high order of consistency.

FREQUENCY RESPONSE

The frequency response of a ferrite head is generally much better than that of a metal head because the effective electrical gap length of the ferrite head is much closer to that of the physical gap. This is due to the stress-free nature of ferrite which allows it to be machined—or polished by tape—without altering its electrical characteristics; an advantage which cannot be claimed for metal heads. The performance of a ferrite head can be improved by using higher bias frequencies. At 100 kc/s, the bias current required is about half that needed by a metal head having a lamination thickness of only 0.2mm—at higher frequencies the bias current reduces to an even smaller fraction of that required by a metal head.

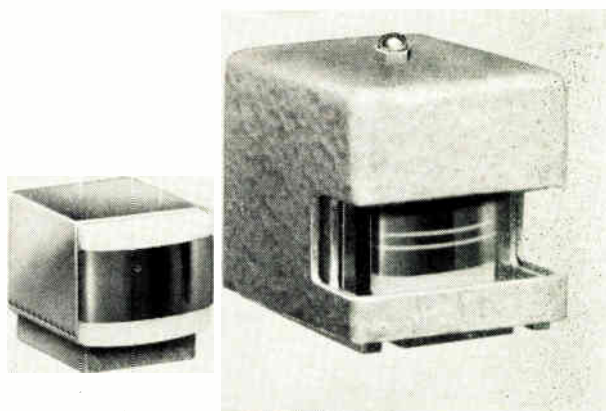

Fixed and adjustable ferrite magnetic heads

TYPES AVAILABLE

Four basic types of record and replay head are available: half, full, twin-track/stereo and quarter-track twin. Bold colour coding allows the type to be checked at a glance. Replay heads have $3\mu\text{m}$ gaps. Record heads are available with $20\mu\text{m}$ (full track only), $12\mu\text{m}$ or $7\mu\text{m}$ gaps.

Audio heads can be supplied as either fixed or adjustable assemblies. In the fixed version, shims can be supplied to adjust the height of the head; adapter plates can also be supplied for alternative mounting arrangements. Single and double Mumetal cans can be provided for screening purposes.

The adjustable version is supplied in a Mumetal screened assembly. Facilities are provided for 'height' and 'tilt' adjustments and for final azimuth adjustment with the Mumetal screen in position. An outer magnetic or non-magnetic screen can also be supplied.

For further details of this range of heads, please use the reader reply card of this journal (see reference number opposite).

What's new from Mullard

Smaller and Faster Trigger Tube

ZC1030 reduces the cost per circuit element

Mullard's latest addition to their extensive range of cold cathode devices is a 'smaller than subminiature' cold cathode trigger tube, Type ZC1030. Advanced design with a new electrode geometry enables this tube to be used at much higher frequencies than any tube of this type previously offered. The ZC1030's extreme reliability, small dimensions, wire-ended and sturdy construction make it an obvious choice for use in printed circuits. Immediate applications for this device will be found in electronic desk calculators, small computers and most industrial counting and switching circuits.

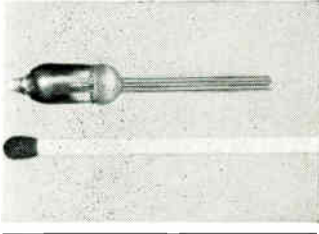

Selected Thyristors for Parallel Operation

A new range of thyristors selected for parallel operation is now available from Mullard. These new types can be used to obtain either forward currents greater than those available from the Mullard BTY99 range or, alternatively, for extreme reliability in control systems in which the incorrect functioning of one cell must not be allowed to affect the operation of the controlled equipment. This new range is coded BTX51 followed by an appropriate voltage suffix.

To work effectively without excessive derating, thyristors for parallel operation must have similar forward voltage drop characteristics. This requirement is met by selecting suitable thyristors for a narrow spread of forward voltage drop. Parallel operation is quite straightforward; full details are given in our data sheets.

Another advantage of parallel operation is that it gives a more uniform temperature gradient over the heat sink area.

Substantial price reductions make this range of devices extremely competitive on a cost per volt/amp basis.

New production techniques combined with Mullard's wide experience in cold cathode technology have reduced the cost of the ZC1030, and thus the cost per circuit element in which it is used, to a really economic level. For example, using ZC1030 tubes with a ZM1080 numerical display tube, a decade counter can now be produced at an extremely competitive price.

Accelerated life tests show that the life expectancy of the ZC1030 will be comparable with the many thousands of hours that have already been achieved in the field with its forerunner, type Z700U. Another feature of the ZC1030, which it shares with other Mullard trigger tubes, is that it will operate satisfactorily at temperatures ranging from -55 to $+70^{\circ}\text{C}$. Visual indication of the 'state' of operation is a built-in facility the ZC1030 has in common with trigger tubes generally—this indication is of particular advantage when scheduled maintenance and testing routines are carried out.

FOUR NEW P-N-P SILICON PLANAR EPITAXIAL TRANSISTORS

Four new competitively priced high performance p-n-p transistors have recently been added to the Mullard range of silicon planar epitaxial devices. P-N-P construction enables these transistors to be used with types similar to BSY38 and BSY39 in complementary circuits. This type of circuit simplifies supply problems and allows the number of components to be reduced.

Types BFX12 and BFX13 are

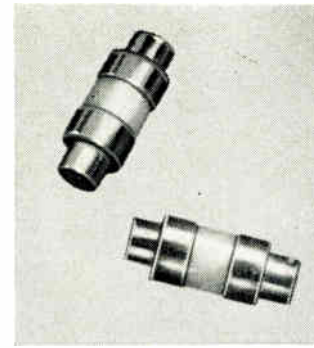

Inexpensive trouble-free cadmium sulphide photoconductive cells

Mullard cadmium sulphide photoconductive cells offer a number of economic advantages in the design of industrial control systems. Their high sensitivity, and consequently simple associated circuitry, enable these devices to operate relays or switch operating mechanisms without the amplifiers normally required in other photoelectric systems.

Used in roles varying from direct relay control to slow speed logic, Mullard cadmium sulphide cells offer unfailing reliability. Twelve types of cell are now available with individual cell dissipations ranging from 70mW to 1W at 25°C . Spectral response extends from 0.3 to $0.95\mu\text{m}$.

Applications include light-beam operated burglar alarms, machine 'guards', and counting systems. Flame failure detection, parking light and street lighting control are other common uses. Full data on this range of Mullard cadmium sulphide cells is given in the new Mullard booklet 'Cadmium Sulphide Cells—Their Properties and Applications'.

LOW NOISE SUBMINIATURE MICROWAVE DIODE

Designers of radar, microwave communication links and associated equipment are showing great interest in Mullard's subminiature microwave germanium mixer diode type AAY39, which has a noise figure of only 6dB at X-band (7 to 12Gc/s).

With an operating range of 1 to 18Gc/s, the noise figure of the AAY39 at S-band (2 to 4Gc/s) is 5.5dB and 7dB at J-band (12 to 18Gc/s). All the parameters quoted are tightly controlled within very narrow limits. In addition to these very impressive performance figures, the AAY39 has a low flicker noise content, a feature which makes it an attractive proposition for Doppler radar systems. Another useful feature of this device is its reversibility which, in balanced mixers, simplifies replacement problems.

The AAY39 is a germanium point-contact diode with truly subminiature dimensions—it is only 0.1in (2.5mm) diameter and 0.28in (7mm) long—and rugged construction. Sealed ceramic encapsulation guarantees complete isolation from atmospheric conditions between the temperature limits of -65° and $+150^{\circ}\text{C}$. Mounting this device in waveguides, coaxial lines or stripline circuits is simplified by its double-ended cartridge construction.

FURTHER DETAILS of the Mullard products described in this advertisement can be obtained from the address below or through the Reader Information Service of Industrial Electronics using the appropriate code number shown below.

Ferrite magnetic heads IE 334
Trigger tube ZC1030 IE 335
Selected thyristors for parallel operation IE 336
Cadmium sulphide photoconductive cells IE 337
P-n-p silicon planar epitaxial transistors IE 338
Subminiature microwave diode IE 339



Mullard Limited, Mullard House, Torrington Place, London, WC1. Telephone: LANgham 6633

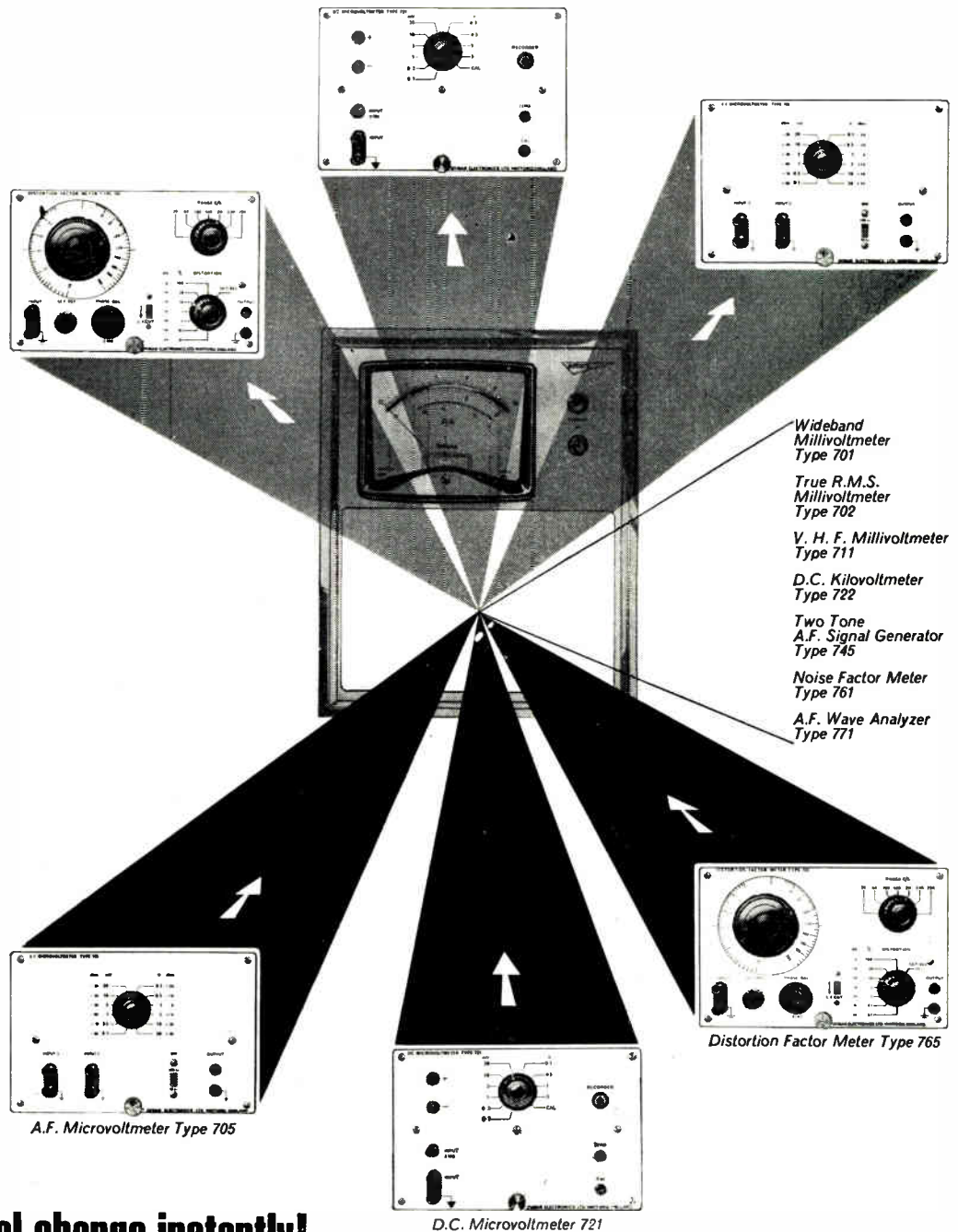

- Wideband Millivoltmeter Type 701
- True R.M.S. Millivoltmeter Type 702
- V. H. F. Millivoltmeter Type 711
- D.C. Kilovoltmeter Type 722
- Two Tone A.F. Signal Generator Type 745
- Noise Factor Meter Type 761
- A.F. Wave Analyzer Type 771

total functional change instantly!
that's Pluginability

—that's the Dymar System—a system of plug-in instruments offering flexibility and considerable capital saving. The basis of the system is the Type 70 Meter Unit which will accept any of a series of plug-ins. A change of function occurs with each combination because it produces a *different instrument*. Just release the retaining rod, withdraw the plug-in and insert another. It's as simple as that and 'Pluginability' sums it up in one word.

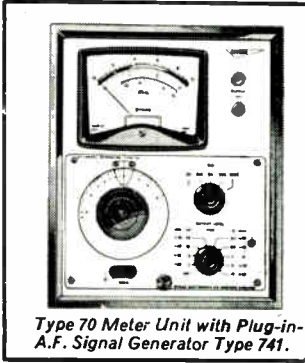

Type 70 Meter Unit with Plug-in-A.F. Signal Generator Type 741.



Full details from:

DYMAR ELECTRONICS LTD. REMBRANDT HOUSE WHIPPENDELL ROAD WATFORD HERTS.
 Telephone: Watford 21297

Brochure: DY601



This illustrates the size of the underwater camera

SEARCHING BY TELEVISION

A small snake-like television camera which can negotiate 16-in. radius bends has been developed by Pye for use in the internal inspection of the pipelines of many major industries.

This is an articulated pipe-inspection camera of 2 $\frac{1}{4}$ -in. diameter. The entire length of the camera, its amplifier and lighting system is 28 in. It has been designed for small-bore pipe inspection and will save time and cost in industry by allowing the internal inspection without breaking into pipes at every few feet. Oil refineries, chemical plants, power stations, gasworks and shipping companies can each find application for this technique.

Pipe inspection and maintenance has always been a problem in industry because long lengths of pipe have so far had to be physically disconnected for periodic checks and repairs. The construction of this new camera will help overcome these problems by enabling continuous lengths of up to 1,000 ft to be inspected.

The camera itself is articulated so that it can pass easily round bends in piping. It consists of two sections, a tube assembly and amplifier unit joined by a flexible metal coupling. An articulated optical assembly with built-in lighting is fitted to the front end of the tube assembly. The camera is lightweight, completely waterproof, and costs about £1,850 complete with the control unit and monitor.

Another camera in the new Pye range is an aid for quick and thorough inspection of the interiors of pipes with larger diameters from 3 to 42 in. This one is supplied complete with lighting and centring attachments to accommodate pipes within this range. Its applications in the civil engineering field include gas, sewer and oil installations. Overall length of this camera is 33 $\frac{1}{2}$ in., diameter 2 $\frac{1}{2}$ in. It weighs 6 $\frac{1}{4}$ lb.

Underwater Inspection

A small, light and rugged underwater television camera has also been produced by Pye. This camera can be used down to a depth of 200 ft, is 25-in. long and 2 $\frac{3}{8}$ -in. diameter. The in-water weight is only nine pounds, which makes it suitable for either hand-held or remotely-controlled use. The fact that it can be easily held and manoeuvred with one hand will appeal to frogmen carrying out underwater

inspection of ships' hulls, dock, harbour and port installations. The camera can also inspect bore and drill holes. Because it is radiation resistant it can be used for nuclear applications. A range of attachments, including lighting units and a buoyancy tank, is available for the camera.

This shows an articulated television camera being lowered down the ventilation pipe of a double-bottomed tank on board the liner the 'Reina del Mar' at Southampton



Applications and Techniques

Level Control by Gamma Gauges in Paper Mills

Two pulp and paper mills of the Wiggins Teape Group are being fitted with Philips gamma gauges for control of the levels of materials in the digesters and bark chutes.

Each of five digesters (the vessels in which the raw materials are boiled in the first stages of paper making) is fitted with a radiation source which emits gamma rays. A detector unit on the opposite side of the digester picks up the radiation and, as the level in the vessel varies, the absorption of the radiation changes producing a variation in the electrical output from the detector. The gauges, manufactured by the M.E.L. Equipment Co., can be fitted to vessels containing liquids, slurries, pulp or similar substances and the detector output is remotely amplified to provide inputs suitable for indicators, chart recorders and automatic level controllers. A built-in relay circuit is actuated for alarm purposes when the level passes the line between the detector and the radiation source.

In the Wiggins Teape installation, the detector output automatically regulates the pneumatic feed control. Fail-safe facilities are incorporated and a lead shield behind the detectors prevents stray radiation. The position of the radiation source holders can be pneumatically adjusted.

Four additional gauges are fitted to the bark chutes for control of the feed to the burners in the steam-raising plant.

For further information circle 47 on Service Card

Intruder Alarm System

Intruders attempting to cross a 10-ft wide strip around protected areas can be detected and located by the Periguard, an acoustical device developed by the Westinghouse Research Laboratories. It operates on the earth tremors caused by the intruders and can be used to guard factory areas, private estates, danger areas or similar locations.

A set of sensitive transducers is buried and completely concealed around the perimeter of the area. The pressure waves in the earth are sensed by the transducers and the electrical

signals produced are used to actuate a warning system.

Although sensitive enough to detect very slight tremors, the system is balanced to eliminate the effects of traffic noise, the sonic booms of aircraft or earthquake tremors. Power consumption is low and the weather-protected sensors are adaptable to any terrain.

For further information circle 48 on Service Card

High Energy Rate Forming

A contract worth £192,000 has been placed by the Ministry of Technology for the development of a high energy rate forming (h.e.r.f.) system. £162,000 will go to the mechanical engineering department of Birmingham University, where a team under Professor S. A. Tobias has been developing an entirely new type of h.e.r.f. machine known as Petro-Forge (see picture), and the remainder has been awarded to the Drop Forging Research Association, who will undertake part of the applied process development in association with the University.

High energy rate forming promises considerable advantages over slower, conventional processes (such as drop hammers and mechanical or hydraulic presses), particularly for the forging of modern materials and components having thin webs, and it may offer improved surface finish, closer control of grainflow, repeatability of mechanical properties and reliability of forgings. In addition, h.e.r.f. machines are generally less massive than their conventional counterparts, indicating lower capital and installation costs.

The system devised by Professor Tobias and his colleagues is unique in that the power stroke

The Petro-Forge Mark 1 (7,500 ft/lb) machine, which is engaged on a variety of cold forming processes such as blanking, cropping, cold forming and compaction. On the right is its control cabinet and on the left is a high-speed camera

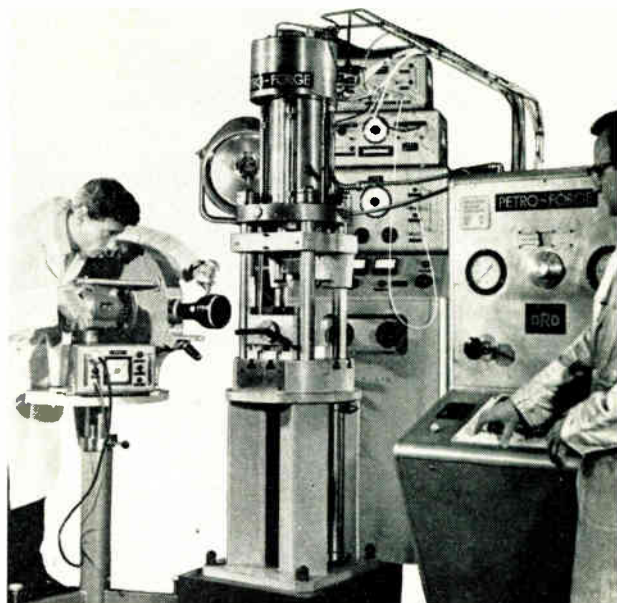

BIG THINKING SMALL **NEW** PACKAGE

EMI 101 SOLID STATE SCOPE



REPLY CARD

Please send me full details of:
EMI 101 Solid State Oscilloscope.

NAME AND POSITION

(BLOCK LETTERS PLEASE)

COMPANY

ADDRESS

TELEPHONE

EXTENSION

NEW EMI 101 SOLID STATE 'SCOPE LIGHT, COMPACT, ACCURATE . . .

From EMI's talented design team comes a new 3-inch general purpose 'scope with a remarkable combination of practical features. There are thousands of design hours behind it.

From the outset the design was based on extensive user research—sifting the day-to-day, down-to-earth requirements of the majority of users of this type of 'scope.

The result is an instrument that weighs only 17 lb, measures only 8½ inches x 9 inches x 15 inches and requires a power consumption of only 20W.

With the 101, quality comes into the low cost oscilloscope market.

Solid state circuitry and new manufacturing techniques make this an instrument where the word reliability really means something.

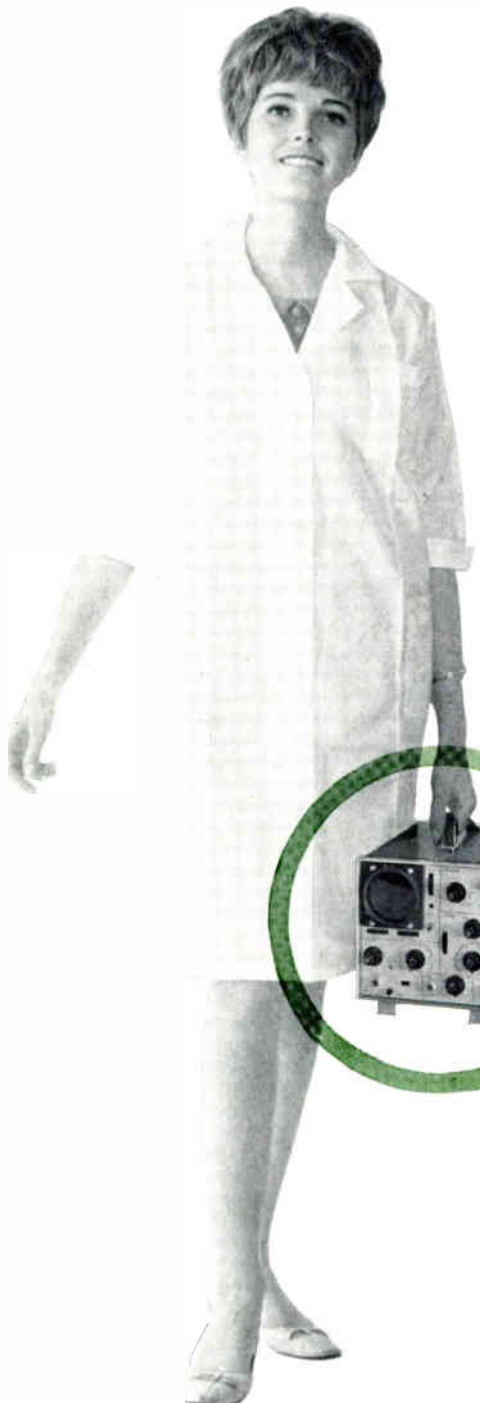

15 Mc/s BANDWIDTH FOR ONLY £170

Consider these features:

- * LIGHT WEIGHT
- * COMPACTNESS
- * LOW POWER CONSUMPTION
- * 18 CALIBRATED SWEEP SPEEDS
- * MAINS OR BATTERY OPERATION
- * WIDE BANDWIDTH—DC to 15 Mc/s
- * VOLTAGE CALIBRATOR BUILT IN

No other 'scope of this type can give you such a combination of practical features! Send the reply card for full details.

Postage
will be
paid by
Licensee

No Postage
Stamp necessary
if posted in
Great Britain
or Northern
Ireland

Business Reply Card Licence No. S0X 64

**Automation Division, Dept. EC5
EMI Electronics Ltd.
Hayes, Middlesex, England**



EMI ELECTRONICS LTD

AUTOMATION DIVISION · HAYES · MIDDLESEX · ENGLAND
TEL: HAYES 3888 · EXT: 2291 · CABLES: EMIDATA LONDON
TELEX: LONDON 22417

for the forming operation is obtained by the combustion of a petrol and air mixture, thereby largely eliminating auxiliary power plants, such as compressed air and gas cylinders. In the current programme, the team will undertake the design and development of a family of full-scale h.e.r.f. machines using petrol combustion, which should lead to the derivation of a specification for a large, supercharged machine capable of industrial exploitation.

For further information circle 49 on Service Card

Woven Matrix for Integrated Circuits

Realizing that the high reliability of modern integrated circuits can easily be lost by poor interconnections, Standard Telecommunication Laboratories have developed matrix interconnection systems to improve reliability.

One technique, the principal aim of which is to simplify design and manufacture rather than minimize volume, involves the use of a matrix of woven fibre-glass tapes, 97-thousandths of an inch wide, each tape supporting a conductor 50-thousandths of an inch wide.

Access to the two sets of conductors can be made from one side only, and a join between crossing conductors can be made by soldering a tinned disc at the cross-over. A break in the conductor is obtained by punching or grinding away the conductor-metal at the required point.

The layout pattern is shown on a card, which may be used as a template for the interconnection process, and, since the matrix can be defined by a series of rectangular co-ordinates, the whole process can be automated.

For further information circle 50 on Service Card

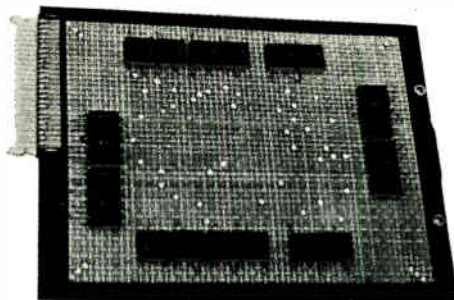

The matrix, shown fitted with thin-film circuit elements, has a 0.1-in. vertical and horizontal pitch and is mounted in a suitable frame to ensure good external connections

Engine Research

A fuel flowmetering system is in use at Leyland Motors Ltd. for engine development. The units provide a digital display of the time taken for an engine to consume a given amount of fuel (diesel or petrol) and the number of engine revolutions during that time.

The principle of the meters, which are based on an original design by B.I.C.E.R.A., is the measurement of fuel consumption by weight. 1 lb or ½ lb of fuel is placed in a tank

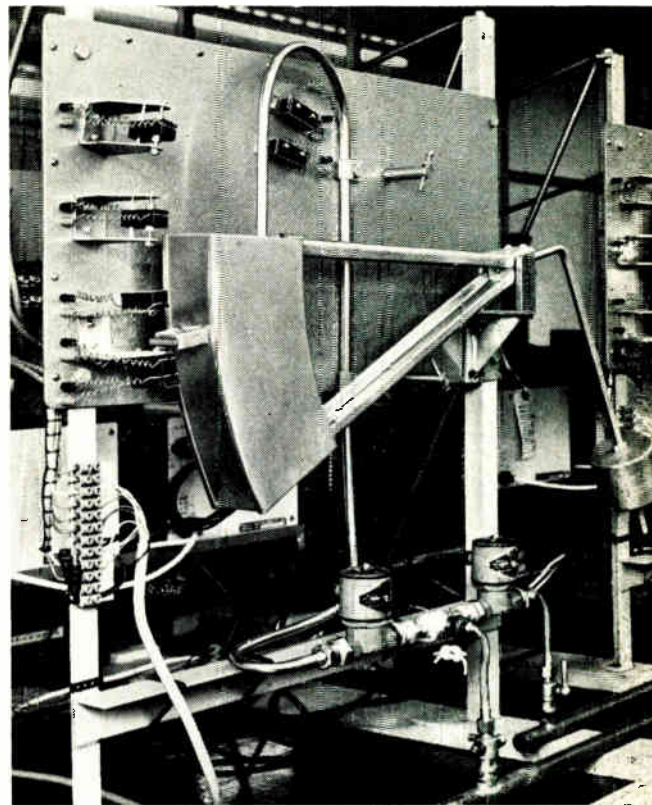

This is the balanced-beam mechanism on one of five flowmeters supplied to one of Spain's largest vehicle manufacturers. As the tank, on the left, empties, the beam moves and the switches, one of which can be seen fixed to the tank, pass through the fields of the magnets attached to the panel

attached to one end of a balanced beam. As the fuel is fed to the engine, the beam moves and dry-reed switches fixed to the beam pass through the magnetic fields of small magnets adjacent to the beam. The switches are actuated and the signals from them are passed to a Racal tachometer type SA520V9 and a Racal totalizer type SA520V8. The time and the number of revolutions are displayed on the digital read-out and after the operation the tank is automatically re-filled and the read-out is returned to zero for the next test run.

This system is accurate to ± 1 rev. and the fuel consumption accuracy is better than that obtained by normal volumetric methods.

Control of Bulk-Sugar Dispensing

A Unipulse metering system, manufactured by Parkinson Cowan Measurement, has been installed at Brickwoods Brewery to control the accurate dispensing of the bulk liquid sugar used in the production of some 200,000 gallons of beer per week. Prior to the installation, the task took several man hours but now the time taken has been reduced to a matter of 5 minutes supervision by one man.

The bulk liquid sugar is fed from tankers to storage vessels which are heated to prevent crystallization. The metering system, consisting of a pre-batch selector and a totalizer unit, dispenses amounts of sugar through pipelines to

Applications and Techniques

continued

the boiling hoppers, the amounts being set on the pre-batch selector. In the hoppers, the unfermented brew is produced by boiling together the sweet wort, sugar and hops.

The system is also used as a weekly check on the amount of sugar used, which is confirmed by the readings of a Pneumercator gauge as required by the Customs and Excise. It can be easily dismantled for cleaning should in-line cleaning be undesirable.

For further information circle 51 on Service Card

Electronic Fog Warning

A photoelectric system, which was initially designed to detect fog and to control foghorns for coastal navigation, has been developed for use on motorways and other major roads.

The equipment, produced by Lancashire Dynamo Electronic Products, consists of a rugged weather-proof light-source transmitter and a remotely-mounted photocell receiver. These will operate over distances up to 1¼ miles. An infra-red beam is projected to the receiver and if this is partially or completely cut off a relay is actuated. The unit can be connected directly to switch on roadside warning signals or a signal can be transmitted, via a roadside telephone network, to a central control room. Here, lights on a control panel indicate the fogbound sections of the roadway so that the operator can switch on warning signs and alert police cars. When the visibility improves the warning system is automatically switched off. A sensitivity control on the receiver allows adjustment of the desired operating level.

A modulated light beam is used to eliminate operation on varying ambient light levels or vehicle headlights. The circuitry is all solid-state and this, together with a 'fail-to-safe' facility, ensures reliability.

For further information circle 52 on Service Card

Ultrasonic Welding of Metal to Plastic

Ultrasonic welding is now being applied by Dawe Instruments to the welding of metal inserts, such as screws, studs and fixing brackets, to plastic mouldings for electronic components, cartons, cameras and similar items. Formerly the inserts had to be fitted at the moulding stage which took time and increased costs.

With the Dawe process the inserts are welded to ready-moulded articles. The instrument used is the Type 1133 Sonicwelder, the design of which has been based on development work done by Dawe's American associates, Branson Industries.

For a screw a hole is pre-drilled or moulded into the plastic and the screw is held at a pressure of about 20 p.s.i. against the hole by a horn connected to an ultrasonic transducer. A 2-sec burst of 20-kc/s ultrasonic energy is applied and the screw vibrates, the friction between the screw and the plastic causing the plastic to melt. The screw is forced in and the still-excited plastic flows in and around the thread and resets. Contraction of the plastic on cooling is negligible as only the material in the immediate vicinity of the screw is melted. Once the plastic has reset the screw can only be removed in the normal manner.

The procedure is similar for studs with knurled or barbed ends.

For further information circle 53 on Service Card

Thyristor Control of Airport Lighting

Five thyristor (s.c.r.) controlled constant-current regulators are being supplied by G.E.C. (Engineering) Ltd. to the New Zealand Civil Aviation Administration for control of airport lighting power supplies.



Smoke generators were used to simulate fog for a demonstration of the warning system

This shows the current regulators under construction. The transformer and the transducer are immersed in oil in a common tank

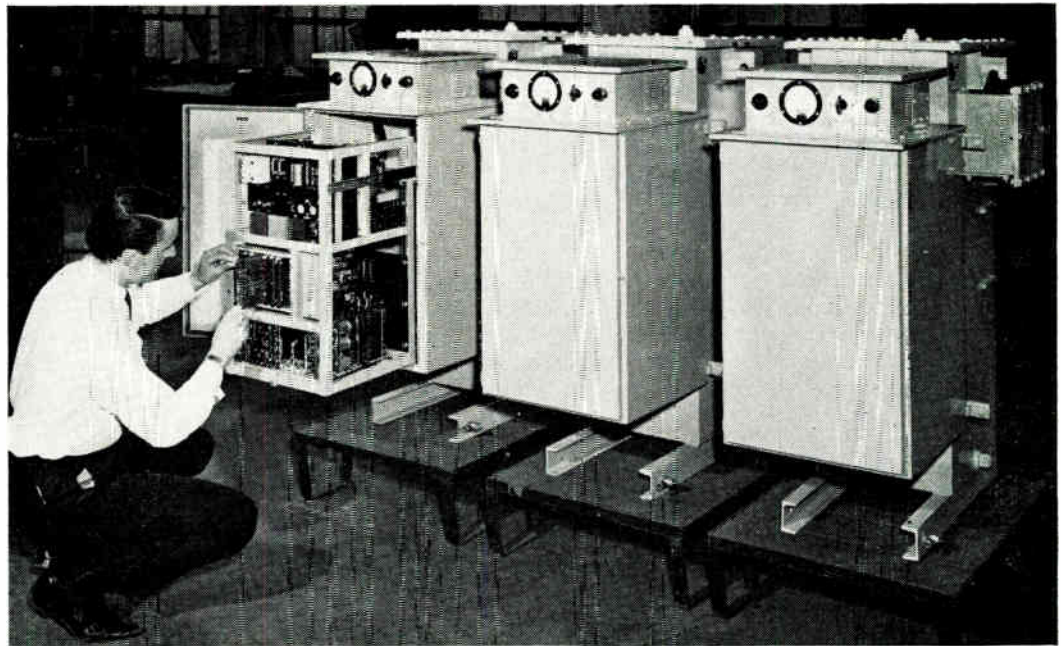

Each regulator consists of a transformer, the primary winding of which is connected in series with the a.c. winding of a transducer, the two being connected across a 230-V a.c. supply. The d.c. winding of the transducer is fed from the output of a thyristor-bridge comparator. A d.c. reference voltage from a stabilized power supply is fed into the comparator together with a reset voltage. This reset voltage is derived from a current transformer connected in series in the output line carrying the regulated a.c. to the lamps. The current from this transformer is converted to a d.c. signal and fed to the comparator. A variation in the reset voltage, resulting from an error in the output current, will produce a variation in the d.c. voltage to the transducer d.c. winding. This alters the magnetization of the transducer core and, as the a.c. winding of the transducer is in series with the primary winding of the transformer, the effective primary impedance presented to the 230-V input will change. A variation in the secondary voltage of the transformer, which feeds the output to the lighting, will be produced to correct the error.

The units are rated at 10 kVA and provide a constant current to the series-connected lamps. A brightness-selection switch is incorporated which is used to adjust the output current from 2.8 to 6.6 A in five steps. The maximum current is regulated to $\pm 1\%$ for a $\pm 10\%$ variation in a single-phase 230-V supply.

For further information circle 54 on Service Card

Automatic Transmission for Small Motor-Cars

A system of automatic transmission for small motor-cars (not the system fitted to the new B.M.C. Minis) is being developed at the Mullard Research Laboratories.

One of the basic requirements of an auto-

matic system is that constant driving power should be supplied to the wheels immediately before and after a gear change to prevent jerking. Automatic control of fixed ratio gear boxes is needed. The torque converters, which can provide a continuously-variable gear between two fixed gear ratios, are unsuitable for small cars and the Daf belt drives are not widely used.

A conventional gear box was chosen for the basis of the system with servo-controlled hydraulic oil pressure actuating the gear-shifting jacks and the clutch. Gear changing is initiated by the wheel speed and the throttle position and the gear change jacks are fitted with position indicators to ensure the correct sequence of operation.

On starting from rest the clutch position is controlled by a moving-coil servo and a hydraulic force amplifier. It is varied via the servo as a function of the engine speed. When changing to a higher gear, the power is cut from the engine by a second butterfly valve inserted into the carburettor. The clutch is opened, the gears are disengaged and engaged without any drive from the engine, and the clutch is re-engaged at a rate determined by the degree of throttle opening. Changing down is effected by the second butterfly opening once the gears have been shifted to a neutral. The engine accelerates and when it reaches the speed at which the minimum jerking would occur, the butterfly is closed and the gear is engaged. The clutch is re-engaged as before.

Electronic control of the manual or the semi-automatic transmission systems which have been introduced by the motor industry is possible, as demonstrated by the Mullard research work, and this would result in a suitable system for the small car. Electronic control is not necessary at the moment for the larger vehicles as the mechanical systems already in use have been shown to be satisfactory.

U.S. Exhibition in London

THE latest electronics exhibition held at the United States Trade Center and sponsored by the United States Department of Commerce introduced the analytical and measuring instruments and laboratory apparatus to be imported from America for 1966. The exhibits included both well-established and new equipment, some of which is reviewed here.

Baird-Atomic Inc., whose U.K. agent is Ealing Scientific Ltd., produce several crystal units (55) for the modulation of helium-neon laser beams at frequencies from d.c. to beyond the video region. When a voltage is applied to the crystal the crystal properties change and cause a linearly-polarized input to become elliptically polarized. The beam passing through the crystal is intensity modulated and is then passed for demodulation through an analysing polarizer, a narrow bandpass filter and a photomultiplier. Baird Atomic also showed a tilted-plate interferometer, the Model QD-1 (56), which is used for beam splitting for spectral analysis of the laser output.

The range of continuous-wave gas lasers (57) from Spectra Physics (represented in the U.K. by Claude Lyons Ltd.) are suitable for propagation studies, optical communication, plasma diagnostics and similar purposes. All models emit light at the visible red wavelengths, although some provide other wavelengths, and various power outputs can be obtained. The range includes a completely self-contained portable unit, the Model 130, which requires no external exciter, and the Model 119 which can be supplied with servo control for long-term stability of ± 5 Mc/s per day. Also featured was the Model 116 which is tunable to 8 visible and 7 infrared wavelengths.

The Claude Lyons stand featured as well the Model 5201A transient amplitude voltmeter (58) manufactured by the Micro Instrument Co. This instrument will read and store the peak values of transient voltages of down to 50 nsec duration. The stored peak value of an input pulse is displayed until the meter is reset or until a pulse of larger amplitude is fed in, the peak value of the larger pulse superseding the original reading. Pulses of smaller amplitude do not affect the reading. D.C. voltages are blocked so that only the transients are measured when the instrument is being used to monitor the transients occurring on d.c. signals or supplies. The five ranges are from 0-10 V to 0-1,000 V and two probes are available to extend the range to 10 kV and 30 kV. An output for a chart recorder is

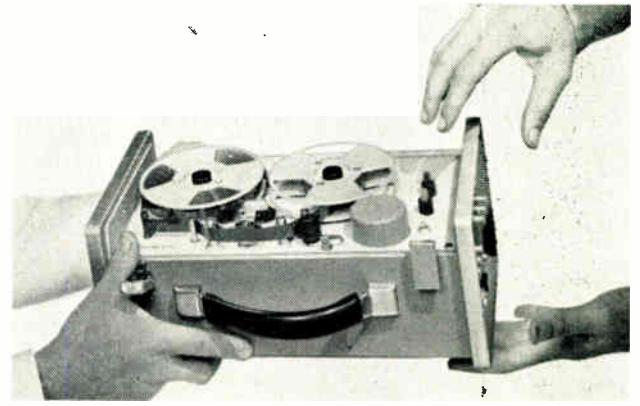

The Model 110 portable data recorder shown here is produced by Pemco. It records data either directly or as a frequency-modulated carrier signal on 1, $\frac{1}{2}$ or $\frac{1}{4}$ -in. tape. Signals in the frequency range 100 c/s to 100 kc/s can be recorded directly. With f.m. carrier recording the response down to 0 c/s makes the unit suitable for recording strain-gauge data, vibration data and other low-frequency data including transients and instantaneous amplitudes (59)

provided and optional features include an output for a digital voltmeter, battery operation and automatic resetting.

Pulse height analysis equipment is produced by The Victoreen Instrument Co. (U.K. agent A.E.P. International Ltd.). Two units were on show, the Scipp 400/1600 (60) and the portable PIP-400 (61). The Scipp 400/1600 (Silicon Computing Instrument, Patch Programmed) incorporates digital circuitry and patch programming and can be converted from a 400-channel to a 1,600-channel system. It is factory-programmed for pulse-height analysis but it can be programmed for other applications and the computing capabilities include integration and digital data differentiation. The PIP-400 is a 400-channel pulse-height analyser containing an independent single-channel analyser. It provides for both analogue and digital readouts suitable for recorders or any of the output accessories which can be obtained.

Versatility of applications is the goal of much modern design work on instrumentation and this was illustrated by the Type 422 oscilloscope (62) exhibited by Tektronix Inc., represented here by Tektronix U.K. Ltd. Weighing only 21 lb and measuring $6\frac{1}{4} \times 10 \times 17\frac{1}{2}$ in., it can be used in awkward, cramped situations. It is rugged and portable and can be supplied as an a.c./d.c. unit suitable for battery operation. Signals below 15 Mc/s can be accepted on both of the two channels and the waveforms are displayed on a rectangular 4-in. display with a sensitivity of 10 mV to 20 V per division (each division being 0.8 cm). A further trend is wider bandwidths and the Tektronix Type 453 oscilloscope (63) has a bandwidth of 0-50 Mc/s. This also is a portable instrument.



One of the most recent of the many small-sized computers now on the market is the Mathatron, manufactured by Mathatronics and marketed by Calcul S.A. This combines the advantages of automatically-programmed digital computers with those of desk calculators. A number of mathematical formulae, sequences and constants can be pre-wired into the machine and others can be inserted into the ferrite-core programme memory. Accurate results to 8 significant figures are presented on a printed tape. Other output modes are printed pages, punched tape or direct connection via the interface to other equipment. Input is via the keyboard, punched tape or the interface. A number of accessories are available, including the paper tape punch and reader and page printer shown on the right (64)

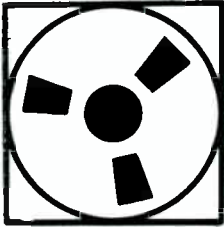

NEW APPARATUS

ELECTRONICS COMMUNICATIONS INSTRUMENTATION CONTROL

1. Mechanism Assessment Computer

In order to provide analysis of readings taken from computer peripheral equipment during tests, I.C.T. have produced a mechanism assessment computer. This consists of a central processor, a card reader and punch, and a typewriter. Information is fed on to the typewriter which also prints the results of the analysed readings. The computer controls the operation of the peripheral and measures the time intervals between successive actions to an accuracy of $\pm 0.2 \mu\text{sec}$. On completion of the test, the computer automatically produces an analysis of the measured and recorded intervals. Equipment that can be tested includes card punches, document readers, random access stores and magnetic tape units. A typical test on a tape transport is the analysis of the speed variations of tape running at a nominally constant speed and

automatically stopped and started by the computer at random intervals which would be encountered in practice. — *International Computers and Tabulators Ltd., I.C.T. House, Putney, London, S.W.15.*

For further information circle 1 on Service Card

2. Differential Pressure Cell

Negretti and Zambra have announced the introduction of the n-cel differential pressure transmitter G 884. It consists of two pressure chambers connected by a flexible diaphragm. A lever mechanism attached to the diaphragm assembly regulates the output air pressure from a nozzle so that this output pressure is linearly proportional to the pressure difference between the two chambers. The pneumatic output varies from 3 p.s.i.g. to a maximum of 15 p.s.i.g. and it can be fed to indicators, recorders or controllers as required. Stability is within $\pm 1\%$

over a pressure difference range of 0–1,000 p.s.i.g.—*Negretti and Zambra Ltd., Stocklake, Aylesbury, Buckinghamshire.*

For further information circle 2 on Service Card

3. Hydraulic Pumps

A series of air-driven hydraulic pumps has been introduced by Olin Mathieson Ltd. and is known as the Haskel AO Series. They will generate oil or water pressures from 100 to 66,000 p.s.i. from an air drive pressure of 100 p.s.i. A predetermined fluid pressure will be held indefinitely and this means that a maintained static pressure is obtained without the need to by-pass excess fluid through a relief valve as in electrically-driven pumps. This reduces the power consumption and makes the pumps suitable for plastic and rubber presses which operate over long curing cycles. Other applications include the testing of

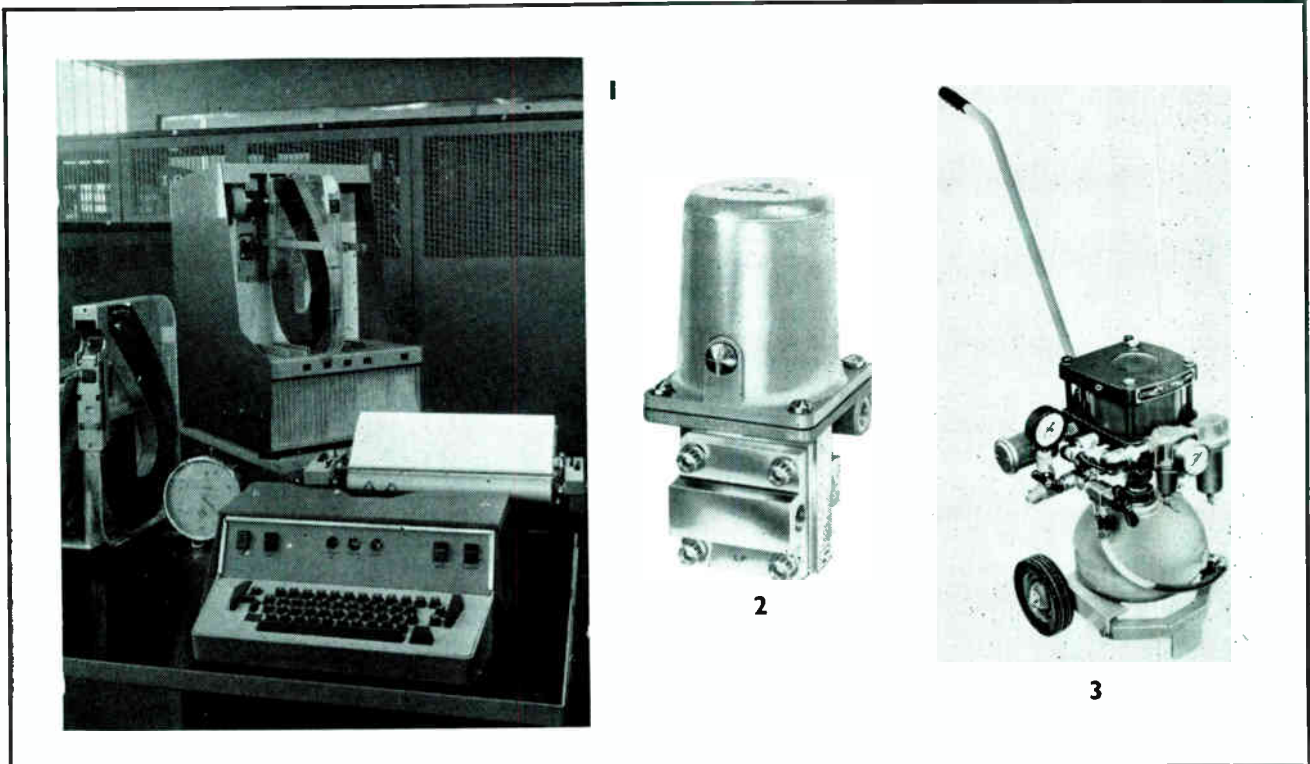

NEW

ELECTRONICS
COMMUNICATIONS
INSTRUMENTATION
CONTROL

high-pressure pipes and vessels, high-pressure lubrication and operation of isostatic presses. The pump can be mounted, together with an oil reservoir, an air-pressure regulator and filters, on a small trolley for mobile applications.—*Olin Mathieson Ltd., North Hylton Road, Sunderland, County Durham.*

For further information circle 3 on Service Card

4. Marking Tapes

Letraset Ltd. have introduced a technique known as Letratapes for applying Letraset Instant Lettering. The letters and numerals are contained on 160-ft long tapes which are held in a dispenser. As the user pulls down the tape, he presses the letter against the surface to be marked and the character is transferred. Good adhesion to any surface is achieved without the need for excessive pressure being applied. Tapes can be obtained which contain single capital letters and numerals, groups of letters for commonly-used codings and commonly used words, and sequences of numerals such as 1-15 and 1-25. They can be applied to drawings (being suitable for dye-line printing), printed-circuit boards, chassis and panels.—*Letraset Ltd., St. George's House, 195-203 Waterloo Road, London, S.E.1.*

For further information circle 4 on Service Card

5. Engine Protection System

A series of engine protection modules, type MPA, have been produced by Teddington Autocontrols Ltd. These modules can be built into a rack to provide a centralized system for indication of fault conditions involving engine speed, temperature, oil pressure, etc. There are four types of module: a mains module containing the mains switch and fuses, a gauge module which can house a thermometer, pressure switch or other type of sensing device, a warning module which gives an audible and visible alarm under hazardous running conditions, and a shutdown module which initiates shutdown of the engine when running conditions exceed preset danger levels. When a fault occurs, the warning sensing switch on the engine closes actuating

a relay so that a lamp is extinguished and a horn is sounded. The horn is silenced by means of a toggle switch and, when the fault has been repaired, the circuit to the horn is automatically remade so that it sounds until the toggle switch is returned to the original position. If the fault is not rectified before dangerous running conditions develop, the shutdown sensing switch closes so that a relay in the shutdown module is energized to actuate a cut-out device on the engine. Once the fault is repaired, the system can be returned to normal by use of a reset button on the shutdown module.—*Teddington Autocontrols Ltd., Windmill Road, Sunbury-on-Thames, Middlesex.*

For further information circle 5 on Service Card

6. Decade Counter Modules

A decade counter module (type DCM 501) has been introduced by Quarndon Electronics Ltd. It is a plug-in counter with a numerical indicator-tube readout and is intended for industrial applications. It can be used for counting at frequencies of up to 1 Mc/s and with the frequency-standard, divider and gating units available, complete counters or digital instruments can be built to meet special requirements. The plug-in unit measures 4½ in. by 1½ in. by 5½ in. and has terminations to fit the standard 32-way printed-circuit board connector. Units are available made with either silicon or germanium semiconductor devices, and the maximum counting speed for the DCM 501 unit is 1 Mc/s, although others are available with counting speeds of 5 Mc/s and 12 Mc/s. For maximum speed, a 2½-V input pulse (with a rise time of 500 nanoseconds) is required, and the output of the unit is sufficient to drive a further unit so that a multi-digit counter can be built up. Crystal frequency standards, gating units and remote display units are available to complete the range.—*Quarndon Electronics Ltd., Slack Lane, Derby.*

For further information circle 6 on Service Card

7. Triode Ion Pumps

Recent work at the A.E.I. laboratories has shown that the continuous handling of gases at pressures of 10⁻⁴ torr by triode ion pumps is practical. Previously, ion pumps have been used mainly at low pressures of 10⁻⁸ torr or less. A range of triode ion pumps has been introduced by A.E.I.

and these have a cathode life in excess of 4,000 hr at an air pressure of 10⁻⁵ torr. Pressures less than 10⁻¹² torr can be achieved so that inherent contamination can be kept below 1 p.p.m. Direct pressure indication is provided on a logarithmic scale. A typical application is the ion pumping of mass spectrometers where the sample gases in the analyser tube are usually 10⁻⁵ to 10⁻⁶ torr and contamination by residual gases must be kept low. The illustration is of the electrodes taken from a pump after 400 hr of operation at an air pressure of 10⁻⁴ torr. A relatively small amount of erosion was shown to take place. The pumps have the advantages over alternative oil diffusion pump systems of lower running costs, portability and freedom from noise.—*A.E.I. Electronics, Trafford Park, Manchester.*

For further information circle 7 on Service Card

ELECTRONICS

8. Twin Low-Pass Filters

An l.f. filter, the SA 500, is being produced by Wayne Kerr Laboratories Ltd. This consists of two identical channels which can be used independently, in cascade or in a band-pass arrangement. A single tuning control allows both sections to be set to any frequency within the range of 0.1592 c/s to 1.592 kc/s. With the two filter sections connected in cascade the attenuation rate is 36 dB per octave. In the band-pass condition there is unity gain and zero phase-shift at the centre frequency with an attenuation rate outside the pass band of 18 dB per octave. The input impedance of each channel is 2 MΩ with an output impedance of less than 60 Ω. This instrument is available for 19-in. rack mounting or in a 20 × 9 × 9-in. case. It operates from normal a.c. mains supplies consuming 20 W.—*The Wayne Kerr Laboratories Ltd., Sycamore Grove, New Malden, Surrey.*

For further information circle 8 on Service Card

9. 24-V Supply

A solid-state d.c. power supply, type PMD 120, has been introduced by Cathodeon Electronic Ltd. This will deliver 0-24 V at 0.5 A, the output being continuously variable over this range. The regulation of the output

is better than 5% with a ripple voltage of less than 5 mV peak-to-peak. The meter can be switched for voltage or current monitoring and it can be switched out to prevent damage once the supply is set. Requiring a 220-240-V, 50 or 60 c/s a.c. input, this unit measures 7 × 5 × 8 in.—*Cathodeon Electronic Ltd., Bircham Road, Southend-on-Sea, Essex.*

For further information circle 9 on Service Card

10. Event Recorder

A solid-state logging device developed under contract to the Building Research Station is now being marketed by the designers, Deakin Phillips Electronics. Using 8-hole punched tape, it records events from up to 127 sources, the logged information identifying the source and denoting its duration, the instant in real time at which it occurs (time signals at intervals of 15 sec being recorded) and its sequence of operation in relation to the other sources. Time signals at other intervals can be arranged and although the system has been designed for recording events in relation to time, any parameters can be recorded with respect to each other allowing correlation records to be made. The output tape is suitable for input to a computer or a tape reader. The equipment supplied to the Building Research Station was designed for the collection of data relating to water usage in a block of flats but it has many other applications.—*Deakin Phillips Electronics Ltd., Tilly's Lane, Staines, Middlesex.*

For further information circle 10 on Service Card

11. Tape Recorder

The VR4 solid-state tape-recorder produced by Van der Molen Ltd. is a 4-track machine which follows the modern trend in this country by having a vertical deck. Although primarily designed as a domestic unit, its robustness and the positioning of the controls at the rear and at the side of the cabinet make it suitable for educational use. There are three modes of input: a microphone input, a pick-up or tuner input and an input to a mixer circuit for superimposition on to recordings on any track. The three outputs are 2-4 V r.m.s. from 10 kΩ for an amplifier or a headset, an output for an 8-Ω extension speaker and an output from one track while a recording is being made on another. The amplifier output to the internal loudspeaker is 5 W of speech or

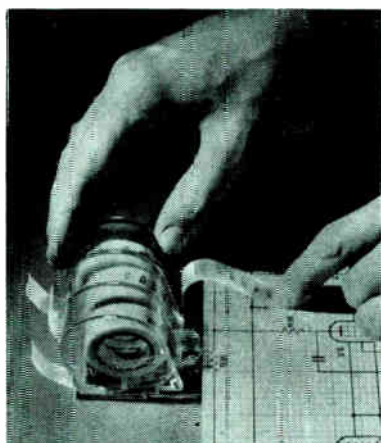

4

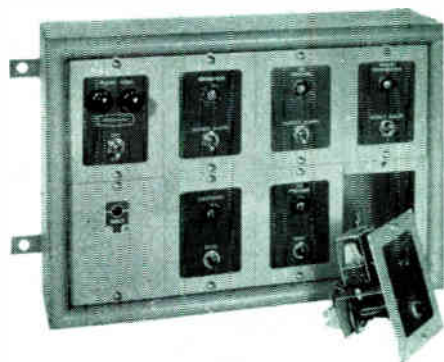

5

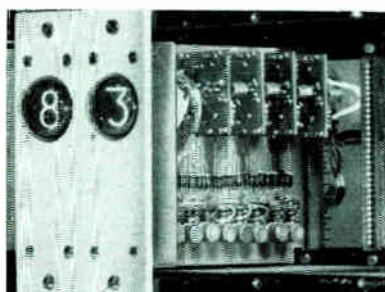

6

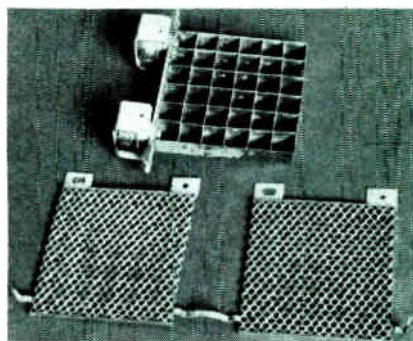

7

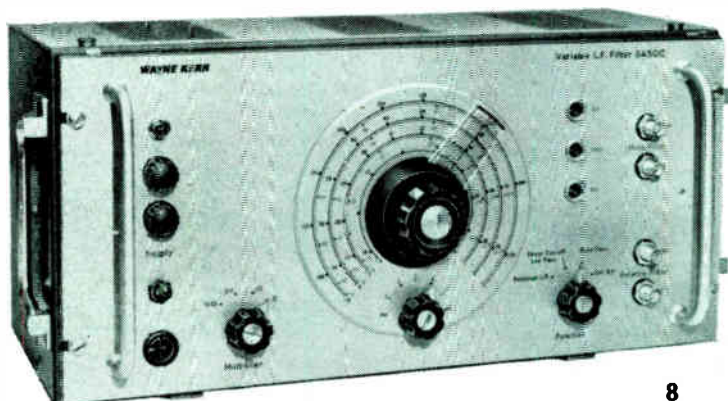

8

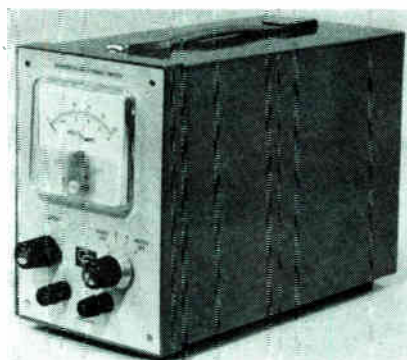

9

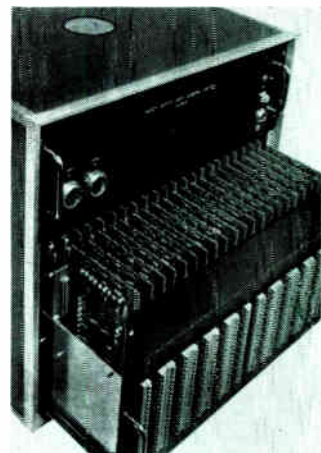

10

NEW

ELECTRONICS
COMMUNICATIONS
INSTRUMENTATION
CONTROL

11

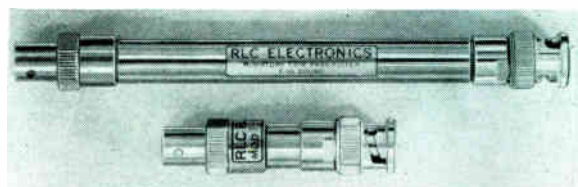
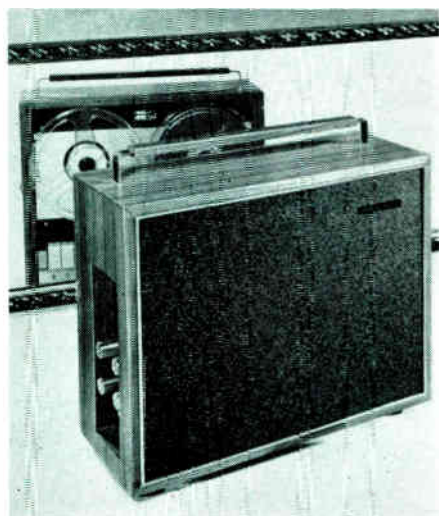

12

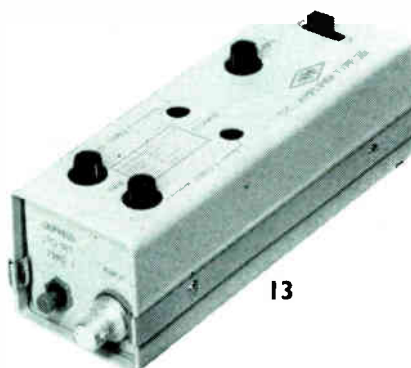

13

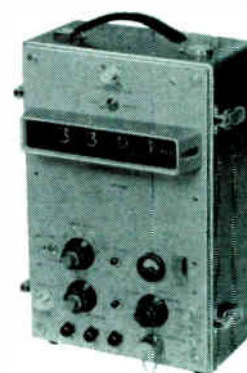

14

music. The three speeds of $7\frac{1}{2}$, $3\frac{3}{4}$ and $1\frac{7}{8}$ -in. per sec provide 3-dB frequency responses of 40 c/s–15 kc/s, 40 c/s–10 kc/s and 60 c/s–5 kc/s respectively.—Available from *H. O. Thomas Electronics Ltd.*, 68-69 Avenue Chambers, 4 Vernon Place, London, W.C.1.

For further information circle 11 on Service Card

12. Low-Pass Filters

Microwave Systems Ltd. are now marketing a range of miniature low-pass filters manufactured by R.L.C. Electronics of America. These have cut-off frequencies from 100 Mc/s to 5 Gc/s and their sizes have been kept to a minimum, the lengths ranging from $7\frac{1}{2}$ in. to $2\frac{1}{4}$ in. The v.s.w.r. in the pass band is 1.35 maximum with a maximum insertion loss of 0.5 dB. The rejection rises sharply above the cut-off frequency and has a minimum value of 60 dB. They are furnished with coaxial connectors. — *Microwave Systems Ltd.*, 9-10 River Front, Enfield, Middlesex.

For further information circle 12 on Service Card

13. D.C. Amplifier

Airmec Ltd. have introduced a d.c. amplifier, type 361, which is fully-transistorized and powered by internal mercury cells having an approximate life of 250 hr. The

voltage gain is continuously variable from 10 to 100 and signals in the range d.c. to about 200 kc/s can be accepted. A frequency response of less than 1 dB down at 80 kc/s and less than 3 dB down at 150 kc/s is exhibited with a load capacitance not exceeding 120 pF. Zero controls are incorporated which will set the output voltage and the open-circuit input voltage to zero. When correctly set the output zero is not affected by change in the source resistance. At 1 kc/s the input resistance is greater than 400 k Ω and the output resistance is less than 1 k Ω . The maximum output level is at least ± 1 V peak at all frequencies into loads greater than 50 k Ω . Input overloads up to ± 30 V peak-to-peak can be applied without damage.—*Airmec Ltd.*, High Wycombe, Buckinghamshire.

For further information circle 13 on Service Card

14. Digital Chronometer

A fully-transistorized deci-millisecond chronometer with digital read-out is announced by Britec. Designed primarily for measurements in the field, it measures $16 \times 10\frac{1}{2} \times 7\frac{1}{2}$ in. and has an internal nickel-cadmium battery which provides 8 hours of continuous operation. The 'Chronoseis' measures the time interval between two control pulses (within the range of 0.1 to 199.9 msec) with an accuracy of

± 0.1 msec in the temperature range -10°C to $+60^\circ\text{C}$. It incorporates a high-sensitivity amplifier, with adjustable gain, making it possible to work with pulses ranging in amplitude from a few microvolts to several volts. A built-in time delay, graduated in 10-msec steps, prevents premature triggering of the control circuit by parasitical interference or unwanted signals, and coaxial outlets are provided on the control panel to enable the control pulses and a 10-msec marker to be fed to an oscilloscope.—*Britec Ltd.*, 17 Charing Cross Road, London, W.C.2.

For further information circle 14 on Service Card

COMMUNICATIONS

15. Monitoring Receiver

A monitoring receiver, type ESU, operating in both the v.h.f. and the u.h.f. bands of frequencies has been announced in the U.S.A. by Rohde and Schwarz. The frequency range of 25–900 Mc/s is covered by three r.f. plug-in units and the unit can be used for monitoring radio reception, interference and laboratory measurements. The receiver is equipped with an oscillator ganged with the tuning control and this enables calibration of the instrument at any test frequency. An output can be

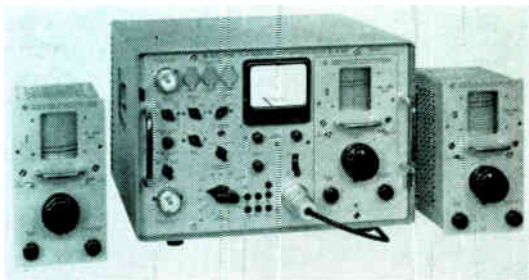

15



17



16

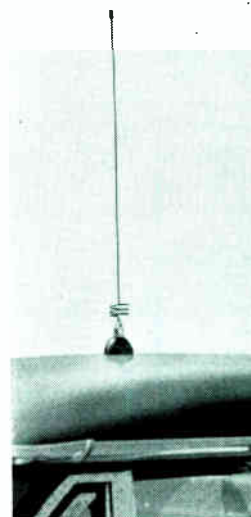

18

taken from this oscillator so that the unit can be used as a transmission test set. An i.f. output can also be taken as well as outputs for a recorder, headphones and a loudspeaker. Both a.m. and f.m. operation is possible and two selectable bandwidths, switch-selected a.f.c. and a b.f.o. are featured. Calibrated aerials for field intensity measurements are available.—*Rohde and Schwarz, 111 Lexington Avenue, Passaic, New Jersey, U.S.A.*

For further information circle 15 on Service Card

16. Underwater Intercom

Communication equipment for use underwater by skin divers has been produced by the Raytheon Co. and is available in this country from the Cossor Communications Co. Known as the 'Yack Yack', it consists of a microphone and sound diffuser, which fit into a face mask to eliminate bubble sounds, and a non-corrosive plastic case worn on the diver's belt and containing an amplifier, a dry-cell battery and a loudspeaker. No special receiver is required and normal speech sounds are carried through the water for up to 50 ft. The equipment has been successfully used at depths of 350 ft. A bleeper alarm is provided which has a range of more than three times the voice range and can be used to alert a diver or to call him to come into the speech range. Surface-to-

diver equipment is also available with which conversations can be made over 100 ft from a boat to a submerged diver.—*The Cossor Communications Co., The Pinnacles, Elizabeth Way, Harlow, Essex.*

For further information circle 16 on Service Card

17. F.M. Transmitter/Receiver

The sonar Model FM-40 now available from Emec Inc. is an f.m. transmitter which can be supplied as a remotely-controlled unit. It has been designed for business use and, being compact, it can be easily installed in motor vehicles. Noise is minimized in the receiver by a squelch circuit and adequate limiting and audio filtering. 37 W of modulated r.f. power are delivered by the transmitter and the unit is supplied with one pair of crystals for 20-29-999 Mc/s. Three other crystal pairs can be obtained as accessories to extend the frequency range to 50 Mc/s. Other accessories include additional squelch circuits, an external speaker and ignition suppression. The power requirements are 110 V a.c. or 12 V d.c.—*Emec Inc., 160 Terminal Drive, Plainview, Long Island, N.Y. 11803, U.S.A.*

For further information circle 17 on Service Card

18. Mobile U.H.F. Aerial

Associated Aerials Ltd. have introduced a low-cost u.h.f. whip aerial,

type MB2/SC 450-470, for use on cars. It is easily fitted to the vehicle roof, there being no need to remove the lining as the feeder cable is brought through by means of a draw-wire. The response is level in the frequency range of 450-470 Mc/s and a good signal will be provided at these frequencies. Tough road and weather conditions will not impair the performance and this ruggedness is ensured by the sturdy construction. The price is 37s. 9d. for single aerials and 32s. 6d. each for ten or more. Each aerial is individually packed and has full installation instructions.—*Associated Aerials Ltd., Knight Road, Strood, Kent.*

For further information circle 18 on Service Card

19. U.H.F. Pocket Radio Telephone

The Pye Telecommunications Pocket-fone is a radio-telephone consisting of separate transmitters and receivers measuring approximately $6\frac{1}{2} \times 2\frac{1}{4} \times 1\frac{1}{8}$ -in. and operating in the u.h.f. band. With these alone, communication over several hundred yards is possible and wide range coverage of about 5 miles can be achieved if a base station is used. Except for the transmitter output power of 100 mW, the performance of the 5-oz receiver and the 10-oz transmitter is comparable to that of a

NEW

ELECTRONICS COMMUNICATIONS INSTRUMENTATION CONTROL

car radio-telephone weighing 10 lb. The power is supplied by miniature re-chargeable or dry-cell batteries and a special circuit enables one battery to be used for 30 hours of continuous receiver operation. The u.h.f. band of frequencies provides an increased number of channels and one particular frequency can be used by several isolated networks without interaction. Also, radio waves at these frequencies can penetrate obstructions and demonstrations have shown no appreciable deterioration of signal levels when links were established between the interior of a building and the inside of a moving vehicle. A further advantage is the short aerial required, the transmitter aerial being only 15-cm long. It is housed inside the transmitter case

and is ejected by a press-to-talk button. The applications of the Pocketfone cover any situation or installation where direct communication among distributed personnel is required.—*Pye Telecommunications Ltd., Newmarket Road, Cambridge.*

For further information circle 19 on Service Card

20. Miniature Microphone

R.C.A. have announced a miniature microphone, the BK-12A, which weighs 20 gm and measures 1½-in. long by ¾-in. in diameter. It can be inconspicuously held in the hand, worn on a lanyard around the neck or clipped to clothing and is suitable for use in television, film location work and public address systems. The frequency response is 60 c/s–18 kc/s and the microphone is omnidirectional up to 6 kc/s. It has a low-impedance voice coil which permits its use with input impedances between 30 and 250 Ω. No output trans-

former is required and this results in a low hum pickup. The effective output level at 1 kc/s is –60 dBm into 150 Ω referred to a sound pressure of 10 dynes/sq cm. Servicing of the microphone is simple; a complete replacement cartridge can be installed in a few minutes. The cartridge may be roughly handled with little risk of damage and the 30-ft cable, which is made of cadmium copper with a p.v.c. casing, is both flexible and durable.—*R.C.A. Great Britain Ltd., Lincoln Way, Windmill Road, Sunbury-on-Thames, Middlesex.*

For further information circle 20 on Service Card

INSTRUMENTATION

21. Trace Substance Analysers

A range of automatic trace substance analysers introduced by Electronic Instruments Ltd. enables the efficiency of water treatment processes to be checked entirely automatically and so eliminate the need for frequent manual estimations of the trace substances. The analysers use a colourimetric analysis technique and are sensitive and stable. The Model 58E Silica Analyser is the most sensitive and can be supplied to read 0.06, 0.1 or 0.2 p.p.m. f.s.d. This analyser, in view of its sensitivity, incorporates automatic standardization between each silica determination. The Model 60C Hydrazine Analyser is not so sensitive and does not have the automatic standardization feature. It is designed to measure hydrazine excess and has a range of 0–0.5 p.p.m. Analysers are also available for the estimation of traces of copper and iron.—*Electronic Instruments Ltd., Lower Mortlake Road, Richmond, Surrey.*

For further information circle 21 on Service Card

22. Transistor Test Set

Portability and robustness, coupled with simplicity of operation, are the features of the 74163-B transistor test set recently introduced by Standard Telephones and Cables Ltd. It will measure the dynamic current gain of both silicon and germanium transistors of the p-n-p and n-p-n types. Gains up to 200 may be measured on a dual-range meter, with an emitter current of approximately 1 mA and a collector

(continued on page 83)



19



20



21

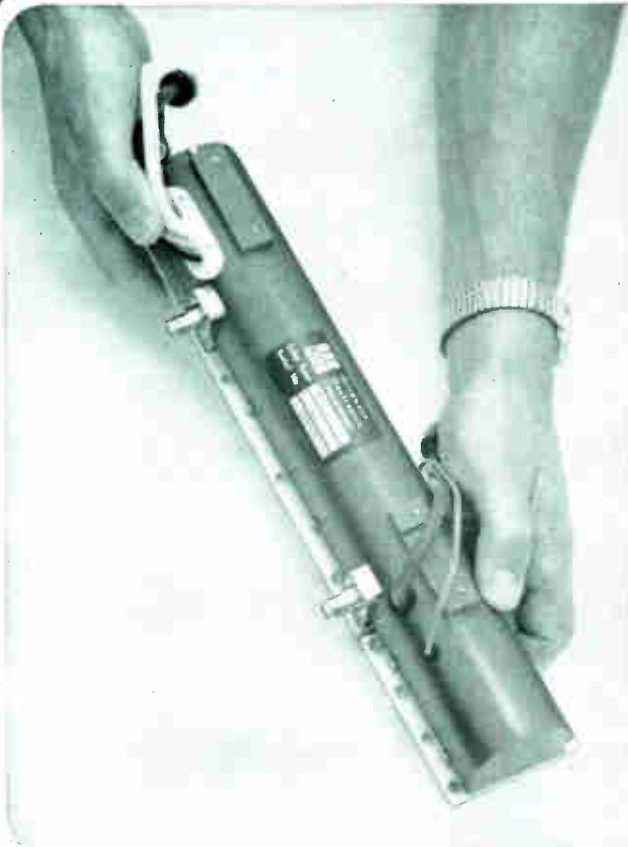

This is MEC's 100 Watt TWT

Conduction cooling has brought MEC's line of 100-watt-CW travelling-wave tubes out of the laboratory and into the most severe military environments. These octave-bandwidth L- through TD.-band TWTs have been delivered to more than a dozen customers internationally for ECM, radar, telemetry and communications applications. Your MEC representative has actual test data and engineering information on the entire MEC line of 100-watt laboratory and militarized TWTs.

Key Features — altitudes to 50,000 feet • temperatures from -40° to 100°C • shock/vibration up to MIL-E-5400 Class 2.

RF Performance — 100 watts CW minimum P_o
• 30 db saturated gain • 20% efficiency.

It Works Here

Typical X-Band Test Data (M5314 Serial 107)

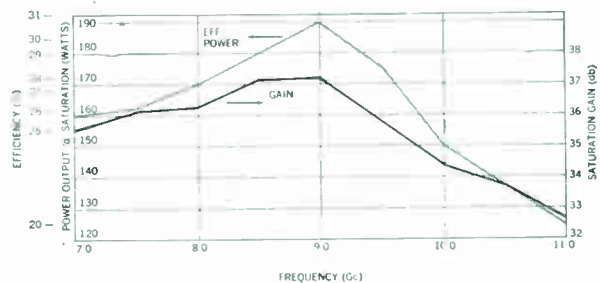

(Comparable data available in L, S and C Bands)



Microwave Electronics
a division of Teledyne

International Division, Frazar & Hansen Ltd.
150 California Street, San Francisco 11, Calif., U.S.A.

Walmore Electronics
11-15 Betterton Street, Drury Lane, London, W.C.2

European representatives : Electronics & Microwave Agency S.R.L., Roma ; Amerikanska Teleprodukter AB, Stockholm ; Telemeter Electronic AG, Zurich ; Telemeter Electronic G.M.B.H., Schleissheim-Munchen

Melabs

STRIPLINE SOCKET CIRCULATORS

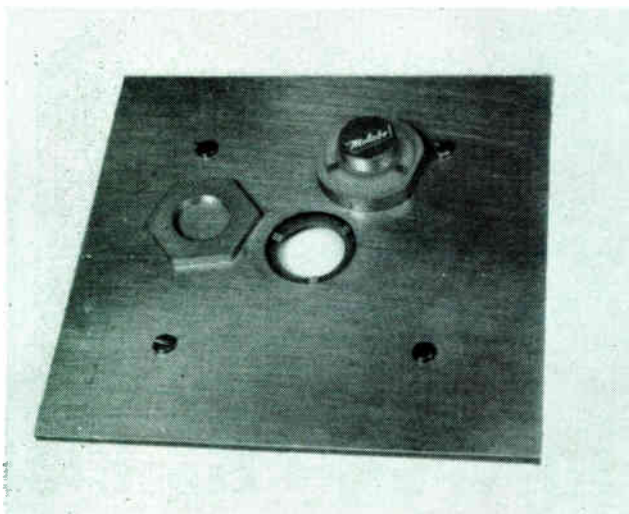

Melabs have introduced a range of microwave ferrite 3-port circulators designed for use in standard semi-rigid striplines where the ground planes are 2 mil, thick copper with no rigid back-up plate. The socket for the circulator is made by cutting two concentric holes at the appropriate location in the stripline package. The circulator is then fitted by inserting it in the socket and tightening the locking nut. Circulators of this type are now available for any frequency from 2 to 12 Gc/s and have an electrical performance comparable to conventional circulators with coaxial connectors.

A similar range of circulators is available suitable for use in rigid striplines having $\frac{1}{4}$ " thick aluminium ground planes. The standard dielectric used is Rexolite 2,200 but other dielectric materials can be provided.

WALMORE ELECTRONICS LTD

11-15 BETTERTON ST DRURY LANE. LONDON, WC2 Tel: TEMple Bar 0201-5

ADCOLA

PRODUCTS LIMITED
(Regd Trade Mark)

SOLDERING EQUIPMENT

SPECIALISING FOR THE SOLDERING JOINTING INDUSTRY

Illustrated

$\frac{1}{8}$ " BIT INSTRUMENT
(LIST 64)
IN
PROTECTIVE SHIELD
(LIST 700)

ALL-VOLT RANGES
FROM
6/7 TO 230/250 V

BRITISH & FOREIGN PATS.
& REG. DESIGNS, ETC.

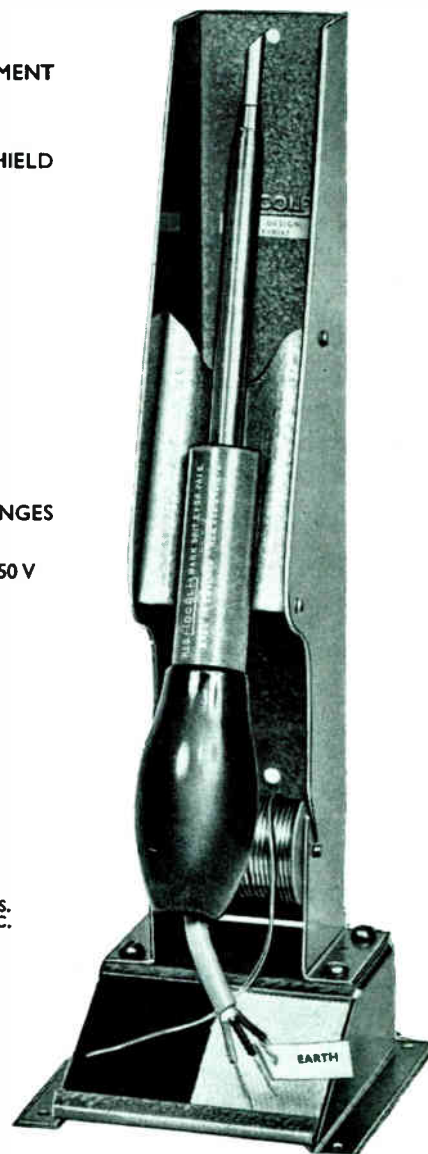

Apply Direct for Catalogues :
ADCOLA PRODUCTS LTD.
ADCOLA HOUSE
GAUDEN ROAD
LONDON, S.W.4
Telephones MACaulay 4272 and 3101
Telegrams SOLJOINT LONDON S.W.4

INDEX TO PRODUCTS

Please refer to appropriate pages to obtain code number for marking enquiry card

A—Advertising pages E—editorial pages

	page		page
Aerials	E81	Photocell relays	E84
Alarm systems	E72	Photoconductive cells	47A
Amplifiers	E80	Plastics mouldings and	
Analysers, trace substance	E82	extrusions	1A, 36A, 66A, 68A
Benches, lamina flow	E87	Potentiometers	2A, Cover 4, E86
Books, technical	67A	Potentiometers, sub-miniature	A5
Cabinets, boxes, chassis,		Power supplies	E78
racks etc.,	29A	Pressure cells	E77
Cables	E94, E70	Printed circuits	68A
Capacitors		Probes, current R.F.	E83
Cover 3A, 32A, 62A,	E86	Pumps, hydraulic	E77
Chronometer, digital	E80	Pumps, triode ion	E78
Circulators, stripline	A50	Radiation monitors	89E
Coils, fine wire	E86	Radio control system	E85
Communications systems		Radiotelephones	30A, 31A, E81
Cover 2, E81		Receivers	E91, E80
Components, electronic		Recorders, chart	56A
15A, 26A, 27A		Recorders, data	67A
Computers	45A, E77	Recording oscillographs	17A
Connectors	66A	Rectifier, semiconductor	13A
Control system, electronic	E84	Relays	
Controllers, liquid level/flow		11A, 19A, 23A, 32A, 60A, 69A	
25A, E72, E73		Resistance material	61A
Controllers, motor-speed	E84	Resistors	16A, 22A, 66A
Controllers, pressure	E84	Sealants, dispensers	E88
Controllers, time/temperature		Solder and soldering tools	50A
37A		Solenoids	68A
Conveyors	E95	Springs and connectors	68A
Counters, decade	E78, 9A	Stove enamelling	70A
Crystals, quartz	42A	Switch, programmer, variable	
Data logger/recorder	E79		E88
Diodes, microwave	47A	Synchros and servomotors	41A
Direction finders, automatic	89E	Systems engineering	38A, 56A
Electronic Equipment, general		Tags, terminals and clips	38A
55A, 58A		Tape punching/reading	
Exposure control, photomicro		equipment	69A
E83		Tape recorders/reproducers,	
Fans	64A	magnetic	54A, E79
Fault detection system, engine		Tapes, marking	E78
E78		Telephone, automatic dialling	E96
Ferrite components	60A	Terminals and terminal	
Filters, low pass	E78, E80	blocks	70A
Flame cutting units	E87	Test set/transistor	E82
Flowmeters	58A, 60A, 62A, 73E	Thermistors	16A
Fog warning system	E74	Thyristors, s.c.r.	28A, 47A
Indicator units	58A	Timers, re-cycling, pulsing	E85
Instrumentation, dynamic		Transformers	12A
testing	21A	Transistors	47A
Instrumentation, electronic	70A	Transistors, field effect	E85
Instrumentation, industrial	18A	Transmitters	E91, E93, E81
Insulation materials	53A	Travelling wave tubes	49A
Integrated circuits	20A	Trimming capacitors	56A
Integrated circuits matrix	E73	Tubes, cold cathode/trigger	47A
Inverters, static	63A	Tubes, neutron generating	E91
Lasers	E68, E91, A40	Tuning fork	36A
Lettering tape	8A	Ultrasonic welding	E74
Lighting controllers, thyristor		Valve testers	10A
E74		Vibration measurement	
Logic modules	E86	equipment	E90
Lubricants, anti-seize	E87	Wafering machines	E87
Lubricants, cleaner	55A	Wire	64A
Magnetic recording heads	46A	Wire, thermocouple alloys	24A
Magnetic tape store	63A		
Magnets and magnetic			
materials	59A		
Meters	9A, 48A, 62A, 65A, 78A		
Micro bonder	E88		
Microphones	E82		
Microscopes	52A		
Microwave components	39A		
Monitors, radiation	E83		
Motors	12A		
Motors, torque	55A		
Mouldings, porcelain steatite	17A		
Multimeters	E83		
Oscilloscopes			
6A, 7A, 14A, 35A, 40A			

MANUFACTURERS' CATALOGUES

Page 70A and Page E98

Badar Machinery Co. Ltd.
 Dynamco Systems Ltd.
 Electrosil Ltd.
 Hilger & Watts Ltd.
 International Nickel Ltd.
 Kodak Ltd.
 Marconi Instruments Ltd.
 M.E.L. Equipment Co. Ltd.
 Photain Controls Ltd.
 Rank Organization Ltd.
 Theta Instrument Corporation
 Thorn Special Products Ltd.

Let the

INDUSTRIAL ELECTRONICS

READER ENQUIRY SERVICE help you to obtain more information

To obtain further details of any of the coded items mentioned in the Editorial or Advertisement pages of this issue, please complete one or more of the attached cards circling the appropriate reference number(s). Your enquiries will be passed on to the manufacturers concerned and you can expect to hear from them direct in due course. Cards posted from abroad require a stamp. These Service Cards are valid for six months from date of publication.

PLEASE USE CAPITAL LETTERS

Pour obtenir tous renseignements sur les produits codés mentionnés dans les articles ou dans les pages publicitaires de ce numéro nous vous prions de remplir une ou plusieurs des cartes ci-jointes en encerclant le ou les numéros de référence appropriés. Vos demandes de renseignement seront transmises aux fabricants intéressés qui, en temps voulu, vous feront parvenir leur réponse. Il est nécessaire d'affranchir les cartes postées à l'étranger. Ces cartes de service sont valides pendant six mois à partir de la date de publication.

PRIÈRE D'UTILISER DES CARACTÈRES D'IMPRIMERIE

Weitere Einzelheiten über irgendwelche Artikel, die auf redaktionellen oder Anzeigenseiten erscheinen, erhalten Sie, indem Sie eine oder mehrere der beigefügten Karten ausfüllen und die entsprechende(n) Kennnummer(n) einrahmen. Ihre Anfrage wird an den Hersteller weitergeleitet, und Sie werden dann direkt von ihm hören, Karten, die im Ausland aufgegeben werden, müssen frankiert werden. Diese Service-Karten sind für sechs Monate vom Ausgabebetrag gültig.

BITTE IN BLOCKSCHRIFT AUSFÜLLEN

Per ulteriori particolari in merito agli articoli menzionati nel testo o nelle pagine pubblicitarie di questo numero, Vi preghiamo di completare una o più delle schede allegate chiudendo in un cerchietto il numero o i numeri di riferimento. La Vostra richiesta sarà inoltrata ai fabbricanti interessati che Vi risponderanno direttamente. Le schede dall'estero devono essere regolarmente affrancate. Questo scontrino di servizio è valido per sei mesi dalla data di pubblicazione.

SI PREGA DI COMPILARE LE SCHEDE IN STAMPATELLO

Con objeto de obtener más detalles de cualquiera de los artículos mencionados en las páginas editoriales o de anuncios de este número, sírvase rellenar una o más de las unidas tarjetas poniendo un círculo al número o números de referencia. Sus consultas serán transmitidas a los fabricantes interesados de quienes tendrán noticias directamente a su debido tiempo. Las tarjetas enviadas desde el extranjero requieren franqueo. Estas tarjetas de servicio son válidas durante 6 meses a partir de la fecha de publicación.

SÍRVASE ESCRIBIR CON LETRAS MAYUSCULAS

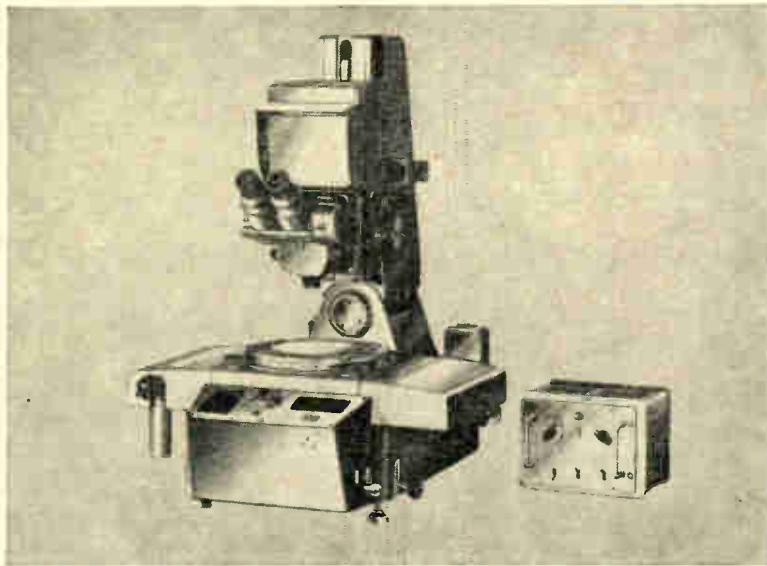

TOOL MAKERS' MICROSCOPES
ABBE METROSCOPES
UNIVERSAL
HORIZONTAL
METROSCOPES
ANGLE DIVISION
TESTERS
UNIVERSAL
MEASURING
MICROSCOPES
SMALL BORE
MICROSCOPES

ZEISS



JENA—THE HOME OF ZEISS

PROJECTION TOOL MAKERS' MICROSCOPE

Embodying a number of essential technical improvements this microscope combines maximum operational comfort with high measuring accuracy ensuring higher productivity with less operator fatigue.

Angle Measurements of tools, profile gauges, templets, etc. Thread Measurements pitch, major and minor diameters, lead, thread angle, position of profile with respect to thread axis and thread forms.

Checking contours against contour patterns. Checking surface quality.

Micrometer screws replaced by built-in illuminated precision glass scales.

Rapid manual displacement of the freely floating stage in X and Y- direction, setting of the coarse motion may be rapidly clamped, sensitive positioning by means of fine control. Accuracy of reading in X and Y traverse is .0001" total capacity. 6" x 3" with magnification from 10x to 50x.

Range of tilt of the upright measuring beam is $\pm 15^\circ$ to the Y-axis. Its vertical position being indicated by a light signal denoting correct positioning within 20" accuracy.

Zeiss Exhibition at the Leipzig Spring Fair, 6-16th March, 1966, Hall 15, Zeiss Pavilion, Leipzig.

For further information and details of the Carl Zeiss Jena range of Mechanical Instruments for length and Screw-Thread Measurements, Opto-Mechanical Instruments for Measuring lengths, Screw-Threads and Contours, please write or telephone:

C.Z. SCIENTIFIC INSTRUMENTS LTD.

Zeiss England House, 93/97 New Cavendish St., London, W.1

Tel.: LANgham 0571/5

voltage of approximately 5 V. The meter is calibrated directly in current gain. Push-button switching facilitates setting-up of the appropriate circuit arrangements, and the voltages of the two internal dry cells can be checked on the meter. A 3-pin socket and a set of 3 terminals are provided so that the transistor to be tested can be connected to whichever is the more convenient.—*Standard Telephones and Cables Ltd., STC House, 190 Strand, London, W.C.2.*

For further information circle 22 on Service Card

23. Electronic Multimeter

Currents as low as 5 nA can be measured on the Philips PM2401 transistorized multimeter now available from The M.E.L. Equipment Co. Sixty-one ranges are provided and these include d.c. voltage ranges from 100 mV to 700 V, d.c. current ranges from 100 nA to 10 A, a.c. voltage ranges from 100 mV to 300 V (2 c/s–2 Mc/s), and a.c. current ranges from 1 mA to 10 A (20 c/s–100 kc/s), these being the f.s.d. readings. Also there are 6 resistance ranges from 0.5 Ω to 50 MΩ. Polarity of measurements is shown on a small indicator and the unambiguous range selection arrangement consists of coloured inscriptions on the front panel around the rotary switch and push buttons for volts, amps and ohms. Accessories are available for extending d.c. measurements up to 30 kV and the frequency range of a.c. measurements up to 700 Mc/s.—*The M.E.L. Equipment Co. Ltd., Manor Royal, Crawley, Sussex.*

For further information circle 23 on Service Card

24. Radiation Monitor

The PCM3 is a compact solid-state radiation contamination monitor recently introduced by E.M.I. Electronics Ltd. It can be used with a variety of probes for simultaneous monitoring of alpha and beta/gamma radiation. A visual indication of radiation is given on an accurate 5-in. scale and an audible indication is given on an internal loudspeaker with separate tones for alpha and beta/gamma radiation. The instrument can also be fitted to actuate an external relay or alarm system. A 'fail-safe' facility is incorporated so that a warning note is emitted from the loudspeaker if the probe is damaged or subjected to excessive radiation.—*E.M.I. Electronics Ltd., Hayes, Middlesex.*

For further information circle 24 on Service Card

NEW

ELECTRONICS
COMMUNICATIONS
INSTRUMENTATION
CONTROL

22

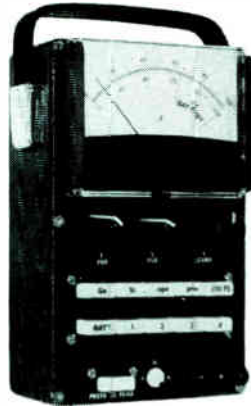

23

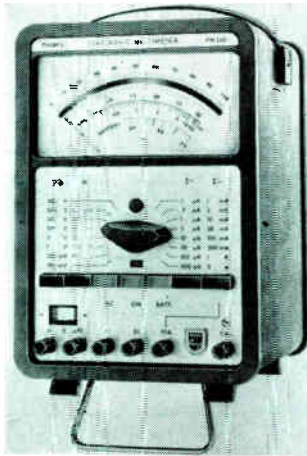

24



25

25. R.F. Current Probe

A current probe for measurement of r.f. and transient currents in the range 20 kc/s to 200 Mc/s is now available from the Atlantic Research Corp. This probe, Model 6676-02, is suitable for use where the minimum of disturbance of circuits is necessary as there is no need for physical contact between the probe and the circuitry. It has a diameter of 1/4-in. and is only 1/2-in. long so that installation in high-density circuitry and components is possible. While the probe is uniformly responsive to currents in the leads passing through it, it is not influenced by surrounding electric and magnetic fields. This is achieved by the electrostatic screening on the secondary winding of the wound ferrite toroid which acts as the current transformer.—*The Atlantic Research Corp., Alexandria, Virginia, U.S.A.*

For further information circle 25 on Service Card

CONTROL

26. Photomicrographic Exposure Control

The Model MF automatic exposure regulation unit from C. Z. Scientific Instruments Ltd. has been produced to overcome the problem of determining the exact exposure period in photomicrographic work. It controls the respective exposure periods needed for the varying brightness of images under a microscope when these images are to be photographed. The unit can be fitted to any microscope and includes a 35-mm camera and a switching unit for adjusting the exposure time. The timing value is set on a dial on the timing unit and this value depends on the format of the photograph, the sensitivity of the photo-

NEW

**ELECTRONICS
COMMUNICATIONS
INSTRUMENTATION
CONTROL**

graphic material and on the developing conditions. The operator checks that the exposure is correct through the viewing lens. With the microscope focused and the timing set, it is only necessary to press the camera shutter release button to obtain a properly-exposed photomicrograph.—*C.Z. Scientific Instruments Ltd., Zeiss England House, New Cavendish Street, London, W.1.*

For further information circle 26 on Service Card

27. Photocell Relay Unit

A robust photocell relay unit, which can be connected to initiate many control functions, has been produced by Photain Controls Ltd. Designated the type PTR/SP, it works in conjunction with a cadmium selenide photocell mounted in a separate receiver unit and fitted with a baffle to exclude ambient light. With an appropriate light projector, it will operate over beam lengths of 1 in. to 100 ft. Time delays can be incorporated to delay the operation of the relay on the light beam being broken or made, and

several units can be connected together to form a complex system. The plug-in relay has two sets of change-over contacts rated at 5 A, 250 V a.c.—*Photain Controls Ltd., Randalls Road, Leatherhead, Surrey.*

For further information circle 27 on Service Card

28. Modular Control Equipment

Versatile control equipment is being produced by William Don Ltd. under the name of Donolec 'Neoset' Mini-Blocks. It consists of a series of circuit modules and transducers which can be built up into complete systems for the control of current, motor speed, temperature, the position of metal parts and many other process variables. The control circuits are actuated by 50-V, 0.3-mA signals and they will initiate alarms or relays for process control. The equipment can be supplied in kit form or in standard instrument cases containing the circuitry for particular applications. It can also be supplied in the form of multi-channel alarm panels.—*William Don Ltd., Kerry Hill Works, Horsforth, Leeds.*

For further information circle 28 on Service Card

29. Pressure Controller

In order to provide a unit which will hold pressure at a given level over a

period of time for applications in vacuum technology, Vacuum Industrial Applications Ltd. have produced the VIA-VAC servo-operated pressure controller type 1. It has been designed for use with hot-cathode ionization gauges having an operating range of 5×10^{-3} to 2×10^{-7} torr, other types of gauge being suitable. The unit can be set to maintain a constant pressure to within $\pm 10\%$ at pressures below 3 microns of mercury. The required pressure is set, by means of a calibrated potentiometer, as a percentage of the full-scale deflection shown on the ionization gauge. A meter on the controller indicates when the required pressure has been reached. When it has been reached, a servo-operated motor operates a valve in the vacuum chamber. The valve opens and shuts to admit gas, maintaining the pressure at the required level.—*Vacuum Industrial Applications Ltd., Netherton Road, Wishaw, Scotland.*

For further information circle 29 on Service Card

30. Motor-Speed Control Units

Hawker Siddeley Dynamics have developed a range of inexpensive motor-speed control units suitable for operation with series wound a.c./d.c. electric motors with ratings

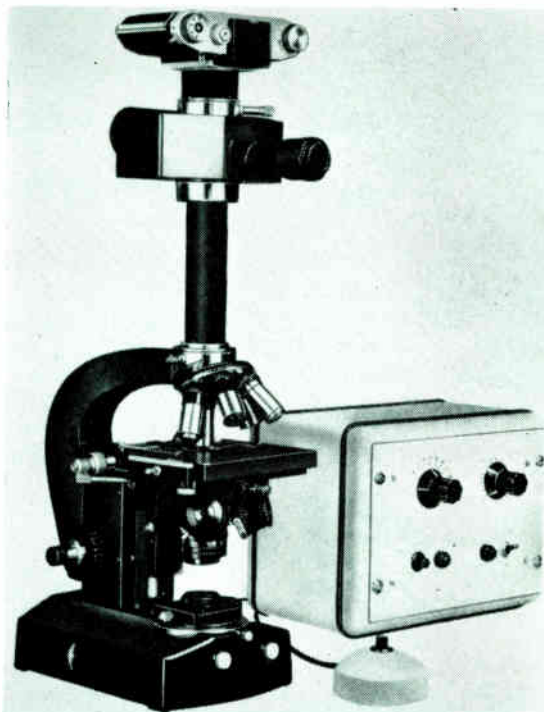

26

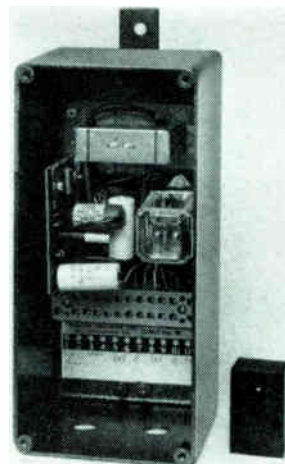

27

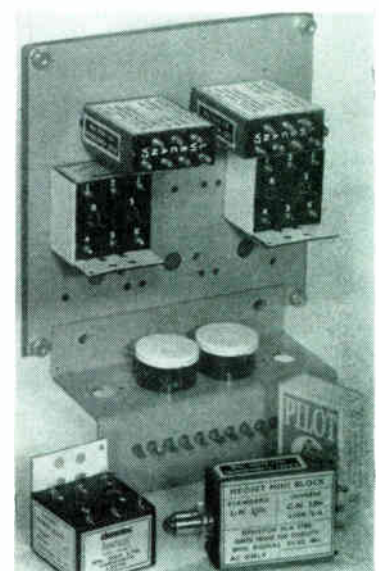

28

up to 10 h.p. The range of units covers speed control over the entire rated speed range of the motor used, and is capable of maintaining any given speed setting within $\pm 2\%$ to 20% dependent upon customer requirements. This stability of regulation is maintained independent of torque and load variations throughout the load range of the motor. The units are available in potted form with colour-coded flying lead terminations suitable for operation with remotely-mounted potentiometers, or in a metal can with an integral potentiometer and terminal block terminations.—*Hawker Siddeley Dynamics Ltd., Manor Road, Hatfield, Hertfordshire.*

For further information circle 30 on Service Card

31. Re-cycling and Pulsing Timer

The Cyclo-Set Timer, produced by Solid State Controls, is a re-cycling and pulsing timer which is suitable for many process-control applications. It consists of a transistorized timer module which has no moving parts and is reliable for a life of 100 million operations. It actuates a plug-in relay with a single-pole change-over contact rated at 5 or 10 A at 250 V a.c. The 'on' and 'off' periods are independently adjustable,

the standard models providing periods of 0.4–60 sec and 1–4 min for both 'on' and 'off' conditions. Other periods are available for special applications. The unit can be obtained for five operating voltages from 12 to 240 V a.c. or for 12 or 24 V d.c.—*Solid State Controls Ltd., 30–40 Dalling Road, London, W.6.*

For further information circle 31 on Service Card

32. Radio Control

Industrial radio-control equipment has been introduced by the Industrial Electronics Corp. of America. It has been designed for use where connecting wires between the controller and the process being controlled are inconvenient. The transmitter, model FM-50, is crystal controlled and the r.f. carrier wave produced is modulated by an a.f. signal. Various types of aerial can be used and a standard coaxial plug is incorporated for attachment of the aerial. The model R-102 receiver is also crystal controlled and incorporates an audio filter and a time-delay circuit to reduce the effects of interference. A relay is actuated by the control signals from the transmitter and the relay contacts are rated at 5 A for 115 V a.c. A typical application is the control of a con-

veyor belt, the output from the receiver being connected to stop the belt and sound an alarm. The range of operation varies from 1,000 ft to 2,500 ft depending on the type of aerial used and transmitters for up to 10 miles can be obtained. Separate carrier frequencies and control tone frequencies are available for multi-channel operation.—*The Industrial Electronics Corp., P.O. Box 862, Melbourne, Florida, U.S.A.*

For further information circle 32 on Service Card

COMPONENTS

33. Field-Effect Transistors

S. G. S. Fairchild Ltd. are offering two metal-oxide field-effect transistors designated the FI 100 and the FI 0049. The FI 100 is suitable for electrometer applications because of the high input impedance (greater than $10^{13}\Omega$) and its good drift characteristics. It will also handle chopper and multiplex switching functions. It exhibits a high on-to-off impedance ratio, a zero offset voltage, low capacitances and low leakage currents. Large input signals can be accepted, the breakdown voltage

29

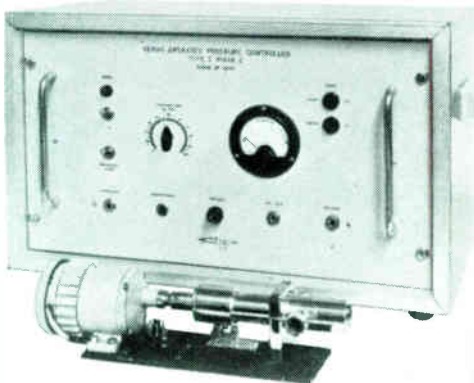

30

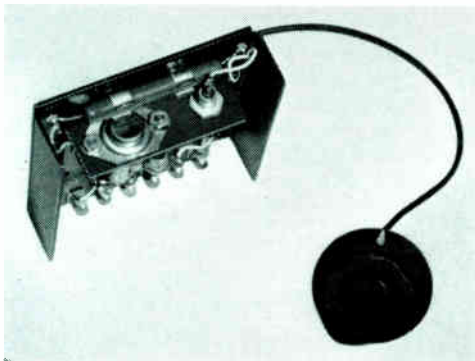

31



32

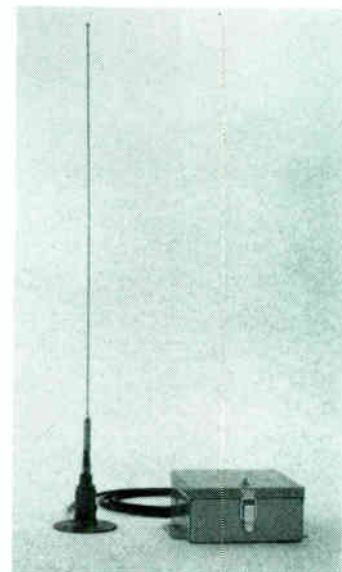

NEW

ELECTRONICS
COMMUNICATIONS
INSTRUMENTATION
CONTROL

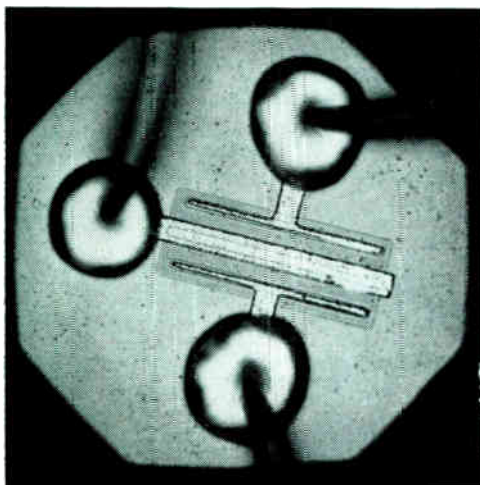

33



36

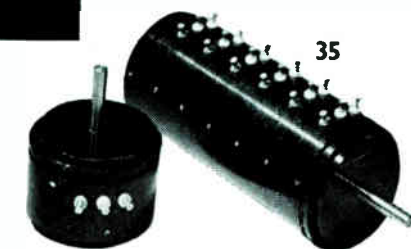

35

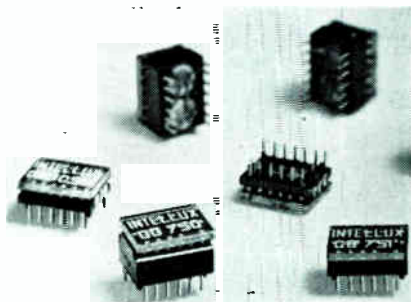

37



34

35. Multi-Gang Potentiometer Range

Now available from STC/P.X. Fox is a range of precision potentiometers with choices from multi-gang and multi-tap construction. Typical of the range is the S11 international frame size, illustrated, which has a 1.062-in. outside diameter. This unit has a torque value of 1 gm/cm per section and an operating life of 3 million cycles. The S11 range offers a linearity of 0.1% at 5 k Ω and above. The potentiometers are available with up to 10 gangs per unit and with a maximum of 10 taps per gang. The Fox potentiometer contact, while giving extremely long life and low torque, achieves noise values as low as 10 Ω .—P.X. Fox General/Controls, Standard Telephones and Cables Ltd., West Road, Harlow, Essex.

For further information circle 35 on Service Card

36. Ceramic Disc Capacitors

Lemco have increased the capacitance of their range of capacitors without a corresponding increase in size. The type 13K ceramic disc capacitor has a $\frac{9}{16}$ -in. diameter with a thickness of $\frac{3}{32}$ in. Two ranges are available, 1,500–5,000 pF, with a working voltage of 750 V d.c., and, with a rated voltage of 350 V d.c., 6,000–10,000 pF. The insulation resistance measured at the rated d.c. voltage is 2.5×10^4 M Ω and the temperature rating is -40 to $+100$ °C. Tolerances of -20 to $+80\%$ and -25 to $+50\%$ are offered or a capacitor with a guaranteed minimum value can be obtained.—London Electrical Manufacturing Co. Ltd., Bridges Place, Parsons Green Lane, London, S.W.6.

For further information circle 36 on Service Card

being greater than 30 V. Successive amplifier stages can be directly coupled without the need for coupling capacitors, resulting in a good d.c. to high-frequency performance. The FI 0049 consists of two FI 100s on a single chip. They can be connected to form series, shunt or series-shunt choppers. Dual input switches can also be constructed or the two FI 100s can be connected in parallel as one device.—S. G. S. Fairchild Ltd., 23 Stonefield Way, Ruislip, Middlesex.

For further information circle 33 on Service Card

34. Fine Wire Coils

Using 49-gauge wire, the smallest gauge that can be wound at present,

Westool Ltd. are producing fine wire coils on specially-designed machines. The coils are wound at high speeds on moulded bobbins and each coil possesses more than 30,000 turns. Copper enamel wire insulated to B.S. 1844M is used, the insulation obviating the need for interleaving and thus reducing the size of the coils. The bobbins have an outside diameter of 0.520 in. with a length of 0.515 in. These components are suitable for timing mechanisms, electric clocks and synchronous motors and they can be custom-built to meet the specialized requirements of particular manufacturers.—Westool Ltd., Bishop Auckland, Co. Durham.

For further information circle 34 on Service Card

37. Logic Modules

A range of miniature logic modules is being produced by Intellux Inc. of the U.S.A. and is now available in this country from Sencom Ltd. These have been constructed in a hybrid form with the passive components deposited by a thin film technique on to a glass substrate. A header is cemented to the substrate and this header holds the T018, T046 or epoxy-packaged type transistors, providing an adequate heat sink and a suitable structural form for the modules. The passive components are hermetically sealed with a fused-glass superstrate on the substrate. The entire assembly is coated with polyurethane to provide

(continued on page 87)

WHAT'S THE NEW DELANCO M.F. TUBE GOT THAT OTHERS HAVEN'T?

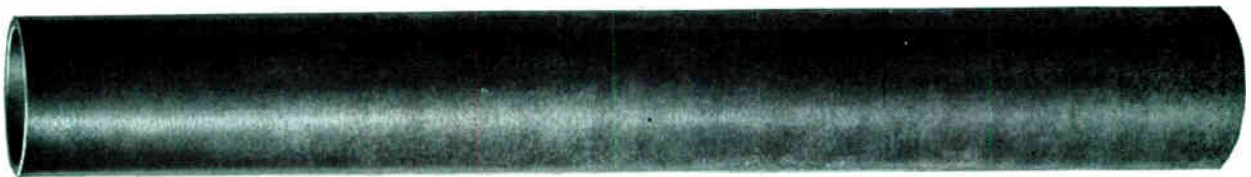

(EVERYTHING!)

Developed by our Technical Staff, M.F. (Melamine Impregnated Fibre) was designed to produce a tube with outstandingly improved electrical properties and high non-arcing properties.

The list of properties achieved by the material are compared opposite with similar properties listed by BSS.934 which cover this field.

Average Values obtained on 'Delanco' Impregnated Vulcanized Fibre Tube.

Values as laid down in BSS.934

Water Absorption	(2-3)%	(20-55)%
Surface Breakdown <i>without</i> pre-drying	18 K.V.	10 K.V. (dry)
Electric strength <i>without</i> pre-drying	9 K.V.	5 K.V. (dry)
Cohesion (BSS.1314) between layers.		
A proof list value of 78 lbs., withstood 250 lbs. easily.		
Density	1.35	1.35
Machineability	Excellent	

ANGLO-AMERICAN VULCANIZED FIBRE CO. LTD • CAYTON WORKS • BATH STREET • LONDON EC1 • GLE 8484

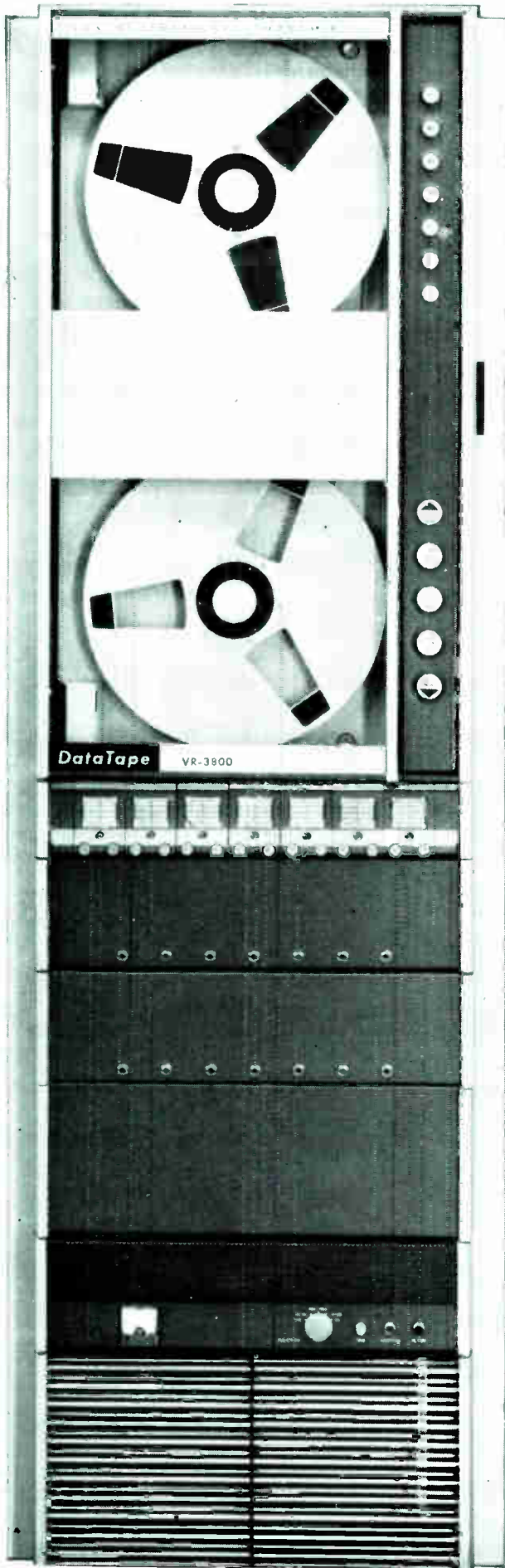

NEW

the VR-3800

a medium priced instrumentation Recorder/Reproducer with six-speed, fully electrically switched transport and electronics.

The VR-3800 offers the basic advantages of Consolidated ElectroDynamics' top-rated systems at a price to suit the industrial user. This adds up to one important fact. The new VR-3800 is destined to become the work horse of midband recorders. For here is a recorder that is competitive in price with lower class instruments, yet records up to 300 kc at 60 ips with unsurpassed reliability.

The VR-3800's outstanding features :

- * Six speeds to 60 ips; both transport and electronics electrically switchable. Speed sensitive plug-ins available for any number of transport speeds required.
- * Seven or fourteen channels are available for data storage in the d-c to 300 kc frequency range.
- * Extended wideband FM offers d-c to 40 kc at 60 ips. Standard FM from d-c to 20 kc at 60 ips.
- * Longer lasting recording heads — smooth all-metal-front-design lasts up to six times longer than conventional heads, and reduces cleaning to a minimum.
- * Record and reproduce amplifiers are solid-state, and the direct system is fully amplitude and phase-equalized at all speeds, providing optimum square wave response.
- * Signal-to-noise ratio is the best available for this class of equipment; distortion is the lowest.
- * Tape tension constantly controlled by closed-loop servo control.
- * Dynamic braking used exclusively. Fail-safe mechanical brakes used only when tape motion is stopped.
- * Optional extras include:— edge tracks in integral head stack, tape speed control servo, reel revolution counter, monitor meters and attenuator, monitor oscilloscopes, shuttle unit.

Consolidated ElectroDynamics

a division of BELL & HOWELL LIMITED

14 Commercial Rd., Woking, Surrey. Tel : Woking 5633

NEW

ELECTRONICS
COMMUNICATIONS
INSTRUMENTATION
CONTROL

leakage protection. This type of construction offers improved reliability due to the reduced number of interconnections used. Also a high packing density is possible because of the miniaturization achieved (a typical module size is $0.375 \times 0.5 \times 0.375$ in.). Standard logic circuits are available but custom-built modules can be readily produced. The modules can be fixed to printed circuits or multilayer boards by conventional manufacturing techniques.—*Sencor Ltd., 557 Finchley Road, London, N.W.3.*

For further information circle 37 on Service Card

PRODUCTION AIDS

38. Flame Cutting Unit

The Binumat numerically-controlled flame cutting machine, developed by Messer Griesheim Ltd., is for use by machine manufacturers and general engineers and is suitable for the economical output of small and large quantity production runs. Cutting instructions are fed in on punched tapes and the tape orders are executed at a maximum speed of about 20 ft per min. The cutting precision is good and likewise or inverted profiles will be cut simultaneously. The tapes can be prepared by semi-skilled personnel. Kerf compensation, selected at a control panel, is included. The electronic circuitry is constructed on a plug-in basis and the driving mechanism for the torch heads and carriage is protected by a fluid system against external influences such as oxide dust.—*Messer Griesheim Ltd., 43-45 Knight's Hill, West Norwood, London, S.E.27.*

For further information circle 38 on Service Card

39. Anti-Seize Compound and Lubricant

The Moly-Paul P.T. Composition, available from K. S. Paul Products Ltd., is an anti-seize compound and lubricant which is resistant to most solvents of petrol origin, including petroleum ether. This makes it suitable for use in the stop-cocks of petroleum flow lines and in the bearings of de-greasing plants. The illustration shows a sample of the compound which has been immersed

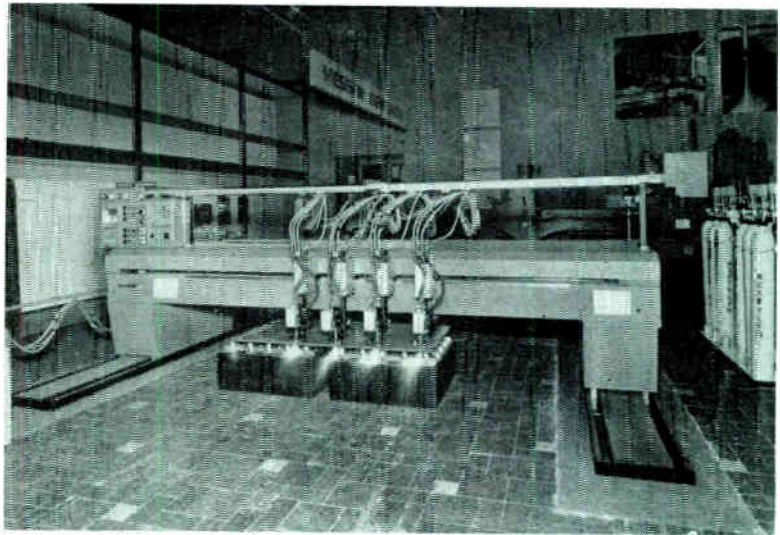

38

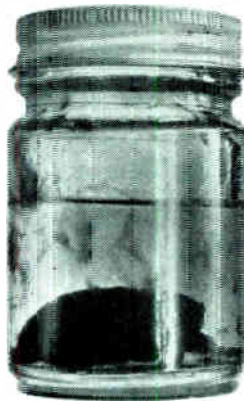

39

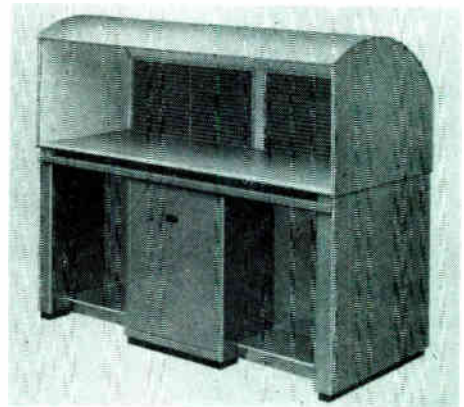

40

in petrol for 8 days without being brought into solution or losing its homogeneous mass. The lubricant is resistant to stress conditions and high pressures and it will remain stable up to approximately 126°C . The stiff consistency is similar to that of a No. 5 grease and the coefficient of friction is 0.06 at 15°C . It is claimed to be totally abrasive-free.—*K. S. Paul Products Ltd., Nobel Road, London, N.18.*

For further information circle 39 on Service Card

40. Lamina-Flow Benches

The SLEE Lamina-flow benches produced by the South London Electrical Equipment Co. Ltd. have been designed to provide clean working conditions for the micro-engineering and similar industries. The working surface is free from encumbrances such as glass visors. A horizontal air flow is blown from the rear of the

bench and another air stream flows down from the top front to be collected at the bottom front lip of the bench for recirculation through the filtration system. This causes an air curtain to be set up which prevents the entry of almost all heavy particles from the front. The clean air flow also removes dust introduced on the operator's hands or clothing. The circulating air passes first through a roughing filter and then through absolute filters which have been designed to extract particles of sizes 0.01-1.3 micron.—*The South London Electrical Equipment Co. Ltd., Lanier Works, Hither Green Lane, London, S.E.13.*

For further information circle 40 on Service Card

41. Wafering Machine

Norton Abrasives Ltd. are now marketing the model 686 wafering machine produced by the Norton Co.

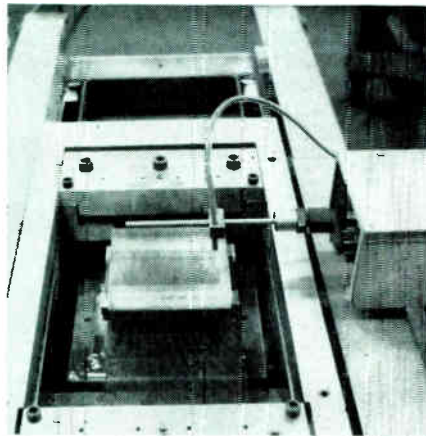

41

NEW

ELECTRONICS
COMMUNICATIONS
INSTRUMENTATION
CONTROL

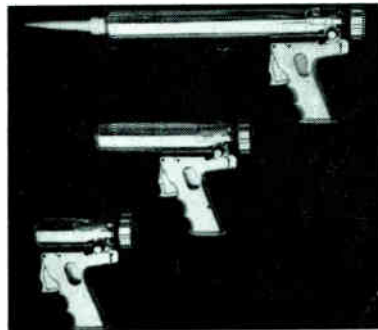

42

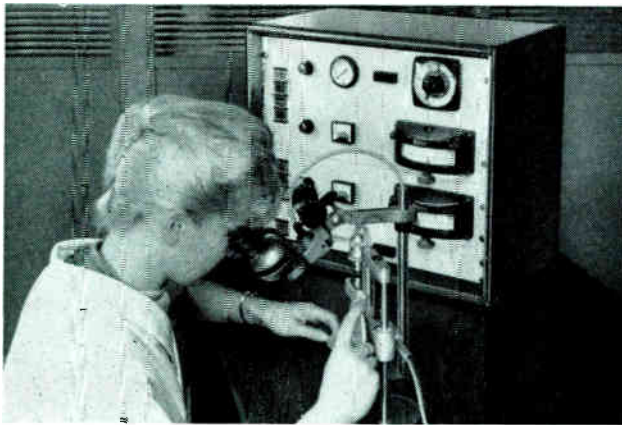

43

of the U.S.A. This is suitable for producing thin wafers of materials for semiconductor manufacture, optical purposes, lasers and other uses. The material, which can be applied to the machine in the form of a block measuring $6 \times 8 \times 6$ in., is sliced by spaced steel blades which move backwards and forwards supplying pressure to an abrasive slurry on the workpiece. Fragile materials are sliced without breakage or chipping and coated materials, such as glass or silicon coated with metal, can be wafered without damage to the coating. The depth of cut is controlled for the cutting of grooves and the blade speed can be set for each job. Production costs are reduced as one man can operate six machines. The control of the size of the wafers produced is such that there is no need for any grinding or lapping operations. The illustration shows a piece of quartz measuring $4.7 \times 5 \times 0.8$ in. being cut into 0.032 in. thick slices.—*Norton Abrasives Ltd., Welwyn Garden City, Hertfordshire.*

For further information circle 41 on Service Card

42. Sealant Dispenser

A range of air-operated guns, suitable for the application of sealants and adhesives, is available in the U.K. from Bush Beach and Segner Bayley Ltd. and is manufactured by Pyles Industries, Inc., of America. These guns will reduce the time taken for the application of adhesives and sealants and can be used for the potting of electronic components, for sealing all types of joints and similar applications. Each gun is fitted with a cartridge of $2\frac{1}{2}$, 6 or 12-oz capacity and this is loaded with the sealant or adhesive to be applied. The rate of flow of the material is regulated by the trigger position and by the air pressure and an exhaust valve prevents any dripping of the material when the trigger is released. The gun can be operated from a portable compressor or a main air system on line pressures of 5–150 p.s.i. Nozzles with orifice diameters from $\frac{1}{16}$ – $\frac{3}{8}$ in. are available.—*Bush Beach and Segner Bayley Ltd., Marlow House, Lloyds Avenue, London, E.C.3.*

For further information circle 42 on Service Card

43. Micro Bonding

A hot gas micro bonder, type B400, has been produced by G. V. Planer Ltd. for the bonding and hot-gas soldering of joints in micro-circuit manufacture and similar processes. A stream of gas, electrically heated and thermostatically-controlled at temperatures up to 400°C , is directed on to the joint to be bonded and the duration of the stream is controlled at pre-set times of up to 15 sec. Interchangeable nozzles provide jet diameters from 0.01 to 0.1-in. and the flow-rate of the gas is controlled by a pressure regulator and gauge. The components to be bonded are supported on a heated substage and positioned by a micromanipulator. Each component is retained in position by a vacuum arrangement and a vacuum tweezer is provided for the handling of small pieces.—*G. V. Planer Ltd., Windmill Road, Sunbury-on-Thames, Middlesex.*

For further information circle 43 on Service Card

44. Variable Programmer

An approach to the problem of programming complex switching operations has been made by Brensal Electronics. They have introduced a variable control programmer (the Mark III) which is completely solid-state throughout and is intended for machine-tool numerical control or process-control applications, where the need for carrying out rapid changes in a complex switching programme frequently arises. Any change may be effected in the programme without interrupting the process being controlled, and switching channels may be effected at much higher speeds than the conventional cam controller or electro-mechanical timer. A complete programme of all channels can be set up on pin board or edge switches in only a few seconds and can be set to last a total time of only a few seconds or, by slowing the master pulse frequency, can be extended to several hours, or even several days. The Mark III has 9,999 increments to which any one or all of its 24 modular switching channels may be set throughout the programme and if more precise resolution is required further module decades may be added to the counter unit to give any required number of pulses in any given time. The number of switching channels can also be increased in modular units up to at least 144 to meet the needs of any application.—*Brensal Electronics Ltd., Charles Street, Bristol, 1.*

For further information circle 44 on Service Card

0.005% IS STANDARD... FOR THE OUTPUT VOLTAGE REGULATION OF THESE HIGH EFFICIENCY ALL SOLID STATE POWER SUPPLIES



FEATURES INCLUDE :-

SCR switching—for improved efficiency and reduced dimensions—up to 840 watts/cu. ft.

Constant Voltage Regulation—with continuously adjustable current limiting.

Constant Current Regulation—with continuously adjustable voltage limiting.

Programmable—for both voltage and current.

Remote Sensing—permits voltage regulation to be maintained at a load point remote from the power supply.

Fast Transient Response—50 us.

High Resolution—coarse and fine controls give setting resolutions of 0.01% of max. voltage, 0.05% of max. current.

Voltage and Current Mode Indicator Lights.

Automatic Crossover—from constant voltage to constant current and vice versa without loss of regulation at any point

ELECTRICAL SPECIFICATIONS

Model Number	Voltage Range (VDC)	Constant Voltage reg. (line and load combined)	Current range (amps)	Constant Current Reg.	Constant Voltage Ripple (RMS)	Constant Current Ripple (RMS)	Transient Response	Temperature	
								Ambient (°C)	Coef. MV/°C
QRC20-8	0-20	±.005% or ±1 mv	0-8	±.05% or ±4 ma	1 mv	2 ma	50 microsec.	0-50	.01% + .5 mv
QRC40-4	0-40	±.005% or ±1 mv	0-4	±.05% or ±2 ma	1 mv	1 ma	50 microsec.	0-50	.01% + .5 mv
QRC20-15	0-20	±.005% or ±1 mv	0-15	±.05% or ±7 ma	1 mv	4 ma	50 microsec.	0-50	.01% + .5 mv
QRC40-8	0-40	±.005% or ±1 mv	0-8	±.05% or ±4 ma	1 mv	2 ma	50 microsec.	0-50	.01% + .5 mv
QRC20-30	0-20	±.005% or ±1 mv	0-30	±.05% or ±15 ma	1 mv	8 ma	50 microsec.	0-50	.01% + .5 mv
QRC40-15	0-40	±.005% or ±1 mv	0-15	±.05% or ±7 ma	1 mv	4 ma	50 microsec.	0-50	.01% + .5 mv
QRC40-30	0-40	±.005% or ±1 mv	0-30	±.05% or ±15 ma	1 mv	8 ma	50 microsec.	0-50	.01% + .5 mv

COSSOR



COSSOR INSTRUMENTS LTD. stock complete units, spares and provide comprehensive service facilities.

- I WOULD LIKE LITERATURE ON.....RANGE.
- I WOULD LIKE LITERATURE ON ALL RANGES OF SORENSEN EQUIP'M'T.
- I WOULD LIKE YOUR REPRESENTATIVE TO CALL ON ME.

PLEASE TICK APPROPRIATE BOX.

NAME.....

COMPANY.....

ADDRESS.....

POSITION IN COMPANY.....

ABBREVIATED SPECIFICATIONS



DCR SERIES



ACR SERIES

HIGH POWER WIDE RANGE D.C. SUPPLIES.

Extremely compact—up to 1.68 kw/cu. ft.
 Wattage ratings from 400 W to 2.5 KW.
 Voltage ranges—from 0-40 V to 0-300 V.
 Current ratings—from 1.25 A to 60 A.
 Constant voltage regulation— $\pm 0.1\%$ (line and load combined).
 Constant current regulation—as low as ± 15 mA.
 Resolution—0.05% of max. voltage, 0.5% of max. current.
 Remote sensing and programming facilities.
 Parallel or series operation.



QRB SERIES

WIDE RANGE D.C. SUPPLIES.

Wattage ratings—30 W and 80W.
 Voltage ranges—from 0-15 V to 0-40 V.
 Current ratings—from 0.75 A to 4 A.
 Constant voltage regulation— $\pm 0.01\% + 1$ MV (line and load combined).
 Constant current regulation— $\pm 0.15\%$ (line and load combined).
 Resolution—0.01% of max. voltage.
 Response time—50 us.
 Output ripple—as low as 150 μ v. rms.
 Output impedance—as low as 20 m ohms.
 Programmable—remote sensing facility.
 Parallel or series operation.



QB SERIES

LOW VOLTAGE RESTRICTED RANGE D.C. SUPPLIES.

Wattage ratings from 12 to 224 W.
 Voltage ranges—from 5-9 V to 40-60 V.
 Current ratings—from 0.5 A to 30 A.
 Constant voltage regulation—0.01% } Line and load
 Constant current regulation—0.01% } combined
 Response time—25 us.
 Programmable. Remote sensing.
 Very low ripple and output impedance (values dependent on model).

AC REGULATORS EMPLOYING SCR SWITCHING.

VA ratings from 500 to 15000 VA.
 Efficiency at full output—up to 95% depending upon model.
 Regulation— $\pm 0.1\%$ for $\pm 10\%$ line change,
 $\pm 0.1\%$ for full load change.
 Stability—0.05% / 8 hrs.
 Distortion—3% Typical.
 Programmable—remote sensing facility.

QMA SERIES REGULATED MODULAR D.C. SUPPLIES.

Semi-variable output voltages in the range 3 V to 50 V.
 Power outputs from 3 to 35 watts.

HIGH VOLTAGE D.C. SUPPLIES.

200 series—portable. 0-30 KV at 6 mA and 0-30 KV in 3 ranges at 3, 6 and 12 mA.

1000 series—0-3 KV at 200 mA to 0-150 KV at 5 mA.

2000 series—3 KW output power 0-3 KV at 1000 mA to 0-350 KV at 8 mA.

5000 series—regulated supplies, self contained or rack mounting. 1 KV-10 KV at 8 mA and 5 KV-30 KV at 4 mA.

9000 series—high voltage modules.
 0-5 KV at 5 mA to 0-6 KV at 10 mA.

FREQUENCY CHANGERS

WIDE RANGE MODELS. Adjustable outputs cover the range 45-2000 cps. At power outputs up to 300 VA.

MEDIUM RANGE MODELS (400 cps. nom) have power outputs up to 2 KVA.

Postage will
be paid by
Licensee

No Postage
Stamp
necessary if
posted in
Great Britain
or Northern
Ireland

BUSINESS REPLY SERVICE
Licence No. HDD 62

THE SALES MANAGER
COSSOR INSTRUMENTS LTD.
THE PINNACLES
HARLOW, ESSEX

COSSOR

Sorensen

COSSOR INSTRUMENTS LTD. and
SORENSEN are members of the Raytheon
International Group.

Radiation Monitoring for Nuclear Power Station

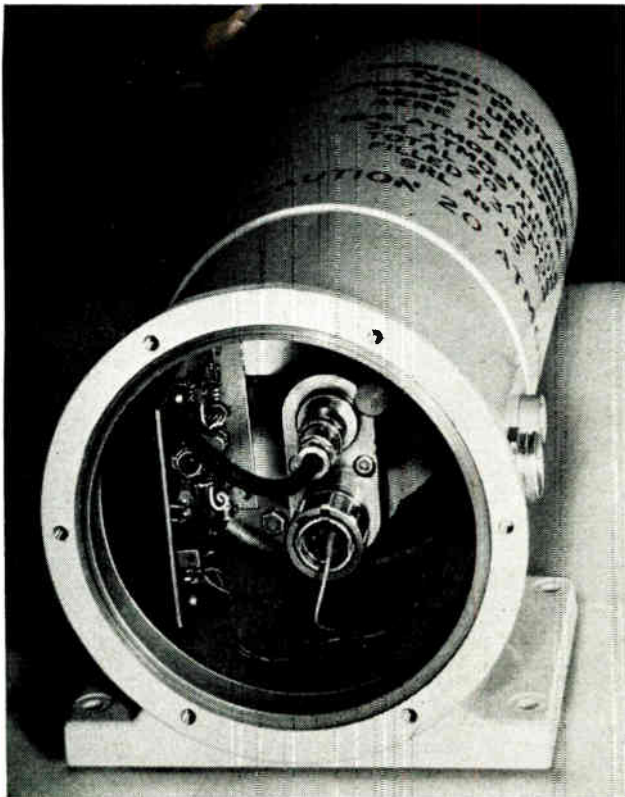

Radiation monitors for gamma measurement, developed and produced by the data equipment division of the Plessey Automation Group, are to be installed in the nuclear power station at Oldbury-on-Severn.

Nineteen channels of area gamma-monitoring equipment are required and comprise wall-mounted main units, which indicate radiation levels, and separate detector units consisting of ionization chambers (see picture), each with a logarithmic d.c. amplifier bolted directly to the chamber casing.

The equipment is transistorized except for an electrometer valve input stage, and the main units contain low-voltage power supplies, an ionization-chamber polarizing voltage supply, alarm circuits, indicator lamps and meters, most of their electronic components being mounted on plug-in printed-circuit boards.

The high-level alarm is adjustable over the complete scale range, while the equipment-failure alarm operates if the output indication falls below an artificial zero, or if the polarizing supply to the ionization chamber fails. The normal polarizing potential is 1,000 V d.c., which is adequate for saturation at dose rates up to 10 roentgens equivalent man/hr, with a maximum permissible voltage for other applications of 3,000 volts.

For further information circle 65 on Service Card

One of the ionization chambers, which is of a robust non-microphonic design and has a standard filling of an argon/nitrogen mixture, selected to give a substantially flat response over the energy range 100 keV to 3 MeV

New Airborne Automatic Direction Finder

The first airborne automatic direction finder (a.d.f.) in the world which conforms fully with the latest airline specification (ARINC 550) and provides completely automatic, solid-state, crystal-controlled tuning, has been developed by the Marconi Co.

This equipment, type AD370, provides pilots with a speedy and reliable means of finding the bearing of any given radio station. It can be fitted directly into all the latest American aircraft types as well as the BAC 111 and the small size, light weight and ease of operation make it suitable for use in all types of military and civil aircraft, including helicopters and high performance fighters.

The circuitry is completely transistorized and there are no moving parts whatsoever in either the tuning stages or the range selection.

The accuracy and stability of the frequency selection is ensured by only 13 crystals, and the need for fine tuning is completely eliminated. There is, in fact, no provision on the control unit for frequency trimming.

The operating frequency is selected on an easily-read decade dial by means of three selector controls for hundreds, tens, units and halves of kc/s. The frequency scale is continuous from 190–1,799.5 kc/s, in steps of 0.5 kc/s. Once the frequency is selected the tuning is performed automatically.

In normal a.d.f. operation, the bearing of the selected station will be shown immediately on the bearing indicator. Alternatively, direction finding can be accomplished manually with the function switch turned to the 'loop' position. The sense aerial is disconnected and the search

coil of the goniometer is rotated by means of a switch on the controller, the null position being indicated by the audio output of the receiver. This facility is normally used only in conditions of abnormal static. The loop rotating switch may be used, however, in normal operation to move the bearing indicator from the indicated reading and to check that it returns to the same position when the loop switch is released. This confirms the operation of the automatic direction finder.

A beat frequency oscillator is provided on the AD370, so that the identity of a c.w. station may be checked.

For further information circle 66 on Service Card

The receiver unit showing, at the top, the thirteen crystals which control the tuning of the complete equipment



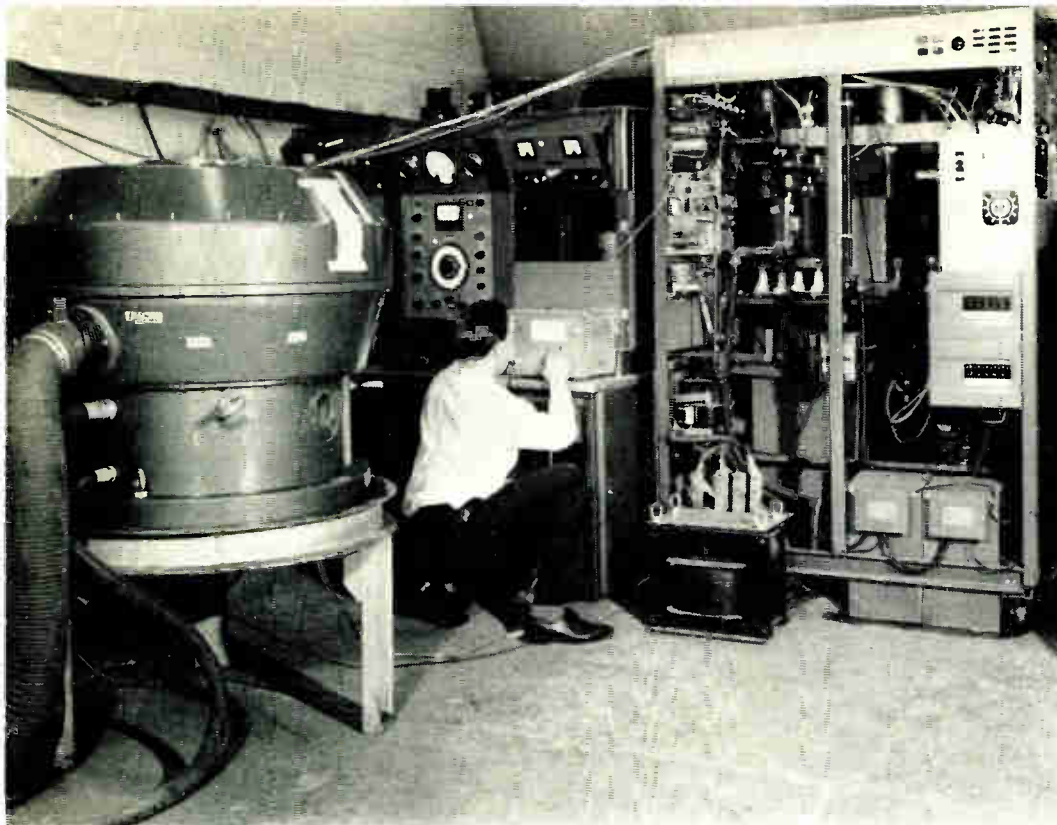

▲ An order for British vibration equipment, valued at £200,000 has been given to Pye-Ling Ltd., of Royston, by the European Space Research Organization for their experimental test centre at Noordwijk in Holland. The test centre, when it is completed this year, will be the largest and best-equipped space research laboratory outside the United States.

The picture shows an engineer checking a part of the equipment, which will be used to test models and full-sized prototypes of rockets and space probes by simulating some of the conditions experienced when in space. The equipment to be tested is firmly secured to the large vibrator on the left, and three systems, which include power amplifiers and control and monitoring facilities, will provide thrust capabilities of 1,000, 8,000 and 15,000 pounds.

For further information circle 67 on Service Card

▼ A highly-accurate steerable aerial, the 150-ft diameter radio telescope at the Algonquin Radio Observatory, Lake Traverse, Ontario, is nearing completion for the National Research Council of Canada. The electronic control system, designed and manufactured by AEI Electronics, is being installed to enable the astronomer to pinpoint radio sources thousands of millions of light years away.

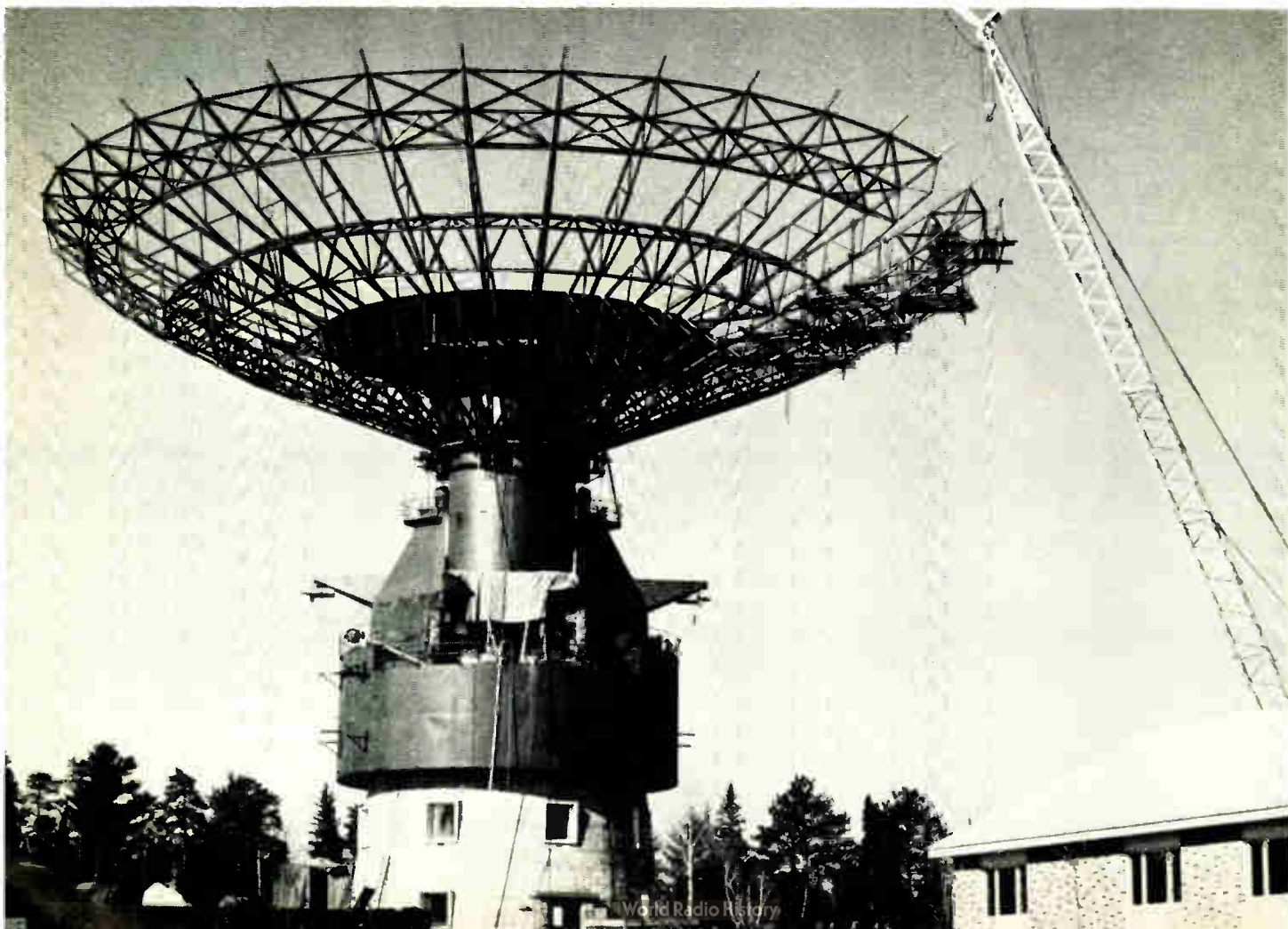

The special properties of laser-produced light, in particular in relation to their use in telecommunication, are under active investigation at the Standard Telecommunication Laboratories, in Harlow.

In theory, the coherence of laser light as an electromagnetic wave should enable it to be propagated in a true waveguide mode along some type of guide or conductor. When this is achieved, the prospect of ultra-wide-band communication will become a reality and it will be possible to convey extremely large amounts of information over one coherent light channel.

The picture shows a scientist at STL making adjustments to a gas laser recently developed for experimental purposes

For further information circle 68 on Service Card

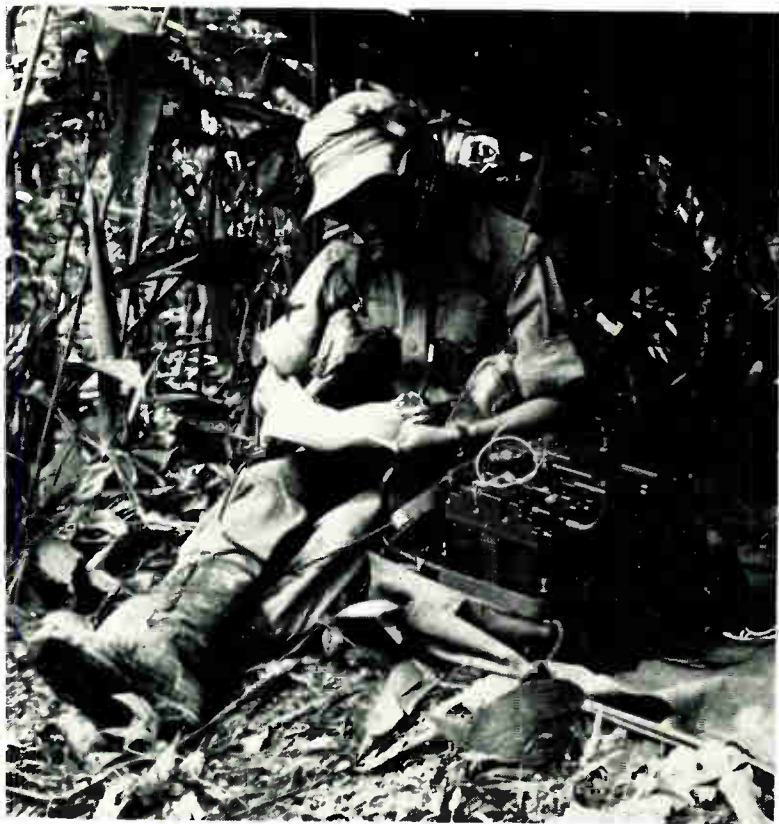
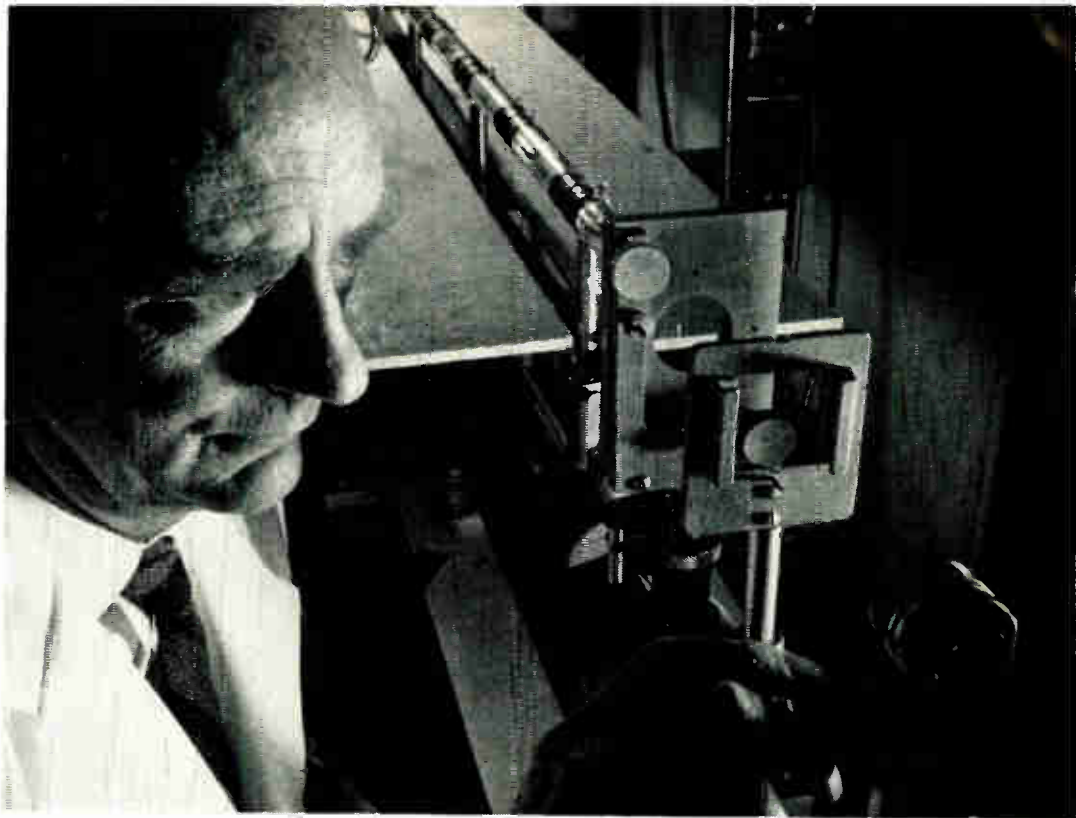

British military manpack radio equipment, which can provide 24-hr communications in deep jungle, has been ordered for the Malaysian army. The contract for the all-transistor transmitter/receiver (known as the A13 and manufactured by the Plessey Electronics Group) was won in the face of severe competition from Japan and the U.S.A., and followed successful trials by the Malaysian Rangers (see illustration).

Developed by Plessey in conjunction with the British Government's Signals Research and Development Establishment, the equipment employs the latest transistor techniques, all units being of a modular construction and easy to maintain. The set weighs only 16 lb and can be tuned to any of 2,400 discrete channels without netting; it may also be used in light aircraft and as a vehicle or base radio station.

The manpack operates from nickel-cadmium secondary cells.
For further information circle 70 on Service Card

The Neutron Division of Elliott Electronic Tubes Ltd. is now producing a range of sealed-off neutron-generating tubes which were originally developed by the Services Electronics Research Laboratory at Baldock. The tubes are normally incorporated in one of several standard housings with driving units, but designs for special applications (such as during the high-temperature stage of the commissioning programme for a nuclear reactor) have been developed.

When not operating, the unit requires no special shielding. Electrical inputs control all the functions, and the tubes, which contain an integral gas supply, ion source and pressure-sensing element, use the deuterium-tritium reaction to produce 14 MeV neutrons from an enclosed target.

The 'L' tube illustrated here produces 10^{10} neutrons per sec, continuous or modulated output, and is claimed to be the most powerful sealed-off neutron source commercially available.

For further information circle 69 on Service Card





ELECTRONIC CONTROL FOR CONCRETE LAYING

A PAVER control system, designed and developed by Honeywell Controls, has been used for the first time in Britain to produce an even surface smoothness during the laying of concrete on road surfaces. It can also be used for bituminous top surfaces and was fitted to an A.B.G. 'Titan' paver, which laid the sections of the new Sevenoaks by-pass in Kent.

With the A.B.G. paver, the level of the paving material is governed by a screeding-plate and compactor assembly, the ends of which are normally controlled by two men. The electronic system performs this operation entirely automatically, controlling the compactor by hydraulic rams to give an even surface of known grade (longitudinal slope) and crossfall (transverse slope), irrespective of irregularities in the base layer.

As the machine travels over the base layer, its attitude is measured by two sensors, relative to two references. The grade reference is a tightly-stretched string or wire, which is extended along the length of the roadway (a few

inches above the required surface) and is sensed by a metal grid attached to the grade sensor; alternatively, an adjacent road surface which is known to be accurate may be used as the reference by using a skid sensor (see Fig. 1). The crossfall reference is an artificial-horizon instrument (comprising a pendulum suspended in a container of oil) which is mounted on a beam assembly joining the two ends of the screeding-plate and compactor assembly; friction effects are negligible and an accuracy of three minutes of arc is possible.

The values of grade and crossfall thus measured are compared with the desired values that have been set by the machine operator on his command panel (see Fig. 2), and suitable corrective action is automatically applied to reduce errors to negligible proportions.

The result of such a system which requires no machine crew other than the driver, is a smooth correctly-graded surface, better than that which could be achieved manually and accomplished much faster.

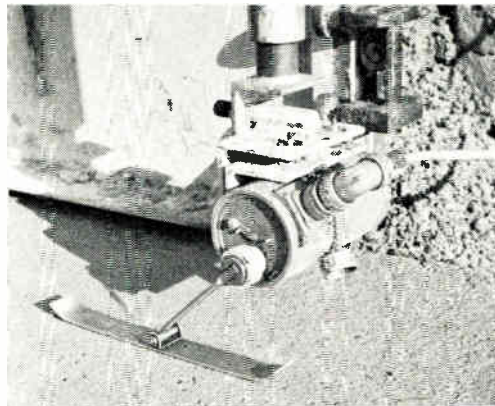
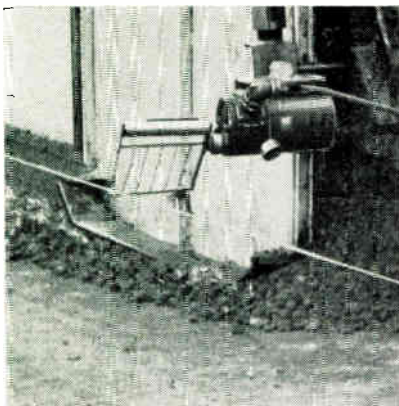
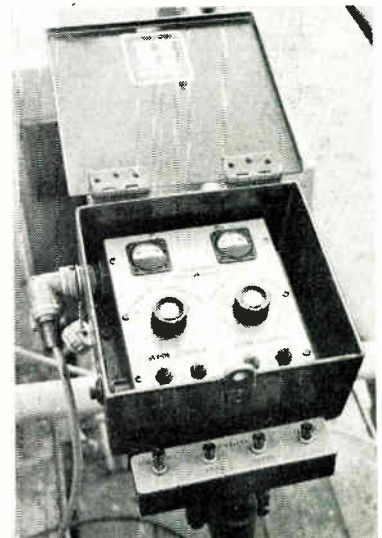

Fig. 1. (Above) The grade-sensing device (an angle-measurement transducer), the input shaft of which may be attached (on the left) to a light metal grid or (on the right) to a skid

Fig. 2. (Right) The driver's control panel. The two meters indicate the difference between the actual measured values and the desired set ones



been elected chairman of the Radio Trades Examination Board. He succeeds **E. A. W. Spreadbury** (Technical Editor of *Electrical and Electronic Trader*) who is retiring after four years as chairman.

Dawe Instruments have announced that **W. V. Richings** has been appointed product manager and chief engineer. He now has responsibility for the power ultrasonics, non-destructive testing, instrument and industrial divisions.

New Year Honours

C.B.E.

M. R. Gavin, Principal, Chelsea College of Science and Technology.

O.B.E.

W. N. Anderson, Head of Telecommunications and Experimental Group, I.T.A.

P. Bowles, Chief Engineer, Rutherford Laboratory.

R. F. Brown, Chairman and Managing Director, Racal Electronics Ltd.

C. W. Earp, Chief Engineer, Radio

Division, Standard Telephones and Cables Ltd.

M. A. Frost, Head of Transcription Service, B.B.C.

L. F. Scantlebury, Staff Engineer, Engineering Dept., G.P.O.

M.B.E.

F. Ahl, lately Communications Officer, Ministry of Aviation Radio Station, Glous.

E. F. Cowley, Chief Telecommunications Superintendent, Lancaster, G.P.O.

F. Fildes, Works Manager, Fire Control Dept., Ferranti Ltd.

W. J. Hatcher, Senior Assistant, Maintenance Co-ordination, Television, B.B.C.

R. W. Hobbah, Senior Engineer, Cable and Wireless Ltd.

S. Pitham, Senior Executive Engineer, Engineering Dept., Goonhilly Radio Station, G.P.O.

G. G. Portch, Sales Engineer, Equipments Rectifier Division, Westinghouse Brake and Signal Co. Ltd.

A. G. Wilson, Senior Scientific Assistant, Radio and Space Research Station.

I.E.E. Honours

The Institution of Electrical Engineers has elected **Sir Harold Bishop**, C.B.E., B.Sc.(Eng.), F.C.G.I., M.I.E.E., to Honorary Membership. This is in recognition of his contributions to sound and television broadcasting, his interest in the training of engineers and his service to the Institution. He was elected President of the Institution in 1953 and, until 1963, was Director of Engineering of the B.B.C.

The 44th award of the Faraday Medal has been made to **J. A. Ratcliffe**, C.B., C.B.E., M.A., F.R.S., M.I.E.E., for his research on the ionosphere and his studies of low-frequency propagation. He is the Director of the Radio and Space Research Station of the Science Research Council.

Company News

W. Mackie & Co. Ltd. have moved from their existing premises in Lambeth Road to a new factory in Willow Lane, Mitcham. The company manufacture motor alternators and other power supply units, including static inverters and automatic control gear for all branches of the electronics industry.

U.K. Solenoid Ltd., of Hungerford, Berkshire, manufacturers of rotary switches and contactors, have opened their new London office at 19 Old Queen Street, London, S.W.1. (Phone: Whitehall 5894), which will be equipped to deal with all sales and technical enquiries in the London area.

The I.E.R.C. division of **Dynamco Systems Ltd.** has been appointed sole U.K. distributor of the semiconductor products marketed by the **Schauer Manufacturing Corp.** of Ohio, U.S.A. The range includes zener diodes and new designs of varistor based on silicon diodes.

Fourteen of the sales and administrative departments of **I.B.M. United Kingdom Ltd.** have been moved to new premises at 40 Basinghall Street, London, E.C.2. These departments, which were formerly situated in different parts of London, include general services and members of the data processing and office products divisions.

M.T.E. Control Gear Ltd. are to manufacture in the U.K. the complete range of 'Loxswitches' under licence from the designers, the **R. B. Denison Manufacturing Co.** of America. These switches are protected against water, dust and oil and lives of more than 45,000,000 operations have been achieved.

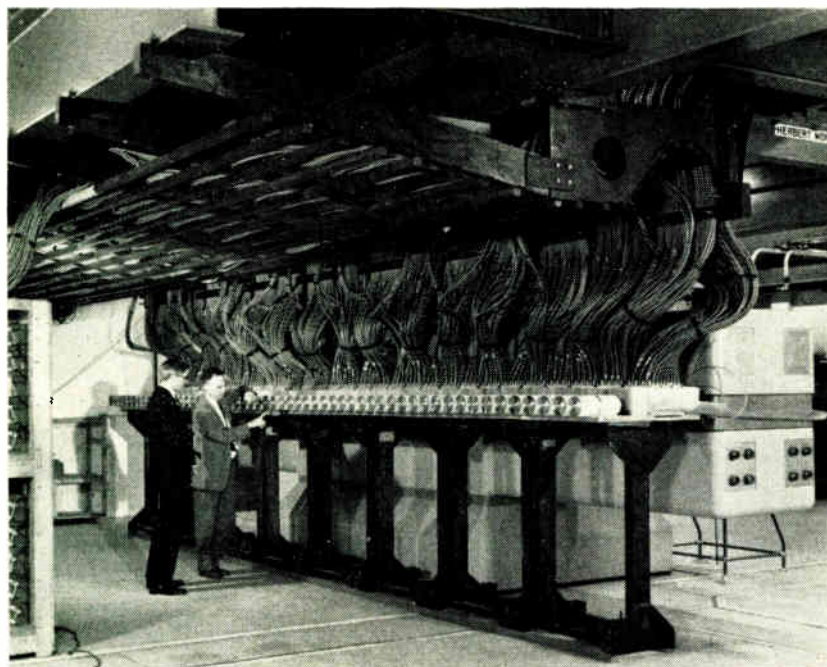

CAPACITORS AND POLYTHENE-INSULATED PULSE CABLES, manufactured by *British Insulated Callender's Cables Ltd.*, are being used in the Thetatron experiments at the Culham laboratory of the United Kingdom Atomic Energy Authority.

The picture shows a rear view of the equipment used in the experiment, the purpose of which is to study the feasibility of controlling the energy released when the nuclei of light atoms are fused together. The problem is to obtain a sufficiently dense gas at temperatures of around 100 million °C and to isolate it from all other matter long enough for fusion reactions to provide a net release of energy.

The capacitor bank to feed the experiment consists of several hundred capacitors arranged in 448 parallel circuits; it stores a total of 1 megajoule of electrical energy and is discharged in a few microseconds into a single-turn coil. The BICC cables form part of these circuits, which carry a gross peak current of 12 million amps and deliver a maximum power input to the coil of 240,000 MW

For further information circle 72 on Service Card

The Westinghouse Brake and Signal Co. Ltd. have formed a marine and industrial controls division. This will deal with the industrial and railway control activities, which were formerly directed by the automotive and industrial products division, and will operate from the main works of the company at Chippenham.

Transitron Electronic Ltd., following the acquisition of the Electronic Fittings Corp., are to commence the marketing and manufacture of the acquired company's products in Europe. Stocks of the range of rack and panel and printed-circuit edge connectors have been set up at a distribution centre in Amsterdam.

Peto Scott Electrical Instruments Ltd. have changed their name to Peto Scott Ltd. The activities of this company now include studio and professional television installations, video tape recording, large-screen television projection, language laboratories and similar equipment.

Monroe International (U.K.) Ltd. and Royal McBee (U.K.) Ltd., who are divisions of Litton Industries Inc., have integrated their activities to form one company known as Litton Business Systems Ltd. It will operate from Litton House, Goswell Road, London, E.C.1, and will manufacture data processing systems, calculating machines, typewriters and other equipment.

Livingston Laboratories Ltd. and other companies in the Livingston Group have moved from their headquarters in Camden Road to new premises. The address for all Livingston companies is now Greycaines Estate, Bushey Mill Lane, North Watford, Hertfordshire.

A merger between the Harefield Rubber Co. Ltd. and Withers (Industrial Trucks) Ltd. has been announced. This has resulted in the formation of a new company known as Harefield Power Handling Ltd.

S.G.E. Signals Ltd. have announced the formation of a new company known as S.G.E. Railway Signals Ltd. This will have its registered offices at Signal House, Lyon Road, Harrow, Middlesex.

The formation of a new company in South Africa, Clarke & Smith Industries South Africa (Pty) Ltd., has been announced. The company will distribute British-made electronic, optical and engineering products, and at a later stage will commence local manufacture.

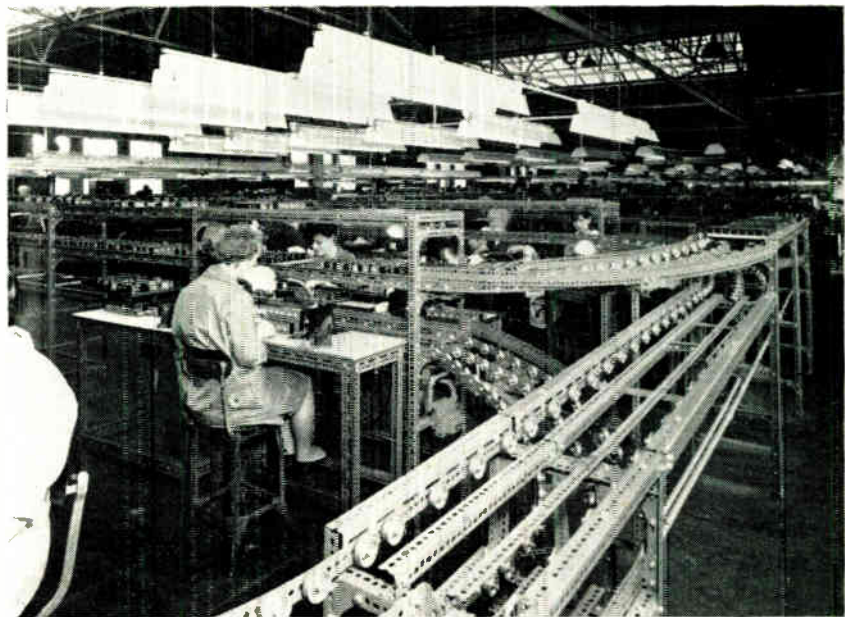

INTERCONNECTED U-SHAPED GLIDEWHEEL CONVEYORS are being used in place of roller-track conveyors in the production and assembly plant for domestic cookers at AEI's instrumentation division at Motherwell. The entire layout was built with slotted angle and glidewheels manufactured by Dexion Ltd., the benches being Formica-surfaced frameworks.

Operatives working on straight sections of the U-track are engaged on similar tasks and sit opposite each other with the conveyor passing between them. These sections have two track levels, pallets being received at one level and passed along to the next work station on the other. The new layout was built in stages over a period of five months, thus ensuring a smooth changeover with no loss of production

For further information circle 73 on Service Card

Laurence, Scott and Electromotors Ltd. have changed the address of their London and South-East Area Office to Franklin Moore House, 185-187 High Road, Chadwell Heath, Essex.

Flowsheet Instruments Ltd. have been appointed the sole agents in Great Britain, Northern Ireland and Eire for Josef Heinrichs Messgerate of Germany. This German firm manufactures a range of flowmeters.

The sole U.K. agents for Fenwall Electronics Inc. of the U.S.A. are now the Radon Industrial Electronics Co. Ltd. They will be marketing the American company's range of thermistor products.

The Preston branch of British Insulated Callender's Cables Ltd. have moved to new premises at Wellfield Road, Preston, Lancashire. These premises are larger and enable a wider range of cables and accessories to be stocked.

Erie Resistor Ltd. have formed a sales and distribution company known as Erie Continental S.p.A. This is based in Milan and is responsible for the export to Italy of the products of Erie's English plants and of the U.S. and Canadian companies.

S. Smith and Sons (England) Ltd. have altered their name to Smiths Industries

Ltd. The companies within this organization manufacture equipment for the motor, aviation, building and other industries.

The Business Equipment Trade Association have transferred their exhibitions and public relations offices to 109 Kingsway, London, W.C.2 (Phone: Holborn 6233).

Electrosil Ltd. has awarded a research studentship to the Department of Electrical Engineering at the University of Newcastle-on-Tyne. It will be worth £550 per annum to the successful candidate.

Evershed Power-Optics Ltd. have formed an American subsidiary company known as Power Optics Inc. This company will serve the needs of TV industries in Canada and the U.S.

"Industrial Electronics" Changes Publication Date

Improved printing schedules now make it possible to publish *Industrial Electronics* earlier each month. The March and subsequent issues are to be published on the last Thursday of the preceding month.



ZAMBIA'S FIRST RADIO MANUFACTURING PLANT, owned by Supersonic Radio Zambia Ltd. (a subsidiary of Standard Telephones and Cables Ltd.), is being built on the outskirts of Livingstone. It should be completed early this year and covers an area of 39,000 sq ft, standing on a 4½-acre site.

The picture shows the foundation stone being laid by the President of the Republic, His Excellency Dr. Kenneth Kaunda.

Press-Button Dialling in London

Soon, for the first time in this country, telephone subscribers will be using press-button dialling. G.E.C. (Telecommunications) Ltd. are installing equipment for a press-button system at the Langham exchange in London under order from the G.P.O.

Two hundred subscribers will be issued with telephones containing ten press-buttons instead of the normal rotary dial. Tests have shown that a number can be selected on press-buttons in half the time it takes to use a dial. Also this method is easier and the chances of errors are less.

The G.E.C. system, known as Multi-frequency dialling, consists of tones generated by transistorized oscillators in the telephones. Each digit is represented by two frequencies and the tones are converted by equipment at the exchange into signals suitable for all types of existing exchange equipment.

The general introduction of the system throughout the country will depend on the results of, and the experience gained from, this installation.

National Computing Centre

To stimulate a rapid increase in the use of computers, simplifying and cheapening the necessary preparatory work, the Ministry of Technology has set up a National Computing Centre, to be located in Manchester. The Centre's main aim will be to reduce wasteful duplication of programming effort by providing users with programme information already available in its library or elsewhere, and by developing and sponsoring the writing of programmes designed to serve users having basically similar problems. It will also organize training in systems analysis, programming principles and computer applications, and the services

of the already established Computer Advisory Service will continue to be available.

The Centre will be set up as an independent non-profit-making company, limited by guarantee, and representatives of manufacturers, users and professional and other interested bodies will be invited to become members of the Centre and to be represented on the council which will run it. It should be fully operational in 1967, and its first director will be Professor Gordon Black, at present technical manager (computing) in the reactor group of the Atomic Energy Authority and part-time professor of Automatic Data Processing in the faculty of technology of Manchester University.

Production Engineering Advisory Service

A Production Engineering Advisory Service is to be set up by the Ministry of Technology to help small and medium-sized firms in the engineering and allied industries to increase their productive efficiency. It will be operated by the Production Engineering Research Association (P.E.R.A.) and is expected to commence at the end of this year.

The service will offer advice, training and assistance on new and improved production methods. All aspects of production engineering and automation will be covered.

Initial visits to factories will be made by Demonstration and Training Units who will give short talks and demonstrations of practical examples of new techniques to production personnel. This part of the service will be offered free.

These visits will be followed, at the request of the firms concerned, by visits from Direct Applications Units who will provide advice and assistance on

particular products. Normally the firms will be required to pay a fee to cover part of the costs of these units.

New Council for S.E.R.T.

At the first Annual General Meeting of the Society of Electronic and Radio Technicians the following officers and members of Council were elected:

Chairman: E. A. W. Spreadbury (Technical Editor, *Electrical and Electronic Trader*).

Treasurer: J. Bearman (Assistant to Group Training and Personnel Officer, British Relay).

Ordinary Members of Council:

W. J. Black (Lecturer, North London College of Further Education).

T. J. Burton (Editor, *Industrial Electronics*).

D. E. G. Gibbons (Telecommunications Technical Officer, Ministry of Aviation).

J. W. Grandey (Chief Engineer, Marconi Aeronautical Service Depot).

K. Tempest (Head of Electrical Engineering Department, Carlshaton College of Further Education).

L. H. Washbourn (Lecturer, Brooklands Technical College).

In addition, the following nominated members will serve on the Council:

E. J. Leicester and J. Redmond both representing the Institution of Electrical Engineers and

J. L. Thompson, representing the Institution of Electronic and Radio Engineers.

The Chairmen of the nine Local Sections of the Society also serve as ex officio members of Council.

One-Button Telephone Dialling

Atlas—an automatic telephone line address system—has been developed by Shipton Automation in conjunction with the British Post Office.

This is basically a desk-mounting unit which makes it possible to dial any telephone number of up to 16 digits by pressing one button only.

The present desk-unit has 32 buttons and therefore facilities for automatically 'dialling' 32 subscribers' numbers, each of up to 16 digits. More than one unit can be joined to the telephone to provide automatic dialling for more than 32 telephone addresses.

The particular number which is generated by each button can be preset by the subscriber. Atlas does not restrict the normal dialling of a telephone.

For further information circle 74 on Service Card

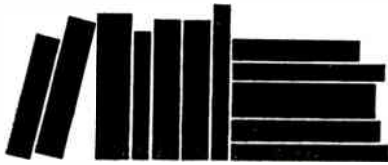

NEW BOOKS

Specification for Dimensions of Semiconductor Devices

B.S. 3934. Pp. 87. British Standards Institution, 2 Park Street, London, W.1. Price 90s.

This new British Standard has been prepared to meet the need within the electronics industry for a record of the dimensions of semiconductor devices in general use.

Although international discussion on this subject is currently in progress, the need for this data required the standard to be published as early as possible. As soon as international agreement is reached on preferred dimensions, drawings will be amended where necessary.

The primary object of the drawings of outlines, bases and gauges is to indicate the space to be allowed for semiconductor devices in an item of equipment, together with other dimensional characteristics needed to ensure mechanical interchangeability. Electrical and thermal requirements for full interchangeability are not covered by the standard. Also included in the standard is a section giving guidance on the interpretation and use of the drawings and an index for quick cross reference.

Interference Reduction Guide (Vols. 1 and 2)

Pp. 221 (Vol. 1) and 364 (Vol. 2). Compiled by U.S. Army Electronics Laboratories. Available from: Clearinghouse, U.S. Department of Commerce, Springfield, Virginia, 22151, U.S.A. Prices \$7 (Vol. 1) and \$7.50 (Vol. 2).

A broad two-volume guide to interference reduction is now available from the U.S. Department of Commerce. Prepared by the U.S. Army Electronics Laboratories, this work provides the engineer with the necessary background and techniques to enable him to minimize the interference generation and interference susceptibility of communication and other electronic equipment that he designs. It is intended for the use of design engineers, qualified technicians, and others familiar with electronic circuitry and modern electronic equipment.

The Use of SI Units

Pp. 13. British Standards Institution, 2 Park Street, London, W.1. One copy free, additional copies price 1s.

Newly-published as part of B.S.I.'s educational and publicity programme for promoting the metric change is an explanatory booklet on the use of SI units (publication PD5686). It has been prepared on the recommendation of the B.S.I. advisory committee on metric conversion and standards which felt that there was a widespread need for a 'popular' explanation of B.S. 3763 (The International System, SI, units) published in 1964.

The SI is a rationalized selection of units in the metric system which individually are not new. It involves the use of a unit of force (the newton) which in some sectors may be less well-known than the unit of force in the system of metric technical units (the kilogramme-force).

The new booklet outlines the historical background to the international recognition of SI metric units, explains what they are, comments on the use of the newton as the unit of force, and indicates also how the units may best be

introduced in industry. The more important British Standards which provide further information on the use of SI units are listed in an appendix.

Biomedical Electronic Instrumentation

Pp. 108. Published by the Noyes Development Corporation, 118 Mill Road, Park Ridge, New Jersey 07656, U.S.A. Price \$10.

This monograph contains the papers given at a Life Science Symposium which was held at the Colgate-Palmolive Research Center in June 1965. Various aspects of medical electronics were featured at the symposium and the papers include such subjects as physiological instrumentation for measurement and recording, the physiological properties of heart muscle, the analysis of bioelectric potentials and other topics of interest both to medical doctors and medical electronic engineers.

European Miniature Electronic Components and Assemblies Data 1965-66 Part 2

Edited by G. W. A. DUMMER and J. MACKENZIE ROBERTSON. Pp. 1123. Pergamon Press, 4 and 5 Fitzroy Square, London, W.1. Price 250s.

This volume covers the electronic components, miniature assemblies, etc., manufactured in France, the Netherlands, Scandinavia and Switzerland. It includes six-language glossaries of component and microelectronics terms.

Fundamental Analogue Techniques

By R. J. A. PAUL. Pp. 216 + x. Blackie & Son Ltd., 5 Fitzhardinge Street, Portman Square, London, W.1. Price 35s.

This book describes the basic principles of analogue computing techniques and contains a wide range of references. The differential analyser is discussed, together with programming, scaling and checking procedures, and chapters follow giving a mathematical study of systems by dynamic analogies and the iterative operation of analogue computers.

Electromechanical Control Systems and Devices

By E. B. CANFIELD. Pp. 328 + xiii. John Wiley and Sons Ltd., Glen House, Stag Place, London, S.W.1. Price 105s.

A practical approach to the subject, which emphasizes, through the use of many-dimensioned problems, the application of proven theory to actual, not hypothetical, hardware control systems. A range of electromechanical components is discussed, as well as various drive systems and non-linearity and feedback problems.

Mechanising Laboratories

By E. A. SMITH, B.Sc., M.B.I.M. Pp. 205. Iliffe Books Ltd., Dorset House, Stamford Street, London, S.E.1. Price 63s.

This book surveys the general range of mechanical aids and instruments available to the research or development

scientist or technologist for improving the efficiency of his laboratory, and provides a useful reference for management on what is being achieved in this field.

Traffic Control—Theory and Instrumentation

Edited by THOMAS R. HORTON. Pp. 218 + xii. Plenum Press, 227 W. 17th Street, New York, 10011. Price \$12.50.

A collection of papers which reviews the state of the art of computerized traffic control in the U.S.A. Studies of typical large-scale systems are given and special equipment instrumentation and techniques are described.

Advances in Electronic Circuit Packaging. Volume 5

Edited by LAWRENCE L. ROSINE. Pp. 297 + vi. Published by the Rogers Publishing Co. Inc. and distributed by the Plenum Press, 227 W. 17th Street, New York, N.Y. 10011. Price \$15.

The 26 contributions which constitute this text are the proceedings of the Fifth International Electronic Circuit Packaging Symposium held in 1964.

The subjects include encapsulation, multilayer-circuit design and interconnection systems.

Free-Electron Theory of Conjugated Molecules

By J. R. PLATT et al. John Wiley and Sons Ltd., Glen House, Stag Place, London, W.C.1. Price 38s. (cloth), 23s. (paper).

This book is a collection of reprints of papers most of which appeared in the Journal of Chemical Physics.

Electrical Insulation Measurements

By W. P. BAKER. Pp. 180 + vii. George Newnes Ltd., Tower House, Southampton Street, London, W.C.2. Price 50s.

Grundlagen der Halbleiterphysik

By DR. O. G. FOLBERTH. Pp. 113. Fachverlag Schiele and Schon GmbH, Markgrafenstrasse 11, 1 Berlin SW 61. Price DM 12,50.

Manufacturers' Literature

Performance Characteristics of Corning Microcircuit Resistors and Capacitors. Specification figures and performance curves for the Corning microcircuit capacitors and thin-film resistors are given in this brochure of eight pages, publication no. 0001 and 2. Illustrations of microcircuits using these components are provided.

U.K. Agents: Electrosil Ltd., Pallion, Sunderland, Co. Durham.

For further information circle 75 on Service Card

Anemotherm Gas Flow Meter. This illustrated 14-page booklet, general information manual No. 302, is concerned with the gas-flow meter which is manufactured by the Anemostat Corp. of America and is available in this country from Dynamco Systems Ltd. Specifications, installation instructions and other details are included.

Dynamco Systems Ltd., Govett Avenue, Shepperton, Middlesex.

For further information circle 76 on Service Card

Projectors and Inspection Enlargers. In a catalogue of 12 pages, publication No. CT 175, Hilger and Watts describe their range of equipment for inspection purposes. Illustrations are included together with specification figures.

Hilger and Watts Ltd., 98 St. Pancras Way, Camden Road, London, N.W.1.

For further information circle 77 on Service Card

Power... When the Power Fails. International Nickel Ltd. describe in this leaflet of six pages, publication No. 6501, the uses and the advantages of nickel-alkaline battery standby power supplies which can be used to enable equipment to continue running in the event of a power failure. A brief survey of the type of equipment available from a number of firms is included.

International Nickel Ltd., Thames House, Millbank, London, S.W.1.

For further information circle 78 on Service Card

Remote Control System. A 4-page illustrated leaflet, bulletin 65-12, from the Theta Instrument Corp. contains details of a remote control system and describes some of its applications. The instrumentation provides a digital display of the parameter being monitored and controlled, and a digital display of the set-point limiting values.

The Theta Instrument Corp., Saddle Brook, New Jersey 07663, U.S.A.

For further information circle 79 on Service Card

Philips Radiation Monitoring. The equipment produced by Philips for monitoring radiation is described and illustrated in this 8-page leaflet. The range of equipment includes pocket-sized monitors, hand contamination monitors and large systems for monitoring an area, as well as other units.

Philips Scientific Equipment, The M.E.L. Equipment Company Ltd., Manor Royal, Crawley, Sussex.

For further information circle 80 on Service Card

Thorn Signal Lamps and Lampholders. This 42-page publication provides details of the Thorn lampholders, signal lamps and neon indicators. Dimensional details and both colour and half-tone illustrations are included.

Thorn Special Products Ltd., Great Cambridge Road, Enfield, Middlesex.

For further information circle 81 on Service Card

Incandescent Lamp, Fluorescent Tube, Semiconductor, Special Purpose Machinery. The Badalex division of the Sale Tilney Group of Companies have produced this booklet of 16 pages to outline the division's machinery for the production of lamps, fluorescent tubes, and semiconductors. These products also include equipment for manufacture of vacuum flasks, valves and other special-purpose machines.

Badar Machinery Co. Ltd., Alexandra Engineering (Southend) Ltd., Weybridge, Surrey.

For further information circle 82 on Service Card

Photain Controls Ltd. This booklet describes in 16 pages the activities of the company. The products include heating and liquid controls, batch counters, semiconductor components and other equipment.

Photain Controls Ltd., Randalls Road, Leatherhead, Surrey.

For further information circle 83 on Service Card

Audio-Visual Techniques Applied to Education, Industry, Commerce. A survey of audio-visual teaching techniques is the content of this 16-page book from The Rank Organization. The subjects discussed include industrial training and time-and-motion study using film and sound. It is concluded with some illustrated examples of the film and television equipment available from Rank.

The Rank Organization, 38 South Street, London, W.1.

For further information circle 84 on Service Card

How Photography Aids Industry and Commerce. The uses of photography in industry are outlined in this 24-page booklet produced by Kodak Ltd. Such applications as microfilming, research and development and others are described.

Kodak Ltd., Industrial Sales Division, Kodak House, Kingsway, London, W.C.2.

For further information circle 85 on Service Card

WODEN for ALL these system components

Torque motors—for precise torque and angular positioning under load. Range—up to 12,000 gm. c.m. $\pm 7^\circ$.



Electro-hydraulic servo valves—for accurate oil flow control in response to any input signal. Single-stage design. Immune to dirt. Max: 4 gpm at 1000 psi.

Programmers—stepping drum types with inbuilt logic, available for interlocking sequential operations. The heart of process control systems. Max: 93 switches, 100 steps.

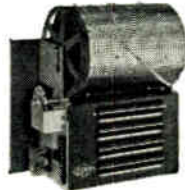

Matrix boards—for optimum switch/space ratio. Highly versatile, yet inexpensive. Max: 10,000 way, up to 5 decks.

Patchboards—for circuits demanding many small changes or a few complex ones. Range—normally up to 1,600 way.



Patchcords—over 20 varieties provide slick patch-board programming.

Card readers—for repetitive programmes. Numerous complex circuits may be stored as punched-cards. Range—up to 1,600 way.



80 column card reader—for static reading of 1 to 960 circuits through the standard 80 column TAB card.

Cross bar switches—for simple effective operations. Easily set up at minimum cost. Any number of 10 x 20 way units may be linked.



WODEN AUTOMATION LTD
OXFORD STREET • BILSTON • STAFFS • ENGLAND

NEW!



ELECTROLUBE
2A-X cuts
maintenance
costs and
ensures
electrical
reliability

Safe on
plastics,
rubber
and paint

Just the smallest squirt
Takes away the dirt.
Fraction of a bean
Keeps your contacts clean.

Look what good old friends
Bring you in their hands.
Get it anywhere
And you save a spare.

'Global availability' and
'world-wide NATO approvals'



only
ELECTROLUBE

"ELECTROLUBE" and "SNORKEL" are Registered Trade Marks of Electrolube Ltd, England
ELECTROLUBE LTD.
OXFORD AVE., SLOUGH, BUCKS, ENGLAND. Tel: SLOUGH 25574

For further information circle 265 on Service Card

CONTROLLED POWER CONTINUOUS POWER SYSTEMS ENGINEERING

Pelapone automatic control systems cover all industries employing automatic production processes or requiring remote control and indication.

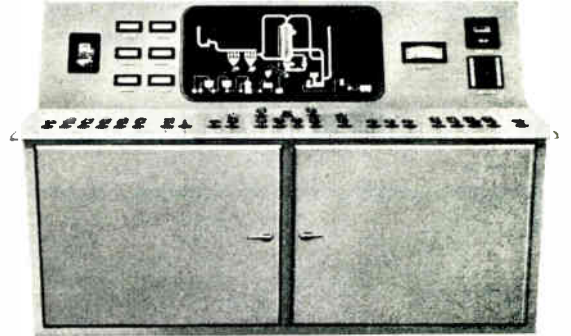

PELAPONE LIMITED

HEAD OFFICE AND WORKS: P.O. BOX No. 4, DERBY.

TEL: DERBY 45436. CABLES: PELAPONE, DERBY. TELEX: 37570

LONDON OFFICE: STEEL HOUSE, EASTCOTE, PINNER, MIDDLESEX.

TEL: PINner 5881. CABLES: PELAPONE, LONDON. TELEX: 21619

For further information circle 266 on Service Card

POLAR COMPONENTS



SMALL BUTTERFLY TYPE TRIMMER
C.952
Capacity 12.8 pF each side
Can be fitted with locking collar in which case type No. is C.953.



TUBULAR TRIMMER
S.56.12
P.T.F.E. Dielectric

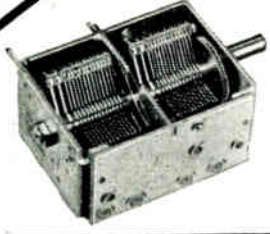

AM/FM GANG CAPACITOR
C.87.302
Fitted geared drive. Capacity 392 x 15 pF. AM only version available. Air gap .0125" Capacity 326 pF each section.



STAND-OFF INSULATOR
TS.1531
Peak working voltage 8 kV
Frequentite Insulation
Various terminations available.



WINGROVE & ROGERS LTD

DOMVILLE ROAD · LIVERPOOL 13

Telephone: Stoneycroft 2265

LONDON OFFICE: 75 Uxbridge Road · Ealing · W.5 · Tel: EALing 7046/7

For further information circle 267 on Service Card

TOUGH
RECORDING
REQUIREMENTS

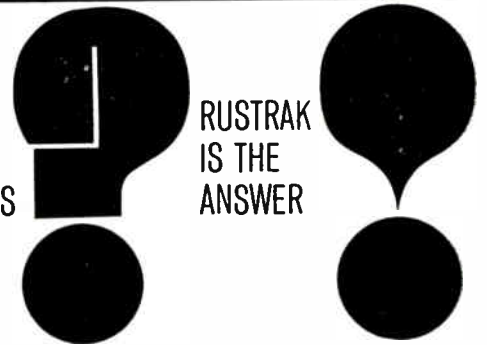

Because Rustrak recorders use pressure sensitive paper (no ink or heated stylus) they will operate with optimum accuracy from sub zero to 160°F.; from below sea level to 100,000 ft.—and under conditions of high humidity. The housing is made to match—a rugged die cast aluminium case. The motor drive mechanism, galvanometer and writing system will all give many years of faithful service under adverse conditions. Rustrak recorders are versatile, too. They are capable of gathering voluminous data at very slow chart speeds. With interchangeable gear trains and motors no less than 99 different speeds are available and information of a duration of 20 milliseconds is clearly visible. Rustrak recorders operate on AC or DC power or from rechargeable batteries. For full information about Rustrak recorders write to:—



WEST Instrument Limited
A Division of
Gulton Industries (Britain) Limited
The Hyde · Brighton 7 · Sussex · England
Tel: Brighton 66271 · Telex: 87172

1-by-4 Plessey Magnetic Tape Store

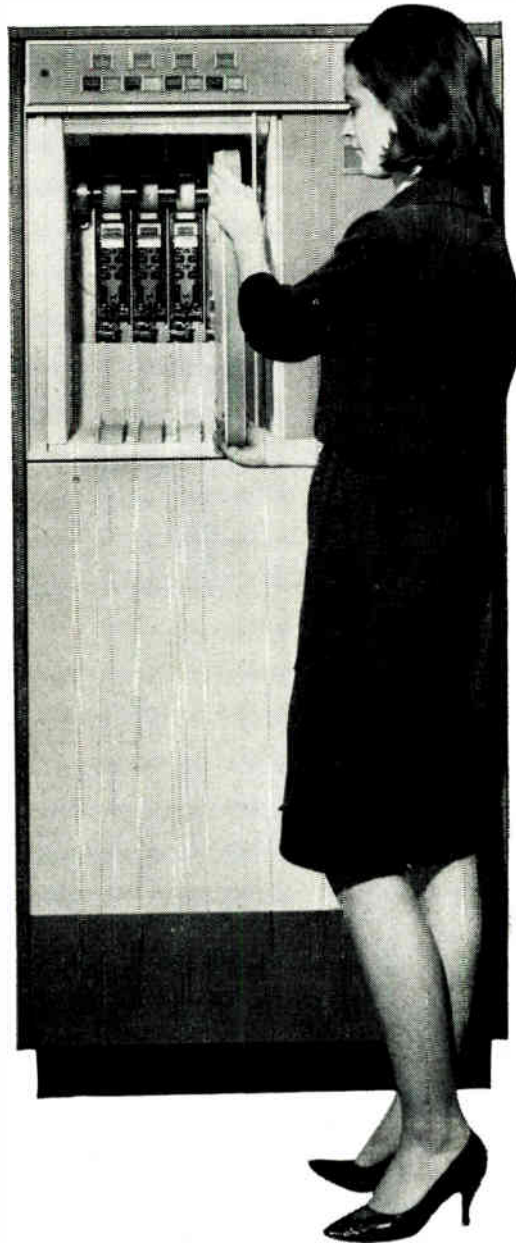

...chosen for ICT 1901

The Plessey 330 Magnetic Tape Store, representing a technical and cost breakthrough, is a reliable *LOW COST* unit with 4 independent tape stations, ideally suited for replacement of punched card systems and for programme storage etc. The 330 Magnetic Tape Store was put through extensive evaluation and proving tests by I.C.T. before its selection for the 1901 Computer. It fully meets the exacting I.C.T. requirements for reliability, performance and operating environment — it can be operated in normal office conditions. The simplicity of the Magnetic Tape Store, particularly in the design of the vacuum capstan drive, removes the complexity of conventional transports providing high-reliability with minimum maintenance. Each in-

terchangeable cassette holds 240 feet of magnetic tape, with a storage capacity of 14-million bits. The nominal data-transfer rate using the Plessey interface is 90,000 bits/second, and fast start/stop times ensure high tape utilisation. Flexible design means that the Plessey 330 can readily be adapted for use in many computer systems, both commercial and scientific. Get the full story on the all-British magnetic tape store that combines top performance with the lowest price yet — contact Plessey today.

PLESSEY
Automation



The Plessey Company Limited, Automation Group, Data Equipment Division, Sopers Lane, Poole, Dorset. Tel: Broadstone 510 Telex: 41272

PA(DE)4

**AVOID
EXPENSIVE
DELAYS IN
RESEARCH &
PRODUCTION**



**ORDER
EX-STOCK*
FROM
LIND-AIR**

**At lower than cost*

Yes, direct from our vast stocks we can supply immediately: Sefram 5 channel PEN RECORDERS at a mere £270 (Net list price £690), 4 channel fully Portable Systems £139. 10. 0, an extensive range of TRANSDUCERS and ACCELEROMETERS for industrial control, Hydraulic equipment including MOOG SERVO VALVES by Dowty for only £70. We also hold at least a hundred thousand British and American PLUGS, SOCKETS and CONNECTORS including Cannon, Thorn, Amphenol, Bendix, Pye, Plessey, Belling-Lee, McMurdo, SCF, Painton, etc. 400 CYCLE components, SYNCHROS, SERVOS, MAGSLIPS, TACHOGENERATORS, RESOLVERS, etc. TRANSISTORS, DIODES, RECTIFIERS and VALVES. Stantelum CAPACITORS, metal oxide RESISTORS. Our MICRO-WAVE stock includes WAVEGUIDE plumbing in all configurations, KLYSTRONS and MAGNETRONS, TR cells and TWTs. RELAYS of all types, Panel METERS, Pressure GAUGES. All at less than manufacturers' prices.

SEND AT ONCE FOR ILLUSTRATED LITERATURE:

LIND-AIR ELECTRONICS LTD

53 Tottenham Court Road · London · W.1

Telephone: LANGHAM 3653 (10 lines)

M^cGEOCH
INDICATOR UNITS

*designed and manufactured
to Customer's requirements*

*(illustration shows typical
illuminated panel type)*



Registered



Trade Mark

also makers of—

SWITCH and FUSE GEAR
CONTROL PANELS & CUBICLES,
WATERTIGHT SOCKETS & PLUGS,
LIGHTING FITTINGS, etc.

WILLIAM McGEOCH & CO. (BIRMINGHAM) LTD. (Dept. E.1.)
BORDLESLEY, BIRMINGHAM 10, also LONDON and GLASGOW

For further information circle 271 on Service Card

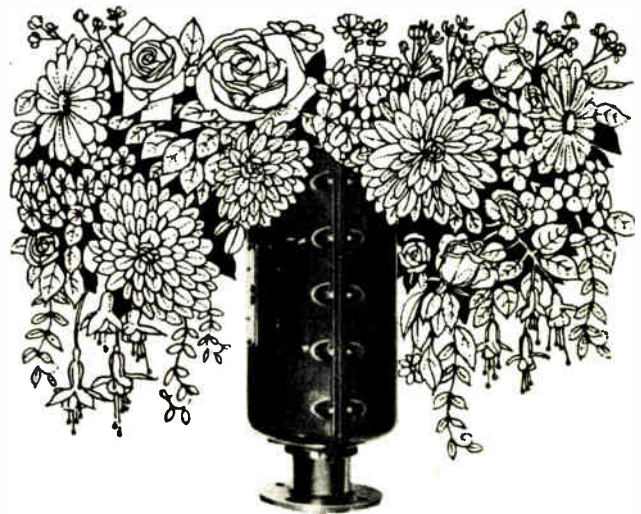

Not for decoration !

The EMFLUX is for measuring
the flow of any conducting liquid

EMFLUX

Now turn to page 60

MAWDSLEY'S LTD Electronics & Instruments Division
DURSLEY · GLOS · ENGLAND

TWO NEW MUREX CATALOGUES FOR MAGNET USERS

Ask for Catalogue **P26**

for **TECHNICAL DATA**

This is a comprehensive publication describing Murex magnet alloys and dealing with their applications and design considerations. The Murex Sincomax technique is fully described and particular reference is made to internal magnet systems. Please write for Catalogue P.26.

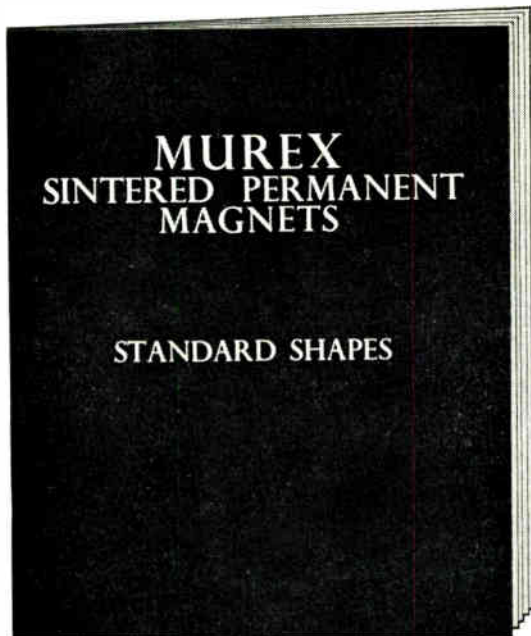
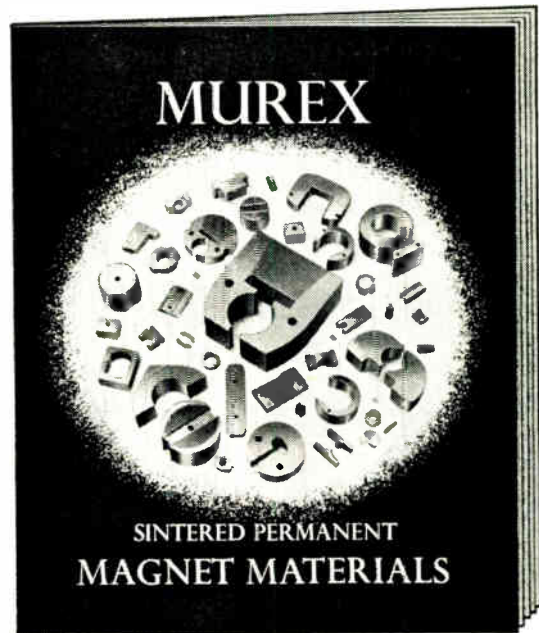

Ask for Catalogue **P27**

for **STANDARD SHAPES**

This useful brochure gives details of over 500 different Murex magnet designs for which dies are available. The delivery times of these standard Murex magnets are good and their use avoids the expense and delay which is often involved in special tooling. Please write for Catalogue P.27.



MUREX LIMITED · RAINHAM · ESSEX

Powder Metallurgy Division

Rainham, Essex 53322 Telex 28632: Telegrams: Murex, Rainham-Dagenham Telex

M37

59

FERRITES

WIRED
OR
WOUND

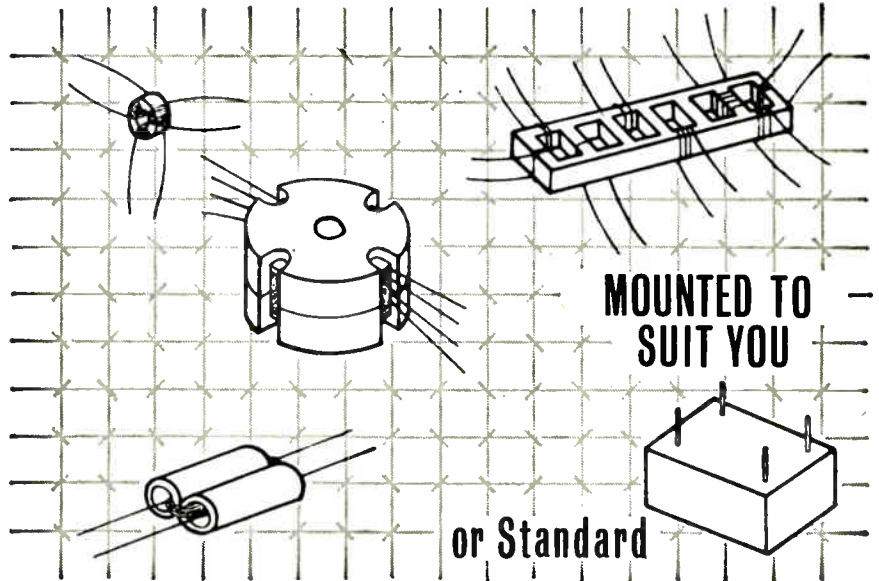

best quality, quickest delivery . . . at the right price

Newport Instruments

LTD

Newport Pagnell, Buckinghamshire, England • Phone: Newport Pagnell 401

PC MINIATURE PLUG-IN RELAYS

light current and
heavy duty types

FEATURES: * Wholly British * interchangeability with foreign relays * high quality * operational accuracy * competitive price.

SPECIALS: * flexible design * speedy delivery.

PC2

PC4

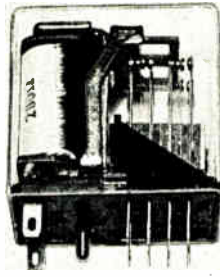

PERIVALE CONTROLS CO. LTD

TELFORD WAY, LONDON W3 SHEpherds Bush 1015 (5 lines)
A MEMBER OF THE BENTIMA GROUP

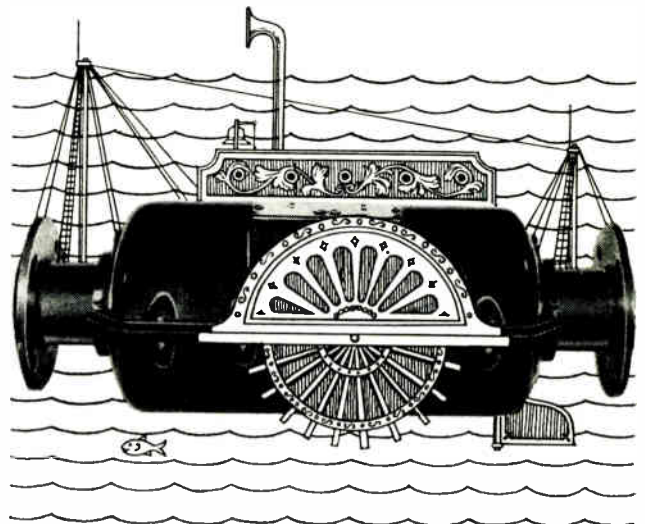

Not for submarining!

The EMFLUX is for measuring
the flow of any conducting liquid



Now turn to page 62

MAWDSLEY'S LTD Electronics & Instruments Division
DURSLEY • GLOS • ENGLAND

METROSIL PROTECTS AND PROLONGS EQUIPMENT LIFE

In transformers . . . tap changers . . . motors . . . and electrical equipment of all types

Metrosil—the remarkable non-linear resistance material developed by AEI—not only safeguards equipment against voltage surges, but protects the rest of the circuit and prolongs equipment life.

Through the use of this low-cost material, manufacturers can increase reliability, add more quality, build longer life into the products they supply.

METROSIL resistors are available in countless types for equipment protection, in disc, rod and other forms with diameters up to 6 in. Resistors can also be made to individual specifications.

For further details, contact your nearest AEI office or write direct to AEI.



ASSOCIATED ELECTRICAL INDUSTRIES LIMITED POWER GROUP RESEARCH LABORATORY TRAFFORD PARK MANCHESTER 17

M573/17

presenting the **NEW selectest** mark II

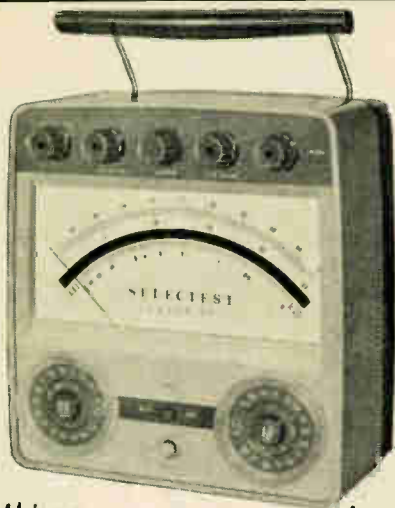

The Selectest is now in use throughout the world. The Mk II incorporates improvements suggested by actual users. The resistors, rectifier, transformer, movement, switches and automatic cut-out are mounted on a robust printed circuit board enclosed in a strong, attractive two-tone Melamine case. Overall dimensions are $9\frac{1}{2}'' \times 7\frac{1}{8}'' \times 4\frac{3}{8}''$. Leather case available as an extra.

SCALES The ultimate in legibility. Three scales with mirror insert and knife-edge pointer to eliminate parallax errors.

ACCURACY Within the limits of B.S.S.89/1054, and complies with Part II of the 6th Schedule of Merchant Shipping (Radio) Rules 1952.

RANGES Selected by two rotary multi-position switches capable of continuous rotation in either direction. The circuit is designed to provide electrical interlocking. External shunts and transformers available for increasing the D.C. and A.C. current ranges.

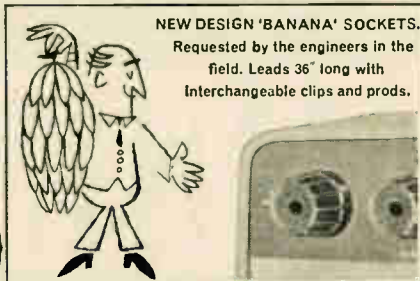

NEW DESIGN 'BANANA' SOCKETS.
Requested by the engineers in the field. Leads 36" long with interchangeable clips and prods.

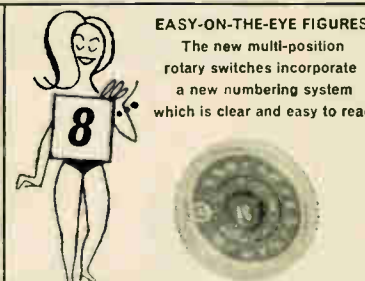

EASY-ON-THE-EYE FIGURES.
The new multi-position rotary switches incorporate a new numbering system which is clear and easy to read.

SALFORD ELECTRICAL INSTRUMENTS LTD

Peel Works, Silk St, Salford, 3, Lancs. Tel: Blackfriars 6688 Telex: 66711
London Sales Office: Brook Green, Hammersmith W6, Tel: Riverside 5245
A Subsidiary of THE GENERAL ELECTRIC CO. LTD. OF ENGLAND



For further information circle 278 on Service Card

Now for more information on the **EMFLUX** system of electromagnetic flow measurement fill in the coupon and get the complete handbook

To **MAWDSLEY'S LTD**
Electronics & Instruments Division, Dursley, Glos
Please send me your *Emflux Electromagnetic Flowmeter Handbook*

NAME

POSITION

COMPANY NAME AND ADDRESS

I.E.

For further information circle 279 on Service Card



Our quality control is your protection

MICA

CERAMIC

ELECTROLYTIC

HEMCOH

THE
CAPACITOR
SPECIALISTS

PLASTIC FILM

METALLISED

MOULDED

LONDON ELECTRICAL MANUFACTURING COMPANY LIMITED
71 Bridges Place, Parsons Green Lane, London S.W.6. Tel. Renown 7071-6

TAS/LEM 2

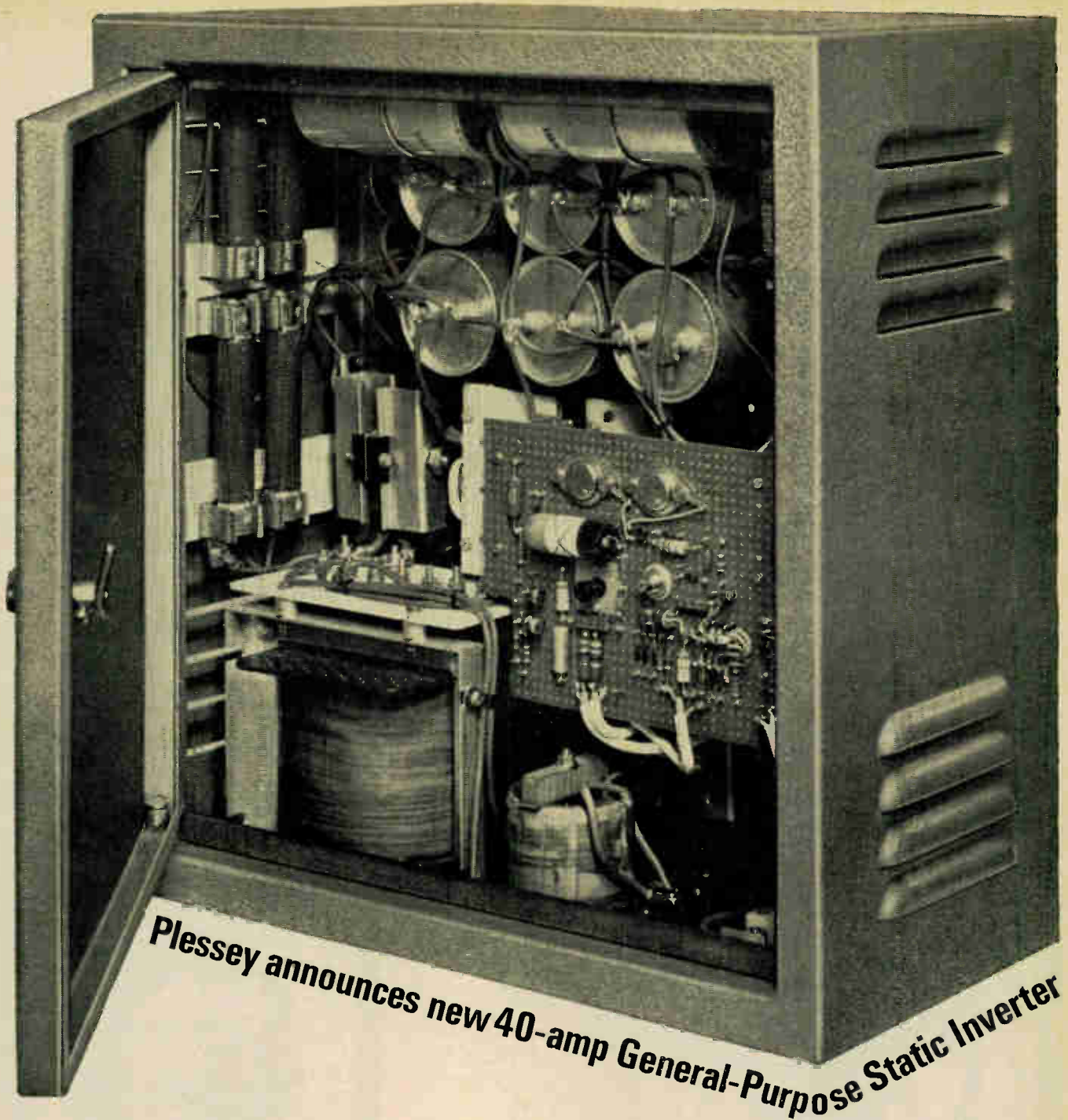

Plessey announces new 40-amp General-Purpose Static Inverter

The new Plessey 40-amp Static Inverter combines, for the first time, the many advantages of static-inverter power supplies with reasonable price and delivery. Basically a 40-amp unit, it produces a maximum of 10 kva, 230-volt, 50 or 60 c/s output from a nominal 220-vdc input, with other input-output combinations to meet individual requirements. This general-purpose unit is readily adaptable to a wide variety of applications, wherever you want maximum reliability and immediate start-up, without maintenance. Typical applications include motor supply, fluorescent lighting, commercial air conditioning and marine purposes.

This 40-amp Static Inverter brings you major collateral benefits from long Plessey experience in developing and producing ultra-high-performance static inverters

for the aircraft industry. To find out all about this versatile new dc-to-ac conversion equipment, contact Plessey today, indicating your required input and output as specifically as possible.

PLESSEY

Dynamics



The Plessey Company Limited
Electrical Equipment Division
Eastern Avenue West, Romford, Essex
Telephone: Ilford 3040

For further information circle 281 on Service Card

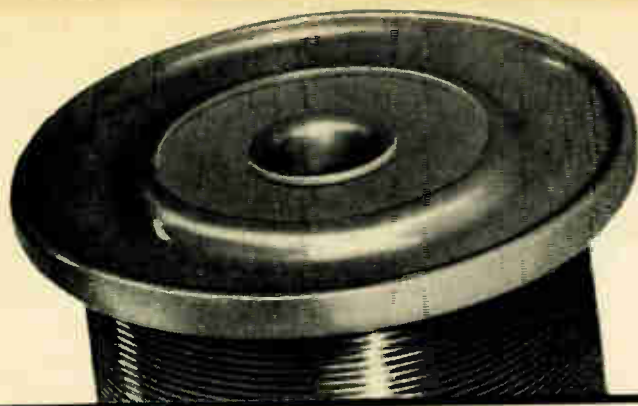

LEWCOS ENAMELLED WIRES

The fine reputation in both oleoresinous and synthetic enamelled wires, of **LEWCOS** among manufacturers of electrical equipment justly reflects the high standards observed in their production. The most modern machinery and the latest techniques ensure the continued leadership of **LEWCOS** products.

THE
LONDON ELECTRIC WIRE
COMPANY & SMITHS LTD.

LEYTON, LONDON, E.10.

A member of the L.E.W. Group

For further information circle 282 on Service Card

ROTRON FANS



NEW MODELS NOW AVAILABLE IN THE U.K!

MUFFIN SENTINEL

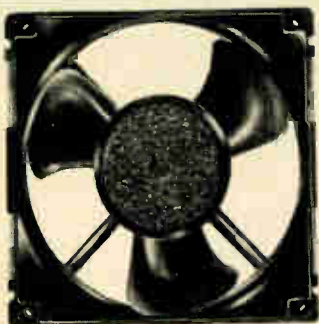

THE GOLD SEAL MUFFIN

Narrow axial depth mounting only 1½" deep. Simple functional design, silent operation, low cost and versatile. Reversible airflow. Light weight—only 1.0 lb. 220v/115v 50 c.p.s. 60 c.p.s. Long trouble-free life. The Sentinel is the Military version.

AXIMAX SERIES 1, 2 & 3

A family of miniature high frequency fans for use in tightly packed electronic equipment.

Aximax 1—the smallest c.p.s. fan available, optimum operation over the specific range of 50,000 to 125,000, maximum CFM 22.5 and max. S.P. at No Delivery 1.52. **Aximax 2**—vaneaxial fan with airflow parallel to the motor shaft, available in sizes up to a max. CFM 59 and max. S.P. at No Delivery of 3.0.

Aximax 3—a larger version of the Aximax 2, available in sizes up to a max. CFM of 162 and max. S.P. at No Delivery of 4.2.



PROPIMAX 3A & 3B

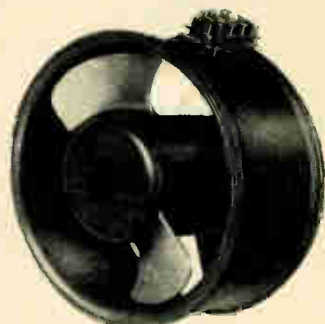

A compact high-performance, lightweight fan in two versions. **Propimax 3A**—2 bladed propeller with a 400 c.p.s. motor. 220 C.F.M. at 22,000 RPM. **Propimax 3B**—4 bladed propeller with a 400 c.p.s. motor delivers 220 C.F.M. at 11,000 RPM. Also available with a 60 c.p.s. motor giving 60 CFM at 3,300 RPM.

Ad. Auriema Ltd

INTERNATIONAL SALES MANAGEMENT SINCE 1921

125 GUNNERSBURY LANE,
ACTON W3 (Telephone ACOrn 8765)

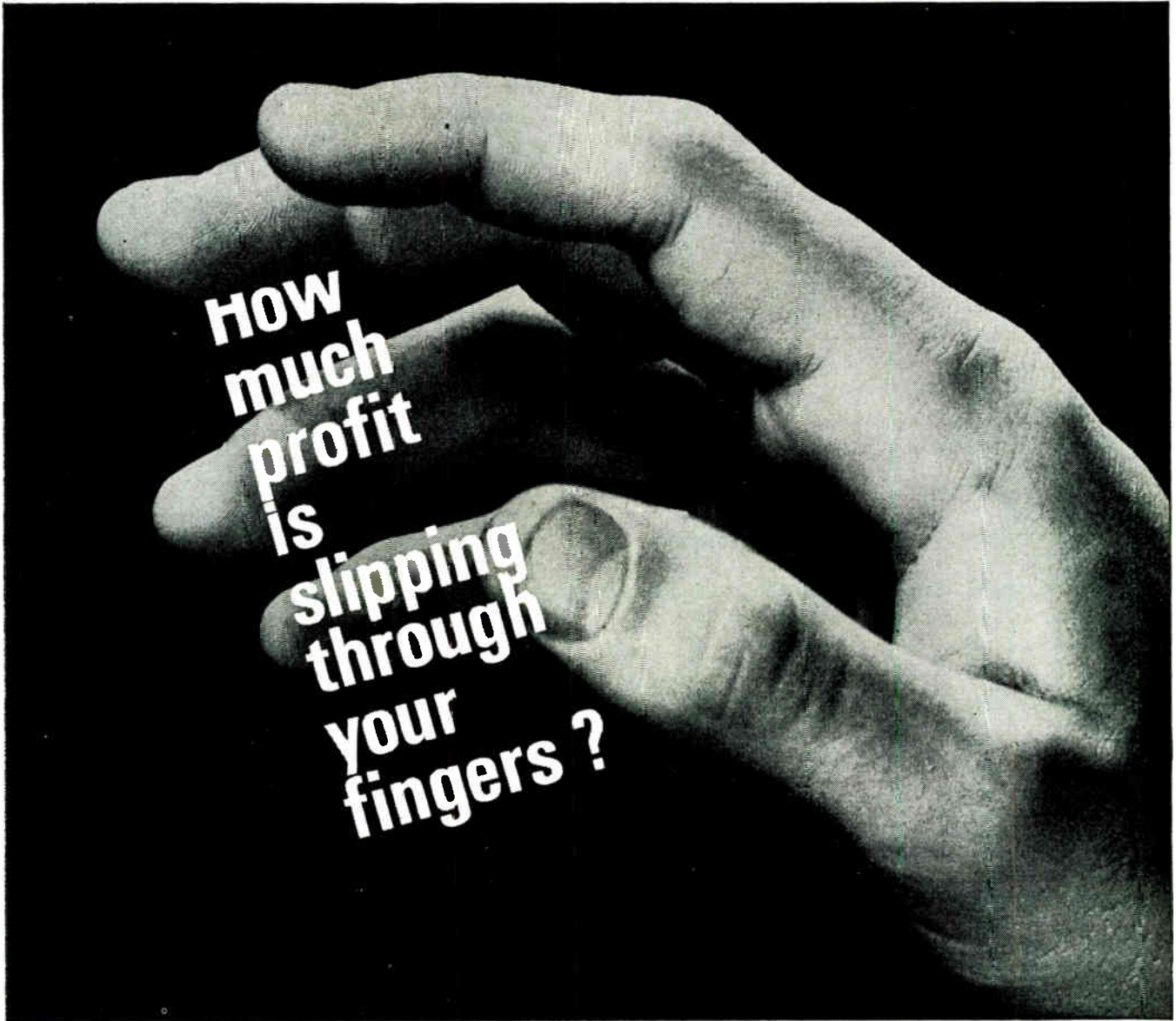

everyone can mechanize and profit . . .

Business may be brisk, with everyone working ; but where are all the profits? Something is robbing your company of its expected returns. Labour costs are rising 8% a year ; values of factory space and production machinery are rising fantastically. Under-utilization of these high-cost productive elements through inefficient handling operations is your worst enemy, and British industry is estimated to waste £800 million yearly in this way. Even if your business is not large, don't ignore the big

savings possible with mechanized handling. Many new ideas are discovered at every Mechanical Handling Exhibition—a survey in 1964 revealed that 47% of visitors had seen something new. Mechanization is your best investment—simple low-cost devices often produce remarkable results. See thousands of new ideas from over 300 exhibitors at the Mechanical Handling Exhibition, Earls Court, 10-20 May. Don't miss this important event—mail the enquiry coupon now.

mechanical handling exhibition

10/20 MAY, 1966, EARLS COURT, LONDON

Mail this coupon now for free tickets and further details
To the Manager, Mechanical Handling Exhibition,
Dorset House, Stamford Street, London, S.E.1.

NAME (please print)

FIRM

ADDRESS

74A

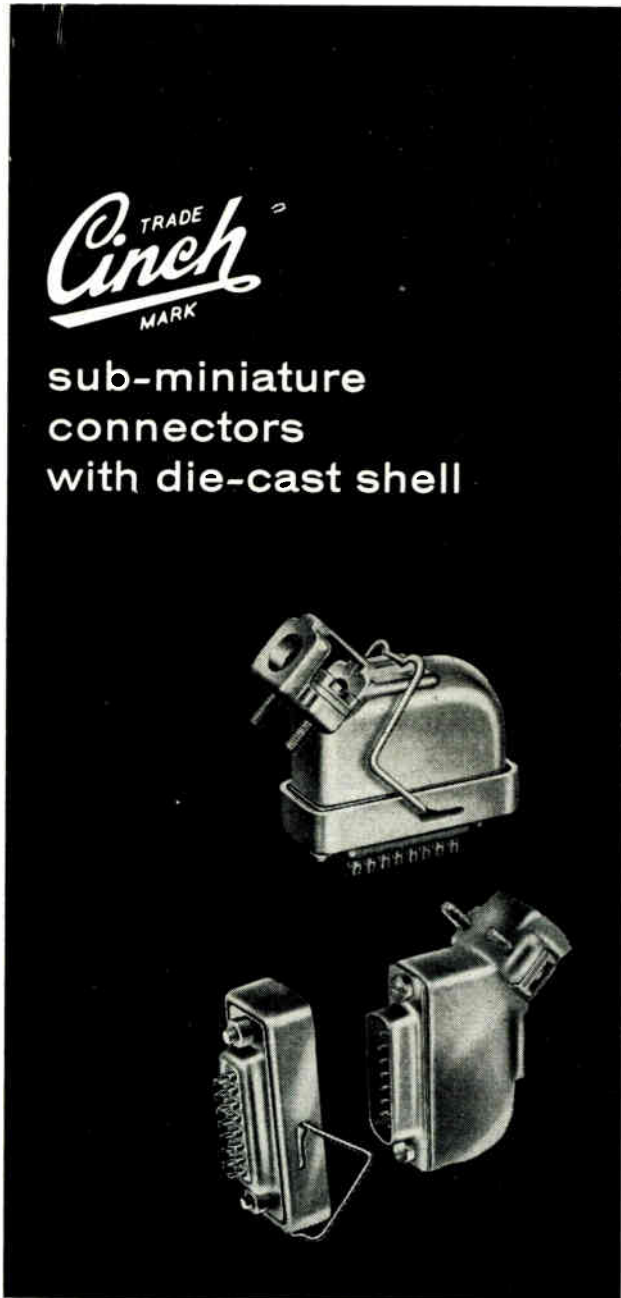

TRADE
Cinch[®]
MARK

sub-miniature
connectors
with die-cast shell

30/2

Small, light, and exceptionally reliable, these connectors are available in 9, 15, 25, 37 and 50 ways. They have a current rating of 5 amps per contact, a working voltage of 750V D.C., a contact resistance of 1.9 milliohms (max), and an insulation resistance greater than 5,000 MΩ. For certain applications floating mounting bushes can be supplied and for cable terminating applications a range of aluminium alloy die-cast shells is available. These have an angled cable entry with semi-permanent cable locking bar and a vibration-proof spring clip which locks the assembly together to avoid accidental disengagement of the mating parts.

CARR FASTENER CO LTD

the firm with the best connections

Stapleford, Nottingham. Telephone: Sandiacre 2661.
Sales Offices: Wembley, Sale.



individually
tested
vitreous enamel
wirewound
RESISTORS

Proved reliability-qualification approval
embraces RCSC types RWV4J-K & L, 1Ω to 100KΩ

CGS resistors offer you highest standard of quality and performance at extremely competitive prices, due to specialisation, an efficient production organisation and selective buying of raw materials. Up to 100 of any RCSC type resistors are available from stock. Leading manufacturers, GPO, Ministry of Aviation, Admiralty, and NATO are among the many users of CGS resistors. RCSC type approved to DEF 5111-1, manufactured under EID and ARB approved inspection conditions.

For price list, catalogue and stock list write or phone: **THE C.G.S. RESISTANCE CO. LTD.**
Marsh Lane, Gosport Street, Lymington, Hants. Tel: Lymington 2811

For further information circle 286 on Service Card

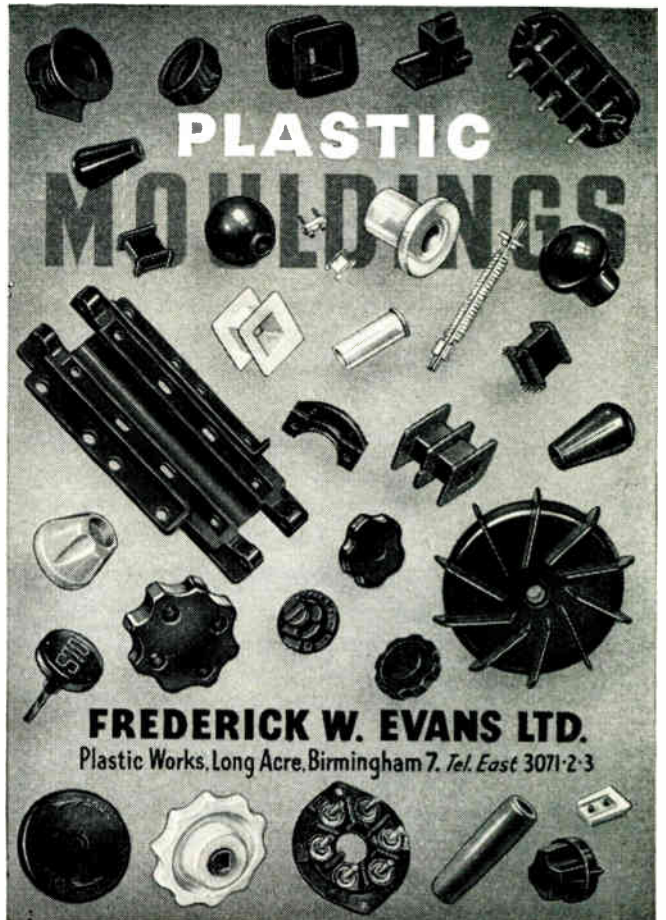

**PLASTIC
MOULDINGS**

FREDERICK W. EVANS LTD.

Plastic Works, Long Acre, Birmingham 7. Tel. East 3071-2-3

PITMAN TECHNICAL BOOKS

Modern Electronic Components

G. W. A. Dummer

Modern electronic equipment is developing at a remarkable rate, and its reliability and complexity is in no small way due to the smaller component, such as the transistor which have taken vast strides forward in the last few years. In this book Mr. Dummer has sought to present the first comprehensive survey of the more common components, together with information on their behaviour under the arduous environmental conditions to which they are subjected. Chapters on component specifications, transistor-circuit components, reliability, etc., are also included, and selected bibliographies to many chapters will help the information. As an aid to the choice of the most suitable component for a particular purpose, this book should be of fundamental value to the many engineers concerned with the design, development, production and use of electronic equipments.

New Second Edition

63s net

Telecommunication Principles

R. N. Renton

One might have thought that a book on principles could have remained unchanged and valid indefinitely, but such has been the pace of developments in telecommunication during the last decade or two that a revised edition of this standard work was thought necessary. The biggest single change is a new chapter dealing with semi-conductor devices (Theory and Application). In addition, the book deals with properties of new magnetic and dielectric materials (including square-loop materials and ferrites). The revised City and Guilds Syllabuses are fully covered and recent questions have been added to ensure that this textbook retains its high reputation for easy comprehension and accuracy.

New Second Edition

50s net

from all booksellers

Pitman Parker St. London WC2

NEW Mark V DATA RECORDERS by LEEVERS-RICH

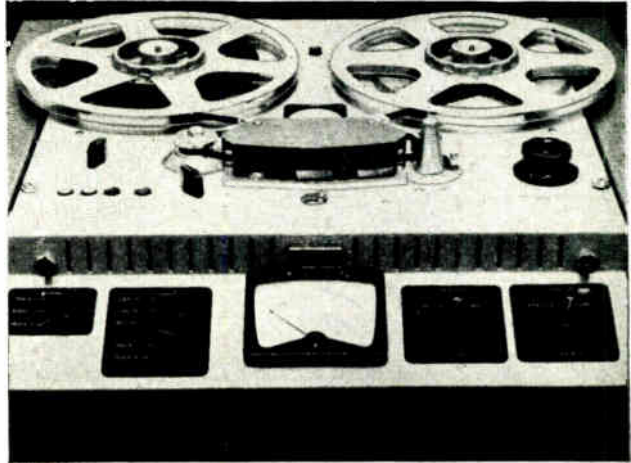

Comprehensive Specifications Very Competitive Prices!

- * New headblock design accommodates four ferrite heads to provide increased bandwidth and lower noise levels.
- * Accurate tape guidance reduces track-to-track errors to a minimum.
- * Four and six speed capstan drives available on $\frac{1}{4}$ -inch, $\frac{1}{2}$ -inch and 1-inch models.
- * Simplified mechanics eliminate maintenance, but permit full remote control.
- * Provision for correlation head scanning on multi-track models.

PRICES range from £885 for $\frac{1}{4}$ " recorders (ED series) to 8-channel recorders at £2055 (HD series).

Also available - Six band audio equalisers (Model 46X) and a complete range of magnetic tape bulk erasers.

WRITE TODAY for full technical information, specifications and quotations to meet YOUR special requirements.

LEEVERS - RICH EQUIPMENT LTD
319 Trinity Road · London SW18 · VANdyke 9054

LEEVERS-RICH

For further information circle 304 on Service Card

springs and pressings for the electronic industry

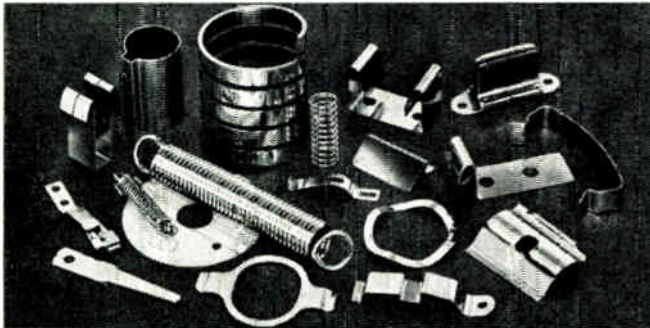

Made to your individual requirements from Beryllium Copper, Nickel Silver, Stainless Steel, Phosphor Bronze, Tantalum, Spring Steel etc.

Write or phone for further details to:

LITCHFIELD BROTHERS LTD.

Broadholme, Belper, Derbyshire, England

For further information circle 289 on Service Card

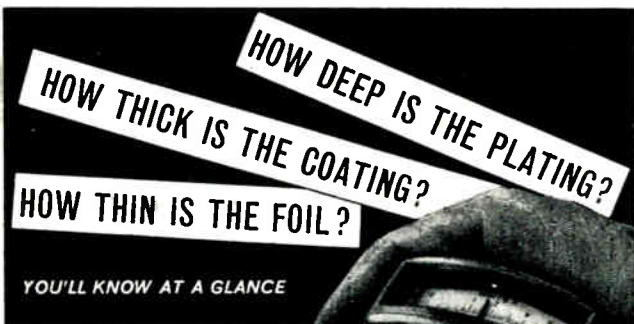

with the **POCKET**

elcometer

The depth of plating, paint or plastic on iron or steel . . . the thickness of non-ferrous coatings on iron or steel or non-ferrous foil . . . you can take these and many other measurements at a glance by means of the Elcometer. Completely non-destructive—like all our surface-metrology instruments—the Elcometer gives an accurate direct reading with fuss-free reliability, even in unskilled hands, even in the middle of a production run.

Choice of over 40 scales ranging from 0.0002" to 0.3"

13 GNS.

elcometer

FAIRFIELD RD. DROYLSDEN 11 MANCHESTER INSTRUMENTS LTD

Please send me free literature on the Elcometer and its companion instruments, the Elcotector and the Pin Hole Detector.

Name of Organisation

Address

For the attention of

For further information circle 292 on Service Card

Solenoids



by

Phil-Trol

The solenoids illustrated above are just two from our very large range. The small type 45 is suitable for $\frac{1}{8}$ " spacing, the larger type 38 for 40 oz. over $\frac{1}{4}$ " on AC, or 14 oz. over $\frac{1}{4}$ " on DC (25% duty cycle). A complete range of AC and DC solenoids is available including push and pull types, spring return, and DC fitted with fully damped silicon rectifier circuits for AC supplies.



for details of the complete range ask for leaflet 113E

PHILLIPS CONTROL (G.B.) LTD.

Dept. K7, Farnborough Rd., Farnborough, Hants. Telephone: Farnborough 41129.

Grams & Cables: Philtrol, Farnborough, Hants.

For further information circle 290 on Service Card

TECHNICAL MOULDINGS

POLYSTYRENE·POLYTHENE
POLYPROPYLENE
CELLULOSE-ACETATE
ABS·DELTRIN
AND NYLON ETC.
DESIGN TOOLMAKING
HOT FOIL STAMPING
MOULDING

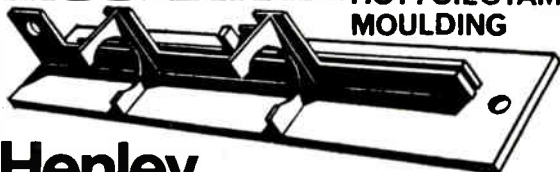

Henley

Plastics Ltd. HENLEY-ON-THAMES TELEPHONE 3861

For further information circle 291 on Service Card

ELECTRONICS PRINTED CIRCUITS

An extremely comprehensive service is available to industry which is unique in its scope and unprecedented in its quality of workmanship and speed of service while at the same time giving that all important individual attention and very competitive price terms that every buyer seeks.

The service consists of inclusive facilities for the design, development, and large scale production of all types of electronic equipment, instruments, etc., together with all processes involved in the design, development and production of printed circuit boards.

The unique location of T.E.S. Ltd., allows this first class service, which is to be found nowhere else, to be brought to your doorstep by an almost daily transportation service to 100 miles all for the price of a telephone call. Shanklin 3096.

Special attention will be given to very welcomed enquiries from customers outside the U.K.

TRANSMETRIX ELECTRONIC SYSTEMS LTD.
Hyde Works, Shanklin, Isle of Wight, Hants

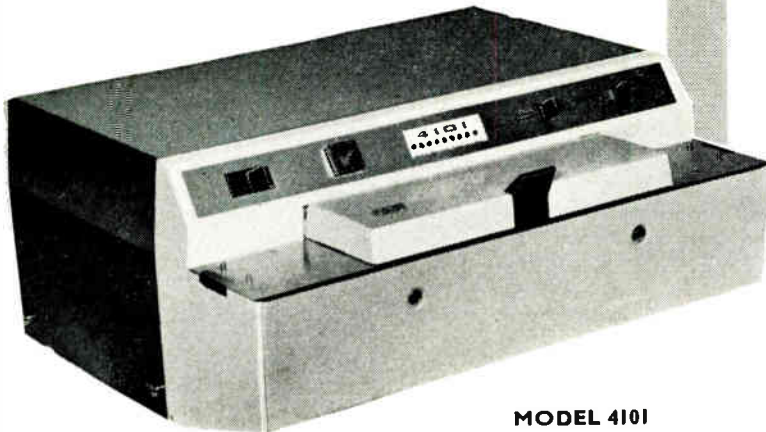

MODEL 4101

How fast can you read?

G.N.T Photo-electric tape reader

which is a read in unit for electronic digital computers and similar equipment requiring high speed operation, can read up to 1000 char/sec.

The Tape can be read at continuous operations from 250 char/sec to 1000 char/sec or intermittently (step by step) at a maximum 400 char/sec.
Forward and Backward Tape Feed. Extremely fast, start and stop of the tape is accomplished by powerful electro magnets and the special design of capstans and idling rollers.
Tape Guide instantly adjustable to 5-, 6-, 7-, or 8-channel tape. Olivetti tape with rectangular holes can be read when fitted with special circuitry.
Square Output Pulses with rise and fall times less than 2µs.
Alarm Circuits give information to the associated electronic equipment about open tape latch, tape out and manual control of the tape feed.
Special Input for the Control of Step-by-Step Operation requiring only a positive pulse to step the tape one character at any rate up to 400 characters per second.

Read Out Panel shows the combination of the characters over the reading station at all times.
The Electronic input and output specification makes this tape reader compatible with most transistorised electronic equipment.
Transistorised circuits mounted on gold plated printed circuit cards.
Start and Stop of Tape. Acceleration time (0-125 cm/sec) approx. 2-3 ms. Stopping time 250-0 cm/sec) less than 0.8 ms.
Tape Width ½", ¾" or 1" Standard, 5-, 6-, 7-, or 8-channel plus sprocket channel.
Tape Bin. The tape reader is supplied with a tape bin capable of holding a 7½" roll of 8 channel tape. (Electronically controlled tape winding gear under development.)
Step by step control of tape by applying a 5-15v positive pulse to a separate input at any rate up to 400 times/sec.
Parity Check circuit cards can be supplied at an extra charge.
Mounting: Available on request as 19" standard rack mounted equipment.



GREAT NORTHERN TELEGRAPH WORKS

SYDHAVNS PLADS 4, COPENHAGEN SV, DENMARK

LONDON OFFICE: 5 ST. HELEN'S PLACE, LONDON, E.C.3. Tel: LONDON Wall 4567

For further information circle 294 on Service Card

WESTON—FOREMOST FOR MOVING COIL RELAYS

MODEL S 170 for control applications

The Model S 170, permanent magnet moving coil relay. Combines extreme sensitivity with high precision. It is eminently suitable for control applications when a relay operating within close tolerances is necessary. The minimum signal current is 5 mic A. d.c.; shunts and series resistors can be incorporated for currents and voltages up to 5 A and 250 V d.c.



MODELS S 124 a miniature alarm relay with "hold-on" contacts

The Model S 124 is of the permanent magnet moving coil type and can be supplied to operate on currents as low as 2 mic A. d.c. High contact pressure is ensured by magnetic attraction between the contacts; these will "hold-on" until reset manually or by remote electrical control. Front-of-panel and flush mounting relays are available.



MODEL S 115 a miniature switching relay

The Model S 115 functions as an "on-off" switching relay and is supplied for operating currents down to 50 mic A. d.c. Single and double coil windings are available. The relay can be mounted in any position and is magnetically self-shielding. The space occupied on the chassis is only 1½ in. x ¾ in.; weight, 1¼ oz.



For full details of the Weston range of relays, please write to:—

SANGAMO WESTON LIMITED • ENFIELD • MIDDLESEX

Telephone: Keats 1100. Grams: Sanwest, Enfield. Telex: 24724



TEXAS INSTRUMENTS LIMITED

Are pleased to announce that they are now marketing their range of instruments, manufactured both at BEDFORD and HOUSTON, direct from Bedford.

The range includes:—

- Pulse Generators
- Potentiometric & Galvanometric Recorders
- High Speed Multiplexer
- High Speed A-D Converters
- High Speed D-A Converters
- Fused Quartz Pressure Gauges & Controllers
- Semi-Conductor Test Equipment
- Parallel Gap Welders

Brochures & Data from:— TEXAS INSTRUMENTS LTD.
 (INSTRUMENT GROUP)
 MANTON LANE, BEDFORD
 BEDFORD 67466

get your gen

The first *three* Gen Books in Marconi Instruments new series are now available free on request. They are:
The Q-Meter Book 297 **The Sig-Gen Book 298**
The AF Book 299

Please use the Reader Service forms to obtain a complimentary copy of any of these useful publications.
 Marconi Instruments Ltd · St. Albans · Herts · England

For further information circle 300 on Service Card

QUALITY STOVE ENAMELLING

Your equipment may cost thousands, and function to perfection, but dust and orange peel on the paintwork are what the customer sees first.

We provide a stove enamelling service where quality is the first consideration.

- ★ Standard finishing of chassis components in quantity.
- ★ Higher quality cases and panels.
- ★ Mirror finish for the perfectionist, with hand polishing.

A collection and delivery service, prompt turn round, colour matching, masking.

MAT-VAL LTD.

6-8 SCRUTTON STREET, LONDON, E.C.2. BISHopsgate 2189

For further information circle 296 on Service Card

JUST WHAT YOU HAVE BEEN LOOKING FOR! MARKWAY

Patent Applied For

BAKELITE TERMINAL BLOCKS

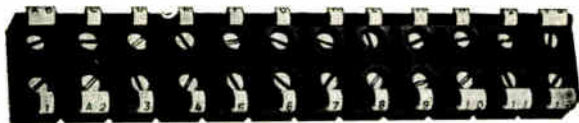

With cable markers

A "METWAY" PRODUCT WITH SPECIAL FEATURES :

- 12 Way—Grooved for easy Cutting
- Spring-on Cable Markers
- Crimping Ferrule for Cable Protection
- Max. Volts—500. Working Temp. +115°C — 45°C



Crimping protecting ferrule



Groove for easy cutting

See us on Stand G19 at the A.S.E.E. Exhibition

● For details ask for List No. NBQ/15/IE

METWAY • KEMP TOWN • BRIGHTON 7



**A-P-T
CASED
TRANSISTOR
UNITS
for
stabilised
output up to
10 amps**

The TCU range of Transistor Stabilised Power Supplies combines outstanding electrical performance with very small size. The units are rated for d.c. outputs of $\frac{1}{2}$ Amp, 1 Amp, 2 Amps, 5 Amps and 10 Amps. The output voltage of each unit is 0-50 Volts, fully variable, and the stabilisation ratio is greater than 1000: 1 throughout the range. A comprehensive overload protection circuit gives both immediate current limiting and delayed trip action. Separate input sockets are provided for the control amplifier so that the effect of lead resistance on the performance can be neutralised when the unit is used to supply a remote load. Full details of our complete range will be sent on request.

A-P-T ELECTRONIC INDUSTRIES LTD.

CHERTSEY ROAD, BYFLEET, SURREY

Phone: Byfleet 41131/2/3/4 PABX. Grams: APTRAN, BYFLEET

Please send me full details of your Transistorised Cased Units.

Please send me details of your full range of products.

NAME

COMPANY

ADDRESS

Lee 4090

CLASSIFIED ADVERTISEMENTS

FULLY DISPLAYED: 55/- per single column inch.
SEMI-DISPLAYED: 45/- per single column inch.
RUN-ON: 4/6 per line of approximately 7 words.
Where an advertisement includes a Box Number 1s. extra.
SERIES DISCOUNTS: 12 insertions, 15%.
Remittances payable to "Industrial Electronics".

Copy is required by 9th of the month for insertion in the following month's issue, by 4th of the month if proofs are required.

Address to:
Classified Advertisement Dept.
Industrial Electronics
Dorset House, Stamford St., London, S.E.1.

SITUATIONS VACANT

STC

TELECOMMUNICATIONS MARKET RESEARCH UNIT

This unit will search for and present detailed statistics of the economy and telecommunications network and development of many countries.

Analysis of this information is of great importance as it will ensure long term planning for future requirements of customers, and of various types and quantities of equipment.

Applications and enquiries are invited from TELECOMMUNICATIONS ENGINEERS who have a good knowledge of transmission networks and traffic handling, and are interested in economics, market analysis and statistics; as well as from: ECONOMISTS with experience in statistics and in the telecommunications industry.

Preferable age range is 30 to 45 years.

Very attractive salary, to be settled by agreement: pension scheme, assistance with housing and other benefits are offered.

All applications are treated with the strictest confidence. Please write to:

C. L. BALDAM, Personnel Officer

Standard Telephones and Cables Limited

Chester Hall Lane, Basildon, Essex

[529]

ELECTRICAL ENGINEERS REQUIRED IN CANADA

for design and development of electrical instruments of highest precision in voltage, resistance, capacitance and temperature measurement.

Applicants should have electrical engineering degree and experience with electrical instruments or digital switching techniques, and should be capable of working independently or with minimum supervision.

MACHINISTS AND TECHNICIANS

for mechanical construction and for wiring and calibration also required.

Assisted passages available for suitable applicants.

Write for further information giving personal details to:—

Personnel Manager

GUILDLINE INSTRUMENTS LTD.

Box 99, Smiths Falls, Ontario, Canada

[515]

ELECTRONIC ENGINEER

required for Development Department of Manufacturing Company on the South Coast. Experience of Relay Designs, Relay Circuits, Transistors and Analogue essential. Work will include developing of supervisory equipment. Good salary. Interesting work. Apply in writing quoting age, experience and qualifications, to

**Personnel Officer
(Reference D)**

Sound Diffusion Limited

80/86 Davigdor Road

Hove 2, Sussex

[535]

**WILL ADVERTISERS PLEASE NOTE
THAT "COPY" FOR THE
MARCH ISSUE
IS REQUIRED BY FEBRUARY 9TH**

Senior Circuit Engineers

We believe that circuit designers are as important as systems designers.

We are looking for two men whose career has fitted them for early promotion to supervisory functions.

We are working in the field of Data Communication, Remote Control, and Instrumentation.

V.F. DATA TRANSMISSION

This Engineer will be experienced in the V.F. field, preferably to G.P.O. standards, with digital technique backing. He must be able to bring new design to a speedy and successful conclusion.

ANALOGUE AND LOGIC DESIGN

This Engineer will be required to cover a broad range of activities, predominantly in the L.F. analogue field, including high quality D.C. amplifiers. Experience in the design of logic modules an advantage.

Starting salaries in the range £1,400—£1,900 per annum.

Practical experience and know-how are more important than academic qualifications, although we expect both Engineers to be of chartered or graduate standard. Assistance will be given with house removal and relocation.

SEND FOR BROCHURE

Our brochure gives more details of the Division and the appointments. Send postcard only, or telephone Personnel Manager, INTEGRATED ELECTRONIC SYSTEMS DIVISION.

Standard Telephones and Cables Limited

Burleigh House, Great Cambridge Road
Enfield, Middlesex. ENField 5343

STC I.E.S.D.

1539

ENGINEER TECHNICIANS

Diplomatic Wireless Service

THE DIPLOMATIC WIRELESS SERVICE has vacancies for about 20 pensionable posts in (a) Grade II and (b) Grade III.

This Department operates a world-wide network of radio communication stations which is in the process of being modernised and expanded and the most up-to-date techniques in radio teleprinter systems are being employed. The duties of engineers in this field involve installation, modification, maintenance and operation of radio transmitters and receivers of the most modern types, remotely tuned aerial systems, teleprinter and voice frequency telegraph equipment. In addition several high-powered broadcasting stations relaying programmes in both the h.f. and the m.f. bands. The transmitters involved include some of the highest powers yet produced for this purpose. The duties in this field include the installation, modifications, maintenance and operation of these very high power transmitters, the most modern receiving equipment, tape recorders, diesel generating plant, etc. The Department's policy is to encourage versatility and to carry out as much installation and modification work as possible with its own staff. The initial appointments will be either to Crowborough (Sussex) or Hanslope (Bucks.). Liability for service overseas.

QUALIFICATIONS: O.N.C. in Electrical or Mechanical Engineering or a City and Guilds Telecommunications, Electrical or Mechanical Engineering Technicians Certificate (Nos. 49, 57 or 293). Equivalent qualifications may be accepted. Higher qualifications will be an advantage.

SALARY (national interim): (a) £1,129-£1,288; (b) £796 (at age 21) to £1,009 (at 28 or over) to £1,129. Promotion prospects.

WRITE (preferably by postcard) to Civil Service Commission, Savile Row, London W.1, for application forms, quoting S/6111/65. Closing date extended to 15th February, 1966. Candidates who have already applied need not do so again.

[528]

ELECTRICAL ENGINEER

Ministry of Defence (Army Department)

ENGINEER required at the ROYAL ORDNANCE FACTORY, Bishopton, Renfrewshire, for the maintenance and extension of the electrical installation of the explosives factory, including 11-kV distribution system, power station, and special plant, etc.

QUALIFICATIONS: Applicants should have satisfied the basic training and examination requirements for Corporate Membership of the I.E.E. Knowledge of the Factory Acts and Electrical Safety Regulations including Explosive Electrical Regulations and I.E.E. Wiring Regulations is essential. Opportunities for promotion. Candidates under age 35 may apply immediately for permanent appointment. Older candidates can be considered for a pensionable appointment after nine months' service.

SALARY (interim) £1,068-£1,633.

APPLICATION FORMS from Ministry of Defence, C.E.2(g)2(AD), Northumberland House, Northumberland Avenue, London W.C.2. Candidates under 35 applying for permanent appointment should obtain forms from the Civil Service Commission, Savile Row, London W.1, quoting S/85.

[527]

S.E. LABORATORIES (ENGINEERING) LTD.

North Feltham Trading Estate, Feltham, Middlesex

have vacancies for the following:

ELECTRONIC TESTERS

Minimum qualifications O.N.C. plus two years' experience on transistorised equipment, and continuation of education for H.N.C. or ability to diagnose faults of a complex nature. Minimum age 25 years. A basic salary of £22.0.0 per week will be paid to men of the right calibre.

TEST ENGINEERS

to be responsible for technical liaison between the Test Departments and the Design Laboratories. To also be responsible for the technical running of the Electronic Test Sections. Minimum qualifications H.N.C.

SE

Apply: Personnel Manager

FELtham 5876

[531]

NORTH WESTERN GAS BOARD

INSTRUMENT ENGINEER

An Instrument Engineer is required at the Headquarters of the Board in Altrincham, Cheshire.

The duties will involve supervision of the design, installation and maintenance of electronic and pneumatic instrumentation of pressure reforming plant and new data collection, transmission and processing systems as may assist the Board in its future operations.

Experience in information telemetry, data processing and computers, is desirable. Experience of chemical process plant instrumentation is essential.

Starting salary will be according to qualifications and in the region of £2,500 p.a., and there is a contributory pension scheme.

Applications should be made to The Secretary, North Western Gas Board, Welman House, Altrincham, Cheshire, within 14 days of the publication of the advertisement.

[534]

STC TELEPHONE SWITCHING DIVISION



Engineers— join in the rapid growth of STC

Standard Telephones and Cables Limited has a growing share in the steadily increasing use of telecommunications throughout the world. This above-average expansion in both production and techniques has created opportunities for qualified Engineers on Telephone Exchange Design and Development in either the electronic or electro-mechanical fields.

We need

CONTRACT ENGINEERS · DESIGN ENGINEERS · ELECTRONIC SYSTEMS DEVELOPMENT ENGINEERS · MECHANICAL DESIGN ENGINEERS · ELECTRO-ACOUSTIC ENGINEERS

Vacancies exist at all levels. Starting salaries will be attractive and negotiated according to qualifications and relevant experience.

For comprehensive details about the work, salary and prospects—as well as information on the company itself—write or telephone for our new booklet.

The Staff Personnel Officer (IN/1), Standard Telephones and Cables Limited, Oakleigh Road, New Southgate, London, N.11. (Telephone ENTerprise 1234, Extn. 601) [531]

BECKMAN Instruments Limited

require the following personnel for a major new project:

Mechanical/Electronic Engineer

Applicants should have practical experience of at least one major project and be familiar with electronic design and production techniques.

Preferred age 24-28 years, with Degree, Dip. Tech., H.N.C. or alternative practical experience.

Instrument Engineer

Applicants should have practical experience of all aspects of instrumentation on a chemical plant. The project will involve mechanical, electronic design and production of widely accepted analytical instrumentation and sample handling equipment.

Preferred age 24-28 years, with Degree, Dip. Tech., H.N.C. or alternative practical experience.

Draughtsman

Applicants should be experienced in mechanical and electronic drawings for production. Knowledge of chemical contracting procedure is desirable but not essential.

Preferred age 22-29 years, with O.N.C. minimum qualification. The successful applicants should be capable of working on their own initiative as part of the Project Team. They will be joining a dynamically growing company where high performance is amply rewarded.

Glenrothes is an attractive new town centrally situated within easy reach of the major Scottish cities (London one hour's flying time) and Scottish sporting facilities (Ski-ing, Glenshee, Golf, St. Andrew's). Housing assistance available.

Apply to Personnel and Welfare Officer, giving brief résumé of career and suitable date for interview.

BECKMAN INSTRUMENTS LIMITED

Glenrothes, Fife, Scotland

Ref. A/1/66 [537]

ARTICLES FOR SALE

PHOTO-ELECTRIC CONTROLS

for Industry

Quick delivery

Send for Catalogues

Hird-Brown Limited

Flash Street, Bolton, Lancs.

Tel. 27311

[305]

CAPACITY AVAILABLE

AIRTRONICS LTD.

for coil winding, assembly and wiring of electronic equipment, transistorised sub-units, sheet metal work. 3a, Walerand Road, London, S.E.13.

Telephone: LEE Green 1706.

[439]

PATENTS

EXPLOITATION OF PATENTS

THE proprietors of British Patent No. 905606 relating to "Improvements in measuring systems" desire commercial working of the patent in the United Kingdom by licence or otherwise. Replies to—Box I.E.530, Industrial Electronics.

Patent No. 862,129 entitled "Interlocked Contactor for the Control and Reversal of Three-Phase Electric Motors," is for sale or Licence.

For details apply to:

CHATWIN & COMPANY, Chartered Patent Agents, 253 Gray's Inn Road, London, W.C.1.

[536]

BUSINESS OPPORTUNITIES

STRATFORD JOHNS STUDIO
12, NEW QUEBEC STREET
MARBLE ARCH, LONDON W.1

TECHNICAL PHOTOGRAPHY

INTERIORS OR EXHIBITIONS, INDUSTRIAL OR TECHNICAL. PIECES OF SPECIFIED EQUIPMENT WHICH NEED TO BE CLEARLY MARKED AND REPRODUCED. TO BE USED FOR TRADE AND TECHNICAL PUBLICATIONS, NATIONAL OR PROVINCIAL PRESS OR GLOSSY MAGAZINE. EXECUTED TO VERY HIGH STANDARD.

MR. EDMUND HELLER, A.R.P.S.

will be pleased to give full information

AMBassador 1818

[481]

QUALITY MANUFACTURED PRODUCTS FROM ONTARIO, CANADA

Looking for new lines to sell? Manufacturers from Ontario, Canada, are seeking established successful sales organisations covering the United Kingdom. Send full particulars of your company and product interest to:

Trade and Industry Department
Ontario House, 13 Charles II Street
London, S.W.1

[460]

TELECOMMUNICATIONS ENGINEERS

required by the

GOVERNMENT OF MALAWI

on contract for one tour of 24-36 months in the first instance. Commencing salary according to experience in scale (including overseas addition) rising to £1,905 a year. Gratuity 15% of total salary drawn. Outfit allowance £30. Free passages. Liberal leave on full salary. Generous education allowances. Quarters at low rental.

Candidates, preferably aged 25-45 years, must have at least 5 years' experience in one or more of the following branches of telecommunications engineering, after completion of two years' approved training: Automatic exchanges and Subscribers' Apparatus; carrier and V.H.F. equipment; H.F. radio; overhead lines or underground cables (construction). They must possess at least one appropriate City and Guilds Certificate. Previous overseas experience and experience in training and supervision of subordinate staff would be advantages. For certain posts the ability to instruct and control large numbers of low graded staff is essential.

Apply to CROWN AGENTS, M. Dept., 4 Millbank, London, S.W.1, for application form and further particulars, stating name, age, brief details of qualifications and experience, and quoting reference M2T/62648/IAF.

[538]

EQUIPMENT FOR HIRE

UV RECORDERS

for hire

Livingston Laboratories Ltd. is now able to offer Consolidated Electrodynamics' well-known direct print UV oscillographs for hire. If you have a data recording problem calling for instant readout and portability why not call on the Instrument Hire Department of Livingston Laboratories, Greycaines Estate, Bnshey Mill Lane, North Watford, Herts. Telephone: WATFORD 44344.

[533]

TUITION

CRANFIELD

Postgraduate Short Course

Microwave Laboratory Practice (for non-specialists)

25th to 29th APRIL, 1966

This is a predominantly practical course of instruction for the many scientists and engineers whose work is being influenced by the more general application of microwaves. It is ideally suited to the needs of both the non-electrical specialist and the electronic engineer about to enter the microwave field. No previous practical experience is required.

Fees, covering tuition, full board and accommodation: 30 guineas.

Further information from:—

The Registrar
THE COLLEGE OF AERONAUTICS
Cranfield, Bedford

[526]

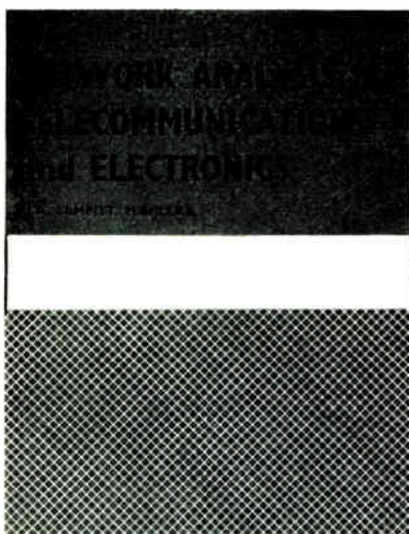

three important new ILIFFE technical books

Network Analysis for Telecommunications and Electronics

R. A. Lampitt, M.I.E.R.E.

This new book makes an inherently complicated subject simple and easy to understand, and serves as a solid foundation for studying the more advanced texts on the subject.

The author, a consulting engineer, is fully aware of the difficulties that the student and practising engineer must face and the methods of overcoming them. The book is therefore invaluable as a reference for practising engineers in electronics and telecommunications and as a textbook for students taking these subjects as part of their degree course, professional examinations, and equivalent diploma courses of colleges of advanced technology.

63s net by post 64s 2d 278 pp. 135 illustrations.

Understanding Digital Computers

Ronald M. Benrey A new book that bridges the gap between the high level textbook and the over simplified treatments of computers. An invaluable introduction to technologists, technicians and the sophisticated layman.

16s net by post 16s 9d 174 pp. illustrated.

Circuits Using Direct Current Relays

A. H. Bruinsma This latest addition to the successful Philips Paperback series gives an insight into a number of uncommon circuits which have already proved themselves in practice, and the possibility of applying direct current relays in commanded or programmed sequence circuits is fully explained. The circuits are dealt with in a manner that avoids the use of complicated mathematics.

13s 6d net by post 14s 5d 100 pp. 66 illustrations

obtainable from leading booksellers

ILIFFE Books Ltd DORSET HOUSE STAMFORD STREET LONDON S.E.1

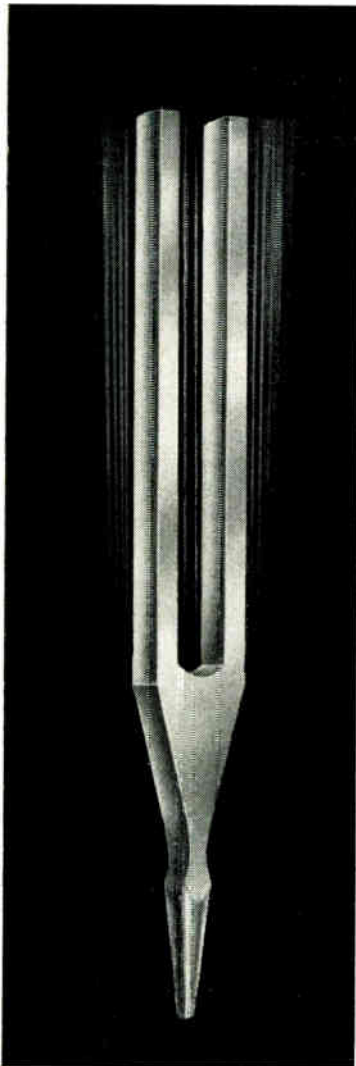

Why wait till things start to HUM?

TRANSISTORIZED VIBRATION METER TYPE 1431

Fully portable for locating vibration and measuring displacement, velocity and acceleration.



VIBRATION METER TYPE 1433

A portable battery operated instrument for locating vibration and measuring displacement, velocity, acceleration and jerk.



Check vibration levels before serious damage can occur
WITH THESE PORTABLE INSTRUMENTS

SPECIFICATION

Types 1433A (British Units), 1433B (Metric Units)	
Frequency Response	1.6c/s to 10Kc/s with standard accelerometer. 1.6c/s to 1Kc/s with high sensitivity accelerometer. Choice of three L.F. cut-off frequencies, 1.6c/s, 16c/s and 160c/s.
Full-Scale Sensitivity	Displacement from 3in. or 0.1in. Velocity from 0.003in/sec or 0.001in/sec. Acceleration from 3in/sec ² or 0.1in/sec ² . Jerk from 30in/sec ³ or 1in/sec ³ .
Power Supply	Self contained batteries. Battery life 100 hrs approx.
Weight	Standard Accelerometer 0.7 oz. Sensitive Accelerometer 8 oz. Cathode Follower 1 lb. Electronic Unit 7 lb.

Types 1431A (British Units), 1431B (Metric Units)	
Frequency Response	5c/s to 2000c/s.
Full-Scale Sensitivity	Displacement: Seven ranges 0-0.003in. to 0-0.3in. zero to peak. Velocity: Nine ranges 0-0.003in/sec to 0-30in/sec peak. Acceleration: Five ranges 0-100in/sec ² to 0-10000in/sec ² peak.
Power Supply	Self contained battery. Battery life 100 hrs approx.
Weight	6½ lb (3Kg) without batteries. 7½ lb (3.4Kg) with batteries.
VIBRATION PICK-UP TYPE 1403/1	Moving coil, velocity type; maximum acceleration 26g approx., weight 11 oz (0.31 Kg) approx.

INDUSTRIAL division of **DAWE INSTRUMENTS LTD.**,
WESTERN AVE., LONDON, W3 Tel: AC0rn 6751 A member of the *Simms* group of companies



Meetings

The Institution of Electrical Engineers

Savoy Place, London, W.C.2. (Phone: Covent Garden 1871).

9th Feb., 5.30 p.m. Joint I.E.E./I.E.R.E. Computer Groups. Paper on 'The Manchester Digital Traffic Simulator'.

9th Feb., 5.30 p.m. Discussion on 'Computer Service Training'.

10th Feb. 6 p.m. The 1965-66 Faraday lecture on 'Computers, Control and Automation'. To be held in the Central Hall, Westminster, London, S.W.1. Details and tickets from Miss Sheila Hardy.

15th Feb., 5.30 p.m. Paper on 'A Control Engineering Approach to Magneto-hydrodynamic Stability'.

16th Feb., 5.30 p.m. Lecture on 'Post Office Towers and Trunks'.

18th Feb., 5.30 p.m. Discussion on 'The Production and Properties of Epitaxial Films'.

22nd Feb., 5.30 p.m. Joint I.E.E./I.E.R.E. Medical Electronics Group. Paper on 'Muscular Control'.

22nd Feb., 5.30 p.m. Joint I.E.E./I.E.R.E. discussion on 'Research in Electrical and Electronic Engineering'.

Society of Electronic and Radio Technicians

33 Bedford Street, London, S.W.2. (Phone: Covent Garden 1152).

7th Feb., 7.30 p.m. at Central Halls, Bath Street, Glasgow. Technical film show.

9th Feb., 7 p.m. at London School of Hygiene and Tropical Medicine, Keppel Street, Gower Street, W.C.1. Lecture on 'Colour Television Systems'.

22nd Feb., 7.30 p.m. Room 215, Physics Block, College of Technology, Stoke-on-Trent. Lecture on 'Television Studio Equipment'.

23rd Feb., 7.30 p.m. at College of Technology, East Park Terrace, Southampton. Lecture on 'Flight Simulation'.

Society of Environmental Engineers

Radnor House, London Road, Norbury, London, S.W.16. (Phone: Pollards 0011).

Meetings are held at 6 p.m. at Imperial College (Mechanical Engineering Department), Exhibition Road, London, S.W.7.

9th Feb. Paper on 'Transducers for Instrumentation'.

23rd March. Discussion on the 'Specification of an Instrumentation System for Packaging'.

The Institution of Electronic and Radio Engineers

8-9 Bedford Square, London, W.C.1. (Phone: Museum 1901-3).

All meetings will be held in the Institution's Lecture Room, 9 Bedford Square, unless otherwise stated. Tickets are required for these meetings.

9th Feb., 6 p.m. Joint I.E.R.E./I.E.E. Electro Acoustics Group. Lecture on 'Trutrack—A New Approach to Low Side Thrust Transcription Arms'.

23rd Feb., 6 p.m. Joint I.E.R.E./I.E.E. Medical Electronics Group. Discussion on 'Mental Stresses Induced by Audio and Visual Hazards'.

The Institute of Physics and The Physical Society

47 Belgrave Square, London, S.W.1. (Phone: Belgravia 6111).

14th Feb. Conference on Spin Resonance and Allied Topics. To be held in London.

23rd Feb. Conference on Stress Analysis of Granular Materials. To be held in London.

28th March. 8.15 p.m. The 1965 Guthrie lecture on Nuclear Fusion Research, to be held at the Oxford College of Technology.

30th March-1st April. Conference on 'Nuclear Structure and Elementary Particles', to be held at the University of Oxford and organized by the Nuclear Physics Sub-Committee.

4th-7th April. Conference on 'Scattering, Non-Linear Optics and Electromagneto Optics'. Organized by the Optical Group and to be held at the University of York. Advance registration will be necessary.

The Institution of Electrical and Electronics Technicians Engineers

26 Bloomsbury Square, London, W.C.1. (Phone: Langham 5927).

The following meetings will be held in the I.E.E. Lecture Theatre, Savoy Place, London, W.C.2, at 6 p.m. Details from the Secretary of the I.E.E.T.E.

7th Feb. Lecture on 'Building a Modern Power Station—Construction and Commissioning Problems'.

7th March. Lecture on 'Control by Computer'.

4th April. Lecture on 'Microelectronics'.



WHAT'S ON AND WHERE

Continued

Conferences, Symposia and Colloquia

15th-16th Feb. Conference on 'Organization for Design', to be held in London and organized by the Institution of Mechanical Engineers, 1 Birdcage Walk, London, S.W.1. (Phone: Whitehall 7476-9).

16th Feb. One day conference on ways of preparing for Quality and Reliability Year. Organized by the National Council for Quality and Reliability, Vintry House, Queen Street Place, London, E.C.4. To be held at the Grand Hotel, Bristol.

22nd-23rd Feb. Seminar on 'Numerical Control for Users', organized by the Production Engineering Research Association and to be held in their exhibition hall at Melton Mowbray. Details from P.E.R.A., Melton Mowbray, Leicester. (Phone: Melton Mowbray 4133).

22nd-25th Feb. Conference on 'Industrial Fastening and Assembly'. Sponsored by *Light Production Engineering* and to be held at the Central Hall, Westminster, London, S.W.1. Details from the Conference Secretariat, Fasex 66, Business Publications (Conference and Exhibitions) Ltd., Mercury House, 103-119 Waterloo Road, London, S.E.1.

2nd-4th March. Tenth Scintillation and Semiconductor Counter Symposium, to be held at the Shoreham Hotel, Washington, D.C. Organized by the Institute of Electrical and Electronics Engineers Inc., 345 East 47th Street, New York 10017.

21st-24th March. Fourth International Aerospace Instrumentation Symposium, to be held at the College of Aeronautics, Cranfield, Bedford. Details from the Symposium Organizer.

12th-15th April. Symposium on 'Electronics, Measurement and Control in Ships and Shipbuilding', to be held at the University of Strathclyde. Organized jointly by the Electronics and Control Section of the I.E.E. Scottish Centre and the Scottish Section of the I.E.R.E.

19th-21st April. Conference on 'The Performance Assessment of High-Vacuum Pumps', to be held at the University of Sussex and organized by The Institute of Physics and The Physical Society, 47 Belgrave Square, London, S.W.1. (Phone: Belgravia 6111).

19th-21st April. Symposium on 'Environmental Engineering and its Role in Society'. Organized by The Society of Environmental Engineers, Radnor House, London Road, Norbury, London, S.W.16. (Phone: Pollards 0011). To be held at Imperial College, Exhibition Road, London, S.W.7.

19th-22nd April. Colloquium on 'Microwave Communication', to be held in Budapest. Organized by the Hungarian Academy of Sciences and the Scientific Society of Tele-

communication. Details from Valkó Péterné, Budapest V, Szabadság Tér 17, Hungary.

3rd-5th May, 1966. British Joint Computer Conference, to be held in Eastbourne, Sussex, and sponsored under the aegis of the United Kingdom Automation Council. Details and registration forms from the Conference Secretariat, Institution of Electrical Engineers, Savoy Place, London, W.C.2. (Phone: Covent Garden 1871).

15th-19th May. Annual conference of the Radio and Television Retailers Association and the Electrical Appliance Association, 19-21 Conway Street, London, W.1. (Phone: Euston 6046). To be held at the Metropole Hotel, Brighton.

20th-25th June, 1966. Third Triennial Congress of the International Federation of Automatic Control. To be held in London and organized by the United Kingdom Automation Council, c/o the Institution of Electrical Engineers, Savoy Place, London, W.C.2. (Phone: Covent Garden 1871).

Exhibitions

8th-17th Feb. Basel

International Fair on Industrial Mechanical Handling, to be held in the halls of the Swiss Industries Fair. Details from the Exhibition Secretariat, IFM 66, CH-4000 Basel 21, Switzerland.

21st-25th March. New York

International Convention and Exhibition on the latest developments in the electrical and electronics field. Organized by the Institute of Electrical and Electronics Engineers Inc., 345 East 47th Street, New York 10017, and to be held at the New York Hilton Hotel and the Coliseum.

22nd-24th March. Melton Mowbray

Exhibition and conference on 'Modern Production Techniques and Equipment'. Organized by the Production Engineering Research Association, Melton Mowbray, Leicester. (Phone: Melton Mowbray 4133).

28th-31st March. London

The Physics Exhibition of the latest instruments and apparatus of use and interest to professional physicists. To be held at Alexandra Palace and organized by the Institute of Physics and The Physical Society. Tickets will be required and full details may be obtained from the Exhibitions Officer, 47 Belgrave Square, S.W.1. (Phone: Belgravia 6111).

18th-22nd April. London

The Fourth International Industrial Finishes Exhibition, to be held at Earls Court. Organized by Technical Exhibitions Ltd., 3 Clements Inn, London, W.C.2. (Phone: Chancery 1200).

30th April-8th May. Hanover

The Hanover Fair, to be held in Hanover-Messegeleende. Details from Schenkers Ltd., Royal London House, 13 Finsbury Square, E.C.2. (Phone: Metropolitan 9711).

2nd-11th May. London

The Seventh Gauge and Tool and Power Press Exhibition. To be held at Olympia and organized by the Gauge and Tool Makers' Association of Great Britain, Standbrook House, 2-5 Old Bond Street, London, W.1. (Phone: Hyde Park 3451-2).



HIGH RELIABILITY ELECTROLYTIC CAPACITORS

MEET G.P.O. SPECS D2085 and D2186



In co-operation with the P.O. Engineering Department, T.C.C. have designed two new ranges of electrolytic capacitors for use in telephone exchanges and specialised electronic equipment where long life and high reliability are required in ambient temperatures from 0°C to 50°C.

The outstanding reliability factor is obtained by the use of high purity aluminium and internal connections are cold pressure welded. These factors coupled with strict production control have gained Post Office Type Approval Certificate No. 4901 for Grade 1 capacitors designed to Spec. D2085 and No. 4092 for Grade 2 designed to Spec. D2186.

Manufacturers can obtain a copy of T.C.C. Bulletin No. 106 by sending in the coupon opposite.

Please send me a copy of T.C.C. Bulletin No. 106

NAME.....

ADDRESS.....

.....

THE TELEGRAPH CONDENSER CO. LTD.

North Acton • London W.3 • Telephone: ACO rn 0061 (16 lines) • Telex: 261383

Also at CHESSINGTON, SURREY and BATHGATE, SCOTLAND



For further information circle 202 on Service Card

ALWAYS RELIABLE

when reliability is put to the test

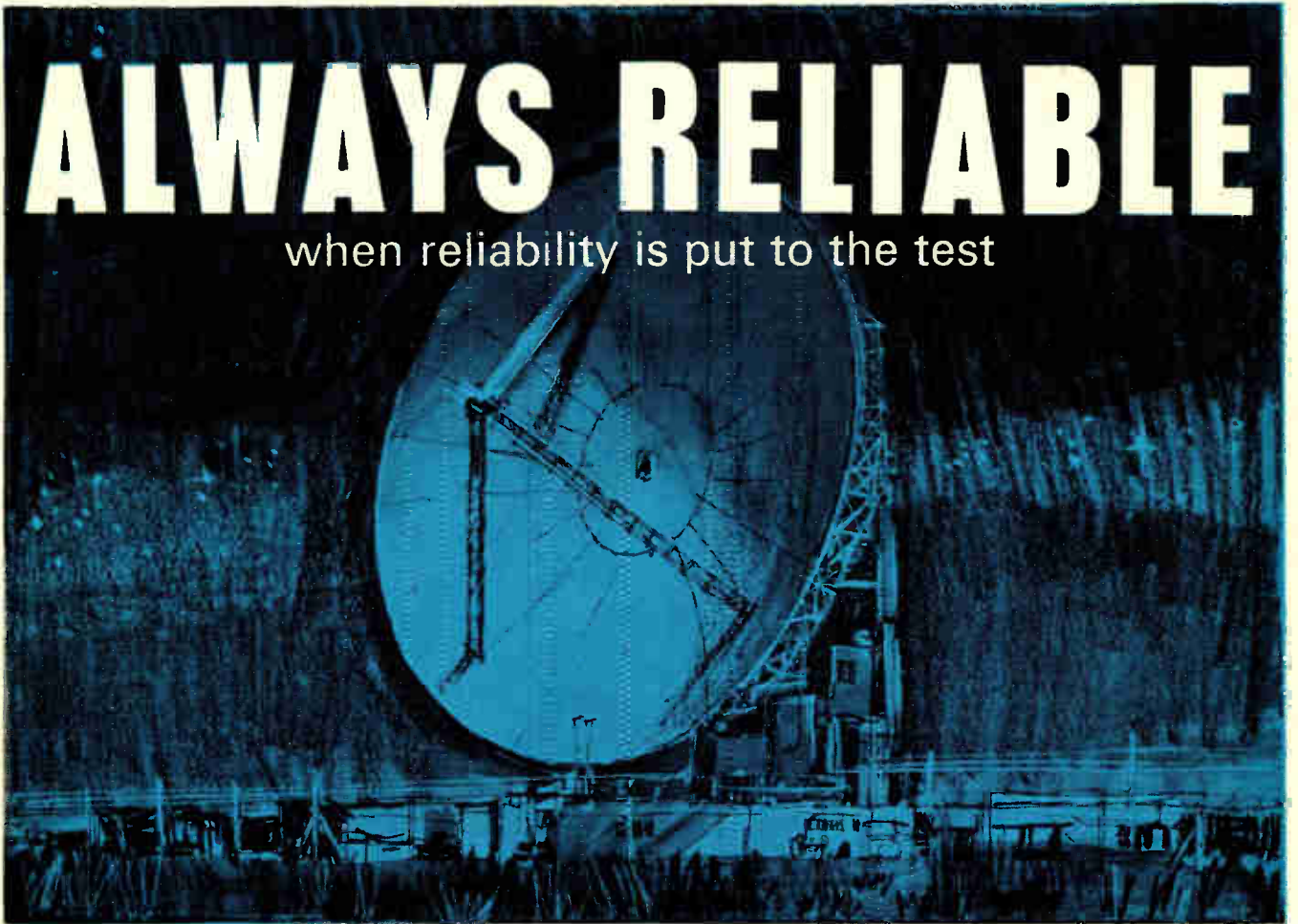

TYPE 200



TYPE 273



TYPE 224



TYPE 271



TYPE 275

Specified extensively for advanced communications equipment, the PAINTON BOURNS TRIMPOT & TRIMIT POTENTIOMETERS are miniature components which represent the peak of performance and reliability. Self-locking precision adjustment screws ensure absolute stability under shock and vibration loads.

With a wide range of operating temperatures and a choice of terminal configuration (stranded insulated leads, solder lugs, printed circuit pins) PAINTON BOURNS TRIMPOT & TRIMIT POTENTIOMETERS meet the most stringent of trimmer potentiometer specifications.

PAINTON BOURNS TRIMPOT AND TRIMIT POTENTIOMETERS

Painton
& CO. LIMITED
KINGSTHORPE · NORTHAMPTON
Tel: 54-91 (10 lines) GPO Reg. Ch. Northampton Telex: 31229

Write today for technical data

Overseas Associated Companies

Australia Painton Australia Pty. Ltd. Benelux Painton S.A. Germany Painton G.m.b.H. Italy Painton Italiana Sweden Svenska Painton A.B. U.S.A. Painton Inc.