

# INDUSTRIAL ELECTRONICS

AUGUST 1965 \$5.00

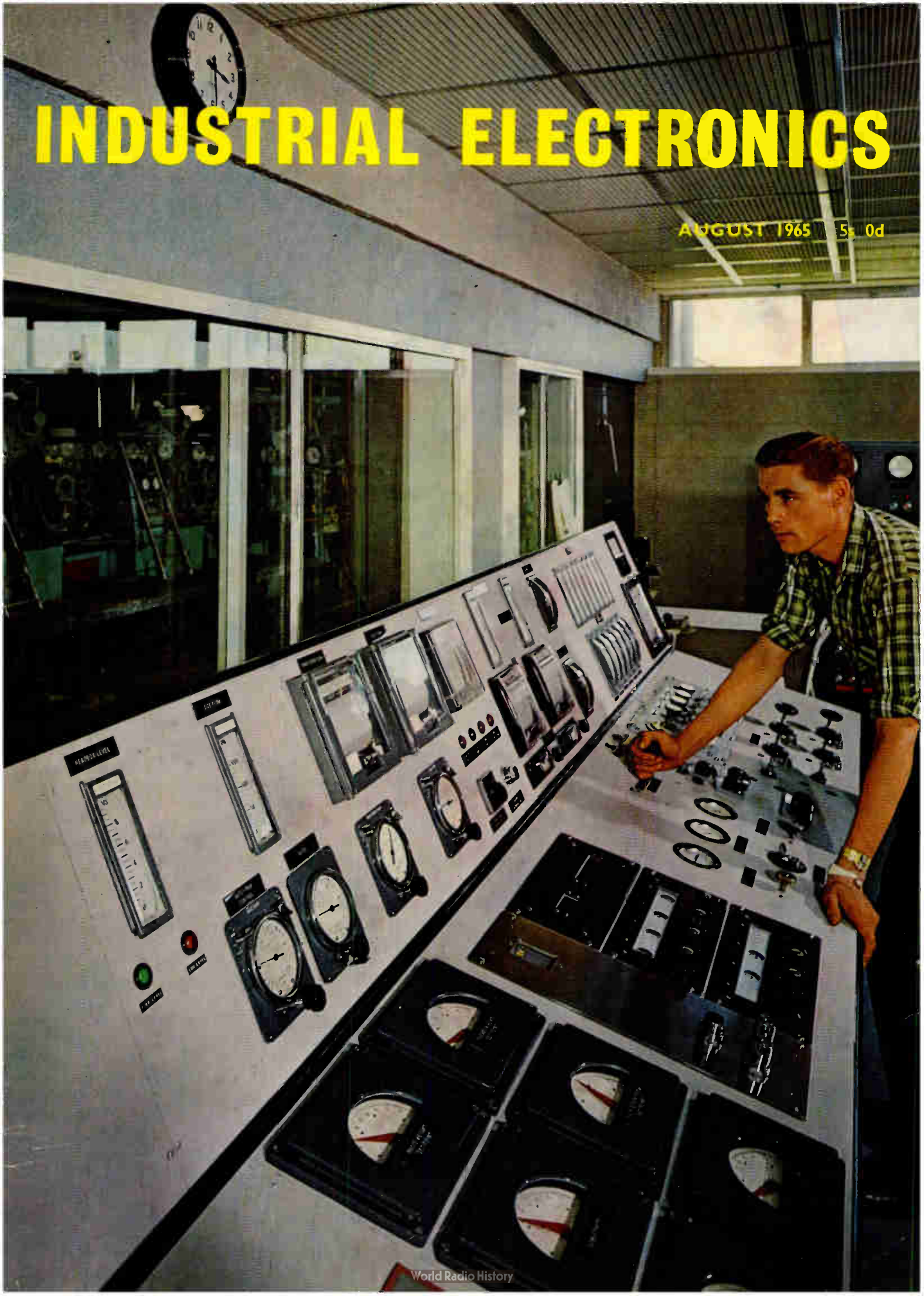

For further information circle 200 on Service Card

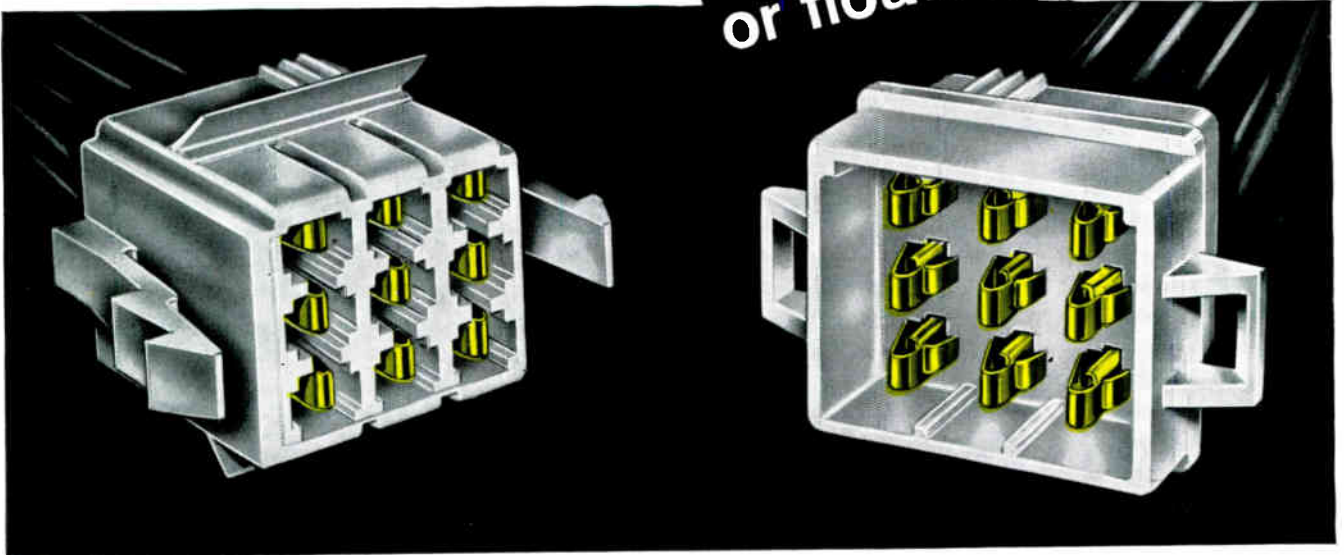
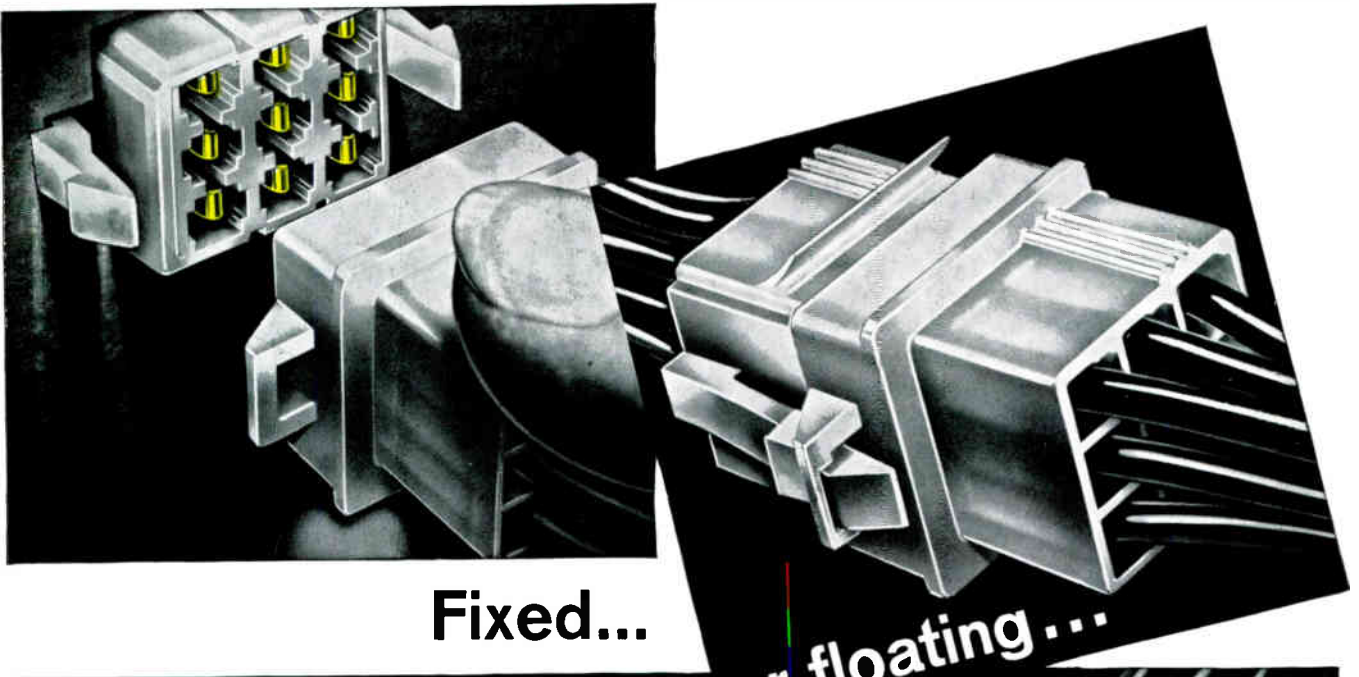

## you can't go wrong

You can use an AMP-LOK Connector panel mounted or free hanging in the harness. Either way it is just as efficient and secure.

To panel mount, just push the plug into the slot in the panel. Wings snap into position behind the panel and hold it fast. With both fixed and floating connectors the cap locks to the plug; yet finger pressure permits instant disengagement. All contacts are enclosed to

prevent damage, and the tough nylon housings are polarized. The range covers 3, 4, 9 and 12 contacts.

The self-cleaning contacts are identical for both plug and cap. Solderless crimping of connector to wire gives perfect conductivity and insulation support. AMP tooling is available for all levels of production. Contacts are self-locking in housings and, although self-aligning, they are positively located.

Write or phone for full information.

**AMP-LOK**  
multiple connectors

**AMP**  
AIRCRAFT-MARINE PRODUCTS  
(GREAT BRITAIN) LIMITED



TERMINAL HOUSE, STANMORE, MIDDX. STONEGROVE 6341  
U.S.A. • AUSTRALIA • CANADA • FRANCE • GERMANY  
HOLLAND • ITALY • JAPAN • MEXICO • PUERTO RICO • SPAIN  
AMP-LOK IS A TRADE MARK OF AMP INC.

AP250

*Industrial Electronics August 1965*

---

# INDUSTRIAL ELECTRONICS

*Incorporating British Communications and Electronics*

---

**Communications   Automation   Instrumentation   Control**

## Contents August 1965

Editor-in-Chief   **W. T. COCKING, M.I.E.E.**

Editor   **T. J. BURTON**

Advertisement Controller   **G. H. GALLOWAY**

Advertisement Manager   **R. H. C. DOHERTY**

Production   **D. R. BRAY**

Drawing Office   **H. J. COOKE**

357   **Comment**

358   **Digital Computer Controls Paper Machine**   *by K. D. Oughton, B.Sc.*  
A computer is now being used to control the basic process variables in a paper machine at Wolvercote Paper Mill and is leading to a significant increase in gross output and product quality as well as a saving of time. The paper-manufacturing process, computer system and method of operation are all described in this article.

363   **Self-tuned H.F. Receivers**   *by J. V. Beard, B.Sc.(Eng.)*  
In point-to-point h.f. communications it is desirable to be able to change frequency rapidly and with a minimum of adjustments. This article describes a system based on a frequency synthesizer for providing the local-oscillator frequency and automatic tuning of the signal-frequency circuits.

369   **Solid-State Industrial Control Instrumentation**   *by James J. Pinto, M.Sc.*  
The basic needs for control instrumentation in industrial processes are surveyed in this article and the methods at present adopted to fulfil these needs are discussed. A generalized solid-state calibrated control instrument is then described and its advantages are explained. The uses of this instrument in a few simple, as well as specialized, applications are described to illustrate the effectiveness of control.

374   **An Introduction to Video Mapping**   *by R. N. Harrison*  
This article provides an introduction to video maps which are an essential part of present-day and future air-traffic control systems. The relationship of the scanning c.r.t., lens and map transparency are considered along with the other items which are basic to a video map.

**VOLUME 3**

**NUMBER 8**

*continued overleaf*

---

© Iliffe Electrical Publications Ltd., 1965

*Permission in writing from the Editor must first be obtained before letterpress or illustrations are reproduced from this journal. Brief abstracts or comments are allowed provided acknowledgment to the journal is given.*

Published on the first Thursday after the 5th of each month by  
Iliffe Electrical Publications Ltd., Dorset House, Stamford Street, London, S.E.1  
Managing Director: W. E. Miller, M.A., M.I.E.R.E.

Telephone: Waterloo 3333. Telegrams/Telex: Electronics Iliffepres 25137 London

ANNUAL SUBSCRIPTION, HOME £3 0s. 0d.   OVERSEAS £3 10s. 0d.  
CANADA and U.S.A. \$10.00.

---

# INDUSTRIAL ELECTRONICS

*Incorporating British Communications and Electronics*

---

**Communications   Automation   Instrumentation   Control**



## OUR COVER

The traditional craft industry of paper making is adopting modern aids to improve efficiency. This month's front-cover picture illustrates part of the computer-controlled system now operating at Wolvercote Paper Mill. The computer system and method of operation are described in the article which starts on page 358

## ● TO SAVE YOUR TIME

We will assist you to obtain further information on any products or processes described or advertised in this issue. Just use the enquiry cards included in this journal.

## Contents *continued*

### 380 Intercommunication Systems

Speedy and reliable intercommunication systems are becoming more and more important in industry and commerce. This article describes many types of systems that are available and the facilities provided by them are discussed.

### 386 Light Quantities and Units

The relationships between the various units used in photometry and illumination are often confusing. This article explains the units and gives the conversion factors between the units.

### What's On and Where?

A regular feature which lists forthcoming events. Professional meetings, symposia, conferences and exhibitions are included. For easy reference this item is positioned facing the inside back cover.

## Features

- |     |  |     |  |
|-----|--|-----|--|
| 362 | High Efficiency Gas Laser                | 388 | Early Bird in Public Service                                   |
| 372 | Telstar II Completes Two Years in Orbit  | 389 | New Apparatus  |
| 373 | British Rail Experiment with T.V.        | 401 | Electronic Displays for Air-Traffic Control                    |
| 377 | New Technique Improves Telephone Cables  | 401 | Electronic Error Correcting Equipment for Radio Communications |
| 378 | New Communications Plant at Basildon     | 402 | Automation in Coal Mining                                      |
| 384 | New Radio Telescope at Cambridge         | 404 | Industrial News  |
| 387 | Automatic Maintenance Information System | 407 | New Books  |
| 388 | Air-Sea Rescue Communication Equipment   | 408 | Manufacturers' Literature                                      |
|     |  | 48  | Classified Advertisements                                      |
|     |  | 51  | Index to Advertisers   |

---

## Next Month

The September issue will include an article describing a method of welding thermoplastic parts together by using ultrasonic power. Other articles will include a discussion of miniature strain gauges which employ semiconducting elements.

For further information  
circle 207 on Service Card

# WELWYN VITREOUS ENAMELLED WIRE WOUND RESISTORS "W" RANGE TO DEF 5115



TYPE	DEF 5115 STYLE	DEF 5115 RATING at 70 C	ROOM TEMPERATURE RATING (20 C)
W21	RFH2-2.5	2.5 watts	3 watts
W22	RFH2-6	6 watts	7 watts
W23	RFH2-9	9 watts	10.5 watts
W24	RFH2-12	12 watts	14 watts



SELECTION TOLERANCE:  $\pm 1\%$ ,  $\pm 2\%$  and  $\pm 5\%$ .

TEMPERATURE COEFFICIENT: For most resistors the temperature coefficient will be found to be in the region of 50 ppm and in no case will it exceed 100 ppm/ C.

STABILITY: After 2,000 hours D.C. cyclic load at 70 C the change in resistance will be less than 5% in accordance with DEF 5115.

AGEING: After three years storage change in resistance will not exceed 1%.

WRITE NOW FOR FULL DETAILS



## WELWYN ELECTRIC LIMITED

BEDLINGTON - NORTHUMBERLAND - ENGLAND

Telephone: Bedlington 2131-9 - Telegrams: Resistor Bedlington.

FACTORIES IN AUSTRALIA AND CANADA

# from rough to finished diagram

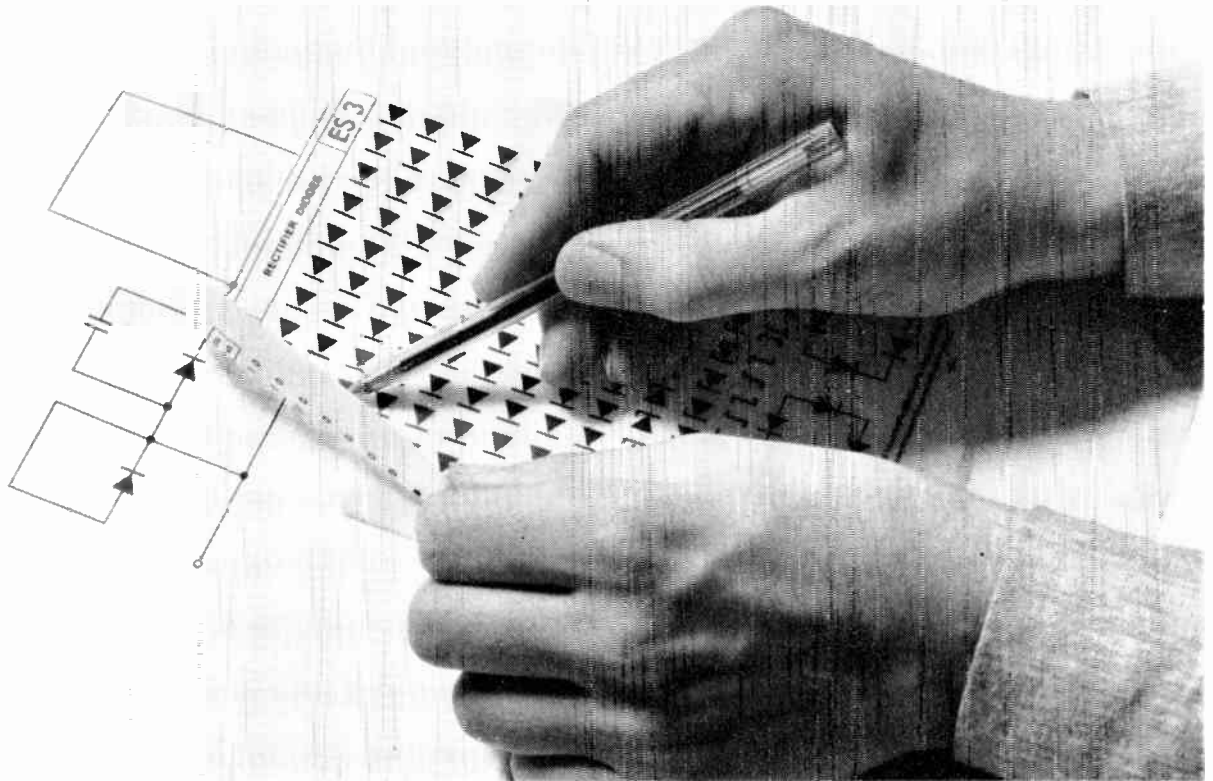

## LETRASET ELECTRONICS SYMBOLS

Letraset Electronics Symbols — more comprehensive than any other system — now provide the answer for the overworked Drawing Office. From rough sketches to high quality finished diagrams in one compact operation, saving valuable time of skilled staff.

Letraset dry transfer circuit symbols — a complete — and completely new — drafting aid for significant reduction of the circuit-planning to diagram production cycle.

Please send brochure giving full details and free sample

Name \_\_\_\_\_

Designation \_\_\_\_\_

Company \_\_\_\_\_

Address \_\_\_\_\_

Telephone number \_\_\_\_\_

IE/1/65

- Simple to use**
- Comprehensive symbol range**
- Designed to BS. 530**
- Easy symbol adaptation**
- Dyeline resistant**
- Convenient 5" x 7½" sheet**
- Symbols fit a ⅛" grid**
- Return coupon for full information**

A Letraset product.  
 Produced and manufactured by Letraset Limited.  
 St. George's House,  
 195/203 Waterloo Rd.,  
 London S.E.1.  
 Letraset Electronic Symbols are on sale at all leading Letraset stockists or from the Letraset showroom at 44, Gerrard Street, London, W.1.

AUGUST, 1965

# STC components review

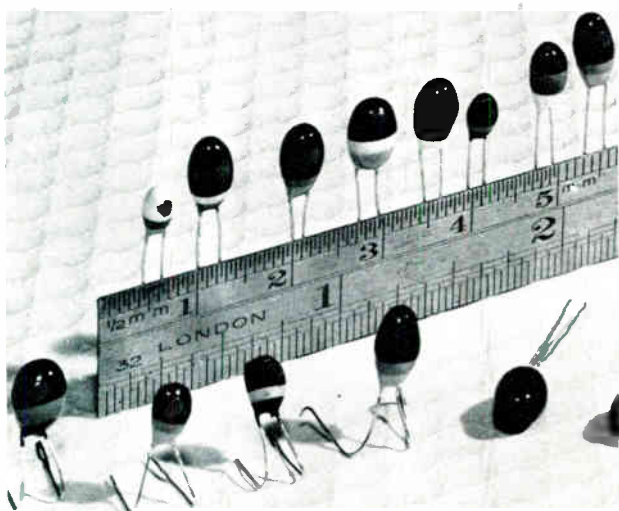

## New low-cost solid tantalum capacitors

This new range of low-cost capacitors from STC brings the advantages of tantalum – small size and extremely long life (including long shelf life without reforming)—within the scope of the semi-professional and general electronics industries.

The internal construction of the new series is similar to the established DEF 5134 patterns but they are dipped in a moisture resistant resin to give mechanical protection.

Working voltages	3V to 35V d.c.
Capacitance range	0.1 $\mu$ F to 50 $\mu$ F
Capacitance tolerance	-20% + 50%
Temperature range	-40°C to + 85°C

These capacitors were developed in conjunction with STC's associates Standard Elektrik Lorenz, Nurnberg.

To obtain full data sheets, use Reader Service card or write, phone or telex STC Capacitor Division, Brixham Road, Paignton, Devon or London Sales Office, Footscray, Sidcup, Kent, Telephone: FOOTscray 3333. Telex: 21836.

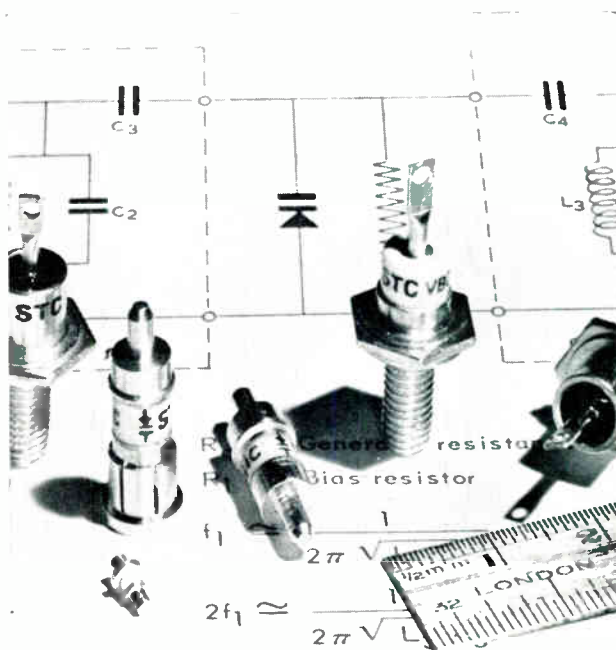

## New range of varactor diodes

STC has just introduced a new range of varactor diodes for use in harmonic generators and up-converters. They have been designed to act as low-loss, voltage variable capacitors at v.h.f., u.h.f., and s.h.f. (microwave) frequencies.

The diodes, which are of the silicon diffused epitaxial type have gold-bonded internal leads and are hermetically encapsulated with a welded final seal. Three basic kinds of encapsulation are used for compatibility with the type of circuit and frequency of operation employed, but the Company can supply alternative types of encapsulation to meet special requirements.

The STC range comprises the following four series of diodes:

VAC Series	Stud type with glass insulator
VBC Series	Stud type with ceramic insulator
VHC Series	Cartridge type with ceramic insulator
VSC Series	Pill type with ceramic insulator

Typical characteristics are:

Type	Breakdown Voltage	Capacitance (-6V)
Stud	90 to 200V	2 to 64 pF
Cartridge	18 to 120V	0.25 to 8 pF

Pill diodes can be supplied with the same breakdown voltage, capacitance and quality levels as the cartridge types.

Write, phone or telex for data sheets to STC Valve Division, Brixham Road, Paignton, Devon, or London Sales Office, Footscray, Sidcup, Kent. Telephone: FOOTscray 3333. Telex: 21836.

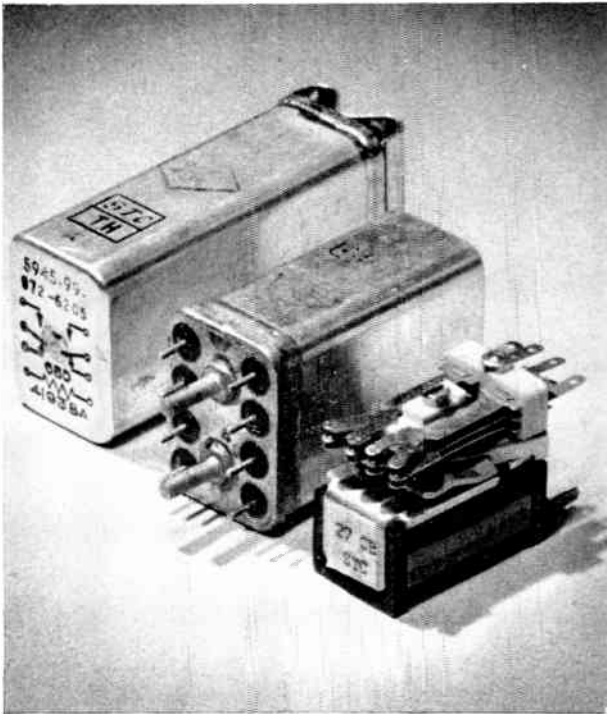

### Midget relays

STC midget relays, developed originally for use in civil and military aircraft, are now available at competitive cost for general industrial use. They have a great space-saving advantage over equivalent types as well as their DEF specification reliability factor. When hermetic sealing is unnecessary, open versions can be supplied.

#### Type 4190

These relays are made in light, medium and heavy duty types. The light duty version is a 2-changeover relay with contacts handling up to 2A. The medium duty relay also has 2-changeover contacts rated at 0.5-3A. The heavy duty midget relay has a one make contact that will switch 10A.

#### Type 4193

A sensitive version of the Type 4190 described above.

#### Type 27

This is a particularly economic midget relay specially designed as a low-cost industrial version of the original range. It is a plug-in relay, has a plastic cover and will switch up to 2A with a 2-changeover action.

*For Data Sheets and prices, write, phone or telex STC Electro-Mechanical Division, West Road, Harlow, Essex. Telephone: Harlow (STD code OBS96) 26811. Telex: 81184.*



### Magnetic materials

STC Magnetic Materials Division offers Europe's biggest single source supply for the widest range of professional, soft type, magnetic materials. These include Permalloy strip wound cores, Permalloy powder cores, powdered iron cores, ferrite ring cores and ferrite pot cores.

STC manufacturing and quality control ensures consistency of product quality, highest permeability and high Q values. The ferrites have achieved reliability acceptance in communications, data processing and control equipment including wide-band and pulse transformers, magnetic amplifiers precision high Q inductors, instrument current transformers and interference suppression inductors.

For customer convenience, STC maintains a toroidal winding service and a winding service for pot cores.

*Write, phone or telex for product summary or specific data sheets to STC Magnetic Materials Division, Edinburgh Way, Harlow, Essex. Telephone: Harlow (STD code OBS96) 26811. Telex: 81146.*



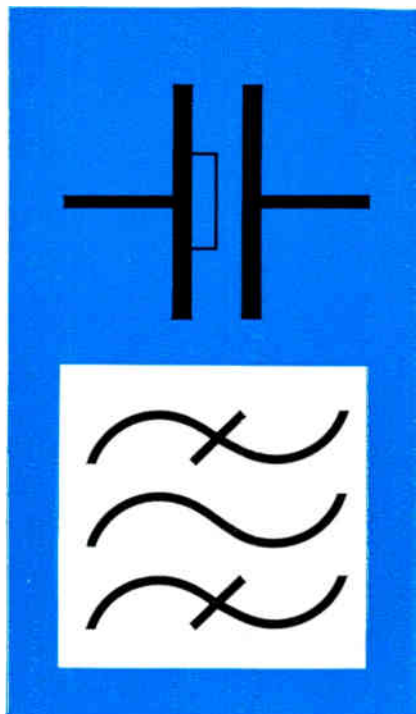

## Quartz crystals and h.f. crystal filters

The STC range of quartz crystal oscillators includes components in glass envelopes and in hermetically sealed cans. The crystals cover the frequency spectrum from 1.5kc/s to 100Mc/s.

STC quartz crystals, made in Europe's biggest quartz crystal plant, have attained reliability acceptance in all fields of national and international communications including ground communications, airborne radio and undersea amplifiers. More than a million units are produced each year and nearly half the production is exported.

Additions to the STC ranges of h.f. crystal

filters provide a choice from 28 units. They have been specifically designed for close channel spacing in v.h.f. and u.h.f. bands and are ideally suited for mobile communications equipment.

Centre frequencies are around 10Mc/s and bandwidths are up to 50kc/s at 3dB. Cost advantages accrue to the user through not having to provide or tune end coils.

*For data sheets covering STC crystals and filters write, phone or telex STC Quartz Crystal Division, Edinburgh Way, Harlow, Essex. Telephone: Harlow (STD code OBS96) 26811. Telex: 81146.*

high-grade components by

**STC**  
COMPONENTS GROUP

# Meet the K-PAC

A new concept in control development. The K-PAC® is a unique and extremely reliable plug-in preset control relay. It replaces the conventional "contact meter" or thermostat type of control and is particularly suitable for economic use in large quantities for applications such as data logging and multiple monitoring systems.

★ Kent—Precision Automatic Control

Write for full details of complete range

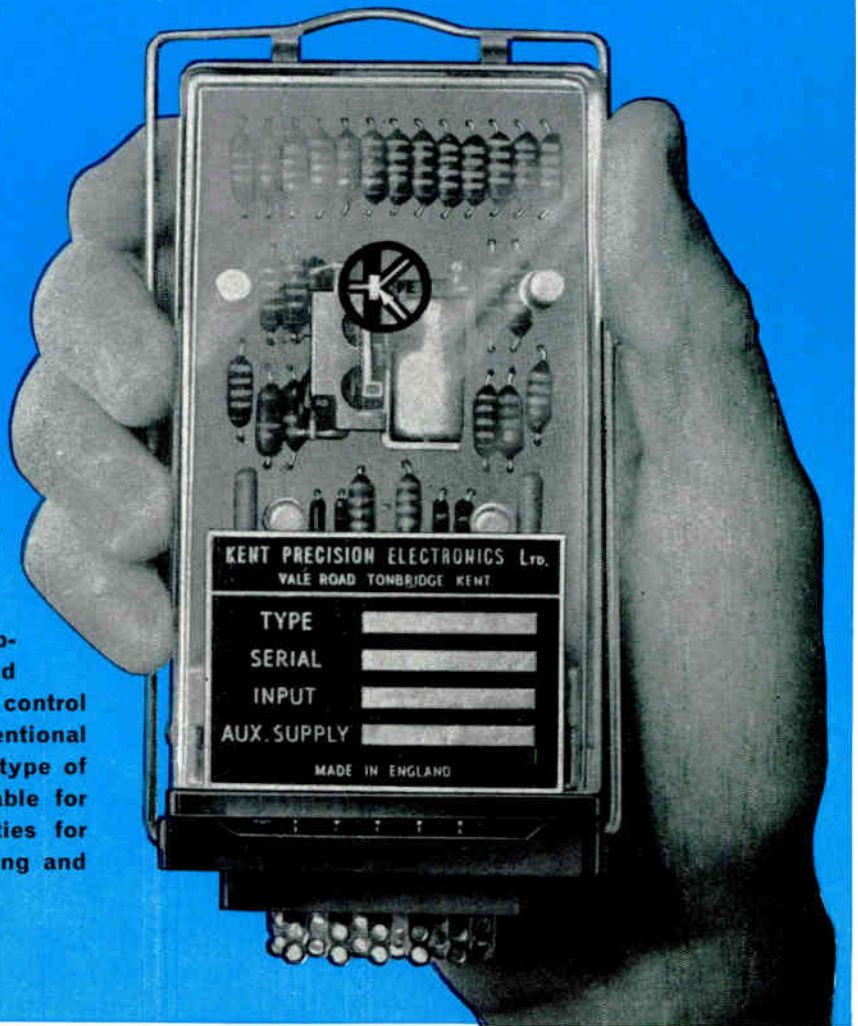

- ★ BREAKS THE PRICE BARRIER
- ★ PRESET TO ORDER
- ★ MICROVOLT SENSITIVITY
- ★ SOLID STATE RELIABILITY
- ★ PLUG-AND-SOCKET FACILITY
- ★ SELF-CONTAINED ISOLATED POWER SUPPLY
- ★ FOR ECONOMIC USE IN LARGE QUANTITIES

Standard K-PAC units:

- K-PAC/1** Relay unit with 50uV sensitivity, less than 50uV/°C drift and relay output change-over contacts rated 5A at 240V AC.
- K-PAC/2** Control unit with thyristor firing circuit for proportional or ON/OFF control.
- K-PAC/3** Thyristor circuit for control of up to 500W at 240V AC.
- K-PAC/4** Chopper Amplifier—less than 3uV/°C drift, equivalent sensitivity 5uV.
- K-PAC/5** AC to DC voltage convertor.
- K-PAC/6** Frequency to DC convertor.
- K-PAC/7** Process timer—can be set in the range 10mS to 60 secs.
- K-PAC/8** mV amplifier—meter-recorder—K-PAC driver.

Standard panel-mounting instruments with linear calibrated scales are available for use in conjunction with the K-PAC range, to provide calibrated control settings.

## APPLICATIONS

The K-PAC has been developed to cater for the need for an economical, compact and simple instrument for control, protection or alarm systems operating from AC or DC inputs, uA - kA, mV - kV. Modern solid state circuitry is used throughout and therefore an important feature is reliability of operation and long, maintenance-free life.

The K-PAC is already being used successfully in the fields of automation and control with improved accuracy and reliability of performance and an unparalleled saving in cost and complexity. The following are some typical applications which illustrate the effectiveness of this elegant and versatile control unit:

1. Mains over and under voltage protection—2 K-PACs are preset at, say, 180V and 260V and contacts are operated for alarm or correction when these limits are exceeded. The use of an extra K-PAC/7 process timer provides inhibition against a fleeting alarm condition which would arise due to transients or momentary fluctuations.
2. Motorised voltage or current regulation—2 K-PACs which are preset to within very close limits of a pre-determined value are used to operate a motorised regulator. When voltage or current falls below this value one of the K-PACs operates to energise the motor so as to increase the value. Similarly, when the voltage or current exceeds the set value the other K-PAC operates to reverse the direction. In a typical application, control to within 1% of 5000A has been easily achieved.
3. Proportional control using K-PACs—Closed loop control may be used using the standard K-PAC modules for accurate proportional control of furnace temperatures, speed control of DC motors, etc. . . . The K-PAC/8 may be used to provide direct indication and recording signals from thermocouples or resistance thermometers.
4. Data logging input systems—A large number of K-PACs which are set to pre-determined values within very close limits are used to monitor a number of variables in a complex process and the state of the relay contacts is fed as binary information into a computer, for direct digital control.



## KENT PRECISION ELECTRONICS LTD.

VALE ROAD, TONBRIDGE, KENT

TELEPHONE: TONBRIDGE 4231

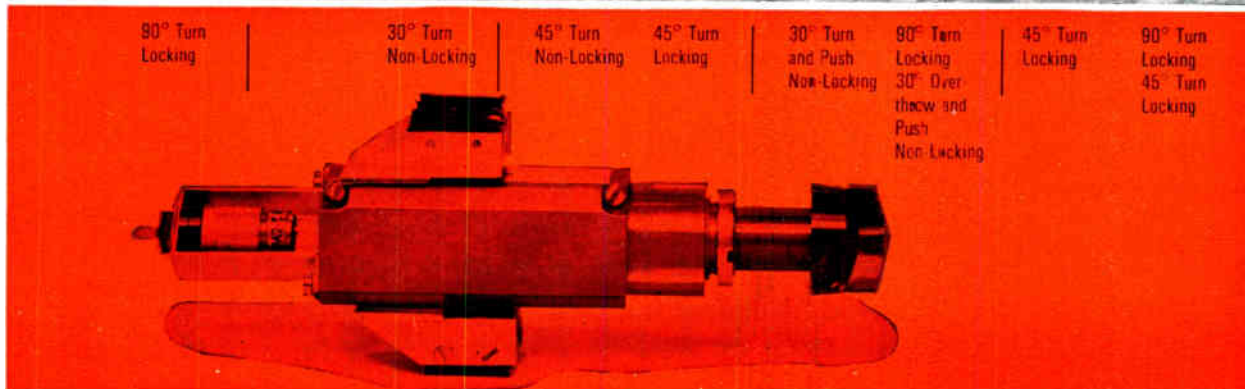
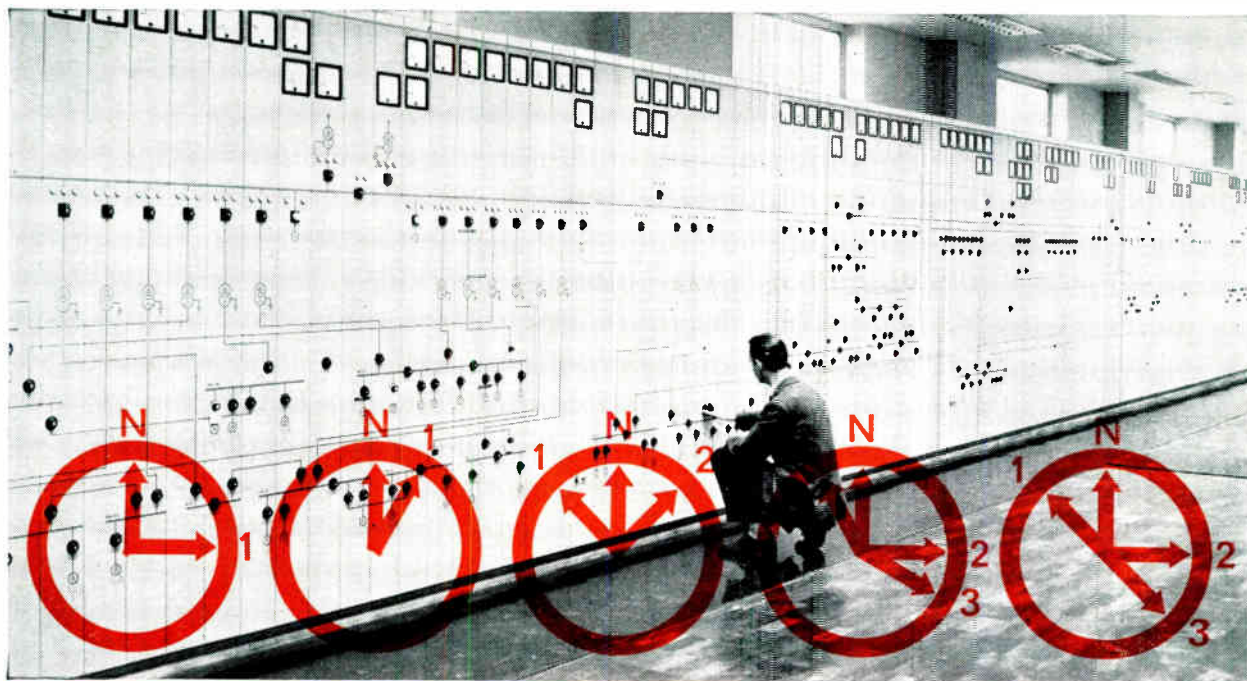

### New STC miniature control switch type 871

The type 871 is an improved control switch which replaces the 4400 range of discrepancy keys. It has been specifically designed to meet the requirements of the CEGB and other major users. Totally enclosed and dustproof, this robust switch operates efficiently under severe climatic

conditions. The 871 has a wide variety of switching operations, locking and non-locking actions. A completely new range of knobs, conforming to CEGB requirements, has been designed. Although intended primarily for use in STC Mosaic Diagrams, it can be mounted equally well in metal or plastic panels. The switch is equipped for an MES pattern lamp which can be

replaced from the front of the control diagram. Alternatively, an STC three-colour lamp indicator can be fitted.

Details from Standard Telephones and Cables Limited, Integrated Electronic Systems Division, Burleigh House, Great Cambridge Road, Enfield, Middlesex. Telephone: ENfield 5343. Telex: 21409.

# STC

world-wide telecommunications and electronics

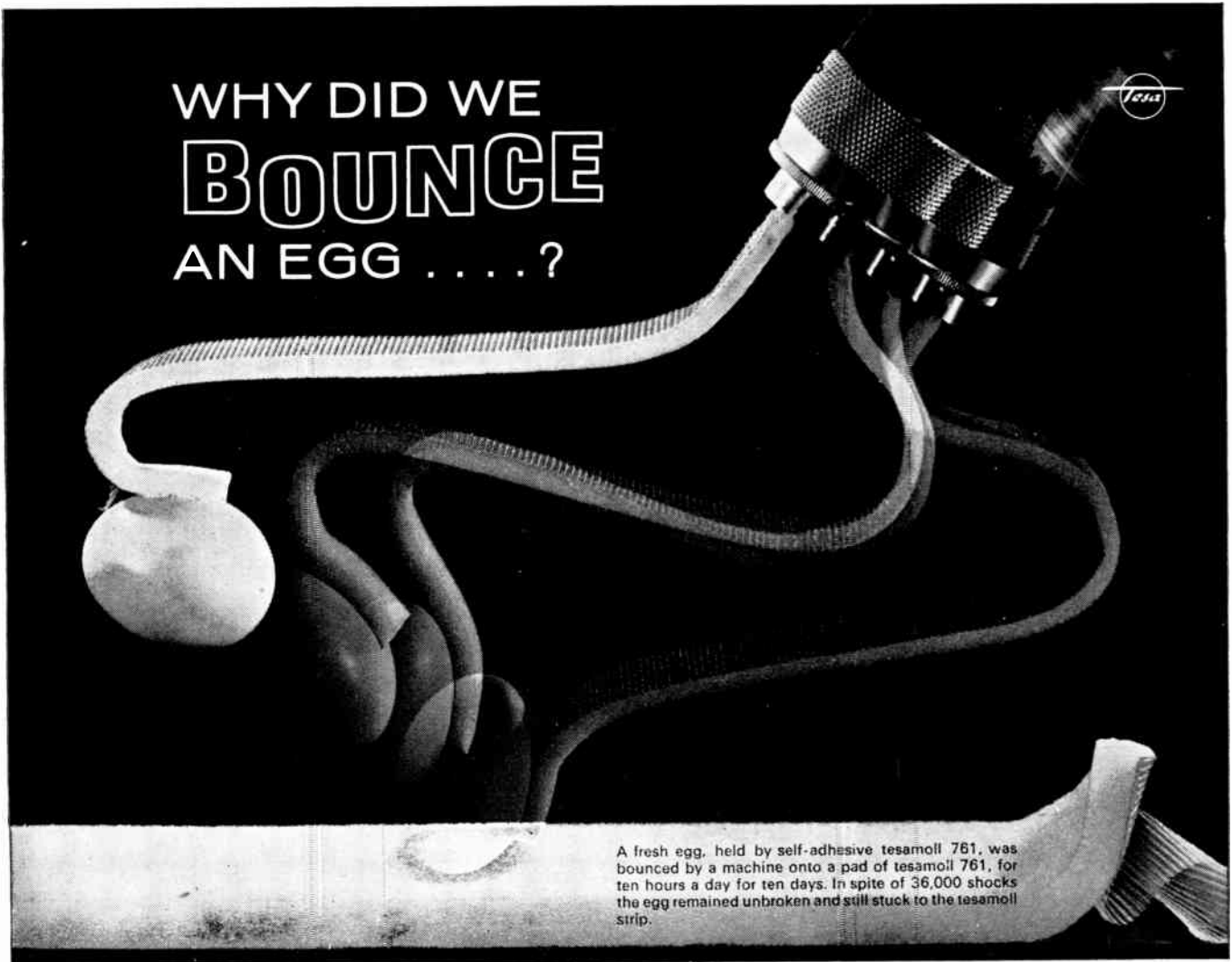

# WHY DID WE BOUNCE AN EGG . . . . ?

A fresh egg, held by self-adhesive tesamoll 761, was bounced by a machine onto a pad of tesamoll 761, for ten hours a day for ten days. In spite of 36,000 shocks the egg remained unbroken and still stuck to the tesamoll strip.

## ... to demonstrate the unique shock absorption of tesamoll

But the real purpose of tesamoll is one with countless applications of major importance to industry — for these self-adhesive industrial foams are purpose made for sealing, seating, cushioning, shock absorption and the suppression of noise and vibration. The ease and speed of application reduces labour costs. So simple and clean to use that unskilled labour is all that is needed for its efficient application.

Unlike other foams, tesamoll has extra reliability with its powerful dense adhesive — sticks instantly and firmly to any clean dry surface — and tesamoll's special process ensures that the material will not separate from the carrier support film.

**tesamoll 761** self-adhesive Urethane, open cell flexible foam of constant density. Purpose made for electronics, radio and television industries. Electrostatically inert, it does not attract dust etc. Suitable over a wide temperature range. Compresses easily, with constant gentle 'push back'—exerts minimum pressure on component it seals.

**tesamoll 771** self-adhesive black rubber, closed cell foam with higher elasticity for uses where heavy shock and higher pressures are likely. Highly resistant to abrasion.

**tesamoll 781** self-adhesive black Neoprene closed cell foam, non-ageing, highly resistant to atmospheric conditions and chemical attack. Characteristics similar to 771.

**tesamoll 700** self-adhesive white P.V.C., closed cell foam, non-ageing, smooth surface top and bottom, extremely flexible. This white P.V.C. will not discolour. Purpose made for use in lamp fittings, signs, scientific apparatus etc.

tesa moll

SELF ADHESIVE INDUSTRIAL FOAMS

Tesa Tapes Ltd. are authorised users of the registered trade mark 'Tesa'  
FREE SAMPLE AND TECHNICAL BOOKLET AVAILABLE ON REQUEST

SEALDRAUGHT PRODUCTS: TESA TAPES LTD. Dolman House, Poyle Trading Estate, Colnbrook, Bucks. Colnbrook (XM4) 2956  
THERE IS ALSO A WIDE RANGE OF TESA TAPES FOR ALL INDUSTRIAL PURPOSES. WRITE FOR DETAILS

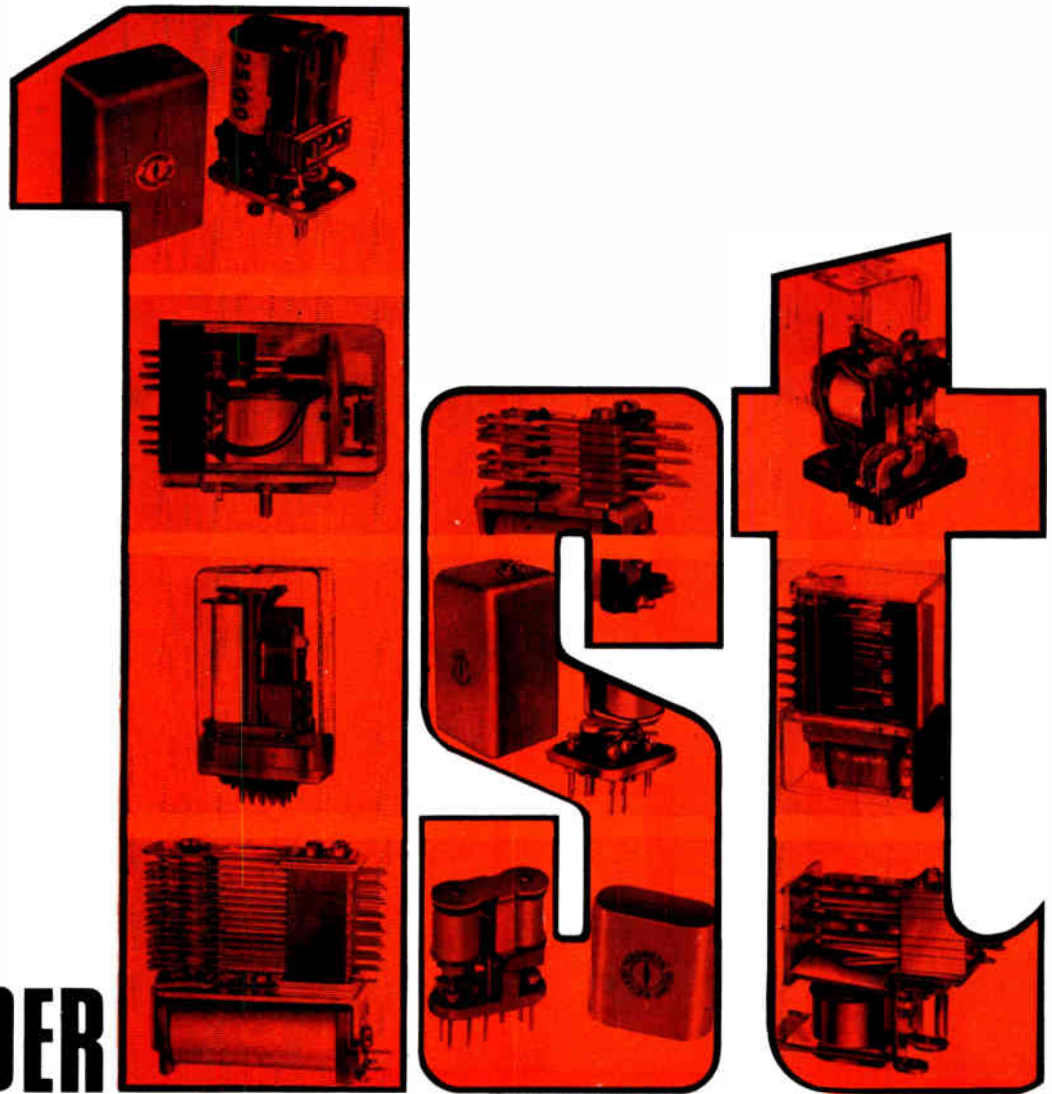

# CONSIDER MAGNETIC DEVICES FOR RELAYS

For the simple reason that we have a very extensive range of relays that covers many requirements of circuit design. If however our wide basic range does not offer a solution to your problem then our Design and Applications Departments are at your service. If you require our Catalogue — a sample — a quotation — our help in any way, make contact with Magnetic Devices Now.



M.O.A.-A.R.R.E.-A.R.B. Approved Inspection

**MAGNETIC DEVICES LIMITED**  
NEWMARKET · SUFFOLK · ENGLAND  
TEL: NEWMARKET 3451 (10 LINES)

Grams Magnetic Newmarket Telex 81245  
MANUFACTURERS OF SOLENOIDS, CONNECTORS & TIMERS  
R.S. 1006

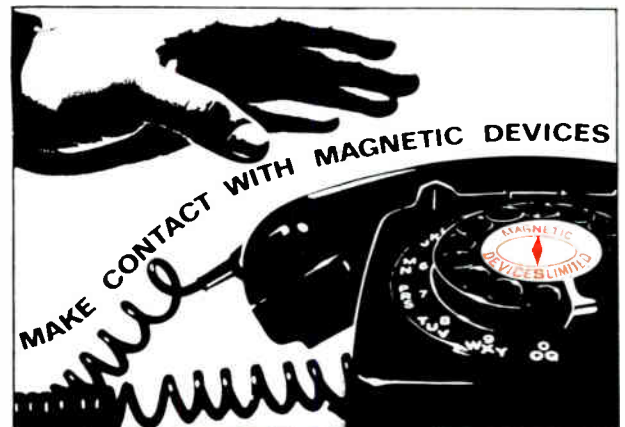

# BRODIE-KENT

## NO. 789 CONTROL VALVE

One of the range of Brodie-Kent control valves which offers combined features never before available on a single valve.

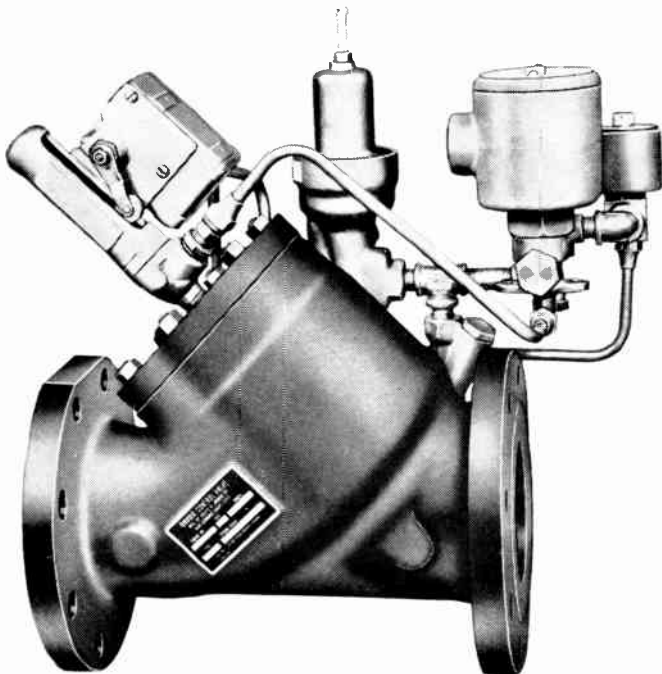

- \* Two-stage cut off by Solenoid (for meters or weigh scales)
- \* High flow control
- \* Adjustable opening
- \* Slow start up (if required)
- \* Positive non-return action
- \* Manual override (if required)

---

### Plus UNIQUE features for all Brodie-Kent valves

- \* Unit-built construction
- \* Linear valve action
- \* Uniform response speeds
- \* High capacity
- \* Sensitive regulation

---

For detailed information, please get in touch with

## GILBARCO LIMITED

CROMPTON CLOSE · BASILDON · ESSEX  
Telephone: Basildon 3090 · Telex 1966

For further details write quoting reference 8(b)

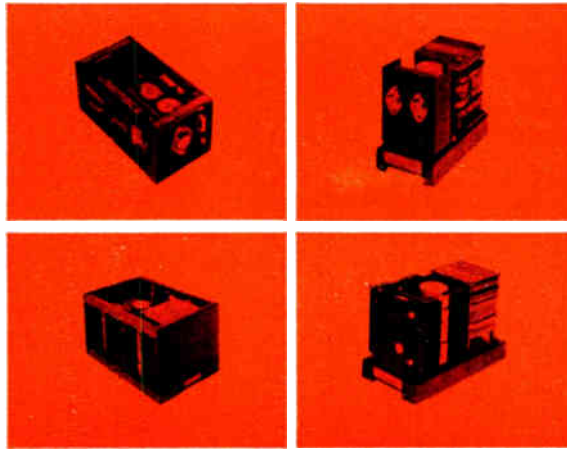

# A QUART OF POWER IN A PINT OF PACK

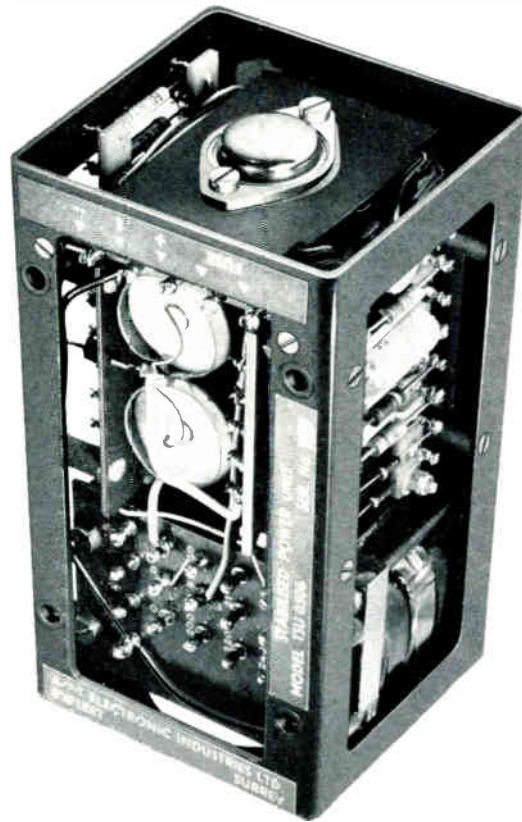

Our TSU-0500 power supply sub unit is small enough to fit snugly into your hand. Yet it will provide stabilised DC output of 0.5 amps at any fixed voltage in the range 6 to 30 volts.

Rated for operation in ambient temperature up to 45°C, the TSU-0500 incorporates a non-destructive overload protection circuit to ensure that output current is limited to a safe value—even if the load is short circuited. Look at this specification:

Unit size:  $5\frac{1}{8}'' \times 3\frac{1}{8}'' \times 2\frac{1}{4}''$ .

Stabilisation: Output voltage changes by less than 0.02% for mains voltage variations up to  $\pm 10\%$  of nominal.

Output Resistance: Varies from 0.01 ohms at 6 volts output to 0.05 ohms at 30 volts.

Output Impedance: Less than 0.5 ohms at all frequencies up to 500 kc/s.

Temperature coefficient of output voltage: 0.05% (500 ppm) per degree C.

Price: £25.

The TSU-0500 is the smallest unit in the TSU range. There are other units rated for outputs of 1 amp., 2 amp., 3 amp., 5 amp. and 10 amp. Full details of our complete range will be sent on request.



**ELECTRONIC  
INDUSTRIES  
LIMITED**

Please send me details of the range of TSU Power Supply units.

Name \_\_\_\_\_

Company \_\_\_\_\_

Address \_\_\_\_\_

Chertsey Road, Byfleet, Surrey Phone: Byfleet 41131 2/3/4 PABX Grams: Aptran, Byfleet

# THE CD 1400 'SCOPE SYSTEM VERSATILE 5" PORTABLE DOUBLE BEAM

The CD 1400 from Solartron is a truly flexible low cost oscilloscope system – backed by the best in modern production techniques. The X and Y plug-in units currently available allow the instrument to be used for the widest range of applications and other plug-ins now under development will extend the system even further. A 5" double gun CRT operating at 4 kV provides bright, high resolution displays at all sweep speeds. Proprietary oscilloscope cameras can be attached, and trolleys are available for maximum mobility.

Both X and Y units plug in, enabling the user to make a wide variety of measurements hitherto only possible with expensive instruments. To date, 2Y+2X operational plug-in amplifiers are available.



\* CX 1441 DC – 15 Mc/s approximately, 100mV/cm, general purpose amplifier suitable for pulse work. Additional  $\times 10$  provides 10mV/cm from DC – 750 Kc/s.



\* CX 1442 1 mV/cm DC differential amplifier with a common mode rejection of 60dB. For use with transducers and servo systems etc. An AC  $\times 10$  position gives a sensitivity of 100 $\mu$ V/cm for low level noise investigation.



\* CX 1443 Basic time-base unit. 18 ranges from 0.5 $\mu$ sec/cm – 0.5sec/cm. Suitable for use with all Y units. "Normal", "Auto" and "HF sync".



\* CX 1444 Time base and sweep delay generator. Performance similar to CX 1443. Delays up to 100m/sec. Suitable for digital computer and television waveform investigation.

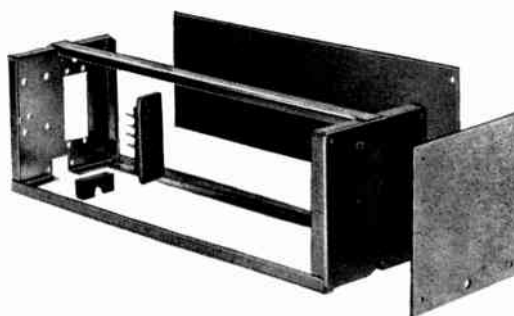

CX 1445-6 Blank X and Y plug-in units available enabling the customer to construct his own units to suit specialized applications.

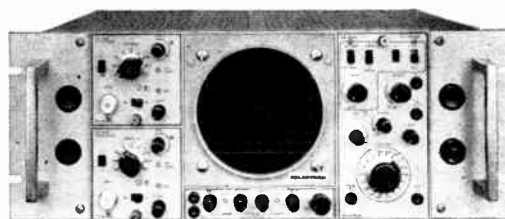

\* CX 1447 A rack-mounting case is available as an alternative for use in standard 19" racks. Side panel design permits simple signal connections from rear of instrument.

\* Measurement Accuracy 5%

## SOLARTRON

THE SOLARTRON ELECTRONIC GROUP LIMITED  
Farnborough, Hants, England. Telephone: Farnborough (Hants) 44433  
Telex: 85245 Solartron Fnbro. Cables: Solartron Farnborough.  
A MEMBER OF THE SCHLUMBERGER GROUP





**SO MUCH  
MORE BEHIND  
A SOLARTRON  
'SCOPE**

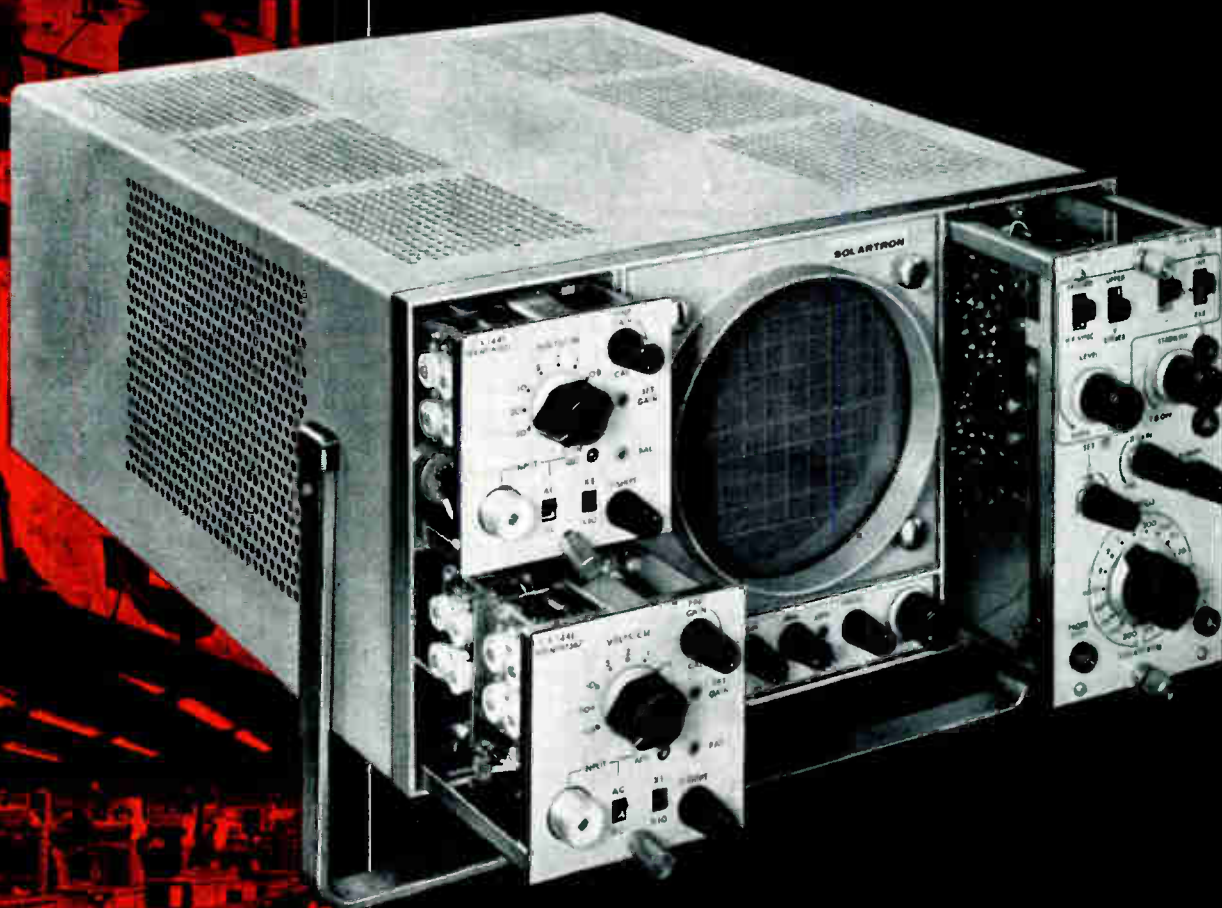

**SOLARTRON**

For Data Systems · Transducers · Computers  
Military Systems · Electronic Instrumentation

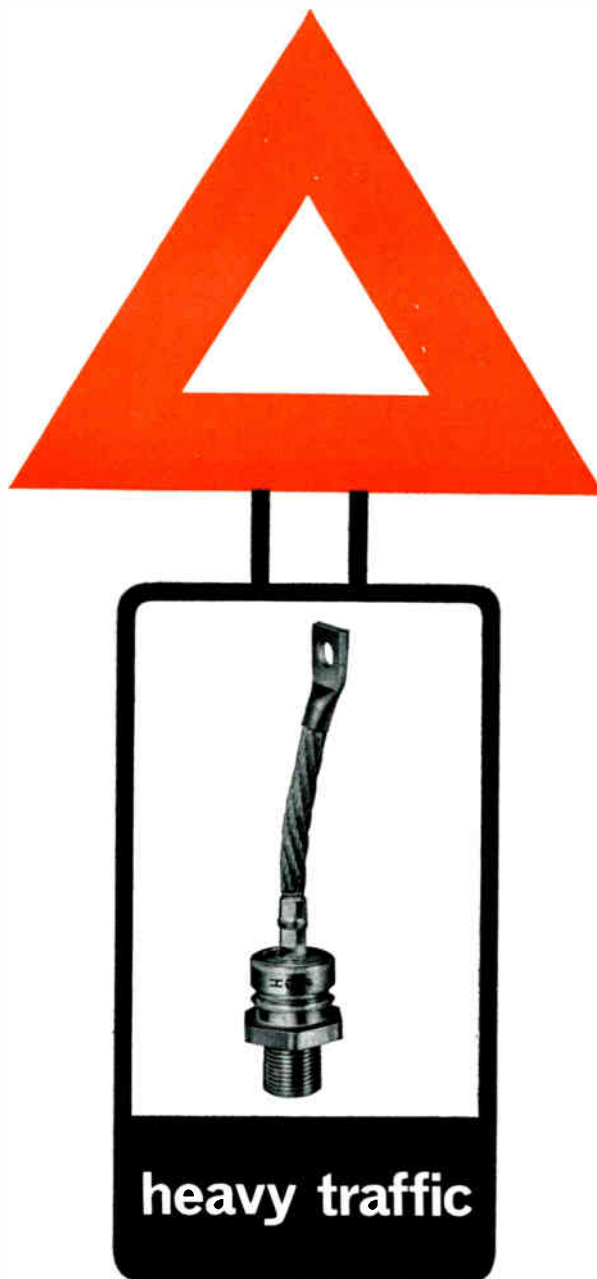

For heavy current up to 250 amp continuous, IR Type 70U diodes are a byword for operational reliability. Reliability proven by customers. With maximum thermal impedance of only 0.2° C/watt and voltage ratings up to 1400 P.T.R.V., there's no stopping their growing popularity.

To find out why, send for details.



## INTERNATIONAL RECTIFIER

Immediate off-the-shelf delivery from IR distributors—phone

COLCHESTER 6173 · CRAWLEY 28700 · (LANCS) TODMORDEN 602 · LEEDS 35111 · LEICESTER 68561  
(LONDON S.E.27) GIPSY HILL 6166 · (MIDDLESEX) SKYPORT 1314 · PORTSMOUTH 20465

INTERNATIONAL RECTIFIER CO. (GREAT BRITAIN) LTD · HURST GREEN · OXTED · SURREY · TELEPHONE OXTED 3215 · TELEX RECTIFIER OXTED 8819 

# Give it the works!

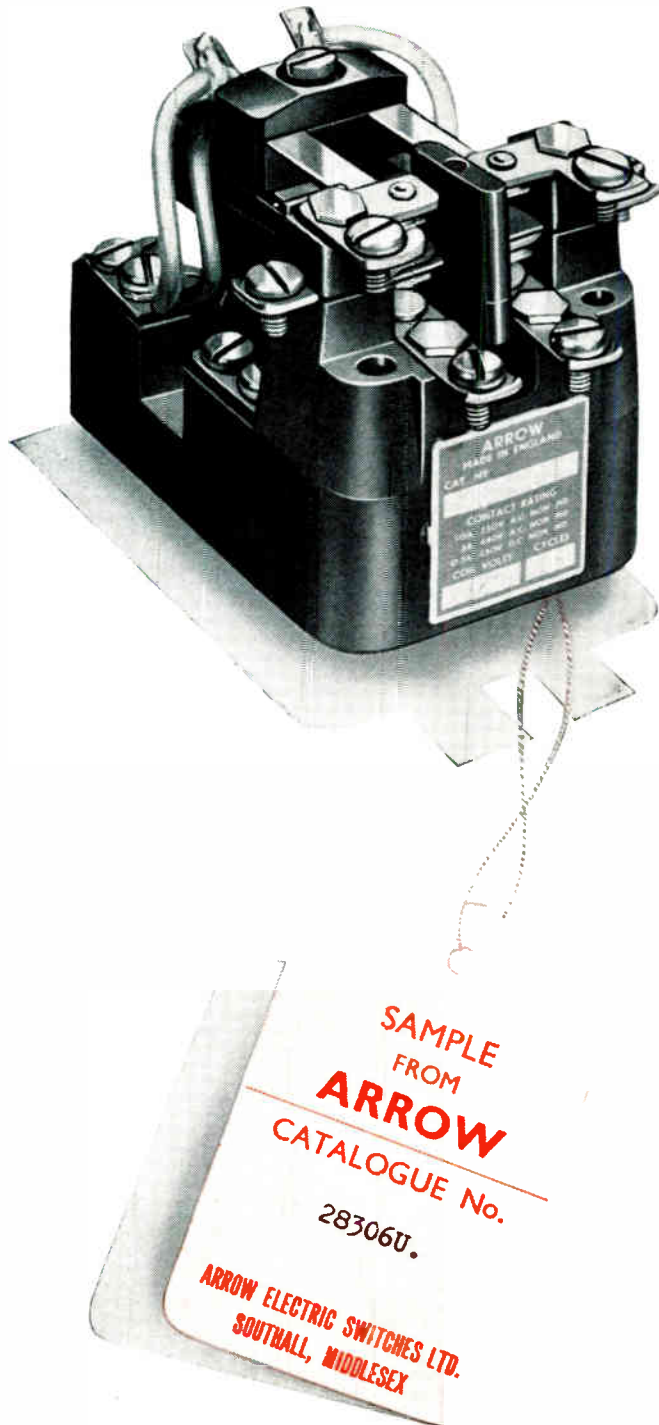

We, at ARROW, understand the responsibility which rests on any engineer's shoulders whose job it is to specify relays. Therefore, knowing our products as we do, we welcome every opportunity to send samples, as we are confident of the results. Illustrated is a small general purpose relay—30 different circuits are offered on the same base. Why not 'give it the works'—you'll get good value for money!

## ARROW ELECTRIC SWITCHES LTD

BRENT ROAD · SOUTBALL · MIDDX

Telephone: SOUThall 2442

A56

a new concept  
of integrated  
circuit reliability  
now available from

**electrosil**

# UTILOGIC®

low cost  
integrated circuits

Electrosil, who have made their name synonymous with component reliability, now introduce UTILOGIC integrated circuits to Britain. UTILOGIC is but one of the large ranges of devices made by the Signetics Corporation, a subsidiary of Corning Glass Works, whose glass-tin-oxide resistors have been so successfully manufactured and sold in the U.K. by Electrosil. UTILOGIC is a new force in micro-electronics for it has the high reliability consistent with products stemming from the Company which has been exclusively manufacturing integrated circuits longer than any other. U.K. production by Electrosil is now under active consideration.

**Five reasons why UTILOGIC is the best buy in digital monolithic integrated circuits of up to 4 mc/s clock rate.**

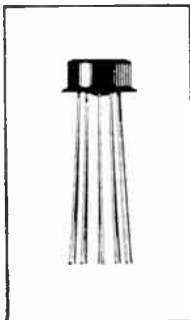

- 1 Very high noise immunity, worst case 0.8v.
- 2 High Fan-out — 17.
- 3 Capable of withstanding high capacitive loading.
- 4 Bistable element (J-K flip-flop) is not critical of rise-time and fall-time of clock waveform.
- 5 Very competitively priced.

## LU UTILOGIC PRICE LIST

		1-24	25-99	100-999
LU 300K	Dual 3-Input Gate Expander	49/9	39/6	29/6
LU 305K	6-Input AND Gate	54/-	43/-	31/3
LU 306K	Dual 3-Input AND Gate	54/-	43/-	31/3
LU 314K	7-Input NOR Gate	54/-	43/-	31/3
LU 315K	Dual 3-Input NOR Gate	54/-	43/-	31/3
LU 316K	Dual 2-input NOR Gate	54/-	43/-	31/3
LU 320K	J-K Binary Element	115/-	92/-	69/-
Temperature Range — +10°C to +55°C				
Encapsulation — 10 lead TO-5				

Elements on this list may be mixed on a single order to obtain the maximum applicable quantity discount.

\* and an Electrosil exclusive—

### AUGAT



This unique equipment enables you to breadboard and test flat package or TO-5 encapsulated devices without soldering or damage to the leads. A simple clip holds the circuit in position and terminates the leads in plug sockets for jumper leads, or contacts for multi-sockets. Up to 50 devices can be accommodated on one board, and removal or replacement without damage is instantaneous. Send now for details.



ask Electrosil today for full details

MICRO-ELECTRONICS  
DIVISION · LAKESIDE ESTATE  
COLNBROOK · SLOUGH · BUCKS  
TEL: COLNBROOK 2996 · 2196

# SPECIFY HUGHES DIODES

... diodes with superior performance and maximum reliability

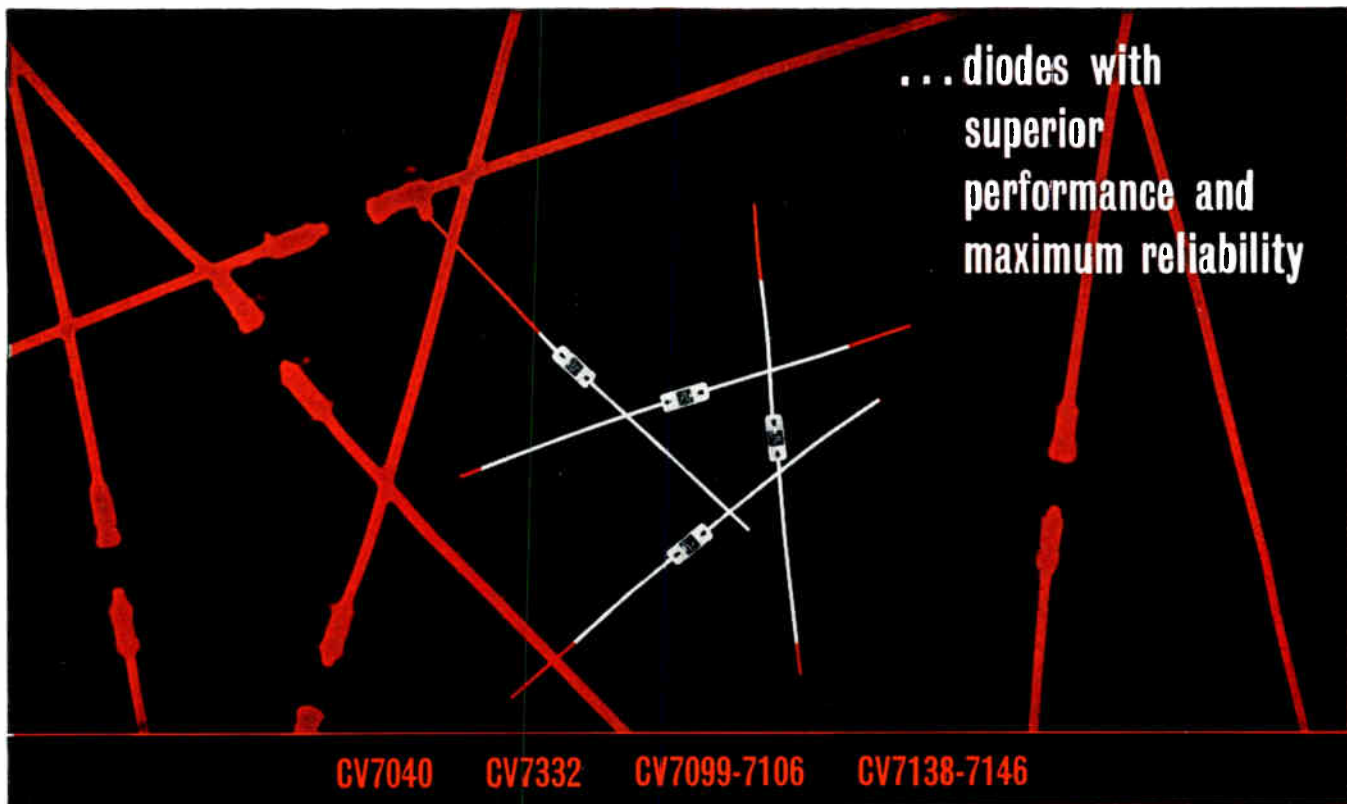

**SILICON SUB-MINIATURE POWER DIODES/RECTIFIERS • ZENER DIODES  
CARTRIDGE RECTIFIERS • VOLTAGE VARIABLE CAPACITORS**

HS1020 HS1001 HS1004 HS1C07 HS1010	General Purpose Diodes	PIV - - - - 50-200V  Max. Avge. Rectified Current - - - 165mA  I <sub>b</sub> at PIV - <0·2μA CV 7040 CV 7332	HS2000 Series (250mW)  HS 7000 Series (400mW)	Zener Diodes	Available in all preferred voltage values from 2·7—33V  Low dynamic impedance  High stability over wide temperature range  CV7099-7106 CV7138-7146
HS3103 HS3104 HS3105 HS3106 HS3108 HS3110	200mA Power Diodes	PIV - - - 300-1000V  Max. Avge. Rectified Current - - - 165mA  I <sub>b</sub> at PIV - <0·2μA	HSC1 HSC2 HSC3 HSC4 HSC5 HSC6 ↕ HSC30	High Voltage Cartridge Rectifiers	PIV - - - - 1-30kV  Max. Avge. Rectified current - - 100mA Case size 0·55" dia. x approx. 0·25" per kV  Welded assemblies of selected high voltage diodes, encapsulated in high grade epoxy resin
1N645 1N646 1N647 1N648 1N649	600mA Power Diode/Rectifiers	PIV - - - - 225-600V  Max. Avge. Rectified Current - - - 400mA  I <sub>b</sub> at PIV - <0·2μA	HC7001 HC7002 HC7004 HC7005 HC7006 HC7007 HC7008	Voltage Variable Capacitors	Capacitance range @ -4V - - - - 35-100pF Peak voltage range - - 25-130V I <sub>b</sub> @ max. voltage - - <1μA @ 25° C Standard Tolerance - - ± 20% (± 10% and ± 5% also available)

Hughes—originators of the world's first sub-miniature all-glass diode—manufacture at their Glenrothes, Scotland, factory an unequalled range of germanium and silicon devices for the most diverse diode applications. Add Hughes service and second-to-none product quality and solve your diode problems in the simplest way—SPECIFY HUGHES.



Write now for complete data on the full range of Hughes semiconductor products, which also includes:—Silicon and Germanium Signal and Switching diodes: PNP and NPN Silicon Transistors.

**HUGHES INTERNATIONAL (U.K.) LTD**

Sales office:

**GLENROTHES - FIFE · SCOTLAND**

**HEATHROW HOUSE, BATH ROAD, CRANFORD, HOUNSLOW, MIDDLESEX. TEL: SKYport 9584/5 and 9961/2. TELEX: 23613.**

M & P HM23

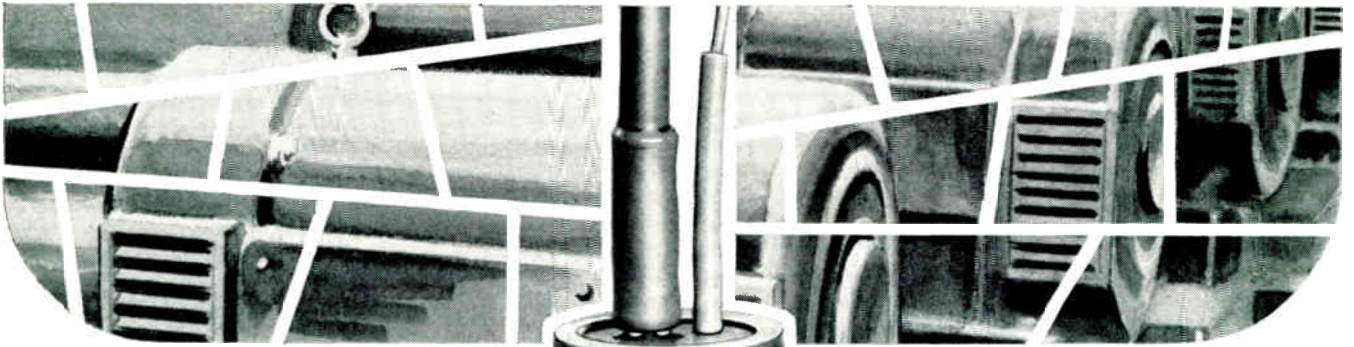

when it's a question

of **SEMICONDUCTORS**

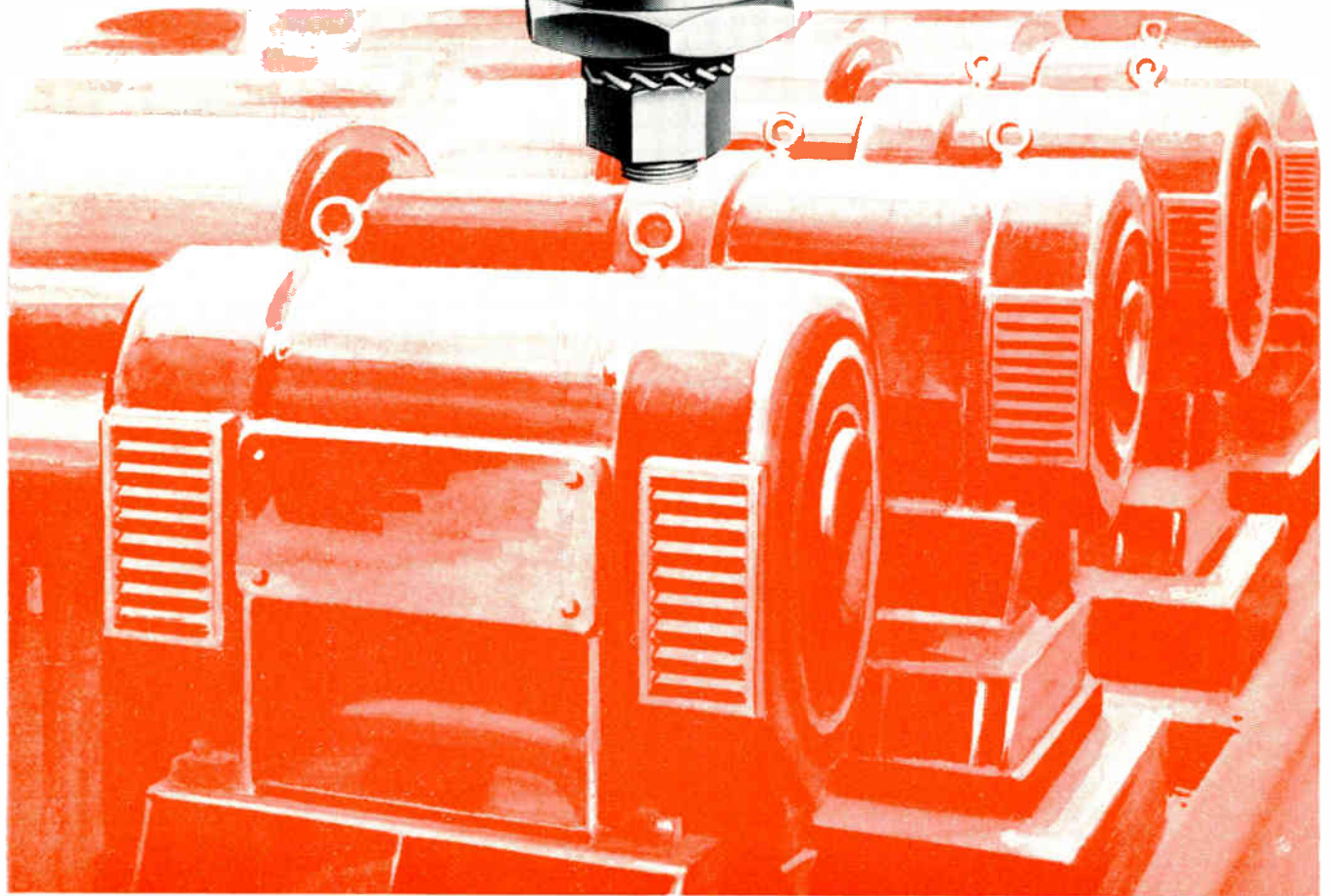

**WESTINGHOUSE**  
*IS THE POWER  
BEHIND IT!*

Whatever your need—d.c. power or the control of a.c. or d.c. power—Westinghouse have the silicon diode or thyristor to meet your application. Special compression bonding techniques employed in the manufacture of Westinghouse semiconductors means greater reliability and improved performance. Add this to the fact that Westinghouse have had over 40 years experience in designing and making semiconductors, and you'll see why more and more industries are solving their current problems by specifying Westinghouse.

Our new SEMICONDUCTORS brochure showing the Westinghouse range of Silicon Diodes, Thyristors and Rectifier Assemblies will tell you a lot more. Why not write for a copy?

Dept. IE 8/65

WESTINGHOUSE BRAKE AND SIGNAL CO. LTD.  
82 York Way, King's Cross, London N.1.  
Terminus 6432 Telex 2-3225

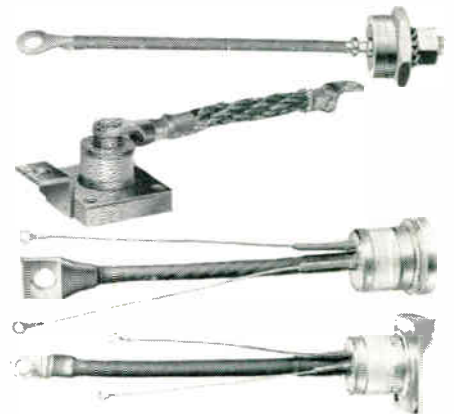

Typical examples of Westinghouse Silicon Power Diodes and Thyristors

# Dawe audio sweep oscillator and controller Type 443B

The only instrument of this kind made in the U.K.

Fields of use include: automatic measurement and recording of the frequency response curves of 4-terminal networks — audio amplifiers — tape recorders — hearing aids — loudspeakers and microphones; recording the acoustic properties of loudspeaker enclosures — studios — concert halls; and for vibration testing.

**Main Features**

- \* 20 c/s to 20 kc/s in a single range.
- \* Logarithmic scale calibration.
- \* High output with very low distortion.
- \* Output, or regulated level, monitored on a panel meter.
- \* Optional output regulation by external reference.
- \* Facility for external motor drive and synchronisation, with a high-speed level recorder.

U.K. LIST PRICE : £270

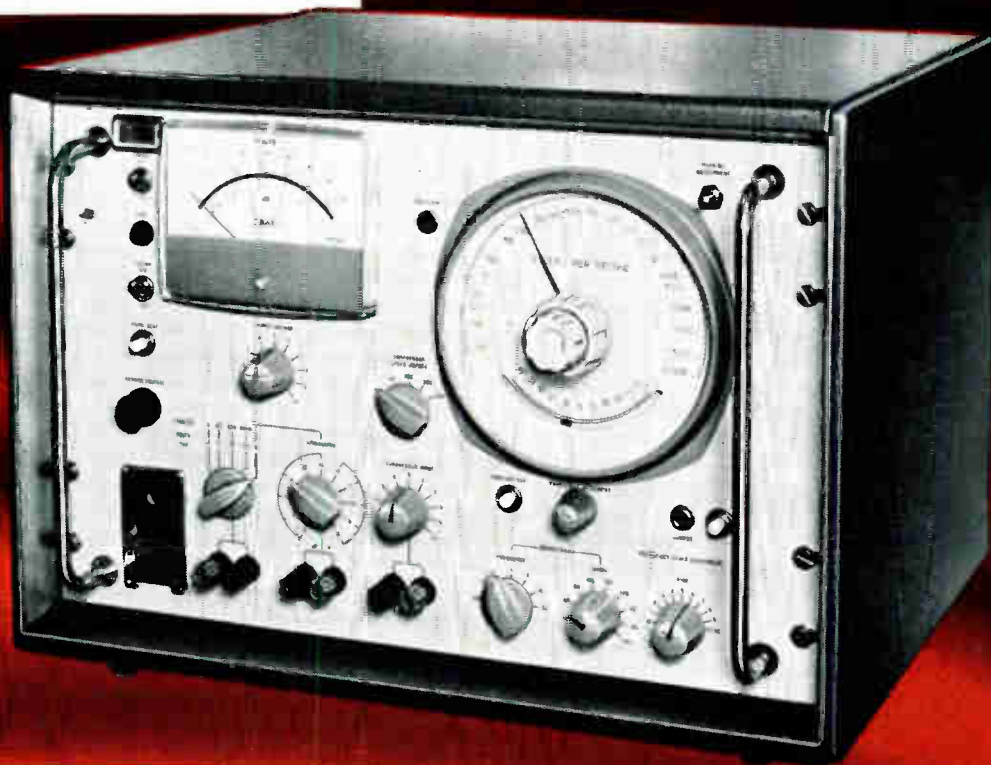

# DAWE

Full technical data from —

**DAWE INSTRUMENTS LTD.,** WESTERN AVE, LONDON, W.2 Tel. BC09n 4751

A member of the *Siemens* group of companies

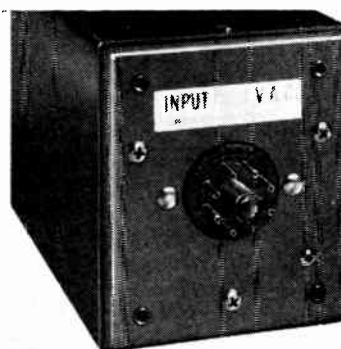

# we can't hide our power supplies under a bushel

The ETHER range of power supplies has been designed to provide stabilised D.C. power for the widest range of applications.

Stabilisation ratios as high as 5000:1, very low ripple and noise, fully transistorised printed circuitry—these, and competitive prices are some of the reasons for choosing ETHER D.C. power supplies. Enquiries for adaptations and units to special requirements are welcome.

- \* Stabilisation Ratios up to 5000:1
- \* Ripple and noise as low as 200 $\mu$ V
- \* Modular construction
- \* Quick delivery
- \* Low cost

ETHER A.C. voltage regulators provide a clean regulated output with very low distortion. Valve and transistor types with outputs from 200VA to 5000VA for rack mounting or as cabinet units.

Write or telephone for comprehensive details to

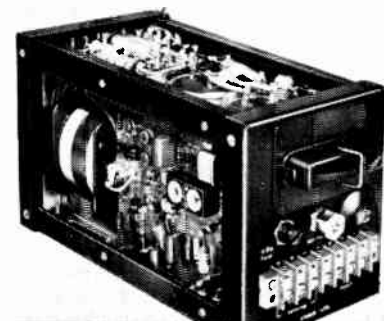

# ETHER

ETHER LTD., CAXTON WAY,  
STEVENAGE, HERTS.  
Telephone: Stevenage 3040-55



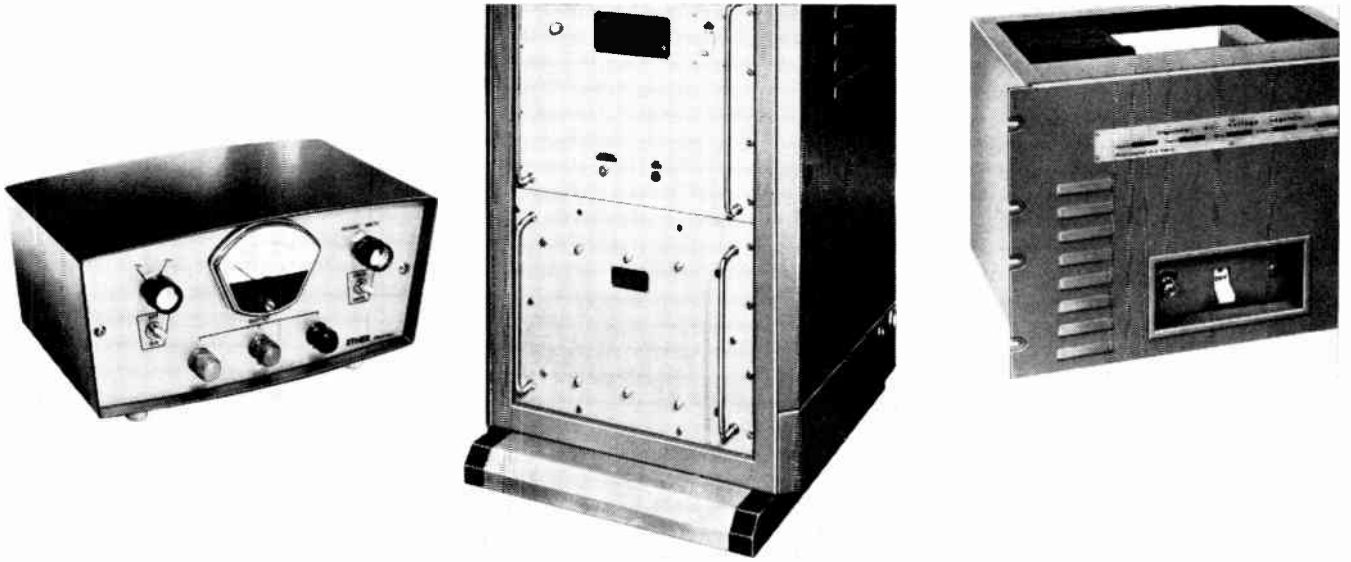

there are too many of them



# DIGITAL COMPUTER CONTROLS PAPER MACHINE

By K. D. OUGHTON, B.Sc.\*

A computer is now being used to control the basic process variables in a paper machine at Wolvercote Paper Mill and is leading to a significant increase in gross output and product quality as well as a saving of time. The paper-manufacturing process, computer system and method of operation are all described in this article.

**A**N Elliott ARCH 1000 computer is now operating in full closed-loop control of the No. 1 paper machine at Wolvercote Paper Mill, near Oxford. The computer was delivered to site at the end of December 1964. It was brought on-line two months later and the first loop was closed on 12th March 1965.

This significant achievement has resulted from a collaborative effort on the part of Wolvercote Paper Mill and Elliott-Automation. It represents a dramatic step forward in the application of modern control techniques to a process which has long been regarded by many as more of a craft than a science. It also provides an effective demonstration of an approach to automation which has much wider applications, not only in the paper industry but to the process industries in general.

This approach recognizes that, over the course of many years, process operators and technologists have acquired a vast amount of skill and experience. It seeks to use this, in suitable combination with modern techniques and equipment, to achieve the maximum benefit that automation has to offer. It also recognizes that the process operators have, and always will have, essential parts to play, although their roles will change as automation applications develop.

Automation is an evolutionary process. The present installation at Wolvercote fulfils only the first stage of plans to extend the scheme into other areas of the Mill operation. The computer now provides the paper-machine

man with an immensely powerful tool, greatly increasing his degree of control over the process and enabling it to run at a level of efficiency which hitherto had been impossible.

## Outline of Process

The No. 1 machine at Wolvercote makes a wide variety of fine papers at 132-in. trim width and a normal speed range of 400 to 900 ft/min.

Fig. 1 shows a flow diagram of the process in operation. The major raw material is cellulose, in the form of wood pulp. This is pulped with water in a 'Hydrapulper' to give a homogeneous suspension of fibre in water at a concentration (consistency) of about 6 per cent. Additives are included as necessary and, after further dilution, the stock is refined. This operation cuts and fibrillates the fibres to prepare the stock for the paper machine. Further dilution brings the consistency down to 3 per cent, at which stage it is referred to as thick stock. The thick stock is diluted with backwater from the paper machine and size solution and clay suspension are added. Clay is important as a filler to give a smooth sheet for printing. The stock is now called thin stock and has a consistency of about 0.7 per cent. It passes through cleaners and screens, to remove lumps, and then into the flow box.

The purpose of the flow box is to distribute the thin stock uniformly as it passes through a long thin orifice, called the slice, on to a moving wire mesh, which is the main feature of the Fourdrinier paper machine. The flow box is pressurized and the pressure is adjusted to control the speed at which the stock flows through the slice. Most of the water and some of the solids drain through the wire, to form the backwater, and a self-supporting, continuous web of wet paper is taken off the wire at the opposite end of the flow box. The paper web is pressed on felt, to remove further moisture, continuously dried on large, steam-filled, rotating cylinders and finally reeled as finished paper with a small moisture content.

The key part of the process is the wet end of the paper

\* Elliott Process Automation Ltd.

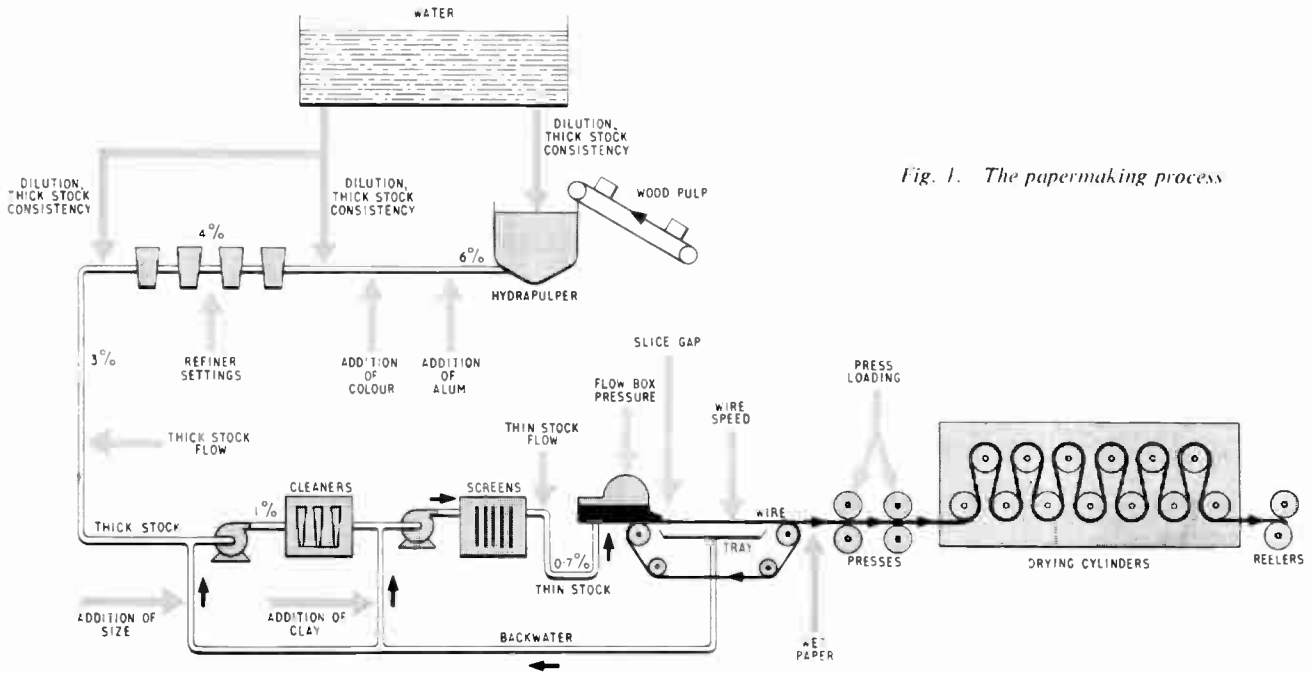

Fig. 1. The papermaking process

machine where the web of paper is actually formed on the wire. It is in this area that the greatest complications arise and the need for speedy control actions lies.

**Computer System**

The ARCH computer exercises direct control over the five major variables at the wet end of the machine. These are (see Fig. 2):

- (1) Thick stock flow
- (2) Clay flow
- (3) Flow box pressure.

In each of these three cases the computer automatically makes adjustments to the set points of conventional pneumatic controllers, using specially designed stepping motors, called link units, driven by pulses from the computer.

- (4) Slice gap—here the computer drives the slice actuator directly.
- (5) Overall machine speed—here the computer adjusts the reference voltage of an electronic speed control system linking the wire, the presses, the drying cylinders and the reeler.

*The paper-machine control room showing the machine operator's console. Installation costs of the equipment will be recovered in two years by the resultant increase in efficiency (Photograph by courtesy of the Controller of Wolvercote Paper Mill)*

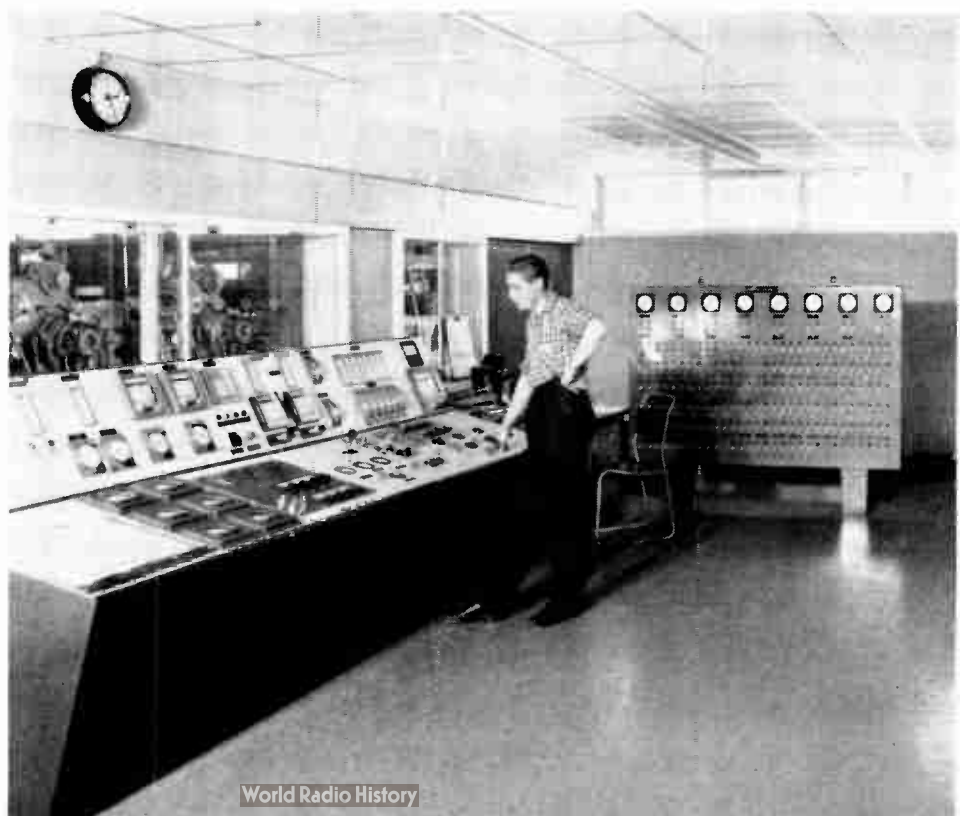

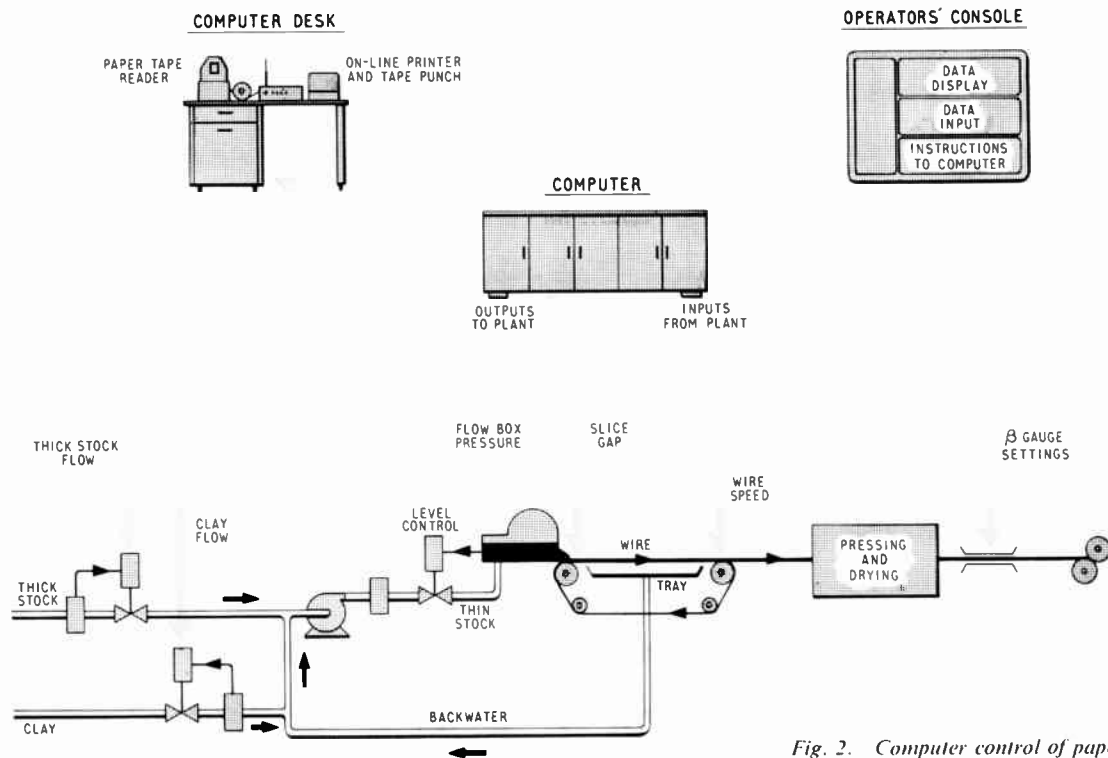

Fig. 2. Computer control of paper machine

The direct inputs to the computer from plant instruments have been omitted from Fig. 2 for the sake of clarity. The major inputs are:

- Thick stock flow
  - Thin stock flow
  - Clay flow
  - Flow box head
  - Slice gap
  - Thick stock consistency
  - Wire speed
  - Reeler speed (always a few per cent higher than wire speed)
  - Final basis weight
  - Paper break detectors.
- Measured by magnetic flowmeter

The final basis weight (weight per unit area) is a particularly important measurement. This is obtained using a beta-ray gauge mounted at the dry end of the machine. This gauge must be properly set up for each grade of paper being run and to obviate mistakes it is set up automatically by the computer at each grade change. This requires a further three outputs from the computer.

The ARCH 1000 digital computer is one of a range designed specially for on-line process control applications. It uses parallel logic with an 18-bit word length and has an add time of 280  $\mu$ sec. The Wolvercote installation has a ferrite-core store of 8,000 words and the whole computer programme is cycled through once every few seconds. Analogue inputs are selected as required by the programme and read in through a common analogue-to-digital converter. Speed measurements are made digitally by counting pulses over fixed intervals of time.

The computer is situated in a new control room overlooking the wire part of the paper machine. This control room also contains the main instrument console from which the paper-machine man now operates his machine.

The console also houses a special panel (illustrated at top right in Fig. 2) which the machine man uses to communicate with the computer. Here he inserts data pertaining to the next grade of paper to be made and results from routine laboratory tests on samples from the current grade. He feeds in instructions regarding grade and other changes, and can also call for a digital display of any of a wide range of data from the computer or a print-out of present running conditions. There are two locks on this panel. The first must be turned before any information will be accepted by the computer. For certain items the second lock must also be turned. The key for this is kept in the possession of the shift superintendent and gives him overriding control over certain important actions.

#### Method of Operation

The main objectives of the system are:—

- (1) To improve product quality
- (2) To increase overall production
- (3) To speed up grade changes.

There are two important aspects to the problem of quality control. The first is to obtain the correct basis weight and fibre to clay ratio of the finished sheet and the second is to ensure that the 'formation' of the fibre on the wire is correct. Formation is a somewhat intangible property, but it is very critical and in particular affects the strength and appearance of the finished paper.

#### Basis Weight

The computer controls basis weight by first setting up standard running conditions for the grade to be made and then continuously trimming thick stock flow by feedback from the beta gauge. The derivation of the correct control for this feedback loop is complicated by the long

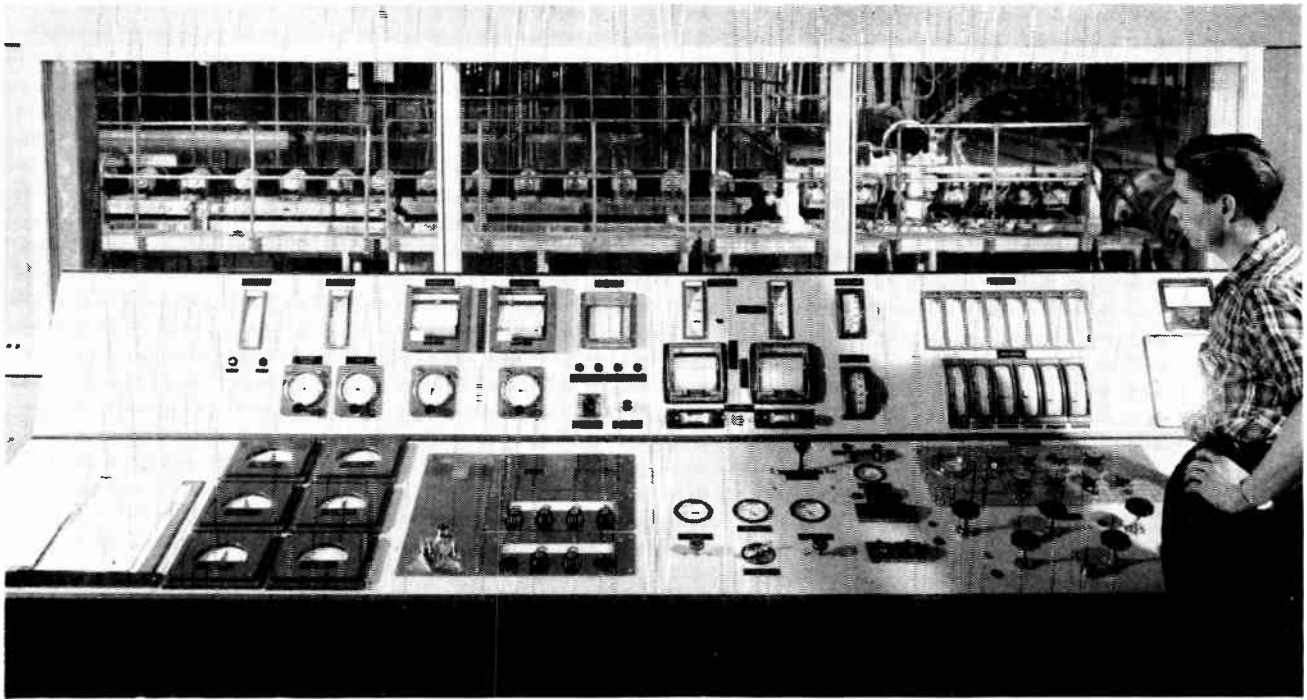

*The machine operator's view, across the control desk, of the wet-end of the paper machine, where the key part of the process is undertaken (Photograph by courtesy of the Controller of Wolvercote Paper Mill)*

transport lag through the paper machine and the fact that this lag changes as the machine speed is changed from one grade to another. The method adopted is one devised by Professor Box, of Wisconsin University, and Dr. Jenkins, of Imperial College.<sup>1</sup>

Essentially this method is based on the concept that best control is given by:—

- (1) Predicting the deviation in basis weight that would occur at some appropriate time in the future if no control were exercised.
- (2) Making a control adjustment to compensate exactly for this predicted future deviation.

The calculation of the current best control adjustment requires, of course, not only a knowledge of the predicted future basis weight but also a knowledge of the process dynamics. The Box and Jenkins method provides both of these by statistical analysis of running data obtained from the paper machine.

#### *Formation*

Formation is difficult to measure objectively but is something which any competent machine man can judge effectively by examination of the wire and the finished sheet, with the help of periodic laboratory tests. The system provides the machine man with the ready means of altering formation by making controlled adjustments to the two factors which chiefly affect this, namely:—

- (1) The ratio between the wire speed and the speed at which the thin stock is discharged from the slice. This ratio is called the paper quality constant.
- (2) The flow-box consistency.

The computer controls the paper quality constant to the required value for each grade by measuring the wire speed

and then computing and setting the correct pressure in the flow box.

There is no suitable instrument available for measuring thin stock consistency, so this is continuously computed from on-line measurements of thick stock flow, thin stock flow, clay flow and thick stock consistency, using material balance equations. Laboratory analyses of thin stock consistency are fed into the computer periodically as a check on these calculations.

If the operator decides that he requires a change in consistency or paper quality constant, in order to improve the formation, he instructs the computer to perform the change, which it then does by making all necessary adjustment to flows, slice gap and flow-box pressure in the correct dynamic relationship, in such a manner that it does not produce a disturbance in basis weight.

#### *Clay/Fibre Ratio*

The clay/fibre ratio is controlled on the basis that a constant clay/fibre ratio in the finished sheet requires a constant, but different, clay/fibre ratio in the flow box (due to the different drainage characteristics of fibre and clay through the wire). The clay/fibre ratio in the flow box is computed as part of the flow box consistency calculations mentioned above and the clay flow rate is automatically adjusted to maintain this ratio at the required value. It is perhaps important to emphasize here that this is not equivalent to simple ratio control between the clay and thick stock flows: the situation is complicated by the differing drainage characteristics of fibre and clay, affect-

ing the backwater, and also the fact that the thick stock itself generally contains some clay.

Periodic laboratory measurements are carried out on the clay concentration in the final sheet and the results are fed into the computer. If the measurement differs from the desired value, the computer calculates a new figure for the required clay/fibre ratio in the flow box and starts to control to this figure.

#### Overall Production

The most important single factor determining the overall production rate is the speed at which the paper machine is run. In the past an operator has been content to run his machine at a steady speed somewhat below the maximum, because of the risk of poor product quality or a paper break if he attempts to increase the speed. Now he can call for an increase in speed, with the knowledge that the computer will make the increase for him and at the same time make all necessary adjustments to other process variables in the correct time sequence. He can now run his machine faster without loss of quality and thus increase the production rate.

Another factor affecting production is the percentage of unacceptable paper, or broke, made. The improvements in control that the computer brings to the process lead to a reduction in broke percentage and a further increase in overall production.

#### Grade Changes

At Wolvercote, as at any other similar mill, a wide range of different grades of paper has to be made. Different grades of paper require different machine speeds, different consistencies, different control parameters, etc., and several grade changes may be required during the course of one day. Without computer control grade changes tend to be troublesome and lengthy but with computer control the operation becomes systematic and is speeded up considerably. The computer does this by storing standard running conditions for all grades and setting up the required new conditions automatically when a grade change is requested.

The mill is now building up a data file of standard running conditions for each grade (of which there are about 80). These standards are continually being improved in the light of operating experience with the new computer control system. A print-out is given of the actual running

conditions at the start and end of each run and also at other times, on demand, to assist in updating the standards.

#### Some Other Facilities

The computer keeps a running calculation of the quantities of good and bad paper made each run. These can be displayed on demand and production summaries are printed out at the end of each run and each shift. The computer also estimates the time left to run before the next grade change and warns the operator as the time to change draws near.

A print-out is given of alarm conditions as they arise, together with a record of the time and nature of any change made by the operator.

An important feature of the system is the flexibility it offers to the operator by the incorporation of a slave mode of control in addition to the normal mode so far described. In the slave mode the operator adjusts the set-points of the controllers himself. The computer monitors his actions and adjusts its output link units to match them. In this way it is always ready for a bumpless transition back to the normal control mode.

If the necessity for a short shut-down arises the freeze mode is entered. This freezes all control set-points so that the paper machine can be subsequently started again with the settings that existed at the time of the shut down.

#### Pay-Off

The pay-off from this installation comes from the increased efficiency of operation of the process. Definite targets were set at an early stage in the project. Specifically these are:—

- (1) 5% increase in gross output
- (2) 2% reduction in broke percentage
- (3) 50% reduction in time lost at start-ups and grade changes.

It is too early yet to give actual figures, but present indications are that there should be no difficulty in achieving these targets.

#### Reference

<sup>1</sup> Some Statistical Aspects of Adaptive Optimization & Control, by G. E. P. Box & G. M. Jenkins, *J.R. Statist. Soc.*, 1962, B, Vol. 24, pp. 297-343.

## High Efficiency Gas Laser

A gas laser that generates the highest continuous output so far observed at infra-red frequencies has been developed at Bell Telephone Laboratories. It produces 16 W of power at 10.6 microns.

The laser has an input-to-output efficiency of more than 4%, or better than 40 times the efficiency of helium-neon lasers. It is of interest because light at a wavelength of 10.6 microns is not absorbed very much by the atmosphere.

The laser tube is 25 mm in diameter and 2 metres long. A concave and a convex mirror at opposite ends of the tube form the laser cavity. The mirrors are spaced 240 cm apart and are coated with vacuum-deposited gold. The laser beam is emitted through a 12.5-mm hole at the centre of the concave mirror.

Calculations show that a power output of about 30 mW for each cubic centimetre of nitrogen and carbon dioxide

at pressures of one torr each should be attainable. Thus by increasing the diameter and length of the laser tube it is expected that output power of the order of hundreds of watts may be obtained from tubes of this type.

The development of this high-powered infra-red gas laser was made possible when it was discovered that the transfer of energy from vibrationally excited nitrogen molecules to carbon dioxide molecules could not only be accomplished, but resulted in extraordinary efficiencies. This is, in part, attributable to the lower-lying energy states of the nitrogen molecule. The lifetimes of the vibrationally excited states in nitrogen are very long, for example, 10,000 times longer than the lifetime of the metastable states of helium under similar physical conditions. This results in getting more than 30% of the vibrationally-excited nitrogen molecules to give off their energy to carbon dioxide and initiate lasing action.

In point-to-point h.f. communications it is desirable to be able to change frequency rapidly and with a minimum of adjustments. This article describes a system based on a frequency synthesizer for providing the local-oscillator frequency and automatic tuning of the signal-frequency circuits.

# SELF-TUNED H.F. RECEIVERS

By J. V. BEARD, B.Sc.(Eng.), A.M.I.E.E.\*

FOR the greatest economy in manpower, equipment for point-to-point h.f. communications should require the minimum of operational adjustments and these should be as simple as possible.

Frequency adjustments in particular should be simple and preferably on directly-calibrated controls. The frequency-setting accuracy and stability of transmitters and receivers should be sufficiently high to obviate fine tuning controls and the need to search for wanted signals on receivers.

Such high-frequency setting accuracy and stability would also remove the need for automatic frequency control (a.f.c.). This would greatly improve the operational reliability of h.f. links since a.f.c. circuits can easily be pulled off tune by noise or adjacent strong signals. During a seven-day trial of a point-to-point circuit between the United Kingdom and North America, it was found that a high stability receiver having no a.f.c. provided an average of thirty minutes per day more traffic-carrying time than a comparable receiver with a.f.c. The two receivers were used under the same bandwidth conditions. In general, only in the case of multichannel telegraphy would a very limited amount of a.f.c. be required since the frequency tolerance of receiving terminals for voice-frequency telegraphy is only about  $\pm 4$  c/s.

The obvious method of obtaining the required frequency setting accuracy (of the order of  $1:10^7$ ) is to use synthesizers, a number of which can be fed from one master oscillator having a much higher order of accuracy and stability than could economically be provided by individual crystal oscillators for each operating frequency. Synthesizers are usually equipped with decade controls and so satisfy the requirement for simplicity of operation.

In order to simplify tuning by unskilled operators and to reduce the time taken to change frequency, ideally it should not be necessary to carry out any operation other than setting the synthesizer. To achieve this the receiver would have to be designed to tune itself automatically.

The need for some such self-tuning system becomes even more desirable if extended or remote operation is required. In the case of extended control, all the receivers would be grouped together in one location and extended control units, containing the frequency synthesizers, would be installed in another room. In the case of remote control it

would generally be necessary for the synthesizers to be operated remotely over one or two pairs in a telephone cable.

## Some Self-Tuning Methods

Fig. 1 shows the elements of a self-tuning receiver with a synthesizer taking the place of the first oscillator. The received signal is amplified by one or more signal-frequency stages and is then passed to the mixer,  $M_1$ , where it is mixed with the output from the synthesizer. The synthesizer frequency,  $f_{01}$ , is normally higher than the signal frequency,  $f_{SF}$  (i.e.,  $f_{01} = f_{SF} + f_{IF1}$ ), because this reduces the number of octaves which the synthesizer has to cover. If, for example, the receiver has to tune from 2.5 to 27.5 Mc/s and  $f_{IF1} = 2$  Mc/s, then with the oscillator high the synthesizer has to cover 4.5 to 29.5 Mc/s, compared with 0.5 to 25.5 Mc/s with the oscillator low.

The frequency synthesizer is fed from a master oscillator or master frequency source, usually at 1 Mc/s. The output frequency is controlled by decades engraved in 'Mc/s', 'kc/s  $\times 100$ ', 'kc/s  $\times 10$ ', 'kc/s' and, in some cases, 'kc/s  $\times 0.1$ '. Although a synthesizer is relatively expensive, it must be remembered that, in a typical receiver, it is equivalent to a bank of 250,000 crystals, each in an oven.

Referring to Fig. 1, the system could be made self-tuning if the synthesizer dials in some way automatically controlled the signal-frequency range switch and the signal-frequency tuning. Firstly, the first intermediate frequency would be made an integral number of megacycles per second so that the synthesizer dials could be more readily calibrated in signal frequency. Secondly, the 'Mc/s' switch could be arranged to control rotary solenoids actuating the range switches. To simplify matters the ranges would start and finish in integral numbers of megacycles per second, for example, 2-4, 4-8, 8-16, and 16-32.

Thirdly, the synthesizer dials would have to be arranged to tune the signal-frequency stages. A way of doing this



ELECTRONICS  
COMMUNICATIONS  
INSTRUMENTATION  
CONTROL

\*The Marconi Co., Ltd.

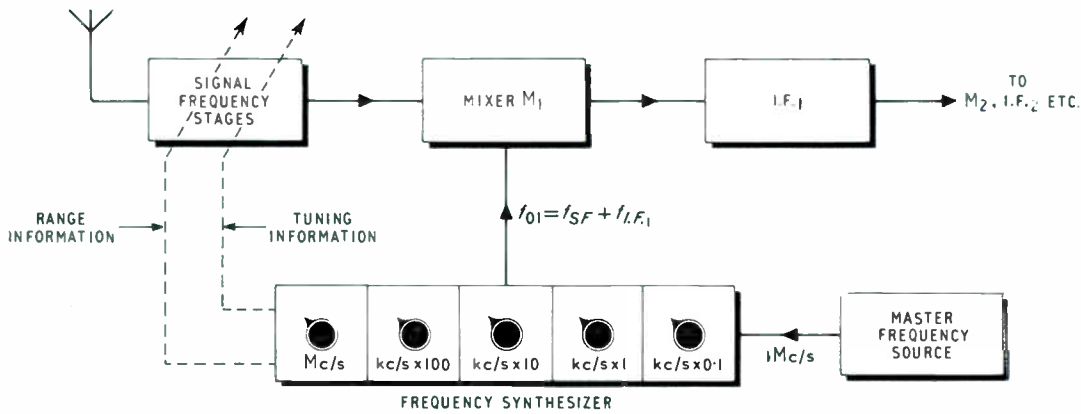

Fig. 1. The elements of a self-tuning receiver in which the tuning of the signal-frequency stages is automatically controlled by the setting of the decade dials on the synthesizer

is shown in Fig. 2. A Wheatstone bridge is fed with a 400-c/s source. The output from the bridge feeds an amplifier and the output of the amplifier drives one phase of a two-phase motor, the second phase being fed directly with the 400-c/s input. The motor in turn drives a multiturn potentiometer and, through reduction gearing, the signal-frequency ganged capacitors. Each switch controlling the synthesizer decades has an extra wafer carrying resistors in series, as shown in the diagram. The total resistance is connected to one arm of the Wheatstone bridge and the multiturn potentiometer to another. When the synthesizer switches are turned the bridge is unbalanced and the motor rotates the potentiometer until it balances again. The law of the potentiometer is arranged to match the law of the tuning capacitors to achieve the correct tuning over the band.

Although this system is quite satisfactory and is employed

in a practical receiver, it has several disadvantages when used with extended or remote control. The synthesizer must be modified to include the resistors on each decade and an extra wafer on the 'Mc/s' decade to provide the range information. Consequently it is not possible to use any synthesizer without modification. The d.c. resistance of the extended control leads is unavoidably included in one arm of the bridge. This could be balanced out, but is nevertheless an undesirable feature. Furthermore, it is not possible to use a simple spot-frequency crystal oscillator instead of the synthesizer since the tuning and range information would not be available.

For these reasons it is preferable to use a system where the only connection between the receiver and the synthesizer is the output from the latter. In this case the receiver has to find the correct range and tune itself.

Fig. 3 shows a possible way of achieving the desired result.

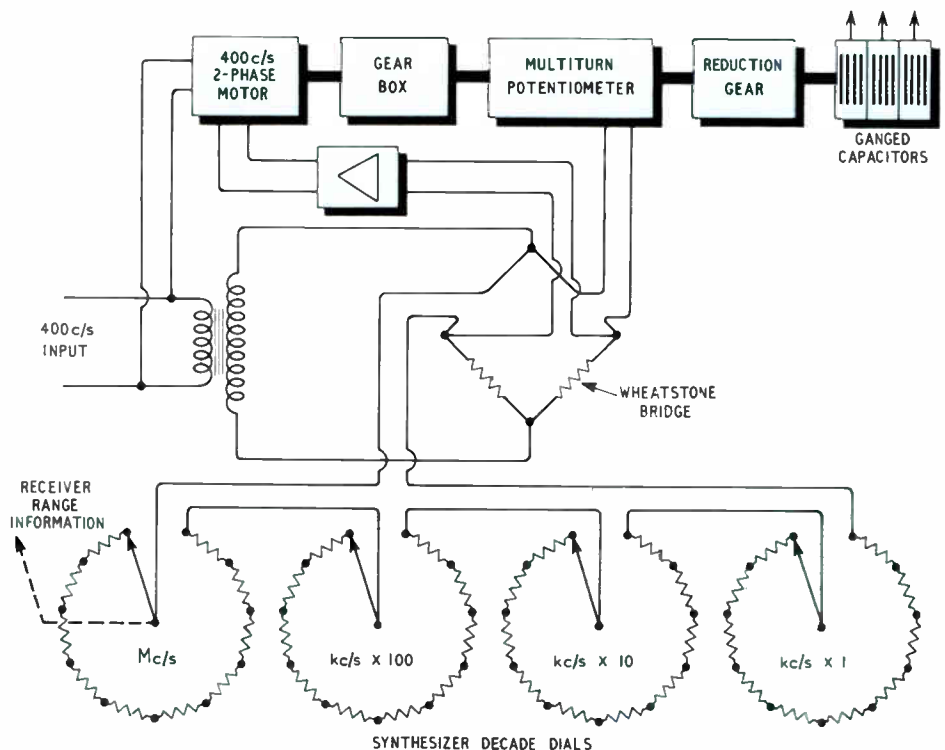

Fig. 2. Servo-balancing Wheatstone bridge system—a possible way of controlling the tuning of the signal-frequency stages from the synthesizer decade dials



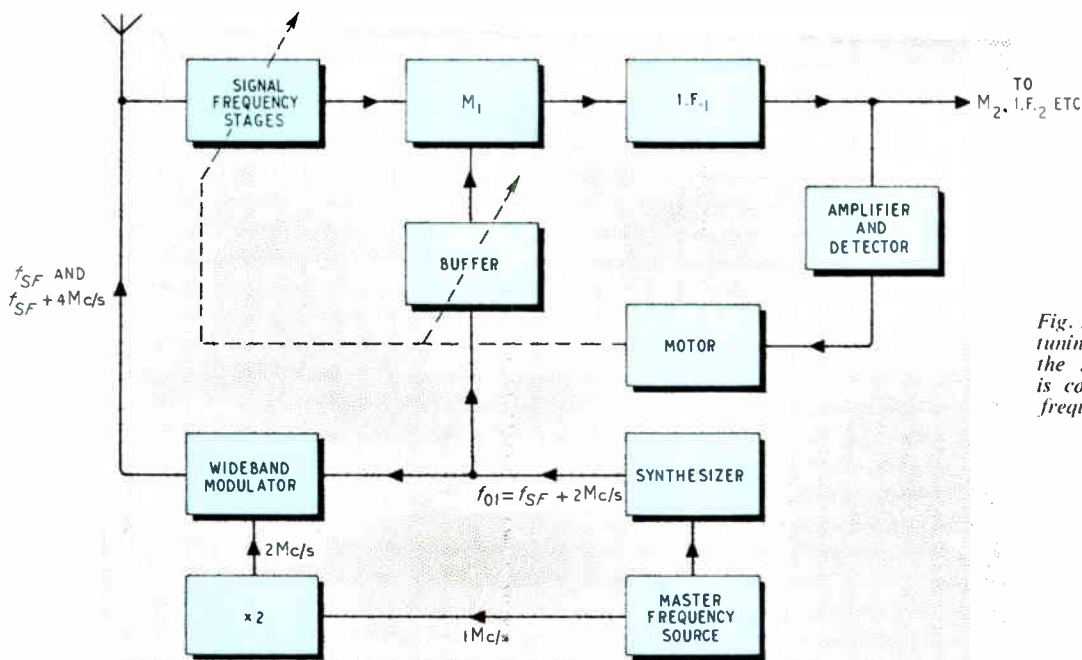

Fig. 3. One method of self-tuning in which the tuning of the signal-frequency stages is controlled by the output frequency of the synthesizer

The synthesizer output at a frequency of  $f_{SF} + 2 \text{ Mc/s}$  is fed to the mixer,  $M_1$ , via a tuned buffer stage, and to a wideband balanced modulator where it is modulated with  $2 \text{ Mc/s}$ . The output from the modulator will contain the wanted frequency,  $f_{SF}$ , and the unwanted frequency,  $f_{SF} + 4 \text{ Mc/s}$ . The output of the first i.f. amplifier,  $I.F.1$ , feeds an amplitude detector which in turn controls the motor. The buffer and the signal-frequency stages are ganged together and are tuned by the motor which should stop when the output from the detector is at its maximum. If the tuning is always commenced from the low-frequency end of the range accidental tuning to  $f_{SF} + 4 \text{ Mc/s}$  can be avoided.

One principal difficulty with this system is that of ensuring that the motor stops when the output is at maximum. A suggested detector is shown in Fig. 4(a). The transformer,  $T_1$ , is centre-tapped so that the two detectors are fed with the same a.c. voltage. As the tuning capacitors are rotated towards the correct tuning point the voltages across  $C_1$  and  $C_2$  will be equal. Thus the output,  $E_0$ , will be zero. However, the capacitance of  $C_1$  is made considerably larger than that of  $C_2$  so that, when the maximum is passed, the voltage across  $C_2$  falls rapidly but that across  $C_1$  falls slowly, giving a resultant output  $E_0$  (Fig. 4(b)). Since the signal-frequency stages are relatively flat and the output would have to fall several decibels below the maximum to give sufficient output to switch the motor-control circuit reliably, this system is not satisfactory and has not been pursued.

Yet another method of self-tuning is shown in Fig. 5. The aerial feeds a wideband (2–30 Mc/s) amplifier. In order to reduce the second-order intermodulation which could easily occur in the untuned amplifier it is preceded by a number of half-octave filters. With such a wideband system the first intermediate frequency must be high and it is usually chosen to be higher than the highest signal frequency, for example  $40 \text{ Mc/s}$ . Even with  $Q_s$  of 100 the bandwidth of this i.f. amplifier

would be about  $0.4 \text{ Mc/s}$ , and, in order to avoid further image responses a second i.f. of 1 or 2 Mc/s would be necessary, followed by a third,  $100 \text{ kc/s}$ , i.f.

It can be seen that this system requires only the selection of the appropriate half-octave filter by the 'Mc/s' decade switch on the synthesizer. However, the synthesizer has to supply first-oscillator frequencies from 42 to  $70 \text{ Mc/s}$ , and a special synthesizer is, therefore, required. Another problem associated with this system is that the first i.f. amplifier has a bandwidth of about  $0.4 \text{ Mc/s}$ , so that many unwanted signals will be amplified and passed to the second mixer. If the bandwidth of the second i.f. is not restricted (it could easily be  $50\text{--}100 \text{ kc/s}$  wide) a number of the unwanted signals will reach the third mixer. Unless the linearity and signal handling capacity of all the s.f. and i.f. stages are very good the blocking and cross-modulation performance of this receiver will be very poor.

### The Preferred Self-Tuning Method

Fig. 6 shows the preferred self-tuning method which has been successfully adopted in a practical receiver. The synthesizer output at  $f_{SF} + 2 \text{ Mc/s}$  is fed into the first mixer,  $M_1$ , with the output from a variable-frequency

Fig. 4. Suggested detector for the self-tuning method shown in Fig. 3

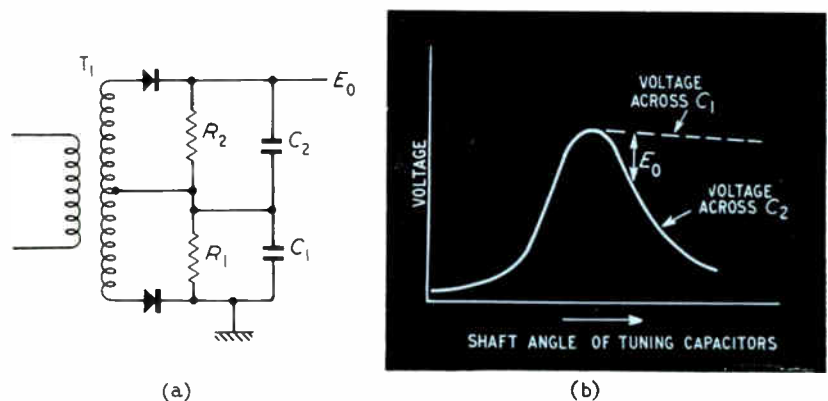

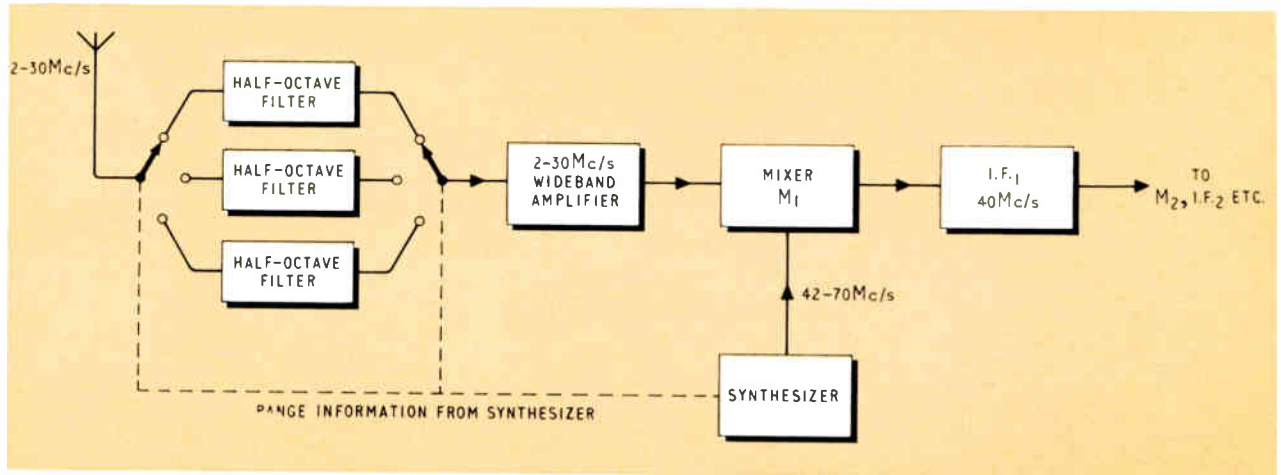

Fig. 5. Another method of self-tuning, in which half-octave filters are used in the signal-frequency input and the first i.f. is higher than the highest signal frequency

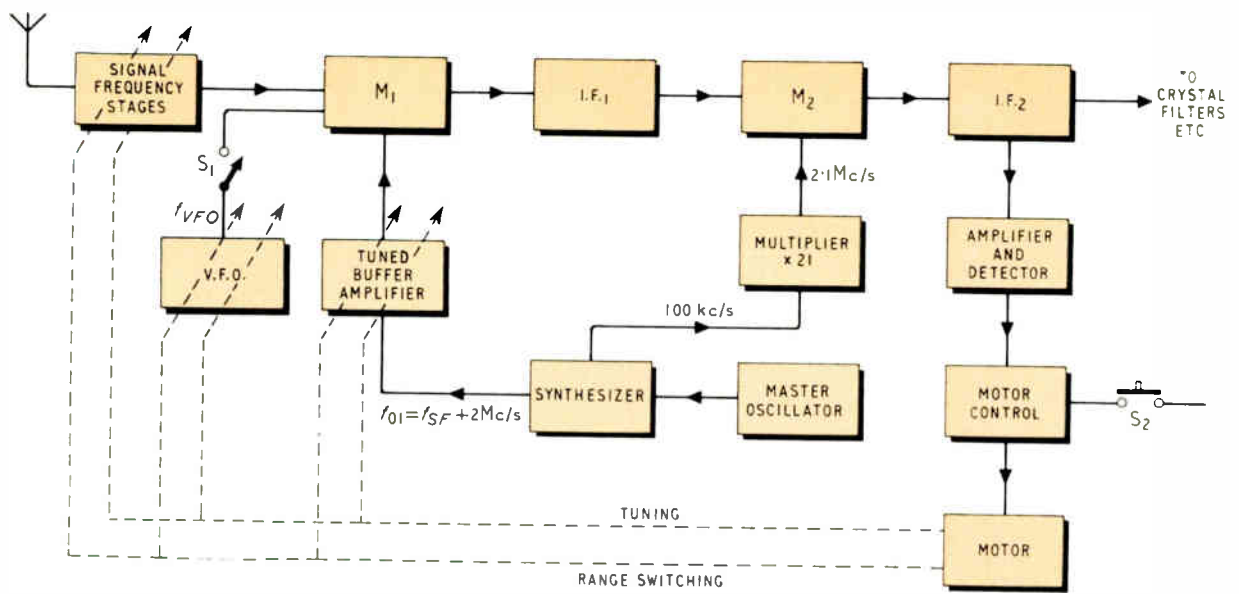

Fig. 6. The preferred self-tuning system in which a variable frequency oscillator is ganged with the signal frequency stages

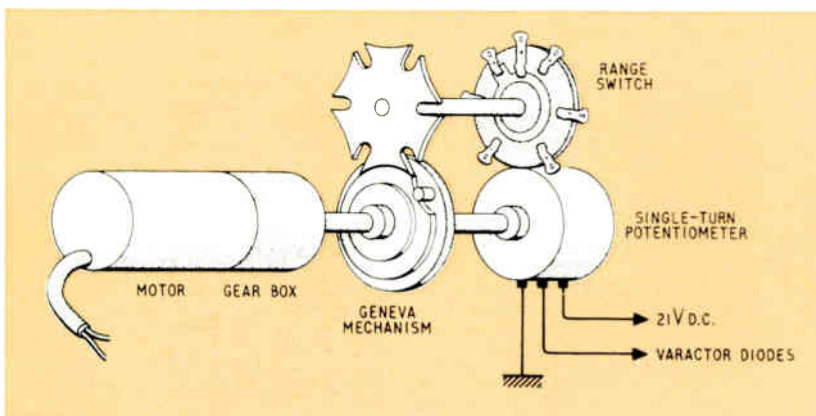

Fig. 7. Tuning and range switching mechanism

oscillator which is ganged to the signal-frequency stages and produces a frequency  $f_{NF}$ . The first i.f. is 2 Mc/s and the second i.f. 100 kc/s. (The second oscillator frequency of 2.1 Mc/s is obtained from a 100-kc/s output from the synthesizer by multiplying it by 21.) The signal output at 100 kc/s is passed to a detector which feeds the motor-control circuit which controls the tuning motor. The motor drives a potentiometer which is coupled to a Geneva mechanism. The potentiometer supplies a variable d.c. voltage to control the tuning of the signal-frequency stages. Tuning is carried out with varactor diodes whose capacitance can be varied by applying a variable d.c. voltage across them.

The potentiometer supplying the d.c. bias voltage is a high grade wire-wound type with an effective track angle of 300 degrees. During the 60 degrees interval of no voltage output from the potentiometer, the Geneva mechanism steps a rotary switch round one position to control the range switching rotary solenoid (see Fig. 7).

### The Tuning Cycle

When the push button,  $S_2$ , is depressed (see Fig. 6) at the extended control unit, a pulse is applied to the motor-control circuits to start the tuning motor. The potentiometer and the Geneva mechanism controlling the range switches rotate until the beginning of Range 1 is reached. At this point  $S_1$  is closed, causing the variable-frequency oscillator to inject a signal into  $M_1$ . The potentiometer and the Geneva mechanism continue to rotate and the tuning cycle now commences. Each range is tuned in turn until the correct tuning point is reached, when the difference in frequency between the synthesizer and the variable-frequency oscillator (v.f.o.) is 2 Mc/s. The tuning signal will now pass through the  $IF_1$  crystal filter and  $IF_2$ , and the output from the amplitude detector will stop the motor. At the same instant  $S_1$  is opened and the tuning cycle is complete.

Compared to the method in Fig. 3, it can be seen that the signal is being swept in frequency through the  $IF_1$  crystal filter, which has the comparatively narrow bandwidth of 14 kc/s. If the motor overshoots by an amount corresponding to a few kilocycles per second, the error in the tuning of the signal-frequency circuits is negligible as they have a 1-dB bandwidth of about 200 kc/s at 10 Mc/s.

### The Choice of the Tuning Element

The receiver shown in Fig. 6 could have been tuned with conventional ganged capacitors, but this would have led to considerable difficulties since the receiver was to be designed for modular construction. Each module is a printed wiring 'book' unit which slides into a frame carrying sockets which mate with gold contacts printed on the module. To allow different versions of the receiver to be built up from a small range of modules, it was essential that each signal-frequency unit should be a separate book. Including the tuned buffer stage between the synthesizer and the mixer, there are, for a double-diversity receiver, a total of eight tuned circuits in three different books, and these have to be tuned by a motor contained in yet another book.

This problem was solved by using varactor diodes. These devices are silicon diodes which are used in the reverse-bias condition. The capacitance of the diode varies with the bias. The circuit arrangement of a typical application is shown in Fig. 8. Two diodes are used back-to-back across the tuning inductor in the collector of the transistor. Fig. 9 shows the relationship between the bias voltage and capacitance for two diodes in a back-to-back arrangement. For the particular diodes chosen the bias voltage,  $V_b$ , varies from 1 to 21 volts for a capacitance variation from 81 to 24 pF.

Although the diodes give a solution to the ganging

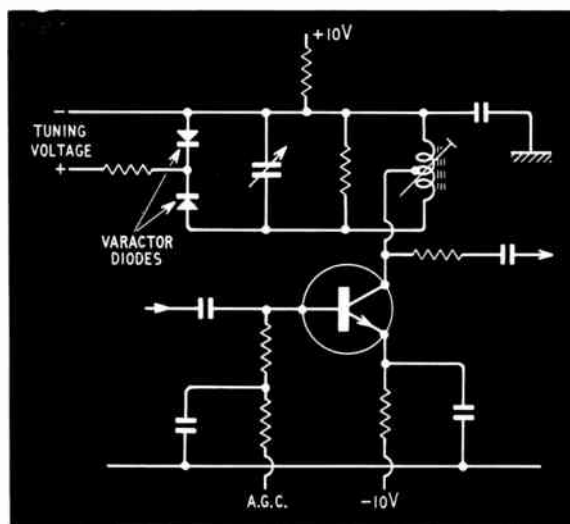

Fig. 8. Typical signal-frequency amplifying stage using varactor diodes, controlled by a d.c. tuning voltage, to tune the inductor in the collector circuit of the transistor

problem, since it is only necessary to supply the bias voltage to each book unit, there are a number of problems associated with their use. These are as follows:

(a) *The Problem of Ganging Tolerances.* It may be shown<sup>2</sup> that the relationship between junction capacitance,  $C$ , and applied bias voltage,  $V_b$ , is of the form

$$C = K(V_b + V_c)^{-n}$$

where  $V_c$  is the diode contact potential. For abrupt junction diodes,  $n \approx 0.5$ .

A number of diodes of the same type were measured. They were all found to follow the same law (i.e. the value of  $n$  was constant) but, due to manufacturing tolerances, the factor,  $K$ , varied, giving the diodes capacitance variations of  $\pm 20$  per cent at a given bias voltage. With working  $Q$ s of 50 it is necessary for the capacitances to be within  $\pm 1$  per cent to maintain a ganging error of less than 1 dB. This posed a manufacturing problem: if 1 per cent diodes were selected the production yield would be very small, resulting in high costs. The diodes were, therefore, selected as back-to-back pairs to give the required total capacitance with a reasonable yield.

(b) *Useful Capacitance Variation.* At low bias voltages the temperature coefficient of the capacitance becomes worse and, what is more serious, the  $Q$  falls below the minimum required to give acceptable gain and image rejection. The lowest bias voltage was, therefore, limited to 1 volt. Unfortunately this limits the usable capacitance variation so that the range factor (the ratio of the maximum to the minimum frequency) is only 1.5. Thus six ranges are needed to cover the band 2.5–27.5 Mc/s whereas not more than four ranges would have been necessary with conventional air-spaced ganged capacitors.

(c) *Spurious Responses.* If only one diode were used across each coil very strong unwanted signals could cause the diode to conduct resulting in cross-modulation. The use of diodes in a back-to-back configuration reduces this effect by a factor of about 30 dB<sup>3</sup>. Furthermore, the limitation of the minimum bias voltage to 1 volt means that an

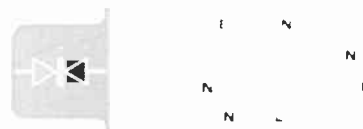

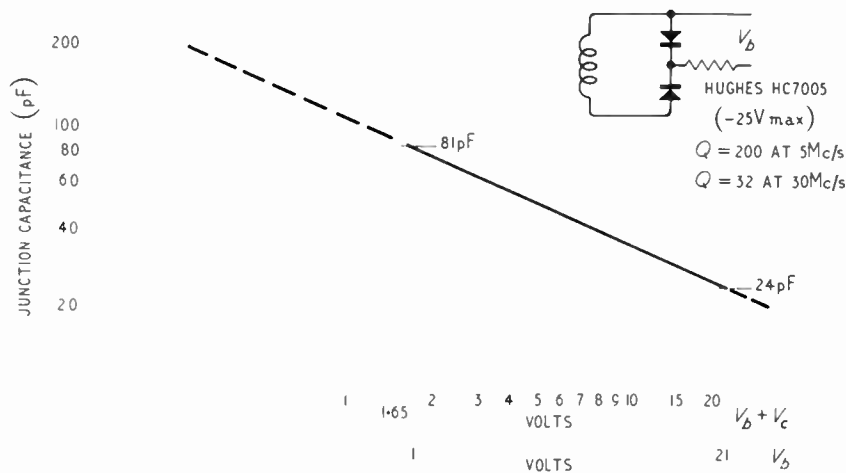

Fig. 9. Typical varactor diode characteristic  
 $V_b$  = bias voltage  
 $V_c$  = diode contact potential

both paths of a dual diversity receiver and both sidebands of an i.s.b. signal.

In a practical extended control system each receiver is controlled by a synthesizer and an extended control unit giving all these facilities. A multi-core cable and two coaxial cables connect the extended control unit and the synthesizer to the receiver. The majority of control functions are carried out by transistor switches in the receiver which are operated by d.c. potentials from the extended control unit, but dry-reed relays are used for switching r.f. circuits such as the aerial switch and the input attenuator.

unwanted signal would have to be comparable with 1 volt to cause trouble. Laboratory measurements have confirmed that under these conditions any cross-modulation was entirely due to the driving transistors.

### Speed of Tuning

Since frequency changes on modern h.f. transmitters can be completed in less than one minute it was decided that the tuning cycle of the receiver should not occupy more than 30 seconds. It was also decided that the reduction in signal level due to tuning errors should not exceed 1 dB.

There are six frequency ranges and in the worst case of changing from a frequency in Range 1 to one in Range 6 it is necessary to switch through each range twice, once with the v.f.o. off and once with it on. The maximum rate of scan is limited by the bandwidth of the  $IF_1$  crystal filter. A 24-second tuning time was chosen, giving a range scanning time of 2 seconds. On the highest range the scanning rate is approximately

$$\frac{(28-18) \text{ Mc/s}}{2 \text{ seconds}} \times \frac{360}{300} = 6 \text{ kc/s per millisecond}$$

(allowing for the fact that only 300 degrees of the tuning potentiometer is usable). Thus the time taken for the tuning signal to pass through the 6-kc/s wide telegraph  $IF_1$  crystal filter is 1 ms. Since the pulse rise time of the filter is about 0.2 ms, it can be seen that there is sufficient time to detect the pulse. In the case of independent sideband receivers the situation is easier since the  $IF_1$  crystal filter has a bandwidth of 14 kc/s.

It is obviously imperative to stop the tuning motor as quickly as possible. This has been achieved by using a fast-switching dry-reed relay which applies a d.c. breaking current through one phase of the two-phase 50-V motor. In practice a tuning error of 0.5 to 1 dB has been achieved.

### Extended and Remote Control

There is more to the control of a receiver than tuning alone. When the frequency is changed it may be necessary to select a different aerial (although the use of log-periodics or rhombics may make aerial changes less necessary than they were in the past). In cases where the wanted signal is of adequate strength, but severe cross-modulation is present, a great improvement can usually be obtained by the insertion of fixed amounts of attenuation (usually 20 or 40 dB) into the aerial circuit. Where a.f.c. has to be used it is necessary to switch it off during the tuning process. For s.s.b. reception one or other sideband may have to be selected. It is also necessary to be able to monitor aurally

Alarm lamps on the extended control are lit by d.c. signals from the receiver if a control function has not been carried out.

To facilitate the application of true remote control over long distances, the front-panel switches in the extended control unit operate relays within the unit. It is thus a simple matter to arrange for these relays to be operated by d.c. signals from remote-control receiving equipment. Rotary solenoids fitted to the synthesizer decade controls allow remote frequency selection to be affected in the same way. Where a number of receivers in the same station have to be controlled remotely, the number of circuits between the receiving station and the remote-control station can be kept to a minimum by employing a system in which the first remote-control instruction selects one of the receivers and the subsequent instructions actuate the controls on that receiver. Suitable remote-control equipment for this application is readily available and has proved its reliability in numerous control and telemetry systems associated with oil and gas pipelines, electricity distribution and water works, as well as cable and radio relay repeaters.

### Conclusions

Of the various possible methods of achieving self-tuning, one which uses a swept variable-frequency oscillator ganged with the tuning of the signal-frequency circuits is preferred. The use of varactor diodes instead of variable capacitors allows electrical ganging of the tuned circuits and facilitates modular construction with the ganged circuits in different units.

A self-tuning receiver with sufficiently accurate frequency selection obviates manual tuning of signal-frequency circuits, searching for wanted signals, and the need for a.f.c. which can be pulled off tune by interference. It also greatly simplifies the application of extended control and remote control for which there is an increasing demand in modern h.f. receiving systems.

### Acknowledgment

The author wishes to thank the Director of Engineering, The Marconi Co. Ltd., for permission to publish this article.

### References

- <sup>1</sup> 'Frequency Synthesizers' by J. A. Gould, *I.E.E. Convention on HF Communication*, March 1963.
- <sup>2</sup> *Transistor Electronics* by D. Dewitt and A. L. Rossoff (McGraw Hill, 1957).
- <sup>3</sup> 'Electronic Tuning with Diode Capacitors' by R. W. Eldred, *Marconi Review*, Vol. XXV, No. 146 (3rd Quarter, 1962).

# SOLID-STATE INDUSTRIAL CONTROL INSTRUMENTATION

By JAMES J. PINTO, M.Sc., A.M.I.E.R.E.\*

The basic needs for control instrumentation in industrial processes are surveyed in this article and the methods at present adopted to fulfil these needs are discussed. A generalized solid-state calibrated control instrument is then described and its advantages are explained. The uses of this instrument in a few simple, as well as specialized, applications are described to illustrate the effectiveness of control.

**E**LECTRONIC industrial process-control systems are generally required for control of such parameters as voltage, current, power, speed, position, temperature, pressure, flow, humidity, density and blending. Each process poses particular requirements in terms of accuracy of control, stability, speed and efficiency. Electrically-controlled processes can be broken down into the control of the basic electrical parameters, the magnitude of the powers involved usually determining whether the parameter is directly controlled, or controlled by means of some secondary factor such as position of a valve or motor. Mechanical or physical processes can usually be controlled with sufficient accuracy by control of a secondary parameter. In all cases, the accuracy of control required usually determines whether ON/OFF or proportional control of the power is used; stability and reduction of dead-space is achieved by the introduction of differential and integral feedback.

All closed-loop control systems may be reduced to the fundamental functions shown in block-diagram form in Fig. 1. The parameter being controlled is monitored by a sensor which feeds into the system a signal which is directly proportional to the magnitude of the parameter. This signal is compared with a reference or command signal and the error or difference is amplified and fed into the power controller, which controls the parameter in order to reduce the error between the sensed and command

signals. The accuracy of control depends on the accuracy of sensing, the stability or accuracy of the reference and the overall gain of the system.

Electromechanical controllers have been in use for some time in general industrial processes. While they are fairly effective and efficient for normal operation, they suffer from the usual defects of electromechanical systems—contact arcing, possible damage and faulty operation due to vibration and many forms of simple mechanical failure.

Contact arcing is eliminated by using photocell sensors instead of physical contacts. However, these systems still suffer from the basic defects of electromechanical operation and are by no means trouble-free. Furthermore, operational feedback for stable and accurate control is difficult to introduce in an electromechanically-operated system, and control equipment for such systems tends to be bulky.

## Solid-State Calibrated Control Instrument

The instrument shown in Fig. 2 was developed to replace the conventional 'contact meter' in all applications. It is all solid-state in construction with the resulting advantages of increased reliability and versatility and reduced size.

The various component parts of the system will now be described with reference to the block diagram of Fig. 1.

**Sensor.** The input sensor is normally any electrical transducer that converts the sensed signal into a 75-mV d.c. input to the instrument. All other inputs, a.c. or d.c., voltage or current, are converted to 75 mV d.c. by means of rectifying, smoothing and attenuation networks. Other parameters to be controlled, such as speed, pressure, etc., are also converted by suitable transducers to a basic 75-mV d.c. full-scale value.

Temperatures up to about 800 °C may be sensed with platinum resistance thermometers and the resistance variation is converted into the basic 75 mV by bridge connection. Temperatures of over 800 °C are usually sensed with thermocouples and the signal is then of the

\* Kent Precision Electronics Ltd.

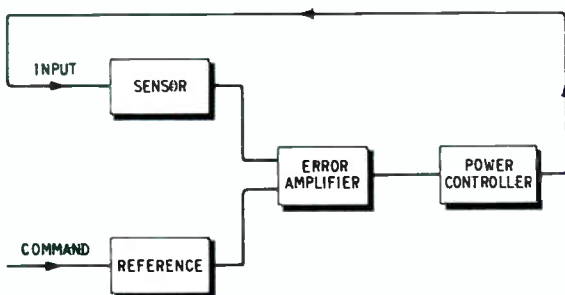

Fig. 1. Block diagram of the fundamental functions of a closed-loop control system

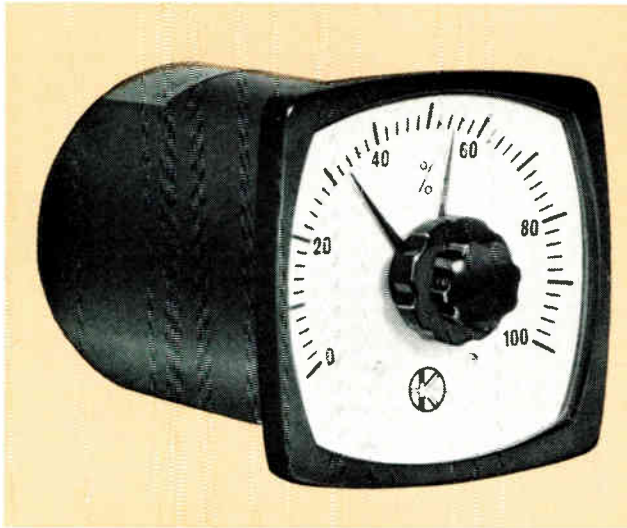

Fig. 2. The solid-state calibrated control instrument designed to replace a conventional 'contact meter'

order of 10 mV full-scale. Operation with low-output thermocouples raises a need for superior drift performance of the sensing amplifier, as will be presently discussed.

**Reference.** The reference voltage is provided by a semiconductor temperature-compensated assembly, including zener and forward-conduction diodes with a combined voltage-temperature coefficient of less than 0.006% per °C. Zener diodes with temperature coefficients as low as 0.0001% per °C are now commercially available. Normal industrial instrumentation requires an accuracy of 1% with about 20 °C ambient temperature variation and hence the zener references used must have temperature coefficients better than 0.05% per °C.<sup>1</sup>

**Error Amplifier.** A direct-coupled transistor low-drift d.c. amplifier is used for error amplification in the system, the use of which results in the overall advantages of small physical size, simplicity, low cost, and operational facility. The limiting factor of operation with this type of system is the zero drift. The drift of the reference voltage would either add to or subtract from that due to the error amplifier and so a drift performance better than that quoted is desirable. With source resistance of less than about 1 kΩ, good transistor low-drift d.c. amplifier design produces drift performance of better than 30 μV/°C using

unselected, inexpensive planar transistors in production quantities.<sup>2</sup>

The operation of instrumentation with electrical transducers for control of parameters such as pressure, flow, speed, etc., normally presents no problems in terms of input requirement, since the transducers can usually be designed for full-scale outputs in excess of 100 mV. However, for control of temperatures of over 800 °C, thermocouple operation is standard and instruments must be designed for a full-scale input of the order of 10 mV. Again, using the specification that stability to within 1% is required for a 20 °C ambient temperature variation, the drift required is 5 μV/°C which approximates to the limiting average performance of balanced transistor direct-coupled amplifiers. At the present time, balanced transistor pairs are available with differential base-emitter voltage-temperature coefficients of not less than 10 μV/°C maximum,<sup>3</sup> though the average value is usually of the order of 5 μV/°C. For more accurate operation from low output transducers, where drift performances of better than 0.5–1 μV/°C are required, temperature-compensated balanced amplifiers may be used,<sup>4</sup> though industrial instrumentation normally uses chopper-stabilized d.c. amplifiers for such applications.

One of the main advantages of d.c. amplifiers in control instrumentation is that operational feedback, function shaping and feedback of integral and derivative terms may be introduced relatively simply. The amplifier developed for use with the control instrumentation under discussion was used with various forms of operational feedback in applications of voltage and speed control; the nature and quality of the feedback depended on the various factors of the particular system and in all cases the performance was as expected.

**Power Amplifier.** The power amplifier consists of the trigger circuit, which senses the output of the error amplifier, and the thyristor output circuit, which controls the load power. Three types of power control circuits could be used, each with particular advantages and disadvantages for specific applications:

- (a) ON/OFF power switch
- (b) Variable phase-angle proportional control
- (c) Integral half-cycle proportional control.

For applications requiring control of powers above the maximum available thyristor ratings, or where thyristor control is uneconomical, or when isolated switching is required, an electromagnetic relay or contactor is switched ON or OFF at the precise point of control for what is known as 'bang-bang' operation. With this mode of control, a voltage threshold detector<sup>5</sup> is used to sense the

Fig. 3. The three basic thyristor output circuits which control the load power: (a) inverse parallel-connected thyristors, (b) four diodes and one thyristor connected in bridge form, (c) two diodes and two thyristors connected as a bridge

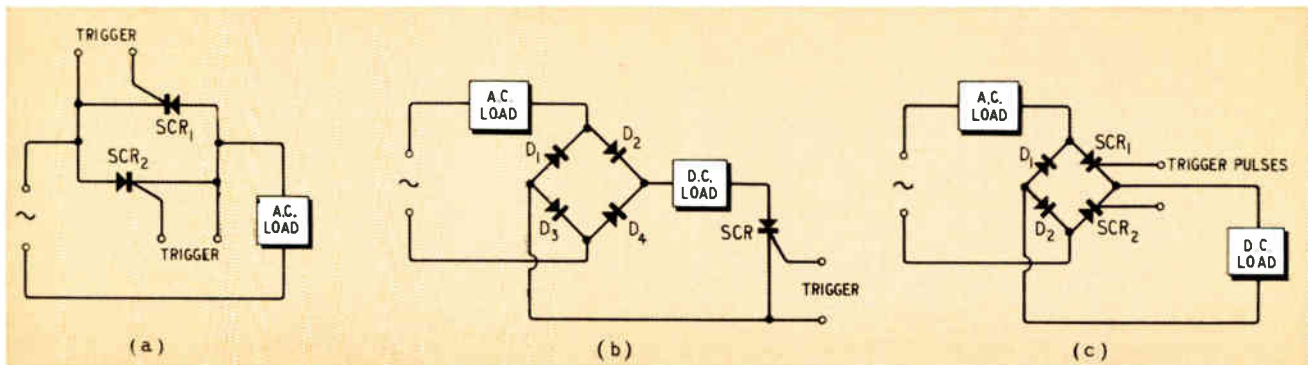

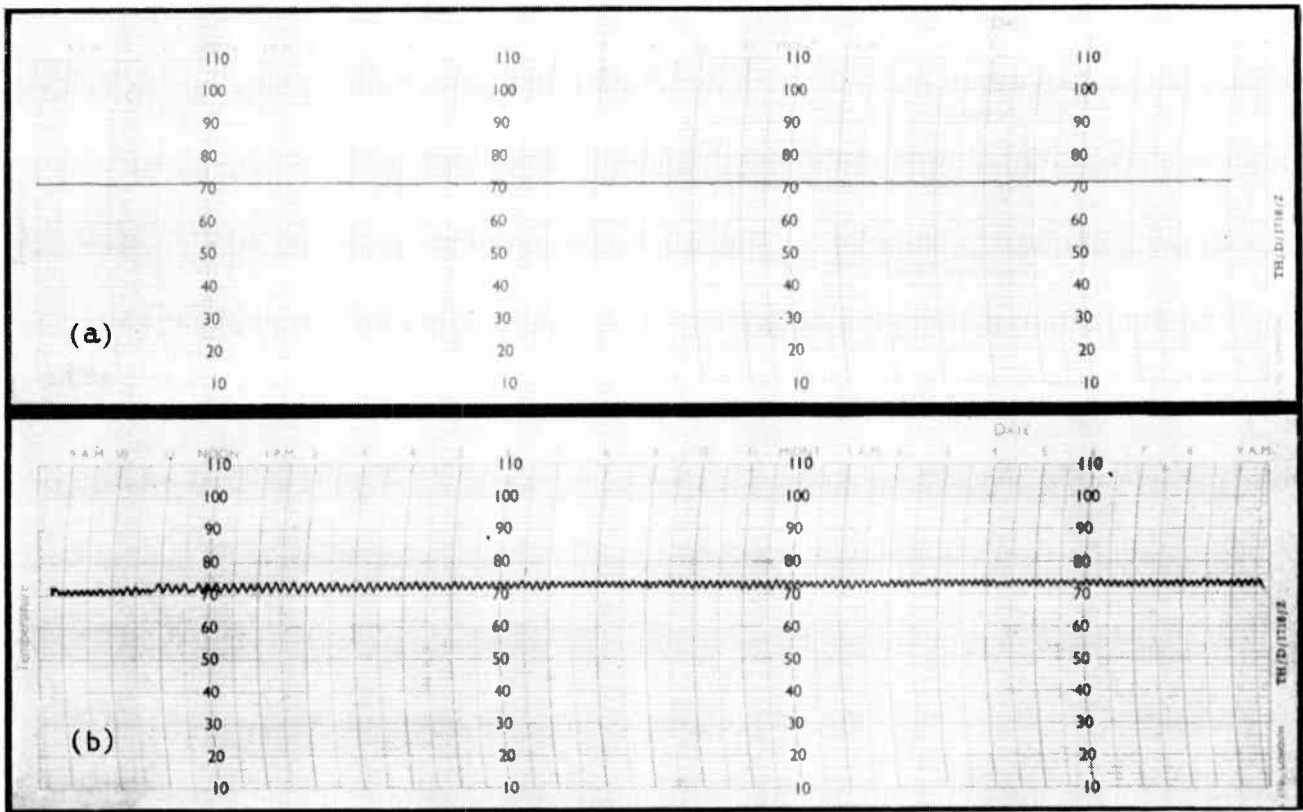

Fig. 4. Performances of two types of controlling systems used for temperature control in a domestic air-conditioning system: (a) graph obtained from integral half-cycle proportional control, (b) graph showing the performance of an ON/OFF controller

output of the error amplifier; when this is above the set level, a triggering pulse is delivered to the thyristor output circuit at the start of each half-cycle so that the output power is switched ON. The basic bang-bang controller is equivalent in all respects to the electromechanical-type ON/OFF regulator, with the advantages of solid-state operation. However, the use of an operational-amplifier input results in the further advantages of operational feedback to attain a required response and reduction of cycling by anticipating the control point.

The output circuit consists of either inverse parallel-connected thyristors, or four diodes and one thyristor connected in bridge form, or two diodes and two thyristors connected as a bridge. These three basic circuits are shown in Fig. 3. The choice of a particular configuration depends on the voltage and current capabilities of the thyristors and diodes available in a particular range.<sup>6</sup> Semiconductor manufacturers normally take the various factors into account when deciding upon a particular configuration, and thyristor/diode stacks are available for various voltage and current ratings. With the particular control system under consideration, the preferred configuration for single-phase circuits for control of non-inductive loads up to 100 A is that shown in Fig. 3(b). Since only one triggering pulse is required, the thyristor is never reverse-biased, and high voltage-surge capacity diodes may be used. The thyristors in Fig. 3(a) normally receive triggering pulses during each half-cycle and therefore also when they are reverse-biased, which causes deterioration of performance.

Proportional control of the output power is commonly achieved by variation of the phase angle at which the thyristor fires during each cycle. In the system under consideration, this method of power control is attained by

feeding a current output from the error amplifier into a capacitor. The time taken for the voltage across the capacitor to reach the threshold voltage of the trigger circuit to which it is connected is then proportional to the magnitude of the error signal. At the point of triggering, the charging capacitor is discharged into the gate circuit and the circuit is so arranged that the capacitor also discharges at the end of each half-cycle of the mains voltage, and therefore 'resets' the system. The gain of the amplifier is of such a magnitude that the firing angle varies from 180° to 0° for an error signal corresponding to 1% of the full-scale input. Using the proportional-control system described, the output power is switched fully ON when the controlled parameter is well below the set value, and switched OFF when it is well above this value. However, at the set point of control, the power is varied proportionally in such a manner that it maintains the controlled parameter at the set point.

Temperature-control systems using this method of control are usually accurate to within 0.5% of the full-scale value, provided the drift in the error amplifier is of a similar order. The natural thermal time constants in temperature-control systems normally result in one overshoot of temperature. However, where the system is used for motor-speed control and similar applications, functional feedback is normally required in the operational amplifier

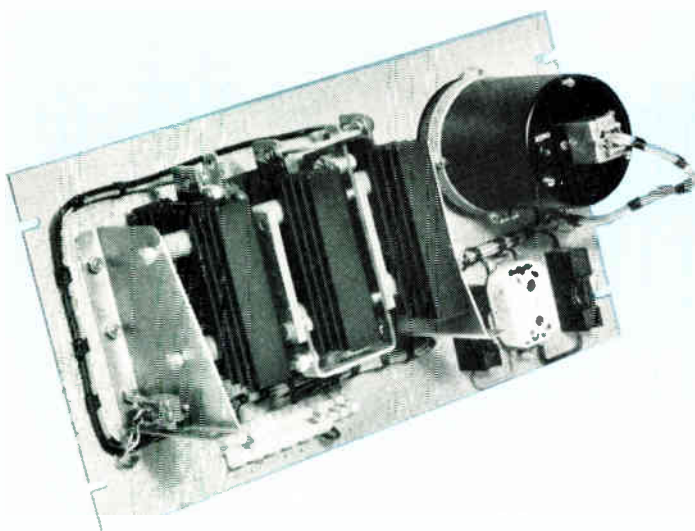
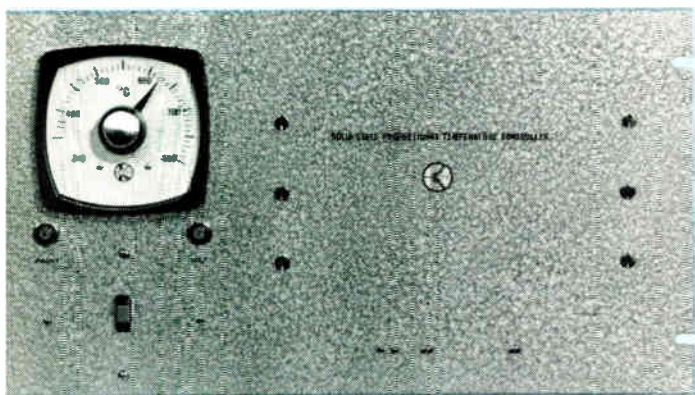

Fig. 5. A 10-kW temperature controller (front and rear views)

for loop stability. Reduction of dead space can usually be attained by the use of integral feedback.

The variable phase-angle method of thyristor power control has some disadvantages that limit its application. The thyristor is normally turned ON when the anode voltage is high, and the switch-on surges generate high-frequency harmonics which extend into the radio broadcasting band, causing interference. When more than one thyristor control system is used on a common mains supply, the interference generated causes interaction and spurious triggering between systems. When the controlled load is even slightly capacitive, the switch-on current surge could be considerable and operation with capacitive loads could cause damage to, or at least deterioration of, the thyristor characteristics, due to current and voltage over-swings. Furthermore, with variable phase-angle control, the power factor of the system is indeterminate and appears to be much less than unity even for resistive loads. While these effects are not very noticeable at low powers, they become objectionable when multiple phase-controlled systems are used at powers above the kilowatt range, and power measurements present problems. A further slight disadvantage is that the controlled power within the proportional band does not vary linearly with error.

All the defects of phase-angle control are overcome by what may be called 'integral half-cycle proportional control'.

With this method of control, the thyristor output circuit is switched ON for entire half-cycles and OFF for entire half-cycles, proportional control being achieved by variation of the ratio of the number of ON and OFF cycles. In the system under consideration, a slight modification in the trigger circuit is used to get a synchronized variable mark/space ratio oscillator. This is controlled by the error amplifier and triggers the output thyristor for integral half-cycles with an ON/OFF ratio, which varies linearly from zero to infinity and is proportional to the magnitude of the error signal. The gain of the system is set so that proportional control is obtained for an error signal representing 1% of the full-scale input parameter, the system being either fully ON or fully OFF beyond these limits. This method of proportional control is applicable only to systems having fairly long time constants, since the basic frequency of ON/OFF control is of the order of 0.5–1 sec. Therefore, while this method of control is ideally suited to temperature-control systems, it cannot be used for systems such as lighting control or motor speed control, which have small natural time constants and would therefore 'judder'. The system was used in a domestic air-conditioning system for temperature control, using a 10-kW heating element, and yielded the graph shown in Fig. 4(a); a performance similar to that of the variable phase-angle system was obtained. However, the improvements obtained with regard to interference-free and surgeless operation, with unity power-factor, were quite satisfactory. The graph in Fig. 4(b) shows the performance of an ON/OFF controller in a similar application. A photograph of a 10-kW temperature controller is shown in Fig. 5.

(To be continued.)

#### References

- <sup>1</sup> 'The Use of Voltage Reference Diodes in Stabilized Supplies', an A.E.I. semiconductor devices application report.
- <sup>2</sup> Pinto, J. J., 'Transistor Low-Drift Amplifiers', *Electronic Engineering*, May 1964.
- <sup>3</sup> Beneteau, P. J., and Murari, E., 'D.C. Amplifiers Using Transistors', *Electronic Engineering*, Vol. 35, 1963.
- <sup>4</sup> Middlebrook, R. D., and Taylor, A. D., 'Differential Amplifier with Regulator achieves High-Stability Low Drift', *Electronics*, July 1961.
- <sup>5</sup> Pinto, J. J., 'Semiconductor Time Delay Circuits', *Electronic Engineering*, March 1964.
- <sup>6</sup> SCR Manual — General Electric Co. of America.

## Telstar II Completes Two Years in Orbit

After completing 4,736 orbits around the earth, Telstar II, the experimental communications satellite, has now turned off its v.h.f. transmitter. This event was timed to occur after 750 days in orbit, in order to prevent its 136 Mc/s signals from interfering with other users and after all useful information had been obtained.

Designed and built by Bell Telephone Laboratories, of New York, Telstar II had three basic objectives: to learn how to extend the life of satellites in space, especially when affected by radiation; to observe its physical condition in space, in particular its temperature, pressure, spin-rate and spin-axis orientation; and to obtain more information on the space environment and the Van Allen radiation belts. It will still be able to transmit transoceanic telephone, television and data messages, since this information is carried on microwave equipment which continues to operate.





*Seen here is the monitor, video-tape recorder and camera control unit*

## British Rail Experiment with T.V.

**C**LOSED-CIRCUIT television has been brought into use by the Eastern Region of British Railways to combat trespassing on the line.

As an experiment, a camera has been installed at Elm Park station scanning the stretch of track on which a train was derailed in March this year.

Not only will the television screen give warning of trespassers, but the picture can be recorded on video-tape.

The installation uses a Philips PM 1000 weatherproof industrial camera with a Dennard outdoor pan and tilt head. These are mounted on top of a post at the end of the platform with the camera facing along the track towards Dagenham East. The camera is a high definition 8-Mc/s bandwidth type and it has a 3,000-1 automatic light level control.

The receiving and control equipment is sited in the porters' room. Between the 19-in. Peto Scott industrial monitor receiver and the control unit for the Som Berthiot zoom lens and the pan and tilt is a Philips EL3400 video-tape recorder. If anything suspicious is seen on the receiver the video-tape recorder can immediately be switched on. It will give up to ½-hr recording time and can then be played back at any time required.

*This shows the closed-circuit television camera mounted in its weatherproof case alongside the rail track*

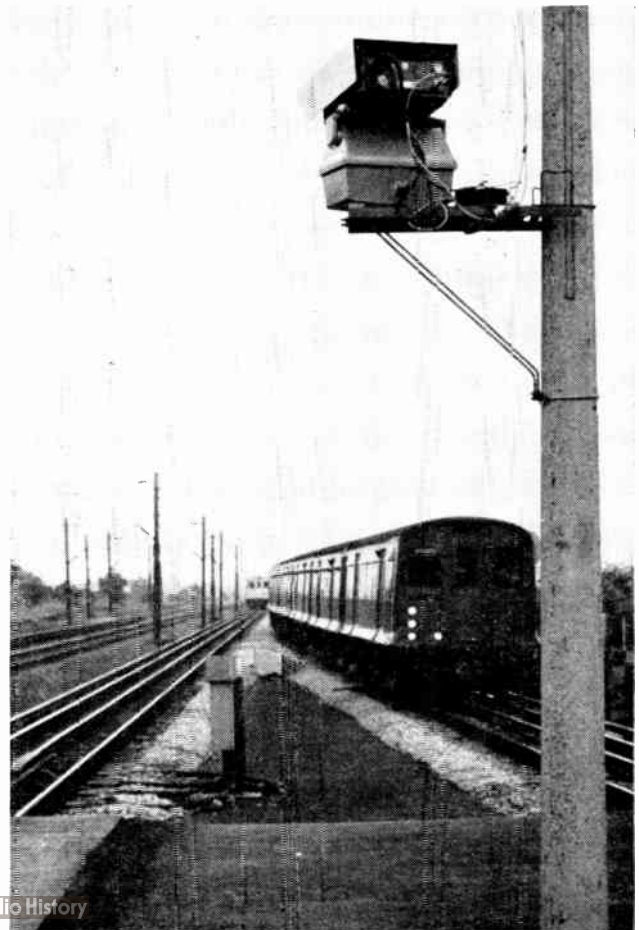

This article provides an introduction to video maps which are an essential part of present-day and future air-traffic control systems. The relationship of the scanning c.r.t., lens and map transparency are considered along with the other items which are basic to a video map.

# An Introduction to Video Mapping

By R. N. HARRISON\*

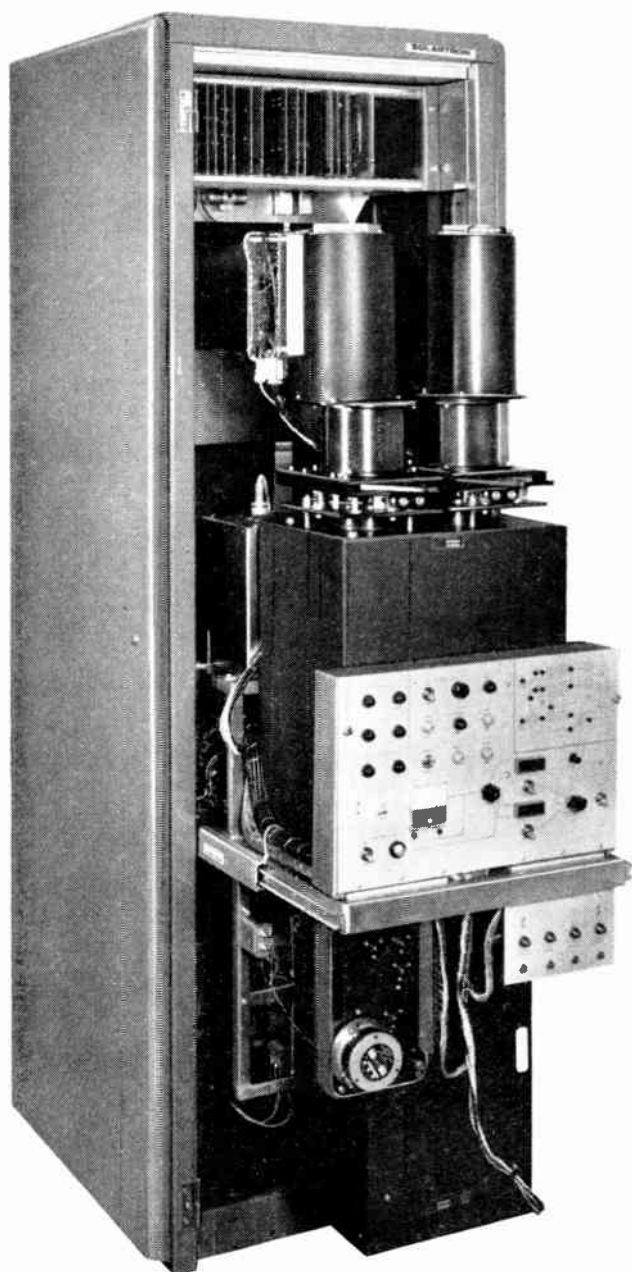

*The Solartron high resolution video map type SY 2046 with the optical table withdrawn from the cabinet. It will be seen that the bulk of the equipment is made up of mechanical, optical and electrical components. Apart from the head amplifiers the electronics of the system are contained in a single nest of cards at the top of the cabinet*

**T**HE two qualities required of the video map are accuracy and clarity—the latter not only in the map itself, but in relation to the radar picture with which it is associated.

The equipment does not itself display a picture. Its function is to reproduce an image as a video signal which is fed to the p.p.i. and displayed with the radar picture. In French, a video map is called a *générateur des cartes*—a map generator—and this is probably a better description.

Video maps are used by air traffic controllers and by defence radar operators: in the future it is possible that they will also be used in conjunction with harbour radar installations. They provide a means of associating a radar picture with geographic features such as coast lines, spot heights and prohibited areas, or with a reference system such as airway boundaries, beacons or the Georef grid. The controller uses the video map to establish precise positional information in terms which are understandable to the pilot. It is a tool which allows him to do his job more exactly—and by corollary, with greater safety.

The principle of using an analogue of the picture to be displayed—an image on a photographic plate or film—and illuminating it by means of a flying-spot scanner was worked out in its essentials in the 1940s. Two variations of this system have been produced. In the first the plate remains stationary, and is scanned by a spot travelling along sequential radial lines in a manner which corresponds to the p.r.f. and rotation rate of the radar concerned. In the second, the spot traverses a straight line on the face of the tube and the map picture is rotated about it. The second system has a significant advantage in that the path of the spot can be the full diameter of the tube. The smallness of the scanning spot relative to the length of the scan is the factor which determines the resolution. With a straight line scan along the diameter of the c.r.t., the resolution is axiomatically twice as good as in a system where the length of scan corresponds to the tube radius.

However it is by no means easy to make a rotating plate having no centre bearing, and there are difficulties in maintaining the accuracy where the scan begins at a point which is itself a deflection, and passes through the region of zero deflection to full deflection the other way.

To understand the problem, let us take separately the elements of accuracy and resolution. Accuracy is split into linearity and bearing accuracy because radar is in essence a means of measuring range and bearing, and the map affords a comparison in these terms between the target and its position on or above the earth's surface.

Bearing accuracy depends on a number of factors both external to, and within the video map. These include: (a) Accuracy of rotational information from the radar head; (b) Azimuthal accuracy of the chart from which the map-

\* The Solartron Electronic Group Ltd.

plate information is derived ; (c) Straightness of the path followed by the c.r.t. spot ; and (d) Accurate centring: the c.r.t. spot must begin its visible movement from a point on the map plate which corresponds exactly to the position of the radar head.

It is essential that accuracy be maintained. Any tendency of the centre to drift, for example, might mean that an aircraft instead of coming in to land down the extended centre-line of the runway might seem to be displaced towards one side. A correction based on the map information would then put the aircraft off its correct track.

Video map linearity is the accuracy of the relationship between the range of features on the map plate and the range of the picture as displayed on the p.p.i. There are two main causes of non-linearity. First, displacement of the scanning c.r.t. spot from the centre of the tube is by an angular movement of the electron beam, but the displacement of the spot takes place on the phosphor of the tube face, which is not itself the arc of a circle. Therefore constant angular displacement of a beam does not produce a linear shift. Secondly, an electron beam has inertia, and cannot instantaneously achieve its outward velocity from the centre of the c.r.t. If it starts from rest at the centre linearity will be affected.

Resolution is the ability to distinguish between two adjacent markings on the map plate, and the better the resolution the closer the markings can be together. The size of the markings does not enter significantly into the comparison of different resolutions. Resolution can be expressed as so many dots along the radius, or as a fraction in terms of radius or diameter. For instance 200 dots along a radius is equivalent to 200 white lines separated by 200 black lines. Each of these dots represents one part in 400 of the radius. There is no convention about using radius or diameter but it should be remembered that one part in 800 of the diameter is only one part in 400 of the radius.

Primarily, resolution is dependent upon the size of the spot of the scanning c.r.t., the bigger the spot the lower the resolution. This is not something which can be countered by drawing finer lines on the map plate. If the spot is big enough and the lines close together, a second line will be illuminated before the spot has left the first, so there will be no distinction between them.

If the scanning spot is big the map lines as seen on the p.p.i. will be thicker than required, and this effect will be particularly significant when the p.p.i. picture is greatly expanded at short range. Under these conditions the spot size of the scanning c.r.t. is, by magnification, many times the size of the p.p.i. spot. The amount of light emitted by a p.p.i. in respect of thick map lines may be over 95 per cent of the total light emitted, as compared with less than 5 per cent which represents aircraft. Such a relationship produces difficulties for the radar operator, and has been one of the factors which has militated against the wider use of video maps prior to the introduction of microspot c.r.t.s. Fig. 1 shows the transit of a c.r.t. spot across a line on a video map.

Small spot size is not only a matter of the right choice of scanning c.r.t. The video map equipment must be designed to maintain the spot at a minimum diameter over the whole face of the plate being scanned. This means that both optical and electromagnetic focus have to be kept within very fine limits. This produces a contradiction which the designer must solve. From the optical point of view the phosphor of the scanning c.r.t. should preferably lie in one plane, but this requires a flat-faced c.r.t., having increased beam length at the circumference compared with that of the centre. On the other hand if the face of the c.r.t. is curved to maintain the same radius for the electron

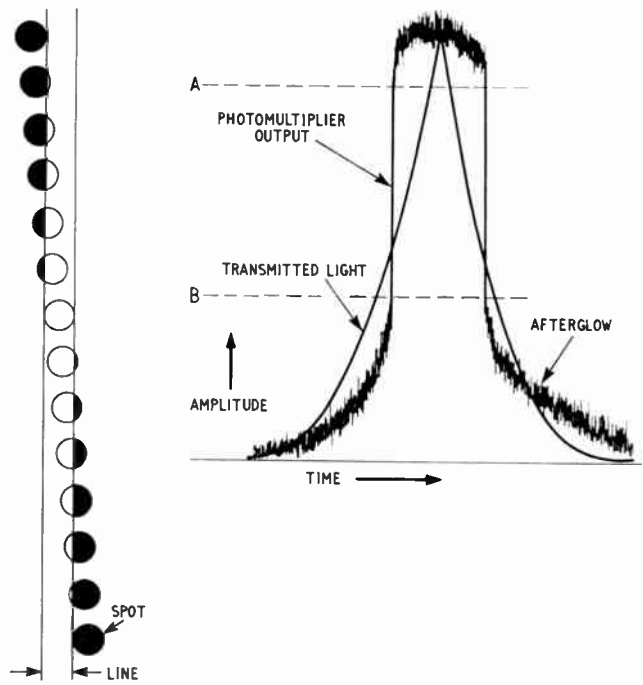
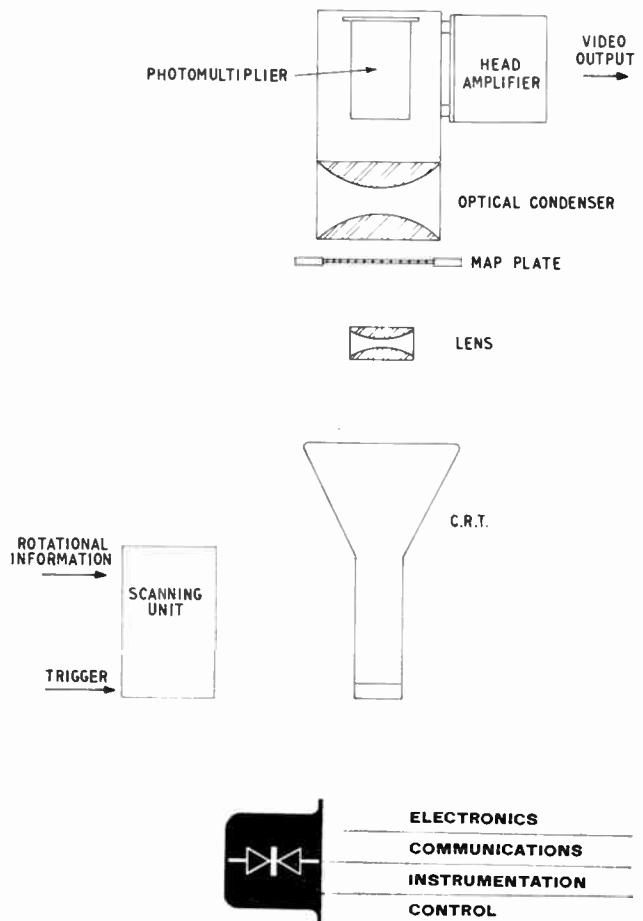

Fig. 1. Transit of a c.r.t. spot across a line on a video map plate. The two curves above show respectively the amount of light transmitted and the corresponding output of the photomultiplier. By chopping the video output below 'A' and above 'B', the video map produces a line with sharp edges and without noise

Fig. 2. Schematic diagram of the video map using a fixed map transparency:



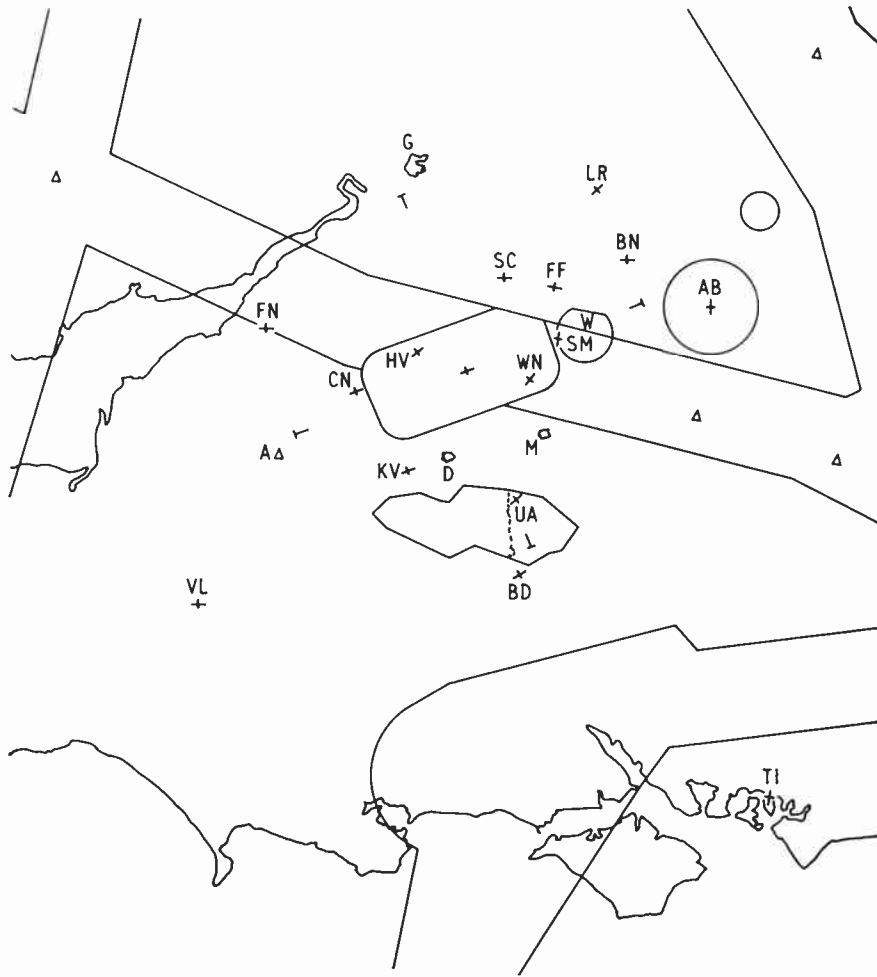

Fig. 3. This shows a portion of a video map master drawing. Open triangles represent reporting points. Airfields are shown by means of the instrument runway accurately inserted in respect of length and orientation, and marked by a short crossbar

beam, the depth of optical focus required will restrict the aperture of the lens (where one is used), or result in undue light spread where there is a direct relationship between the plate and the face of the scanning c.r.t. The curvature of the tube face will also result in map distortion of a type which it is not easy to correct.

So far we have considered only the relationship of the scanning c.r.t., lens and map transparency, but there are a number of other items which are basic to a map. These are illustrated in Fig. 2. On the input side there must be a scanning unit which takes turning information from the radar head and translates it into a rotational relationship between the map plate and the c.r.t. being scanned. The other input is the radar trigger, needed so that the c.r.t. spot can be made to move outwards along the radius of the map at a time which corresponds to the firing of the radar transmitter.

In the illustration, which is of a map with fixed transparency, the light passing through the plate is collected by an optical condenser so that the maximum amount reaches the photomultiplier. The photomultiplier is accommodated immediately above the condenser, and has its head amplifier alongside. The output of the equipment is a video signal

which can be passed directly to the p.p.i. display, and mixed there with the radar video. When mixing at the display is adopted, the radar operator has control over the separate video levels. The usefulness of this facility is enhanced by the ability of current video mapping equipments to produce thinner lines on the p.p.i. With thin sharp lines, operators can work satisfactorily with the map video level well down as compared with that of the radar video.

In the final analysis, the accuracy of the video map depends on the accuracy with which the map transparency and the scanning c.r.t. can be aligned. This can be put quite simply by saying that if two identical transparencies are used in two separate maps (or in two halves of a dual optic map), and if the video outputs from the two photomultiplier heads are combined at the display, the two map pictures should coincide.

Apart from linearity and bearing accuracy, this requirement makes three major demands on the system:

(a) The drawing and photography in transparency must be to a very high standard (Fig. 3 shows a portion of a video map master drawing); (b) There must be means of locating the transparency in relation to the scanning c.r.t. in terms of  $X$ ,  $Y$  and  $\theta$ , with provision for precise final adjustment; and (c) The gain of the video amplifier must be capable of being maintained exactly at a pre-set level.

Let us go back now to the rotational information. This can be transmitted as either changing a.c., changing d.c., or in digital form. Changing a.c.—taken from a mag'slip at the aerial head—is probably the most convenient form, but



changing d.c. can be used to achieve the same bearing accuracy at comparatively small increase in cost. With digital turning information, accuracy depends simply on the number of bits used, but the cost of translating the information is considerably greater.

Until comparatively recently, the manner in which rotational information was transmitted was not of any great significance, but now that more radars are being located at remote sites, the transmission of rotation information becomes important from a cost/distance standpoint.

It can be argued that it is better to put the video map at the radar head, and by transmitting mixed map and radar video, avoid altogether the problem of transmitting extremely accurate rotational information. There are a number of objections to this, not least that it limits the map/radar relationship to a 1 : 1 basis. It is accepted that different operators using a single radar frequently require different video maps, even when working in the same field of operation, and joint military/civil use of radars makes it essential to provide a choice of map. It would be possible to locate several video map equipments at the radar head and transmit a choice of mixed outputs, but this increases transmission difficulties rather than reducing them.

In thinking about transmission problems, we have touched upon the question of the operators' requirements. In this introduction to video mapping it is worth considering some of the points which operators find important :

(a) The map should be accurate, and the accuracy should be demonstrable at any time against (say) range marks and angle marks ; (b) The map should be thinly drawn and there should be no part of it which has an unduly high brilliance level compared with the remainder ; (c) It should be possible to adjust the relative video levels so that the map never obscures the radar picture ; and (d) The map should contain all the information necessary and no more.

For many years operators have used range and bearing as a means of defining position. They have in fact related the position of an aircraft to that of the radar site. This is not an adequate means of controlling aircraft in controlled airspace, and with remote radars it is in any case no

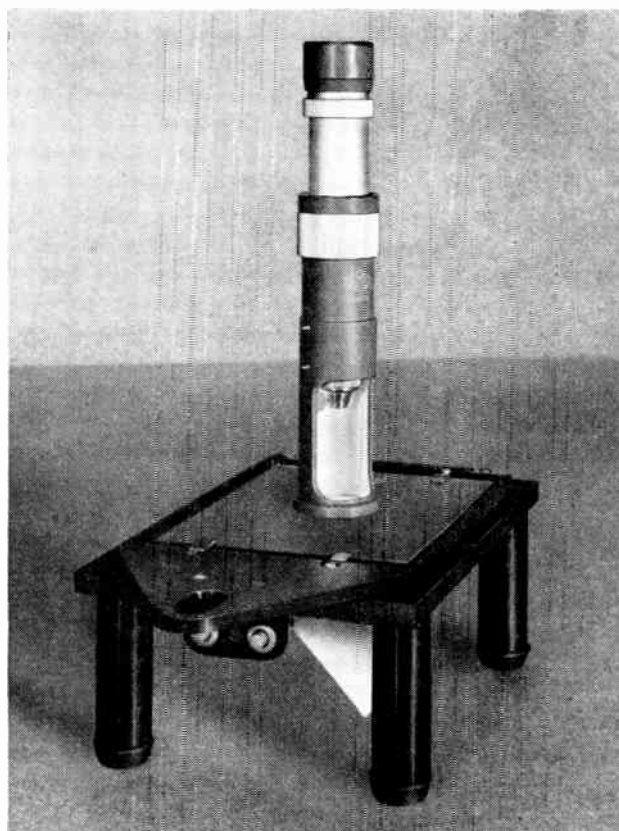

*A video map plate being aligned in the map plate carrier using an alignment jig and a calibrated microscope*

longer practicable. It is fortunate that the current improvements in video mapping have come at the time when radar operators are being displaced from their position at the centre of the world they survey.

## New Technique Improves Telephone Cables

*Elly Enfield Tubes have been awarded a contract to supply the G.P.O. with more than 750 miles of  $\frac{1}{4}$  in. o.d. aluminium tubing p.v.c. sheathed. The tubing will be used in a new G.P.O. plan to prevent major breakdowns in the underground cabling that leaves main exchanges all over Britain. Desiccated air at a pressure of 9 lb per square inch will be passed into these tubes which link up with the main cables.*

*A frequent cause of previous breakdowns has been cracking and corrosion of the lead sheaths of the cables, thus letting in damp and causing low insulation resistance. The compressed dry air will withstand the entrance of water to a depth of 22 feet.*

*The G.P.O. believes that this new method will help to provide a more reliable service for its customers and reduce maintenance costs.*

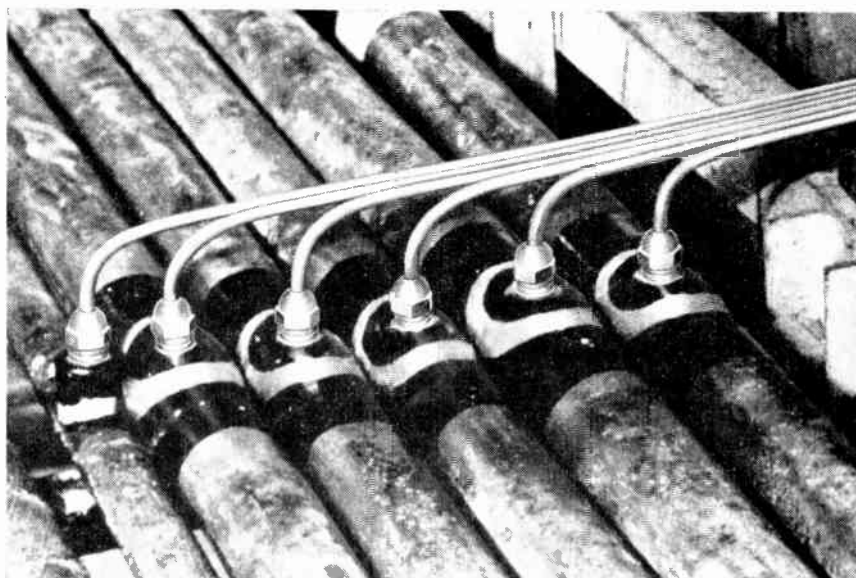

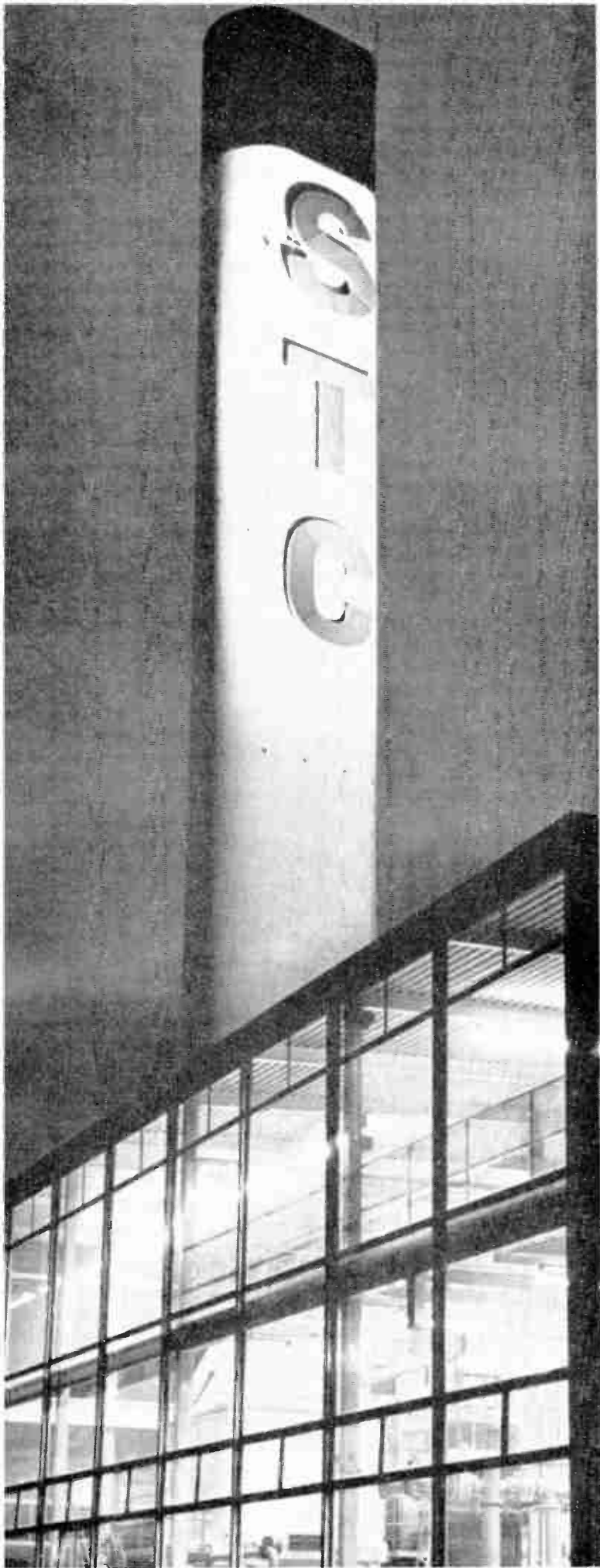

# New Communications

A modern communications plant, the new factory of Standard Telephones & Cables at Basildon, Essex, was officially opened recently by the Postmaster General, the Rt. Hon. Anthony Wedgwood Benn, M.P.

Costing some £2½ million and covering 450,000 sq ft this is the largest single expansion of STC since the war and is also Europe's most modern plant for producing telecommunications equipment.

The Transmission Systems Group, which has now established its headquarters at Basildon, is one of the three major product groups in STC. It consists of five manufacturing Divisions—Land Line Systems, Microwave Systems, Submerged Repeaters, Testing Apparatus, Transmission Supplies—together with Group Marketing and Installation Divisions.

The greater part of the Division's production at Basildon



▲ These giant turntables are novel in that they bring mass production efficiency to small quantity runs. The outer concentric rim revolves independently of the inner turntable. Up to twenty circuit boards can be mounted on the outer rim and nests of trays containing components are fixed to the inner turntable. In this way, the operator can first assemble one type of component on to each of the circuit boards and follow with a second type of component and so on. The advantage came from the fact that while the operator will be slow when assembling a component on to the first two or three boards her speed and efficiency are quickly increased

# Plant at Basildon

and the satellite factory at Newport covers carrier multiplex equipment. This equipment, by which large numbers of voice-frequency channels are 'stacked' into a wideband signal for transmission over cables, radio links, submarine cables or satellites is now completely transistorized. The multiplex channel unit—the basic unit of long distance telephone systems—has become progressively smaller, more reliable and cheaper.

Similarly, the trend to miniaturization has led to compact repeaters that can be placed in manholes, thus doing away with the necessity for costly repeater buildings.

The planning of the factory takes into account that the equipment to be produced ranges from small quantities of very specialized devices to very large numbers of simple parts. The accompanying pictures illustrate some of the techniques adopted to meet the diverse needs of production.

*Flow-soldering is one of the production techniques used for the assembly of telephone terminal equipment. This machine shown here was designed and constructed by STC engineers. When components have been assembled on the boards all of the soldered joints are made in one operation on this machine. The boards, fitted in special jigs on an endless belt, pass over heaters, through flux and then over a bath of molten solder. Although this is still being 'run-in' only 4% of the soldered connections do not come up to standard on inspection*

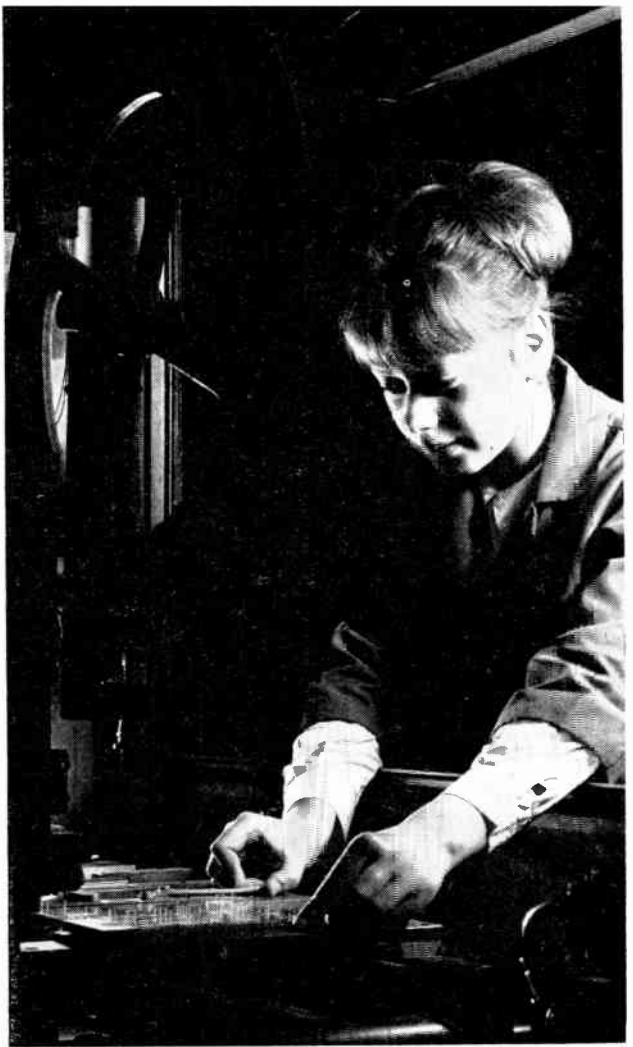

*Many machines which are automatically controlled by punched tapes are used for drilling printed circuit boards and inserting small terminal posts. Here the operator removes a finished board from one of the machines*

*The training of both operators and apprentices for the manufacture of complex technical products always poses problems. STC have solved these problems by setting up a really extensive training centre which uses all of the modern training aids including films, film strips, slides, models, etc. The average period of training for each operator is six weeks. Seen here in the training centre is one of the apprentices studying the design and construction of one of the latest component assemblies used in transmission equipment*



**Speedy and reliable intercommunication systems are becoming more and more important in industry and commerce. This article describes many types of systems that are available and the facilities provided by them are discussed**

**T**HE importance of speedy and reliable communication has been recognized as of paramount importance in the economics and efficiency of industry and commerce. Greater demands than ever before are being placed on all electronic equipment and on intercommunication systems in particular. In order to meet these demands manufacturers have made miniaturization a keynote of much development work and in this respect communication equipment does not lag behind. Mobility is another factor of increasing importance in this field, for many people in business so often find themselves 'tied to the telephone' that it is now necessary for them to reverse the procedure and literally to take their telephones with them wherever they go. The number of users of the available intercommunication facilities is growing ever larger and the G.P.O. and telephone equipment manufacturing companies are developing electronic instrumentation of increasing complexity and diversity in order to cater for the new requirements.

Recent years have witnessed great advances in the design and reliability of new equipment from the elementary and

Line communication is also inconvenient and at times impossible when it is required that one or more of the terminal stations should be mobile. Operators of police-cars, fire-engines, ambulances and many other vehicles require to communicate with a fixed base station. Hudson Electronics Ltd. manufacture both f.m. and a.m. v.h.f. radio-telephone systems for mobile use and the equipment provides one or more operating channels from the base station which may also be used as a repeater station. Similar equipment is produced by Ultra Electronics Ltd. who are concerned also with miniature communication transmitter-receivers and with one-way receivers. These units are fully transistorized and are suitable for all applications where individuals on foot need communication with a base station.

G.E.C. (Electronics) Ltd. are also in this field with their 'Lancon' pocket two-way radios. Plessey-U.K. Ltd. manufacture a larger one-man transmitter-receiver primarily intended for military use and accompanied with it is a complete system for communication between a base-station and mobile-stations.

#### **Paging Systems**

Miniaturization of transmitters and receivers has made possible personal paging systems. Each of a number of individuals carries a small receiver which is in radio contact

---

# **Intercommunication Systems**

---

robust speaking-tube (still used in marine transport) to complex private telephone systems. These advances have resulted in a comprehensive range of intercommunication systems for industrial and similar applications. In this article we discuss some of the different types of equipment available and describe the facilities they offer.

#### **Radio Telephone Systems**

Communication via a line or cable is often inconvenient. This occurs when receiving and transmitting stations are in remote regions or situated on terrain where line construction is impracticable or uneconomic. Under these conditions radio links have to be used. These radio links, such as the type 700 single-channel radio-telephone equipment of the Automatic Telephone and Electric Co. Ltd., extend existing line telephone networks to sparsely-populated or underdeveloped areas. The A.T. & E. equipment operating in the v.h.f. band, as do most radio-telephone links, is fully transistorized and can, therefore, be powered by a 12-V battery. All the facilities normally provided for subscribers on the line telephone network can be provided for the user of radio-telephone equipment. The transmitter is switched on when the handset is lifted and dialling is exactly the same as for a normal system.

with a central control transmitter. When called from the central control the person concerned can go to the nearest telephone in order to reply or, as is provided by some other designs such as the Multitone Electric Co.'s system, he can talk back using a portable transmitter. This transmitter is small enough to fit in the palm of the hand and the receiver may be carried in the top pocket of a jacket. These systems have been installed in hospitals, factories, business organizations and similar establishments. Simpler paging systems are marketed by Cass Electronics Ltd., with their 'Tele-tracer' system, Telephone Rentals Ltd. and other companies. These consist of a centralized transmitter, or a small number of transmitters, working in the v.h.f. band. Associated with the transmitters are a number of personal pocket receivers. When a particular individual is required a signal is transmitted which causes a buzzer to sound in the receiver of the person concerned. This person then goes to the nearest telephone. Even simpler paging systems are available like that of the Reliance Telephone Co. Ltd. Particularly useful for noisy locations, it uses a system of coloured lights. Key personnel are allotted codes composed of combinations of four steady or flashing lights which are displayed in prominent positions and wired to a central control. An audible signal can also be provided to attract





▲ The Ampliphone headset with ear defenders and attached microphone

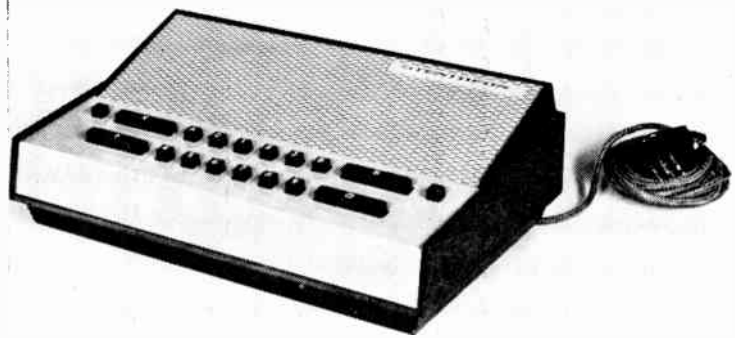

▲ Derritron Electronics' Duplex system control unit for up to several hundred extensions; it has fully voice-operated units and multiple speech channels. Microphone and loudspeaker are separate within the cabinet and no instrument control is necessary by the person called



▲ The Plessey A13 radio set in the one-man pack form

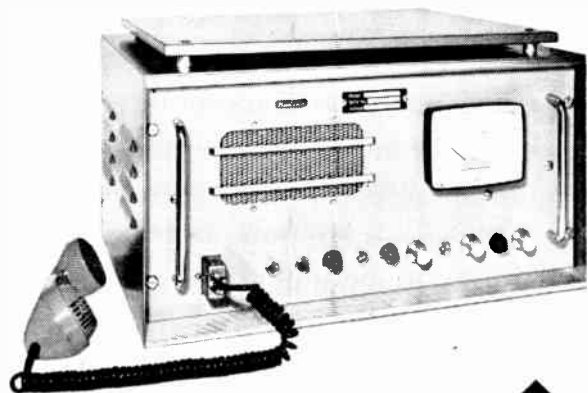

▲ The Hudson fixed radio telephone station model FM120



▲ The Pye 'Edas' master telephone station with push-button 'dialling' and automatic selection of any one of 19 preselected extensions

▲ The automatic send and receive model 32 A.S.R. Teletype Page Printer of G.E.C.

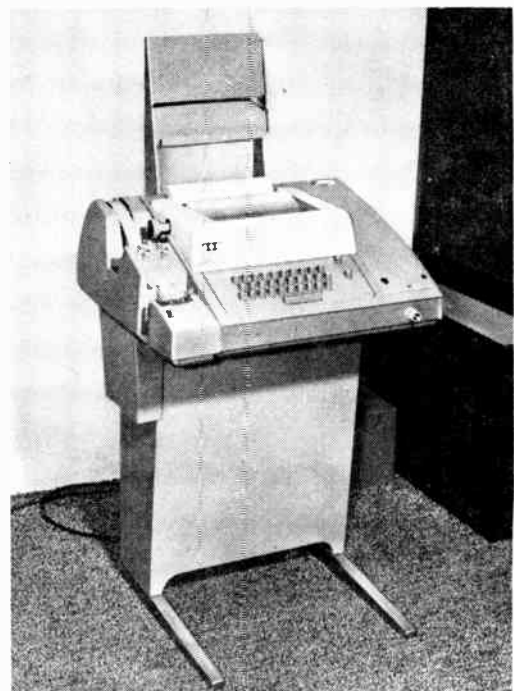



▲ The Ultra 3A4 Packset being used at a golf tournament to relay scores to the clubhouse

Checking a demonstration model of A.E.I.'s Automatic Number Identification (A.N.I.) equipment which identifies the exchange and number of a telephone subscriber making a call on S.T.D.

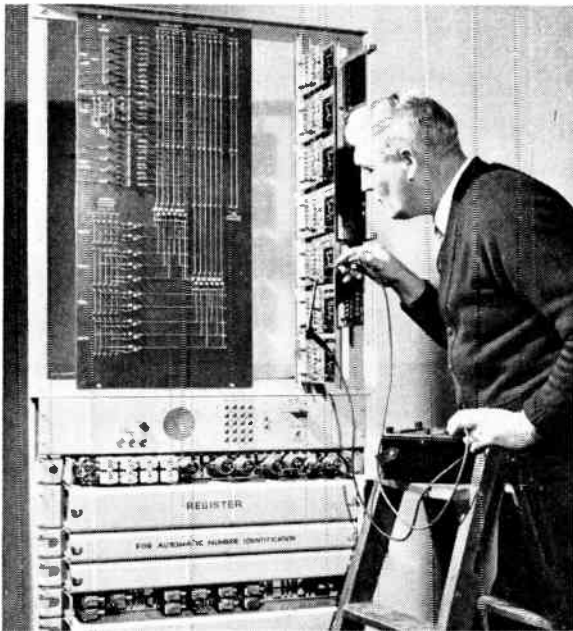

▶ The Multitone 'Talk-Back' transmitter



▲ An S.T.C. transistorized loudspeaking telephone, which can be linked with any internal telephone system of the automatic step-by-step type in addition to giving direct connection with up to ten key internal stations. Special operations, such as priority signalling and outside line selection, are controlled by the press buttons in the top



▲ A Reliance desk unit, which enables telephone communications to be established without using a handset. A microphone on the desk picks up speech from any part of the room while an amplifier ensures that the incoming conversation is loud and clear. A handset is provided for private conversations

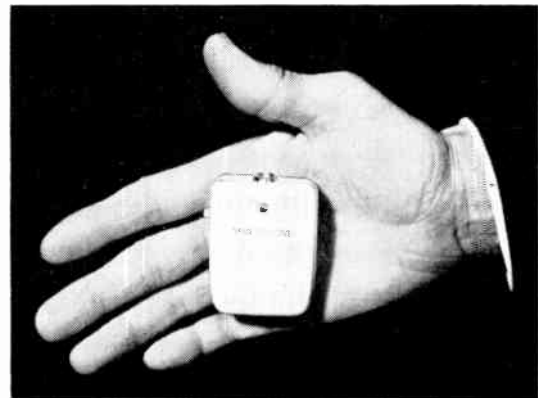

attention. Hospital paging systems are available and the type produced by G.E.C. (Electronics) uses a luminous call system. Two-way speech facilities between patients and nurse are provided over a telephone link and a light shows a particular nurse that a patient requires attention. Unlike the paging systems mentioned above, these last two are static wired systems not employing radio contact.

### Other Radio Systems

One-way radio communication is provided by radio-microphones and these were initially designed for artists and interviewers in radio and television broadcasting. A pocket transmitter is connected to a microphone and a nearby receiver picks up the radiated signals from this, detects them and feeds the output to a public address or other audio system.

An example of these radio microphones is the Model FMT/604 produced by Lustraphone. This transmitter is crystal controlled and operates in the frequency band 174.6-175 Mc/s with a power output of 10 mW. The unit measures  $3\frac{1}{16} \times 2\frac{3}{4} \times 1$ -in. and weighs approximately 6 oz. only. Other models are available which combine both microphone and transmitter in a single tubular construction which can be held in the hand. Such equipment is suitable for any application where public address is required without the encumbrance of trailing wires to the microphone.

The idea of using a modulated radio-frequency carrier is not limited to systems employing radiation to and from an aerial. With some equipment, like the A.E.I. 'Clearcall Carrier' system which has been designed for industrial use, the modulated carrier is fed along a line. The advantage of this is that more than one channel is provided over one twin-core or coaxial cable, each channel having a different carrier frequency, and in this way ten channels are available with the low-frequency 'Clearcall' system. The transmitters and receivers need not be connected directly to the cable and a certain amount of mobility is possible if they are inductively coupled to a nearby length of cable carrying the radio-frequency signal.

A combination of an intercommunication system and a broadcast radio receiver is often used for providing the facilities of both to a number of rooms or departments of a building without duplication of cables and loudspeakers. A feature of such systems is that messages can be relayed to and from a control unit and any one room over the intercommunication part of the system without disturbing the broadcast radio programmes being fed to the other rooms. Redifon Ltd. have applied this system to ships and sea-going vessels with their Marine Intercommunicator which includes a public-address system. The additional accessory of a baby-alarm, which automatically alerts the control unit when a baby cries for attention, is available with the Newlyn Electronics Ltd. system which is primarily intended for hotel and guest house use and employs a v.h.f. receiver capable of handling two broadcast channels.

### Trailing-Wire Personal Intercommunication Systems

For some applications a complex radio system is not required and it is economical and just as convenient to use one of the trailing-wire systems currently on the market by which individuals communicate via lines interconnecting telephones or headphones and microphones with associated amplifiers. A portable system, which may be fitted as a temporary installation on building sites and similar loca-

tions, is provided by the Stanofone manufactured by S.T.C. Ltd. This gives clear communication over distances of up to 20 miles using a pair of wires or a single wire with an earth return and combines all the necessary equipment, including batteries, in a lightweight hand-set. Distance is not the only factor to be overcome by intercommunication systems, high ambient noise levels also sometimes have to be counteracted. The Transifone, manufactured by Lustraphone and marketed both by them and the Marconi Marine Co. Ltd., is one of the many similar telephone systems designed for use under such conditions. It consists of ear-padded headphones with an attached microphone of the noise-cancelling type associated with a transistorized pocket amplifier. This system is of low cost and portable and has the advantage that the user has both hands free at all times while communicating. Various types of headphones and microphones are available including a noise-cancelling microtelephone type. Amplivox Ltd. manufacture a similar system and some of the headphones supplied by them are fitted with ear defenders which protect the user's ears against excessive noise produced by machines or installations surrounding him.

### Systems and Accessories

The inconvenience of having to go to the front door or an entrance lobby of a building in order to receive a visitor is eliminated by the intercommunication systems connecting a loudspeaker and microphone panel at the door to internal telephones. Connection can be made to any one of a number of 'phones and the door can be automatically operated by pressing a button on the 'phone. Systems such as this are manufactured by A.E.I. and Modern Telephones (Great Britain) Ltd.

The use of tape recorders associated with a telephone makes it possible to record messages from callers while the person being called is not available to answer the 'phone. Conversations can be recorded for reference purposes and the Tel-Stor system of Shipton Automation (Sales) Ltd. can be set to give a recorded reply to callers as can the Ansafone. Another recording accessory is the Dictaphone system which is also used for recording telephone conversations and for recording dictated letters or messages to be passed on for typing. It uses a non-magnetic type of recording tape. Shipton are also among the manufacturers of the language laboratories which combine a recording system with two-way communication to and from a central control.

Communication of messages in a written form is also possible with the teleprinters available from a number of firms. Equipment suitable for this is the G.E.C. Teletype Page Printer which will transmit information over telephone wires and the transmitters and receivers are capable of page printing, tape-punching and tape reading. This system uses a typewriter keyboard but the Electrowriter, manufactured by Shipton Automation, will transmit hand-written messages as they are being executed.

Each company within industry has its own particular communication needs, most of which can be met by existing equipment. Future research and experimentation will perhaps progress towards the concept of a unified all-purpose circuitry system into which a comprehensive range of plug-in transistorized units for both audio and visual communications may be inserted as required. A service whereby any person can communicate at once and at will with any other person at any time and in any place is the ideal.

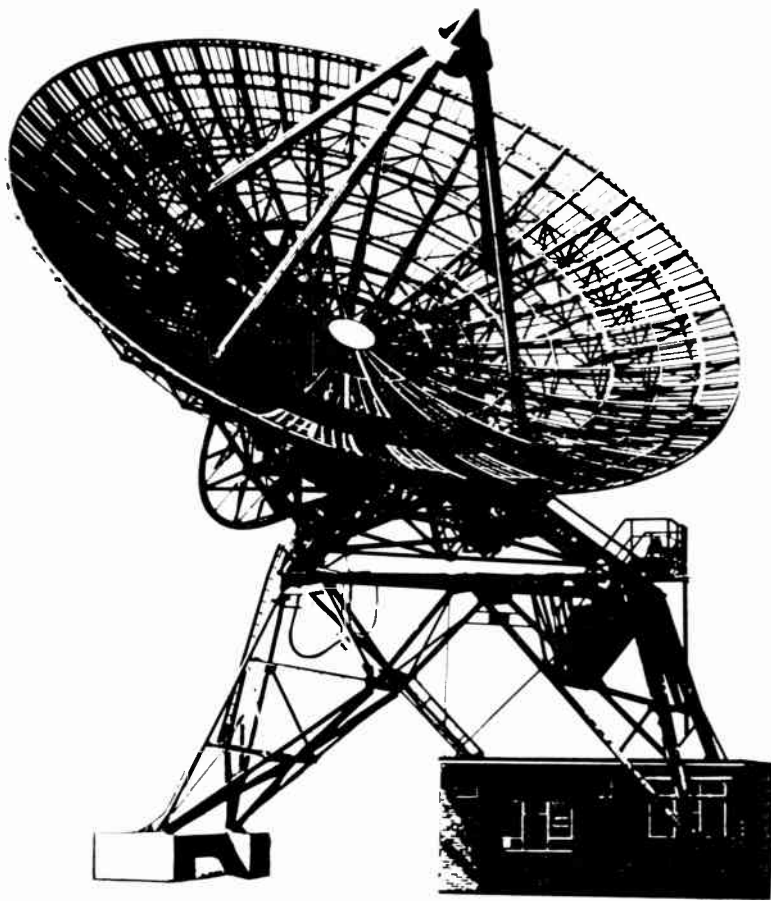

# NEW RADIO TELESCOPE AT CAMBRIDGE

**A** SCIENCE RESEARCH COUNCIL radio telescope was recently inaugurated by the Minister of State for Education and Science at the Mullard Radio Astronomy Observatory, Lord's Bridge, Cambridge. Construction of the telescope commenced in 1962, with the aid of a grant of £570,000 from the Department of Scientific

and Industrial Research, but research in radio astronomy has been going on at the Cavendish laboratory since 1946, under the directorship of Professor Martin Ryle, F.R.S.

Radio astronomy is the study of celestial objects from the radio waves they emit. Observations made with radio telescopes provide information about our galaxy (the Milky

*The control room of the new radio telescope. Dials on the console show the positions of the three reflectors, which are controlled automatically by the programme tape and reader on the left. The receivers are grouped in the racks on each side of the console*

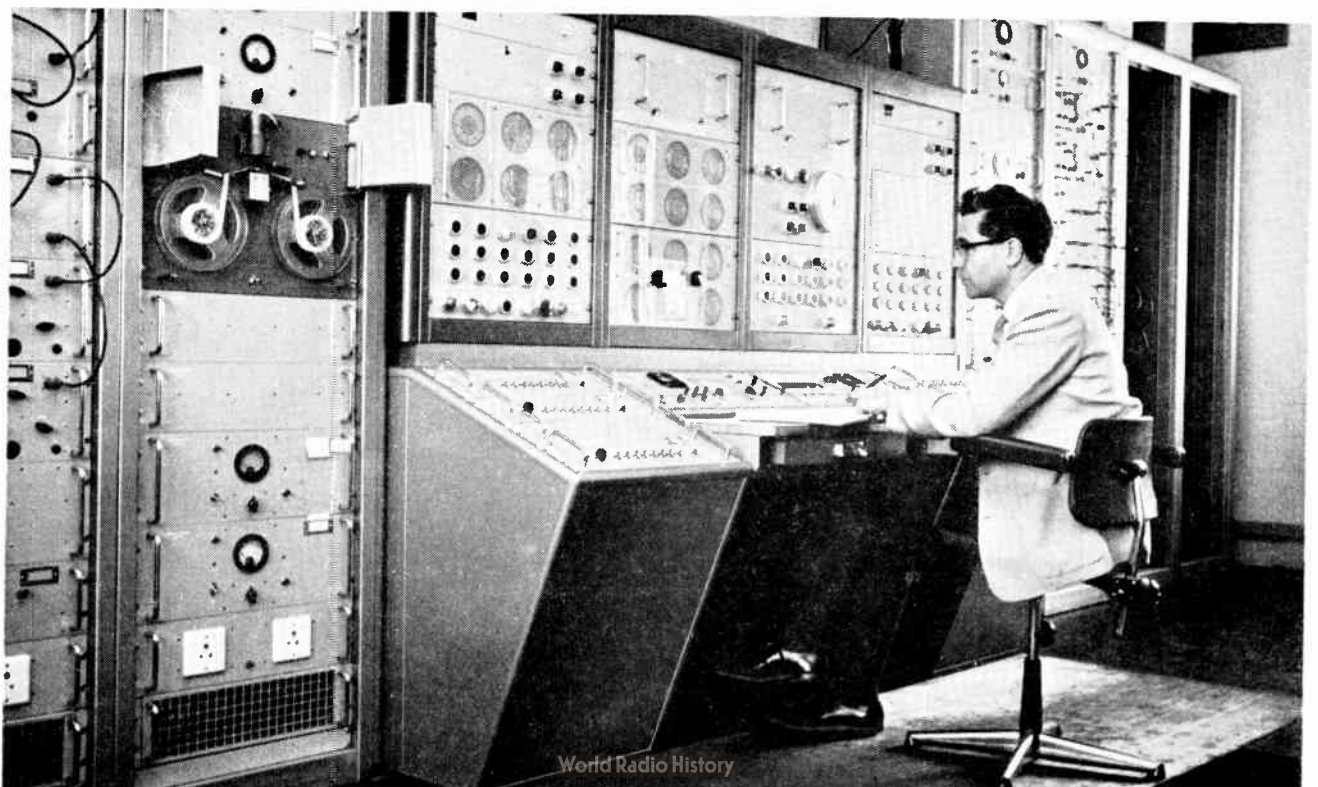

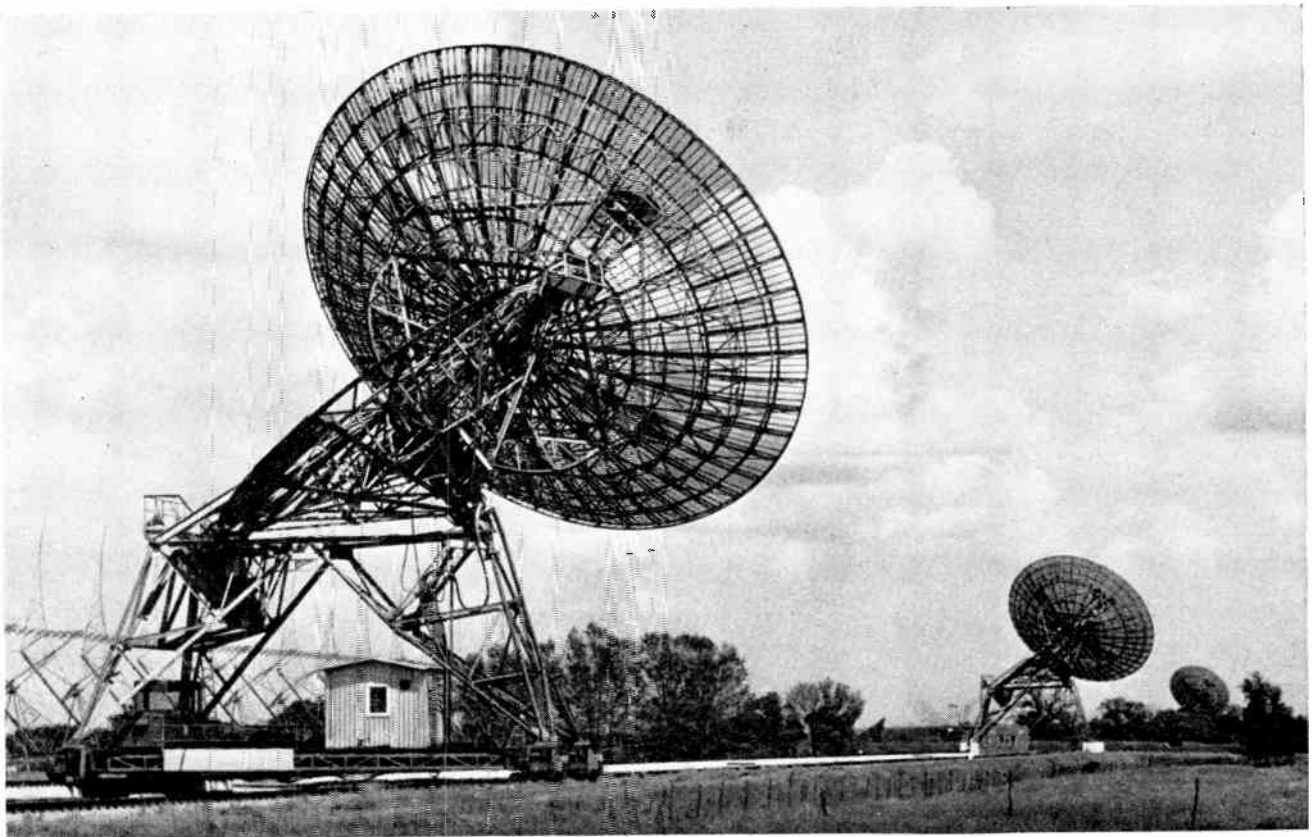

*The new telescope's three paraboloidal reflectors, which are equivalent to a single reflector one mile in diameter. The carriage of the reflector in the foreground may be positioned along the 2,600-ft rail track to an accuracy of  $\frac{1}{8}$  in*

Way system) and about radio galaxies and quasars (quasi-stellar radio sources). The radio waves from some of these latter have been travelling to us for thousands of millions of years and indicate what the Universe was like in the distant past.

A radio telescope consists of a directive aerial system connected to a highly sensitive radio receiver. The ability to separate two close sources depends on the size of the aerial and the operating wavelength, finer detail being achieved with a large aerial and short wavelength. The use of very short wavelengths, however, means that a very large aerial must be built with great precision and at a correspondingly great cost.

A more economical technique has therefore been developed at Cambridge; it is based on the use of two or more small aeriels which are moved so that they occupy, successively, the positions of the individual components of a much bigger aerial.

The new radio telescope has three 60-ft-diameter reflectors, two fixed 2,464 ft apart and one movable; they are arranged on an east-west axis and can follow any point in the sky.

Because of the rotation of the earth, two rings of a large equivalent aperture are built up each day and, by daily alteration of the position of the movable aerial, further rings are scanned until a resolving power equal to that of a paraboloidal reflector one mile in diameter is achieved. The telescope observes simultaneously on two wavelengths of 21 cm. and 75 cm., feeds its results into a computer and takes no longer to survey a given area of sky than would the complete large aerial.

The main effort at the Observatory has been concentrated on the study of extragalactic radio sources, a substantial

minority of which are the remarkable quasars. These represent by far the greatest concentrations of energy known in the Universe for, although only 1/100th the size of a galaxy, they emit extremely powerful radio waves and have 100 times the optical luminosity of the brightest galaxies known.

The importance of radio astronomy has been recognized in this country not only because of the lead we at present hold over the rest of the world, but also because many of the advanced developments in radio telescope and receiver design have been applied in such fields as satellite tracking, communications and automatic instrument control.

Furthermore, the resulting opportunity for scientists to undertake fundamental research is meeting the urgent need for training experts in the fields of space research, electronics and automation.

#### INFORMATION WANTED ?

If you require further details of products or processes described or advertised in INDUSTRIAL ELECTRONICS you will find it convenient to use the enquiry cards which will be found immediately preceding page 395. The sheet of cards can be folded out to enable you to make entries while studying the editorial and advertisement pages.

**A**LTHOUGH light is usually considered to be rather outside the field of the electronics engineer, it is becoming increasingly a concern of his. The photocell is the link between light and electronics and is very much within the province of the electronics engineer.

Those who are not steeped in the technicalities of light often find the quantities involved, and the units in which they are measured, very confusing. There are many different units and sometimes they appear to be used wrongly!

The four quantities are:

**Luminous Intensity.** This refers to the total amount of light which is produced by a source of light. It is the light power produced by a source, and usually a point source.

**Luminous Flux.** This refers to light as it exists as an electromagnetic wave. It is again light power as it exists in transit in a propagating medium.

**Illumination.** Sometimes called *illuminance*, this is the light power falling on a surface. It is usually expressed as a power density (power per unit area).

**Luminance.** This must be carefully distinguished from illuminance. It is used for a surface regarded as a source of light. When a surface is illuminated some of the incident radiation is reflected or diffused from that surface. Some of the light may pass through the material and be radiated from the surface on the other side. Luminance refers primarily to what may conveniently be termed reradiation from a surface. However, the term is also sometimes used for a primary source of light of extended area, e.g., electro-luminescent panels.

At one time luminance was called brightness but now the latter term is reserved exclusively for the subjective effect. Careful reading of the older textbooks is thus necessary to be sure which meaning of brightness is meant.

Usually, luminance is the luminous intensity per unit projected area of a surface in the direction from which it is viewed. There is a second definition, however, which refers only to a perfectly diffusing surface for which the luminance is independent of the direction of viewing. It again refers to the luminous intensity per unit area, but the direction of viewing, and so the projected area, do not come into the matter.

### Units

All the quantities concerned are either powers or power densities. In the International System (S.I.) Units, which is the m.k.s. system with additions (see B.S. 3763:1964), the units are the candela for luminous intensity, the lumen for luminous flux, the lux for illumination and the candela per square metre for luminance.

The basic unit is the candela and it is such that the luminance of a full radiator at the temperature of solidification of platinum is 60 units of luminous intensity per square centimetre.

In other systems of units, the basic unit is the candle or candle-power and originated in an actual candle of specified construction. For all practical purposes, the candela, the

candle and the candle-power are the same. Thus there is a constant unit of luminous intensity for all systems of units.

The lumen, the unit of luminous flux, appears only in the S.I. system. Other systems do not have a unit for this quantity, but it is sometimes used with other systems. The lumen is one candela per steradian.

If a point source of light having a luminous intensity of one candela is placed at the centre of a sphere of radius one metre then each square metre of surface area subtends a solid angle of one steradian at the centre. The light flux within each such solid angle is one lumen. Since there are  $4\pi$  steradians to a sphere, it follows that a point source of one candela produces  $4\pi$  lumens of luminous flux.

The unit of illumination is the lux and is equal to one lumen per square metre. Thus, one lumen of luminous flux falling upon a square metre of surface illuminates it by one lux.

The remaining unit is that of luminance and is the candela per square metre. It is the luminous intensity per square metre of projected area of a surface in the direction from which it is viewed.

Since the units are all defined in terms of the candela and areas and solid angles, it is possible to have a system involving only one light unit as such. There are already the candela and the candela per square metre; since one lumen equals  $1/4\pi$  candela, this could be used in place of the lumen and then instead of the lux

there would be  $1/4\pi$  candela per square metre. Similarly, the lux or the lumen could be used as a single unit. This, however, is not recommended.

Provided that the definitions of the quantities involved are understood and are kept clear in one's mind, the S.I. system of units is a very simple one and it is recommended for general usage.

Unfortunately, other units are still in common usage. It is because of this that light units are so muddling. The commonest other unit is the foot-candle. This is a unit of illumination. Consider a point source of light of one candle (candela) at the centre of a sphere of radius one foot. Each square foot of surface area subtends one steradian at the centre and the illumination on that square foot is called one foot-candle, because it is produced by one candle at one foot distance.

Comparing this with the S.I. units there is one lumen in each steradian and so an illumination of one lumen per square foot. The difference between the foot-candle and the lux is thus merely one of the unit of surface area. In the one case one lumen is spread over a square foot, in the other it is spread over a square metre. The foot-candle is thus a larger unit than the lux and one foot-candle equals 10.764 lux.

As has already been stated, all systems have the same unit of luminous intensity. There are only two units of illumination, the lux and the foot-candle, and the lumen is the only unit of luminous flux. There are, however, eight units of luminance! Most of them are the candela per unit area and vary according to the unit area employed. Some, however, are in terms of the lumen per unit area and so would appear to be units of illumination rather than of luminance!

The lumen per unit area is also a measure of luminous flux density and it would appear that some workers prefer to express luminance in terms of the flux density produced by it rather than by itself.

# LIGHT QUANTITIES AND UNITS

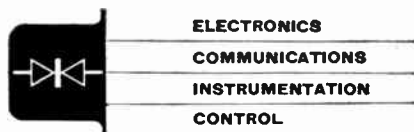

Unit	Definition	cd/m <sup>2</sup>	Lux
Apostille ...	10 <sup>-4</sup> lambert	<b>0.318</b>	<b>4</b>
Foot-candle ...	1 lm/ft <sup>2</sup>	<b>0.856</b>	<b>10.764</b>
Foot-lambert	1/4π cd/ft <sup>2</sup>	<b>0.855</b>	<b>10.764</b>
Lambert ...	1/π cd/cm <sup>2</sup>	<b>3,180</b>	<b>40,000</b>
Nit ...	1 cd/m <sup>2</sup>	<b>1</b>	<b>12.56</b>
Phot ...	1 lm/cm <sup>2</sup>	<b>797</b>	<b>10<sup>4</sup></b>
Stilb ...	1 cd/cm <sup>2</sup>	<b>10<sup>4</sup></b>	<b>1.256 × 10<sup>6</sup></b>
Lux ...	1 lm/m <sup>2</sup>	<b>0.0797</b>	<b>1</b>

Table 1 lists the units of luminance in alphabetical order in column 1. Column 2 defines the unit and columns 3 and 4 state how many candelas per square metre and lux it is equivalent to. In these last two columns certain figures are printed in black type. These are ones which are simple conversions of the areas and constants of the definitions. The figures in lighter type have an extra lumen to candela conversion or vice versa. Thus, for example, the lambert is defined as 1/π candle/cm<sup>2</sup>. The direct conversion is to 10,000/π cd/m<sup>2</sup>=3,180 cd/m<sup>2</sup> and this is printed in black type. Now one candela equals 4π lumens, so one lambert equals 40,000 lux, but this is printed in light type because it is in a different kind of unit from that of the definition.

It was said earlier that light units can be confusing. As an illustration, on p. 209 of "Photoelectricity and its Applications" by V. K. Zworykin and E. G. Ramberg (John Wiley, 1949), there is a graph showing how the current from a selenium cell varies with the incident light. There are three light scales to this graph, foot-candles, lux and lumens. Cross-reading these scales one gets 1 lumen=900 lux=80 foot-candles, roughly. Now from Table 1, 1 foot-candle=10.764 lux, so 80 foot-candles=860 lux,

which is near enough to the 900 read off the illustration. What are we to make of 1 lumen=900 lux, however? The statement is obviously wrong because a lux is a lumen per square metre and so cannot be equated to any number of lumens.

Looking again at the illustration, we find it includes the information that the photocell has an area of 1.75 square inches. This is 11.3 cm<sup>2</sup> or 0.00113 m<sup>2</sup>. Now one lumen falling on this area is 1/0.00113=885 lumens/m<sup>2</sup>=lux, which is near enough to the figure from the lux scale.

The three scales provided give the impression that they are just scales of different units of illumination. The foot-candle and lux scales are just that. The meaning is that a certain current is obtained when the cell is illuminated by so many foot-candles or lux. The meaning of the lumen scale, however, is that the current is obtained by placing the cell so that a luminous flux of so many lumens falls on it. This well illustrates how confusing light units and their usage can be.

Now consider a light metre which is, of course, basically the same as a photographic exposure meter. It may consist of a selenium barrier-layer photocell and a microammeter and little else. What units should be used for calibrating it?

There is no question at all but that the meter responds to the illumination of the surface of the photocell. It would appear, therefore, that it should be calibrated in terms of lux. If the user is more interested in measuring luminous flux, however, he may prefer a calibration in lumens. Again, if he uses it to measure luminance he will like a scale reading directly in candela/m<sup>2</sup>. Such meters, therefore, exist with all sorts of scale calibrations and a conversion will require that the area of the cell be known.

When light measurements are to be made it is necessary to think carefully about which of the four quantities it is that one wants to measure.

## Automatic Maintenance Information System

An automatic system which has been designed to help to keep large electronic systems in operation and in good repair has been developed by the Surface Division of the Westinghouse Defense and Space Center. The system, which is called ADMIRE (Automatic Diagnostic Maintenance Information Retrieval), reduces the amount of personal training required, and reduces the need for training simulators and automatic test equipment on very complex electronic systems.

Some applications of the ADMIRE system are: radar control centres, ship and shore naval control stations, military and space command and control centres, large automated industrial plants, electrical power distribution and control stations, and communication centres.

The system consists of five parts: the equipment to be maintained; a monitor with sensors to isolate and indicate malfunctions; circuits which relate the symptoms to a minimum number of faults; a control computer to diagnose and select applicable maintenance information; and a display device which presents programmed instructions to guide the operator in repairing the fault.

In the system, data from the malfunction sensors is converted to digital form. As long as the sensed parameters are in specified operating ranges, the output is interpreted as a binary zero. Otherwise, the output is interpreted as a

binary one. Thus, a fault symptom results in an indication. If more than one symptom is present, the system will diagnose the fault or faults through programmed instructions or by means of the control computer. Symptom-fault sets are minimized and the most probable fault selected. The presentation device subsequently provides maintenance instructions to personnel manning the equipment.

The programmed information for ADMIRE, including technical manuals and other maintenance information, is stored in film-reel magazines. In the future this could be standard form for manuals as the reels are an integral part of the machine, can be stored easily, updated quickly, and their information is readily available. A five-inch reel of 16-millimeter film, for example, can be scanned in eight seconds. The more complex the system, the more magazines are necessary.

In the most advanced ADMIRE system, the information is automatically projected in either still or motion picture frames on a screen which can be desk or console mounted. When a simpler version is used, only the first frame is shown and the operator instructed which other frames to retrieve. In a low-cost system, automatic retrieval is omitted and the operator interprets the monitor panel by using a book of cards which corresponds to the number of the frame he should view.



*This picture shows the type 301 beacon as it is worn with a life-jacket of the kind used by dinghy sailors and yachtsmen*

## Air-Sea Rescue Communication Equipment

**A**N amateur use for one of the most recent developments of military electronics which is now standard equipment was demonstrated by the Royal Navy at Portland Bill off Weymouth recently.

The device employed was a pocket radio transmitter. It is one of a range known as Sarbe beacons (the name comes from 'search and rescue beacon equipment'), made by Burndept Electronics.

The beacon weighs only 36 oz with the battery and was originally designed to rescue airmen. The Navy's demonstration showed how the Sarbe can contribute to the safety of dinghy sailors, the single-handed voyager.

The beacon works by transmitting an audio signal on international distress frequencies. Carried in the pocket of a lifejacket, or packed in a survival kit, it communicates the position of a survivor to passing aircraft. With the aid of the signal, rescue aircraft can come directly on to the scene.

Three models of the Sarbe beacon are made by Burndept: (1) Type B.E. 301 without speech facilities, currently in production for the R.A.F. This is the simplest and lightest set of the range. The transmitter measures only  $5\frac{1}{8} \times 2\frac{1}{2} \times 1$  in. with a battery of similar size, and the total weighs 36 oz. A steel strip aerial springs erect when a toggle is released; signal range is at least 80 miles to an aircraft at 10,000 ft.

(2) The B.E. 310 is a version which also receives and transmits speech over a range of approximately 12 to 15 miles. The 'non-speech' signal range is the same as the type B.E. 301. Weight is 48 oz.

(3) The Sarbe 346, which sends signals over a longer distance, operates simultaneously on both international distress frequencies, 121.5 and 243 Mc/s, making it compatible with v.h.f. and u.h.f. airborne communication equipments.

Designed firstly for use by civil airlines, the 346 flotation beacon transmits a signal receivable 100 miles away by an aircraft at 10,000 ft, 150 miles at 20,000 ft and 200 miles at 30,000 ft. The weight of this model is 10 lb, the length 27 $\frac{1}{4}$ -in. and the diameter 4-in.

Intended for larger yachts and ships to ensure speedy identification of the position of survivors, the flotation beacon is attached to a liferaft or lifeboat by means of a nylon cord. When the raft is inflated in the water, or the boat lowered, the beacon floats out as the cord unwinds. This releases stabilizers and then the aerial, which at once springs erect. A button-switch connects the battery to the transmitter and the beacon automatically starts signalling on the crystal-controlled frequencies.

**For further information circle 45 on Service Card**

## Early Bird in Public Service

Early Bird, the communications satellite hitherto used for experimental transatlantic transmission of television, still pictures, high speed data, telex and telegraphy, has now been incorporated into the public telephone service.

Transatlantic telephone traffic is at present increasing by about 16% each year and an estimated one million calls are predicted for 1965. Previously, submarine cables alone have routed the 141 telephone circuits linking the United Kingdom with the North American Continent. With the introduction of Early Bird an additional 24 circuits (more being available when required) have been provided to complement the existing system.

All commercial telephone traffic across the Atlantic will now be connected through London's recently opened international telephone exchange, at Wren House, and upon the success of Early Bird will largely depend the structure of the proposed global intercommunications system—planned to be inaugurated by late 1967, or early 1968, and to consist of a number of similar synchronous (fixed orbit) satellites.



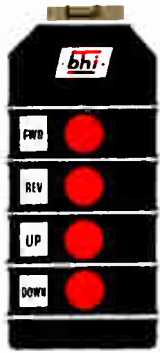

91,000 Type pendant one or more standard contact blocks for pushbutton operation in hard rubber case.

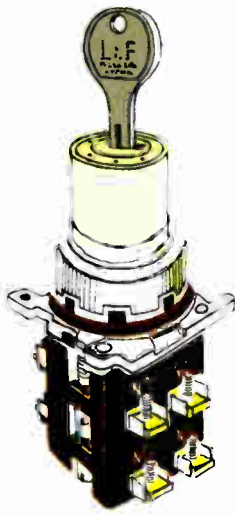

91,000 Type Key-operated switch cylinder-lock switching with usual choice of contact arrangements.



Brookhirst Igranite Ltd  
Elstow Road · Bedford



Oil-tight limit switch adjustable roller lever.



91,000 Type Joystick control multi-directional control by small positive-action joystick.



Single-contact pneumatic timer delayed contact operation or resetting.



Oil-tight limit switch forked operating lever.



Double-contact pneumatic timer any combination of instantaneous contact, delay after energisation or after de-energisation.



Oil-tight limit switch wobble stick operator.

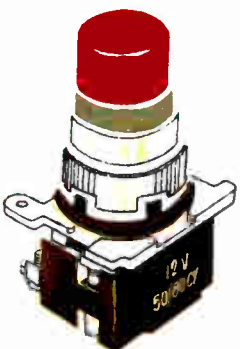

91,000 Type Illuminated pushbutton combined indicator lamp and pushbutton for panel mounting.

**Ring the changes in control with BHI 91,000 Series Heavy Duty Oil-Tight Units**

Basis of the 91,000 range is a standard contact block which can be used singly or ganged. Pushbuttons, multi-directional joystick, lever, knob or key operation are available, all occupying the same amount of panel space. Indicator lamps, illuminated pushbuttons and press/test buttons which light up when pressed complete a truly versatile range.



**Ganged contact blocks**

Up to four contact blocks per gang. Two contact sets per block, either N.O., N.C. or Changeover. Silver contacts. External screw connections. Put them together in any combination.

**Pushbuttons**

Positive action pushbuttons: choice of five colours, five operators – standard, long, mushroom, jumbo, staydown mushroom. One-hole panel fitting to standard 91,000 series size.

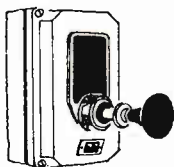

**Joystick master controller**

Up to eight switching positions about a central off position. Up to 12 N.O., N.C., or C/O circuits. 91,000 series one-hole mounting. Positive latching if required.

**Rotary versions**

Rotary versions add versatility by plunger operation from cam. Seven different cams give seven different contact sequences . . . with further variation according to the arrangement of contact blocks. Operation by key, lever or knob. Complete unit takes same space, same fixing hole as pushbuttons.

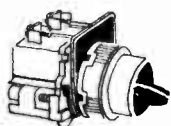

Brookhirst Igranic Limited  
Elstow Road · Bedford  
Telephone : 67433 · Telex : 82261

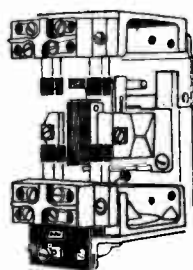

**Pneumatic Timing Relay with 0.2 to 60 sec. delay –**

screwdriver changeover of mode of operation  
One or two timing heads can be used with a single coil, each set separately to provide delay after energisation or de-energisation. One timing head and one instantaneous contact can be used. Setting up is quick, and timing then remains consistent. Contacts will make 8A or break 5A at 600V ac over a long, reliable life. Two-screw fixing, choice of operating voltages, backlash-free timing adjustment make this a simple yet versatile unit with many uses. It's the BHI type 906 pneumatic timer.

Oil-tight, and positive in action one basic switch can be fitted for operation dozens of different ways

A standard moulded block enclosing contacts of the single-pole, changeover, twin-break type is mounted in die-cast housing. Oil-tight cover; operation is through an oil-tight diaphragm. The contact block can be replaced by contactless switching if required. Two tapped and two through holes in the housing are provided for mounting. Action is so designed that contact is fully positive even at minimal operating speeds. Spring-return or stayput operation available on most versions.

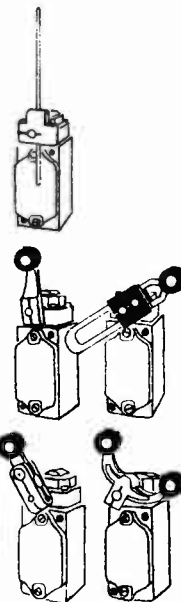

**... Rotary Operators**

In which the operating lever can be clamped at any angle on a rotating shaft. Also available with bare shaft for your operator.

- Adjustable rod
- Roller lever
- Adjustable roller lever
- Precision roller lever
- Forked lever
- rollers in line or offset

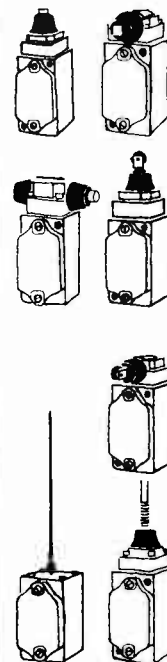

**... Linear Operators**

- Top push button
- Side push button
- Side push rod
- Top push roller
- Side push roller
- vertical or horizontal
- Cats whisker
- Wobble stick

Full technical data is available from BHI. Ask for: full details of the 91,000 range

- Publication ZB88
- Type 906 pneumatic timer
- Publication ZB56
- Oil-tight Limit Switches



50-mm stiff flying leads projecting from the back. It can operate in any position over ambient temperature conditions of  $-30$  to  $+60$  °C.—*Photain Controls Ltd., Randalls Road, Leatherhead, Surrey.*

For further information circle 37 on Service Card

37

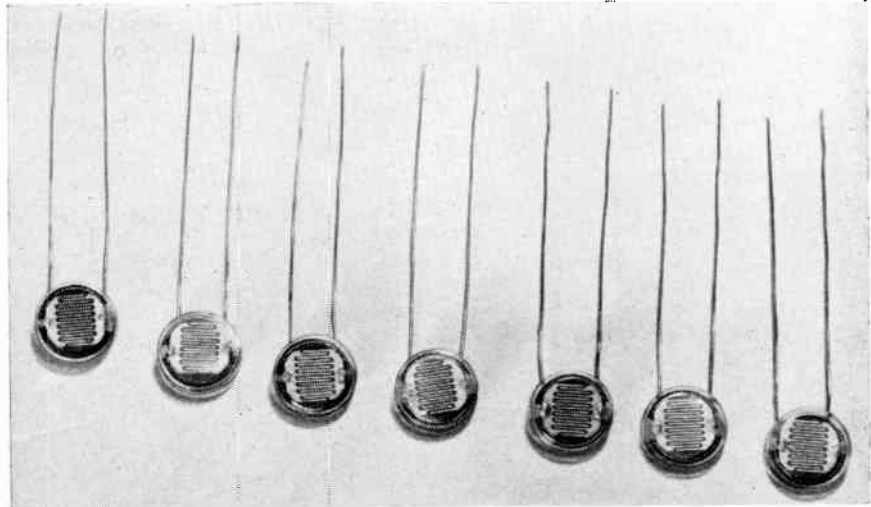

### 38. Cadmium Selenide Photocells

Hird-Brown announce the introduction of two low cost cadmium selenide photo-conductive cells, types NSL-3531 and NSL-3561, encapsulated in a clear, high temperature epoxy resin.

They are of the high sensitivity vacuum-deposited types, measuring  $1.7\text{ k}\Omega$  at 1.0 footcandle,  $40\ \Omega$  at 100 footcandles and  $10.7\text{ k}\Omega$  and 1.0 footcandle,  $400\ \Omega$  at 100 footcandles respectively. Minimum dark resistance and maximum voltage rating is  $2.0\text{ M}\Omega$  and 80 V peak and  $20\text{ M}\Omega$  and 400 V peak, a.c. or d.c. respectively. Maximum power dissipation 0.2 W.

Maximum case diameter is 0.520 in. and the height is 0.250 in.—*Hird-Brown Ltd., Flash Street, Bolton, Lancashire.*

For further information circle 38 on Service Card

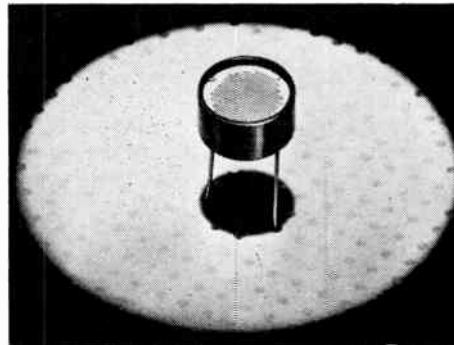

38

39

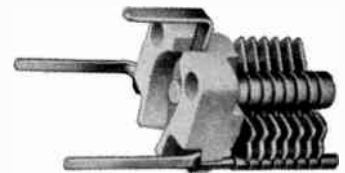

### 39. Air-Dielectric Trimmer

A miniature trimmer, now available from Wingrove & Rogers, has terminals suitable for direct mounting on 0.1-in. module printed-circuit boards in addition to the standard version designed for chassis mounting by two 10 BA screws. The stator and rotor assemblies are made of silver-plated brass, mounted on a ceramic base.

Maximum capacitance of the type No. C.3701/7 is 16.5 pF with a minimum figure of 3.5 pF. Insulation resistance is better than 1,000 M $\Omega$  and the unit is capable of withstanding up to 500 V peak.—*Wingrove & Rogers Ltd., Domville Road, Liverpool, 13.*

For further information circle 39 on Service Card

40

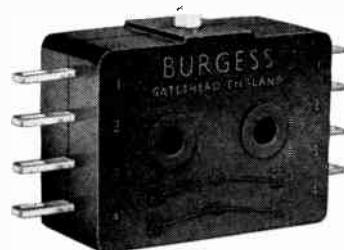

41

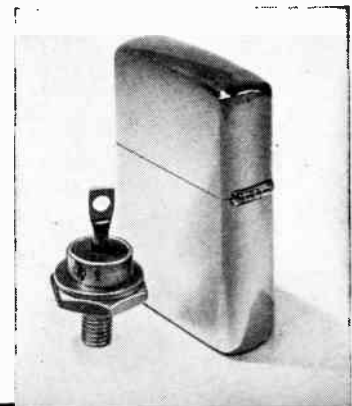

### 40. Double-Pole Switch

A double-break switch, which will control four circuits to provide instantaneous changeover facilities in double-pole applications, it is rated at 15 A at 250 V a.c. and includes snap action, good repeat characteristics and high short-circuit capacity. The eight terminals provided are suitable either for soldering or for quick-connect receptacles. The built-in actuator is a strong nylon plunger, which may be depressed in overtravel until it is flush with the switch case, though lever and roller-lever auxiliary actuators are available, as is a manual push-button

version of the switch.—*Burgess Products Co. Ltd., Dukes Way, Team Valley, Gateshead, 11.*

For further information circle 40 on Service Card

### 41. Ultra-Fast 30-A Silicon Rectifier

Exceptionally fast recovery time of 200 nsec, maximum, is offered by a new series of high-current silicon rectifiers announced by Texas Instruments.

The rectifiers, type 1N3909-1N3913, are rated at 30 A at 100 °C case temperature, 50–400 V. They offer high surge current capability up to 300 A; improved radiation tolerance; high-frequency, high rectification efficiency up to 200 kc/s. They are available in the JEDEC DO-5 stud package in both forward and reverse polarity.

With a typical recovery time of 70 nsec, the TI 1N3909 rectifier series is well suited for such applications as high-frequency power supplies, high-

# NEW

ELECTRONICS  
COMMUNICATIONS  
INSTRUMENTATION  
CONTROL

speed switching and multi-phase rectifier applications. In converters and inverters the fast recovery characteristics of these rectifiers permit high-frequency operation with significant reduction in size and weight of magnetic components—transformers and inductors—and increases in rectification efficiency. — *Texas Instruments, Inc., Semiconductor Building, 13500 North Central Expressway, Dallas, Texas, U.S.A.*

For further information circle 41 on Service Card

## PRODUCTION AIDS

### 42. Temperature-Controlled Soldering Iron

A low-voltage soldering pencil with an unusual form of temperature control is now available in the U.K. from Weller Electric Corporation.

At the base of the interchangeable tip (see inset) is a disc of nickel-iron alloy; positioned close to it is a permanent magnet controlling the

power on/off switch in the handle. When cold, the magnet is pulled in contact with the disc, connecting the heating element to the supply. When the tip reaches the required temperature, the disc becomes non-magnetic (because of the Curie point principle) and the magnet retracts, disconnecting the supply. When the tip cools, the disc becomes magnetic again.

Because this change of characteristic of nickel-iron alloys occurs at critical temperatures, close control is obtained. It is thus possible to have a set of interchangeable tips, each with its own temperature rating. — *Weller Electric Corporation, Blatchford Close, Horsham, Sussex.*

For further information circle 42 on Service Card

### 43. Moulded Edge Connectors

Recently introduced by Carr Fastener is an inexpensive moulded edge connector. Moulded in black polypropylene or white flame-retardant polypropylene the mouldings provide for 0-100 in. or 0-150 in. pitch of contacts.

There are three types of brass or phosphor bronze contacts allowing for solder slot, 90° solder slot, or printed circuit terminations, coupled with three different mounting brackets which provide closed end, open end or an earthing contact. Any number of ways up to 40 is offered by the 0-100 in. connector reducing to 38 when end-fix brackets are required.

Similarly, the 0-150 in. connector offers up to 26 ways, 24 if end-fix brackets are used. Nickel-plated polarizing keys can be inserted in any position.

Standard contact finishes are immersion tin or silver plate. Working voltages are: 0-100 in. pitch 500 V d.c. or a.c. peak and for the 0-150 in. pitch, 350 V d.c. or a.c. peak. The current capacity for both is 5 A max. per contact.—*Carr Fastener Co. Ltd., Stapleford, Nottingham.*

For further information circle 43 on Service Card

### 44. Heat Exchanger Units

A range of forced air cooled, water re-circulating, heat exchanger units has been announced by Hirst Electronic. They are designed to meet the increasing demand for water economy within the engineering and allied industries.

Applications include water-cooled welding equipment, transformers, furnaces and rectifier equipments, high-frequency induction heaters and specialized industries such as those using plastics moulding plant.

A range of 18 models is available, with a nominal range of heat extraction from 4 to 40 kWh (15,000 to 140,000 B.Th.U.), and pressures from 10 to 100 p.s.i. The type G4 (illustrated) is rated at 17 kWh (58,000 B.Th.U.) and a maximum pressure of 100 p.s.i.—*Hirst Electronic Ltd., Gatwick Road, Crawley, Sussex.*

For further information circle 44 on Service Card



42

43

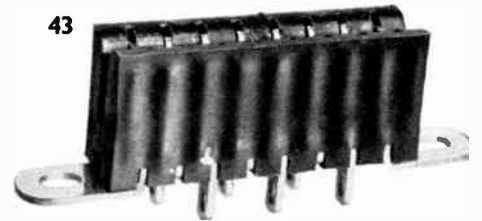

44



*This shows the Marconi tabular display in operation in a typical radar display console. The tabular display, in the top left-hand corner of the picture, is displaying flight progress data relating to the right-hand radar display. Each radar track on this display can be marked, and labelled with an identity code corresponding to the data display. By using a computer, each marker and its associated label can be made to follow the aircraft track as it moves across the screen*

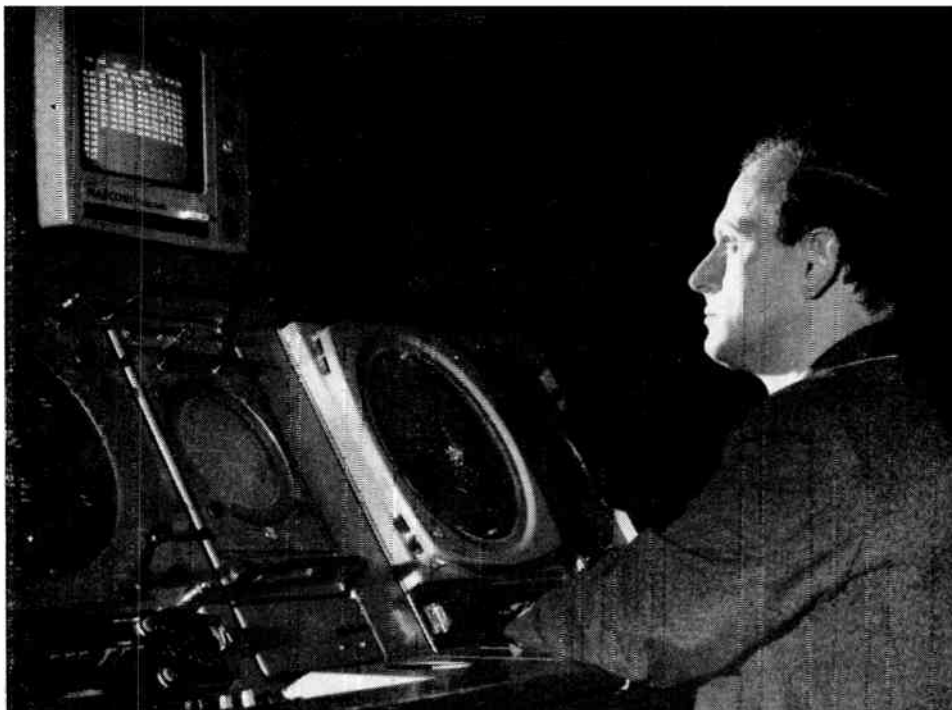

## Electronic Displays for Air Traffic Control

Advanced experiments in air traffic control, at Prestwick in Scotland, are to include five Marconi electronic data displays which can 'write' characters and symbols on the face of a c.r.t. at the rate of 50,000 characters per second.

The Prestwick experiments are based on the use of a Ferranti APOLLO computer to process information on aircraft movements, in order to present the appropriate data to air traffic controllers more rapidly and more effectively than is otherwise possible. This type of automation in air traffic control will help controllers to forecast conflicts more quickly and will give them the capability of controlling the greatly increased air traffic which is expected by the early 1970's.

The very high writing speed makes the tabular display ideal for use with computer systems, since a complete block of information can be 'written' almost instantaneously. In addition, any part of a complete display can be altered, either by information from the computer or by means of a manual keyboard, in a fraction of a second and without affecting the rest of the displayed data.

The existing display system for these experiments at Prestwick, which are being conducted by the National Air Traffic Control Services, is based on the use of conventional teleprinter techniques and hand-written flight or progress strips which are comparatively slow to produce and difficult to alter in a changing traffic situation.

## Electronic Error Correcting Equipment for Radio Communications

'Autospec', a single-channel single-path error detecting and correcting system (employing a special code to permit the correction of errors without the use of a return path), has been incorporated in an American-built radio communications network in South Korea.

Invented and manufactured by the Marconi Co., it is used to improve the quality of the teleprinter channels of the circuit (by reducing the teletype error rate), and has also made possible a reduction in the transmitter power required for the microwave tropospheric scatter link.

The fully transistorized and completely automatic equipment (some of whose aerials are shown in the picture) employs both line-of-sight and tropospheric scatter microwave transmission and provides voice and teletype facilities; it can be easily incorporated in existing teleprinter circuits and is suitable for most radio applications.



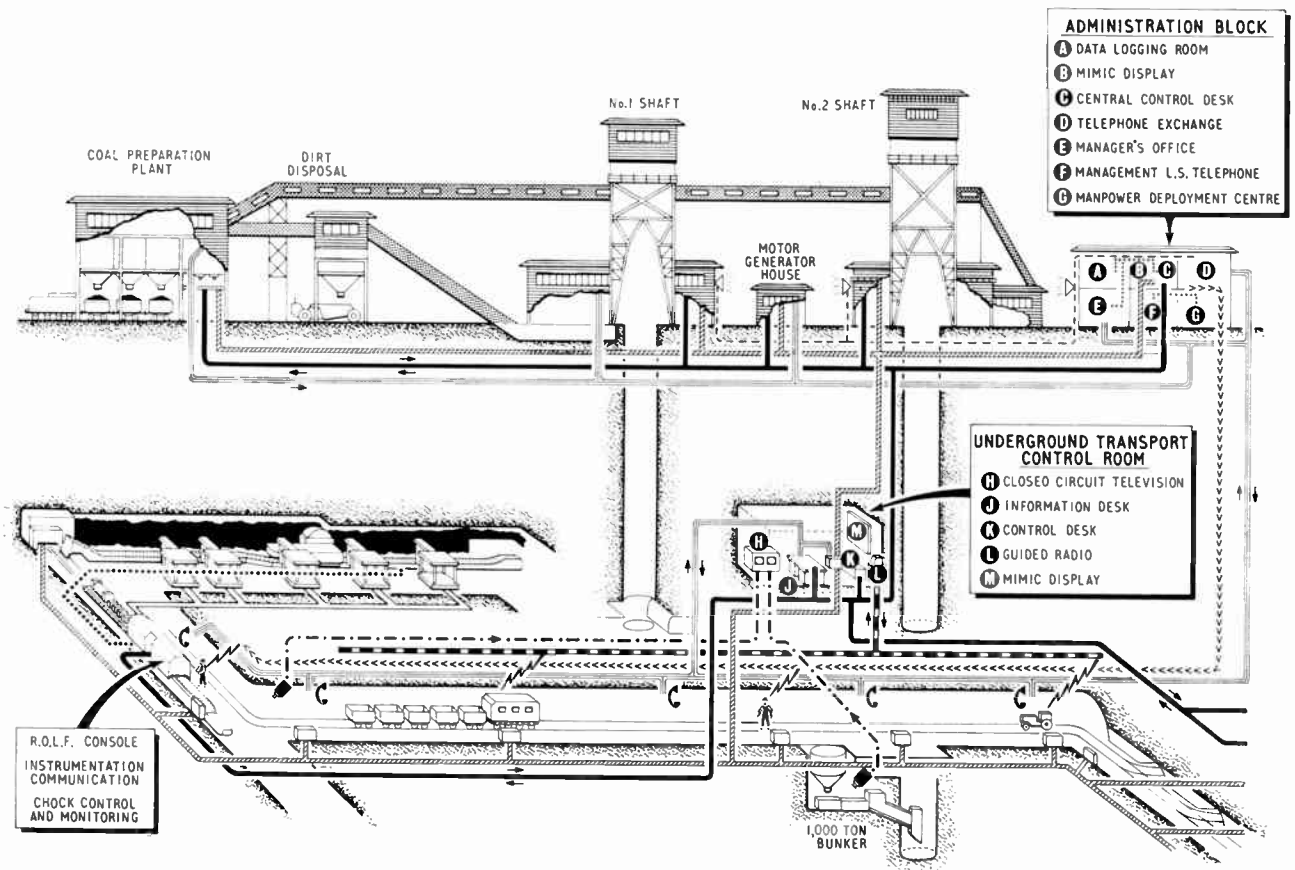

# AUTOMATION IN COAL MINING

**T**HE world's first integrated system of remote-control, monitoring and communication for coal mining is now being installed at Bevercotes Colliery, in the East Midlands Division of the National Coal Board. The result of applying advanced automation techniques will increase productivity to 1½ million tons of coal a year by 1968. Five remotely-operated coal faces will eventually be worked, to give an output of eight tons per manshift from a total labour force of only 770 men.

In 1964 A.E.I. was appointed main contractor for the control and communications equipment of the colliery, its design and manufacture being undertaken in co-operation with N.C.B. engineers.

The colliery has been divided into a number of operational sectors: the four coal faces, the underground transport system, the two shafts and the coal preparation plant. Each has a sector controller, located in his sector control room, who is answerable to the colliery controller at the central control room on the surface (Fig. 1).

A number of local control points are provided at key areas in the colliery, and most of the monitored information is fed to the central control room and the underground control room (Fig. 2); in both there is a mimic diagram which gives an immediate indication of the mine-machinery operating conditions.

*Fig. 1. The surface control room continuously receives information on the relevant conditions at the coalface, in the roadways, at the shafts and in the coal preparation plant. The controller has a complete up-to-the-minute picture of the operation of the whole colliery and is in direct contact with the management and local sector controllers.*

*The control desk has facilities for displaying key analogue and digital information and provides the management, at regular intervals, with a printed synopsis of the vital statistics necessary for the overall supervision of the mine.*

*Adjacent to this central control is the data-logging room, where a chart record of the mimic diagram information can be prepared and other data is processed*

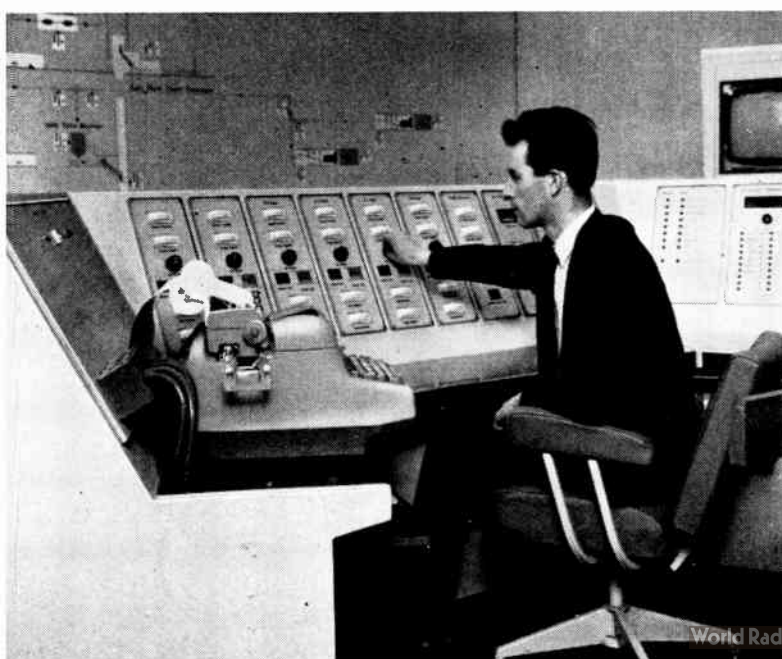

Fig. 2. The underground control room controls every main conveyor and the operating conditions of all underground equipment are displayed on the mimic diagram. The closed-circuit television screens on the right display the conditions at the pit-bottom bunker and those where the gate conveyors transfer the coal on to the trunk conveyor. Also located here is the base station for the two-way inductive-loop radio communication system, for maintaining contact with all the underground vehicles

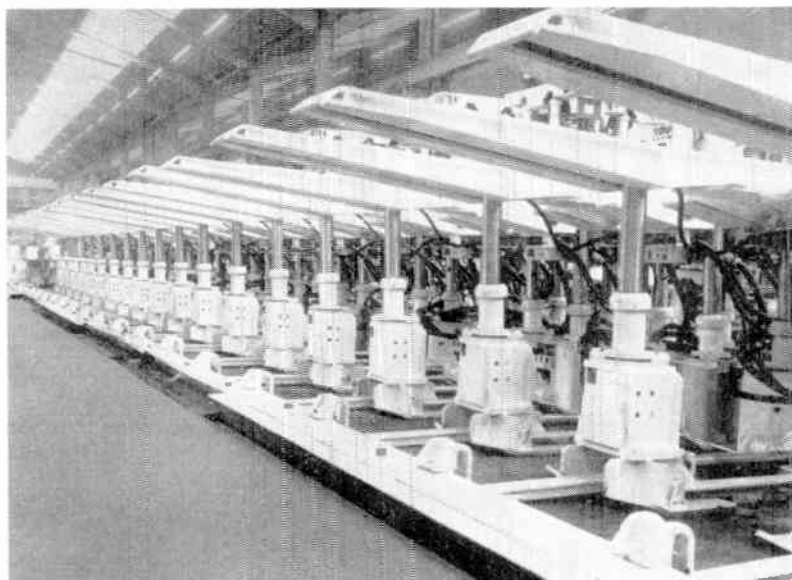

Fig. 3. A surface mock-up of the multiple hydraulic chock system, manufactured by Gullick Ltd. Each chock is released separately, moved forward on its ram and reset to support the roof. The whole system is monitored continuously, control signals progressing it automatically

At each sector, data such as methane concentration, coal-cutter position and amount of coal in the bunker is continuously monitored, fed automatically to sector controls and controlled as necessary. Machinery operation is also monitored, a comprehensive fault-finding system being incorporated.

At the coal face a ROLF (remotely operated longwall face) system is installed which is controlled from a cabin in the tunnel at one end of the face. The coal cutter and face conveyor are moved forward progressively by rams, which extend from hydraulic chocks (see Fig. 3).

Belt conveyors transport the coal from the face to a 1,000-ton capacity pit-bottom bunker and thence on to the bunker discharge belt; this belt feeds the coal into skips (one of which has a capacity of 550 tons per hour), which are wound to the surface automatically. From the surface the coal is taken to the processing plant (see Fig. 4).

A comprehensive communications network includes a

200-line PABX telephone exchange, which serves the whole colliery and comprises extension, surface automatic and underground magneto telephones. A personnel paging system (by radio-telephone linkage) is provided and a two-way 'clearcall' industrial communication system is used in the coal preparation plant; a management loudspeaking system radiates from the central control desk to give rapid contact with all sector controllers. All the communications equipment is designed to be compatible with the 24-channel G.P.O. voice-frequency multiplex system.

With little more than three years' preparation, the N.C.B. can justly claim that Bevercotes is one of the most advanced mines in the world. As more sophisticated electronic equipment is designed and perfected, it is possible to foresee the advent of process-control computers regulating not only one pit, but also several simultaneously; their use would improve production efficiency and, most important of all, further ensure the safety of mining personnel.

Fig. 4. The processing plant has a total capacity of 600 tons per hour of raw coal, destined for power station consumption. In the plant the coal is washed, sized, blended and sampled, being continuously weighed using Floronic equipment. The end product is delivered to four 1,000-ton output bunkers, where it is weighed and loaded into rail wagons. The console and mimic diagram in the processing plant control room (shown here) monitor and control all sixteen weighing points throughout the process and indicate all valve and by-pass positions, specific gravities, tank and bunker levels and tonnages. Fault-indicating panels are also incorporated—on the right and left of the console

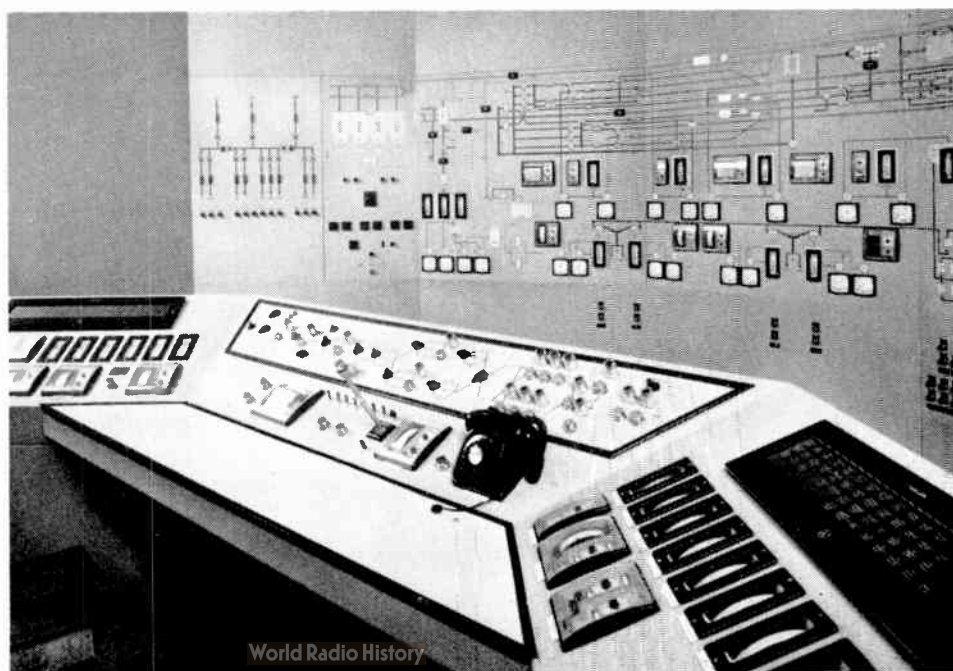



### Personal News

**P. L. Reed** has been appointed public relations manager of British Insulated Callender's Cables Ltd. He succeeds **D. G. Denoon** who is retiring after 40 years with the company.

**Dr. G. L. J. Bailey** has been appointed assistant managing director of International Nickel Ltd. He is now responsible for the development and research department and the market development department.

**I. I. J. Turner** has been appointed commercial manager at the Applied Electronics Laboratories of G.E.C. (Electronics) Ltd., Stanmore. The laboratories have recently been acquired by G.E.C. from the Ministry of Aviation.

Simms Motor & Electronics Corporation Ltd. have announced the appointment of **John Lockett** as controller of group public relations. Mr. Lockett succeeds **Alan Hess** who retired recently.

**J. A. Hutton, B.Sc.**, is the general service manager of the new Service Department of Bush Radio, Murphy Radio and Rank Telecommunications. This new unit is part of the Rank-Bush-Murphy factory at Welwyn Garden City and is now fully operational. **M. J. H. Brady** is the technical liaison manager between the marketing department of Rank-Bush-Murphy and the new unit.

**E. L. E. Pawley, O.B.E., M.Sc. (Eng.), M.I.E.E.**, has been appointed chief engineer, external relations of the B.B.C. He will be responsible to the director of engineering for contracts with the G.P.O. on engineering planning.

The Electrical Research Association, Leatherhead, Surrey, have announced the appointment of **R. F. Wilson** as research commercial manager. He will be negotiating research contracts with member firms.

The Television Society have elected **Thomas Kilvington, B.Sc. (Eng.), M.I.E.E.**, as chairman of the council for the year 1965/66. He is head of The Radio Planning and Provision (Internal) Branch of the Post Office Engineering Department. **H. W. Barnard** (Editor, *Wireless World*) has been elected vice-chairman.

For his work in the development of fuel cells, **F. T. Bacon**, Consultant to Energy Conversion Ltd., has been awarded the Royal Society's S. G. Brown Award and Medal. The nomination was made by the Institution of Mechanical Engineers, of which he is an Associate Member.

**W. D. Lewis** has been appointed by Westinghouse Electric International as vice-president and regional director for the Scandinavian countries and Finland with headquarters in Stockholm.

Appointed as general manager of the Controls Company of America (U.K.) Ltd., **Alan W. Arben** also joins the company's European Corporate Committee. A company secretary with the firm for two years he was formerly a member of the management team of the Uganda Co. Ltd. in East Africa.

**Alan E. Crawford, M.I.E.R.E., A.R.Ae.S., Assoc. I.E.E.**, joins Radyne Ltd. as manager of the new Ultrasonics Products Group, having left the Sonics Division of Elliott Bros.

**W. Gregson** has been appointed manager of the electrical division of Towler Brothers (Patents), a member company of the MI Group, and he is succeeded as chief development engineer of Lancashire Dynamo Electronic Products by **Dr. D. J. Matthews**.

The B.B.C. have announced the appointment of **W. R. Fletcher, B.Sc. (Eng.), A.M.I.E.E.**, as superintendent engineer, television studios and outside broadcasts.

### Obituary

**John Thoroughgood** died on 15th June at the age of 56. He was well known, both in this country and abroad, in his capacity as Chief Publicity Executive and also for his sales activities with EEV.

He joined The English Electric Company in 1951 and took up full employment with English Electric Valve Co. in 1954.

### Birthday Honours Correction

**Mr. F. C. Wright** (Director, Standard Telephones and Cables Ltd.) was appointed a C.B.E. in this year's Birthday Honours List and not a K.B.E. as mentioned in the July issue.

**B.B.C. TRANSMITTING AERIAL CARRIER**—Shown here is the 70 ft long cylinder (of  $\frac{3}{16}$ -in. mild steel and 78-in. in diameter) being manufactured for Associated Aerials Ltd. by Clarke Chapman & Co. Ltd., and destined for the B.B.C. aerial installation at Skriaig in Scotland. The cylinder will carry an array of transmitting aerials for Band 1 television broadcasting

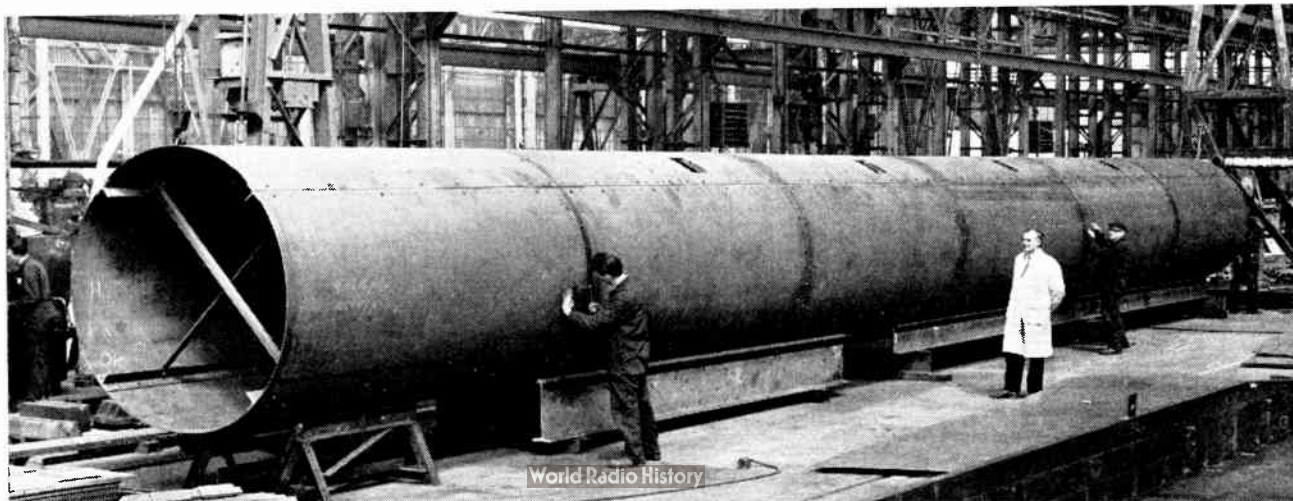



## Company News

**The Marconi International Marine Co. Ltd.** have purchased A.E.I.'s marine radio business. Marconi Marine will continue to market A.E.I. marine radio equipment and provide maintenance and servicing facilities.

**The F. and M. Scientific Corporation** have now become a wholly-owned subsidiary of the **Hewlett-Packard Co.** F. and M. of Avondale, Pennsylvania, manufacture gas chromatographs and instruments used in the chemical and allied industries.

One telephone number, Ilford 3040, now serves all the offices, factories and research laboratories of the **Plessey Co. Ltd.** in the Ilford and Romford areas. This includes the following divisions of Plessey: the Head Office, the production divisions at Vicarage Lane, Ilford, the Aircraft Electrical Division, Romford, the Marine Systems Division, Ilford, and Ketay Ltd., Chadwell Heath.

**Advance Electronics** and **Van Der Heem Electronics N.V.** of Holland have completed an agreement by which Advance will sell to Common Market countries and Austria through the Van Der Heem sales organization. Van Der Heem will sell their products through the Advance sales organization to the U.K., the Commonwealth and the E.F.T.A. countries.

**The Livingston Group** have formed a new company to handle its interests in the industrial and scientific instrumentation fields. It will be based at the Livingston Group headquarters under the general managership of David J. Davis and will be called Livingston Electronics Ltd.

**Metal Industries Ltd.** has acquired from International Rectifier Corporation of Los Angeles a 50 per cent interest in International Rectifier Europe S.A., a sales organization for I.R. semiconductors in Europe.

**The University Capacitor Co.**, a subsidiary of the London Electrical Manufacturing Co., has been renamed **Lemcap Ltd.** The company will continue to manufacture electrolytic and polyester capacitors and will devote future research to the field of miniaturization.

**The National Research Development Corporation** have the new address of: P.O. box number 236, Kingsgate House, 66-74 Victoria Street, London, S.W.1. Telephone: Tate Gallery 3400.

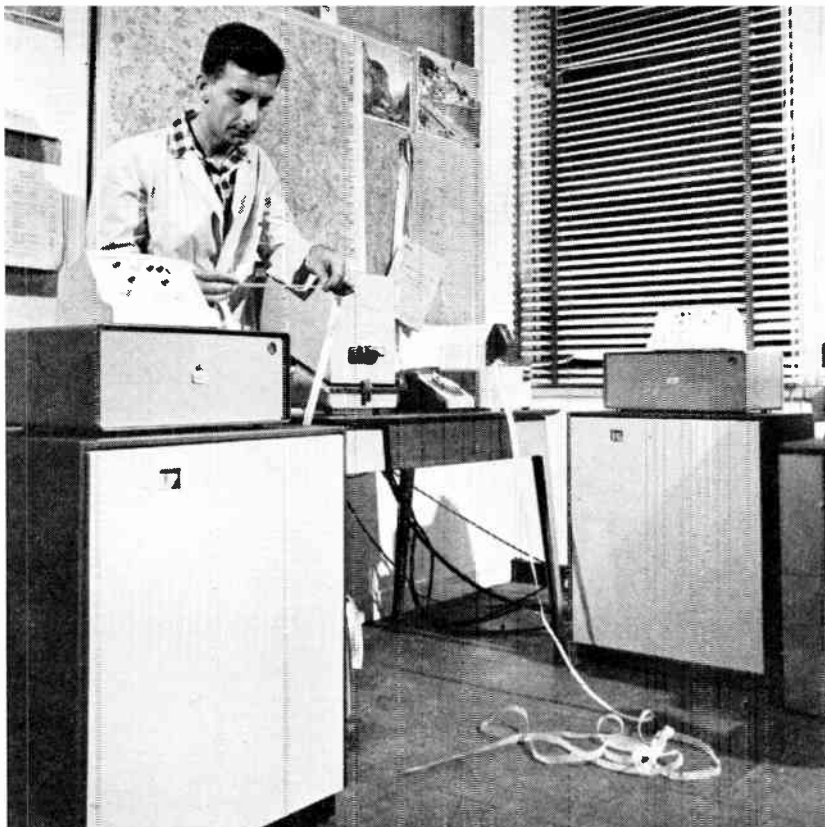

**DATA LINK ACROSS THE ATLANTIC**—The first data link across the Atlantic using the U.K. public telephone network has now come into operation; it transmits press and publishing data between the *Time and Life* Buildings in London and New York. The equipment has been supplied by Standard Telephones and Cables Ltd. and the U.K. part of the link uses the G.P.O.'s recently introduced Datel 600 service.

The system enables subscribers to send written and numerical information as well as speech over telephone lines, using the S.T.C. GH205 single-way telephone-speed data-transmission system which is capable of transmitting up to 94 letters or figures per sec.

Data is punched on to paper tape at a teleprinter keyboard, the tape data then being converted into suitable trains of pulses which incorporate means of (intensive) error detection and correction. Transmission takes place at up to 15 words per sec—about five times as fast as speech—and the terminal equipment decodes the signals, producing a replica paper tape from which a typescript can be subsequently prepared.

The picture shows the London office equipment consisting of two GH205 units on top of which are the G.P.O. Modem 1A and an S.T.C. control unit

The new address of **The Engineering Institutions Joint Council** is 2 Little Smith Street, Westminster, London, S.W.1. Telephone: Sullivan 3912-4.

**George Kent Ltd.**, Luton, have formed two subsidiary companies, Kent-Evershed Ltd. and George Kent (Petrochemical Ltd.). Kent-Evershed Ltd. is a merger of George Kent and Evershed and Vignoles and will be concerned with flow metering for water and gas distribution. George Kent (Petrochemical) Ltd. will specialise in instrumentation and process controls for the chemical and petroleum industries.

**Stratton and Co. Ltd.** has been officially re-named **Eddystone Radio Ltd.** They will continue to produce the Eddystone range of communication receivers. This change follows the acquisition of Stratton's from Laughton and Sons Ltd. by English Electric; the company will operate as a subsidiary of the Marconi Co.

**Dawe Instruments Ltd.** have been appointed the sole U.K. agent for A/S **Danbridge of Copenhagen** who manufacture a range of decade resistance, capacitance and inductance boxes.

## Electrosil Enter Microelectronics Market

The entry of Electrosil Ltd. into the microelectronics markets of Britain and Europe was announced recently.

A microelectronics division has been formed by Electrosil to market a range of devices which includes integrated and thin film circuits. The integrated circuits are made by Signetics Corporation of the United States. New developments to be introduced include specially designed low-cost commercial circuits for immediate application in computers and data-processing equipment. The divisional manager will be J. A. Tempel and the assistant manager is F. W. Stephenson.

In addition to Signetics integrated

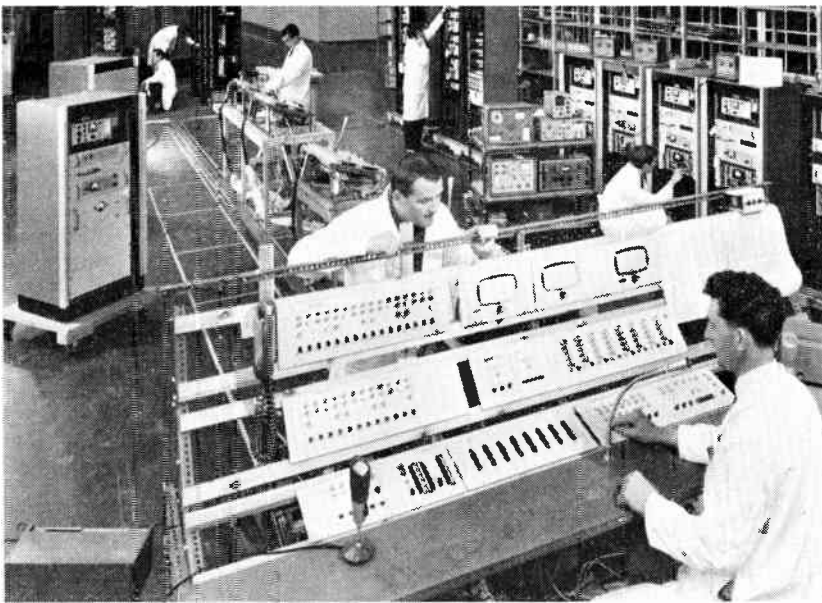

**RADIO-TELEPHONE SCHEME FOR DANISH POLICE**— A mobile radio-telephone system is soon to be installed in Copenhagen for the Danish State Police. Engineers are here shown testing part of the equipment, which has been manufactured by Pye Telecommunications; it will form part of a network, incorporating many new features, to be established shortly throughout the whole of Denmark

circuits and Corning thin films, the division will offer flat packages, and the 'Augat' integrated circuits, sockets and accessories, for testing and bread-boarding microelectronic devices, without soldering or damaging the leads.

Under the new marketing arrangements, Signetics products are available in the U.K. and throughout the E.F.T.A. countries direct from the Electrosil distribution centre in Shannon, Eire. The microelectronics division will service all these countries.

For further information circle 46 on Service Card

### New Fellows of the Television Society

Two new Fellows of the Society are Dr. Vladimir K. Zworykin and F. C. McLean, C.B.E.

Dr. Zworykin is an honorary vice-president of R.C.A. and technical consultant to R.C.A. laboratories. He was concerned with the invention of the iconoscope and kinescope.

F. C. McLean, C.B.E., B.B.C. director of engineering, has been much concerned lately with the development of colour television and has served on committees of the European Broadcasting Union.

### Alarm for Nuclear Power Station

The first computer alarm system in the world is to be installed at the 600 MW C.E.G.B. nuclear power station being built at Oldbury by the Nuclear Power Group. Designed and supplied by A.E.I. Automation Ltd., it uses cathode-ray tubes for the display of alarm messages and the basis of the system is a high-speed digital computer.

Four times a second each of 3,000 plant alarms are checked and if a fault occurs the computer analyses the fault conditions and deduces the cause. The cathode-ray tubes display to the operators and superintendents the alarm message together with a statement of recommended action.

### Computer Service for Banks

The first multiple computing service for banks and savings institutions has been installed in New York by the National Cash Register Co. Ltd. Over a million savings accounts are being handled by an NCR 315 CRAM computer which is linked to consoles in a number of banks via telephone lines.

Bank clerks using this system are able to spend less time on book-keeping and the service to customers is speeded-up. Although many banks use the computer, no one bank has access to another's accounts.

### S.I.M.A. Annual Report

At the recent A.G.M. of the Scientific Instrument Manufacturers' Association, the forty-eighth Annual Report was presented to its Members.

Providing a complete review of the Association's activities and progress during 1964-1965, it also contains summaries of the work of the Committees of the Council and the activities of the Specialized Groups. Of particular interest is the Technical and Standardization Committee, which has approached the problem of rationalizing certification and safety classification of electrical equipment.

Also, the Working Party on National Standards of Measurement has been investigating, among other issues, the question of national specifications and the possibility of establishing a National Standards Authority under the control of the Ministry of Technology.

### London Radiophone Service Opens

The London radiophone service came into operation on 5th July. This is a further step by the Post Office in the extension of its pilot radiophone service now operating in South Lancashire. The new area to be covered is 25-30 miles radial distance from Central London. The South Lancashire service has 120 subscribers and has been operating since 1959. Initially the London service will cater for 350 subscribers.

The new service is similar to the South Lancashire service in that it will be possible to make telephone calls to and from subscribers' vehicles. However, it incorporates several new features. Selective calling has been introduced which will ensure that only the subscriber for whom a call is intended will know when it is being put through. The operating procedures are different in the two systems and equipment designed for one system is not suitable at present for the other.

Provided they are in the service area, subscribers can make and receive calls to any part of the country. The subscription to the service will be £7 10s. 0d. a quarter. Telephone calls within the area of coverage will cost 1s. 3d. for the first three minutes and 5d. for each additional minute. Calls outside the service area will be charged at normal trunk call rates plus 1s. 0d. radio call fee for the first three minutes and proportionately thereafter.

The subscriber will need to buy or rent the mobile radio-telephone equipment from an approved supplier.

For further information circle 47 on Service Card

### Author's Acknowledgment

In the article 'Continuous Weighing and Control in Heavy Industry' by A. C. Elstow, published in the July issue, no particular reference was made to the company who were responsible for the design and erection of the Kaldo plant, bunkers and associated instrumentation in Sweden. This work was in fact undertaken by Head Wrightson Iron and Steel Works Engineering Ltd., of Stockton.

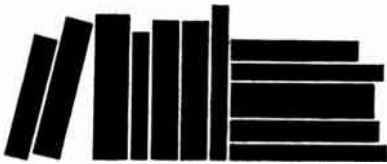

## NEW BOOKS

### **Studies of Solar Flare Effects and Other Ionospheric Disturbances with a High Frequency Doppler Technique**

By V. AGY, D. M. BAKER and R. M. JONES, National Bureau of Standards Technical Note 306, 158 pages. Available from the Superintendent of Documents, U.S. Government Printing Office, Washington, D.C., U.S.A., 20402. Price 75 cents (postage 19 cents extra).

This Technical Note presents a study of ionospheric disturbances using a Doppler technique. The theoretical results include a calculation of the frequency shifts to be expected from changes in the parameters of a parabolic model ionosphere and a method of determining the height variation of the time rate of change of electron density during ionospheric disturbances. The frequency shift, with oblique propagation, is shown to be the same as that with vertical propagation on the equivalent vertical-incidence frequency.

The experimental results include a comprehensive catalogue of all flare effects observed from 1st October 1960 to 31st December 1962, a statistical study of these flare effects, and the Doppler records of some solar flare effects detected during this period. A model in which the time rate of change of electron density is zero below the bottom of the E layer, and constant above that height, explains the frequency dependence of the maximum Doppler shifts observed during some solar flares.

### **U.K. Kompass: 1965 Edition**

Published in three volumes by Kompass Register Ltd., R.A.C. House, Lansdowne Road, Croydon, Surrey. Price £15 15s. (for 3 Vols.).

The U.K. Kompass is a detailed and up-to-date register of British industry. Two volumes are devoted to naming suppliers of more than 33,000 products manufactured in the United Kingdom. The third volume gives details of over 24,000 manufacturing companies: their locations, directors, share capital, number of employees, products and other essential information.

### **Transmission Loss Predictions for Tropospheric Communication Circuits**

By P. I. RICE, A. G. LONGLEY, K. A. NORTON and A. R. BARSIS. National Bureau of Standards Technical Note 101. Pp. 378 (two volumes). Price \$2 (postage 50 cents extra). Available from the Superintendent of Documents, U.S. Government Printing Office, Washington, D.C., U.S.A., 20402.

This two-volume Technical Note presents comprehensive methods for predicting cumulative distributions of transmission loss for a wide range of radio frequencies over any type of terrain and in several climatic regions. Such quantitative estimates of propagation characteristics help to determine how well proposed radio systems will meet requirements for satisfactory service, free from harmful interference. Thus they should provide an important step toward more efficient use of the radio-frequency spectrum.

The report covers detailed point-to-point prediction methods. The prediction of long-term median reference values of transmission loss is based on current radio propagation theories. Meteorological parameters are used to distinguish between climatic regions, and largely empirical predictions of long-term variability are based on radio data recorded over more than a thousand propagation paths in various parts of the world.

This Technical Note is the last one of a series (Nos. 95 to 103) on tropospheric radiowave propagation which was prepared by CRPL under sponsorship of the U.S. Air Force.

### **Radio-Frequency Connectors Part 1**

I.E.C. Publication 169 : Part 1 : 1965. Pp. 61. Available from British Standards Institution, 2 Park Street, London, W.1. Price 60s.

The first part of I.E.C. Publication 169 has now been issued. This Part 1 relates to connectors for r.f. transmission lines for use with electronic equipment and provides 'General requirements and measuring methods'. It establishes uniform requirements for the electrical, climatic and mechanical properties as well as safety aspects; for test methods; for interchangeability and compatibility both between connectors and between connectors and cables; and for classification of connectors into groups according to their ability to withstand extremes of temperature and humidity.

This recommendation is intended to be used in conjunction with other I.E.C. publications such as Publications 68 and 96. Parts laying down detailed specifications for different types of connectors will be issued as they become ready.

### **Fixed Metallized Paper Dielectric Capacitors for Direct Current**

I.E.C. Publication 166 : 1965. Pp. 49. Available from British Standards Institution, 2 Park Street, London, W.1. Price 50s.

This first edition of Publication 166 relates to fixed capacitors with self-healing properties, for direct current, with a rated voltage not exceeding 6,300 V, containing a dielectric of impregnated paper and thin deposited metal electrodes, intended for use in equipment for telecommunications and in electronic devices employing similar techniques.

These capacitors are divided into two categories—type 1, which may be protected by self-healing properties; and type 2, for which the self-healing of the metallized dielectric at voltages both below and above the rated voltage is relied upon to provide protection for a capacitor in normal use.

Divided into three sections and five appendices, Publication 166 establishes uniform requirements for judging the electrical, mechanical and climatic properties of capacitors; and describes test methods—visual examination and check of dimensions, electrical tests, robustness of termina-

tions, soldering, rapid change of temperature, vibration, container sealing, climatic sequence, damp heat, and endurance. These tests should be carried out according to I.E.C. Publication 68, 'Basic environmental testing procedures for electronic components and electronic equipment'.

### **Standard Frequency and Time Services of the National Bureau of Standards**

National Bureau of Standards Miscellaneous Publication 236. Pp. 8. Available from the Superintendent of Documents, U.S. Government Printing Office, Washington, D.C. 20402, U.S.A. Price 15 cents (postage 4 cents extra).

The National Bureau of Standards broadcasts eight technical services in the field of standard frequency and time signals, using four transmitting stations so that the transmissions can be received anywhere in the world. The services include standard radio frequencies, standard audio frequencies, standard musical pitch, standard time intervals, time signals, UT 2 corrections, radio propagation forecasts, and geophysical alerts. These widely used transmissions are available to anyone throughout the world who has the appropriate receiving facilities.

Miscellaneous Publication 236 describes the services and lists the schedules of the broadcasts as of 1st January 1965. This 1965 edition of Miscellaneous Publication 236 supersedes the editions of 1960 and 1961, and annual revisions are planned.

### **Eurolec 1965 Pocket Guide to the Electronics and Instruments Industry in the U.K.**

Pp. 153. Published by David Rayner Associates, 18 Pentonville Road, London, N.1. Price 18s.

Ten firms in the U.K. electronics and instruments industry account for just over 60% of the total labour force. Another 26.3% of the labour force is taken up by 37 firms, with the rest being shared between nearly 900 companies. Of the 47 companies which together employ nearly 90% of the labour force 12 are foreign-owned and account for about one-fifth of the total people employed in the U.K. electronics and instruments industry.

These figures are quoted from this pocket guide to the electronics and instruments industry.

The main part of the guide is devoted to listing about a thousand firms in, or associated with, the electronics and instruments industry. Each firm is given with the products or services it offers, together with the name and telephone number of the sales contact at that company. Also given are branch offices, the names of any distributors a company may have, and a company's parent (if it has one) and its number of employees.

Some 650 non-British companies with agents in the U.K. are listed in a separate section, this list being claimed by the publishers to be the most comprehensive to have been published in the electronics and instruments field.

## **Manufacturers' Literature**

**Brush Recorder Mark 200 series 1707.** The 20-page illustrated brochure (No. 1707) provides details of the 1707 series of chart recording systems. It contains examples of the various recorders produced and accessories and auxiliary equipment are described.

*Aveley Electric Ltd., South Ockendon, Essex.*

**For further information circle 48 on Service Card**

**The E.M.I. Community Television System.** Intended for relay companies, local authorities and those concerned with communal television, this 12-page illustrated brochure (B/CTV issue 2) gives the non-technical aspects of the system. Choice of the systems available, aerial siting cost, etc., are discussed and a list of those areas in which the installations have been or are about to be completed is provided.

*E.M.I. Electronics Ltd., Broadcast and Recording Equipment Division, Hayes, Middlesex.*

**For further information circle 49 on Service Card**

**Harrison Digitizers.** Details of several types of digitizers are given in this brochure of 20 pages together with an introduction explaining the basic principles of the technique, the codes used and the principles of operation of the units. Each model described is illustrated.

*Harrison Reproduction Equipment Ltd., 209 Lynchford Road, Farnborough, Hampshire.*

**For further information circle 50 on Service Card**

**Multi-Channel UHF/VHF Radio Telephone Equipment.** This is a 6-page booklet describing the applications of the radio telephone equipment (Type 900) manufactured by A. T. and E. Ltd. Specifications and performance figures are given and there are illustrations of the various units used.

*A. T. & E. (Bridgnorth) Ltd., Bridgnorth, Shropshire.*

**For further information circle 51 on Service Card**

**Mullard Microwave Components.** Specifications for and illustrations of the latest range of microwave components from Mullard are given in their 4-page leaflet. These include circulators, isolators, waveguides and balanced mixers for telecommunications and radar applications.

*Mullard Ltd., Industrial Markets Division, Mullard House, Torrington Place, London, W.C.1.*

**For further information circle 52 on Service Card**

**Closed Circuit Television in the Coal Industry.** This 54-page publication gives full details of several systems of closed-circuit television produced by Pye for the coalmining industry. Illustrated with photographs and block diagrams, it includes specifications for the television and ancillary equipment.

*Pye H.D.T. Ltd., Coldhams Lane, Cambridge.*

**For further information circle 53 on Service Card**

**R. & S. Modules for Data Processing.** In a 46-page booklet, data sheet 1207 100 E-1, Rohde & Schwarz, W. Germany, describe a data-processing system giving details and illustrations of the individual stages of the system. An introduction discusses the problems and operation of such a system.

*Aveley Electric Ltd., South Ockendon, Essex.*

**For further information circle 54 on Service Card**

**Survey of Kent Products.** Each of a range of measuring and controlling instruments is described with illustrations in a 12-page brochure, publication number PG 902. This is an extensive range of products covering several aspects of industrial instrumentation.

*George Kent Ltd., Luton, Bedfordshire.*

**For further information circle 55 on Service Card**

**High Speed Data Links.** Two leaflets have been prepared by G.E.C. outlining the DT10A series of high speed data links which permit transmission of data via the public telephone network or private lines to and from a central computer. The first leaflet, publication number DTC/10 (A) Ser/1, describes the basic details and applications of the system. The other leaflet of seven pages, publication number DTC/10A Ser. Tech., provides technical details.

*G.E.C. (Electronics) Ltd., Data Transmission and Collection Dept., East Lane, Wembley, Middlesex.*

**For further information circle 56 on Service Card**

# A GLASS AND A HALF OF COMPONENTS GO INTO EVERY INTEGRATED CIRCUIT

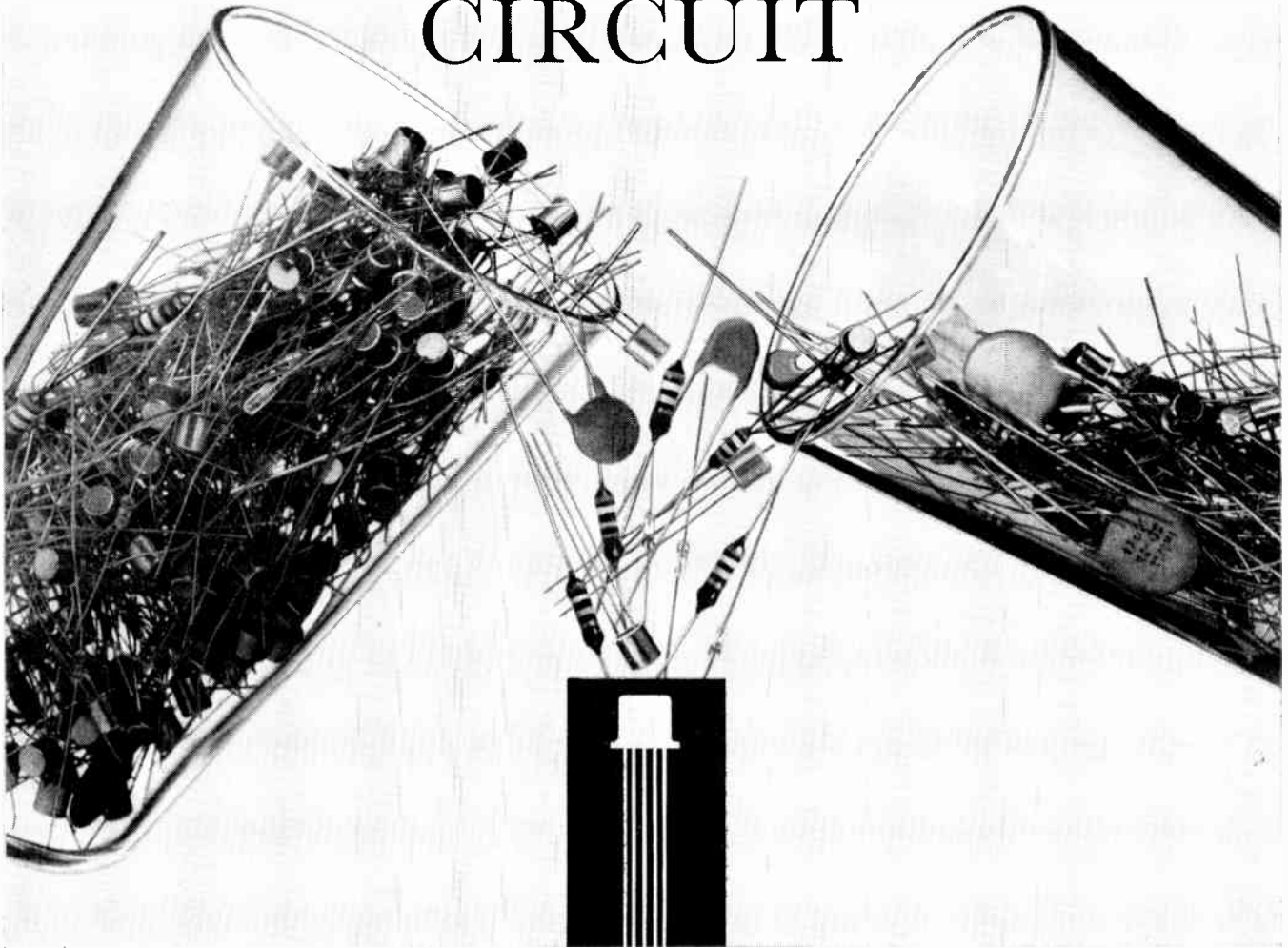

Roughly speaking. More precisely, Semiconductors Ltd. integrated circuits offer a range of sophisticated elements which by their versatility, compact form and low cost permit a completely new approach to many common requirements in circuit design.

**The SL 700 Series**, for example, are high-gain d.c. operational amplifiers, extremely tolerant of supply line

variations. Input d.c. offset voltage is typically 100mV and offset current 0.3 $\mu$ A. High gain versions have open loop gains of approximately 70dB, while alternative versions from the same basic chip enable gain to be traded for stability.

**The SL 500 Series** is a 100 Mc/s wideband amplifier, primarily intended for use in linear I.F. strips operating at centre frequencies between 10 and

60 Mc/s.

The amplifier gives a current gain of 26dB between 5 Mc/s and 100 Mc/s and the circuit incorporates AGC giving at least 40dB gain control range.

*These are just two of the many advanced, monolithic, silicon integrated circuits available.*

*It will always pay you to check with Semiconductors Limited before initiating new equipment designs.*

**Semiconductors Limited**

Cheney Manor, Swindon, Wilts. Tel: Swindon 6251



# DOUBLE BEAM COSSORSCOPE 2300

Model 2300 is a compact, precision calibrated oscilloscope designed specifically for high-sensitivity, low-frequency applications in electrical engineering, servo analysis, electro-mechanical transducer displays, electro-myography and electro-cardiography. A double-gun cathode-ray tube is employed. Two identical amplifiers are provided with a choice of either single-ended or differential inputs.

The triggering system provides four modes of operation: Auto, A.C. Slow, A.C. Fast, and D.C., and the sweep may be triggered from any selected point on the positive or negative slope of the signal. Mechanical triggering is available, whereby an external contact closure, developed across the MECH and COMMON terminals of the oscilloscope by the apparatus under test, will trigger the time-base, an external voltage source being unnecessary. Single-stroke operation can be primed or triggered by a push-button.

- Frequency response d.c. to 200 kc/s (-3 dB) ■ Identical Y amplifiers 1 mV/cm to 50 V/cm
- 19 calibrated timebase ranges 5 sec/cm to 5  $\mu$ sec/cm ■ Voltage calibration  $\pm 3\%$  and time calibration  $\pm 3\%$  ■ Mechanical triggering Z modulation and equal X-Y facilities

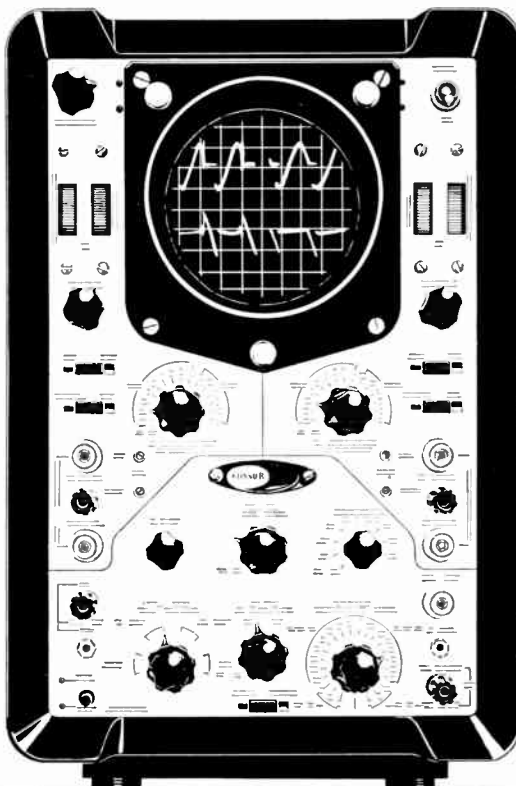

**COSSOR**  
A Member of the Raytheon International Group

**COSSOR INSTRUMENTS LTD.**  
The Pinnacles, Elizabeth Way,  
Harlow, Essex, England.  
Tel: Harlow 26862 Cables: Cossor Harlow

**DO-IT-YOURSELF  
AUTOMATION**



# **NEW LIVINGSTON HIGH-SPEED BATCHING COUNTER**

—counts 1,200 items a minute, batches up to five times per second

There's nothing fancy looking about the exterior of the new Livingston High-Speed Batching Counter. Its tough moulded aluminium case is never likely to win a prize for industrial design. But it has a tough, made-to-do-a-job quality often lacking in today's automation aids claimed to be able to stand up to rough factory-floor treatment.

If you have a batching or counting problem, the Livingston LC 501 Fast Batching Counter can help you solve it—and save time and money too. It is specially suited for fast automatic batching operations into individual packs or containers—counts 1,200 items a minute, batches up to five times per second without losing counts during re-set period.

A feature of the LC 501 is a built-in logic circuitry which enables a main and secondary batching programme to be handled.

A digital readout can be used in conjunction with photoelectric, inductive or capacitive sensors. Provision is also made for the inclusion of a batch totalling counter if required.

Livingston Control has an extensive range of robust control modules, which are interchangeable and designed to be built brick by brick into a comprehensive system to meet your specific needs.

We don't recommend dropping these units off a bench for the fun of it, but if you do happen to do so, it won't harm the solid-state electronic circuitry inside. It has been designed to take just such punishment.

Write today for full information on our control and automation aids.

## **LIVINGSTON CONTROL LTD**

Greycaines House, Bushey Mill Lane  
Watford, Herts  
Telephone: Watford 41291

**To Livingston Control Ltd.**  
Greycaines House, Bushey Mill Lane  
Watford, Herts



*Please send me full details on your control and automation aids*

NAME.....

ADDRESS.....

.....

.....

IE 8

Sensitivity  $40\mu\text{V}(1^\circ\text{C})$

Multi-Million Operational life

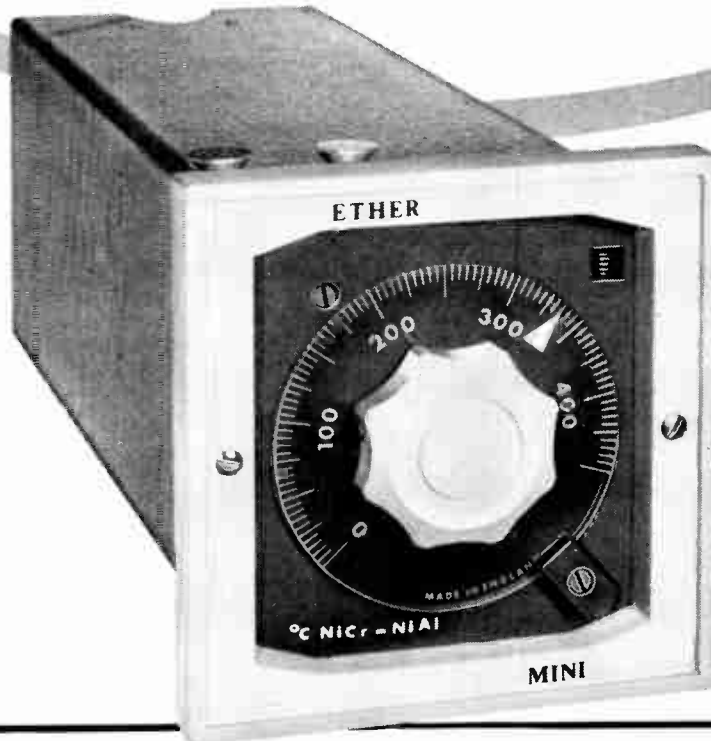

**ETHER**

**TRANSISTORISED  
TEMPERATURE REGULATOR**  
MINI TYPE 17-90

*Accurate, Reliable Temperature Control up to  $2000^\circ\text{C}$*

The difference signal between the output of a thermocouple and an internal reference voltage is fed to a transistorised amplifier to operate a relay. The relay will operate on an input signal differential of less than 40 microvolts, equivalent to less than  $1^\circ\text{C}$ , with base metal thermocouples, and less than  $2^\circ\text{C}$  with precious metal types. Provision is made for increasing this differential by a factor of 10 where very close control is not required. The relay has a life expectancy of several million operations at maximum load rating. Set point is adjusted by a precision potentiometer, and read by the position of an illuminated cursor on a calibrated scale. A signal lamp is provided to show the control condition. Standard ranges from £27-10-0.



Send for full details to:—

CAXTON WAY, STEVENAGE, HERTFORDSHIRE  
Telephone : Stevenage 3040-55



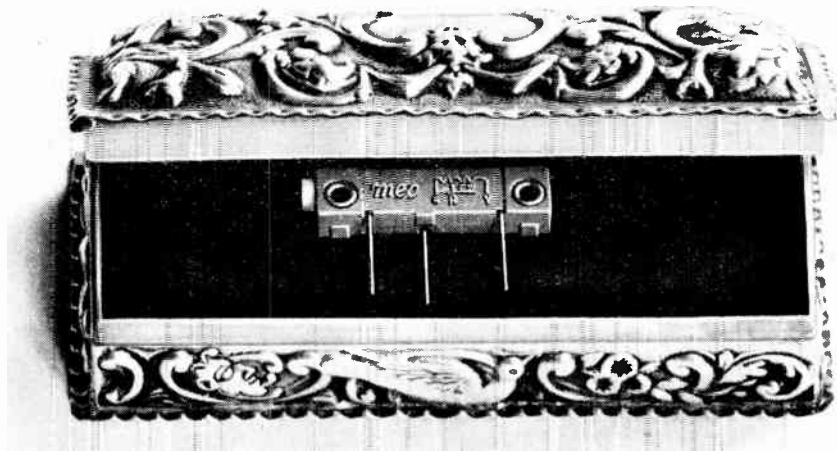

## A Mecpot is forever

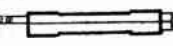
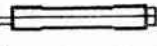
Like a precious stone, the Mecpot once set retains its value  But there the comparison ends for Mecpot trimmer potentiometers are inexpensive, versatile, easily adjusted, and with three connection types can fit any circuit  Resistance values from 10 to 20,000 ohms  Maximum rating 1 watt at 20°C. de-rating to  $\frac{1}{4}$  watt at maximum temperature of 85°C.  Three models: MP30  with solder tags for conventional chassis mounting; MP31  with L-shaped tags for insertion into printed circuits; MP32 illustrated above, actual size, with pins spaced along the body, for direct mounting on printed boards, no other fixing being necessary  Write or phone for full specification and samples.

Miniature Electronic Components Ltd., St. John's, Woking, Surrey. Woking 5211.

**m-e-c**

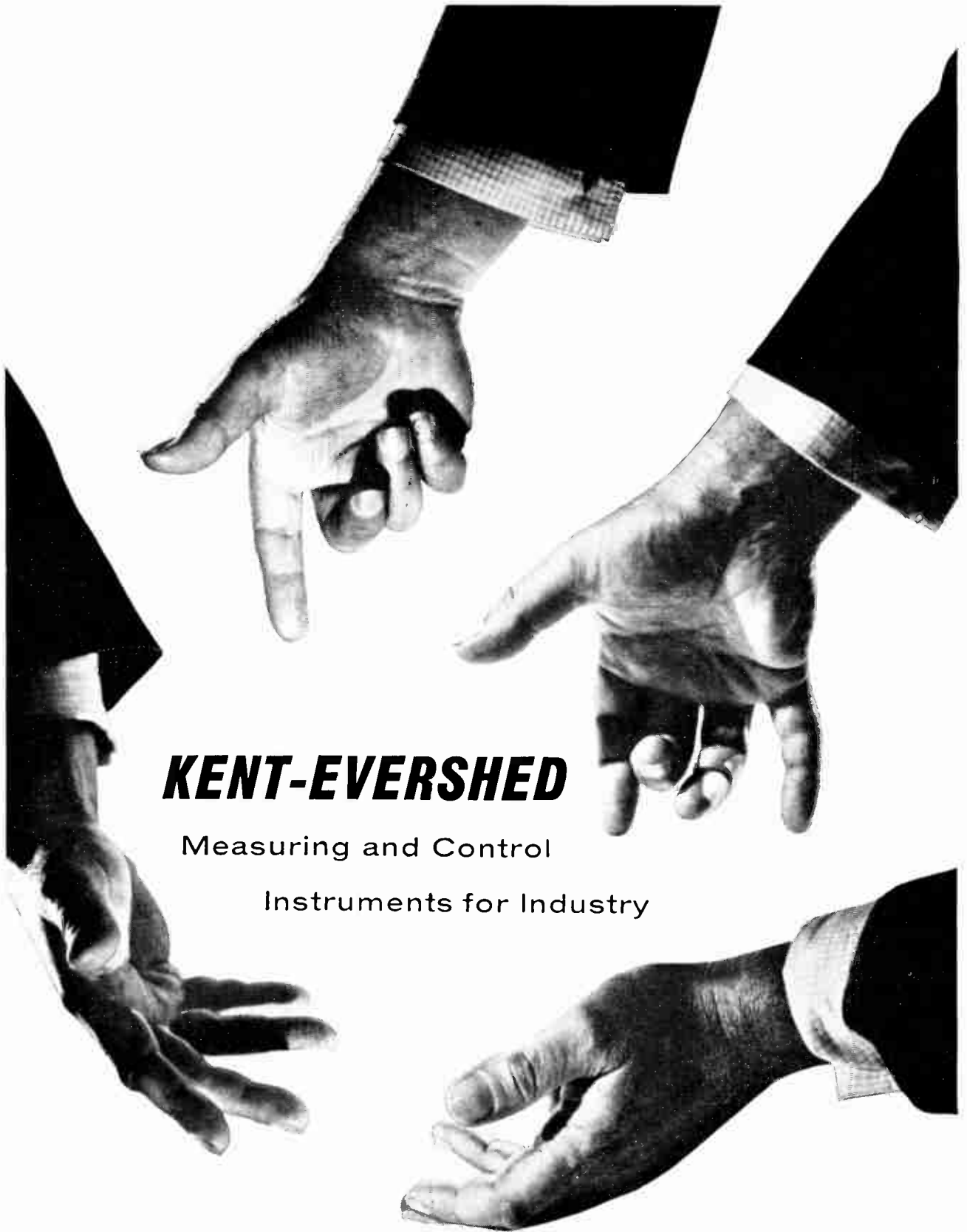

# **KENT-EVERSHED**

Measuring and Control

Instruments for Industry

INSTRUMENTATION · MEASUREMENT · TESTING & CONTROL EQUIPMENT

**Kent-Evershed Limited** Acton Lane Works · Chiswick · London · W4 · Telephone: Chiswick 3670 EV8

*A member of the Kent group of companies.*

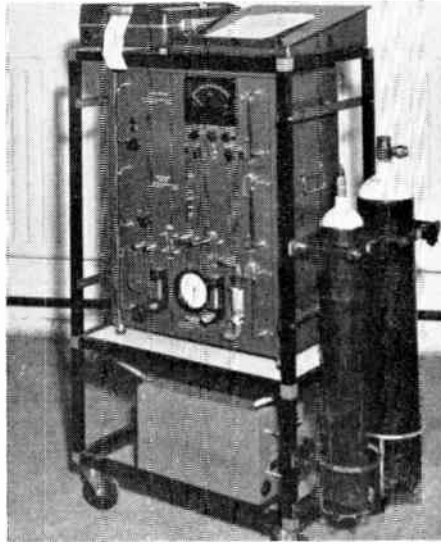
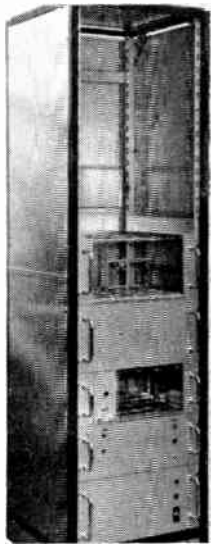
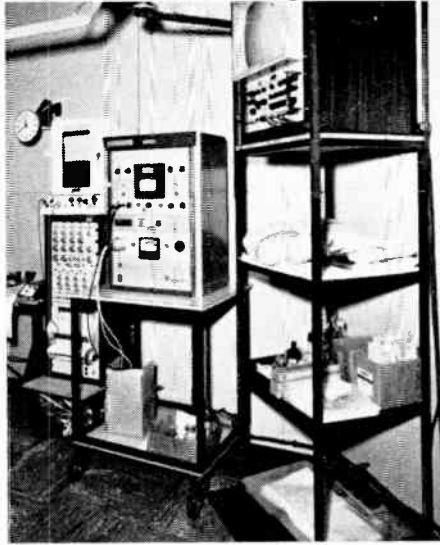

## clean, simple—looks terrific

**What's that?** Dexion Speedframe.  
**What's it for?** Test consoles and benches; trolleys, switchgear mountings, monitor stands; one-off prototypes or complete furnishing and equipment projects.

**What's it do?** Any-size, rigid frames in moments. Uses 1" or 2" square-tube. Tailor-made for every project at far less cost than ready-made frames!

**What's the catch?** No catch. No welding, bolting, equipment, finishing or painting either.

**What's it need?** No skill. Little outlay. Unlimited ideas.

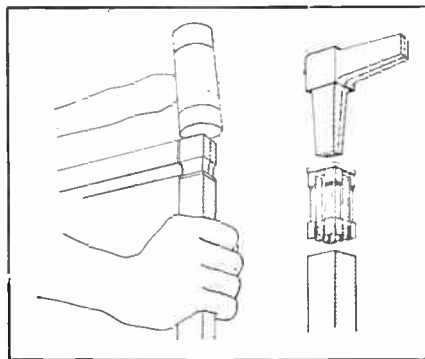

**Here's the Speedframe tube-jointing idea:**

**Joint** which, when hammered into the tube, is wedged by an **insert** which in turn jams tight inside the **tube** to keep the joint weld-firm.

**You could do with Speedframe in your next project,**

We'll be delighted to send you material specifications, fresh ideas on Speedframe in electronics, further details of Dexion products. Send in the coupon now.

Please rush me full details and prices.

1" system    2" system    Prices

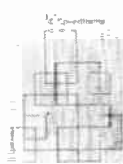

Name \_\_\_\_\_  
 Position \_\_\_\_\_  
 Company \_\_\_\_\_  
 Address \_\_\_\_\_

Phone \_\_\_\_\_  
 Speedframe Division, Dexion House,  
 Empire Way, Wembley, Middlesex.  
 Tel: WEMbley 1281                      B.247

**Dexion Ltd**

# Ultra-High Vacuum Feed-through From RCA

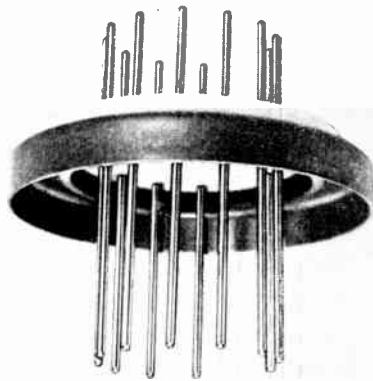

RCA-VC2123, 11-pin instrumentation feed-through

RCA-VC2127, 36-pin instrumentation feed-through

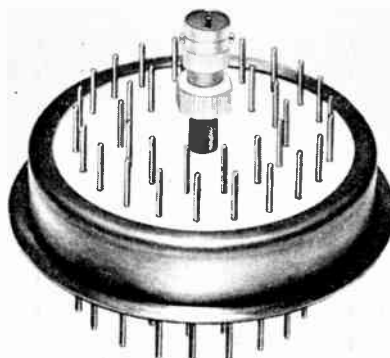

RCA-VC2113, 1000-ampere, 5000-volt feed-through

## Typical examples for connecting electrical circuits into high vacuum systems

What are the electrical circuit requirements within your high vacuum system? 40,000 volts? 1000 amperes? Coaxial line? Thermocouple or other instrumentation wire? RCA offers you a wide variety of new economical, electrical, ceramic-metal and glass-metal feed-throughs to meet your electrical circuit requirements. Reliability and exacting tolerances are assured through three decades of vacuum-tube experience.

Standard designs are available. Single, multiple, and combination units can be "flanged" to meet your specific needs. We can suggest connectors for all our feed-throughs. Let us quote on your requirements.

RCA Vacuum Components Product Guide, VAC-100, a short-form catalogue on gauge tubes, electron beam guns, pumps, valves, flanges and accessories, windows, feed-throughs, systems, and custom-made components.



Maximum Ratings		No. of Conductors	RCA Type No.	Conductor Description			
Amp	Volts			Diameter Inches	Length Inches	Solid (S) or Hollow (H) Metal*	
2 <sup>a</sup>	500	1	J1896	0.125	2.13	S	K
2 <sup>b</sup>	5000	1	VC2121	0.062	0.39	S	Ni
5	40,000	1	J1897-1	0.250	15.50	S	SS
30	2000	1	J1914	0.125	2.00	S	M
40	5000	1	VC2116	0.100	4.13	S	Ni
250	5000	1	VC2113	0.500	5.00	S	Cu
1000	5000	1	VC2110	0.375	7.19	H	Cu
2	250	7	J1945	0.040	1.25	S	K
2	500	8	J1952	0.050	5.00	S	K
See footnote c	50	10	J1914	0.070	0.85	H	Ni
2	250	11	VC2123	0.040	1.38	S	K
See footnote d	250	11	J15031	0.040	1.38	H	K
5	500	36	VC2127	0.050	1.75	S	K
1 <sup>f</sup>	500	1		0.040	1.75	S	K

a) UHF, 50-ohm coaxial type.  
 b) Nickel-cadmium battery, cap. 500 psi.  
 c) Thermocouples up to 16 AWG  
 d) Thermocouples up to 26 AWG  
 e) Nickel plated material: K-Kovar, Ni-Nickel, Cu-OFHC copper, M-Molybdenum, SS-304 Stainless Steel  
 f) UHF, Coaxial type



THE MOST TRUSTED NAME IN ELECTRONICS

RCA GREAT BRITAIN LIMITED Sales Division, Lincoln Way, Windmill Road, Sunbury-on-Thames. Associate Company of Radio Corporation of America. Telephone: Sunbury 5511.

**RACAL**

**Announce a NEW Decade Divider Unit**  
Frequency Measurement of the  
SA.535 counter/timer is  
extended to 15 mc/s



**Racal SA.548  
Decade Divider Unit**

Extends frequency range  
to at least 15 Mc/s  
Trigger level offset up to  $\pm 300V$   
All-semiconductor  
**U.K. Price £70**  
**Delivery ex stock**

**Racal SA.535  
Universal Counter/Timer**

- Frequency Measurement to 1.2 Mc/s
- All-semiconductor
- Print-out facilities
- Time, Period and Frequency measurement
- Compact and Portable
- Six-digit in-line or vertical display

**U.K. Price £195**  
**Delivery ex stock**

The frequency range of the Racal SA.535 counter may now be extended from 1.2 Mc/s to 15 Mc/s, using the new SA.548 Decade Divider Unit. Trigger levels can also be offset up to  $\pm 300V$  facilitating discrimination against unwanted signals. The SA.548 is mains-operated and forms a plinth upon which the SA535 stands.

**RACAL**

Write for full details:  
**Racal Instruments Limited**  
Dukes Ride, Crowthorne, Berks  
Tel: Crowthorne 2272/3 and 3763  
Telex: 84166 Cables: Racal, Bracknell

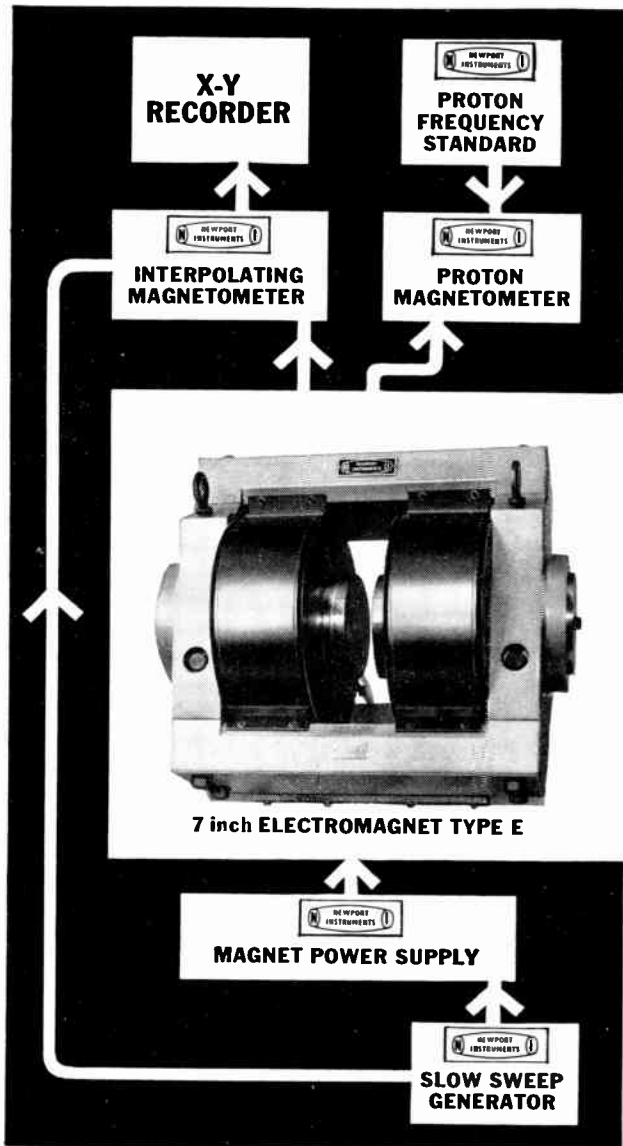

## LEADERSHIP with a system

Within the wide range of NEWPORT electromagnet systems, we can offer magnets for every laboratory application. NEWPORT leadership in the field of electromagnet technology is 'leadership with a system'—with any of the special systems designed and built by NEWPORT.

We at NEWPORT offer a service to match our reputation as the best-known name in the field of electromagnets, magnet power supplies and magnetometers. Standard or custom-built, our magnets and magnet systems represent not only accuracy and dependability—but economy of price.

Let us send you a copy of the NEWPORT Catalogue—now.

# Newport Instruments

LTD

Newport Pagnell, Bucks, England, Tel: Newport Pagnell 401

# OXLEY

TYPE 062

## SUB-MINIATURE "BARB" INSULATORS

A new OXLEY Patented sub miniature insulator which is speedy to assemble and with outstanding physical characteristics

The P.T.F.E. bush, which is supplied with the heavily silver Plated brass "barb" partly inserted, is located in an ordinary .062 dia. hole and the barbed spill is pressed firmly through the assembly, thus expanding the P.T.F.E. bush on the far side of the chassis and locking the complete assembly firmly in the chassis

Working voltage 500 V.DC; Capacity less than 5 pF; Temperature range -55°C to 200°C; Resistance to pull in either direction 3 lbs; Chassis thickness .22 24; SWG .022" .028 0.56 0.72 mm; Mounting hole dia. .062" - 1.16" 1.58 mm

100 of these insulators mounted, occupy only one square inch of chassis space

**OXLEY DEVELOPMENTS CO., LTD.**  
ULVERSTON : LANCASHIRE.  
Telephone : ULVERSTON 2567

For further information circle 247 on Service Card

**● RUBBER ACCESSORIES**

Ask for Cat. No. MEI/62C/IE

**METWAY • KEMP TOWN • BRIGHTON 7**

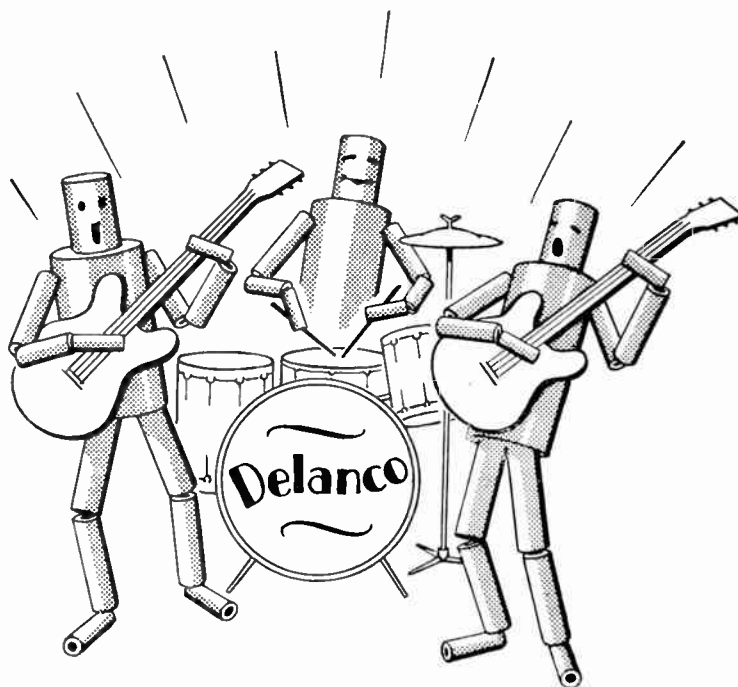

## **TOP OF THE TUBES**

### **Delanco S.R.B.P., S.R.B.F Glass Laminates**

**for Electrical, Mechanical and High Heat application**

Delanco Tubes are available in Paper, Fabric or Glass Based Laminates in round, square or rectangular form (even oval) over a vast range of dimensions from the very small to the very large. They can be manufactured to specified internal and external dimensions and they can be threaded, milled, turned, drilled and machined to almost any shape or requirement.

In fact, because of their lightness and strength, wearing and insulating qualities, economical price and in glass, heat resistance, LAMINATED TUBES are the ideal materials for all electrical, mechanical and high heat applications.

In addition, they are available — QUICKLY!

Consult our Technical Department for advice and suggestions.

# **ANGLO-AMERICAN VULCANIZED FIBRE CO. LTD.,**

CAYTON WORKS · BATH STREET · LONDON E.C.1.

Cle 8489 15 lines Grams: "PROMPSERV" LONDON.

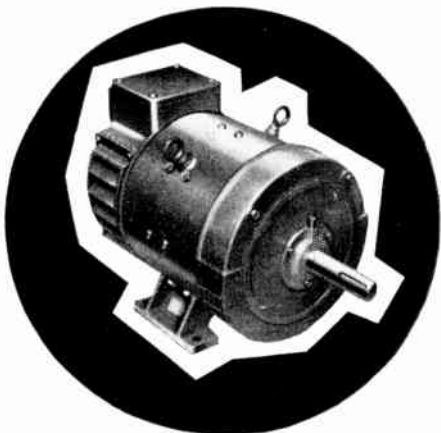

'X' type D.C. motors,  $\frac{1}{2}$  - 40 h.p.

**You can't say DEPENDABLE  
without EPE**

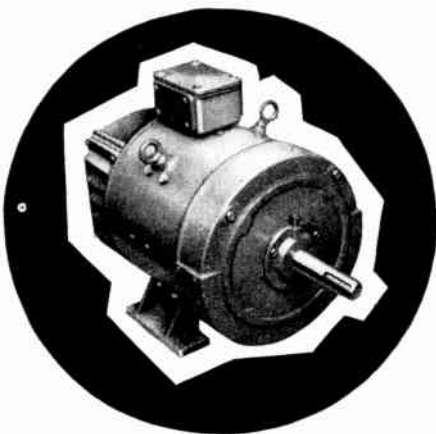

'Y' type D.C. motors,  $\frac{1}{2}$  - 40 h.p.

## D.C. Motors for electronic speed control



THE ELECTRICAL POWER ENGINEERING CO. (B'HAM) LTD.  
EPE WORKS, BROMFORD LANE, BIRMINGHAM 8  
Telephone: SEchford 2261  
Grams: Torque Phone, Birmingham

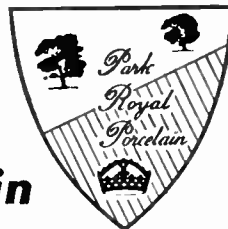

**Porcelain**

**Steatite**

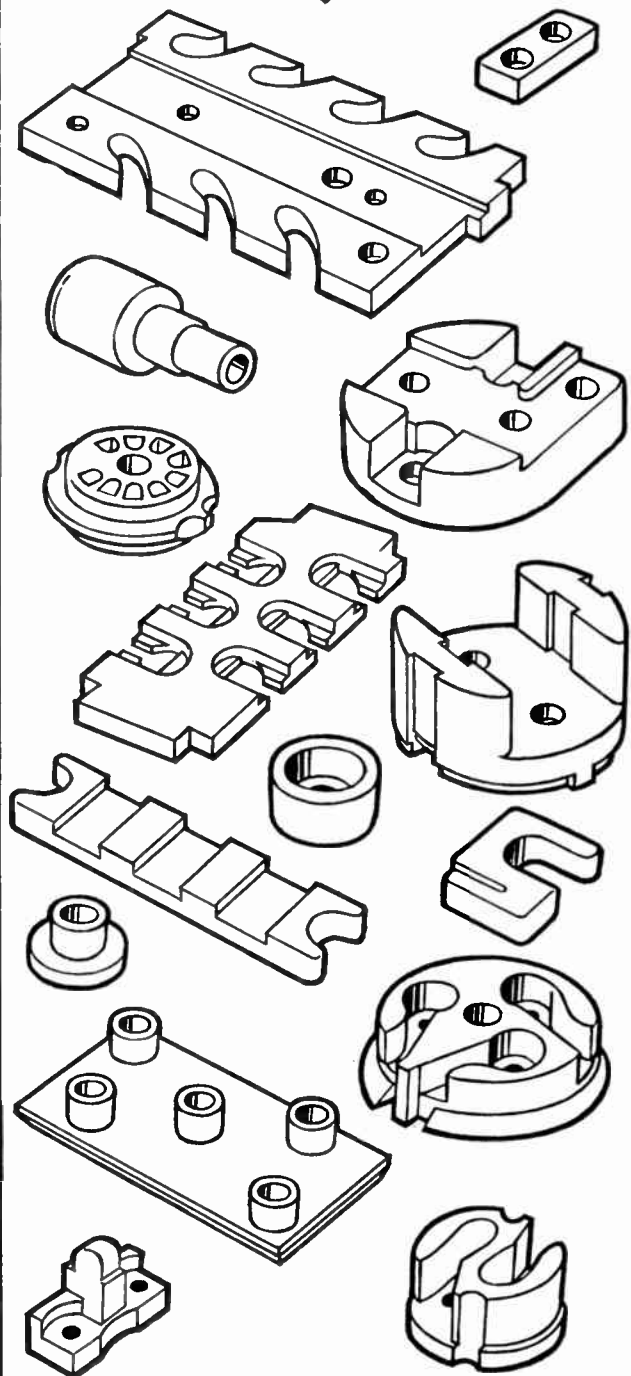

## V. G. PORCELAIN CO. LTD

GORST ROAD  
PARK ROYAL  
LONDON, N.W.10

Telephones:  
ELGAR 1411/7  
Telex:  
London 25589



# Wire wound potentiometers your business?

## YOU KNOW YOU NEED SPECIAL WIRES

to achieve very high accuracy, linearity and resolution in your potentiometers, and so do we. That's why we have developed JMC Potentiometer Wires.

These wires are produced to the closest practicable limits on resistance per unit length, in some wires as close as  $\pm 1.5\%$ . Stringent production and inspection control ensures that they have perfect finish, absolute roundness and freedom from coil or twist. You use them in this condition for they are exactly wound on special reels.

All JMC Potentiometer Wires can have a coating of "Diamel" or "Trimel" controlled to close limits along the entire length.

# *special wires are our business!*

Ask for free data sheet

**JOHNSON, MATTHEY & CO., LIMITED**  
 73-83 HATTON GARDEN, LONDON, E.C.1  
 Telephone: Holborn 6989                      Telex: 21465  
 Vittoria Street, Birmingham, 1              Telephone: Central 8004  
 75-79 Eyre Street, Sheffield, 1              Telephone 29212

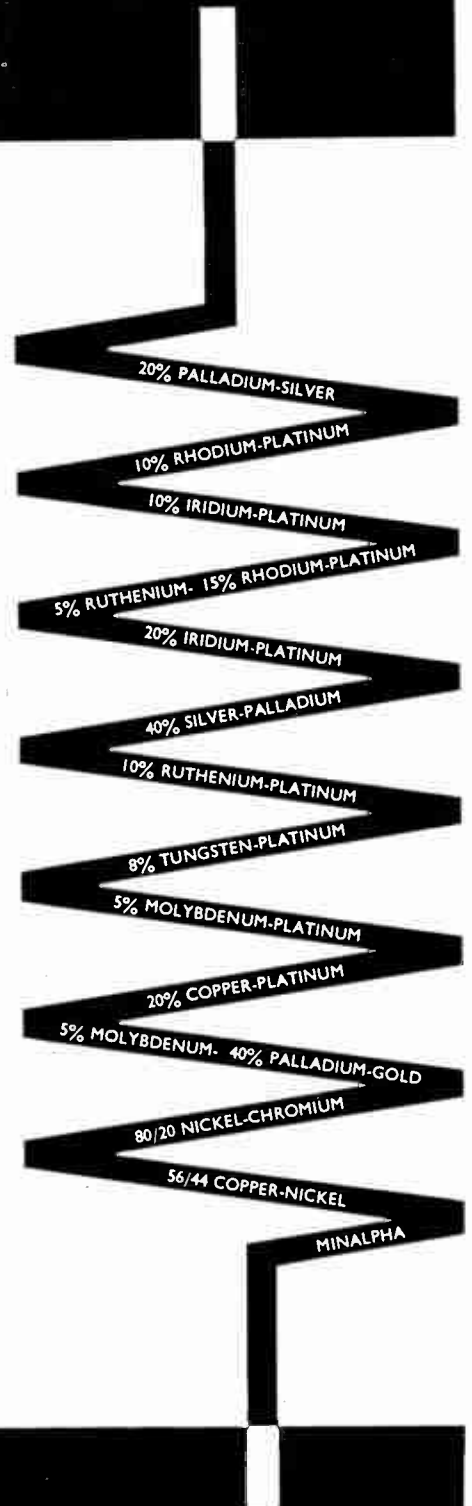

# JMC POTENTIOMETER WIRES

# presenting the **NEW selectest** mark II



The Selectest is now in use throughout the world. The Mk II incorporates improvements suggested by actual users. The resistors, rectifier, transformer, movement, switches and automatic cut-out are mounted on a robust printed circuit board enclosed in a strong, attractive two-tone Melamine case. Overall dimensions are 9 $\frac{1}{4}$ " x 7 $\frac{1}{8}$ " x 4 $\frac{1}{2}$ ". Leather case available as an extra.

**SCALES** The ultimate in legibility. Three scales with mirror insert and knife-edge pointer to eliminate parallax errors.

**ACCURACY** Within the limits of B.S.S.89/1054, and complies with Part II of the 6th Schedule of Merchant Shipping (Radio) Rules 1952.

**RANGES** Selected by two rotary multi-position switches capable of continuous rotation in either direction. The circuit is designed to provide electrical interlocking. External shunts and transformers available for increasing the D.C. and A.C. current ranges.



**NEW DESIGN 'BANANA' SOCKETS.**  
Requested by the engineers in the field. Leads 36" long with interchangeable clips and prods.

**EASY-ON-THE-EYE FIGURES.**  
The new multi-position rotary switches incorporate a new numbering system which is clear and easy to read.

**SALFORD ELECTRICAL INSTRUMENTS LTD**  
Peel Works, Silk St, Salford, 3, Lancs. Tel: Blackfriars 6688 Telex: 66711  
London Sales Office: Brook Green, Hammersmith W6. Tel: Riverside 5245  
A Subsidiary of THE GENERAL ELECTRIC CO. LTD. OF ENGLAND.

For further information circle 253 on Service Card

NUMBER ONE IN ELECTRICAL CONNECTORS...

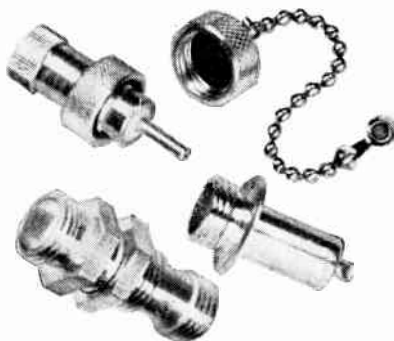

## JONES TYPE CO-AXIAL CONNECTORS

Low cost miniature co-axial with brass shells, screw thread coupling.

**CANNON ELECTRIC (GREAT BRITAIN) LTD.**

25-27 Bickerton Road  
London N.19  
Tel.: ARchway 3088



For further information circle 254 on Service Card

## VITALITY BULBS

Tested and proven  
A.I.D. and A.R.B.  
Miniature and Sub-miniature  
indicator bulbs, from 1 to 50v,  
in sizes from 4.0 mm.

Catalogue from:—Vitality Bulbs  
Ltd., Neville House, Wood Green,  
N. 22. MULberry 1931.

For further information circle 255 on Service Card

## ELECTRONICS PRINTED CIRCUITS

An extremely comprehensive service is available to industry which is unique in its scope and unprecedented in its quality of workmanship and speed of service while at the same time giving that all important individual attention and very competitive price terms that every buyer seeks.

The service consists of inclusive facilities for the design, development, and large scale production of all types of electronic equipment, instruments, etc., together with all processes involved in the design, development and production of printed circuit boards.

The unique location of T.E.S. Ltd., allows this first class service, which is to be found nowhere else, to be brought to your doorstep by an almost daily transportation service to 100 miles all for the price of a telephone call. **Shanklin 3096.**

Special attention will be given to very welcomed enquiries from customers outside the U.K.

**TRANSMETRIX ELECTRONIC SYSTEMS LTD.**  
Hyde Works, Shanklin, Isle of Wight, Hants

# BRIDGES

modern variations of established ideas

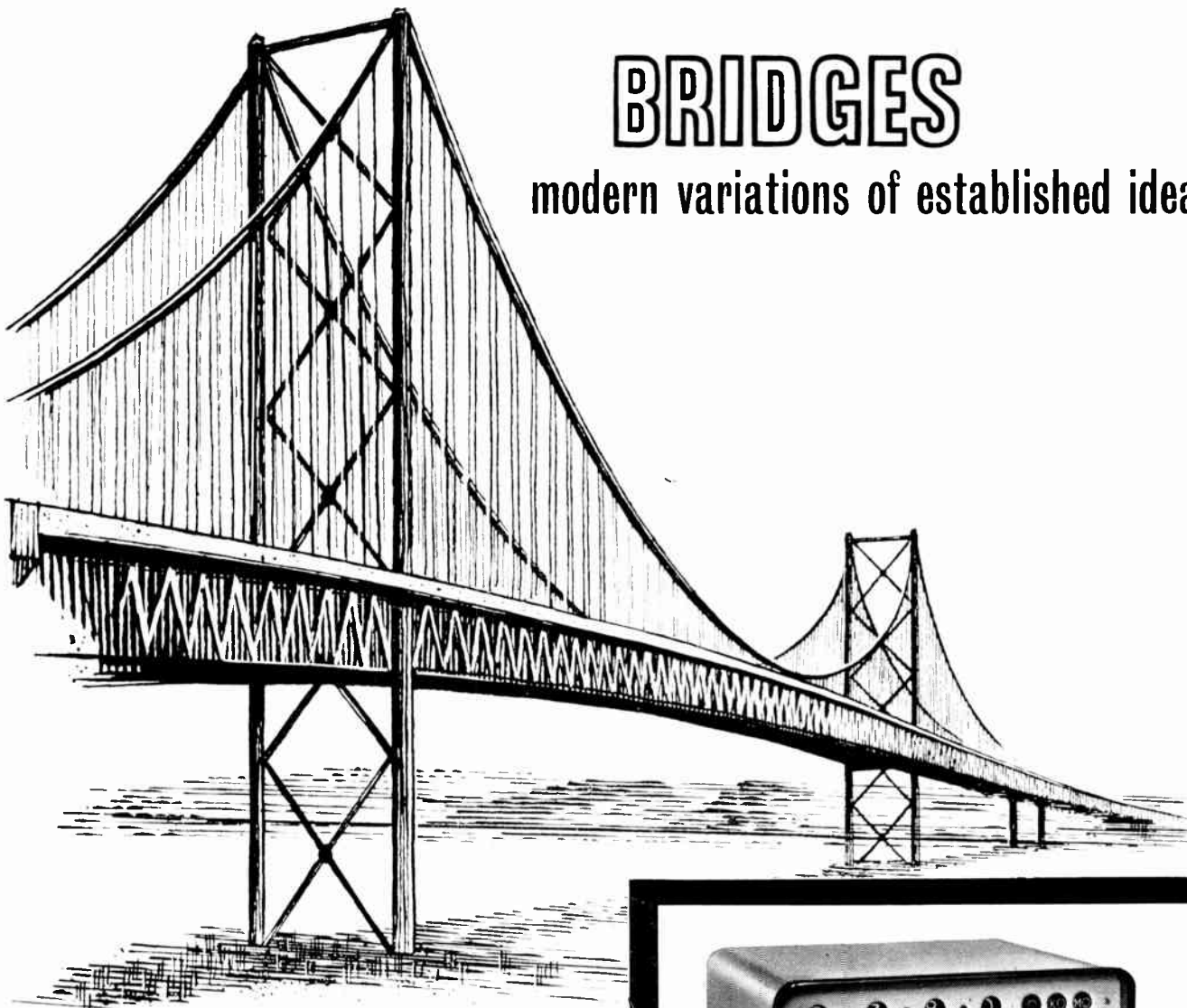

The new Forth Bridge  
and the new

## Digital Wheatstone Bridge

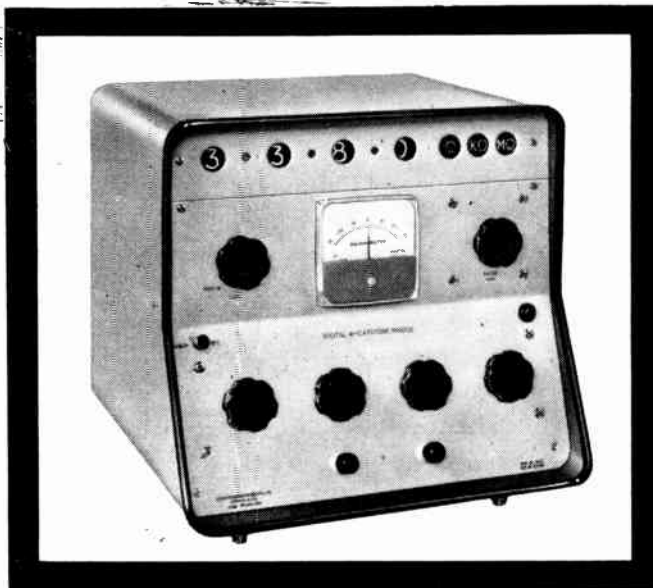

The old Forth Bridge is superseded. The same purpose is served but much more efficiently. This also applies to the modern version of the Digital Wheatstone Bridge. The high standard of accuracy and reliability is still there and the purpose is the same but there are many modern innovations. The illuminated display gives an instant and unambiguous digital readout of four figures, decimal point and the correct unit, i.e. Ohms, Kiloohms or Megohms and there is therefore no need to work out the ratio in use. Resistance coils, wound in Constantan are adjusted to an accuracy of better than  $\pm 0.1\%$ . Test potentials of approximately 2.5 and 100 volts are obtained from supply mains and either 'Low' or 'High' can be preselected.



**DERRITRON INSTRUMENTS LIMITED**  
24 UPPER BROOK STREET · LONDON W1  
HYDE PARK 2291

IE/E/65

**A 0.0025 in. WIDE  
CIRCUIT COMES UP  
SHARP AND CLEAR  
ON TAYLOR  
COPPER-CLAD  
LAMINATE**

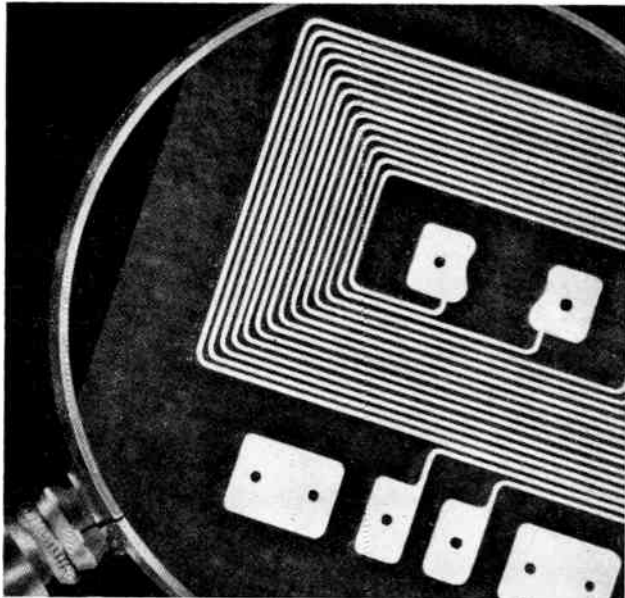

9 x magnification of a  $\frac{1}{2}$  in. square printed circuit with Taylor copper-clad laminate.

For information request data sheet 8-1B from

**WALMORE  
ELECTRONICS LTD**

11-15 BETTERTON ST., DRURY LANE, LONDON, WC2 Tel: TEMple Bar 0201-5



*precision data sensors  
and systems  
temperature · pressure*

**REC  
PLATINUM  
RESISTANCE  
THERMOMETERS**

**1000°K**

**W  
I  
D  
E  
T  
E  
M  
P  
E  
R  
A  
T  
U  
R  
E  
R  
A  
N  
G  
E**

**INDUSTRIAL IMMERSION  
AND SURFACE SENSORS**

- Wide choice of characteristics from Stock and stock-assembly models.
- Temperature ranges 13–800 °K.
- Made-to-Order service for high and low temperature models and special applications.

**STOCK  
MODELS**

SINGLE ELEMENT MODELS	E666	} 70–820 °K adjustable immersion length
DOUBLE ELEMENT MODELS	E692	
	E693	} 2½" min. – 19" max.
	E694	

all welded stainless steel sheaths for complete hermetic seal.

**STOCK-ASSEMBLY  
IMMERSION SENSORS**

We hold stocks of thermometer sheaths, connection heads and resistance elements for quick assembly to order. You select sheath and head types and ohmic value of elements to suit system characteristics. You save the cost of a special order.

**SURFACE SENSORS**

- High accuracy models for attachment to surfaces by welding, brazing, cementing, metal spray, screwing, etc.
- Miniature versions only .025" in thickness.

Send for full details in bulletins:

E 12636 Rev. A

Immersion thermometers

E 8648

Surface sensors

E 126321

Vapour pressure thermometers

**VAPOUR PRESSURE for cryogenic temperatures  
THERMOMETERS (He, H<sub>2</sub>, N<sub>2</sub>, O<sub>2</sub>, etc.)**

Write for descriptive bulletins and specifications on temperature sensors, pressure sensors, temperature standards, temperature control modules and complete measuring, indicating and control systems, de-icing heaters, etc.

to

**RESEARCH & ENGINEERING  
CONTROLS LTD**

Durban Road · Bognor Regis · Sussex

Telephone: Bognor Regis 4101-2-3-4 Telegrams: Sensor Bognor Regis

# series 901 imlok

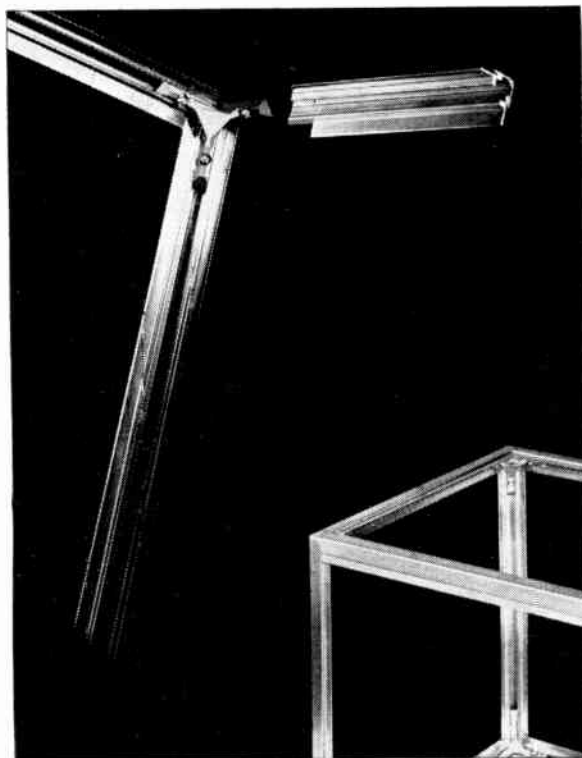

Series 901 Imlok will make really attractive cases and cabinets of practically any design you may conceive – quickly, cheaply and without tooling costs. There are parts in the system to give you either fixed or removable panels, (recessed if you wish), sliding or hinged panels doors and drawers. Full details of all the component parts and full instructions on how they are used are shown in the new series 901 Imlok Manual, together with a whole host of illustrations (many in full colour) of typical units that can be made. Alternatively, you can have your equipment housings custom-built by Imhofs to your exact requirements in any stage of manufacture up to a fully panelled and painted unit. Be sure to send today for your own free copy of the new series 901 Imlok Manual.

send today for your own free copy of the new 56 page series 901 Imlok Manual – a complete guide to the most versatile system for making instrument and equipment enclosures



Alfred Imhof Limited Dept. IE/8  
Ashley Works Cowley Mill Road  
Uxbridge Middlesex  
Telephone Uxbridge 37123  
Telegrams Imcase-Uxbridge-Telex  
Telex 24177

*Agents in*

Algeria Australia Belgium Brunei Canada Denmark Finland  
France Germany Holland Iraq Israel Italy Jordan Kuwait Lebanon  
Malaysia Mexico Morocco New Zealand Nicaragua Norway  
Portugal Saudi Arabia South Africa Southern Rhodesia  
Sudan Sweden Switzerland Syria Thailand Tunisia USA Zambia

# CLASSIFIED ADVERTISEMENTS

**FULLY DISPLAYED** : 55/- per single column inch.  
**SEMI-DISPLAYED** : 45/- per single column inch.  
**RUN-ON** : 4/6 per line of approximately 7 words.  
Where an advertisement includes a Box Number Is. extra.  
**SERIES DISCOUNTS** : 12 insertions, 15%.  
Remittances payable to "Industrial Electronics".

Copy is required by 12th of the month for insertion in the following month's issue, by 9th of the month if proofs are required.

Address to :  
Classified Advertisement Dept.  
Industrial Electronics  
Dorset House, Stamford St., London, S.E.1.

## SITUATIONS VACANT

### PRINCIPAL EXECUTIVE ENGINEER

EAST AFRICAN POSTS AND TELECOMMUNICATIONS  
ADMINISTRATION

**V**ARIED duties include control of planning, installation and maintenance of (a) 12 and 3 channels carrier equipment and voice frequency telegraph systems, or (b) 2,000 type automatic telephone exchange equipment, rural exchanges, PABX's and subscribers' automatic and magneto equipment of all types, operator controller 2VF signalling equipment, also training of local staff. For (a) experience and knowledge of VHF or UHF radio systems desirable.

Candidates (over 35) must be A.M.I.E.E. or A.M.I.E.R.E. with not less than 15 years' experience relevant to above duties.

Salary in scale of £2,502-£2,664 per annum (including overseas allowance) plus 12½% new salary increase. 25% terminal gratuity. Contract for one tour of 2 years at first. Free family passages and medical attention. Education allowances. Disturbance allowance (£200 married, £100 single) payable on first appointment. Quarters if available at moderate rental or hotel allowance in lieu.

Candidates, who should be nationals of the United Kingdom or the Republic of Ireland, should apply for further details to:—

Appointments Officer  
MINISTRY OF OVERSEAS DEVELOPMENT  
Room 301, Eland House, Stag Place  
London S.W.1

giving full name and age, together with brief details of qualifications and experience, and quoting Ref. RC.292/54/02.

[457]

## CAPACITY AVAILABLE

### SIDIEN PRODUCTS LTD.

*Electronic and Magnetic Aids*

We specialise in  
**'ONE OFFS'**

Your pet idea for process control designed and manufactured.

**8 Radnor House, 93-97 Regent Street, London, W.1.**  
REGent 5351

## SCOTTISH HOME AND HEALTH DEPARTMENT

### SENIOR WIRELESS TECHNICIANS

2 pensionable posts for men aged 23 and over: one at Edinburgh and one at Thorn-tonhall, Glasgow. Considerable travelling involved.

**QUALIFICATIONS:** High standard of practical knowledge of wireless principles and equipment, thorough training and at least 5 years' experience, together with ability to supervise and instruct junior technical staff and to drive private and commercial vehicles, essential. Also required, O.N.C. in Electrical Engineering, including some electronics, or City and Guilds Intermediate Certificate in Telecommunications (old syllabus, i.e. subject No. 50) plus Radio II, or Intermediate Telecommunications Certificate (new syllabus, i.e. subject No. 49) plus Certificates in Mathematics B, Telecommunications Principles B, and Radio and Line Transmission B, or equivalent or higher standard of technical education.

**SALARY:** £1,091-£1,285.

**WRITE:** Establishment Officer, Room 365B, St. Andrew's House, Edinburgh, 1, for application form. Closing date 18th September, 1965. [452]

## AIRTRONICS LTD.

for coil winding, assembly and wiring of electronic equipment, transistorised sub-units, sheet metal work. 3a, Walerand Road, London, S.E.13.

Telephone: LEE Green 1706.

[439]

DESIGN & PROTOTYPE CONSTRUCTION.—Somerset Electronics Ltd. Phone Shepton Mallet 2219.

[387]

## SCOTTISH HOME AND HEALTH DEPARTMENT WIRELESS TECHNICIAN

Unestablished post at Thorntonhall, Glasgow, for a man at least 21 on 1st August, 1965.

**QUALIFICATIONS:** Sound theoretical and practical knowledge of wireless engineering and wireless communications equipment, including V.H.F. apparatus required. Appropriate C. and G. or similar qualification an advantage. Must be able to drive private and commercial vehicles.

**STARTING SALARY:** £792 (age 21) to £929 (age 25 or over); scale maximum £1,067.

**WRITE:** Establishment Officer, Room 364, St. Andrew's House, Edinburgh, 1, for application form. Closing date 18th September, 1965. [453]

### TECHNICIAN OR SENIOR TECHNICIAN

required to operate, maintain, develop and construct radio and film equipment. Applicants should hold H.N.C. or equivalent qualification and must be able to work with students; experience of broadcasting or film work an advantage. Salary ranges: £600-£675; £725-£840; £840-£1,040 per annum, according to age, qualifications and experience. Supplement for recognised qualifications. Applications, giving full personal details including previous posts and also the names of two referees, should be sent to The Professor of Drama, The University, Bristol 8, within two weeks of the appearance of this advertisement. [455]

### ELECTROMECHANICAL DESIGN

Engineer required for Systems Division of expanding mid-Sussex Industrial R. & D. organisation. Work involves preparation of Feasibility Studies, Design Layouts, Analysis and Client Liaison. Applicants must be versatile and discerning. Mech./Elec. Engineering background to H.N.C. standard with workshop experience and working knowledge of Indust. Electronics/Control Engineering. Attractive salary, working conditions and prospects. Box I.E. 454.

### APPOINTMENTS FILLED

Dissatisfaction having so often been expressed that unsuccessful applicants are left in ignorance of the fact that the position applied for has been filled, may we suggest that Advertisers notify us to that effect when they have arrived at a decision? We will then insert a notice free of charge under this heading.

### ARTICLES FOR SALE

#### PHOTO-ELECTRIC CONTROLS

for industry

Quick delivery Send for Catalogues

#### Hird-Brown Limited

Flash Street, Bolton, Lancs.

Tel. 27311

[305]



Harwell

## A MICROWAVE ENGINEER OR PHYSICIST

with several years' post-graduate experience, preferably in high-power microwaves or radar systems, is required to work on a large electron linear accelerator at the Atomic Energy Research Establishment, Harwell. Some knowledge of electron linear accelerators is desirable but not essential. The successful applicant will be responsible for the scientific aspects of the operation of, and of modifications to, the accelerator, and will work in collaboration with the engineering staff associated with the machine. He should be capable of carrying out design work for new accelerators as these reach the planning stage.

The appointment will be made in the Scientific Officer or Senior Scientific Officer grades, and applicants should have a first class or good second class honours degree. A suitable applicant who is not qualified for the Scientific Class may however be considered for appointment in the Experimental Officer Class.

The starting salary will be within the range £960 - £2,230 (Scientific Officer or Senior Scientific Officer) depending on applicant's post-graduate experience. The starting salary of an Experimental Officer Class appointment would be within the range £590 - £1,795.

Superannuation Scheme : Housing

Please write for full details and application forms to:—

Personnel Department (A 5116/113),  
United Kingdom Atomic Energy Authority,  
Atomic Energy Research Establishment,  
Harwell, Didcot,  
Berkshire.

[458]

## ASSISTANT CONTROLLERS

POSTS AND TELECOMMUNICATIONS DEPARTMENT

SARAWAK

**DUTIES:** To undertake the installation and maintenance of all types of modern telecommunications equipment including multi-channel radio and automatic exchanges. A knowledge of associated line plant is desirable. To train staff in the practical aspects of their duties and be responsible for running a small zone centre.

Candidates, who should normally be nationals of the United Kingdom or the Republic of Ireland, must not be over 45 years of age and should possess Graduate or A.M.I.E.E. or equivalent qualifications.

Salary (including gratuity) in scale £1,855-£3,544 p.a.: 2-3-year contract. Free family passages and medical attention. Child and education allowances. Generous leave.

Please apply for details giving your full name and age, together with brief details of your qualifications and experience and quoting RC.292/155/01, to:—

Appointments Officer  
MINISTRY OF OVERSEAS DEVELOPMENT  
Room 301, Eland House, Stag Place  
Victoria, London S.W.1

[456]

### EDUCATIONAL

A.M.I.E.R.E., A.M.I.Mech.E., City & Guilds, G.C.E., etc. Become a Technician or Technologist for high pay and security. Thousands of passes. For details of Exams. and Courses in all branches of Electronics, Engineering, etc., write for 156 page Handbook—FREE. B.I.E.T. (Dept. 192), London, W.8. [380]

IF YOU HAVE  
STAFF PROBLEMS  
WHY NOT LET US HELP  
YOU?  
BOOK NOW FOR  
SEPTEMBER

**TELECOMMUNICATIONS ENGINEER**

POSTS AND TELEGRAPHS DEPARTMENT

BASUTOLAND

*Duties:* To be responsible to the Director of Posts and Telegraphs for the administration of the telecommunications services in Basutoland.

Candidates, who must not be over 50 years, should possess a full technological certificate in telecommunication engineering or an approved equivalent, plus seven years' experience in a responsible position.

Salary in scale £1,135—£2,343 p.a. (including overseas allowance), plus a 12½% terminal gratuity. 2—3 year contract. Free family passages and medical attention. Education allowances.

Please apply for further details giving full name and age together with brief details of qualifications and experience and quoting RC 292/18/01 to:—

Appointments Officer  
MINISTRY OF OVERSEAS DEVELOPMENT  
Room 301, Eland House  
Stag Place  
Victoria  
London, S.W.1

1459

"TRANSISTOR Inverters and Converters." By Thomas Roddam. The rapid development in recent years of portable transistor equipment such as radio receivers, tape recorders, record players, and scientific instruments including those incorporated in rockets and satellites, has brought in its train the need for a light and efficient means of providing both a.c. and d.c. voltages from low voltage d.c. sources. The transistor inverter and converter between them satisfy these requirements, the inverter which changes d.c. to a.c. being used either alone or as the heart of a converter which can supply as many d.c. voltages as may be needed. This is the first definitive book to be published on the subject and the author has produced a single theory to cover all the various types of transistor inverter circuits available. Earlier chapters deal with the large signal operation of transistors, and linear and saturable inductors. He then develops a unified circuit theory for transistor inverters from a consideration of the negative circuit impedance of oscillators which is followed by consideration in detail of various types of inverters such as push-pull, square wave, transistor bridge, sine-wave and driven. Containing many well tried designs as well as original designs by the author, this book will be invaluable to the electronic engineer with no previous experience of inverters and to the established designer who wishes to widen his knowledge of the subject. 42s net. By post 43s 1d from Iliffe Books Ltd., Dorset House, Stamford Street, London, S.E.1.

"WIRELESS Servicing Manual." By W. T. Cocking, M.I.E.E. This is the tenth edition of a book which since 1936 has been known to radio servicemen everywhere as a reliable, thorough and comprehensive guide to solving most of the problems that arise in the repair, maintenance and adjustment of the modern radio receiver. In the present edition a major addition is a chapter devoted to transistors and transistor sets. The author of WIRELESS SERVICING MANUAL is well known to a wide circle of readers as former editor of *Electronic Technology* and now of *Industrial Electronics*. His crisp lucid style makes this hand-book of utmost value to the service man and amateur alike. 25s net. By post 26s 1d from Iliffe Books Ltd., Dorset House, Stamford Street, London, S.E.1.

an important new book for students,  
practising engineers and physicists

 ILIFFE

# MATRIX ALGEBRA FOR ELECTRONIC ENGINEERS

P. HLAWICZKA, B.Sc.(Eng.), B.Sc., A.M.I.E.E.

Provides a basic course in matrix methods for students of electronic engineering, and for practising engineers who have not had the opportunity of studying the subject before. Any electronic engineer or physicist without a working knowledge of matrix algebra is finding himself increasingly handicapped, and this new book will be invaluable to all who wish to master this important subject which has now become part of their stock in trade.

To the uninitiated, the whole subject looks mysterious, but with the aid of this book any electronic engineer should readily be able to learn sufficient to solve problems involving

two-part networks, active and passive, such as are presented by transistor circuits.

The book, whose author has degrees in both mathematics and engineering and thus understands the problems from both sides, is divided into two parts. Part I is strictly elementary and requires for background only a knowledge of basic algebra. Part II is distinctly more difficult, but will still be within the capacity of students approaching graduation, and of engineers intending to read papers formulated in terms of matrices.

MATRIX ALGEBRA FOR ELECTRONIC ENGINEERS is confidently recommended to students, practising engineers and physicists.

45s net by post 46s 1d 240 pp 71 diagrams

obtainable from leading booksellers

**ILIFFE Books Ltd.**

DORSET HOUSE

STAMFORD STREET

LONDON SE1



A.P.T. Electronic Industries Ltd. ....	11
Adcola Products Ltd. ....	27
Aircraft Marine Products (G.B.) Ltd. ....	<i>Cover ii</i>
Anglo-American Vulcanized Fibre Co. Ltd. ....	41
Appointments Vacant.....	48
Arrow Electric Switches Ltd.	15
British Electric Resistance Co. Ltd. ....	30
Brookhirst Igranic Ltd. ....	23, 24
C.Z. Scientific Instruments Ltd. ....	28
Cannon Electric (Gt. Britain) Ltd. ....	44
Classified Advertisements .....	48
Cossor Instruments Ltd. ....	32
Dawe Instruments Ltd. ....	19
Derritron Instruments Ltd....	45
Dexion Ltd. ....	37
Electrical Power Engineering Co. (B'ham) Ltd.....	42
Electrosil Ltd. ....	16
English Electric Valve Co. Ltd.	29
Ericsson Telephones Ltd. <i>Cover iii</i>	
Ether Ltd.....	20, 21, 34
Evershed & Vignoles Ltd. ....	36

General Precision Systems Ltd.	22
Gilbarco Ltd. ....	10
Hughes International (U.K.) Ltd. ....	17
Imhof, Alfred, Ltd. ....	47
International Rectifier Co. Ltd.	14
Johnson, Matthey & Co. Ltd.	43
Kent Precision Electronics Ltd.	6
Landis & Gyr Ltd. ....	26
Letraset Ltd. ....	2
Livingston Control Ltd. ....	33
Magnetic Devices Ltd. ....	9
McMurdo Instrument Co. Ltd.	26
Metway Electrical Industries Ltd. ....	40
Miniature Electronic Components Ltd.....	35
Newport Instruments Ltd. ....	40
Normalair Ltd. ....	51
Oxley Developments Co. Ltd.	40

Painton & Co. Ltd. ....	<i>Cover iv</i>
RCA Great Britain Ltd. ....	38
Racal Instruments Ltd. ....	39
Research & Engineering Controls Ltd. ....	46
S.E. Laboratories (Eng'g) Ltd.	25
Salford Electrical Instruments Ltd. ....	44
Semiconductors Ltd. ....	31
Solartron Electronic Group Ltd. ....	12, 13
Standard Telephones & Cables Ltd. ....	3, 4, 5, 7
Tesa Tapes Ltd. ....	8
Transmetrix Electronic Systems Ltd. ....	44
V.G. Porcelain Co. Ltd.....	42
Venner Electronics Ltd. ....	52
Vitality Bulbs Ltd. ....	44
Walmore Electronics Ltd. ....	46
Welwyn Electric Ltd. ....	1
Westinghouse Brake and Signal Co. Ltd. ....	18

For further information circle 260 on Service Card

THIS MAN  
HAD  
A  
PROBLEM

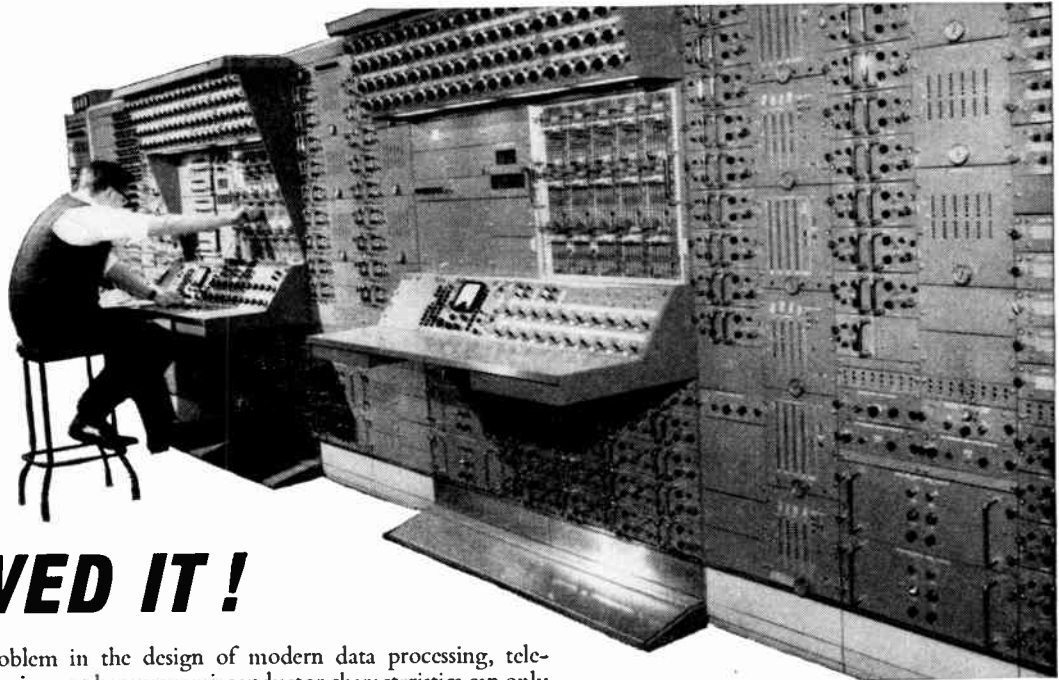

## WE SOLVED IT!

Overheating is a major problem in the design of modern data processing, telecommunications and radar equipment because semi-conductor characteristics can only be specified over a narrow temperature range. This problem can be eliminated by installing a Normalair high efficiency cooling system which will maintain these critical components at their correct operating temperatures.

These purpose designed systems have been developed specifically for this application and are the outcome of an intensive research programme. The equipment is self-contained, electrically powered and designed to provide an adequate supply of ducted cold air. Normalair equipment can also be supplied for the overall conditioning of electronic laboratories or for the solution of any other temperature control problem of any size or complexity.

### **NORMALAIR LTD**

Subsidiary of Westland Aircraft Limited

#### **YEOVIL SOMERSET**

**TELEPHONE YEOVIL 5222**

**Europe's largest and most experienced producer of pressurization, air conditioning and oxygen breathing systems and components for aircraft.**

NORMALAIR (Australia) Pty. Ltd. 26/32 Fraser St, Airport West, W.6, Victoria, Australia. NORMALAIR (Canada) Ltd. 1425 The Queensway, Toronto 18, Canada.

# the same clear readout...



# ...and more in the box

## TSA3334 MK111 Frequency Meter and Counter

*NOW!  
7 day delivery.*

- Blanking circuit now fitted, switching off display whilst count progresses
- Improved sensitivity — now 100mV
- Period measurement over 1, 10 and 100 cycles
- Count facility added, 1.2 Mc/s maximum
- Operates off one 12V battery or A.C. mains
- Price £135 (U.K. only)

*Complete technical details on request from*



**VENNER ELECTRONICS LIMITED**  
KINGSTON BY-PASS · NEW MALDEN · SURREY · MALDEN 2442

*Overseas subsidiaries*  
VENNER A. G. BURGERNZIELWEG 16 · 3006 BERNE · SWITZERLAND  
VENNER N. V. HELMSTRAAT 3 · DEN HAAG · HOLLAND



## Meetings

### The Institute of Physics and the Physical Society

47 Belgrave Square, London, S.W.1.

**29th Oct.** (postponed from 30th Sept.) at Queen Mary College, Mile End Road, London, E.1, 'Spectroscopic Studies of Vibrational Modes'.

### Society of Relay Engineers

Obelisk House, Finedon, Northants.

**19th Oct. 2.30 p.m.** at the Institution of Electrical Engineers, Savoy Place, London, W.C.2. 'Testing Methods and Equipment Applicable to V.H.F. and H.F. Wired Television Systems'. Tickets will be required.

## Conferences, Symposia and Colloquia

**6th-10th Sept.** Convention on 'Machines for Materials and Environmental Testing'. Held at the Manchester College of Science and Technology, Manchester. Organized jointly by The Institution of Mechanical Engineers and The Society of Environmental Engineers from 1 Birdcage Walk, London, S.W.1 ('Phone: Whitehall 7476).

**6th-10th Sept.** 9th Conference of the European Organization for Quality Control. To be held in Rotterdam—details from the organization's Secretariat, Weena 700, Rotterdam 3, Netherlands.

**8th-10th Sept.** Symposium on 'Electronics in Industry'. Held at The University of Durham, Durham. Organized jointly by The Ministry of Technology and The Institution of Electronic and Radio Engineers from Wellbar House, Gallowgate, Newcastle-upon-Tyne, 1 ('Phone: Newcastle-upon-Tyne 27575).

**13th-18th Sept.** Engineering Materials and Design Conference. Held in conjunction with an exhibition at Olympia, London. Organized by Industrial & Trade Fairs Ltd., Commonwealth House, 1-19 New Oxford Street, London, W.C.1 ('Phone: Chancery 9011).

**19th-25th Sept.** International Conference on Elementary Particles, to be held in Oxford. Organized by the Rutherford Laboratory in collaboration with the Science Research Council. Details from The Rutherford Laboratory, Chilton, Didcot, Berks. ('Phone: Abingdon 1900, Ext. 438).

**20th-23rd Sept.** Annual Inspection Conference on 'Engineering Inspection in the Future'. Held at New College, Oxford. Organized by The Institute of Engineering Inspection, 616 Grand Buildings, Trafalgar Square, London, W.C.2.

**20th-23rd Sept.** Conference on 'Assembly, Jointing and Fastening Methods' at Melton Mowbray. Sponsored by the Production Engineering Research Association. Applications to attend should be sent to the Conference Organizer, PERA, Melton Mowbray, Leicestershire. ('Phone: Melton Mowbray 4133).

**20th-25th Sept.** International conference on 'Thermionic Electrical Power Generation'. Held at The Institution of Electrical Engineers, Savoy Place, London, W.C.2 ('Phone: Covent Garden 1871). Organized jointly by I.E.E. and O.E.C.D. European Nuclear Energy Agency.

**21st-23rd Sept.** Symposium on 'Applications of Microelectronics'. Held at Department of Electronics, The University, Southampton. Jointly organized by the I.E.E. and I.E.R.E. from The University of Southampton.

**21st-24th Sept.** First European Conference on Magnetism, Vienna. To be held at Technischen Hochschule, Vienna. Conference Secretariat: Verein Deutscher Eisenhüttenleute, 4 Dusseldorf, Breite Strasse 27.

**23rd-24th Sept.** Conference on 'Non-Metallic Thin Films'. To be held at Chelsea College of Science and Technology, London. Organized by The Institute of Physics and The Physical Society, 47 Belgrave Square, London, S.W.1 ('Phone: Belgravia 6111).

**27th-30th Sept.** Conference on 'Optics in Space'. Organized by the Institute of Physics and the Physical Society and to be held at the University of Southampton. For registration and details apply to I.P.S., 47 Belgrave Square, London, S.W.1 ('Phone: Belgravia 6111).

### **29th Sept.-2nd Oct. Manchester**

The Twentieth Annual Electronics, Instruments, Controls and Components Exhibition and Convention, Belle Vue, Manchester. Organized by The Institution of Electronics, 78 Shaw Road, Rochdale, Lancs.

**5th-6th Oct.** Conference and Exhibition on 'Ultrasonics in Industry', to be held at St. Ermin's Hotel, St. James's, S.W.1. Applications to the organizers: *Ultrasonics*, Dorset House, Stamford Street, S.E.1 ('Phone: Waterloo 3333).

**18th-19th Nov.** Conference on 'Computational Methods in Crystallography' to be held at the Institution of Electrical Engineers, London, and organized by the Institute of Physics and the Physical Society, 47 Belgrave Square, S.W.1 ('Phone: Belgravia 6111).

**22nd-23rd Nov.** International Conference on U.H.F. Television, to be held at the I.E.E., Savoy Place, London, W.C.2. Sponsored by the I.E.R.E., the I.E.E. Electronics Division, the I.E.E.E. and the Television Society. Information from 9 Bedford Square, London, W.C.1 ('Phone: Museum 1901). Note that this conference was to have been held from the 1st-2nd Sept.

## Exhibitions

### **27th Aug.-5th Sept. Stuttgart**

Deutsche Funkausstellung 1965—The German Radio and Television Exhibition. Held on the Killesberg in Stuttgart. Organized by Stuttgarter Ausstellungs-GmbH, 7 Stuttgart 1, Am Kochenhof 16.

### **3rd-12th Sept. Brussels**

Ninth European Machine Tool Exhibition at the Palais de Centenaire, Palais 1, Brussels 2, Belgium. Organized by the European Committee for the Co-operation of Machine Tool Industries. Details from: The Machine Tools Trade Association, 25 Buckingham Gate, London, S.W.1 ('Phone: Victoria 7542).



# WHAT'S ON AND WHERE

Continued

## 7th-11th Sept. Basle

INEL 65 International Exhibition of Industrial Electronics, Basle, Switzerland. 61 Clarastrasse, 4000 Basle ('Phone: Basle 323850).

## 9th-19th Sept. Paris

Salon International de la Radio et de la Television, Porte de Versailles, Paris. Organized jointly by the Office de Radio-diffusion—Television Francaise and the Federation Nationale des Industries Electroniques. Details from the Societe pour la Diffusion des Sciences et des Arts, 16 rue de Presles, Paris 15<sup>e</sup>.

## 11th-26th Sept. Moscow

International Exhibition, 'Chemistry in Industry, Construction and Agriculture', Sokolniki Park, Moscow. Organized by the U.S.S.R. Chamber of Commerce. Further details: Industrial & Trade Fairs Ltd., Commonwealth House, New Oxford Street, London, W.C.1 ('Phone: Chancery 9011).

## 12th-26th Sept. Brno, Czechoslovakia

7th Brno International Trade Fair. Details from: Mezinarodni veletrh Brno tiskove stredisko, Hlinky 104, BRNO, Czechoslovakia.

## 13th-17th Sept. London

Engineering Materials and Design Exhibition. Held in conjunction with a conference at Olympia, London. Organized by Industrial & Trade Fairs Ltd., Commonwealth House, 1-19 New Oxford Street, London, W.C.1 ('Phone: Chancery 9011).

## 14th-22nd Sept. Utrecht

HET Instrument 1965 Exhibition, Royal Dutch Industries Fair, Utrecht. Further details from: Cooperative Vereniging, 'HET Instrument' u.a., Sparrenlaan 2, Soest, Holland.

## 28th Sept.-1st Oct. Brighton

Medical Electronic and Instrumentation Exhibition (in conjunction with The European Symposium on Medical Electronics) at Exhibition Hall, Brighton, Sussex. Organized by Events Promotions Ltd., Ashbourne House, Alberon Gardens, London, N.W.11 ('Phone: Meadway 5555).

## 28th Sept.-2nd Oct. Manchester

The 20th Annual Electronics, Instruments, Controls and Components Exhibition and Convention, Belle Vue, Manchester. Organized by The Institution of Electronics, Pennine House, 78 Shaw Road, Rochdale, Lancs. ('Phone: Rochdale 48759).

## 2nd-10th Oct. Ljubljana, Yugoslavia

XIIth International Exhibition on Modern Electronics. Details from: Gospodarsko razstavisce (Ljubljana Fair), Ljubljana, Titova 50, Yugoslavia.

### Radio Show Cancelled

The organizers of The 1965 Radio Show have now announced that it is cancelled. The show was to have been held at Earls Court, London, from 25th Aug. to 4th Sept.

## 4th-13th Oct. London

Business Efficiency Exhibition, London (Olympia). Organized by Business Equipment Trade Association, 64 Cannon Street, London, E.C.4 ('Phone: Central 7771).

## 13th-19th Oct. Dusseldorf

3rd International Congress and Exhibition of Measuring Instrumentation and Automation (Interkama), Dusseldorf, Germany. Represented by John E. Buck (Trade Fair Agencies) Ltd., 47 Brewer Street, Piccadilly, London, W.1 ('Phone: Gerrard 7576).

## 27th-30th Oct. London

R.S.G.B. Radio Communications Show, Seymour Hall, London. Organized by P. A. Thorogood, 35 Gibbs Green, Edgware, Middlesex.

## 30th Oct.-7th Nov. Genoa

Second International Communications Fair, organized by the Genoa International Fair, Viale Brigade Partigiane, Genoa, Italy. To be held in conjunction with the Second International Aircraft Exhibition.

## 30th Oct.-7th Nov. Genoa

Second International Aircraft Exhibition, organized by the Genoa International Fair, Viale Brigade Partigiane, Genoa, Italy. To be held in conjunction with the Second International Communications Fair.

## 3rd-10th Nov. Oslo

Automatica 65—an exhibition of automatic control. Held in the Exhibition Hall, Skoyen, Oslo. Details from: Studiesel-skapet For Norsk Industri, Forskningsveien 1, Oslo 3.

## 15th-20th Nov. London

Industry '65 Exhibition—the International Industrial Equipment and Services Exhibition at Earls Court, London. Organized by the Industrial and Trade Fairs Ltd., Commonwealth House, 1-19 New Oxford Street, London, W.C.1 ('Phone: Chancery 9011).

## New Exhibitions

**ALTEX the Automatic Laboratory Techniques Exhibition** is to be held at the Royal Horticultural Hall, Westminster, London, S.W.1, from 1st to 3rd February 1966. Sponsored by Laboratory Equipment Digest it is believed that ALTEX will be the first exhibition of its kind in the world to be devoted exclusively to the application of the latest automatic, semi-automated and fully-automated apparatus. The exhibition is being organized by Southern Exhibitions Ltd., 11 Liverpool Terrace, Worthing, Sussex ('Phone: Worthing 6584).

**The International Medical Engineering and Automation Exhibition, 'MEDEA '67'**, will take place at Earls Court, London, from March 13th to 18th 1967. Organized by Industrial Exhibitions Limited, it is the successor to that company's International Medical Electronics Exhibition held in 1960. The new title indicates the trend of the exhibition which will cover all aspects of biological engineering, medical electronics and instrumentation, medical automation, hospital physics, electro-medical and X-ray equipment, and related techniques. It will be open to exhibitors from all countries and a special section will be offered to non-commercial organizations such as hospitals, research institutions and universities.

A national conference will be held during the exhibition and is now being discussed by an exploratory committee. Another committee, headed by L. A. Woodhead, a member of the Council of the Scientific Instrument Manufacturers Association, will deal with exhibition matters.

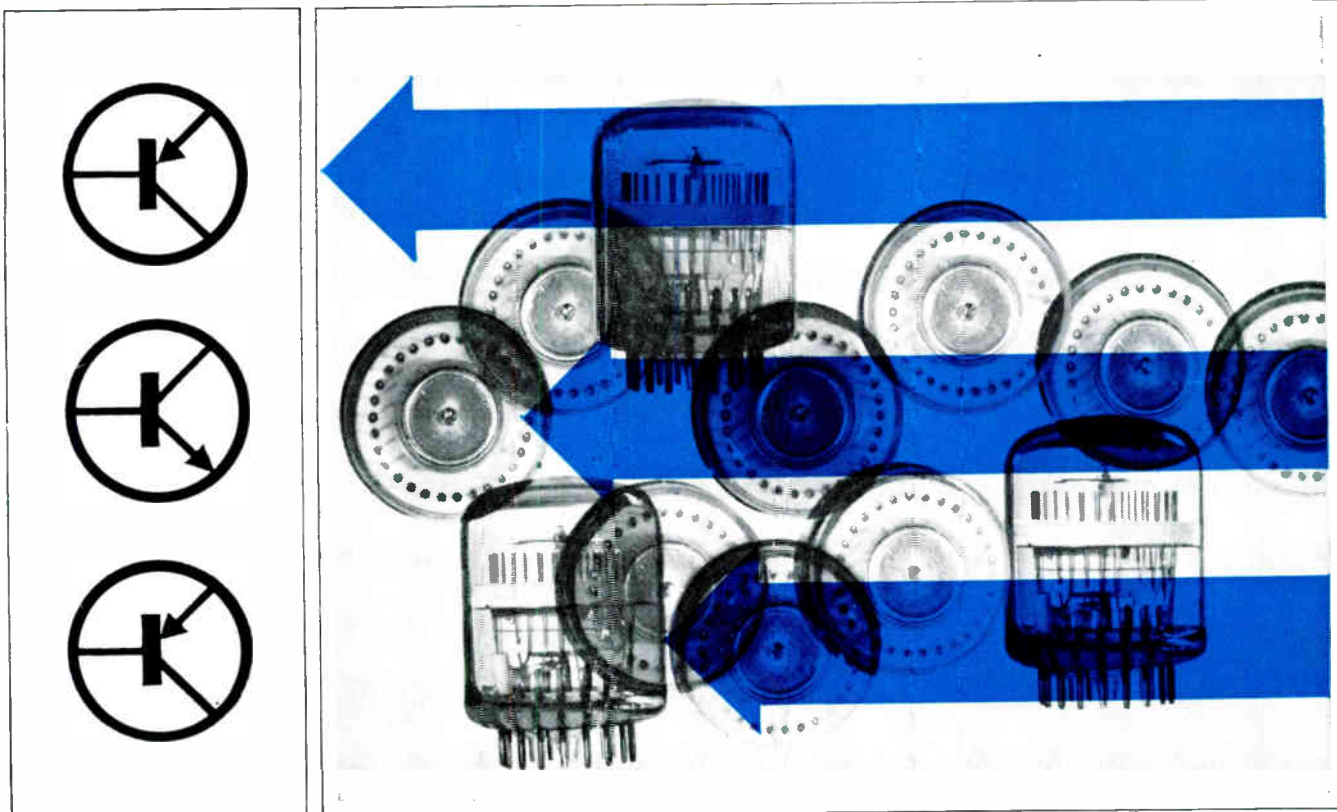

## counting economy

Dekatron\* cold-cathode tubes have a long tradition of international service and reliability and the latest all-glass miniaturized GS 10H is no exception. Capable of handling counting speeds of up to 4 k.p.s., this extensively tested tube, in conjunction with a transistorized single pulse drive, reduces the process of multi-stage, uni-directional counting or selecting to its simplest, most economical and most reliable terms. The tube is also capable of fully reversible, bi-directional operation when incorporated in a suitable circuit. Readout, as in other Dekatron tubes is made directly from glow-position or by means of one of the range of Digitron\* register tubes. For data sheets please write or phone:— The Technical Services Dept., Tube Division, Beeston, Nottingham. Tel. Nottm. 254831.

\*Registered Trade Marks

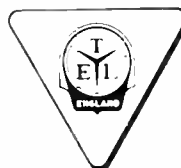

**ERICSSON TELEPHONES LTD • ETELCO LTD**

A Principal Operating Company of the Plessey Group Head Office and Main Works: Beeston, Nottingham. Tel: 254831. Telex 37666  
 Registered Office: 22 Lincoln's Inn Fields, London, WC2. Tel: HOLborn 6936

ER 122

Industrial Electronics August 1965

# PAINTON RELIABILITY

at the right price for these  
**FIVE NEW CONNECTORS**

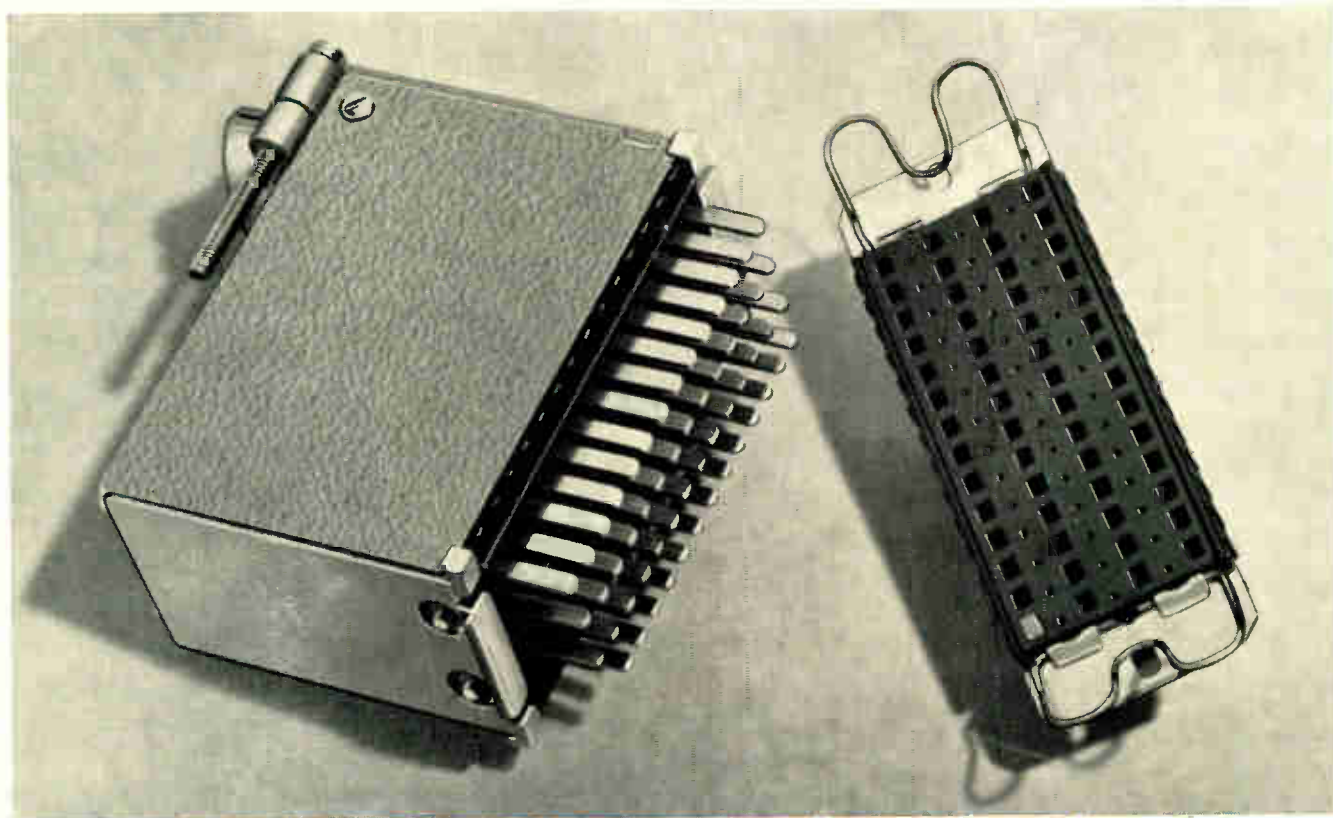

**35** WAY

**47** WAY

**55** WAY

**59** WAY

**71** WAY

These new additions to the Painton **159 Series** Connectors embody the space-saving configuration and high standards of reliability already well established for this range of components, and are offered at sensible prices. Send for leaflet P.S.10

These Types specially developed for the G.P.O. & approved by them as PO203.

**Painton**  
 & CO LIMITED

KINGSTHORPE · NORTHAMPTON  
 Tel: 34251 (10 lines) · Grams: 'Ceil' Northampton · Telex 31576

Overseas Associated Companies Australia Painton Australia Pty. Ltd. · Benelux Painton S.A. · Germany Painton G.m.b.H.  
 Italy Painton Italiana · Sweden Svenska Painton A.B. · U.S.A. Painton Inc.