

# INDUSTRIAL ELECTRONICS

DECEMBER 1964 5s 0d



# 4400 WATTS

**THE HIGHEST  
DISSIPATION  
BRITISH MADE  
ZENER DIODE  
YOU CAN BUY—  
SURGE SUPPRESSION  
UP TO 4.4kW for 100 $\mu$ s**

## BZY91 ZENER SERIES

STEADY DISSIPATION (65°C mounting base) 75W max  
100 MICROSECOND SURGE (65°C mounting base) 4.4kW max  
100 MILLISECOND SURGE (65°C mounting base) 170W max

There are twenty-two  $\pm 5\%$  nominal tolerance zener diodes of either polarity available in the new Mullard BZY91 series, and every one of them can dissipate considerably more power than any other zener diode made in this country. Their ratio of transient to d.c. dissipation is also extremely high. The BZY91 series covers the range from 10 to 75 volts. All types are available immediately from stock—in whatever quantity you need—for surge-protection, stabilisation, voltage-reference or other zener applications.

Write for technical and price information on BZY91 zener diodes to:  
Mullard Ltd., Industrial Markets Division,  
Mullard House, Torrington Place, London, WC1.

**Mullard**

World Radio History

MIS 112



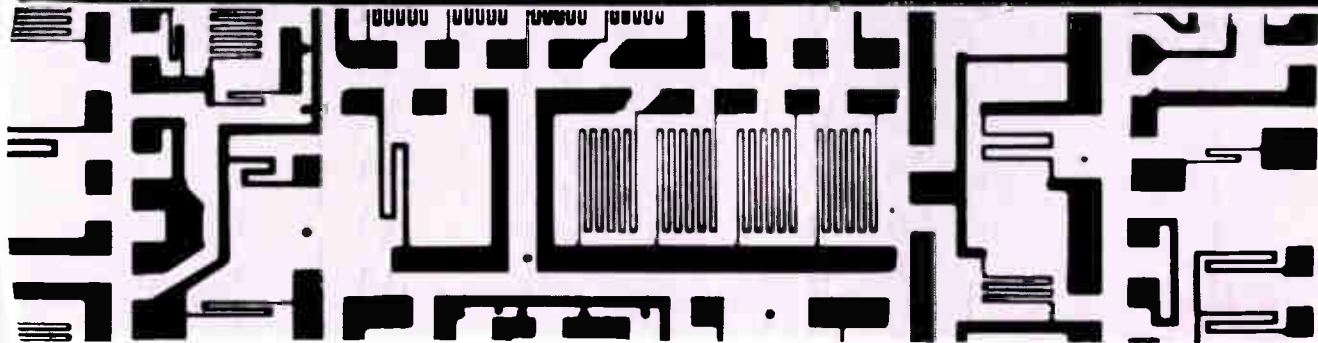






For further information  
circle 203 on Service Card

With over 20 years unique  
experience in the manufacture  
of Film Resistors—Welwyn now offer an  
**UNPARALLELED SERVICE IN THE FIELD OF  
THIN FILM INTEGRATED CIRCUITS**



## **THIN FILM CIRCUITS from WELWYN**

*Leading the field in the latest production techniques—Welwyn offer*

- Thin Film Integrated Circuits in volume production—NOW.
- Thin Film Integrated Circuits at **PRICES MORE THAN ATTRACTIVE** when compared with assemblies of high grade discrete components.
- Thin Film Integrated Circuits individually engineered to **YOUR SPECIAL REQUIREMENTS**.
- Essential Present Day reliability standards in every Welwyn Thin Film Circuit.

The new Welwyn brochure  
**"THIN FILM INTEGRATED CIRCUITS"**  
is now available—write for your copy.  
Circuit Engineers are also requested to  
submit their particular requirements for  
evaluation in the Welwyn technique,  
or to ask for general samples.



**WELWYN ELECTRIC LIMITED**

BEDLINGTON - NORTHUMBERLAND - ENGLAND

Telephone : Bedlington 2181-9 - Telegrams : Resistor' Bedlington.

FACTORIES IN AUSTRALIA AND CANADA



FOR THE IMPORTANT middle range—from low-current logic to high-current output—RCA 2N2938 geometry offers today's best combination of economy and performance in ultra-high speed transistors.



# RCA 2N2938

## Switch 10 ma to 200 ma with RCA 2N2938

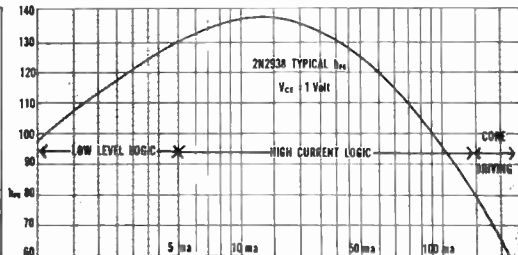
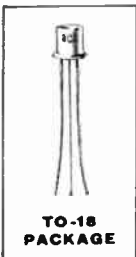
And you can do it economically, too . . . if your ultra-high speed logic circuit designs incorporate RCA 2N2938. This one high performance type can be all you need. From low-level logic switches to high-current applications, this silicon double-diffused planar epitaxial type is designed to fill today's need for a broadly applicable computer transistor.

Featuring high gain-bandwidth product and low capacitance, RCA 2N2938 is part of RCA's line of high-speed silicon switching transistors covering the range from 0.1 ma to 1 amp.

Assuring high beta over an extra wide range of collector currents, these types provide excellent switching speeds at high currents.

TYPICAL CHARACTERISTICS OF RCA ULTRA-HIGH-SPEED SWITCHING TRANSISTORS

	2N2475	(TA-2090A) 2N2938	2N2477
$f_T$ Typical	800 Mc	690 Mc	300 Mc
$C_{DB}$ Typical	2.4pf	3.5pf	8pf
Watts dissipation at 25°C FA	0.3	0.3	0.6
$V_{CE}$ (Sat) Max.	0.4 volt at 20 Ma	0.4 volt at 50 Ma	0.65 volt at 500 Ma
$h_{FE}$ Min.	30 at 20 Ma	30 at 50 Ma	40 at 150 Ma
Turn-On Time Max.	20 nsec (20 ma)	30 nsec (50 ma)	25 nsec (150 ma)
Turn-Off Time Max.	15 nsec (20 ma)	30 nsec (50 ma)	45 nsec (150 ma)



**THE MOST TRUSTED NAME IN ELECTRONICS**

**RCA GREAT BRITAIN LIMITED**, Sales Division, Lincoln Way, Windmill Rd., Sunbury-on-Thames  
ASSOCIATE COMPANY OF RADIO CORPORATION OF AMERICA. Telephone: Sunbury 5511

quality  
equipment  
needs  
quality  
batteries—  
**MALLORY**



This tiny second/day/month/year counter developed by Bulova for major American satellites gives years of reliable, accurate operation on the power of a miniature Mallory Mercury cell.

Precision-made Mallory batteries are built differently—inside and out—to give the powerful performance modern equipment demands. They last many times longer, deliver their energy uniformly without need for rest, retain their capacity while lying idle. And they're leakproof and corrosion resistant. Whether designing new products or using battery operated equipment, make Mallory batteries your choice for quality performance. Find out about *Mercury types* in miniature single and multivolt sizes, *Manganese types* in standard 1.5V sizes.

**MALLORY** *for new ideas in batteries*

**MALLORY BATTERIES LIMITED CRAWLEY SUSSEX** *Crawley 26041*

**DISTRIBUTORS TO THE ELECTRONICS INDUSTRY:**

A. C. Farnell Ltd, **LEEDS 2**; Wireless Electric Ltd, **BRISTOL 1**; Hawnt & Co. Ltd, **BIRMINGHAM 6**;  
Needham Engineering Co. Ltd, **SHEFFIELD 1**; Harper, Robertson Electronics Ltd, **GLASGOW C2**;  
Stewart Aeronautical Supply Co. Ltd, Crawley, **SUSSEX**; Scientific Furnishings Ltd, Poynton, **CHESHIRE**;  
Cables & Components Ltd, **LONDON, NW10**



# CHASSIS and CASES

by *Smith's*  
of  
EDGWARE ROAD

**ELECTRONIC COMPONENT DISTRIBUTORS**

287/289 EDGWARE ROAD, LONDON, W.2.  
Tel: PADDINGTON 5891/7595

We shall be pleased to quote for all your component requirements

## BLANK CHASSIS

**SAME DAY SERVICE**

Of over 20 different forms made up to **YOUR SIZE**. Order EXACT SIZE you require to nearest 1/8th. (Maximum length 35in., depth 4in.) Specials dealt with promptly.

**SEND FOR ILLUSTRATED LEAFLETS**

or order straight away, working out total area of material required and referring to table below which is for four-sided chassis in 18 s.w.g. (for 16 s.w.g. add 1/8th).

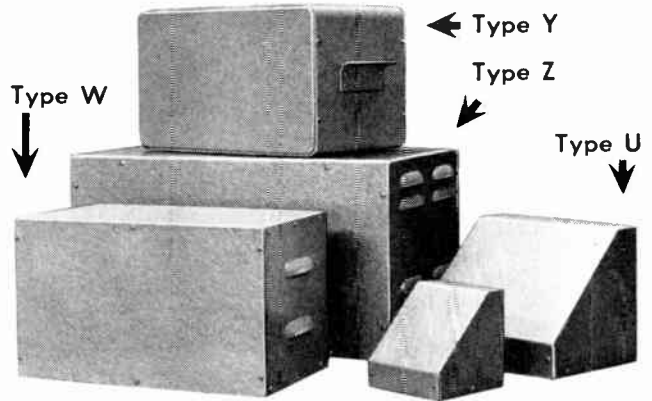
48 sq. in.	4/-	176 sq. in.	8/-	304 sq. in.	12/-
80 sq. in.	5/-	208 sq. in.	9/-	335 sq. in.	13/-
112 sq. in.	6/-	240 sq. in.	10/-	368 sq. in.	14/-
144 sq. in.	7/-	272 sq. in.	11/-	and pro rata.	
P. & P. 2/6		P. & P. 2/9		P. & P. 3/-	

Discounts for quantities. Finishes arranged for quantities of 25 or over

**FLANGES** (1/2in. x 1/2in.), 6d. per bend.

**STRENGTHENED CORNERS** 1/- each corner.

**PANELS**: Any size up to 3ft. at 4/6 sq. ft. 18 s.w.g. (16 s.w.g. 5/3). Plus post and packing (over £2 free).



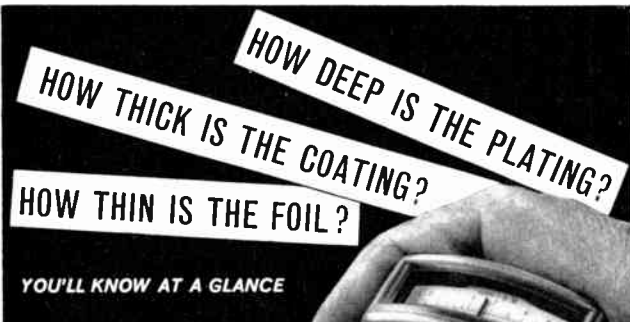
## CASES

**ALUMINIUM SILVER HAMMERED FINISH**

Type	Size	Price	Type	Size	Price
U	4 - 4 - 4*	9/6	Y	8 - 6 - 6*	25/-
U	5 1/2 - 4 1/2 - 4 1/2	14/6	Y	12 - 7 - 7	39/-
U	8 - 6 - 6	20/-	Y	13 - 7 - 9	44/-
U	15 - 9 - 9	42/6	Y	15 - 9 - 7	46/-
W	8 - 6 - 6	19/6	Z	17 - 10 - 9	63/-
W	12 - 7 - 7	32/6	Z	19 - 10 - 8 1/2	67/6
W	15 - 9 - 8	42/-			

Plus post and packing (over £2 free).

Type U has removable bottom or back. Type W removable front, Type Y all screwed construction, Type Z removable back and front.



with the **POCKET elcometer**

The depth of plating, paint or plastic on iron or steel... the thickness of non-ferrous coatings on iron or steel or non-ferrous foil... you can take these and many other measurements at a glance by means of the Elcometer. Completely non-destructive - like all our surface-metrology instruments - the Elcometer gives an accurate direct reading with fuss-free reliability, even in unskilled hands, even in the middle of a production run.

Choice of over 40 scales ranging from 0.002" to 0.3" **13 GNS.**

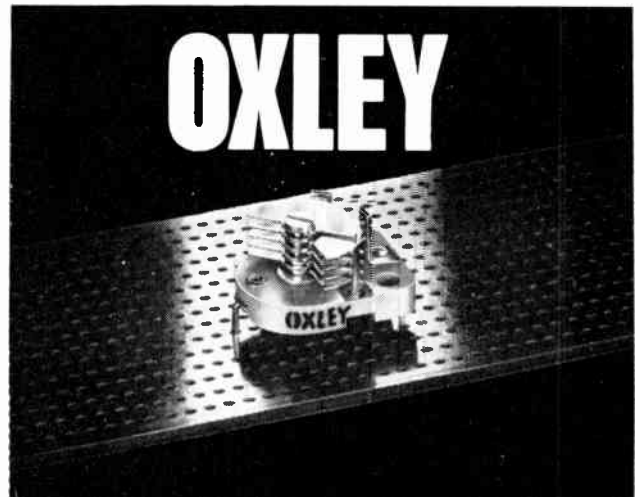
**elcometer** FAIRFIELD RD. DROYLSDEN 11 MANCHESTER INSTRUMENTS LTD

Please send me free literature on the Elcometer and its companion instruments, the Elcolector and the Pin Hole Detector.

Name of Organisation.....

Address.....

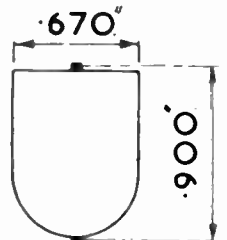
For the attention of.....



## AIR DIELECTRIC TRIMMER

**NOW OBTAINABLE WITH TERMINALS FOR PRINTED CIRCUIT MOUNTING**

Capacities from 4.5-100 pF.  
Insulation greater than 10,000 megohms.  
Power Factor less than .001.  
Acetate dust cover optional.



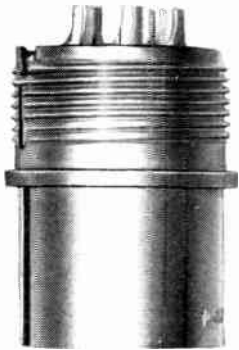
Write for technical details of these or any other Oxley products.

**OXLEY DEVELOPMENTS CO. LTD.**  
ULVERSTON, LANCASHIRE. Telephone: Ulverston 2567





# Amphenol-Borg



# Connectors



If you want connectors, especially in a hurry, Livingston Control will see that you get them. With standard items available off the shelf and custom connectors assembled to order within a few hours, there is no need for a connector to be the "missing link" in any of your production or panic jobs.

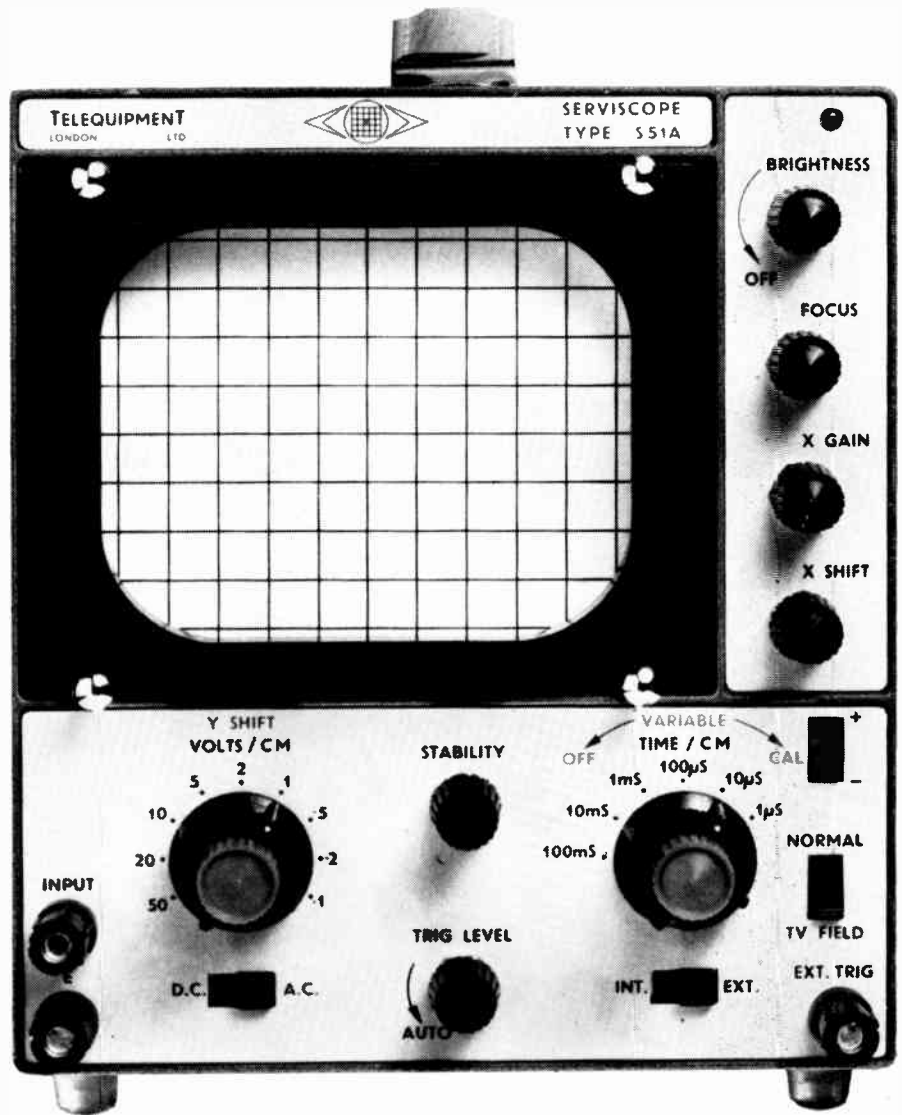


If you want connectors — for immediate requirements or for some future need — write to, or ring, Livingston Control's Components Division.

## LIVINGSTON CONTROL LIMITED



Greycaines House  
Bushey Mill Lane, North Watford, Herts.  
Telephone: Watford 41291



## 5" OSCILLOSCOPE FOR £49

\*The Serviscope type S51A is an instrument of good general specification with as large a display — on a 5" flat-faced screen, PDA tube — as is normally available on a portable oscilloscope today. It has been designed and built to make successful operation by non-technical personnel possible; the simplicity of the controls, the ease of reading and the ruggedness of its construction make it eminently suitable for general use in industry. Applications include inspection, production control, training and monitoring.

This new Serviscope is the latest in a line of portable, reliable, low-cost instruments, which are playing an increasingly useful role in the world of electronics. A descriptive leaflet giving full specifications of the S51A will be sent on request.

**Max. bandwidth 3 Mc/s (— 3dB approx.) · Max. sensitivity 100 mV/cm · Calibrated input attenuator 100 mV/cm to 50 V/cm · 6 preset sweep speeds plus 10:1 variable control**  
 Automatic sync. trigger with level control · DC coupled flyback blanking  
 Medium or long persistence tube phosphors at no extra cost

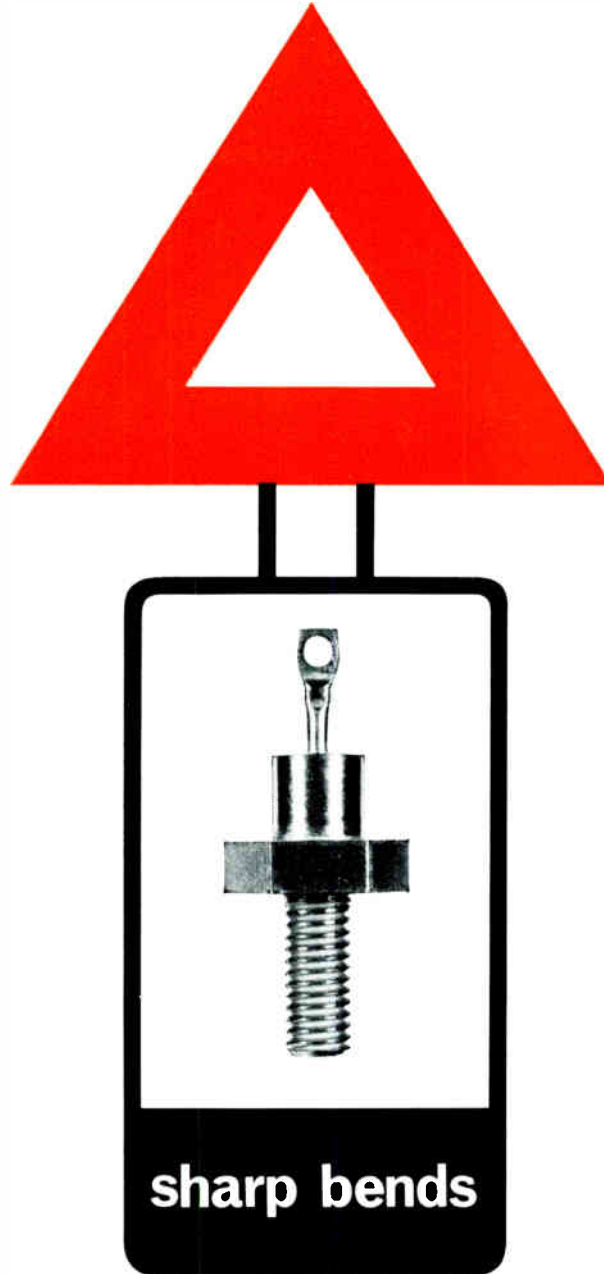
### SERVISCOPE type S51A

\* 'Serviscope' is a registered trade mark of

Telequipment Limited, 313 Chase Road, Southgate, London, N.14 · Fox Lane 1166

# TELEQUIPMENT





Over 300 of them: wicked square corners that can't be cut. There's one in the performance curve of every IR zener. Ask for details of zeners from 400mW to 50W, and 3.6V to 200V. The 1W and 10W range is fully type approved.



## INTERNATIONAL RECTIFIER

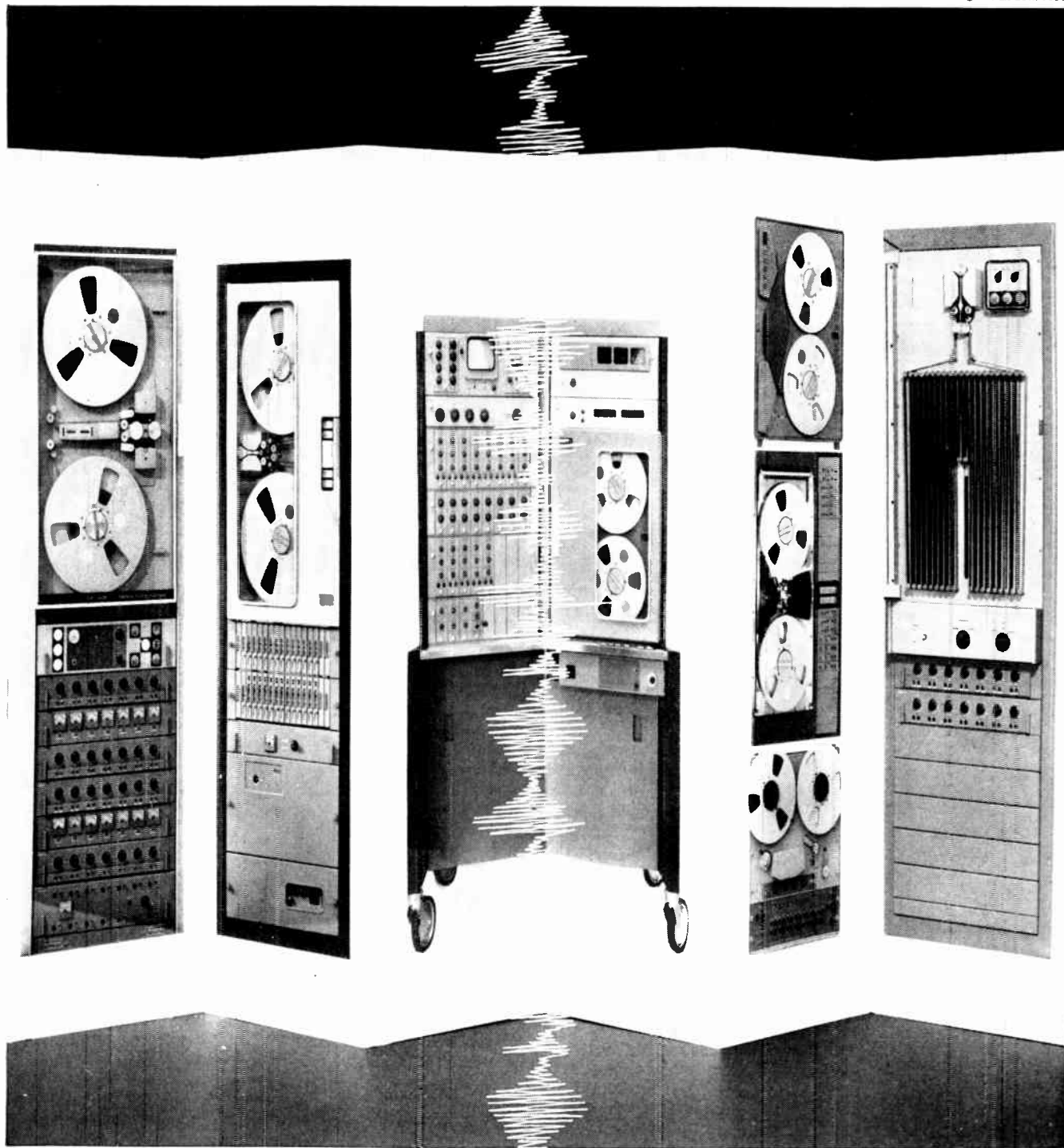
Immediate off-the-shelf delivery from IR distributors—phone

COLCHESTER 6173 · CRAWLEY 28700 · GLASGOW DOUGLAS 8671 · (LANCS) TODMORDEN 602 · LEEDS 35111  
LEICESTER 68561 · (LONDON S.E.27.) GIPSY HILL 6186 · (MIDDLESEX) SKYPORT 1314 · PORTSMOUTH 61785

INTERNATIONAL RECTIFIER CO. (GREAT BRITAIN) LTD · HURST GREEN · DXTED · SURREY · TELEPHONE DXTED 3215 · TELEX RECTIFIER DXTED 8819







**Ampex instrumentation recorders, M.D., B.Sc., Ph.D., D.Sc.**

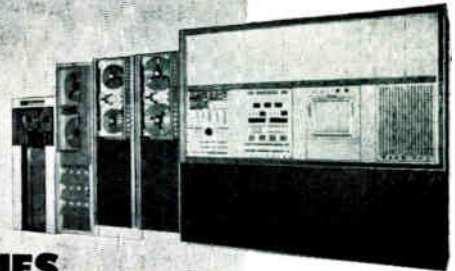
No matter what your field of testing or research, Ampex has a magnetic instrumentation recorder that can give you faster, more accurate, more usable data. Reason: any phenomena that can be converted into an electrical signal can be recorded, stored and processed on magnetic tape. And magnetic tape has no end of advantages. It permits time base expansion and contraction. Slow playback for data analysis on conventional readout devices. High-speed playback for computer processing. It can provide nearly any parameter needed to recreate experiments, or simulate environmental testing. You can store several million bits of data on a 10½ inch reel of magnetic tape. Record 14 or more different events at the same time. Erase



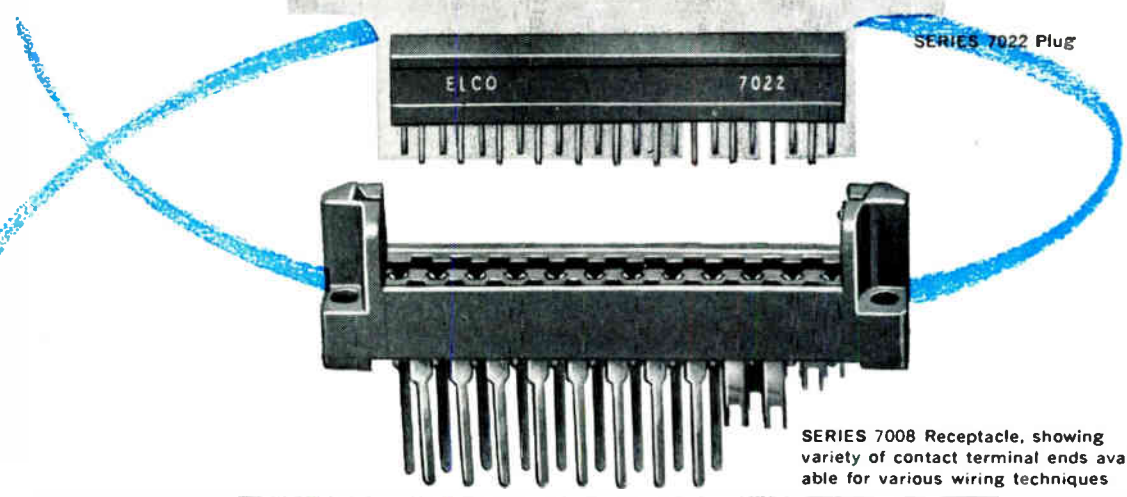
and reuse the tape, or store it permanently. Suggestion: why not write Ampex and find out how instrumentation recording can be applied to your particular operation. Why Ampex? Because we make more different kinds of recorders. Recorders with a wider range of recording techniques: Direct Performance, FM, PCM (2000-bpi), PDM, Frequency Shift Modulation. With frequency ranges from DC up to 1.5 Mc., sinusoidal or pulsed. Signal-to-noise ratios averaging as high as 46 db. Recorders that can record 23 hours, compress them to twelve minutes. Or expand 12 minutes to 23 hours. Write to: Ampex Great Britain Limited, Acre Road, Reading, Berkshire. Sales and service throughout the world.

# WHY

did **SYSTEMS ENGINEERING LABORATORIES** select **ELCO VARICON\*** connectors for the system employed to translate **Polaris missile telemetry data?**



Polaris Data Processor



SERIES 7008 Receptacle, showing variety of contact terminal ends available for various wiring techniques

- Series 7021-22 Plugs mate with 7 of our Receptacle Series!
- Requires only one hole per contact on module cards!
- Assures perfect spacing and perfect mating with Receptacles!
- Makes possible simultaneous staking; minimizes card warpage; simplifies circuitry layouts!
- Results in higher production efficiency and greater economy!

"Because," states SEL, of Ft. Lauderdale, Fla., "we needed highest possible reliability. In the matter of connectors, this meant ELCO VARICON® connectors." So SEL selected our Series 7022 card-edge, printed circuit connector plugs, and Series 7008 receptacles, for the data processing system which translates input digital data into output tapes after Polaris test firings. Series 7022, along with Series 7021, is a one-piece, all-molded miniature plug, with upper and lower tier, one-legged ELCO VARICON® contacts. SEL also specifies ELCO VARICON® contacts exclusively for all its NASA, and NASA's prime contractors' data acquisition systems. Why not request ELCO VARICON® connector literature, too, for "highest possible reliability!"



Can be supplied to meet P.O. approval.

For information on the full range of **VARICON\*** Connectors write to:

## MAGNETIC DEVICES LTD

Newmarket England. Newmarket 3451 (10 lines)  
Grams: Magnetic Newmarket. Telex 81245

Manufacturers of Relays, Solenoids and Timers  
Sole Licensees in Great Britain of the Elco Corporation, Willow Grove, Penn, U.S.A.

\*TRADE MARK



MOA-A.R.R.E-A.R.B.  
Approved Inspection



# FERRANTI

## SILICON PLANAR TRANSISTORS

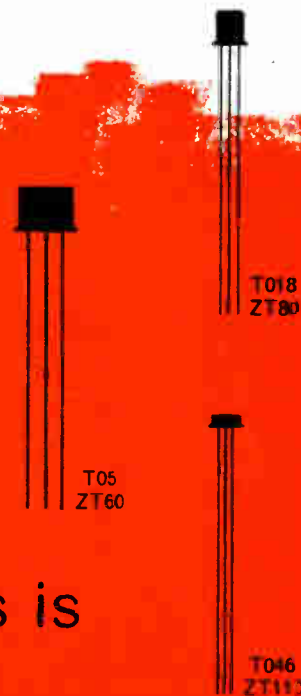
Designed and manufactured in Britain for you

You should specify

**\* BURN IN**

statistics show that this is the only way to achieve **MAXIMUM RELIABILITY**

**\* Every Ferranti transistor from the production line is FULLY DYNAMIC TESTED FOR 48 HOURS !**



Rating or Characteristic	Symbol	ZT60 ZT80 ZT110	ZT61 ZT81 ZT111	ZT62 ZT82 ZT112	ZT63 ZT83** ZT113	ZT64 ZT84** ZT114	ZT66 ZT86** ZT116	ZT67 ZT87 ZT117	Test Conditions
Collector Base Voltage	$V_{CB0}$	25	45	45	60	60	100	25 volts	$I_E = 0$
Collector Emitter Sustaining Voltage	$V_{CE0(Sus)}$	25	35	35	45	45	80	25 volts	$I_B = 0$ $I_C = 5mA$
Emitter Base Voltage	$V_{EB0}$	4	4	4	5	5	5	4 volts	$I_C = 0$
Collector Peak Current	$I_{Cpk}$	500	500	500	500	500	500	500mA	
DC Collector Current Gain	$h_{FE}$	38-162	38-162	78-250	25-85	75-170	35-85	78-250	$I_C = 10mA$ $V_{CE} = 6V$
Collector Base Reverse Current	$I_{CBO}$	0.5	0.5	0.5	0.05	0.05	0.05	0.5 $\mu$ A	$V_{CB} = V_{CB0}$
Collector Saturation Voltage	$V_{CE(Sat)}$	0.4	0.4	0.4	0.4	0.4	0.4	0.4 volts	$I_C = 50mA$ $I_B = 5mA$ $I_C = 10mA$ $I_B = 2mA$
AC Current Gain (typical)	$h_{fe}$	10	10	10	10	10	10	10	$f = 20mc/s$ $I_C = 10mA$
Power Dissipation	$P_{tot}$	300	300	300	300	300	300	300mW	$P_{tot} = 350mW$ for ZT60 series
Minimum Burn-In Period	$t_{BPmin}$	48	48	48	48	48	48	48 hrs.	$P_{tot}$ $T_{amb} = -25^\circ C$

\*\* CV 7371 CV 7372 CV 7375

**FERRANTI**  
First into the Future

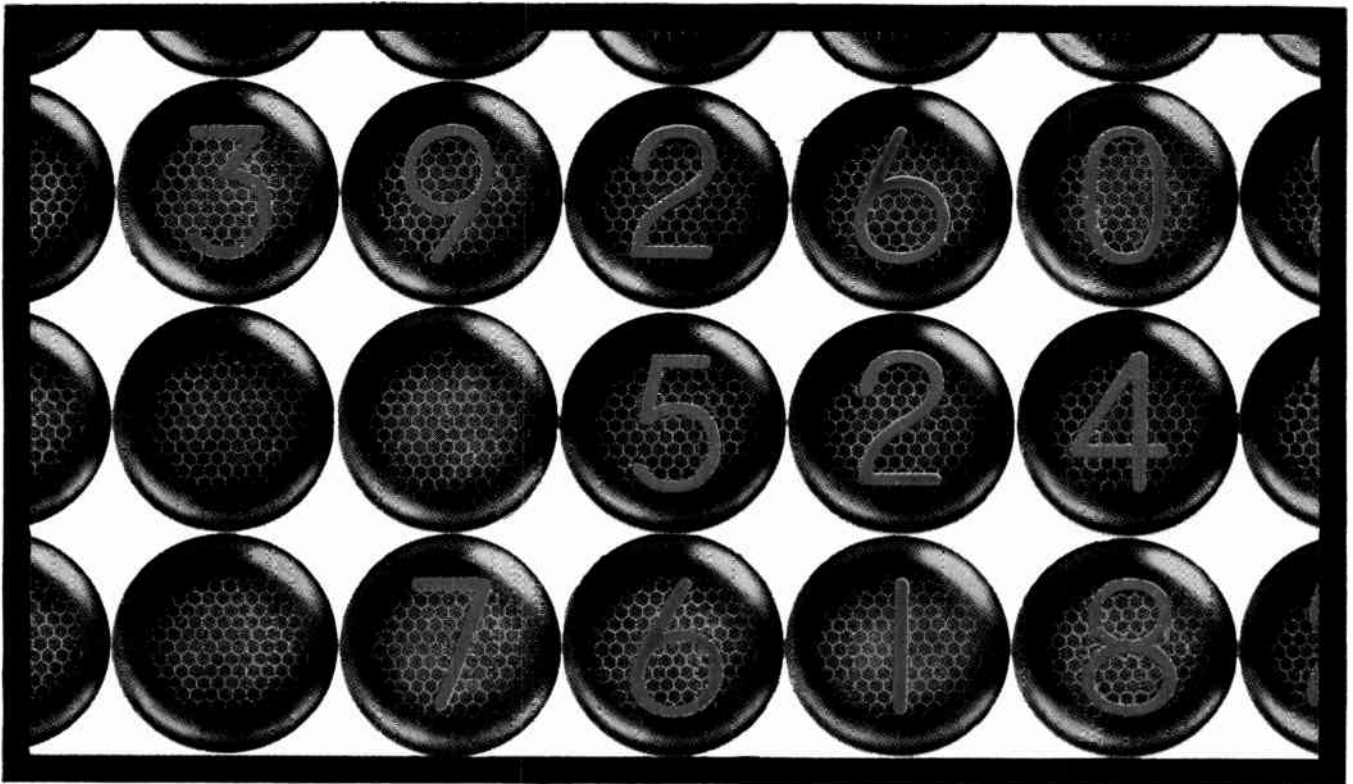
Write for further details:

**FERRANTI LTD · GEM MILL · CHADDERTON · OLDHAM · LANCs** · Telephone: MAIn 6661

FE 258 2

Industrial Electronics December 1964

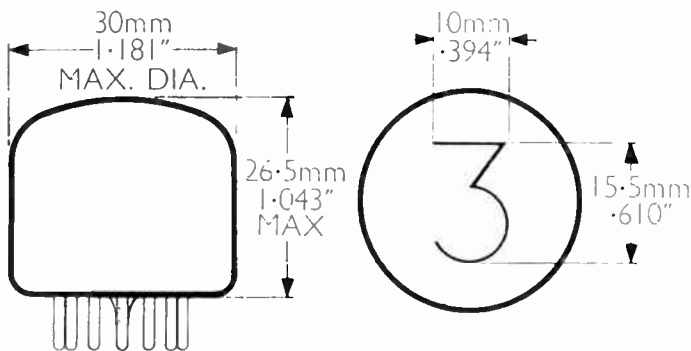




# DIGITRON<sup>\*</sup> GR 10 M. FOR ALL READOUT APPLICATIONS

Close control of manufacturing processes and the introduction of new gas mixtures has led to tremendous improvements in the reliability and life of Cold Cathode Indicator Tubes. Their vivid, unambiguous display, even under adverse ambient lighting conditions, has led to an ever increasing demand in the Instrumentation and Industrial fields. Low power consumption and simplicity of access makes them adaptable to all forms of switching, whether electro-mechanical or electronic.

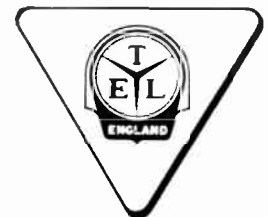
The GR10 M is the latest addition to the Ericsson range of Digitron Display Tubes. This new and aesthetically satisfying, end-viewing tube, with plug-in 13 pin glass base, presents an economical answer to all your digital readout problems. For further information please contact Tube Division, Technical Services Department, Ericsson Telephones Ltd., Beeston, Notts. Tel: Nottingham 254831.



## OTHER DIGITRON TUBES AVAILABLE

	CHARACTERS	CHARACTER HEIGHT	NOM. CURRENT	VIEWING	
GR 7M	+ - VA Ω % ~	15.5 mm.	.610 ins	2 mA	END
GR 10K	0 - 9	19 mm.	.748 ins	2 mA	END
GR 10J	0 - 9	30 mm.	1.181 ins	4.5 mA	SIDE
GR 10N	0 - 9	60 mm.	2.362 ins	14 mA	SIDE

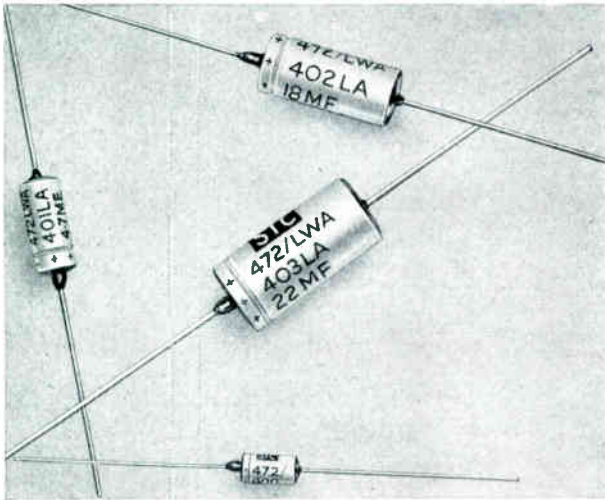
\* Digitron is an Ericsson Registered trade mark.



## ERICSSON TELEPHONES LTD · ETELCO LTD

A Principal Operating Company of the Plessey Group Head Office and Main Works: Beeston, Nottingham. Tel: 254831. Telex 37666  
Registered Office: 22 Lincoln's Inn Fields, London, WC2. Tel: HOLborn 6936

# STC components review



## Fully approved solid tantalum capacitors

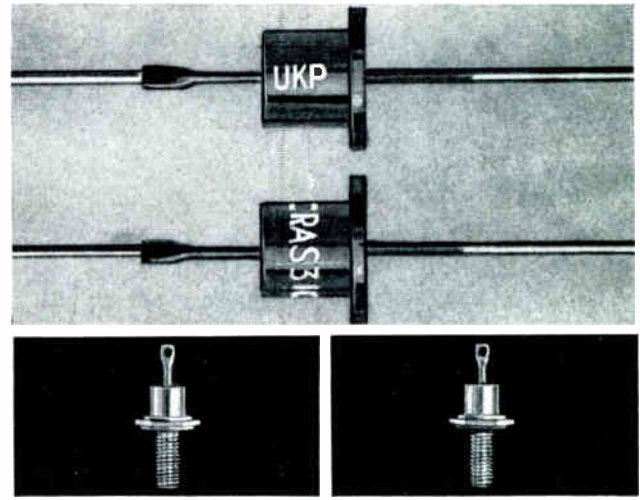
STC solid tantalum capacitors are Qualification Approved by the joint services RCSC. The approval was granted following a successful test programme carried out to DEF 5134A-1 and covers all voltages up to and including the 35 volt series.

Capacitance range	0.01 $\mu$ F to 330 $\mu$ F
Voltage ratings	50, 35, 20, 15, 10 and 6 V. d.c.
Humidity class	H6
Temperature range	-55 C to 125 C (derated above 85 C)

The range, which conforms to both DEF 5134A-1 and MIL-C-26655 2, is manufactured entirely in the United Kingdom under full Quality Control. All units are aged for 7 days before shipment. Capacitors to 5% and 10% tolerances are available in addition to the standard 20% capacitance tolerance.

Also marketed by STC is a range of resin moulded solid tantalum capacitors with radial and axial terminations.

Write, 'phone or Telex for Data Sheets to STC Capacitor Division, Brixham Road, Paignton, Devon. Telephone Paignton 58685. Telex 4251.



## Silicon avalanche rectifiers

STC's silicon avalanche rectifier, Type RAS310AF, now has Joint Services Type Approval to CV7476. This is a diffused junction silicon rectifier with a 4kW reverse power surge rating and it is virtually self-protecting against voltage transients. This feature offers simplicity and economies; high voltage stack construction is simplified, rectifiers can be series-connected without equalizing resistors and, in many applications, equalizing capacitors are unnecessary.

### RAS310AF BRIEF DATA

Rated mean forward current (25° C ambient)	1.25A
Rated crest working voltage	1 000V
Minimum reverse avalanche voltage	1 250V
Rated maximum reverse surge power	4 kW
Rated maximum junction temperature	140° C
Standard outlines	VASCA SO-16 JEDEC DO-1 IEC 1-101

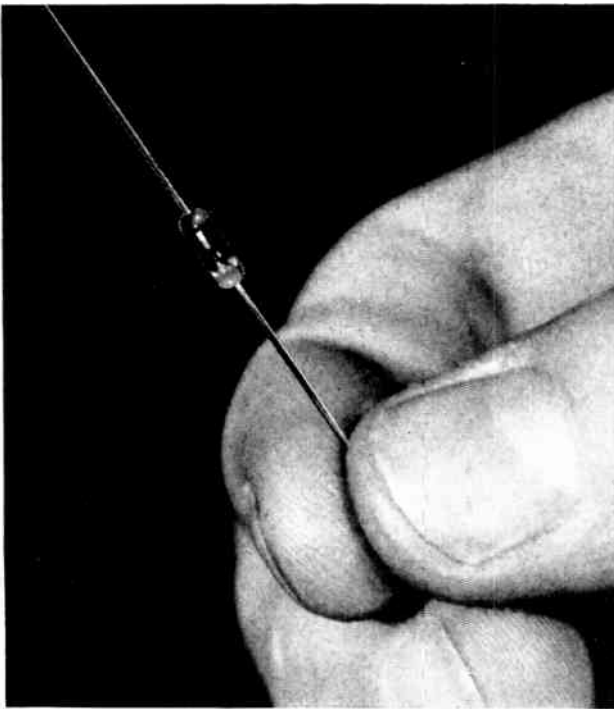
### 5A AVALANCHE RECTIFIER

Latest addition to the STC silicon avalanche rectifier range is the RAS508AF. This 5A device also has a 4kW reverse power surge rating with the consequent advantages outlined above for the RAS310AF.

### RAS508AF BRIEF DATA

Rated mean forward current (125° C stud)	5A
Rated crest working voltage	800V
Minimum reverse avalanche voltage	1 000V
Rated maximum reverse surge power	4kW
Rated maximum junction temperature	150° C
Standard outlines	VASCA SO-10 JEDEC DO-4 IEC 1-103

Write, 'phone or Telex for Data Sheets to STC Semi-conductor Division (Rectifiers), Edinburgh Way, Harlow, Essex. Telephone Harlow 26811. Telex 81146.



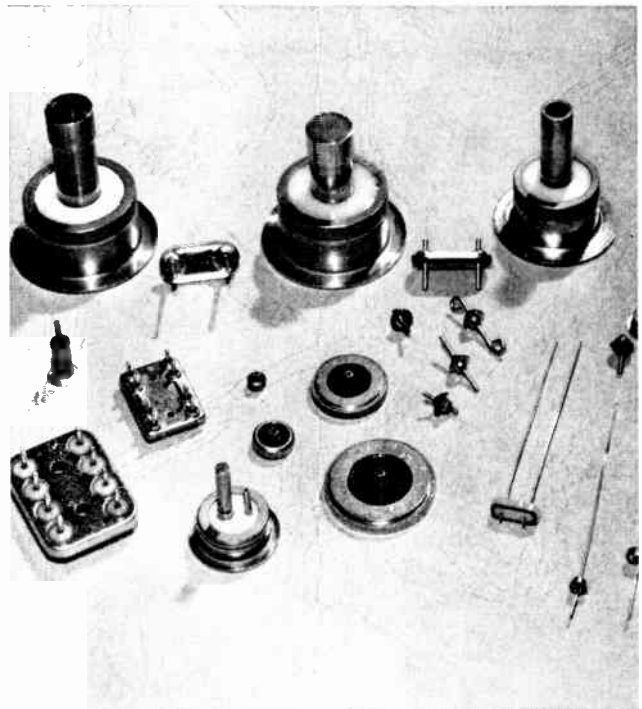
### Gold-bonded diodes . . . range increased

Three new germanium gold-bonded diodes have been added to the STC range. These are the DK19, DK20 and DK21 which are specially designed for use in high speed switching applications; and along with existing types DK13, DK14 and DK15, represent a range having extremely good electrical stability and robust mechanical construction. Each type has a sub-miniature glass encapsulation and conforms to the JEDEC DO-7 outline. They are competitively priced and available from stock.

**BRIEF DATA**

Type	V <sub>R</sub> max (V)	I <sub>R</sub> at V <sub>R</sub> max (μA)	I <sub>F</sub> max (mA)	Typical capacitance (pF)	Typical str. red. charge at 10mA (pC)	Equivalent to
DK19	25	180 at 60 C	110	1.0	280	0A47
DK20	50	25	100	0.4	350	HG5004
DK21	8.0	150	30	1.3	20	AA213

For further information, write, 'phone or Telex Semiconductor Division (Transistors), Footscray, Sidcup, Kent. Telephone FOOtscray 3333. Telex 21836.



### High quality hermetic seals

These are produced by STC Valve Division for many applications which include transformer and relay terminations, capacitor end-caps, semiconductor encapsulation and crystal bases. STC seals are notable for high insulation resistance, freedom from leakage and resistance to weather, fungus growth and mechanical shock. In addition to the supply of seals from the wide range immediately available, STC, with its long-established manufacturing resources in this field, is fully prepared to supply suitable quantities of hermetic seals to meet customers' special requirements. Categories of seals available are:—

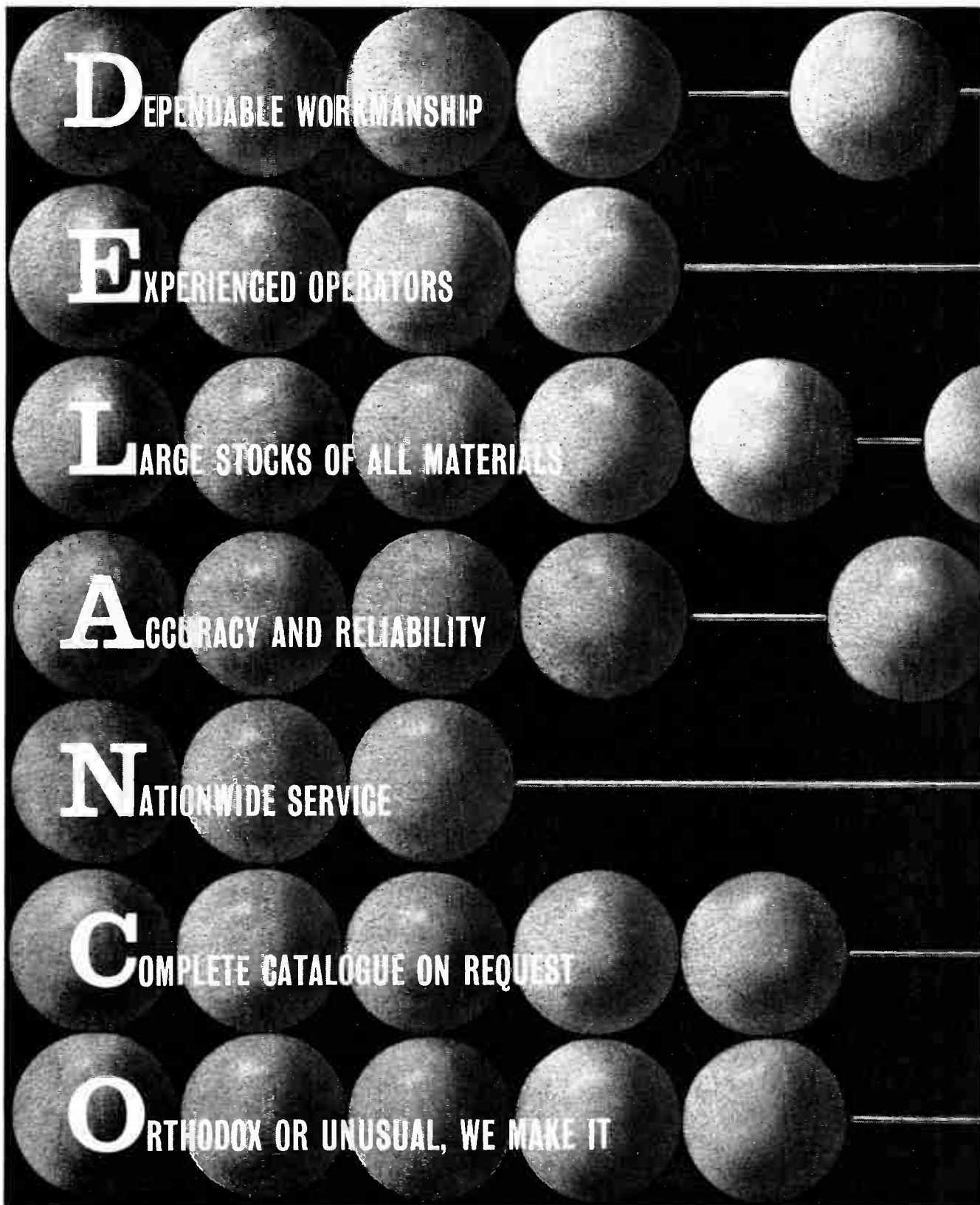
- Single Terminal Types:** General purpose—wire termination, general purpose—eyelet termination, tubular end, capacitor end-cap, fly lead.
- Multi-Terminal Types:** Crystal base, Multi-terminal lids.

For detailed information concerning STC seals write, 'phone or Telex STC Valve Division, Brixham Road, Paignton, Devon, or London Sales Office, Footscray, Sidcup, Kent. Telephone FOOtscray 3333. Telex 21836.

high-grade electronic components by

**STC**  
COMPONENTS GROUP





VULCANIZED FIBRE · LEATHEROID · PRESSPAHN · COMPOSITE  
INSULATION · SILICONE & EPOXY BONDED GLASS FIBRE  
BAKELITE SHEET, TUBE & ROD · COPPER CLAD LAMINATES  
MICA AND MICANITE · AND PRECISION MACHINED  
AND PRESSED PARTS IN ALL INSULATION MATERIALS

ANGLO-AMERICAN VULCANIZED FIBRE COMPANY LTD, CAYTON WORKS, BATH STREET, LONDON, E.C.1. CLE: 8484 (15 LINES)



IT ALL ADDS UP TO  
***Delanco***

*Industrial Electronics* December 1964

**PNP**

**PLANAR PASSIVATED**

2H1254 2H1255 2H1256 2H1257 2H1258 2H1259 HT100 HT101	T0-18 Case	A unique range of double-diffused 100 Mc/s switching transistors. BV . . . . up to 50V hFE . . . . specified max/min values within range 14 - 150
2N1254-9	T0-5 Case	$V_{ce(sat)}$ 0.3V $t_d + t_r$ 25nanosec

2H1254-9 Type Approved CV 7484-9

2N1131 2N1131A 2N1132 2N1132A 2N1132B	T0-5 Case	Medium power general purpose transistors available in either TO-5 or TO-18 case style. Min $f_t$ 60 Mc/s BV . . . . up to 60V hFE . . . . specified max/min values within range 20 - 200
2N721 2N722	T0-18 Case	$V_{ce(sat)}$ 1.5V

**NPN**

**PLANAR PASSIVATED**

2N706 2N706A 2N706B 2N707 2N708 2N753 2N914	T0-18 Case	A preferred range of 300 Mc/s transistors with excellent switching characteristics. BV . . . . up to 56V hFE . . . . specified max/min values within range 9 - 120 $V_{ce(sat)}$ 0.4V
---	---------------	--

2N717-720A 2N870-1 2N910-2 2N956 HT400-1	T0-18 Case	70 Mc/s medium power general purpose transistor available in either TO-18 or TO-5 case style. BV . . . . up to 120V hFE . . . . specified max/min values within range 20 - 100
2N696-9 2N1613 2N1711 2N1893 2N1889-90	T0-5 Case	$V_{ce(sat)}$ 1.5V

**Manufactured at their Glenrothes, Scotland, factory the Hughes range of Silicon Transistors is centred on those types having the broadest basis of common 'preference' by the various Authorities specifying world-wide Military and Aviation equipment requirements. The use of these types in your prototype equipment will avoid expensive re-design at the production stage. For commercial applications, the HT100/1 and HT1400/1 complementary devices offer the opportunity of "going Silicon" at surprisingly low cost.**

**SPECIFY HUGHES TRANSISTORS**



**... transistors with superior performance and maximum reliability**

Write now for complete data on the full range of Hughes semi-conductor products, which also includes:— Germanium and Silicon Switching Diodes, Silicon Power Diodes and Rectifiers, Voltage Reference (Zener) Diodes, High Voltage Cartridge Rectifiers.

**HUGHES INTERNATIONAL (U.K.) LTD**

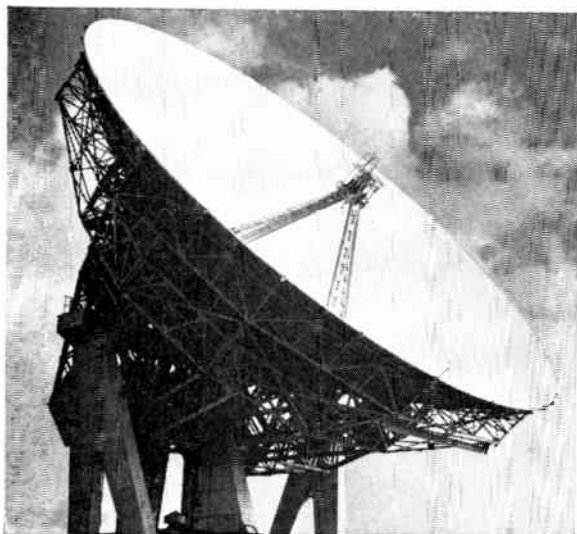
**GLENROTHES • FIFE • SCOTLAND**

Sales Office :  
KERSHAW HOUSE, GREAT WEST ROAD, HOUNSLOW, MIDDLESEX. TEL : HOUNSLOW 5222.

M & P HM24



# G.E.C. MODULAR SYSTEMS SOLVE EVERY PROBLEM OF REMOTE CONTROL



**Communications Control** A static transmitter, aligned with Telstar's orbit, is operated from Goonhilly by G.E.C. remote control equipment. Similar applications include the remote control of the master transmitter on the South Yorks Mobile Radio-phone scheme; and the operation from Prestwick Ground Control Station of radio transmitters at Stranraer.

G.E.C. Electronics' modular systems provide the economic answer to any remote control problem. Whether the distance involved is one mile or hundreds of miles, G.E.C. (Electronics) Ltd. can build up from its comprehensive range of standard frequency and time division multiplex modules the ideal system for any application. This rational, modular approach gives fullest design flexibility and cuts costs by eliminating expensive special engineering. Simply by adding extra modules the systems can grow as the plant they control grows. G.E.C. modular systems outmatch conventional methods on cost, on versatility and on reliability.

## These are some of the basic G.E.C modular systems

- ★**Teledata**—data and control transmission equipment which operates between a number of points over a single pair of wires.
- ★**Comantel**—automatic answering unit for use with Teledata transmitters and receivers over the telephone system.
- ★**Teleshift**—transistorised frequency shift transmission equipment for faster signalling under adverse conditions.
- ★**Telecode**—scanning equipment which economically transmits digital control information over long distances.
- ★**Teleducer**—transistorised equipment for transmission of analogue quantitative measurements over line or radio circuits.

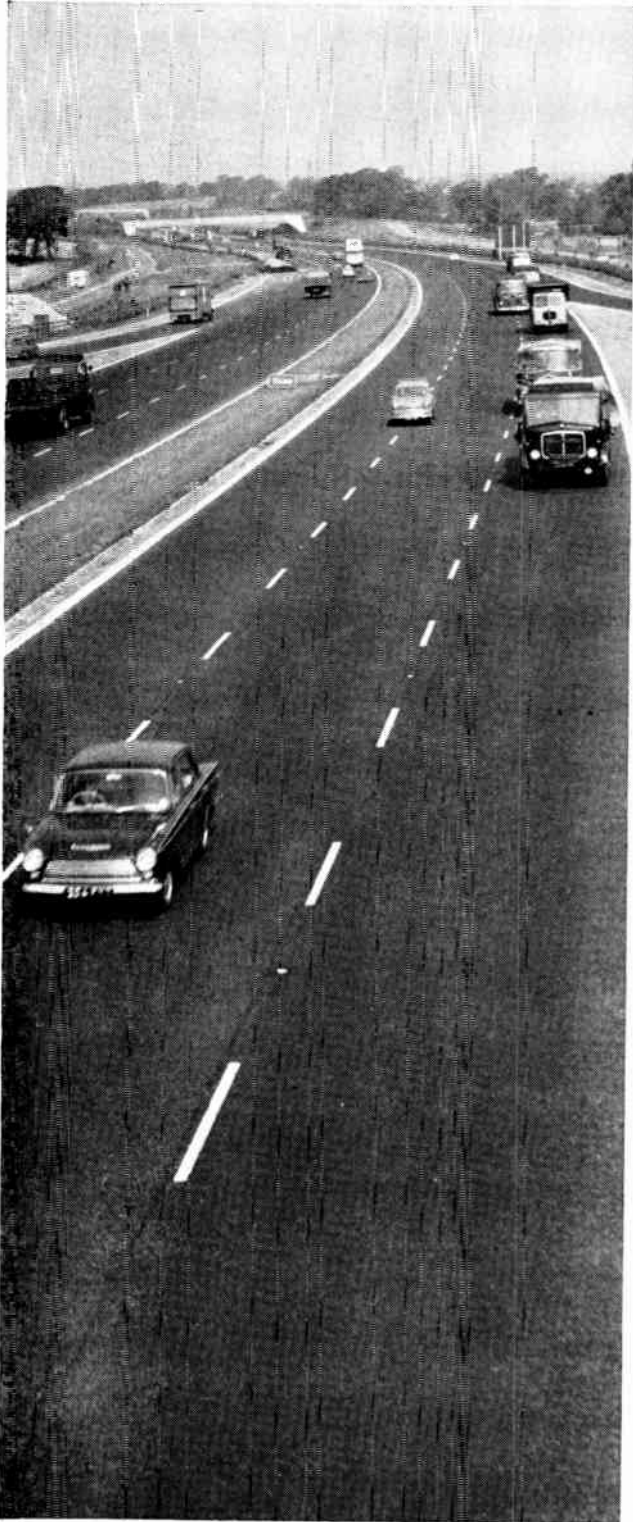


**Fire Fighting** In establishing a "new look" for fire services, centralised control has been adopted to achieve faster, more efficient utilisation of available fire fighting forces. G.E.C. equipment is now being used for "central mobilising" throughout Great Britain.



**Water** The trend to centralised control of remote pumping stations demands accurate and reliable remote control and telemetry systems. G.E.C. modular equipment, already installed in many undertakings throughout Great Britain, provides economic remote control of outlying installations.





**Motorways** G.E.C. frequency division multiplex equipment is used widely on Britain's new Motorways. In conjunction with the emergency telephone system, it pinpoints accidents within seconds, enabling the nearest emergency services to be alerted without delay.

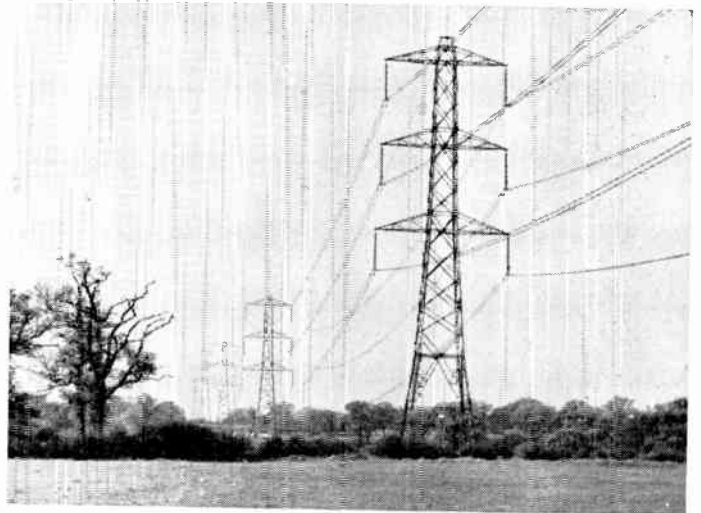


## **modular remote control and telemetry**

INSTRUMENTATION & CONTROL DEPARTMENT, EAST LANE, WEMBLEY, MIDDLESEX. ARNold 435



**Refineries and Pipelines** G.E.C. (Electronics) Ltd. has installed remote control systems for many different applications on behalf of major oil companies. A typical example is the use by Shell-Mex and B.P. Ltd. of G.E.C. equipment to operate motorised valves at isolated points on pipelines. Control in this instance is exercised over the G.P.O. telephone system.



**Electricity Supply** G.E.C. equipment has been installed by many electricity supply undertakings for control and alarm purposes. A recent example has been for voltage control and monitoring at all distribution sub-stations by one of the largest area boards.

### **CONSULT G.E.C. ELECTRONICS NOW**

This coupon attached to your letterhead or a phone call to ARNold 4353 will put you in touch with the G.E.C. Electronics' team of systems engineers who will gladly help you solve your remote control problems.

NAME .....

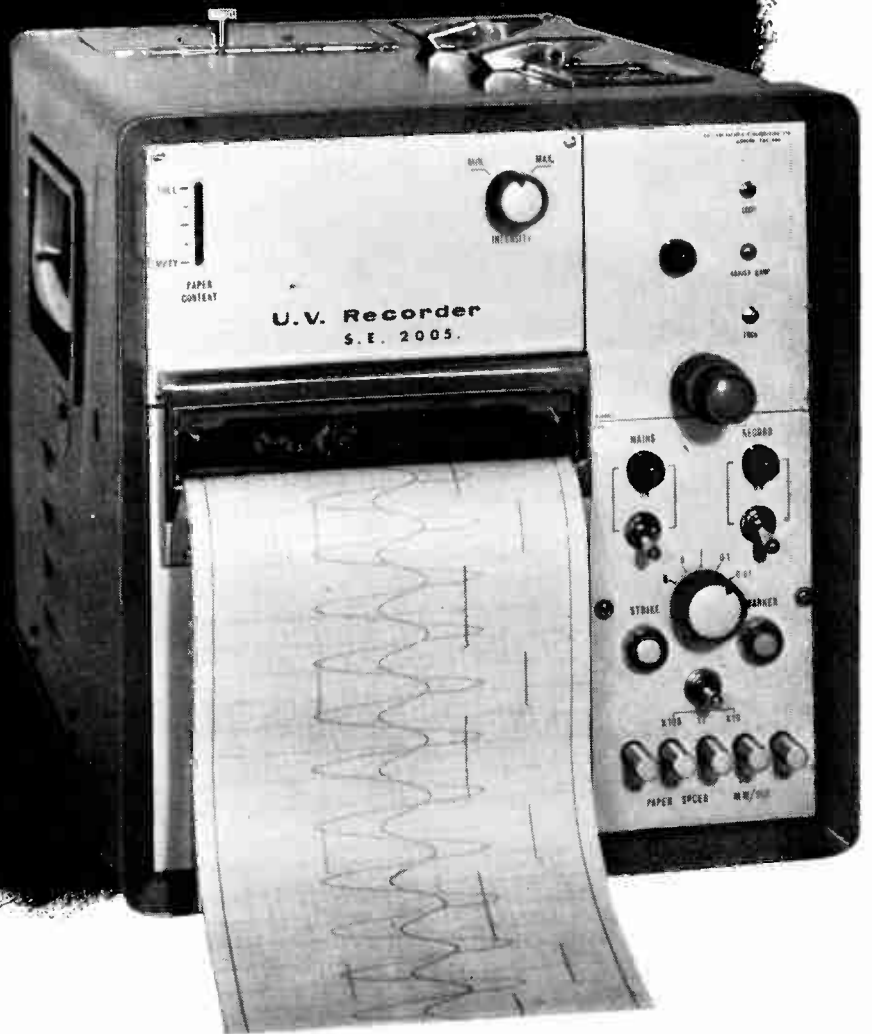
POSITION .....

IE3

# The Best Value in the World

## S. E. Recorder 2005

- 15 PAPER SPEEDS (0.05 to 80 in. per sec)
- RAPID AND POSITIVE CHART SPEED SELECTION
- FULL WIDTH TIMER LINES
- INTEGRAL CAST CONSTRUCTION FOR OPTICAL RIGIDITY
- FRONT-PANEL PLUG-IN UV LAMP-HOUSE FOR EASY REPLACEMENT AND ADJUSTMENT
- GRID LINE PROJECTION
- ACCEPTS DIFFERENT PAPER WIDTHS FOR ECONOMY
- GALVANOMETER WITH UP TO 8,000 c/s
- TRACE INTENSITY CONTROL
- PAPER CONTENTS INDICATOR
- 6 or 12 CHANNEL SYSTEMS



Ring or write for full details of this remarkable new S. E. Recorder and all associated equipment. Applications Engineers will gladly demonstrate anywhere.

**S E LABORATORIES | ENGINEERING | LTD**

A subsidiary of S. E. Laboratories (Holdings) Ltd.

606 North Feltham Trading Estate, Feltham, Middlesex. Telephone: Feltham 5876

COMPLETE INSTRUMENTATION SYSTEMS

# INDUSTRIAL ELECTRONICS

## Comment

The industrial applications of electronics are commonly to the control of machines of one kind or another. This control is usually effected through electro-mechanical devices, although there is sometimes a hydraulic or pneumatic link. We say link because the electro-hydraulic stage usually involves an electro-mechanical device; the hydraulic system, for example, is controlled by a mechanical valve which is itself controlled by an electric current.

A good many different technologies are involved in any large installation and no one can be expert in all. It is for this reason that most design work is nowadays teamwork. With a team comprised of experts in differing fields problems of communication arise and it is usually essential for each member to have at least some knowledge of the other specialist's subjects.

We have noticed in recent years that technologists in other fields are increasingly finding it necessary to know something of electronics. We think that electronics people ought in their turn to acquire some knowledge of these other technologies. Unless they do, there cannot be that proper overlap of knowledge between members of a team.

Our own sphere is electronics together with that part of electrical science which is essential to electronics and which it would be pedantic to divorce from electronics. It has always been customary to regard a great many ancillary devices as within our field; transducers of all kinds, for example. We have always felt it desirable to treat matters which are on the fringe of our field, and sometimes this has made it necessary to go outside it. To explain an electro-mechanical device, for instance, may require an excursion into pure mechanics.

We intend in the future to do this rather more in order to assist in the great essential of our time, intercommunication between technologies. We want to make it clear, however, that our essential interest will be unchanged and will still be electronics and its applications.

### Yo-Yo

This is the name given to a Westinghouse development which aids the transference of cargo from one ship to another at sea. It appears to be basically an electronic control system for a crane which enables the load to be kept at a constant distance above the deck. A 'deck sensor' is fitted to the load to detect the position of the deck and produce signals to control the crane which is, of course, in the other ship.

While this may well prevent a load crashing on to a deck as one ship rises while the other falls, it clearly does not solve all the problems. With rolling

and pitching ships there are large relative horizontal movements as well and nothing is said about whether Yo-Yo can control these in any way.

### The Maser

This year the Nobel Prize for Physics has been awarded to the originators of the maser. One half is to C. H. Townes who is now Provost of the Massachusetts Institute of Technology and the other half is shared between N. G. Basov and A. M. Prokhorov of the U.S.S.R. Academy of Sciences Lebedev Institute of Physics.

On the one hand Townes and on the other Basov and Prokhorov indepen-



dently succeeded in producing the first devices using the maser principle in 1953.

### Units

One of the biggest difficulties experienced by any newcomer to a subject is in getting used to the system of units used for measurement. The sizes of things at first mean nothing and it takes time before familiarity comes.

It is this getting used to units which is the biggest obstacle to any change in them. Even those of us who are familiar with the metrical system and are, so to speak, somewhat bilingual, find difficulty in some areas. We all know how big an inch or a foot is: most of us know how big a centimetre is, but even then if we are told that something is 15 cm wide it does not mean much to us. Our mental processes are something like this, 'An inch is 2.54 cm, so 5 cm is 2 in., and 15 cm is 6 in., about'.

Even with the 24-hour clock, which British Railways have recently introduced, we have to deduct 12 from the p.m. times of the trains to find out at what time they really run. To say that the train leaves at 17.39 means nothing at all to most people. They have to deduct twelve to find out that it is the 5.39. Are we alone in finding it hard to avoid deducting only 10? We find there is a strong tendency just to ignore the 1 and take the time as 7.39.

We ourselves think that the 24-hour clock system is one which creates unnecessary difficulties for nearly everyone. We have all been brought up on a 12-hour clock and all clocks and watches in normal use have a 12-hour dial.

We are, of course, well aware that the 24-hour time scale is nothing new and that it has been long used in the services and by air lines. However, we ourselves think that the chances of a 2-hour error with the 24-hour clock are much greater than those of a 12-hour error if one mixes up a.m. and p.m. The whole point is that apart from certain special circumstances no one thinks in terms of 24 hours. We still leave the office at 5.15 to catch the 17.39 train!

It is the same with temperature scales. We use both, but not in the same conditions. Weather in centigrade means nothing at all to us, just as transistor junction temperature in Fahrenheit would mean nothing.

The whole point is that we normally do not think about units at all but get used to certain numbers as having a meaning. In any change of units we all have to get used to new numbers for familiar things.

The change from c.g.s. to m.k.s. units was one which did not produce the same difficulties, because in most cases the m.k.s. units were the common practical units. Most people, therefore, did not have to

change at all. Those who through special circumstances used c.g.s. rather than practical units quite often still do!

### Transistors in Cables

We recently commented that one proof of the reliability which can be attained with valves is the fact that they are used in the repeaters of submarine cables where they are expected to have lives of 20 years' continuous operation. As we rather expected the transistor has invaded this field now.

Two transistorized repeaters are being fitted to the cable between St. Margaret's Bay and La Panne. This cable is only 47½ nautical miles and in the past has had no repeaters. Fitting them will increase the channel capacity from 216 to 420. Their installation should be completed by 1st December.

Thus transistors are now considered to be reliable enough for underwater use.

### White Noise

We have often commented on some of the technical terms used in electronics. Some of them strike the newcomer as quite inappropriate and the meanings of some are not at all obvious.

Noise is a case in point. What does a non-technical person make of the statement that a piece of apparatus has a low noise level, when that apparatus produces no audible output at all? The term originated, of course, in early radio apparatus in which signals were often accompanied by hissing and crackling noises. These arise from random variations in the values of electrical quantities; the resulting random e.m.fs are usually at microvolt level.

Noise sets a limit to the amount of amplification which can usefully be employed. The voltages due to it are present in all apparatus and the name 'noise' is retained whether or not the output is an audible one. When the output is presented on a cathode-ray tube with an intensity-modulated display, as in television, it is sometimes called 'snow', whereas with a deflection-display, as in an oscilloscope and some radar apparatus, it is often known as 'grass'.

What now is 'white noise'? It is noise of uniform spectrum. If a selective receiver, having constant selectivity and gain at all the frequencies to which it is tuned in turn, is fed with white noise its output is independent of the frequency to which it is tuned. If white noise is subject to Fourier analysis its spectrum is continuous, containing all frequencies, and all the component frequencies have the same amplitude. Noise is called white by analogy with light, since white light normally comprises more or less equal components of all visible frequencies.



# SPEED MEASURING RADAR

By N. W. STANBURY\*

Apparatus for measuring the speed of motor vehicles is described in this article. It is a radar device utilizing the Doppler effect. Similar equipment can be employed as a speed indicator in Hovercraft.

**D**URING 1955, British police forces began looking into the possibility of using some form of radar equipment for instantaneous speed measurement. Speed meters utilizing the Doppler principle of frequency change in electromagnetic radio-waves reflected from moving objects had been available in the U.S.A. since before 1950. However the early type of equipments had several shortcomings, not the least of which was that the transmitted beam pointed towards the oncoming traffic. As is readily understandable, this type of system is open to inaccuracy and ambiguity when two or more vehicles are present in the beam.

It was due to the possibility of such errors occurring that the organizations interested in introducing and using such equipment in the United Kingdom decided not to use speed-measuring equipments based on the American system.

In 1957, The Marconi Company Ltd. were approached by the Lancashire Constabulary with regard to the possible development and production of a new equipment suitable for use in the United Kingdom. By the early part of 1959, Marconi engineers had developed a prototype 'PETA' (Portable Electronic Traffic Analyser, type S350) which was then handed over to the Lancashire Constabulary for evaluation purposes. The significant difference between the 'PETA' and the earlier type of traffic radars is that the beam, emitted from a slotted waveguide 'window,' is angled across the road at 20° and is confined to a 4' horizontal

beam-width. Each car passes through the beam as opposed to along it, and vehicles more than eight feet apart will provide separate indications on the meter display. Another facility provided by 'PETA' is the incorporation of a 'memory' circuit which is explained more fully later in the text.

By 1960 the first deliveries of production equipments were being carried out and to date over 150 equipments have been supplied to police forces and traffic engineering organizations throughout the world.

The standard equipment comprises three units, aerial, power-supply and meter display. The power-supply unit draws current from a 12-V car battery and provides stabilized supplies for the aerial unit. This unit houses the transmitter and receiver, the former utilizing an X-band pre-tuned reflex klystron operating in the frequency band 10,675 Mc/s to 10,699 Mc/s. The c.w. power output of approximately 12 mW is divided equally between the aerial and a section of the waveguide containing a variable mismatch. The reflected signal is received at the common aerial and mixed in a crystal detector with the reflected transmitter energy from the mismatch. The resultant audio output passes through a low-pass filter (to limit the bandwidth) to a five-stage a.f. amplifier before passing on to the meter unit.

This audio information is used to drive a limiter, multi-vibrator and pulse amplifier. The resultant train of pulses is fed to a frequency-sensitive network producing a voltage proportional to speed.

Two modes of operation are provided, 'Hold-off' and 'Hold-on'. Using the 'Hold-off' mode, a valve voltmeter reads the voltage output for the period of time that the vehicle is in the beam. When using 'Hold-on' or 'Memory' the same output is fed into a capacitor which the valve-voltmeter reads for approximately 1½ seconds, after which a timing circuit discharges the capacitor and the meter returns to zero. During this period the meter will accept no further signals.

\* The Marconi Company Ltd.



*Speed-measuring equipment fitted in the rear of an estate car*

During the design and development of 'PETA' it was considered extremely important that, should the equipment malfunction, the fault condition should be immediately and clearly apparent. To this end a wavemeter is incorporated to check the transmitted frequency, and calibrating signals corresponding to 40 and 70 m.p.h. are provided so as to enable the equipment to be checked at any instant of time and as frequently as the operator wishes. In addition, it is customary for the police to carry out a 'run-through' with a patrol car travelling at a known speed before the start of an exercise and again at the termination in order to ensure that the readings are accurate.

In this connection it should perhaps be added that the police forces do not use the 'PETA' equipment to trap the unwary motorist. Sections of road which are under surveillance are invariably signposted as such to forewarn road users; in short, the device is used as a deterrent.

Siting the equipment is simplicity itself; all that is neces-

sary is to position the short side of the aerial parallel to the road, a procedure which even the most inexperienced operator usually carries out with complete accuracy and at the very worst does not err by more than  $\pm 2^\circ$ , at which angle the speed error introduced is negligible. Even if the equipment was set up with its beam parallel with the line of traffic flow (i.e., a  $20^\circ$  misalignment) there would be only a 2.4 m.p.h. increase in registered speed on a vehicle travelling at 40 m.p.h., and this would of course be immediately detected in the initial tests.

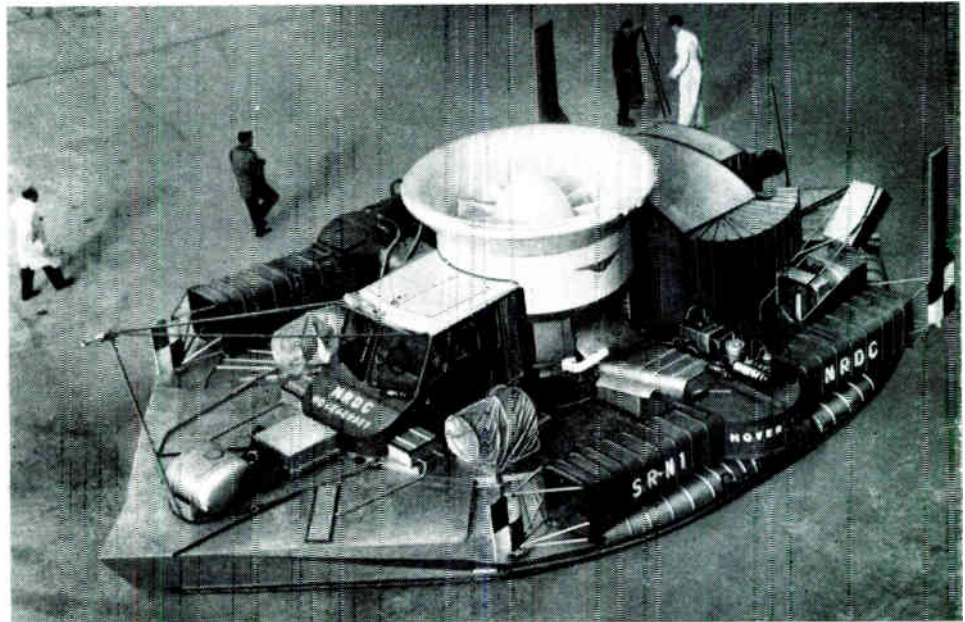
The circuitry of 'PETA' is so designed that, with the aerial correctly aligned, a Doppler shift of 2.4 kc/s will cause full-scale deflection on the meter (a reading of 80 m.p.h.), each 30 c/s representing a speed of 1 m.p.h. Two check oscillators are built into the meter unit and these produce spot frequencies of 1.2 kc/s (40 m.p.h.) and 2.1 kc/s (70 m.p.h.). The speed scale is linear and calibrated checks can be easily carried out at any time.



*'PETA' in use for statistical analysis of traffic speeds*



A modified 'PETA' fitted to a Hovercraft. The aerial unit is an oblong box mounted at 45° in the stern



It might perhaps be appropriate at this point to refer to a statement made earlier in the year in the motoring press to the effect that such radars constitute a hazard to the public by reason of radiation effects. This, as every electronics technician will have realized, is a completely unfounded accusation. The radiation level at the aerial aperture of 'PETA' is in the region of 0.013 mW/cm<sup>2</sup>—approximately 1/1,000 of the accepted safe continuous exposure level—hardly dangerous!

As mentioned earlier 'PETA' is not only used by the police. Several universities use this equipment for civil engineering courses and 'PETA' is also used by several county councils for highway planning purposes. Sets are also used in Holland, Australia, Jamaica, British Guiana,

Bahrain, Malaya, Bermuda, Sierra Leone, Thailand and Southern Rhodesia.

Recently the Marconi Company were asked whether an equipment could be used to measure the speeds of racing cars at the R.A.C. European Grand Prix which was held at Brands Hatch motor-racing circuit in Kent. For this event it was necessary to double the speed range from 0–80 to 0–160 m.p.h. and it was felt that this problem could be overcome by realigning the aerial unit.

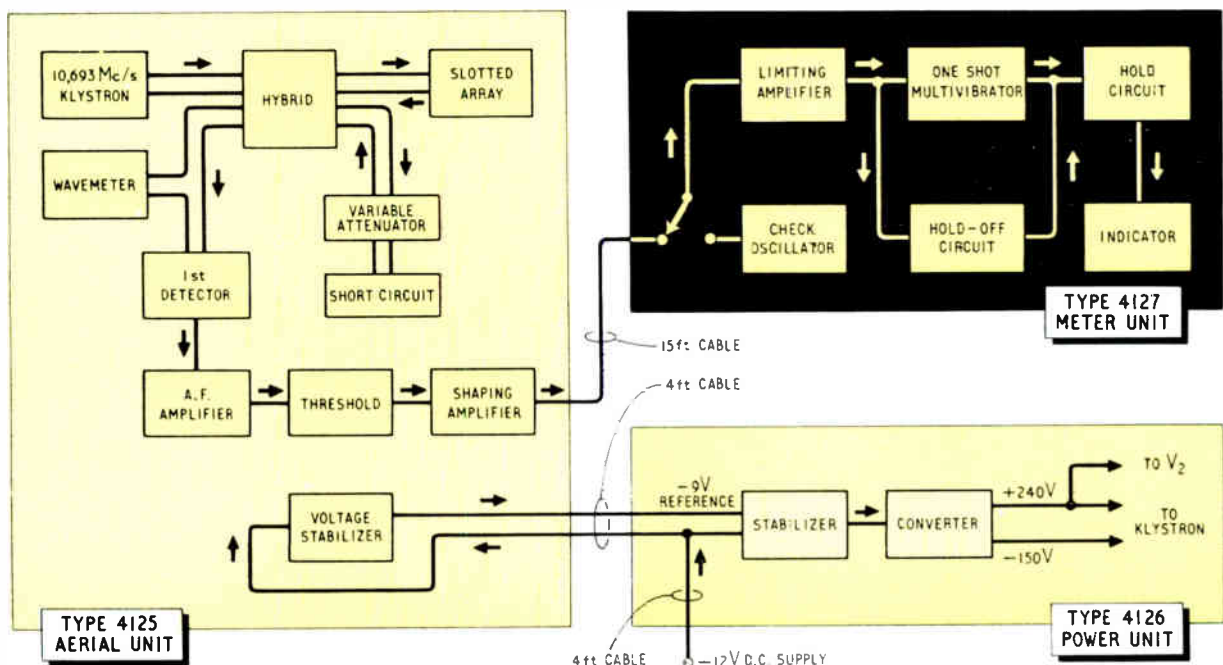
The basic equation relating Doppler frequency  $f_d$ , vehicle speed  $V$ , and beam angle  $\theta$  is:

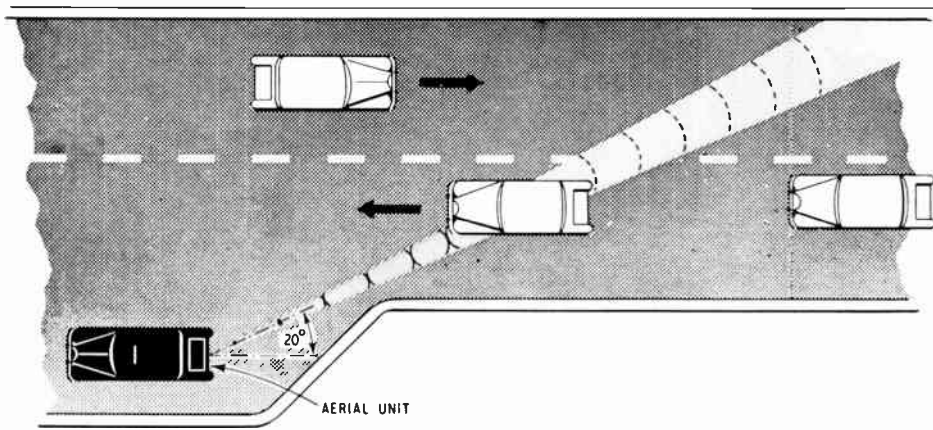
$$f_d = f_t V k \cos \theta$$

Where  $f_t$  = transmitter frequency

and  $k$  = a constant based on the speed of light.

Block diagram for 'PETA'





*This diagram illustrates the manner of operation. The aerial unit is here shown in the boot of a car standing in a lay-by*

To provide a Doppler shift of 15 c/s for every mile-per-hour change in speed (half the normal Doppler shift) it was necessary to determine a new angle  $\theta$ . This was simply done by finding the angle whose cosine

$$= \frac{\cos 20}{2} = 62^\circ.$$

By now recalibrating the meter and realigning the beam at 62 to the direction of the target, we have a speed-meter capable of indicating speeds up to 160 m.p.h.

The increase in beam angle does, however, make the siting angle more critical as, unlike the case of the 20° beam of the standard 'PETA', an error of 1° in siting will introduce a significant error ( $\pm 5$  m.p.h. at 160 m.p.h.). To obtain correct siting it was therefore necessary to produce some kind of siting device, and this eventually took the form of a theodolite, with which an extremely high degree of accuracy is obtained.

During the meeting the equipment worked extremely well and the maximum speeds recorded were in the region of 130 m.p.h. Even with the relatively small Formula I and II cars sufficient signal was returned to produce a clear indication on the meter display.

'PETA' is not the only equipment which the Marconi Company manufactures for speed-measuring purposes. Readers may know that Hovercraft have a unique problem in being unable to use the more normal forms of speed indicator available to ships and aircraft: a ship's trailing 'log' cannot be used owing to a Hovercraft moving over land in addition to water and the Pitot tube also used on present speedboat speed indicators suffers for the same reason. The aircraft Pitot tube or air-speed indicator cannot be used because of the extremely complex air currents surrounding an air-cushioned vehicle. Marconi engineers therefore developed a speedmeter using the Doppler principle; this employs a centre-fed parabolic aerial pointing downwards over the rear of the Hovercraft. A similar type of circuitry to that used in 'PETA' converts Doppler shift into a speed indication shown on a meter calibrated from 0-100 knots.

The Doppler principle is also utilized to measure the velocity and retardation of projectiles. The electronic velocity analyser (EVA), was originally designed for use at proving and trials establishments to measure the muzzle velocity of guns. EVA has recently been ruggedized for use by the Army in the field. Its introduction permits considerable economy in time, ammunition and barrel life, as calibration is obtained from the measurement of a single round during normal shooting. Velocity and retardation

statistics to an accuracy of  $\pm 0.15\%$  within a range of 500-5,000 ft/sec are derived from high-speed pen recordings on teledeltos paper.

Another version of EVA has also been developed so that the speeds of aircraft taking off and landing on an aircraft carrier flight deck can be recorded. This version is known as Sea-EVA.

#### Acknowledgment

The author wishes to thank the Director of Engineering & Research, The Marconi Company Ltd., for permission to publish this article.

The efficiency of any control system is, to a great extent, governed by the ability of the component parts to operate satisfactorily with each other. More concisely, each component should be perfectly matched to its neighbours over the operating range of the system.

In ship propulsion systems, a lot of dynamic mismatching is experienced at present because it has not been possible to study and analyse the numerous components in sufficient dynamic detail. However, the problem is now being studied with the aid of analogue computers.

The first stage in preparing for the simulation was completed at the Yarrow-Admiralty Research Dept. of Yarrow & Co. The objects of the three-stage study were:

1. To represent mathematically the dynamic performance of the steam propulsion plant of a 'County' class destroyer.
2. To determine the effect of throttle opening on the boiler, steam turbine, condenser, all associated auxiliary machinery, propeller performance and ship's dynamics, including ship resistance which was measured from a model.
3. To compare the theoretical results with those obtained from trials of an existing vessel.

Stages 1 and 2 have now been completed and a propulsion and ship dynamic system have been set up or simulated on an Electronic Associates 'Pace' computer.

All that remains is the stage-3 or verification study, in which the results measured on the simulator are to be compared with those measured in an actual ship system.

**I**N industry today the manufacture of components such as cams, dies, turbine blades, etc., is often achieved by some method of copying from a template. Such copying systems can be applied to almost any type of small or medium machine tools, jig borers, vertical and horizontal milling machines, lathes, etc. Some tracing systems are in the form of attachments to existing machines, but, in the majority of cases, they are an integral part of the machine-tool controls.

In the past one of the major problems in copying was the manufacture of a master template. This was achieved by normal jigs and fixtures and, in most cases, needed hand finishing. This problem has been overcome today by the introduction of continuous-path milling machines using magnetic tape, as described in an article by J. N. Muir in the November 1963 issue of *Industrial Electronics*. Due to the high accuracy of machine tools using this form of equipment, no hand finishing of templates is required.

There are many ways in which tracing from a template can be achieved using some form of tracing head and stylus.

Mechanical manual  
Variable potentiometer  
Moving contacts  
Inductance bridge and  
Oil valves

For the purpose of this illustration only the inductance-bridge principle, as manufactured by A.E.I., will be considered. It can be made highly accurate, has the ability to provide normal machining functions, and gives fully-automatic stepless following.

There are three forms of tracing using templates, namely one-dimensional, two-dimensional and three-dimensional. In each case the numbers of dimensions referred to are those under automatic control from a tracing head.

#### Single-Dimensional Tracing System

In a one-dimensional system only one axis is under the control of the tracing head, the others being independent and having their own feed motors.

The speed of tracing over a template is governed by the independent feed motors and is limited by the accuracy required and steepness of contours on the template.

The three basic elements of a one-dimensional system are a tracer head, which makes contact via a stylus with the model and measures the relationship between the moving parts of the machine and the model; an amplifier, which processes the signals obtained from the head; and a motor, electrical or hydraulic, which is controlled by the output from the amplifier.

The tracing head consists of a soft-iron laminated armature, mounted between two coils forming an inductance bridge. The armature is mechanically coupled to the stylus. Movement of the stylus axially therefore increases one gap and decreases the other, this unbalance of the bridge produces a signal output proportional to the stylus deflection.

In the arrangement shown (Fig. 1), with zero deflection on the stylus the bridge is balanced and there is no output from the head. Under this condition d.c. reference is applied to the amplifier.

As the tracing head is deflected inwards the output from the bridge rises linearly. It is rectified and compared with the d.c. reference and the 'difference' is fed into the amplifier.

To control the motor the electronic circuits are so arranged that for zero deflection of the stylus the output is a maximum from the amplifier, causing the motor to drive the stylus towards the template. As the stylus is

# One-, Two- and Three-Dimensional Tracing for Machine Tools

By J. ROBB\*

The manufacture of cams, dies, etc., is commonly carried out by copying from a template. This article describes apparatus which enables this to be done automatically.

\* A.E.I. Electronics Group.



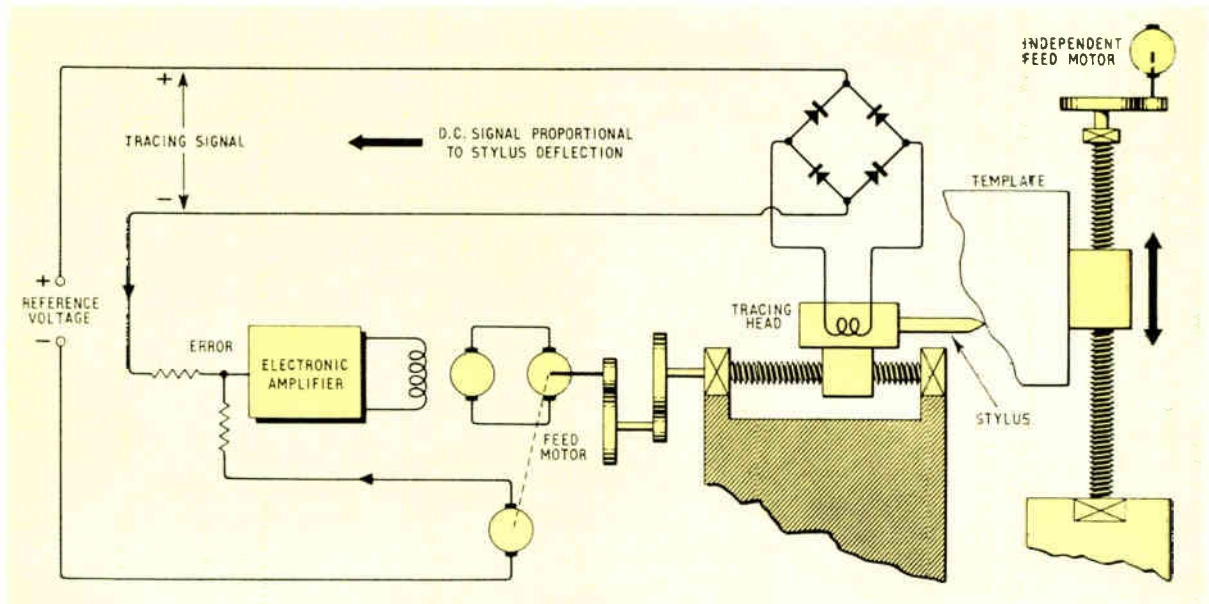


Fig. 1. Schematic diagram of single-dimension tracer control

depressed by the template the difference voltage is gradually reduced to zero, hence the motor slows down and stops. Further depression of the stylus increases the head output beyond the d.c. reference voltage, resulting in an input to the amplifier of opposite polarity and causing the motor to rotate in the opposite direction.

This system thus causes the tracing-head body, which is attached to the moving member of the machine, to follow up any motion of the stylus tip so as to maintain a constant relative displacement of the two.

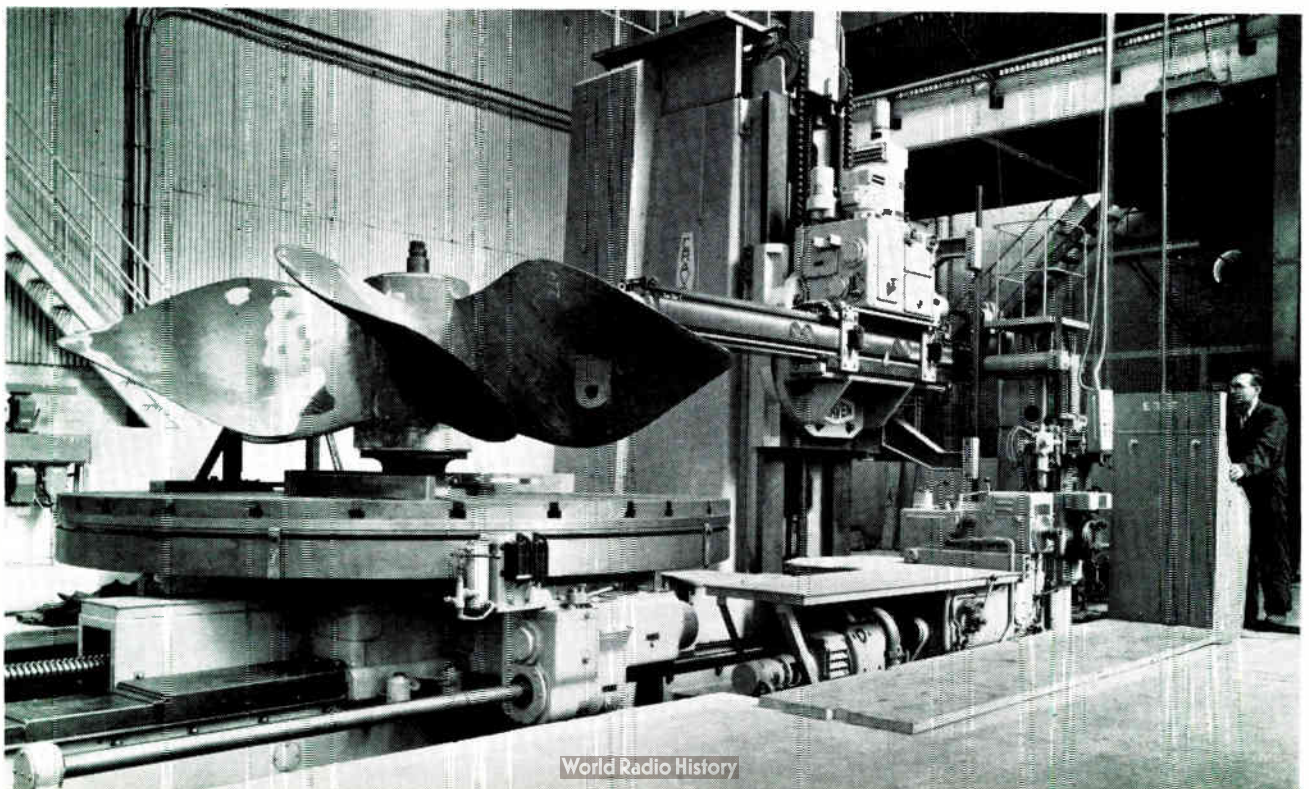
As the signal into the amplifier can be of either polarity, the drive motor must be continuously variable in speed and reversible. In cases where the feed motors are electrical the amplifier output can be designed to control the generator

field of a Ward Leonard system, having the tacho-generator as the secondary feedback for performance and stability purposes.

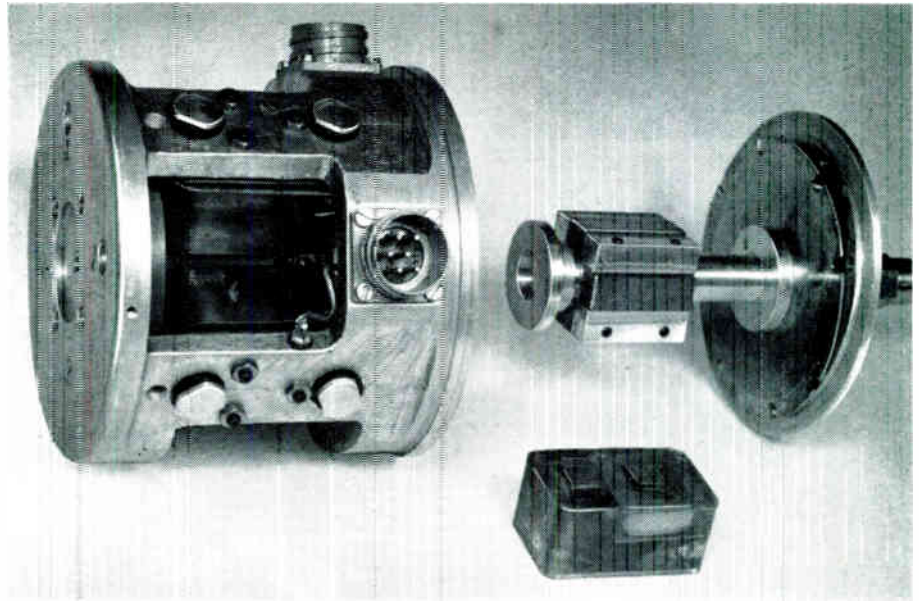
When hydraulic feed motors are used the amplifier output controls a torque motor which in turn drives a 'flapper type' pilot stage of a two-stage electro/hydraulic servo valve, which in turn controls the flow of oil and thus the speed of the feed motor.

One-dimensional tracing systems are limited to applications in which the direction of cutting does not vary over more than about  $160^\circ$ . When applied to lathes the tracing head and cutter are normally mounted at approximately  $45^\circ$  to the axis of the workpiece so that faces at right angles to one another can be machined.

One-dimensional tracing equipment applied to Craven propeller profiling machine



Tracing head for two-dimensional tracer control



**Two-Dimensional Tracing Equipment**

This system continuously controls two axes giving fully-automatic stepless following around 360° contours (see Fig. 2).

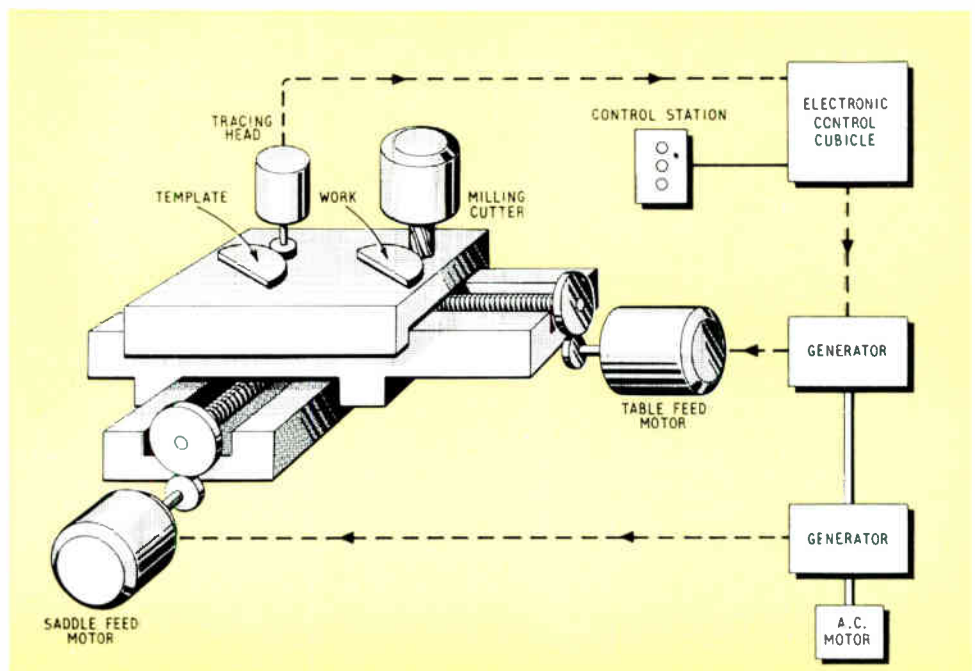
The tracer head gives continuous measurement of the direction of the tangent to the profile at the point of contact, and the amount of deflection normal to the profile.

The tracing head contains four coils (similar to those used in a one-dimensional head) in opposing pairs, the pairs of coils being mutually at right angles to one another. Unlike the one-dimensional tracing head, where the stylus deflection is axial, the two-dimensional head is deflected in a plane at right angles to its axis. Constraint is by a diaphragm and is proportional to deflection and opposite in

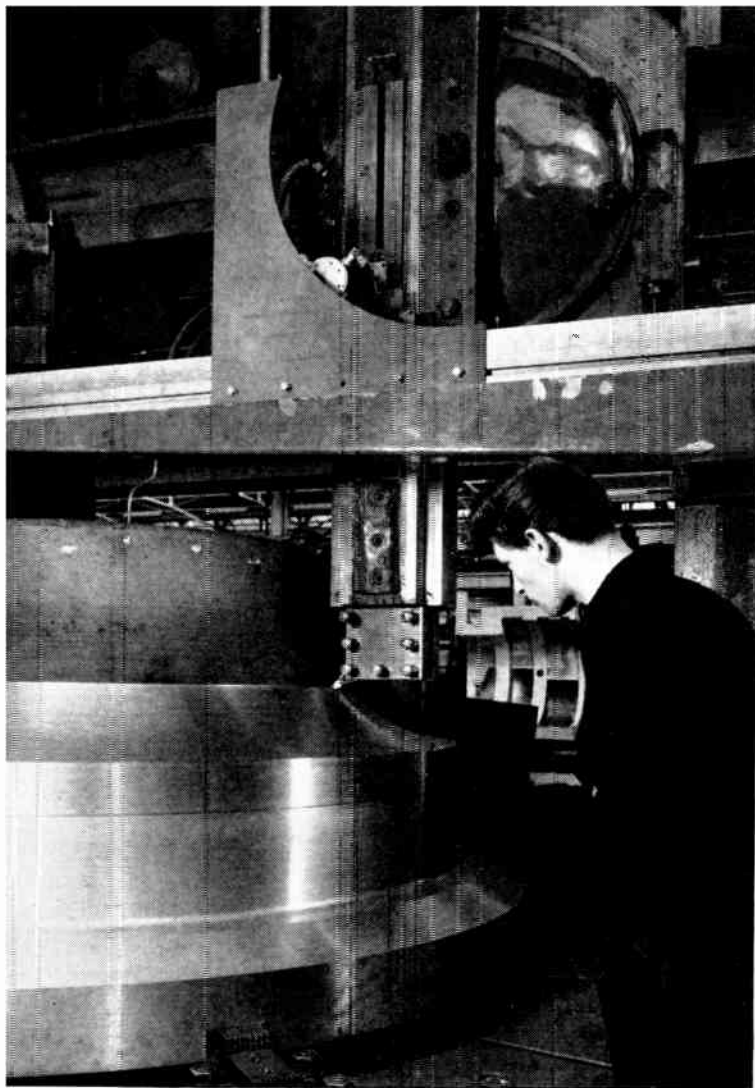
direction. Thus, any movement of the stylus will produce proportional movement of an armature which is mounted between the pairs of coils, resulting in an unbalance of the inductance bridges formed by each pair of coils. The voltage produced at the output terminals of each bridge measures the component of the stylus movement along the coil axis. The two bridges are energized with a two-phase supply, one phase being displaced by 90° from the other. The vector sum of the output voltages, obtained simply by connecting them in series, represents, in magnitude and phase, the magnitude and direction of stylus displacement.

The electronic circuits change the phase of this vector by 90° to control the speed and direction of the machine feed motors in such a way as to cause the stylus to follow

Fig. 2. Block diagram of two-dimensional tracer on vertical milling machine

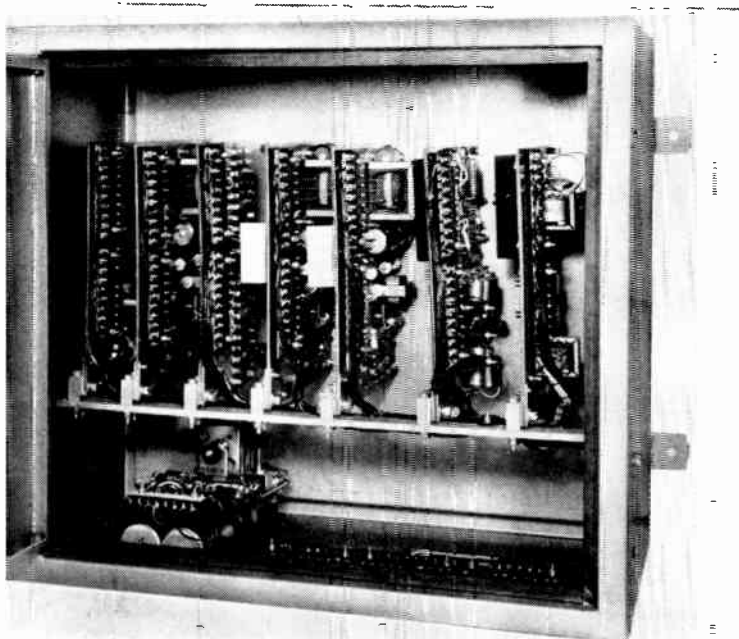






*Two-dimensional tracers on Richard vertical-boring mill*

*Two-dimensional tracers control cubicle using semiconductor devices mounted on printed-circuit boards*



the contours tangentially. For some vector phase angle  $\theta$  the motor speeds are  $V \cos \theta$  and  $V \sin \theta$ , where  $V$  is the constant tangential speed normally under the operator's control.

To maintain a constant stylus deflection during tracing, the amplitude of the total tracer-head signal is used to modify the  $90^\circ$  phase shift of the tracing system. Without this correction the tracer head would tend to over- or under-deflect. This is achieved by rectifying and continuously comparing the magnitude of the vector sum of the head signals with a pre-set d.c. voltage known as the index bias; the difference controls the phase shifting circuit, the output of which is then fed into two phase-conscious rectifying circuits, one for each axis, resulting in two d.c. voltage outputs having a sine/cosine relationship.

In order to obtain accurate control of the feed motors, high-gain speed regulators with velocity feedback are used on each axis. The input to each speed regulator is the output of the corresponding phase-conscious rectifying circuit. The positive or negative output voltage from each speed regulator is used to control either the generator field in a Ward Leonard system or the pilot stage in an electro-hydraulic servo valve.

In a Ward Leonard system the variable armature voltage would be connected to the armature of the d.c. drive motors for each axis. Each motor field is fed by a constant d.c. voltage. In the case of the electro-hydraulic servo valve the output from the speed regulators may accurately control the pilot stage in the valve. The 'flapper' is directly coupled to a shaft of a small torque motor and by altering the angle relative to centre zero the pressure on either side of the valve increases or decreases so causing a flow of oil which in turn controls the speed of the hydraulic motor.

In each case velocity feedback is obtained by driving a tachogenerator from the output shaft of the motor, the voltage produced by the tachogenerator opposing the input to the speed regulators.

Due to the low inertia of hydraulic motors a much quicker response is obtained, hence greater speeds over sharp radii are achieved compared with that from a Ward Leonard system.

By incorporating in the electronic circuitry a positive and negative d.c. reference, stepless speed control for normal milling on both axes can be obtained by potentiometer. A 'steering' facility is also available which enables the operator to control both axes from one potentiometer, and is normally used to guide the stylus on to the template. This control can also be used for rough milling, if desired.

In a system such as this provisions would normally be made for the following:—

(a) *Automatic Take-over*

When the steering control is used to guide the stylus on to the templates, each speed regulator is fed from a reference supply. The stylus having made contact with the template and deflected some nominal amount, a relay operates and disconnects the steering reference from the speed regulator and brings the system under the control of the tracing head.

(b) *Over-Deflection*

Should the stylus be deflected beyond 160% of index deflection, this circuit immediately reduces the input signals to the speed regulators to zero, hence the system stops tracing.

(c) *Retract*

Should the stylus be over-deflected due to some mal-operation of the machine, a relay can be operated by means of a push-button which, when depressed, provides a signal to the speed regulator which shifts the machine slide away from the stylus until the stylus deflection is zero.



### Three-Dimensional Tracing System

In this system three feed motions on the machine are under control. This is achieved by having a tracing head containing three separate pairs of coils, each pair at right angles to the other.

The inductive bridge formed by each pair of coils operates on the principle previously described and can be considered as a combination of the one- and two-dimensional tracing heads.

Equipment of this type is normally applied to die-sinking machines where (i) the axial direction is controlled by moving the spindle in and out of the headstock, with the stylus moving in unison (z axis); (ii) where the vertical direction is controlled by moving the headstock up and down the column (y axis); (iii) and the horizontal direction by moving the whole column and headstock along the bed slideways (x axis).

When tracing, two of the axes have their head signal combined and amplified in order that the required phase information can be obtained in a manner similar to the two-dimensional system. Hence, the correct steering command signals can be passed into the speed regulators. However, as the stylus is compliant in all three directions (x, y and z) the amplitude of the above combined signals is phase-shifted so that it is always in quadrature with the third axis, to which it is then added. This a.c. signal is then fed to the tracing amplifier, resulting in the correct information being supplied to the speed regulators for each axis.

As explained earlier, the speed regulator output can control an electro/hydraulic servo valve or a Ward Leonard set.

If, for example, axial/vertical is selected then vertical lines can be cut across the face of the workpiece, having the same profile as the template, and having reached the end of one line, the machine operator can automatically, by means of limit switches, or at will move the cutting tool and stylus some pre-set amount in the horizontal axis, then continue tracing in the opposite direction. Thus, by continuously scanning the workpiece in this manner the whole face of the die can be machined to a copy of the template.

In a similar manner the operator can have selected axial/horizontal and set in incremental feed in the vertical axis.

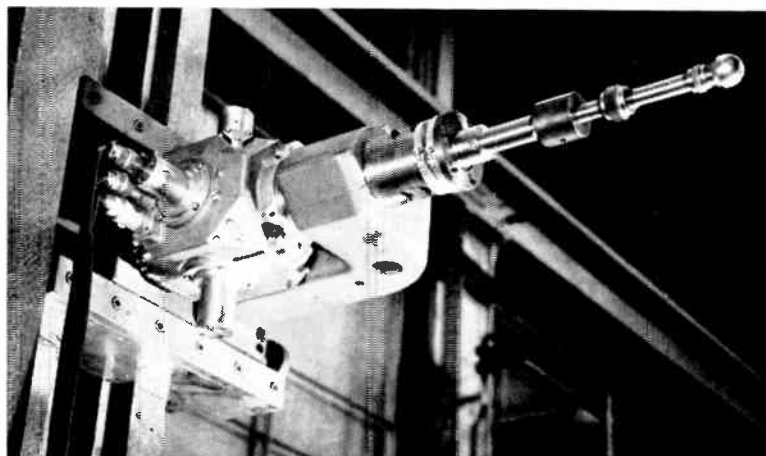
Another method of tracing known as 'Profiling with Depth' can be selected by having all three motions continuously in use. It consists basically of two-dimensional tracing in the horizontal and vertical axis with one-dimensional tracing in the axial direction, this form being most useful when cutting the edge of a shallow die or projection on the face of a die.

The remaining method of scanning a three-dimensional template is 'Steering-with-Depth'. The operator can select any path across the table by setting the steering potentiometer to the desired angle, then by switching in the spindle axis any variation in depth along the selected path can be accurately controlled. This form of control is comparable to one-dimensional where direction of the independent drive is variable throughout 360°.

### General

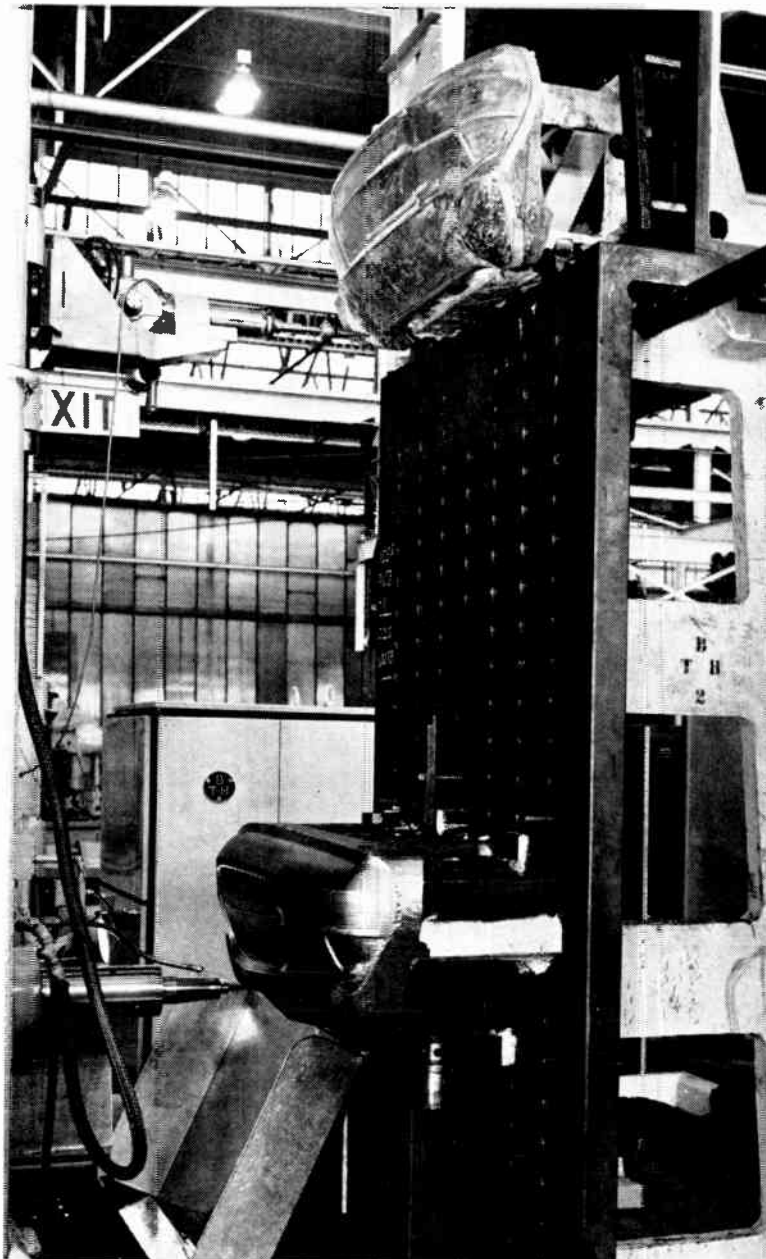
Today, with the introduction of solid-state devices and printed-circuit wiring, the electronics associated with such systems are much more comprehensive and reliable.

The machine tool manufacturers have also played their part in designing machines to have a minimum amount of backlash by using re-circulating ball nut leadscrews and anti-friction slides (as explained in the article in the January 1964 issue of this journal). This has resulted in improved accuracies and better surface finish.



*Tracing head for three-dimensional tracer control*

*Three-dimensional tracing in die sinking machine*



Reed switches are operated by magnetic fields. These are commonly derived from solenoids, but where mechanical operation is needed permanent magnets can be used. This article discusses the matter and gives figures for various conditions for typical switches and magnets.

WIDESPREAD interest in the use of reed switches with permanent magnets for proximity switching led to the examination by the author's company of the field requirements of various makes and types of switch so that suitable shapes and sizes of magnet could be decided. This account gives details of the many measurements made during the course of the investigation and describes some of the numerous ways in which these switches can be used.

Reed switches, or as they are often called, dry reed relay inserts, generally consist of two flat reeds of soft nickel-iron alloy hermetically sealed into a glass envelope so that they overlap to give a contact area.

The contact surfaces are plated with gold or other noble metal to reduce the contact resistance and the glass envelope is filled with an inert gas. The contacts are separated and one or both of the reeds is flexible.

When the switch is placed in a magnetic field which is approximately parallel to the axis of the reeds the contacts become magnetized with opposite polarities and an attraction force is created between them. When this force is sufficient to overcome the spring forces of the reeds they are attracted together and since the attraction force increases inversely with the separation distance the switch closes with a snap action. The converse occurs as the field is weakened and the contacts open.

By the nature of its basic design the reed switch is a highly reliable device with a fast operational speed and a very long life ( $10^8$  or more operations) making it suitable for a wide range of switching applications.

The large-scale use of reed switches in telephone relays, where they replace electro-mechanical switches and are operated in solenoids, has proved their complete reliability and they are now used for an ever-increasing number of devices where currents of up to 1 A have to be switched.

Permanent magnets, often of quite small dimensions, give sufficient field to operate the reeds and can be used in many applications where mechanical movement is involved.

The change of field necessary to open or close the switch

\*Technical Director, Marrison & Catherall Ltd.

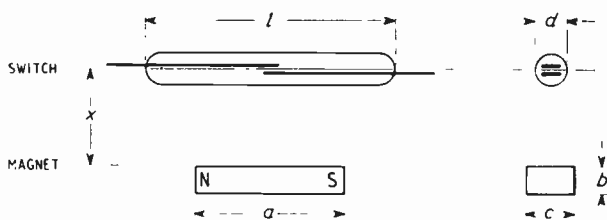


Fig. 1. Normal arrangement of magnet and switch

may be obtained by relative movement between switch and magnet or by movement of a shunt or other magnet to control the operating field.

Switch makers have hitherto been concerned primarily with solenoid operation leading to the calibration of switches in terms of field strength or ampere turns. This is somewhat misleading when permanent magnets are used since the field distribution which they produce is quite different from that of solenoids and consequently it is usually impracticable to correlate permanent-magnet field and coil field or ampere turns. This is particularly so with very small magnets. Although switches of various makes have been tested the measurements which are given in detail relate to a range made by Hivac Ltd, who provided for the purpose of the investigation a series of calibrated switches of varying sensitivities. Users will find a great similarity of operating characteristics with other types of switch of similar size. The overall dimensions of the switches tested are given together with the dimensions and materials of a number of suitable permanent magnets.

### Magnet Characteristics

The first part of this article deals with a range of critically designed small magnets which will operate reed switches at distances of up to 30 mm.

The dimensions of these magnets and the way in which they are fitted with the

switch are shown in Fig. 1 and Table 1 and the distances through which they will operate various switches are given in Table 2.

Two measurements are given for each test, which are the distances at which the switch contacts close and open respectively when the direction of relative movement is at  $90^\circ$  to the axis of the reeds. Magnetic tests relate to the lowest performance level which can be expected from normal production using magnets in the fully-magnetized condition. The difference in operating distances between the best and the worst magnets of any type is small and should never exceed 6%. Obviously larger magnets than those specified in Table 1 will operate switches through greater distances. The dimensions of three larger bar magnets and various U-shaped magnets are given in Fig. 2 and the distances through which they will operate the least sensitive of the five types of reed switches already considered, are given in Table 3. These distances also relate to movement in the  $x$  direction.

The field strengths at various distances from the magnet in a direction parallel to the axis of magnetization of most of the magnets specified are given on the curves of Fig. 3. While it is not possible to correlate these field strengths directly with the operating field values quoted by switch manufacturers, the curves serve a useful purpose in permitting the determination of operating distance of switches of a particular type but of different sensitivities.

Magnetic hysteresis in the reeds is the cause of the difference, which is sometimes considerable, between the 'pull-in' field or distance and the value at which the switch releases and it will be seen that this discrimination varies considerably between switches of a particular type. This is a characteristic which is, in the author's experience, common to all makes of switch. Poor discrimination is

**Table 1**

(All dimensions are in millimetres)

**SWITCH DIMENSIONS**

SWITCH TYPE	ENVELOPE		COIL DIMENSIONS		
	Diameter	Length	Outer Diameter	Inner Diameter	Length
XS 2	5	47	17.5	7	48
XS 5	5	47	17.5	7	48
XS 7	5	47	17.5	7	48
XS 4	3.5	26	22	6	11
XS 6	3	20	22	6	11

**MAGNET DIMENSIONS**

TYPE	RECTANGULAR BARS			
	Material	Length <i>a</i>	Thickness <i>b</i>	Width <i>c</i>
MC 3460	ALNICO	22.2	4.76	9.52
MC 3461	ALNICO	22.2	3.97	7.94
MC 3462	ALCOMAX IV	25.4	3.97	7.94
MC 3463	ALCOMAX IV	22	4	7
MC 3465	ALCOMAX IV	11.1	3.18	7.94

TYPE	CYLINDRICAL BARS		
	Material	Length <i>a</i>	Diameter
MC 3545	ALCOMAX IV	12	4
MC 3546	ALCOMAX IV	15	5
MC 3547	ALCOMAX IV	18	6

**Table 2**

Operating Characteristics of Small Bore Magnets

Specified Ampere-Turns	PERMANENT MAGNET TYPE MC (OPERATING DISTANCE mm)							
	3460	3461	3462	3463	3465	3545	3546	3547

**SWITCH XS 2**

60/39	16 /21.5	12 /17.5	22 /27.5	18/24.5	6.5/11	5.5/8	9 /14	13/17.5
77/50	13.5/18.5	9.5/14	19 /25.5	15/21	5 / 8	3.5/6	7 /10.5	11/15.5
82.45	12.5/16.5	9 /12.5	17.5/22.5	14/18.5	4.5/ 7.5	2.5/5	6.5/ 9.5	10/14
117/60	9 /15.5	6 /12	14 /21.5	11/17.5			3.5/ 8	6/12.5

**SWITCH XS 5**

53/25	15 /26.5	11 /19.5	22.5/35.5	17.5/29	6 /12.5	3.5/8	7.5/14	12.5/22
72/27	10.5/20	7.5/16	18 /32.5	13.5/27	3.5/11		4.5/13	9 /20
77/31	11.5/21.5	8 /17	18 /31	13 /24	4 / 9		6 /12	9.5/19
97/29	9 /21.5	6 /19	14 /30.5	11 /26.5	2.5/10.5		4 /14	7.5/20

**SWITCH XS 7**

34/20	21 /27	16 /22	30 /40	23.5/30.5	9 /13	7.5/11.5	12 /16.5	19 /26.5
35/18	22.5/32.5	16 /23	28 /38	23 /31.5	10 /16	7.5/12	11.5/17.5	17.5/24.5
54/27	14 /22.5	11 /19.5	22 /33.5	16.5/25.5	5 / 9.5	3.5/ 8.5	7 /13	11.5/19
77/26	10.5/23	7.5/18	17.5/34	13.5/28	3.5/11		5 /13	9 /21
85/30	10.5/22.5	7 /18	15.5/27	12 /23.5	3 /10		4.5/12	8 /18

**SWITCH XS 4**

32.5/18	20 /26.5	16 /24	25 /36	22/31.5	11.5/17	9 /15	13.5/20	17 /25
35 /24	19.5/26	16 /21	23.5/31	21/27.5	11.5/15.5	9 /12.5	13 /17.5	16.5/22
42.5/24	16 /25	14.5/21.5	21.5/32	18/26.5	10 /15	8.5/13	11 /17	15 /22
57 /28	14.5/23	12 /19	18.5/29	16/25.5	8.5/14.5	7 /12	10 /16.5	13 /21

**SWITCH XS 6**

22.5/20	24 /27	21.5/23	30/34	29 /26	14.5/17	12 /14	16.5/19	22 /25
35 /19	19 /27	16 /24	24/35	21 /31	11 /17	9.5/15	13.5/19.5	17.5/26
40 /18	17.5/29	14.5/23	23/36	19.5/30.5	10 /17.5	8.5/16	12 /20	15.5/26
54 /18	16 /30	13 /25	20/37	17 /31.5	10 /18.5	8 /15.5	11 /21.5	14 /26.5

The ampere turns and distances are the values at which the switches close and open respectively.



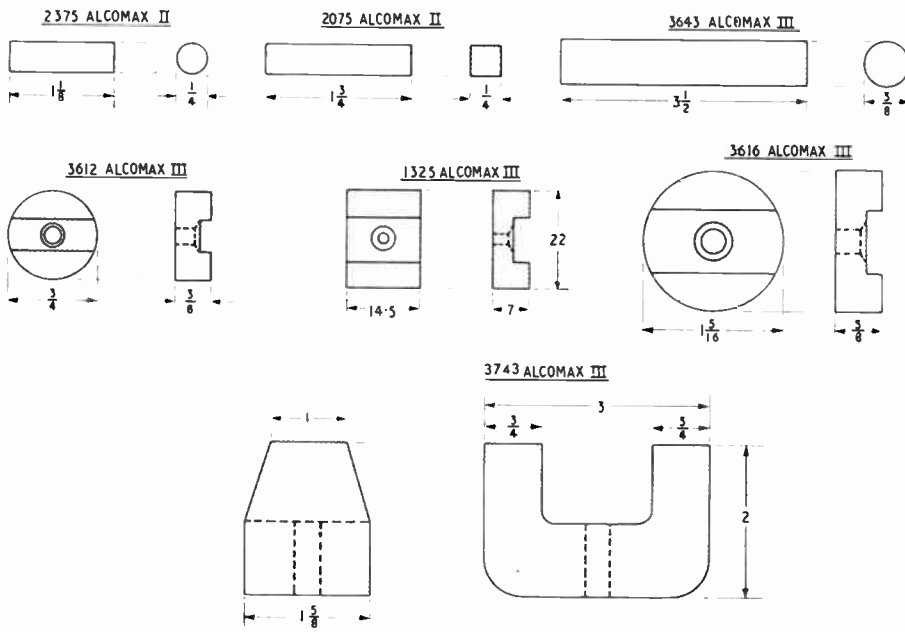


Fig. 2. Dimensions of the larger magnets. All dimensions are in inches except those of 1325 which are in millimetres

Fig. 3. Curves of field strength versus distance: (a) is for Alnico bars MC3460 and 3461, (b) for Alcomax IV bars MC3462, 3463 and 3465, (c) for Alcomax IV cylinders MC3545, 3546 and 3547, (d) for larger bar magnets MC2075, 2375 and 3643, and (e) for Alcomax III U-magnets MC1325, 3612 and 3616

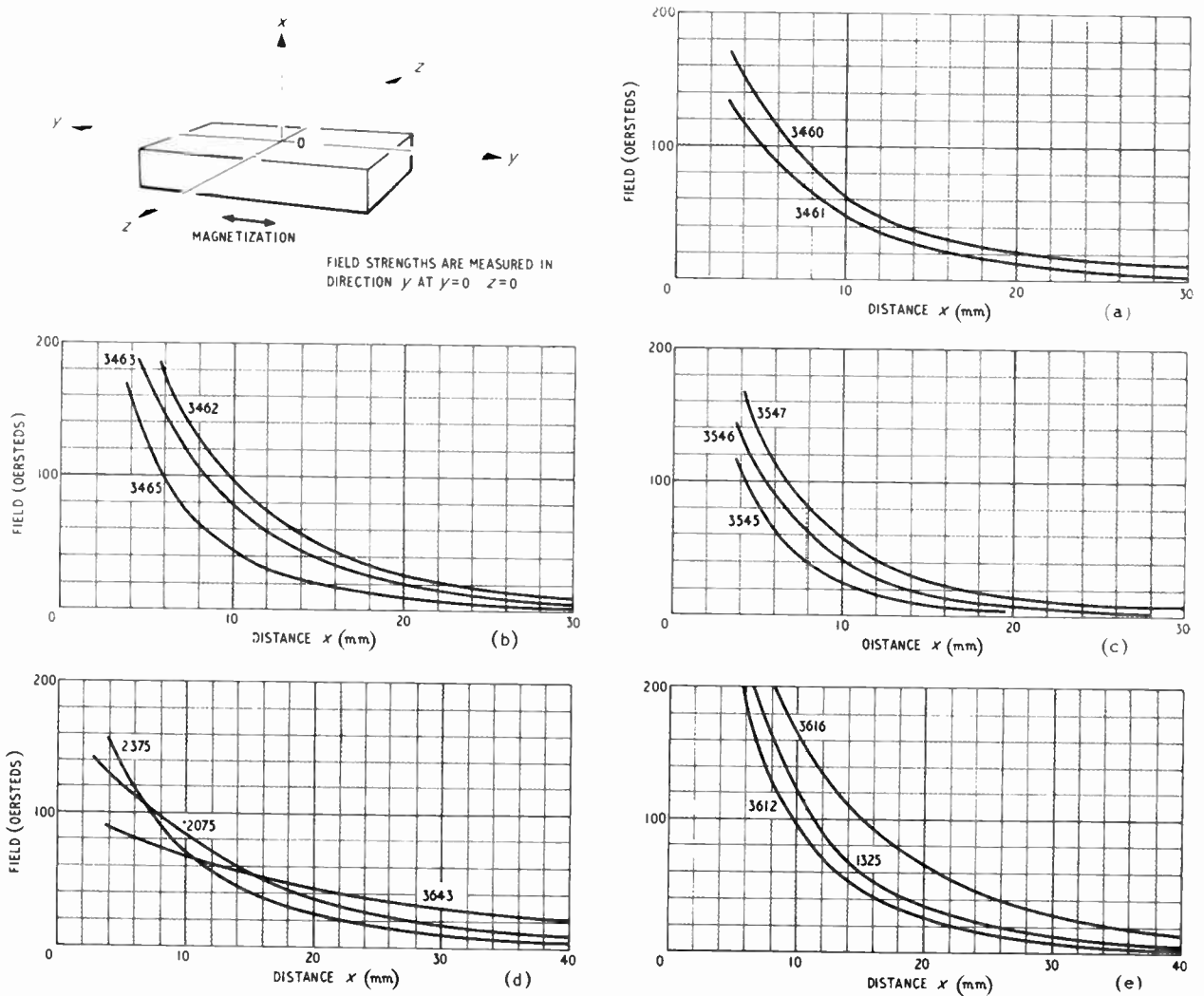


Table 3

OPERATING CHARACTERISTICS

Working distances ON/OFF for least sensitive switches

Switch	MAGNET TYPE MC						
	2375	2075	3643	3612	1325	3616	3743
	mm	mm	mm	mm	mm	mm	mm
XS 2	12/20	23/24	25/48	11/19	14/21	25/36	90/120
XS 4	15/30	22/41	15/55	16/30	20/40	25/45	75/140
XS 7	12/25	26/47	38/72	13/27	16/34	27/51	104/165
XS 5	12/40	23/48	40/115	12/30	12/16	38/55	95/170
XS 6	17/60	22/50	32/120	20/36	20/60	27/56	88/155

MAGNET TYPE MC	MATERIAL	DIMENSIONS (inches)			Maximum Field (Oersteds)
		D	d	L	
3644	Alcomax II	0.826	0.480	0.354	385
3645	Alnico	0.971	0.871	0.422	200
3285	Alnico	1.50	1.00	0.250	110
1367	Alcomax III	1.830	1.340	0.594	250

generally a nuisance although a system is described later in which this property may be exploited.

It has so far been assumed that switch operation is achieved by relative movement in direction *x* but of course it follows that any movement which changes the magnetization of the reeds may cause operation and it follows that satisfactory working may be obtained by relative movement endwise, direction *y* or sideways, direction *z*. In direction *z* the clearance and discrimination distances tabulated for *x* direction movement generally apply.

Movement in direction *y* can give improved discrimination (i.e., the difference between 'make' and 'break' distance is reduced) if the system is designed with care. Average performance switches of all the types considered were tested with the bar magnet MC.3460. When the spacing between the magnet and switch was 6.5 mm, the movement in direction *y* necessary to give operation varied between 3 mm and 6 mm. This is the distance between the points at which the switch opened and closed. This discrimination distance increases as the clearance between the switch and magnet is reduced although the rate of increase is small. However, systems using relative movement in this way must be designed with care.

Faulty Working of Switches

The field distribution of a bar magnet on a line parallel to its axis is generally as shown in Fig. 4. It will be seen that the field reverses near the ends of the magnet and may reach a value high enough to operate a reed switch. Thus a switch moving in the direction shown may make three close/open sequences as it passes over the magnet as shown in the diagram.

Generally, the more critically designed smaller magnets specified in Table 1 do not produce sufficient reverse field to give this spurious operation.

Switching by Rotation

Most reed switches are unaffected by fields at right angles to the axis of the reeds and operation can be obtained

therefore by rotation of the magnet or alternatively of the reed switch. Switches open and close twice per revolution and the angle during which 'make' and 'break' is obtained may be controlled by varying the distance between the magnet and the reed. This is demonstrated by Fig. 5 which gives the relationship between distance and 'closed angle' for switches XS2, XS4 and XS6 and magnets MC.3465 and MC.1325.

Switch Biasing

Switches which are 'normally open' may be converted to 'normally closed' operation by the use of two magnets. This is demonstrated in Fig. 6. The switch is mounted with a fixed magnet which closes the reeds. A second magnet, which may be of the same size as the first one where distances *X* and *X<sub>1</sub>* are similar will open the switch if brought into the position shown at (b) with unlike poles together. Removal of the second magnet causes the switch to close.

Where distance *X<sub>1</sub>* is greater than *X*, it may be necessary to use a second magnet which is larger than the first one, but when using dissimilar magnets care must be taken not

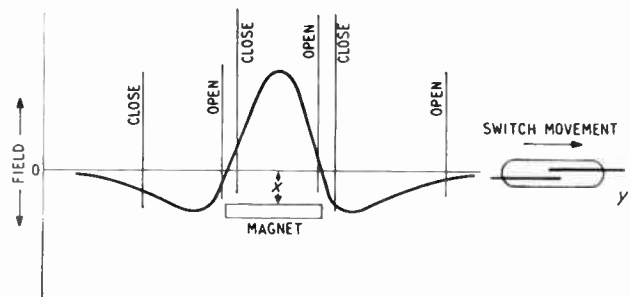


Fig. 4. This diagram illustrates the spurious switching which can occur when movement is in the *y* direction

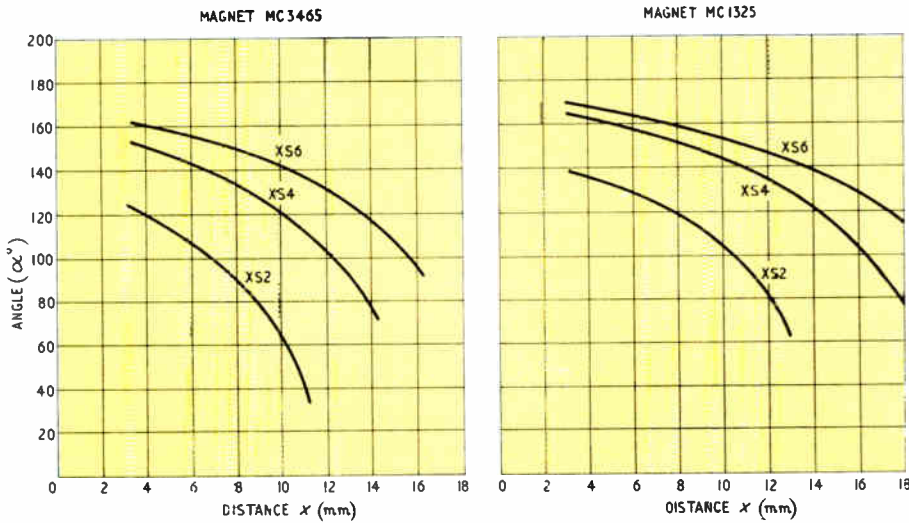
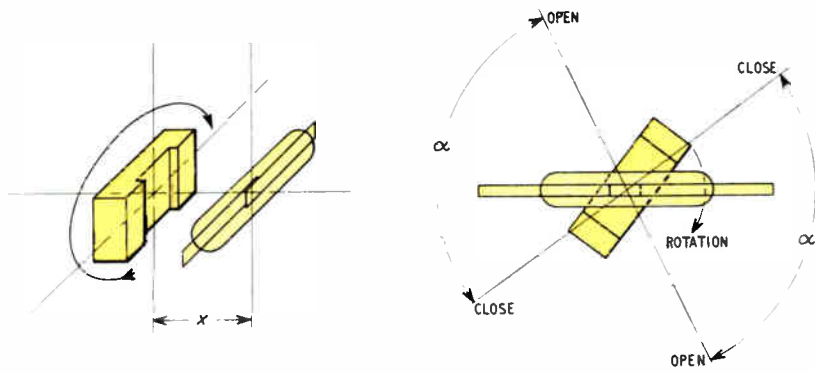


Fig. 5. The performance with rotary movement of the magnet is shown here

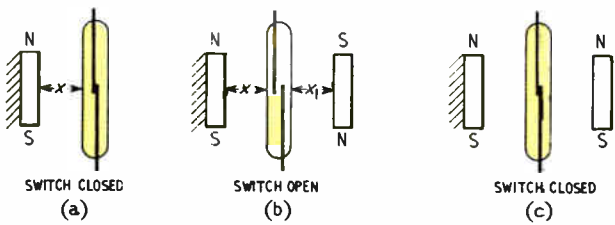


Fig. 6. The conditions for a magnetically-biased switch are shown here

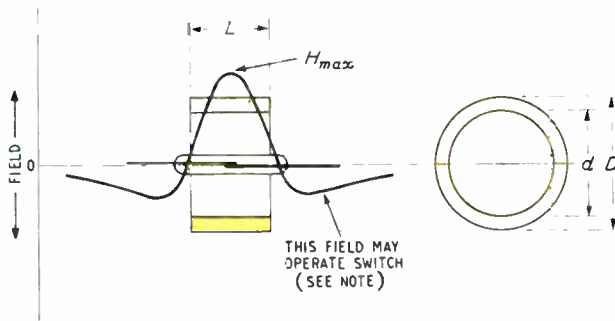


Fig. 7. Characteristics of axially magnetized rings

Fig. 8. A moving steel shunt can be used to operate the switch

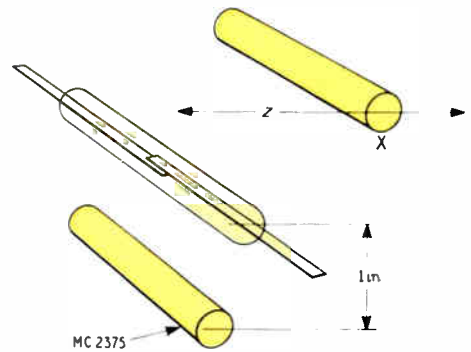
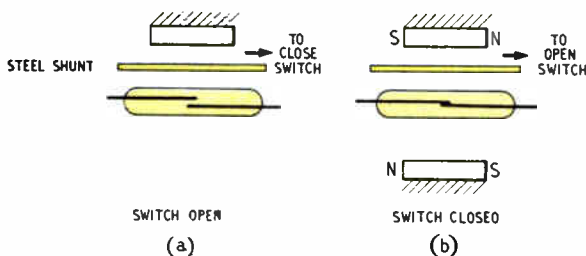
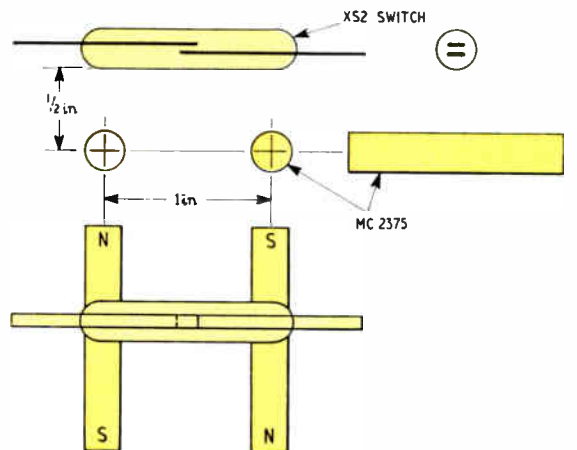


Fig. 9. Two magnet system in which magnet X moves in the z direction

Fig. 10. Two magnets mounted as shown here can give very critical operation by a small third magnet





to demagnetize the smaller biasing magnet by too close proximity with the more powerful switching magnet.

The two-magnet system is also useful when switching is to be by rotary movement. If one of the magnets is rotated the switch will open and close once per revolution, in contrast to the two sequences when one magnet only is used; Fig. 6(b) and (c) make this clear.

### Annular Magnets

Annular magnets which are axially magnetized can be used with advantage in many applications since their internal field is substantially uniform and, consequently, accurate positioning of the reed inside the annulus is not vitally important. In choosing rings for this purpose care must be taken to avoid unwanted operation in the reversed field remote from the ring as described earlier. Fig. 7 shows the arrangement and magnet dimensions as well as the form of the field obtained.

### Shunt Switching

Switches may be operated by means of a thin steel shunt inserted between the magnet and switch. This is shown in Fig. 8. A steel sheet passed between the fixed magnet and switch of Fig. 8(a) opens the switch and in (b), which has two magnets, causes the switch to close.

The shunt may be moved in either the *y* or *z* directions and by careful control of its size and shape precise switching and control of switching is easily achieved. The shunt may be in the form of a simple plate moving linearly, or it may be a disc rotating in the gap between magnet and switch. The edge of the plate or periphery of the disc is cut away as required.

### Quasi-Stable Switching

The hysteresis properties inherent in the magnetic reeds, which are often a disadvantage, can be put to good account in certain circumstances.

If a switch is fixed in such arrangement with a magnet or magnets that the field which it sees is intermediate between the 'make' and 'break' values putting the switch in what might be termed a quasi-stable condition, superimposing only a small additional field will cause the switch either to close or open in which condition it will remain until a field of the same order but opposite direction is applied to restore the original condition. The snap action of the reeds ensure stability in the switch itself and an adequate contact pressure is obtained.

This application has many possibilities for limit switching and, while it is not possible to deal with the matter extensively in this article, two systems are described which may provoke ideas for the use of reed switches and magnets for limit or proximity-switching problems. The systems use some of the magnets described earlier and were investigated using a medium sensitivity XS4 switch calibrated at 82/45 ampere turns.

When the switch is mounted as shown in Fig. 9 a magnet as at X,  $1\frac{1}{2}$  in. away from the switch, moved in direction *z*, will open or close the switch, which remains open or closed depending on polarity. Alternatively one pole of a larger magnet, brought into the vicinity of the switch and associated magnet, may be sufficient to cause operation, the opposite pole restoring the original condition.

Another arrangement shown in Fig. 10 uses two bar magnets with the switch arranged laterally. It is mounted away from the centre line and can be made very critical indeed. A relatively small third magnet is sufficient to upset the field conditions and cause operation when applied at a considerable distance. With the spacings as shown, a  $\frac{1}{4}$  in.  $\times$   $\frac{1}{4}$  in.  $\times$   $1\frac{1}{2}$  in. magnet, MC.2075, operates the system from a distance of 2 in.

### Magnet Performance Stability

The performance changes of Alcomax and Alnico magnets are very small both with time and due to temperature fluctuation and vibration. They are unlikely to affect significantly their working with reed switches. If magnets are handled carefully after magnetizing and during assembly, the total drop in performance from these causes should not exceed 2%.

Electrical stabilization (i.e., partial demagnetization) before assembly will in most cases reduce the danger of a performance change due to these causes. A stabilization of 2% is normally sufficient.

The effect of demagnetization due to mishandling may be serious as is the case with most permanent-magnet applications. Various of the bar magnets described were deliberately mishandled by sticking them on to steel surfaces and by bringing pairs of magnets into magnetic opposition, and so partially demagnetizing them. This reduced the distance through which they would operate various switches by up to 25% depending on the severity of the mishandling.

Magnets, therefore, should be handled carefully after magnetizing and if supplied magnetized, care should be taken with regard to packing methods.

The type numbers of magnets mentioned in this article are those of the author's company. Materials mentioned are standard alloys of the Permanent Magnet Association, and details of their magnetic properties may be obtained by application to the author. Alternatively, reference may be made to various publications, notably 'Permanent Magnets and Magnetism', Iliffe, which gives information on all the Permanent Magnet Association materials as well as equivalents of other makers.

In an article of this nature, space limitations preclude mention of more than a few of the infinite number of ways of using reed switches, but it is hoped that those which are described will be of some assistance to engineers with a switching problem. There is no doubt whatever that the reed switch is a remarkable device and it is the author's opinion that as its merits become widely known, it will be the means of solving more and more switching problems many of which will use permanent magnets.

## Guide for Printed Board Material

The Electronic Engineering Association has produced a publication entitled 'Guide for the Quality of Copper Clad Epoxide Bonded Glass Fabric Laminate, suitable for Precious Metal Plating'. This has been prepared in an attempt to cover a subject on which little or no positive information has been previously published, and is intended for the guidance of both manufacturers and users.

The guide covers the quality considered necessary for copper clad epoxide bonded glass fabric laminate which is to be used for printed boards incorporating previous metal plated contact areas. Special emphasis has been laid on the question of surface imperfections of the copper. Flame retardancy tests are included and three standards are specified to meet varying requirements.

The guide has been prepared by the Printed Wiring and Associated Techniques Committee of E.E.A. and is based on extensive work by certain member companies of the Association.

Copies of the guide are obtainable, free of charge, from the Information Officer, Electronic Engineering Association, 61 Green Street, London, W.1.

# BALL BEARING INSPECTION BY ELECTRONICS

**T**O assist inspection departments to cope with the considerable volume of work, Hoffmann have developed and constructed several automatic aids for the inspection of ball bearings. One of these is a machine which automatically rejects any bearing that does not contain its full complement of balls, or has a rivet missing from the bearing cage. Both checks are performed simultaneously.

It operates as a free standing machine, bearings being fed into it from a vibratory hopper. It can inspect a range

of similar bearings having tracks of identical dimensions and fitted with the same design of ball and cage assembly. Provided these features are standard, the machine can handle ball bearings of varying outside diameter and bore. Bearings are inspected at the rate of 12 per minute although this speed of operation could be increased if required.

As a bearing enters the feed chute from the vibratory hopper it depresses a microswitch which actuates the automatic inspection machine. The race then continues to roll down the chute until arrested by a stop.

The sequence of operations performed by the machine is controlled by a series of cams mounted on a common shaft driven by an electric motor. At the beginning of the inspection cycle, the first action performed by one of these cams is to retract the stop, thereby allowing the bearing to roll forward to the inspection position where it is arrested by a second stop. Next, a truncated conical spigot (a free-running centre) advances, abuts against the inner race and moves the bearing laterally until the inner race is brought into contact with a permanently rotating pressure pad and the outer race with a stationary location. The pressure pad is driven at 300 r.p.m. by a separate electric motor, hence in this position the inner race of the bearing revolves relative to the outer race.

Missing balls or rivets are detected photo-electrically by two separate circuits. To detect missing balls three light sources are provided. These project narrow beams of light via three small diameter holes through the bearing being inspected towards three similar holes behind which phototransistors are situated. The beams of light are directed through the gap existing between the outside diameter of the bearing cage and the inside diameter of the outer race. And the light-source photo-transistor pairs are so disposed

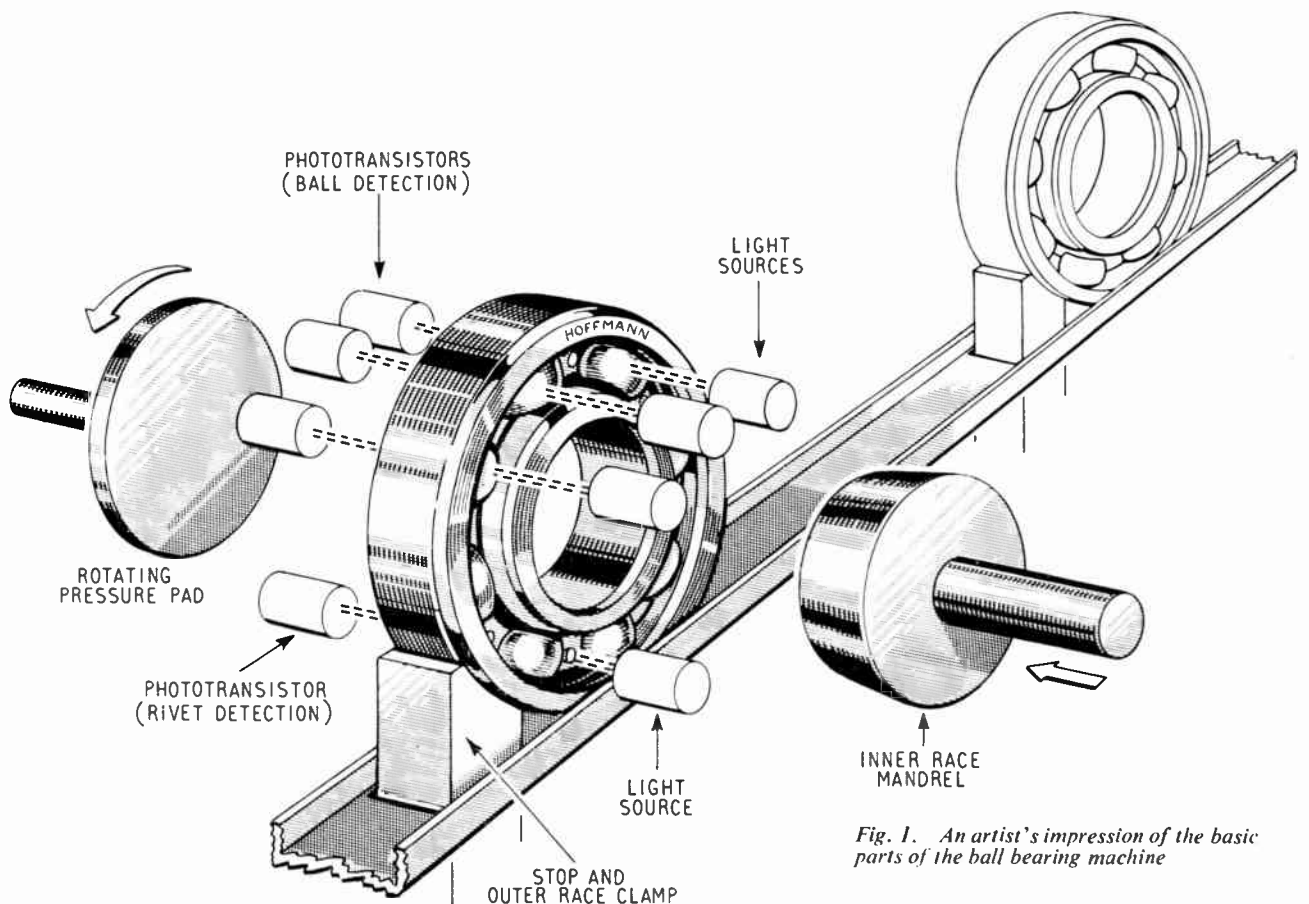


Fig. 1. An artist's impression of the basic parts of the ball bearing machine



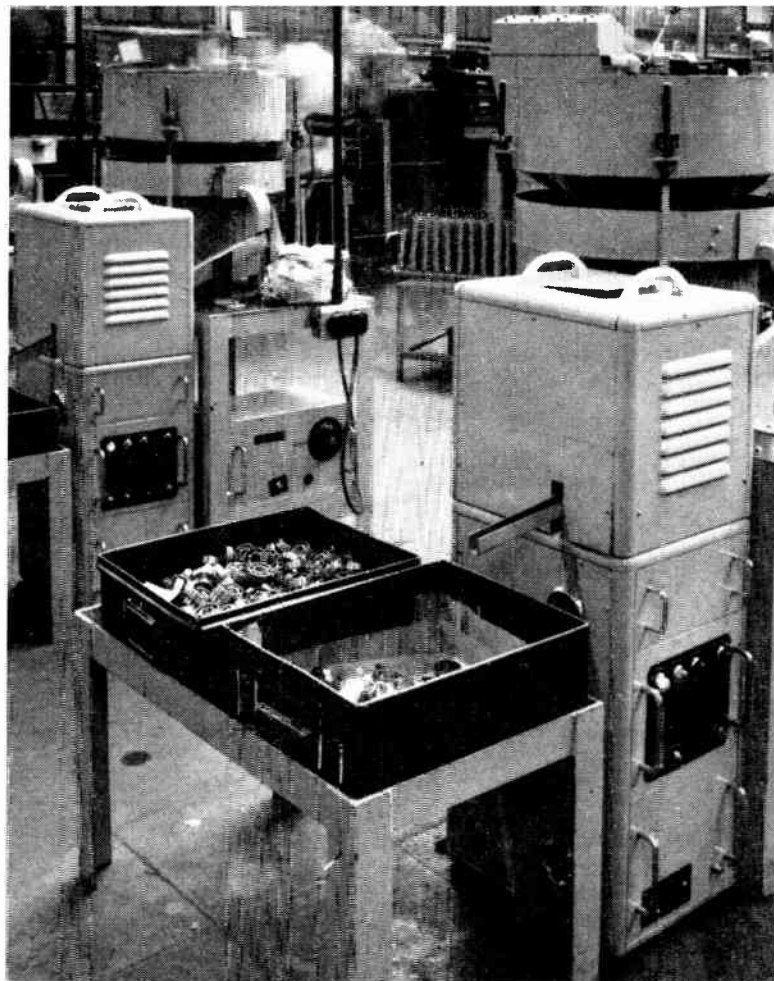
at various angular settings relative to the centre of the bearing that at any instant only two beams of light will pass through the bearing uninterrupted by the presence of balls.

Should a ball be missing, however, at some stage as the bearing rotates all three light beams will shine unobscured on to the three photo-transistors. Thus when the combined signal emitted by all three photo-transistors exceeds a preset level (approximately 70 % of the maximum signal strength) a thyatron in the associated classification circuit is fired. This energizes a relay which in turn controls a solenoid-operated shutter that diverts the defective bearing into a reject tray after it is released from the inspection station.

Detection of missing rivets is a much simpler procedure involving one light source and one photo-transistor. When a rivet is missing a sharply peaked pulse is produced by the photo-transistor and this signal is used to operate the reject shutter. Fig. 1 schematically illustrates the component parts of the machine.

At the end of the inspection cycle, the bearing is released from the pressure pad, the stop at the inspection station is retracted allowing the bearing to continue down the chute and fall into the accept bin, or be diverted into the reject tray as appropriate. Whenever a bearing is rejected, signal lights are illuminated to show the reason for rejection. A yellow light indicates a missing rivet, and a red light a missing ball.

The inspection machine is set up with the aid of standard rejected bearings. Setting up comprises ensuring that 'reject' signals of suitable magnitude are obtained from the photo-transistors. This is done by adjusting potentiometers situated in the bulb filament circuits.



*This shows the ball bearing inspection machine operating at Hoffmanns*

## Automatic Tippler Weighbridge in South Africa

An interesting British-built tippler weighbridge for unloading coal-laden railway wagons is in use at Rooiwal power station, South Africa.

The installation has the built-in facility of obtaining the net weight of the coal from each wagon. In operation, the gross weight of the wagon is automatically recorded, then the wagon is tipped and unloaded, next the tare weight taken, and finally the difference—which is the net weight of the coal delivered—is recorded. The three sets of figures are recorded in digital form by an Addox-X printer. W. & T. Avery Ltd. built the weighing equipment.

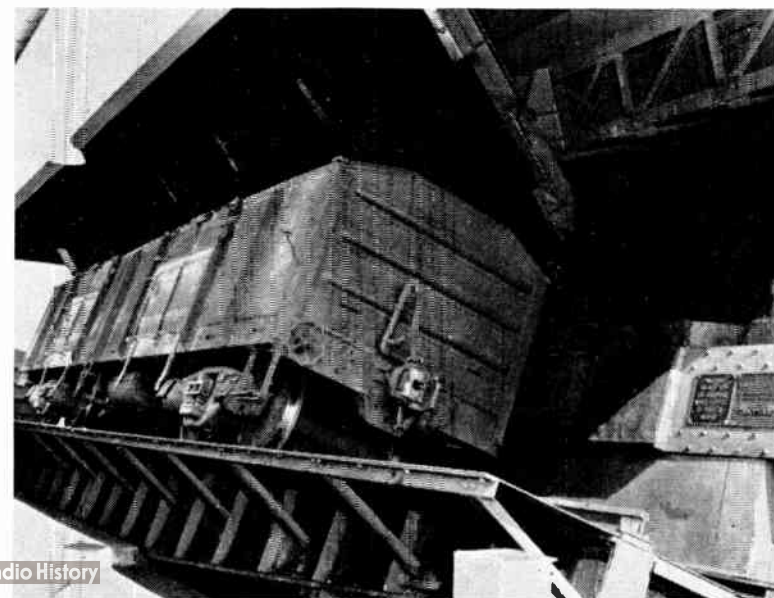
The weighbridge has a capacity of 200,000 lb (100 short tons) but within this figure it is divided into four chart ranges of 50,000-lb increments. The unit weights which bring about the change in capacity are automatically added according to the weight of the wagon on the weighbridge. To initiate the depositing or subtracting of a unit weight a signal is received from one of three sources: (a) from an analogue generator incorporated in the dial mechanism of the weighbridge which can give a signal to either deposit or remove a unit weight; (b) from a reset position switch in the digitizer which gives a signal to deposit two unit weights; (c) by the tippler which, when it reaches the fully tipped position, gives a signal to remove all the unit weights so bringing the indicator into the actual chart range. On receipt of a signal from either of the three sources, a

solenoid is energized and a circuit to either of the micro-switches is brought in applicable to the number of unit weights to be deposited.

Complete cycle time for weighing and emptying one truck, including digital recording, is only 22 seconds.

**For further information circle 48 on Service Card**

*A wagon on the tippler weighbridge. Gross, tare and net weight of each wagon is recorded automatically within 22 seconds*





# EQUIPMENT REVIEW

## 1. Distribution Amplifier

C-Cor Electronics have announced the availability of a low-distortion distribution amplifier, the model 1071. A typical application is the distribution of a number of standard-frequency signals in a laboratory.

With a pass-band of 1 kc/s to 20 Mc/s, output capability of 1 V r.m.s. to each output and gain adjustable from -3 dB to +3 dB, distortion is less than 0.5%. Input and output impedances are 50  $\Omega$ ; isolation is 40 dB between outputs.

The solid-state unit is packaged in plug-in modular form. A complete unit consists of one to five amplifier modules with three outputs per module plus a regulated power-supply module. —*Sylvan Ginsbury Ltd., 72 West 45th Street, New York, N.Y., U.S.A.*

For further information circle 1 on Service Card

## 2. Lightweight Accelerometers

B & K Laboratories have introduced a range of small robust accelerometers designed for the majority of vibration measurements, and particularly for applications involving severe environmental conditions such as humidity, high temperatures, magnetic fields, and corrosive atmospheres.

Four different types are available, two with provision for water cooling and top-entry connections, the other two having side-entry connections. A choice of frequency ranges is also available, the smaller types having titanium bases and frequency ranges from 2 c/s to 8 kc/s or 2 c/s to 12 kc/s, and the larger types with steel bases, having frequency ranges from 2 c/s to 10 kc/s or 2 c/s to 18 kc/s. Sensitivity of the smaller models is 10/20 mV/g and the larger models 40/60 mV/g; each accelerometer is supplied with its own calibration chart.

All models have low transverse sensitivity, negligible mounting error, and can be operated at temperatures up to 260 °C. The water-cooled models can be operated at up to 1,000 °C. These accelerometers are

supplied singly in a box, complete with accessories, or in packages of five, with connecting cables.—*B & K Laboratories Ltd., 4 Tilney Street, Park Lane, London, W.1.*

For further information circle 2 on Service Card

## 3. Miniature Couplings

Oxley Developments have recently introduced a miniature component coupling which employs p.t.f.e. bushings for the insulated bearings, thus reducing friction and eliminating wear. It provides a means of leading out

spindles from inconveniently mounted components, and can also be used to save space on equipment panels by allowing the distance between controls to be reduced.

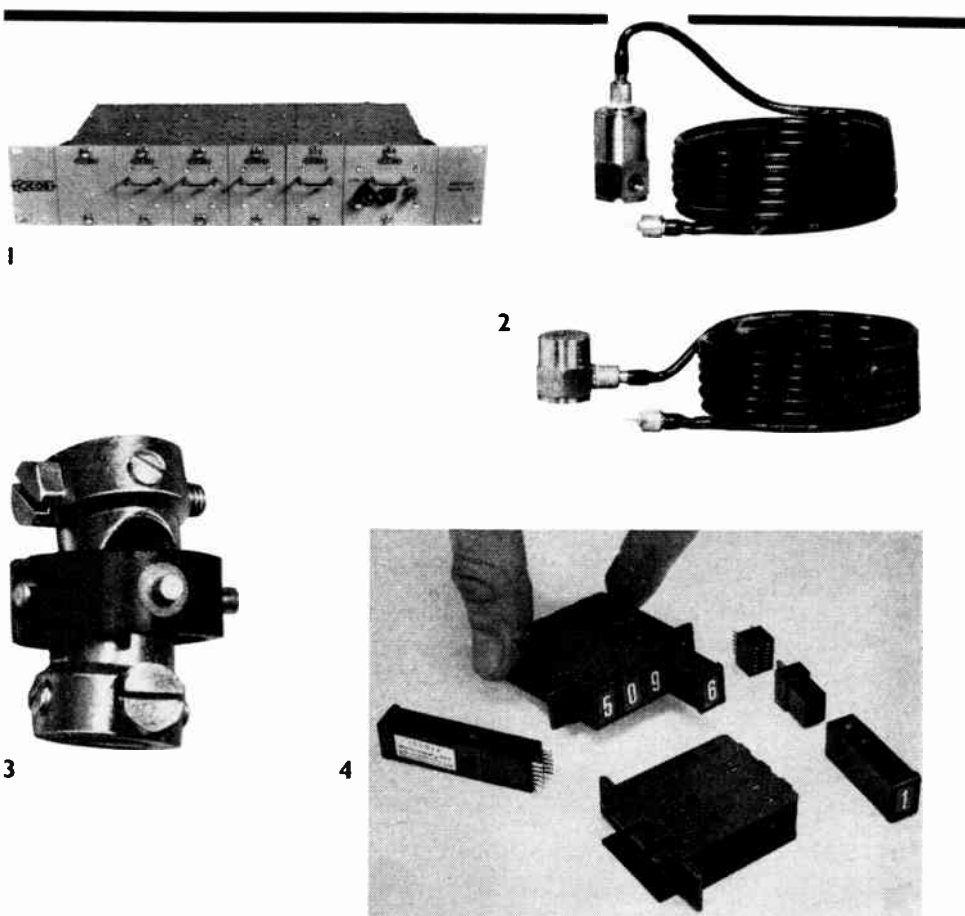
The coupling accepts standard  $\frac{1}{4}$ -in. diameter shafts which are secured by grub screws and tapered screws to eliminate backlash. It allows 5° angular and  $\frac{1}{32}$  in. axial displacement and will transmit a torque of 15 oz in. —*Oxley Developments Co. Ltd., Ulverston, Lancs.*

For further information circle 3 on Service Card

## 4. Miniature Digital Indicator

A miniature digital indicator with illuminated readout, the Teldix model MA-11 'Micro-Indicator', is now available in this country through Kynmore Engineering.

Each individual display unit consists of three parts (socket, lamp unit and display unit) which plug firmly together. The figures 0 to 9 and one set of colour bars can normally be displayed, but special units can be provided to display letters, symbols, or any required sign. The white-on-



black characters are 0.11 in. wide by 0.22 in. tall. Overall dimensions of a single unit are 0.34 in. wide, 0.51 in. deep and 1.82 in. long. Cassettes are available to accommodate any number of units mounted side by side to make up decade or other displays.

Choice of logic circuitry is left to the user, most types of transistorized decade logic being suitable. Operating from 1½ V at 70 mA ( $\pm 5$  mA for maximum lamp life), power consumption is 0.1 W. Characters are visible at angles of up to 30° from the normal in daylight. Nominal lamp life is 500 hr.—*Kynmore Engineering Co. Ltd., 19 Buckingham Street, London, W.C.2.*

For further information circle 4 on Service Card

### 5. Subminiature Rotary Switch

A subminiature rotary switch now available from Diamond H Controls has been designed to suit applications where extreme compactness is required. Only ¼ in. in diameter over contact lugs, it accommodates switching of up to 5 sections and incorporates the 'Oak' double-wiping self-cleaning contact

giving negligible noise and circuit resistance.

Indexing up to 12 positions, 30° throw is provided with a balanced rotary torque of approximately 16 oz in. Contact rating is 100 mA at 50 V d.c., and minimum insulation resistance is 10 MΩ. This robust switch, which is available with or without a water seal, has a stop strength of 5 lb in. and terminal strength of 1 lb pull. Ambient temperature range: -55 to +85 °C.—*Diamond H Controls Ltd., Gunnersbury Avenue, London, W.4.*

For further information circle 5 on Service Card

### 6. Cordless Programme Boards

A programme board permitting the switching of any required number of channels without the usual patch cord and plugs method, is now being manufactured by Sealectro. This Sealectro-board employs pins that interconnect the two axes' busbars, or where required, individual terminations. In addition to these connecting pins, row-to-row on the same axis, or diagonal pins for axis-to-axis connections are also available.

The Sealectroboard may be used for

programming computers, test equipment, machine tool control, and any other application requiring flexibility in multi-channel switching.—*Sealectro Ltd., Hersham Trading Estate, Walton-on-Thames, Surrey.*

For further information circle 6 on Service Card

### 7. Box Gauging Units

Startrite Designs have introduced a series of gauges to ensure a high degree of interchangeability in the construction of cases and other assemblies for the electronics industry.

The gauge illustrated, No. 1091/1, is for gauging boxes to ARINC specification. It will measure and control all features to ensure compatibility with ATR racking conditions. Ancillary gauges, checking plug float and lengthwise positions, are provided.

The whole gauging procedure is described and illustrated on data sheets which accompany each gauge. Work is now proceeding on the construction of semi-universal gauges which will accommodate a wide variety of box types and sizes.

The company provides a liaison and advisory service which is available to all members of the electronics industry. — *Startrite Designs Ltd., Waterside Works, Gads Hill, Gillingham, Kent.*

For further information circle 7 on Service Card

### 8. Brushless Synchros

Elliott-Automation have announced the introduction of 'Ellsyn' brushless synchros available as size 11 control transmitters and transformers. They possess many advantages over conventional components, but retain similar electrical and mechanical characteristics.

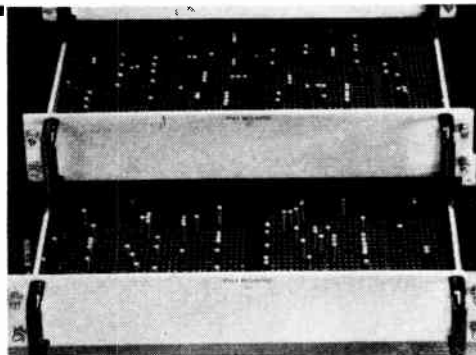
Brushes and slip rings have been replaced by miniature injection transformers, thereby eliminating brush contact problems and reducing friction to approximately a quarter of the level found in conventional synchros.

The units are suitable for operation in temperatures up to +125 °C with maximum errors of  $\pm 14$  minutes of arc. Work is now proceeding to improve this performance and to permit operation in ambient temperatures up to +150 °C. Both the 115-V and 26-V brushless synchros have been designed to be interchangeable with conventional units. — *Servo Components Division, Elliott-Automation Ltd., Century Works, Lewisham, London, S.E.13.*

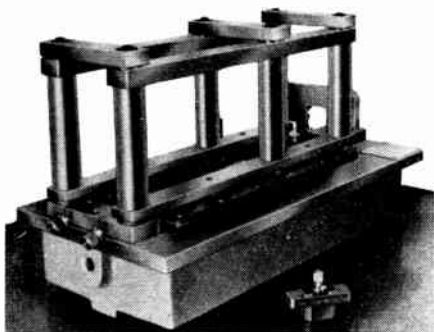
For further information circle 8 on Service Card



5



6



7



8

## EQUIPMENT REVIEW

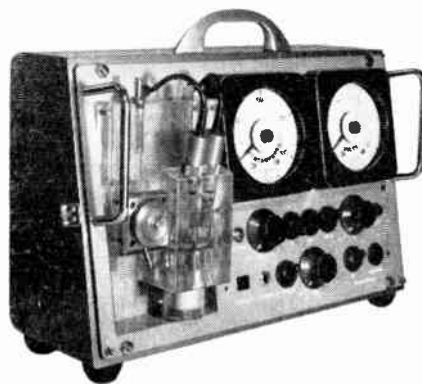
### 9. Dissolved Oxygen Meter

A portable meter which will provide a quick and accurate means of carrying out spot sample tests to obtain the dissolved oxygen content of water, and thus give early warning of corrosion dangers, is now in production at North Hants Engineering Co. under licence from the N.R.D.C. The concentration of dissolved oxygen can be obtained by taking three readings from the associated microammeter and carrying out one simple calculation. The whole test can be completed in three minutes by any maintenance engineer.

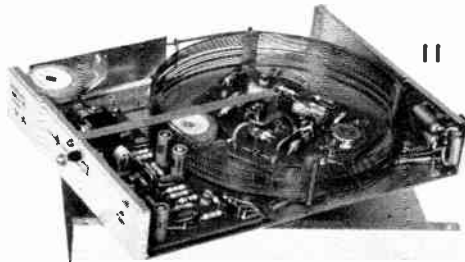
The case and front panel are robustly manufactured from light alloy and have a durable acid-resistant finish. Both the microammeter and voltmeter have ribbon suspension movements to provide high shock resistance, and are hermetically sealed. The cell unit is constructed from Perspex and has an integral stirrer and drive motor of a packless design to prevent ingress of oxygen.

The measuring range of the meter is 0 to 0.1 p.p.m. of dissolved oxygen with an accuracy of  $\pm 0.001$  p.p.m., and up to 0.5 p.p.m. with lower accuracy. An external ammeter can be connected to the socket provided on the panel to give a greater range. Average sensitivity is  $200 \mu\text{A}$  per 0.1 p.p.m., and the temperature range is from 0 to 40 °C. The case measures 16 in. long  $\times$  10 in. high  $\times$  7 in. deep. Weight: 28 lb.—*North Hants Engineering Co. Ltd., Four Marks, Alton, Hants.*

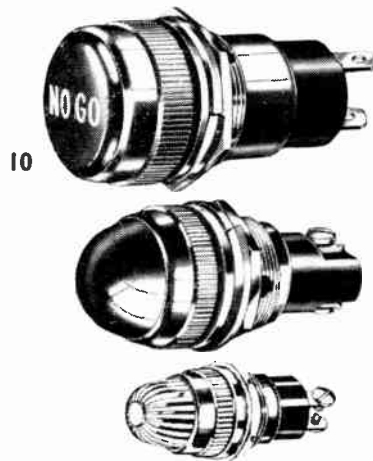
For further information circle 9 on Service Card



9



11



10

### 10. Oil-Tight Indicator Lights

Dialight Corporation have introduced three series of oil-tight indicator lights, designed for heavy-duty industrial applications, which provide a complete seal against oil, water, dust, and fumes on the face of the panel.

The series comprise assemblies for mounting in  $\frac{1}{8}$ , 1, and  $1\frac{3}{8}$  in. diameter panel clearance holes. Lamps accommodated include a wide range of low and high-voltage incandescent and neon units. Assemblies designed for neon lamps with bayonet bases offer built-in resistors for use on circuits up to 250 V.

Other features of these indicator lights are: rugged construction to withstand severe vibration conditions, glass or plastic lenses in a choice of several shapes with omni-directional light spread, and discs (inscribed with words, letters, symbols, or numbers) inserted behind flat lenses to display specific messages. Optional details

include choice of lens surface, seven lens colours, three terminal types (screw, soldering, or quick-connect) and various metal finishes.—*Dialight Corporation, 60 Stewart Avenue, Brooklyn, N.Y. 11237, U.S.A.*

For further information circle 10 on Service Card

### 11. Low-Cost Delay Line Stores

A range of low-cost ultrasonic delay lines has been announced by M.E.L. A typical application is in long shift registers. It is claimed that, whereas flip-flop shift registers become uneconomical over about 20 bits, with these delay lines shift register stores with a capacity of up to 1,000 bits are an economic proposition.

Designated 'Delay Modules YL2108', each unit in the range is supplied complete with magnetostrictive wire delay element and solid-state input and output electronics.

Any delay is available from 100  $\mu\text{sec}$  to 3.2 msec, each type of unit being adjustable over a range of 20  $\mu\text{sec}$ .

These delay lines will operate over a temperature range of  $-10$  °C to  $+60$  °C with bit rates of up to 350 kc/s. A 12-V power supply is required, and the units are suitable for most types of p.n.p. and n.p.n. transistor logic systems.

The lines can serve as temporary memories in calculating machines, invoicing machines, on-line computers and similar applications. They are contained in steel cases measuring  $9\frac{1}{4} \times 6\frac{1}{4} \times 1\frac{1}{2}$  in., which may be mounted in any position.—*The M.E.L. Equipment Co. Ltd., 207 King's Cross Road, London, W.C.1.*

For further information circle 11 on Service Card

### 12. Programme Controller

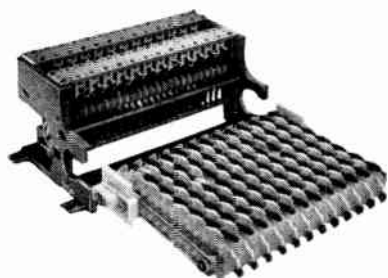
A programme controller, type PBMS, designed and built by Schmersal of Western Germany, is announced by Elremco.

The basic instrument consists of a chassis, which is fitted with a capacitor phase-shift reversing motor with integral gearbox, driving a cassette of endless belts of plastic links, which clips into the chassis. Interchange of cassettes takes only a few seconds, thus facilitating rapid programme changes.

The drive unit can be arranged for continuous running, for step-by-step operation, or for combinations thereof, forward and reverse.

The required programme is set up by manually inserting suitably shaped plastic segments into sockets in the endless belts. Segments can be supplied in five colours to assist channel

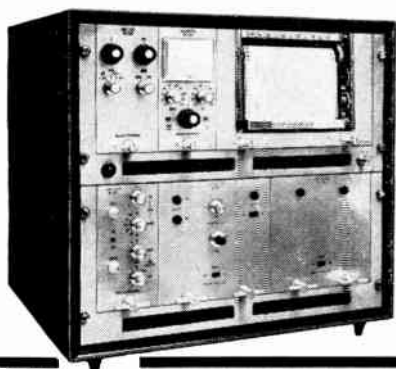




12

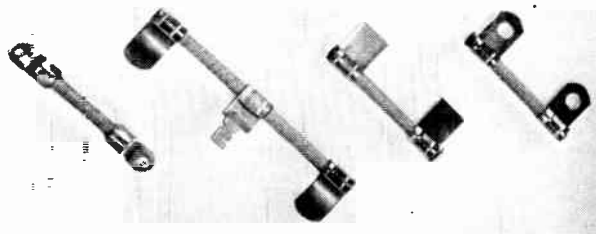


13



14

15



identification, and can be cut to provide very short timing intervals. Chassis with 6, 12, 18 and 24-belt channels are at present available and a number of controllers can be electrically interlocked where the system requires more than 24 channels.

Individually interchangeable double air-break snap-action microswitches are fitted, each having one changeover contact. The contact ratings for non-inductive circuits are: 10 A/110 V, 6 A/250 V and 1 A/440 V a.c.; 6 A/24 V, 2 A/110 V and 1 A/250 V d.c.

Programme belts up to 15 ft long can be supplied, and the time per segment can vary from 0.16 sec to 30 min.—*Electrical Remote Control Co. Ltd., The Fairway, Bush Fair, Harlow, Essex.*

For further information circle 12 on Service Card

### 13. Transistorized Transmitter-Receiver

A fully-transistorized transmitter-receiver which provides a choice of 11 channels in the 27-Mc/s band has been introduced by Raytheon.

Despite its compact size, 8½ in. wide by 3½ in. high by 10½ in. deep, the Ray-Tel TWR-5 has a sensitive loudspeaker installed in the front panel. It can be installed in any attitude; e.g., under a dashboard, overhead, against

a side wall, or on top of a desk or shelf.

The set is pre-wired to accept selective calling accessories which can be plugged into a socket at the rear. Ample internal space is provided to change crystals or carry out servicing. The large channel selector dial can be read easily by day or night.

The photograph shows the apparatus recessed into the glove compartment of a car.—*Cossor Communications Co. Ltd., The Pinnacles, Elizabeth Way, Harlow, Essex.*

For further information circle 13 on Service Card

### 14. Automatic Scanning Spectrometer

The model NE8602 automatic scanning spectrometer, now available from Nuclear Enterprises, is designed to provide in permanent form a strip-chart record of the activity and energy spectrum of gamma, alpha, or beta-emitting samples.

It has applications in routine analysis of radio-isotope abundance, radiochemical purity, identification of unknown isotopes, and also in the field of teaching.

The instruments used are 'Edinburgh' series transistorized modules mounted in a cabinet with a Moseley type 680 strip-chart recorder. The recorder is suitably modified to pro-

vide a baseline threshold sweep voltage to the pulse-height analyser. During scanning the sweep voltage is substituted for the normal analyser pulse-height control and is varied in sympathy with the position of the recorder chart. The window-width control is manually set up for each scan or series of scans. There is available the possibility of single-cycle or continuous-cycle scanning, and the rate of scan may be varied to suit experimental conditions.

Suitable lead castles or probe units to provide the detection facility are available.—*Nuclear Enterprises (G.B.) Ltd., Sighthill, Edinburgh, Scotland.*

For further information circle 14 on Service Card

### 15. Wire Wound Resistors

Darstan are manufacturing a range of low-priced wire-wound resistors suitable for current control or heating applications, with values up to 500 Ω/in.

Standard tolerance is ±10%; closer tolerances can be supplied as required.

The uninsulated units (illustrated) consist of a glass-fibre core on which a resistance wire is spirally wound; the insulated versions have the same basic construction, but are encapsulated in a heat-resistant plastic. The

## EQUIPMENT REVIEW

power ratings are 5 W and 3 W per in., respectively.

Standard terminations are  $\frac{3}{8}$  in. wide tag ends suitable for spot welding, soldering or bolting in position. Other terminals are available.—*Darstan Ltd., 263 Church Road, Thundersley, Essex.*

For further information circle 15 on Service Card

### 16. Step-and-Repeat Camera

W. Watson & Sons have recently announced the Mk. II step-and-repeat camera intended primarily for the manufacture of photographic masks on maximum resolution material for use in the semiconductor industry, for producing either single devices or integrated microcircuits. The camera is, however, equally suited to the making of other gratules with repeated patterns within a 1 in.  $\times$  1 in. field.

The photographic plate is held on a mechanical stage which carries a standard plate ruled with a rectangular grid to define the step-and-repeat spacing. An inverted microscope with its own vertical illuminator is focused on the standard ruled plate, and the advancement of the mechanical stage is controlled precisely by setting the intersections of the rulings on the standard plate to cross lines in the inverted microscope. Advancement can be set to the grid spacing or to any small multiple of it.

The reduction lenses in the camera are based on microscope objective lens designs. The fine-focusing adjustment is monitored pneumatically by a sensitive air-gauging system, and exposure is controlled by an automatic timer.—*W. Watson & Sons Ltd., Barnet, Herts.*

For further information circle 16 on Service Card

### 17. Thyristor Drive Module

Mullard announce thyristor drive module MY5000, which is designed to simplify the use of thyristors in a wide range of ordinary electrical applications. This is the simplest module of a range and will drive up to two 70-A thyristors at the same time; for example, as two legs of a single-phase bridge circuit.

Although more complicated drive modules are necessary for sophisticated motor-speed control with complex feedback loops, this low-cost module will provide a most satisfactory economic solution for the many simple applications of motor-speed control, furnace control, light dimming and also the control of a.c. power by a back-to-back thyristor arrangement.

One of the problems for thyristor users is the provision of reliable drive

pulses that will satisfactorily fire the thyristors and also control the position of the pulse by means of a control element or feedback loop. Each application naturally requires its own feedback loop arrangement, but by using this module, which provides properly toleranced thyristor drive pulses, only the d.c. and feedback problems remain.

The trigger module MY5000 is completely protected against environmental effects by plastic encapsulation, a feature which protects the circuit components and interconnections from damage by mechanical vibration or shock.—*Mullard Ltd., Mullard House, Torrington Place, London, W.C.1.*

For further information circle 17 on Service Card

### 18. 'Pixie' Decade Indicator Tube

Burroughs have announced the B9012 'Pixie' tube. This is a gas-filled cold-cathode indicator tube containing ten glow positions (cathodes) located 36° apart, which are visible through numerical perforations in a disc (the common anode).

The B9012 can display up to ten independent bits of information simultaneously. It is particularly suitable for counting applications and 'status' displays. Power requirements are low, 400 mW per bit. Readability is up to 10 ft in high ambient light.—*Walmore Electronics Ltd., 11-15 Betterton Street, London, W.C.2.*

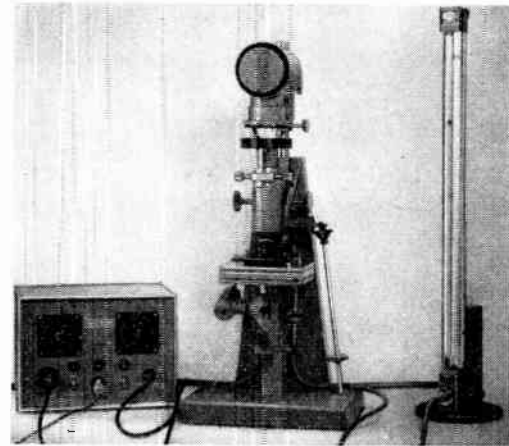
For further information circle 18 on Service Card

### 19. Variable-Speed Lapping Machine

A machine for flat lapping of metal and other materials to very high standards of accuracy using diamond compounds has been announced by Engis Ltd. Retaining features of earlier models, such as quickly interchangeable cast-iron and fibre lapping plates and automatic work-holding attachments, the new type III machine can be set to run at any speed between 40 and 400 r.p.m. at the turn of a handwheel. This enables optimum lapping conditions to be selected.

Using recommended techniques and lapping compounds, items such as pump seals and valve seats can be lapped to a flatness better than one light band (this refers to the interferometric method of measuring flatness using optically flat quartz blocks. One light band corresponds to a flatness of 11.6 millionths of an inch) and a surface roughness less than 1 millionth of an inch.—*Engis Ltd., Parkwood Trading Estate, Maidstone, Kent.*

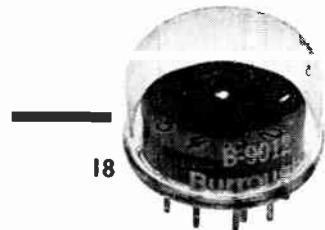
For further information circle 19 on Service Card



16



17



18



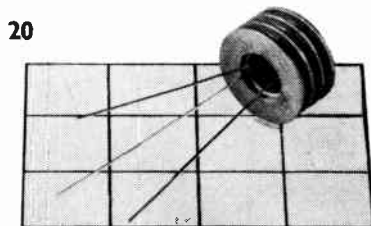
19

## 20. Printed-Circuit Heat Sinks

Two heat sinks recently introduced by Jermyn Industries are designed for quick assembly on to printed-circuit boards. Made of aluminium, the heat sink consists of two parts which screw together on to the weld flange of the transistor; heat is radiated through fins on the outside of the heat sink.

Type 2211 (thermal resistance 38 °C/watt) fits TO5 transistors, and type 2220 (thermal resistance 37 °C/watt) fits TO18. No fixing is required: the complete assembly solders direct on to the printed-circuit board.—*Jermyn Industries, Vestry Estate, Vestry Road, Sevenoaks, Kent.*

For further information circle 20 on Service Card



22



## 21. Power Unit for Tunnel Diodes

Coutant Electronics have introduced a stabilized power unit for tunnel-diode circuitry, designed to match into standard printed strip lines. Output connections are made by soldering the strip lines directly to the double-sided printed circuit in the power unit, with provision for ground-plane continuity.

The output voltage is continuously variable between 0 and 100 mV at a current of 8 A, and two auxiliary supplies of +5 V and -5 V at 6 A are provided for associated transistor circuits.

Remote error signals are transferred from the load to the control amplifier through miniature coaxial cables and connections. The response time of the stabilizer to step changes of load current approaches the theoretical minimum attainable, depending mainly upon the length of strip line employed between the power unit and the sensing point.

The power supply utilizes an all-silicon semiconductor line up and will operate in ambient temperatures up to 60 °C. It is designed for standard 19-in. rack mounting and occupies a panel height of 5½ in.—*Coutant Electronics Ltd., 3 Trafford Road, Richfield Estate, Reading, Berks.*

For further information circle 21 on Service Card

## 22. Improved Oscilloscope

Tektronix have recently introduced the 545B oscilloscope to replace the 545A. A 6 × 10 cm display is provided by a flat-faced tube with electrostatic focus and deflection.

Distributed - amplifier techniques have been superseded by a hybrid vertical-amplifier circuit, the passband being 0 to 33 Mc/s. Two separate timebases are provided; they can be used separately or one can be used to delay the time of the other. A ×5 sweep magnifier is also provided. The

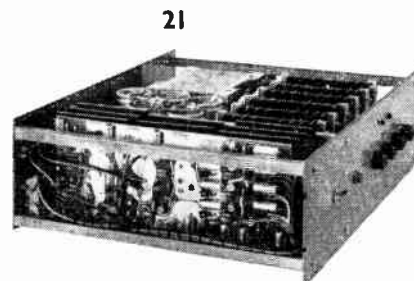
signal delay is 200 nsec and is introduced by a non-tunable braided cable.

Environmental capabilities permit operation of the instrument up to 15,000 ft and at temperatures from 0 to +50 °C. The dimensions are 16¾ × 13¼ × 23¾ in. and the basic weight is approximately 64 lb. Two new plug-in units have been added to the existing 17 'letter-series' units which may be used with this oscilloscope.—*Tektronix U.K. Ltd., Beaverton House, Station Approach, Harpenden, Herts.*

For further information circle 22 on Service Card

## 23. Portable Engine Tuning Testers

Crypton have introduced the 'Porta-line' range of four portable low-cost instruments which together cover most requirements in engine testing and fault diagnosis. These testers are particularly suitable for the smaller service station and operators of small,



21

23



petrol-engined fleets. They can readily be incorporated in line servicing systems to speed up scheduled engine and electrical adjustments.

The model B400 ignition tester (illustrated) provides a rapid overall check of the vehicle ignition system and indicates, within commercial limits of accuracy, the output and resistance of circuits. It tests ignition output, ignition leakage, high resistance and ignition polarity. The model B401 tach-dwell tester checks distributor dwell-angle, dwell variation, cylinder balance and automatic gear-change speeds.

The model B402 electrical tester is a comprehensive instrument for in-situ tests of generators, regulators, cut-outs, wiring and accessories. It covers 6, 12 and 24-V systems and has a built-in series resistance, current-regulator loading resistance and positive/negative earth switch.

Finally, the model B403 combustion



## EQUIPMENT REVIEW

tester checks the complete carburetion system, indicating such faults as incorrect mixture, choked or worn jets and blocked air filters. Additional scales are provided for engines operating on propane or butane.

All 'Portaline' testers have moving-coil meters with clear-view Perspex covers and colour-zoned scales which are matched in the appropriate switch positions for easy operation.—*Crypton Equipment Ltd., Bridgwater, Somerset.*

For further information circle 23 on Service Card

### 24. Field Strength Meter

A portable field-strength meter manufactured by Prestel SRL of Milan is available from Hatfield Instruments. The 6T4G is designed for checking v.h.f and u.h.f. field strength over the ranges 40–270 Mc/s and 470–900 Mc/s.

The meter is scaled directly in  $\mu\text{V}$ : two scales are provided with f.s.d. of 1,000 and 50,000  $\mu\text{V}$ . Provision is made for the connection of a headset for monitoring and identifying signals, and facilities are provided for both coarse and fine tuning. The instrument can also be used to locate sources of interference with the aid of a portable directional aerial turned to produce maximum indication on the meter.

Completely transistorized, the unit employs a standard 4.5-V battery with a life of approximately 100 hr, measures  $8 \times 6 \times 3$  in. and weighs 2 lb 6 oz. The strong leather carrying case is provided with a shoulder strap enabling the instrument to be used in difficult situations, leaving the hands free. Price: £45 15s complete with carrying case, exclusive of batteries.—*Hatfield Instruments Ltd., Burrington Way, Plymouth, Devon.*

For further information circle 24 on Service Card

### 25. Electromagnet for Demonstrations

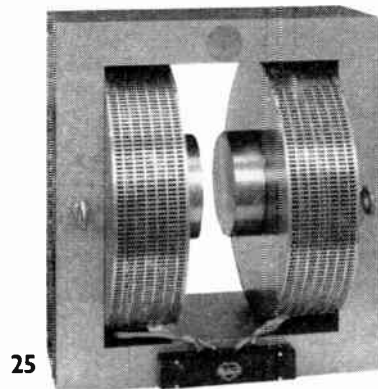
By using a 7-in. electromagnet now available from Mullard, lecturers in universities, technical colleges and similar educational establishments can demonstrate some of the phenomena associated with the fundamental physical properties of matter, such as nuclear resonance, Hall effect and magnetic susceptibility.

A feature of this air-cooled magnet, type EE1022, is the ease of access to the air gap. This has been made possible by keeping the distance between the coils as great as possible, so as to leave the gap area free from obstruction. The magnet can therefore be used in cryogenic experiments, involving the use of a Dewar.

Various pole-piece configurations enable the gap geometry to be varied,



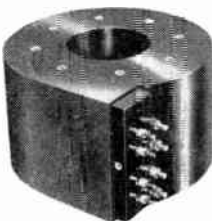
24



25



26



27

and a series of accessories is available to extend the magnet's range of applications. All pole-pieces are fully adjustable for optimum field uniformity and are made from high-quality iron and have been ultrasonically tested for flaws. Approximate overall dimensions are  $24 \times 25 \times 19\frac{1}{2}$  in. A suitable power supply is also available.—*Mullard Ltd., Mullard House, Torrington Place, London, W.C.1.*

For further information circle 25 on Service Card

### 26. D.C. Transformers

W. H. Sanders (Electronics) have produced a range of d.c. current transformers for measuring direct current in the range 10 A to 15,000 A with an accuracy of up to 1%.

D.c. transformers offer various advantages over shunts above 3,000 A: they are cheaper in initial cost, have a lower power dissipation and are lighter in weight. In addition, the length of the leads to the indicating instrument is not restricted, with distances of up to several hundreds of

yards quite practicable; also there is no direct contact between the bus-bar and the indicating instrument.

The d.c. transformer provides a much higher output voltage than does a shunt, and the load circuit is completely insulated from the cable or bus-bar for voltages up to 10 kV. The majority of the range are completely resin encapsulated, but the extreme sizes are vacuum impregnated and varnish dipped. Prices range from £7 12s for 10 A up to £72 for 15,000 A.—*W. H. Sanders (Electronics) Ltd., Gunnels Wood Road, Stevenage, Herts.*

For further information circle 26 on Service Card

### 27. Miniature Waveguide Switches

Roberts Electronics who are the sole agents in this country for Paradyamics Inc. are now marketing a series of high-power miniature waveguide switches.

Called the 650-651 series, these extremely small lightweight switches of the balanced-rotor class give inser-

tion loss comparable to an equal length of waveguide, with maximum isolation. All units are pressure sealed, safe rated and tested to comply with the extreme environment conditions stipulated by military specification MIL-E-5272.

Available in three-port and four-port models, the switches have interchangeable drive mechanisms, maximum v.s.w.r. of 1.10 and fail-safe switching. Units operate over a full waveguide frequency range from 1.12 to 18.0 Gc/s.—*Roberts Electronics Ltd., 17 Hermitage Road, Hitchin, Herts.*

For further information circle 27 on Service Card

### 28. Variable Power Supply Units

Recently introduced by Belix are the types CM 5002 and CM 5010 power-supply units. Using a standard 19-inch panel, both units can be rack mounted when necessary.

A continuously-variable adjustment, operating in conjunction with the current-meter ranging switch, provides from 0 to 50 V output at up to 2 A for the CM 5002, and up to 10 A for the CM 5010.

Four-terminal output connections allow for line losses to the supplied equipment, and both units provide a stabilization ratio of better than 2,000 to 1. The units, which weigh 37 lb

and 67 lb respectively, will meet their performance specification at ambient temperatures of up to 35 °C.—*The Belix Company Ltd., Victoria Road, Surbiton, Surrey.*

For further information circle 28 on Service Card

### 29. Electronic Timing Unit

Research Electronics announce the production of an electronic programme control unit, the model 6101A.

The instrument is designed for the control of two consecutively repeating time intervals or 'on' and 'off' periods, each independently set from 0.1 sec to 999 sec. Applications include temperature cycling, test rig programming, etc.—*Research Electronics Ltd, Bradford Road, Cleckheaton, Yorks.*

For further information circle 29 on Service Card

### 30. Miniature Chart Recorder

Radiatron have announced a miniature 6-channel potentiometric chart recorder, made by Jaquet of Switzerland, which features a writing width of 100 mm and a flush-mounted front measuring 144 × 144 mm overall.

The recorder is robustly designed for industrial applications. The input is floating and can be applied to a d.c. or a.c. potential of 100 V to earth. Up to 50% a.c. hum will not influence the measurements. Maximum permissible

input impedance is 20 kΩ and measuring accuracy is 0.5%.

Versatility is achieved by using plug-in units for changing the measuring ranges and the number of channels. Paper speeds and channel sequence can be selected independently by means of gear trains. Total power consumption: 18 VA.—*Radiatron, 7 Sheen Park, Richmond, Surrey.*

For further information circle 30 on Service Card

### 31. Zener Diodes

Semitron have announced three new ranges of Zener diodes. The first of these, encapsulated in the standard TO18 package, is capable of dissipating 300 mW, which can be increased to 400 mW by mounting on a suitable heat sink.

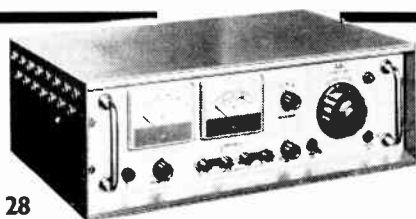
The other two ranges are power devices mounted in the SO16 and SO10 envelopes; the former is a wired-in type capable of dissipating 1.4 W in free air, and the latter is a stud-mounting diode which will handle 10 W on a heat sink.

All the units are available in the standard preferred voltages.—*Semitron Ltd., Cricklade, Wiltshire.*

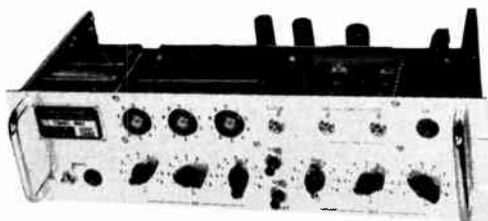
For further information circle 31 on Service Card

### 32. Electrochemical Marking Machines

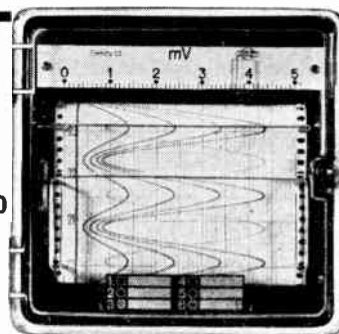
Lectroetch announce the introduction of two new power units for electro-



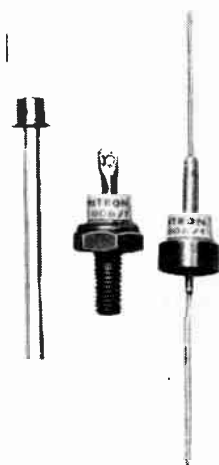
28



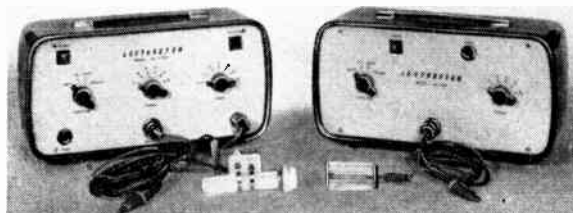
29



30



31



32

## EQUIPMENT REVIEW

chemical marking, models L25 and LT25, designed to provide a permanent stress-free method of marking metals with either a.c. or d.c. marks. The L25 is a standard model and the LT25 incorporates a timer. The controls have been simplified so that the units can be used by completely unskilled operatives.

The pre-set timer unit of the model LT25 is calibrated for periods of 1 to 10 sec, although this timing arrangement can be adjusted to operate for longer periods. The timing circuit is triggered by a micro-switch attached to the hand marking tool. Both units have a maximum output of up to 15 A at 25 V. Weighing under 10 lb each, they may be easily transported by means of a carrying handle.—*Lectro-etch (Gt. Britain) Ltd., Spur Road, Feltham Trading Estate, Feltham, Middlesex.*

For further information circle 32 on Service Card

### 33. Programmer for Airmec Autoset

The type N385 programmer is designed as an optional alternative to the Airmec wide-tape programmer normally supplied as part of the Autoset machine-tool control system. All the basic functions of the Autoset are retained with the new programmer although the methods of reading and handling the tape are entirely different.

The N385 is built round the Creed model 92 mark III tape reader, which may be adjusted to take 5-hole  $\frac{1}{8}$ -in. wide tape or 8-hole 1-in. wide tape. A code selector device fitted to the tape reader enables almost any of the standard data-processing codes to be used, including the E.I.A. 8-hole, BS 5-hole and 8-hole machine tool codes. BS

8-hole computer code, E.M.I. 5-hole code, Ferranti Mercury and Orion codes, etc.

Since a sequential tape reader is used, the length of the block of data on the tape may be adjusted to suit each application. The normal block length is 18 rows but a further 5 rows on the tape may contain teleprinter function codes, operation numbers, or other data not required by the Autoset. Extra tool selectors or decoding units for digital-readout indicators may also be provided. The programmer can be fitted with a tape-spooling device accommodating tapes with up to 1,500 operations. It is also possible to load endless lengths of tape up to 12 ft long, permitting programmes of up to 80 operations to be repeated without re-winding the tape.—*Airmec Ltd., High Wycombe, Bucks.*

For further information circle 33 on Service Card

### 34. Oscilloscope Trolley

Alden have introduced a trolley with a tilting interchangeable top tray which can accommodate all types of oscilloscope, British, American and Continental. The assembled dimensions of this trolley, which can be packed flat for storage or shipment, are: height 34 in., width  $15\frac{1}{2}$  in., depth 24 in., weight approx. 28 lb.

The materials used in construction are satin-anodized aluminium with plastic-coated steel panelwork. Underneath the top assembly is a power-supply tray and below this are four chromium rubber-tyred wheels, two with brakes. An integral mains-socket gallery for three instruments is fitted at the rear.

The top tray can be released by

turning four screws and alternatives fitted for extra width or length: this allows two small oscilloscopes to be used on one trolley. The tray tilts and locks with a finger-grip release behind the front handle. At the rear, the extension handle gives easy movement even when the trolley is fully loaded. An accessory drawer for components is also provided.—*Associated Instrument Marketing Ltd., 22 Charing Cross Road, London, W.C.2.*

For further information circle 34 on Service Card

### 35. Magnifying Bench Viewer

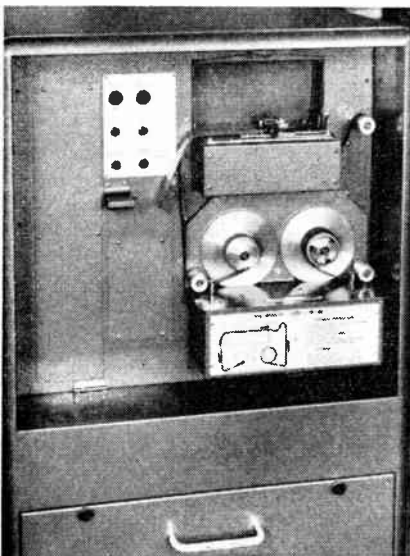
Vision Engineering have recently added to their range of optical assembly and inspection equipment the  $\times 2$  'Stereoramic' bench viewer. It is intended for applications where simple low-power magnification is required.

The basis of this bench viewer is a large optical lens measuring  $6 \times 4$  in. which provides a magnification of approximately  $\times 2$ , without distortion or chromatic aberration. Shadowless illumination is provided by built-in glare-free fluorescent tubes, mounted on each side of the lens and complete with reflectors. This arrangement provides a good concentration of balanced light. Ultra-violet tubes may be substituted for fluorescent dye penetrant work.—*Vision Engineering Ltd., Send Road, Send, Woking, Surrey.*

For further information circle 35 on Service Card

### 36. Liquid Level Sight Plug

Liquid level sight plugs incorporating a built-in reflector, designed by the Technical Development Co. of Pennsylvania, have been introduced to the U.K. by Vactric Control. The presence of oil in gearboxes or the fluid level in



33



34

35



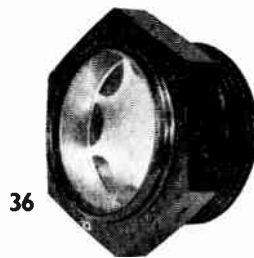


other types of housing can easily be checked by visual inspection through the plugs.

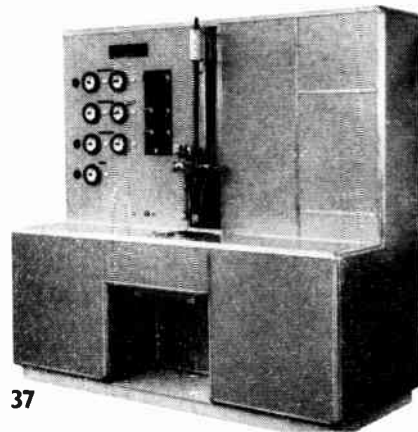
The reflector clearly shows the fluid level even in dark locations, and an additional advantage is its damping action when there is active agitation of the fluid within the gearbox as the liquid tends to become trapped between the reflector and the transparent window, and a median level is shown.

The plug is manufactured from aluminium alloy or steel and normally has a shatterproof plastic lens. In the aviation grade, plugs are available in three types according to operating temperature requirements, in six thread sizes between  $\frac{1}{4}$  in. (16 UNF) and  $2\frac{1}{2}$  in. (16 UN). In the industrial grade there are two thread ranges, each with four thread sizes,  $\frac{1}{2}$  in. (16 UNF) to  $2\frac{1}{2}$  in. (16 UN), and  $\frac{1}{2}$  in. NPT to 1 in. NPT. Other thread sizes may be obtained to special order.—*Vactic Control Equipment Ltd., Garth Road, Morden, Surrey.*

For further information circle 36 on Service Card



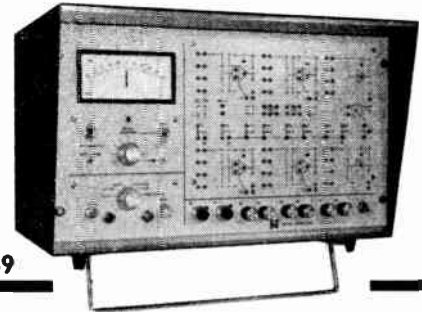
36



37



38



39

### 37. Automatic Coating Machines

Ashdown Bros. & Co. (Engineers) are manufacturing a range of automatic and semi-automatic fluidized-bed machines for applying epoxy resin coatings to electrical and other components.

The linear machine (illustrated) will reciprocate the component vertically and carry out ultrasonic cleaning, induction heating and immersion in a horizontal reciprocating fluid bed. This will give a single coating application, but the heating and dipping operation on the component can be repeated if a thicker coating is required.

The fully-automatic version will load, unload and cure the components by means of a continuous oven which is an integral part of the machine. The temperature of the oven is variable between 140 and 240 °C and it will cater for a production rate of four treated components per complete processing time.

Each machine has a central control panel carrying timers, electrical relays and interlocks which control the pre-heating, ultrasonic cleaning, induction heating and fluid-bed dipping of the component, and a separate panel for controlling the continuous oven.—*Ashdown Bros. & Co. (Engineers) Ltd., Chantry Avenue, Kempston, Bedford.*

For further information circle 37 on Service Card

### 38. Frequency Counter

A compact 2-Mc/s 5-digit frequency counter, the 5534A, has been introduced by Hewlett-Packard. Measuring

facilities include single and multiple period average measurement in decade steps up to  $10^5$  periods, pulse-operated time interval with either the 100-kc/s timebase frequency of the instrument or any externally applied frequency up to 2 Mc/s, frequency ratio or multiples of ratio, and the counting of random events.

A clear display of the counter reading is provided by cold-cathode numerical indicator tubes. Readout storage provides a continuous display of the most recent measurement, even while the instrument is making a new measurement. Sampling time is, therefore, reduced to a minimum.

High sensitivity and a 1-M $\Omega$  input resistance (shunted by 15 pF) enable the instrument to detect and measure signals down to 100 mV r.m.s. The cabinet is suitable for bench or rack mounting and the plug-in printed board structure provides easy accessibility for instrument maintenance.—*Hewlett-Packard Ltd., Dallas Road, Bedford.*

For further information circle 38 on Service Card

### 39. Analogue Tutor

To meet the need for early practical training in analogue computing and simulation techniques, System Computers have introduced a self-contained portable analogue tutor. Special attention has been paid to simplicity of construction and servicing.

The Analogue Tutor mark 2 not only provides teaching authorities with

the opportunity and facilities for introducing and demonstrating systems investigation and behaviour analysis into biological, chemical, mechanical or electrical study subjects, but is designed clearly to demonstrate to students the basic principles of analogue computation. Among other things, the complete front-panel assembly is made removable to show the construction throughout.

Six operational amplifiers are provided. Four may be used as summers or integrators and the remaining two as summers only. Provision is also made for the addition of a standard multiplier unit.

With the exception of the operational amplifiers, which are mounted in pairs on removable modules inside the console, the actual computing components (feedback resistors and capacitors, input resistors, etc.) are plugged directly into the face of the graphic patch panel. This absence of limitation on the value of the components has obvious advantages over fixed component systems in respect of versatility and cost.—*System Computers Ltd., Queensway, Team Valley, Gateshead 11.*

For further information circle 39 on Service Card

### 40. Track/Erosion Resistance Tester

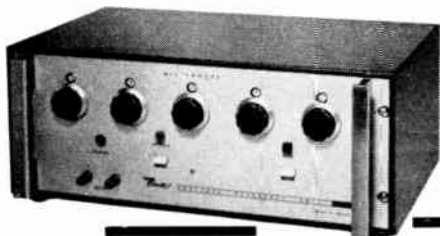
Designed to evaluate the relative tracking and erosion resistance of various materials by the 'liquid contaminant inclined plane method', the TERT-1 tracking and erosion resist-



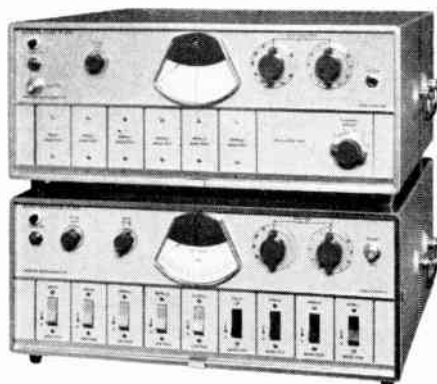
40



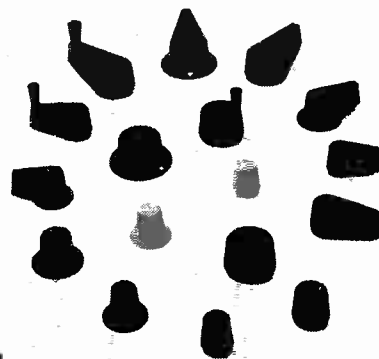
41



42



43



44

ance test set has been introduced by Industrial Instruments Inc. The versatility of this method permits evaluation of a broad range of insulation materials subjected to alternating current. The voltage and/or liquid contaminant rate may be easily controlled to simulate different service stresses and environmental conditions.

The test method determines the ability of solid electrical insulating material to withstand the action of voltage stresses along the surface of the solid when wet with an ionizable, electrically-conductive liquid contaminant. The test is designed to represent service exposure such as condensation, rain and other conditions which produces a film of water on the insulation service in which ionizable and other contaminants may dissolve.

The TERT-1 features a large, clear chamber for sample observation; as many as ten testing stations can be accommodated. The regulated power supply delivers test voltages up to 7.5 kV.—*D. A. Pitman Ltd., 91 Heath Road, Weybridge, Surrey.*

For further information circle 40 on Service Card

#### 41. Torque-Balance Watt Transducer

A torque-balance watt transducer, providing a direct-current output proportional to watt input is now avail-

able from Westinghouse. The transducer is suitable for high sensitivity and low power-factor watt measurement. It can provide computer input and can be used for control purposes. Other applications include multiple-readout operations and totalizing. Both 2.5 and 5-A ratings are available at either 100, 200, or 350 V. A 115-V, 50-60 c/s, 30-W power supply is required.

Designed according to a torque-balance scheme, the instrument uses a dynamometer mechanism to produce a torque proportional to the input watts, and a d.c. core magnet mechanism to produce a counter torque. Balance is detected by phototubes, a lamp, and a vane which is connected to the shaft of the moving-element. A d.c. amplifier increases the output of the phototubes to a level suitable for operating the moving element.

The self-checking feature is obtained by connecting the dynamometer and d.c. coils in series, causing the unit to balance at the calibrated output current; a self-contained d.c. power supply provides the signal for balancing. The taut-band suspension system assures friction-free operation and permits accuracies of the order of 0.1%. The outputs of two or more transducers can be paralleled to provide multi-phase power measurements.

—*Westinghouse Electric International Company, Electric Utility and Marine Division, 200 Park Avenue, New York 10017, U.S.A.*

For further information circle 41 on Service Card

#### 42. Voltage Reference Unit

Bendix Electronics have developed a voltage reference unit designed for precise voltage calibration. A zener diode with an extremely low temperature coefficient, and an error-correcting amplifier are incorporated into the design.

The instrument has a range from 0 to 100 V, which is available in switched steps of 1 mV. Precision decade resistors are used for the voltage selection, each decade having ten equal increments to facilitate linearity measurements without changing the range.—*Bendix Electronics Ltd., High Church Street, New Basford, Nottingham.*

For further information circle 42 on Service Card

#### 43. White-Noise Test Set

Marconi Instruments have introduced a transistorized white-noise test set, type OA 2090, which is designed for testing cable and radio multi-channel links with capacities of up to 2,700 channels, and meets C.C.I.R. recommendations. It comprises two units





47



and is considerably smaller in size and weight than its predecessors.

The noise generator uses a semiconductor diode as the noise source and will accommodate up to nine quick-change filter units; both band-limiting and band-eliminating filters are incorporated. The noise-band limits and the slot positions are selected by simple switch operations while the power level reference is continuously monitored. The system loading is adjustable by an attenuator at the output.

The receiver unit has provision for up to six spot frequencies and also employs interchangeable filter units which correspond to the generator band-stop filter frequencies. An input attenuator is so marked that the noise power ratio in dB is read directly.

The dimensions of each unit are:  $7\frac{1}{2} \times 18\frac{1}{2} \times 17$  in. Weight: 26 lb. Rack mounting versions are also available.—*Marconi Instruments Ltd., St. Albans, Herts.*

For further information circle 43 on Service Card

#### 44. Control Knobs

A range of economically-priced control knobs for instruments and communications, industrial and other commercial equipment has been introduced by Raytheon.

The 'Designer 400' series comprises



46

#### 46. Temperature Controller and Indicator

A temperature controller, fitted with a visual temperature indicator, has been produced by the Electronics Division of Fords (Finsbury) Ltd.

A special feature of this instrument, marketed under the name of Dioford, is the remote semiconductor probe. This is only  $\frac{3}{4}$  in. long and  $\frac{1}{8}$  in. in diameter, and may be placed up to 75 ft from the instrument, using uncompensated wiring, without loss of efficiency. Fitted with the indicator, this instrument is suitable for the close control and indication of temperatures up to 260 °C. When supplied without the indicator, which is independent of the control circuitry, it is particularly suitable for use under conditions where considerable vibration is experienced. A plug-in relay, contained within the instrument, is adequate for switching powers of up to 1½ kW without the use of other contactors.

The instrument is of compact and robust construction, measuring  $4\frac{1}{2} \times 9 \times 6$  in. Both bench and panel-mounted models are available. Semiconductors are used throughout.—*Fords (Finsbury) Ltd., Chantry Avenue, Kempston, Bedford.*

For further information circle 46 on Service Card

ten functional styles in a choice of eight colours. Included are cranks, pointers, and round knobs with and without dial skirts.

The knobs are injection moulded from a tough plastic, and two set screws and metal bushings ensure strength for high-torque applications.—*Raytheon-ELSI, S.p.A., Villagrazia, Palermo, Italy.*

For further information circle 44 on Service Card

#### 45. Miniature Corona Stabilizer

The Victoreen Instrument Co., Ohio, have introduced a miniature corona stabilizer, the GV1A, which has been designed to meet the requirement for a very small and reliable diode for high-voltage regulation and reference. Typical applications are in satellites, oil-well logging and pocket radiation monitors.

Brief features of the GV1A are: voltage in the range 300 V to 2 kV, and current up to 100 µA. This unit weighs 0.8 gm and measures 1 in. in length by 0.2 in. in diameter. It will withstand 10 g vibration from 5 to 55 c/s, and has a temperature coefficient of 0.009% per °C from -55 to +125 °C. Available from *Walmart Electronics Ltd., 11-15 Betterton Street, Drury Lane, London, W.C.2.*

For further information circle 45 on Service Card

#### 47. Low-Cost Digital Frequency Meter

To meet the demand for a moderately-priced digital frequency meter suitable for a wide range of general laboratory and industrial applications, Dawe Instruments have introduced the type 719A digital frequency meter. With a five-digit illuminated readout and a 10-kc/s quartz-crystal oscillator, it is suitable for a wide range of applications including frequency, period and speed (in rev/min) measurement, as well as random pulse counting.

Frequency may be measured from d.c. to 10 Mc/s, period and random pulses up to 99,999 sec. Overall accuracy is  $\pm 1$  count,  $\pm$  crystal accuracy, the crystal being set to one part in  $10^6$  at room temperature. The numerical display gives automatic decimal point and 'count exceeded' indication, the final display being visible for a preset period from 1 to 15 sec, or until reset manually. Transistorized construction is employed throughout, and a novel decade divider circuit has simplified the circuitry.

Power consumption is only 15 W (mains) and weight is 35 lb. Dimensions are  $20\frac{1}{2} \times 11 \times 12$  in. deep, the case being suitable for rack or bench mounting.—*Dawe Instruments Ltd., Western Avenue, Acton, London, W.3.*

For further information circle 47 on Service Card



# Automatic Malt Blending Plant

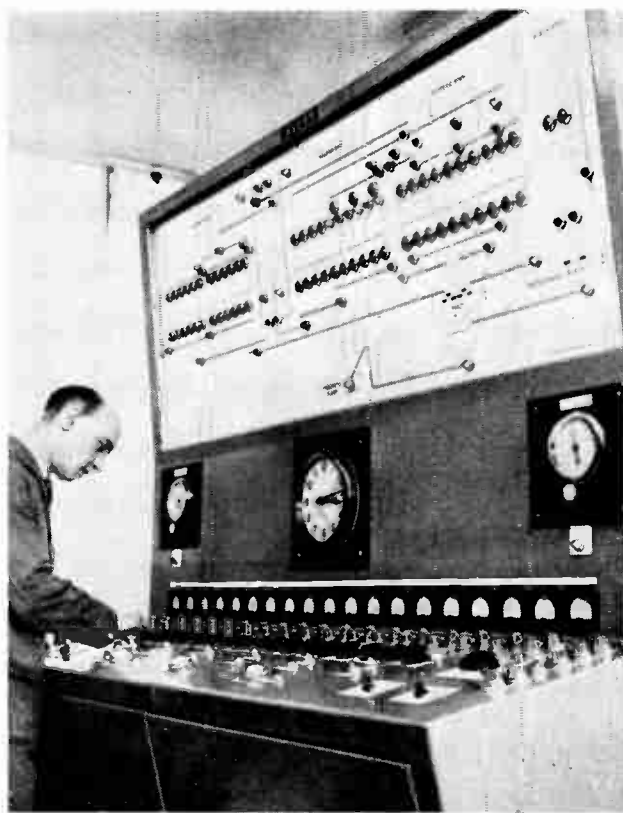
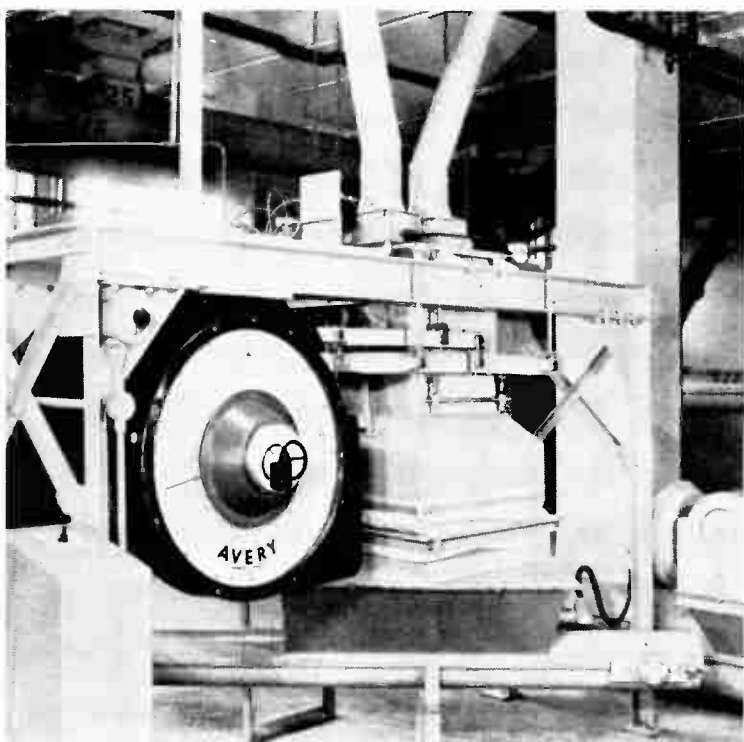
**M**AJOR developments in hand at Mitchells & Butlers' Birmingham brewery promise to make it one of the most modern and efficient installations of its kind in the country.

When it was decided to introduce the intake of malt in bulk form the opportunity was taken to incorporate fully automatic batching and blending for brewing.

The malt is conveyed on elevators from the pits to the top of the building from where it is conveyed to bins. Black malt is also received and conveyed in a separate conveyor to two bins. Altogether there are 34 bins. The arrangement is such that six different types of malt may be blended in any desired proportions, the addition of black malt being a separate feature. Maximum output is 10 tons per hour and the time taken for 1 batch (336 lb) is 54 sec, equal to 66.6 batches per hour.

Control of the entire blending plant is from a central console situated in the basement. It was supplied by W. & T. Avery who were also responsible for all the weighing equipment. The console houses the automatic weighing controls and remote controls for all conveyors and other associated plant. Incorporated on the desk is a

*This illustrates the main malt scale*



*All the weighing equipment is controlled from this single console*

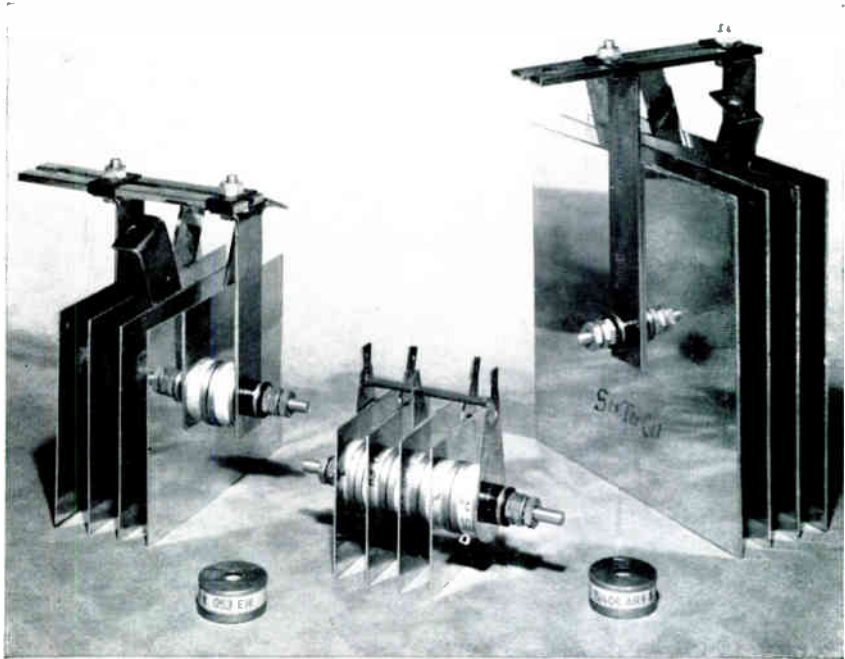
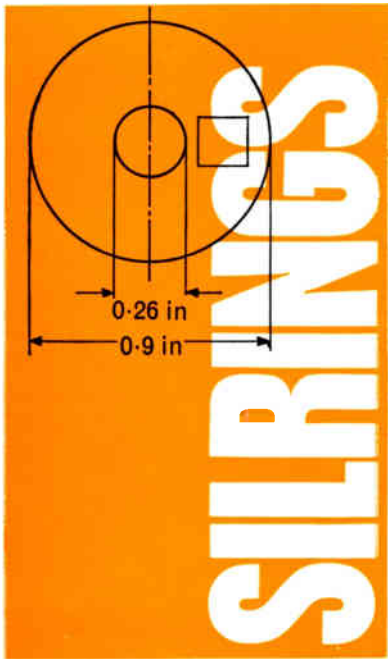
mimic diagram with indicator lights showing the entire flow circuits. The lights indicate if conveyors and elevators are running and whether bin slides are in the open or closed position. (All the bins have hand-operated slide valves.)

When blending, the desired percentage may be drawn from any of the six sources in turn. The malt is fed into a master weighing hopper via conveyors and then feeds into a receiving hopper for dispatch to the storage hoppers prior to milling. Simultaneously black malt is drawn from either of the two hoppers through a separate weigh hopper and is then fed to the same receiving hopper from a variable-speed conveyor. This arrangement allows the black malt to be trickle-fed throughout the entire blending process.

The main scale for the malt is an Avery 43N type consisting of an open-lever system, a 39 cu ft weigh hopper with pneumatically operated gates and a dial indicator. The dial indicator is fitted with an analogue generator, the output of which works in conjunction with a digitizer and setting panel to cut-off the feed of materials at the required weights.

## INFORMATION WANTED?

If you require further details of products or processes described or advertised in **INDUSTRIAL ELECTRONICS** you will find it convenient to use the enquiry cards which will be found in the back of the journal. The sheet of cards can be folded out to enable you to make entries while studying the editorial and advertisement pages.



## Silicon rectification using selenium stack practice

New in Britain, SILRING rectifier stacks from STC offer the circuit designer and equipment engineer a unique combination of compactness, simplicity and low cost.

SILRING power diodes are rugged ceramic/metal case ring diodes with diffused silicon junctions. Their heavy gauge

copper end-plates form the anode and cathode of the device and act as thermal conductors to the stack cooling fins. This arrangement provides maximum efficiency without overloading and consequent lowest price-per-watt rectification.

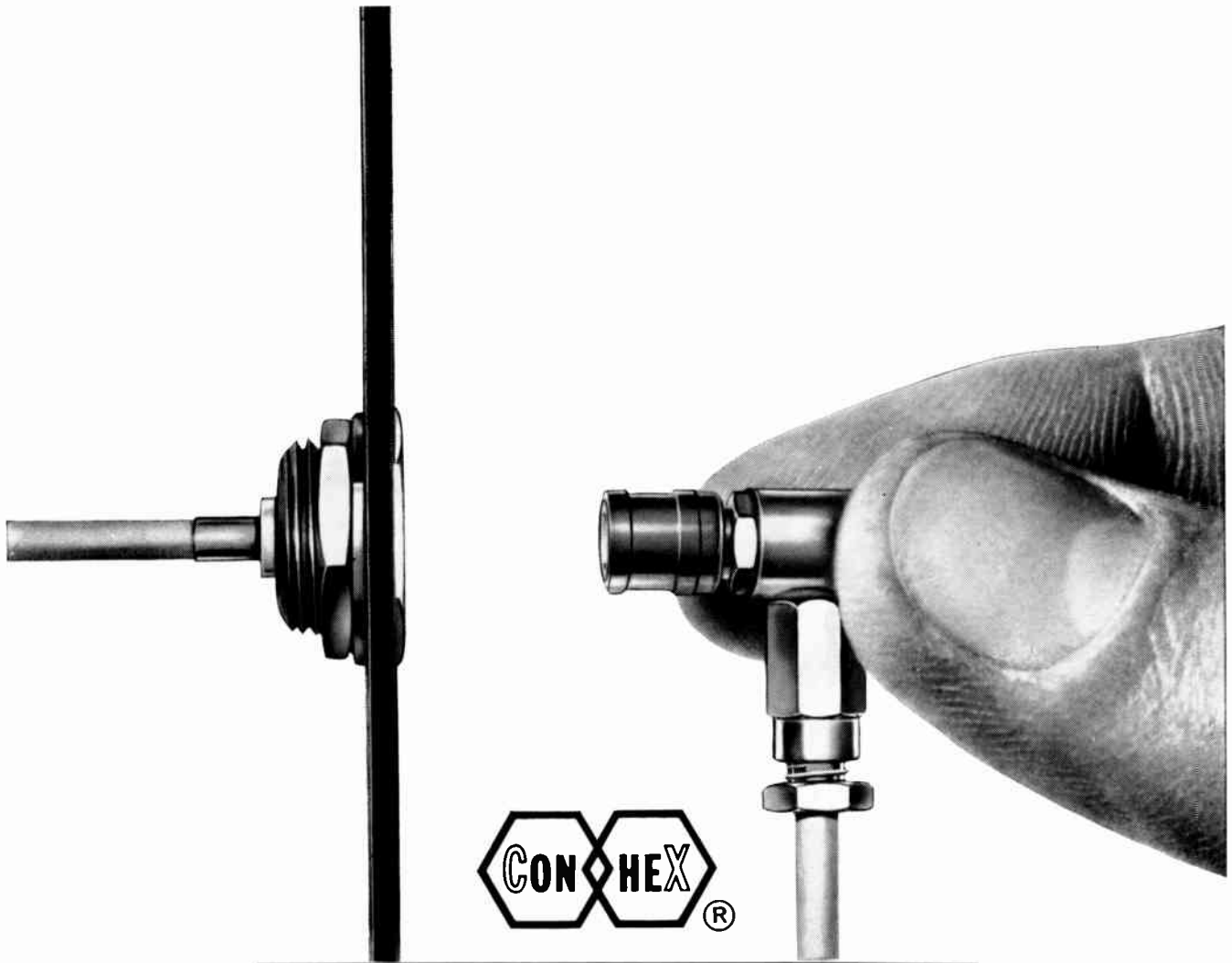
This simplicity of stack construction enables STC to

offer quick delivery of a range of voltage and current outputs in a variety of electrical configurations.

For Data Sheets and prices write, 'phone or Telex STC Semiconductor Division (Rectifiers), Edinburgh Way, Harlow, Essex. Telephone Harlow 26811. Telex 81146.

**STC**  
COMPONENTS GROUP

high-grade electronic components by



## THE APPROVED SUB-MINIATURE RF CO-AXIAL CONNECTORS

### Check these features

**SPECIFICATION** — Produced to Mil-C-22557 and shortly to DEF 5322A (PROV).

**CONSTRUCTION**—Built-in strength and reliability. Robust functional design with captivated beryllium copper contacts ensuring perfect alignment, ease of assembly without special tools and incorporating a patented cable grip stronger than the breaking strain of the cable.

**RANGE** — Widest range of cable end and chassis mounting, straight and right-angle styles, in screw-on, snap-on and slide on types, 50 ohm and 75 ohm impedance, with full range of adaptors to BNC, TNC, etc. Flexible or semi-rigid cables.

**PERFORMANCE** — Optimum impedance matching with specified cables, very low contact resistance, suitable for use at frequencies up to 10 Gc/s.

**AVAILABILITY** — Popular styles from stock. Wide usage by Government research organisations and all leading manufacturers.



**SEAELECTRO**  
LIMITED



Hersham Trading Estate · Lyon Road · Walton-on-Thames · Surrey. Telephone: Walton-on-Thames 26285 · Telex: 28350



# Electronics at the IMEKO III and I & M VI Conferences

STOCKHOLM, SEPTEMBER 1964

The Third International Measurement Conference (IMEKO III) and the Sixth International Instruments & Measurements Conference (I & M VI) were held in Stockholm on 14th–19th September 1964. In this article some details are given of interesting circuit developments described at the conferences.

**A**LTHOUGH primarily conferences on instruments, measurements and automatic control, there were some items of general electronic interest in the papers. There was also an associated exhibition. Some of these items of general interest are described here.

## D.C. Amplifiers

It is unusual to find really novel circuit configurations in this field, but a system using integration followed by differentiation does seem to be a new approach to the problem of measuring very small direct currents or voltages.<sup>1</sup> The schematic circuit is shown in Fig. 1, where the operational amplifier and feedback capacitor  $C_f$  together with

though with a corresponding reduction in speed of response. A second feature is that irregularities in the operation of the resetting circuit D, SW should not cause errors: the output is proportional to the rate of change of voltage on  $C_f$  (i.e., to the input current) and the resetting system affects only the length of interval between the negative pulses. Of course, the output cannot be read on a d.c. meter merely by smoothing, since this is equivalent to integration which would recover the waveform of (b) having no d.c. component; so it is necessary to suppress the negative pulses of Fig. 2(c). (The authors did this in a rather devious way which they called 'reducing the ripple'.)

The voltage amplification of the system is equal to  $C_i/C_f$ ,

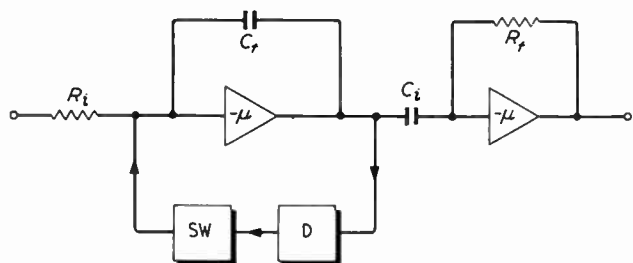


Fig. 1. Amplification of small direct current by integration and differentiation. D = voltage discriminator; SW switch for discharging capacitor  $C_f$

the input resistance  $R_i$  form an integrator; and the voltage-discriminator D and switch SW reset the integrator when the desired maximum voltage on  $C_f$  has been obtained.

As can be seen from the waveform of Fig. 2(b), the integrator is reset to a negative value equal to the value at which it was tripped, so that the signal to be passed to the differentiating capacitor  $C_i$  has no d.c. component. Since the second operational amplifier passes d.c., its output will be as shown at (c), with the desired d.c. component, in spite of the a.c. coupling ahead of this stage.

The basic advantage of the system is that by the use of integration it allows a larger voltage to be attained before performing anything in the nature of chopping,

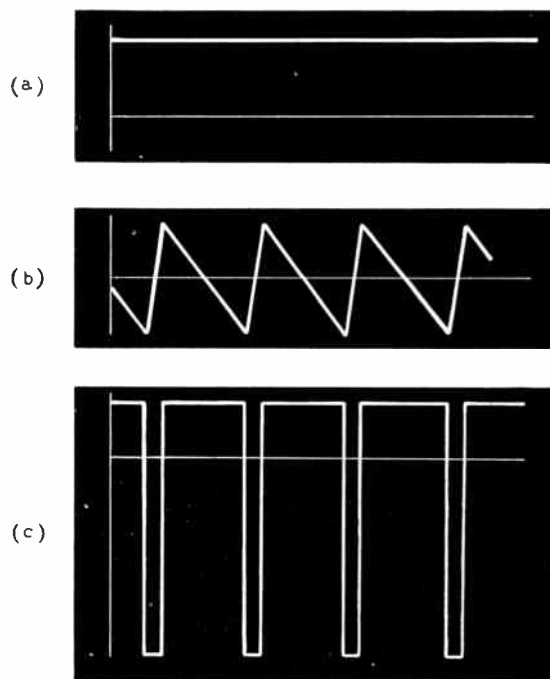


Fig. 2. Waveforms in system of Fig. 1. (a) input; (b) voltage applied to  $C_i$ ; (c) output voltage

and the authors suggest that one could have a multistage system with integrators and differentiators alternating in the chain. Suggested limiting values for components are:  $R_f = 10^9$  ohm;  $C_f = 10$  pF;  $C_i = 0.1$   $\mu$ F. The circuit outlined in Fig. 1 should then be capable of measuring down to  $10^{-12}$  A with an accuracy of better than  $\frac{1}{2}\%$ . The experimental amplifier (of which a detailed circuit is given in the paper) used an electrometer valve at the input of each of the operational amplifiers and one electrometer valve in the resetting system, but otherwise was transistorized.

An improvement in more conventional d.c. amplifiers, capable of a bandwidth of tens of kc/s, was described by J. C. Martin in a paper to the Special Section on Automatic Control of the Instruments and Measurements Conference.<sup>2</sup> For differential inputs, the balanced amplifier has the merit of giving common-mode rejection, but it is not normally possible to provide overall negative feedback of the differential output. The method proposed by Martin to overcome the problem of common earth points is to use a pre-amplifier which is floating (i.e., neither side tied to earth) and must therefore be screened and fed from floating power supplies which in turn are fed from a screened power transformer. There will be a substantial capacitance connection to earth from the floating amplifier, but this can be largely offset by the use of an emitter-follower which will cause the screen potential to follow that of the signal terminal to which it has most capacitance. Although the drift is not as low as that of a chopper amplifier, the bandwidth can be much greater, and the author claimed the following performance from an amplifier with bandwidth of 150 kc/s and input impedance of 10 megohms: drift for source impedance up to 1,000 ohms, 4  $\mu$ V in 4 hr and 0.5  $\mu$ V/ $^{\circ}$ C; noise, 20  $\mu$ V; common mode rejection, 120 dB for common-mode signals up to 10 V; input drift for 100-k $\Omega$  source, 50  $\mu$ V/ $^{\circ}$ C. (Further details are to be published in *Revue G n ral de l'Electronique* and in *Automatisme* in the latter months of 1964.)

#### Automatic Wagner Earth

When the normal four-arm bridge is used on a.c., trouble arises from the fact that the detector and the source cannot both be tied to earth and in general the detector will not be at earth potential when the bridge is balanced. (This

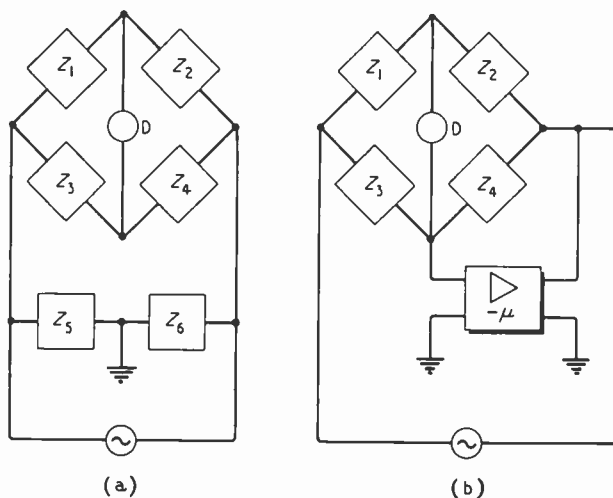


Fig. 3. (a) Conventional Wagner earth. The ratio  $Z_5/Z_6$  is adjusted to equal  $Z_1/Z_2$  and  $Z_3/Z_4$ ; (b) automatic earth balance

is one reason for the popularity of the differential-transformer bridge, which allows three corners of the bridge to be brought to the same potential at balance.) The classical solution was to add a tapped impedance system, or 'Wagner earth', across the source so that the source was effectively earthed at a tapping point having the same ratio as the bridge when balanced, and the detector was then at earth potential (Fig. 3(a)), but this has the disadvantage of requiring a further two adjustments (amplitude and phase of the Wagner earth) before a perfect balance is obtained. In the scheme proposed by Hara and Hoshino<sup>3</sup> any potential between detector and earth is fed to a high-gain amplifier which injects into the source circuit a voltage in the sense to annul the detector-earth voltage (Fig. 3(b)). The simplest method is to make the amplifier gain very large, so that a true bridge balance is obtained, but this may be difficult when the bridge frequency is high. For a 500-c/s bridge, a suitable amplifier consisted of a pentode amplifying valve with a second pentode as high-resistance anode load and a cathode-follower output: the amplification was 1,900 times for a bandwidth of a few kc/s, and the system was used on a bridge measuring inductance to 10 p.p.m. Alternatively, the bridge setting can be noted for two or more known values of amplifier gain, and the true balance corresponding to infinite gain can be calculated.

#### Constant-Width Oscilloscope Sweep

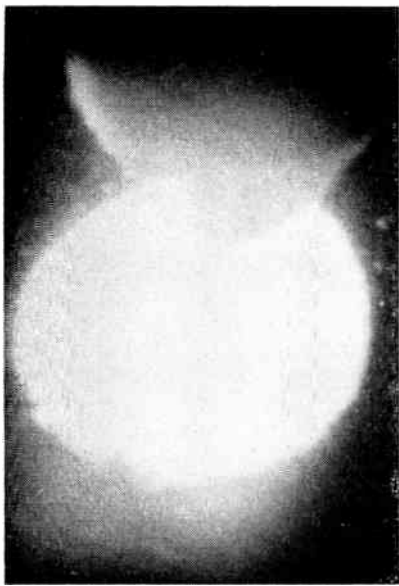
When observing cyclic phenomena, it is desirable to synchronize the oscilloscope timebase so that it displays an integral number of cycles; but unless the sweep velocity is adjusted to suit, the length of trace will vary in jumps if the number of cycles displayed is changed. A possible solution<sup>4</sup> is to add an automatic amplitude control to a triggered timebase. This consists of a control of the charging current of the timing capacitor, which is governed by a peak voltmeter on the sweep output so that when the charging cycle is shortened by earlier triggering the charging current is correspondingly increased. The discharge is always initiated by a trigger from the waveform under observation, so to obtain a display of several cycles a counting circuit is introduced between the trigger generator and the timebase. The author suggested that it would be possible to work from 20 c/s to 400 c/s with no more than 5% change in amplitude. A current meter in the charging circuit would indicate frequency, but in view of the large ratio covered it would be necessary to use either a logarithmic scale or automatic range-changing.

#### References

- <sup>1</sup> 'Small Direct Current Measurement by the Method of Integration and Differentiation', D. T. Jovanovic, R. P. Ilic and B. M. Stojanovic, *Acta Imeko*.
- <sup>2</sup> 'A Low Drift Feedback Transistor D.C. Differential Amplifier for Industrial Process Control', by J. C. Martin, *Proceedings of the I & M Special Section on Automatic Control, Stockholm, 17-18 Sept. 1964*.
- <sup>3</sup> 'Self-Balancing Earth Device for Precise Bridge', by K. Hara and T. Hoshino, *Acta Imeko*.
- <sup>4</sup> 'Oscilloscope Sweep Circuit', by P. Wahren, *Proceedings of the I & M Special Section on Automatic Control, Stockholm, 17-18 Sept. 1964*.

Note.—*Acta Imeko* 1964. Vols. 1-3 have been published and Vol. 4 is expected to be available soon. The volumes are obtainable from Kultura Hungarian Trading for Books and Newspapers, Budapest 62. Postbox 149.

The *Proceedings of the I & M Special Section on Automatic Control* are to be published. Enquiries should be addressed to the Organizers of the Sixth International Instruments & Measurements Conference, Stockholm, Sweden.



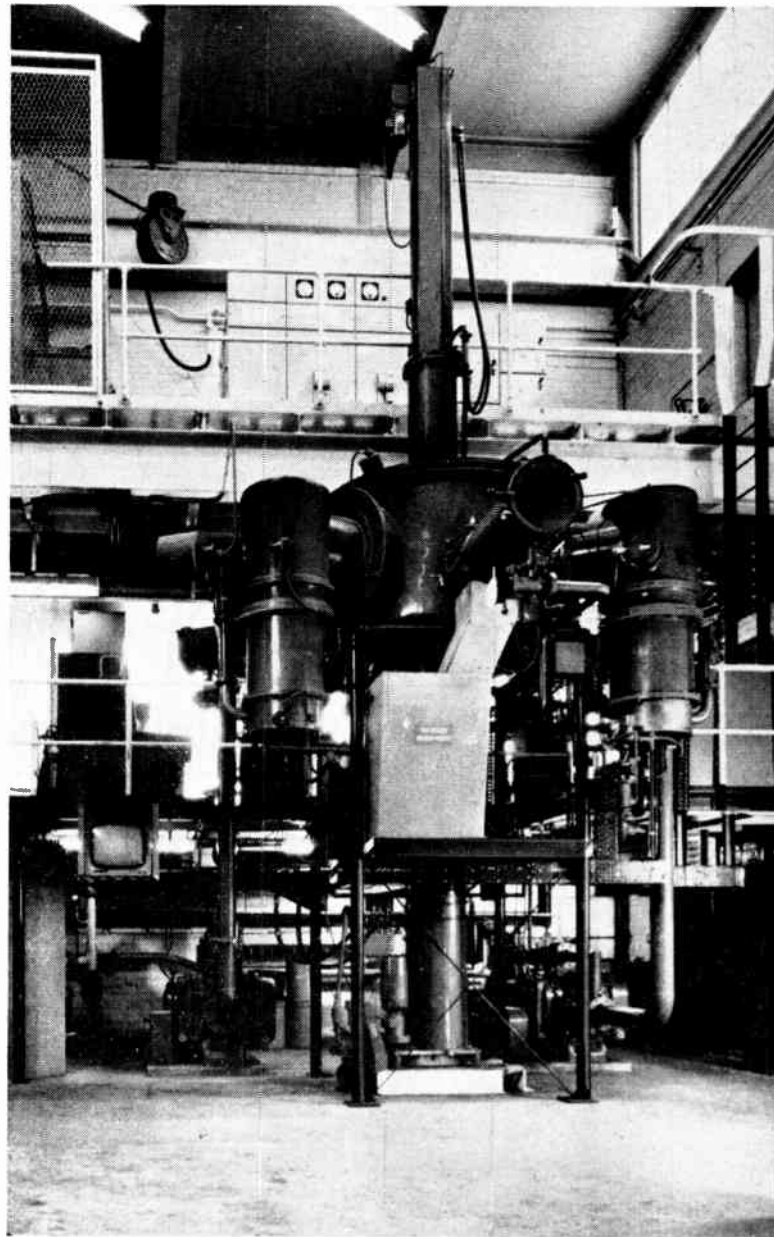
*Closed-circuit television shows a metal ingot suspended over the molten pool during the second melting process*

# ADVANCED ELECTRON BEAM FURNACE

ONE of the largest and most modern electron beam furnaces in the world has recently been put into operation by Murex Ltd., of Rainham, Essex, a leading producer of refractory metals such as tantalum, niobium, molybdenum and tungsten. The furnace, which was supplied by Degussa Wolfgang A.G. of West Germany, has a rating of 250 kW and is the first of a 'third generation' of furnace designs, with the emphasis firmly on the practical production use of the equipment. With its transverse electron guns, automatic feed mechanisms, closed-circuit television system and refined controls, it can fairly be described as the most advanced furnace of its type at present in operation.

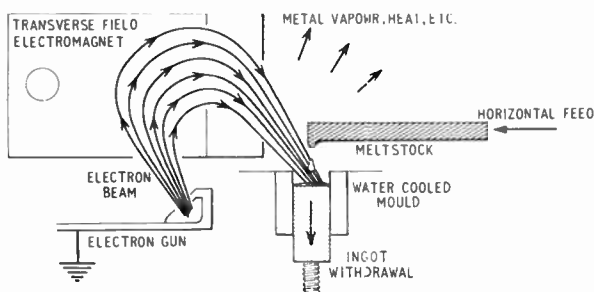
The furnace has been installed with the twofold object of producing refractory metals of a higher degree of purity and in greater quantities than in the past. At present, it is producing ingots of tantalum and niobium, both pure and alloyed, as one stage in the production processes, but it will soon be available for the custom melting of other pure metals and alloys. Ingots can be produced ranging from 3 in. in diameter for tungsten (melting point 3,400 °C) to 8 in. in diameter for metals with lower melting points. A melting rate of 60 kgm per hr has been achieved for a 2-in. diameter ingot of tantalum alloy, but slower rates are normally used where a high degree of purification is required.

The transverse electron guns employed in this furnace are claimed to be more reliable than ring cathodes and other types of electron gun which tend to fail through contamination of the filaments by splashes of metal or metal vapour, or as a result of the condensation of metallic impurities. In this design (diagram A) the guns are remote

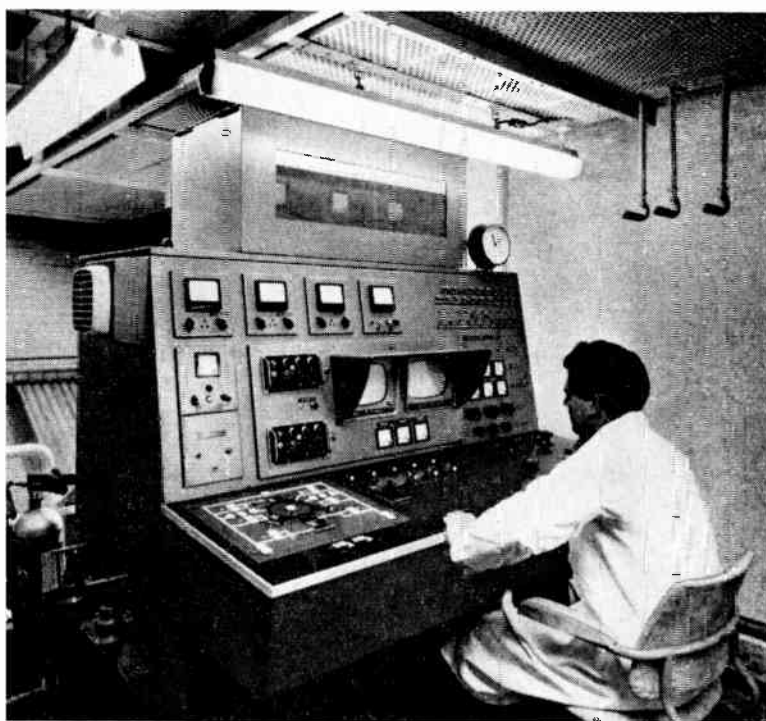


*The 250-kW electron beam furnace*

*Diagram A. Principle of the transverse field electron gun system*

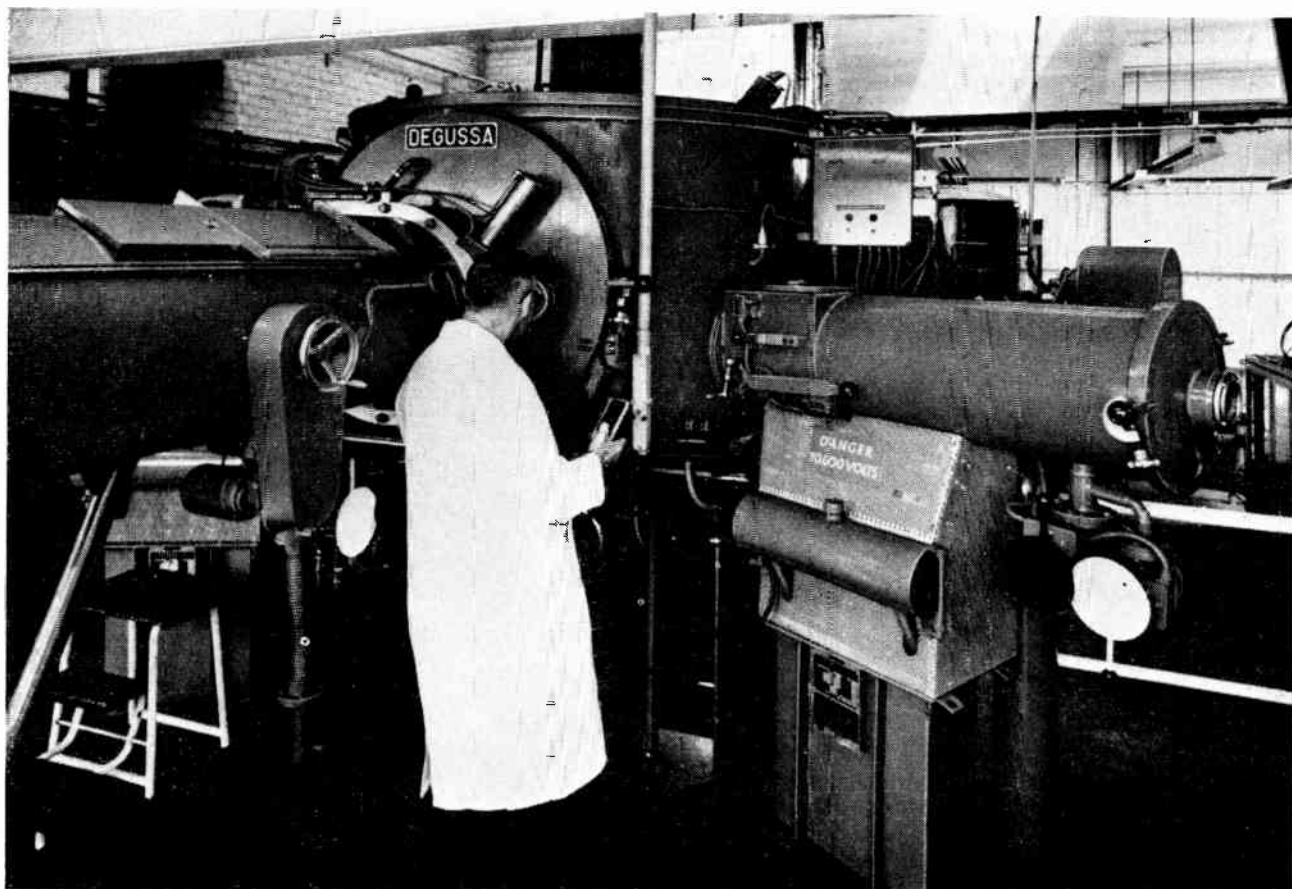






*Fig. 1. The control console*

*Exterior view of the main chamber*



*Fig. 2. First melting as seen on the television monitor*

from and below the level of the molten pool of metal and the electron beam is turned through approximately 180° in a vertical plane by the horizontal field of an electromagnet immediately above each filament. The beam thus strikes down into the mould, and the provision of three guns, installed symmetrically about the mould, ensures an even distribution of energy to the molten pool. Each gun can be withdrawn into a separate chamber for maintenance purposes during the operation of the furnace. A 20-kV d.c. constant-current circuit is incorporated to limit arcing in the furnace due to sudden gas evolutions from the charge,

and, in addition, a high-speed contactor short-circuits the h.t. system momentarily in order to extinguish the discharge.

Automatic operation is used for the feeding of the meltstock into the furnace, either horizontally or vertically, and for the withdrawal of the ingot, although manual overriding is possible. The regularity provided by this feed mechanism is an important factor in the production of ingots with good surface qualities. Horizontal feeding is carried out from a magazine of eight chambers which can be refilled during a melt. The stock is automatically pushed over the mould where it interrupts the electron beam, melts and drips into the molten pool, from the bottom of which an ingot of pure metal is gradually withdrawn.

The ingot thus produced is normally re-melted by lowering it from the vertical feeder, as shown in diagram B, until one end meets the electron beam just above the pool and again melts and drips into the mould. With either method, the ingot is continuously and automatically withdrawn into the ingot chamber, and when the ingot is complete a new chamber can be fitted with the minimum interruption to melting. This is, in fact, a continuous casting process taking place in high vacuum and, as the rate of solidification is controllable, the electron beam furnace has the advantage of achieving a greater removal of all gases and impurities more volatile than the meltstock than is possible in other high vacuum furnaces or with any other method of melting, short of zone refining. The pressure during melting normally lies between  $10^{-4}$  and  $10^{-5}$  torr, depending upon the material.

All the controls for the automatic operation of the furnace are grouped on the control console shown in Fig. 1. The melting operation can be viewed by both direct observation through a protected window and by means of a Pye closed-circuit television system having three

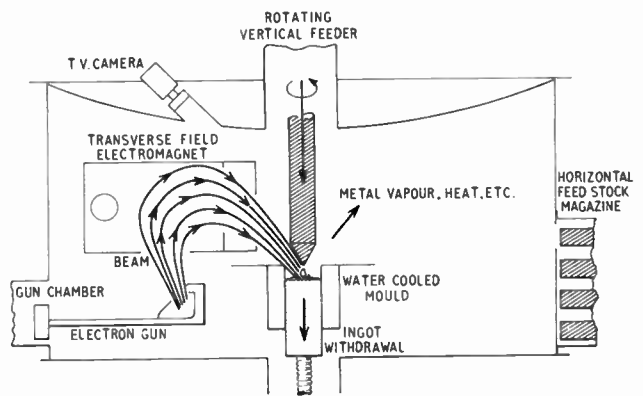


Diagram B. Schematic diagram of transverse field electron beam melting furnace

monitors, two being in the control console. Two cameras mounted on top of the furnace are sighted through a rotating disc with a radial slot, fixed inside the furnace to reduce the light transmitted, and the fogging of the glass, by a factor of 1,000. Because of the ability to adjust the brightness and contrast, the use of the two monitors on the control console has advantages over direct observation as, for example, in the focusing of the electron beams. Fig. 2 is a photograph of the c.c.t.v. screen during first melting, as indicated in diagram A; the hot end of the horizontally-fed meltstock can be seen to the left of the molten pool. The title block shows a view similar to that in diagram B, with the end of the vertically-fed meltstock suspended over the mould during second melting.

## Data Logger Monitors

### Tanker Performance at Sea

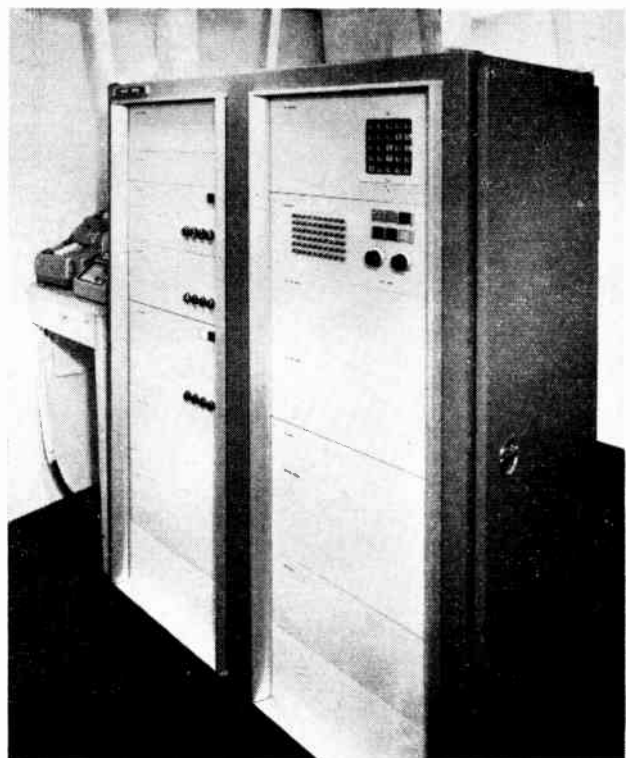
A 52-point data logger, designed to specification of Shell Tankers Ltd., has been installed by Honeywell Controls in *S.S. Solen*. The equipment is monitoring and recording all data relevant to the ship's performance while at sea.

The logger accepts a total of 52 inputs from transducers mounted in various locations in the ship and automatically records them on punched tape and also on a strip printer. The information is then relayed by the *Solen* radio transmitter on telegraphy channels to the Shell Centre in London.

The system enables the full *Solen* log to be collated in about three minutes, including integration times. Previously this took one and a half hours even under ideal conditions. Log cycles can be recorded automatically at periodic intervals or on demand in such conditions as heavy seas or during watch changes.

Until now the only means of measuring the performance of a ship has required taking the ship out of service and putting it through repeated tests over an accurately measured mile.

The 52-point data logger





# SIMPLE TRANSISTOR CIRCUITS FOR INDUSTRIAL USE

(Continued from page 540, November issue)

Continuing the discussion of simple transistor circuits, the basic circuits described last month are here developed into practical circuit elements.

### Multivibrator for Pulse Repetition Frequency Generation

This circuit is shown in Fig. 10 and is a modified form of the multivibrator described last month. The component values were chosen using the formulæ given and bearing in mind the range of pulse-repetition frequency (p.r.f.) required. The output pulse is taken from the collector of  $Tr_3$ , and in order that the positive-going edge may be used to trigger the following stage, the additional components

$R_5$  and  $D_1$  are used to isolate the collector of  $Tr_3$  from the integrating effect of  $C_2$  during the turn-off period, thus giving a rapid rate of rise of collector voltage at  $Tr_3$ .† The period of non-conduction of  $Tr_1$  and  $Tr_2$  is decreased by the inclusion of these components.

To provide pulse durations of up to a minute, large values of  $C$  and  $R$  are needed. So that a large value of base resistance can be used, the transistor must have a very large current gain (see the multivibrator section last month). This is achieved by means of the super-alpha pair  $Tr_1$  and  $Tr_2$ , which gives a current gain of approximately the product of the gains of the individual transistors. With equal values of  $C_1$  and  $C_2$ , the range of variation

\* Ferranti Ltd.  
† Rozner, F., Letter to the Editor (*Electronic Engng.*), Vol. 29, p. 355 (1957). Pat. App. No. 27787/55.

Fig. 10. Practical circuit of multivibrator for generating repetitive pulses. The resistors should have a tolerance of  $\pm 10\%$  and  $RV_1$  can be a carbon potentiometer. Capacitor values are given in Table 1

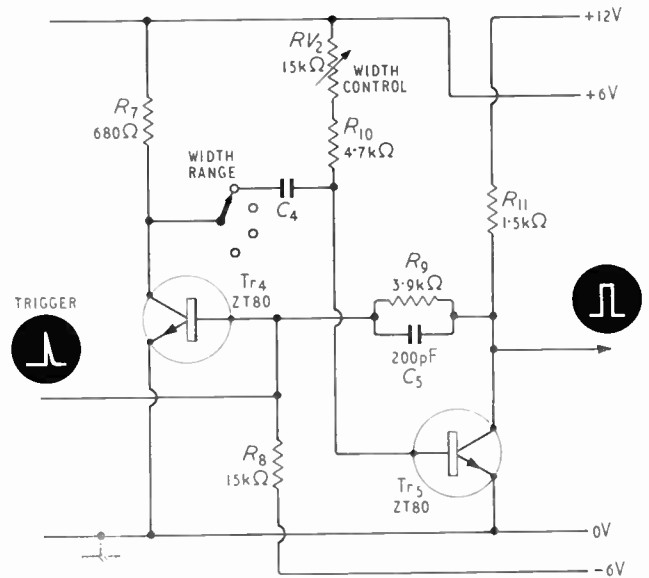
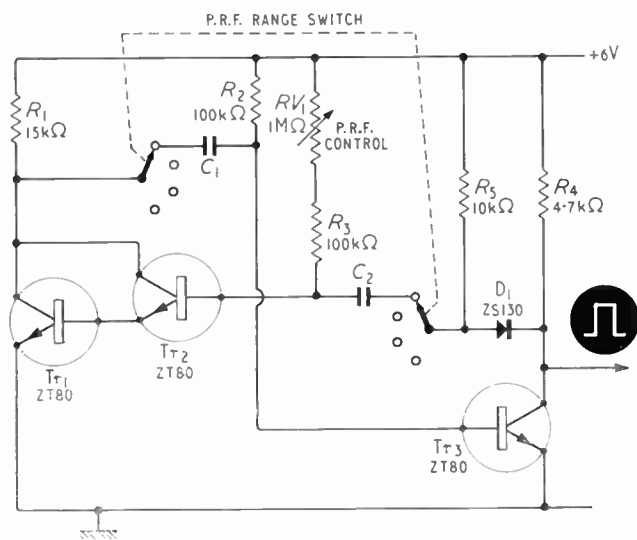


Fig. 11. Circuit of monostable multivibrator. Resistors should have a tolerance of  $\pm 10\%$  and  $RV_2$  should be a wirewound potentiometer. Capacitor values are given in Table 2



**Table 1**  
Pulse Repetition Time

Switch Position	Range	Value of $C_1$ and $C_2$
1	0.8 to 4 msec	0.005 $\mu$ F
2	4 to 20 msec	0.025 $\mu$ F
3	20 to 100 msec	0.12 $\mu$ F
4	100 to 500 msec	0.6 $\mu$ F
5	0.5 to 2.5 sec	3 $\mu$ F*
6	2.5 to 12.5 sec	15 $\mu$ F*
7	12.5 to 60 sec	75 $\mu$ F*

\* Tantalum Electrolytic.

N.B.—Faster repetition rates can be obtained, if desired, by using smaller values of  $C_1$  and  $C_2$ .  $C_1$  and  $C_2$ , nominally  $\pm 20\%$ , should be padded out if necessary to provide overlapping ranges.

of p.r.f. with the circuit values given is approximately 6 to 1. Values of  $C_1$  and  $C_2$  are given in Table 1 to provide a variation of p.r.f. from 1,200 per sec to 1 per min in seven overlapping ranges. Tantalum electrolytic capacitors are desirable for the larger values to obtain good stability of calibration.

If for any reason it is necessary to increase the supply voltage, care must be taken to ensure that the reverse base-emitter voltage rating of the transistor is not exceeded. This also applies to  $TR_5$  in Fig. 11 which follows.

**Monostable for Pulse-Width or Delay Generation**

The monostable multivibrator is shown in Fig. 11 and is triggered by means of a short-duration positive pulse applied to the base of the 'normally off' transistor  $TR_4$ . The width of the rectangular positive-going pulse at  $TR_5$

**Table 2**  
Pulse Width

Switch Position	Range	Value of $C_4$
1	0.5 to 2 $\mu$ sec	150 pF
2	2 to 6 $\mu$ sec	500 pF
3	6 to 22 $\mu$ sec	1,700 pF
4	22 to 80 $\mu$ sec	6,000 pF
5	80 to 250 $\mu$ sec	0.02 $\mu$ F
6	250 to 900 $\mu$ sec	0.07 $\mu$ F
7	0.9 to 3 msec	0.25 $\mu$ F
8	3 to 11 msec	0.85 $\mu$ F
9	11 to 40 msec	3 $\mu$ F*
10	40 to 130 msec	10 $\mu$ F*
11	130 to 450 msec	35 $\mu$ F*

\* Tantalum Electrolytic.

N.B.— $C_4$  and  $C_5$  nominally  $\pm 20\%$ .  $C_4$  must be padded out if necessary to give the required overlap of ranges.

collector can be varied by switching the timing capacitor  $C_4$  and by adjustment of variable resistor  $RV_2$ .

With the component values shown in Fig. 11 and the values of  $C_4$  given in Table 2, the pulse width can be varied from less than 0.5  $\mu$ sec to more than 450 msec in 11 overlapping ranges.

Where the narrowest pulse widths are required (less than 10  $\mu$ sec) the turn-off time of the transistor may represent an appreciable proportion of the required pulse width, so that the simple formula given last month does not apply. For such narrow pulses it is also necessary either to select

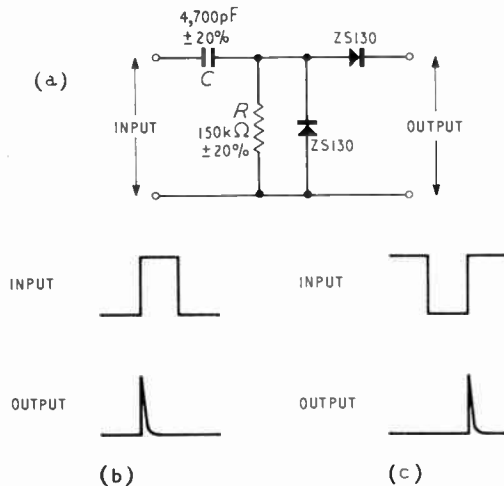


Fig. 12. (Left) Differentiator (a) which produces a positive-going output spike from the positive-going edge of an input pulse. If the input pulse is positive-going the spike coincides with the leading edge (b), but if it is negative-going (c) it coincides with the trailing edge

Fig. 13. (Below) Circuit and component values for an inverter stage

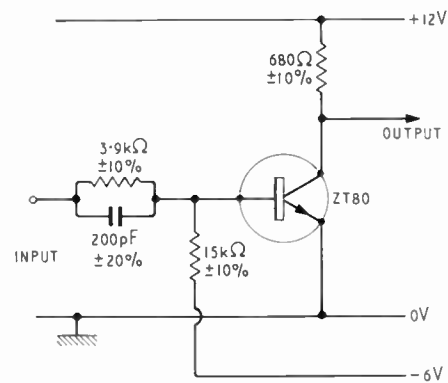




Fig. 15 indicates how the output circuit may be modified to provide either positive or negative output pulses of variable amplitude. The 'fine' control may be left out if precise control is not needed. This form of output circuit has been found to be more useful in practice than an emitter-follower stage.

A pulse generator provided with a c.r.o. trigger output is shown in block form in Fig. 16(a). The output pulse is delayed from the trigger output to enable the observation of switching occurring at the leading edge of the pulse. A simple isolated trigger output circuit is shown in Fig. 16(b). Its input is connected directly to  $Tr_3$  collector (Fig. 14(b)).

The combination of circuit elements shown in Fig. 17 makes possible the generation of two separate pulses of independently variable widths occurring at the same p.r.f., with one output delayed from the other by a variable amount.

The delay generator time ranges may be chosen from Table 2 as required.

Fig. 18 shows a pulse generator arranged to switch a Type B.P.O. 3000 Relay. The p.r.f. and width ranges should,

of course, be restricted to the maximum speed capabilities of the relay. Note also that the response time of the relay will modify the times given in Table 2. The diode across the relay coil is necessary to limit the positive inductive switching spikes at  $Tr_6$  collector. If desired, a small value of resistor may be connected in series with the diode to decrease the release time of the relay.

### Applications of the Pulse Generators

The circuits given should prove useful for general experimental use in industry. Further extensions suggested are that the general-purpose unit could switch a thermionic valve, such as the Ferranti EL84, directly at its control grid for providing higher voltage pulses, or could be connected to switch a power transistor for the generation of higher current pulses (see Figs. 19 and 20).

The timed relay circuit is useful in process control and where general repetition switching is required within the speed limitations of the relay.

*(To be concluded.)*

Temperatures to within 12 degrees of absolute zero can be produced as a simple routine operation with a Philips cryogenerator recently announced by The M.E.L. Equipment Company. This machine, the A20, reaches its lowest temperature within fifteen minutes of switching on, is simple to handle and may be left unsupervised for long periods. Its overall dimensions are 36 x 20 x 36 in.

While it now provides an equipment for research and development work down to 12 °K (-261 °C), it is also intended to form the basis of a second generation of plants that will reach temperatures as low as 4 °K (-269 °C). The programme is planned so that it will be possible to incorporate the A20 in these more advanced cryogenic systems as they become available.

Applications of the A20 machine include advanced low-temperature research work, cryopumping and 'cold-spot' applications such as the cooling of masers and superconducting solenoids. It also provides an efficient method of liquefying and recondensing hydrogen and neon.

Like its predecessors, the A20 operates on the Stirling cycle. An electric motor drives compressor and displacer pistons in a single cylinder. These, in conjunction with a heat exchanger system, cause a sealed gaseous helium refrigerant to expand after compression, with an accompanying absorption of heat.

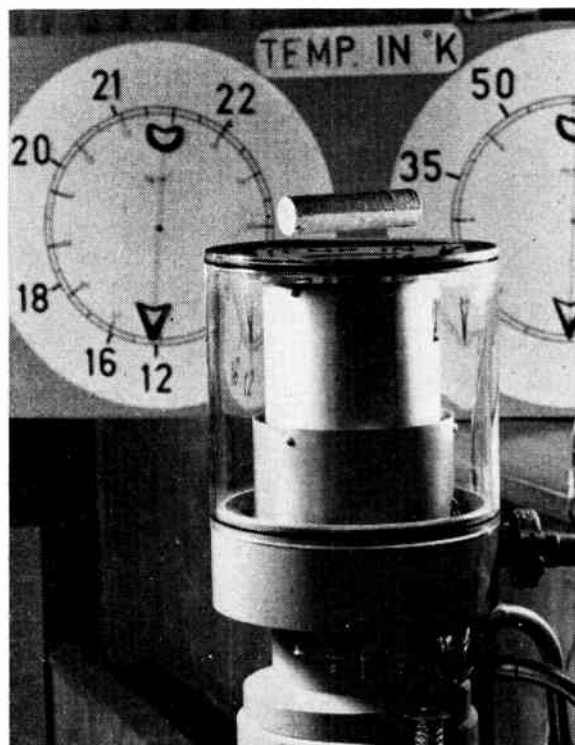
The earlier models operate at temperatures down to 70 °K and the advance down to 12 °K is based upon the use of a stepped displacer piston which provides two-stage expansion. Where an application requires it, refrigeration may be produced simultaneously at two tempera-

tures corresponding to the two expansion levels. This is of particular value where precooling of a gas before liquefaction can lead to higher operating efficiency.

With the present models heat is extracted through the machine's cylinder head with the advantage that the object (liquid or gas) to be refrigerated does not have to be introduced into the interior of the machine. Consequently, work may be carried out at any pressure and there is no risk of oil or other contamination.

For further information circle 49 on Service Card

## ROUTINE CRYOGENICS



*'Levitation' of a permanent magnet above the cooling head of the Philips A20 cryogenerator.—A niobium-tin disc is made superconducting by cooling to 12 °K. As the magnet is brought close to the disc, currents are induced in it which create a field which opposes the approach of the magnet. Owing to the superconductivity of the disc, the currents are high and circulate continuously. At a critical distance the force of the opposing field is sufficient to support the magnet in space*





### Personal and Company News

STC have established a transmission supplies division, based at a new factory in East Kilbride, which will be responsible for making the mechanical parts for long distance telephone, television and teleprinter transmission equipment. Manager of the new division is W. H. Nicholls. STC have also announced the formation of a data systems division, headed by H. McGregor Ross.

Claude Lyons have been appointed exclusive U.K. representatives for Intercontinental Instruments Inc. They have also been appointed exclusive U.K. distributors for Spectra-Physics Inc., who manufacture a range of helium-neon gas lasers.

The first company set up in continental Europe by C-E-I-R Ltd. and its American associate, C-E-I-R Inc., has been formed and will have its headquarters at The Hague, Holland. C-E-I-R NV Ltd. will have an initial capital of £30,000 of which 62½% will be subscribed by C-E-I-R Ltd. and 37½% by C-E-I-R Inc.

A new division has been formed by E.M.I. Electronics to take over the company's activities in the telephone field. Known as the telephone equipment division, it is managed by Derrick S. Ainsworth.

The directors of George Kent announce that the company has acquired 51% of the issued share capital of Eltromet of Hitchin, Herts., manufacturers of panels and associated equipment for industrial instrumentation schemes.

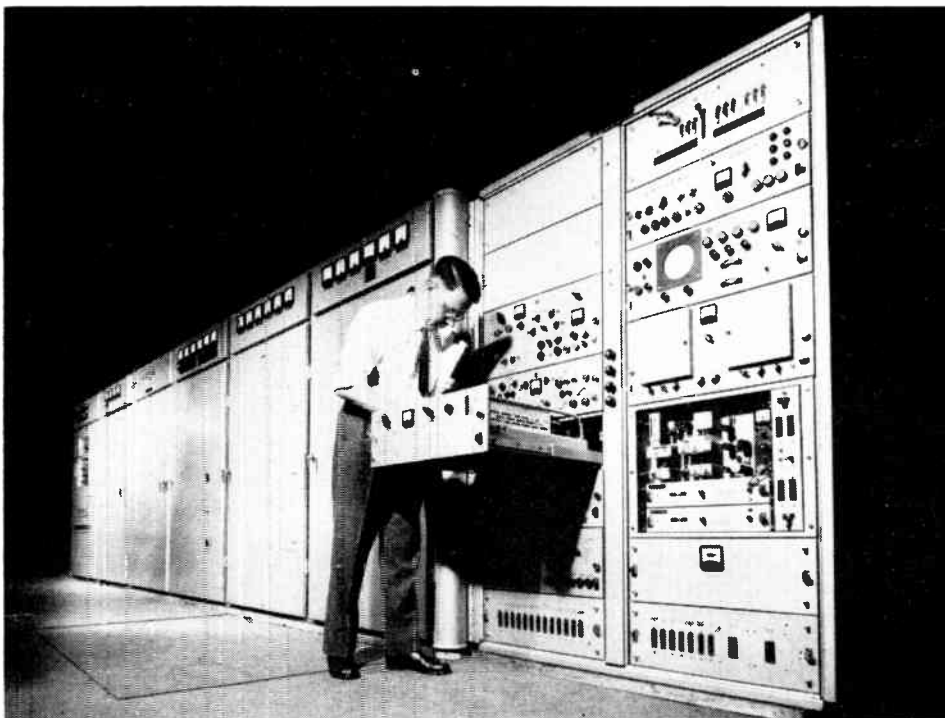
The Data Products Corporation has opened a European sales and service office in Amsterdam.

The changing of the name of Dobbie McInnes (Electronics) Ltd. to d-mac limited, 55 Kelvin Avenue, Glasgow, S.W.2, has been authorized by the Registrar of Companies. The change in no way affects the liability of the company in respect of purchases, sales or other contracts.

Thomas Industrial Automation have moved to Electronic Centre, Deansgate Lane, Timperley, Altrincham, Cheshire. Telephone: Altrincham 5555.

Osmor Radio Products have moved to new premises at 540 Purley Way, Croydon, Surrey. The telephone number, Croydon 5148-9, remains unchanged.

Smiths Aviation Division announce that they have assumed responsibility for the marketing of K.L.G. and Lodge Aviation products. These include spark plugs, igniters, thermocouples and thermocouple harnesses previously handled by the spark plug and ceramics division.



**TELEVISION TRANSMITTERS FOR BBC-2**—The photograph shows the first of twelve Marconi 25 kW u.h.f. television transmitters ordered by the BBC for their 625-line service. The transmitter has been installed at Sutton Coldfield and will form one of a pair which will bring BBC-2 to a further 3½ million viewers in the Birmingham area next summer. The opening of this station is the second stage in the British Broadcasting Corporation's scheme to cover the entire country with bands IV and V (u.h.f.) television transmitting stations. Each station will have two transmitters operating in parallel and will be capable of radiating either black and white or compatible colour transmissions to 625-line standards



**SORTING GERMANIUM WAFERS**—Small germanium wafers are sorted at the rate of 3,000 an hour into ten thickness grades by this machine in the transistor division of Standard Telephones & Cables at Footscray, Kent. The machine can detect a difference in thickness of 0.0001 in.

Under an agreement recently signed with Vitramon Inc., **Erg Industrial Corporation** has secured the exclusive licence for the manufacture and sale of Vitramon switching modules in the U.K.

**Ketay** have announced the conclusion of an exclusive agreement with Harowe Servo Controls Inc., whereby Ketay will supply the complete Harowe range, comprising conventional and brushless synchros, resolvers, induction potentiometers, motors and motor generators, throughout the U.K., Europe and the Commonwealth.

**Taylor Electrical Instruments** has appointed Wireless Electric of Bristol, as main distributors of Taylor instruments and panel meters for South-West England, and Farnell Instruments as main distributors for instruments in the North of England.

**Centrum Electronics** have announced the appointment of Universal Electronic Instruments, of Church Street, Leeds 10 (telephone Leeds 75437), as Yorkshire distributors of their full range of direct speech intercommunication equipment.

**Professor A. R. J. P. Ubbelohde, F.R.S.**, has accepted the chairmanship of the Science and Engineering Advisory Panel of the British Council, in succession to Professor H. H. Read.

Following his appointment as deputy chairman of the Advisory Council on Technology, **Professor P. M. S. Blackett, F.R.S.**, has tendered his resignation as a member of the N.R.D.C. and as a consultant to Electric and Musical Industries.

**H. S. Winterbourne**, chief information officer of the D.S.I.R., has been appointed chief information officer of the Ministry of Technology and will hold both posts concurrently.

**Belling & Lee** announce the appointment of H. G. Griffiths as technical sales representative in the greater Birmingham area. Mr. Griffiths can be reached by telephone at Birmingham Central 1794, extension 226.

A. Geoffrey Slemeck has been made president and managing director of **ITT Standard**, the European marketing organization of International Telephone and Telegraph Corporation. Mr. Slemeck is succeeded as marketing director of STC by Kenneth P. Wood who, in turn, is succeeded as general manager at the radio division by J. M. Wilson.

R. W. Beattie, manager of the capacitor division of the **Telephone Manufacturing Company**, has been appointed an executive director.

John Lopez has been appointed export sales manager of **Londex**, Richard Holmes has been appointed special products sales manager, and W. R. Wilson has been appointed publicity manager.

Allan E. Parritt, M.B.E., has been appointed general manager of **Foxboro-Yoxall**.

W. T. Blacklock has been appointed instrumentation sales manager of **Ampex Great Britain**; David J. Lambert has been promoted to audio/video sales manager and Harry Arksey to magnetic tape/consumer audio sales manager.

**G. H. Metson, M.C., D.Sc.**, deputy director of research at the Post Office, has been appointed director of research in succession to R. G. Halsey, C.M.G.

H. Edward Howard has been appointed chairman of the board of directors of **Advance Electronics**, following the retirement of A. W. Stapleton. E. G. Wakeling has become deputy chairman in addition to his former position as managing director.

**DATA LINKS FOR ATLAS COMPUTER**—A network of 14 high-speed data links has been provided by G.E.C. (Electronics) for the University of London's Atlas computer installation at Gordon Square, W.C.1. The links will enable colleges and other outlying stations to make rapid use of the computer and derive maximum benefit from its very high computing power by transmitting large amounts of data over a telephone line with speed and accuracy.





D. Lewis, chief accountant of **International Rectifier Co. (Great Britain)**, has been appointed company secretary in addition to his present duties.

**G. Caldwell, B.Sc., A.M.I.E.E.**, is to be the new head of the department of electrical engineering at the Borough Polytechnic, London.

Philip Holland, former M.P. for Acton, has joined the **Ultra Electronics Group** as personnel manager.

**Racal Instruments** have announced the appointment of A. F. Boff as technical director.

Neil MacDonald, A.C.A., has been promoted to controller and secretary of the **Solartron Electronic Group**.

G. W. R. McLaren has joined the sales organization of **Fielden Electronics** as technical representative responsible for the North-West area.

D. S. C. Miller, secretary and chief accountant of **Crypton Equipment**, has been appointed to the board of the company.

J. T. Wiltshire has been appointed controller of **G.E.C. (Electronics)** with responsibility for finance and production.

**Brookhirst Igranic** have announced a number of board changes: A. E. Williams has become sales director, A. R. H. Bennett has been appointed engineering director, and R. Cutler, secretary and chief accountant, has joined the board.

### **E.E.A. Joins Eurospace**

The Electronic Engineering Association has joined Eurospace as a collective member. This is a natural follow-on to the formation of the E.E.A. Space Committee in July 1963. Eurospace, the European Industrial Space Study Group, is an international organization, formed in 1961. Its objects are to promote the development of space activities in Western Europe. It operates in close harmony with ELDO and ESRO.

### **London International Engineering Exhibition, 1965**

The 1965 London International Engineering Exhibition—successor to the Engineering, Marine, Welding and Nuclear Energy Exhibition—will be held at Olympia and Earls Court, London, from 21st to 30th April 1965.

The Exhibition is sponsored by the London Chamber of Commerce and by the British Mechanical Engineering Federation and the British Electrical and Allied Manufacturers' Association, and is organized by F. W. Bridges & Sons Ltd., Commonwealth House, 1-19 New Oxford Street, London, W.C.1.

**MICROWAVE POWER TRANSMISSION**—In this first public demonstration of microwave power transmission, given recently by Raytheon, an array of semiconductor diodes was used to convert the microwave energy into d.c. power for the electric motor which turned the rotor blades. The 'helicopter', which reached a height of 50 ft, was centred over the 5 kW transmitter by means of vertical tethering lines. Using transmitting valves at present under development, which can generate nearly 100 times as much power at 70% efficiency, a more sophisticated beam-riding vehicle could be maintained at high altitude for long periods

### **I.C.T. Computer Courses**

International Computers and Tabulators Ltd. has just published details of a further series of courses for private students; the range has now been extended to include some one-week courses for higher management. Some of the courses are held in the evenings in London and others are full-time residential courses.

The evening courses cover computer programming, punch operating and an introduction to data processing.

The residential courses, of which there are seven, include a data-processing course for executives, a sixteen-week course on the principles and practice of systems analysis and a one-week course covering the general principles of computer programming.

Full details of the courses are available from: Education Liaison Services, I.C.T. Ltd., I.C.T. House, Putney, London, S.W.15.

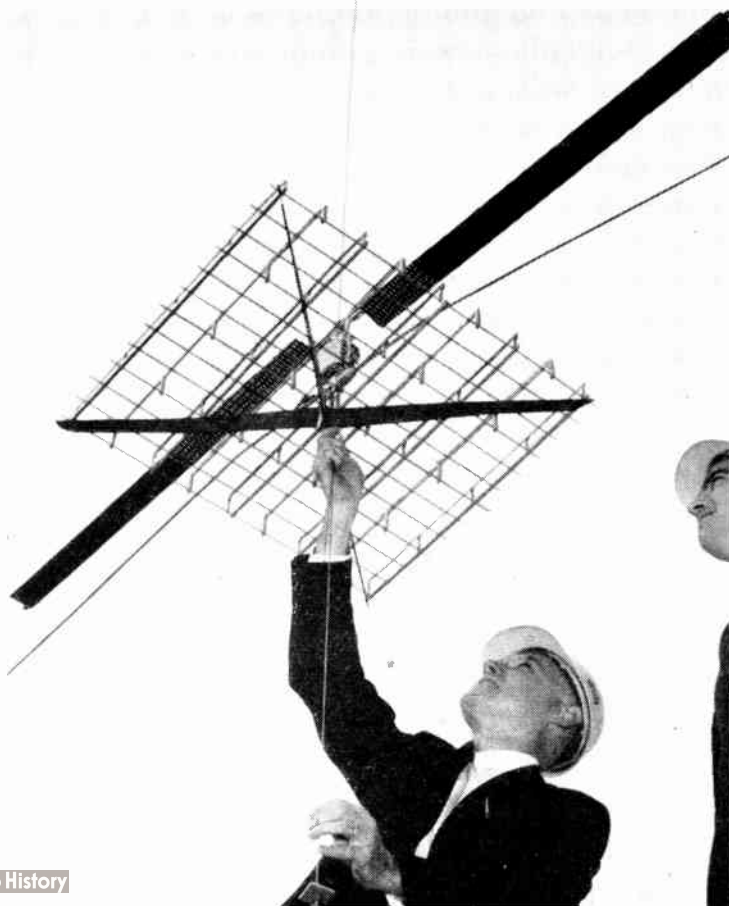
### **Electronic Instruments On-Hire**

The Singer Co., Metrics Division, Bridgeport, Connecticut, has instituted a new lease plan that makes it possible for potential users to acquire instruments on a 'short term lease' (with purchase optional), or on a standard 'equipment lease' basis. The plan calls for The Singer Co. to be the lessor and is extended to all qualified companies and institutions.

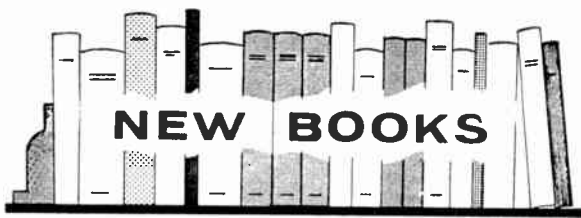
For further information circle 50 on Service Card

### **Short Radar Course at Norwood**

A special course of six lectures in radar technology is commencing 2nd February 1965 at Norwood Technical College, Knights Hill, London, S.E.27 (Phone Gipsy Hill 2268). The lectures on applications of microwave electronics in radar will be given jointly by staff of Decca Radar Training School and the College. The fee for the course is 15s.







### Electromagnetic Theory for Engineering Applications

By W. L. WEEKS. Pp. 744 + xix. John Wiley & Sons Ltd., Glen House, Stag Place, London, S.W.1. Price 135s.

The starting point of this book is formed by seven fundamental equations, which include Maxwell's, which summarize all knowledge of electricity and magnetism. The reader is assumed to be already well acquainted with the experimental evidence for the validity of these equations. The main object of the book is to 'exhibit the mathematical techniques which can be employed in the solution of modern electromagnetic problems and in the quantitative description of modern engineering devices'.

In view of this it is no surprise to find that the book makes considerable demands on the reader's mathematical knowledge and that it is definitely one for the specialist in electromagnetic field problems.

### Elements of Feedback and Control

By A. M. HARDIE. Pp. 344 + xi. Oxford University Press Ltd., Amen House, Warwick Square, London, E.C.4. Price 55s.

Although the treatment of the subject is basically mathematical the reader is not called on to possess any great mathematical knowledge. Little more than an understanding of differential equations is needed. After the introductory chapter, the response of mechanical systems is treated, followed by a discussion of simple control systems.

Negative-feedback amplifiers form the subject of the next chapter in which their similarity to control systems is brought out. The refinements of control systems (i.e., velocity and acceleration feedback, etc.) are then dealt with. Stability is next treated in two chapters, first by the Nyquist method and secondly by the use of logarithmic gain and phase characteristics.

The treatment is sound and the author's advice, that the student should experiment with systems of his own devising, is good advice. If he follows it and digests the contents of the book he should acquire a good basic knowledge of the subject.

### Mechanical and Electrical Vibrations

By J. R. BARKER, Ph.D., F.Inst.P. Pp. 221 + vi. Methuen & Co. Ltd., 11 New Fetter Lane, London, E.C.4. Price 21s.

As its title states, this book deals with vibration in mechanical and electrical systems. It starts with simple free vibrations and goes on to the general theory of linear vibrating systems with a finite number of degrees of freedom. This occupies well over half the book, and in the remainder concepts of admittance and impedance, gyroscopic systems and the gyrator and, finally, electro-mechanical transducers are treated.

Although mathematics is freely used, it is mainly restricted to differential equations and complex numbers. Only one chapter depends greatly on anything more advanced.

### Project FIST (Fault Isolation by Semi-automatic Techniques)

By GUSTAVE SHAPIRO et al. Pp. 71. Published by the National Bureau of Standards and available from the Superintendent of Documents, U.S. Government Printing Office, Washington, D.C. 20402, U.S.A. Price 55 cents.

The maintenance of modularized, non-computer, electronic equipment may well be radically changed by FIST. The method of fault isolation by semi-automatic techniques developed at the National Bureau, to which the acronym FIST has been applied, is a diagnostic method for rapidly isolating faults without removing the modules from the prime equipment. Although the method was devised to permit the novice technician to check module performance without being required to interpret data, it also enables the skilled technician to isolate rapidly a malfunctioning module without reference to technical manuals, and without prior knowledge of the equipment being tested.

This monograph discusses the techniques, procedures, circuits, and test equipment that are integral parts of the FIST system.

### Basic Industrial Electronics

By ALFRED HAAS. Pp. 208. Iliffe Books Ltd., Dorset House, Stamford Street, London, S.E.1. Price 35s.

This book is an elementary review of the kind of circuits and accessories to them which are employed in industrial electronics. It is intended to present an overall picture of this field and because of this it necessarily lacks detail.

Valves are used in most of the circuits rather than transistors and this does make it rather easier to understand, although it makes the book less representative of modern practice.

### Advances in Radio Research

Edited by J. A. SAXTON. Vol. 1, pp. 226 + x. Price 50s. Vol. 2, pp. 215 + x. Price 50s. Academic Press Inc. (London) Ltd., Berkeley Square House, Berkeley Square, London, W.1.

These books are in sections by different authors. Vol. 1 includes 'Measurement of the Radio Refractive Index of the Atmosphere' by A. W. Straiton, 'Tropospheric Refraction' by B. R. Bean, 'Attenuation of Radio Waves in the Troposphere' by B. R. Bean, and 'Electromagnetic Surface Waves' by James R. Wait. Vol. 2 includes 'Ionospheric Indices' by C. M. Minnis, 'Antennas and Receivers for Radio Astronomy' by John W. Findlay, and 'Radio Noise from Thunderstorms' by F. Horner.

### Thin Film Electronics in the U.S.A.

By G. SIDDALL. Pp. 28. Published by The British Electrical & Allied Industries Research Association, Cleeve Road, Leatherhead, Surrey. Price 18s.

Before initiating a programme of thin-film research in the Electronics Division at the Electrical Research Association, it was considered essential to visit the U.S.A. The object was to obtain some first-hand knowledge of thin-film research and development work in a reasonable cross-section of industrial laboratories and research institutions. Altogether, visits were made, at the end of 1962, to twenty establishments.

This report is based on the results of these visits. In 28 pages, this gives a broad view of the way in which thin-film electronics is expanding in the U.S.A. Some of the various problems which are encountered in research, development and production are also included.

## Manufacturers' Literature

---

**Electrothermal Electronic Equipment & Components.** This 1964-65 catalogue describes in 50 pages the current range of Electrothermal products. They include temperature controllers, environmental test chambers, thermal chambers, precision resistors and Ministry approved valve retainers.

*Electrothermal Engineering Ltd., 270 Neville Road, London, E.7.*

**For further information circle 51 on Service Card**

**Mifax Business Machines.** A 12-page brochure giving a non-technical description of the Mifax business facsimile communication system operating over the public telephone network. It includes a thumbnail history of facsimile transmission, a brief specification, a description of the operation and an example of a received facsimile copy compared with the original.

*Muirhead & Co. Ltd., Beckenham, Kent.*

**For further information circle 52 on Service Card**

**Plannette Range of Blowers.** In this 4-page leaflet a range of axial flow blowers, from 4½ in. to 12-in. diameter, is described. The leaflet includes photographs and comprehensive technical data for each model together with detailed performance graphs.

*Plannair Ltd., Windfield House, Leatherhead, Surrey.*

**For further information circle 53 on Service Card**

**G.E.C. Brushless A.C. Generators.** The G.E.C. range of brushless a.c. generators is described in this 12-page Publication P1199. In these machines the normal d.c. exciter is replaced by a revolving-armature a.c. exciter, the output of which is rectified by semiconductor diodes and fed to the revolving field system of the main a.c. generator by leads passing through hollow driving shafts.

*G.E.C. (Engineering) Ltd., Electrical Engineering Works, Witton, Birmingham 6.*

**For further information circle 54 on Service Card**

**Weir Encoder and Serializer.** This single-sheet leaflet gives details of an instrument which accepts and stores information presented in parallel in any digital codes, records the information and presents it serially to a printer, punch or other digital recorders.

*G. & J. Weir Ltd., Cathcart, Glasgow, S.4.*

**For further information circle 55 on Service Card**

**Vibro-Meter Catalogue.** In six pages this publication briefly covers the range of Vibro-Meter products. They include: inductive transducers; piezoelectric transducers; strain gauges; power units and measuring bridges; and indicating and recording equipment.

*Vibro-Meter Corporation, Haletop Civic Centre, Wythenshawe, Manchester 22.*

**For further information circle 56 on Service Card**

**International Rectifier Catalogue.** Listed in this catalogue, SFC 4, are silicon diodes from 4 mA to 250 A (up to 1,600 p.i.v.); thyristors from 3 to 150 A (up to 1,300 p.i.v.); Zener diodes from 400 mW to 50 W (3.1 to 200 V). Information is also given on selenium stacks, suppressors, silicon diode/thyristor assemblies, high-voltage columns and special Zener reference elements.

*International Rectifier Co., Hurst Green, Oxted, Surrey.*

**For further information circle 57 on Service Card**

**Mazda Semiconductors 1964-65.** In pocket-sized booklet form this publication provides abridged data on the Mazda range of germanium audio transistors and television silicon diodes. Also included is a 'Comparable List'.

*Thorn-A.E.I. Radio Valves & Tubes Ltd., 155 Charing Cross Road, London, W.C.2.*

**For further information circle 58 on Service Card**

**Mullard Semiconductors Designers' Guide.** The 24-page guide contains 'Quick Find Charts' for transistors which list the devices under the main headings of collector voltage, total dissipation, and cut-off frequency. This basic information is augmented in subsequent pages under device headings which also include the full range of diodes, rectifier diodes and thyristors. Full dimensional drawings and details of the international encapsulation outlines are given.

*Mullard Ltd., Industrial Markets Division, Mullard House, Torrington Place, London, W.C.1.*

**For further information circle 59 on Service Card**

**Perkin-Elmer Model F11 Gas Chromatograph.** Described in this 12-page brochure is an instrument with a range of interchangeable units which makes it possible to select a chromatograph to fit the particular requirements of the user. Included are details of the dual column analyser unit with a differential flame ionization detector.

*Perkin-Elmer Ltd., Beaconsfield, Bucks.*

**For further information circle 60 on Service Card**

**Siemens Screened Cubicles & Interference Suppression Filters.** A range of screened cubicles and a range of interference suppression filters are described in detail in this 61-page booklet. Available in the U.K. from

*R. H. Cole Electronics Ltd., 7-15 Lansdowne Road, Croydon, Surrey.*

**For further information circle 61 on Service Card**

**Elliott Angular Displacement A.C. Pick-Offs.** In four pages this leaflet (Publication W.22/1) covers a range of a.c. pick-offs. When energized from an a.c. supply these give a linear output voltage which is proportional to angular shaft displacement.

*Elliott Brothers (London) Ltd., Century Works, Lewisham, London, S.E.13.*

**For further information circle 62 on Service Card**

**Sperry Gravimaster.** A new version of the Gravimaster is described in this 6-page brochure. This is an instrument for the continuous in-line measurement of liquid density or solid content of slurries.

*Sperry Gyroscope Co. Ltd., Great West Road, Brentford, Middlesex.*

**For further information circle 63 on Service Card**

**'Filtercons'.** Two ranges of Erie high-frequency low-pass filters have been up-rated. This 8-page publication describes them and all other 'Filtercons' produced by

*Erie Resistor Ltd., South Denes, Great Yarmouth, Norfolk.*

**For further information circle 64 on Service Card**

**Brentford Stepless On-Load Voltage Regulators.** Brief specifications for a range of industrial voltage regulators are given in this 16-page brochure. They range in current-handling capacity from 5 to 100,000 A/phase and voltage operation is from 25 to 33 kV/phase.

*Brentford Transformers Ltd., Manor Royal, Crawley, Sussex.*

**For further information circle 65 on Service Card**

---

### ★ FOR THE BUYER

You must have read about a number of products and processes in this issue of which you would like further details. You can obtain this information very easily by filling in and posting one or more of the enquiry cards to be found inset in the back of the journal.

# INDEX

## INDUSTRIAL ELECTRONICS VOL. 2 1964

	MONTH	PAGE		MONTH	PAGE
<b>A</b> .E.I. Control System for Radio Telescope .. ..	June	272	Disc Recording and Reproduction, P. J. Guy .. ..	July	353
— Introduce an Alpha-Numeric Display .. ..	May	217	E.E.A. Guide for a Method of Measuring the Solder-ability of Round Wires .. ..	Aug.	403
Abbey National Install a Computer .. ..	July	343	Einführung in die Anwendung moderner Rechenautomaten, H. Bühler .. ..	Aug.	403
Accurate Pressure Transducers for Extreme Environments, P. J. Colburn .. ..	Sept.	407	Electrical Control Systems in Industry, C. S. Siskind .. ..	Apr.	202
Advanced Electron Beam Furnace .. ..	Dec.	581	Electromagnetic Slow Wave Systems, R. M. Bevensee .. ..	Nov.	546
Aerial Gain, Improved Method of Measuring, B. Collins and B. Sykes .. ..	July	345	— Theory for Engineering Applications, W. L. Weeks .. ..	Dec.	593
Aerials, Polyester/Glass Fibre .. ..	Aug.	368	Electronic Data Processing Symposium, The .. ..	Jan.	52
Alignment of U.H.F. Television Tuners .. ..	Sept.	440	— Information Display Systems, Edited by J. H. Howard .. ..	June	306
Analogue Computer for Road Research .. ..	Aug.	361	— Valve Bases, Caps and Holders, Addition to B.S. 448 .. ..	June	306
— Service .. ..	Mar.	137	Electronics for Students of Mechanical Engineering, H. Sutcliffe .. ..	July	353
Analysers, Low-Cost Statistical .. ..	Mar.	146	Elements of Feedback and Control, A. M. Hardie .. ..	Dec.	593
Application of Fibre-Optic Faceplates in Cathode-Ray Tubes, The, L. S. Allard .. ..	June	273	Enamelled Copper Conductors (Self-fluxing) Part 1: Round Wire (British Standard 3188 : Part 1A : 1963) .. ..	Jan.	51
— Silicon Planar P-N-P-N Switches, S. Lukens .. ..	Sept.	438	Étude des Circuits Électriques Vol. 2: Régimes de Fonctionnement, J. Lagasse .. ..	Aug.	403
Applying Analogue Computers to Industrial Process Control, W. E. Willison .. ..	Feb.	62	Fixed Capacitors, G. W. A. Dummer .. ..	July	353
Automatic Cake-Baking Plant .. ..	July	315	— Mica Dielectric Capacitors, Part I: General Requirements and Tests (British Standard 2132 : Part 1 : 1963) .. ..	Jan.	51
— Coin Segregating, Counting and Bagging .. ..	Mar.	112	Fundamentals of Microwave Electronics, V. N. Shevchik .. ..	June	306
— Control of Mineral Bunkers, G. Cooper .. ..	Oct.	460	Graphical Symbols for Components of Servo-Mechanisms : Part 2. General Servo Mechanisms (B.S. 3238 : Part 2) .. ..	June	305
— Malt Blending Plant .. ..	Dec.	578	Guide to the Design and Construction of Electronic Equipment, A .. ..	Jan.	51
— pH Control .. ..	May	212	International System (SI) Units, The (B.S. 3763 : 1964) .. ..	Oct.	497
— Seat Reservation System for B.E.A. .. ..	Jan.	42	Introduction to Lasers and Masers, A. Lytel .. ..	July	354
— Statistical Analysis, W. E. Mason .. ..	Feb.	58	— Space Communication Systems, G. N. Krassner and J. V. Michaels .. ..	Nov.	545
— Tippler Weighbridge in South Africa .. ..	Dec.	565	Loudspeakers, E. J. Jordan .. ..	Aug.	403
Axial-Flow Fan Design Charts .. ..	Nov.	513	Magnetic and Electric Suspensions, P. J. Geary .. ..	Nov.	545
			— Tape for Automatic Data Processing (British Standard 3658 : 1963) .. ..	Jan.	51
<b>B</b> AKERY Equipment, Rumanian Automatic .. ..	Oct.	477	Magnetohydrodynamic Generation of Electrical Power, Edited by R. A. Coombe .. ..	Aug.	403
Balancer, Shipyard Install Dynamic .. ..	Jan.	16	Maintainability Design, Edited by F. L. Ankenbrandt .. ..	Apr.	202
Ball Bearing Inspection by Electronics .. ..	Dec.	564	Measuring the Electrical Properties of Electronic Tubes and Valves (I.E.C. Publication 151: Parts 1 to 4) .. ..	July	354
Beer Plant, Controller for .. ..	June	283	Mechanical and Electrical Vibrations, J. R. Barker .. ..	Dec.	593
Blending Plant, Automatic Malt .. ..	Dec.	578	Mesures Électriques et Électroniques, J. Thurin .. ..	Aug.	403
<b>BOOKS:</b>			Metallurgy of Advanced Electronic Materials, Edited by G. E. Brock .. ..	July	353
Acoustics, G. W. Mackenzie .. ..	Nov.	545	Methods of Measurement of Essential Electrical Properties of Receiving Aerials in the Frequency Range from 30 Mc/s to 1,000 Mc/s (Supplement to I.E.C. Publication 138) .. ..	July	353
Acoustique et Electroacoustique: Vol. II, J. Matras .. ..	Nov.	545	Microphones 2nd Ed., A. E. Robertson .. ..	June	305
Advances in Electronic Circuit Packaging, Vol. 3, Edited by L. L. Rosine .. ..	Jan.	51	Microwave Solid-State Engineering, Edited by L. S. Nergaard and M. Glicksman .. ..	Sept.	449
— Radio Research, Edited by J. A. Saxton .. ..	Dec.	593	— Tubes and Semiconductor Devices, G. D. Sims and I. M. Stephenson .. ..	Feb.	102
Amplifiers, H. L. York .. ..	Aug.	403	Modern Dictionary of Electronics, Compiled by R. F. Graf .. ..	July	354
Analog Computer Techniques, 2nd Ed., C. L. Johnson .. ..	June	305	Physics of Failure in Electronics, Edited by M. F. Goldberg and J. Vaccaro .. ..	Jan.	51
Analogue and Digital Computer Methods, D. J. Harris .. ..	Nov.	545	— Magnetic Recording, The, C. D. Mee .. ..	Aug.	403
Analyse des Réseaux Électriques à Tubes et à Transistors, A. Kaufmann, B. Grabowski and J. Thouzery .. ..	Mar.	154	Principles of Coding, Filtering and Information Theory, L. S. Schwartz .. ..	July	354
Analysis of Linear Time-invariant Systems, W. M. Brown .. ..	Mar.	154	Problèmes d'Électronique, R. Guillien .. ..	Aug.	403
Aufgaben aus der Fernmeldetechnik nebst Lösungen, K. Buttler .. ..	Nov.	546	Project FIST (Fault Isolation by Semi-automatic Techniques), G. Shapiro et al. .. ..	Dec.	593
Automatic Data Processing, F. P. Brooks, Jr. and K. E. Iverson .. ..	May	255	Radio Reception, H. Henderson .. ..	Aug.	403
— Voltage Regulators and Stabilizers, G. N. Patchett .. ..	Oct.	498	Recommendations for the Selection, Formation and Definition of Technical Terms (British Standard 3669 : 1963) .. ..	Feb.	102
BEAMA Directory (2nd Edition): 1964-65, The .. ..	Apr.	202	— on Semiconductor Rectifiers (Mono-Crystalline) (B.S. 3771 : 1964) .. ..	Oct.	498
Basic Electronics, 2nd Ed., R. G. Kloeffler, M. W. Horrell and L. E. Hargrave, Jnr. .. ..	Mar.	153	Reference Data for Radio Engineers .. ..	Nov.	546
— Industrial Electronics, A. Haas .. ..	Dec.	593	Research and Development Engineer as Manager, The, T. Moranian .. ..	July	354
— Pulse Circuits, R. Blitzer .. ..	Oct.	497	Sasco Radio and Electronic Master Catalogue .. ..	Oct.	497
Beginner's Guide to Electronics, T. L. Squires .. ..	Nov.	546			
British Instruments Directory and Buyers' Guide: 4th Ed. .. ..	June	305			
— Valve and Semiconductor Industry .. ..	Sept.	449			
Brown Boveri 1964 Electron Tube Handbook .. ..	Nov.	545			
Ceramic Insulating Materials for General Electrical Purposes (B.S. 1598 : 1964) .. ..	Apr.	202			
Composition Variable Resistors (For Use in Telecommunications and Allied Electronic Equipment): Part 1, General Requirements and Tests (B.S. 2122 : Part 1 : 1964) .. ..	May	256			
Design and Operation of Digital Computers, Dr. G. Haas .. ..	Jan.	51			
Dictionnaire Générale d'Acoustique et d'Electroacoustique, H. Piraux .. ..	Aug.	403			
Digital Computer Technology and Design, Vol. 1, W. H. Ware .. ..	Jan.	52			
— Vol. 2, W. H. Ware .. ..	Feb.	102			
— Magnetic Recording, A. S. Hoagland .. ..	Aug.	403			
— Storage Systems, W. Renwick .. ..	July	353			



	MONTH	PAGE
Satellite Communications Physics, Edited by R. M. Foster, Jr.	Mar.	154
Semiconductor Fundamentals, Devices and Circuits, A. H. Seidman and S. L. Marshall	June	305
Sensitive Switches Part I: Terminology (International Electrotechnical Commission Publications 163-1 1963)	an.	51
Sensitivity Indices for Hall Generators, S. Rubin and G. J. Rogers	May	255
Single Sideband Principles and Circuits, E. W. Pappenfus, W. B. Bruene and E. O. Schoenike	Sept.	449
Specification for Radio-Frequency Cables: Parts 1 & 2 (B.S. 2316: Parts 1 & 2: 1963)	May	255
Static Electromagnetic Frequency Changers, L. L. Rozhanskii	July	354
Supplement No. 1 to Glossary of Terms Used in Telecommunication (Including Radio) and Electronics: Terms Used in Wired Broadcast and Broadcast Relay	July	353
Tape Recording and Reproduction, A. A. McWilliams	Aug.	403
Telecommunication Facilities in Buildings Part 3: Sound Distribution Systems (Publication CP327)	Oct.	497
Television Engineering	Jan.	51
Testing and Calibration of Ultrasonic Therapeutic Equipment (I.E.C. Publication 150)	July	353
Théorie et Technique de la Transmission Télégraphique, Vol. I Théorie, R. Roquet	Aug.	403
Thin Film Electronics in the U.S.A., G. Siddall	Dec.	593
Training Revolution, The, J. Wellens	July	354
Transistor Applications, R. F. Shea	Oct.	497
— Inverters and Converters, T. Roddam	Mar.	153
Ultrasonic Delay Lines, C. F. Brockelsby, J. S. Palfreeman and R. W. Gibson	Apr.	202
Units and Standards of Measurement Employed at the National Physical Laboratory: Light	Sept.	449
Universal Decimal Classification: English Edition (B.S. 1000 (621.3))	May	256
Vacuum and Solid State Electronics: An Introductory Course, D. J. Harris and P. N. Robson	June	305
— Technology, A. Guthrie	Aug.	403
Who Makes Machinery? 1964 Edition	Nov.	545
Brewer System, C. D. Fruin	Oct.	467
Britain's First Permanent Video-Phone Link	Aug.	396
By TV to the Continent	Oct.	469
C.E.G.B. Telemetry System, The, J. W. Dillow	Apr.	157
C.R.T., High Resolution	Mar.	147
Cake-Baking Plant, Automatic	July	315
Camera for Microelectronics, Multiple Pin-Hole, T. E. Price	Feb.	85
Capacitor Production, Solid Tantalum	Apr.	195
Car Body Finishing Temperatures, Data Logger Monitors	May	232
Cathode-Ray Tubes, Educational, D. M. Sutherland	Mar.	143
Cathodic Protection, S.C.R. Regulator for	Apr.	170
Central Read-out System for Radio-isotope Assay	Aug.	390
Checkweighers, Production Line Electronic	Mar.	138
Checkweighing and Grading, High-Speed Electronic	Oct.	479
Check Weighing Equipment, J. A. Musto and R. W. Newman	Aug.	357
Chemical and Biological Applications of High-Intensity Ultrasonics, B. Brown	Apr.	191
— Plant Control by Digital Computer	Nov.	541
Cigarette Filling, Electronics Watch, P. J. Robins	Mar.	135
Circuits, A Hybrid Approach to Integrated, D. R. Tibbetts	Aug.	391
Coded Magnetic Characters, G. E. Thorne	Nov.	505
Coin Segregating, Counting & Bagging, Automatic	Mar.	112
Cold-Cathode Tube Applications	June	284
COMMENT: Jan. 1, Feb. 53, Mar. 103, Apr. 155, May 203, June 257, July 307, Aug. 355, (Correspondence) Sept. 449, Sept. 405, Oct. 451, Nov. 499,	Dec.	547
Computer, Abbey National Install a	July	343
— Chemical Plant Control by Digital	Nov.	541
— Corrects Wagon Wastage, P. J. Robins	Jan.	10
— for Road Research, Analogue	Aug.	361
— Handles 6,000,000 Telephone Accounts, G.P.O.	Sept.	444
— Making Animated Films by	Aug.	372
— Rental Services Expanded	June	287
— Service, Analogue	Mar.	137
Computers to Industrial Process Control, Applying Analogue, W. E. Willison	Feb.	62
Continuous Weighing of Bulk Cement, A. Ditcher	Apr.	168
Control of D.C. Motors by Thyristors, J. Forbes-Simcock	May	205
— System, Elliott Sequence, G. S. Smith	July	309
— New Sequence	Feb.	61
— Versatile Line Milling	July	344
Controller for Beer Plant	June	283
Co-ordinate Setter, A Punched-Tape Controlled Digital, G. T. Ohlsen	Nov.	515
CORRESPONDENCE:		
Words, M. G. Scroggie	Sept.	449
Counter, The Electronic, O. H. Davie	July	339
Counters Today and Tomorrow, Electronic, D. R. Ollington	Apr.	163

	MONTH	PAGE
— Used in Length Measurement, Digital, G. Cooper	Aug.	369
Cryogenics, Routine	Dec.	589
DATA-Handling Equipment for a High-Speed Wind Tunnel, F. Shaw	July	316
— Logger Monitors Car Body Finishing Temperatures	May	232
— Tanker Performance at Sea	Dec.	583
— Loggers for Ship Research	July	348
— Logging on Board Ship, A. J. Boseley	June	259
Developments in Electronic Reading Machines, John B. Rudkin, Aug. 397, Sept. 410,	Oct.	475
Digital Counters Used in Length Measurement, G. Cooper	Aug.	369
— Techniques in Industry, G. Cooper Apr. 185, May 233, June 267, F. Shaw July 316, G. Cooper Aug. 369, G. Cooper and F. Shaw Sept. 421, G. Cooper	Oct.	460
— Transmission System	Apr.	173
Direct Analogue Equipment for the Study of Water Distribution Networks, A. R. W. Williams	Oct.	457
— Ultrasonic Thickness Measurement	July	320
Display, A.E.I. Introduce an Alpha-Numeric	May	217
Doppler in Aircraft, G. Thomas, Feb. 55,	Mar.	117
E.R.A. Installed at Leeds	Mar.	116
— Eastern Gas Telemetry System	Oct.	492
Educational Cathode-Ray Tubes, D. M. Sutherland	Mar.	143
Effect of Minor Constituents of Soft Solder, The, B. M. Allen and W. Rubin	Nov.	534
Electron Microscope Features Ease of Operation	Apr.	194
Electronic Counter, The, O. H. Davie	July	339
— Counters Today and Tomorrow, D. R. Ollington	Apr.	163
— Gas-Control System	Jan.	8
— Measurement of Golf Ball Resilience	Sept.	418
— "Pig" Detection, P. R. Forrer	Mar.	110
Electronically Controlled Forging	May	239
Electronics at the IMEKO III and I & M VI Conferences	Dec.	579
— in a New Steel Plant	Sept.	419
— Golf-Club Shaft Production	Sept.	445
— The Service of Medicine	June	301
— Watch Cigarette Filling, P. J. Robins	Mar.	135
Elliott Sequence Control System, G. S. Smith	July	309
Encapsulating with Plastic Shells, Milton Ross	Sept.	441
Equalization of Level	Jan.	17
EQUIPMENT REVIEW: Jan. 18, Feb. 74, Mar. 120, Apr. 174, May 242, June, 292, July 326, Aug. 374, Sept. 426, Oct. 480, Nov. 522,	Dec.	566
Error-Detection Equipment for Telex	July	349
EXHIBITIONS:		
A.S.E.E.	Mar.	140
Business Efficiency 1964	Nov.	518
Electronics for Medical Diagnosis	June	301
Farnborough Air Show 1964	Oct.	470
IMEKO III and I & M VI Conferences	Dec.	579
Instruments, Electronics & Automation, Preview May 220, Report	June	276
Physics and The Physical Society, The Institute of	Feb.	92
Swiss Watch Fair 1964	June	291
Experimental Wireless	Jan.	33
FABRICS for Colour Television Testing	Mar.	149
— Fan Design Charts, Axial-Flow	Nov.	513
Fast Thermal Scanner Assists Medical Research, M. Swiss	May	215
Feed Drives for Automatically Controlled Machine Tools, M. Monk	Jan.	3
Fibre-Optic Faceplates in Cathode-Ray Tubes, The Application of, L. S. Allard	June	273
Film Granularity Measurement by Kodak	May	213
Films by Computer, Making Animated	Aug.	372
Forging, Electronically Controlled	May	239
Function Generator, Transistorized Non-Linear, P. Kundu and S. Banerji	Jan.	35
Furnace, Advanced Electron Beam	Dec.	581
G.P.O. Computer Handles 6,000,000 Telephone Accounts	Sept.	444
Gas-Control System, Electronic	Jan.	8
Golf Ball Resilience, Electronic Measurement of	Sept.	418
— Club Shaft Production, Electronics in	Sept.	445
Growing Quartz Crystals	Aug.	373
Guide for Printed Board Material	Dec.	563
HIGH Resolution C.R.T.	Mar.	147
— Sensitivity Image Intensifiers for U.K.A.E.A.	Sept.	414
— Speed Electronic Checkweighing and Grading	Oct.	479
— Radiography, D. J. Davis and D. C. Laval	Aug.	386
"Home-Made" Transistor Signal Source	May	229
Hybrid Approach to Integrated Circuits, A. D. R. Tibbetts	Aug.	391

	MONTH	PAGE
IBM Accounting System	Feb.	60
<b>ILLUSTRATED NEWS:</b>	Jan.	34, 47
Image Intensifiers for U.K.A.E.A., High Sensitivity	Sept.	414
Improved Method of Measuring Aerial Gain, B. Collins and B. Sykes	July	345
Industrial Applications of Radioactive Tracers, Denis Taylor	Feb.	89
— Electronics Binding Service	Jan.	50
<b>INDUSTRIAL NEWS:</b>		
A.E.I. Computer Centre	June	304
ARCH 8000 Process Control System	June	304
A.S.E.E. 1966	Oct.	495
Acoustics Research	Feb.	100
Anglo-French Liaison	May	254
Audio-Visual Teaching Aids Conference	July	352
Automation at the Consumer End of the Brewing and Catering Industries	Jan.	50
BEAMA/Nigeria Overseas Committee	Feb.	100
Boiler House Control Room	Feb.	101
Carbon Content of Stainless Steel	Aug.	401
Chair of Control Engineering at Bangor	May	254
Closed-Circuit Television at Shoe Warehouse	Apr.	200
Coalface Roof Supports, Automatic Control for	Sept.	448
Colour Camera for TSR-2 Flight Simulator	Oct.	496
Component Testing Facilities, Enlarged	Nov.	542
Computer Price Cut by 25%	Feb.	101
Computers in the City	Aug.	402
Computing System at Tin-Plate Works	Apr.	199
Corsair Computer, The	May	254
Data Links for Atlas Computer	Dec.	591
— Processing Equipment	Feb.	98
— Transmission Service, P.O.	Aug.	402
Dawe Instruments Sponsor Lectureship	Sept.	448
Detector for Imperfect Cable Joints	May	252
Digital System Logs Flight Information, New	Apr.	201
Doubling Radiotelephone Channels	Oct.	496
E.E.A. Joins Eurospace	Dec.	592
Effects of Computers on Office Employment	Feb.	101
Electron Microscope	May	253
Electronic Instruments On-Hire	Dec.	592
— Swim Timing Assembly	Aug.	400
Electronics at Birmingham University	Mar.	153
Elliott 503 Computer	May	254
Engine Tuning Facilities	July	352
Environmental Testing of Components	Oct.	494
Europe's First Facsimile Newspaper	Apr.	201
Free 'Robotester' Course	Nov.	544
G.E.C. Electronics Launches P.C. Service	Sept.	448
Generators, Alkali Metal	Nov.	544
Giant Diffusion Pump	Oct.	496
Grant for Computer Control of Printing	Apr.	201
Head-up Display Equipment	June	304
Honours, New Year Feb. 100, Birthday	July	351
I.E.E. Election and Award	Apr.	200
Inclusion Identifier	Sept.	446
Inductors Design and Manufacturing Service	Sept.	448
Industrial Calculations	Mar.	153
Integrated Laser Service	May	254
London International Engineering Exhibition, 1965	Dec.	592
Mail Segregating Machine	Jan.	48
Marine Automation System for 'Esso Warwickshire'	Nov.	544
Material Testing Service	July	351
Microminiaturization, The Meaning of	Nov.	543
Microwave Power Transmission	Dec.	592
Miniature Television Camera	June	303
Mobile Demonstration Unit	Feb.	100
Noise and Vibration Reduction Exhibition	Oct.	496
Nuclear Instrumentation System	July	352
<b>PERSONAL AND COMPANY NEWS:</b>	Jan.	48,
Feb. 98, Mar. 150, Apr. 199, May 252, June, 302,		
July 350, Aug. 400, Sept. 446, Oct. 494, Nov. 542...	Dec.	590
Plessey Expand	Mar.	153
Power Station Supervisory Equipment	July	351
Quality Control	June	304
Racal Expand	July	352
Radar Information Decoder	Mar.	151
— Link Assists Thames Navigation	June	304
— on Causeway	Jan.	49
Radiation Testing of Insulated Materials	Oct.	496
Radio Telescope	July	350
Rapid Colour Matching Service	Feb.	101
Reactor Control System	Apr.	201
Remotely-Controlled Signalling for British Railways	Aug.	402
Sorting Germanium Wafers	Dec.	591
Static-Switching Controls at Gas Works	June	302
Superconducting Thin Films	Apr.	201
Tape-wound Transformer Cores	Aug.	402
Telemetry for Algerian Pipeline	Oct.	495
Telephone Beam System	Sept.	447
Television at Cape Kennedy, Marconi Colour	Nov.	543
— Society Premiums	Sept.	448
— Station	Feb.	99
— Transmitters for BBC-2	Dec.	590
Theatre Sound System	Mar.	151
Traffic Control by Computer, Wide-Area Road	Sept.	447
Troposcatter Aerial	Jan.	49
Tropospheric Scatter Power Amplifier	Mar.	150
Two-Channel Closed-Circuit TV	Nov.	544
Valves, 500,000,000	Jan.	50

	MONTH	PAGE
VASCA Appointments	Sept.	448
Video Telephone	Mar.	152
Vidicon Colour Camera	Jan.	50
Industrial Telemetry, R. C. Griggs	Aug.	362
Inertial Navigation, A. R. M. Murray	July	313
Integrated Circuits	Nov.	504
Introduction to Vibration Measurement and Analysis, An, W. G. A. McCormick	Nov.	501
Inverter Drives for Telerecording, Static	Nov.	514

<b>L</b> ASER Equipment, Versatile	July	322
— Ophthalmoscope, The	July	348
— Welding of Semiconductor Integrated Circuit Interconnections, T. E. Price	Oct.	478
Lighting from the Motorist's Viewpoint, Measuring Road Loading Machine, Static-Switching Control System for a Pallet, G. Cooper and F. Shaw	Feb.	73
Log Recorder Improves Trawler Efficiency	Sept.	421
Logging System, Tank, J. T. Dobson	July	321
Logicon Building-Block System, R. E. Young	Jan.	30
Low-Cost Statistical Analysers	Apr.	161
	Mar.	146

<b>M</b> ACHINE Tools, Feed Drives for Automatically-Controlled, M. Monk	Jan.	3
— One-, Two- and Three-Dimensional Tracing for, J. Robb	Dec.	553
Magnetic Characters, Coded, G. E. Thorne	Nov.	505
Magnets for Reed Switches, F. Knight	Dec.	558
Making Animated Films by Computer	Aug.	372
<b>MANUFACTURERS' LITERATURE:</b> Jan. 52, Feb. 102, Mar. 154, Apr. 202, May 256, June 306, July 354, Aug. 404, Sept. 450, Oct. 498, Nov. 546,	Dec.	594
Manufacturing Multi-Range Meters, Ainsley Cattle	June	263
Maximum Demand Power Indicator, G. Cooper	June	267
Measuring Oxygen in Hot Gases	Feb.	88
— Road Lighting from the Motorist's Viewpoint	Feb.	73
Metallurgical Applications of High Intensity Ultrasonics, B. Brown	Mar.	113
Microwave Band Designations	Aug.	394
Mineral Bunkers, Automatic Control of, G. Cooper	Oct.	460
More Remote Control for Brighton Waterworks	May	219
Multiple Pin-Hole Camera for Microelectronics, T. E. Price	Feb.	85

<b>N</b> EW MATERIALS:		
Expanded Cobalt	Sept.	425

<b>O</b> BITUARIES:		
Darnley-Smith, G.	May	253
Dowsett, H. M.	Mar.	152
Eastham, Melville	Aug.	401
Huggins, Percy	Feb.	99
Kemp, Roland John	Jan.	50
Pearce, S. F.	Jan.	50
Willson, H. C.	Sept.	447
One-, Two- and Three-Dimensional Tracing for Machine Tools, J. Robb	Dec.	553
Operability, R. C. Winton	July	323
OSCAR Will Control Steelmaking	Jan.	17
Oscilloscope Display Projection	Aug.	399
Oxygen in Hot Gases, Measuring	Feb.	88

<b>P</b> H Control, Automatic	May	212
'Pig' Detection, Electronic, P. R. Forrer	Mar.	110
Pneumatic Sound Generator	Jan.	7
Polyester/Glass Fibre Aerials	Aug.	368
Pozidrivs Supersede Phillips Screws	Feb.	72
Printed Board Material, Guide for	Dec.	563
Production and Properties of High-Intensity Ultrasonics, B. Brown	Jan.	44
— Line Electronic Checkweighers	Mar.	138
Protecting Aircraft Distribution Systems, K. F. Bacon	July	334
Punched-Tape Controlled Digital Co-ordinate Setter, A. G. T. Ohlsen	Nov.	515

<b>Q</b> UALITY-Control Aid in Turbine Blade Production	Aug.	395
Quartz Crystals, Growing	Aug.	373

<b>R</b> ADAR, Speed Measuring, N. W. Stanbury	Dec.	549
Radioactive Tracers, Industrial Applications of, Denis Taylor	Feb.	89
Radiography, High-Speed, D. J. Davis and D. C. Laval	Aug.	386
Radio-isotope Assay, Central Read-out System for	Aug.	390
Railway Locomotive Simulator	May	216
Reading Machines, Developments in Electronic, John B. Rudkin, Aug. 397, Sept. 410,	Oct.	475
Recorder Improves Trawler Efficiency, Log	July	321
Remote Control by Telephone	Mar.	148
Routine Cryogenics	Dec.	589
Rumanian Automatic Bakery Equipment	Oct.	477

	MONTH	PAGE		MONTH	PAGE
S.C.R. Regulator for Cathodic Protection .. .. .	Apr.	170	Trainers, Visual Display .. .. .	Sept.	420
Screws, Pozidrivs Supersede Phillips .. .. .	Feb.	72	Transducers for Extreme Environments, Accurate Pressure, P. J. Colburn .. .. .	Sept.	407
Selenium Rectifier for Television Sets .. .. .	Nov.	517	Transistor Circuits for Industrial Use, Simple, F. Bamforth, Nov. 537, .. .. .	Dec.	584
Semiconductor Test Sets, New .. .. .	May	238	— Operating Conditions, W. Tusting, Mar. 132, Apr. 171, May 230, .. .. .	June	288
Sequence Control System, New .. .. .	Feb.	61	Transistorized Non-Linear Function Generator, P. Kundu and S. Banerji .. .. .	Jan.	35
Ship Propulsion Analysis .. .. .	Dec.	552	— Ultrasonic Probe .. .. .	Jan.	43
Shipyards Install Dynamic Balancer .. .. .	Jan.	16	Tuners, Alignment of U.H.F. Television .. .. .	Sept.	440
Signal Source, 'Home-Made' Transistor .. .. .	May	229	Turbine Blade Production, Quality-Control Aid in .. .. .	Aug.	395
Simple Transistor Circuits for Industrial Use, F. Bamforth, Nov. 537, .. .. .	Dec.	584			
Solder, The Effect of Minor Constituents of Soft, B. M. Allen and W. Rubin .. .. .	Nov.	534			
Solid Tantalum Capacitor Production .. .. .	Apr.	195			
Speed-Measuring Radar, N. W. Stanbury .. .. .	Dec.	549			
Static Inverter Drives for Telerecording .. .. .	Nov.	514			
— Switching Control System for a Pallet Loading Machine, G. Cooper and F. Shaw .. .. .	Sept.	421	<b>ULTRASONIC</b> Cleaning, B. Brown .. .. .	Feb.	69
Statistical Analysis, Automatic, W. E. Mason .. .. .	Feb.	58	— Probe, Transistorized .. .. .	Jan.	43
Statistics with Steel Balls .. .. .	Oct.	466	— Thickness Measurement, Direct .. .. .	July	320
Steel Plant, Electronics in a New .. .. .	Sept.	419	Ultrasonics, Chemical and Biological Applications of High-Intensity, B. Brown .. .. .	Apr.	191
Sun Powers New Radio Warning System .. .. .	June	275	— Cleans Dental Drills Faster .. .. .	July	348
Suspended Solids Recorder, A New, G. B. Thorpe .. .. .	Sept.	415	— Metallurgical Applications of High Intensity, B. Brown .. .. .	Mar.	113
Switches, Application of Silicon Planar P-N-P-N, S. Lukens .. .. .	Sept.	438	—, Production and Properties of High-Intensity, B. Brown .. .. .	Jan.	44
—, Magnets for Reed, F. Knight .. .. .	Dec.	558			
Symposium on Cold-Cathode Tubes and their Applications .. .. .	June	284			
			<b>VERSATILE</b> Laser Equipment .. .. .	July	322
<b>TV</b> Outside Broadcasts, 11-Gc/s Links for .. .. .	Mar.	134	— Line Milling Control System .. .. .	July	344
— to the Continent, By .. .. .	Oct.	469	Vibration and Eccentricity Monitoring at Richborough Power Station .. .. .	May	241
Tank Gauging Development, New .. .. .	July	325	— Measurement and Analysis, An Introduction to, W. G. A. McCormick .. .. .	Nov.	501
— Logging System, J. T. Dobson .. .. .	Jan.	30	— in Steam-Turbine Blade Development, I. Finbow .. .. .	Jan.	14
Telemetering System, The C.E.G.B., J. W. Dillow, Apr. 157, .. .. .	May	209	— Monitoring Equipment for Industrial Plant .. .. .	Feb.	68
Telemetry, Industrial, R. C. Griggs .. .. .	Aug.	362	Video-Phone Link, Britain's First Permanent .. .. .	Aug.	396
— System, Eastern Gas .. .. .	Oct.	492	Visual Display Trainers .. .. .	Sept.	420
Telescope, A.E.I. Control System for Radio .. .. .	June	272			
Television Aids Translation in the Theatre .. .. .	Nov.	540	<b>WARNING</b> Equipment, Theft, Fire or Flood .. .. .	Oct.	493
— Testing, Fabrics for Colour .. .. .	Mar.	149	— System, Sun Powers New Radio .. .. .	June	275
Telex, Error-Detection Equipment for .. .. .	July	349	Water Distribution Networks, A Direct Analogue Equipment for the Study of, R. W. Williams .. .. .	Oct.	457
Theft, Fire or Flood Warning Equipment .. .. .	Oct.	493	Waterworks, More Remote Control for Brighton .. .. .	May	219
Thermal Scanner Assists Medical Research, Fast, M. Swiss .. .. .	May	215	Weighbridge in South Africa, Automatic Tippler .. .. .	Dec.	565
Thyristor Control of Ward Leonard Drives, B. J. Hodgskiss .. .. .	Mar.	105	Weighing of Bulk Cement, Continuous, A. Ditcher .. .. .	Apr.	168
— Firing Circuit for A.C. Power Applications, A. E. R. Orr .. .. .	Nov.	509	Weights and Measures Stamp Load Cell Weighbridge .. .. .	Feb.	67
Thyristors, Control of D.C. Motors by, J. Forbes-Simcock .. .. .	May	205	Words ( <i>Comment</i> ) Aug. 356, ( <i>Correspondence</i> ) .. .. .	Sept.	449
Toe-in Indication Equipment, F. R. Towner .. .. .	Oct.	453			

## Index to Authors

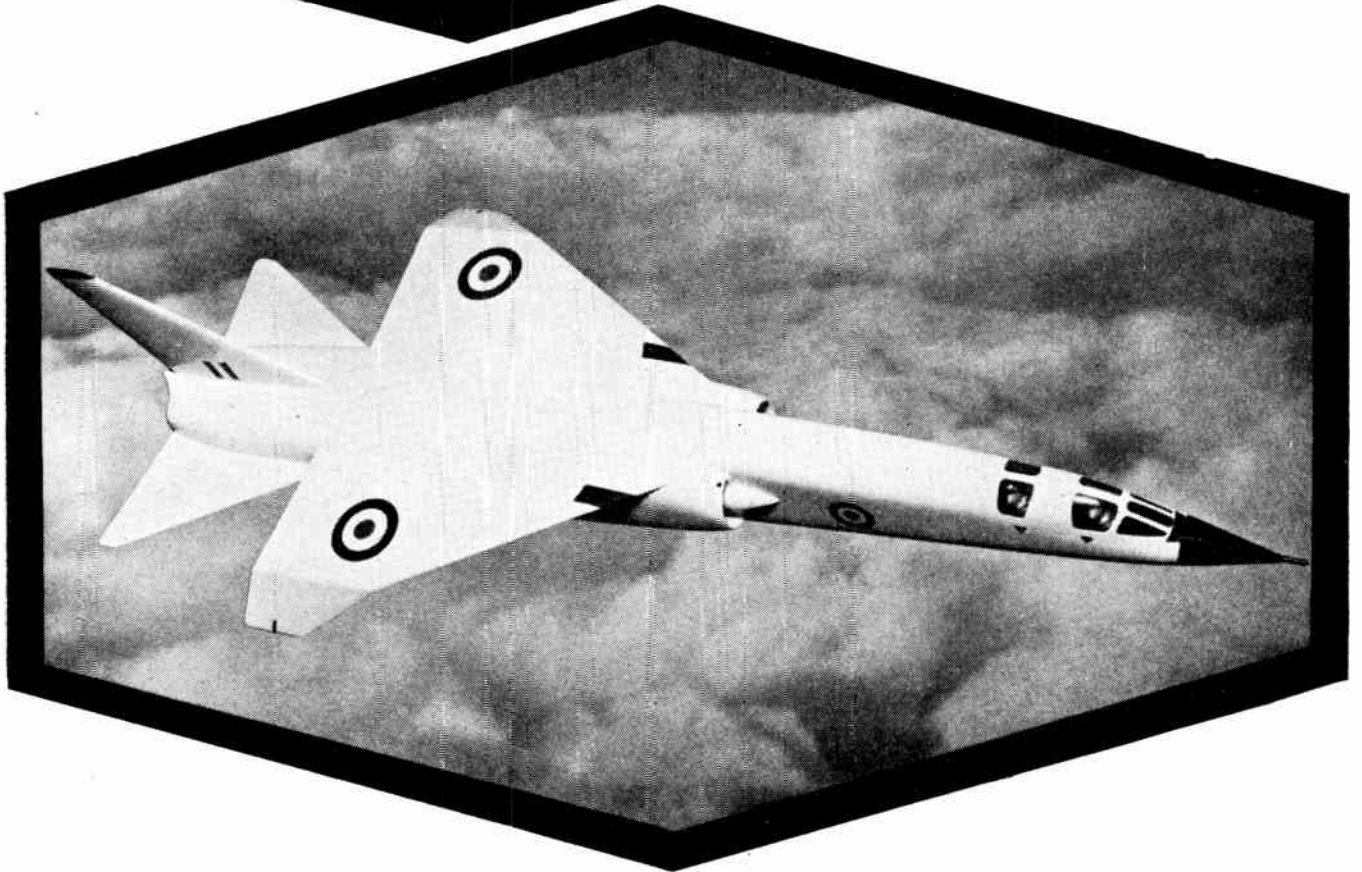
ALLARD, L. S. .. .. .	June	273	MONK, M. .. .. .	Jan.	3
ALLEN, B. M. and RUBIN, W. .. .. .	Nov.	534	MURRAY, A. R. M. .. .. .	July	313
			MUSTO, J. A. and NEWMAN, R. W. .. .. .	Aug.	357
BACON, K. F. .. .. .	July	334	NEWMAN, R. W. with MUSTO, J. A. .. .. .	Aug.	357
BAMFORTH, F. .. .. .	Nov.	537, Dec. 584			
BANERJI, S. with KUNDU, P. .. .. .	Jan.	35	OHLSSEN, G. T. .. .. .	Nov.	515
BOSELEY, A. J. .. .. .	June	259	OLLINGTON, D. R. .. .. .	Apr.	163
BROWN, B. .. .. .	Jan. 44, Feb. 69, Mar. 113, Apr. 191		ORR, E. R. .. .. .	Nov.	509
CATTLE, AINSLEY .. .. .	June	263	PRICE, T. E. .. .. .	Feb. 85, Oct. 478	
COLBURN, P. J. .. .. .	Sept.	407			
COLLINS, B. and SYKES, B. .. .. .	July	345	ROBB, J. .. .. .	Dec.	553
COOPER, G. Apr. 185, May 233, June 267, Aug. 369, .. .. .	Oct.	460	ROBINS, P. J. .. .. .	Jan. 10, Mar. 135	
COOPER, G. and SHAW, F. .. .. .	Sept.	421	ROSS, MILTON .. .. .	Sept.	441
			RUBIN, W. with ALLEN, B. M. .. .. .	Nov.	534
DAVIE, O. H. .. .. .	July	339	RUDKIN, JOHN B. .. .. .	Aug. 397, Sept. 410, Oct. 475	
DAVIS, D. J. and LAVAL, D. C. .. .. .	Aug. 386				
DILLOW, J. W. .. .. .	Apr. 157, May 209		SHAW, F. .. .. .	July	316
DITCHER, A. .. .. .	Apr.	168	SHAW, F. with COOPER, G. .. .. .	Sept.	421
DOBSON, J. T. .. .. .	Jan.	30	SMITH, G. S. .. .. .	July	309
			STANBURY, N. W. .. .. .	Dec.	549
FINBOW, I. .. .. .	Jan.	14	SUTHERLAND, D. M. .. .. .	Mar.	143
FORBES-SIMCOCK, J. .. .. .	May	205	SWISS, M. .. .. .	May	215
FORRER, P. R. .. .. .	Mar.	110	SYKES, B. with COLLINS, B. .. .. .	July	345
FRUIN, C. D. .. .. .	Oct.	467			
			TAYLOR, DENIS .. .. .	Feb. 89	
GRIGGS, R. C. .. .. .	Aug.	362	THOMAS, G. .. .. .	Feb. 55, Mar. 117	
			THORNE, G. E. .. .. .	Nov.	505
HODGSKISS, B. J. .. .. .	Mar.	105	THORPE, G. .. .. .	Sept.	415
			TIBBETTS, D. R. .. .. .	Aug.	391
KNIGHT, F. .. .. .	Dec.	558	TOWNER, F. R. .. .. .	Oct.	453
KUNDU, P. and BANERJI, S. .. .. .	Jan.	35	TUSTING, W. .. .. .	Mar. 132, Apr. 171, May 230, June 288	
LAVAL, D. C. with DAVIS, D. J. .. .. .	Aug.	386	WILLIAMS, R. W. .. .. .	Oct.	457
LUKENS, S. .. .. .	Sept.	438	WILLISON, W. E. .. .. .	Feb.	62
			WINTON, R. C. .. .. .	July	323
MCCORMICK, W. G. A. .. .. .	Nov.	501	YOUNG, R. E. .. .. .	Apr.	161
MASON, W. E. .. .. .	Feb.	58			



We don't make  
supersonic jets

- but we help to  
make them better

**UNION  
CARBIDE**



The electronic components in a supersonic jet *must* work without failure. Their selection therefore is most critical as only components of the highest reliability and closest tolerances can be accepted. The electronic system in the British Aircraft Corporation TSR2 includes Kemet solid tantalum capacitors. Kemet capacitors are also used in the British Aircraft Corporation VC10, the Hawker Siddeley ship-to-air guided missile Sea Slug, and their air-to-ground guided bomb Blue Steel—fair proof of their reliability in performing vital functions in extreme conditions. But Kemet tantalum capacitors can be more down to earth too. They are best for all terrestrial electronic equipment including computers wherever accuracy and consistent reliability are essential.

KEMET J-SERIES CAPACITORS comply with US MIL-C-26655A UK DEF/5134-A/1. EID & ARB release available.

**KEMET PRODUCTS.**

Polar and non-Polar solid tantalum capacitors—'J' and 'N' series (standard), 'C' series (for commercial applications), 'P' series (for printed circuits); Barium Getters; Silicon Monoxide; Laser/Maser Crystals; Alumina; Dunker motors.

**UNION CARBIDE LIMITED,**

ENGINEERING PRODUCTS DIVISION,  
8 GRAFTON STREET, LONDON W1.

Sales & enquiries: Aycliffe Industrial Estate, Co. Durham. Aycliffe 2180. Telex 58568.

U.K. distributors for 'J' series capacitors:

**SASCO**, GATWICK ROAD, CRAWLEY, SUSSEX. CRAWLEY 28700.

## **CAPACITORS** ANOTHER PRACTICAL PRODUCT OF UNION CARBIDE

CHEMICALS • CRYOGENICS • DYNEL FIBRE • ELECTRONIC COMPONENTS • FERRO-ALLOYS • FLAME PLATING • MOLECULAR SIEVES • SILICONES • SUPER ALLOYS • UCON LUBRICANTS

The terms Kemet, Dynel, Ucon and Union Carbide are trademarks of Union Carbide Corporation.

wcw2

# HONEYWELL CONTROLS WHAT NATURE ABHORS

Honeywell Instrumentation System controls high purity steel production at the new William Beardmore & Co. Ltd vacuum degassing plant, Parkhead, Glasgow.



---

Vacuum degassing was adopted by William Beardmore & Co. for their new plant as an efficient method of producing high purity steel. And to control the process, they chose the safety and efficiency of a Honeywell instrumentation system. Result—the most modern plant of its kind in Britain.

---

### **ONE MAN CONTROL**

The main panel instrumentation indicates and records critical temperatures of molten metal within the 20' deep vacuum chamber, pressures of the steam ejection system, cooling water flow and the steam condensers supply. Control point for the operator is a desk, sited in front of the panel, which diagrammatically displays the installation. 75 to 80 tons of steel are treated at one time, in 100 ton ladles to allow for vigorous boiling action. Molten metal is poured from the electric-arc furnace into a large ladle which is quickly transferred to the vacuum degassing chamber. The chamber cover is lowered, a neoprene seal making the chamber airproof for immediate vacuum degassing.

### **HONEYWELL ILLUMINATED PUSHBUTTONS DEFINE PROCEDURE**

Vacuum is achieved by a six stage steam ejection system, each stage being brought in according to a well defined procedure by depression of a Honeywell Illuminated Pushbutton Unit. Pressure readings are followed on four circular indicating instruments, one instrument taking over from the next as the pressure decreases until, after some 8 minutes, a final value of 0.5 torr is attained. Nitrogen gas at 15 lb/sq. in. is injected near the bottom of the ladle to induce a 'boiling' action. This exposes a greater volume of metal to the effect of the vacuum for efficient extraction of dissolved oxygen, hydrogen and other gases.

### **PROCESS SAFEGUARDED**

Honeywell Pyr-O-Vane instruments form part of an alarm system giving immediate warning should metal break out of the ladle during the degassing operation. A high speed single point recorder on the panel charts the temperature of the steel as the ladle is lowered into the chamber—which determines the total time in the chamber to give a predetermined final pouring temperature. Temperature is again measured at the end of the degassing operation.

### **COMPLETE HONEYWELL CAPABILITY**

Modern processes and Honeywell Instrumentation go hand in hand to provide optimum efficiency, maximum safety. Any process, any industry—Honeywell have the instrumentation to control it, have 75 years of International experience and know-how in developing systems to meet the most exacting demands. If they haven't already a solution to *your* process control problems, they'll find it quickly, economically, efficiently. Ask them.

Honeywell Controls Limited  
Greenford Middlesex Waxlow 2333

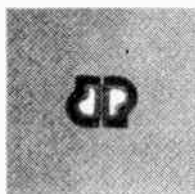
**Honeywell**  
INDUSTRIAL PRODUCTS GROUP

**HONEYWELL INTERNATIONAL** Sales and Service offices in all principal cities of the world. Manufacturing in United Kingdom, U.S.A., Canada, Netherlands, Germany, France, Japan.





# FIELD-EFFECT TRANSISTORS



Siliconix offer the widest range of FET's



### features

- P-Channel unipolar
- High input impedance
- High transconductance (up to 2,500)
- Low pinch-off voltage (1.7 volts types available)

### Typical Applications

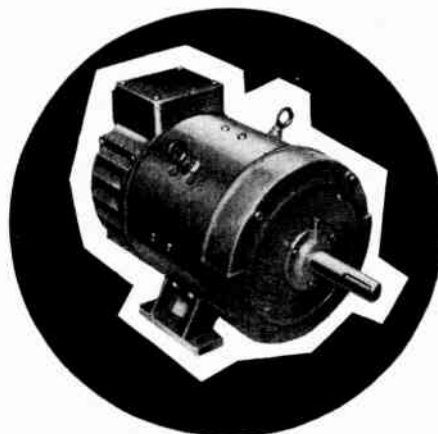
- D.C. amplifiers
- Choppers
- Voltage controlled receivers
- High input impedance amplifiers
- Compact voltmeter

### Photosensitive F.E.T.

Spectral range : 4,000 - 11,000 Å

## WALMORE ELECTRONICS LTD.

11-15 BETTERTON STREET, DRURY LANE, LONDON, W.C.2.  
Telephone: TEMple Bar 0201-5



'X' type D.C. motors, 1/4 - 40 h.p.

You can't say **DEPENDABLE** without **EPE**



'Y' type D.C. motors, 1/4 - 40 h.p.

## D.C. Motors for electronic speed control



THE ELECTRICAL POWER ENGINEERING CO. (B'HAM) LTD.  
EPE WORKS, BROMFORD LANE, BIRMINGHAM 8  
Telephone: STEchford 2261  
Grams: Torque Phone, Birmingham

**INSTRUMENTAL POPULARITY**

Popularity, as certain youthful musical groups have found after losing pieces of shirt and locks of hair to their admirers, can be a two-edged sword. Blind adulation by fanatics *en masse* places a heavy burden on the object of admiration to live up to an expected standard.

Pop-singers, for one reason or another, retain the height of popularity for relatively short periods, probably, the cynics will say, because each is no better nor worse than his predecessors.

On the other hand, our 700 series of measuring instruments 'topped the charts' over seven years ago and is still the most popular single design of meter. Admiration for this type has, if anything, increased since it was first developed, and is far from blind, but popularity in this case poses us no problems because we know the 700 series reflects the reputation we have built up over the years and it can stand up to the most critical examination.

Don't get the idea, though, that this is an antiquated design. Its continued popularity lies in the length and clarity of the scale, its adaptability to special dial markings, and the clean lines of the case beloved of equipment stylists; all features which commended the 700 series when it was introduced and will do so for many years to come.

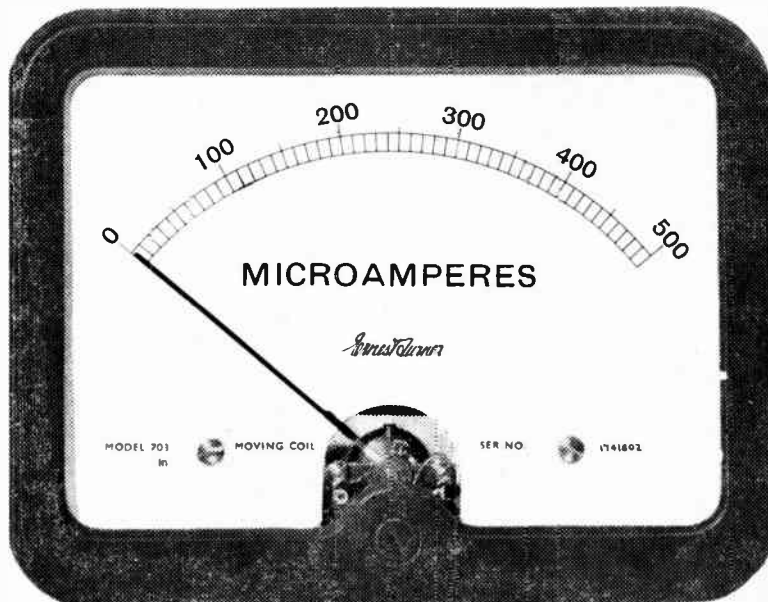
Orders for 702's, 703's and 705's keep flowing in, but far from tearing our hair out or losing our shirts, we stuck out our necks a few months ago and added the miniature 701 to the range.

Naturally, users of the 700's have at their disposal the full Ernest Turner service in respect of special variations, fittings and dial markings. The descriptive literature gives details of self-contained ranges, and we are able to supply external fittings for extended ranges when required. Our dial manufacturing service should need no introduction, and we can produce dials carrying markings to specification, whatever the units involved. A further possibility which we have found is appreciated by many customers is the manufacture of instrument cases in colours—although our standard colour for opaque mouldings is black, other colours can be supplied to order at little extra cost.

The



page



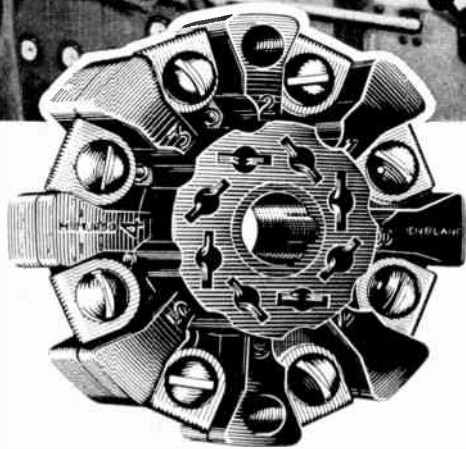
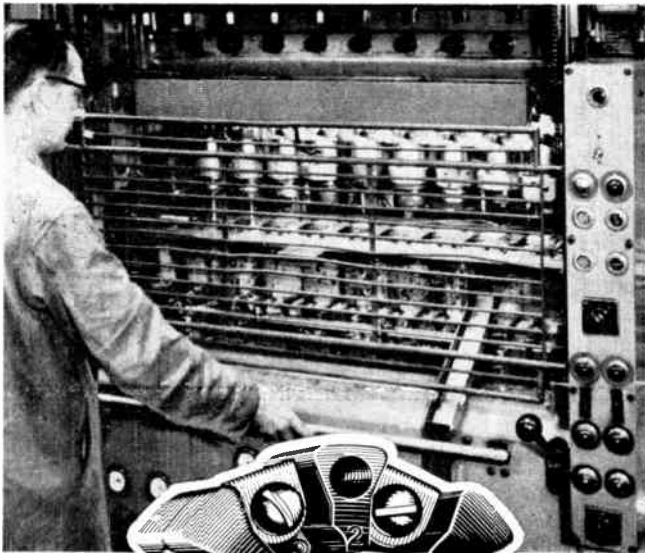
Illustrated above is the Model 703, approximately actual size. The scale length is nominally  $3\frac{1}{8}$  in. and the movements available are moving coil, rectifier, moving iron and thermo couple. Also in the series are Models 705 (scale length  $4\frac{3}{4}$  in.), 702 (scale length 2 in.) and the miniature 701 (scale length  $1\frac{3}{8}$  in.) which is eminently suited to portable applications.

Full details of ranges and fittings are given in Catalogue No. 85/21, available on request from :

**ERNEST TURNER  
ELECTRICAL INSTRUMENTS LTD**

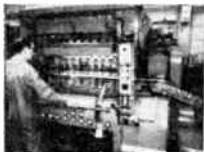
CHILTERN WORKS · HIGH WYCOMBE  
BUCKINGHAMSHIRE · ENGLAND

Tel : High Wycombe 1301



## Octal Socket

**McMurdo** B8/UPM Moulded International Octal Socket with screw terminations for top surface mounting. Specially designed for plug-in relays with octal bases.



**Press Room**  
9 stage Transfer Press making valvholder skirts.

# McMurdo

## McMurdo Instrument Co. Ltd.

Rodney Rd., Portsmouth, Hants.  
Tel. Portsmouth 35555. Telex 8612.  
Contact our Sales Office for details of our full range

# LUGTONS

E.I.D.  
Approved  
Store

● Appointed Distributors of

## McMURDO COMPONENTS

over **600 TYPES** normally in stock

Lugton's also distribute A. H. HUNT, S. G. BROWN, ACOS, BRIMAR, G.E.C., MULLARO VALVES, AVO, BELLING-LEE, BULGIN, IMPERIAL IRONS, etc.

**LUGTON & CO. LTD. INDUSTRIAL DEPT.**  
Radio House, 209-212 Tottenham Court Road, London, W.1  
Tel.: MUSEum 3261/9 Ext. 101

For further information circle 233 on Service Card

## THE SPEARETTE PRINTED CIRCUIT SERVICING RACK

**WORTH INVESTIGATING**

WARLINGHAM, SURREY  
Upper Warlingham 2774

**SPEAR ENGINEERING CO. LIMITED**

For further information circle 234 on Service Card

## TRANSMETRIX

*For the highest quality and most rapid service in  
DESIGN LAYOUT MANUFACTURE CAPACITY*

### PRINTED CIRCUITS

and

### WIRING ASSEMBLY

*The expert staff and unique facilities of T.E.S.  
can save you TIME AND MONEY.*

**Phone: SHANKLIN 3096**

**TRANSMETRIX ELECTRONIC SYSTEMS LTD.**  
SHANKLIN · ISLE OF WIGHT · HAMPSHIRE

For further information circle 235 on Service Card

## VITALITY BULBS

FROM 1V to 50V IN SIZES FROM 4.5mm to 18mm DIAMETER

Tested and Proven

Miniature and Sub Miniature

Indicator Bulbs: Catalogue

Vitality Bulbs Ltd.

Neville Place, Wood Green, N.22

Bowes Park 0016



For further information circle 236 on Service Card



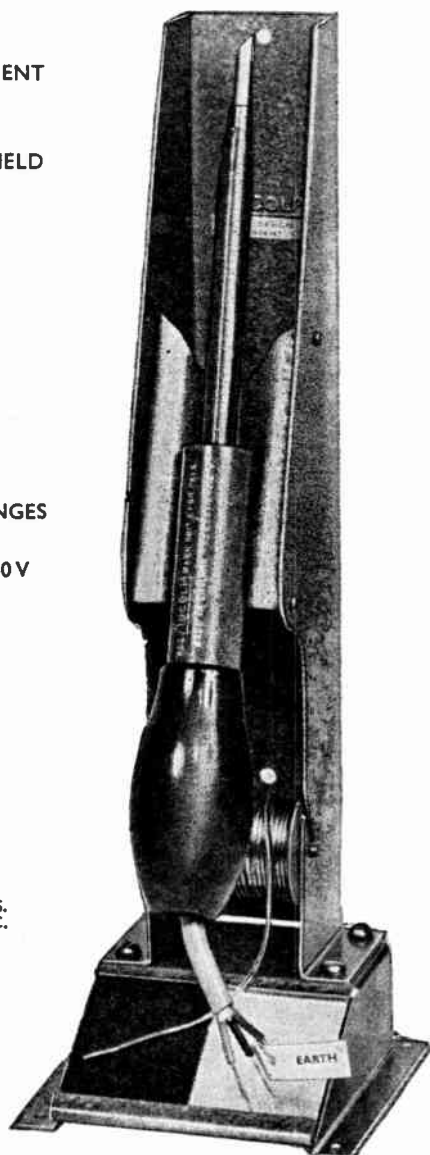
**SOLDERING  
EQUIPMENT**

**SPECIALISING FOR THE  
SOLDERING JOINTING INDUSTRY**

**Illustrated**

$\frac{3}{16}$ " BIT INSTRUMENT  
(LIST 64)  
IN  
PROTECTIVE SHIELD  
(LIST 700)

ALL VOLT RANGES  
FROM  
6/7 TO 230/250 V



BRITISH & FOREIGN PATS.  
& REG. DESIGNS, ETC.

Apply Direct for Catalogues :

**ADCOLA PRODUCTS LTD.**

**ADCOLA HOUSE**

**GAUDEN ROAD**

**LONDON, S.W.4**

Telephones MACaulay 4272 and 3101

Telegrams SOLJOINT LONDON S.W.4

Industrial Electronics December 1964

E\*\*

27

# Let the

## INDUSTRIAL ELECTRONICS

### READER ENQUIRY SERVICE

# help you to obtain more information

To obtain further details of any of the coded items mentioned in the Editorial or Advertisement pages of this issue, please complete one or more of the attached cards circling the appropriate reference number(s). Your enquiries will be passed on to the manufacturers concerned and you can expect to hear from them direct in due course. Cards posted from abroad require a stamp.

**PLEASE USE CAPITAL LETTERS**

Pour obtenir tous renseignements sur les produits codés mentionnés dans les articles ou dans les pages publicitaires de ce numéro, nous vous prions de remplir une ou plusieurs des cartes ci-jointes en encerclant le ou les numéros de référence appropriés. Vos demandes de renseignements seront transmises aux fabricants intéressés qui, en temps voulu, vous feront parvenir une réponse. Il est nécessaire d'affranchir les cartes postées de l'étranger.

**PRIÈRE D'UTILISER DES CARACTÈRES D'IMPRIMERIE**

Weitere Einzelheiten über irgendwelche Artikel, die auf redaktionellen oder Anzeigenseiten erscheinen, erhalten Sie, indem Sie eine oder mehrere der beigefügten Karten ausfüllen und die entsprechende(n) Kennnummer(n) einrahmen. Ihre Anfrage wird an den Hersteller weitergeleitet, und Sie werden dann direkt von ihm hören, Karten, die im Ausland aufgegeben werden, müssen frankiert werden.

**BITTE IN BLOCKSCHRIFT AUSFÜLLEN**

Per ulteriori particolari in merito agli articoli menzionati nel testo o nelle pagine pubblicitarie di questo numero, Vi preghiamo di completare una o più delle schede allegate chiudendo in un cerchietto il numero o i numeri di riferimento. La Vostra richiesta sarà inoltrata ai fabbricanti interessati che Vi risponderanno direttamente. Le schede dall'estero devono essere regolarmente affrancate.

**SI PREGA DI COMPILARE LE SCHEDE A  
TAMPATELLO**

Con objeto de obtener más detalles de cualquiera de los artículos mencionados en las páginas editoriales o de anuncios de este número, sírvase rellenar una o más de las unidas tarjetas poniendo un círculo al número o números de referencia. Sus consultas serán transmitidas a los fabricantes interesados de quienes tendrán noticias directamente a su debido tiempo. Las tarjetas enviadas desde el extranjero requieren franqueo.

**SÍRVASE ESCRIBIR CON LETRAS MAYUSCULAS**

# Dawe audio sweep oscillator and controller Type 443B

The only instrument of this kind made in the U.K.

Fields of use include: automatic measurement and recording of the frequency response curves of 4-terminal networks — audio amplifiers — tape recorders — hearing aids — loudspeakers and microphones; recording the acoustic properties of loudspeaker enclosures — studios — concert halls; and for vibration testing.

#### Main Features

- \* 20 c/s to 20 kc/s in a single range.
- \* Logarithmic scale calibration.
- \* High output with very low distortion.
- \* Output, or regulated level, monitored on a panel meter.
- \* Optional output regulation by external reference.
- \* Facility for external motor drive and synchronisation with a high-speed level recorder.



# DAWE

Full technical data from:—

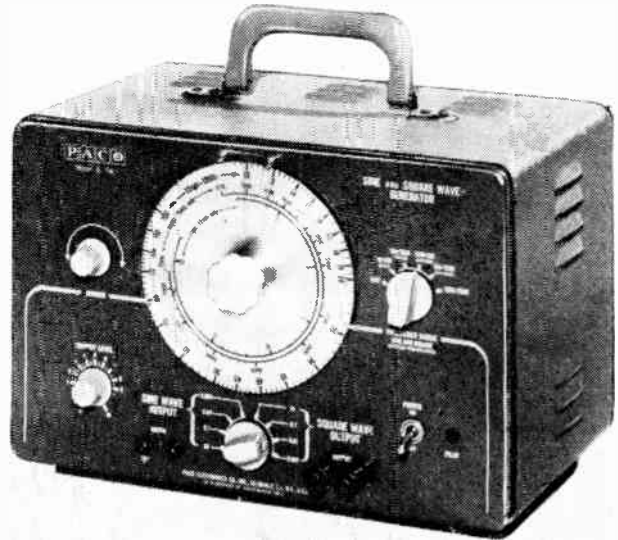
**DAWE INSTRUMENTS LTD., WESTERN AVE., LONDON, W.3 Tel: ACO 6175**

A member of the *Simms* group of companies

# We could write volumes ... but the specification speaks for itself

## VERY WIDE RANGE SINE/SQUARE WAVE GENERATOR MODEL G.34

Providing signals with negligible distortion from lowest audio to ultrasonic frequencies the G.34 is ideal for performance testing of audio equipment. Sine waves from 7 c/s to 750 kc/s within 1 dB at from 0 to 10 volts (600 ohms impedance) are available. Distortion is less than 0.3% from 20 to 20,000 c/s. Square waves are available from 7 c/s to 300 kc/s at 20 volts peak-to-peak (no load) with a rise time of less than 0.15 microseconds. Price complete: £40-7-0.

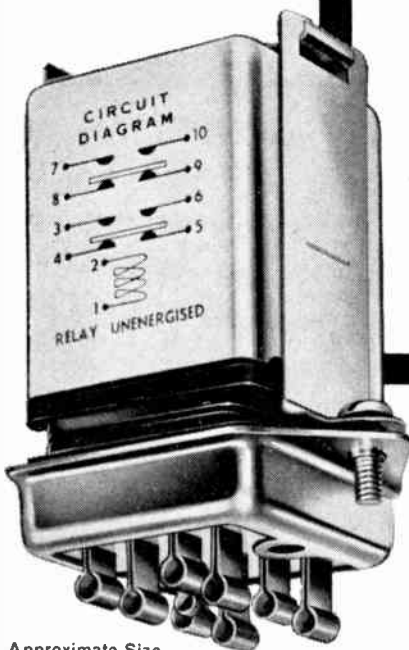


Write today for further details to: Dept. W.

**electric limited**

335 WHITEHORSE ROAD · CROYDON · ENGLAND  
Tel: THOrnton Heath 9905

For further information circle 239 on Service Card



## DIAMOND H GENERAL PURPOSE RELAYS (BW SERIES)



Versatile Mounting  
Arrangements

Panel Mounting  
with Solder Tag



Side Mounting



Socket Mounting



- 25 amp 250 volt A.C. double pole double throw
- Compact—only 1½" x 1½" x 1⅞" without socket
- Plug-in, solder tag or fast on terminations
- Coils available for 4-250 V., A.C. 50-60 cycles & 4-250 V., D.C.
- Mechanical life expectancy—in excess of 10 million cycles
- Weight—10 ozs. or less
- Plug-in, Side or Panel mounting

**PROVED PERFORMANCE! RELIABILITY! LONG LIFE! SILENT!  
PROMPT DELIVERY!**

**DIAMOND H CONTROLS LTD.** GUNNERSBURY AVENUE, CHISWICK, LONDON, W.4. CHISWICK 6444



# all this for £29.0.0!!!

- A fully engineered stroboscope with Xenon flash-tube giving intense white illumination at flash repetition rates of 100-15,000 per minute.
- Transistor circuit design combining accuracy and simplicity
- Portability: the mains-powered Flash-Tac weighs only 7½ lbs. and measures 10" x 8" x 7" overall.
- Suitability for all industrial and laboratory uses; ideal for educational purposes.

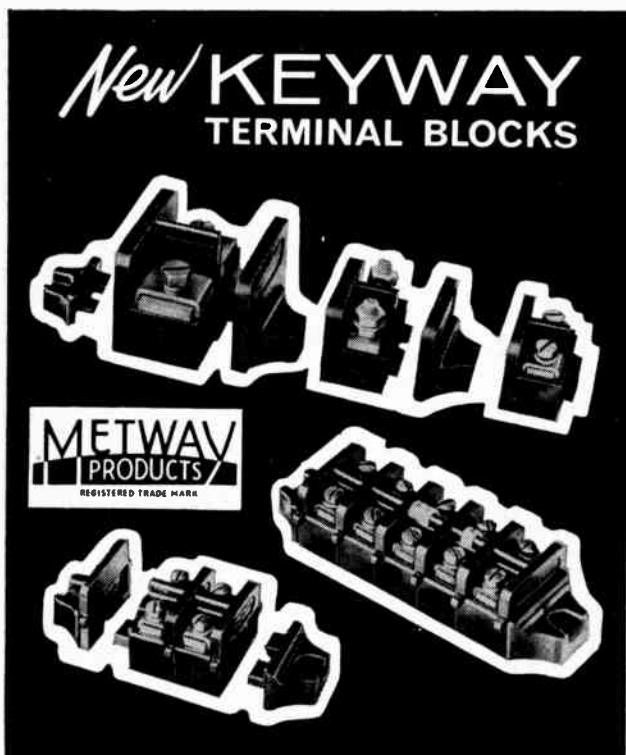
## The Flash-Tac Stroboscope

the unequalled combination of specification, quality and price.

For further information, write or telephone  
Electronic Applications (Commercial) Limited,  
Endeavour House, North Circular Road, London, N.W.2.  
Telephone: Speedwell 4651



For further information circle 241 on Service Card



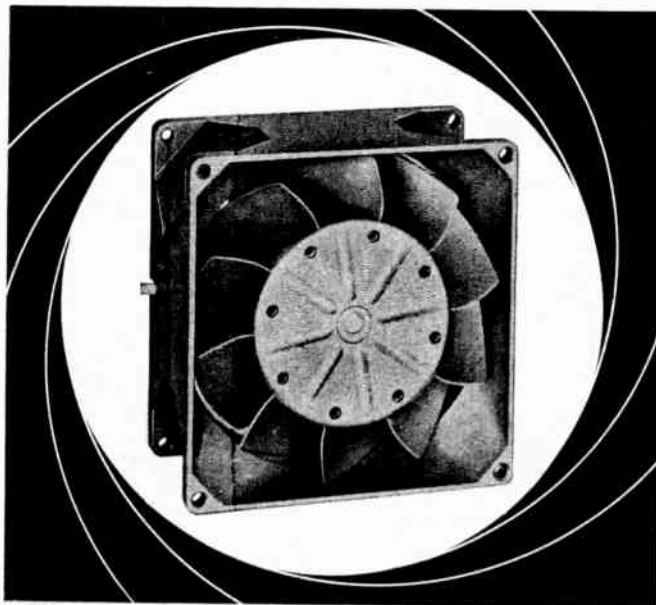
- 4 Amperages: 5-20, 30-40, 50-60, 75-100.
- All 4 sizes can be interlocked.
- No limit to the number of ways.
- Non tracking. Clamp down or pillar terminals.
- Press-on cable markers in letters and numerals.

Ask for Cat. No. NBQ16/IE.

**METWAY · KEMP TOWN · BRIGHTON 7**

For further information circle 242 on Service Card

## PAPST-FANS



### Miniature Axial Fans for High Reliability Applications

Compact design — High air delivery rate  
Minimum maintenance — Maximum reliability  
Quiet PAPT-MOTOR (external rotor system)

PAPT-MOTOREN KG 7742 St. Georgen W-Germany

# AUTOMATIC WATCHMAN

## FREES MEN FOR PRODUCTION



### FOR INSTANT WARNING OF VARIATIONS IN

- PRESSURES
- TEMPERATURES
- FLOWS
- HUMIDITY
- WEIGHTS
- ETC. ETC. or
- STOPPAGE OF MOTORS
- OR MECHANICAL FAILURE

Alarm Scanning and Data Logging for any Number of Points.

Continuous Scanning with High and Low Limit Settings for Critical Quantities.

Display on Mimic Diagrams.

Logging at Preset Time Intervals, On Demand or On Alarm.

Print-out by Electric Typewriter, Strip Printer or Tape Punch incorporating Time, Identification Codes, Values, etc.

Reliability and Minimum Maintenance assured by use of Solid State Circuitry.

A Westinghouse Automatic Watchman can be tailored to YOUR exact requirements.

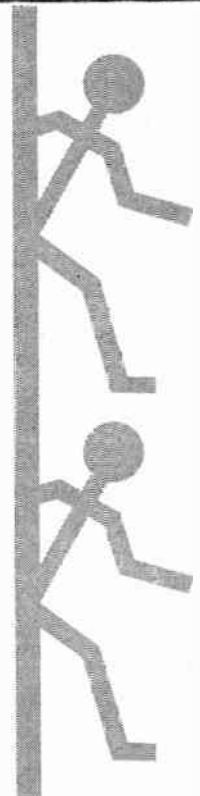
### INSTALL—



## ALARM SCANNING & DATA LOGGING FOR LOW COST AUTOMATION

For further information write to:—

**WESTINGHOUSE BRAKE AND SIGNAL CO. LTD. AUTOMATION DEPT., NEW ROAD, CHIPPENHAM, WILTS**





# JEM Photocells

Because their rugged, extra heavy steel base provides an indestructible glass-to-metal seal, Jem Photocells are proof against extreme weather conditions, vibration and mechanical shock. Bending and twisting of their leads cannot cause internal distortion or cause intermittent shorts.

## CDS-9 SERIES

Type No.	I FC Simulated Daylight 50 V AC Output	Nominal Resistance 50 FC 2800 K° Incand.	Max. Dark Current or Min. Ro	Max. Dissip.	Max. Voltage Dark
901	1.5 ma	165 ohms	25 µa	All ½ watt continuous, 2 watts 1 minute	1000 V
904	12 ma		70 µa		500 V
913			1.5 meg.		500 V
701	1.5 ma	670 ohms	25 µa	All ½ watt continuous, 1 watt 1 minute	500 V
703	6 ma		40 µa		350 V
711			4 meg.		500 V

CDS-9 (actual size)



Jem Photocells do not need light ageing after being in darkness for a considerable time, their advanced characteristics enable measurements to be made after only momentary exposure to light.

Tables at left give typical examples from the Jem range of 16 ultra-reliable Photocells.

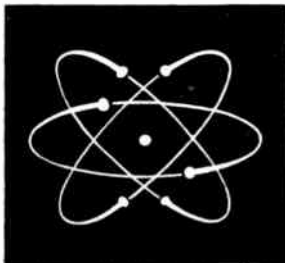
## CDS-7 SERIES

Send for further details of the full range of JEM Photocells

Sole technical representatives for U.K.

**HCD Research Ltd** 77 Gloucester Road, Croydon, Surrey. Tel: THOrnton Heath 7485

CDS-7 (actual size)



## two important new books for electronics students and technologists

### Transistor Circuits in Electronics

Basic principles for amplifier, oscillator and switching applications

S. S. Hakim, Ph.D., B.Sc., A.M.I.E.E. : R. Barrett, B.Sc., A.M.I.E.E.

Specially written for students taking electronics as their main subject in degree Dip. Tech. and H.N.C. courses. No mathematical knowledge higher than elementary calculus is assumed but the reader is expected to be familiar with Kirchhoff's Laws. Numerical examples have been introduced wherever necessary to illustrate the principles involved.

63s net by post 64s 5d 341 pp illustrated

### Electronics and Instrumentation

Robert L. Ramey

The purpose of this book is to provide a sound groundwork for understanding the basis of existing instruments and their applications. It will prove a useful introduction to instrumentation for students of electronics and a single course in electronics and instrumentation for students in other branches of science and engineering.

55s net by post 56s 4d 321 pp 207 illustrations

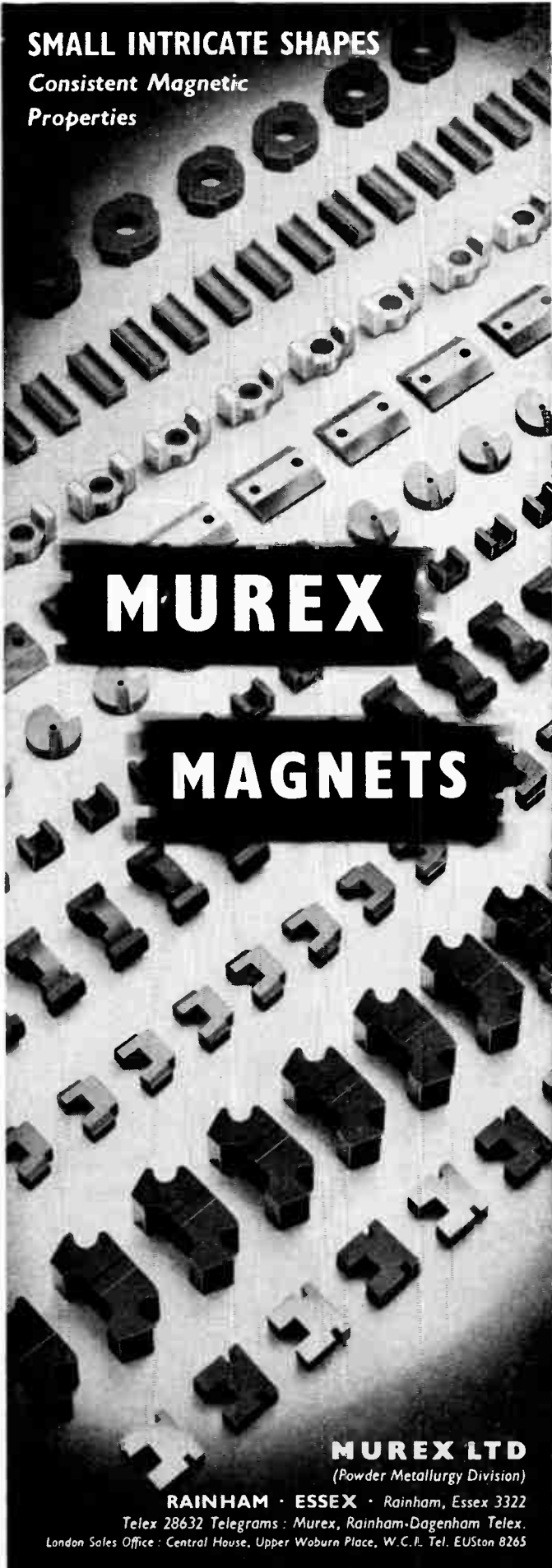
obtainable from leading booksellers

**ILIFFE Books Ltd.** DORSET HOUSE STAMFORD STREET LONDON SE1



# SMALL INTRICATE SHAPES

Consistent Magnetic Properties



# MUREX

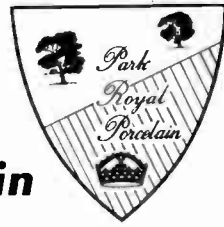
# MAGNETS

**MUREX LTD**  
(Powder Metallurgy Division)

**RAINHAM · ESSEX · Rainham, Essex 3322**

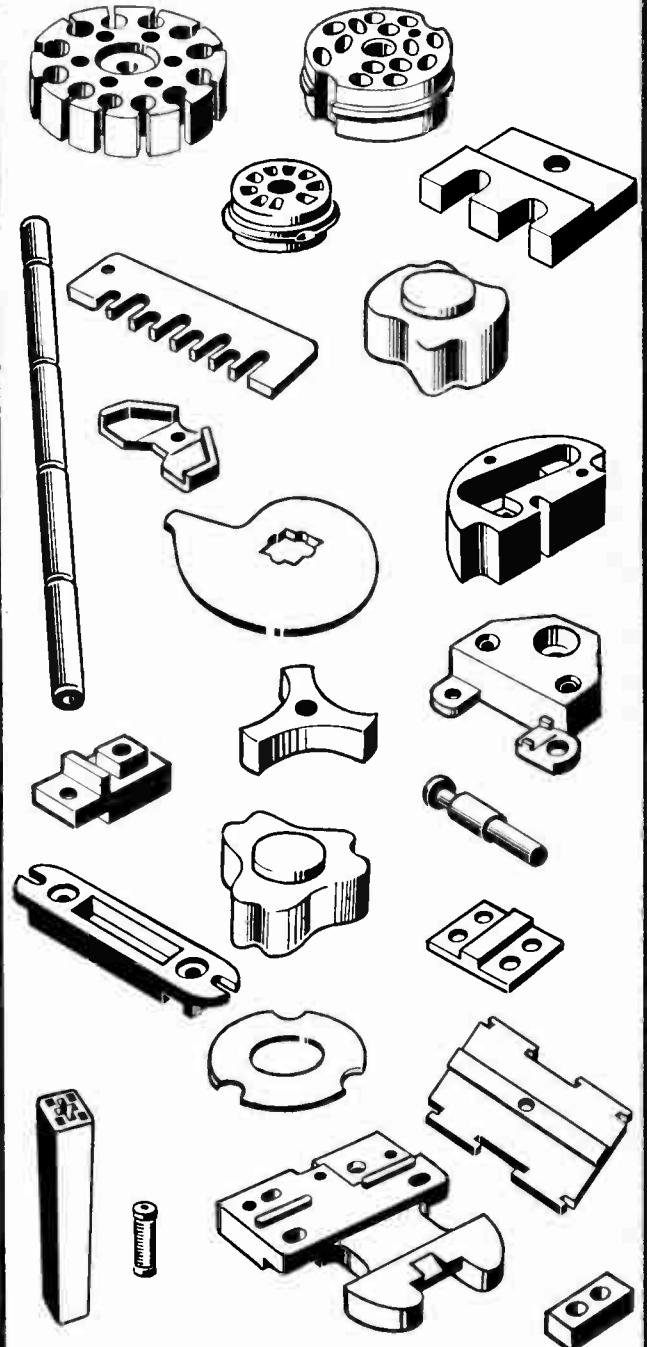
Telex 28632 Telegrams: Murex, Rainham-Dagenham Telex.

London Sales Office: Central House, Upper Woburn Place, W.C.1. Tel. EUSton 8265



**Porcelain**

**Steatite**



## V. G. PORCELAIN CO LTD

GORST ROAD  
PARK ROYAL  
LONDON, N.W.10

Telephones:  
ELGAR 1411/7  
Telex:  
London 25589

# CLASSIFIED ADVERTISEMENTS

**FULLY DISPLAYED:** 55/- per single column inch.  
**SEMI-DISPLAYED:** 45/- per single column inch.  
**RUN-ON:** 4/6 per line of approximately 7 words.  
Where an advertisement includes a Box Number Is. extra.  
**SERIES DISCOUNTS:** 12 insertions, 15%.  
Remittances payable to "Industrial Electronics".

Copy is required by 21st of the month for insertion in the following month's issue, by 15th of the month if proofs are required.

Address to:  
Classified Advertisement Dept.  
Industrial Electronics  
Dorset House, Stamford St., London, S.E.1.

## SITUATIONS VACANT

### *our requirements:*

## EXPERIENCED ELECTRONIC ENGINEERS OR TECHNICIANS

#### AGE GROUP:

19 to 40 years.

#### THE WORK:

The servicing, or testing and faultfinding of equipment.

#### THE PRODUCTS:

Sound and vibration meters, stroboscopes, ultrasonic cleaning units, storage oscilloscopes, valve volt meters, etc., plus non destructive testing equipment.

#### EXPERIENCE REQUIRED:

A good electronics background or practical experience as a radar fitter in the forces.

#### QUALIFICATIONS:

Ideally O.N.C. or H.N.C. electrical or equivalent but consideration will also be given to applicants who are still studying or those without formal qualifications who can satisfy the other requirements by reason of their practical experience.

#### THE RETURN:

A secure job with excellent prospects of promotion. A salary based on ability and worth to the Company. Other benefits include:—Free travel from certain areas, sickness and pension scheme, a staff canteen, social club.

#### HOW TO APPLY:

Write with full details to:—

The Personnel Officer,  
**DAWE INSTRUMENTS LTD.**  
Western Avenue,  
Acton, W.3

359

## TECHNICIAN ENGINEER

Skilled Technician male or female with experience in construction/assembly of electronics and optical apparatus required to help develop a new process of mineral sorting. The successful candidate must be capable of working independently and be able to contribute to the basic design of mechanical and electronic equipment. Salary according to experience. Applications should be made to PROFESSOR M. G. FLEMING, DEPARTMENT OF MINERAL TECHNOLOGY, IMPERIAL COLLEGE, LONDON, S.W.7. [362]

## HAMMERSMITH HOSPITAL AND POSTGRADUATE MEDICAL SCHOOL

Du Cane Road, London, W.12

### Department of Medical Physics

SENIOR ELECTRONICS TECHNICIAN required for responsible post. Fields of departmental research activity include nucleonics, radiation therapy and analogue and digital data processing. Experience in pulse circuitry an advantage but not essential. Commencing salary within range £854-£1,085 per annum, depending on qualifications and experience. Detailed applications, naming two referees, to Secretary, Board of Governors, Hammersmith Hospital, Du Cane Road, London, W.12, by 14th December. [366]

Electronic Engineer, experienced in servicing Electronic Tachometers in spare time required. London Area. Please give details to Box IE.356.

Original testimonials should not be sent with applications for employment

## ARTICLES FOR SALE

### PHOTO-ELECTRIC CONTROLS

for industry

Quick delivery Send for Catalogues

### Hird-Brown Limited

Flash Street, Bolton, Lancs.  
Tel. 27311 [305]

Nameplates, engraving, diesinking, stencils.—Stilwell & Sons Ltd., 16a Far Gosford Street, Coventry. [309]

## SCRAP METAL

Non-ferrous Scrap Metals, all grades, Swarf, Off-cuts, etc., purchased at highest rates.

H. Barnett Ltd.,  
Victor Road, London, N.7.  
Est. 1865 ARChway 5461 [307]

## ELECTRICAL ENGINEER

Due to further expansion a senior vacancy has arisen for a highly qualified Electrical Engineer with degree or equivalent qualification. The ability to accept responsibility and to use one's initiative is vital. The work is interesting and varied, carrying an attractive salary and excellent future prospects within our rapidly growing Company. Pension and Life Assurance Schemes exist.

Please apply in writing giving details of experience to date to:

The Personnel Officer  
**COMMERCIAL PLASTICS (ENGINEERING) LTD.**  
Willington Quay, Wallsend, Northumberland

355

# ASTARON-BIRD LIMITED

Fleets Lane, POOLE, DORSET

This well established firm on the South Coast invites applications for the following vacancies:

## SENIOR ELECTRONIC ENGINEER

### (RADAR DEVELOPMENT)

Qualifications required: Degree or Corporate Membership of the I.E.E. or I.E.R.E., at least five years' experience of the development and design of Radar or similar equipment; sound knowledge and experience in transistor circuits including high power stable pulse and time base applications. Some knowledge of ultrasonics and microwaves would be an advantage.

## DESIGN DRAUGHTSMAN

Qualifications required: H.N.C. or O.N.C. in Mechanical or Production Engineering. Knowledge of electronics an advantage. Experience in the design of electro-mechanical equipment with practical experience in the light engineering industry. Knowledge of radar equipment could be an advantage.

Applicant should be prepared to work on his own initiative and see the job through from development to introduction to full production.

Applications giving age, qualifications, experience in chronological order and present salary or salary expected, should be addressed to the

**PERSONNEL MANAGER**

361

# in EDP HONEYWELL ARE SETTING THE TREND

Outstanding success of Honeywell in E.D.P. has led to expansion of their manufacturing programme, creating a number of opportunities for experienced men at Newhouse, Scotland.

**COMPUTER SYSTEMS ENGINEERS.** A number of important vacancies for Electronic Engineers of all grades to work on pre-delivery checkout of computer systems. Qualifications range from G.C.E. level and O.N.C. to degree standard or previous computer experience. Successful applicants will be given comprehensive training in computer techniques, before being assigned a position in the Test Team.

**HEAD OF PERIPHERAL CHECKOUT.** A keen young Engineer with at least 2 years' computer experience in the commissioning or maintenance fields. He must have a strong mechanical background and experience on at least two of the following: TAPE DRIVES, PRINTER, CARD READER, CARD PUNCH. The successful applicant will be responsible for the complete checkout of all Peripheral Equipment manufactured at Newhouse.

**PERIPHERAL ENGINEERS.** Engineers with or without computer experience to work in the Peripheral Checkout Department.

**QUALITY ENGINEERS.** Rapid expansion of H.200 Computer production creates vacancies in the Quality Control Department. We are looking for hard-working, ambitious men with experience in the following fields: Vendor appraisal and selection of U.K. components; Defining Inspection and Test Procedures; Calibration and Standards Engineering; Goods Inward Inspection (mechanical and electrical); On-line Inspection Auditing; Quality Control in the Computer Field. H.N.C. or equivalent would be an advantage, but not essential.

**PRODUCTION ENGINEERS.** Successful candidates will probably have experience in light electro/mechanical engineering, coupled with technical educational standard of O.N.C./H.N.C. Mechanical, Electrical or Production Engineering. More important than this however, is the ability to successfully carry projects from design stage to production, with minimum supervision.

**WRITING AND MAINTENANCE OF ENGINEERING TEST PROGRAMMES.** The ideal applicant should have a flair for writing programmes, and preferably have computer engineering experience.

**PRODUCTION CONTROL.** Vacancies exist for preferably experienced personnel in the following categories: (a) Inventory Analysts; (b) Production Expeditors; (c) Shipping Co-ordinators; (d) Production Scheduling and Shop Loading; (e) Clerical Assistants for Control of Computer Data.

Applicants should have a first class educational background, preferably with an engineering bias. Applicants with these qualifications, but insufficient experience of electronic equipment production, will receive suitable training.

**If you are capable of filling one of the above posts, this is your chance to join an International Company, which plans to double its size in the next 5 years at their Newhouse Plant. Salaries are attractive, and a Group Life Insurance Scheme and Pension plan is in operation. Interviews can be arranged at London, Birmingham, Manchester and Glasgow.**

Write brief details quoting Ref. No. PWW 124 and post applied for to:

**J. Clark, Personnel Manager, Honeywell Controls Ltd.  
Newhouse Industrial Estate, Motherwell, Scotland.**

357

# free

**Ph.D., B.Sc., B.A., DIP.TECH., H.N.C., H.N.D.** As a qualified man, you are eligible for enrolment, free of charge, on the Graduate Appointments Register, currently retained to find men for over 160 industrial posts at salaries from £950 to £4,000.

**IF YOU FEEL THAT A MOVE AT THIS STAGE COULD BE IN YOUR OWN BEST INTERESTS, WRITE TODAY:** Letters stating your qualifications, and if applicable, the reference number above, should be addressed to: The Director, Peter M. Brown.

**THE GRADUATE APPOINTMENTS REGISTER, 96-88 EDGWARE ROAD, LONDON W2, AMB 3200**

368



Following the development of a new wide range of electronic process control instruments

# TAYLOR INSTRUMENT

## COMPANIES (EUROPE) LIMITED

are about to begin full production of this new range and are seeking suitably qualified men for progressive and permanent appointments as

### ELECTRONICS PRODUCTION ENGINEER

with sound knowledge of transistor circuits and fully conversant with modern methods of economic manufacture and test procedures. Applicants should possess H.N.C. Elect. or Electronics.

### ASSEMBLY METHODS ENGINEER

to specify methods and tooling for intricate electronic and mechanical assemblies. Applicants must have a wide experience of efficient methods of soldering and assembly with particular reference to bench layout and tooling. O.N.C. Elect. desirable.

### ELECTRONICS TECHNICIANS

with considerable experience of testing transistorised amplifiers, power supplies, etc., be fully conversant with modern types of test equipment and be able to examine and solve technical production problems associated with the manufacture of electronic process control instruments. Applicants should possess H.N.C. or have a breadth of experience in a similar capacity.

### ELECTRONIC TEST ENGINEERS

to test and fault find transistorised instruments. Previous experience essential.

### TIME STUDY ENGINEER

to conduct time studies in electronic assembly and test department to established standard times for the operation of an individual incentive scheme.

These are excellent opportunities to join a successful and rapidly expanding company in this new and exciting field of the industry. Assistance would be offered with housing and removals. Free Life Assurance and contributory pension scheme after qualifying period.

Write giving full particulars to

The Personnel Manager,  
Taylor Instrument Companies (Europe) Ltd.,  
Gunnels Wood Road, Stevenage, Herts.

369

## CAPACITY AVAILABLE

# WEYRAD

## COILS AND I.F. TRANSFORMERS IN LARGE-SCALE PRODUCTION FOR RECEIVER MANUFACTURERS

- |                    |   |                     |                     |
|--------------------|---|---------------------|---------------------|
| <b>P.9 SERIES</b>  | 10 mm. × 10 mm. × 14 mm.  | Ferrite cores 6 mm. | 472 kc/s operation. |
|                    | Single-tuned I.F.s and Oscillator Coils.  |                     |                     |
| <b>P.55 SERIES</b> | 12 mm. × 12 mm. × 20 mm.  | Ferrite cores 4 mm. | 472 kc/s operation. |
|                    | Single-tuned I.F.s and Oscillator Coils.  |                     |                     |
| <b>T.41 SERIES</b> | 25 mm. × 12 mm. × 20 mm.  | Ferrite cores 4 mm. | 472 kc/s operation. |
|                    | Double-tuned 1st and 2nd I.F.s and Single-tuned 3rd I.F. complete with diode and by-pass capacitor. |                     |                     |

These ranges are available to manufacturers in versions suitable for most of the popular types of Transistors. The Oscillator coils can be modified to enable specific tuning capacitors to be used provided that bulk quantities are required.

**OUR WINDING CAPACITY NOW EXCEEDS  
50,000 ITEMS PER WEEK**

On the most up-to-date and efficient machines backed by a skilled assembly labour force for all types of coils and assemblies.

**Weymouth Radio Manufacturing Co. Ltd., School Street, Weymouth, Dorset**

358

## ELECTRONIC TESTERS and SERVICE ENGINEERS

required for interesting work on Radio Transmitters, Receivers, Amplifiers, Test Instruments and General Electronic Apparatus.

If you have a monotonous job and want to better yourself apply for a post with us which offers:—

**SECURE EMPLOYMENT • SCOPE FOR ADVANCEMENT • FIVE DAY WEEK • STAFF STATUS  
HOLIDAY AND SICK PAY ALLOWANCE • CONGENIAL WORKING CONDITIONS**

Apply to: Personnel Department, Labgear Ltd.,  
Cromwell Road, Cambridge.

365

### ELECTRONIC DEVELOPMENT ENGINEERS

are required by Vickers Research Ltd. for their laboratories at Sunninghill, Berkshire. Applicants should possess minimum qualifications of H.N.C. in Electrical Engineering or a degree and experience in semiconductor circuitry. Preference will be given to those exhibiting a flair for original ideas. The successful candidates will be expected to work largely on their own initiative and will be responsible for all stages in the development of electronic equipment. The amenities provided are excellent and salaries are commensurate with experience and qualifications. Application forms are obtainable from the Personnel Officer, Vickers Research Ltd., Sunninghill, Ascot, Berks. 367

### TO INSERT AN ADVERTISEMENT IN THE CLASSIFIED SECTION

TELEPHONE  
**INDUSTRIAL ELECTRONICS**  
WATERLOO 3333  
EXT. 210

#### Capacity Available (continued)

**INJECTION MOULDING**  
up to 4oz. Vacuum Forming up to 8ft. x 4ft. Cheap dies and short runs a speciality.  
SHAVELSON, 2-6 CODE STREET, LONDON, E.1. BIS 0225. 1335

#### AIRTRONICS LTD.

for coil winding assembly and wiring of electronic equipment, transistorised sub-units, sheet metal work. 4 Ashmead Road, London, S.E.8. Telephone: TIDE-way 2249. 1311

#### APPOINTMENTS FILLED

Dissatisfaction having so often been expressed that unsuccessful applicants are left in ignorance of the fact that the position applied for has been filled, may we suggest that Advertisers notify us to that effect when they have arrived at a decision? We will then insert a notice free of charge under this heading.



## TEST ENGINEERS

### A CHALLENGING OPPORTUNITY

**EXPERIENCED TEST ENGINEERS** are required for the proving of complex DATA HANDLING equipment for civil and military applications. The work covers all aspects from prototype stage to the fully engineered product both during manufacture and installation.

**APPLICATIONS** are invited from engineers who have, or are studying for, O.N.C. or equivalent qualifications.

There are staff appointments at all levels with good prospects of career advancement.

Write or telephone for an appointment to the Personnel Officer, Decca Radar Limited, 2 Tolworth Rise, Surbiton, Surrey. Tel. DERwent 6688.

363

## Burgot

ALARMS LTD.

### A member of the Chubb group of Companies

This Company is a leader in the expanding intruder alarm field. It offers interesting and challenging positions embracing a wide range of electronic applications including sonics, ultrasonics, advanced signalling and radar techniques. The Development Group is growing rapidly and has vacancies for:

#### ELECTRONIC ENGINEERS

Who should have H.N.D., H.N.C. or equivalent and comprehensive experience in transistor circuit design. Salaries generally up to £1,500 p.a. but this figure can be exceeded when circumstances warrant.

#### ELECTRONIC DRAUGHTSMEN

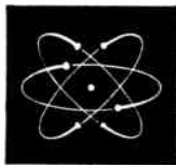
With H.N.C. or equivalent and at least five years' design experience on printed circuit applications and electro-mechanical devices such as tape recorders. Salaries up to £1,300 p.a.

The company operates a contributory Pension Scheme and offers generous Sickness Benefits in addition to other staff advantages.

Please write giving details of qualifications and experience to:

Chief Engineer, Burgot Alarms Ltd.  
26 Westbourne Grove, London, W.2

364



an important new book  
on an  
important subject

## Electronic Digital Integrating Computers

F. V. MAYOROV EDITED BY DR. YAOHAN CHU

An important book on an important and developing subject for all engineers interested in high speed computing combined with accuracy, simplicity, compactness and cheapness, and for all students of the subject. This work, the first to be published on this subject in the English language, is based on a Russian book and gives the principles, organisation, applications, circuits, memories and input-output devices of electronic digital integrating computers. It describes both serial and parallel machines as well as both binary and decimal types. The translator has added examples of American, British and Japanese practice and has also included a Bibliography of a number of Western sources.

85s net by post 86s 6d 382 pp. 273 diagrams.

obtainable from leading booksellers

**ILIFFE Books Ltd.**

DORSET HOUSE · STAMFORD ST. · LONDON S.E.1

further thoughts by 'Cathode Ray'

## ESSAYS IN ELECTRONICS

M. G. SCROGGIE, B.Sc., M.I.E.E.

This book may be regarded as a sequel to an earlier work, 'Second Thoughts on Radio Theory' but widened in scope to include electronics. The 22 essays adapted from the popular 'Wireless World' series cover a wide range of subjects including: scientific theories; what is electric current?; Kirchhoff's Laws; Flux-cutting or Flux-linking; negative feedback and non-linearity, etc. This is a book that every electronic and electrical engineer should read. It can be guaranteed that no one will fail to learn something to his advantage.

42s net by post 43s 1d 301 pp. 204 illustrations

obtainable from leading booksellers

**ILIFFE Books Ltd.**

DORSET HOUSE STAMFORD STREET LONDON S.E.1

For further information circle 250 on Service Card

NUMBER ONE IN ELECTRICAL CONNECTORS...



## ROYAL-D PLUGS

D Subminiature series with crimp snap  
in contacts and "Little Caesar" Rear-  
Release System.

**CANNON ELECTRIC  
(GREAT BRITAIN) LTD.**

25-27 Bickerton Road  
Upper Holloway  
London N.19 Tel: ARChway 3088



## Index to Advertisers

Adeola Products Ltd. ....	27	Magnetic Devices Ltd. ....	9
Ampex Great Britain Ltd. ....	8	Mallory Batteries Ltd. ....	3
Anglo-American Vulcanized Fibre Co. Ltd. ....	14	McMurdo Instrument Co. Ltd. ....	26
Appointments Vacant ..... 34, 35, 36, 37		Metway Electrical Industries Ltd.	30
		Mullard Ltd. ....	Cover ii
		Murex Ltd. ....	33
Cannon Electric (Great Britain) Ltd. ....	38	Oxley Developments Co. Ltd. ....	4
Classified Advertisements 34, 35, 36, 37			
Dawe Instruments Ltd. ....	28	Pabst-Motoren KG ....	30
Diamond H Switches Ltd. ....	29		
		RCA Great Britain Ltd. ....	2
Elecometer Instruments Ltd. ....	4		
Electrical Power Engineering Co. (B'ham) Ltd. ....	24	Sealectro Ltd. ....	20
Electronic Applications (Commer- cial) Ltd. ....	30	S.E. Laboratories (Eng'g) Ltd. ....	18
Ericsson Telephones Ltd. ....	11	Smith, H. L., & Co. Ltd. ....	4
Eric Resistor Ltd. ....	Cover iv	Spear Engineering Co. Ltd. ....	26
		Standard Telephones & Cables Ltd.	12, 13, 19
Ferranti Ltd. ....	10		
		Telegraph Condenser Co. Ltd. ....	Cover iii
G.E.C. (Electronics) Ltd. ....	16, 17	Tequipment Ltd. ....	6
		Tran-matrix Electronic Systems Ltd. ....	26
H.C.D. Research Ltd. ....	32	Turner Ernest Electrical Instru- ments Ltd. ....	25
Honeywell Controls Ltd. ....	22, 23		
Hughes International (U.K.) Ltd. ....	15	Union Carbide Ltd. ....	21
Iliffe Books Ltd. ....	32, 38	V.G. Porcelain Co. Ltd. ....	33
International Rectifier Co. Ltd. ....	7	Vitality Bulbs Ltd. ....	26
K.L.B. Electric Ltd. ....	29	Walmore Electronics Ltd. ....	24
		Welwyn Electric Ltd. ....	1
Livingston Control Ltd. ....	5	Westinghouse Brake & Signal Co. Ltd. ....	31
Lugton & Co. Ltd. ....	26		





# 'DRITAN'

## SOLID TANTALUM CAPACITORS



<b>Working Voltages</b>	6, 10, 15, 20, 35 and 50.
<b>Capacitance Tolerance</b>	± 20% standard ± 10% or ± 5% to special order
<b>Temperature Range</b>	—55°C to +125°C, with voltage derating over 85°C
<b>Maximum leakage current</b>	$I(\mu A) = 0.02 C(\mu F) V(\text{volts})$ at 25°C $I(\mu A) = 0.2 C(\mu F) V(\text{volts})$ at 85°C

Made to the most stringent performance characteristics, T.C.C. "Dritan" Capacitors have a porous sintered tantalum anode, with a solid, non-corrosive manganese dioxide electrolyte. Low levels of dissipation factor and high frequency impedance, unrivalled in the industry, afford higher permissible ripple currents than ever before. Their small size makes them particularly suitable for use in transistorised equipment such as R.F. tuning, integrating and differentiating circuits, and servo systems in which high capacitance with small physical size is essential.

All sizes and ratings comply with MIL-C-20655A. T.C.C. "Dritans" are rated for operation over a temperature range of —55°C to +125°C, with appropriate voltage derating over 85°C.

### JOINT SERVICE APPROVAL

T.C.C. "Dritan" Capacitors with capacitance tolerances of ±10% and ±20%, up to and including 35 volts working, have been granted full Joint Service Advance Approval by the Radio Components Standardisation Committee to DEF-5134-A-1 (which is in final draft form and will shortly be published by H.M.S.O.) Humidity Classification H6. Temperature Category T5. Grade SP3, as detailed in DEF-5011.

Full details of "Dritan" Electrolytics are given in T.C.C. Technical Bulletin No. 63, a copy of which will be sent on request.

**THE TELEGRAPH CONDENSER CO. LTD.**

Electronics Division • North Acton • London, W.3 • Tel. ACOm 0061 • Telex: 261383  
also at CHESSINGTON, SURREY and BATHGATE, SCOTLAND

For further information circle 202 on Service Card

# ERIE<sup>®</sup>

## HIGH VOLTAGE

### DOUBLE CUP

# Ceramicon<sup>®</sup>



**15kV**  
CHV410



**20kV**  
CHV413P



**30kV**  
CHV400P



**30kV**  
CHV411P

The unique design of the ceramic dielectric employed in the 'Double Cup' series of Eric Ceramicon provides for the particularly robust construction and reliability demanded of high voltage capacitors.

Ceramicon Style	CHV400P	CHV410	CHV410	CHV411P	CHV413P
Capacitance - pF	100	1000	300	100	1000
Working Volts, d.c. at 70°C	30kV	15kV	20kV	30kV	20kV
Working Volts, d.c. at 85°C	25kV	12kV	15kV	25kV	15kV
RF load rating -VA	750	500	500	1000	750
Maximum rms current -A	5	5	5	10	5
Minimum leakage resistance	50kMΩ	50kMΩ	50kMΩ	50kMΩ	50kMΩ

Write for CHV literature

Illustrations actual size



**ELECTRONIC COMPONENTS**

*(Illustration of Eabling by courtesy of Central Electricity Generating Board)*