

INDUSTRIAL ELECTRONICS

MAY 1964 5s 0d

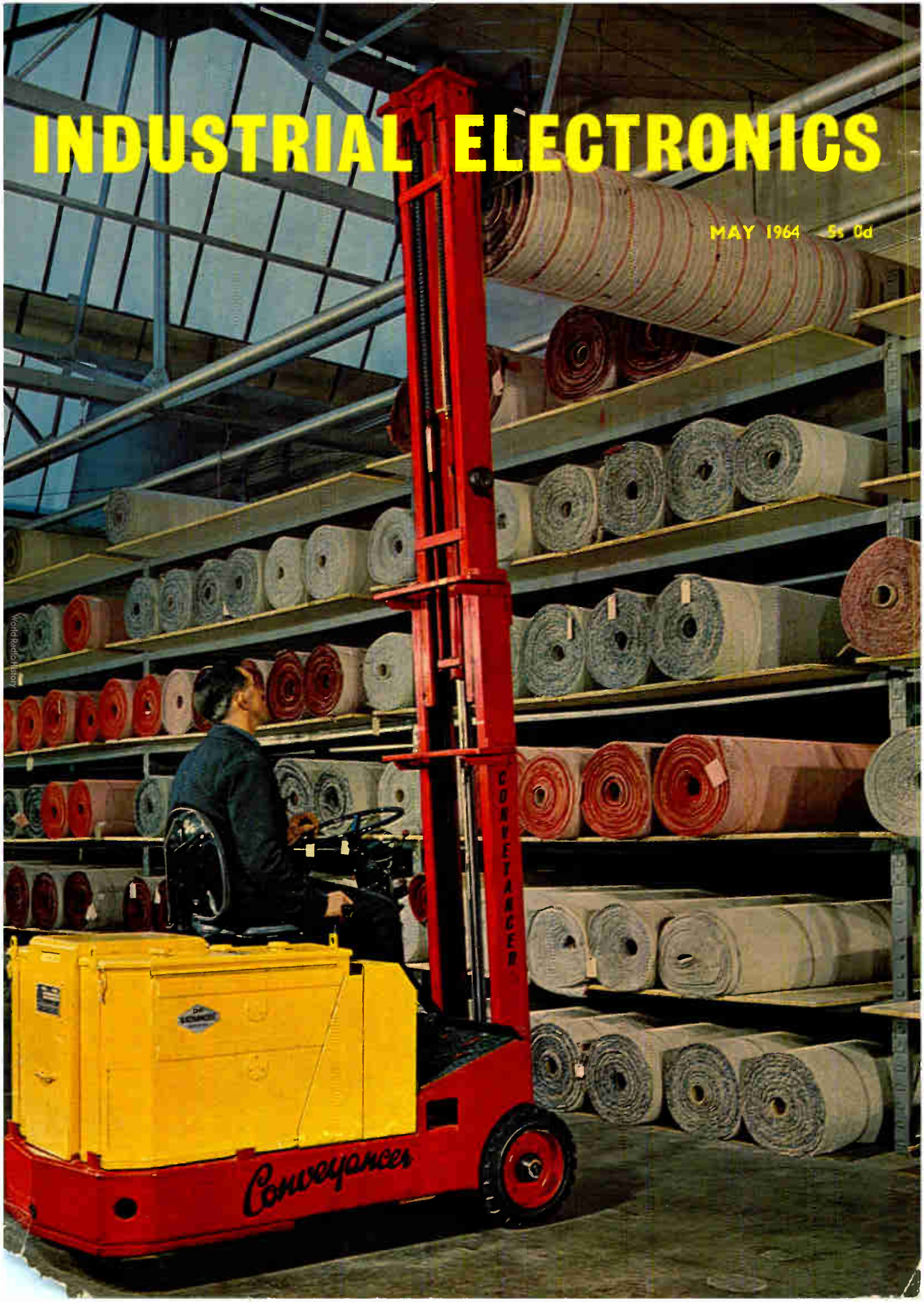

World Radio History

Conveyances

For further information circle 200 on Service Card



an **OPEN** & SHUT case for the **MS HYFEN** connector

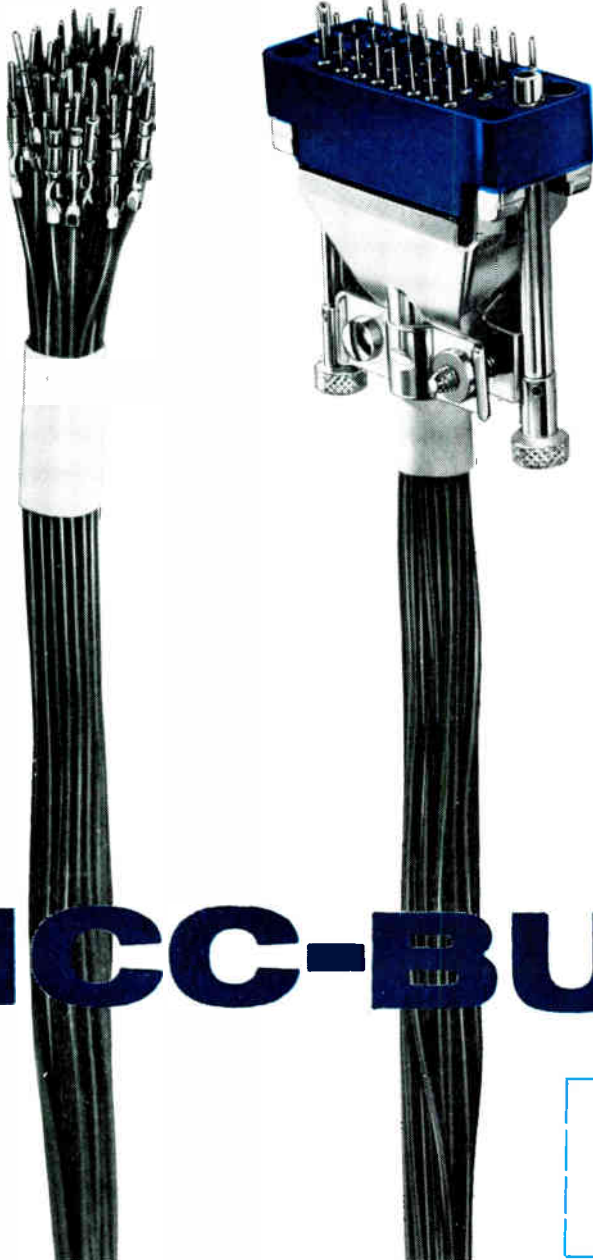

NOTE THESE FEATURES:

crimped snap-lock removable contacts / high speed assembly / factory pre-assembled hardware / fault finding and commissioning simplified / low mating forces / manual or automatic installation tooling / reduced production costs / hood accommodates multi-core cable sheath

Plated to maintain low contact resistance under the most severe conditions of environment, the miniature Hyfen connector provides reliable high-density connections. It is available in 14, 20, 26, 34, 42, 50, 75 and 104 contact sizes. The new hinged protective hood swings wide open to give full access for easy insertion, removal and inspection of contacts. BICC-BURNDY manufacture all types of connectors for the electronics industry.

BICC-BURNDY

ST HELENS LANCS

For full information on the MS HYFEN, attach this coupon to your Company's letterhead and mail it to:

BICC-BURNDY LIMITED
ST HELENS · LANCS
E.Y.

Industrial Electronics May 1964

Great Britain's
largest producers of
METAL OXIDE FILM RESISTORS
since their introduction onto
the British market, by Welwyn, in 1957

•
Every Welwyn "Metox" resistor is
backed by product history dating
from 1954 when metal oxide
Research and Development started
at Bedlington

•
Welwyn *Quality Control* couples
the inherent reliability of
"Metox" metal oxide resistors
to the highest performance standards
appropriate to each range

•
And now Welwyn
"Metox" Midget Oxide Resistors
type F25 are

QUALIFICATION APPROVED
to D.E.F. 5114A

WRITE NOW FOR FULL DETAILS



WELWYN ELECTRIC LIMITED

BEDLINGTON • NORTHUMBERLAND • ENGLAND •

Telephone : Bedlington 2181-9 • Telegrams : Resistor, Bedlington.

FACTORIES IN AUSTRALIA AND CANADA

quality
instruments
need
quality
batteries—

MALLORY

Precision-made Mallory batteries are built differently—inside and out—to last many times longer, to deliver power more steadily, to retain their energy while lying idle (for two years or more, if necessary), to be leakproof and corrosion free in short, to meet all the requirements of quality equipment. That's why so many leading manufacturers now fit or recommend Mallory batteries for their products, why **other leading battery manufacturers elect to sell them under licence!**

When performance quality counts, Mallory batteries are always the choice. Fit them to *your* test instruments and prove for yourself—they make a power of difference!

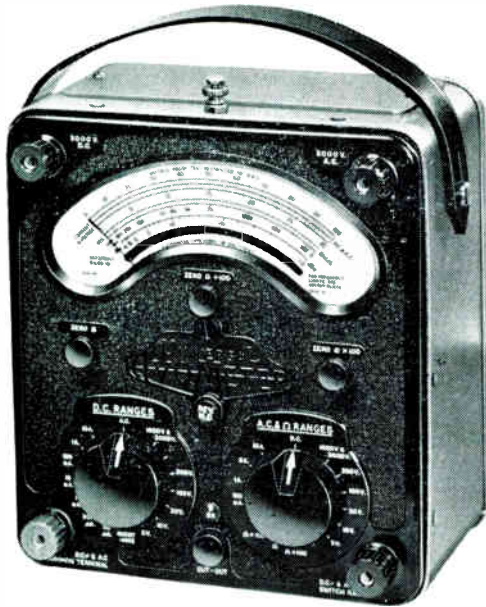

Powerful Mallory batteries are available to fit most AVO meters and other leading makes of test instrument.

Contact your Mallory Distributor for details.

Win an AVO—free!

Enter a simple 'Watts in a Laden Jar' competition on Mallory Stand G58 at the I.E.A. Exhibition for your chance to win one of three AVO meters.

MALLORY

for new ideas in batteries

MALLORY BATTERIES LIMITED Crawley Sussex Crawley 26041

Distributors to the Electronics Industry:

A. C. Farnell Ltd. Leeds 2; Wireless Electric Ltd. Bristol 1; Hawnt & Co. Ltd. Birmingham 6;
Needham Engineering Co. Ltd. Sheffield 1; Harper, Robertson Electronics Ltd. Glasgow C2;
Stewart Aeronautical Supply Co. Ltd. Crawley, Sussex; Scientific Furnishings Ltd. Poynton, Cheshire;
Cables & Components Ltd. London NW10

Yes, it's 1964

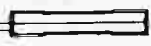
Once upon a time, potentiometers were large, solid, ugly brutes, with only one virtue—they looked reliable. □ Now in 1964 you can use Mecpot miniature trimmer potentiometers that are small, compact, especially designed for modern instrumentation and control circuits—and more reliable than ever before. □ Resistance values from 10 to 20,000 ohms. □ Maximum rating 1 watt at 20°C. de-rating to $\frac{1}{4}$ watt at maximum temperature of 85°C. □ Three models: MP30 with solder tags for conventional chassis mounting; MP31  with L-shaped tags for insertion into printed circuits;

 MP32 with pins spaced along the body, for direct mounting on printed boards, no other fixing being necessary. □ Write for full specification and samples
□ Miniature Electronic Components Ltd.,
St. John's, Woking, Surrey. Woking 5211.

m-e-c



Mullard establishes specialized microwave components service

One of the most significant steps in support of the rapidly developing radar and telecommunications field has been taken by Mullard in the establishment of a manufacturing and technical advisory service for high-performance microwave components. The increasing complexity of present and future communications networks makes it necessary for engineers to reduce the time given to individual component design in order to concentrate on the complete system. Furthermore, the present trend in radar and communications equipment towards higher frequency and higher power levels has emphasized the need for a ready supply of specialised components to enable the equipment manufacturer to realise the full potential of modern microwave valves. These components include isolators and circulators, mixers and hybrids, and narrowband and broadband filters. A basic range of these components is available to meet immediate requirements; components to customers' individual specifications can also be manufactured, making use of the Company's unrivalled knowledge of ferrite and solid-state devices as well as the extensive information available on the well-established thermionic microwave devices.

Isolators and circulators

A wide range of broadband field displacement and resonance isolators capable of handling heavy power loads under c.w. and pulse conditions is available. These isolators incorporate ferrite materials, and there is a basic range of components covering frequencies from 3 to 12Gc/s approximately. Three-port and four-port circulators in both strip-line and waveguide construction are available with typical isolation values $> 20\text{dB}$.

Mixers and hybrids

Broadband mixers and hybrids using the coaxial line technique offer the advantages of smaller size and greater bandwidth over equivalent components using rectangular waveguides. The frequencies covered by the range are from 1 to 11.5Gc/s.

The small size of the mixers and the absence of tuning requirements makes them ideal for receiver and modulator applications. Intended for use with crystals CV2154 and CV2155, or the lower-noise types CV7108 and CV7109, they have a maximum out-of-balance value of 1.5dB and a minimum isolation of 15dB.

The balanced hybrids for power splitting, duplexer, and multiplexer applications offer a typical isolation of 20dB. The input V.S.W.R. is 1.5, and the out-of-balance value is 1.0 to 1.5dB.

Filters

A basic range of narrowband and broadband filters with low insertion losses is available for frequencies up to 10Gc/s. Filters



Measuring the gain of an S-band low-noise parametric amplifier. The amplifier is cooled with liquid nitrogen to reduce its contribution to the system noise temperature by a factor of approximately three

with special characteristics can be designed to customers' requirements, a computer being used to solve the complex design formulae involved.

Quantity production of parametric amplifiers

Parametric amplifiers are in quantity production, supplementing the well-established range of Mullard magnetrons, klystrons, and travelling-wave tubes. The precision engineering aspects of quantity production have been given special attention to maintain the highest standard of repeatability of performance. A typical parametric amplifier in production is an S-band type with a noise factor of 3dB and a bandwidth of 25Mc/s at a gain of 20dB. A significant feature of the design of all these amplifiers is the ease with which the operating frequency can be changed without recourse to external measuring equipment.

For further details on the Mullard range of microwave valves and components, please use the reader reply card of this journal (see reference number opposite).

What's new from Mullard

72 new products on Mullard stand at I.E.A.

By restricting their product displays to recently introduced devices, Mullard are taking a positive step towards helping visitors to their I.E.A. Stand to identify quickly "What's new in industrial electronics".

Whereas the technical information bureau on the north-west corner of their stand will be packed with data on over 1200 products, the outer display and discussion areas will be given over to 72 new valves, semiconductor devices and components, and six working demonstrations.

New fields of activity

Integrated Circuits and Specialized Microwave Components are two completely new fields of activity entered into by Mullard in recent weeks. In addition to seeing representative products, visitors will be able to discuss the anticipated trends in these fields and the Mullard plans for meeting equipment manufacturers' immediate requirements.

The smallest working demonstration on the stand—an integrated gate circuit—contrasts in size with the largest single product—a 5ft high klystron for Bands IV and V television transmission.

The significant advances made in obtaining proof of thin-film reliability will be indicated by special displays describing the extensive test programmes laid down by Mullard and the important results achieved so far.

FOUR NEW 50z KLYSTRONS EACH GIVING 65mW POWER OUTPUT

Extended frequency range

Four new low-cost coupled-cavity klystrons, each giving 60mW power output, have been introduced by Mullard. They cover the frequency range 8.6 to 10.6Gc/s and are typically suited for use in doppler transmitters, high altitude radar equipment, and as local oscillators in parametric amplifiers.

Special construction ensures that frequency drift during initial warm-up is small and enables more exact tuning to be achieved.

The ruggedness of these klystrons is evidenced by the fact that at an acceleration of 10g and a vibration up to 2000kc/s the frequency modulation is typically less than 1Mc/s.

Derived from the highly successful YK1040, all four klystrons are fitted with flying lead connections.

Individual frequency ranges are given below:

YK1041	8.6—9.4Gc/s
YK1042	8.1—8.9Gc/s
YK1043	9.3—10.1Gc/s
YK1044	10.1—10.6Gc/s



PENCIL TRIODES FOR U.H.F. OPERATION

A range of four pencil triodes is available for operation at frequencies up to 4Gc/s. The 'pencil' construction ensures both efficient operation at ultra high frequencies and a small physical size. The four valves available are types 5876, 5893, 6263 and 6264, all for use in the grounded-grid configuration.

Type 5876 is a high- μ triode for use as a frequency multiplier at frequencies up to 1.5Gc/s approximately, or as an oscillator at frequencies up to 1.7Gc/s. When operating as an oscillator, an output power of 3W can be obtained at 0.5Gc/s and of 0.75W at 1.7Gc/s. Type 5893 is a medium- μ triode for operation as an anode pulsed oscillator up to 3.3Gc/s. Both types can also be used in the r.f. and i.f. stages of receivers operating at 1Gc/s.

The other two valves are fitted with external anode radiators to enable higher output powers to be obtained. Type 6263 is a medium- μ triode for operation as an oscillator or power amplifier. As an oscillator, a load power of 5W (continuous rating) or 7W (intermittent rating) can be obtained at 0.5Gc/s. As a power amplifier a load power of 7W (continuous rating) can be obtained with an input power of 2.2W. Type 6264 is intended mainly for use as a frequency multiplier but can also be used as an oscillator or power amplifier. When operating as a frequency tripler from 170 to 510Mc/s, a load power of 2.1W (continuous rating) is obtained from an input power of 2.75W.

Very fast photomultiplier for laser experiments

Developed from the 56AVP, this very-fast photomultiplier has a bandwidth of 200Mc/s and is the latest addition to the Mullard range of high-quality photomultiplier tubes. Incorporating the recently introduced high-quantum-efficiency trialkali photocathode, it is ideally suited for experiments in the rapidly expanding field of laser applications.

The tube, the 56TVP, has 14 high-speed dynodes and a semi-transparent trialkali curved cathode which gives higher quantum efficiency in the green, yellow



and orange regions of the spectrum. The cathode has a minimum useful diameter of 42mm, an average luminous sensitivity of 100 μ A/lm, and a maximum response at a wavelength of 0.42 μ m.

At a total voltage of 2500V, the anode has an average sensitivity of 10000A/lm.

Reader Enquiry Service

Further details of the Mullard products described in this advertisement can be obtained through the Reader Enquiry Service of Industrial Electronics, using the appropriate code number shown below.

Microwave components service	206
Four new klystrons	207
Photomultiplier	208
Pencil triodes	209



Mullard Limited, Mullard House, Torrington Place, London, W.C.1. Telephone: LANgham 6633

CAM11

● I.E.A. EXHIBITION, OLYMPIA, STAND N.204

LEADERSHIP IN VISUAL PRESENTATION

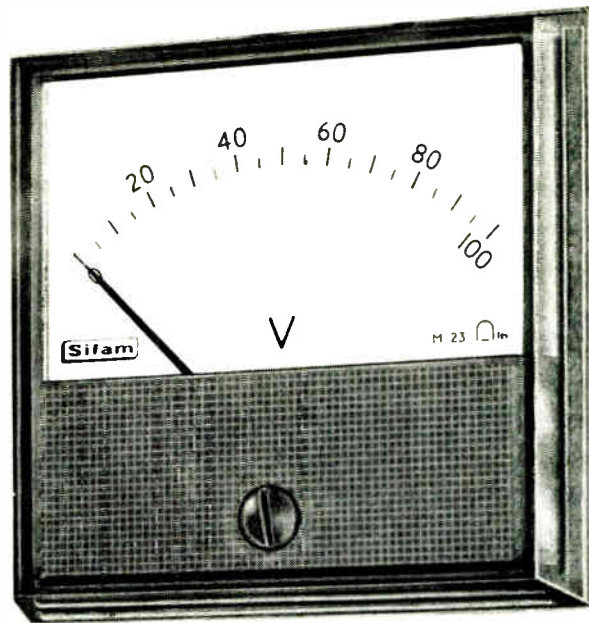

"Clarity" Type 23. 2.4 in. square. Scale length: 1.96 in.

Designers and engineers concerned with the production of modern equipment, and looking for instruments with the same contemporary approach to styling, will find their need completely satisfied in the SIFAM CLARITY Range.

Uncluttered, functional, with well-proportioned scale and body, this new range is a masterly expression of modern instrument design at its best, and represents an advance in visual presentation which has won recognition and approval from users and independent authorities alike.

Scale areas or markings can be supplied in accordance with the new British Standard recommendations, or to customers' requirements. The instruments can be supplied as Millivoltmeters, Temperature Indicators for use with thermocouples, Decibel Meters or with special calibrations to suit particular applications.

Let us arrange for a Sifam Technical Representative to show you the new "CLARITY" range or write for the new Data Sheets 106/C and 106/C1.



Instruments

SIFAM ELECTRICAL INSTRUMENT CO. LTD. Woodland Road, Torquay, Devon Telephone: Torquay 63822/3/4

CLARITY

- * The completely transparent moulded fronts permit a greater scale length for a given frontal area.
- * Interchangeable masks are available in a choice of contemporary colours to blend with customers' equipment.
- * The lance type pointer is readily visible when the instrument is read at a distance, whilst its fine point allows accurate reading of indicated values.
- * Elimination of solid surround provides both greater clarity and readability.

"CLARITY" Type 22
Scale length:
2.2 in. (56 mm)

"CLARITY" Type 32
Scale length:
2.75 in. (70 mm)

"CLARITY" Type 42
Scale length:
3.75 in. (95 mm)

SEE THESE 4 NEW INSTRUMENTS DEMONSTRATED AT STAND G 32 I.E.A. MAY 25-30

PORTABLE WAVE ANALYSER

A fully transistorized instrument covering the range 3c/s to 30kc/s.

CRYSTAL CALIBRATOR

Frequency accuracy of 0.02% is available at three selected frequencies for oscillator calibration and testing.

RESISTOR TOLERANCE INDICATOR

Gives a *direct* reading of the tolerance of a resistor being bridge tested. A tolerance of $\pm 0.001\%$ can be detected.

KELVIN-VARLEY DIVIDER

Provides an accurately-known division ratio while presenting a constant load resistance.

ON DISPLAY AT THE SYNCHRO CENTRE

will be Design Approved Synchros to the latest British, N.A.T.O. and American specifications.

Other Demonstrations

SERVO COMPONENTS & TEST EQUIPMENT

High Temperature Servo Components.
Environmental Test Apparatus. Portable Synchro Line-up Test Set.

FACSIMILE EQUIPMENT Mifax Business Machines.

EQUIPMENT FOR SHIPS

Integrating Power Meter for measurement of S.H.P. and R.P.M.

AND a wide selection of other Muirhead precision instruments.

WRITE FOR CATALOGUE

Brief descriptions in English, French and German of many Muirhead products, including precision instruments, facsimile communications equipment, components, synchros, servomotors and allied test equipment. An excellent quick reference to buyers and engineers.



PRECISION ELECTRICAL INSTRUMENTS

Muirhead & Co. Limited, Beckenham, Kent, England. Tel: Beckenham 4888
Muirhead Instruments Limited, Stratford, Ontario, Canada. Tel: Area Code 519, No. 271-3880
Muirhead Instruments Inc., 1101 Bristol Road, Mountainside, New Jersey, U.S.A.
Tel: Code 201, No. 233-6010





*for
high heat
insulation*

YOU'LL NEED TO KNOW ABOUT DELANCO GLASS FIBRE LAMINATES

If you need a material with a working temperature of up to 250 C very high dielectric strength and low loss properties PLUS high mechanical strength and exceptional machining properties you need look no further than the DELANCO range of glass fibre laminates, in sheet, tube, rod or in parts accurately machined to your drawings.

In fine and medium weave glass cloth base, with a bonding agent of silicone, Epoxy, melamine or phenolic, each grade having characteristics suitable for specialised applications. These applications are mainly in the electro-mechanical fields, but more recent technological advances in other fields are bringing regular enquiries for many new trades.

Class C Transformers, for example, Aircraft construction, and plating jigs, give some idea of the versatility of this material.

For machined parts only, we have one of the most modern

tool departments in the country, and all tools and fixtures are made by operators with first-hand knowledge of the materials on which these tools will be used.

Parts can be blanked, routed, milled, drilled and counter-bored, and metal tags and terminals can be fitted. Engraving on the finished parts is also done in our own works.

For further Technical Details send for Delanco Catalogue.

Delanco

for Electrical Insulation

Anglo-American Vulcanized Fibre Co. Ltd.,
Cayton Works, Bath Street, London, E.C.1.
CLF 8884, Grams: Prompserv, Cent, London,
Delanco Works, Leonard Street, London, E.C.2.





**FIRST
STOP
FERRANTI**

STAND No G79 at IEA OLYMPIA, LONDON
25th — 30th MAY 1964

Style 'A' panel instruments . Types CF and NF miniaturised switchboard instruments . DEF 62 hermetically sealed instruments . Power Transducers . Commercial Grade Electronic Summation Metering . Load Demand Control System . Miniclip 8-range Clip-on Volt-Ammeter . New range of Classic instruments . Low torque multi-gang types 11 and 20 precision potentiometers including two improved designs in synchro sizes 08 and 11 . New range of carbon film potentiometers . 200 and 300 series encapsulated Logical Circuit Elements . Stabilized Power Supplies . Solid State Digital and Analogue Circuits . Advanced Semiconductor Devices . C.R. Tubes and Valves for Military and Industrial Applications . Microwave Valves . Getter Ion Pumps . Ceramic-Metal Seals . Hermes, a small, fast computer with almost unlimited growth potential and versatility . A commercial digital data link for transmitting data over conventional telephone lines . Demonstration model warehouse designed to show the ability of the Ferranti Argus 100 Process Control Computer.

FERRANTI
First into the Future

FERRANTI LTD. Head Office and Works: HOLLINWOOD, LANCS. Tel: FAIlsworth 2000

low cost high precision

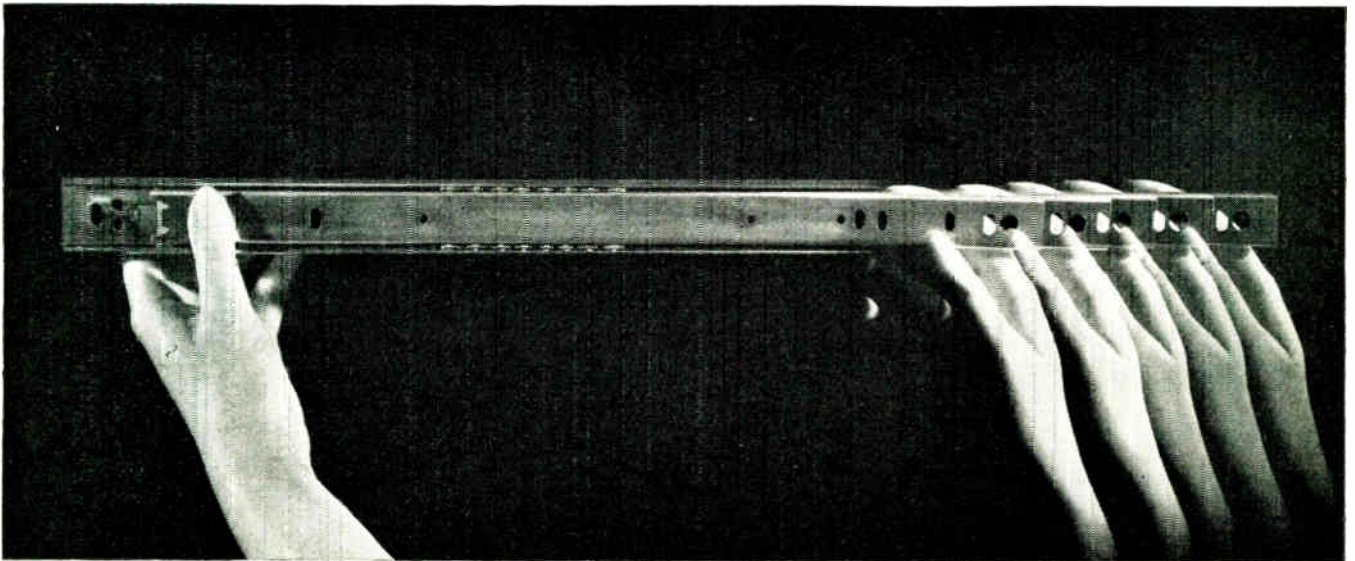

New from Imhofs—Imslide Accuride Series; a range of superb telescopic runners which have been designed to offer you a lower priced slide with a high degree of accuracy and versatility. Made to constant and precise tolerances from high tensile steel with a bright nickel finish, giving an excellent appearance that will enhance any equipment to which they are fitted. Unique stainless steel retainers keep the bearings evenly spaced and give an extremely smooth movement of the slide. Seven different models to choose from—including automatic disconnect—each in three standard lengths. Capable of carrying loads of up to 170 lbs according to model. Prices from £1.14.2. a pair. Send today for full details of the Imslide Accuride Series; also new models in the 300 and 500 Series of Imslide Telescopic Runners.

IMslide

—Accuride

*See Imslide on Stand
No. G379 at the I.E.A. Exhibition
Olympia from May 25—30.*

SERIES TELESCOPIC RUNNERS

Alfred Imhof Limited

Dept. No. IE15 Ashley Works Cowley Mill Road Uxbridge Middlesex
Telephone: Uxbridge 37123 Telex No. 24177
Telegrams: Imcase-Uxbridge-Telex

Agents in Algeria Australia Belgium Brunei Canada Denmark Finland France
Germany Holland Italy Lebanon Malaysia Mexico Morocco New Zealand Nicaragua
Norway Portugal South Africa Southern Rhodesia Sweden Switzerland Thailand
Tunisia USA Zambia

W4

0
1
2
3
4
5
6
7
8
9



COUNTERS
and
frequency
standards

A yellow sine wave graphic is positioned below the text 'COUNTERS and frequency standards'. The wave starts on the left, rises to a peak, falls to a trough, and then continues as a flat horizontal line before rising again to a peak and falling to a trough on the right.

HEWLETT-PACKARD COUNTERS

50 Mc/s counter 5245L



A SOLID STATE COUNTER OF UNPARALLELED ACCURACY AND VERSATILITY

FREQUENCY MEASUREMENTS: 0-50Mc/s direct count
50Mc/s-2500Mc/s with plug-in converters.

SENSITIVITY: 100mV r.m.s.

TIME BASE STABILITY: $\pm 3 \times 10^{-9}$ per day.

PERIOD AVERAGING: Over 1 to 10^5 periods to maintain high accuracies at low frequencies.

TIME INTERVAL MEASUREMENTS: 1 μ sec. to 10^4 secs. using 5262A plug-in.

SCALING: By decades up to 10^4 . Divides down input signal whilst maintaining full accuracy of time base.

8 DIGIT NIXIE DISPLAY WITH STORAGE

REMOTELY PROGRAMMABLE

BCD OUTPUT TO DRIVE ϕ DIGITAL RECORDER 562A

PRICE: £1,184

5243L:

The specifications of the 5243L are identical to the 5245L except that the maximum direct count frequency is 20Mc/s.

PRICE: £1,065

ECONOMY VERSIONS OF 20 Mc/s AND 50 Mc/s COUNTERS

5242L 0-20 Mc/s, time base stability ± 2 parts in 10^7 per month

5244L 0-50 Mc/s, time base stability ± 2 parts in 10^7 per month

Both units similar to 5243L and 5245L excluding plug-in, programming and scaling facilities.

Hewlett-Packard manufacture a wide range of frequency counters, frequency measuring systems and standards. Please write for further information.

Measurement of frequency to 40KMc/s.

Through the use of phase locking techniques, precise frequency measurements of signals to 40KMc/s can be made by using ϕ H06-540B transfer oscillator, Dymec 5796 Synchroniser in combination with harmonic mixers and ϕ high frequency counters. Measurement accuracy is equal to the counter time base reference regardless of frequency or transfer oscillator drift.

New ϕ 2590A combines transfer oscillator and synchroniser in one instrument for frequency measurement to 12.4KMc/s with counter accuracy.

ϕ Application Note 2 describes measurement techniques. Copy on request.

HAVE PLUG-IN VERSATILITY

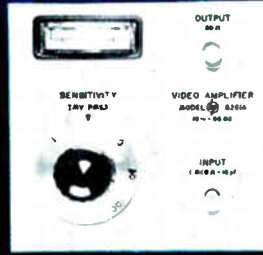
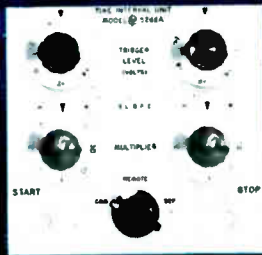
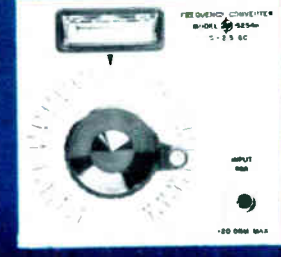

EXTEND THE VERSATILITY OF THE 5243L and 5245L BY ADDING THESE PLUG-INS

5251A FREQUENCY CONVERTER

Extends frequency range to 100Mc/s.
Sensitivity 50mV r.m.s.
PRICE: £110

5253B FREQUENCY CONVERTER

Extends frequency range from 50Mc/s—512Mc/s.
Sensitivity 50mV r.m.s.
PRICE: £182

5259A FREQUENCY CONVERTER

Extends frequency range from 450—1000Mc/s.
Sensitivity 100mV.
PRICE: £125

5254A FREQUENCY CONVERTER

(Used only with 5245L counter)
Extends frequency range from 500Mc/s to 2500Mc/s.
Sensitivity 50mV r.m.s.
PRICE: £314

5262A TIME INTERVAL UNIT

Permits 0.1μsec. resolution for measurement of pulse length, pulse spacing and time between electrical events.
Signal level and slope selection.
PRICE: £110

5261A VIDEO AMPLIFIER

Increases counter sensitivity to 1mV r.m.s. over the range 10c/s—50Mc/s.
PRICE: £118

5264A PRESET UNIT

Permits counters to read in rationalised units (r.p.m., lb/in², etc.) by selecting variable gating period in units from 1 to 100,000. Coincidence circuit gives output signal when count reaches a pre-set value.
PRICE: £248

5265A DIGITAL VOLTMETER

Adds digital voltmeter capability. 6 Digit presentation of DC voltages. Accuracy ± 0.1% of reading. High input resistance 10.2 megohms. Automatic polarity selection and indication. DVM mode or counter mode remotely programmable. All solid state circuitry.
PRICE: £220

HIGH ACCURACY TIME AND FREQUENCY STANDARDS

HEWLETT-PACKARD MANUFACTURE A RANGE OF HIGHLY STABLE QUARTZ OSCILLATORS, FREQUENCY DIVIDERS AND TIME COMPARATORS. SHOWN BELOW IS THE 103AR QUARTZ OSCILLATOR. THIS INSTRUMENT PROVIDES STANDARD FREQUENCIES OF 1Mc AND 100Kc/s WITH EXCELLENT SPECTRAL PURITY AND A LONG TERM STABILITY OF 5 PARTS IN 10¹⁰ PER DAY. PRICE: £723



FREQUENCY STANDARD RECEIVER 5090A

Designed to receive the standard Droitwich transmission, which has a frequency stability of 5 parts in 10¹⁰ per day, and provide phase stable outputs at 100Kc/s and 1Mc. Bandwidth less than 1 c.p.s. Sensitivity 1μV. Phase comparator circuit gives D.C. recorder output proportional to phase difference of two similar frequencies between 50Kc/s—10Mc/s.

PRICE: £160

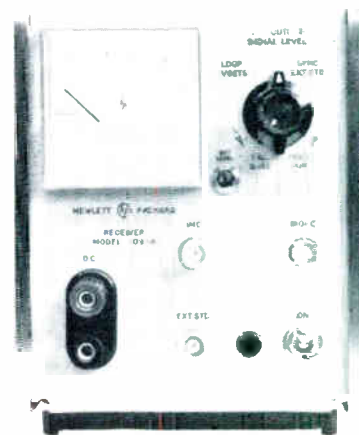

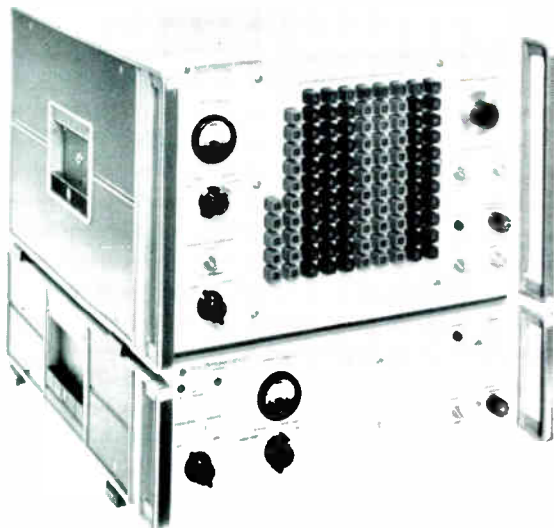

FREQUENCY SYNTHESIZER 5100A/5110A

Five thousand million crystal controlled frequencies.

⊕ 5100A and 5110A frequency synthesizer has push button selection of frequencies in 0.01 c.p.s. steps from 0.01 c.p.s. to 50Mc/s. Non-harmonically related output is 90dB below selected frequency.

Aging Rate:

Less than ± 3 parts in 10^9 per day with internal standard. Can be used with external standard.

Frequencies can be switched by remote programming in less than 1mS.

Built in search oscillator for smooth variation of the output frequency.
PRICE: £5,799.

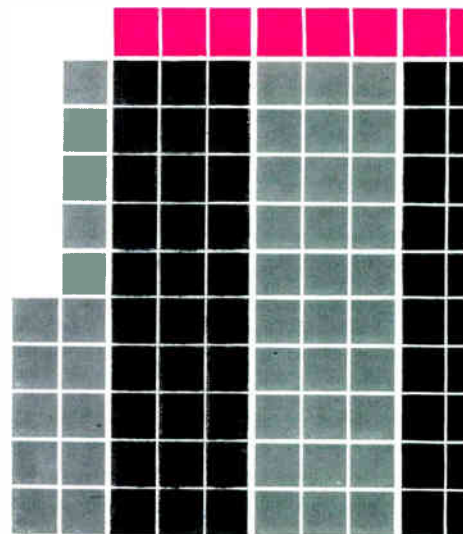

DIGITAL PRINTER:

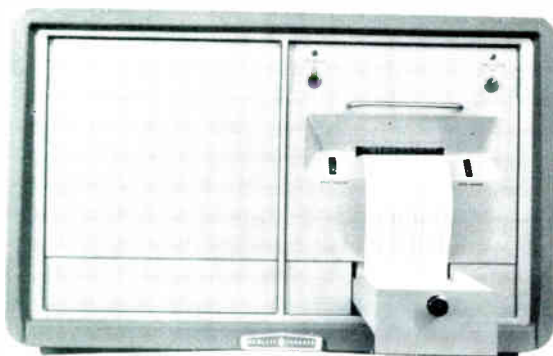

⊕ H23-562A DIGITAL RECORDER is a transistorised electro-mechanical device providing a printed record of digital data from electronic counters and digital voltmeters. Parallel data entry and low inertia moving parts allow printing rates as high as 5 lines/sec., each line containing up to 11 digits. Twelve digit capacity is available on special order. Source information can be coded either 10 line or BCD. Data can be entered from two sources and printed simultaneously.

A unique data storage feature

allows the driving source to transfer its data to the H23-562A in 2 milliseconds. As soon as data transfer is completed, the driving source is released to gather more information.

PRICE: Depends on options required. For use with 5243L and 5245L counters £756.

⊕ printers are designed to print out information from frequency counters, digital voltmeters, etc., and are available with a number of different options to suit a wide variety of applications.

For detailed technical information write or telephone:

HEWLETT-PACKARD LTD.

DALLAS RD., BEDFORD

Bedford 68052



European Office: Hewlett-Packard, S.A.
54 Route des Acacias, Geneva, Switzerland.



AVEL INSTRUMENTATION

Time is Money,
Can YOU Buy Time?



YES!

With the
Unique



'Polyskop'

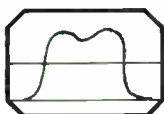
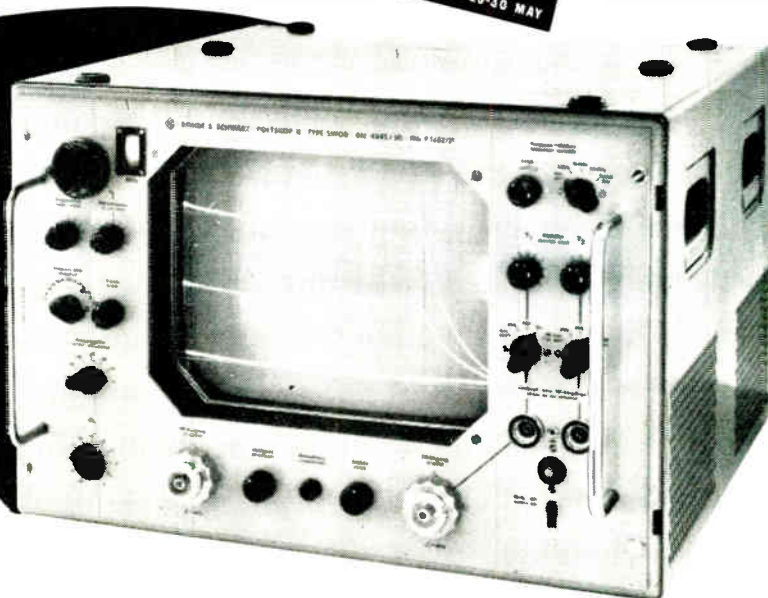

Broadband Filters & Amplifiers

The alignment of amplifiers and filters using point by point methods can be eliminated with the 'Polyskop' in one Fiftieth of the time normally taken.

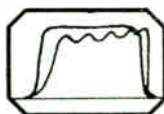

Alignment of Test Items and Comparison against Standard

The large screen display and versatility of the 'Polyskop' provides for greater accuracy and time saving.

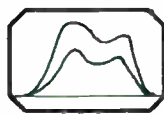

Multi-Section Filters

The facility for direct comparison of sections and the inherent high accuracy and versatility of the 'Polyskop' results in improved accuracy in a much shorter time.

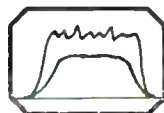

Band-Pass Filters

Alignment and analysis of filter characteristics in the shortest possible time is a feature of the reliability and versatility of the 'Polyskop'.

* 11" x 8½" DISPLAY SCREEN

* DUAL TRACE DISPLAY

* FREQUENCY RANGE
UP TO 1200 Mc/s.

This is the only instrument which eliminates the necessity of 'point by point' measurements by providing sweep signal generator, visual indicator, attenuator, and frequency markers in ONE INSTRUMENT. The 'Polyskop' combines simplicity of operation and versatility with high degree of accuracy at frequencies up to 1200 Mc/s.

Leading manufacturers throughout the world have proved that the use of this instrument in both production and research has resulted in greater efficiency and reliability.

Aveley Electric

Limited

Distributors in United Kingdom for:

Measuring instruments of quality

SOUTH OCKENDON · ESSEX
TELEPHONE: SOUTH OCKENDON 3444
TELEX: 24120 AVEL OCKENDON

For Further Information Write or Phone

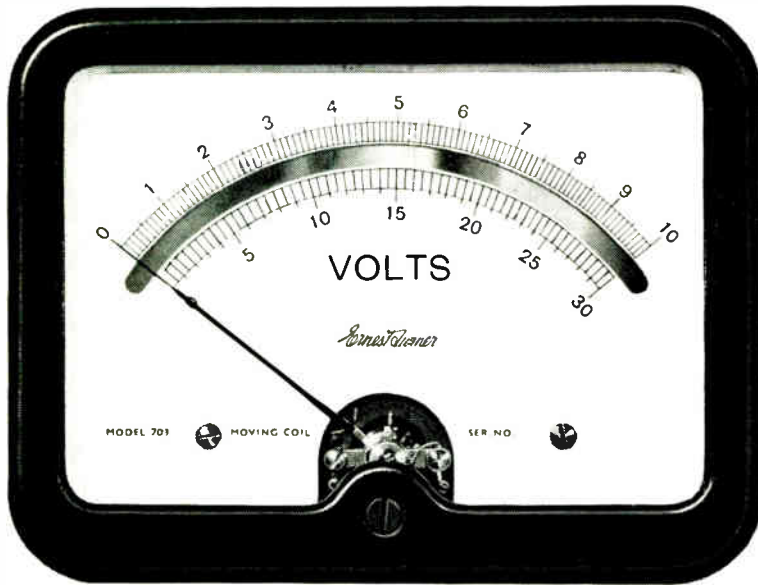

**The full range of
Ernest Turner
Instruments will be
on display on
Stand No. G.23
I.E.A. Exhibition**

Illustrated above is the Model 703 rectangular instrument shown approximately actual size. It is fitted with the mirror scale and knife edge pointer, which is particularly useful when maximum reading accuracy is required. The instrument shown is a two-range type, which under certain conditions can be supplied self-contained. As with all Ernest Turner instruments, the dial markings can be supplied so that the instrument indicates physical constants other than those actuating the movement. The full range of Ernest Turner electrical measuring instruments is described in Catalogue No. 85/21, available on request.



ERNEST TURNER ELECTRICAL INSTRUMENTS LTD.
HIGH WYCOMBE - BUCKINGHAMSHIRE - ENGLAND. *Tel: High Wycombe 1301*

Be sure to see **TMC** at the I.E.A. Exhibition Stand G81

TMC ELMEG ELECTRO-MECHANICAL COUNTERS

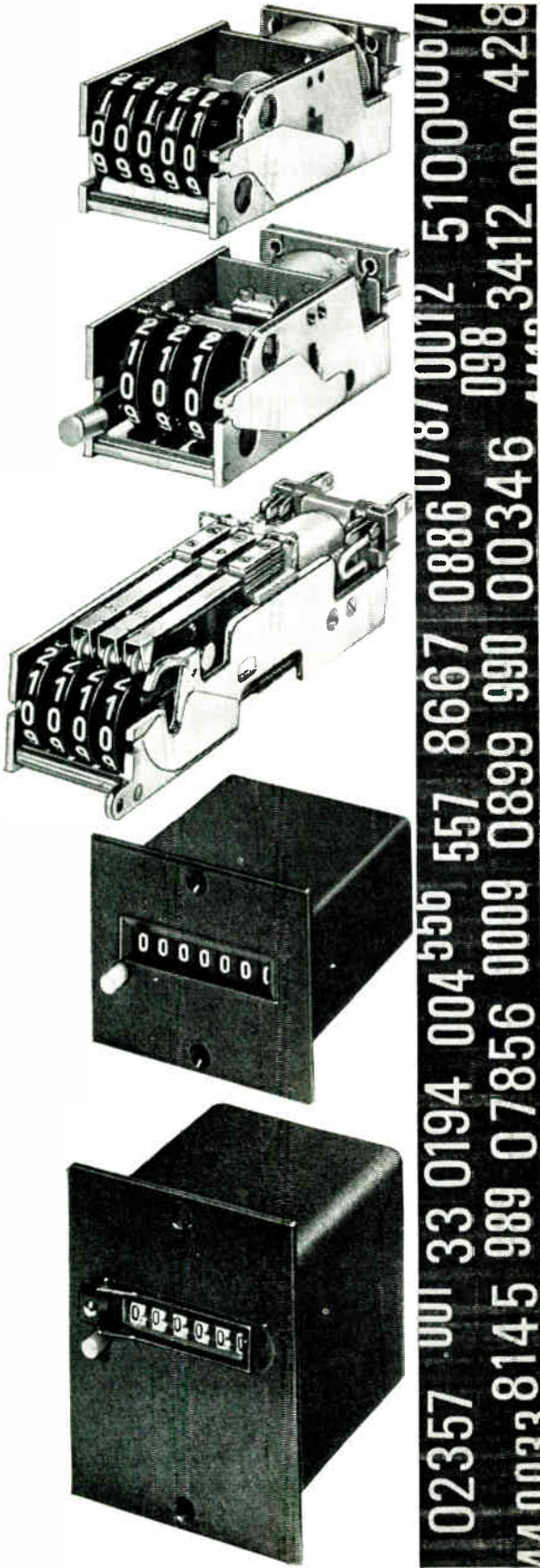

Every TMC Elmeg Counter is a 'Special', precision engineered to meet the needs of the broadest possible range of control and measurement equipment — that is why these counters are the automatic choice of the discerning engineer who demands top reliability, quick delivery and down to earth prices.

Bi-directional Counters which will accept signals from two independent sources and display the sum or the difference.

Pre-determined Counters Set the wheels — they count the number; reset and the count begins again — ad infinitum.

Totalising Counters With resets both electrical and mechanical which do not jam when an impulse coincides with resetting.

High Speed Counters

Low Speed Counters

Continuously rated Counters

Print-out Counters

These and many others are available from TMC — write for details of the complete range.



TELEPHONE MANUFACTURING COMPANY LIMITED

Components Unit,
Martell Road · West Dulwich · London · S.E.21 · Telephone: GIPsy Hill 2211 · Telex: 28115

TMC is a Registered Trade Mark A MEMBER OF THE  GROUP OF COMPANIES

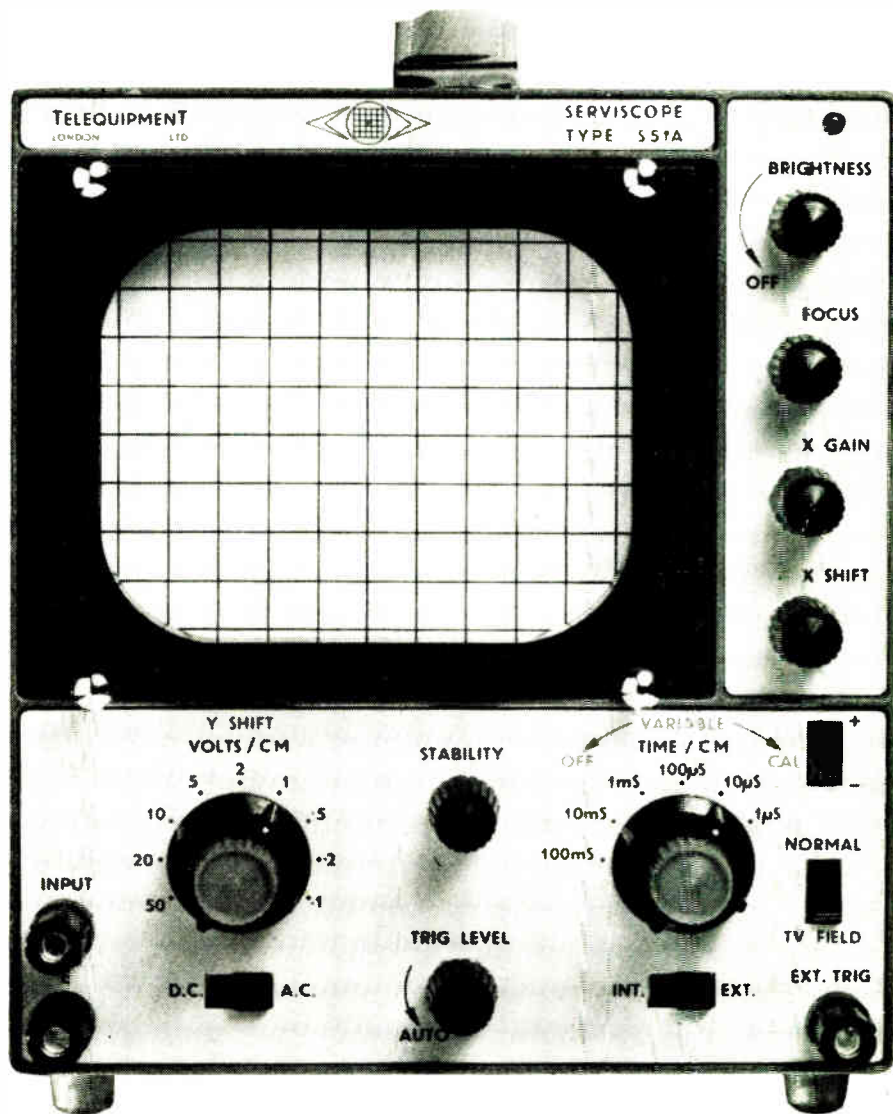
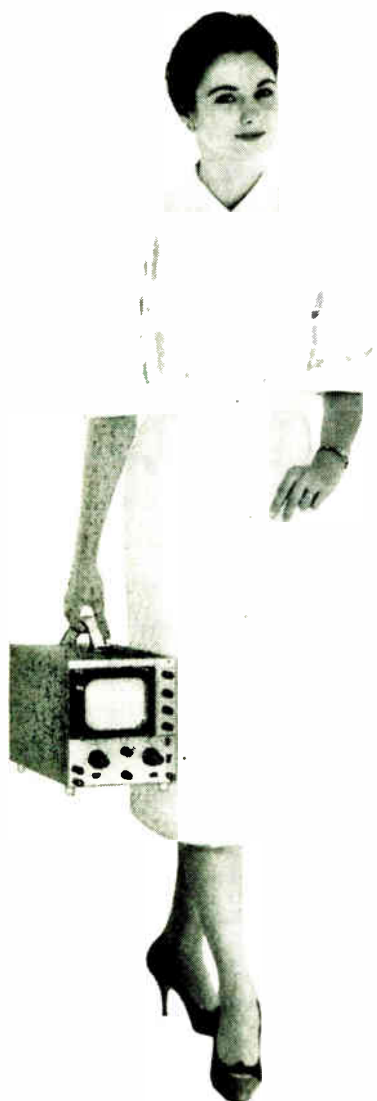

5" OSCILLOSCOPE FOR £49

The Serviscope^{*} type S51A is an instrument of good general specification with as large a display — on a 5" flat-faced screen, PDA tube — as is normally available on a portable oscilloscope today. It has been designed and built to make successful operation by non-technical personnel possible; the simplicity of the controls, the ease of reading and the ruggedness of its construction make it eminently suitable for general use in industry. Applications include inspection, production control, training and monitoring.

This new Serviscope is the latest in a line of portable, reliable, low-cost instruments, which are playing an increasingly useful role in the world of electronics. A descriptive leaflet giving full specifications of the S51A will be sent on request.

Max. bandwidth 3 Mc/s (-3dB approx.) · Max. sensitivity 100 mV/cm · Calibrated input attenuator 100 mV/cm to 50 V/cm · 6 preset sweep speeds plus 10:1 variable control
Automatic sync. trigger with level control · DC coupled flyback blanking
Medium or long persistence tube phosphors at no extra cost

SERVISCOPE type S51A

STAND G109 1EA

^{*}'Serviscope' is a registered trade mark of
 Telequipment Limited, 313 Chase Road, Southgate, London, N.14 · Fox Lane 1'66



Visit the I.E.A. Exhibition
OLYMPIA, MAY 25-30
STAND N243

GETTING THE MEASURE OF SOUND SPECTRA

Applications	Analysis of complex vibrations and sound waves in the audio-frequency range. For direct measurement of vibrations or sound amplitudes when a suitable pick-up or microphone is connected to the input—facilitates tracing vibrations in mechanical systems—can be used as a tuned detector in an electrical bridge.
Range	2 c/s to 20 Kc/s in 8 steps. The frequency response is $\pm 1\frac{1}{2}$ db, and the accuracy $\pm 2\%$.
Input Voltage	Full scale deflection 1mV—30V, in 10 ranges.
Meter Scales	0-3-2V; 0-10V; and -6 to +10db. Total decibel range -76 to +30db. Reference 1V.
Input Impedance	1M Ω in parallel with approximately 50pf on 1-30mV ranges, and 20 pf on higher ranges.
Selectivity	Band width approximately 8% of tuned frequency for frequencies at -3db response or all-pass.
Output	1 V r.m.s. approximately, on open circuit. Source impedance 5K Ω and 100 μ f in series. Any load may be connected to the output.
Power Supply	Dry batteries, Ever-Ready PP9 or equivalent. Contained in separate and easily accessible compartment.
Dimensions	13in. (330mm) wide, 7in. (180mm) deep, 8 $\frac{1}{2}$ in. (220mm) high. Weight 15lb (7kg) approximately.
Price	In U.K. £180.

The Dawe range of instruments includes a complete series for the measurement, analysis and recording of sound and vibratory signals, including variable Bandwidth, Octave, and One-Third Octave Filters. Send for further details.



**DAWE TYPE 1461A
A. F. ANALYSER**

DAWE

Full technical data from:—

DAWE INSTRUMENTS LTD., WESTERN AVE., LONDON, W.3 Tel: ACOrn 6751

A member of the *Simms* group of companies

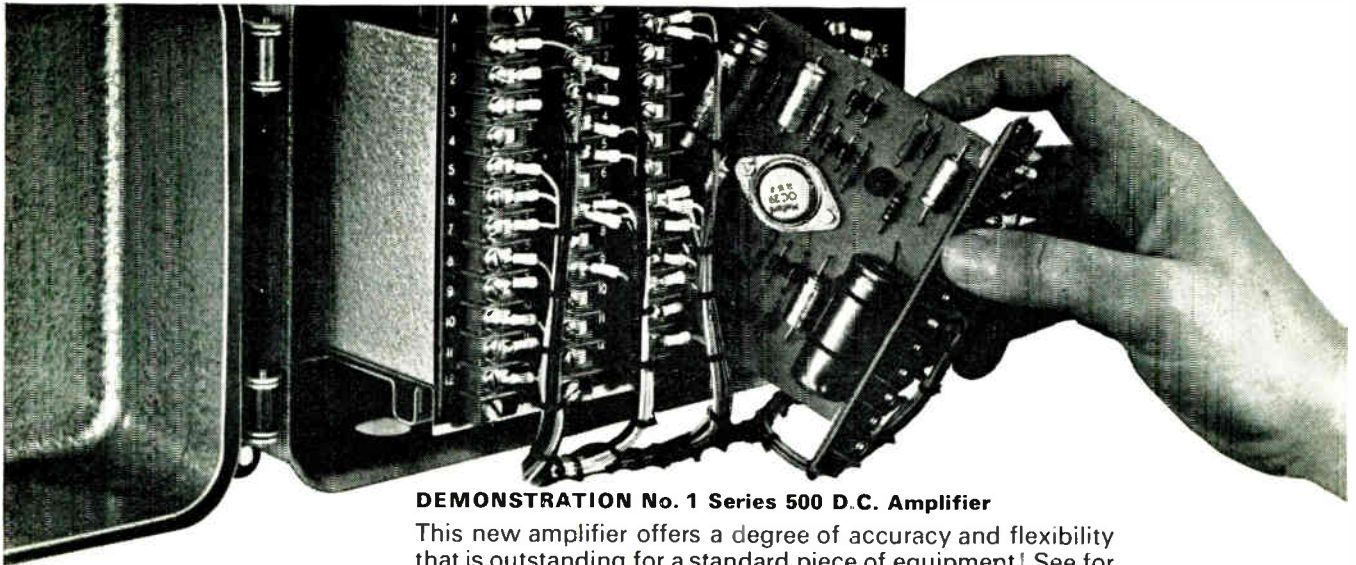

DEMONSTRATION No. 1 Series 500 D.C. Amplifier

This new amplifier offers a degree of accuracy and flexibility that is outstanding for a standard piece of equipment! See for yourself at the Evershed stand G53—where it will be maintaining an accuracy of 0.25% under a variety of unfavourable test conditions, including mains voltage variation of $\pm 10\%$.

EVERSHED IN ACTION on Stand G53

DEMONSTRATION No. 2

Tank Logging

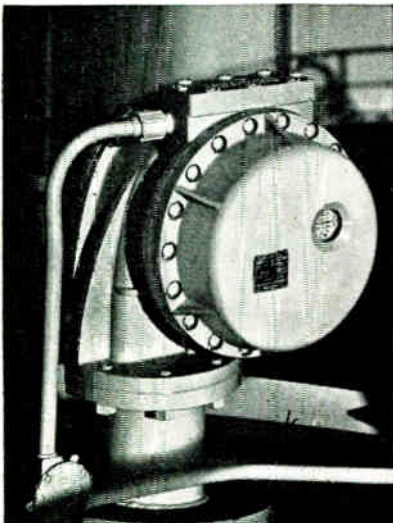

Continuous logging of level and temperature, using Precise Tank Gauge and Average Temperature Spiral. Also demonstrated will be a new development using a magnetic follower for level measurement in high pressure tanks and in corrosive fluids.

DEMONSTRATION No. 3 Dionic Conductivity System

using solid state circuitry. This new Dionic unit offers greatly improved linearity.



DEMONSTRATION No. 4 Mass Flow

using standard 300 Series equipment. Temperature, pressure and flow will be varied at will and an Evershed Solid State Computer will calculate the formula—

$$\frac{h P_m}{P_b} \cdot \frac{T_b - K}{T_m - K}$$

DEMONSTRATION No. 5 New Evershed Solid State Computing

will show multiplication, division, integration. Squaring, square root, ratio, and isolation boards are also available.

DEMONSTRATION No. 6 Electronic switching

will be displayed. During manual adjustment of control, alarm lamps will operate at preset points.

New Evershed Transmitters

the latest additions to the Evershed range, will be on view.

Get in touch with Evershed if you would like tickets for the I.E.A. exhibition. If you are unable to come we shall be pleased to send literature on these or any other Evershed products.

Evershed & Vignoles Ltd., Acton Lane Works, Chiswick, London, W.4. Chiswick 3670

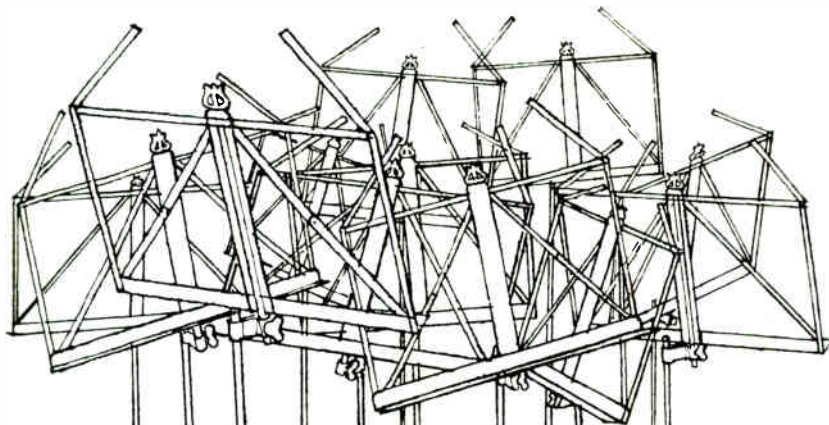

CAPACITORS PLAY MANY PARTS

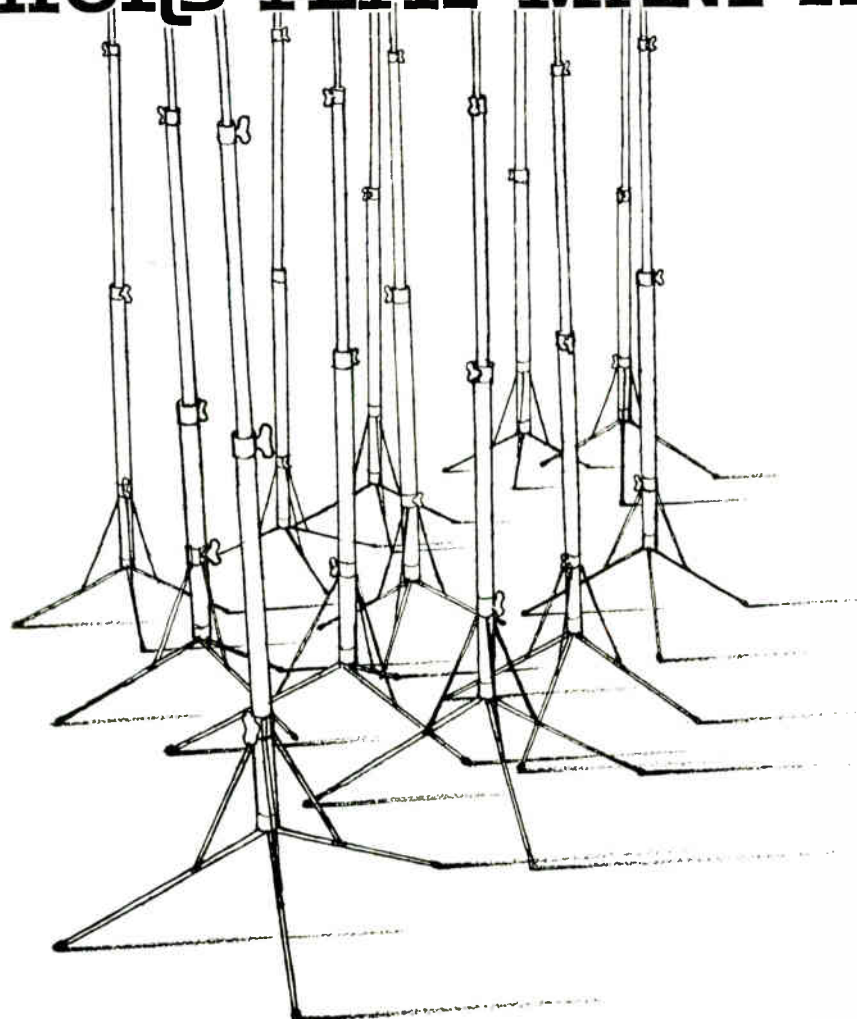

TMC KNOWS THE SCORE



TMC is a Registered Trade Mark

CAPACITOR DIVISION
TELEPHONE MANUFACTURING COMPANY LIMITED
Sevenoaks Way · St Mary Cray · Orpington · Kent · Tel: Orpington 27020 · Telex: 28115

A MEMBER OF THE  GROUP OF COMPANIES

BREAKTHROUGH

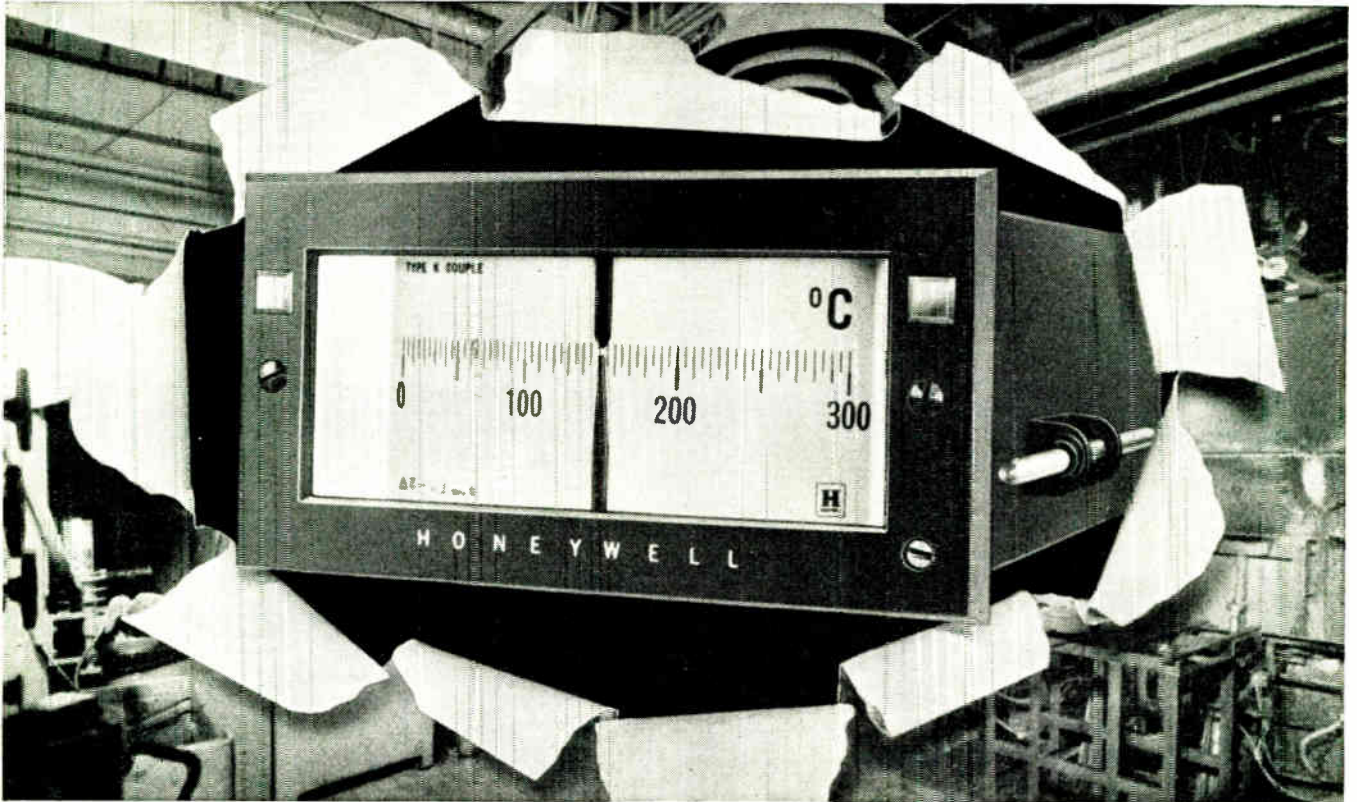

a completely new approach to reliable temperature indication/control

HONEYWELL SERVOTRONIK

a revolutionary null balance servo driven potentiometric instrument that —

eliminates

- delicate millivoltmeter movements
- all site adjustments
- shipping problems

offers

- on/off, 3 zone or anticipatory control
- operation from thermocouple, resistance bulb or millivolt source
- automatic cold junction compensation
- wide range of temperature scales with zero suppression available
- control action indication by integral pilot lamps
- reliable, long-lasting solid state circuitry
- robust, vibration resistant operation
- maximum economy of panel space
- robust power driven indication

For full details of this outstanding British development write now to:

Honeywell Controls Limited
Greenford Middlesex Wuxlow 2333

Honeywell

PROCESS CONTROL DIVISION

further information circle 225 on Service Card

THIS UNIT-CONSTRUCTION DATA ACQUISITION EQUIPMENT COMBINES HIGH ACCURACY PROVEN RELIABILITY VERSATILITY · FLEXIBILITY

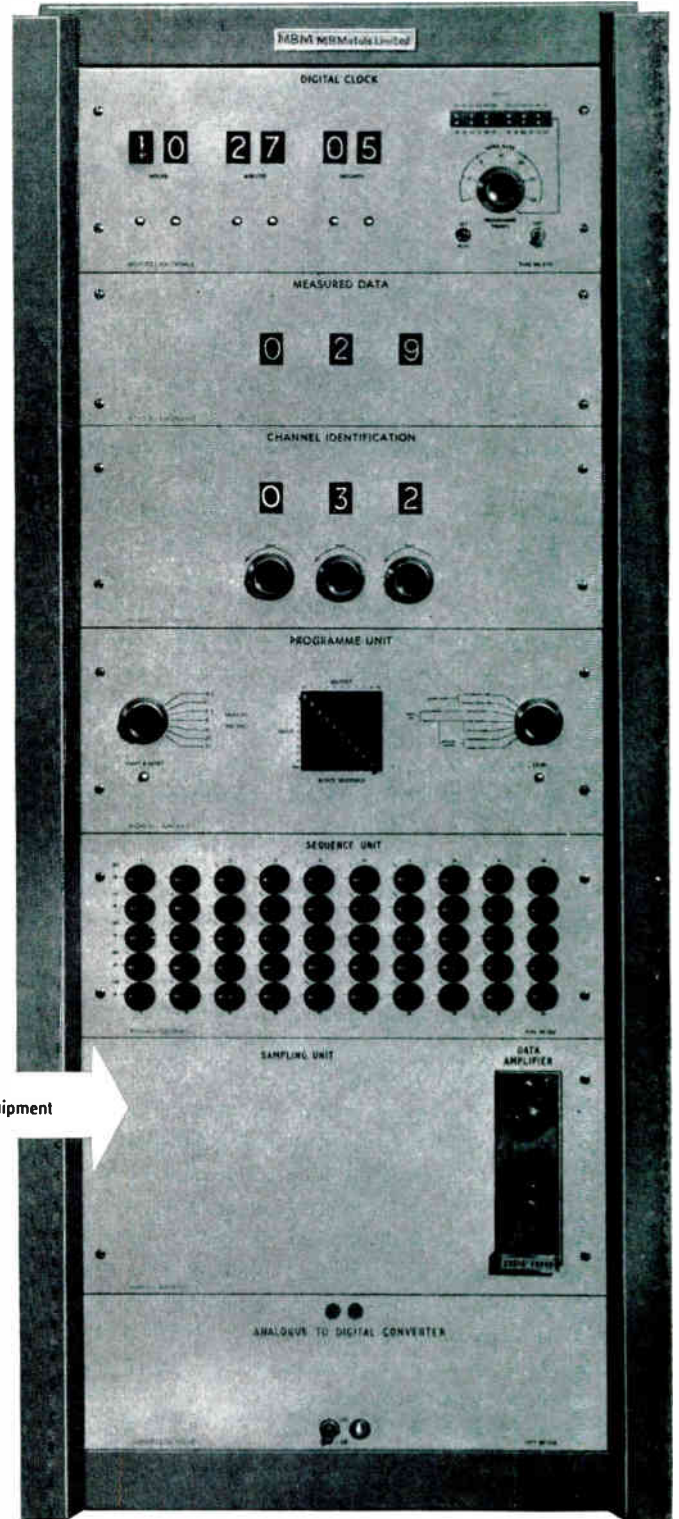

Visit Stand G394 at the IEA Exhibition Olympia

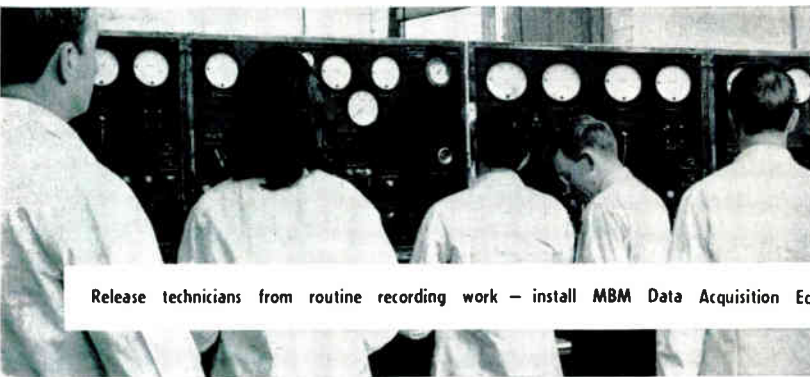

Release technicians from routine recording work — install MBM Data Acquisition Equipment

MBM Transistorised Data Logging/Alarm Scanning equipment—comprising high quality standard modules, custom-assembled to meet exact requirements—can be used as a nerve centre for the control of automated systems. It provides a highly sophisticated Systems Engineering Service at an economic price.

Full information immediately available from: TECHNICAL SALES OFFICE

MBM MBMetals Limited

PORTSLADE SUSSEX ENGLAND TELEPHONE: BRIGHTON 46981

A member company of Carbon Electric Holdings Limited 

The equipment — a product of Advanced Systems Division — caters for temperature, pressure, strain flow measurement or any physical parameter. Typical applications include: nuclear and conventional power plant instrumentation, process plant monitoring, structure testing, wind tunnel instrumentation, engine test cells, rocket motor test cells, environmental testing, electronic equipment routine testing, temperature measurement and control, component testing, medical and biological research.

STC components review

MAY 1964

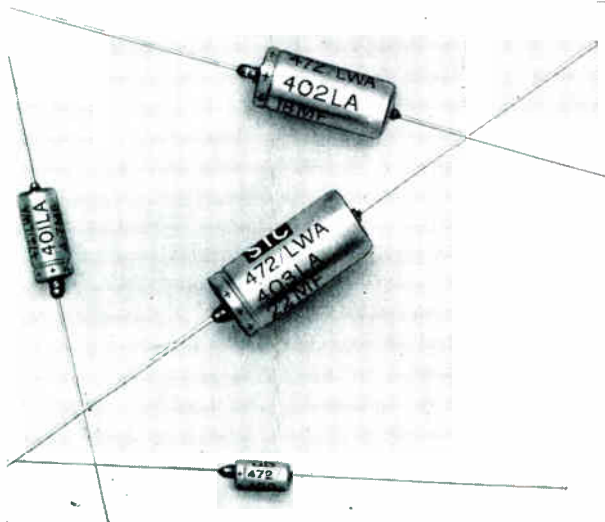

SOLID TANTALUM CAPACITORS

The STC solid tantalum capacitor series includes ratings up to 50 volts. Rated working voltages at 85 C are: 50V, 35V, 20V, 15V, 10V and 6V d.c. This range of capacitors is manufactured entirely in the United Kingdom under full Quality Control and all units are aged for 7 days before shipment.

Capacitors to 5% and 10% tolerances are now available, in addition to the standard 20% capacitance tolerance.

- Designed to DEF 5134-A-1 and MIL-C-26655/2 (Styles CS12 and CS13)
- Temperature range: -55 C to +125 C (with voltage derating above +85 C)
- Humidity classification: H6 (DEF 5011)
- Capacitance range: 0.47 μF to 330 μF.

MoA APPROVAL Departmental Approval Certificate Number NS.3020/2, covering STC Solid Tantalum capacitors, has been granted by the Ministry of Aviation. The approval is based on a successful test programme carried out by SRDE to Draft DEF 5134-A-1 and is pending the finalization of this specification.

Write, 'phone or Telex for Data Sheets to STC Capacitor Division, Brixham Road, Paignton, Devon or London Sales Office, Footscray, Kent. Telephone FOOTscray 3333. Telex 21836.

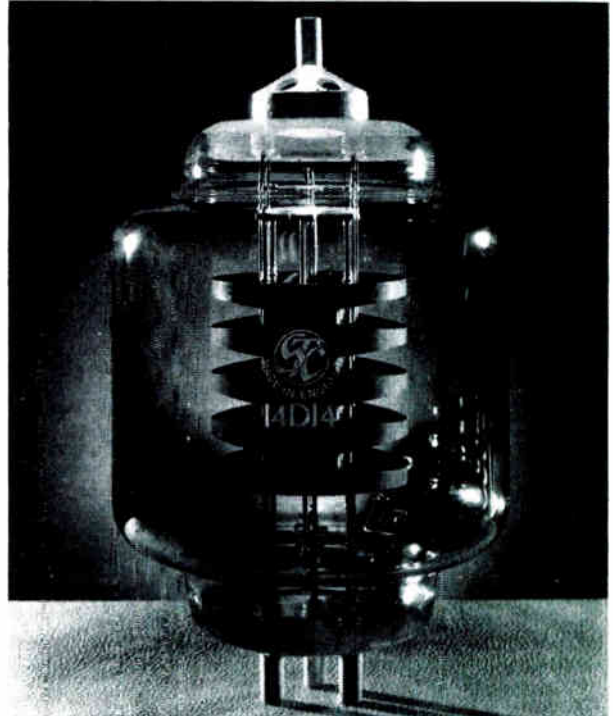

AF POWER AMPLIFIER VALVES

STC manufacture Power Amplifier Valves for a range of applications including use as vibration, modulation and public address amplifiers. Typical is the Type 14D14 shown above and which has a safety factor on anode dissipation of 250%. It is intended for use where the load impedance is variable and where the valve may be subjected to high dissipation. The electrical characteristics, other than anode dissipation, are similar to those of type 4212E.

ABRIDGED DATA

Code	μ	Screen Grid (μ)	g _m (mA/V)	P _a max. (W)	AF Output Class AB2 (2 valves p.p.) (W)	RF Output Class C		
						W	Mc/s	
4242A+ (CV25)	12.5	—	4.0	85	220	142	6.0	} Triodes
4212E† (CV1252)	16	—	8.4	275	1 400	930	1.5	
14D14	16	—	8.0	750	1 400	930	1.5	
5B/255M (CV391)	—	9.0	6.0	25	80	40	60	} Beam Tetrodes
813 (CV26)	—	8.3	3.75	100	—	275	30	

† Replaces type ES85

‡ Group 5 version replaces types 1501 & 14D13

Write, 'phone or Telex for Data Sheets to STC Valve Division, Brixham Road, Paignton, Devon or London Sales Office, Footscray, Sidcup, Kent. Telephone FOOTscray 3333. Telex 21836.

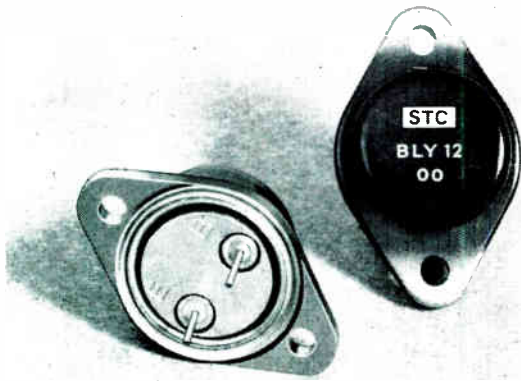

A NEW SILICON POWER TRANSISTOR

has been added to the STC range. This is the BLY12, a silicon epitaxial planar high frequency transistor with a collector dissipation of 25 watts and encapsulated in a JEDEC TO-3 package. It is suitable for use both as a high current high voltage switch and as a high frequency power amplifier up to 20 Mc/s. Delivery is available from stock.

BRIEF DATA

f_T at 100mA:.....60 Mc/s (This figure is maintained for currents approaching 1A.)
 h_{FE} at 2A:.....30-100
 $V_{CE(sat)}$ at $I_C=2A, I_B=0.2A$:.....1 V max.

RATINGS

V_{CBM}60V
 V_{CEM}30V
 $I_{C(pk)}$5A
 PCM25 W in a heat sink

OUTLINE: JEDEC TO-3

SILICON PLANAR DOUBLE TRANSISTORS FROM STOCK

The BFY20 is a matched pair of BFY18 silicon planar transistors mounted together on a 6-lead header and encapsulated in a TO-5 case, the transistors being electrically isolated. The common mounting minimizes the temperature difference between the two transistors, making the device ideal for use in D-C amplifiers. The BFY20 is now fully available from stock.

BRIEF DATA

f_T at 10mA:.....245 Mc/s typ
 I_{CBO} at 9 V:10 nA max
 h_{FE} at 100 μ A:.....10 min
 V_{BE} matched to within 10 mV
 PCM rating:..... 600 mW total

Write, 'phone or Telex for Data Sheets to STC Semiconductor Division (Transistors), Footscray, Sidcup, Kent. Telephone FOOTscray 3333. Telex 21836.

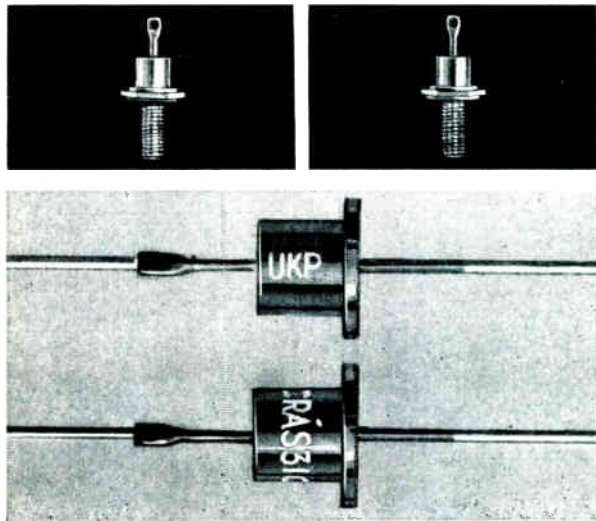

AVALANCHE RECTIFIER GETS CV APPROVAL

STC's silicon avalanche rectifier, Type RAS310AF, now has Joint Services Type Approval to CV7476. This is a diffused junction silicon rectifier with a 4kW reverse power surge rating and it is virtually self-protecting against voltage transients. This feature offers simplicity and economies; high voltage stack construction is simplified, rectifiers can be series-connected without equalizing resistors and, in many applications, equalizing capacitors are unnecessary.

RAS310AF BRIEF DATA

Rated mean forward current (25 C ambient)	1.25A
Rated Crest Working Voltage	1 000V
Minimum Reverse Avalanche Voltage	1 250V
Rated Maximum Reverse Surge Power	4 kW
Rated Maximum Junction Temperature	140 C
Standard Outlines	VASCA SO-16 JEDEC DO-1 IEC 1-101

5A AVALANCHE RECTIFIER

Latest addition to the STC silicon avalanche rectifier range is the RAS508AF. This 5A device also has a 4kW reverse power surge rating with the consequent advantages outlined above for the RAS310AF.

RAS508AF BRIEF DATA

Rated mean forward current (125°C stud)	5A
Rated Crest Working Voltage	800V
Minimum Reverse Avalanche Voltage	1 000V
Rated Maximum Reverse Surge Power	4kW
Rated Maximum Junction Temperature	150°C
Standard Outlines	VASCA SO-10 JEDEC DO-4 IEC 1-103

Write, 'phone or Telex for Data Sheets to STC Semiconductor Division (Rectifiers), Edinburg Way, Harlow, Essex. Telephone Harlow 26811. Telex 81146.

high-grade electronic components by

STC
COMPONENTS GROUP

For further information circle 230 on Service Card

2N2876

**VHF Power Amplifier
with all elements
isolated from case**

10 watts output (min) @ 50 Mc
3 watts output (min) @ 150 Mc

TA-2431*

Epitaxial Type, 25 amp (max)

V_{CEO} (min) = 80 volts
f_T (min) = 20 Mc

10-Mc High-Voltage Types

TA-2110* Family, 10 amp (max)
V_{CEO} to 300 volts
V_{CEX} to 400 volts

TA-2422* Family, 5 amp (max)
V_{CEO} (min) to 375 volts
V_{CEX} (min) to 700 volts

STAND
G 364
IEA EXHIBITION

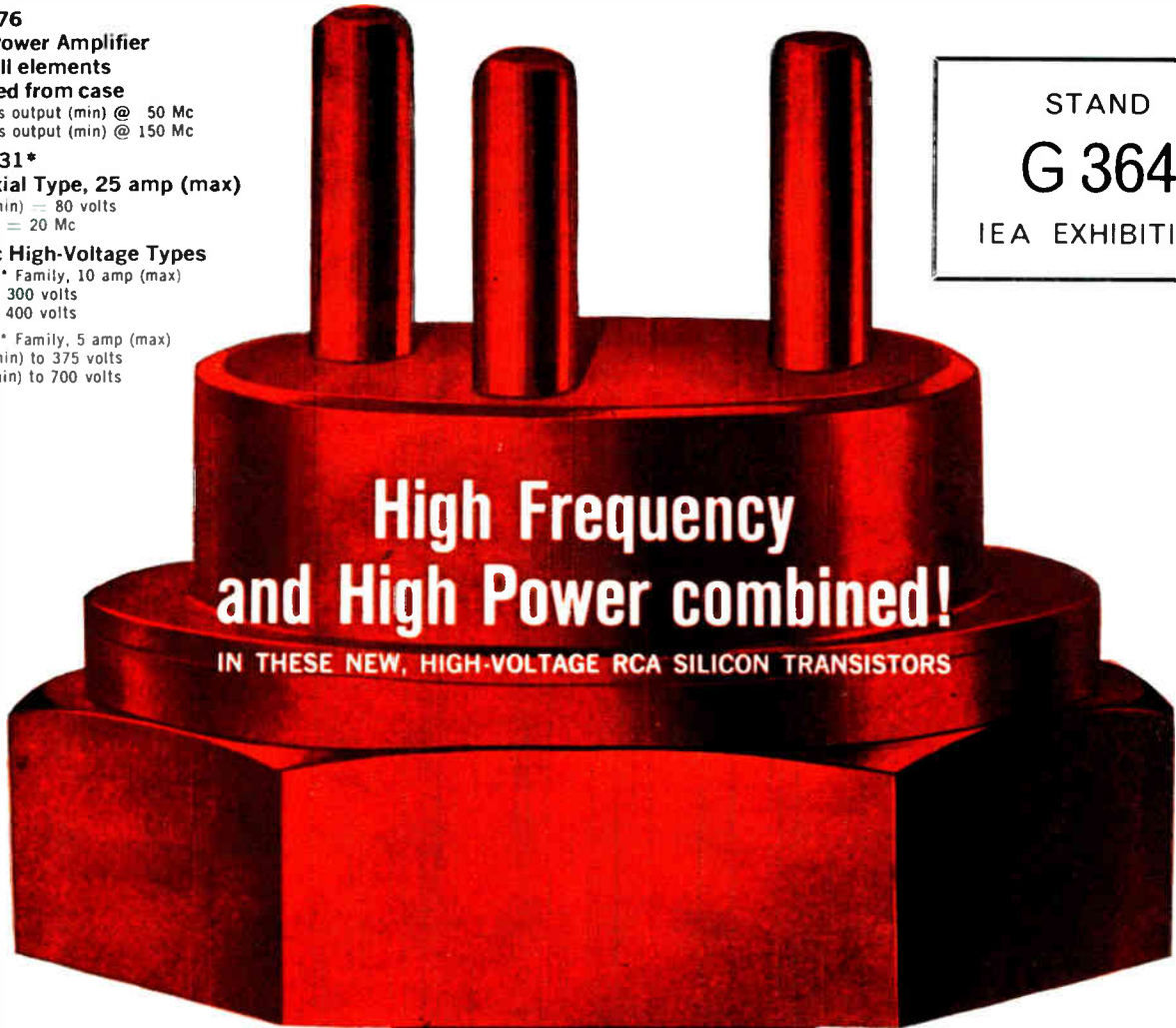

**High Frequency
and High Power combined!**
IN THESE NEW, HIGH-VOLTAGE RCA SILICON TRANSISTORS

RCA opens a new area of power applications to high-frequency transistors through high-efficiency packaging design and new advances in silicon technology.

RCA announces important advances in semiconductor design that bring new power performance to high-frequency transistors.

The interdigitated electrode structures of these silicon devices provide a long emitter periphery which accounts for their superior current-handling capability and excellent gain. New, advanced double- and triple-diffusion techniques, and epitaxial technology, provide an extra degree of uniformity in characteristics and performance.

These new types are packaged for power in specially designed double-ended stud packages. Hermetically sealed packages and heavy copper-alloy studs offer high mechanical reliability, high torquing capability, and low thermal resistance. An example of advanced case design is the RCA 2N2876 featuring ceramic seal in the feed-through terminals, isolated collector, low-silhouette for packaging flexibility, and low inductance for top RF performance.

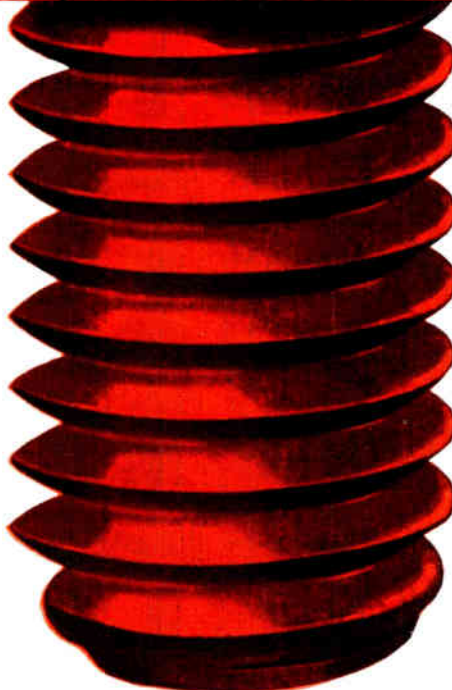

All finished units are subjected to stringent conditioning tests, including a 100 per cent helium leak check and temperature cycling.

	RATINGS			PERFORMANCE
	I _c max. (amp)	V _{CEV} (volts)	V _{CEO} (volts)	Minimum Power Output (watts)
VHF Power Amplifier 2N2876	2.5	80	60	10 @ 50 Mc 3 @ 150 Mc
RCA DEVELOPMENTAL TYPES TENTATIVE RATINGS AND CHARACTERISTICS				
	I _c † (amp)	V _{CEX} (volts)	V _{CEO} (volts)	h _{FE} @ I _c (amp)
20-amp, 20-Mc Epitaxial Power Switch TA-2431	20	120	80	22-80 @ 15
10-Mc High-Voltage Types 10-amp				
TA-2110 Family	10	400	300	40-120 @ 5
TA-2314	10	300	250	35-130 @ 5
3 amp TA-2422 Family	3	250	200	12-40 @ 2
TA-2415	3	450	300	12-40 @ 2
TA-2417	3	450	300	12-40 @ 2
TA-2422	3	700	375	20-60 @ 1

† Suggested Operating Current * Developmental Type
All these types are rated and tested for safe operation (without second breakdown)



THE MOST TRUSTED NAME IN ELECTRONICS

272

RCA GREAT BRITAIN LIMITED, Sales Division,
Lincoln Way, Windmill Road, Sunbury-on-Thames
Telephone: Sunbury 5511
ASSOCIATE COMPANY OF RADIO CORPORATION OF AMERICA.

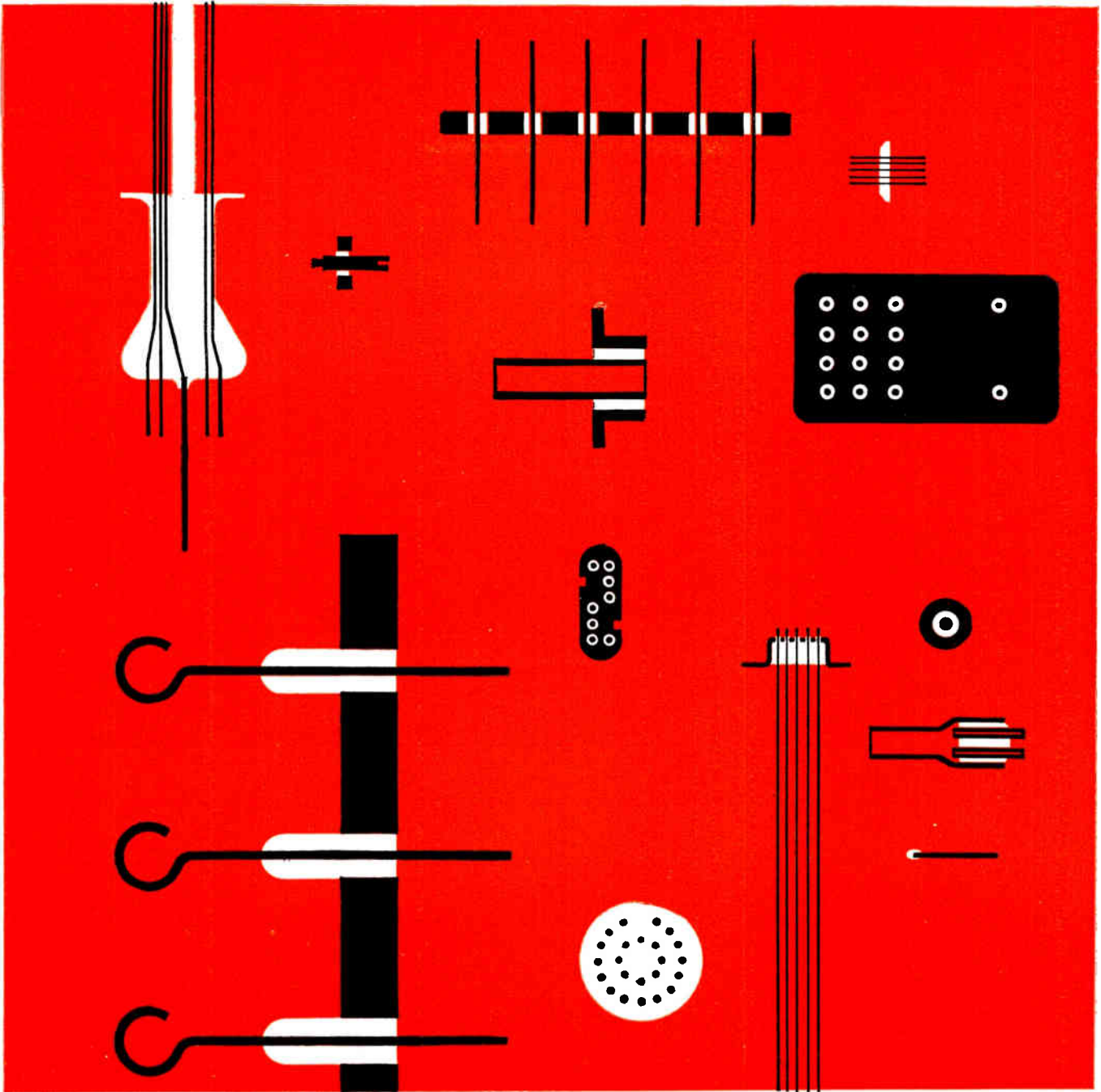

GLASS TO METAL SEALS

We are now able to offer a wide range of glass to metal seals (simple, compound and multiple). This range is further extended by facilities to produce the seals in compression, matched or fully bonded vacuum forms with a wide variety of finishes including precious metals. Deliveries are good and prices highly competitive. High quality and uniformity are ensured by advanced manufacturing techniques. Our technical liaison engineers will be pleased to meet you at any time to discuss glass to metal seal design and applications. If you would like further data on this new service to industry, please phone or write to the address below.



A TYPICAL MULTIPLE COMPRESSION SEAL

a NEW service to industry



**ERICSSON TELEPHONES LIMITED
ETELCO LIMITED**

A Principal Operating Company of the Plessey Group

ERICSSON TELEPHONES LIMITED · ETELCO LIMITED · TUBE DIVISION · BEESTON · NOTTINGHAM · TEL: 254831

ER69

Six of the best

Just six out of tens of thousands of different items from the AMP range of terminals, connectors and splices. If a suitable unit exists for your needs, AMP will supply; if it doesn't, they will invent it. Call and discuss A-MP products and the economies they can effect in your programme.

Stand N 203 IEA Exhibition



AMPILLUME* Neon Pilot Indicators

Low in cost, easy to install, efficient, unbreakable and shock-proof. Resilient moulding with either A-MP Faston* receptacles or flying leads.



AMPIN - AMPEDGE*

Amp-in Connectors for locating wires at any point on the surfaces of printed circuit boards.
Amp-edge Terminals to fit into slots along the edges of boards.

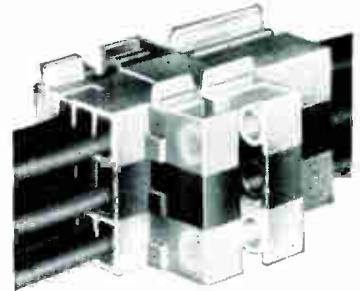

FASTIN-FASTON* '187' Modular Connectors

Three-circuit tab housings and receptacle housings for building up connectors of any size—panel mounted or free hanging.



A-MP* Re-usable Component Jacks

for the simple, economical testing of printed circuit components. Solderless contacts eliminate risk of heat damage.

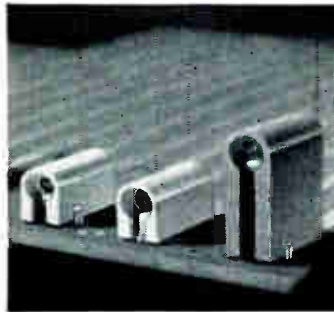

A-MP* Test Probe Receptacles

permit the testing of printed circuits by probe at any point, without interruption of circuit operation.

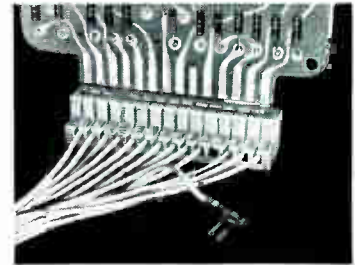

AMPin-cert DUO-TYNE* Connectors

Flag contacts in multiple housings for use with printed circuit boards. Contacts individually replaceable. Ten sizes—3 to 22 contacts.

AMP

AIRCRAFT-MARINE
PRODUCTS (G.B.) LTD

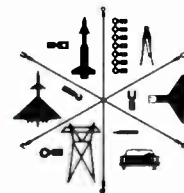

AMPLO HOUSE, SAFFRON HILL, LONDON EC1 TEL: CHA 2902

AMP products and engineering assistance are available through associated companies in:
U.S.A. · Australia · Canada · France · Germany · Holland · Italy · Japan · Mexico · Puerto Rico
* TRADE MARKS OF AMP INCORPORATED HARRISBURG U.S.A.

AP. 255

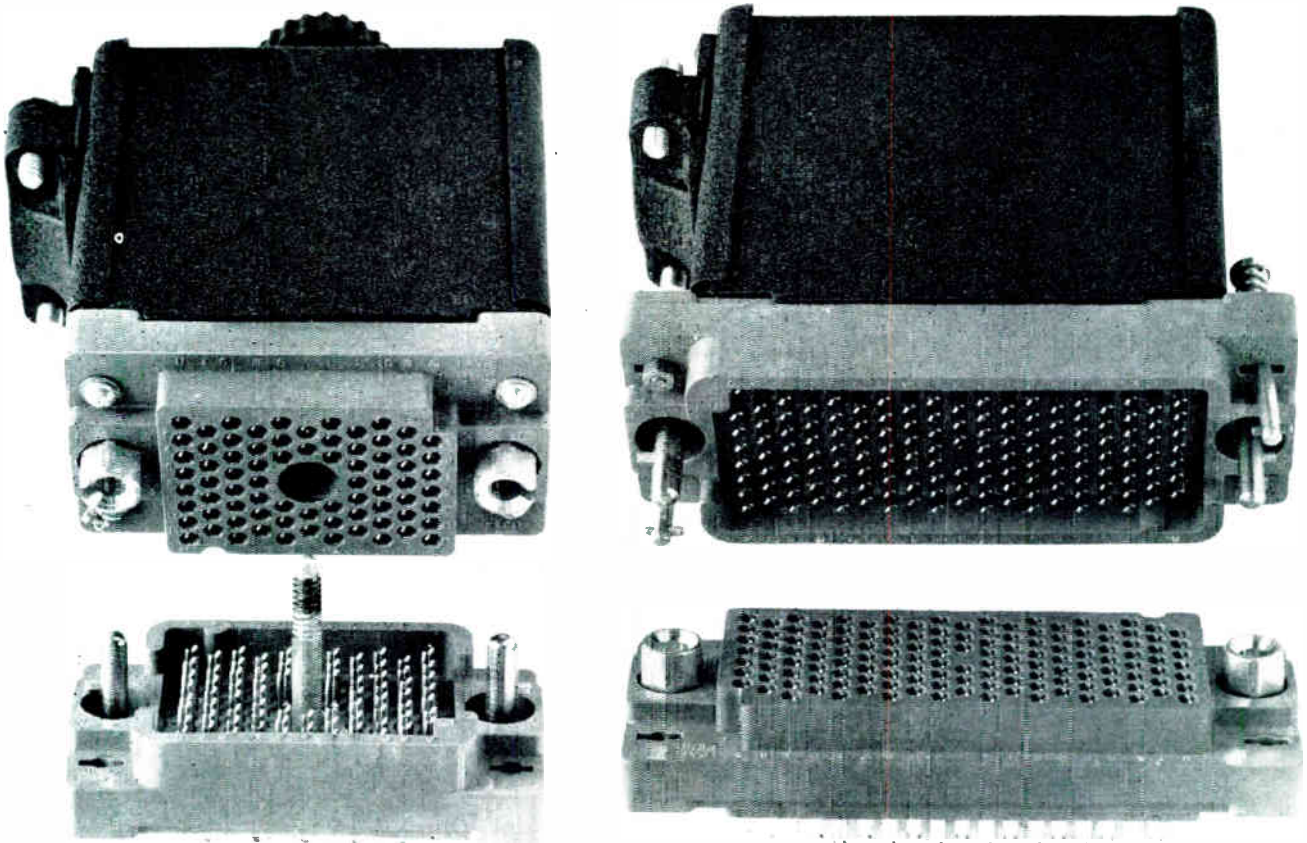

Series 8017 and 8018 Multiway Plugs and Sockets

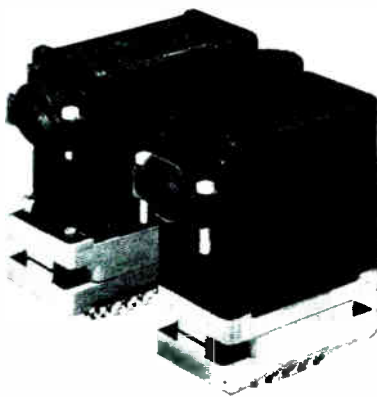

M.O.A.-A.R.R.E.-A.R.B.
Approved Inspection

The Contacts are the well-known **VARICON*** fork type Hermaphroditic contacts rated at 5 amps. They can have crimped connections and be removable from the moulding or be fixed contacts having solder terminations. The 8017 has 75, 100 or 130 ways and the two halves are secured by a screw arrangement. The 8018 has 80, 110 or 140 ways and is secured by bayonet clamps.

* TRADE MARK

MAGNETIC DEVICES LIMITED

Newmarket - England - Tel: Newmarket 3451 (10 lines)
Grams: Magnetic Newmarket

P.9623

semiconductoritis?



Reliability + Consistent Quality + Proved Service + Fast Delivery

When Semiconductoritis* strikes, prescribe Hughes... service and deliveries will improve immediately and Hughes quality control will ensure no unpleasant side-effects. Hughes prescribe from a comprehensive list of PNP/NPN Silicon planar Transistors, Silicon planar and Germanium computer diodes, Silicon power and Zener diodes and voltage variable capacitors—for immediate and regular application. Be sure, too, that Hughes research is constantly alert for new strains of semiconductoritis* and will be ready with appropriate remedies.

* Semiconductoritis: a production frustration caused by the failure or non-availability of solid-state components.

Why not phone or write now for Technical Data or Quotations. Alternatively, our Sales Engineers will be delighted to call and discuss your immediate or future needs.

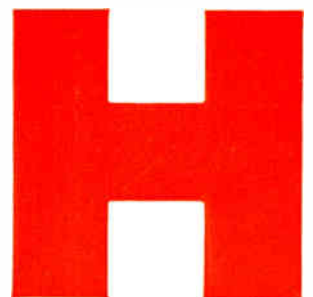

HUGHES INTERNATIONAL (U.K.) LTD

U.K. SALES: KERSHAW HOUSE, GREAT WEST ROAD, HOUNSLOW, MIDDLESEX. TELEPHONE: HOUNSLOW 5222
OVERSEAS ENQUIRIES: HUSINT S.A., 3 RUE AMI LULLIN, GENEVA

M & P HM18

thin-film circuits □ vacuum pumping devices □ integrated circuits □ multi-track recording heads □ high speed gallium arsenide diode □ VHF/UHF varactor diode □ subminiature zener diodes □ high voltage thyristors □ low saturation voltage planar transistors television monitor tubes □ infra-red image converter □ U/V photocell for gas flame control □ tunnel diodes □ 12kW UHF power klystron □ specialized microwave components □ low-cost vidicon camera tube

Mullard highlights at the IEA



The above are just a few of the important developments in valves, semiconductor devices and passive components that Mullard will be exhibiting at the 1964 Instruments, Electronics and Automation Exhibition.

Join us on Stand G37 and discuss these and other developments with our engineers.

In any case be sure to call for your copies of our latest Quick Reference Catalogues, giving abridged data on over 1,200 electronic devices.

Instruments Electronics and Automation Exhibition, Olympia, London, May 25th—30th.

Meet Mullard on stand G37

MH 12

Mullard

Mullard Limited, Mullard House
Torrington Place, London, W.C.1 Tel: LANgham 6633

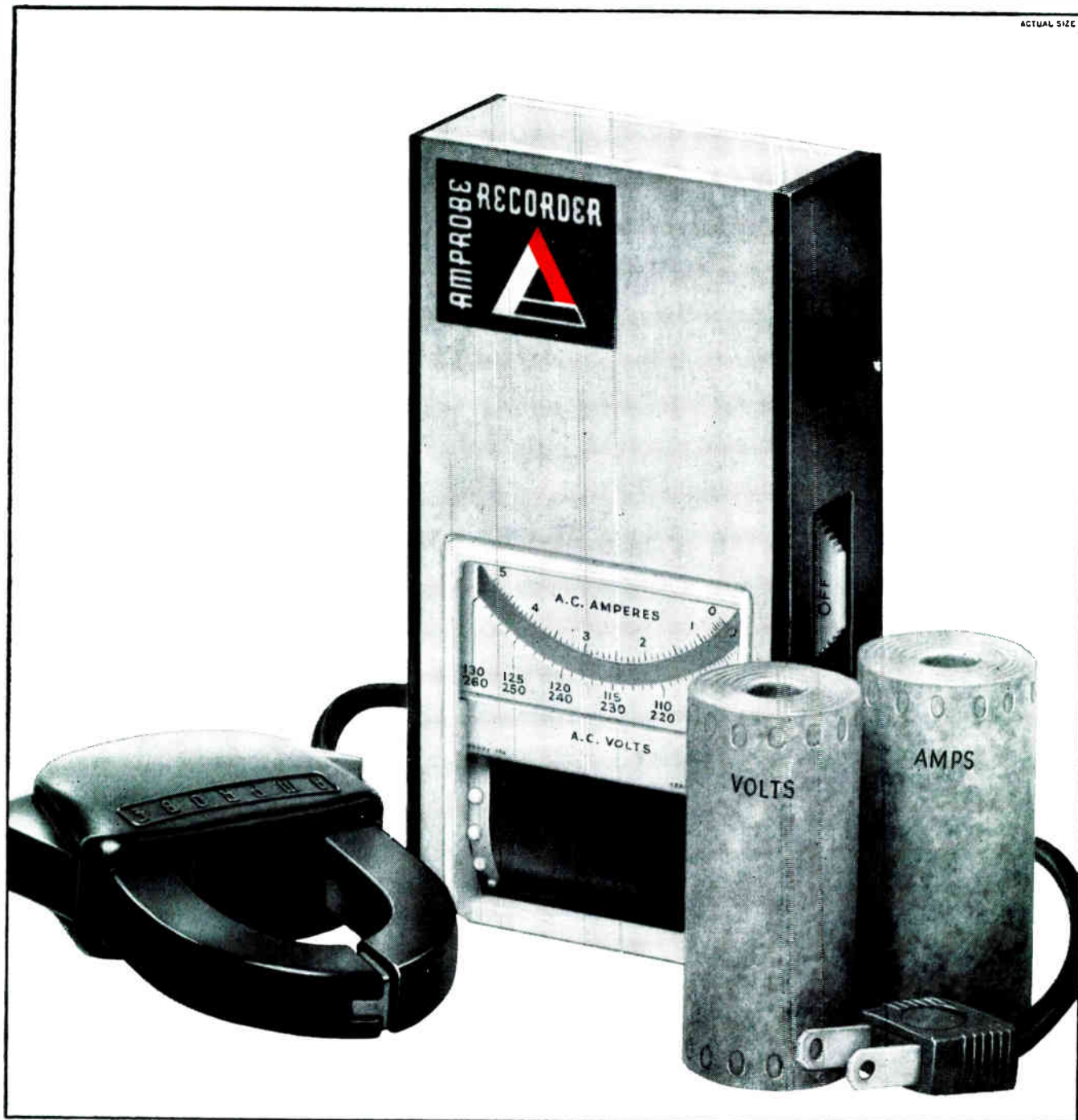

NOW . . . AMPROBES ADD A NEW DIMENSION TO INSTRUMENTATION

Amprobe Recorders are the smallest, lightest least expensive precision instruments available today, which are universally adaptable to the measurement of any variable by the use of suitable transducers. Their miniature size is due to a unique, simple mechanism, yet they are capable of doing as complete a job as larger, more elaborate meters. Their unusual flexibility is due to the use of the latest in advanced components. Certain basic Amprobe Recorders are readily adaptable to many diversified and special applications.

The New Amprobe Recorders troubleshoot for you 24 hours a day, providing permanent, continuous records of operating conditions on pressure-

sensitive paper with simple drop-in loading. They are available in many models and ranges in Portable or Flush Panel-Mount Types, and can be used as either indicating meters or monitoring recording devices. Simple, precise and foolproof, Amprobe Recorders are time-and-labour saving tools necessary in today's electrical-electronic equipment installations. Write for detailed catalogue sheet and nearest stockists.

AMPROBE

U. K. MARKETING DIVISION
CANADIAN INSTRUMENTS | 35 WAVERLEY ST.
AND ELECTRONICS, LTD. | NOTTINGHAM

Give it the works!

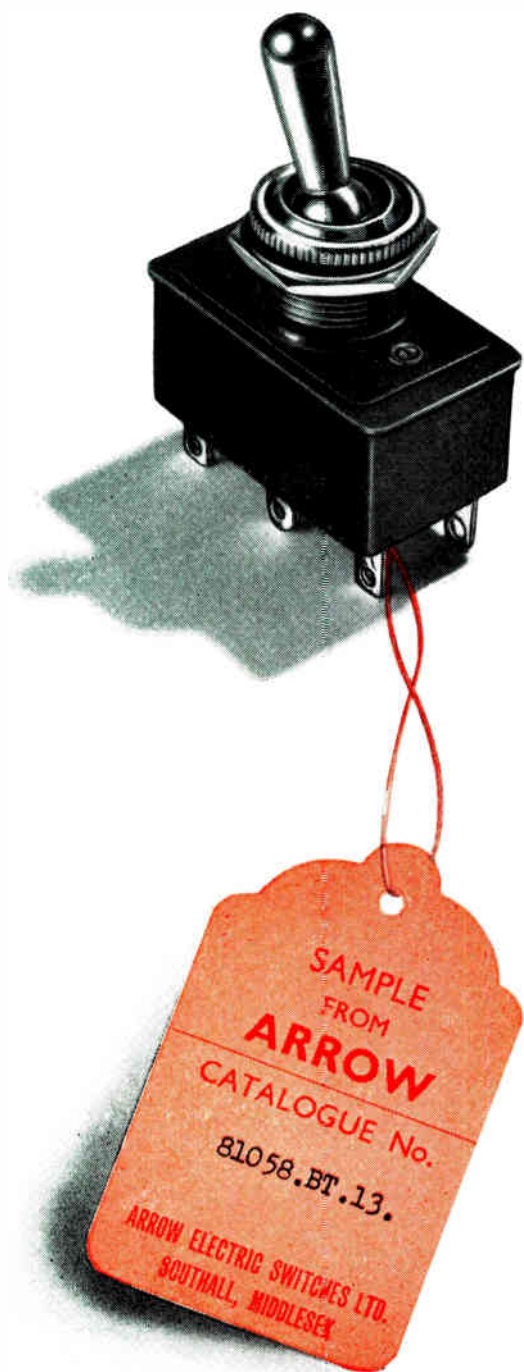

We, at ARROW, understand the responsibility which rests on any Engineer's shoulders whose job it is to specify switches. Therefore, knowing our products as we do, we welcome every opportunity to send samples to be given 'the works', as we are confident of the results.

Illustrated is a small switch specially designed for instrument applications where low contact resistance is essential. Many circuit arrangements up to D.P.D.T. are offered.

I.E.A.
Stand
GII2

ARROW
ELECTRIC SWITCHES LTD

BRENT ROAD · SOUTHALL · MIDDX

Telephone: SOUthall 2442

SOLDERING MINIATURE COMPONENTS

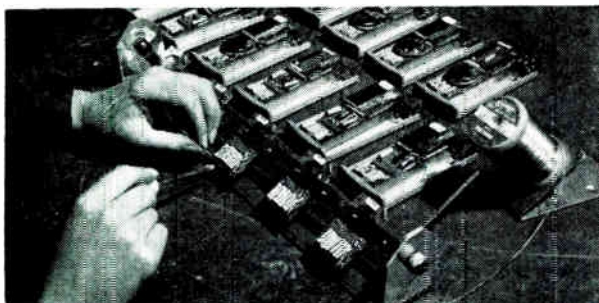

Multicore being used to solder connections on pocket receivers—part of the Westrex personal call system.

CHOOSE THE BEST SPECIFICATION OF ERSIN MULTICORE SOLDER FOR YOUR PRODUCTION SOLDERING PROCESS

The continual reduction in size of electronic components may make it advisable for you to use new specifications of Ersin Multicore Solder to obtain maximum efficiency and reliability. Alloy, diameter of the solder, type and percentage of flux in the solder and wear of soldering iron bits are all points to be considered.

ALLOYS

Generally only 60/40 or Savbit Type 1 alloys should be used. Savbit will promote soldering efficiency by reducing considerably the wear of miniature soldering iron bits.

ERSIN

Multicore

SOLDER

MULTICORE
SOLDERS LTD.
HEMEL
HEMPSTEAD
HERTS.

DIAMETERS

18 s.w.g. to 22 s.w.g. are the gauges most suitable. Ersin Multicore is also available in even gauges down to 34 s.w.g.

The use of gauges of 18 s.w.g. and finer will reduce the amount of solder used per joint with consequent saving in cost of solder and reduction in flux residue. The following table gives details of the number of feet per lb. of fine gauges. Compare these lengths with 60/40 16 s.w.g. which has 102 feet per lb.

SWG	FEET PER LB	
	60/40	SAVBIT No. 1
18	182	170
19	282	244
20	324	307
22	538	508
24	865	856
28	1292	1279
28	1911	1892
30	2730	2695
32	3565	3552
34	4950	4895

FLUX

The rapid soldering of miniature components makes it essential that the flux in the solder shall be very active and fast, yet of course entirely non-corrosive. Ersin Type 362 flux, incorporated in Ersin Multicore Solder, has won world wide recognition for utmost reliability and consistent high quality. It complies with all relevant British and U.S.A. Government specifications.

As standard the flux percentage by weight of solder is 3.4%. **Now available for production soldering processes is Ersin Multicore Solder with 362P flux in 60/40 and Savbit No. 1 alloys. These solders have a flux percentage of 1.6 and 1.55 respectively, less than half that hitherto incorporated in standard Ersin Multicore Solder. To promote the extra rapid spread of the considerably lower percentage of flux contained in the cores and to deodorise the resin base, an exclusive agent, Pentacol, has now been combined with the flux. The well-known, approved, non-corrosive qualities of Ersin flux type 362 remain unchanged.**

Ersin Multicore Solder with 362P flux thus provides the same high speed soldering as standard Ersin Multicore Solder with the advantage that less fumes are liberated during the soldering process and less flux residue is left. Due to the lower percentage of flux, a greater amount of solder is obtained for a standard length of wire. Economies are achieved by the fact that it is often possible to use a finer gauge of the new solder to provide the same amount of solder on a joint as compared with the standard Multicore product.

All Multicore Solders are covered by one or more of the following Patents: 433,194; 675,954; 704,763; 721,881.

SAMPLES FREE to Production Engineers

We will be delighted to send free samples of any of the above specifications to production engineers who apply for them on their Company's notepaper. Please state alloy and gauge required, and if samples should be in standard Ersin Multicore Solder or 362P low flux content solder.

We will also send a complimentary copy of the technical reprint "Erosion of Soldering Iron Bits."

Telephone: BOXMOOR 3636

CINNE13

Potting shed?

May we welcome you to our Stand No. E293 at the I.E.A. Exhibition, Olympia, 25-30 May?

Araldite epoxy resins are ideal for potting—but this is not a potting shed. Here Araldite is being used to seal capacitor windings at Telephone Manufacturing Co. Ltd. The Araldite filler cures, with negligible shrinkage, to form a complete seal. It adheres strongly to metal surfaces—provides perfect insulation and resists tracking. It is impervious to moisture. Araldite sealing formulations pour and cure at room temperature. In many cases curing can be speeded up by heating.

May we send you a copy of our publication 'Araldite epoxy resins in the electrical industry'?

ARALDITE EPOXY RESINS ARE USED:

- for casting large high-grade electrical insulators and insulation around equipment such as transformers, switchgear components etc.
- for impregnating, potting and sealing electrical windings and components.
- for constructing glasscloth laminates in electrical, nuclear, mechanical and aircraft engineering.
- for bonding metals, ceramics, glass, rubber, plastics, wood etc.
- for constructing tools for forming plastics or sheet-metal, patterns for moulding foundry sand, jigs and fixtures for checking accuracy of assembly etc.
- for chemical resistant-flooring and floor surfacing.
- for anti-corrosion protection of wood, concrete, metals etc.

Araldite epoxy resins



C I B A

Araldite is a registered trademark CIBA (A.R.L.) LIMITED DUXFORD CAMBRIDGE TELEPHONE: SAWSTON 2121 41787

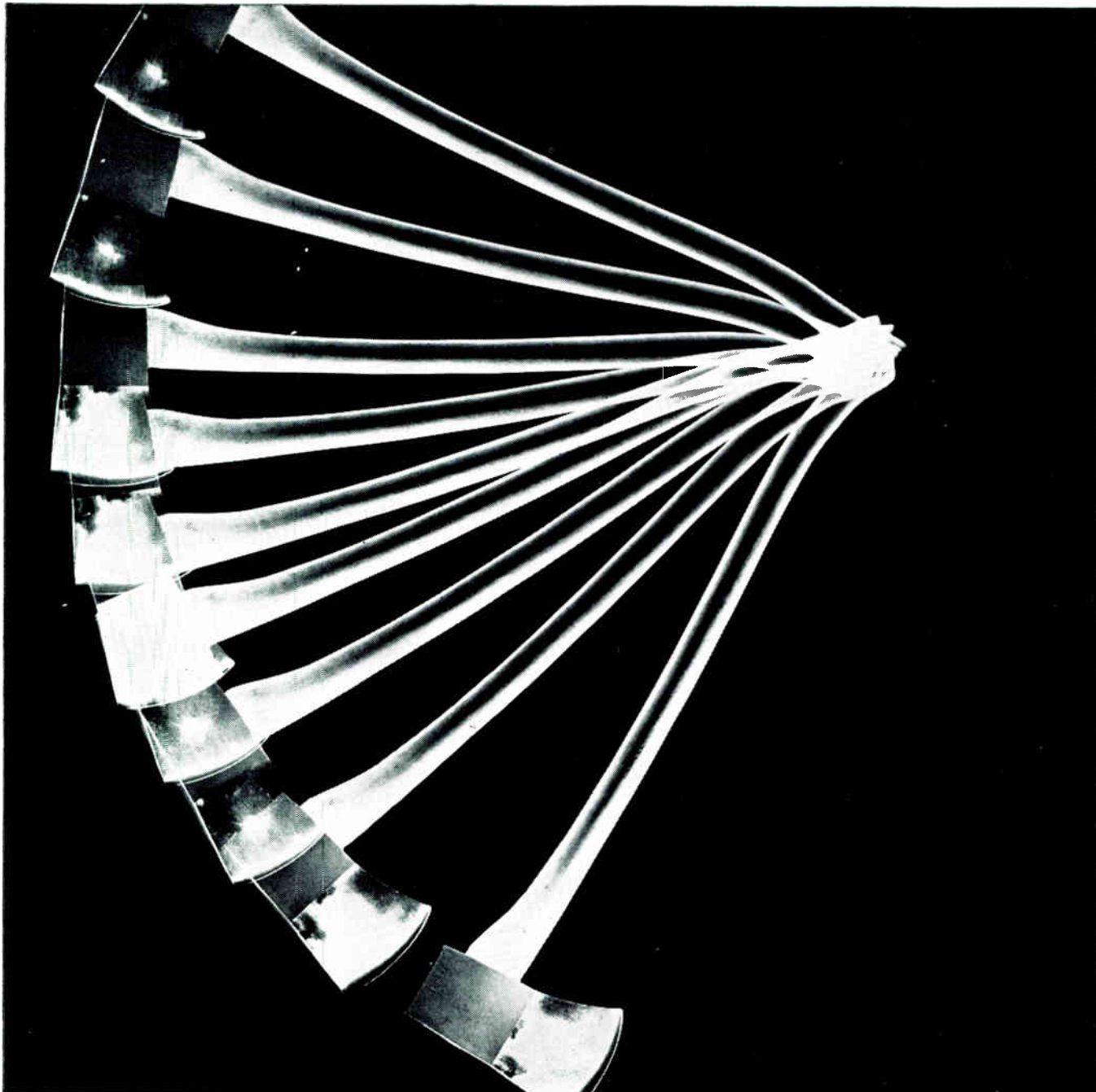

Cheapest way to chop

DC to AC — with an AEI Synchronous Chopper. It fits a standard B9A 9-pin thermionic valve holder, is suitable for feeding both high resistance and transformer-coupled low impedance circuits, its low noise level allows a 1 microvolt signal to be detected. Typical applications are: recording thermo-couple and ionisation chamber outputs; drift correction in analogue computer amplifiers; general instrumentation. Stability is high, operational life is long. Available in two models: CK3 for 50 c/s; CK4 for 100 c/s.

CK3 & CK4 SYNCHRONOUS CHOPPER

WRITE FOR DETAILS AND TECHNICAL DATA TO: AEI INSTRUMENTATION DIVISION, INSTRUMENT AND METER DEPARTMENT, TRAFFORD PARK, MANCHESTER 17



Associated Electrical Industries Limited
Instrumentation Division

S M362



Today's finest value
for only

£20

STABILISED POWER SUB-UNIT

MODEL 4931

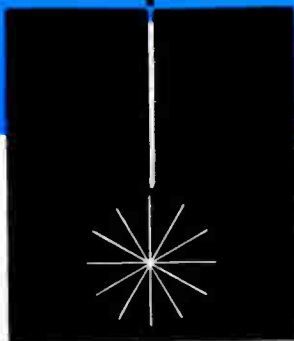
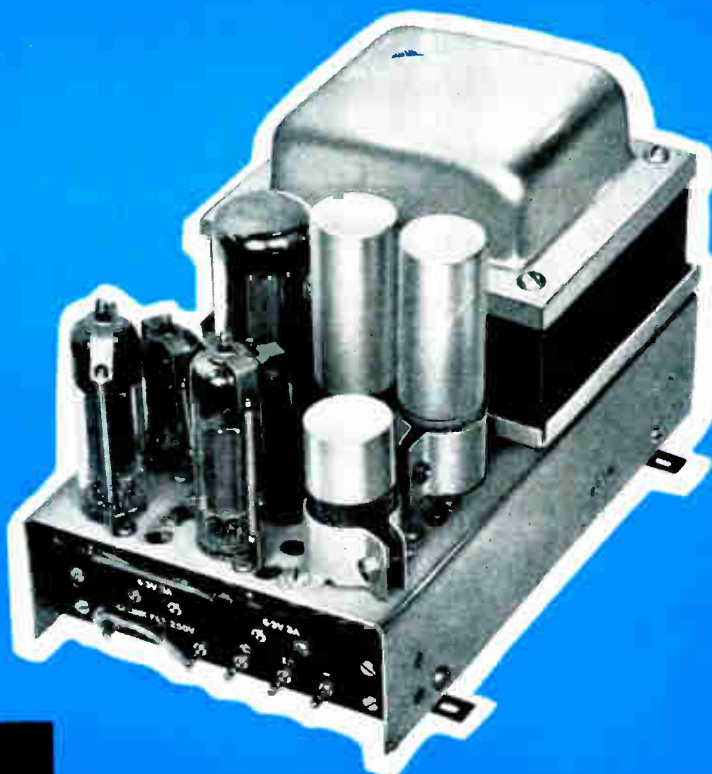
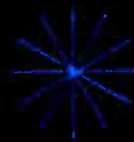

This very small unit, supplying **250 or 300 V.D.C.** at **150 mA. max.** is ideal for building into your equipment. At this price, with a stability of $\pm 0.1\%$ it is no longer worthwhile designing your own power pack.

Please send details on the following stabilised power sub-units:—

- 4931. 250 or 300V.D.C. at 150mA.
- 4964. 150 or 200V at 150mA.

4931

4964

Name _____

Company _____

Address _____

Detach and send to:—

A·P·T

**ELECTRONIC
INDUSTRIES
LIMITED**

CHERTSEY ROAD, BYFLEET, SURREY
PHONE: BYFLEET 41131 2/3/4 PABX GRAMS: APTRAN, BYFLEET

IE 364

NUMBER ONE IN ELECTRICAL CONNECTORS...

1

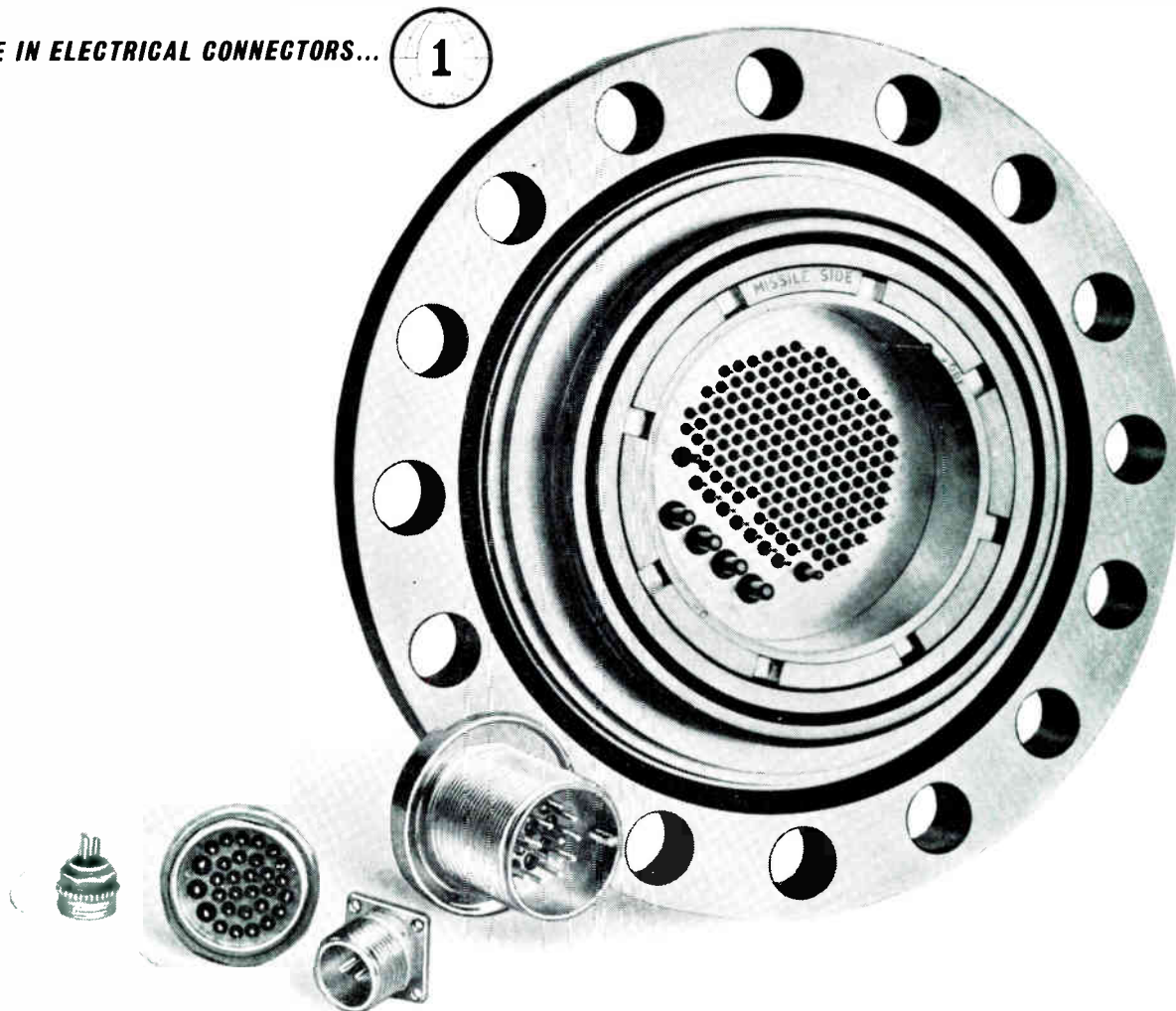

CANNON HERMETICALLY SEALED PLUGS Cannon Electric produce a vast range of true hermetically sealed connectors. These assemblies are manufactured using compression glass. This provides an excellent and rugged seal, high insulation resistance and strength. The seals are effected by virtue of different coefficients of expansion of glass and metal. The following features are characteristic of the Cannon hermetically sealed lines:-

- 1. Shock: Withstand 50G and certain small types withstand drop test of 100G.
- 2. Immersion: Connectors pass MIL-C-5015 test for immersion.
- 3. Corrosion Resistance: Withstand at least 50 hours of salt spray, to meet MIL-C-5015.
- 4. Pressure: Generally speaking, small sizes withstand up to 1000psi, medium sizes up to 750psi and large sizes up to 500psi. Certain standard connectors, i.e. KPTH-10-6P stand up to 6000psi.
- 5. Thermocouple and co-axial contacts available.
- 6. Leakage Rate: Standard MS types have leak rate less than 1 micron cubic foot per hour (20 cu/ins. per year) at normal atmosphere and

pressure and other series, e.g. KH series, have leak rates less than .001 micron cubic foot per hour (.02 cu/ins. per year).

7. Temperature: Depending on type Cannon hermetics can operate from -100°F to +1000°F.

NEW The new Cannon lightweight Aluminium hermetically sealed connector, 45% lighter than standard steel types. Write for bulletin T-369 for further details.

Consult Cannon for all special hermetic plug requirements, and indeed for all your connector requirements, consult Cannon, the world's foremost manufacturers of electrical connectors.

© "CANNON" IS A TRADEMARK REGISTERED IN U. S. PATENT OFFICE AND IN OTHER COUNTRIES BY CANNON ELECTRIC COMPANY

CANNON ELECTRIC (GREAT BRITAIN) LTD.

168 Old Street, London E.C.1, England

PLANTS IN: LONDON • BORNEM, BELGIUM • PARIS • TOKYO • MELBOURNE • TORONTO
LOS ANGELES, SANTA ANA & ANAHEIM, CALIF. • PHOENIX, ARIZ. • SALEM, MASS.

Sales offices and representatives in principal cities of the world

© 1963 CANNON ELECTRIC COMPANY

European Enquiries: Cannon Electric International Inc. Bornem, Belgium. Telephone: (03) 77.06.14.

Scandinavian Enquiries: Sweden: Ab Gosta Backstrom, Box 12089 Stockholm 12. Denmark: Tage Schouboe, 7 Skyttegade, Copenhagen. Norway: Morgenstjerne & Co., Wessels Gate 6, Oslo. Finland: OY Chester AB, Uudenmaankatu, 23.A, Helsinki.



INDUSTRIAL ELECTRONICS

Comment

A great deal of attention is now being paid to the techniques of business management. It is usually considered that the important part of management is decision making, that is, deciding on the proper course of action to achieve some desired end. In principle, therefore, it is nothing more than what we are all doing continually throughout our lives.

From the scientific point of view the proper thing to do is to collect all the relevant information and work out the proper course of action. Such a process is very much like that of a logical argument and it could be translated into Boolean algebra and then carried out by a computer. This would undoubtedly be beneficial for it should not be hard to introduce optimization processes and certainly one could try out the effect of changes in the course of action very quickly.

If all this were practicable, the whole process of management could be automated. However, in practice, schemes of this nature break down because it is impossible to collect all the relevant information. As a nation, we are said to distrust logic. What we really distrust is the soundness of conclusions based on a chain of logical reasoning, because we know that all too often the soundness of the logic is used to cover up the inadequacy of the initial information. In the same way, when electronic aids are employed there is a grave danger that their inherent accuracy of processing will tend to make people accept their answers without questioning, forgetting that all depends on the accuracy and adequacy of the input information.

In the normal process of management decisions do have to be made on the basis of inadequate information. This must be accepted, but it does not mean that electronics cannot help management. It can and in two ways. Sometimes it can help in data collection, usually it can help in data sorting and processing. Sometimes a computer can transform data by deducing new information from that which has been collected. Electronics can thus help management by increasing the amount of information available to it and also by putting it into the most suitable form for assimilation.

The second way in which electronics can help is in working out quickly the results of proposed courses of action. It makes it much easier and quicker to draw up in advance plans for future action to cover all sorts of possible and uncontrollable events.

Management Games

We said above that management must often make decisions on inadequate information. This is well recognized and a good deal of investigation into management processes is being carried on. One method involves the playing of management games. In fact, one is being played at the Research Development Production Exhibi-

tion (Olympia, 4th-9th May). The participants in these games are divided into competing teams. The teams are presented with fictitious situations of the kind that occur in business and they have to decide upon the proper course of action to deal with them, in a hurry and with incomplete information. Furthermore, what one team decides to do affects what another team is doing. The idea is to test the effectiveness of

COMMENT (Continued)

individuals in a business-like situation where mistakes have no important consequences.

Sometimes the teams have a computer to help them in working out quickly the probable results of proposed actions.

In these games the criterion of effectiveness seems to be the making of more right than wrong decisions. It seems to us that this is not a very sound criterion. Surely it is not so much the ability to make more right than wrong decisions that is important as that, on balance, the benefit from decisions shall be greater than the harm resulting from the wrong ones. Many, many right decisions may be more than counterbalanced by one really bad one, just as one good decision can outweigh many minor mistakes.

Fault Finding

A new way of tracking down incipient faults in electronic equipment has been described at the International Convention of the I.E.E.E. It is based upon taking an infra-red photograph of apparatus; a Land camera can be used to provide a print within ten seconds. The density of the print varies inversely with the temperature of the object and so a thermograph of the equipment is obtained in which lighter parts correspond to objects of higher temperature.

An incipient fault in a component, such as a resistor, is often accompanied by a rise of temperature. Consequently, a part which is developing a fault may stand out more clearly than usual in the thermograph and so be detectable.

Radio Power Transmission

It has long been the dream of engineers to be able to transmit, or rather receive, large amounts of power by radio. We mean, of course, received power measured in watts or kilowatts. There is no basic difficulty in generating and radiating high power at radio frequencies. Normally, however, the power in the radio wave is so distributed over space that at a given point it is practicable only to receive a few microwatts.

For power transmission by radio to be efficient it is necessary to confine the radio wave to a very narrow beam. The beam should obviously be of smaller cross-sectional area than the receiving aerial, if this aerial is to intercept substantially all the radiated power. Hitherto this has been impracticable but some recent experiments which show promise were described at an I.E.E.E. convention. At the moment only a few hundred watts have been transmitted and

that only over a distance of 25 ft, but it is stated that it should eventually be possible to transmit 100 kW for 5 miles.

Microwaves are used, of course, and a valve has been developed to produce 425 kW at 72% efficiency. New rectifiers for the receiver have been developed; and, most important of all, aerial systems which enable at least one-half of the transmitted power to be received. This is what really does seem extraordinary and we find it hard to imagine that it is possible to produce a microwave beam which is so nearly parallel sided.

Acoustic Amplifier

Amplifiers which are capable of operating at high frequencies are normally electronic. An acoustic signal is converted into an electrical by a microphone, say, amplified by an electronic amplifier, and then reconverted into an acoustic signal by a loudspeaker. There is now news of a way of amplifying which does not use such conversion.

It comes from I.B.M. and the method is similar to a parametric amplifier. The signal at some 8.5 Gc/s is applied together with a 'pump' signal of 16.45 Gc/s to a magnesium oxide crystal. Because of non-linearities in the crystal, interaction occurs between the waves with a power transference from the 'pump' signal to the input signal. So far a gain of 3 dB has been achieved with a crystal 2 cm in length.

The frequencies used are very high and not ones which we ourselves should call acoustic. They are extreme ultrasonic frequencies. However, the waves are undoubtedly acoustic in type in that they are longitudinal in air and produce a mechanical vibration of the crystal.

Although it is not stated, it seems undoubted that electronics still comes into this 'non-electronic' amplifier, even if only to generate the pump frequency.

I.E.A. Exhibition

We include in this issue a guide to the Instruments, Electronics and Automation Exhibition. This includes a plan of the exhibition and a list of exhibitors. In addition, there is a pre-view of some of the exhibits.

It is two years since the previous I.E.A. Exhibition, which is quite a long time, so quickly does electronics develop. We must thus expect a good deal of change, which always makes for an interesting exhibition.

A further report of the exhibits will appear in next month's issue.

A smooth stepless control of a d.c. motor can be obtained by using thyristors (silicon controlled rectifiers) and this with high efficiency. This article explains how such a system works and the cover picture illustrates one application of it, to a fork-lift truck.

CONTROL OF D.C. MOTORS BY THYRISTORS

By J. FORBES-SIMCOCK*



Conveyancer fork truck fitted with thyristor control

SINCE the development of thyristors (silicon controlled rectifiers) to handle as much as 150 amperes there has been increasing interest in their application to the control of battery electric vehicles. Experience over the past two years has shown that the traction motors of all fork lift trucks, tractors and road delivery vehicles can be controlled reliably with optimum efficiency using the thyristor. Other types of conventional control systems can be classified into two main groups as follows, stepped control and carbon-pile control.

Stepped controllers employ contactors to switch the mode of battery or field connections and/or to control the resistance in series with the machine. It is scarcely practicable to control smoothly the speed and torque over the full range of the traction motor with controllers of this type. In Fig. 1 the performance of a stepped controller is shown where the series resistance is reduced in four steps. The first step takes the current to (a) which, as shown, corresponds to 150% of full-load current. When the current has fallen to say 80% of full load current at (b) a section of the series resistance is shorted out and the speed increases to (d). This operation is repeated until (j) when the motor is connected directly to the battery and is delivering full speed at about 80% of full-load current. In this system discontinuities occur at (b), (d), (f) and (h) and considerable power is wasted in the resistance in the process.

The carbon pile controller on the other hand will afford smooth control over a limited range and is sometimes used in conjunction with field mode switching. Nevertheless power is again wasted and appears as heat in the carbon pile.

The use of the thyristor for traction motor control, however, affords smooth stepless control over the full range of torque and speed of the motor. This control is achieved

with high efficiency and almost entirely eliminates the losses inherent in the two conventional systems described above.

To explain the general principle of thyristor control of d.c. motors reference is made to an equivalent circuit diagram shown in Fig. 2. The inductance L and resistance R of the traction motor are shown in series with a battery of voltage E and switch SW_1 . Another switch SW_2 is shown connected across L and R . With SW_1 closed and SW_2 open the current i will increase as shown in Fig. 3. If SW_1 remains closed i will rise to a value E/R which is shown as 500 amperes. If now SW_1 is opened and SW_2 is closed i will decay to zero. Both the rates of rise and decay of i are

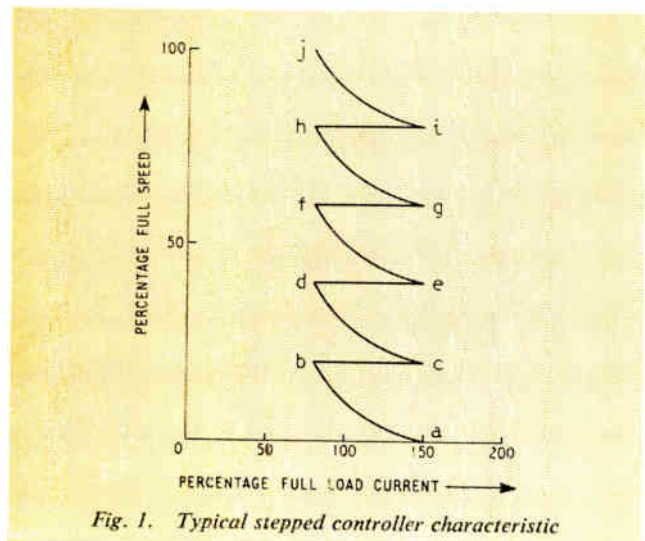

Fig. 1. Typical stepped controller characteristic

*Cableform Ltd.

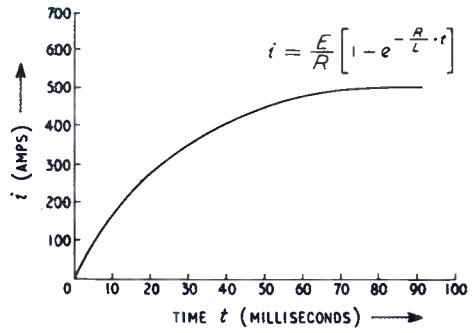
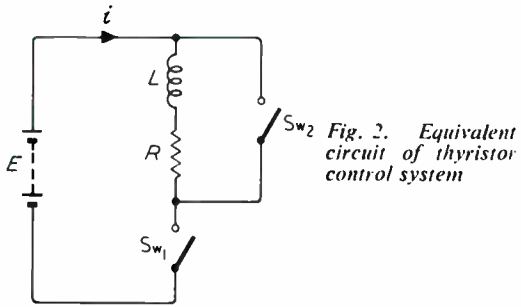

Fig. 3. Rise and decay characteristic of motor current i

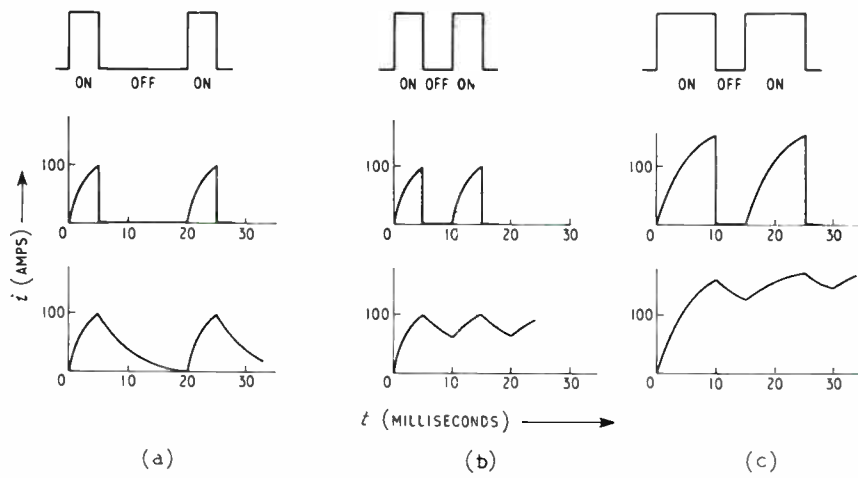
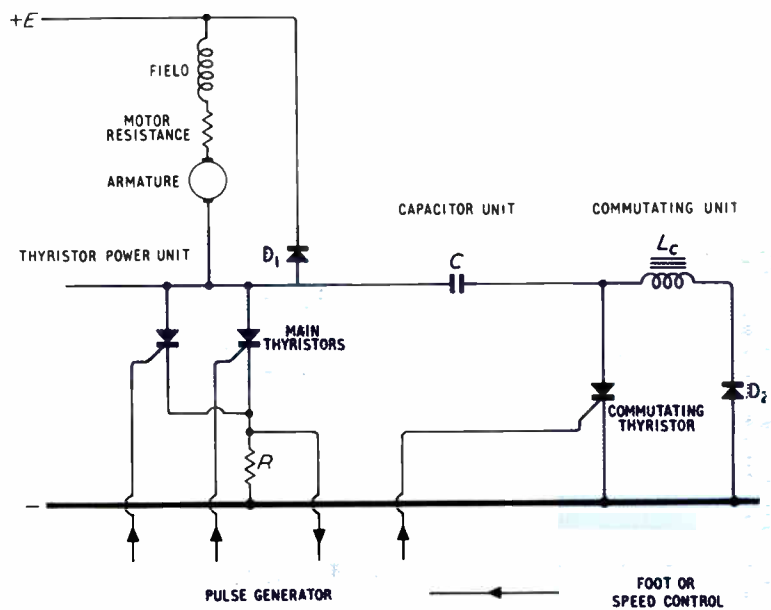

Fig. 4. Waveforms of thyristor control system

Fig. 5. Thyristor control system circuit diagram



dependent on the time constant L/R of the motor. Now if we assume that when one switch is open the other is always closed we now refer to Fig. 4 (a) showing SW_1 closed for 5 msec and i rising to 100 amperes. SW_1 is now opened for 15 msec with SW_2 closed, with i decaying to zero. This completes one cycle of control which, when repeated, gives rise to the average currents shown. Fig. 4 (b) shows the effect of reducing the 'off' time of SW_1 to 5 msec while maintaining the 'on' time at 5 msec. Here we see the same peak current of 100 amperes but higher average values of current from the battery and in the motor.

Fig. 4 (c) shows the effect of increasing the 'on' time to 10 msec while maintaining the 'off' time at 5 msec. Here the peak current is allowed to rise to 200 amperes with appreciable increase in the average current. Hence by controlling the 'on' time as well as the 'off' time together with the variation of the time relationship between them the current in the circuit can be controlled at any desired level.

In Fig. 5 SW_1 is replaced by the main thyristors and SW_2 by the shunt diode D_1 ; one or more thyristors are used in parallel depending upon the current to be controlled. Switching times are controlled by the pulse generator which starts with a short preset 'on' time (say 2 or 3 msec) and a relatively long 'off' time. Depression of the vehicle speed control progressively reduces the 'off' time until both 'on' and 'off' times are equal (i.e., transition from Fig. 4 (a) to (b)). Further movement of the speed control now increases the 'on' time while the 'off' time remains sensibly constant (i.e., transition from Fig. 4 (b) to (c)) until finally the motor is drawing continuous current from the battery. As shown in Fig. 6 (a), the pulse generator supplies pulses with a variable frequency and mark-to-space ratio. If V is the output voltage of the speed control and $t_1/(t_1+t_2)$ the duty ratio of the pulses generated, then Fig. 7 shows the controller characteristic where $V=K.t_1/(t_1+t_2)$, between v_1 and v_2 .

The leading and trailing edges of these pulses are now differentiated and shaped. They are then applied to the gates of the main and commutating thyristors as shown in Figs. 6 (b) and (c) respectively. These trigger pulses are of amplitude 8 volts (say) fed into open circuit and generated from a source of impedance of about 10 ohms. This ensures that up to four thyristors of the Mullard BTY64 series can be fired simultaneously from a single pulse provided the pulse current is shared equally by the thyristor gates. Sharing resistors at these gates ensure that this is so.

A typical BTY64 trigger characteristic is shown in Fig. 8 where the load lines drawn are for one, two and four thyristors triggered from the pulse source described above. The shaded area of the diagram shows the locus of possible firing points for the thyristor junction temperature range -40 to $+125^\circ\text{C}$. So provided the load line concerned lies above and to the right of the shaded area, and the trigger pulse duration exceeds the turn-on time of the thyristor (about 3 μsec), firing will take place. In practice an emitter follower driving the thyristor gates through a sharing resistance provides adequate power.

Referring now to Fig. 5, assume that the main thyristors have been fired and current is flowing from the battery through them into the motor. The process of 'turning off' the thyristors is explained below. The commutating unit shown in conjunction with the capacitor C (charged to battery voltage E) discharges the capacitor energy through both the commutating and main thyristors. This discharge establishes a current in the main thyristors in opposition to the motor current already flowing. Then providing the net value of the main thyristor current falls below the holding value the thyristor will be turned off. This commutation process is achieved as follows: In Fig. 5 when the main thyristor is 'off' the commutating capacitor C will

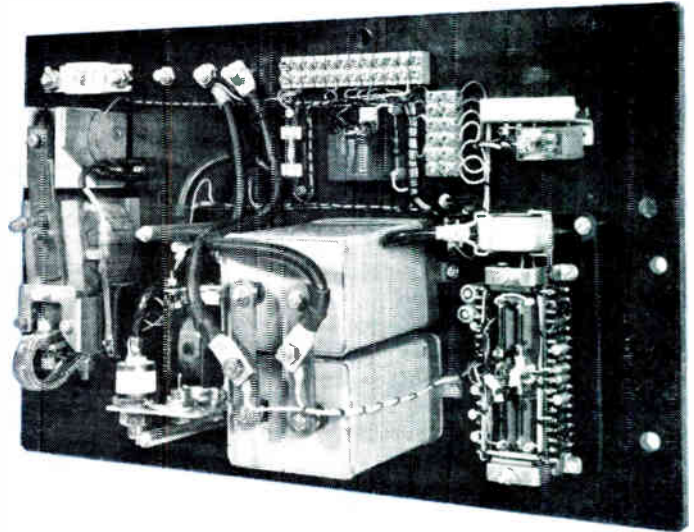

Rear view of Pulsomatic control panel for a 60-V 9 h.p. delivery vehicle. The thyristors and diodes are not shown in the photograph

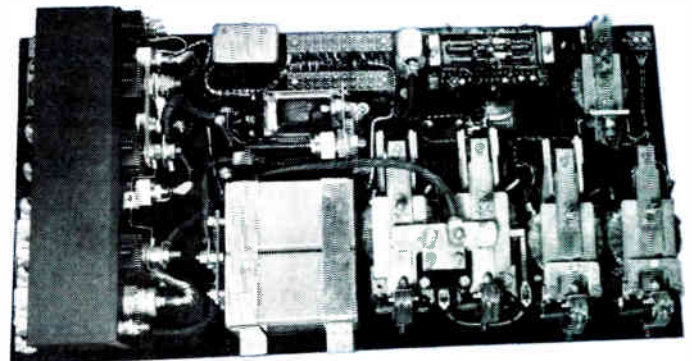

The back of the Pulsomatic control panel for a 56-V, 7 h.p. fork lift truck weighing 6,000 lb. It measures 25½ in. by 12½ in. by 6½ in. including the thyristors and diodes

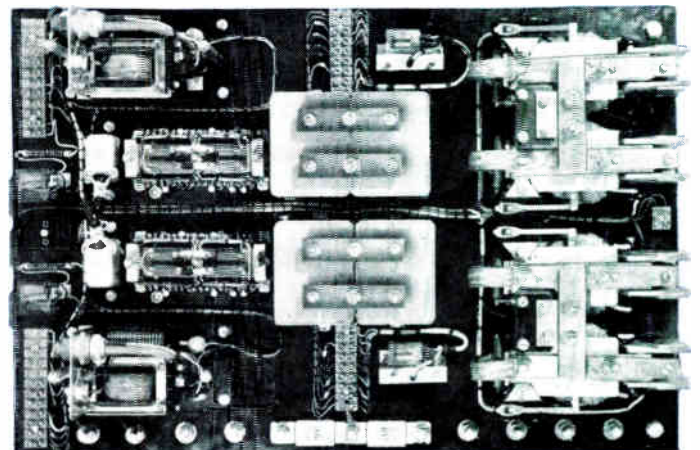

A 3-ton locomotive (Greenwood & Batley Ltd.) for an iron ore mine has two 5 h.p. motors which can be controlled independently by this panel

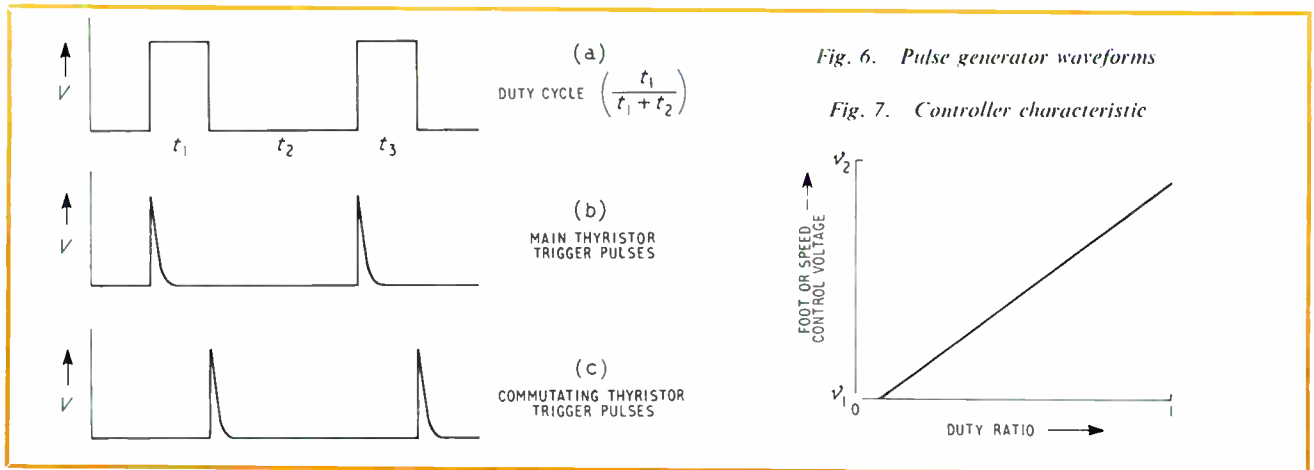

charge to battery voltage E through the motor impedance and the commutating thyristor. The commutating thyristor must therefore always be triggered first in a control sequence. The inductance L_c and capacitor C form a resonant circuit when the main thyristor is triggered and the stored energy in the capacitor will begin to transfer through the series diode to the inductance L_c . When the resulting discharge current has increased to a maximum the voltage across the capacitor is zero. At this instant in time energy in the circuit is all magnetic and the current continues to flow maintained by the magnetic field of L_c to form a voltage of reversed polarity across C . When all the energy has been transferred back again from L_c to C the voltage on C has the original value but is reversed in sign. The current is also diminished to zero again at this time and one half-cycle at a resonant frequency, $f_r = 1/2\pi \sqrt{L_c C}$ has been completed.

The next half-cycle cannot continue because the series diode D_2 prevents a reversal of current flow. C therefore remains charged as shown in Fig. 9 until it is discharged when commutating the main thyristor. With the main thyristors switched off C again acquires a charge of $+E$ volts through the motor impedance and commutating thyristor. When this charging current falls below the holding value of the commutating thyristor, this thyristor will turn off and the voltage at A, Fig. 9, will remain at nearly zero waiting for the main thyristor to be fired again. A cycle of control is thus completed.

In addition to the basic system described it is essential to prime the main thyristor to ensure the correct mode of operation. A micro-switch operated by the speed control is arranged to unclamp the main thyristor gate just prior to the start of a control phase. This will always ensure that the commutating capacitor C is charged to $+E$ before the main thyristor fires for the first time. If this condition was not fulfilled the main thyristor could not be commutated after being fired and the battery would be connected to the motor on full conduction—a condition which needless to say is highly undesirable! Also as the control is effected by an input voltage it is convenient to modify this voltage by a function of the load current drawn. This is the basis of current limiting which can be used particularly where stalled currents of 800 amperes (say) or more are experienced. This limiting is initiated by the voltage sensed across the fractional ohmic resistance R in Fig. 5 and as a result full protection is given to the motor and main thyristors without depreciating vehicle performance.

Systems of dynamic, rheostatic or controlled 'plug' braking can also be included in the system to improve vehicle handling.

In summary the thyristor 'Pulsomatic' control system can be said to be a proven reliable system for the control of series d.c. motors with particular reference to battery electric vehicles, offering as it does significant economy of battery energy together with true stepless control and reduction of maintenance.

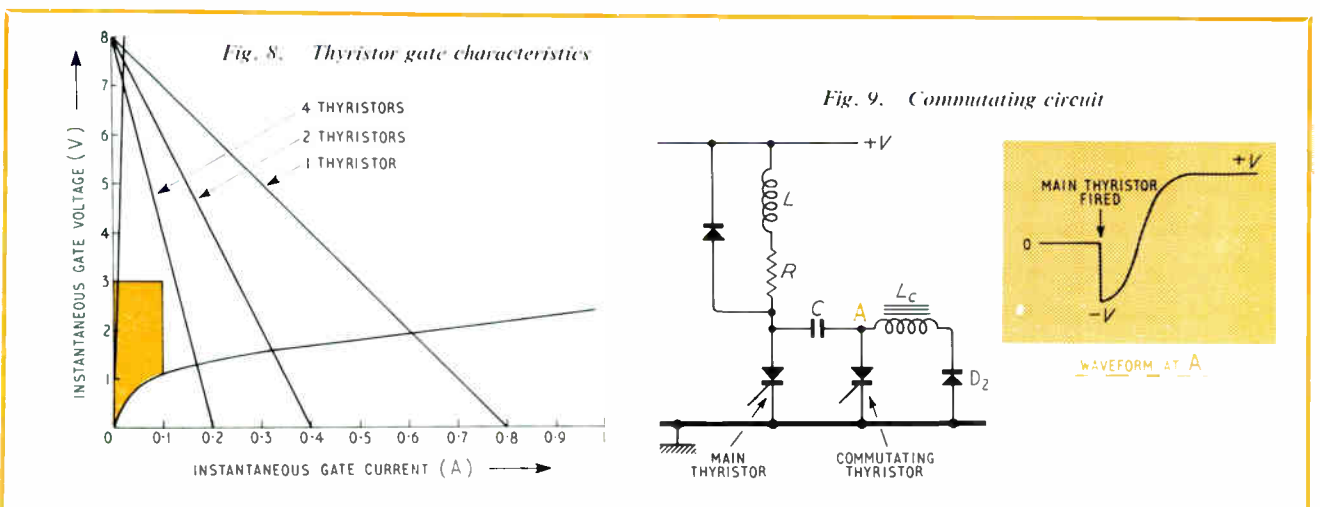

The C.E.G.B. Telemetry System

Part 2

By J. W. DILLOW, B.Sc.(Eng.), A.M.I.E.E.*

In this second part of the article, the communication system by which the telemeter signals are conveyed to control centres is described. Time-division multiplex is employed.

frequencies, two signalling channels at 2,220 and 2,340 c/s were provided. Time-division multiplex techniques were employed so that ten telemeter readings could share each channel and an electronic scanning distributor was designed for this purpose which is known as a ten-way sender.

The Ten-Way Sender

ENGLAND and Wales are split into seven Grid Control areas. Each area has a Grid Control Centre which controls the activities of some 50 power stations or major Grid Transmission stations. In turn, each Grid Control Centre is co-ordinated by a National Control Centre situated in London. Programmes are issued by the National Control Centre and each Grid Control Centre orders up the necessary generation within its own area in order to fulfil the programme. In general terms there is a rented Post Office circuit from the Grid Control Centre to each major station and this circuit is used for telephony, telemetering and general indications. As well as the lines to the major stations, there is a line from each Grid Control Centre to National Control and also to its adjacent Grid Control Centres. The map (Fig. 7) gives some idea of the magnitude and distribution of stations within the areas.

The ten-way sender allows each integrating meter to be connected to the line for a 20-millisecond period in a continuously-operating sequence. The cycle time of the system is such that a number of cycles elapse between successive operations of the meter contacts. The greater the number of cycles, the less the amount of distortion and in practice, using 50-baud signalling, a 10-element code together with start, stop and synchronizing signals, has a cycle time of about 300 milliseconds and this can define meter pulsing at a rate up to $66\frac{2}{3}$ i.p.m. with adequate fidelity. (The

In addition to the main communication network shown on the map, there are a considerable number of lines radiating outwards from the major stations to smaller stations which are termed minor stations, so that signalling can take place between minor stations and the Grid Control Centres, passing through a major station as an intermediate signalling point.

Frequency Allocations

The main purpose of the communication network is to provide a comprehensive telephone system with a special calling system so that control can easily contact people in authority at the remote points. However, speech is restricted to a band from 400 to 2,000 c/s, and voice-frequency signals above the speech band are used for telemetering signals. When the network was first established, the available Post Office lines could not be guaranteed to transmit frequencies higher than 2,400 c/s, although the range has been extended in recent years. In order to use standard

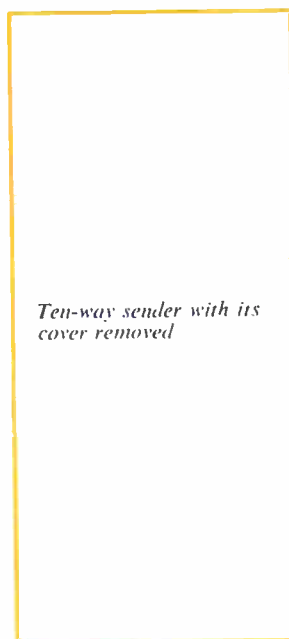

Ten-way sender with its cover removed

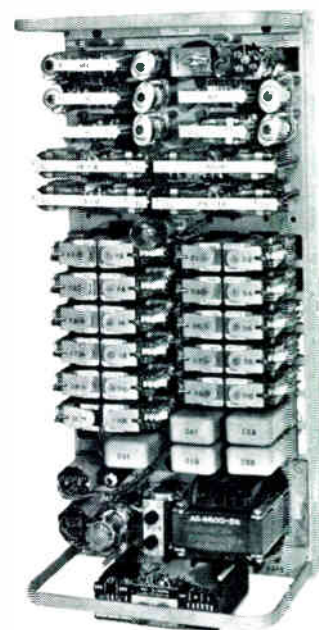

*Central Electricity Generating Board.

Fig. 7. Grid control network

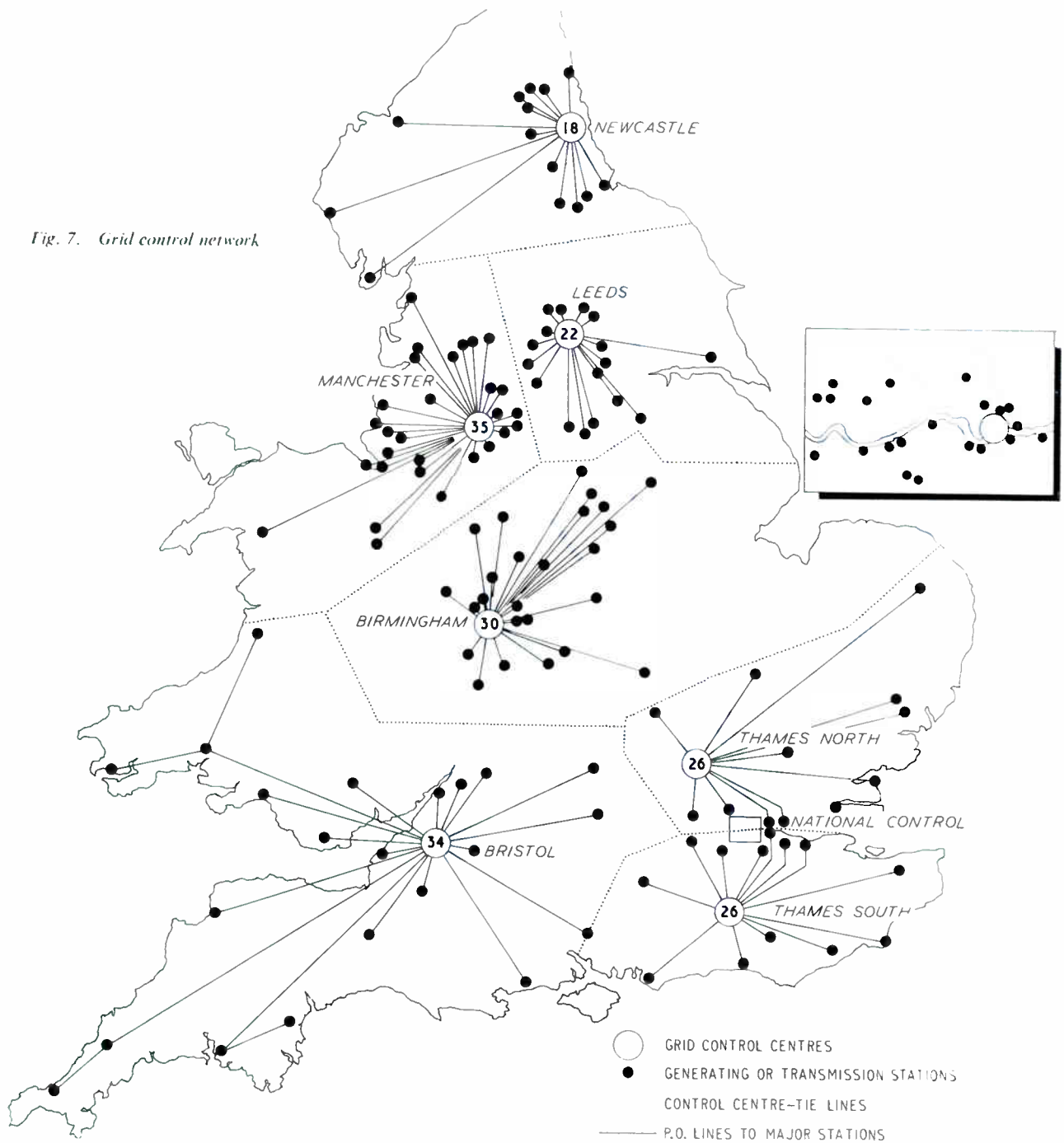

actual figure of $66\frac{2}{3}$ i.p.m. is due to established metering practice; e.g., a load of 100 MW on a meter operating at 25 units per impulse gives a pulse rate of $66\frac{2}{3}$ i.p.m.)

A cold-cathode tube ring counter sets the position of a keying circuit according to the position of each pulsing contact in turn. This keying circuit operates a static modulator which allows tone to be transmitted to line when an A relay is operated and no tone when the relay is released. The code structure is shown in Fig. 8. The cycle starts with a 20-millisecond space signal followed by ten elements which may be mark or space according to the pattern of the ten pulsing relays. The twelfth element is sent alternately as mark and space; this is recognized as a

synchronizing signal by the receiving equipment. The cycle is completed by a stop signal consisting of at least two periods of mark. This stop signal allows the receiving equipment to be rephased at the beginning of each cycle. In practice, occasional stop periods have to be lengthened in order to eliminate 'pattern-locking' trouble and for simplicity these lengthened stop periods are used on alternate scans.

The electronic sender requires a mains power supply to operate it, but the fact that it fails when supply is lost is not a serious disadvantage as under those circumstances there are no readings to be sent anyway. A picture of a ten-way sender is shown in a photograph, and this is operated

with a metal cover painted white internally which reflects the light from a small filament lamp so as to ensure correct operation of the cold-cathode tubes.

The Ten-Way Receiver

The ten-way receiver has a voice-frequency receiver with an output relay whose contacts repeat the tone signals on the line. The starting space signal allows a multivibrator to run free in synchronism with the sending end. This multivibrator steps another cold-cathode tube ring counter which distributes pulses to the marker relays. Each relay is a both-side stable telegraph relay with two windings. The common side of the two windings is connected to a cold-cathode tube which is controlled from the main distributor. Telegraph relays are operated to one side or the other depending upon the state of the line relay at the instant when its own tube is struck. Thus the ten telegraph relays take up positions identical with those of the ten pulsing relays at the sending end.

A local flip-flop changes its state every scan directly after the 11th step of the distributor. The output of the flip-flop is gated with the 12th signal element which is sent as mark or space on alternate scans. Provided the outputs correspond, the system is in synchronism but if there is disagreement, then a warning lamp is lit for each telemeter included in the scan. The system automatically resynchronizes itself after a disturbance.

At the end of each cycle, the distributor steps to its resting position where it stops its multivibrator and awaits a new starting signal.

The output from each ten-way receiver is connected to

ten individual telemeter receivers. The direction of the power flow where appropriate is transmitted via a different signalling link and the information is included in with other general indications. Although a delay occurs in sending in the change of direction, this is of little significance since the power flow must be zero at the time when a change of direction occurs.

Inter-Area Metering

As the programme stipulated by National Control requires each area to operate with a specific power transfer to or from its neighbours, the flows on the inter-area power lines are particularly significant and so they are metered independently at each end and the impulses are transmitted to the respective control rooms.

In the event of a failure of an integrating meter or a communication link, it is arranged that readings can be re-transmitted from an adjacent area so that both control rooms have a complete picture.

In order to carry out this operation quickly and simply (without the aid of a telecommunications engineer) the inputs to each inter-area telemeter are taken via a patch-board so that the pulses being delivered to a telemeter can also be re-transmitted by a ten-way multiplex link to the neighbouring control centre, where the output of the 'patching receiver' can be connected to the telemeter which is normally operated via a local circuit. The patch-board has break jacks in order to disconnect the normal input. In practice each ten-way multiplex can transmit five magnitudes and five directions. This is normally adequate to cater for any equipment failures.

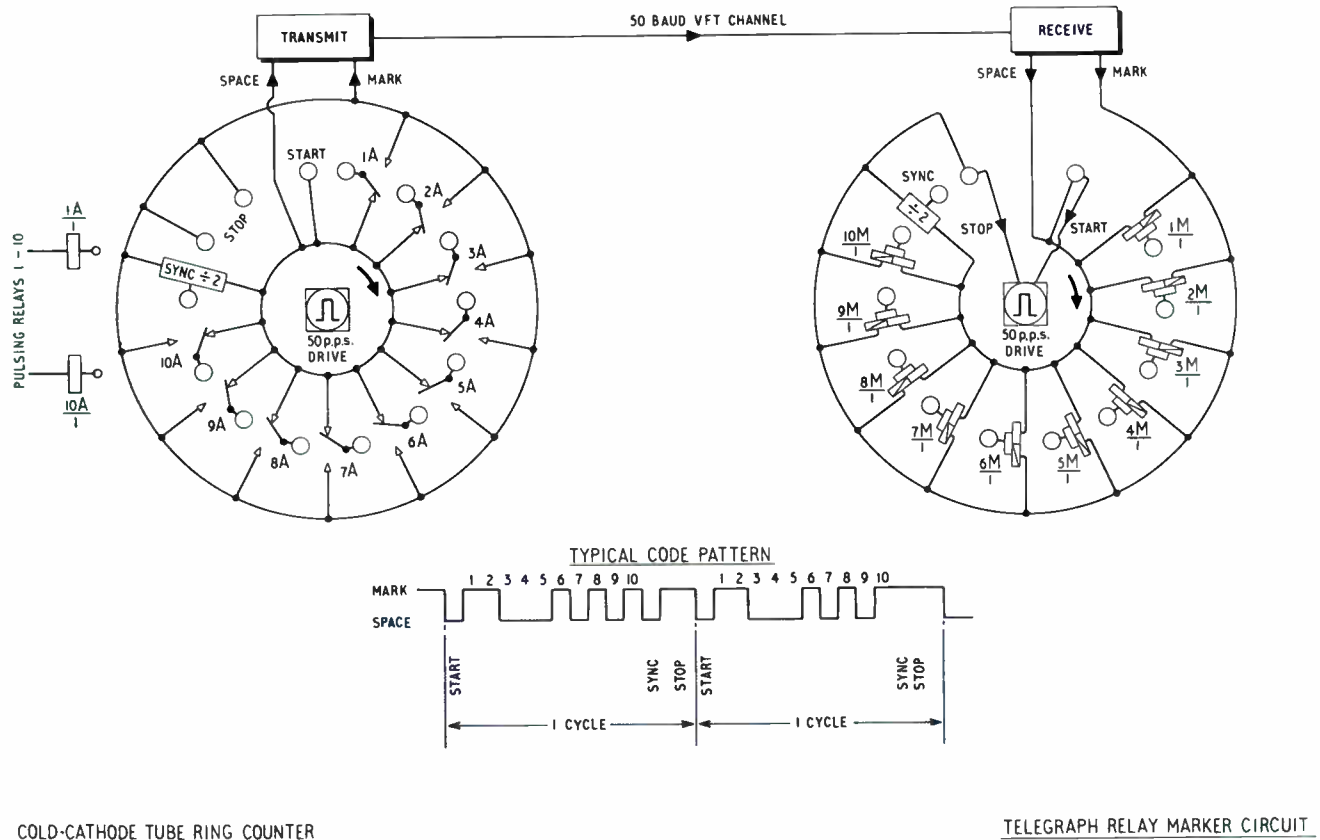

Fig. 8. Details of the ten-way multiplex system

It is important to ensure that the direction of flow is correctly signalled, as in an interconnector an import at one end demands an export at the other. There are certain rules to be observed to ensure that the direction is correct and reversing cords are used in certain cases. Any correction that is necessary is always made at the sending end.

It must be stressed that the ability to provide a simple patching network is a very great advantage of the pulse-rate telemetering system. The original pulses (as born) are transmitted over as many links as may be required, there being no loss of accuracy due to the regeneration of pulses.

Minor Links

At a large number of minor stations, only one or two readings have to be transmitted. It is uneconomical to use the ten-way multiplex system for this and a simple two-way system is employed which uses P.O. relays.

Here, any pulses born from Meter No. 1 are sent as short pulses (40 milliseconds) on the line, and those from Meter No. 2 are sent as long pulses (120 milliseconds).

The output of a two-way decoder can then be coupled into the input of a ten-way sender and be sent to the control station together with eight more readings which may be generated at the major station or, alternatively, from other two-way links.

A recent development allows three readings to be sent instead of two. The equipment is semi-transistorized with relays as inputs and outputs, the remainder being transistorized. In this system, short pulses are sent to line and are one, two or three in number according to the source of the reading. A pulse counting system was adopted since a pulse length system requires a 3:1 ratio of pulse length to provide satisfactory discrimination and this would make the cycle time too long.

Multiplex Links from Area to National Control

A more sophisticated version of the ten-way multiplex equipment has been produced for the links between Area and National Control.

This equipment uses transistors instead of gas tubes and is in effect a double scanner system. The code structure is similar to that used on the earlier system, but an extra element is added which is used to indicate the direction of one meter at a time.

On the first scan, all ten magnitude contacts are scanned the direction contact of Meter No. 1. On the next scan, the same ten magnitude contacts are examined plus the direction contact of Meter No. 2. This continues cyclically until an eleventh scan which is sent as a special code (all mark) which is used to synchronize the secondary scanner.

Although an extra element is included in each scan, the average cycle time is slightly less than that of the original system, as it is no longer necessary to provide long stop signals to eliminate pattern-locking troubles. Now a discrete code that cannot be imitated by a random pattern is sent once every eleventh scan and this is a completely satisfactory way to synchronize the system.

Although transistors are used instead of gas tubes, relays are still used for inputs and outputs. The comparatively delicate telegraph relays have been discarded and P.O. No. 10 long life relays are used throughout.

References

¹ Dunn, R. H., and Chambers, C. H., 'Telemetering for System Operation', *Proceedings I.E.E.*, Paper No. 1400 M, October 1952 (Vol. 100, Part I, p. 39).

² Burns, G. A., Fletcher, F., Chambers, C. H., and Gunning, P. F., 'The Development of Communication, Indication and Telemetering Equipment for the British Grid'.

AUTOMATIC pH CONTROL

Automatic pH control equipment recently installed at Philips Records Walthamstow factory has abolished the tedium of manual measurement and is enabling a closer control on quality to be maintained. It is used in the electroforming department which produces the nickel 'stampers'—the dies from which the vinyl records are ultimately pressed.

The degree of acidity of the plating solution plays an important part in the nickel electroforming process. Small departures from the specified pH value can cause internal stresses in the deposited metal and result in deformation of the nickel shell that is formed. Also, changes as small

as 0.2 pH can seriously affect the hardness figure of the metal. A tight and continuous control of pH is therefore essential.

The plating baths are assembled in three groups of eight, the plating solution being continuously circulated by pump through each group of baths. The pH potential is sensed by a flow cell containing a glass and a calomel electrode together with an automatic temperature compensation element. A high-impedance amplifier pH meter is mounted near the flow cell, and is in turn connected to a potentiometric recorder on a central instrument panel.

When the alkalinity of the plating solution increases to a predetermined value during processing, a set-point switch on the recorder starts a timer. This opens a solenoid-operated valve for fifteen seconds and an acid is slowly injected into the plating solution circulating through the baths. A second timer prevents further dosing during the following fifteen minutes. This enables the solution to become completely homogeneous, and ensures that dosing is based only on pH readings that are truly representative. The process and control constants are such that the pH value is maintained to within ± 0.05 pH, and correct operation can be confirmed at any time by reference to the recorder chart.

The system was devised and assembled by the factory's own personnel in conjunction with M.E.L. Equipment Co. Ltd.

For further information circle 44 on Service Card

Checking correct operation of the automatic pH system. In the foreground: one of the three groups of plating baths

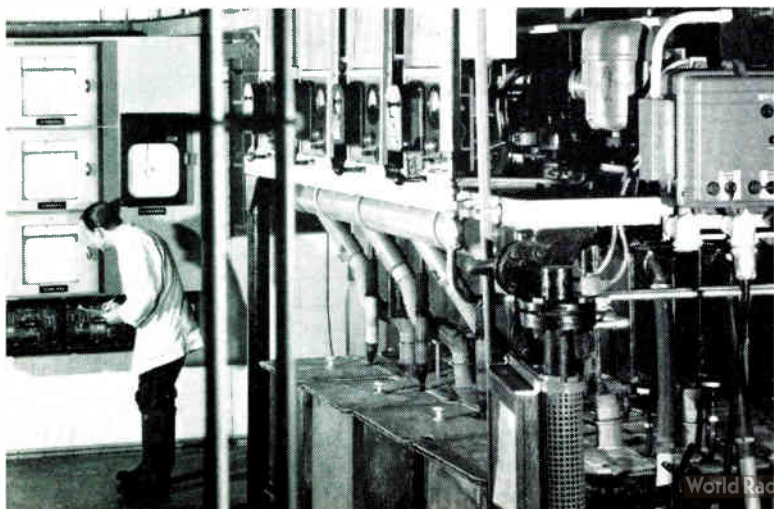
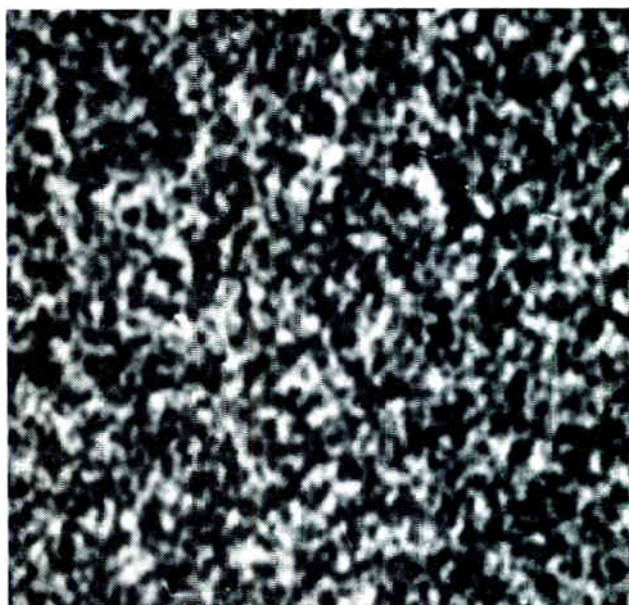

Fig. 1. Grey tone part of a film enlarged 250 times, showing the agglomeration of light-sensitive grains in the developed emulsion



FILM GRANULARITY MEASUREMENT BY KODAK

KEEN amateur photographers and anyone concerned with photographic enlarging will be familiar with the problem of graininess. What happens when a photograph is enlarged beyond a certain point is shown in Fig. 1, a gross over-enlargement of a portion of a photograph

which, in the original, appeared uniform grey. The fine mosaic pattern of this enlarged version is due to the emergence of the grain structure which made up the grey of the original negative.

All photographic materials are grainy to a greater or lesser extent, for the simple reason that the light-sensitive coatings used are an emulsion of fine powder (silver halide crystals) in gelatin spread on a transparent base. The graininess is determined by the irregular distribution of the developed grains, which is such that noticeable variations of density are produced even in areas large compared with the size of the grains. Graininess, however, is a subjective judgement which, while adequate for the darkroom or photographic studio, is insufficiently exact for the research laboratory where an objective comparison of the properties of films is required. The term used here is 'granularity' which, for a uniformly exposed and developed photographic emulsion, can be defined in terms of the root-mean-square value of the fluctuations in density of the emulsion.

At the Harrow laboratories of Kodak Ltd. granularity is measured in this way with a specially designed unit shown in Fig. 2. The unit is in effect a type of microdensitometer. The Harrow equipment uses a Dawe type 612A true r.m.s. valve voltmeter as an indication of granularity, and a type 1470 band-pass filter to control the derived signal.

The film to be studied is scanned optically by a narrow beam of light. The light passing through the film is directed on to a photomultiplier whose output, after various corrections, gives a direct measure of r.m.s. fluctuations in density and hence of granularity.

The practical equipment, as shown in Fig. 2 is a little more complex. The optical system is in fact stationary while the film specimen is mounted on a microscope stage (Fig. 3) which moves in a circle normal to the scanning light beam.

The illuminating optics comprise a high-intensity light source, double-condenser lens system, light baffles and a

Fig. 2. The equipment specially designed by Kodak to measure the granularity of photographic emulsions. The results from this unit at Harrow are directly comparable with results from a similar unit in the U.S.A.

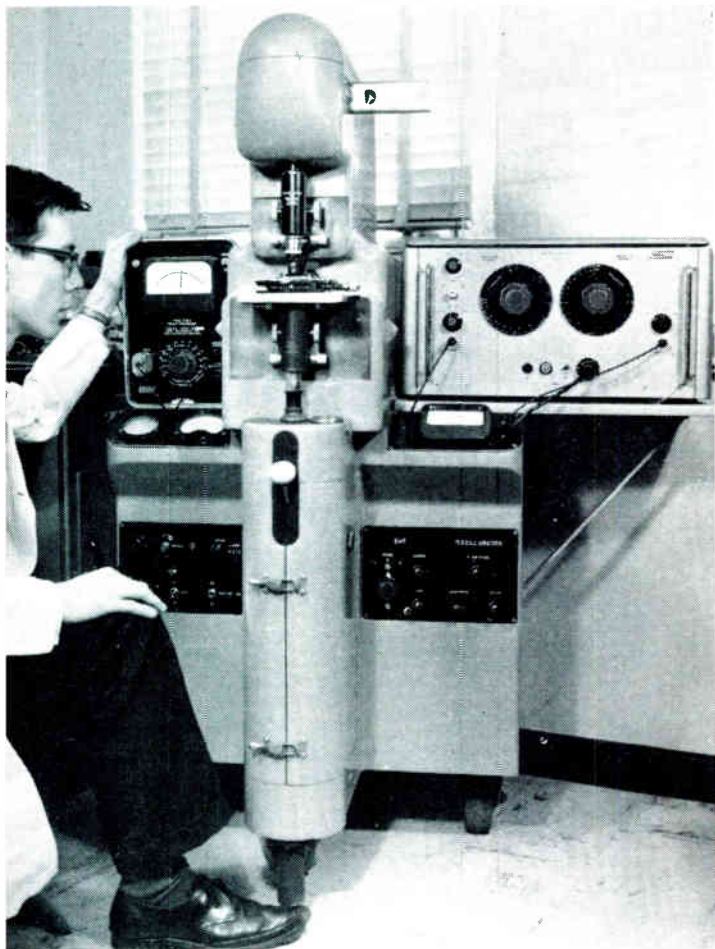

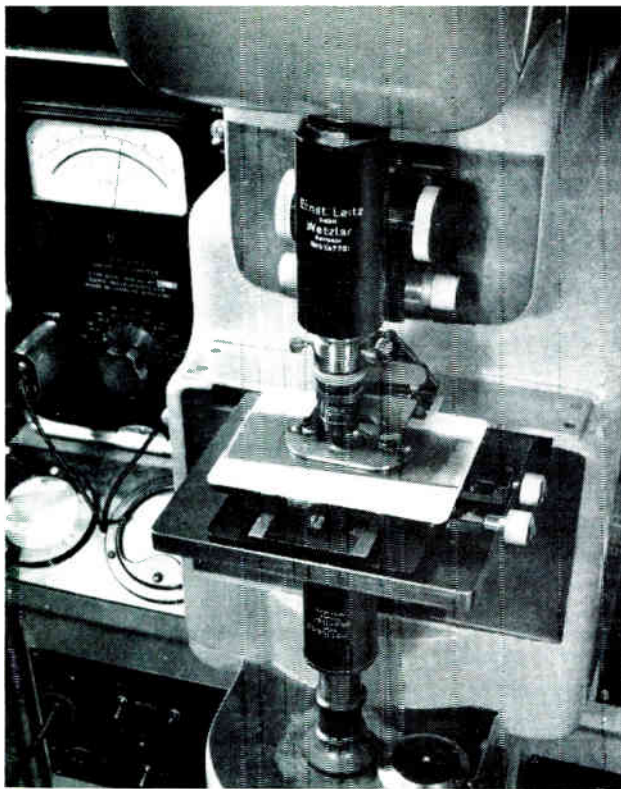

Fig. 3. Part of the optical system, showing the specimen stage of the microscope; it moves in the horizontal plane to provide a circular scan from the stationary light beam

mirror which deflects the light downwards through a microscope, and hence on to a sample. The incident light finally reaching the film is a uniform pencil beam of some 0.007-in. diameter. There is also provision for inserting colour filters in the light beam.

Transmitted light is recovered from only a small part of the incident light beam after it has passed through the

specimen. The recovered light beam is generally a thousandth of an inch (24 microns) in diameter although 6, 12, 24 and 48 micron beams can be provided. The pick-up optics also contain a focusing system, which is folded back when readings are being taken, and a condenser lens to focus the light on the photomultiplier. The light eventually collected is passed into an eleven-stage photomultiplier.

To obtain comparative readings of granularity, the photomultiplier is always set to give an output of 10 μ A. The current signal from the photomultiplier is then passed through a resistor, the resultant voltage, after filtering, being fed to the true r.m.s. valve voltmeter. A diagram of the circuit is shown in Fig. 4.

Although the multiplier output is a theoretical measure of granularity, filtration is important, since in practice the signal contains spurious low-frequency components and a fairly high percentage of noise. Low-frequency components may be caused by blemishes, or by small variations in the average density from one part of the film to another. Noise, from a number of sources, is largely white.

In the equipment at Harrow, low-frequency signals are eliminated entirely by a fixed high-pass filter set at 20 c/s cut-off. Before a subject can be captured and its image transferred to a photographic print, many operations must be carried out, known collectively as the photographic process. This involves the use of sensitized emulsions (film and photographic papers) and of optical systems (camera and enlarger), all of which have some effect on the final product. A detailed knowledge of the frequency characteristics of the granularity signal is useful for an understanding of the transfer of an image through the process.

The technique is only applicable to developed emulsions deposited on a transparent substrate since the measuring section uses transmitted, not reflected, light. To obtain useful readings the specimen must be uniformly exposed and developed, and kept clean and free from blemishes. Films, photographic plates and colour transparencies have been satisfactorily examined, filters being used for colour work.

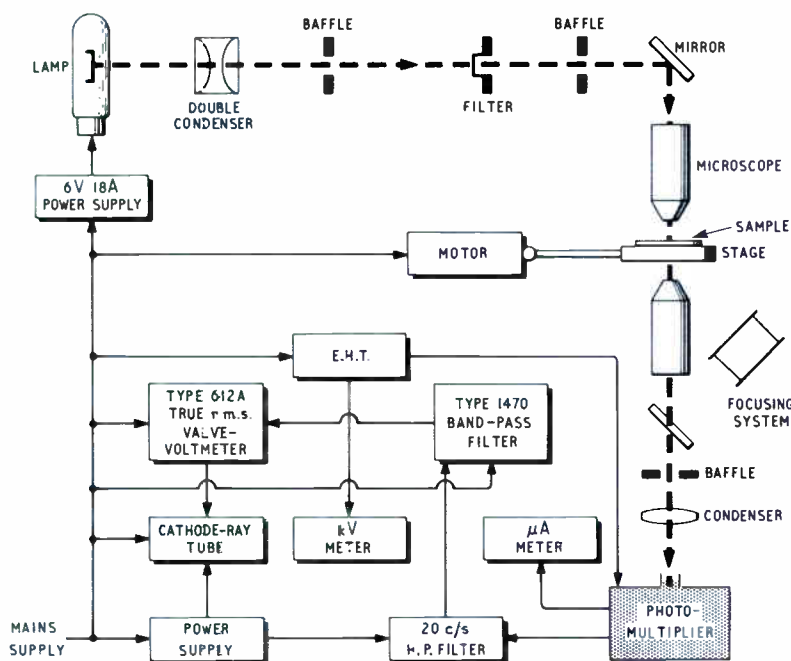
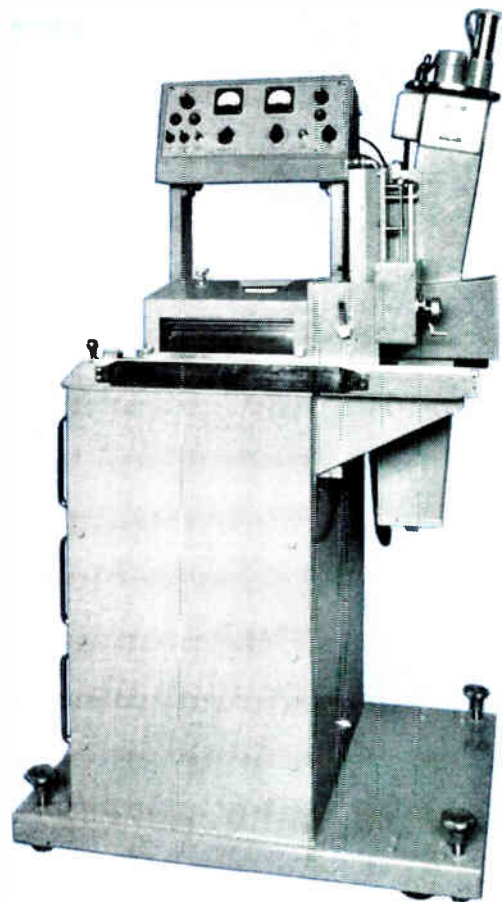

Fig. 4. Diagrammatic arrangement of Kodak's film granularity measuring equipment. The specimen stage is driven mechanically from the motor. Filters are used to separate the three emulsions of colour films and transparencies

Mark II Pyroscan. The optical column is on the right and the control panel at the top

Subcutaneous variations of temperature occur near the site of some disease. The apparatus described enables the temperature pattern of the human body to be measured and displayed pictorially.

By M. SWISS, A.F.Inst.Pet.



FAST THERMAL SCANNER ASSISTS MEDICAL RESEARCH

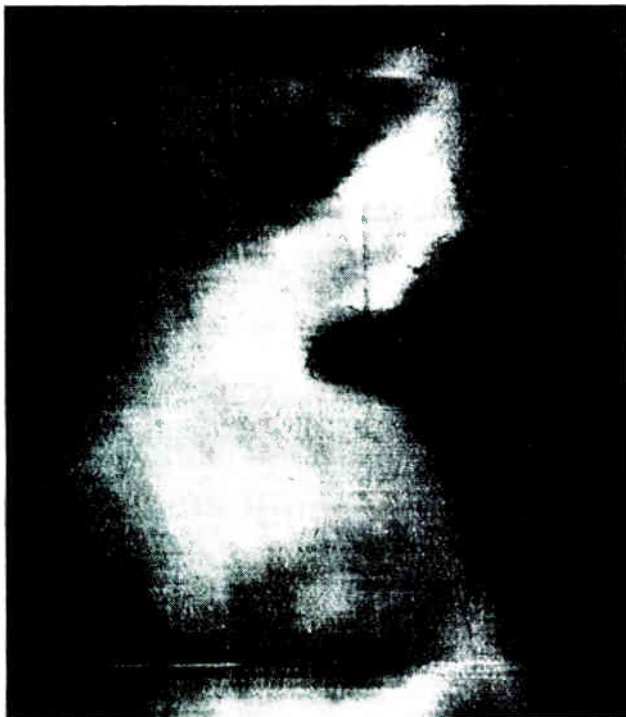

Female cancer patient with 1-in. diameter tumor of right breast. This is 2°C warmer than the surrounding tissue and the left side

SEVERAL means are known by which infra-red radiation can be made visible to the eye or on a photographic plate. The history of heat-detecting apparatus goes back several decades and some use has already been made of it for medical purposes. Considering the human body as a heat generator, its internal temperature is about 37°C and that of the skin (in calm air at 20°C) is 32°C. Forty-five per cent of heat loss from the body is by radiation and this can be increased by lowering the temperature of the surroundings. Recording temperature difference between healthy and diseased parts of the body is assisted by keeping the patient for a while in a cool room. In general the procedure is quite long. Taking the human body as a 'black body' the heat loss (72 watts per sq m) occurs at wavelength of about 9.5 μ . In practice there is a considerable amount of radiation over the whole range of infra-red. Yet, it was recognized eight years ago that '... a quickly obtainable visual image of the heat patterns between 10 and 15 μ ... (supplying also) normal reference points (on a body) ...' is required for diagnosis.*

Announcements have already been made in the U.S.A. of apparatus capable of detecting human body radiation, but the British device described by C. Maxwell Cade (of S. Smith & Sons Ltd.) in a paper read to the Conference of Medical Electronics last year† deals with what is claimed to be the only European instrument of this type. It is also said that this is at least ten times faster than any other

* Lawson, R. N., *Can. Med. Serv. J.*, Vol. 13, p. 517, 1957.

† Cade, C. M., *Liege Conference on Medical Electronics*, 19th July 1963.

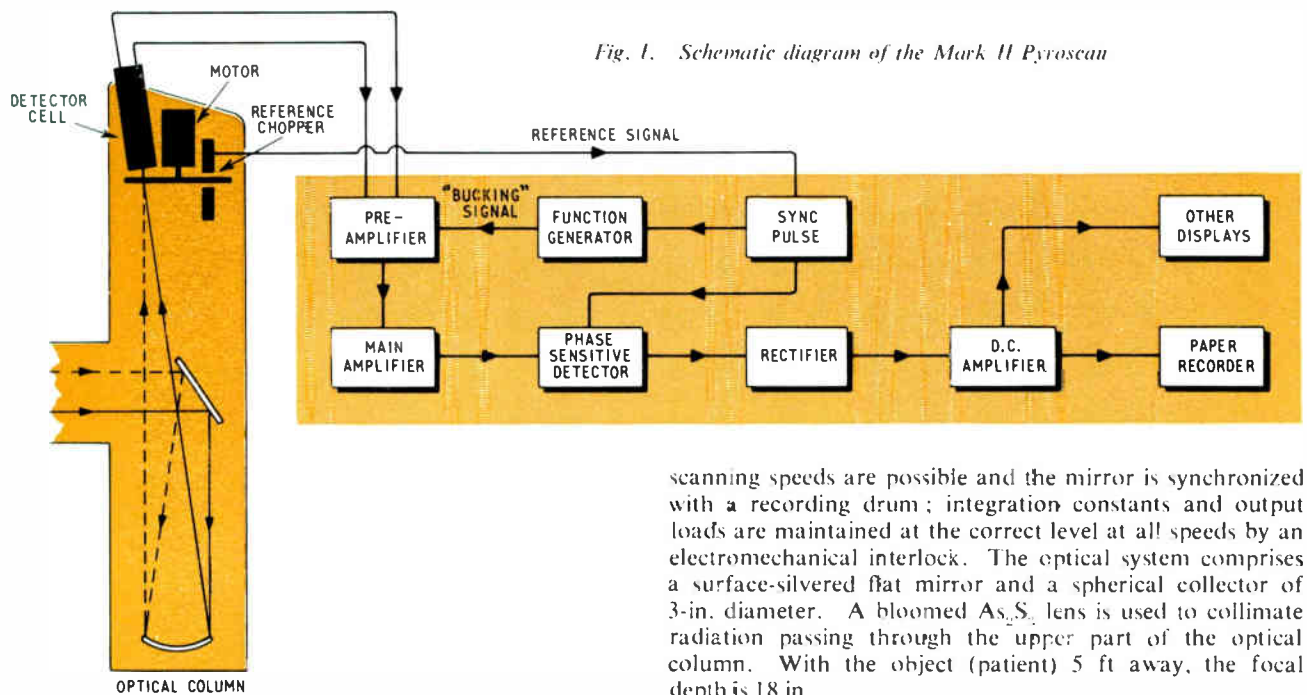

Fig. 1. Schematic diagram of the Mark II Pyroscan

apparatus. An infra-red photograph using wavelengths in the range $0.7-1.5 \mu$ ignores the details of the skin surface, such as pigmentation, and presents a picture of subcutaneous layers. In general the skin is considerably transparent to a wide range of infra-red radiation.

Any subcutaneous disturbance of the blood vessels can be used as an indication of disease and such differences between the normal and disturbed state can be detected. The British device, called Pyroscan, has been used for some time in various hospitals. Mark I was used at Middlesex Hospital for cancer research, at Bath for work on rheumatoid arthritis and at Queen Mary's Hospital for the study of burns. This was not sensitive enough to detect temperature differences of less than 1°C , but Pyroscan II can achieve this. It is a photon-sensitive detector specifically sensitive in the range $5-10 \mu$ but also at longer wavelengths. It requires refrigeration.

As shown in Fig. 1, a scanning mechanism causes a flat mirror to oscillate in a horizontal plane, while the whole of the scanning frame is slowly tilted. Four different

scanning speeds are possible and the mirror is synchronized with a recording drum; integration constants and output loads are maintained at the correct level at all speeds by an electromechanical interlock. The optical system comprises a surface-silvered flat mirror and a spherical collector of 3-in. diameter. A bloomed As_2S_3 lens is used to collimate radiation passing through the upper part of the optical column. With the object (patient) 5 ft away, the focal depth is 18 in.

The detection unit uses a Mullard indium antimonide cell mounted in a Dewar flask filled with liquid nitrogen. The response time is about 1 micro-second and the wavelength response extends to about 5.5μ . The radiation reaching the sensitive element is chopped by a perforated disc rotating at 1,000 r.p.m. to provide a.c. signals. Phase reference is also provided by the same disc which chops the light from a small lamp falling on a photocell. A 'bucking circuit' cancels out all large standing signals. The electronic system comprises a pre-amplifier and an amplifier giving between them a total voltage gain of 120 dB. Though standard transistor arrangements are used in the circuitry, the very high engineering level reached was the result of a great development effort.

In order to display the picture on electro-sensitive paper an ordinary recorder suffices, though for digital temperature indicators, high-speed pen recorders or oscillographs, separate facilities would be needed. Though basically observing temperature differences, the Pyroscan gives also a record of absolute temperature by using a comparator unit trained on to a standard source.

RAILWAY LOCOMOTIVE SIMULATOR

General Precision Systems have announced the award of a contract from British Railways Midland Region for an electric locomotive simulator which incorporates a motion system and a full-colour visual display of a railway track with complete terrain features, for training in the operation of the driving controls. Delivery is scheduled for this summer.

This equipment will be the first in the world, providing a standard of realism in railway operation and environment only so far matched by the latest synthetic flight trainers. The use of such a facility to achieve high driving competence, route familiarization and safety, represents a progressive approach compatible with other facets of the British Railways modernization programme.

The simulator will include a replica of the driver's compartment which, complete with functional controls and indicators, will be moved in such a manner as to reproduce

the sensory effects of braking, acceleration and sway. The outside world will be reproduced in full colour by a special ciné projection system, providing visual effects programmed to driver reaction, or such effects as are required to be superimposed by the instructor, including fully variable colour signalling.

As in a flight simulator, the 'brain' of the system will be an electronic computer, which accepts inputs either from the driver's cab or the instructor's control panel, and continuously delivers output signals regulating the cab motion, indicator displays, visual and sound effects as appropriate. Such effects as close or loose coupling, length and weight of train, rail adhesion conditions and various types of possible malfunction can be introduced and their effects accurately portrayed.

For further information circle 45 on Service Card



A general view of a prototype equipment, with 21-in. cathode-ray tube mounted on a mobile base, and containing a power unit

A.E.I. Introduce an Alpha-Numeric Display

DATA in the form of numbers, letters and special characters can all be transmitted at high speed from many points in a plant or installation and instantly presented on a c.r.t. This is the basis of the recently-developed A.E.I. alpha-numeric display type 1200.

The system consists of a cubicle containing a core store, character-generating circuits, some organizational equipment and a c.r.t. display console. The electronic circuits can be used to drive more than one display tube, all showing the same information or each displaying smaller amounts of different data.

Data Presentation

The display is built up of a series of alphabetical, numerical or special characters positioned according to instructions from a 64×64 address core store. This defines the scope of the system—namely, that a maximum of 4096 characters and random spaces may be displayed within a format on the c.r.t. of 90 characters or spaces horizontally, and 64 lines vertically.

In many industries it is desirable to keep instrumentation displays as compact as possible. For example, in the power generation field unit control desks are often over 40 ft long and it is difficult for an operator to supervise effectively the operation of the plant under his control. This means that in the design of such large panels it is often necessary to compromise with the grouping of instruments, thereby losing valuable comparative information because an operator cannot readily observe a number of related instruments simultaneously. The '1200' overcomes this difficulty by a variant in its display in the form of a bar graph.

Bar Graph Display

The ordinary pointer instrument has a two-fold purpose. It gives an indication of the numerical value of the quantity

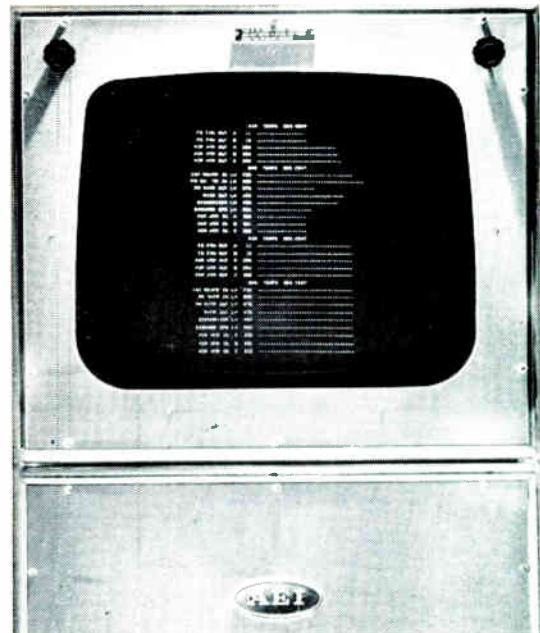

Bar graph indications giving 'thermometer' scale readings which replace conventional pointer instruments

being measured and the position of a pointer—in relation to the end of a scale—quickly provides an approximate indication of a value without having to read the value itself. Both these properties must be reproduced by a c.r.t. display if pointer instruments are to be replaced.

The '1200' does just this. The format of the display is such that legends or codes appear at the left of the tube in column form, each followed by the associated numerical value. Occupying most of the tube face is a series of bars whose lengths are analogues of the numerical values. These bars start from the same position on any one line and, in the simplest case, the full-scale lengths represent the full-scale values measurable by the individual plant transducers. Such a display produces a characteristic pattern on the tube face which an operator will recognize without having to read actual numerical values.

Another simplified pattern for an operator to work from can be created by making all analogue bar lines of the same length when quantities are at their normal steady-state values. A departure from the pattern could be easily recognized and reference to numerical values would allow action to be taken.

Again, another pattern can be included where, when the value of a particular quantity falls outside specified limits, the numerical indication is shifted to one side to attract an operator's attention.

EXAMPLE APPLICATIONS

Production Control

The main capability of the system is to present large quantities of rapidly-changing data on to one or more screens. This feature matches the complexities of production control in many industries where a large number of processes are manufacturing at high speed many different product items. Efficient production control depends on a controller having an instant knowledge of the production position of all orders throughout the plant.

This information can be presented to the controller of the plant, or each division of the plant, by the '1200'. Thus, information on the state of each order as it passes through

A close-up view of a typical data display on a c.r.t.

different sections of the works is communicated to the data system. Information can be fed into the system by a combination of manual input stations, automatic transducer signals and outputs from other data processing systems.

Electrical Power Industry

This is a prime example of an industry in which large quantities of data relating to the operation of a plant or system are required at a central point. This requirement exists for both the generation and the transmission sides of the industry.

There are three types of problem which present themselves:

(i) In a large modern power station there is a real problem in presenting alarm information to a plant operator. There can be, in such a system, 2,000–3,000 alarm circuits. This means that the operator is called upon to watch considerable areas of alarm facias. The use of the '1200'—in conjunction with a computer—enables any alarms which are active to be presented at one position within an area which the operator can see at a glance. In addition, by using a computer to sort and analyse the alarm data, the display system presents the operator with only that information needed by him to rectify any condition that has arisen.

(ii) A second use of this display which can offer significant advantages is in the handling of data that is needed infrequently.

(iii) The analogue or bar chart form of display that is possible on this '1200' equipment can be used very effectively to present the information normally found on a master instrument panel. With this class of information the operator must be able to take in, at a glance, a general picture of the data relating to the unit he is controlling. He must also be able to make a more detailed appraisal if he so wishes. The bar chart form of display enables him to do this.

Air Traffic Control

The growing volume of traffic, and the ever-increasing speeds in aviation today, present special difficulties to air traffic control. This need in a.t.c. to collect data is being met with the increased use of computers. But of equal importance is the speedy interpretation of flight data, in a precise, unambiguous and readily understandable form, on which the actual control decisions can be made quickly. This requirement can be met by the '1200' which provides a visual data presentation in real time.

Time-consuming and complicated hand-written slips, at present an essential part of a.t.c. routine, can therefore be dispensed with. Microfilm print-out provides an easily-stored, complete record by means of 16-mm film cameras which photograph display data on a separate c.r.t.

Nuclear Power Station Alarm Systems

In a modern power station, there may well be up to 3,000 alarm circuits being fed into the central control room. Certain plant abnormalities may initiate only one alarm signal, while other abnormalities may set off a complex set of alarms—the underlying cause of which would be extremely difficult to ascertain quickly.

This problem can be overcome by using the type '1200' in conjunction with a digital computer and an electronic scanner. Each alarm circuit would be checked at least four times a second.

The type '1200' alpha-numeric display system has been developed and manufactured by the Electronic Apparatus Division of A.E.I.'s Electronics Group.

For further information circle 46 on Service Card



150V DC WKG	250V DC WKG	400V DC WKG
Capacitance (µF)	Capacitance (µF)	Capacitance (µF)
0.1	0.1	0.033
0.15	0.15	0.047
0.22	0.22	0.068
0.33	0.33	0.1
0.47	0.47	0.15
0.68	0.68	0.22
1.0	1.0	0.33
1.5	1.5	0.47
2.2	2.2	0.68
3.3	3.3	1.0
4.7	4.7	1.5
6.8	6.8	2.2
10	10	3.3

New Metallized Polyester Capacitors

Low cost and capacitances up to 10µF are two of the plus-points of the new STC Polyester Capacitor range. For equivalent performance, they are 40% smaller than foil and paper capacitors and they can be used

as replacements in most instances. STC Polyester Capacitors are ideal for use in communication, control and measuring equipment, in coupling, filter and timing elements and for any application where reliable performance, high operating temperatures and small size are important factors. The capacitors have axial terminal wires, are wrapped

in polyester and are sealed at each end with thermosetting resin. Write, 'phone or Telex for Data Sheet to STC Capacitor Division, Brixham Road, Paignton, Devon or London Sales Office, Footscray, Sidcup, Kent. Telephone FOOTscray 3333, Telex 21836.

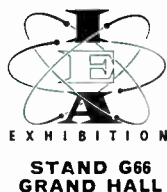

high-grade electronic components by

STC
COMPONENTS GROUP

Sperry invite you... STAND E273

NEW DATA HANDLING
ACQUISITION ■ TRANSMISSION ■
STORAGE ■ LOGGING ■ DISPLAY ■

NEW SYSTEMS
DIGITAL DENSOMETER ■
MASS FLOW MEASUREMENT ■

NEW HYDRAULICS
ROTARY ACTUATOR ■
DIGITAL ACTUATOR ■

NEW COMPONENTS
LATCHMASTER ■ MK 2 SYNDIC ■
INDUSTRIAL CONTROL MODULES ■

For advance information on the full range of Sperry Exhibits contact David R. McNaught.



at the I.E.A.

SPERRY GYROSCOPE COMPANY LTD., BRENTFORD, MIDDX. PHONE: ISLEWORTH 1241.

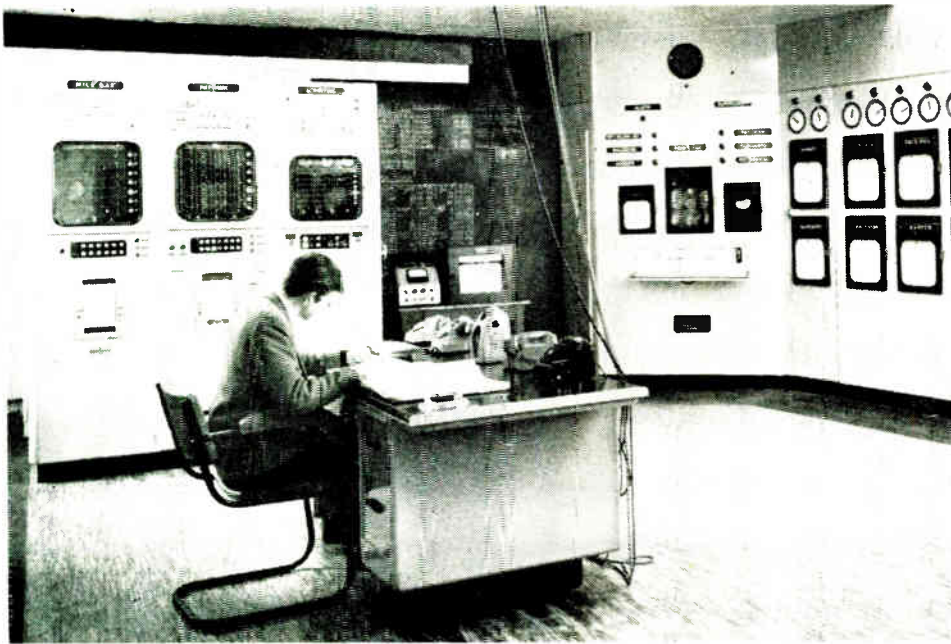

Part of the control centre

More Remote Control for Brighton Waterworks

THE remote control of a further pumping station of the Brighton Corporation Waterworks' system has recently been brought into service, using 'Wescall' remote supervisory equipment. This relay-type time division multiplex equipment, supplied and installed by Westinghouse Brake and Signal Co., uses an audio-frequency transmission link. The stepping speed is 10 steps per second and, for the new station, 6 controls and 15 indications are transmitted. The system is capable of extension to meet future requirements.

The new pumping station is situated at Sompting, approximately 12 miles west of Brighton, and houses two bore-hole pumps, one of 100,000 g.p.h. and the other 40,000 g.p.h. capacity. The pumped water is treated at the unattended station by super- and de-chlorination, and by the addition of ammonium sulphate. Pump control is effected from the Bond Street office of Brighton Corporation Waterworks, and is programmed on a patchboard for 7 days in advance, as previously arranged for the Mile Oak and Patcham pumping stations. The Sompting control cubicle and mimic diagram at Bond Street is made to match the earlier equipments, so forming a compact multiple suite.

The Sompting outstation equipment includes all essential interlocking and sequence control for automatic operation. The functioning of the pumps and the treatment plant is monitored locally and indicated over the remote supervisory equipment on the mimic diagram at Bond Street. The line circuit is a G.P.O. rented omnibus circuit which is shared with other equipment operated by the Waterworks. In the event of a line or supervisory equipment failure, the operator at Bond Street is warned, and means are provided to revert to a programmed local time control arrangement.

For further information circle 47 on Service Card

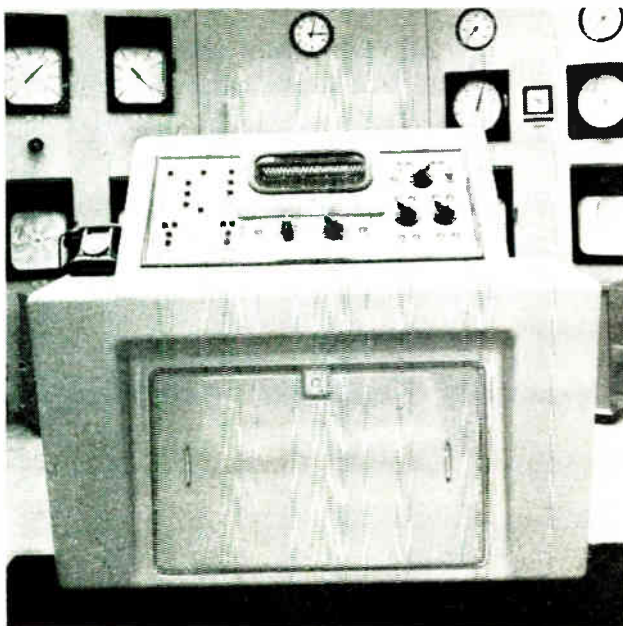

The remote control console at Sompting pumping station

INFORMATION WANTED ?

If you require further details of products or processes described or advertised in INDUSTRIAL ELECTRONICS you will find it convenient to use the enquiry cards which will be found in the front of the journal.

AUTOMATION EXHIBITION, 1964

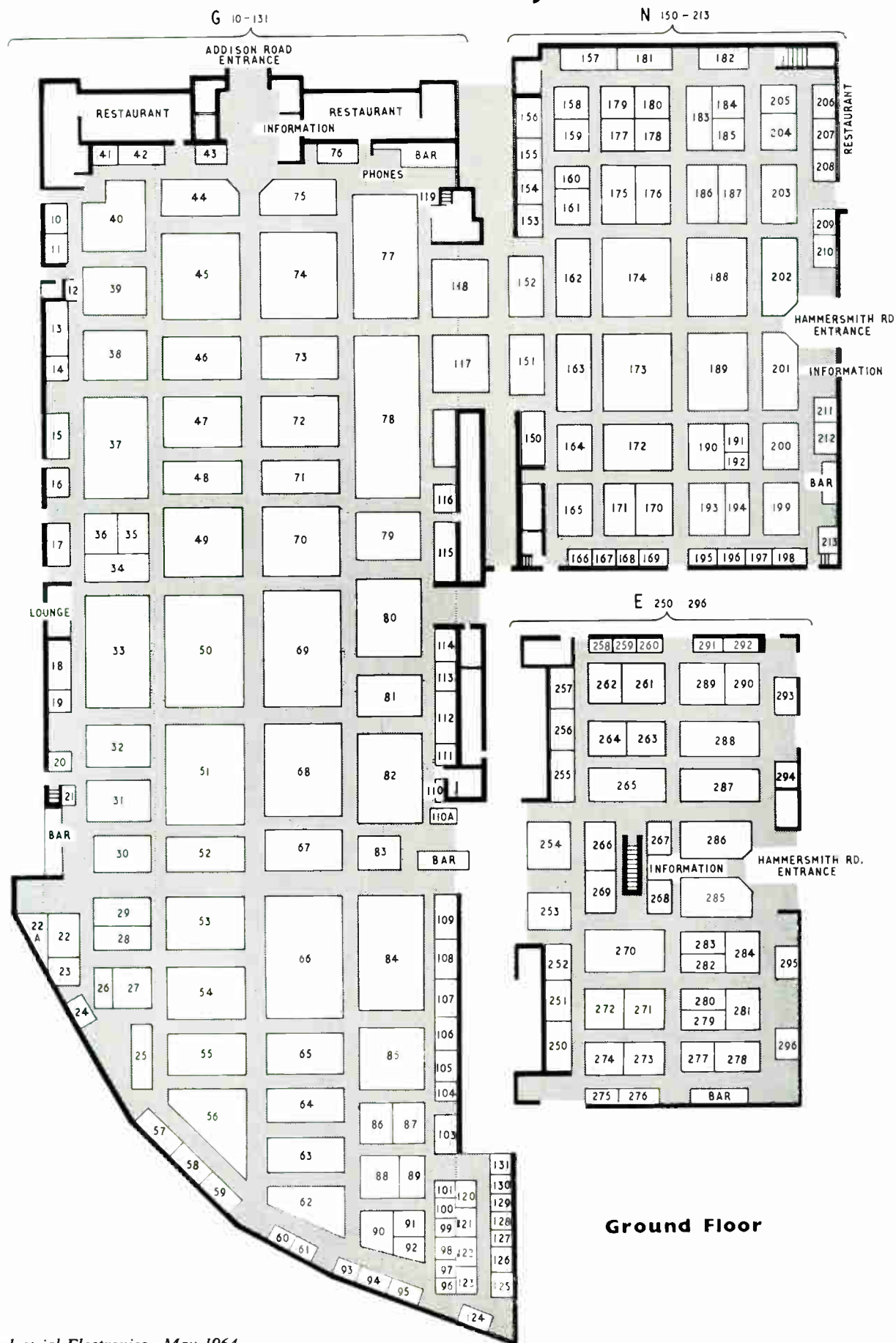

Ground Floor

Erie Resistor	G 350	Alfred Imhof	G 379	Measuring Instruments (Pullin)	G 44
Ether Langham Thompson	G 51	Impectron	N 422	Mec-Test	N 166
Europa Engineering Co.	E 558	<i>Industrial Electronics</i>	N 408	Medintron	G 360
Evans Electroelenium	G 17	Industrial Pyrometer Co.	N 443	Metal Detection	N 168
Evershed & Vignoles	G 53	Infotronics Corp.	N 432	Meterflow	G 63
Fabrique Maret	E 561	Instron	E 263	Micronia Amplifier Corp.	G 117
Fairey	E 281	Instruments & Communications	N 432	Microponent Development	N 434
Faraday Electronic Instruments	G 47	International Electro-Comp. Co.	E 501	Micro Tek Instruments Inc.	N 432
Farnell Instruments	E 524	International Electronics	E 552	Microtube S.A.	E 561
Farris Engineering	G 33 & G 50	International Engineering Conces- sionaires	N 438	Millivac Instruments Inc.	G 117
Ferranti	G 79	International Research & Develop- ment	N 441	Mine Safety Appliances Co.	G 92
Fielden Electronics	G 38	International Systems Control	G 70	Miniature Bearings	N 438
Fieldtech	N 205	Isotope Developments	G 33 & G 50	Miniature Electronic Components	G 43
J. P. Filhol	G 101	Japan Electron Optics Lab. Co.	G 108	Mining & Chemical Products	N 404
Fischer & Porter	E 254	Karl Jautz GmbH	E 267	Model & Prototype Systems	N 213
Fisher Governor	G 33 & G 50	Jenaer Glaswerk Schott & Gen.	N 427	Moore, Reed & Co.	E 519
Fleming Instruments	G 371	Jennings Radio Mfg. Corp.	G 359 A	Morganite Carbon	E 280
Flexonics	N 400	Joelin Mfg. Co.	G 12	Morganite Resistors	N 185
Formica	E 555	Johnson, Matthey & Co.	N 433	Motorola Semiconductor Products Inc.	G 86
Formica	E 555	K. & N. Electronics	E 539	Muirhead & Co.	G 32
Foster Instrument Co.	N 159	K.D.G. Instruments	E 264	Mullard	G 37
P. A. Fox	G 116	KOVO	E 269	Murex	N 406
Foxboro-Yoxall	G 56	Kappa Electronics	G 369	N.S.F.	N 407
Frako GmbH	E 267	George Kent	G 39	Nalder Brothers & Thompson	E 253
Friden	E 285	Kent Mouldings	G 66	Negretti & Zambra	G 73
Furzehill Laboratories	N 206	Kerry's (Ultrasonics)	N 160	Neoflex	E 267
G.E.C. (Electronics)	G 70	Ketay	G 68	Newmarket Transistors	E 270
G.E.C. (Telecommunications)	E 288	Keyswitch Relays	E 547	New Western	G 73
G.K.N. Screws & Fasteners	E 282	Kings Electronics Co. Inc.	E 566	Louis Newmark	G 103
General Controls	G 116	Knott Elektronik Vertrieb	N 431	Newport Instruments	N 195
General Instrument International Corp.	E 508	H. Kuhnke	E 515	Non-Linear Systems Inc.	N 431
General Post Office	G 357	Kumag A.G.	N 409	C. A. Norgren	N 192
General Radio Co.	G 117	Kynmore Engineering Co.	N 193	Nuclear Enterprises	E 250
Glass Developments	E 518	Laboratoire Electro-Acoustique	N 206	O.M.I. Instruments	G 353
Gloster Equipment	G 55	Laboratoire Industriel d'Electro- nique Belin	G 77	Oliver Pell Control	G 386
Gloucester Controls	N 436	Landis & Gyr	E 531	Optical Works	G 14
Goodmans Industries	G 107	Langendorf Watch Co.	E 561	P. & H. Engineering Co.	E 260
James Gordon & Co.	G 33 & G 50	J. Langham Thompson	G 51	P.S.B. Instruments	N 415
Gordon Valves	G 33 & G 50	Lectrotron	G 60	Pacific Semiconductors Inc.	N 404
Graphic Instruments (Research)	E 276	Leeds Meter Co.	N 181	Packard Instruments	N 430
Graviner Manufacturing Co.	N 211	Leeds & Northrup	N 162	Painton & Co.	E 261
Greibech Instruments Corp.	G 117	Leesona Holt	E 554	Palatine	G 50
Gresham Lion Electronics	N 424	Leevers-Rich Equipment	E 541	Pall	G 12 & G 401
Gudenbrod Bros. Silk Co. Inc.	G 12	Les Laboratoires de Physique Applique	G 77	G. A. Stanley Palmer	G 353
H.C.D. Research	E 505	Levell Electronics	E 268	Panax Equipment	N 152
H.V.L. S.A.	G 359	Leybold-Elliott	G 33 & G 50	Paramatic Engineering	G 100
Thomas Haddon & Stokes	E 282	Linvar	G 20	Parechoc S.A.	E 561
Haefner & Krullmann	N 409	Paul Lippke K.G.	E 275	Parkinson Cowan Measurement	G 29
Hahn Magnet	E 267	Livingston Laboratories	G 84	Parmeko	G 42
Hallam, Sleigh & Cheston	G 28	Livingston Control	G 84	Payne & Griffiths	N 212
Hallikainen Instruments	G 33 & G 50	Londex	G 33 & G 50	Pedoka	N 439
W. F. Hamilton (Instrumentation)	E 561	London Electric Wire Company & Smiths	N 410	Perkin-Elmer	N 401
Harris Plating Works	E 258	Joseph Lucas	G 72	George A. Philbrick Researches Inc.	N 431
Harwin Engineers	G 91	Lumatron Products/G.A.S.I. Inc.	N 431	Phoenix Telephones	N 444
Hassett & Harper	N 191	Lund Bros. & Co.	E 565	Photoelectronics (M.O.M.) Holdings	G 59
Hatfield Instruments	N 210	Claude Lyons	G 117	Pignone Sud S.p.A.	G 389
Hawksley & Sons	G 47	M.B. Metals	G 394	Pirelli Applicazioni Elettroniche S.p.A.	E 508
Headland Engineering Develop- ments	G 351	M.C.P. Electronics	N 404	Plannair	N 418
Dr. Johannes Heidenhain	G 95	M.E.L. Equipment	G 82 & G 114	G. A. Platon	G 13
Hendrey Relays	G 378	M-O Valve Co.	E 288	Plessey Co.	G 68
J. Hengstler Co.	E 514	McMichael	G 70	Polaron Instruments	G 108
Henley Inc.	E 501	McMurdo Instrument Co.	G 103	Potter Instrument Co.	N 432 A
Henry & Thomas	G 360	Magnetic & Electrical Alloys	N 183	Printed Circuits	N 410
Hewlett-Packard	N 174	Magnetic Devices	N 164	R. B. Pullin & Co.	G 44
Richard Hirschmann	E 267	Karl Maier	E 267	Pulsonic	N 429
Hirst Electronic	E 503	Malaker Laboratories Inc.	N 195	Pye	E 270
Hivac	N 171	Mallory Batteries	G 58	Pyro-Werk GmbH	E 556
J. H. Hoffmann Internationaal N.V.	E 516	Manigley Freres	E 561	Quentin & Cie	G 77
Honeywell Controls	N 188	Marconi Co.	G 69	R.C.A. Great Britain	G 364
Hottinger Baldwin Messtechnik GmbH	N 427	Marconi Instruments	N 189	Raaco	E 510
Hughes International	G 366	I. Markovits	G 21	Racal	N 173
A. H. Hunt	G 31	Marrison & Catherall	G 372	Radiatron	E 511
Hunt & Mitton	G 15	Mawdsley's	G 361	Radionic Products	E 566
I.E.C.	N 438	Mazda Equipment	G 27	Rank Organisation	G 45
T. & W. Ide	G 119	Measuring Instruments (Pullin)	G 44	Rathdown Industries	E 543
Ilford	E 284	Mec-Test	N 166	Record Electrical Co.	E 500
Iliffe Books	E 550	Medintron	G 360		
		Metal Detection	N 168		
		Meterflow	G 63		
		Micronia Amplifier Corp.	G 117		
		Microponent Development	N 434		
		Micro Tek Instruments Inc.	N 432		
		Microtube S.A.	E 561		
		Millivac Instruments Inc.	G 117		
		Mine Safety Appliances Co.	G 92		
		Miniature Bearings	N 438		
		Miniature Electronic Components	G 43		
		Mining & Chemical Products	N 404		
		Model & Prototype Systems	N 213		
		Moore, Reed & Co.	E 519		
		Morganite Carbon	E 280		
		Morganite Resistors	N 185		
		Motorola Semiconductor Products Inc.	G 86		
		Muirhead & Co.	G 32		
		Mullard	G 37		
		Murex	N 406		
		N.S.F.	N 407		
		Nalder Brothers & Thompson	E 253		
		Negretti & Zambra	G 73		
		Neoflex	E 267		
		Newmarket Transistors	E 270		
		New Western	G 73		
		Louis Newmark	G 103		
		Newport Instruments	N 195		
		Non-Linear Systems Inc.	N 431		
		C. A. Norgren	N 192		
		Nuclear Enterprises	E 250		
		O.M.I. Instruments	G 353		
		Oliver Pell Control	G 386		
		Optical Works	G 14		
		P. & H. Engineering Co.	E 260		
		P.S.B. Instruments	N 415		
		Pacific Semiconductors Inc.	N 404		
		Packard Instruments	N 430		
		Painton & Co.	E 261		
		Palatine	G 50		
		Pall	G 12 & G 401		
		G. A. Stanley Palmer	G 353		
		Panax Equipment	N 152		
		Paramatic Engineering	G 100		
		Parechoc S.A.	E 561		
		Parkinson Cowan Measurement	G 29		
		Parmeko	G 42		
		Payne & Griffiths	N 212		
		Pedoka	N 439		
		Perkin-Elmer	N 401		
		George A. Philbrick Researches Inc.	N 431		
		Phoenix Telephones	N 444		
		Photoelectronics (M.O.M.) Holdings	G 59		
		Pignone Sud S.p.A.	G 389		
		Pirelli Applicazioni Elettroniche S.p.A.	E 508		
		Plannair	N 418		
		G. A. Platon	G 13		
		Plessey Co.	G 68		
		Polaron Instruments	G 108		
		Potter Instrument Co.	N 432 A		
		Printed Circuits	N 410		
		R. B. Pullin & Co.	G 44		
		Pulsonic	N 429		
		Pye	E 270		
		Pyro-Werk GmbH	E 556		
		Quentin & Cie	G 77		
		R.C.A. Great Britain	G 364		
		Raaco	E 510		
		Racal	N 173		
		Radiatron	E 511		
		Radionic Products	E 566		
		Rank Organisation	G 45		
		Rathdown Industries	E 543		
		Record Electrical Co.	E 500		

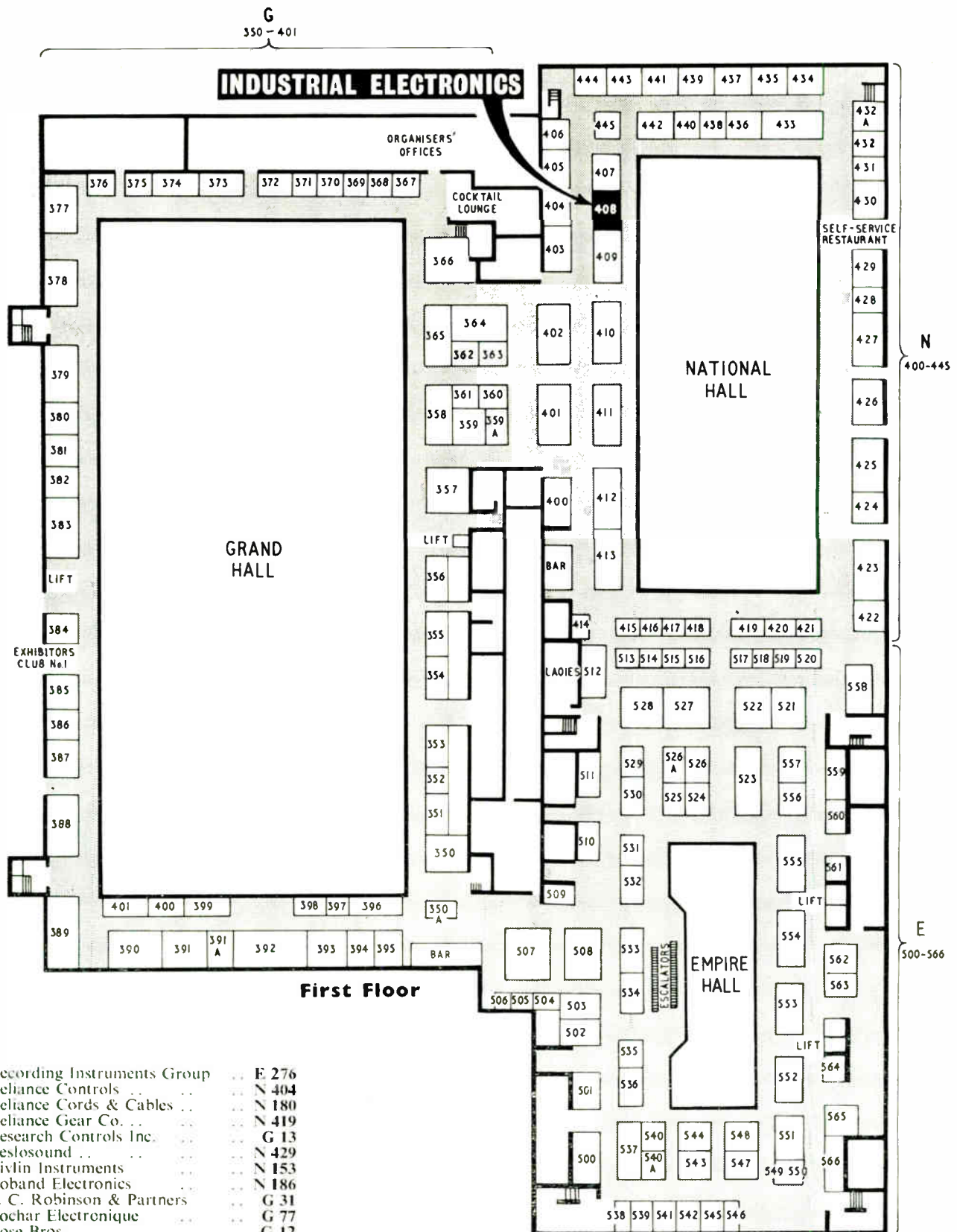

First Floor

- Recording Instruments Group ... E 276
- Reliance Controls ... N 404
- Reliance Cords & Cables ... N 180
- Reliance Gear Co. ... N 419
- Research Controls Inc. ... G 13
- Reslosound ... N 429
- Rivlin Instruments ... N 153
- Roband Electronics ... N 186
- F. C. Robinson & Partners ... G 31
- Rochar Electronique ... G 77
- Rose Bros. ... G 12
- Ross, Courtney & Co. ... N 405
- Rotameter Mfg. Co. ... G 33 & G 50
- Rotax ... G 72
- Rotron Controls ... G 33 & G 50
- Roulements Miniatures S.A. ... N 438
- Royal Worcester Industrial Ceramics ... G 362
- Royce Electric Furnaces ... E 291
- Royston Instruments ... G 10
- Rustrak Instruments ... E 290

- S.F. Laboratories ... G 63
- S.G.S.-Fairechild ... N 412
- SFIM (Great Britain) ... N 400
- Salford Electrical Instruments ... E 288
- George Salter & Co. ... E 296
- Sanders Group ... G 388
- Sangamo Weston ... G 75
- Scama ... E 549

- Schaevitz Engineering ... N 400
- Adolf Schnorr K.G. ... N 438
- K. Schnyder-Liechti S.A. ... E 561
- Sealectro Corp. ... E 509
- Self Organizing Systems ... E 566
- Semiconductors ... G 68
- Semikron M.B.H. ... E 505
- Service Electric Co. ... G 19

Servo Consultants	E 538	Tannoy Products	E 527	United Electric Controls	N 431
Seton Creaghe Engineering	N 438	Taylor Instruments	G 57 & G 65	Uni-Tubes	N 202
Sferax S.A.	N 438	Techmation	N 432		
Siemens & Halske A.G.	N 409	Techna	G 363		
Sierex	E 535	Technivision Group	G 387	Vactite Wire Co.	N 410
Sifam Electrical Instrument Co.	N 204	Technograph & Telegraph	N 155	Vactric Control Equipment	N 178
Simplifix Couplings	G 125	Tectonic	N 421	Vacwell Engineering Co.	N 152
Sirco Controls	G 97	Teddington Aircraft Controls	E 546	Varad Inc.	G 117
S. Smith & Sons	N 202	Tektronix U.K.	G 67	Varian Associates	N 154
Societe Analac	G 117	Telcon-Magnetic Cores	N 183	Veeco Instruments	E 504
Societe d'Electronique Materiel		Telcon Metals	N 183	Veeder-Root	G 16
Automatique Controle	G 77	Teledictor	G 111	Venner Electronics	G 76
Societe Europeane des Semiconducteurs	N 404	Telegraph Condenser Co.	G 36	Vero Electronics	E 529
Societe d'Instrumentation Schlumberger	G 77	Telehoist	G 34	Victoreen Instrument Co.	N 431
Solartron Electronic Group	G 77	Telektron	E 528	Visual Engineers	G 73
Sorensen-Ardag	E 501	Telephone Manufacturing Co.	G 81		
South London Electrical Equipment Co.	G 115	Telequipment	G 109		
Southern Instruments	G 49	Temco	N 183	Wandleside Cable Works	E 559
Sovirel	N 150	Texas Instruments	G 52	Wandleside Warren Wire Co.	E 559
Spear Engineering Co.	G 370	Thermal Syndicate	G 358	War Office	N 172
Sperry Gyroscope Co.	E 273	Thermionic Products	G 74	Watch Stones Co.	E 561
Spirol Pins	E 561	Thorn-A.E.I. Radio Valves & Tubes	G 27	Waters Mfg. Co.	N 438
Standard Telephones & Cables	G 66	Thorn Electrical Industries	G 118 & E 271	Waycom	E 537
Stanton Instruments	G 105	H. Tinsley & Co.	N 158	Wayne Kerr Laboratories	G 34
Steatite Insulations	G 104	Tintometer	G 110	Welwyn Electric	G 365
Stewart Aeronautical Supply Co.	E 566	Tiro-Clas S.A.	E 513	West Instrument	E 290
Stratton & Co.	E 279	Tolana S.A.	G 77	Westinghouse Brake & Signal Co.	N 165
Studer S.A.	E 561	Toolpro	N 183	Westool	N 194
Swartwout Co.	G 33 & G 50	Topper Cases	G 24	Whiteley Electrical Radio Co.	N 201
Swiss Instruments & Components	G 400	Transitron Electronic	N 179	Williams & James	N 432
Swiss Jewel Co.	G 12	Trumeter Co.	E 294	Wire Products & Machine Design	G 113
Sylvania International	N 411	Ernest Turner Electrical Instruments	G 23	Witte & Sutor Kondensatoren und Geratebau K.G.	N 402
Sylvania-Thorn	G 27	Turton Bros. & Matthews	G 41	Woden Transformer Co.	E 277
R. H. Symonds	G 12	20th Century Electronics	G 381		
Symonds Engineering Co.	G 12	Tylors	N 161		
Synchronome Co.	E 264			X-Lon Products	N 416
System Computers	N 441				
		Ultra Electronics	G 80	Yellow Springs Instrument Co.	E 566
T.R.G. Inc.	G 117	Ultrasonoscope Co.	E 518		
TRW Semiconductors Inc.	N 404	Union Carbide	N 435	G. H. Zeal	E 533
		Union Optical Co. of Japan	G 108	Zenith Electric Co.	G 117

EXHIBITION PREVIEW

THE fifth of the highly successful International IEA Exhibitions, now held every two years, brings to London seven hundred international firms. They will show and demonstrate £20 million worth of the latest equipment playing an indispensable role in all branches of modern industry, engineering and science and touching on the present and future lives of everyone.

Measurement is fundamental to all engineering and, therefore, measuring devices hold pride of place on many stands. For industrial purposes, Panax are demonstrating a transistorized battery- or mains-operated radioactive gauge (48) for quick and accurate determination of surface coating thickness from only one side of the object. Intended primarily for measuring plastics coatings, it can also deal with paint and plating applied to many materials. The instrument is of the 'backscatter' non-destructive type and the design of the probe is such that the working distance between the radioactive source and the object remains substantially constant even

with curvatures of small radius. With this plastics film thicknesses ranging from 50×10^{-6} to 2×10^{-3} in. can be measured.

For measurements of another kind English Electric are showing their Di-Scan system (49). This is a non-contacting infra-red scanning device which measures any linear dimension of hot metal and has been designed specifically for use in the arduous conditions encountered in rolling mills. Its particular advantages are a measurement accuracy of ± 0.25 in.; high speed of operation, enabling it to be used on stationary or moving stock; an easily extended measuring range; and digital display of the measured length.

Contrast in measurement is provided by Combustion Instruments' 'Combinst' micro-force balance (50) which weighs down to two-millionths of a gram. This can be used to measure small applied forces or static torque and can be integrated into an apparatus which may be remote from the indicator. It requires no massive

vibration-free mounting and can be set up quickly and easily. The balance head consists essentially of a moving coil in a magnetic field, the coil being mounted on a pivoted beam. The application of a small force displaces the beam momentarily, but such movement unbalances the illumination on two photo-diodes provided by a small lamp. The diodes are connected into a bridge circuit and as this becomes unbalanced an increased current is made to flow through the moving coil, thereby restoring it to the original position. The amount of increased current required to return the coil is a direct measure of the force on the beam.

If in the past small-force measurements have proved difficult, some engineers will say that such problems can hardly be compared with those encountered in the measurement of moisture in absorbent materials. Engineers in various fields will always argue that theirs is the greater problem. However, in the realm of moisture content measurement Kappa Electronics promise with their latest developments

some relief to anguish caused by the lack of knowledge. Among their range of moisture meters on show is model AB66 (51) which is designed specifically to measure the moisture content of paper and board sheet material and materials that possess a reasonably flat surface. Measurement of moisture content is made by making physical contact to the material with a flat sensing plate. By h.f. electrostatic radiation the instrument provides an indication that may be related to either the dielectric constant of the material or, in the case of a highly conducting substance, its impedance at h.f. This measurement is converted into moisture content by reference to a table that has been prepared with the aid of samples of known moisture content. Moisture range is 0.1% to about 60%, dependent upon the composition of the material. Fully transistorized and operating from an internal battery the instrument is truly portable and can be used in situ.

A combination of old and new skills could well describe the Zeiss toolmakers' digital measuring microscope 100/50 (52). It is to be shown for the first time in the U.K. by Degenhardt. This instrument basically comprises a measuring microscope and an electronic digital measuring system with an in-line digital display. The value set or measured is presented to the operator in the form of numerals on an easy-to-read number panel. Consequently, there is no need for composing the read-out value from various dials. Within the co-ordinate system, every value measured can be made with respect to any zero point selected by the operator. The instrument is equipped for connection to a digital printer to provide a printed record of all measurements.

20th Century Electronics are featuring a programmed fully automatic mass spectrometer leak detector (53). This is a complete leak detection equipment for individually leak testing small sealed components. Transistors and similar sealed devices which have been filled with helium during manufacture or subsequently 'soaked' in helium can be individually tested and sorted automatically by this machine at rates of up to 1,000 per hour. Testing to leak rates better than $10^{-8}/\text{cm}^3/\text{sec}$ is achieved. The equipment introduces the component from atmosphere into the high vacuum system through a series of stages. The 'Centronic' mass spectrometer, which can be used separately from the automatic handling plant, is available in various forms. One version requires no liquid nitrogen or other refrigerant.

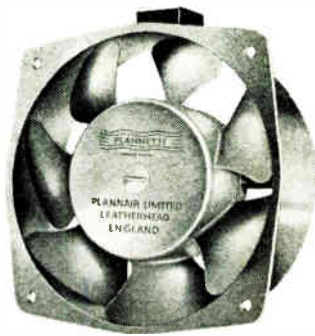

▲ The Plannair Plannette 10-in. diameter axial flow blower measuring only 3-in. deep and has a performance of 560 cubic feet per minute (54)

▼ Production models of this Painton 'Miniflatpot' are to be seen on their stand. It is only $\frac{3}{8}$ -in. long \times $\frac{5}{16}$ -in. square. Resistance range is 10 Ω to 10 k Ω (55)

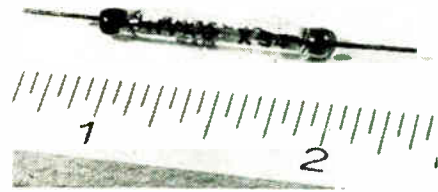
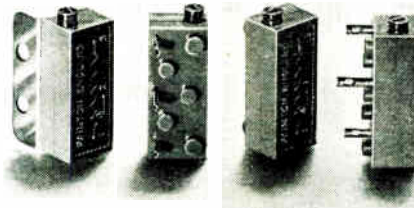

▲ Hivac are showing this dry reed relay insert type XS4. It has a maximum current rating of 150 mA and maximum power rating of 5 W into a resistive load. Operation time is less than 1 msec with the appropriate coil and the closed resistance is less than 300 m Ω (56)



▲ This compact Elesta electronic timer is available in a range of delay times from $\frac{1}{10}$ sec. It measures $2\frac{1}{2}$ -in. diameter \times $4\frac{1}{2}$ -in. long (57)

Although electronically-controlled machine tools are now being used more extensively there are still many new and older machine tools which could be fitted with electronic control and measuring systems. However, many users think, rightly so, that extensive modifications to old machines are not worthwhile and in the case of new machines costly and elaborate electronic control systems cannot be justified. Paramatic Engineering have developed and will be displaying their digital follower system (58) that goes a long way in answering these objections. This is designed for applications in the field of continuous accurate monitoring of machine tools and can be fitted easily to new and old machines alike. This equipment not only measures and displays continuous true position of the work carriage, but also allows pre-selection of any dimension within its range. The standard model D.F.6 is capable of recording all linear movement over a range of 6 in. with an accuracy within 0.001 in. Any chosen datum may be selected within this range. The basic system is made up from a follower control head, a counter with a numerical display and an electronic unit. In

operation the spring-loaded plunger of the control head is in contact with the moving part to be monitored. The plunger follows the moving part and drives the electronic counter via a servo mechanism. A unique feature of the system is incorporated in the electronics. This makes it possible for the servo follower to seek any new position from one direction in its final movement so that errors which might occur through backlash are eliminated.

For the benefit of the semiconductor manufacturing industry Censor Patents & Versuchs-Anstalt are exhibiting two fully-automatic measuring instruments. Model GPS (59) measures the thickness of germanium and silicon dice and sorts them into ten pre-set acceptable grades at a rate of up to 3,600 an hour. The thickness range is 0.0008 to 0.04 in. The second machine model GPR (60) measures the specific resistivity of germanium and silicon dice and also sorts them into ten pre-set acceptable grades at a rate of up to 4,000 per hour. The resistivity range is from 0.20 to 200 Ω cm.

For further information about specific items circle the appropriate number, shown in brackets in this report, on the Service Card.



For on-line composition control with laboratory accuracy, Foxboro are showing this industrial chromatograph. Two types of programming units are available for single and multi-stream applications (61)

To be demonstrated by Hewlett-Packard, this 5,100 A frequency synthesizer produces 5×10^9 signal frequencies ranging from 0.01 c/s to 50 Mc/s by push button command or remote contact closure (62)

This Epsilon MR1000 digital tape transport is shown here recording mechanical phenomena of precision lathe operation. Information concerning depth and rate of cut, vibration, temperature of cutting tool, etc., is being recorded for subsequent analysis with a view to improving techniques and reducing costs. The recorder is being shown at the I.E.A. (63)

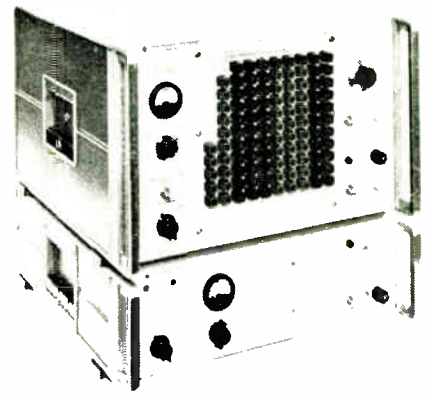

This industrial alarm and indicator unit, type LE463, is one of the devices to be featured by Hatfield Instruments. In conjunction with a sensor, it can be arranged to close relay contacts in the event of either high or low temperature, or both, occurring in the locality of the sensor. The high and low temperature limits can both be pre-set (64)

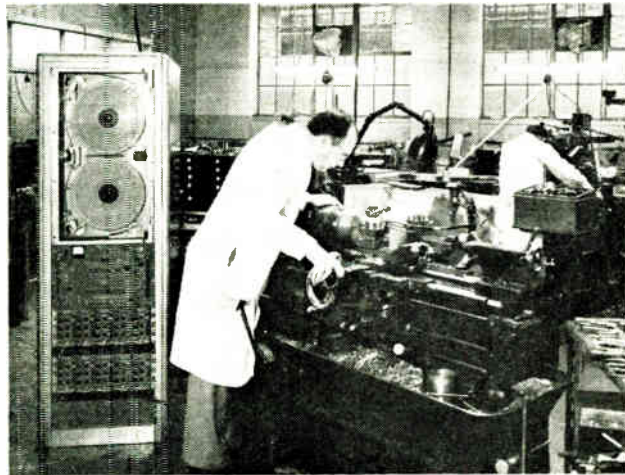

With ultrasonics now playing a greater part in production lines, one would expect to find a representative range of ultrasonic devices on show. This is certainly true. Complete equipments for cleaning and degreasing and others for non-destructive testing can be seen on quite a few stands. Dawe Instruments are displaying for the first time their non-destructive thickness gauge known as the type 1109 Visigauge 14 (65). This features ease of operation and a direct-reading scale. It can be used in direct contact in air or for certain applications in liquid. The measuring thickness range is from 0.006 to 2 in. and the accuracy is 0.1% to 2% dependent upon the application and thickness range. For various applications different frequencies are required. This is catered for by plug-in oscillator units covering the range 0.75 to 20 Mc/s.

Ultrasonoscope Co. are to include in their display the new portable

Mark 2C ultrasonic flaw detector (66). This has a maximum depth range of 24 ft in steel and incorporates one or two unusual facilities to aid the inspection of materials. For example, to facilitate the setting of the necessary standards which determine the acceptance or rejection of the material under test, the amplitude of a defect echo on the trace can be set by an attenuator.

Instruments

Not surprisingly, surveys have shown that the primary attraction, at the I.E.E. Show, New York, for most electronic engineers is the exhibit of instruments and test equipment. No survey is necessary to discover that instruments will attract a great deal of attention at this year's I.E.A. exhibition for there are hundreds to see. New tools to aid the engineer abound — timers, counters, signal generators, oscilloscopes, pulse genera-

tors, recorders, etc., etc., will provide hours of pleasure for a great many people.

Advance Electronics (formerly Advance Components) celebrate their change of name by introducing for the first time at a public exhibition four completely new instruments. These include an inexpensive 20-ke/s counter (67), a transistorized pulse generator type PG54 (68) having pre-pulse and main pulse outputs separated by a delay, wideband oscilloscope type OS41 (69) with bandwidth of 22 Mc/s and a sensitivity of 50 mV/cm, and a 100-Mc/s square-wave generator type SG21 (70). The square-wave generator provides an output of 1 V into 50 Ω that is continuously variable in frequency from 9 ke/s to 100 Mc/s. It has two coincident positive-going outputs with

(Continued on page 227)

For further information about specific items circle the appropriate number, shown in brackets, in this report, on the Service Card.

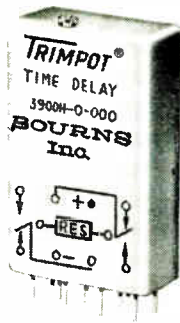

MODEL 3900

Time Delay Range from 0.1 to 200 seconds · Stable Operation from 20 to 30 v. D.C. · Reverse Polarity Protection · Instantaneous Re-cycle Operation Available · Less than 0.06 amperes required for continuous operation.



MODEL 3040

350 C. Maximum Operating Temperature · 5 watts dissipated at 70 C. · Specifically designed to operate in high intensity radioactive environment, 150 Megarad total gamma radiation, 5×10^{15} fast neutron/cm² total neutron radiation · Compact size, $1\frac{1}{4} \times \frac{3}{8} \times .29$ ".



PAINTON ANNOUNCE

3 new advanced
Bourns Components

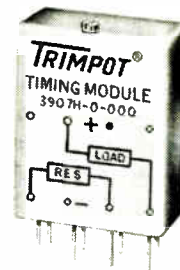

MODEL 3907

Time Delay Range from 0.1 to 200 seconds · Output capable of switching 6 watts · Stable Operation from 20 to 30 v. D.C. · Reverse Polarity Protection · Less than 0.03 amp. plus load current required for continuous operation.

These three new components are the latest additions to the large range of TRIMPOT® Miniature components designed for use wherever the ultimate in reliability and performance is required.



See them on STAND E261
OLYMPIA - LONDON
25-30th MAY, 1964

PROGRESS WITH PAINTON-BOURNS RELIABILITY

**Painton
& CO LIMITED**

KINGSTHORPE · NORTHAMPTON

Telex: 34251 (10 lines) · Grams: "Cml" Northampton · Telex: 31576

Australia Painton (Australia) Pty. Ltd. · Benelux Painton S.A. · Italy Painton Italiana S.p.A. · Sweden Svenska Painton A.B. · U.S.A. Painton Int

MORE THAN

MILLION FEET



OF WANDLESIDE P.T.F.E. CONNECTING WIRES AND FLEXIBLES ARE USED ANNUALLY IN WIRING UP ENGLISH ELECTRIC LEO COMPUTERS

The delicate and sensitive "brain" of a computer requires the most intricate of wiring systems. Wiring is the life-blood of a computer, so it is essential that it is of the highest quality. Wandleside P.T.F.E. insulated wires and flexibles guarantee absolute accuracy and reliability under the most stringent conditions. We can manufacture to both Ministry or Commercial specifications.

If you have a problem with

- MINIATURIZATION
- HIGH AMBIENT TEMPERATURE CONDITIONS
- SOLDERING IN CONFINED AREAS
- SOLDERING TO MINIATURE CONNECTORS OR COMPONENTS

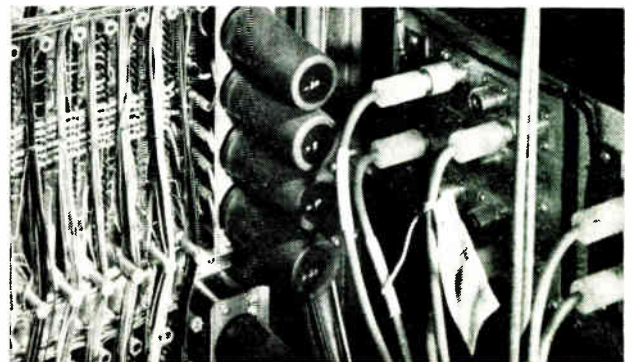

Consult

WANDLESIDE WARREN WIRE COMPANY

In Association with
WANDLESIDE CABLE WORKS LIMITED

(Falks Group)

Our Technical Advisory Service is at your disposal. Samples and prices on application. P.T.F.E. insulated wires and flexibles are available in eleven standard colours and a full range of bi-colours and tri-colours. Stocks are carried at both our London and Dunmurry works. We hold M.O.A. design approval for P.T.F.E. aircraft cables.

WANDLESIDE WARREN WIRE CO. LTD., DUNMURRY, NORTHERN IRELAND. Telephone: DUNMURRY, 2536 Telex: 74339 Telegrams: DERRIAGHY, DUNMURRY, N. IRELAND. London Office: 106 Garratt Lane, S.W.18 Telephone: YANDYKE 7544 Telex: 261355 Telegrams: WANDLESIDE, LONDON, S.W.18

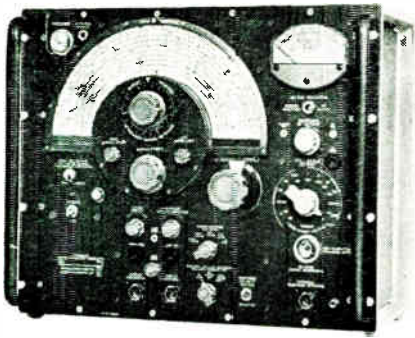

▲ This General Radio type 1025-A sweep frequency generator features true 'standards' performance in either manual or sweep operation. Frequency range is 700 kc/s to 230 Mc/s (71)

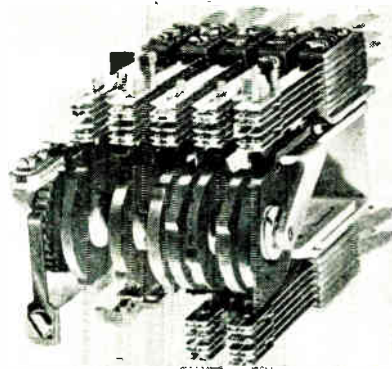

◀ This illustrates a 7-cam ratchet relay being exhibited by G.E.C. Telecommunications. It has been designed for use in pulse-operated circuits and is useful for decimal and binary coding (72)

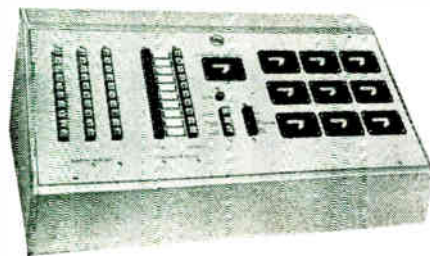

English Numbering Machines are demonstrating this 488 statistical analyser. It has a quantity selection keyboard and channel selection keys so that the required numbers can be fed into one of nine totalizing registers (73)

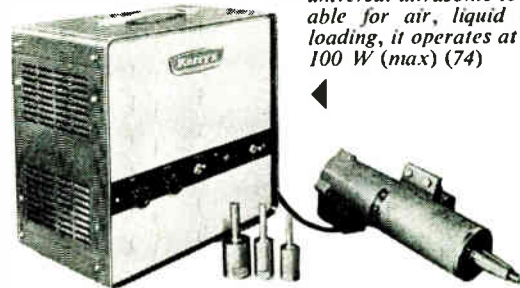

◀ Among the industrial ultrasonic equipment shown by Kerry's is this 'Vibrason' universal ultrasonic tool. Suitable for air, liquid or solid loading, it operates at 20 kc/s, 100 W (max) (74)

short rise times and independently adjustable levels.

The 'International' aspect of the show is particularly noticeable in the various overseas instruments to be seen around Olympia. The U.S. is very well represented. Typically, the Amprobe Instrument Corporation recorders, printers and meters, featured on the stand of Budgen Instruments, indicate the trends on the other side of the Atlantic in certain instrumentation. The latest Amprobe 50- μ A chart recorder (75) uses pressure-sensitive strip charts (2½ in. \times 30 in.) and is easier to load than the average camera. Designed for laboratory or industrial environments, it is available with chart speeds of 1, 6 or 12 in. per hour (12 in. per hour is standard). At 12 in. per hour, an impression is made once every 5 seconds. The accuracy is $\pm 2\%$ of full scale. Operation is from 250 V 50 c/s; other models for different mains are available.

Other instruments with U.S. parentage are being demonstrated by Hughes International. Their 'Tono-Corder' model 203 (76) illustrates some of the modern techniques developed for the display of half-tone images and graphical data on a cathode-ray storage tube. With this, half-tone images of the input signals are presented on a 5-in. direct view tube for immediate analysis or for photographing. Five or more grey shades are available,

depending on the writing speed. Writing speeds of up to 30,000 in./sec can be achieved and still provide images with good grey-scale selectivity and high resolution.

Electronic counters have been described as the 'tool' with a very great future in both industry and research. A few years ago, when engineers were struggling to push up counting speeds and with design problems, this description could justifiably be doubted. However, today counters are being used in ever greater numbers and more and more firms are producing them. One of the earliest companies in this field, Venner Electronics, are displaying and demonstrating their range of counters and ancillaries. A pre-production model of the TSA 3338 time/frequency equipment (77) is making its appearance at the show. With an 8-digit in-line projection display, the equipment enables direct frequency measurement up to 50 Mc/s, and time measurement in units of 0.1 μ sec, to be made. The instrument is also capable of multi-period measurement and random pulse counting.

Among the impressive display on Marconi Instruments' stand is an instrument which clearly indicates that semiconductors are now the instrument designer's first choice. This instrument is claimed to be the world's first solid-state wide-range signal

generator. Designated m.f./h.f. a.m. signal generator type TF2002 (78), it provides high quality a.m. signals from 10 kc/s to 72 Mc/s and features high discrimination (with an effective scale length of more than 2½ miles) and exceptionally low leakage and spurious modulation. Each of the 8 frequency bands has a separate permeability-tuned oscillator and output circuit. Crystal check points are available at intervals of 1 Mc/s, 100 kc/s or 10 kc/s with subsidiary points at ± 1 kc/s relative to the main points. Internal a.m. up to 100% is produced by a continuously tuned oscillator covering the audio band.

Components

Without component parts, instruments, electronics and automation do not exist. It is, therefore, to be expected that 'components' form a sizeable part of the I.E.A. exhibition.

For the transmitter engineer the English Electric Valve Co. are introducing a completely new range of high-current r.f. vacuum variable capacitors which have a current rating of 75 A. The voltage ratings vary from 8 to 30 kV. The range is made up of the two basic types UG and UH (79) and there are to be five

◀ For further information about specific items circle the appropriate number, shown in brackets in this report, on the Service Card.

variations of each type. Units with nominal capacitances are available from a few pF to 2,000 pF; capacitance variations of the order of 40:1 are easily achieved. By using standard parts in the fundamental design, 'tailor made' capacitors of this type are a practicable proposition.

Fixed capacitors of all types are also to be seen in great numbers and many forms. Conventional types are there, of course, alongside some of the newer developments including tantalum, plastics moulded and potted types, those using metallized foil and metallized polyester capacitors. Typical of the metallized polyesters is the Wima MKS range (80) shown by Waycom. These are of rectangular construction and have been designed to operate over the temperature range 100 °C to -55 °C. Values covered are 0.01 to 2 μ F at voltages from 250 to 400 V d.c. An indication of physical size is given by the 250 V 0.1 μ F model which measures 5 \times 10 \times 18 mm.

A representative trend in developments in resistors can be seen on the stand of Erie. Recent progress in this field has resulted in smaller components with improved stability and the ability to operate in extreme environments. Erie's types NG and NGA (81) $\frac{1}{8}$ W (at 70 °C) subminiature ceramic encapsulated carbon film resistors are indicative of the modern trend. These provide a resistance range of 10 Ω to 1 M Ω , both types being designed to NATO style NRNO6 and DEF style RC4-L requirements.

Noble and base metals for component fabrication form part of Johnson, Matthey's display along with their new Silver Star miniature capacitors (82). These capacitors cover the range from 5 to 5,000 pF at working voltages up to 350 V.

Semiconductors, valves and tubes not to be outdone by other components are at the show in their hundreds. All of the leading manufacturers of these devices are there. Rank Cintel, for example, are demonstrating a new form of alphanumeric display cathode-ray tube known as the Matricon (83). In this 9-in. tube a broad beam of electrons floods a plate which has a matrix of apertures. Each aperture has an independent connection, such that a pulse of about 25 V suppresses the beam through it. In this way any desired character is formed in one go on the tube face. Since all parts of a character are simultaneously illuminated the brightness is much greater than in a c.r.t. character generator in which the character is formed by a single moving spot. Prototypes have

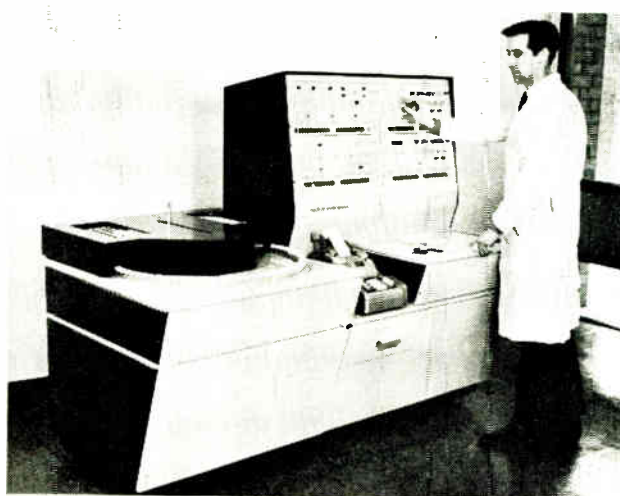

Nuclair Enterprises are demonstrating this automatic liquid scintillation spectrometer NE8303 and 'Gamm-matic' add-on unit NE6407. The system handles up to 50 samples, enabling measurements to be made, at high efficiencies, of tritium carbon-14, iron 55 and other radioisotopes, with completely automatic counting and printing of data (85)

This edgewise thumbwheel-operated selector switch with digital input and read-out is one of the products displayed by Contraves. Any number of wafers may be assembled into blocks. Many contact combinations are available (86)

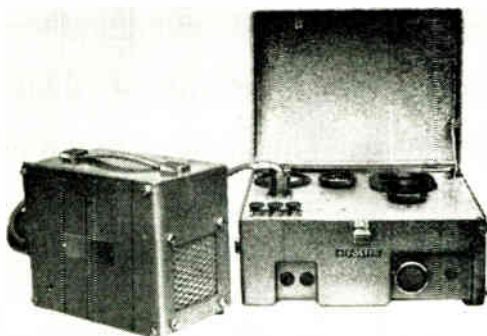
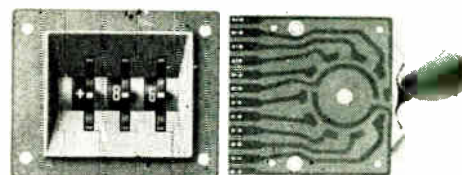

Foster Instruments are showing a number of instruments including this portable relative humidity and dry bulb temperature indicating outfit. It can be used as a recorder or a recording controller. At present it is available in the ranges 20 to 100% R.H., 10 to 40 °C and 30 to 100% R.H., 10 to 65 °C (87)

produced characters in less than 10 μ sec with a brightness that is adequate for daylight viewing.

More To Be Seen

In what has gone before it has been possible to group items in a logical form. However, many more products are to be seen at the show and in this final section a number are described.

A morse-code automatic-keying device (84) is featured by Barr and Stroud. This has been developed to key automatically a short predetermined morse-code message. In its present form it is intended for distress signalling. It can be modified for other applications. A very high order of reliability is attained by the use of semiconductors and ferrite cores. Battery operated, it is capable of signal generation for a matter of weeks. The

duration of message sequence in the prototype is approximately 2 min at a nominal speed of six words per minute. It measures 4 \times 9 \times 10 cm.

Silicon controlled rectifier (thyristor) units (88) for industry are the latest development by Teledictor. Each unit comprises a transformer to suit the incoming voltage and load rating, a drive module and the appropriate thyristor (s.c.r.). Power output of the rectifier is determined by the setting of the drive module which triggers off the rectifier at any conduction-angle value of 0 to 180° over the half-cycle. Half- or full-wave rectification of single- or three-phase a.c. inputs can be provided for d.c. outputs of up to 100 A at 250 V.

Royce Electric Furnaces also feature an application of thyristors (s.c.r.s) in their diffusion furnaces (89). As an example of their performance—a

solid diffusion furnace controlled at 1,230 °C reaches temperature in 2½ hr and provides a thermal flat zone of 14 in. having a temperature uniformity of ±1 °C. In 8 hr from switching on, this flat zone is extended to 20 in. and in 24 hr to 23 in. Throughout a test period of 100 hr the temperature remained stable within ±1 °C.

No matter what the purists say, computers are to the majority synonymous with automation. They cannot, therefore, be ignored here since they represent a large proportion of the show and, certainly, cover more floor

space than any other group of products.

Large, medium and small computers are all there to be seen and to be played with—both analogue and digital systems. One demonstrates the optimization of production. Another demonstration links together a series of computers which will not only control mechanical work of the factory floor but also takes over much of the managerial work. Processing of orders and replacement of stock is included.

On the A.E.I. stand anyone will have a chance to be a steelmill controller for five minutes. Visitors will be

able to feed information into the A.E.I. prototype 959 (90) digital computer, collect the computer's print-out calculations and see how such control reduces steel wastage.

Once every two years this exhibition provides an opportunity to see all that is new in instruments, electronics and automation. Since the last show in 1962 a great deal of development in these fields has taken place and so there is much to see and much to enjoy.

For further information about specific items circle the appropriate number, shown in brackets in this report, on the Service Card

'Home-Made' Transistor Signal Source

Though equipped with the most modern test gear, engineers at Pye Telecommunications factory at Cambridge have found that a simple transistor signal source greatly aids the checking of radiotelephones.

This is basically the well-known two-transistor multivibrator built into a pen torch case with a 1½-V battery by the engineers themselves, at a cost of about 16s. The resultant output is a square-wave signal of 0.5 V peak-to-peak at 1 kc/s. The output signal is rich in harmonics and therefore provides components up to about 500 kc/s. Thus with some experience this low-cost signal source can be used to indicate faults quickly in audio and r.f. circuits.

An engineer is seen here using the transistor signal source to check a 'Cambridge' radiotelephone

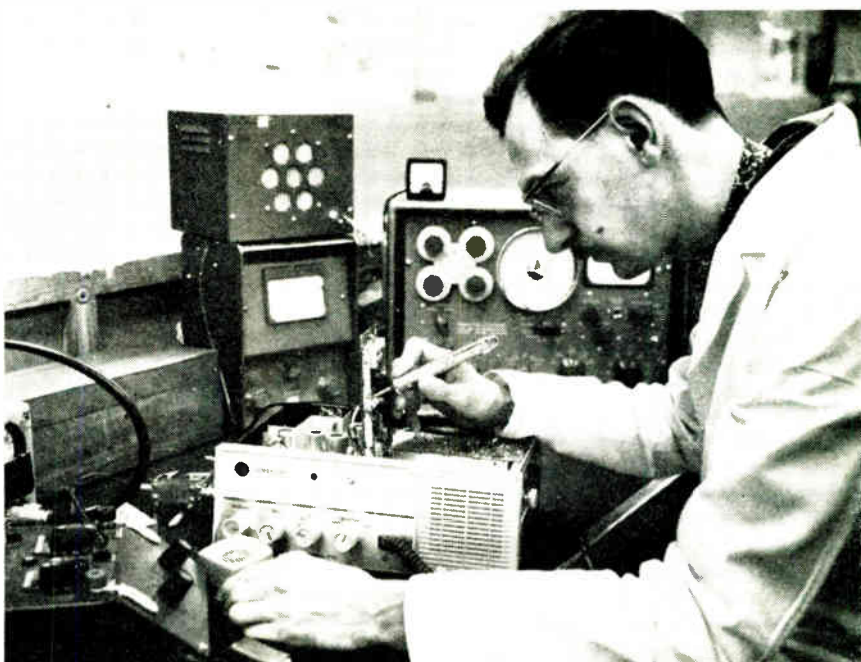

A close-up of the complete device

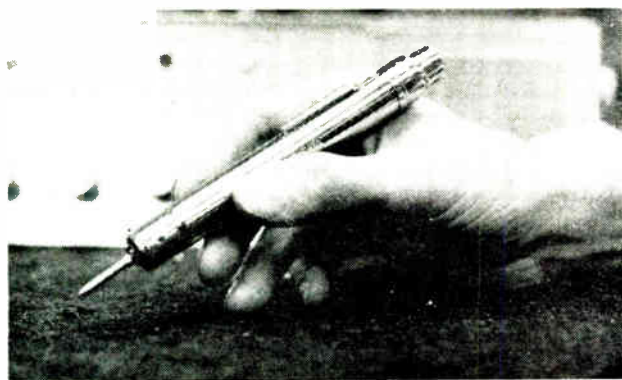

The circuit for the 'home-made' transistorized signal source

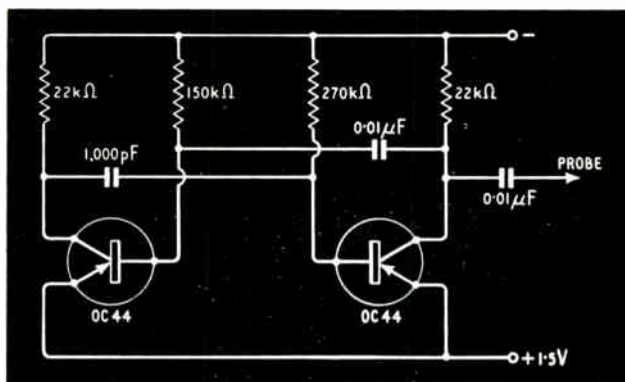

TRANSISTOR OPERATING CONDITIONS-3

Continuing the discussion of the effects of temperature upon a transistor circuit, this article deals with the most useful practical circuit for minimizing these effects. It is considered in some detail and simple relations for determining circuit values are given.

By W. TUSTING

REASONS were given in the previous article for the choice of a particular bias circuit as being the most generally useful. This circuit is repeated here as Fig. 1(a) and at (b) is given its equivalent circuit. The elements R_b and E_{bb} can be used as such, but in practice E_{bb} is usually derived from E_{cc} through a potential divider R_1, R_2 . Transposition between the two forms is easy, for

$$E_{bb} = E_{cc} \frac{R_2}{R_1 + R_2} \quad (1)$$

$$R_b = \frac{R_1 R_2}{R_1 + R_2}$$

and conversely,

$$R_1 = R_b \frac{E_{cc}}{E_{bb}} \quad (2)$$

$$R_2 = R_b \frac{E_{cc}}{E_{cc} - E_{bb}}$$

From Fig. 1(b) we can write the two basic equations and then a little algebra gives us

$$I_c = \frac{\alpha' (E_{bb} - V_o) + I_{co}(R_b + R_e)}{R_e + R_b/(1 + \alpha')} \quad (3)$$

$$= S \left[\frac{(E_{bb} - V_o)}{R_e + R_b} + I_{co} \right] \quad (4)$$

where

$$S = \frac{R_b + R_e}{R_e + R_b/(1 + \alpha')} \quad (5)$$

The term $\alpha'/(1 + \alpha') = \alpha$ is omitted because it is usually

negligibly different from unity. Few transistors will have α' less than 30 and $30/31 = 0.966$.

The term S is a stability factor which equals $(1 + \alpha')$ if R_e is zero, and tends to unity if R_b becomes very small. The effect of I_{co} is a minimum if $S = 1$ and a maximum if $S = 1 + \alpha'$. In practice it is usually hard to make S less than 5; usually, S lies between 5 and 10. It will generally be necessary to start a design with an arbitrary choice of S . An arbitrary choice of R_e is also usually necessary, then all the other component values follow from re-arrangements of the other equations.

$$R_b = R_e \frac{S - 1}{1 - S/(1 + \alpha')} \quad (6)$$

$$E_{bb} = (I_c/S - I_{co})(R_e + R_b) + V_o \quad (7)$$

As an example, let $S = 6$, $I_{co} = 5 \mu\text{A}$, $I_c = 1 \text{ mA}$, $E_{cc} = 4.5 \text{ V}$, $V_o = 0.15 \text{ V}$, $\alpha' = 50$ and $R_e = 1 \text{ k}\Omega$. Then

$$R_b = 1 \times \frac{5}{1 - 5/51} = 5.54 \text{ k}\Omega$$

$$E_{bb} = (1/6 - 0.03)(6.54) + 0.15 = 1.22 \text{ V}$$

$$R_1 = 5.54 \times 4.5/1.22 = 20.45 \text{ k}\Omega$$

$$R_2 = 5.54 \times 4.5/3.28 = 7.6 \text{ k}\Omega$$

If the temperature rises from 25°C to 55°C , I_{co} becomes $40 \mu\text{A}$, which is an increase of $35 \mu\text{A}$. The increase of I_c will be S times this, or $210 \mu\text{A} = 0.21 \text{ mA}$, which is not at all unreasonable.

The choice of R_c must be made on collector-circuit considerations. There is a drop of $I_c R_c + I_e R_e \approx I_c (R_c + R_e)$ across the resistances. So the collector-emitter voltage V_{ce} is E_{cc} less this. If $R_c = 2 \text{ k}\Omega$ with $R_e = 1 \text{ k}\Omega$ there is a drop of 3 V at 1 mA , leaving 1.5 V for V_{ce} , which is not unreasonable. At high temperature with $I_c = 1.21 \text{ mA}$ the drop becomes 3.63 V and V_{ce} is only 0.87 V . This is small, but not unduly so for an amplifier which must handle small signals only.

There is no suggestion here that the above example is an optimum one by any means. It is chosen merely to show how simple it is to calculate component values, and the order of stability achievable.

As an illustration of the sort of accuracy obtainable with the method a comparison is given in Table 1 between calculated figures and those of a transistor manufacturer. The circuit is that of Fig. 1(a) and the first three columns give E_{cc} , R_1 and I_c from the maker's data for the OC71. The remaining columns show the details of the calculation. The final

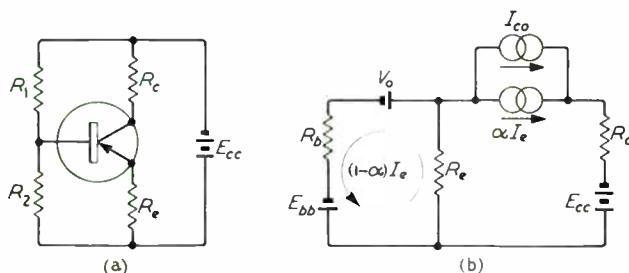

Fig. 1. The circuit considered is shown at (a) and its equivalent at (b)

column shows the difference between the calculated and maker's figures for collector current, expressed as a percentage.

This assumes that the maker's figures are right, but it is improbable that I_c is exactly either 1 mA or 1.5 mA. The voltage and resistance values are all expressed in whole numbers and it is exceedingly unlikely that the dependent quantity current would also come out so neatly. In all probability the real current figures have been rounded off. In any case, the results show that the method of calculation is a reasonably accurate one.

Collector circuit conditions have been mentioned briefly. In practice it is necessary to go into them much more thoroughly, because it is in their effect upon the collector conditions that variations of collector current, however caused, are so important. Although everything can be done algebraically the equations get complicated and it is simpler to use a graphical method. It is not only simpler to do so, but it gives a better picture of what is happening.

The graphical method is basically the old one of drawing load lines upon the device characteristics. It differs because for our purposes we do not need the transistor characteristics! At least, we do not need a full set of collector-volts-collector-current curves. We need only some limiting conditions.

The first of these is the minimum permissible collector-emitter voltage $V_{ce\ min}$. This is about 0.2 V for most small germanium transistors and we shall take it here to be 0.25 V. The second limit is the minimum permissible collector current. At some low temperature I_{co} is very small and the limit then is with I_c nearly zero. At high temperature, it is a little more than SI_{co} for that temperature.

It might be thought that the limit should be at I_{co} , not SI_{co} , because of this current only I_{co} flows directly from the base; the remainder $(S - 1)I_{co}$ flows from the emitter and is due to I_{co} in the base circuit altering the base bias. It is true that at this current the emitter may be far from current cut-off, but the current is not available for signal handling. It must be reserved for temperature changes.

A third limit is to peak current and a fourth to peak voltage, while collector dissipation sets a fifth.

Fig. 2 shows a general sketch of a diagram having all these limits marked in. Operation must be confined within the clear area bounded by the $V_{ce\ min}$, $I_c\ peak$, P_c , $V_{ce\ peak}$ and SI_{co} lines. All these limits except SI_{co} come from the maker's data. They are limits on the use of a particular transistor. Sometimes $V_{ce\ peak}$ must be reduced if R_b is large and of

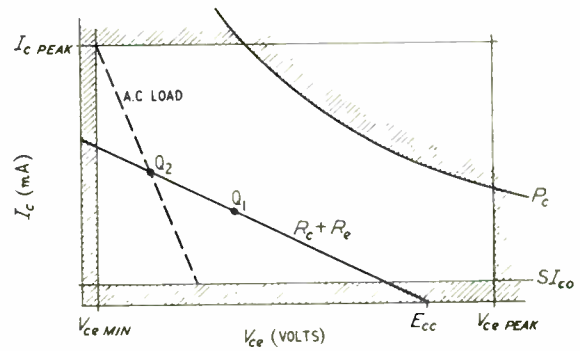

Fig. 2. General form of diagram showing the limits to collector current and voltage set by the various transistor ratings

course P_c must be plotted for the maximum operating temperature. Similarly, I_{co} must be for the maximum temperature. The value of S , and hence of SI_{co} , is under the control of the designer, so that a choice of value for S must be made before SI_{co} can be drawn in.

On this diagram a load line for $R_c + R_e$ is drawn in from the supply voltage E_{cc} . In doing this we are assuming that I_e is negligibly larger than I_c . The operating point must be somewhere along this line and if the a.c. and d.c. loads are the same it will usually be chosen mid-way between the current and voltage limits, for example, at the point Q_1 . For the load line drawn in Fig. 2 the other three limits are nowhere approached. With a lower-resistance load $I_c\ peak$ might set the left-hand limit instead of $V_{ce\ min}$. With one still lower P_c might set it.

As long as E_{cc} does not exceed $V_{ce\ peak}$ this last can be a limit only with an inductive load, and we are not considering that here.

When the a.c. and d.c. loads are unequal, an a.c. load line must be drawn through the operating point. If R_e is by-passed for signal frequencies the a.c. load line for Fig. 1(a) will be R_c . If another resistance is fed from the collector through a capacitor it will be this resistance in shunt with R_c .

The operating point will then be chosen so that equal current swings about the operating point are possible along the a.c. line. This will usually mean that this point is at a higher current than in the case of only a d.c. load. Thus in Fig. 2, for a purely d.c. load one would bias the base so that the operating point is at Q_1 , but for an a.c. load as shown dotted, one would bias at about Q_2 .

Having chosen the operating point, one knows I_c and can use the earlier equations to determine R_1 and R_2 . As temperature falls, SI_{co} drops and the operating points move to the right along the d.c. load line by the same amount. The a.c. load line moves with it, but the permissible negative peak current is unchanged, for the SI_{co} line has moved by the same amount as the operating point.

So far the effect of temperature on V_o has been ignored, beyond stating in Part 1 that it changes by about $-2.5\ mV/^\circ C$, then

$$V_o = V_o' - 0.0025(T - 25) \text{ volts.}$$

The variation of I_{co} with temperature, which has hitherto been expressed as doubling for each $10^\circ C$ rise of temperature, can also be put into the form of an equation. If I_{co}' is the value of I_{co} at $25^\circ C$, we have

$$I_{co} = I_{co}' \text{ antilog} \left(\frac{T - 25}{33.3} \right)$$

To illustrate the effect of the variation of V_o , assume $\alpha' = 50$, $I_{co} = 10\ \mu A$ at $25^\circ C$, $R_e = 1\ k\Omega$ and $R_b = 6\ k\Omega$, so that $S = 6.25$. The results are shown in Fig. 3. The curve

TABLE I

E_{cc} (V)	R_1 (k Ω)	I_c (mA)	E_{bb} (V)	$E_{bb} - V_o$ (V)	R_b (k Ω)	$R_b / (1 + \alpha')$ (k Ω)	$R_e + R_b / (1 + \alpha')$ (k Ω)
6	39	1	1.225	1.075	7.95	0.165	1.165
6	22	1.5	1.875	1.725	6.87	0.145	1.145
9	62	1	1.25	1.1	8.6	0.179	1.179
9	39	1.5	1.835	1.685	7.95	0.165	1.165
12	82	1	1.305	1.555	8.92	0.186	1.186
12	56	1.5	1.82	1.67	8.47	0.177	1.177

E_{cc} (V)	$R_e + R_b$ (k Ω)	S	$S \frac{E_{bb} - V_o}{R_e + R_b}$ (mA)	SI_{co} (mA)	I_c (mA)	Difference (%)
6	8.95	7.67	0.922	0.0345	0.9565	-4.35
6	7.87	6.87	1.505	0.031	1.536	+2.4
9	9.6	8.14	0.935	0.0366	0.9716	-2.84
9	8.95	7.7	1.447	0.0346	1.4816	-1.23
12	9.92	8.35	0.975	0.0376	1.0126	+1.26
12	9.47	8.05	1.42	0.0362	1.4562	-2.91

For $R_e = 1\ k\Omega$, $R_2 = 10\ k\Omega$, $\alpha' = 47$, $I_{co} = 4.5\ \mu A$, $V_o = 0.15\ V$

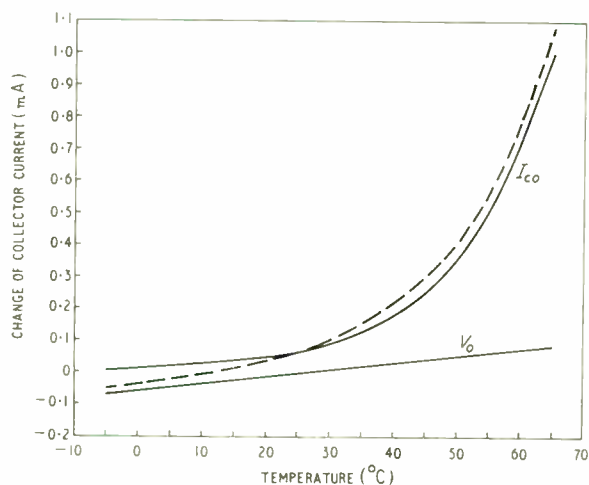

Fig. 3. For particular circuit values, the curves show the change of collector current due to the variation with temperature of I_{co} and V_o . The dotted curve shows the total effect

labelled I_{co} shows the change of collector current with temperature which is due to the variation of I_{co} , while that labelled V_o gives the change due to variations of V_o . The total change of I_c due to both causes is indicated by the dotted curve. It is plain that the effect of I_{co} predominates at high temperatures and that of V_o is much the greater at low temperatures. At 65 °C, the effect of the change of V_o is only about 8% of that of I_{co} . This is small enough to ignore in comparison. At -5 °C, it is I_{co} which is negligible. However, the magnitude of the change of I_c due to V_o is only -0.044 mA and in the type of amplifier that we are considering this is negligible in

comparison with the main part of the collector current, which will usually be at least 1 mA.

Generally speaking, therefore, it is justifiable to ignore the changes of V_o with temperature and to treat the temperature as affecting only I_{co} . There may, however, be special cases where it is necessary to take into account the effect on V_o .

The stabilizing circuit does not directly affect variations of I_c due to changes of V_o , but indirectly it can do so. From equation (3) it is clear that the collector current is proportional to $E_{bb} - V_o$. The effect of changes of V_o can be reduced by making E_{bb} large in comparison. For the same current R_c and R_b must then be proportionately increased and S remains unchanged. Then E_{cc} must be increased because of the greater voltage drop across R_c .

As an example, consider the earlier one for which we had $S = 6$, $I_{co} = 5 \mu\text{A}$, $I_c = 1 \text{ mA}$, $E_{cc} = 4.5 \text{ V}$, $V_o = 0.15 \text{ V}$, $\alpha' = 50$, $R_c = 1 \text{ k}\Omega$, $R_b = 5.54 \text{ k}\Omega$, $E_{bb} = 1.22 \text{ V}$.

Let us suppose now that $V_o' = 0.15 \text{ V}$ at 25 °C and T varies from 0 to 55 °C. Then the variation is from

$$V_o = 0.15 + 0.0025 \cdot 25 = 0.15 + 0.0625 = 0.2125 \text{ V}$$

$$V_o = 0.15 - 0.0025 \cdot 30 = 0.15 - 0.075 = 0.075 \text{ V}$$

So $E_{bb} - V_o$ ranges from $1.22 - 0.2125 = 1.0075 \text{ V}$ to $1.22 - 0.075 = 1.145 \text{ V}$ whereas the nominal value is $1.22 - 0.15 = 1.07 \text{ V}$. The variation is from -0.0625 to -1.075 V, or -5.85% to -7%. The percentage change of collector current will be the same.

If we increase E_{bb} to 3 V, then $E_{bb} - V_o$ will be nominally 2.85 V and it will change by -0.0625 V at 0 °C to +0.075 V at 55 °C. The percentage changes will be -2.2% to +2.63%. Since $E_{bb} - V_o$ is $2.85/1.07 = 2.66$ times its previous value, both R_c and R_b must be multiplied by this factor to become 2.66 k Ω and 14.5 k Ω respectively. Previously $I_c R_c$ was 1 V, now it is 2.66 V, consequently E_{cc} must be increased by 1.66 V to 6.16 V for the other conditions to be unchanged.

Data Logger Monitors Car Body Finishing Temperatures

At the new Linwood, Paisley, plant of Pressed Steel Co., Hillman Imp car bodies are phosphated, painted and trimmed before being delivered by an enclosed overhead conveyor to the adjoining factory of Rootes.

This illustrates the compactness of the data logger



Honeywell Controls have supplied a data logger which, in conjunction with industrial control devices, provides a centralized record of temperatures on the cleaning, phosphating and paint finishing plant.

This temperature monitoring system comprises a standard 60-point data logger built to customer requirement as a compact console desk overlooking the paint finishing plant. Controls on the desk allow the operator to initiate a log cycle of all inputs and these are recorded at a speed of one point per second by an electric typewriter across one line of a pre-printed log sheet. There is a built-in facility for automatic initiation of the log cycle at pre-set intervals.

As an alarm facility, any temperatures which are outside pre-set limits are recorded in red. In between log cycles the operator can select any input channel for individual display on the desk in digital form.

This centralized monitoring system, which replaces the conventional method of recording variables on individual instruments located at source, is based on modules from the Honeywell series 3000 data acquisition system, which can provide data logging, alarm scanning and visual digital indication with computing functions.

The system is accurate to 0.01 per cent of reading, or one digit, whichever is greater, and operates without the need for special air conditioning.

For further information circle 92 on Service Card



INSTRUMENTATION SERVICE TO INDUSTRY

10 DAYS DELIVERY

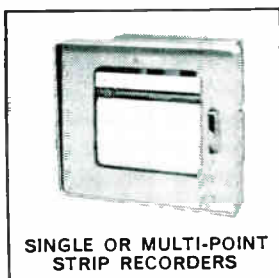

SINGLE OR MULTI-POINT STRIP RECORDERS

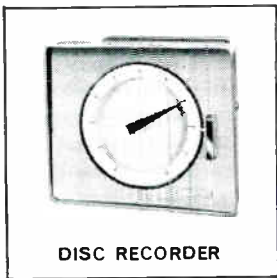

DISC RECORDER

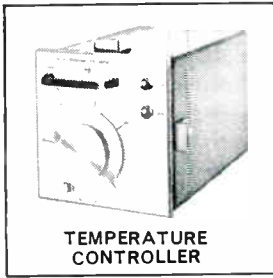

TEMPERATURE CONTROLLER

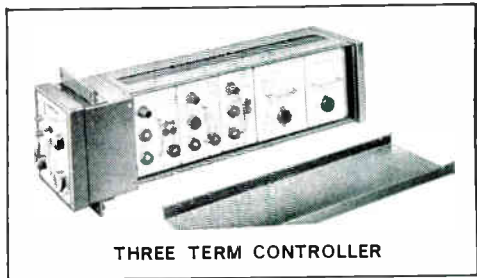

THREE TERM CONTROLLER

Visit us at the I.E.A. Exhibition, Stand G122, Grand Hall, Olympia May 25-30

For instrumentation problems that cannot wait LDEP have made it possible for a competitive range of instruments to be available on a 10 day delivery.

Full information on the range of single and multi-point strip and disc chart recorders, temperature controllers and three-term controllers is available simply by contacting Control and Instrumentation Division:-

**LANGASHIRE DYNAMO ELECTRONIC PRODUCTS LTD
RUGELEY, STAFFS. Tel: Rugeley 371**



'Triple Rating' means 3 sizes of metal oxide film resistors cover all standard applications

SIZE	SEMI PRECISION	HIGH STABILITY	GENERAL PURPOSE
 TR4	1/10 W	1/8 W	1/4 W
 TR5	1/8 W	1/4 W	1/2 W
 TR6	1/4 W	1/2 W	1 W
2000 hr. max. load life drift at 70°C ambient	= 0.5%	1%	2%

Electrosil

The Electrosil Triple Rated range offers extensive savings in stock, economy in bulk purchase and standardisation in design. Previous style references were as follows:—

TR4=CO7, TR5=NJ60 &—CJ20, TR6=NJ65 &—CJ32

Qualification Approval

The Triple Rated range is unique in that qualification approval has been given to TR5 and TR6 in both the semi precision and general purpose categories. Approval status is as follows:

Electrosil Style	DLF. 5114A Style	Rating in Watts 70 C.	Tolerance	Ohmic Range
TR5 (NJ60)	RO3 E	1/8	1%	68 Ohms - 120K
TR6 (NJ65)	RO3-D	1/4	1%	68 Ohms - 470K
TR5 (CJ20)	RO2-C	1/2	5%	22 Ohms - 470K
TR6 (CJ32)	RO2-B	1	5%	33 Ohms - 1 Megohm



PALLION, SUNDERLAND, CO. DURHAM Tel: Sunderland 71557 · Telex 53273

RI

OFFICIAL DISTRIBUTORS: Stewart Aeronautical Supply Company Ltd, Gatwick Road, Crawley, Sussex. Phone: Crawley 28700 (10 lines)

Townsend-Coates Ltd, Coleman Road, Leicester. Phone: Leicester 68661 (5 lines)

Continuing the discussion of digital techniques, this article describes a very simple static-switching system and basic counting techniques as a lead-in to the full-scale applications to follow.

DIGITAL TECHNIQUES IN INDUSTRY – 2

By G. COOPER*

THE previous article developed the concept of simple electronic circuits working in an ON/OFF ('1' and '0') mode to reproduce the logic functions to which switching systems can be reduced. The first article also described the representation of numerical information in digital form and very briefly touched on its arithmetic manipulation. Subsequent articles will describe practical systems using the techniques described, and the purpose of the present article is to bridge the gap between logic element and full-scale equipment by demonstrating how the basic elements are brought together to form simple systems and sub-systems which are themselves grouped together to form complete installations.

As indicated in the introduction, the main uses of logic elements can be broadly divided into logical systems (for example sequencing and interlocking) and numerical systems (position controls, counters, and data handling in general). A small static-switching system is the simplest example of the grouping of logic units to carry out a practical task, and the static-switching system described here, for the control of a very simple injection-moulding machine, illustrates most of the basic principles.

Static-Switching Scheme

The controlled motions of an injection-moulding machine reduce schematically to two rams, the main ram and the injector ram, as shown in Fig. 1. These are both double-acting air-cylinders, controlled by single-acting spring-return electro-pneumatic solenoid valves which are energized to advance the rams, de-energized to return them.

The main ram position is sensed by limit switches LS_1

and LS_2 , and the injector ram by limit switches LS_3 and LS_4 . These limit switches can be of conventional patterns, but it is good practice to use proximity limit switches with static-switching systems. The example shown in the photograph is of a permanent-magnet bridge type. The presence of ferrous metal near the operating face unbalances the bridge, and the resultant out-of-balance flux is detected by its effect on the magnetization characteristics of a toroidal nickel-iron core which forms part of the centre limb of the bridge. The effect is detected, amplified and 'squared' into the ON/OFF signal ('1' = -10 V d.c., '0' = 0 V d.c.) used in the digital system, by a sub-unit whose output stage is formed by the transistor trigger amplifier described in the last article.

A fifth similar proximity switch (not shown in the diagram) is used to prove that the machine guard is in the safe closed position.

The operation cycle is as follows:

1. When the 'start' pushbutton is pressed, the main ram moves forward and closes the die.
2. When LS_2 signals that the die is closed, the injector ram injects the required quantity of material as it moves forward to a mechanical stop.
3. When LS_3 signals that the injection is complete, a freeze delay (adjustable to up to 40 sec duration) starts, and at the end of the delay the injector ram is withdrawn to allow it to refill with, and preheat, a new charge of material.
4. After a further cooling delay (also adjustable up to 40 sec) the main ram is retracted and the completed moulding ejected mechanically.
5. With the rams back on LS_1 and LS_4 respectively, the

*Lancashire Dynamo Electronic Products Ltd.



(Left) Permanent-magnet bridge-type proximity switch (Brookhirst Igranic)

(Below) Fig. 1. Diagrammatic layout of injection moulding machine motions

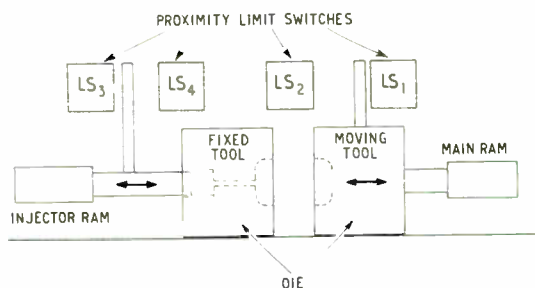

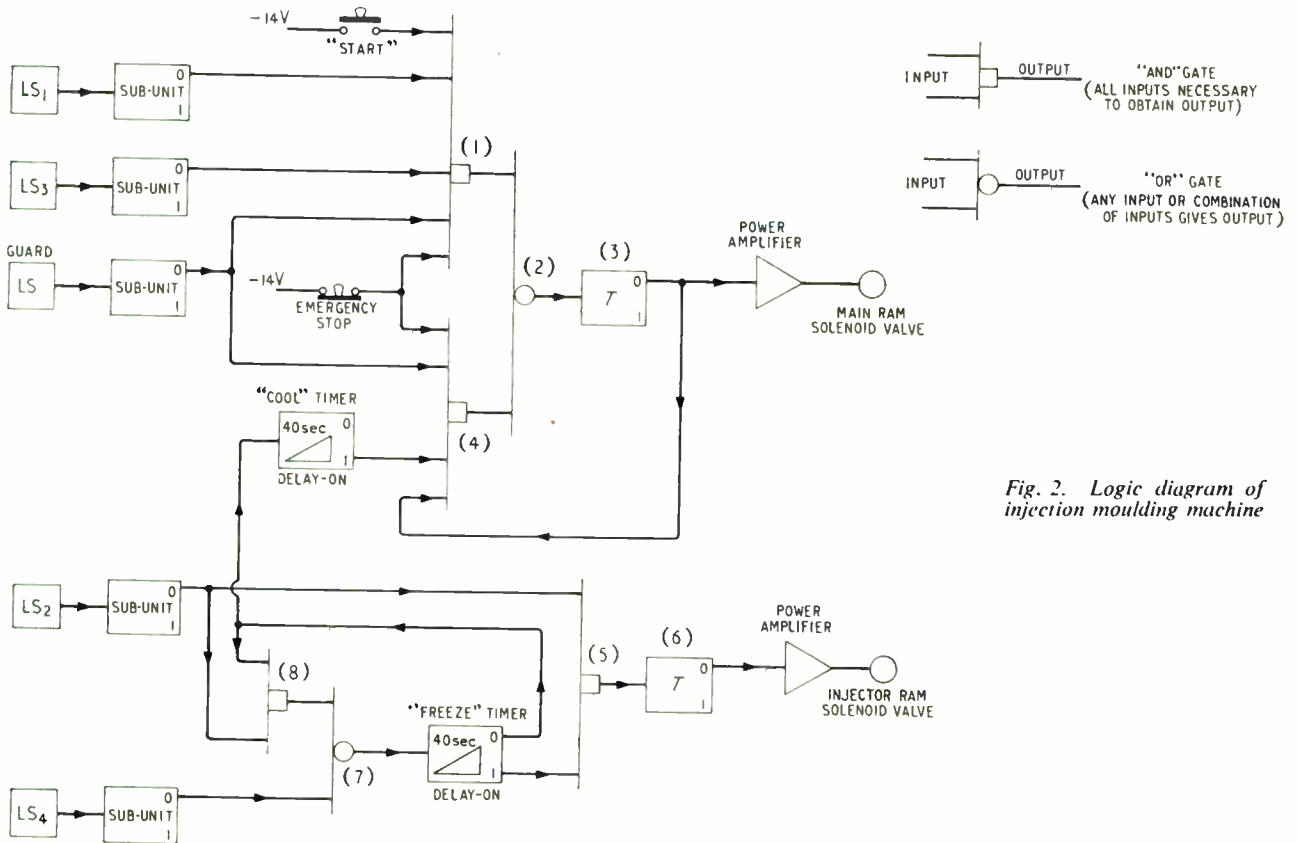

Fig. 2. Logic diagram of injection moulding machine

cycle can now be restarted by pressing the 'start' button. 6. In addition to this cycle, pressing the emergency-stop button or opening the guard must at all times retract the main ram and open the die.

Fig. 2 shows the logic scheme to perform this simple cycle. In the starting condition LS_1 and LS_2 are operated. The guard is closed, and the emergency stop button is not pressed.

It must be remembered that the outputs of the various units shown in Fig. 2 are those in their quiescent condition. Thus, for example, the sub-unit connected to LS_1 gives outputs of '0' and '1' at its two output terminals when LS_1 is in its quiescent open condition. When LS_1 closes, the outputs of the sub-unit change over to '1' and '0'. As only the output from the quiescent '0' terminal is used in this instance, what happens is that the sub-unit gives '0' output (i.e., zero volts) when LS_1 is open and a '1' output (i.e., -10 V) when LS_1 is closed.

Initially, before the 'start' button is pressed LS_1 is closed because the main ram is to the right in Fig. 1. Similarly LS_3 is closed because the injector ram is to the left. The guard LS and the emergency stop are also closed. Thus, the sub-units attached to LS_1 , LS_3 and the guard LS all give '1' outputs (i.e., -10 V).

Therefore, when the 'start' button is pressed, all the inputs of AND gate (1) are present, and an output appears. This output energizes trigger amplifier (3) via OR gate (2) and energizes the power amplifier controlling the main ram solenoid. The output of AND (1) is a '1' as is also the output of OR (2), so the trigger output changes from '0' to '1'. The main ram now starts to move forward, breaking

LS_1 , hence removing one input (and therefore the output) from AND gate (1). To prevent this action bringing the advance of the main ram to an untimely halt, the instruction to advance must be remembered (c.f. a self-maintaining contact in a relay system). This is done via AND gate (4), whose inputs are completed when trigger (3) becomes energized, feeding the output from its '0' terminal (which is now '1') back to AND gate (4). The output of AND gate (4) therefore maintains the energization of the main ram solenoid, even when the output of AND gate (1) has disappeared due to the breaking of LS_1 or the release of the start button.

Note, however, that pressing the emergency stop push-button or opening the guard removes inputs from both AND gate (1) and AND gate (4), and de-energizes the main ram solenoid whatever the limit switch or start pushbutton positions. The safety interlocks, therefore, are completely overriding.

The advance of the main ram now operates LS_2 , which, since the 'freeze' timer is not energized, completes the inputs to AND gate (5) and hence via trigger (6) initiates the advance of the injector ram.

The injector ram operates LS_4 at the end of its travel, applying an input to OR gate (7) and hence to the freeze timer. After the set time delay, the outputs of the freeze timer change over, the lower input of AND gate (5) is de-energized and the output of AND gate (5) disappears. The injector ram solenoid is therefore de-energized, and the ram retracts from LS_4 on to LS_3 .

The '0' output (which is, of course, now a '1') of the freeze timer, which appears at the end of the freeze delay,

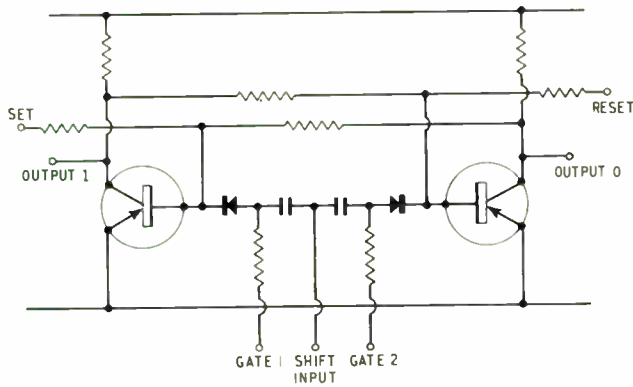
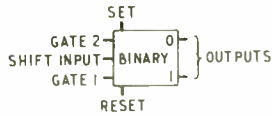
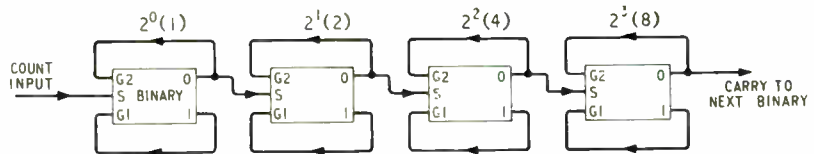

Fig. 3. Binary circuit and symbol

COUNT INPUTS	2^3	2^2	2^1	2^0
0	0	0	0	0
1	0	0	0	1
2	0	0	1	0
3	0	0	1	1
4	0	1	0	0
5	0	1	0	1
6	0	1	1	0
7	0	1	1	1
8	1	0	0	0
9	1	0	0	1
10	1	0	1	0
11	1	0	1	1
		etc		

Fig. 5. Table of binary counter states

Fig. 4. 4 digit binary counter



is fed to the input of the cool timer, which now starts to time out. It is essential that the input to the cool timer is maintained throughout its timing period, and therefore a memory must be used to prevent the freeze timer resetting when the injector ram starts to retract, and de-energizes LS_4 .

This is achieved by feeding back the '0' output of the freeze timer to an input of AND gate (8). Since at this stage of the cycle the main ram is still fully forward, LS_2 is operated, and AND gate (8) will generate an output which will maintain the input to the freeze timer via OR gate (7) even after LS_4 has de-energized. The cool timer now times out, and its output '1' disappears. AND gate (1) also is generating no output (since LS_1 is not operated, if for no other reason) and the main ram memory circuit now 'unlatches', and the main ram starts to retract. As it does so, it de-energizes LS_2 , which removes an input from AND gate (8), and 'unlatches' the freeze timer memory. The freeze timer now resets and in its turn resets the cool timer. Thus, when the retraction of the main ram is complete, the machine and control system are both back in the starting condition, and the cycle can be re-initiated by pressing the 'start' button.

This simple system has been described in some detail so as to show how all the commonly-encountered relay system features such as process timers, self-maintained outputs, overriding interlocks, etc., are reflected in a logic system.

To give an idea of scale, the system described, including the units associated with the proximity switches, would use seven standard plug-in logic units, occupying a panel area of about 8 in. square by 9 in. deep. In fact, unless factors

such as very bad ambient conditions were involved, it is not likely that such a simple control would be carried out in static switching.

The Binary Unit as a System Element

The introductory article described how numerical information can be expressed in digital form and discussed briefly how digital arithmetic can be carried out using AND/OR/TRIGGER networks. Since separate sets of logic elements are used for each digit, the manipulation of multi-digit numbers takes place in parallel, and a 12-digit parallel adder, to take an example, is no more complex than (and uses the same basic logic circuits as) the simple static-switching system described above. The essentially common feature in both static switching and parallel digital arithmetic is that all inputs respond to the d.c. level of the applied signal: no voltage='0' input, -6 V to -14 V d.c.='1' input.

Two of the basic logic functions described in the introductory article, the binary and the pulse units, are a.c. input coupled, and respond to changes of the input level, rather than the level itself. The use of the pulse unit in system work is straightforward, and will be apparent when it is encountered in the applications to be described in subsequent articles. The binary unit, which is very widely used in, and indeed central to, many of the applications, is a basically simple circuit capable of many variations of interconnection, not all of which are perhaps clear on inspection. It is appreciated that the binary is a very well-known circuit. Those familiar with the particular art may

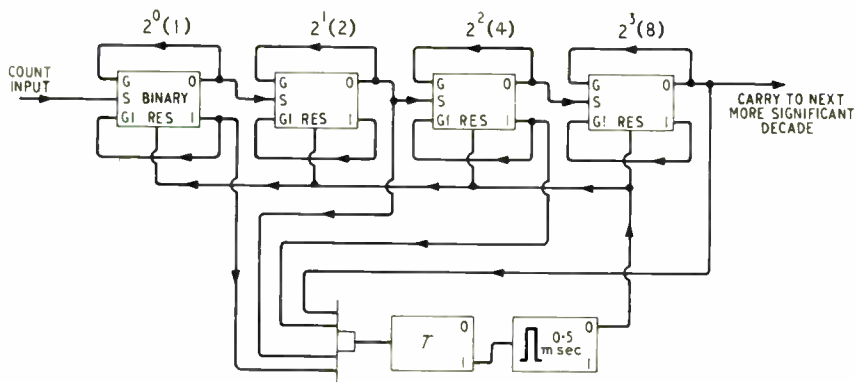

Fig. 6. Scale of 10 counter

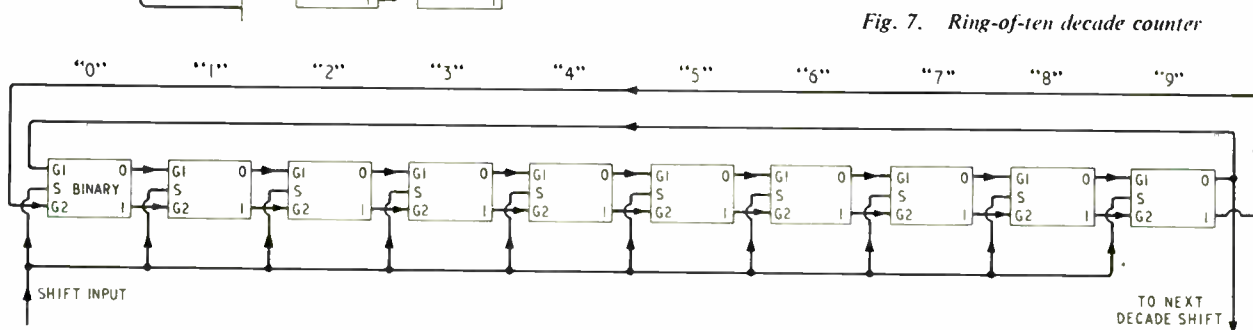

Fig. 7. Ring-of-ten decade counter

rest assured that the following sections on basic binary counters and registers contain nothing particularly novel, and may therefore skip them with an easy mind. Nevertheless the notes may be found useful if only for the sake of ensuring clarity of terminology in the subsequent descriptions of complete systems.

A reasonably detailed description of the binary circuit was given in the earlier article, and the reader is referred back to this.

For completeness, however, the binary circuit diagrams and symbol are shown in Fig. 3, and the following list of input/output relationships describes the circuit's capabilities:—

1. A '1' signal applied to the RESET input resets the binary to the 'off' state ($0/P=0$). In the absence of other signals, the binary will remain reset after the signal is removed.
2. A '1' signal applied to the SET input sets the binary to the 'on' state ($0/P=1$). In the absence of other signals the binary will remain set after the signal is removed.
3. The function of the shift input is to provide a 'turning-off' pulse to the bases of the two transistors making up the binary. A 6-V positive-going step on the shift input is required to do this. The function of the two gate inputs associated with the shift input is to route the 'turning-off' pulse to one or other transistor. A gate input held at '1' prevents the turning-off pulse reaching the base of the transistor associated with it, and it therefore follows that at least one of the pairs of gate inputs must be held at '1' whenever a 'shift' input is applied, so that the pulse does not reach both bases. This would result in indeterminate action of the binary. The internal connections are such that when $G_1=1$, and $G_2=0$, the binary is set by a shift signal, and when $G_1=0$ and $G_2=1$ it is reset. If the binary is already set or reset respectively, then the shift signal has no effect. A binary can have two (or more) sets of shift and

gate inputs, and in fact the binary circuit actually used in all subsequent applications is equipped as standard with two sets. It is important to note that when a binary has two sets of shift gate inputs, the action of a particular shift input is controlled only by its own gates, and is quite unaffected by the state of the gates associated with the second shift input.

Counting in the Binary Scale

The simplest application of binary units is to form a binary (scale of 2) counter. Fig. 4 shows the arrangement of the first four units of such a counter.

Consider the binary marked 2^0 . The gate inputs are fed back from the '0' and '1' outputs so that when the binary is in the reset state $G_1=1$, $G_2=0$. The first shift signal fed in from the count input will therefore set the binary. The gates will now, of course, change to the $G_1=0$, $G_2=1$ condition, as the outputs change over, and the next 'count input' will reset the binary. This cycle of set, reset will be repeated for successive 'count input' signals.

As the 2^0 binary resets, the '0' output goes from a negative potential ('1') to earth ('0'). This is, of course, a 'positive-going step', and therefore applies a shift edge to second binary, 2^1 . The gates of this binary are connected similarly to those of the 2^0 binary, and the 2^1 binary therefore sets.

The 2^1 binary will reset on the next reset of the 2^0 binary (on the fourth count input), setting the 2^2 binary, and this action will be repeated for successive binaries in the chain as more count inputs are applied.

The states of the binaries against total number of count inputs applied is shown in the table, Fig. 5, and it will be clearly seen that they represent the total number of count inputs in the binary scale (scale of 2). The number of binaries forming the counter can be extended to permit any desired number of inputs to be totalized, at repetition rates of from very slow up to several thousand counts per second.

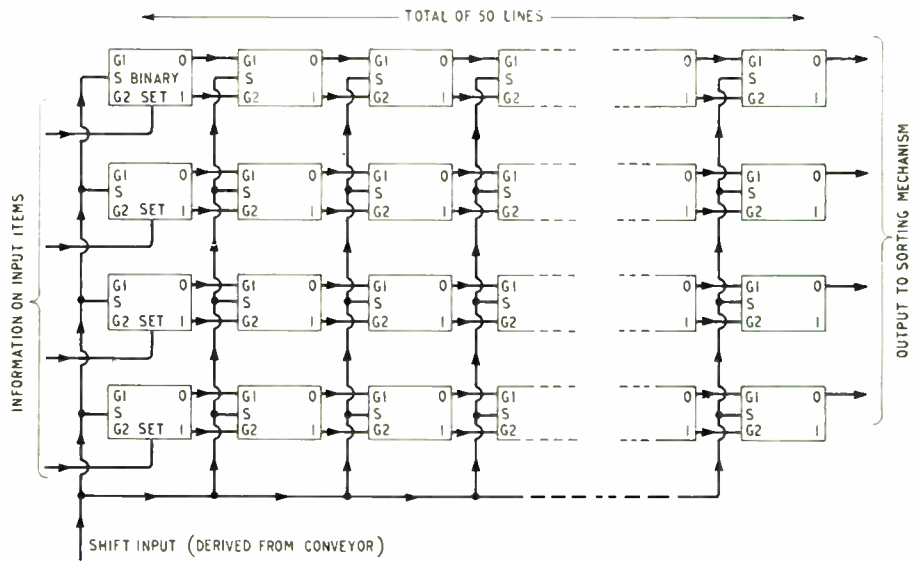

Fig. 8. Typical shift register

The binary counter described is of the 'count-up' form, since it starts at zero and increases in content with applied counts inputs. A useful variation is the 'count-down' counter, which is often used in pre-set counting applications. Here the binaries forming the counter are individually set and reset (usually by a pulse applied through switches on to their d.c. set and reset inputs) to the required number. The shift input to each succeeding binary is taken from the '1' output instead of the '0' output of the preceding binary, but otherwise the connections are identical. Inspection will show that as count inputs are applied, the content of the counter now reduces, and eventually after the preset number of count inputs have been fed in, reaches zero. The zero condition is easily detected (by an AND gate fed from all the binary '1' outputs, for instance) and a signal generated to indicate that the preset number of counts has been received.

Counting in Non-Binary Scales

Counters working in other than binary scale are often required. For instance, counting in units, tens, hundreds (scale of ten); inches and feet, etc. For counting in scale of ten, the binary-decimal code is often used, where each decimal digit is *separately* coded into a 4-digit binary number. The four binaries counting the units are required to count normally from 0 (0000) to 9 (1001), then on the next count pulse reset to 0 (0000) (instead of counting on to 10 (1010)), and at the same time generate a count to the binaries counting tens.

This can be achieved by the arrangement shown in Fig. 6. The binaries are connected exactly as for a straight binary counter, but after the tenth count input, when the binary states are 1-0-1-0 (right to left), all the inputs of the AND gate are energized. The trigger '1' output therefore disappears, and the pulse unit generates an output. This pulse is fed to the d.c. reset inputs of all the binaries and instantaneously resets them to 0000, the state 1010 being

a transient one lasting only a few microseconds. The re-setting of the 2^3 binary feeds a count input to the first binary of the tens scale, which is connected in exactly the same manner.

There are simpler ways of scale-of-ten counting, one of which will be described in a later application article, but the above method illustrates the principle, and has the merit of being usable for any non-binary scale, e.g. dozens (for counting eggs) or fifties (for producing 1-sec signals from 50-c/s electricity mains).

Ring Counters and Shift Registers

In all the configurations described so far, the gates of each binary have been controlled by its own outputs. There is, however, an important group of applications in which the gates are controlled by other signals.

One important application in this category can be regarded as an extension of the previous discussion on counters. This is used when each count of, for example, a decade scale of counting is required to appear on a separate output line (i.e., ten states) each represented by a '1' signal on one of ten outputs. This need occurs when, for instance, a printer actuated by 10-digit solenoids, '0' to '9' is to be used to log the counter content. Some types of numerical display also require ten-line inputs.

The ten binaries shown in Fig. 7 are connected to perform the function of one decade of such a counter, in what is often called a 'ring of ten'.

The gates of each binary are controlled by the outputs of the binary to its left, and all the shift inputs are connected in parallel. The ten output states are defined by a single set state moving from the '0' position through to the '9' position on nine successive shift inputs. The set state returns to the '0' position on the tenth shift input feeding a shift to the next more significant decade as it does so.

The action can be seen by studying the response to a single shift input. If the counter is at, say, 3, then the fourth

binary from the left is set, and all the others are reset. Therefore, all binaries but the fifth have gates $G_1 = '0'$, $G_2 = '1'$, and on the next shift input these binaries will either reset (in the case of the 4th) or remain reset if already in this state (as in the case of the 1st, 2nd, 3rd, 6th, 7th, 8th, 9th and 10th).

The fifth binary on the other hand, has its gates at $G_1 = '1'$, $G_2 = '0'$ and will therefore set on the shift pulse. The shift pulse has had the effect of moving the single set state along by one binary, and has increased the counter content by one. Inspection will show that this action is repeated on successive shift pulses, the output stepping one to the right each time.

The shift register works on the same principle as the ring counter, except that the end is not closed back on the start. It can, in fact, probably be most simply thought of as an electronic information conveyor.

Consider a mechanical conveyor being used to convey a mixed string of items through a plant, and feeding an automatic sorting system at the far end. Clearly it is essential to know what items are on the conveyor and in what order they will arrive at the sorting mechanism, so that the divertors of the mechanism can be correctly set up.

If there are, for example, about twelve different types of items using the conveyor (different sizes of car tyres, or sacks of various animal feedstuffs), then the identity of a particular item can be expressed as a four-digit binary number. If the conveyor length is such that, using an automatic spacing

mechanism, it will carry up to 50 items in transit, then fifty four-digit binary numbers must be stored for later use by the sorting mechanism.

The shift register shown in Fig. 9 will perform the necessary information handling for such a hypothetical system.

When an item is loaded on to the conveyor, the left-hand line of the shift register is set to the appropriate code, e.g. 500 × 13 tyre, Code 9, 1001. When the conveyor has moved along one 'loading pitch', a shift pulse derived from a conveyor driven pulse-generator is fed in parallel to the shifts of all the binaries making up the register. The code is therefore now transferred to the second line from the left by exactly the same action as described for the ring counter. The information will move further along as the conveyor generates further shift pulses, and will arrive at the sorter at exactly the same time as the item it represents.

If at any time during the transit of the first item further items are loaded on to the conveyor, the information on these items will follow down the shift register at the correct spacing, and, at all times, items and information will arrive together at the sorter. The shift register has therefore formed an electrical equivalent of the mechanical conveyor.

The ring counter, binary decimal counter, binary counter and shift register are very much the basic 'tools of the trade' in building up many numerical systems, and reasonable familiarity with them will be found essential in order to follow easily the applications to be described from next month onwards.

New Semiconductor Test Sets

Aveley Electric have been appointed U.K. agents for a comprehensive range of semiconductor test sets which are produced by Fairchild Semiconductor, U.S.A.

The most comprehensive of the range is the series 250 which can be set up easily to measure up to 16 parameters of up to 16 different types of semiconductor. A patch-board on the front of the tester is provided for this and for a given type of transistor removal of one of the patch

plugs ensures that the parameter represented by the plug is ignored during the automatic testing sequence.

In addition, the sets of parameters to be tested are pre-set into the machine by plug-in units; these can also be changed to provide different test parameters.

The test sequence is completely automatic and fast—a 16-parameter test takes approximately 2 seconds.

For further information circle 93 on Service Card

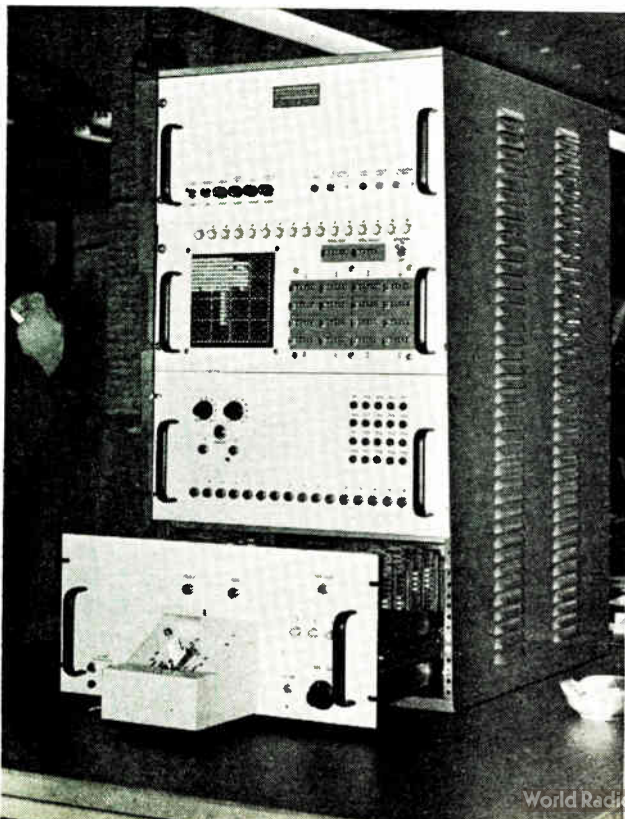

(Left) The complete tester

(Below) A close-up of the parameter patchboard

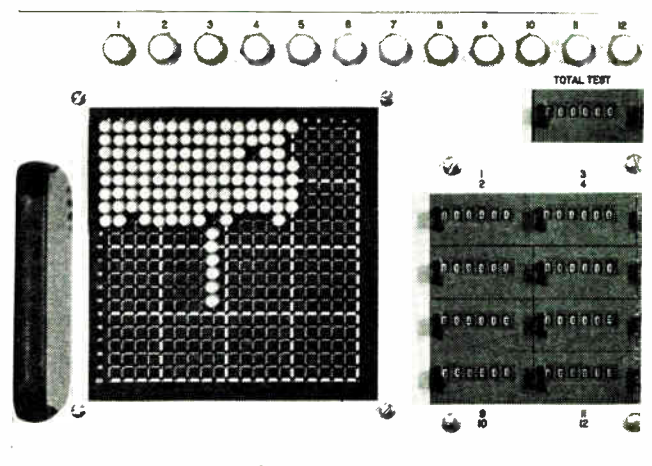

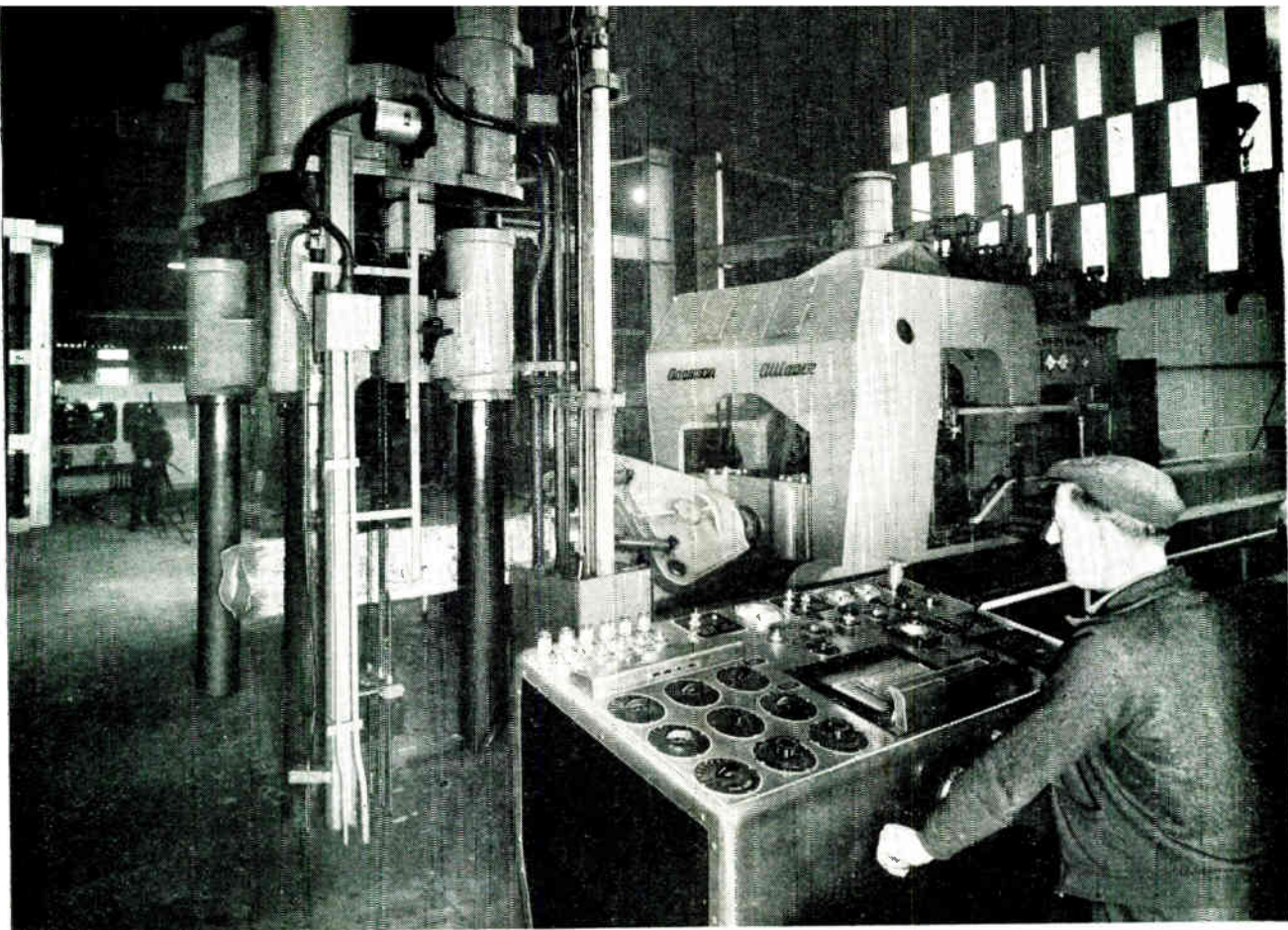

A view of the complete installation showing the control desk in the foreground and the press and manipulator in the background

ELECTRONICALLY CONTROLLED FORGING

AT the Ince Forge Works of Parks Forge, Wigan, a new high-speed forging manipulator has been installed, the movements of which can be integrated with those of the hydraulic press which it serves. It is believed to be the most advanced machine of its kind in production in Europe, and probably in the world.

With this manipulator the operator can not only carry out normal processes of manipulation but, by suitable pre-selection of the longitudinal movements and angles of rotation of the forging, parts of the forging process can be carried out semi-automatically.

The manipulator serves an 800-ton open-die forging press which has a direct hydraulic drive and electronic stroke and thickness control. The machine is capable of planishing at 120 strokes per min, and penetration rates up to 2 in. per sec are obtainable during forging.

The control desk is appended to the press control console, and has been designed so that one operator can work the two machines.

Manual control is by means of two joysticks, one for long travel and rotation, the other for hoisting, lowering and tilting.

Longitudinal movements of the manipulator can be integrated with the movement of the press crosshead. By means of a dial on the console it is possible to pre-select increments of longitudinal movement, which repeat automatically after each squeeze of the press, the upwards movement of the press crosshead initiating the manipulator travel. Thus, together with the thickness and stroke control available on the press, a complete pass can be made auto-

matically for plain sections or during cogging. At the end of a pass the raising of the press control handle stops the movement of both press and manipulator. The forging is then rotated, and the manipulator moved back to its starting position by manual control for the next pass.

Pre-selection of rotation can be obtained by another dial on the console, and by means of a push-button the manipulator will rotate through the pre-selected angle. By this means fast, accurate rotational positioning of the forging is achieved and square, hexagonal and octagonal sections can be made accurately.

'Rounding up' (i.e., making circular sections) can also be done semi-automatically. By throwing a switch on the console, the peel automatically rotates through $11\frac{1}{2}^\circ$ after each squeeze of the press.

Electronic Control System

The complete electronic control equipment for the automatic thickness control of the forging press and the operation of the manipulator is the manufacture of Lancashire Dynamo Electronic Products.

The automatic thickness control comprises fully transistorized plug-in standard digital units. The control system employs a digitizer which is mounted on the fixed crosshead of the press and defines the position of the moving tool. The digitizer generates an electrical signal (in 12-digit binary number form) that defines the position of the moving tool to $\pm \frac{1}{32}$ in. with a possible stroke of over 100 in.

The system provides for return stroke setting, slow down, swage block setting and zeroing lamps. Compensation is

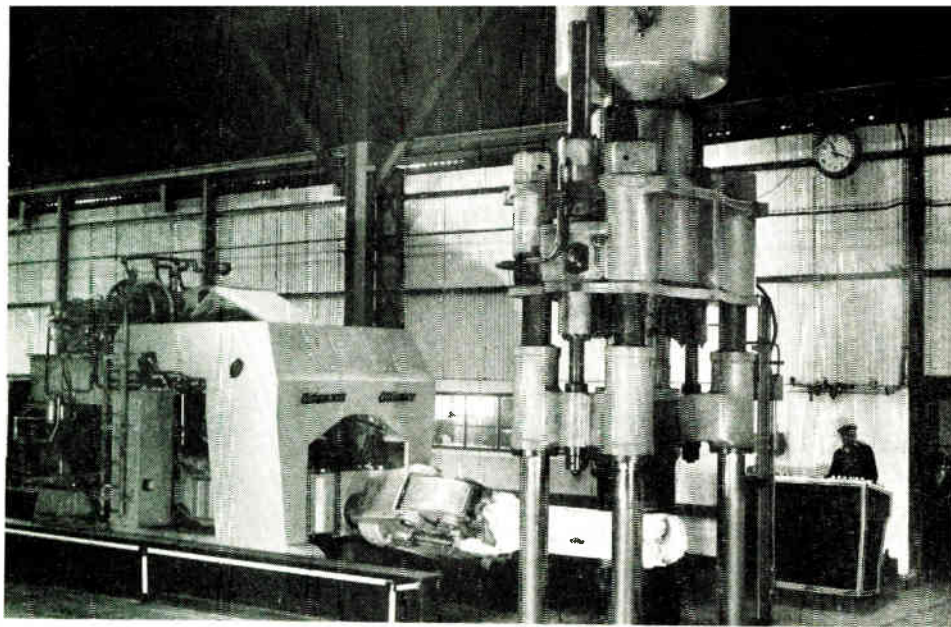

This shows the manipulator jaws and part of the 56-ft manipulator track

provided for the stretch of the press columns and also for the velocity of forging.

The manipulator control uses the same standard digital units as are used for the forging press control. The system provides for the operation of the correct high-speed solenoid valves through transistorized amplifiers to provide for all the manual movements of the manipulator.

Automatic traverse and automatic rotation of the work-piece in step with the operation of the forging press is provided to allow the maximum speeds of operation to be obtained from the combined equipment.

OPERATION

Automatic Press Control

As the press descends, the digitizer generates a continually-changing electrical signal (12-digit binary number) that defines the position of the moving tool. This binary number is fed into circuitry which prevents ambiguous information being read out as the digits change. The binary number is then taken to the main subtractor. Here the number is compared with a binary number that is equal to the thickness of the forging required plus a number equal to the zero setting when the upper and lower tools are in contact. As the press descends, the subtractor output represents the error, and when the press reaches the required reversal position, this 'error' becomes zero, which generates a signal to operate the electro-hydraulic valve in the pilot system, which in turn reverses the press.

The press now moves upwards, the increasing error signal being continually compared with the stroke setting. When these two numbers are equal, a signal is generated which via a second electro-hydraulic valve, reverts the hydraulic directional-control valve, and the press commences a further stroke.

Facilities are provided for a dwell-period (0-5 sec) at the top of the press stroke to allow manipulation to take place and for slow down to allow the press to fall at up to three times its forging speed to a point above the stop forge position where the fast approach solenoid will be de-energized.

Compensation is provided to allow for the stretch of the press columns by the incorporation of pressure-transducers, and for velocity by the incorporation of a 400-c/s tachometer driven by the digitizer. The velocity and stretch signals are added algebraically in an analogue summing unit, to produce a single correction signal.

Circuitry is incorporated to enable the operator to re-zero the press if the tools are changed. The binary number generated by the digitizer is displayed on a set of 12 lamps.

Automatic Traverse

As the press descends from the top of the set stroke, the output of the press control subtractor decreases. At the point where the subtractor output equals the setting on the 'initiate manipulator' setting switch a signal is fed to the timer input. (Note: The output pulse from the timer is generated by the removal of the input signal.) The press descends to the 'stop forge' position, reverses and at the point where the subtractor output is again coincident with the initiate setting the input to the timer is removed, and the timer generates an output pulse.

The length of the pulse is controlled by the 'set increment' switch and is variable from 0.15 to 3 sec. The length of travel of the manipulator carriage can be varied from $\frac{1}{4}$ in. to 20 in. in twenty steps using these pulses to energize the fast retreat solenoids.

The above action repeats as long as the press continues to cycle or until the 'auto travel' switch is switched to 'off'.

Automatic Rotation

A contactless magnetic pulse generator is coupled to the manipulation peel, the gearing being such that 12 pulses equal $11\frac{1}{4}^\circ$ of rotation, the smallest required rotational increment.

The pulses from the pulse generator are fed into an 8-bit reversible binary counter via direction discriminating circuits. The direction sensitive circuits also permit either clockwise or anticlockwise rotation to feed ADD pulses to the counter (vice versa for 'subtract' pulses).

Provision is made for either one short rotation or continuous rotation in synchronism with the press strokes. Fast rotation is energized for all increments of automatic rotation until the peel is 7° from the required position when the fast solenoids are de-energized leaving the peel to complete its rotation at a creep speed. The fast rotation being 10 r.p.m. and the creep speed being 1 r.p.m., the peel deceleration to creep speed is only completed 1 to 2° before reaching the final position and thus ensures maximum positioning speeds.

Improved Production

Before the manipulator, with semi-automatic control, was fitted to this forging press five men were required to produce 23 to 25 tons of forging per shift week.

Now four men produce 35 tons per shift week and output is expected to reach 50 tons per shift week. An additional saving is expected on the number of 'reheats' required for large forgings. Because of the increased speed of operation it will be unnecessary to reheat large forgings so often.

We don't make
supersonic jets

-but we help to
make them better

**UNION
CARBIDE**

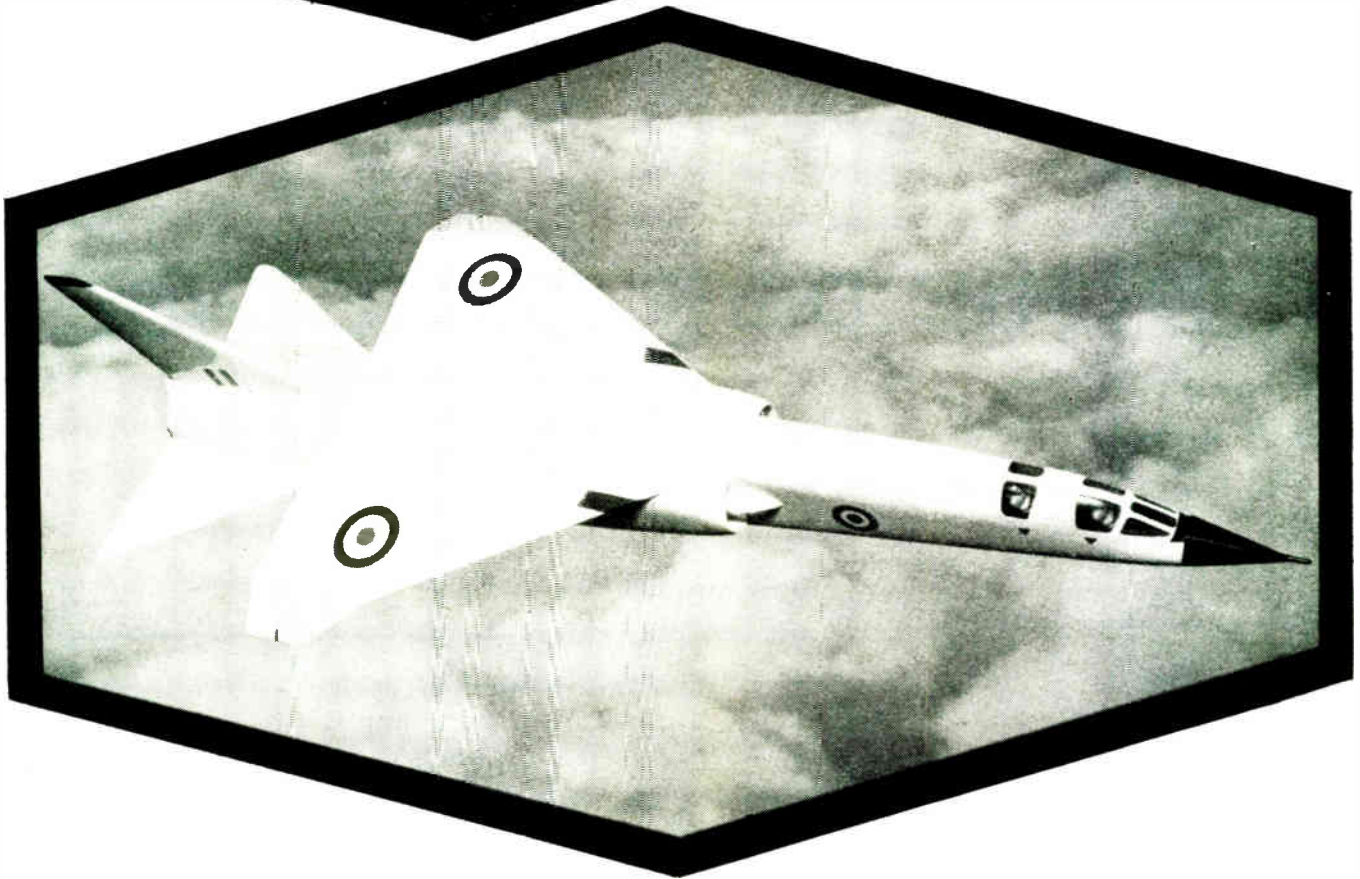

The electronic components in a supersonic jet *must* work without failure. Their selection therefore is most critical and only gear of the highest reliability and closest tolerances can be accepted. The electronic system in the British Aircraft Corporation TSR 2 includes Kemet solid tantalum capacitors. Kemet capacitors are also used in the British Aircraft Corporation VC10, the Hawker Siddeley ship-to-air guided missile Sea Slug, and their air-to-ground guided bomb Blue Steel—fair proof of their reliability in performing vital functions in extreme conditions. But Kemet tantalum capacitors can be more down to earth too. They are best for all terrestrial electronic equipment including computers wherever accuracy and consistent reliability are essential.

KEMET J-SERIES CAPACITORS comply with US MIL-C-26G55A UK DEF/5134-A/1 EID & ARB release available.

KEMET PRODUCTS. Polar and non-Polar solid tantalum capacitors—'J' and 'N' series (standard), 'C' series (for commercial applications), 'P' series (for printed circuits); Barium Getters; Semiconductor Silicon; Silicon Monoxide; Laser/Maser Crystals; Alumina.

We will be happy to send you further information on any of these products.

UNION CARBIDE LIMITED,
KEMET DIVISION, 8 GRAFTON STREET, LONDON W1. MAY 8100.
Production at Aycliffe Trading Estate, Co. Durham.

U.K. distributors for 'J' series capacitors:
SASCO, GATWICK ROAD, CRAWLEY, SUSSEX. CRAWLEY 28700
The terms KEMET, DYNEL, UCON and UNION CARBIDE are trademarks of UNION CARBIDE CORPORATION.

Visit us on stand N435 National Hall, Olympia at the
IEA EXHIBITION MAY 25-30

CAPACITORS ANOTHER PRACTICAL PRODUCT OF

**UNION
CARBIDE**

Chemicals including Polyols, Silicones & Ucon Lubricants · Cr.ogenics · Dynel Fibre · Electronic Components · Ferro-Alloys · Flame Plating

wcv2

ILFORD

IN THE DRAWING OFFICE

New products from ILFORD provide a big advancement in drawing office practice. The new techniques improve accuracy, save man-hours and create nothing less than a revolution in draughtsmanship.

ILFORD Draflex and **ILFORD K&E Stabilene** polyester-base drafting films supersede conventional tracing cloths, paper and films. Exceptional dimensional stability, toughness and near-100% transparency allied with new techniques make finer, faster templates, printed-circuit diagrams, guides for auto-profiling and masters for optical comparators.

ILFORD

*Draflex
Azoflex
Ilfoprint*

AZOFLEX automatic dyeline-printing machines and "**Formula**" papers provide speed and improved facilities for the print room. Automatic dyeline machines can print up to 4,000 parts lists an hour—and *collate them, too!*

ILFORD Ilfoprint machines and materials for contact or projection printing. Enlargement and ultra-speed processing of drawing office miniaturised negatives.

See our permanent exhibition at Ilford House, 135 Oxford St., London W.1. Phone: REGent 8731.

*For all that's best
in reproduction*

Ilford Limited, Document Copying Department, Ilford, Essex. Telephone: ILFord 3000

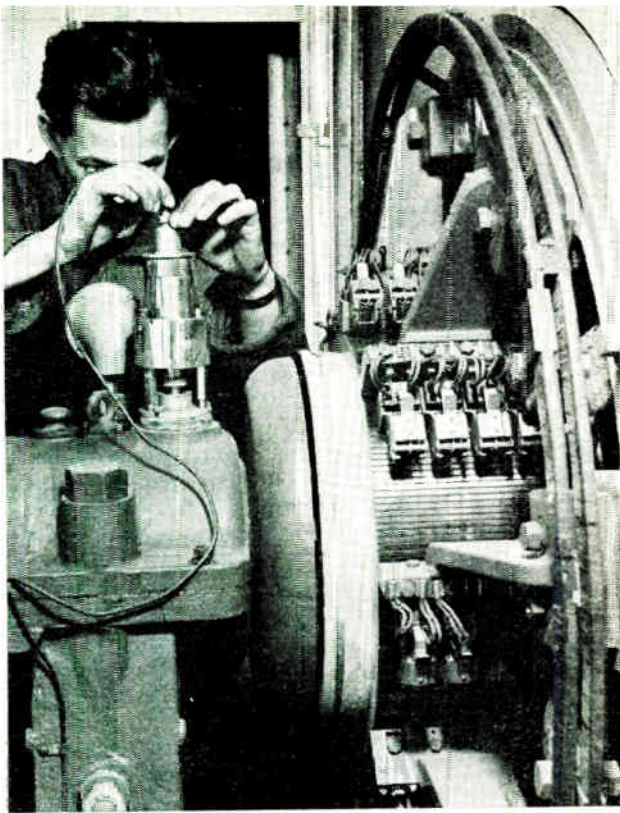

(Left) Making final adjustments to a vibration pick-up. This one is on the bearing of the exciter of one of the alternators

(Below) Part of one of the three instrument and control panels. The turbine vibration and eccentricity meters and recorders are immediately in front of the operator. The alternator vibration meters and recorders are mounted on the rear panel

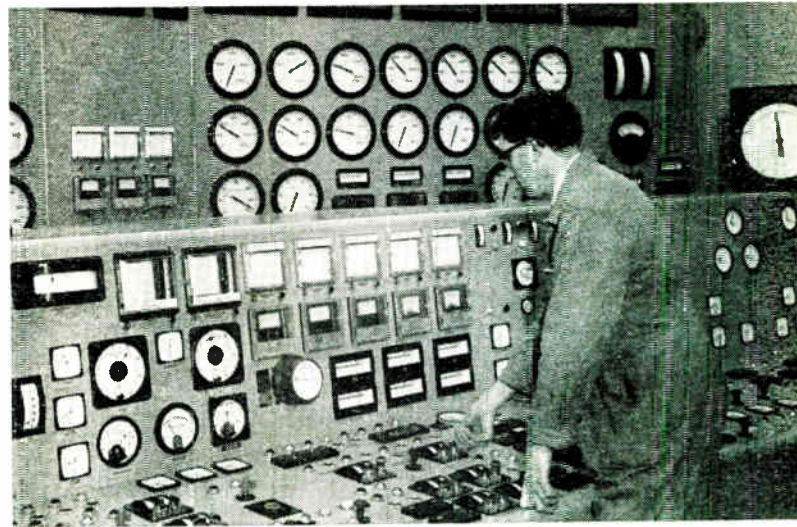

Vibration and Eccentricity Monitoring at Richborough Power Station

PHILIPS' turbine supervisory equipment has been installed at the C.E.G.B.'s new 360-MW generating station at Richborough, Kent.

The equipment is being used for continuously monitoring and recording vibration and rotor eccentricity on the station's three 120-MW turbo-alternators.

By monitoring rotor eccentricity, the operating staff can control start-up and shut-down of the turbines so that limits of unbalance are not exceeded. During continuous operation as well, the indication of eccentricity is an aid in distinguishing between normal and irregular running. The monitoring of vibration, similarly, is a constant check on the smooth running of the machines.

Four eccentricity and four vibration pick-ups are mounted at key positions on each machine, and are connected to indicating amplifiers and paper chart recorders on instrument panels in the control room. Each recorder is fitted

with a set-point which operates a central visual and audible alarm. A warning lamp beneath each recorder enables any instrument in the alarm condition to be immediately located. Should one of the monitoring channels itself develop a fault, an "Equipment Faulty" lamp is illuminated on that channel.

Eccentricity is measured by pick-ups in which the self-inductance varies with the air gap between the pick-up pole pieces and a magnetic collar on the rotor shaft. There is no contact between moving parts and consequently no wear. Vibration is measured by electro-dynamic pick-ups in which a permanent magnet follows the vibration. The coil assembly, due to its method of mounting, remains stationary and a voltage proportional to the velocity of the vibration is induced.

For further information circle 94 on Service Card

Schematic diagram showing the location of eccentricity and vibration pick-ups in the turbine monitoring system at Richborough generating station, Kent

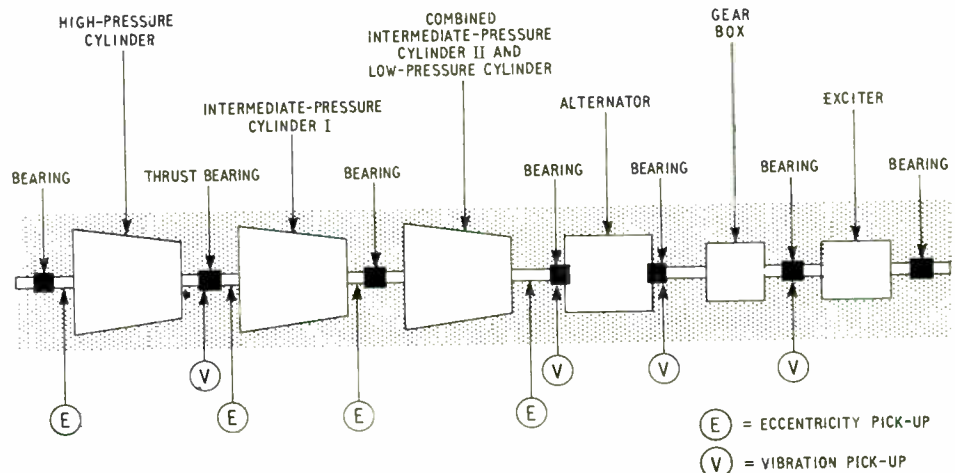

EQUIPMENT REVIEW

1. Multi-Junction Thermocouples

Spembly Technical Products are now producing as standard a multi-junction thermocouple for the measurement of small temperature differences.

This unit is 4ft 6in. long with a flattened silver tube at one end and a glass tube at the other, joined together by flexible p.v.c. tubing. Eleven nickel-chrome/constantan hot junctions are contained in the silver tube, with a corresponding number of junctions in the glass tube at the cold end. The junctions are in series giving an output of $650 \mu\text{V}/^\circ\text{C}$ with a total resistance of 250Ω . Maximum operating temperature is 100°C .—*Spembly Technical Products Ltd., New Road Avenue, Chatham, Kent.*

For further information circle 1 on Service Card

2. Protective R.F. Power Monitor

An instrument from Bird Electronic Corporation, now available from Livingston Laboratories, will continuously monitor both forward and reflected power in transmission lines. Designated 'Wattcher', the model 3127 contains its own power supply, audible and visual alarms and two meters for indicating incident power and reflected power, the latter featuring a manually-set overload point.

The instrument provides for automatic shut-down of a transmitter in the event of a fault occurring in the transmission line system or aerial. The Wattcher can be supplied with frequency and power ranges to satisfy customer requirements. — *Livingston Laboratories Ltd., 31 Camden Road, London, N.W.1.*

For further information circle 2 on Service Card

3. Receiver Test Set

The Cossor model CT381 test set, developed for the Admiralty and now in production, is intended for use in the r.f. and i.f. calibration and realignment of communication receivers.

Combining a sweep frequency generator with a 5-in. c.r.t. display unit, the CT381 has a range of centre frequencies from 10 kc/s to 33 Mc/s, frequency deviation being controllable from 3 kc/s (max) at 10 kc/s, to 500 kc/s (max) at 33 Mc/s. Output level at 75Ω is 100 mV, with 100 dB calibrated attenuator.

Deviation can be reduced to a level suitable for displaying response curves below 500 c/s bandwidth. Triangular or sawtooth type sweeps are available and the timebase speeds are variable from 1 sweep in 10 sec to 1,000 per sec. The timebase is free running and can be synchronized from an internal or external source when the response curve indicator is used for general display purposes.

The model CT381 incorporates both linear and logarithmic vertical deflection amplifiers, the latter having a 60 dB range. Frequency markers are supplied from an external unit, and tolerances of tens of cycles at 500 kc/s

with pro rata increases at higher frequencies are typically obtained.—*Cossor Electronics Ltd., The Pinnacles, Harlow, Essex.*

For further information circle 3 on Service Card

4. Potentiometer-Noise Test System

A test system that determines the amplitude distribution of electrical noise in potentiometers at ten levels simultaneously, is announced by Quantech Laboratories, Inc. Potentiometers may be tested as two- or three-terminal devices, and the tests may be dynamic or static, as desired. The model 2174 has an input sensitivity range from $30 \mu\text{V}$ to 30 mV, peak-to-peak, and frequency range is from 100 c/s to 100 kc/s, or 1 kc/s to 100 kc/s, selected by a front-panel control.

Noise output from the potentiometer under test is applied to the system through a common pre-amplifier input, from which it is distributed to the ten channels. Operating controls, signal outputs and indicating meter for each channel are wholly independent of those for all other channels.

Meters indicate directly the percentage of time the pre-set noise-amplitude level of the particular channel is exceeded (or not exceeded, as desired) and full-scale ranges of 100%, or 10%, may be selected for any channel. Amplitude levels are established by directly calibrated precision ten-turn potentiometers. Either total time integration (in which case noise information is accumulated over a one-minute period) or running-time integration may be selected.

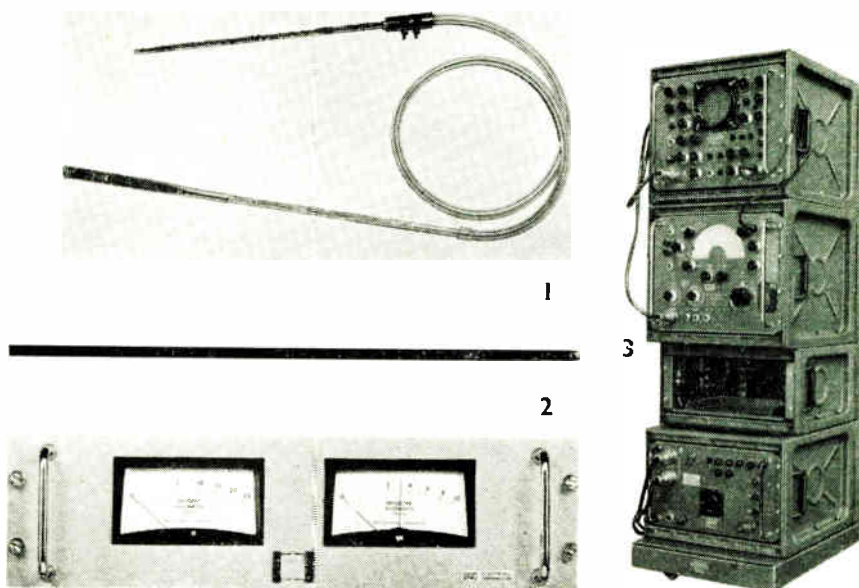

Noise information is stored for each channel for one minute (other accumulation and/or storage times available on special order).

Signal outputs of meter readings and d.c. noise analogue are available from each channel for remote monitoring, controlling or data processing. Overall accuracy of the system is $\pm 5\%$, as limited by the pre-amplifier response. The system, together with all of its regulated power supplies, is packaged in standard 19-in. rack-mount form. Mechanical drive and d.c. power supply for potentiometer under test are not included.—*Livingston Laboratories Ltd., 31 Camden Road, London, N.W.1.*

For further information circle 4 on Service Card

5. Deep Water Transducer

A general-purpose ceramic transmitting and receiving transducer for use at depths of up to 2,000 ft has been announced by Massa Division, Cohu Electronics, Inc. The transducer, model TR-14A, has an omnidirectional pattern in the horizontal plane and a vertical beam approximating to a 5-in. line.

As a receiver the TR-14A has a flat response over the frequency range of 5 kc/s to 20 kc/s and has a sensitivity of -102 dB with reference to 1 V/microbar. The transducer may be used as an underwater sound generator over the frequency range of 10 kc/s to 50 kc/s. The transmitting sensitivity is maximum at 30 kc/s, at which frequency a sound level of $+82$ dB above 1 microbar/A is developed at a distance of 1 yd. Capacitance is

0.04 μ F.—*Massa Division, Cohu Electronics, Inc., 280 Lincoln Street, Hingham, Mass., U.S.A.*

For further information circle 5 on Service Card

6. Automatic On-Stream Titrometer

A range of equipment now available from Elliott's Quality Control Division is designed for the automatic monitoring of chemical process liquids, checking product quality and plant efficiency, and examining effluents, by repetitive titrimetric measurement of concentrations of critical constituents. The instrument takes its sample from a sampling pipeline, adds any necessary reagents or diluents, titrates to the end point and records the result. After draining and washing, the cycle is repeated.

The entire analysis, from sampling to recording of results, is completely automatic and the measured information is available for automatic control systems. Multi-source monitoring, titrations to two or more end points for different constituents, automatic computation of differences and ratios, and chemical zero suppression are examples of facilities which can be provided to suit individual applications.—*Elliott Brothers (London) Ltd., Quality Control Division, Blackwall Lane, Greenwich, London, S.E.10.*

For further information circle 6 on Service Card

7. Cells for Laser Applications

Kappa Scientific Corporation have introduced the series 8 and series 12 Kerr cells for laser applications. These cells are hermetically sealed and

the windows are optically flat to a quarter-wavelength. They are filled with high-purity nitrobenzene which eliminates space-charge effects and produces an extremely uniform electric field.

Series 8 Kerr cells are available in four standard electrode spacings: 0.4, 0.5, 0.6, 0.75 in. Series 12 control the largest laser rods.—*Ad. Auriema Ltd., Impetron House, 125 Gunnersbury Lane, London, W.3.*

For further information circle 7 on Service Card

8. Digital Limit Selector

Digital Measurements announce a digital limit selector DM5080 and a logic unit DM5006 which together form an alarm setting system for use with digital voltmeters, digital data recording systems, counters, etc. Up to three decimal decades can be accepted by the logic unit which will drive up to 16 limit selectors.

'High-limit' selectors produce an output when the input to the alarm setting system is equal to, or greater than, the selected level. 'Low-limit' selectors produce an output when the input to the system is below the selected level. The selectors are easily converted from 'high limit' to 'low limit' and vice versa, by altering link connections.

The output can be used to initiate automatic remedial action or to inform a plant operator of off-limit conditions by means of lighted panels, audible alarms, etc. Alternatively, where inputs from various sources are being recorded by a logging system, the colour shift on the typewriter or

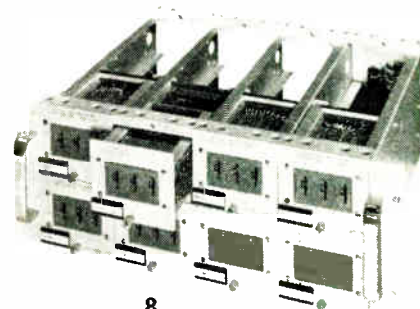
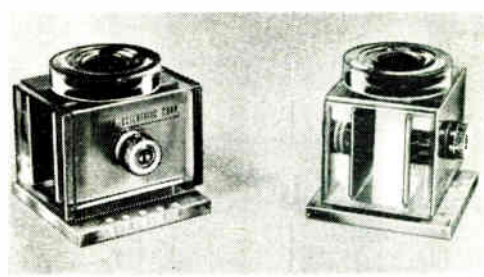
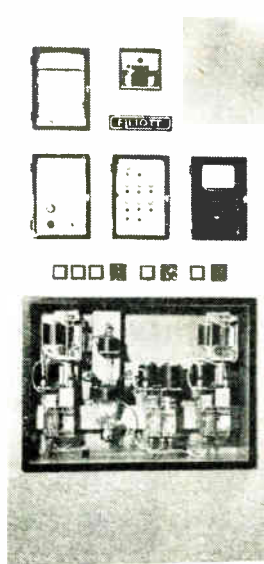

EQUIPMENT REVIEW

printer can be operated automatically.

The units are in the form of modules; a 19-in. rack-mounting frame, 7 in. high, is available to hold either 8 selectors or the logic unit and 4 selectors. The selectors are powered from the logic unit which operates on 100–125 V or 200–250 V a.c. supplies. —*Digital Measurements Ltd., Salisbury Grove, Mytchett, Aldershot, Hants.*

For further information circle 8 on Service Card

9. Coating Thickness Gauge

A pocket thickness gauge for measuring non-conductive coatings on non-ferrous bases has been produced by Elcometer Instruments. The Minitor, which is 4½ in. long, 2½ in. wide and 1¾ in. deep, is suitable for measuring the thickness of paint, plastics, phenolic resins, rubber, enamel, etc.

Operating on the eddy-current principle, it has a p.c. board incorporating transistors and sub-miniature components powered by a Mallory battery which gives approximately 60 hr of use. The diecast aluminium case incorporates a 1¼-in. scale, and the instrument is insensitive to fairly large changes in alloy specification. The probe, which is tipped with a special hard wearing compound, is housed in a spring-loaded assembly built into the base.

There are three models: the 'three contact', for general use on all surfaces; the 'flat base', for measurements on soft materials; and the 'V-base' for measurements on round bar. Separate probes can be supplied and scales available at present range from 0–500 microns to 0–10 thousandths of an inch. Price of the Minitor, with leather case and setting shims, is £48. —*Elcometer Instruments Ltd., Fairfield Road, Droylsden, Manchester.*

For further information circle 9 on Service Card

10. High-Strength Polyester Tape

Sellotape Products have introduced a self-adhesive polyester tape for use in electrical applications where physical strength is important. The tape is based on 0.005-in. polyester film coated with a highly tenacious thermosetting adhesive. Typically, curing takes 1 hr at 150 °C.

Capable of continuous electrical operation at temperatures between 130 and 155 °C, the tape can be used up to a temperature of 180 °C for short periods. It has a tensile strength of 100 lb per in. width, a breakdown voltage of 13 kV, and a high resistance to solvents. These characteristics make the tape particularly suitable for strap-

ping windings and wiring on heavy rotating equipment such as generators and alternators.

Available in widths of ¼, ⅜, ½, ⅝, ¾, ⅞, 1, 1¼, 1½ and 2 in., the tape is wound in 36-yd lengths on a 3-in. diameter core.—*Industrial Division, Sellotape Products Ltd., Sellotape House, 54/58 High Street, Edgware, Middlesex.*

For further information circle 10 on Service Card

11. 2 kW X-ray Generator

Research & Control Instruments have announced a high tension generator developed by Philips for use with high power X-ray diffraction tubes. Short measuring times are made possible by the output of 2 kW, which is twice that of earlier generators. Voltage is adjustable in 1-kV steps from 10 kV upwards, and the tube current is adjustable from 4 to 36 mA in 17 steps and continuously. The stability of the generator is also much greater than that of its predecessors, tube current and voltage being stable to within 0.03% for mains fluctuations of ±10%.

The complete equipment comprises

a diffraction worktable unit type PW1310 (left) housing the high-voltage transformer, and a control cabinet type 1320 (right) for controlling and stabilizing the high voltage and tube current. Two versions of the equipment can be supplied: a 60-kV model intended primarily for X-ray diffraction and diffractometry, and a 100-kV model also suitable for these applications plus X-ray spectrometry. —*Research & Control Instruments Ltd., Instrument House, 207 King's Cross Road, London, W.C.1.*

For further information circle 11 on Service Card

12. Twin Thermal Delay Switch

Latest addition to the range of STC thermal delay switches is the type SSI10/1D. It consists of two mechanically separate switches mounted in a common glass envelope, each unit giving a maximum closing delay time of 110 sec.

The switches can be used independently or in conjunction with one another. When used in a circuit which gives a delay comprising the sum of the two making times and the two breaking



9

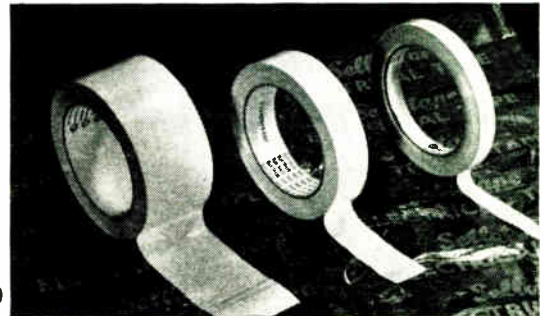

10

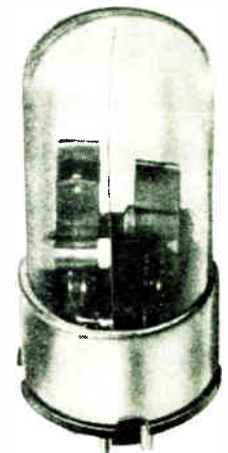
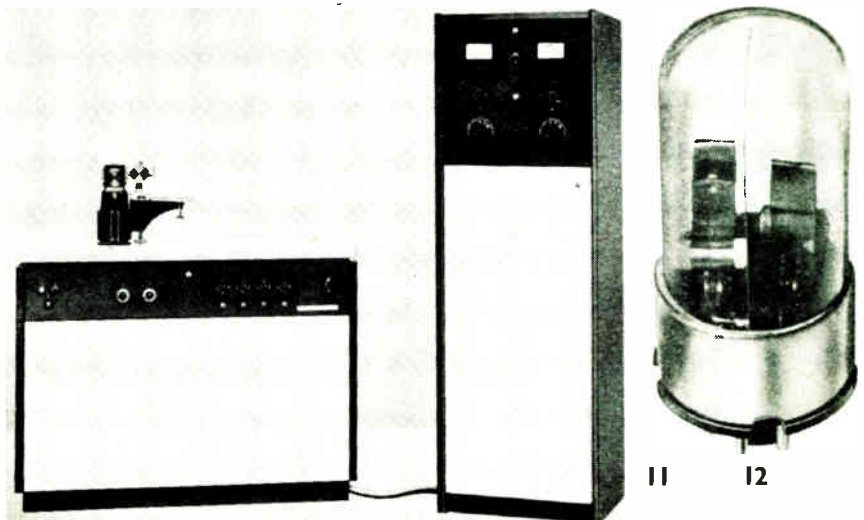

11

12

times, the switch unit will give a delay of about 240 sec; this delay is virtually independent of heater-voltage variation and ambient temperature and retains close tolerance throughout switch life.

The SS110/1D has a small wafer octal base and has the following characteristics: V_h and I_h of 6.3 and 0.5 (per switch), respectively; min. and max. delay times at 20 °C of 90 and 110 sec (per switch), respectively; max. contact ratings of 100 V, 1 A a.c. or 220 V, 1 A d.c. (on make) and 50 V, 0.1 A d.c. (on break).—*Standard Telephones & Cables Ltd., Valve Division, Brixham Road, Paignton, Devon.*

For further information circle 12 on Service Card

13. Powder Dry-Spray Unit

Recently announced is the Hursant 'Electro-Mist' unit. This is an electrostatic powder dry-spray system which coats small articles such as door handles, screwdriver handles, soap racks and filing baskets, suited to dip coating. Its great advantage over conventional powder dipping systems is that it needs only a small quantity of

material to create a mist. This means that frequent colour changes are possible with little wastage. The Electro-Mist unit operates from the standard Statispray Mk. 3 generator. —*Hursant Developments Ltd., Hursant House, North Feltham Trading Estate, Bedfont, Middlesex.*

For further information circle 13 on Service Card

14. Noise Excluding Headset

An addition to the range of noise-excluding headsets manufactured by Denis Ferranti Meters is the lightweight 'Eargard' type Z538. This extremely light but robust headset is comfortable to wear and although containing normal-size service-approved transducers, weighs only 13 oz. It has been designed for use in high ambient noise, and the degree of attenuation provided ranges from 10 dB at 300 c/s to 35 dB at 4 kc/s.

The earshells are made from high-impact-proof plastic material and are fitted with foam-filled seal cushions. A fully adjustable, boom-mounted, noise-cancelling microphone is fitted to one of the shells. The microphone

can be either moving-iron or carbon type giving outputs of 10 mV and 200 mV, respectively. The telephone inserts are of the rocking-armature type with an impedance of 300 Ω each and have a frequency response which is flat within +3 dB from 200 to 3,500 c/s.—*Denis Ferranti Meters Ltd., Caernarvon Road, Bangor, Caernarvonshire.*

For further information circle 14 on Service Card

15. Laser Q-Switch

Laser peak power outputs can be increased several hundred times with a 'laser lever' introduced by Raytheon. The LA-9 Q-switch shortens the output of a pulse laser to 100 nsec from a normal range of 0.5 to 3.0 msec thus increasing the peak power output by more than two orders of magnitude. Pulse length reductions and subsequent peak power increases are accomplished with a rotating prism driven at selected speeds up to 24,000 r.p.m. Delay of the flashlamp pulse and Q-switch triggering can also be varied to achieve peak performance.

Simple to install, this accessory is attached to any of Raytheon's current pulse laser heads with only two mounting screws and the interchanging of two electrical cables. Change over from normal operations to Q-switching can be accomplished within a few minutes without lengthy modifications to either the laser head or its power supply.—*Raytheon-ELSI, S.p.A., Villagrazia, Palermo, Italy.*

For further information circle 15 on Service Card

16. High-Q X-Band TR Cell

A miniature microwave valve recently introduced by A.E.I., the BS332, is a tunable, integral cavity TR cell for operation in the 3-cm band. It is designed for use in branched duplexers in WG16. Tuning range is 9,200–9,600 Mc/s with loaded Q of 130. Maximum peak transmitter power level is 50 kW, flat leakage is 30 mW (1-μs pulse) and spike is 0.1 erg/pulse (40 kW).—*Associated Electrical Industries Ltd., Electronic Apparatus Division, Valve & Semiconductor Sales, Carholme Road, Lincoln.*

For further information circle 16 on Service Card

17. Laboratory Timer

Pioneer Designs are offering an electronic timer which incorporates a pulse-operated trigger circuit with variable sensitivity, adjustable by an individual front panel control. Sensitivity can be controlled so that low d.c. and a.c. voltages applied from an

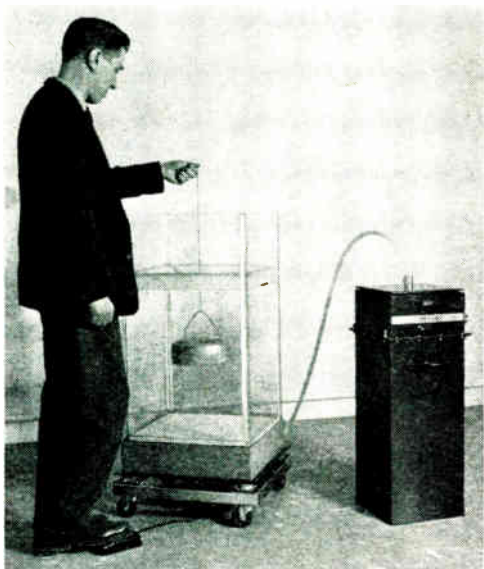

13



14

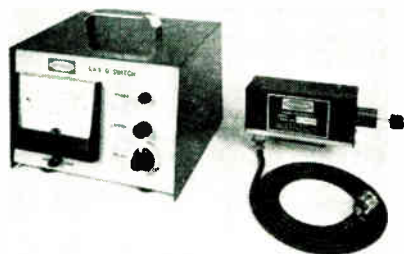

15



16

EQUIPMENT REVIEW

plete interchangeability of units in an installation.

The absence of all moving parts enhances performance repeatability and provides a zero-backlash, infinite resolution capability. XT 33 transducers are normally supplied fitted with $\frac{1}{4}$ -in. BSP threaded union and five-core screened cable entry.—*Coutant Electronics Ltd., 3 Trafford Road, Richfield Estate, Reading, Berks.*

For further information circle 25 on Service Card

26. Floor-Position Indicator Tube

STC have introduced a lift floor-position indicator tube, type GN-4BG, which displays basement, ground and eight additional floor numbers in a single 1.1-in. diameter circle. Specifically designed for use inside passenger or goods lifts and beside lift-well doors, this long-life, cold-cathode end-viewing device is enveloped in a compact glass bulb coated with a red/orange filter to enhance the display.

Twin passenger-lift systems operating over eight floors, ground and basement normally require 220 indicator lamps; only 22 indicator tubes are required to cover the same system. The minimum supply voltage is 170 V and the nominal cathode current 2.1 mA.—*Standard Telephones and Cables Ltd., Valve Division, Brixham Road, Paignton, Devon.*

For further information circle 26 on Service Card

27. 400-c/s Phase Shifter

Theta has announced the phase generator model PG-9, which will shift the phase of any 400-c/s input voltage without causing an amplitude variation. Since the device shifts a full 360° in a continuous manner it is claimed by the manufacturer to have many more testing applications than the familiar RC networks.

The miniature geared dial is calibrated in degrees. Specifications: input voltage, 115 V max.; output voltage, 35 V; phase accuracy to 20 min-of-arc; dial vernier ratio, 100:1; size $3\frac{1}{16}$ in. square by $3\frac{1}{2}$ in. deep. Phase generators for frequencies other than 400 c/s are also available.—*Theta Instrument Corporation, Saddle Brook, New Jersey, U.S.A.*

For further information circle 27 on Service Card

28. Programming Board Terminal

Designed for use in a programming board as part of a replaceable patching system, the Sealectro PL-080 'press-fit' Teflon terminal features a spring-actuated contact. The unit has a plunger extending above the shoulder of the Teflon body, with a 0.125-in. diameter contact button.

The stationary portion of the lug, which extends through the bottom of the body, is designed to mate with an 0.08-in. diameter jack. Overall height of the unit is 0.762 in., and it may be obtained in a choice of ten EIA

colours for colour-coding chassis points.—*Sealectro Ltd., Hersham Trading Estate, Walton-on-Thames, Surrey.*

For further information circle 28 on Service Card

29. High Density P.C. Connectors

ISEP (International Standard Equipment Practice) printed-circuit edge connectors now available from STC have contacts with a pitch of 0.1 in. between centres. These connectors are designed to meet the requirements for high-density, multi-pole edge connectors for printed circuits containing large numbers of miniature components.

The three sizes available, 11-, 25- and 33-way, can be supplied with either wrap or solder tags. The connectors, with precious-metal contacts rolled flat from wire, to eliminate sharp edges, meet the G.P.O. tests in full.—*Standard Telephones & Cables Ltd., Electromechanical Division, West Road, Harlow, Essex.*

For further information circle 29 on Service Card

30. High-Voltage Attenuator

A high-voltage attenuator for use with transient recorders, oscilloscopes, etc., has been designed and developed by P.C.D.-Southern, an associated company of Southern Instruments. The instrument incorporates a balanced 'T' network of 75- Ω input and output impedance capable of attenuating a 250- μ sec. 4.2-kV pulse by 72%.

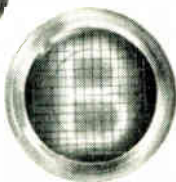

26



27

28

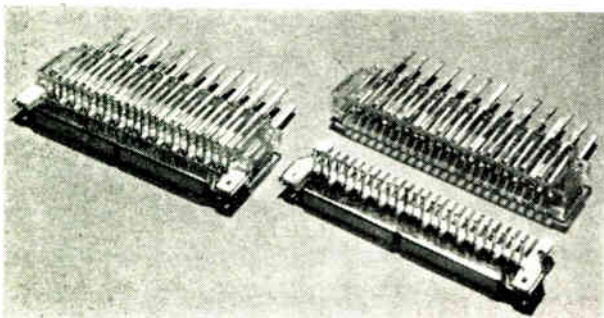

29

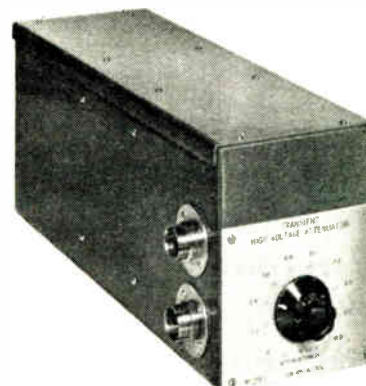

30

The degree of attenuation ranges from 0 to 10.9 dB and is controlled by a switched gain control having ten steps, each of which increases the voltage division ratio by a factor of $1/\sqrt{0.75}$. Two attenuators may be coupled in series if required. The frequency range is d.c. to 10 Mc/s.—*P.C.D.-Southern Ltd., Frimley Road, Camberley, Surrey.*

For further information circle 30 on Service Card

31. Cold Crimp Insulation

'Cold crimp' is a technique in insulation designed by AMP for their Faston and other ranges of connectors. The semi-rigid p.v.c. insulating sleeve is crimped on to the terminated wire using a hopper-fed Automachine. By this method it is claimed that a consistently reliable insulation is obtained every time with considerable reductions in time and labour over conventional manual methods.

The picture illustrates the range of sizes which are available to insulate Faston connectors, Shur plugs and pin receptacles. The insert shows a blank sleeve and a Faston terminal before crimping. The sleeves are available clear or coloured.—*Aircraft-Marine Products (Great Britain) Ltd., Amplo House, 87-89 Saffron Hill, London, E.C.1.*

For further information circle 31 on Service Card



31

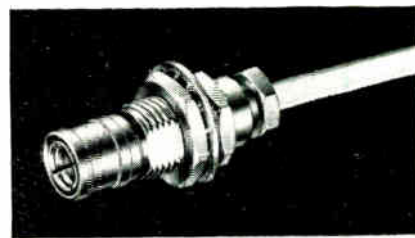

32

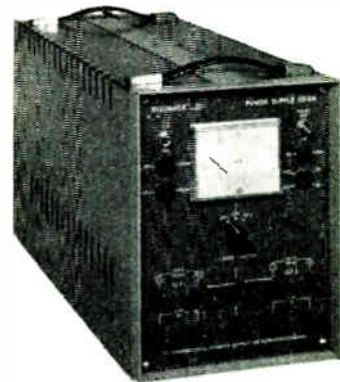

34

33

32. Snap-on Bulkhead Plug

Sealectro is now offering a 50-Ω Conhex bulkhead plug No. 3120, for use with RG-188/U coaxial or similar cables where connection must be changed frequently or where space limitations prohibit the use of a wrench to tighten the coupling nut. Mating connectors of this type lock firmly together and snap open with a straight pull.

This unit features 0.0001-in. gold plating and Teflon insulation. Outer contacts are protected against damage resulting from angular mating and unmating forces by a protective retaining sleeve which is an integral part of the connector.—*Sealectro Ltd., Hershham Trading Estate, Walton-on-Thames, Surrey.*

For further information circle 32 on Service Card

33. Heat Shrinkable Sleeving

Thermofit SCL, an irradiated, modified polyolefin, dual-wall tubing, is now available from Raychem U.K. The outer, cross-linked wall shrinks upon heating, without melting; the non-cross-linked inner wall melts during heating, and is forced to embed whatever it surrounds by the shrinking of

the outer wall. Upon cooling, the entire mass becomes a hard tough homogeneous moulding.

Applications include the moisture-proof encapsulation of components such as capacitors and resistors. Electrical cable junctions such as wire splices and screened cable terminations are readily moisture-proofed as illustrated as the inner layer fills the spaces between the wires.—*Raychem U.K. Ltd., Brantham, Manningtree, Essex.*

For further information circle 33 on Service Card

34. Regulated Power Supply

Feedback have announced a general-purpose power supply unit for bench use which will provide (a) two separate 'floating' 300-V supplies delivering 150 mA each, (b) an h.t. pack delivering + and - 300 V at 150 mA, (c) an h.t. pack delivering + or - 600 V at 150 mA, or (d) an h.t. pack delivering + and - 300 V at 300 mA. For operation under constant minimum load conditions, a simple internal connection increases the maximum current loading on each supply to 200 mA.

There are three 6.3-V outputs, two of which are 'floating'. These are capable of feeding up to 16 A of heater current; the large meter reads

the current from each output. Long term stability against supply variations is greater than 300:1 for total excursions of 15% of the nominal value of the supply. Output impedance is less than 1 Ω and the total ripple content is less than 3 mV r.m.s. The outputs are available either on front panel-mounted terminals or from two six-way Painton sockets at the rear. The equipment has a panel size of 8.5 in. wide by 12.5 in. high and is 22 in. long. It weighs 36 lb. Price: £135.—*Feedback Ltd., Park Road, Crowborough, Sussex.*

For further information circle 34 on Service Card

35. Micro-Circuit Test Kit

Two evaluation micro-circuits, each containing a dozen thin-film tin-oxide resistors, are being marketed by Elettrosil in a test kit manufactured by Corning Electronic Components. Each twelve-resistor micro-circuit is on a wafer $1\frac{1}{8} \times 1\frac{1}{8}$ in.; the resistors have values of 500 Ω, 5 kΩ and 50 kΩ. Substrate material is alumina, glazed with an alumino-silicate glass.

Included in the kit is a schematic diagram of the test circuit, a photograph of the circuit before coating and lead attachment, and technical information listing typical Corning micro-



35



36

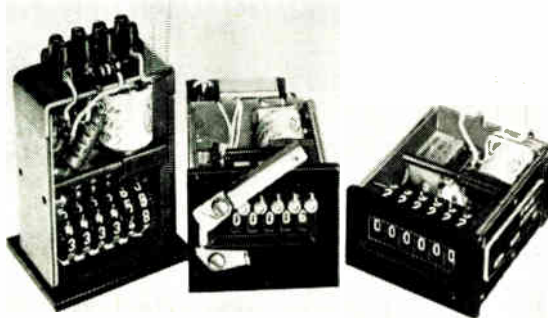

37



38



39

circuit performance and specifications. The latter reports that no catastrophic or degradational failures occurred during 1,400,000 hours of thin-film resistor load life testing. Details of six load life test programmes are tabulated.—*Electrosil Ltd., Pallion, Sunderland, Co. Durham.*

For further information circle 35 on Service Card

36. DME Ramp Tester

A self-contained, transistorized DME ramp test set has been announced by the Tel-Instrument Electronics Corporation. The T-11A is intended for checking the operation of standard commercial airborne DME systems including Narco, Collins and Bendix,

both when installed in an aircraft and on bench test. It can also be used to check the DME portion of military TACAN systems.

The instrument measures 15.88 × 9.53 × 6.98 cm; and weighs 0.68 kg. It contains a receiver, pulse delay and forming networks, and a transmitter. Hand-held a few feet from the aerial, it picks up a radiated signal and transmits an encoder reply which gives 5-, 30- or 97-n.m. readings on the indicator. Accuracy of the miles indication is 0.5 n.m. or 2%, whichever is greater. In addition, it indicates the p.r.f. of the DME transmitter over the ranges 0 to 50 and 0 to 150.—*Ad. Auriema Ltd., Impetron House, 125 Gunnersbury Lane, London, W.3.*

For further information circle 36 on Service Card

37. Electromagnetic Counters

A range of high quality vibration and shockproof electromagnetic counters has been introduced by Cheesman Automation. These counters are made by F. Kubler, of Germany, and cover a wide range from non-reset to batch counters for most a.c. and d.c. coil voltages.

Counting speeds up to 50 imp/sec are available on d.c. and 35 imp/sec on a.c. with duty cycle ranging from 100% to 60%, depending upon speed of counting. Power consumption also varies with speed from 2.0 W to 4.5 VA max.

Standard models have six 0.158-in. high 4-mm digits while batching counters have 5 digits only. A feature of the counters with hand or hand and electric reset is the optional locking bar which prevents accidental resetting. Three of the available types are illustrated: transistorized, batching and hand-reset. Front- or rear-fixing is available for all types.—*Cheesman Automation Ltd., High Drive, France Hill Drive, Camberley, Surrey.*

For further information circle 37 on Service Card

38. Large Scale X-Y Plotter

A solid-state X-Y analogue recorder with a plotting surface measuring 45 × 60 in. designed for a wide range of industrial applications such as automatic drafting, highway planning and data reduction, is available from Electronic Associates. Known as the 45 by 60 Variplotter X-Y recorder model 99.361, it has a continuously variable scale factor which permits scaling from 0.05 to 10 V/in., and may be purchased with accessories to permit digital plotting in three modes of operation: point, symbol, and line plotting.

When in the point or symbol plotting mode, the plotter can plot at least 80 points or symbols per minute with a maximum error of ±0.05%. Repeatability is better than ±0.01% for successive plots. In the line plotting mode, the plotter plots 20 lines per min from 0.015 to 4 in. long. The end points of the line are accurate to ±0.5%, and the total lines produced maintain an accuracy greater than ±0.1%.—*Electronic Associates Ltd., Burgess Hill, Sussex.*

For further information circle 38 on Service Card

39. Cold Cathode Thyatron

The 'Hamlin' HA 300 cold-cathode thyatron, now available from Flight Refuelling, can idle for extended periods of time with zero power con-

(Continued on page 251)



A NEW SERIES
OF SOLID STATE 10-INCH POTENTIOMETER
RECORDERS
with...

 **VARIAN**

MODEL G-40
MODEL G-41
MODEL G-42

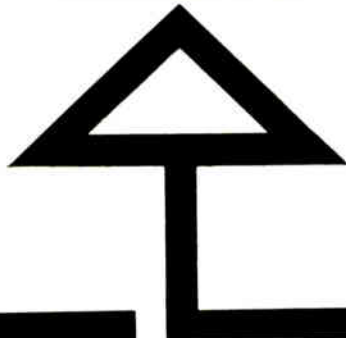

True differential input circuit, providing both high impedance and high rejection, including operation with unbalanced inputs. Compact, lightweight design, for both portable and rack mounting use. Three distinct models initially available for laboratory, industrial and O.E.M. applications.

MODEL G-40

Offers maximum versatility and performance. Eight push-button ranges from 1 mv to 100 volts, plus vernier control for continuous adjustment between ranges. True differential input circuit. Full scale zero adjustment plus 5 scale widths zero suppression.

MODEL G-41

For greatest sensitivity in specific applications. Span continuously adjustable between 1-10 millivolts. True differential input circuit.

MODEL G-42

For maximum economy in specific applications. Span continuously adjustable between 10-100 millivolts. Conventional high impedance input circuit, single ended, d.c. floating.

SEE THEM AT STAND N.154 AT THE I.E.A.

Varian Associates Limited, Fox Oak, Seven Hills Road, Walton-on-Thames, Surrey. Weybridge 48174 Telex 261351
European Head Office: Varian AG, Baarerstrasse 77, Zug, Switzerland.

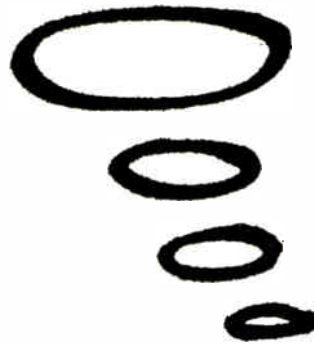

Thinking small in process computing, the blood sugar analysis computer above. Thinking big in data logging, the steel works computing logger opposite. Or smaller, or bigger, or any size thinking in between. ARCH computers can be digital, analogue or hybrid. Your choice of word lengths is from 18 to 39 bits, maximum core storage up to 32,000 words, addition times including access from 2 to 576 microseconds. The ARCH *modular* approach allows you to introduce process computing and data logging techniques step-by-step. Your first step—find out more about ARCH now. *Enquiries to the Sales Manager,*

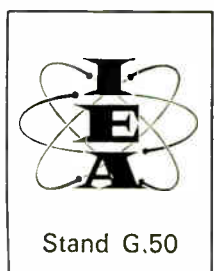

ELLIOTT process computing division

EA A Member of the Elliott-Automation Group ELLIOTT BROTHERS [LONDON] LIMITED ELSTREE WAY BOREHAMWOOD HERTS ELSTREE 2040

ARCH
thinks big

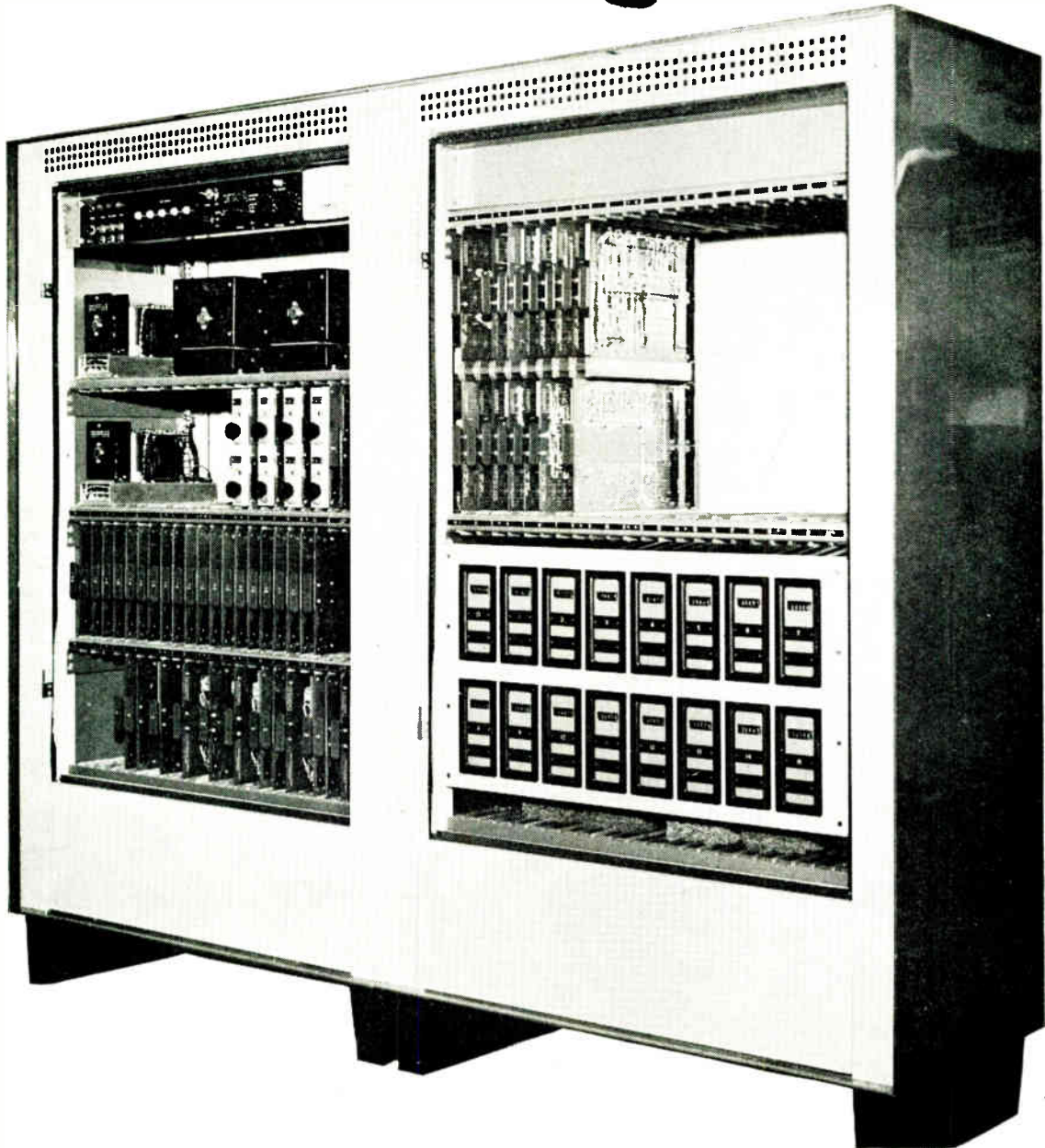
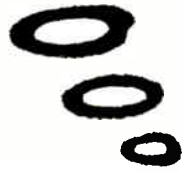

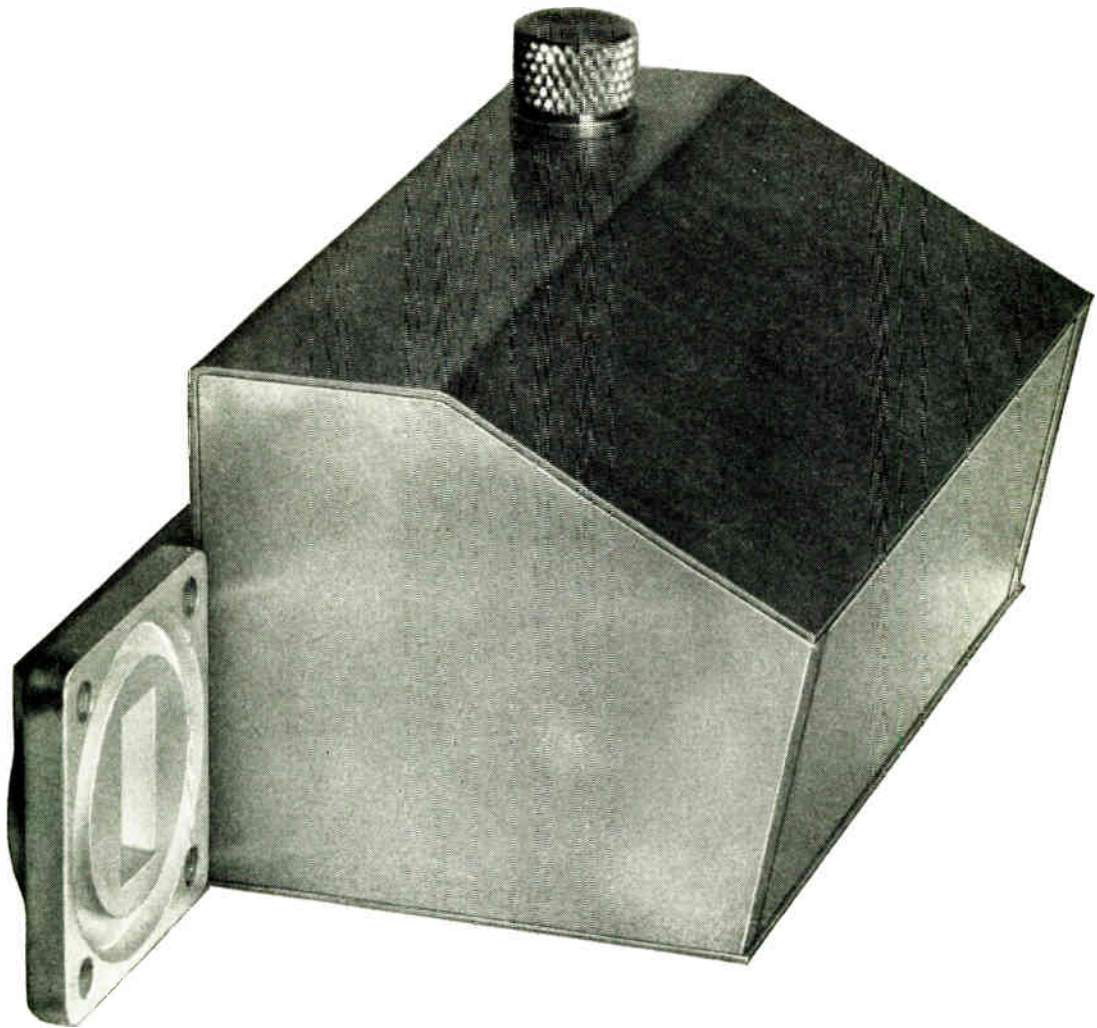

M-O V present solid state microwave power sources!

Now M-O V announce a new range of packaged semiconductor microwave generators. Small, light and exceptionally robust, they require far less elaborate power supplies than conventional reflex klystrons. J-band devices are now in production (and may be seen on M-O V stand E 288 at the IEA). Devices up to J-band will be available shortly—all featuring exceptionally wide electronic tuning range.

J-BAND SEMICONDUCTOR SOURCE—SPECIFICATION

Output frequency:	12—15 kMc/s
Tuning Range:	280 Mc/s electronically tuned (3dB points)
Modulation Sensitivity:	15 Mc/s/volt
Temperature Stability:	2 parts in 10 ⁴ per °C.
Power Output:	15mW min.
Spurious Response:	—30dB up to 280 Mc/s about centre frequency
F.M. Noise:	20c/s in 100 cycle bandwidth
Size:	16 cu. in.
Weight:	12 oz.

Our technical information centre is ready to help with your application problems. Write for further details on these or other M-O V products, or telephone RIVerside 3431. Telex 23435.

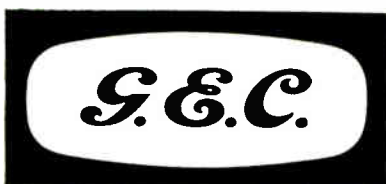

M-O VALVE CO LTD

BROOK GREEN WORKS · HAMMERSMITH · LONDON W6

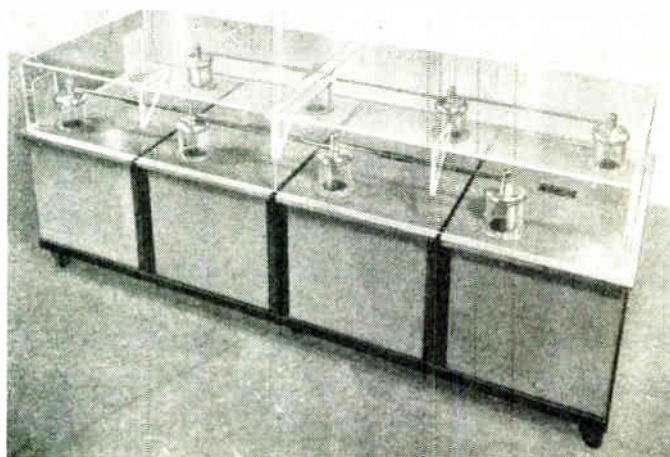

40

chassis is less than 1 pF. It can be supplied in 10 different colours and in any required finish, silver or gold preferred.—*Oxley Developments Co. Ltd., Ulverston, Lancs.*

For further information circle 41 on Service Card

42. U.V. Flow Analyser

The model 'M' u.v. flow analyser, available from V. A. Howe & Co., is modular in design, consisting of a basic instrument plus optional plug-in functional assemblies. It can be used as a fixed wavelength liquid analyser (flow or static), a flow analyser with automated spectral scan or a u.v./visible spectrophotometer. The basic instrument is a manual-set, double-beam, direct-reading u.v. spectrophotometer coupled to a ratio recorder which charts the % T of a flowing material which changes with time.

An electronic log converter is available to convert the linear % T signals to optical density units or linear absorbance, and, by means of a two-speed scan drive, it is possible to effect a motorized scan across any part or all of the u.v./visible spectrum. In addition, a tungsten lamp accessory is available that will direct the visible light into the monochromator slit, thus extending the range of the instrument to 700 μ , and an automated scan control can be added for recording the spectral curves of those fractions that exceed a pre-set concentration.—*V. A. Howe & Co. Ltd., 46 Pembridge Road, London, W.11.*

For further information circle 42 on Service Card

43. Large Dielectric Slabs

Raytheon's dielectric material for waveguide loading, waveguide and microwave optics components, and aerials, is now available in slabs twice as large as those previously offered: panels $9\frac{1}{2}$ in. square and either $\frac{1}{2}$ in. or 1 in. thick can now be supplied as well as the $4\frac{1}{2}$ -in. squares. The material can be machined readily with tungsten carbide tools, and bonded with epoxy or similar adhesives. Special shapes can be prepared to customer's specifications.

Designed specifically for microwave applications, 'Ray-K' combines extremely low-loss tangent (less than 0.0007 at 10 Gc/s) with very close dielectric constant tolerance (guaranteed within $\pm 2\%$, but usually within $\pm 1\%$) over a wide range of values. Standard values of dielectric constant are 3, 4, 5, 6, 8, 10, 12, 14, 16, and 20. Intermediate and higher values can be ordered.—*Raytheon-ELSI, S.p.A., Villagrazia, Palermo, Italy.*

For further information circle 43 on Service Card



41



42

sumption, and then be actuated by an external pulsing circuit, usually a high-voltage pulse coil. The mercury-pool cathode furnishes mercury vapour which ionizes to allow electron discharge whenever the external pulse is sent through a metal band around the switch. This method of switching increases reliability and life wherever high current on-off switching is required.

De-ionization time is 10 μ sec. breakdown voltage 15 kV and the current carrying capacity over 200 A instantaneous, 3 A continuous duty. For ignition, a 10 to 15 kV pulse is recommended, and the voltage drop across the switch is approx. 5 to 10 V. The thyatron is 1 in. in diameter and 6 in. in length.—*Industrial Electronics Division, Flight Refuelling Ltd., Wimborne, Dorset.*

For further information circle 39 on Service Card

40. Discharge-Free Capacitors

F. C. Robinson and Partners announce that a complete range of ionization-discharge-free capacitors is now available.

When carrying out ionization discharge tests, with any detector, maximum sensitivity is achieved only when the blocking capacitor value is high

compared with that of the specimen. With this in mind values from 1,000 pF to 0.05 μ F at 50 kV r.m.s., 2,000 pF to 0.1 μ F at 25 kV r.m.s., 5,000 pF to 0.5 μ F at 10 kV r.m.s. and 0.01 μ F to 2 μ F at 5 kV r.m.s. are being produced as standard items. Higher working voltages or larger capacitance values may be attained by connecting units in series or in parallel. The photograph shows a parallel bank of 0.05- μ F 50-kV models.

Depending on the voltage rating and capacitance value, some types are of tubular construction, whilst others are built into oil-filled steel tanks or rigid p.v.c. containers.—*F. C. Robinson & Partners Ltd., Davies House, 181 Arthur Road, Wimbledon, London, S.W.19.*

For further information circle 40 on Service Card

41. Lead-Through Insulator

Oxley Developments have introduced the type 093/6/H lead-through insulator (illustrated actual size), based on the patented 'Barb' principle. It is easy to insert into a 0.093-in. drilled or punched hole, is rated at 1.5 kV d.c., and is designed for thick chassis—of the order of 7 to 10 s.w.g.

The breakdown voltage is greater than 4 kV d.c., and the capacity to



Personal and Company News

Leslie B. Copestick has joined D. McDonnell and R. L. B. Wall on the board of **Fenlow Electronics Ltd.** and has been appointed chairman.

Mullard Equipment Ltd. and Research and Control Instruments Ltd. have joined forces in one company to be known as **The M.E.I. Equipment Company Ltd.** In dealing with products handled formerly by Mullard, the new company will operate from the existing headquarters at Manor Royal, Crawley, Sussex. For products formerly in the range of Research and Control Instruments, it will operate for the time being from Instrument House, 207 King's Cross Road, London, W.C.1.

F. N. Sutherland, C.B.E., deputy chairman and managing director of The Marconi Company Ltd., has accepted the invitation of the Council of the **Electronic Engineering Association** to become its president for the ensuing two years. Sir John Toothill, C.B.E., director of Ferranti Ltd., will be vice-president.

Dawe Instruments Ltd. have become the sole U.K. licensee and agent for equipment manufactured by Branson Instruments Inc., U.S.A.

D. C. Cooper, 46, has joined the Electrical Products Division of **AMF Ltd.** as sales manager. He is based at the Whitstable, Kent, factory.

L. G. Hawkins has been appointed manager of the new **STC** factory at East Kilbride in Scotland.

Aircraft-Marine Products (G.B.) Ltd., announce that they are to set up a new production unit at Bideford, North Devon. Future plans for the company include further development and expansion in both Scotland and Devon.

D. T. Robb has joined the **Telephone Manufacturing Company Ltd.** as manager of the Components Unit of the Telephone Equipment Division.

The **Derritron Group** announce the appointment of Brian Montandon as group industrial sales manager (U.K.).

To permit further expansion into the range of components other than connectors, **Ultra Electronics Ltd.** has bought the shares owned by Continental Connector Corporation of New York in Continental Connectors Ltd., which has now become Ultra Electronics (Components) Ltd., a wholly-owned subsidiary. All production will remain in the hands of Ultra Electronics Ltd.

E. Hoeksma, chief production executive, and K. O. Rees, head of Entertainment Markets Division, have been appointed directors of **Mullard Ltd.**

Imperial Metal Industries Ltd. has decided to accept, subject to the satisfactory completion of formalities, an offer by **The Morgan Crucible Co. Ltd.** for the entire share capital of Steatite and Porcelain Products Ltd., a subsidiary company wholly owned by I.M.I.

It is announced that **Wilmot Packaging Ltd.** is now an independent company. The directors, C. M. Wilmot and David Knightly, have purchased, through a holding company, the whole of the share capital from Harper Engineering & Electronics.

E. B. Banks, M.I.E.E., has been elected president of the **B.E.A.M.A.**, and C. R. Wheeler, C.B.E., has been elected deputy president. Mr. Banks is joint managing director of the English Electric Co. Ltd. and Mr. Wheeler is chairman of A.E.I. Ltd.

C. K. Page has been appointed production manager of **Taylor Electrical Instruments Ltd.**

One of 12 portable transistorized bolometers, ordered from Plessey by the Central Electricity Generating Board, being used on an overhead power line in Southern England. The bolometer detects faults by measuring the increased infra-red radiation set up by an imperfect cable joint. The first prototype has been loaned to the Swedish State Power Board, to assist in locating defective fitting in high-voltage sub-stations. The instrument will detect a temperature difference of better than $\pm 5^{\circ}\text{C}$ at ranges up to 120 ft, and can be used at distances of up to 160 ft under favourable conditions

For further information circle 95 on Service Card



Much of the research and advance development work on products manufactured by **The M-O Valve Company Ltd.** is carried out in the valve laboratories of the Hirst Research Centre, G.E.C. Ltd. M-O V. have now assumed complete financial responsibility for this work, and the valve laboratories at Wembley, together with the M-O V. development laboratories at Hammersmith, will form their research and development division. W. E. Willshaw, head of the Valve Division of the Hirst Research Centre, has been appointed to the board of M-O V. as director responsible for research and development. V. A. Cheesman, technical manager of The M-O Valve Company Ltd., joins the board as commercial director.

The **Richard Sutcliffe Engineering Group** announces the following appointments: Harry Geoffrey Varley, as hydraulics consultant for Richard Sutcliffe Engineering Systems Ltd., based on the Southern Region Sales Office at 28 Savile Row, London, W.1; Jack I. Smith, as works manager of Richard Sutcliffe Ltd. and David Peace as production manager.

Vidor Ltd. announce two sales appointments: John H. F. Wilken, M.A., joins the company as home sales manager, and Frank J. Wood, who last year was appointed general manager of the company, has now assumed responsibility for Vidor's overseas trade and becomes general manager of export sales.

B.I.C.C. Ltd. announce that W. J. J. Curry, B.Sc., Ph.D., M.I.E.E., has relinquished his appointment as director and general manager, Telephone Cables Division, to become managing director of the Indian Cable Company Ltd., a B.I.C.C. associated company, in Calcutta. R. E. Beal, B.Sc., A.M.I.E.E., director and commercial manager, Telephone Cables Division, has been appointed acting general manager of the Division and has already taken up these duties.

Welwyn Electric Ltd. announce that V. R. Warren has been appointed field sales controller. Welwyn also announce the appointment of The Radio Resistor Co. Ltd., Palmerston Road, Wealdstone, Harrow, Middlesex, as stockists and distributors in the U.K.

R. L. Burberry has been appointed sales representative for the home counties by **Chilton-Solenoid (U.K.) Ltd.**

Wayne Kerr Ltd. are transferring their production facilities to larger premises in South Bersted, near Bognor Regis. The transfer will release accommodation for the expansion of the company's laboratories at Chessington and Tolworth. The administrative headquarters remain at Chessington.

The president-elect of the **Electrical Research Association** for 1964/5 is Sir Ronald German, C.M.G. Sir Ronald has been director general of the Post Office since 1960.

A. M. H. Dann, A.C.A., has been appointed company secretary of **Digital Measurements Ltd.** Mr. Dann succeeds R. Chatterton, who will now be free to concentrate on his primary duties as production and works director.

Bedco Ltd. have taken over the Watford factory of Datum Metal Products Ltd. The facilities of the two factories will provide a complete sheet-metal work service to the electronic industry: the Electronic Metalwork Division of Bedco at Harpenden will supply products of non-standard design, while the Datum Metal Products Division will continue to provide the existing range of Datum products.

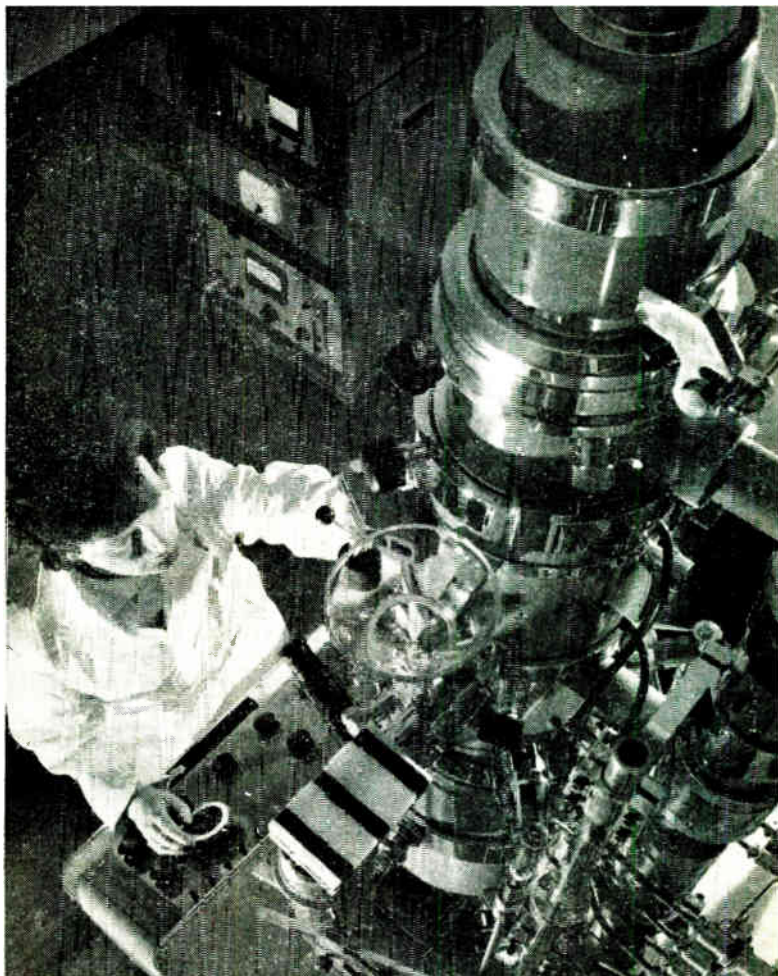

This powerful electron microscope at Standard Telecommunication Laboratories, Harlow, magnifies up to 200,000 times and is one of the instruments used to study the nucleation processes during the evaporation of metallic thin films. Two special 16-mm cameras, one inside the microscope and one outside, are used to record the growth behaviour of the films. The technique in one case involves photographing a fluorescent screen in the path of the electrons: for this the external camera is used. Alternatively an image may be formed directly on the film in the internal cine camera

E. Silberman, chairman of **The Reliance Telephone Company Ltd.**, a member of the G.E.C. Group, has been appointed to the board of the parent company as an associate director.

At the annual general meeting of **Advance Components Ltd.** it was agreed to change the company's name to Advance Electronics Ltd. The appointment of P. G. Moore, A.C.A., as company secretary, has also been announced.

The British Petroleum Company Ltd. has acquired a 60% shareholding in C-E I-R (U.K.) Ltd., which specializes in operational research, business data processing, and computer techniques. The cost of acquisition is £350,000. BP also has an option to take up a further 20% holding within two years.

Obituary

Rank-Bush Murphy Ltd. have announced that G. Darnley-Smith, C.B.E., who founded Bush Radio Ltd. in 1932, died on Easter Monday at Branscombe, Devon. Mr. Darnley-Smith, who was 71, became managing director of the company and was its deputy chairman when he retired in 1962. One of the best-known figures in the radio and television industry, he became chairman of the Radio Industries Council in 1946.

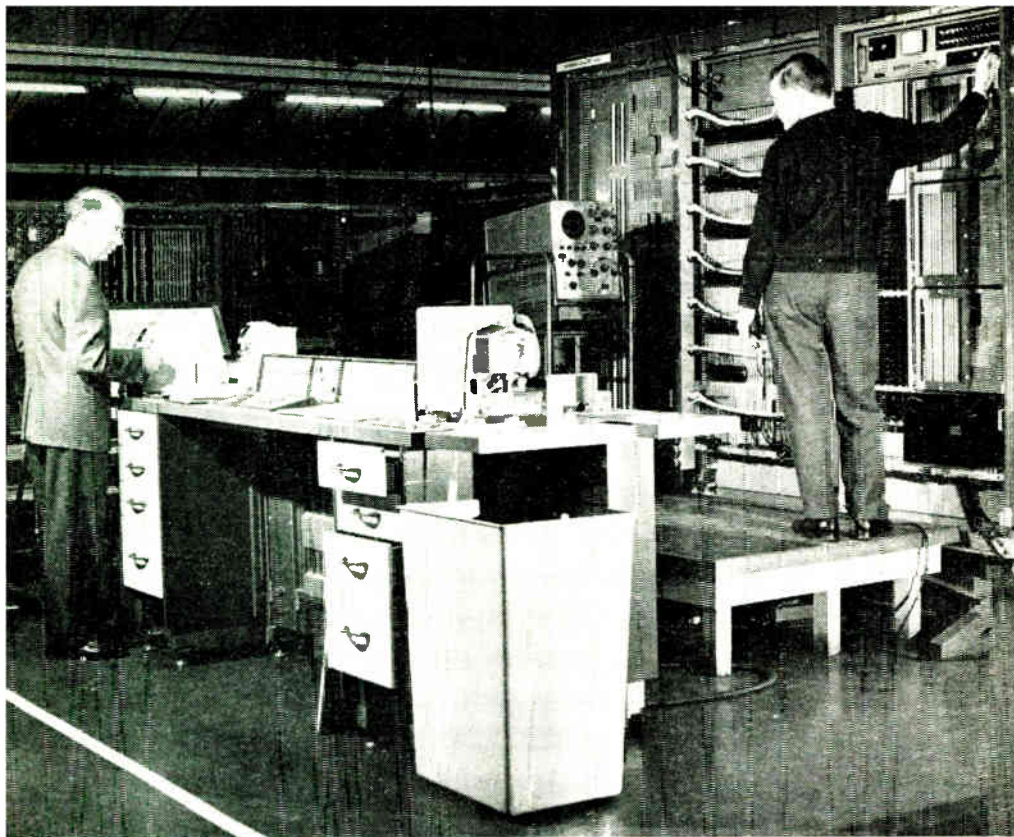

Commissioning an Elliott 503 computer. Within six weeks of the delivery of the first 503 to Tasmania, orders for a total of ten of these high-speed machines have been received. All ten are for scientific or industrial research applications. The average price of the systems so far ordered exceeds £90,000, although the price of a typical basic 503 system is £67,000. The performance of the 503 is exceeding expectations: speeds in excess of 100,000 calculations per second have been achieved—an increase of 10% on the published specification—and in some functions there has been an improvement of more than 20%. Floating point multiplication, for instance, takes only 34 μ sec against the 44 μ sec originally specified

For further information circle 96 on Service Card

Chair of Control Engineering at Bangor

R. J. A. Paul has been appointed to the newly created Chair of Control Engineering within the School of Engineering Science at the University College of North Wales, Bangor. Mr. Paul is at present the deputy head of the Department of Electrical and Control Engineering at the College of Aeronautics, Cranfield. He had wide experience of control engineering in the motor and aircraft industries before going to Cranfield and his recent researches have been concerned with the use of computers in adaptive control systems.

Mr. Paul's appointment fills the third chair in the Bangor School of Engineering Science, the others being electronic engineering and materials technology. The School has grown out of the electrical department which has been in operation for many years. This course has always had and still maintains a close affinity with the basic sciences, particularly physics and mathematics. The undergraduate course in electronic engineering includes general principles of electronics, electrical materials, and electrical machines. In essence it provides a basic course in electrical science, mechanical science and materials science against a background of electronics and control.

More specialized courses are offered for the M.Sc. degree in such subjects as electrical materials science, control engineering, electronic devices and electronic circuits. The number and quality of the applicants for places in the School indicates that there is a large demand for courses of this nature.

Anglo-French Liaison

A new collaboration agreement has been concluded between Hawker Siddeley Dynamics Ltd. and Engins Matra Société Anonyme. Under the terms of the agreement, the two companies will work in close liaison on the research, development and manufacture of all Anglo-French projects that come within their joint fields of specialization—missiles, electronics and space research. The two companies have already worked closely together during the past few years on such products as automatic test equipment.

The Corsair Computer

A contract has been awarded to Rank Cintel by the Ministry of Aviation for the production of the Corsair digital differential analyser, the original design of which came from RAE, Farnborough. This all-transistor machine, designed for the rapid and accurate solution of all forms of differential and other equations, combines the advantages of both digital and analogue techniques. The individual integrators are identical and may be programmed as in an analogue computer; within each integrator, however, the computation is performed digitally. Interconnection of these units is via a patch panel on the front of the instrument.

The Corsair thus retains the accuracy and some of the flexibility of the general-purpose digital computer while having, because of its special organization, the directness of application of the analogue computer. A number of ancillary equipments are also included in the contract to constitute a complete installation; e.g., analogue-to-digital, digital-to-analogue and decimal-to-binary converters.

Integrated Laser Service

As a result of their successful co-operation in the development and manufacture of laser equipment and components, International Research & Development Company Ltd., of Newcastle upon Tyne, and Thermal Syndicate Ltd., of Wallsend, announce the formation of the Nelas Division. This is intended to provide an effective integrated laser service covering the complete field of development, manufacture and marketing of gas and solid-state laser devices, systems, components and accessories.

The four managers of the Nelas Division are J. Elliott, sales manager, and Dr. K. H. Jack, research director, of Thermal Syndicate Ltd., and Dr. H. Rose, research manager, and Dr. F. E. Templeman, commercial manager, of International Research & Development Co. Ltd. As a result of this closer link between the two companies, more efficient production has made it possible to reduce the price of the Nelas ruby laser R.1 from £725 to £625 and of the Nelas gas laser G.1 from £625 to £525.

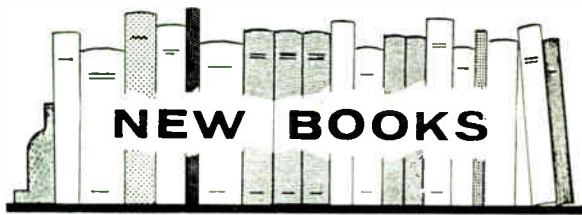

Specification for Radio-Frequency Cables: Parts 1 & 2

British Standard 2316 : Parts 1 & 2 : 1963. Pp. 23. British Standards Institution, 2 Park Street, London, W.1. Price 12s. 6d.

Many interested organizations in the electrical and telecommunications industries—including the Cable Makers' Association, British Radio Equipment Manufacturers' Association, Electric Cable Makers' Federation, British Broadcasting Corporation, the Services and others—have co-operated with the British Standards Institution in the preparation of this new Standard.

This publication covers coaxial and balanced twin cables designed to transmit r.f. power, and gives requirements and tests for the types of cable used by the Services, and in the industrial and domestic fields.

The standard is divided for convenience into three parts, the first two of which are published in one volume. Part 1 gives general requirements and test methods for r.f. cables, while Part 2 details the special type approval and sampling procedures, and any other special requirements, for cables supplied for the use of British Government Services.

Part 3 is published separately in loose-leaf form at a cost of 2s. per sheet: it consists of data sheets setting out the electrical and mechanical requirements for each type of cable, together with engineering information. This form has been adopted for Part 3 to allow for data sheet revisions and additions. A contents sheet is available for Part 3 (at a cost of 2s.), listing the sixty data sheets initially available.

The climatic tests specified in Part 1 of the standard are described in detail in B.S. 2011, 'Basic methods for the climatic and durability testing of components for telecommunication and allied electronic equipment', to which reference must be made.

Sensitivity Indices for Hall Generators

By SHERWIN RUBIN and GEORGE J. ROGERS. Pp. 22. Published by U.S. Department of Commerce, National Bureau of Standards, and available from Superintendent of Documents, U.S. Government Printing Office, Washington, D.C. 20402. Price 20 cents (postage 5 cents extra).

When a current-carrying conductor is acted upon by a magnetic field a voltage will be set up across the conductor in a direction perpendicular to the direction of the current. This is the Hall effect. The voltage is the Hall voltage, and it is a function of the product of the current and the component of the magnetic field normal to the current path.

The sensitivity of any device may be defined as the ratio of output response to a specified change in the input variable. Since the output of Hall generators is proportional to the product of two inputs magnetic induction and control current, the product sensitivity (the ratio of Hall voltage to the product of control current and magnetic induction) has long been used to characterize the sensitivity of these devices. Product sensitivity is useful when the application depends upon the product relationship between two inputs, for example, when the Hall generator is used to measure power or for analogue multiplication and division. However, Hall generators are also used to measure magnetic induction, and in other applications in which one of the two

input variables is held constant. In these cases indices are needed which express the sensitivity of the Hall generator output to either control current or magnetic induction independently of the other. In addition, product sensitivity is defined only in the linear case; i.e., when it is assumed that the Hall generator characteristic can be closely approximated by a straight line through the origin. But small-signal applications do not depend on the linear characteristics of the Hall generator, and are not confined to the linear region of operation. For these applications, the definitions for control-current and magnetic sensitivity must be extended to include the small-signal case, especially since a small-signal product sensitivity is not now available in a useful form.

For these reasons, two additional sensitivity indices have been developed to deal with situations requiring knowledge of the Hall output sensitivity as a function of one of the two inputs, when the other is held constant. These indices are derived in this NBS Technical Note 233. Relations between the new indices and between either of them and the product sensitivity index are also given. It is shown that any one of the three sensitivity indices can be derived from any one of the other two, and an example of a derivation is given.

Automatic Data Processing

By FREDERICK P. BROOKS, JR. and KENNETH E. IVERSON. Pp. 494 + xxv. John Wiley & Sons Ltd., Glen House, Stag Place, London, S.W.1. Price 80s.

There are nine chapters in this book. In the first, 'Fundamentals of Data Processing', number systems, symbolic logic, binary coding, and error detection are treated among other related matters. The treatment is brief and will no doubt be useful as an *aide memoire* to those who have previously studied these matters. It is, however, inadequate for the newcomer to the subject.

Chapter 2 is entitled 'Manual Data Processing'. Initially, it comprises little more than explanations of the meanings of terms such as archives, accounting, accrual, balance sheet, profit and loss statement, ledger and so on. Mechanical aids, such as the cash register, are touched upon and then methods of reproducing documents are described ranging from carbon paper to printing and photo-copying. Sorting and filing are mentioned and the principles of some mechanical calculators are briefly explained.

In Chapter 3 'Punched card equipment' is dealt with. Here the cards and key punches are described and ancillary equipment such as verifiers, sorters, collators, tabulators, calculators, etc., are treated in diagrammatic fashion. The discussion of these things is really too condensed to be readily followed by the beginner.

The remaining chapters cover computer coding, computer organization, programming, searching and sorting, metaprograms, and system design. These chapters are much more complicated than the three early ones.

The authors claim that the material is presented in a form appropriate to a two-semester course for college seniors, that the chapters are largely independent and may be used in various combinations for shorter courses and, particularly, that the book is suitable for self-study. Their only reference to prior knowledge on the part of the student is to mathematics. They assume a certain mathematical maturity but they also say college algebra suffices, which does appear rather contradictory.

Since the authors say nothing about it, there is an implication that the user of the book need have no prior knowledge of data processing or computers. However, anyone who does not have a good deal of prior knowledge is unlikely to make much headway.

The book is stated to have grown out of a graduate

course at Harvard and presumably that course proved successful. It can only be concluded that the tutors provided the additional material needed to make much of the book intelligible.

The authors appear to be so soaked in their subject and so familiar with its jargon that they do not realize the difficulties of the newcomer to it. They write so tersely and use so little redundancy that for any understanding of what one reads it is necessary to have at one's finger tips all that has come before.

Composition Variable Resistors (For Use In Telecommunications and Allied Electronic Equipment): Part 1, General Requirements and Tests

British Standard 2122: Part 1: 1964. Pp. 32. British Standards Institution, 2 Park Street, London, W.1. Price 15s.

General requirements and tests for composition variable resistors are given in this Part 1 of the latest of a series of standards, published by the BSI, for components used in telecommunications and allied electronic equipment.

The aim of the series is to ensure that components will function satisfactorily even when subjected to extremes of temperature and humidity, and of mechanical shock such as might be experienced during transit or while in operation. The tests also check the ability of components to withstand normal assembly processes such as soldering.

Most of the tests required by this standard are described in detail in B.S. 2011 'Basic methods for the climatic and durability testing of components in telecommunication and allied electronic equipment'.

Part 1 of the new standard, B.S. 2122, gives requirements for variable resistors of composition track type, with or without switches, for mains applications, having a nominal track resistance within the range 100 Ω to 2.2 Ω .

Part 2 of the standard will provide a list of standard sizes and ratings.

Universal Decimal Classification: English Edition

British Standard 1000 (621.3): 1964. Pp. 67. British Standards Institution, 2 Park Street, London, W.1. Price B.S. 1000 (621.3), £2; B.S. 1000A, £3.

Librarians, information officers, and specialists in many fields are already familiar with the Universal Decimal Classification (UDC) system which makes for rapid information-retrieval on any subject. It is a classification system which ranges over the whole field of knowledge and can be used for the arrangement of literature—text-books, pamphlets, patents and so on—as well as for the arrangement of entries in catalogues, indexes, abstracts and bibliographies.

Versions of the UDC are now published in English, French, German, and several other languages (including Russian). The B.S.I. is responsible for the English version and has published an abridged edition (B.S. 1000A: 1961) and a full edition, which is issued in separate sections as parts of B.S. 1000.

The section for electrical engineering, B.S. 1000 (621.3), has recently been brought fully up to date. The new edition makes better provision for such topics as amplifiers, oscillators and pulse generators, networks and waveguides, solid-state and photoelectric electronic devices, particle accelerators, electronic tubes and signal quality. Important sections dealing with, for instance, electric lamps and electric heating, telegraphy and telephony, television, and radar and radio, have also been revised, and the index has been greatly expanded.

Specialists on the subject will need not only this publication but the abridged edition, B.S. 1000A, which contains a full introduction to the use of UDC and a synopsis of the whole system.

Manufacturers' Literature

Microwave Valve Reference Chart. This quick-reference chart contains abridged information on the current range of Mullard magnetrons, klystrons and travelling-wave tubes. Separate tables allow selection by power, frequency or type number. Data on the characteristics of associated rectangular waveguides has also been included.

Mullard Ltd., Transmitting & Microwave Valve Division, Mullard House, Torrington Place, London, W.C.1.

For further information circle 97 on Service Card

Stability of Permanent Magnets. A general introduction to the subject, a table classifying the causes of permanent-magnet instability, and four tables giving relevant characteristics for various materials, are included in this 6-page technical bulletin. *Permanent Magnet Association, 301 Glossop Road, Sheffield 10.*

For further information circle 98 on Service Card

Selective Expansion Meters. A 4-page brochure dealing with the theory and operation of Greibach selective expansion meters, together with details on calibration, protective features and construction. Specifications, typical ranges and prices of d.c. ammeters and voltmeters are shown.

Greibach Instruments Corporation, 315 North Avenue, New Rochelle, N.Y., U.S.A.

For further information circle 99 on Service Card

STC Ministac Manual. Comprehensive information on the Ministac system of modular-circuit construction is given in this well-illustrated 36-page manual. Its prime purpose is to enable design engineers to specify their requirements for modular frames or complete modules. Detailed sections describe manufacture and assembly, design examples, component mounting methods, packing densities, etc.

STC Semiconductor Division (Rectifiers), Edinburgh Way, Harlow, Essex.

For further information circle 100 on Service Card

Control Knobs. A wide variety of single and double knobs for electronic equipment is covered in this 10-page catalogue. Listed with illustrations and brief specifications are knobs made from phenol, urea and impact polystyrene plastics, ranging in diameter from $\frac{1}{2}$ in. to 2 $\frac{1}{2}$ in.

Barclay-Stuart (Plastics) Ltd., Brunswick Street, Luton, Beds.

For further information circle 101 on Service Card

Electrical Instruments Short Catalogue. A 36-page illustrated publication giving abridged specifications and performance data for several hundred electrical instruments, including a number of recently introduced items. An index is provided.

Cambridge Instrument Co. Ltd., 13 Grosvenor Place, London, S.W.1.

For further information circle 102 on Service Card

Grating Spectrophotometers. Details of the Perkin-Elmer models 237 and 337 grating spectrophotometers, designed for high-resolution throughout the fundamental infra-red range, are provided in this illustrated 10-page brochure.

Sales Department, Perkin-Elmer Ltd., Beaconsfield, Bucks.

For further information circle 103 on Service Card

Benefits of Good Design. D.S.I.R. have published a 26-page booklet of case-studies in engineering design, which illustrates the Fielden Committee recommendations. The re-design of seven products is reviewed and the resultant marketing benefits clearly shown.

The Library, D.S.I.R., State House, High Holborn, London, W.C.1.

For further information circle 104 on Service Card

A.C. Line Voltage Regulators. A 4-page brochure describing the Kelk range of 'Stedivolt' a.c. line voltage regulators, with single- and 3-phase models rated from 800 VA to 350 kVA.

George Kelk Ltd., 5 Lesmill Road, Don Mills, Ontario, Canada.

For further information circle 105 on Service Card

PLUGS & SOCKETS

IMMENSE RANGE—IMMEDIATE DELIVERY

AMPHENOL

Co-axials
Microphone
MS range
MS Type Hermetic Seal
MS Type Minnie
Printed Circuit

SERIES 26, 57, 67, 69, 75,
77, 78, 80, 86, 91, 97, 126,
133, 143, 165, 172

BELLING & LEE

Co-axials
Screenectors
Unitors

CANNON

MS Range

ELCO

Edge Connectors
Micro-Miniature Varicon
Printed Circuit
Rack & Panel
Varicon

ETHER

Miniature
Printed Circuit
Sub-Miniature

*Additional British Types under A.M. sections 5A, 5B, 5C, 5D, 5X,
10H, 105G, 105X, 110H.*

*Joint Service 'Z' No's, Army ZA No's, Admiralty AP No's, Nato
Part No's and P.O. Types.*

KINGS

Co-axials
UG Range (Including
Captive Contacts)
SERIES BN, BNC, C, HN,
LC, LT, PULSE LN, N,
UHF, TWN, KG, TNC,
KP, SM, KM, TPS

MC MURDO

DEE Range
Octal Plugs and Sockets
Printed Circuit Edge
Red Range
Standard Range
Strip Connectors

MAGNETIC DEVICES

Miniature Sealed Co-axials
Multi-way Back Mounting

MK. IV

Aluminium
Brass

PAINTON

Heavy Duty Multicon
Maxicon
Microcon
Miniature Jones
Multicon
Printed Circuit
159 Series

THORN

MS Range
Miniature Bayonet Lock Range

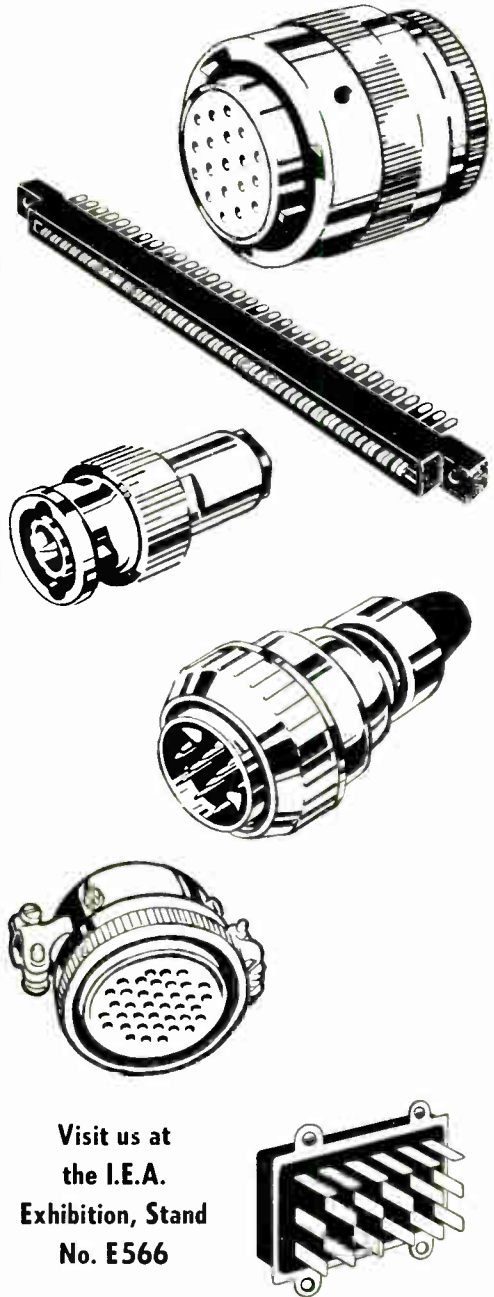

A Products List Covering The Complete Range Of Electronic Components Stocked By SASCO Available Upon Request

SASCO

STEWART AERONAUTICAL SUPPLY CO. LTD.

Gatwick Road, Crawley, Sussex.

Tel: Crawley 28700

Telex No. 87131 Cables: SASCO, Crawley, Telex

For further information circle 255 on Service Card

WANTED?

**LGL are at IEA
on STAND G84**

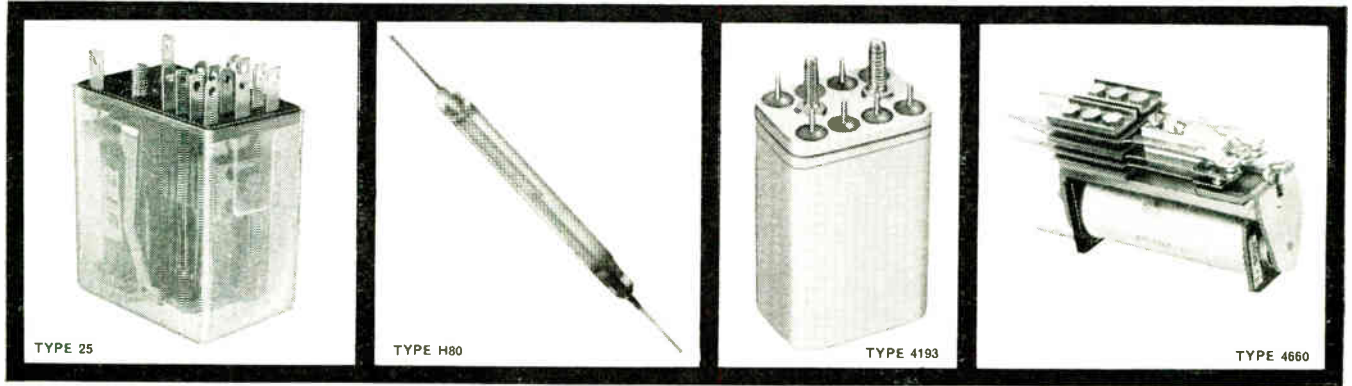

MIDGET RELAY

DRY REED

HERMETICALLY SEALED

HEAVY DUTY P.O. TYPE

STC RELAYS ARE EX-STOCK FROM



LIVINGSTON CONTROL LIMITED

Greycaines House Bushey Mill Lane N. Watford Herts Tel: Watford 41291

For further information circle 256 on Service Card

A unique and indispensable guide to prominent people in the electrical industry

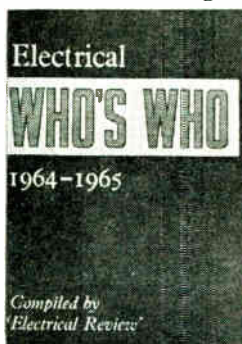

1964-1965 Electrical Who's Who

This is the eighth edition of ELECTRICAL WHO'S WHO, the established guide to prominent people in all branches of the electrical industry, and in related organisations such as Government Departments. Every entry has been carefully checked, particular attention having been taken of the many reorganisations by electrical manufacturers. Executives, technologists, consultants — everyone in the industry will find ELECTRICAL WHO'S WHO 1964-1965 even more useful and necessary than its predecessors.

55s net

by post 57s 3d
9" x 6" 534 pp

obtainable from leading booksellers

Published for 'Electrical Review' by

ILIFFE Books Ltd DORSET HOUSE STAMFORD ST LONDON SE1

For further information circle 257 on Service Card

An important book—the first fully comprehensive work to appear in this field

ultrasonic flaw detection in metals

Theory and practice

B. Banks, A.M.Inst.W., Hon.F.N.D.T.S.

G. E. Oldfield, A.Met., A.I.M.

H. Rawding, A.N.D.T.S.

This book covers what is now one of the most important branches of the new science of non-destructive testing. The use of ultrasonics extends from the examination of material before initial working to the subsequent periodic examination of components and structures after installation to detect flaws caused by such factors as metal fatigue or irradiation. Invaluable to all engineers connected with quality production and, above all, gives the Test Inspectorate the "know-how" which otherwise would take many years of personal experience to acquire.

63s. net by post 64s 297 pp. 168 illustrations

obtainable from leading booksellers

Published for WELDING AND METAL FABRICATION by ILIFFE Books Ltd.

Dorset House Stamford Street London S.E.1

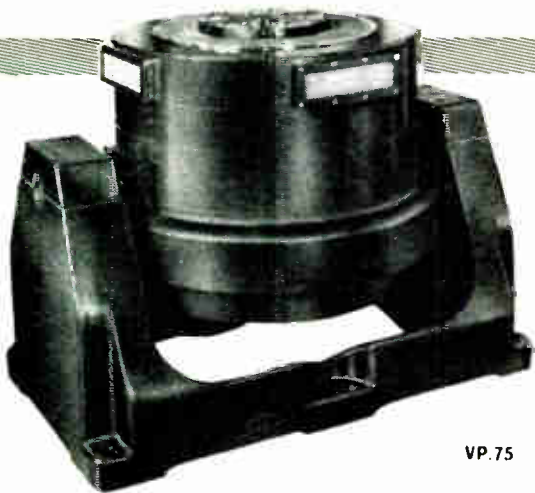
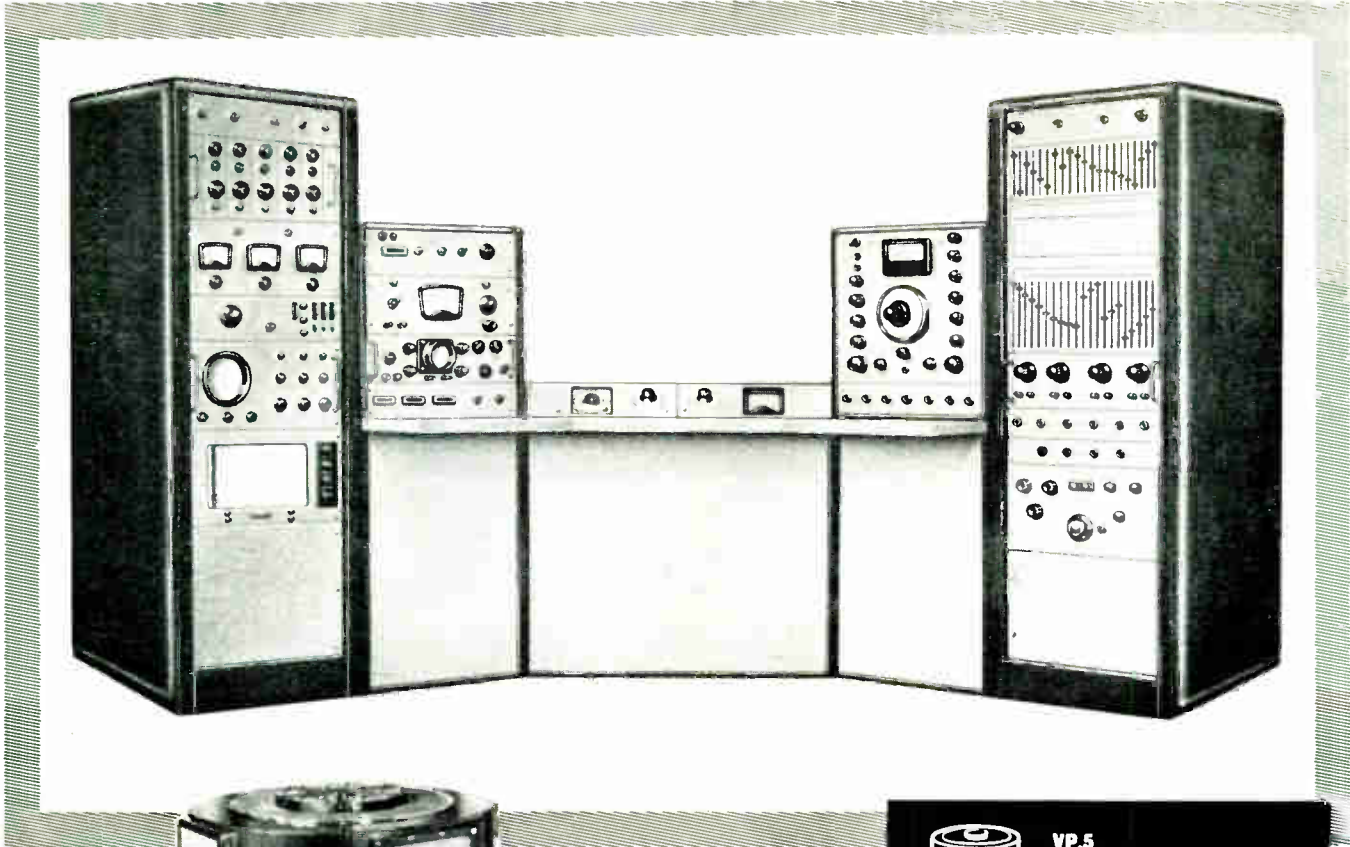

VP.75

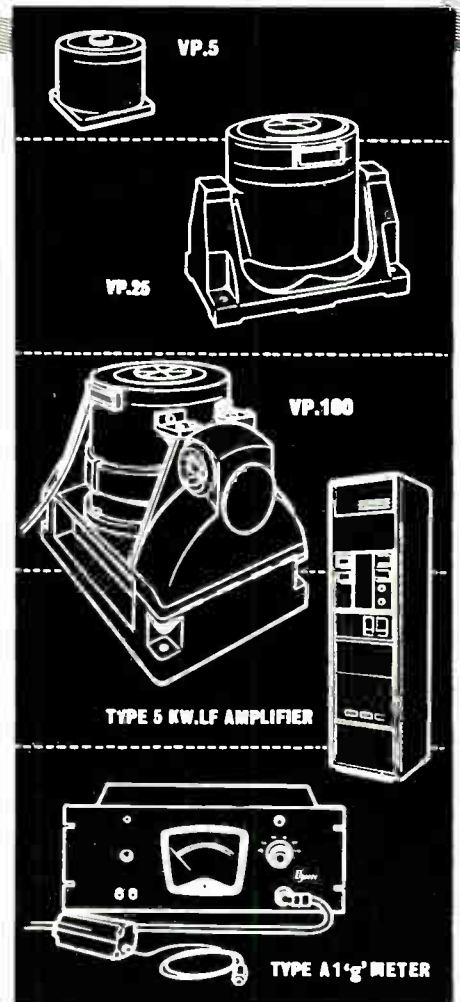

VIBRATION TESTING

When one considers the failure of an aircraft, rocket, motor car, or any equipment, due to inadequate development, the cost of environmental testing is not as expensive as might, at first sight, appear. It is a necessary requirement to establish the performance and life of all structures and components. Our resources enable us to offer complete Vibration Test Systems whether sine wave or complex fully automatic Random Noise.

For further details or copy of our illustrated booklet "Vibration Test Systems", please write direct to our Sales Office:-



DERRITRON ELECTRONIC VIBRATORS LTD

24 Upper Brook Street, London W1 Telephone Hyde Park 2291

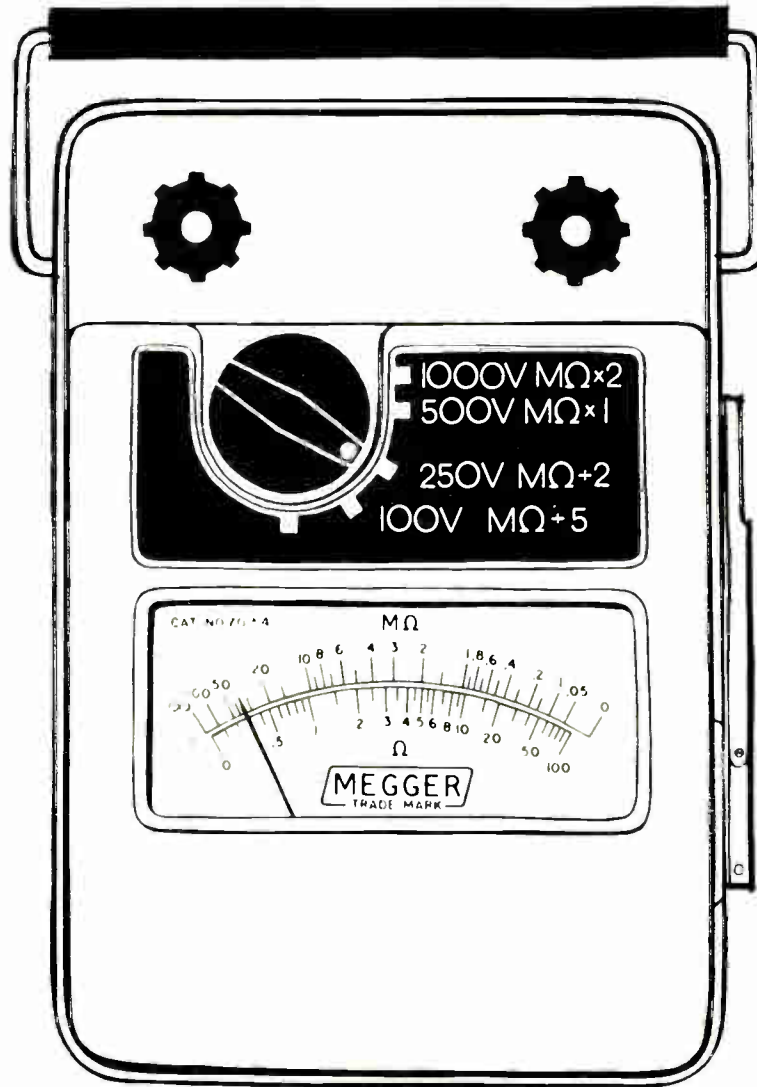

Meet the new Major 'Megger' testers!

Widest range of insulation tests with only four instruments. Compact and versatile, these four new 'Megger' instruments provide the convenient answer to all insulation and continuity test needs. All have testing voltages of 100, 250, 500 and 1,000 with corresponding insulation ranges. Three are of the low range type and incorporate a continuity range. The high range instrument has a 'discharge' position on the range switch instead of a continuity range; a guard terminal is also fitted on this tester. Major 'Megger' testers are enclosed in a robust steel case, size 7" x 4½" x 5⅜", and each instrument weighs only 5½ lb. Write for details and prices, or contact leading wholesalers.

Insulation range megohms	Continuity range ohms	Catalogue Number
0-200	0-100	70154
0-200	0-10,000	70155
0-2,000	discharge position	70156
0-100	0-500	70157



Stand No. G 53 I.E.A. Exhibition

Evershed & Vignoles Ltd · Instrument Division · Acton Lane Works · Chiswick W4 · Telephone: CHiswick 3670

TW659

'ENGLISH ELECTRIC'

HIGH QUALITY Instrument Cathode Ray Tube

T948 5-inch P.D.A.
Mesh Tube for Wide-band
High-speed Oscilloscopes

- HIGH X and Y sensitivities of 9V/cm and 3V/cm respectively.
- EXCELLENT BRIGHTNESS giving high writing speeds and negligible distortion.
- GOOD SENSIBILITY with small spot size.
- UNIFORM DEFLECTION SENSITIVITY with changes of screen potential from 6.0 to 15kV.
- MINIMUM deflector plate inductance and interplate capacitance.
- VERY LOW background illumination.

The **English Electric** high quality instrument cathode ray tube, T948, has been designed for precision wide-band high speed oscilloscope applications. Its special post deflection accelerator mesh and advanced gun design provide the many features essential for modern transistorized oscilloscopes. The T948 has a flat clear glass faceplate and an aluminised screen. It is available with two phosphors; blue green (equivalent to P31) suffixed 'H' and yellowish/green (equivalent to P2) suffixed 'N'. Both phosphors have medium short persistence. *Write for full information on the T948, 'H' and 'N' and other EEV instruments, projector, monitor and radar display tubes.*

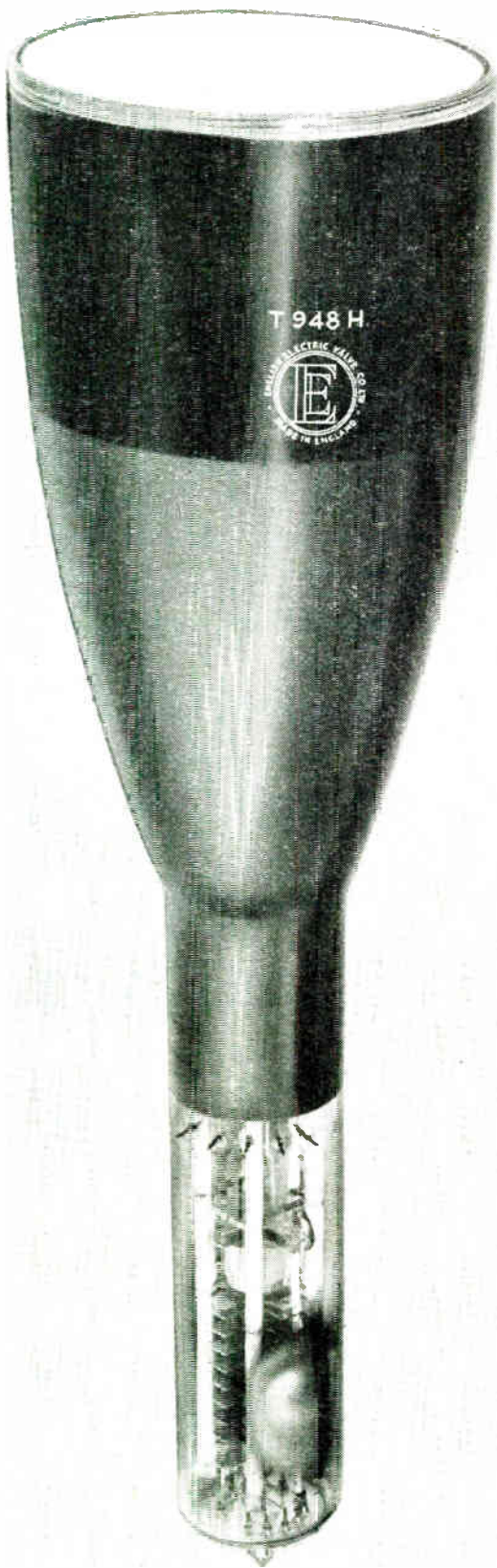

ENGLISH ELECTRIC VALVE COMPANY LIMITED

AGENTS THROUGHOUT THE WORLD

Chelmsford, England. Telephone: Chelmsford 3491



SEMICONDUCTORS FOR ELECTRONICS

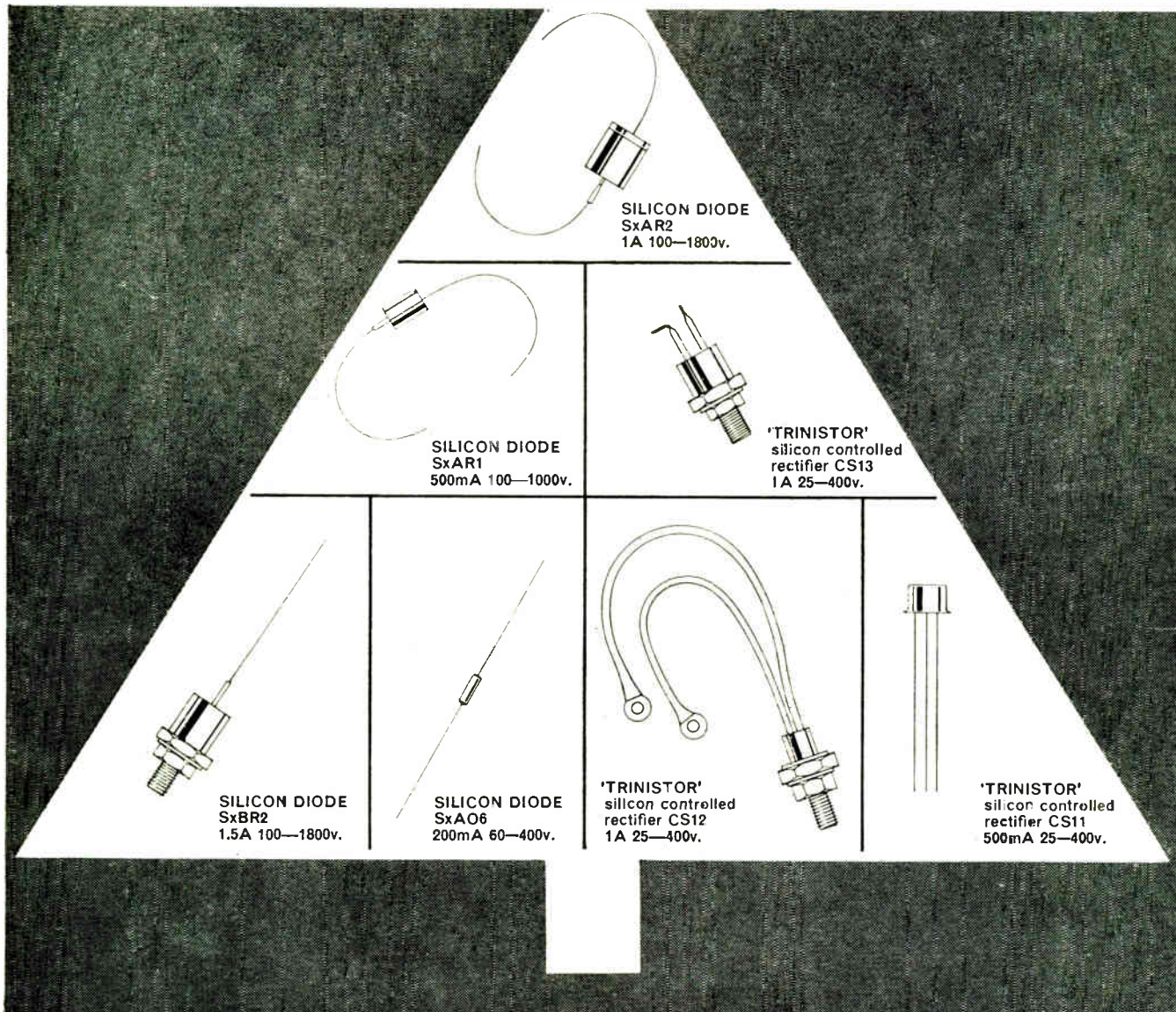

Please write for full details to: Dept. IE5/64, Rectifier Division, Semiconductor Dept.
WESTINGHOUSE BRAKE AND SIGNAL CO LTD
82 York Way, King's Cross, London, N.1. Tel: TERminus 6432 Telex No 2-3225

VISIT STAND No. N.165

I.E.A. EXHIBITION, OLYMPIA, 25-30 MAY 1964

...and YET ANOTHER STEP

FORWARD...



An improved AvoMeter

Model **8** Mk III



This new model incorporates increased sensitivity in the lower AC ranges and wide frequency characteristics, with the traditional AvoMeter features including the AVO automatic cut-out mechanism and interlocking rotary switches for quick range selection.

I.E.A. Exhibition
Stand N.176
Olympia May 25-30

Fused ohms circuit provides increased protection against inadvertent overload.

Improved temperature coefficient over whole range.

Now measures up to 400 amps d.c.

AVO LTD AVOCET HOUSE · 92-96 VAUXHALL BRIDGE ROAD · LONDON · S.W.1

Telephone: VICTORIA 3404 (12 lines)



A8/9

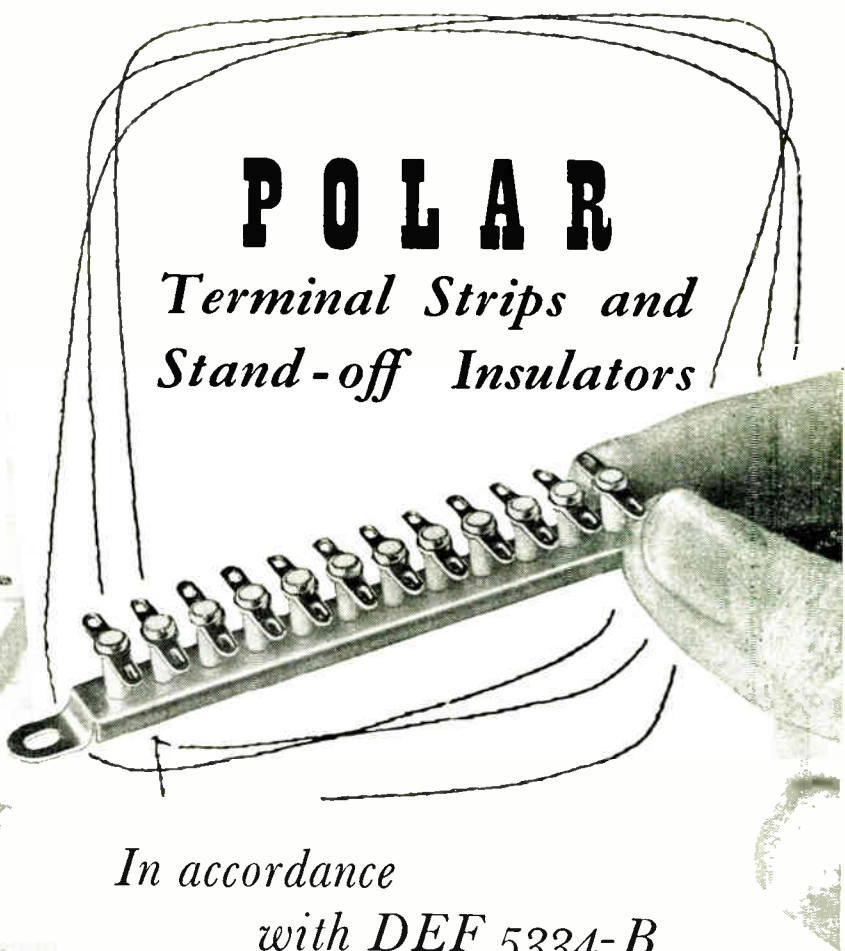
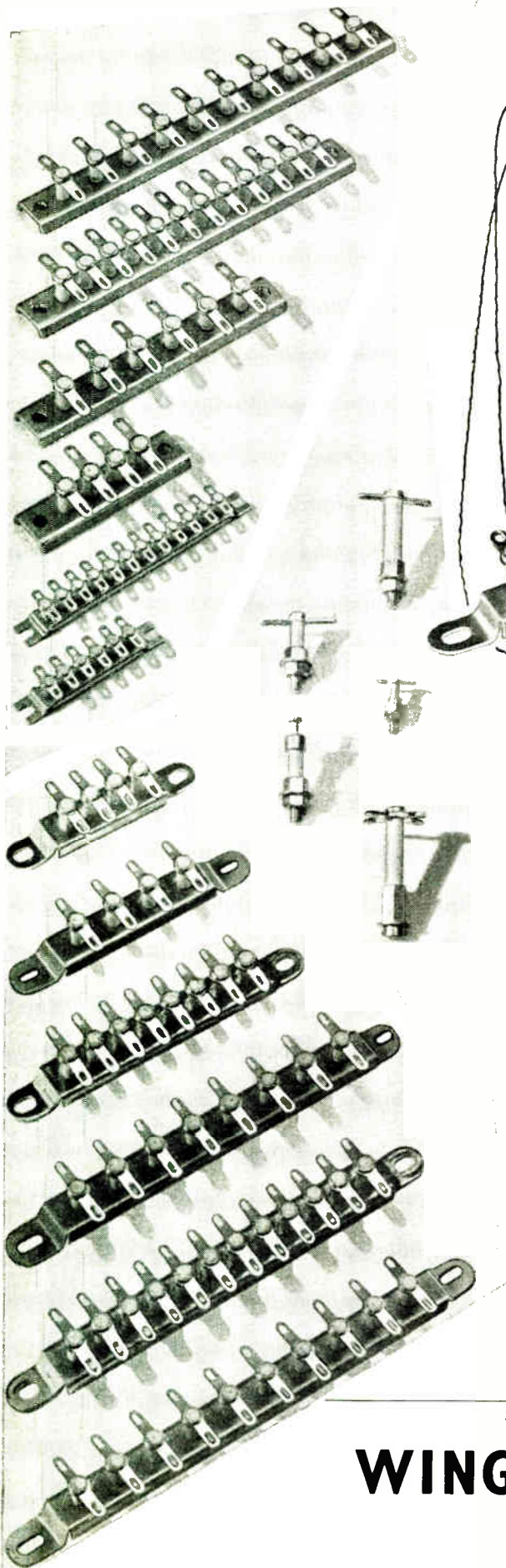

POLAR

Terminal Strips and Stand-off Insulators

In accordance with DEF 5334-B

Suitable for all forms of assembly, these high efficiency inexpensive Terminal Strips and Stand-off Insulators are available in a wide range of sizes.

The Stand Off Insulators are mounted by means of Screwed Stems or Tapped holes. Connections may take the form of Tags, Spills or Screwed Stems.

Terminal Strips in Cadmium plated steel with pillars of sintered aluminium oxide, are available in several types with $\frac{5}{16}$ " $\frac{1}{4}$ " or $\frac{3}{8}$ " spacing between terminals. Insulation resistance better than 10,000 megohms.

P.T.F.E. leadthroughs and stand-offs also available. Specialists in high-grade variable capacitors.

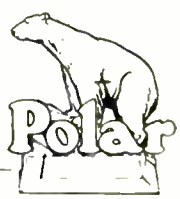

Samples and Prices on application to Department i.E.

WINGROVE & ROGERS LTD.

HEAD OFFICE: Domville Road, Old Swan, Liverpool, 13.
 Phone: Stonecroft 2265 Grams & Cables: Components Liverpool
 LONDON OFFICE: Paramount House, 75 Uxbridge Road, Ealing, W.U. Tel: EALing 1046

Murex MAGNETS

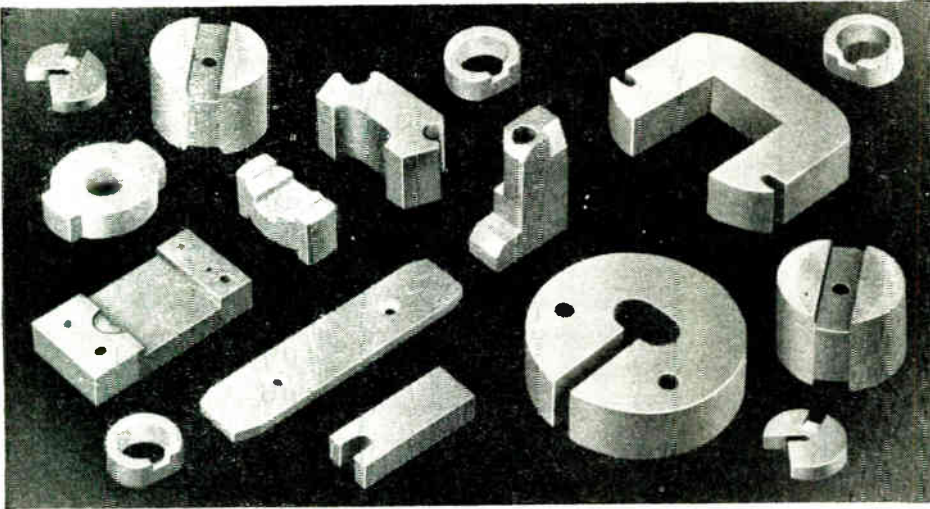

High quality, small size,
sintered permanent magnets
for a wide range
of applications

Qualified technical staff available to advise
on magnet design and performance.
Technical catalogue on request.

Loudspeakers
Moving Coil relays
Kilowatt hour meters
Polarised relays
Protective switchgear
High speed generators
Alternators
Volts meters
Ampere meters
Exposure meters
Microphones
Earphones
Hearing aids
Gramophone pick-ups
Thermostats
Timer switches
Level indicators
Water meters
Electric motors
Gyroscopes
Torque motors
Synchronous motors
Hysteresis motors
Flowmeters
Valves (magnetic)
Magnetometers
Filters
Pressure gauges
Calendars
Toys
Telephone call timers
Vibrating reedconverters
Jewellery
Radar equipment
Guided missiles
Ohm-meters
Sump plugs
Automatic lens control
Trigger switch
Flux meters
Automatic transmission
Galvanometers
Fuel gauges
Speedometers
Laboratory stirrers
Electric clocks
Vibrators high speed
Automatic train signals
Aircraft engine Tachometer
generators
Aircraft engine speed
indicators
Aircraft navigation equipment
Aircraft homing indicators
Temperature controllers
Micro switches
Pneumatic valves
Conveyor systems
Crack detectors

MUREX LTD · RAINHAM · ESSEX

(Powder Metallurgy Division)

Telephone: Rainham, Essex 3322 • Telex 28632 • Telegrams: Murex, Rainham-Dagenham Telex

SUB-MINIATURE LAMPS FROM THORN

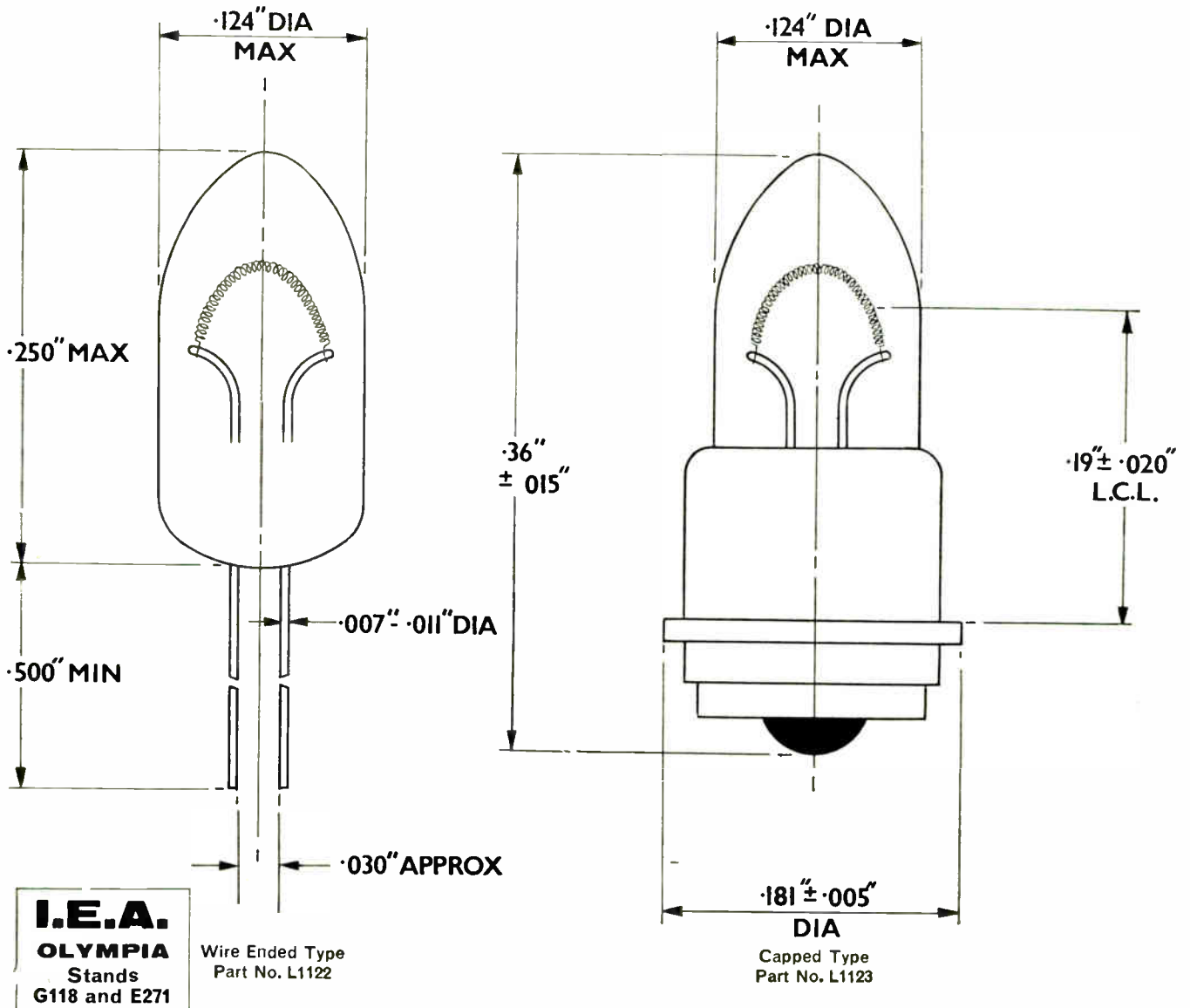

As a result of extensive development work by the laboratories of Atlas Lighting Limited, Thorn Electronics now offer a sub-miniature lamp that combines small size with robustness and long life. It is available in capped and non-capped versions and is particularly suitable for integrally lit aircraft instruments and similar applications

- * Positive and uniform positioning of filament
- * Precision made bulb to extremely close tolerances
- * Highly efficient light source
- * Little power demand and uniformity of light output

SPECIFICATION

Voltage	Current	Lumens	Average life (hours)
6.0	0.070 ± 10%	0.75 ± 25%	5,000
5.0	0.060 ± 10%	0.35 ± 25%	60,000

Now available: Lampholder assembly for L1123 version with red, green, blue and amber caps to BS 1376 : 1953



For full details please write to:

Thorn Electronics Limited, SPECIAL PRODUCTS DIVISION,
105-109 Judd Street, London, W.C.1. Telephone: Euston 4433

DTV 19

COSSOR

1964

I.E.A. Stand G30

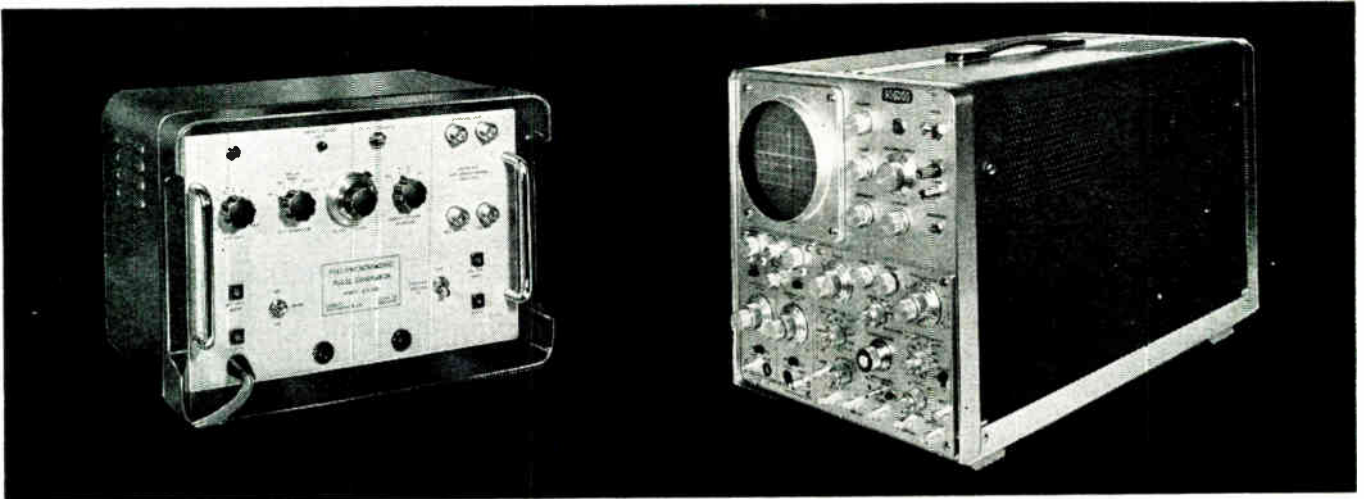

TWO NEW INSTRUMENTS FROM THE COSSOR 1964 RANGE

Setting the standard for years to come is the solid state **modular oscilloscope series CD100**. This oscilloscope which represents many years' research and development effort comprises a frame containing the C. R. T., power supplies, and an aperture which accepts two modules. Typical modules include single and dual trace amplifiers with bandwidths up to 35 Mc/s and sensitivities down to 500 $\mu\text{V}/\text{cm}$; sweep generators, some with delayed sweep; sampling units with bandwidths up to 100 Mc/s; swept frequency oscillator heads for spectrum analysis up to 1,000 Mc/s. Of great interest too, is the **pulse generator CG200**. The output pulse rise-time does not exceed 0.7 nanoseconds up to the maximum output of 100V and the output can be of either polarity.

COSSOR

For full specifications please write to:-

COSSOR INSTRUMENTS LIMITED

THE PINNACLES, HARLOW, ESSEX, ENGLAND. TELEPHONE HARLOW 26862

when quality counts...



SODECO COUNTERS

SODECO electromagnetic counters are designed for use in modern production control and data handling systems where absolute reliability is essential.

IMPULSE counters convey the total of events in an easily read in line register.

PREDETERMINING counters supply a control function after a predetermined number of counts. They also provide visual read out.

PRINTING counters are particularly important wherever speed or complexity of instrumentation exceed human ability. Remote events are registered and permanently recorded on paper tape.

All counters can be situated separately or in banks at the point where they can be most easily read.

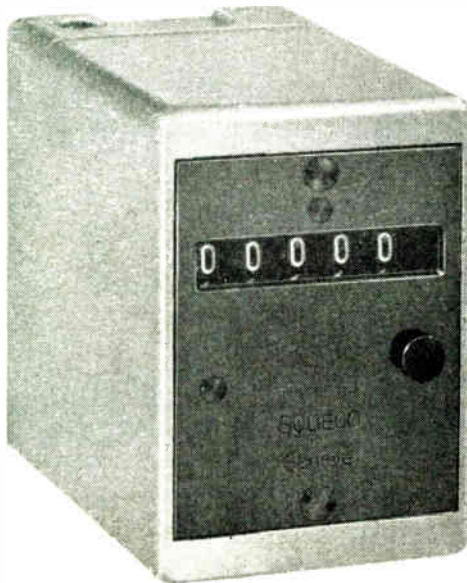

The new TCeB counter illustrated above is more compact than the well known TCE model. Counters having 5 or 6 figures are standard and have maximum speeds of 10 i.p.s. for A.C. and 25 i.p.s. for D.C. operation. The life expectancy is in excess of 200 million counts. Manual push button or non resettable features are offered.

The size of figures which are white on a black background measure 0.08" wide 0.16" high.

The Flush Mounting unit is 1.654" wide 2.047" high 2.677" depth. Projecting Pattern 1.969" wide 2.756" high 3.268" depth. Base fixing centres 1.181" x 2.047".

Both mechanisms are protected against dust and unauthorised entry by means of sealed housings.



PRODUCTS
MEASURE
COUNT CONTROL
PRECISELY

LANDIS & GYR LTD
VICTORIA ROAD
ACTON · LONDON W3
ACORN 5311

ESSENTIAL

for sampling
and
monitoring

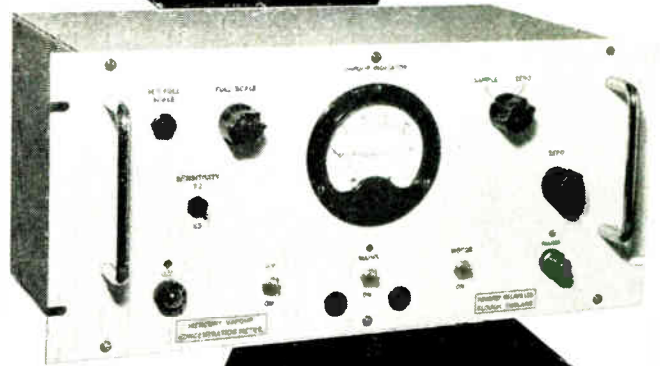

HENDREY

Mercury Vapour Concentration Meter

Type E 3472

Hendrey Relays

See the Hendrey Range
on Stand No.
G.378 (first floor)
I.E.A. Exhibition
Olympia,
May 25th—31st

HENDREY RELAYS LTD. 390-394 BATH ROAD · SLOUGH · BUCKS

Telephone: Burnham 609 611 Telegrams: "Hendrelay", Slough

MANUFACTURING ELECTRICAL ENGINEERS
CONTROL AND LABORATORY APPARATUS

On Admiralty, Principal Ministries and Post Office Lists.
A.R.B. & M.O.A. Approved Design & Inspection



NEW

Bendix®

BIG LEAF TRANSISTORS

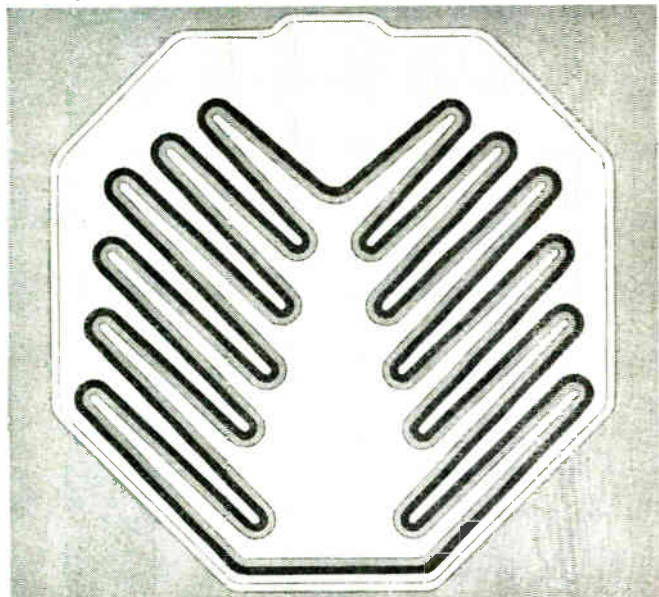

Bendix Silicon 'Big' Leaf Planar Epitaxial NPN Power Transistor

... highest power-frequency combination in the industry

Now with 12 digits instead of six, and 40% greater emission area. This range of leaf transistors will give you Class C power outputs of 25 watts, and gain-bandwidths up to 300 mcs. Applications include HF mobile and portable transmitters; high current switching and high frequency inverters; HF, VHF, Class A and Class C amplifiers and oscillators. 'BIG' stands for *Bendix Interdigitated Geometry*. It stands for still greater overall efficiency—even than its predecessors.

4 FULL RANGES OF SPECIALISED SEMI-CONDUCTORS

- SILICON LEAF TYPE POWER TRANSISTORS
- SILICON POWER VARACTOR DIODES
- GERMANIUM DIFFUSED ALLOY POWER TRANSISTORS
- SILICON POWER RECTIFIERS



Full information from the U.K. Distributors for Bendix International Operations, the Bendix Corporation.—

FieldTech Ltd

LONDON AIRPORT · HOUNSLOW · MIDDLESEX
 Telephone: SKYport 2141 · Telex 23734 · Cables: Fieldtech Londonairport

WHITELEY

Epoxy Resin Mouldings

I.E.A.
 Exhibition
 Stand
 N201

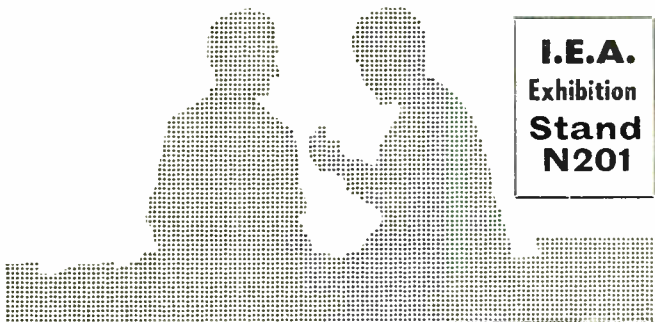

Great mechanical strength, excellent electrical insulation and complete climatic protection are ensured in Whiteley Epoxy Resin mouldings. Low shrinkage and strong adhesion to components and leads renders these Resins particularly suitable for encapsulation. Full details will be gladly sent on request.



Line Isolating Transformer

Transformer Y.17525 is a low loss audio frequency transformer, for use as an isolating transformer on circuits employing 17 c/s signalling, i.e. Post Office telephones. The insulation of the 'line' winding provides isolation against voltage surges of up to 25 KV rms. and continuously applied voltages of 14 KV rms. Please write for full details.

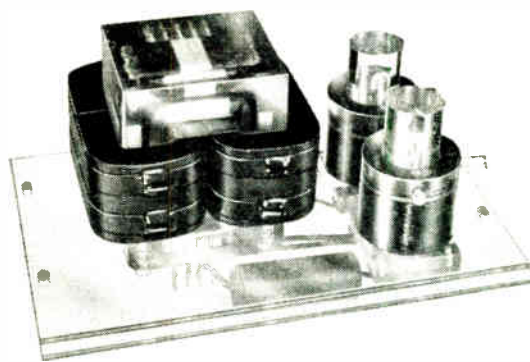

WHITELEY ELECTRICAL RADIO CO LTD

MANSFIELD · NOTTS Tel: Mansfield 1762/5

WB171A

For further information circle 271 on Service Card



Direct Reading Resistance Bridge

ONE KNOB OPERATION

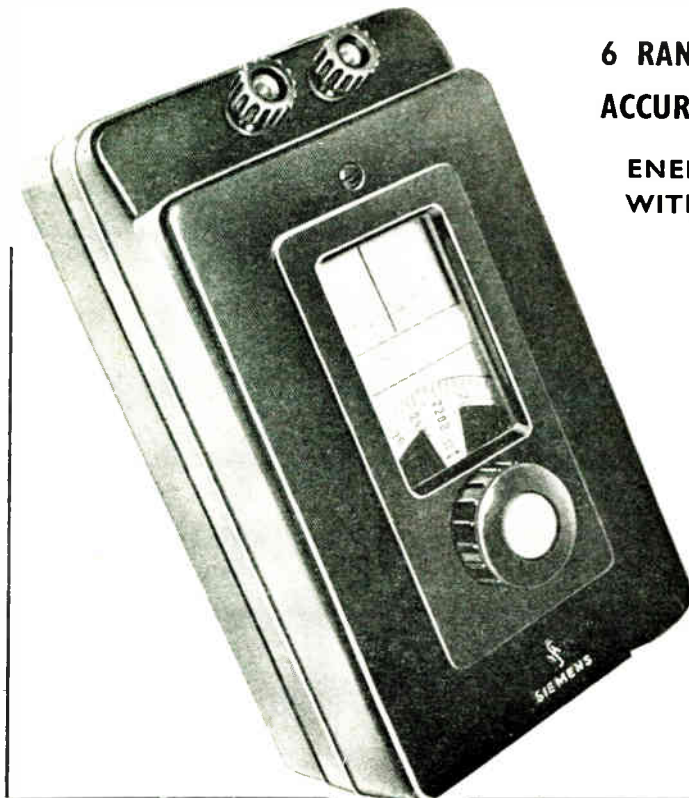

6 RANGES 40 milliohms to 50,000 ohms

ACCURACY $\pm 1\%$ or ± 5 milliohms

ENERGISED BY BUILT IN TORCH BATTERY WITH PROVISION FOR EXTERNAL SUPPLY

AUTOMATIC SWITCHING

The multiplier scale is switched automatically with the range selector

SIEMENS & HALSKE AKTIENGESELLSCHAFT
WERNERWERK FÜR MESSTECHNIK · KARLSRUHE

UK Distributors
R. H. COLE (ELECTRONICS) LTD.
26-32 CAXTON STREET, LONDON, S.W.1
Tel.: SULLivan 7060 Telex 23864

For further information circle 272 on Service Card

make sure
you know
all
the answers

1964

WIRELESS & ELECTRICAL
TRADER
YEAR BOOK
RADIO, TELEVISION & ELECTRICAL APPLIANCES

All the facts, technical data and business information needed by radio and electrical dealers and service engineers—at your fingertips in one compact quick-reference volume.

Includes: Directory of Principal Trade Organisations; Official Addresses; Legal Guide; G.P.O. and other Licences; Rates of Pay; Addresses of Electricity Boards; Valve Base Diagrams; Specifications; Wholesalers; Proprietary Names Directory; Buyers' Guide; Trade Addresses, etc.

27s 6d net by post 29s. 448 pp.

obtainable from leading booksellers

Published for "Wireless & Electrical Trader" by

ILIFFE Books Ltd.

DORSET HOUSE STAMFORD STREET LONDON SE1

For further information circle 273 on Service Card

PROMPT DELIVERY

Many Types
Ex Stock

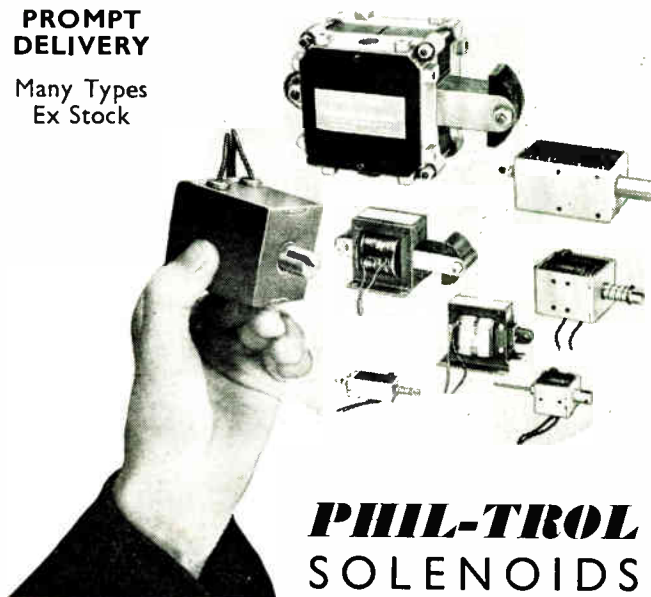

PHIL-TROL SOLENOIDS

NEW! We are now able to offer Types 38, 39, 40 and 35, 36 and 37 solenoids in encapsulated versions suitable for exposed positions and with fully protected coils. We can also supply these solenoids with chromium plated and polished plungers for more rigorous conditions.

Send for full details and copy of pamphlet 108A.

The Phil-trol range of solenoids goes from miniatures to extra strong power types in both AC and DC versions.

PHILLIPS CONTROL (G.B.) LTD.

Dept. K.7, Farnborough Road, Farnborough, Hants

Telephone: Farnborough 1120

Grams & Cables: Philtrol, Farnborough, Hants

HAVE YOU A GLASS TO METAL SEALING PROBLEM?

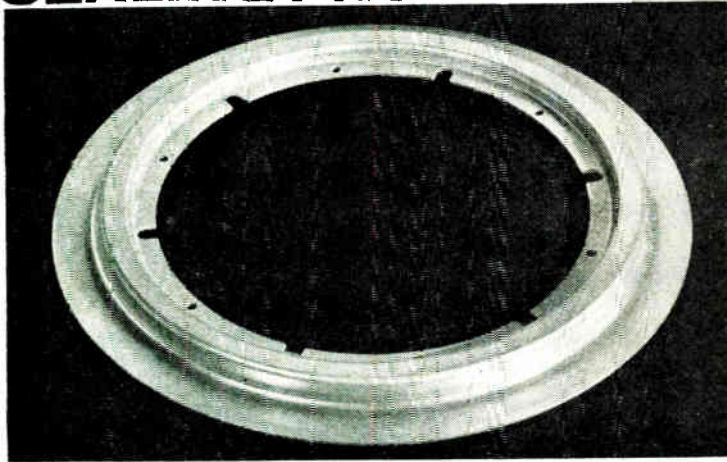
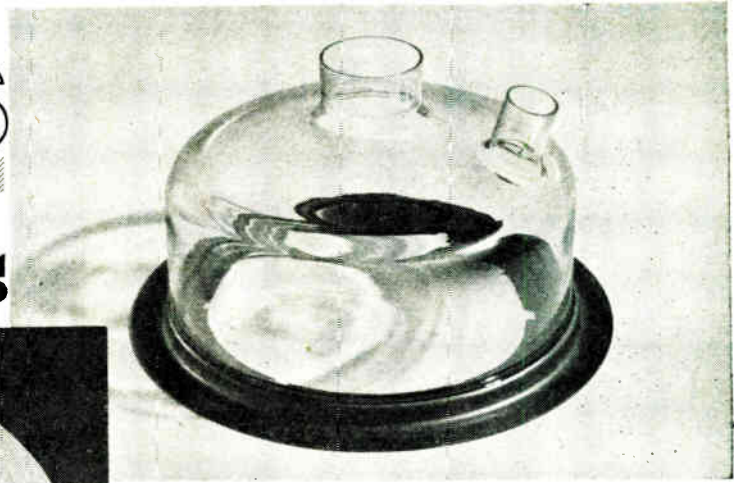

For this 9 inch diameter glass to metal sealing ring

MULLARD LTD

use TELCOSEAL 1, one of the five glass sealing alloys manufactured by

TELCON METALS LTD

These are available as strip up to 6" wide (normal production) in thicknesses down to 0.008", but widths of 10", 12" and 18" can be specially produced. All alloys can be supplied in the forms of drawn wire and rod.

For further details, please apply to:

TELCON METALS LTD

P.O. Box 12 · Manor Royal · Crawley · Sussex · Telephone: Crawley 28800 · Telex: 87248 · Telegrams: Telcon, Crawley

MEMBER OF THE **BICC** GROUP OF COMPANIES

For further information circle 275 on Service Card

invaluable books for technicians

and students in electronics ILIFFE BOOKS LTD.

television and radio published by

Ultrasonic Delay Lines

C. F. Brockelsby, B.Sc., A.R.C.S., A.M.I.E.E.

J. S. Palfreeman

R. W. Gibson, B.Sc. (Eng.), Grad.I.Mech.E.

This is the first book to be written specifically on the subject, which has important applications in radar, radio, television, electronic computers, pulse-forming networks, correlation techniques and multi-channel communication systems.

Though the book is written mainly for engineers and physicists actively engaged in the subject, it will be found of absorbing interest by scientists and technologists working in other fields.

65s net by post 66s 3d 297pp illustrated

obtainable from leading booksellers

Published for Wireless World by

ILIFFE Books Ltd.

DORSET HOUSE STAMFORD STREET LONDON S.E.1

Essays in Electronics

further thoughts by 'Cathode Ray'

M. G. Scroggie, B.Sc., M.I.E.E.

These essays are grouped according to subject and arranged in a logical sequence. This is a book that every electronic engineer and every electrical engineer should read.

42s net by post 43s 1d 301pp 204 illustrations

Microphones

2nd edition

A. E. Robertson, B.Sc.(Eng.), A.M.I.E.E.

Concentrating mainly on the principles of operation, this book is intended for the user rather than the designer. Primarily written as a training manual for BBC technicians, it will also prove invaluable to all users of high quality microphones whether for broadcasting, public-address systems, or recording of all types.

75s net by post 76s 2d 359pp plus 9pp of plates

STEPPING CARD READERS B47 & B50

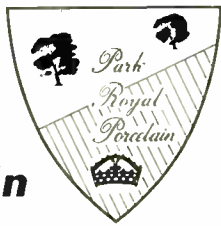

Porcelain

Steatite

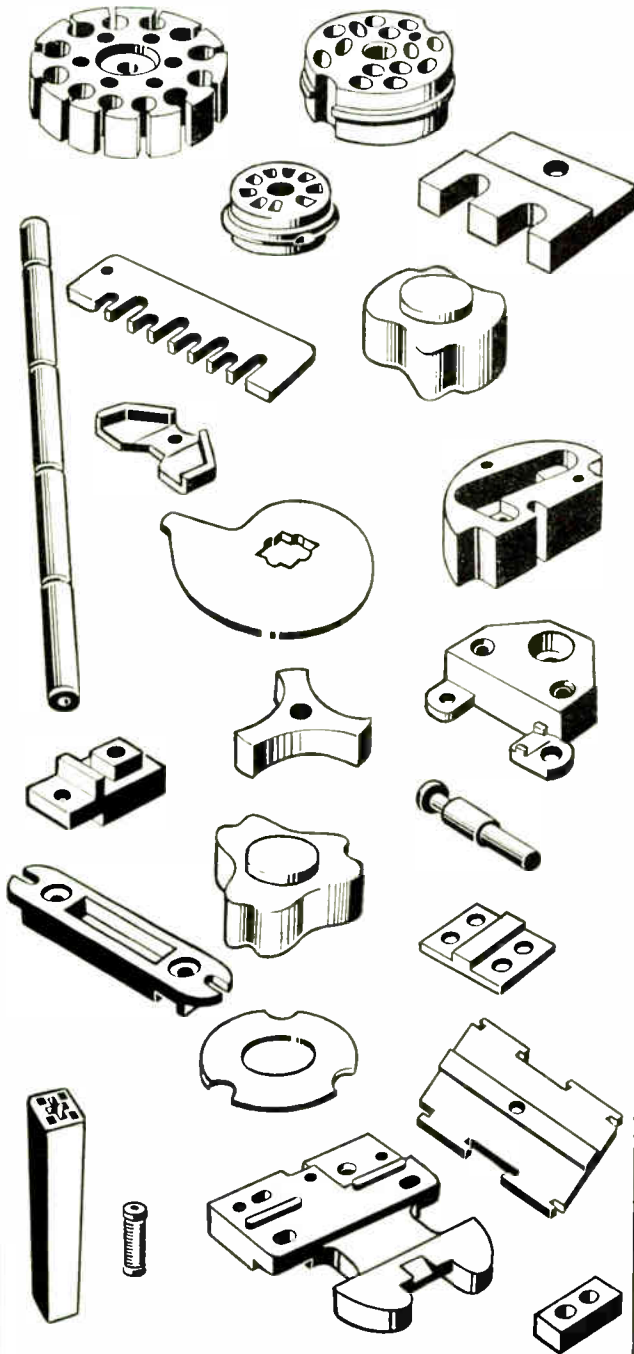

**V. G. PORCELAIN CO
LTD**

GORST ROAD
PARK ROYAL
LONDON, N.W.10

Telephones:
ELGAR 1411/7
Telex:
London 25589

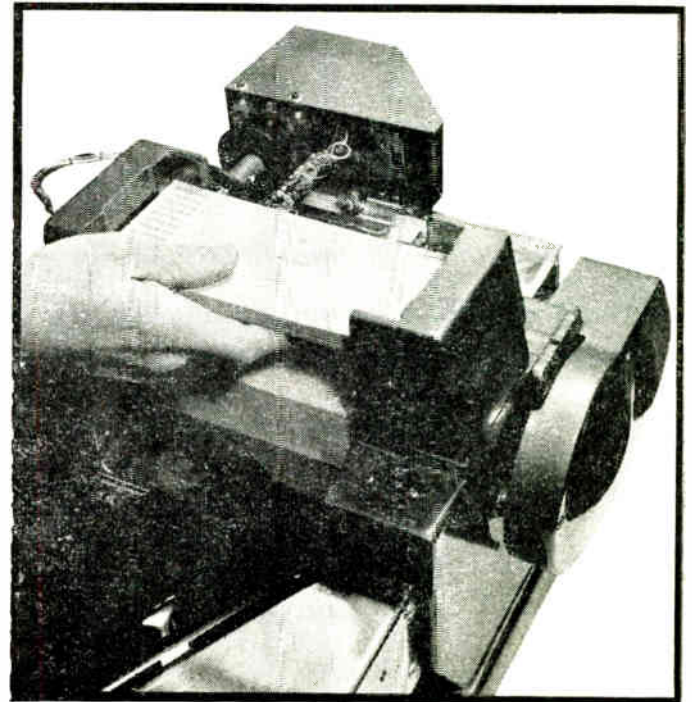

The B47 and B50 Stepping Card Readers are designed to handle standard 80 column punched cards at speeds of up to 30 columns per second. They enable equipment under control to be operated on a demand and response basis and can be programmed, by means of interchangeable programme wheels, to operate only on pre-selected card fields.

The B50 is designed for single shot operation where cards are dropped singly into the receiving hopper.

The B47 is for automatic feed; up to 700 cards may be stacked in the input magazine. (As illustrated).

For full details write for leaflet

Associated Automation Limited

AUTOMATION ACCESSORIES DIVISION

70 DUDDEN HILL LANE · LONDON N.W.10 · TELEPHONE WILLESDEN 8070



A member of the Elliott-Automation Group



INSTRUMENTS, ELECTRONICS, AND AUTOMATION
EXHIBITION, OLYMPIA, MAY 25-30, 1964

Visit the Elliott-Automation Stand G.50

TA 228

NEW



BURROUGHS NIXIE® TUBE B 5971

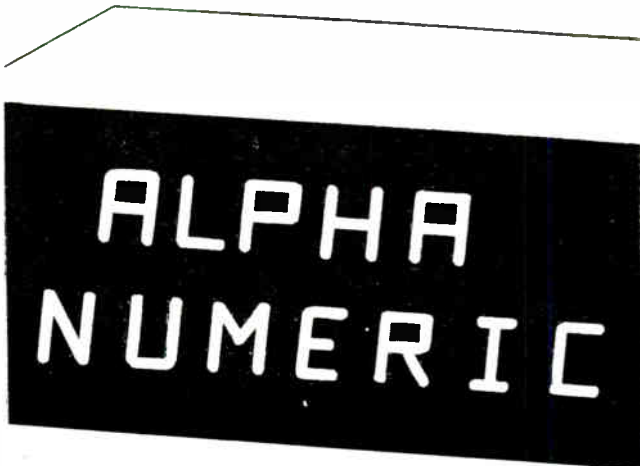

Displays in one tube:

- all letters of the alphabet
- numerals 0-9
- special characters

U.K. REPRESENTATIVES

WALMORE ELECTRONICS LIMITED

11-15 BETTERTON STREET, DRURY LANE
LONDON, W.C.2
Telephone: TEMple Bar 0201-5

Industrial Electronics May 1964

when quality counts... Telecontrol

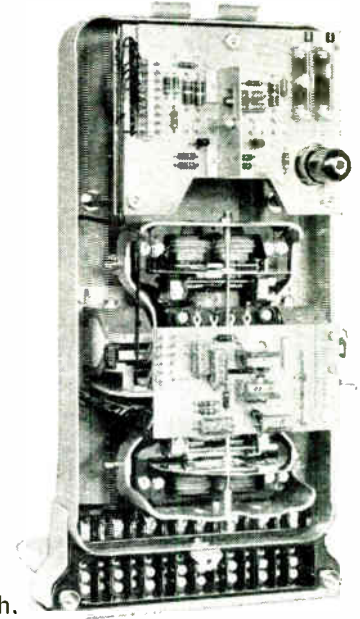

LG Telemetering and Telecontrol systems have been fully proven by many years use in a wide range of applications in Europe and the Commonwealth.

They have the following outstanding features:

- Modular construction enables systems suitable for all applications to be provided from a minimum of units. Transducers are available for the primary measurement of many values.
- Simple direct wire systems for short distances.
- Torque balance systems for medium distances.
- GPO approved voice frequency transmission for unlimited range.
- Time division or frequency division methods as required.
- Integration simplified using impulse rate transmission.
- Alarm and Indication systems and, Remote control by high security coded signalling.
- Display on conventional moving coil indicators or recorders.
- LG Telemetering systems are suitable for supervision and control in electricity generation, transmission and distribution, gas and water services, industrial plants, railway systems and oil refineries, as well as having many other applications.

DR/TC/1A



PRODUCTS
MEASURE
COUNT CONTROL
PRECISELY

LANDIS & GYR LTD
VICTORIA ROAD
ACTON · LONDON W3
ACORN 5311

ROTAX NUMERICAL CONTROL EQUIPMENT



Reliable low-cost accuracy

Automatic control of machine tools demands a high degree of accuracy in sensing shaft motion and position. This requirement is achieved economically with Rotax numerical control equipment, which consists basically of a digital shaft encoder coupled to a recirculating ballscrew.

Such a combination signals increments of as little as 0.1 thou, to accuracies of 0.5 thou and less. The precision of the equipment derives from use of finely engineered Rotax ballscrew shafts—already used as measuring instruments by every major machine tool manufacturer—and shaft position signalling by photoelectric means. The Rotax shaft encoder is gearless, and thus avoids backlash, hysteresis, and vibration troubles.

The complete equipment is available to suit all machine tool applications. Ballscrew shaft lengths range up to 30 feet, and Rotax encoders cover all normally used systems—Gray, B.C.D., sine, etc.

If you're designing automatic machines that need accuracy at low cost, talk to a Rotax engineer about numerical control now, the number's Elgar 7777, Ext. 302.

See us at the I.E.A. Exhibition on stand No. G/72.

ROTAX

INSTRUMENTATION DIVISION

ROTAX LIMITED, INSTRUMENTATION DIVISION,
WILLESDEN JUNCTION, LONDON N.W.10. TELEPHONE: ELGAR 7777

DECADE COUNTER UNITS

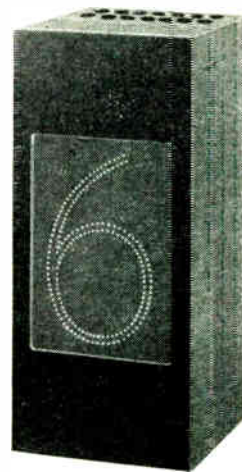

BY

KGM

TAKE . . . any required number of K.G.M. Decade Counter Units and make simple interconnection.

ADD . . . one K.G.M. Power Unit for every six Counter Units.

CONNECT . . . to an appropriate pulse source.

RESULT . . . a complete installation which will count up to 5 kc/s presenting the reading in brilliant figures.

This simple system is readily adaptable to a multitude of individual requirements. Solid state switching gives long life, fast operation, and compact construction.

Send now for the leaflet which gives details and dimensions and see just how adaptable K.G.M. Decade Counter Units can be.

KGM

electronics limited
BARDOLPH RD RICHMOND
Phone: RICHmond 7171 Surrey

From Europe's most modern capacitor plant—Subminiature aluminium Foil capacitors in 42 standard ratings

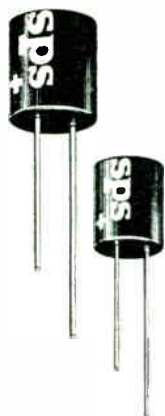
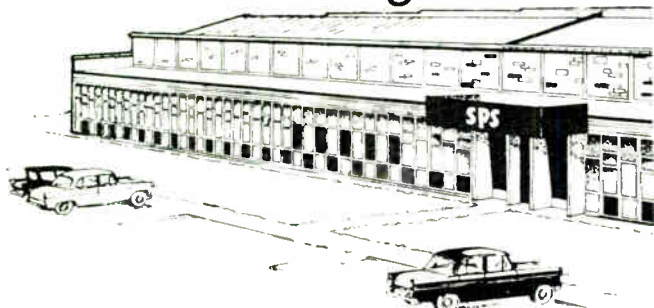

The most modern and efficient capacitors obtainable today.

For 8 years SPS International has been producing in the U.S.A. a range of miniature lightweight capacitors designed to cope with every extreme of temperature. Now the whole benefit of this experience has been brought to the new SPS factory at Shannon, Ireland, making the same high-quality capacitors available at short notice to any part of Britain. SPS capacitors guarantee complete reliability and long life thanks to the techniques of total encapsulation perfected over a long period in the U.S.A.

Ideal for transistorized communications equipment, portable radios, hearing aids, electronic instruments, audio cross-over networks, hi-fi tuners and amplifiers, recorders, test equipment and other low voltage circuits.

CAPACITANCE—20% ± 100% of rated capacity.

DISSIPATION FACTOR: Less than 8% at 50 WVDC.

D.C. Leakage: Less than 6µA after 1min. applied WVDC.

OPERATING TEMPERATURE: 65°C at rated WVDC.

Available in 42 standard ratings, with intermediate values at no extra cost. For complete technical information and assistance write or telephone SPS International Ltd., European manufacturing arm of a leading U.S. supplier of quality capacitors.

SPSI

SPS INTERNATIONAL LIMITED
SHANNON AIRPORT, IRELAND. Tel: Shannon 245

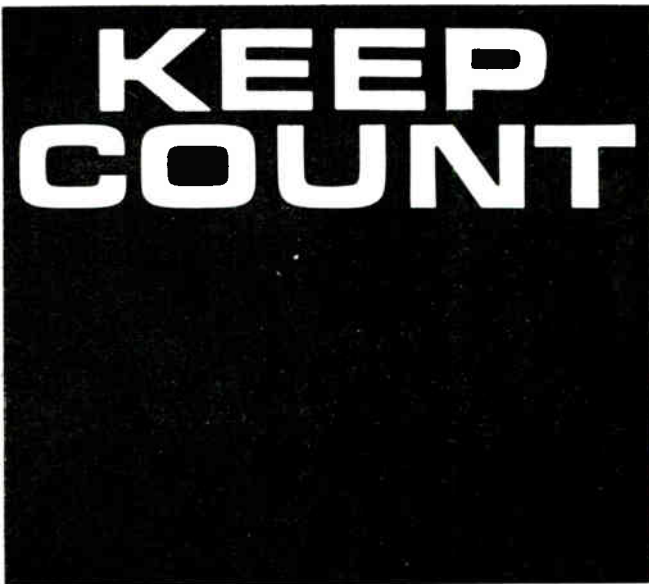

with ENM
Electrical Impulse counters

Any measurements of quantity, size, time, weight, speed, temperature, fluid-flow, when converted to electrical impulse, can be recorded and printed.

Model 481

Six figures—Add only or add and subtract. Manual, Semi-Automatic and Fully Automatic printing on paper roll, card or card sets.

Up to 3000 counts per minute (add)—2600 (add and subtract). Electrical reset to zero, or non-reset.

Panel Size: 3.75 in. (95.3 mm.) x 8.30 in. (210.8 mm.).

1 2 3 4 5 6
Actual Printing Size

Visit Stand G.35
I.E.A. Exhibition
Olympia
25th to 30th May, 1964



Model 443

Six figures—Add only or add and subtract. Manual or Electrical Reset—or non-reset.

Standard Models—up to 2100 counts per min.

High Speed Models—up to 3000 counts per min.

Panel Mounted only.
Panel Size: 1.8 in. (46.0 mm.) x 2.75 in. (69.0 mm.)



1 2 3 4 5 0
Actual Indicating Size

Write for fully illustrated data sheets and information regarding your particular counting applications.



ENGLISH NUMBERING MACHINES LTD

DEPT. E.10, QUEENSWAY, ENFIELD, MIDDLESEX. TEL: HOWARD 2611. TELEX: 24725

NEW ELECTROTHERMAL CHAMBER

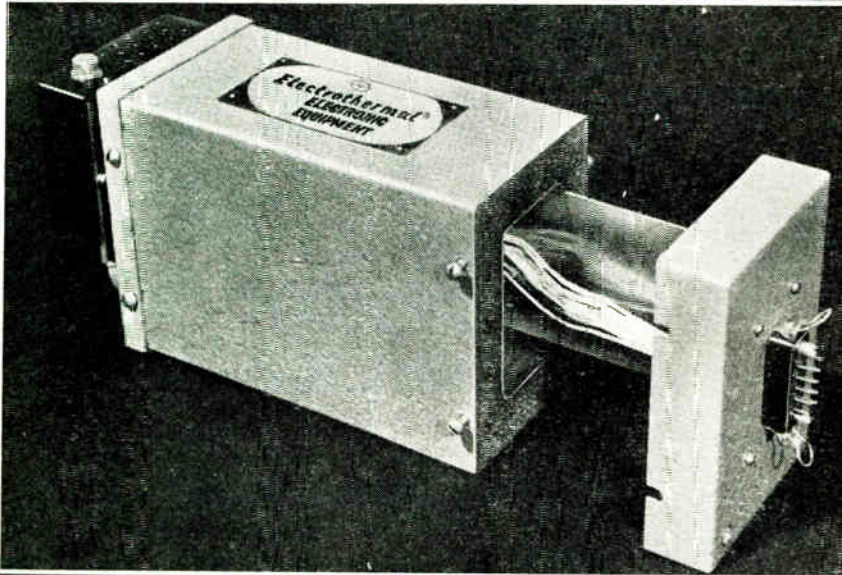

The Electrothermal Chamber (FC 7902/1) is a small, robustly constructed, thermostatically controlled oven designed to accommodate small temperature sensitive components.

It is preset to operate at any temperature within the range 40-90 C.

A small mounting platform is supplied for fixing components or boards within the chamber and 14 colour-coded leads are available for external circuit connection.

Request Publication No. 400 for full details.

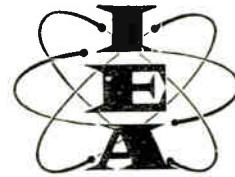

**VISIT US
ON STAND
No G87**

Electrothermal®

ELECTROTHERMAL ENGINEERING LTD
LONDON E.7 Telephone GRA 9911 Telex 24176



For further information circle 285 on Service Card

NORMA

VIENNA

NO MORE CRANKING!

A Portable light weight insulation test suitable for measuring the insulation resistance of all components, installations, etc. Cranking is obviated by the utilisation of a transistor converter; the power supply being two 4½ volt dry batteries. The test voltage and range are selected by push buttons which facilitate quick and easy reading of the resistance value.

INSULATION TEST SET MODEL 667



I.E.A. STAND No. G. 367

RANGES with push button selection

DELIVERY EX STOCK

	100 Volts	250 Volts	500 Volts	1,000 Volts
Scale 1	0 to 0.1 Mohm	0 to 0.25 Mohm	0 to 0.5 Mohm	0 to 1 Mohm
Scale 2	0.05 to 1 Mohm	0.125 to 2.5 Mohm	0.25 to 5 Mohm	0.5 to 10 Mohm
Scale 3	1 to 1,000 Mohm	2.5 to 2,500 Mohm	5 to 5,000 Mohm	10 to 10,000 Mohm

CROYDON PRECISION INSTRUMENT COMPANY
HAMPTON ROAD · CROYDON · SURREY Telephone THORNTON HEATH 4025 & 4094

**LCL are at IEA
on STAND G84**

**This
or this**



Whatever your choice
Amphenol - Borg
connectors are
EX-STOCK from



LIVINGSTON CONTROL LIMITED

Greycaines House Bushey Mill Lane N. Watford Herts Tel: Watford 41291

For further information circle 287 on Service Card

Are you using
outdated ordering
methods? **SAVE TIME
SAVE MONEY**

**WITH ONE ORDER TO . . .
D-T-V GROUP**

THE LEADING INDUSTRIAL
ELECTRONIC DISTRIBUTORS

Here's why...

- **SAME DAY DESPATCH.** An average of over 90% of all items ordered are despatched from our huge stocks.
- **MANUFACTURERS' PRICES.** Components are supplied at manufacturers' quantity column prices.
- **LARGEST STOCKS** of specialized components and equipment. If it's electronic we will supply or notify you immediately.
- **ONE ORDER** reduces handling costs, phone calls, paper work, ledger work, packing charges and stock control operations.
- **LATEST DEVELOPMENTS.** IF IT'S NEW in this country or abroad D.T.V. will be informed. Many of the largest companies have been pleased with the D.T.V. Group's product advice.



Let us add your name to our mailing list.

(Dept. I.E) **D.T.V. GROUP**

126 HAMILTON ROAD, WEST NORWOOD, LONDON, S.E.27

For further information circle 288 on Service Card

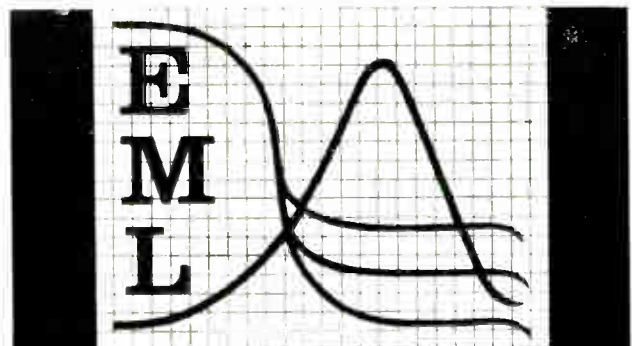

**Planned maintenance
of electronic
equipment cuts costs
increases efficiency**

Electronic Maintenance Limited provides effective, efficient and economical maintenance of radio and radar installations data processing and computer systems, industrial automation systems, closed circuit television equipment, etc.
Write for full details to:

Electronic Maintenance Limited
67/70 North Hill, Colchester, Essex.
or telephone: Colchester 78421/2

For further information circle 289 on Service Card

NOW...
 an even wider range of
WESTON
CLEAR FRONT
 contemporary instruments

The Weston Clear Front Contemporary Series now includes square, rectangular, miniature and fan shaped instruments. Clear moulded covers give excellent light transmission. Behind the new-look face is the traditional accuracy and reliability of Weston instrumentation. For current or voltage measurement. Cover masks available in 7 attractive colours.

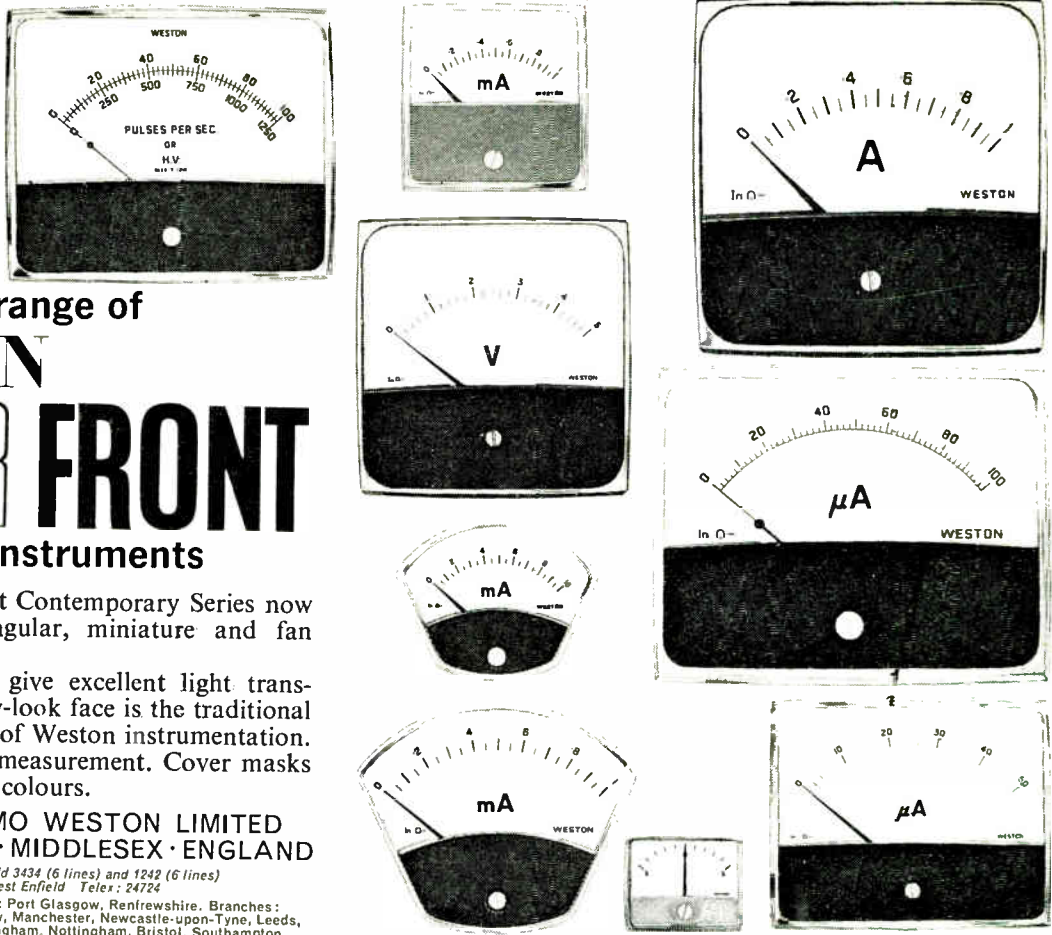

SANGAMO WESTON LIMITED
ENFIELD · MIDDLESEX · ENGLAND
 Telephone: Enfield 3434 (6 lines) and 1242 (6 lines)
 Telegrams: Sanwest Enfield Telex: 24724
 Scottish Factory: Port Glasgow, Renfrewshire. Branches:
 London, Glasgow, Manchester, Newcastle-upon-Tyne, Leeds,
 Liverpool, Birmingham, Nottingham, Bristol, Southampton.

For further information circle 290 on Service Card

OLYMPIA  STAND E 269

ELECTRONIC MEASURING INSTRUMENTS

- | | |
|------------------|------------------|
| GENERATORS | PHYSICAL METERS |
| VOLTAGE METERS | TIME & FREQUENCY |
| Component METERS | METERS |
| OSCILLOSCOPES | SUPPLY SOURCES |

ELECTRONIC MICROSCOPES



PRAGUE, CZECHOSLOVAKIA

Distributors for Great Britain:
KANDEM ELECTRICAL LTD. (Dept. C), 711 Fulham Rd., London, S.W.6

Pergamon research journals for industry



SOLID-STATE ELECTRONICS

An International Journal

Editors:

Dr. W. Crawford Dunlap (Editor-in-Chief), *Raytheon Company, Waltham, Mass.*

Dr. L. Pincherle, *Department of Physics, Bedford College, London.*

Prof. Dr. H. Welker, *Siemens-Schuckertwerke, Aktiengesellschaft, Erlangen.*

Dr. G. M. Hatoyama, *Sony Corporation, Research Laboratory, Yokohama.*

This journal publishes papers in the field of applied solid-state physics including transistor technology in all its aspects, transistor theory and design, crystal growing and handling, preparation of junctions and transistor process technology. Also covered are applications of intermetallic and other binary and ternary semiconductors, applications of ferrites and ferroelectrics, the design and performance of galvano-magnetic devices, thermo-photovoltaic cells and solid-state batteries. The journal considers techniques of automation, microminiaturization and multiple-circuit fabrication, as well as problems of packaging, stability, reliability and device life.

MICROELECTRONICS AND RELIABILITY

(formerly **Electronics Reliability and Microminiaturization**)

Editor-in-Chief:

G. W. A. Dummer, *Royal Radar Establishment, Malvern, England.*

This international journal brings together the various publications concerning reliability and microminiaturization which at present appear in journals not specializing in these subjects. It covers the practical, theoretic and statistical aspects of reliability, and the design, construction, engineering, testing and theoretical appraisal of microminiaturization systems.

Write for specimen copies and subscription rates, mentioning this journal

PERGAMON PRESS

Headington Hill Hall, Oxford

44-01 21st Avenue, Long Island City 1, New York



ONLY 1 1/2" DEEP

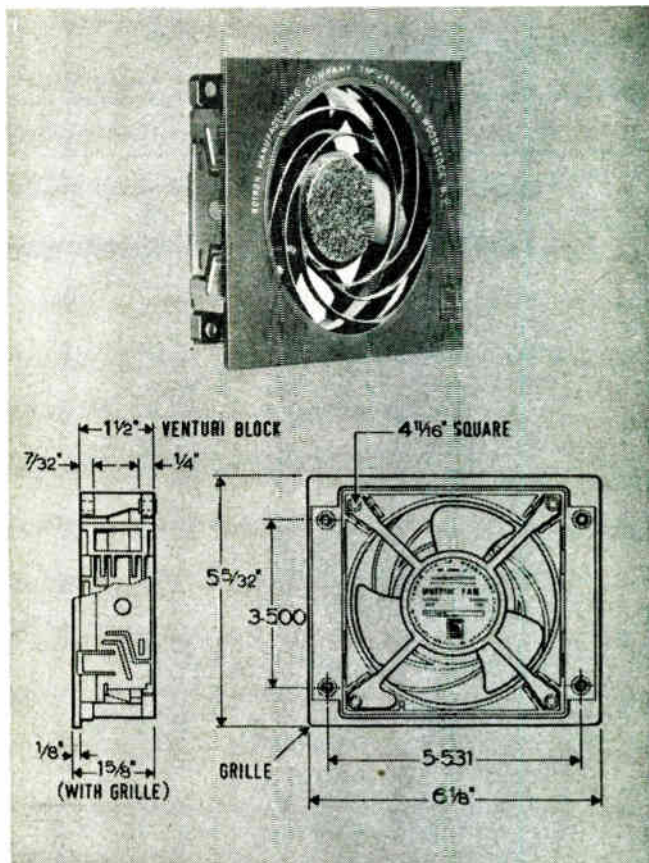

Low Cost... High Efficiency... Silent...

The **Rotron Gold Seal Muffin Fan** introduces to the commercial products market a new high degree of reliability and performance for cooling and ventilating. The simple functional design, substantial air performance, narrow axial depth mounting, versatility, attractive appearance, silent operation and low cost make this the logical choice of the design engineer. Technical information and Distribution: A.K. Fans Ltd., 20 Upper Park Road, London, N.W.3.



AD Stand N422
at IEA
Exhibition
**AURIEMA
LTD**

125 Gunnersbury Lane, London, W.3. Tele: ACOrn 8762

For further information circle 293 on Service Card



Groove for easy cutting

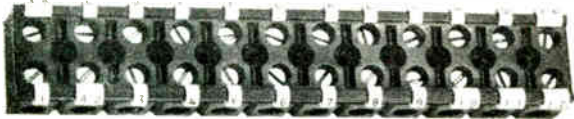

With cable markers



Crimping Protecting Ferrule

JUST WHAT YOU HAVE BEEN LOOKING FOR!

MARKWAY Bakelite Terminal Blocks
Patent applied for

A "METWAY" PRODUCT WITH SPECIAL FEATURES:-
 12 Way - Grooved for easy Cutting
 Spring-on Cable Markers
 Crimping Ferrule for Cable Protection
 Max. Volts - 500. Working Temp. +115°C-45°C

● For details ask for List No. NBQ/15 IE

METWAY · KEMP TOWN · BRIGHTON

For further information circle 294 on Service Card

CLEVELAND ELECTRONICS INC. OF AMERICA

"CLETRON" Deflection Components

1/2" - 1" - 1 1/2"

- Vidicon Focus Coils.
- Vidicon Deflection Yokes.
- Vidicon Alignment Coils.
- Vidicon Deflection Assemblies (Yoke, Focus and Alignment Coil).
- Horizontal and Vertical Deflection Output Transformers.

3"

- Image Orthicon Magnetic Deflection Yoke.
- Image Orthicon Focus Coil.
- Image Orthicon Alignment Coil.

4 1/2"

- Image Orthicon Deflection Assembly.

Some of the features that make "Cletron" products so popular throughout the U.S.A.:

- Geometric Distortion less than 1%.
- Coils covered with Mu-Metal Shield.
- Available to Industrial, Reinforced and Military Specifications.
- Will operate Vidicon, Uvicon and Permachon Tubes.

Data Sheets, Literature and Prices from
EXCLUSIVE U.K. DISTRIBUTORS:

T. J. SAS & SON LTD. DEPT. 1

VICTORIA HOUSE, VERNON PLACE, LONDON, W.C.1
 Telex: 24508 (Telephone: HOLborn 0611)

For further information circle 296 on Service Card

OXLEY

The OXLEY printed circuit sockets are designed for direct mounting on .1" module printed circuit board with standard .05" minimum diameter holes, and accepts our standard plug Type 50P.156.

The mounting is arranged so that the plugs may be inserted in a plane parallel printed circuit board thus permitting close stacking of circuit boards.

PRINTED CIRCUIT SOCKETS

Sockets can be supplied from 1 to 12 ways, colours can be in black, brown, red, orange, yellow, green, blue, violet, pink, grey and white.

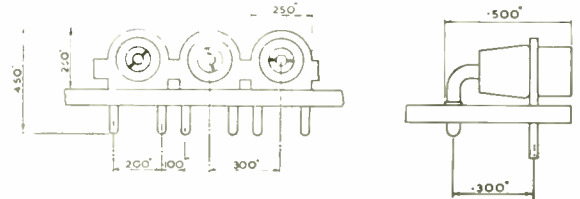
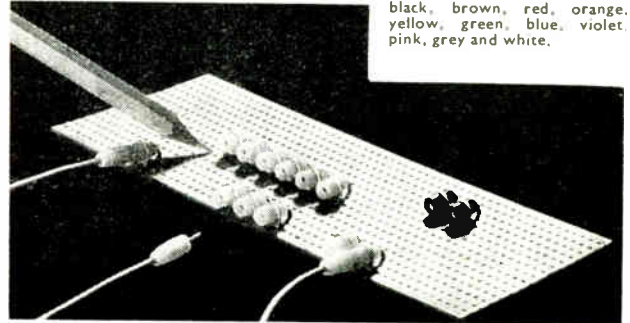

Write for technical details of these or any other Oxley products

OXLEY DEVELOPMENTS CO. LTD.
 ULVERSTON, LANCASHIRE Tel: Ulverston 2567

For further information circle 295 on Service Card

VITALITY BULBS
 FROM 1V to 50V IN SIZES FROM 4.5mm to 18mm DIAMETER

Tested and Proven
 Miniature and Sub Miniature
 Indicator Bulbs: Catalogue
 Vitality Bulbs Ltd,
 Neville Place, Wood Green, N.22
 Bowes Park 0016

For further information circle 297 on Service Card

Numerical methods for high speed computers

G. N. Lance, M SC, PH D, MAIS, AFR A.E.S

This book assembles the most useful numerical methods developed by research mathematicians, with the particular aim of explaining the facilities that computers offer. Most of these methods have never been published before except to a very limited readership and all have been tested for their practical value. The book will be found invaluable by mathematicians, programmers, engineers, physicists and scientists generally.

42s net by post 42s 11d 166 pages from leading booksellers

Published by **ILLIFFE Books Ltd.**
 DORSET HOUSE, STAMFORD STREET, LONDON, S.E.1

CLASSIFIED ADVERTISEMENTS

FULLY DISPLAYED : 50 - per single column.
SEMI-DISPLAYED : 35 - per single column inch.
RUN-ON : 3 6 per line of approximately 7 words.
 Where an advertisement includes a Box Number Is. extra.
SERIES DISCOUNTS : 12 insertions, 15%
 Remittances payable to "Industrial Electronics".

Copy is required by 20th of the month for insertion in the next issue. If proofs of displayed classified are wanted by 15th of the month.

Address to :
 Classified Advertisement Dept.
 Industrial Electronics
 Dorset House, Stamford St., London, S.E.1.

SITUATIONS VACANT

Electronic and Automation Company requires experienced applications engineer/salesman to operate mainly in South-East England. Applicants must have a good knowledge of automation especially level control systems. Good salary dependent on qualifications and experience. Write to Box 5297. [2054]

MISCELLANEOUS

Stearman Optical Company Ltd. of 7 Fitzroy Square, W.1 are manufacturing a unique hard-resin lens with remarkable optical and scratch-resistant properties. The material has many industrial applications. Telephone: Euston 3396. [2055]

SCRAP METAL

Non-ferrous Scrap Metals, all grades, Swarf, Off-cuts, etc., purchased at highest rates.
 H. Barnett Ltd.,
 Victor Road, London, N.7. ARChway 5461 [2041]

SERVICES OFFERED

Precision Sheet Metal Work for the Radio & Electrical Trade. Chassis, Panels, Brackets, etc. Power Press Capacity up to 100 tons. Press brake capacity up to 105 tons 8ft. x 7/32in. All spray and stove finishes. A.I.D. approved. — The Kaymet Company, Kaymet Works, Sylvan Grove, London, S.E.15. Telephone: NEW Cross 6644. [2036]

CAPACITY AVAILABLE

AIRTRONICS LTD.
 for coil winding assembly and wiring of electronic equipment, transistorised sub-units.
 4 Ashmead Road, London, S.E.8
 Telephone: Tideway 2249 [2043]

FOR SALE

PHOTO-ELECTRIC CONTROLS for industry

Send for catalogues

HIRD-BROWN LIMITED
 FLASH STREET, BOLTON
 Telephone 27311 [2027]

We undertake the design and development of process control systems, equipment and static switching devices. Henry Reeves Limited, 19 St. Michael's Street, Oxford. Oxford 41102. [2053]

Ring Newbury 347 for a quick and efficient service in manufacture Wiring and Assembly of printed circuits at attractive prices. Or write to Newbury Electronics Ltd., West Mills, Newbury, Berks. where this capacity is available immediately. [2049]

For further information circle 298 on Service Card

an invaluable new book

mathematical techniques in electronics and engineering analysis

J. W. HEAD, M.A.(CANTAB.), F.INST.P., A.M.I.E.E.

This book is of the utmost value not only to the electronic and electrical engineer but to all technologists and scientists who have mathematical problems to solve in connection with their work and wish to learn the quickest and most practical methods of dealing with them. Divided into two parts, the first part consists of general mathematical techniques. The second part deals with more specialised applications of mathematics to problems in electronics and electronic engineering.

45s net by post 46s 224 pp. 67 illustrations

obtainable from leading booksellers

ILIFFE Books Ltd.

Dorset House · Stamford Street · London · S.E.1

For further information circle 299 on Service Card



International authorities
 discuss current and
 future projects

TELECOMMUNICATION SATELLITES

Theory, practice, ground stations, satellites, economics

K. W. GATLAND, F.R.A.S., F.B.I.S., A.R.Ae.S.

This book brings together many international authorities to explain in detail the projects they are working on and future lines of development. Ranging from the Echo balloon satellite to active repeater satellites, this comprehensive survey is an indispensable book for all engaged in the telecommunication field.

85s net by post 86s 4d 440 pp. illustrated

obtainable from leading booksellers

ILIFFE Books Ltd.

DORSET HOUSE · STAMFORD STREET · LONDON SE1

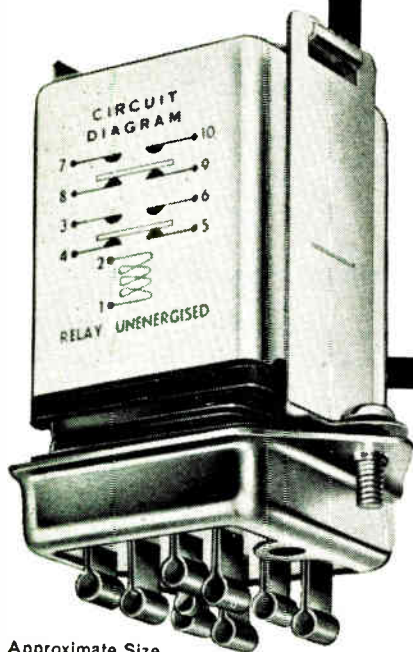

Approximate Size

Versatile Mounting Arrangements

Panel Mounting with Solder Tag



Side Mounting



Socket Mounting



DIAMOND H GENERAL PURPOSE RELAYS (BW SERIES)



- 25 amp 250 volt A.C. double pole double throw
- Compact—only 1½" x 1½" x 1⅞" without socket
- Plug-in, solder tag or fast on terminations
- Coils available for 4-250 V., A.C. 50-60 cycles & 4-250 V., D.C.
- Mechanical life expectancy—in excess of 10 million cycles
- Weight—10 ozs. or less
- Plug-in, Side or Panel mounting

**PROVED PERFORMANCE! RELIABILITY! LONG LIFE! SILENT!
PROMPT DELIVERY!**

DIAMOND H CONTROLS LTD. GUNNERSBURY AVENUE, CHISWICK, LONDON, W.4. CHISWICK 6444

Index to Advertisers

Ad Auriema Ltd.	75	Ferranti Ltd.	9	Phillips Control (G.B.) Ltd.	66
Adcola Products Ltd.	23	FieldTech Ltd.	65	Plannair Ltd.	24
A.E.I. Ltd. (Switchgear Division)...	38	Hendrey Relays Ltd.	64	R.C.A. (Gt. Britain) Ltd.	28
Aircraft Marine Products Ltd....	30	Hewlett Packard Ltd.	11, 12, 13, 14	Rotax Ltd.	70
Anglo-American Vulcanized Fibre Co. Ltd.	8	Honeywell Controls Ltd.	22	Sangamo Weston Ltd.	74
Appointments Vacant	77	Hughes International (U.K.) Ltd... ..	32	Sas, T. J., & Son Ltd.	76
A.P.T. Electron Industries Ltd....	39	Ilford Ltd.	48	SIFAM Electrical Instrument Co. Ltd.	6
Arrow Electric Switches Ltd....	35	Iliffe Books Ltd.	54, 66, 67, 76, 77	Sperry Gyroscope Co. Ltd.	42
Associated Automation Ltd....	68	Imhof, Alfred, Ltd.	10	SPS International Ltd.	71
Aveley Electric Ltd.	15	KGM Electronics Ltd.	70	Standard Telephones & Cables Ltd.	26, 27, 41
Avo Ltd.	59	Kovo Tesla, Prague	74	Stewart Aeronautical Supply Co. Ltd.	53
BICC-Burndy	Cover ii	Lancashire Dynamo Electronic Products Ltd.	45	Telcon Metals Ltd.	67
Canadian Instruments & Electronics Ltd.	34	Landis & Gyr Ltd.	64, 69	Telegraph Condenser Co. Ltd.	Cover iii
Cannon Electric (G.B.) Ltd....	40	Livingston Control Ltd.	54, 73	Telephone Manufacturing Co. Ltd.	17, 21
CIBA (A.R.L.) Ltd.	37	Magnetic Devices Ltd.	31	Tequipment Ltd.	18
Cole, R. H. (Overseas) Ltd.	66	Mallory Batteries Ltd.	2	Thorn Electronics Ltd.	62
Cossor Instruments Ltd.	63	MB Metals Ltd.	25	Turner, Ernest, Ltd.	16
Croydon Precision Instrument Co.	72	Metway Electrical Industries Ltd... ..	76	Union Carbide Ltd.	47
Dawe Instruments Ltd.	19	Miniature Electronic Components Ltd.	3	Varian Associates Ltd.	49
Derritron Electronic Vibrators Ltd.	55	M-O Valve Co. Ltd.	52	V.G. Porcelain Co. Ltd.	68
Diamond H. Controls Ltd.	78	Muirhead Precision Instruments Ltd.	7	Vitality Bulbs Ltd.	76
Direct T.V. Replacements Ltd.	73	Mullard Ltd.	4, 5, 33	Walmore Electronics Ltd....	69
Electronic Maintenance Ltd.	73	Multicore Solders Ltd.	36	Wandleside Cable Works Ltd....	44
Electrosil Ltd.	46	Murex Ltd.	61	Welwyn Electric Ltd....	1
Electrothermal Engineering Ltd....	72	Oxley Developments Co. Ltd.	76	Westinghouse Brake & Signal Co. Ltd.	58
Elliott Bros. Ltd.	50, 51	Painton & Co. Ltd.	43	Whiteley Electrical Radio Co. Ltd.	65
English Electric Valve Co. Ltd.	57	Parmeko Ltd.	Cover iv	Wingrove & Rogers Ltd.	60
English Numbering Machines Ltd.	71	Pergamon Press	75		
Ericsson Telephones Ltd.	29				
Evershed & Vignoles Ltd.	20, 56				

**NEW
NEW**



**NEW
NEW
NEW
NEW
NEW
NEW
NEW**

**are
exhibiting their
full range of
capacitors
on
Stand G36**

AT THE I.E.A. EXHIBITION

SEE THESE OUTSTANDING NEW TYPES

- ★ Aluminium Foil extended temperature range for -55°C to 125°C operation
- ★ 'MIL C' Tantalum capacitors
- ★ Monolithic ceramics
- ★ Plug-in electrolytics

New components produced by our American associate will also be on display



THE TELEGRAPH CONDENSER CO. LTD.

NORTH ACTON, LONDON W.3 · Telephone: ACO rn 0061 (16 lines) Telegrams: Telefarad, Wesphone, London. Telex: 261383 (also at) CHESSINGTON, SURREY · BATHGATE, SCOTLAND

For further information circle 202 on Service Card

PARMEKO

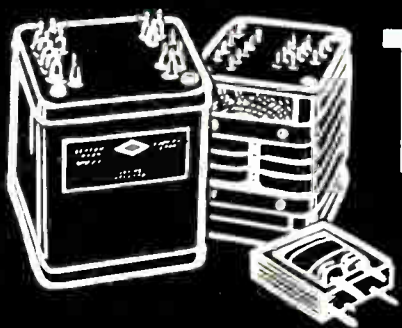

TRANSFORMERS AND REACTORS

TRANSFORMERS AND MAGNETIC AMPLIFIERS

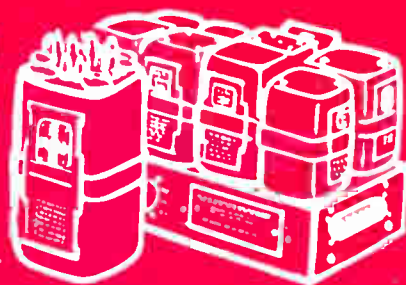

CONTROL AND SYSTEM

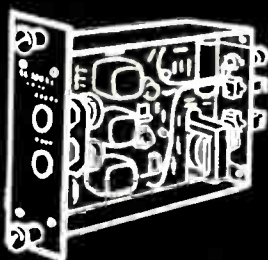

EQUIPMENT COMPONENTS

Unparalleled quality, reliability, and precision have made Parmeko products internationally famous. Leaflets giving full technical information are available on request.

PARMEKO LTD

PERCY RD · LEICESTER · ENGLAND
Telephone Leicester 32287