

# INDUSTRIAL ELECTRONICS

FEBRUARY 1963 5s 0d





# LOOK-NO CONTACTS!

## NORBIT STATIC SWITCHES for automatic control systems NEVER NEED MAINTENANCE

No maintenance, no 'sneak circuits', operation in *any* position, constant speed and a life unaffected by the number of operations.

These are only some of the many reasons why electrical and electro-mechanical engineers, in increasing numbers, are using Norbit static switches instead of relays in a wide variety of automatic control and alarm applications, from lift systems to food processes.

Since they use no moving parts contactless Norbit switches need no adjustments, no cleaning and suffer no mechanical wear or variation in operating speed. Time wasting 'cut and try' methods are also eliminated during system design—using Norbits you can plan your complete system on paper and know that what you plan will work in practice.

Furthermore, one basic Norbit gives you any switching function you need. No contacts, no sparking, no heat to dissipate,

unaffected by detrimental atmospheres—dust, abrasive particles, humidity, corrosive fumes, hazardous atmospheres—the reliability of Norbit static switches has been proven in practice and by exhaustive quality testing.

**Here's all you need to know** How does the Norbit switch if it uses no contacts? Just regard the Norbit as a switch which does not open or close, but one which either conducts or does not conduct. Furthermore, there's *no need* for you to know any electronic theory to understand Norbits and apply their many advantages.

**Free to the practical engineer** Write for a free copy of 'Static Switching Simply Explained'. This booklet gives you a completely non-mathematical explanation of Norbit static switches—what they can do and how they can be used. Write today for this practical guide to contactless switching using Norbits.

**MULLARD EQUIPMENT LIMITED**

MANOR ROYAL, CRAWLEY, SUSSEX  
Telephone Crawley 28787



# INDUSTRIAL ELECTRONICS

incorporating *ELECTRONIC TECHNOLOGY*



Volume I Number 5 February 1963

## contents

Editor **W. T. COCKING, M.I.E.E.** 241

Assistant Editor **T. J. BURTON** 243

Advertisement Manager **G. H. GALLOWAY**

### Comment

#### Dynamic Balancing *by W. G. A. McCormick*

Highly accurate balancing of rotating parts is essential to prevent vibration. The article describes apparatus which indicates the magnitude and position of the balancing weight which must be added.

#### 247 **The Polyvac Process** *by D. J. Webb, B.Sc.*

In this article is described apparatus for spectrochemical analysis which presents its output in the form of a typed record. It comprises a special spectrometer, electronic measuring apparatus and a computer.

#### 251 **Oscilloscopes in Industry** *by M. Davies*

Some of the industrial applications of the cathode-ray oscilloscope are reviewed in this article. These applications include the measurement of the effects of shock and vibration as well as the more conventional stress, torque, pressure, displacement, velocity and acceleration.

#### 268 **The Minivac** *by A. G. Cowley*

Electronic computers are complex devices. For teaching purposes something simpler is adequate and in this article an inexpensive computer simulator is described. It is designed to enable the student to acquire familiarity with computer principles.

#### 270 **Measuring Transistor Time Constant** *by T. E. Price, Ph.D.*

Two ways of measuring the collector-base time-constant of an alloy-type transistor operating in the common-base mode are described. The results obtained are compared.

#### 273 **Feedback Amplifier Stabilization** *by S. S. Hakim, B.Sc., Ph.D.*

A method of designing an interstage correcting network for stabilizing a feedback amplifier is explained. The method is illustrated by a practical example.

#### 278 **The Goonhilly Aerial Control System** *by D. Wray, B.Sc. (Eng.)*

When using a satellite for communications, the ground aeri-als have always to be pointed at the moving satellite. This article describes the way in which this is automatically effected at Goonhilly. As a control system it is most unusual in that it operates from predicted data on the satellite's position.

*continued overleaf*

Published on the first Thursday after the 5th of each month by

ILIFFE ELECTRICAL PUBLICATIONS LTD.

Managing Director: W. E. Miller M.A., M.Brit.I.R.E.

Dorset House, Stamford Street, London, S.E.1.

Telephone: Waterloo 3333.

Telegrams: Wirenger, London, Telex

Cables: Wirenger, London, S.E.1.

ANNUAL SUBSCRIPTION, £3 0s. 0d.,  
CANADA and U.S.A. \$8.50.

# contents

INDUSTRIAL ELECTRONICS FEBRUARY 1963

## continued

- 283 Satellite Communications**  
This article summarizes some of the aspects of satellite communications which were discussed at an I.E.E. Conference. Present satellite uses are shown to be chiefly to obtain data both for communication link design and, by telemetry, for improvement of reliability.
- 285 Duality and Tunnel Diodes** *by P. J. Langlois, M.Sc.*  
After a discussion of duality with reference to the tunnel diode, which is a current-operated negative-resistance device, this article shows how tunnel-diode circuits can be derived from gas-tube circuits.
- 289 The 1963 I.P.P.S. Exhibition**  
A review of some of the interesting items shown at this year's Annual Exhibition of The Institute of Physics and The Physical Society, which was held in London from 14th to 17th January in the Old and New Halls of The Royal Horticultural Society.

## FEATURES

- |  |  |
|--|--|
| 246 Relay Dust Covers                    | 288 Electronic Conveyor Belt Weighing System |
| 255 Applications Illustrated             | 292 Industrial News                          |
| 256 Equipment Review                     | 295 Correspondence                           |
| 276 New Glass for Ultrasonic Delay Lines | 295 New Books                                |
| 277 Applications Illustrated             | 296 Manufacturers' Literature                |
| 284 Measurement of Ocean Temperatures    | 31 Classified Advertisements                 |
|  | 32 Index to Advertisers                      |

### Next Month

The March issue will include an article dealing with the collection of analogue data in an industrial plant and it describes the way in which this information is made suitable for on-line computer processing. Other articles will deal with the magnetic testing of materials and tunnel diode computer stores.

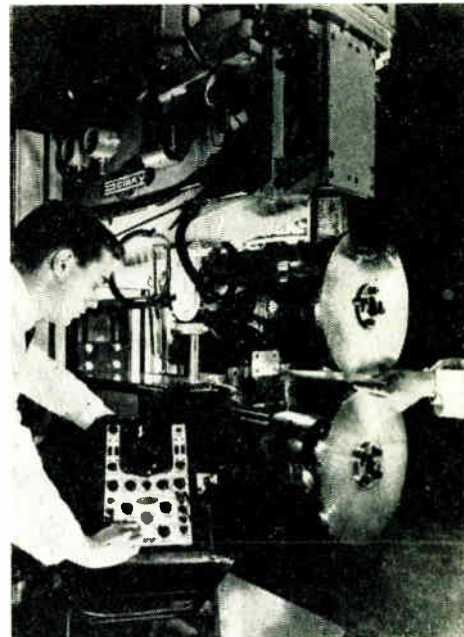

### OUR COVER

An interesting picture showing the Cossor Model 2000 oscilloscope being used at the Slough factory of Sciaky Electric Welding Machines Ltd. to check the performance of an aircraft seam welder before despatch. Elsewhere in this issue is included an article describing some of the industrial applications of oscilloscopes.

### TO SAVE YOUR TIME

We will assist you to obtain further information on any products or processes described or advertised in this issue. Just use the enquiry cards to be found in the front and back of the journal.

© Iliffe Electrical Publications Ltd., 1963

Permission in writing from the Editor must first be obtained before letterpress or illustrations are reproduced from this journal. Brief abstracts or comments are allowed provided acknowledgment to the journal is given.

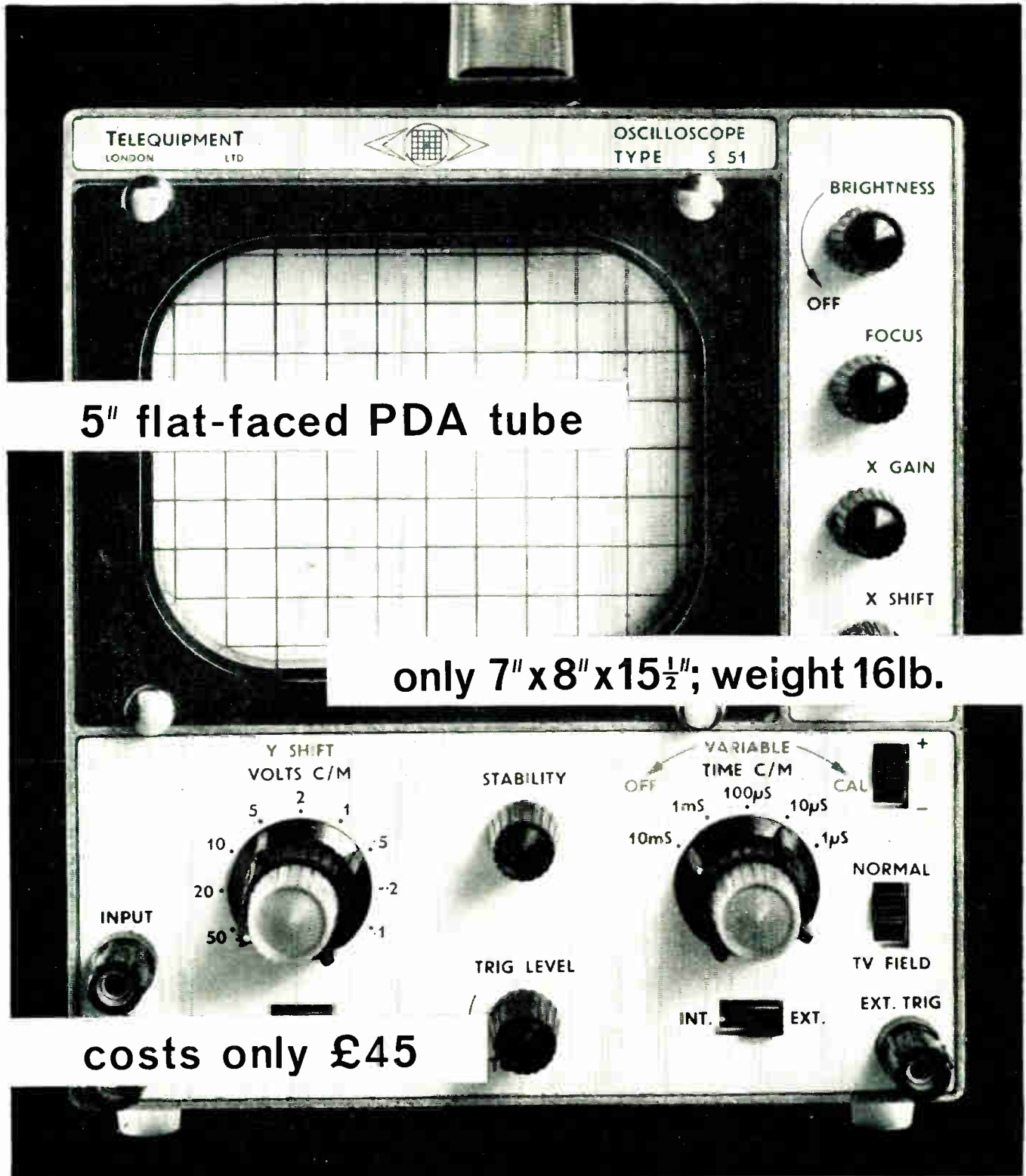

5" flat-faced PDA tube

only 7" x 8" x 15½"; weight 16lb.

costs only £45

The Serviscope\* type S51 has been designed to meet the growing need for a reliable, low-cost, instrument of good general performance for industrial and educational applications. It is small in size, light in weight, strongly constructed, and has a clearly laid-out front panel for ease of operation. The exceptionally large screen can be read from a considerable distance, and is very suitable for group instruction and production control work.

**Abridged specification:**

- Max. Bandwidth 3 Mc/s
- Max. Sensitivity 100 mV/cm
- Calibrated input attenuator 100 mV/cm — 50V/cm
- Time base has 5 pre-set speeds plus variable control and expansion
- Automatic, selective and TV sync. triggering
- DC coupled flyback blanking

Complete details will be sent on request.

**TELEEQUIPMENT**



\*Serviscope is the registered trade mark of Teleequipment Limited 313 Chase Road Southgate London N14 Fox Lane 1105

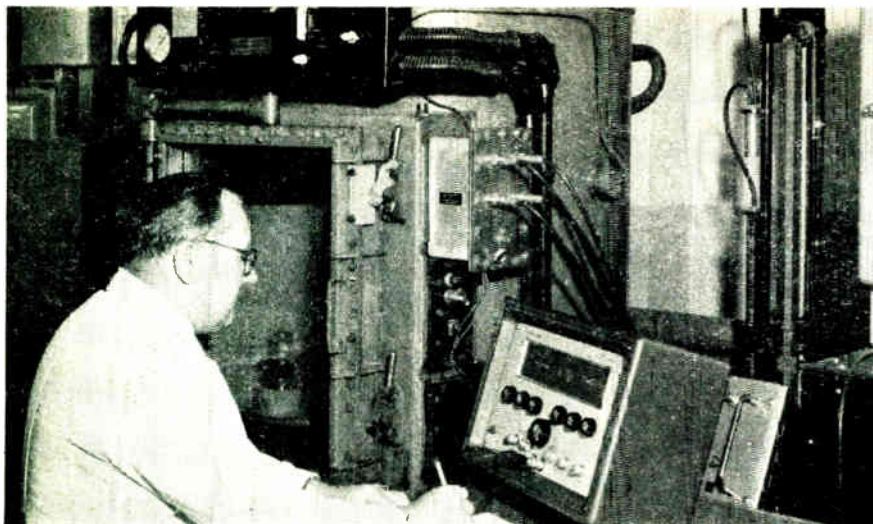

Measurements on insulating materials at  $-50^{\circ}\text{C}$  inside a Kelvinator

Low Impedance Adaptor Q221 for measurements below 10 ohms.

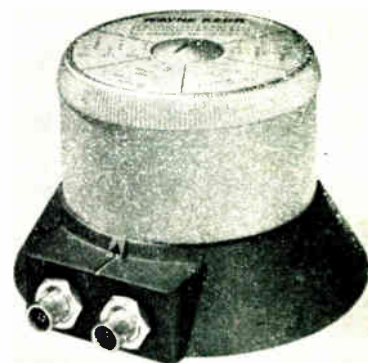

## Precise bridge measurements using long leads!

### B221 INCLUDES ACCURATE RATIO TRANSFORMERS

#### REMOTE MEASUREMENTS

It is becoming increasingly necessary to make bridge measurements on components situated inside biological shields, environmental chambers, process plant, etc. with the operator located at some remote point. The B221 measurement leads can be extended to more than 100 ft. and, even so, 1 picofarad can be measured without loss of accuracy or additional trimming.

#### IN-CIRCUIT MEASUREMENTS

It is no longer necessary to remove components from a circuit to measure them.

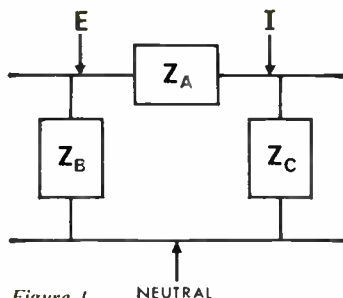

Figure 1. NEUTRAL

Referring to Fig. 1,  $Z_A$  can be measured without disconnecting  $Z_B$  or  $Z_C$  by using the neutral terminal of the Bridge. It is therefore possible to measure components without unsoldering them from their surrounding circuit (of particular value when dealing with printed circuits or encapsulated assemblies) and measurements on transistors, polarised capacitors or energised inductors are simplified, since the d.c. supply circuits can effectively be isolated from the component under test.

#### SIMPLICITY OF OPERATION

The bridge is extremely easy to operate. The resistive and reactive terms are shown

in separate windows together with decimal points and units of measurement which are changed automatically with the range switch. The effect is to give an in-line read-out without the need for multiplying factors. The controls for each term are independent and can be balanced separately. Two magic eyes, each with a double shadow, provide four degrees of sensitivity and facilitate rapid location of the balance point.

#### EXTREMELY WIDE RANGE

In conjunction with the Low Impedance Adaptor Q221, the range of the bridge is:

- R 50  $\mu\Omega$  - 50,000M $\Omega$
- C 0.0002pF - 5F
- L 0.005 $\mu\text{H}$  - 1,000H

This unusually wide range is achieved using only two fixed resistive standards and two fixed capacitive standards whose values are multiplied or divided by ratios of up to 10,000,000:1 by means of tapped transformers. Thus it is possible to choose such standard values that stray reactances and inherent losses are at a minimum. The four fixed standards are associated with decade switches which provide the first two digits of the resistive and reactive terms. A potentiometer and variable capacitor, respectively, form the continuously-variable control for each term, providing the third and fourth digits.

#### ACCURACY AND DISCRIMINATION

The Bridge accuracy is 0.1 per cent from:  
10 $\Omega$  to 100M $\Omega$   
0.1pF to 10 $\mu\text{F}$   
1mH to 1000H

Provided all the decades are used the discrimination is 0.02 per cent over the whole range of the Bridge and Adaptor.

#### SOURCE AND DETECTOR

Source and detector are incorporated in

the bridge, tuned to 1592 c/s ( $\omega=10^4$ ). Bridges for other frequencies, such as 1000 c/s, can be supplied. Provision is made for the use of an external source and detector operating between 50 c/s and 20 kc/s.

#### BASIC CIRCUIT AND THEORY

In the simplified diagram, Fig. 2,  $Z_u$  is the unknown impedance and  $Z_s$  represents the internal standards. The requirement for a condition of balance is that the ampere-turns produced in T2 by the current from  $Z_u$  shall be equal and opposite to that due to  $Z_s$ . This can be achieved for different values of  $Z_u$  using the same  $Z_s$  by varying the taps on T1. Range switching (not shown) is achieved by altering taps on both T1 and T2 on the  $Z_u$  side.

Full details of the circuit principles, including adaptation for the measurement of low values of impedance, are described in Monograph No. 1, a general treatise, unrelated to any particular instrument and applicable to a.f., r.f. or v.h.f. bridges.

Please write or telephone for a copy of the Monograph, the B221 leaflet, or a demonstration of the bridge.

## WAYNE KERR



The Wayne Kerr Laboratories Limited  
New Malden, Surrey, England  
Telephone Malden 2202

Wayne Kerr Corporation  
1633 Race Street,  
Philadelphia, 3, Pa, USA  
Telephone LOcust 8-6820

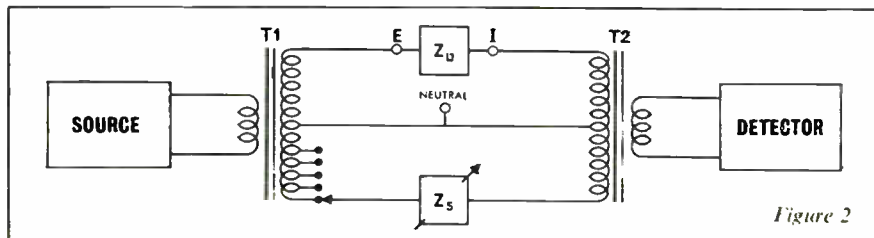
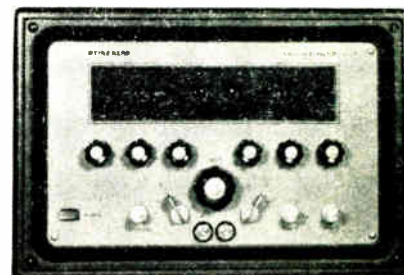

Figure 2



WK 36

# DESIGN WITH SILICON FEATURES AT GERMANIUM PRICES

## FERRANTI SILICON INDUSTRIAL MESA TRANSISTORS

### SPECIAL FEATURES

- HIGH GAIN
- LOW LEAKAGE CURRENT
- HIGH FREQUENCY CUT-OFF
- HIGH TEMPERATURE OPERATION
- RELIABLE & RUGGED CONSTRUCTION
- AVAILABLE NOW

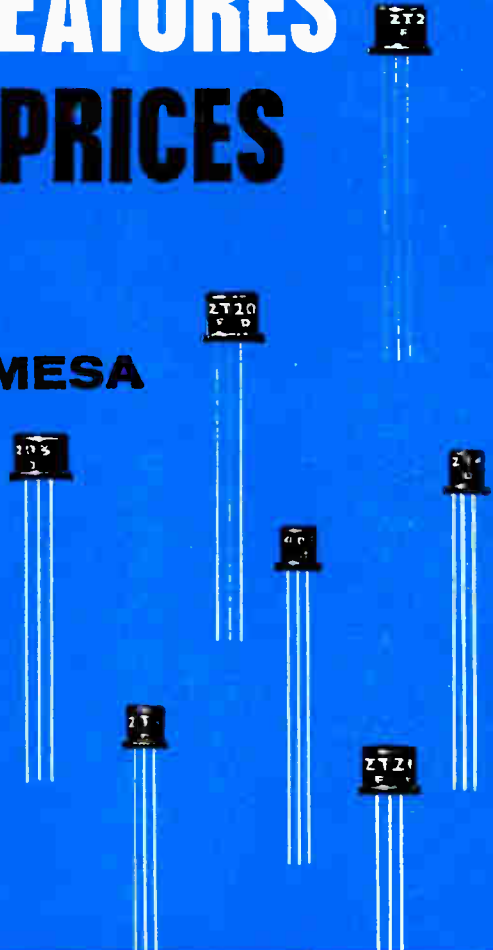

RATINGS		CHARACTERISTICS AT 25°C				
			ZT202 ZT402	ZT203 ZT403	ZT204 ZT404	TEST CONDITIONS
Collector Base Voltage	30 volts	Collector Base Reverse Current $I_{CBO}$	1 $\mu A$	1 $\mu A$	1 $\mu A$	$V_{CB} = 30V$ $I_E = 0$
Collector Emitter Voltage	20 volts	Emitter Base Reverse Current $I_{EBO}$	10 $\mu A$	10 $\mu A$	10 $\mu A$	$V_{EB} = 5V$
Emitter Base Voltage	5 volts	Collector Emitter Saturation Voltage $V_{CE sat.}$	1 V	1 V	1 V	$I_C = 10 mA$ $I_B = 2 mA$
Collector Current	50 mA	Collector Output Capacitance $C_{OB}$	10 pF	10 pF	10 pF	$V_{CE} = 6V$ $I_E = 0$ $f = 1 Mc/s$
Total Dissipation 25°C Amb. Temp.	300 mW	Common Emitter DC Current Gain (min) $h_{FE}$	20	40	80	$V_{CE} = 6V$ $I_C = 10 mA$
Storage & Operating Temperature Range	-40 to +100°C	Gain Bandwidth Product $f_T$ Typical	110Mc/s	110Mc/s	110Mc/s	$V_{CE} = 6V$ $I_C = 10 mA$

**FERRANTI**  
First into the Future

FERRANTI LTD · GEM MILL · CHADDERTON · OLDHAM · LANCs  
Telephone: MAIn 6661 London Office: Telephone TEMple Bar 6666

FE 238/2



Tough, elastic Silentbloc Spindle Bands combine high transmission efficiency with very long working life.

Originally produced to satisfy the very exacting requirements of spindle driving in the textile industry, Silentbloc Spindle Bands are now widely used for low-power drives in many types of machinery and apparatus. Three examples are illustrated here.

They are available in a wide range of diameters and loop lengths.

**Mechanical Handling** (*illustrated top left*)

Dependability under varying load conditions is demonstrated by the use of Silentbloc Spindle Bands as belt conveyors in this "Solarcheck" automatic high-speed, high-accuracy electronic check-weigher.

(*Solartron Electronic Group Ltd., Thames Ditton*).

**Engraving Machine** (*illustrated top right*)

Accurate tracing results from the use of a Silentbloc Spindle Band drive to the cutting tool of this Taylor-Hobson engraver.

**Diamond Polishing Machine** (*illustrated right*)

Severe tension fluctuations produced by planetary movement of the grinding head are successfully withstood by this Silentbloc Spindle Band.

(*Triefus & Co. Ltd., Crawley*)

**SILENTBLOC**

**SILENTBLOC LIMITED**  
**Manor Royal Crawley Sussex**

Telephone: Crawley 27733 (STD Code: OCY3) Telegrams: Silentbloc Crawley

Andre Rubber Co. Ltd. is another Silentbloc Company

Silentbloc products are also manufactured by Silentbloc (Australia) Pty. Ltd., Melbourne Broadway 5209





# COMPONENTS REVIEW

FEBRUARY, 1963

## NEW DOUBLE TRANSISTOR

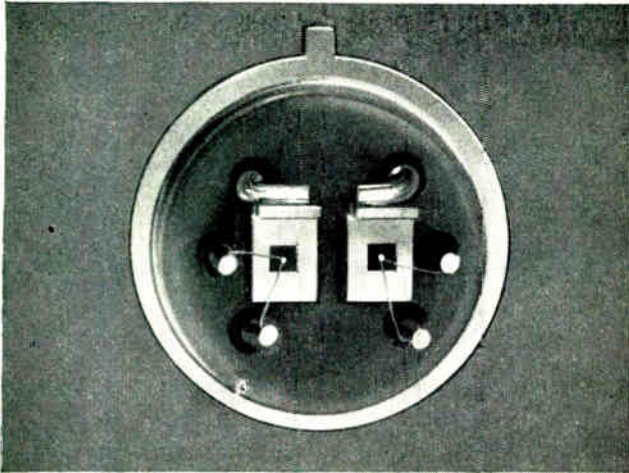

### *matched pair in TO-5 case*

The BFY20 is a matched pair of BFY17 SILICON PLANAR npn transistors encapsulated in a 6-lead TO-5 case. The common mounting minimizes the temperature difference between the two transistors, making the device ideal for use in d.c. amplifiers.

The BFY20 is the first of a range of transistor pairs; unmatched pairs of various other STC silicon planar transistors will be announced shortly.

#### Brief Data

$f_T$	( $V_{CE} = 9V, I_C = 10mA$ )	245 Mc/s	(Typ)
$I_{CBO}$	( $V_{CB} = 9V, I_E = 0$ )	10 nA	(Max)
$h_{FE}$	( $I_C = 100\mu A, V_{CB} = 0$ )	10	(Min)
$V_{BE}$	matched to within	10 mV	
$P_{CM}$	(total)	600 mW	

Write, 'phone or Telex for the latest data sheet to STC Transistor Division, Footscray, Sidcup, Kent. Telephone Footscray 3333. Telex 21836.

## 50 VOLT SOLID TANTALUM CAPACITORS

The STC solid tantalum capacitor series has been further extended by the addition of a 50 volt rating. Rated working voltages at 85°C are now: 50 V, 35 V, 20 V, 15 V, 10 V and 6 V d.c. This range of capacitors is manufactured entirely in the United Kingdom under full Quality Control and all units are aged for 7 days before shipment.

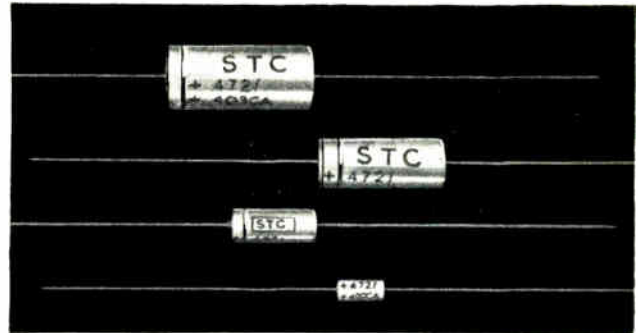

- Designed to MIL-C-26655/2 (Styles CS12 and CS13)
- Temperature range:  $-55^{\circ}C$  to  $+125^{\circ}C$  (with voltage derating above  $+85^{\circ}C$ )
- Humidity classification: H6 (DEF 5011)
- Capacitance range: 0.47  $\mu F$  to 330  $\mu F$

Performance data available on request.

In addition to this range, STC manufacture the following wet-electrolyte tantalum capacitors:

Type approved foil  
High Temperature foil  
Miniature foil  
Special Quality foil  
and also a range of wet-electrolyte  
Sintered Anode capacitors.

Write, 'phone or Telex for Data Sheets and prices to STC Capacitor Division, Brixham Road, Paignton, Devon or London Sales Office, Footscray, Kent. Telephone Footscray 3333 Telex 21836.



## THREE NEW RELAYS

### TYPES 24 AND 25

These miniature industrial relays and sockets are now available in quantity. They are interchangeable in form, fit and function with well-known continental types. For maximum economy, the preferred configuration is 2-changeover contacts (Type 24) or 4-changeover contacts (Type 25), with coil voltages as required.

To ensure optimum reliability of performance, silver/gold contacts are used together with a cover formed from non-gassing plastic. For a.c. operation, suitable STC quality rectifiers are available; voltages should be specified with order.

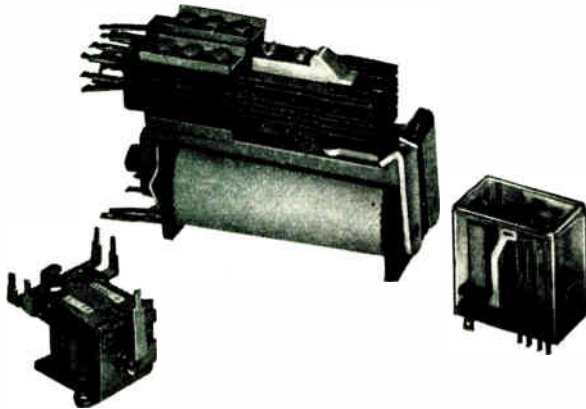

### TYPE 11200 TWIN RELAY

These are, basically,  $2 \times$  PO 3000 Type relays, but special flat coils are fitted, together with two special armatures each operating one springset. One or two windings can be supplied for each core. For 50 V d.c. working, 1 000–2 000 ohms coils are used but they are available from 5–3 000 ohms if required. The Type 11200 twin relay is recommended where price and space-saving are important considerations.

### TYPE 11301 'DOLLAR' RELAY

A d.c. relay for general use where space and cost are important and where high current capacity is not required. 'Dollar' relays are available for 6, 12, 24, 48 or 60 volts working with coil resistances from 100–6 000 ohms. They have one changeover contact which will switch either 0.3 A at 50 V d.c. or 1.0 A at 50 V d.c. depending on contact material.

### OTHER TYPES

Other types in the STC ranges include reed switches and relays, PO 3000 Types and PO 600 Types. PO 3000 Types are available in quantity with ten days delivery.

Write, 'phone or Telex for STC relay literature and prices to STC Electro-mechanical Division, West Road, Harlow, Essex. Telephone Harlow 21341. Telex 81184.

## STC NOW MARKET BEYSCHLAG RESISTORS

The STC Rectifier Division has been appointed sole distributor in the UK for Beyschlag Carbon Film Resistors.

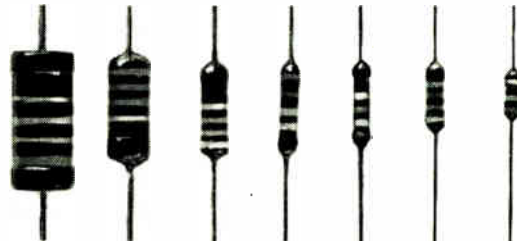

Actual Size

Beyschlag Carbon Film Resistors, used extensively in professional and home entertainment applications in Europe, are made in a modern, fully mechanized plant situated in Western Germany. The very large output from the factory, which has a capacity of 3 million units daily, results in low cost production which enables the products to be marketed at highly competitive prices. The quality and uniformity of the product is assured by individual, automatic testing at all stages of production.

All Beyschlag Carbon Film Resistors are of the insulated type, band coded and supplied in the preferred ohmic values in ratings from 1/20th watt to 2 watts. They are particularly suitable for applications where minimum drift and long term reliability are essential.

STC will continue the manufacture and sale of its own Military Approved types of 1% tolerance which are already well known in the industry.

The UK satellite Ariel 1, still orbiting, contains a large quantity of STC High Stability Carbon Film Resistors. These components are used in circuitry in the Data Store, Cosmic Ray Analyzer and Photomultiplier. Illustrated is the Photomultiplier Assembly canister.

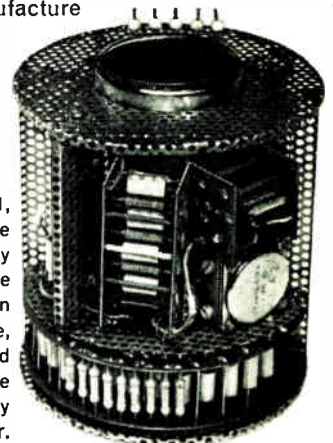

Write, 'phone or Telex for Data Sheets and prices to STC Rectifier Division, Edinburgh Way, Harlow, Essex. Telephone Harlow 26811. Telex 81146.

**STC COMPONENTS REVIEW**

# COMPLETE NEW RANGE OF POWER TRIODES for industrial RF heating

The design of these valves continues the STC philosophy of low  $\mu$ , high mutual conductance valves for r.f. heating oscillators. This yields high circuit efficiency, low drive requirements and a large safety factor on grid dissipation. This last feature is especially important since circuit design does not always afford complete compensation for change in load impedance with corresponding change in grid drive.

A choice of anode cooling techniques is available for all types — forced air (J codes), water with integral coiled water jacket (R codes) or vapour (Z codes).

Also, a choice of metal/glass or metal/ceramic envelope construction is available for all types. The use of ceramic ('C' codes) permits a considerable increase in maximum operating frequency.

Water cooled valves are to be made available with a choice of connexion of water pipes above or below the valve mounting flange. The former is usually essential when the valve is mounted in a tuned cavity but, for lower frequency induction heating sets, connexion from the underside is often more convenient.

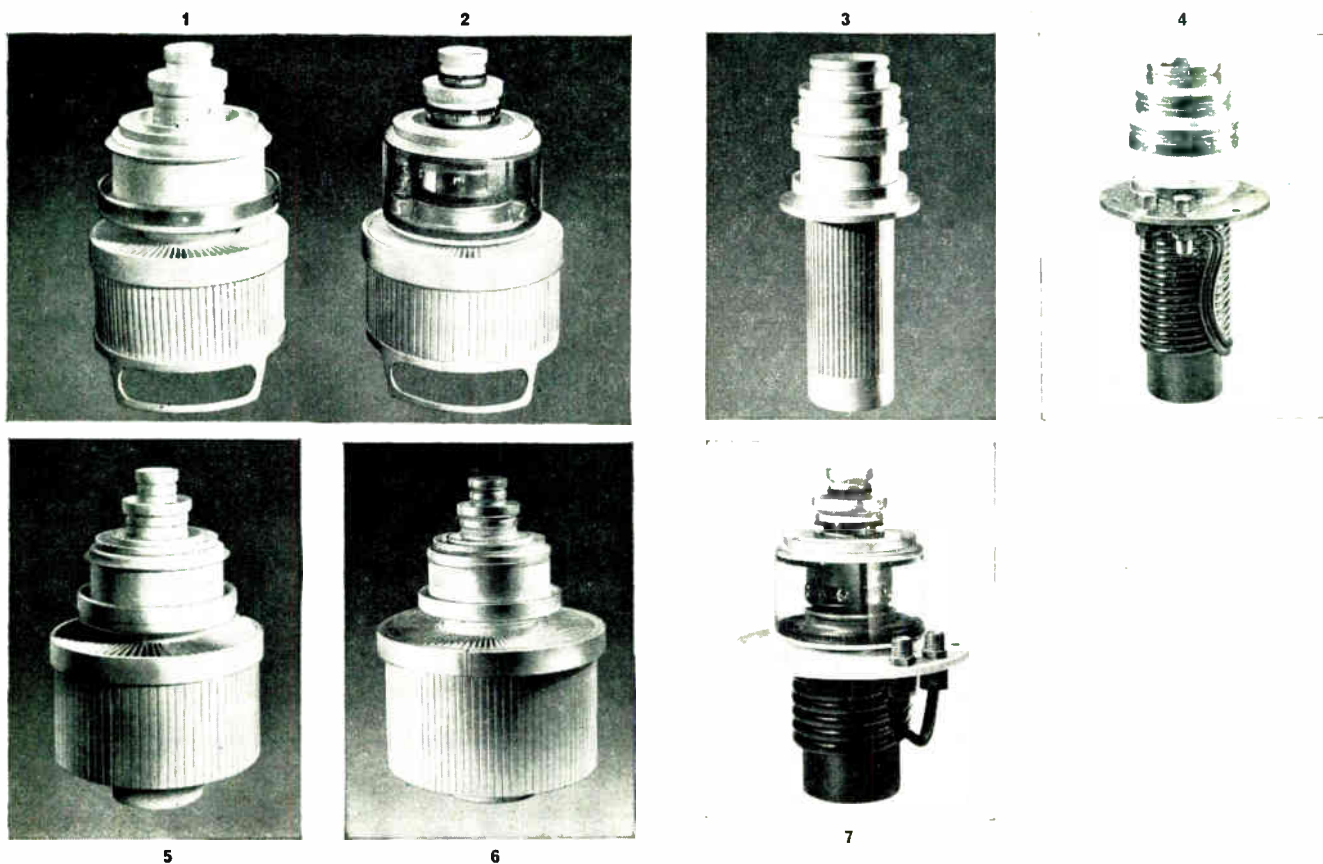

**ABRIDGED DATA**

	3J/187E	3R/187E	3JC/187E	3J/203E	3R/203E	3JC/203E	3J/223E	3R/223E	3JC/223E	3RC/223E	3ZC/223E	3R/262E	3RC/262E	3ZC/262E
Typical Output kW	5	5	5	12	12	12	25	25	25	25	25	40	40	40
f max Mc/s	120	120	220	50	50	220	30	30	100	100	100	30	80	80
$i_a$	12	12	12	12	12	12	12	12	12	12	12	12	12	12
$\phi_m$	22	22	22	32	32	32	32	32	32	32	32	60	60	60
$V_a$ kV	5	5	5	6	6	6	6	6	6	6	6	6	6	6
$P_a$ max kW	3	3	3	6	6	6	10	12	10	12	12	24	24	24
Cooling	Forced Air	Water	Forced Air	Forced Air	Water	Forced Air	Forced Air	Water	Forced Air	Water	Vapour	Water	Water	Vapour
Illustration	2	7	1			5			6			4		3

Write, 'phone or Telex for data sheets to STC Valve Division, Brixham Road, Paignton, Devon or London Sales Office, Footscray, Kent. Telephone Footscray 3333. Telex 21836.



**Standard Telephones and Cables Limited**  
**COMPONENTS GROUP · FOOTSCRAY · SIDCUP · KENT**



**UNIVERSALLY**

### **GOLD CATHODE TUBES PROVE THEIR RELIABILITY**

Day and night, somewhere cold cathode tubes in hundreds of equipments are signalling when a pre-set count is reached: timing to accuracies of up to 1/10 millisecond: dividing or frequency measuring: providing time reference marks on pen recorders: controlling machine tools: counting pulses from photocells, geiger tubes, magnetic pickups: acting as sequence switches: generating pulse trains: adding and subtracting: stabilising voltages and many other applications. If you would like more information about cold cathode tubes send for descriptive booklets.

Tube Division,  
Technical Services Department,  
Beeston, Nottingham. Tel: 254831

**ERICSSON TELEPHONES LIMITED  
ETELCO LIMITED**

# specify

# H GERMANIUM GENERAL PURPOSE and COMPUTER DIODES

- Reliability
- High conductance
- Low leakage
- Fast recovery characteristics
- Rugged, sub-miniature all-glass construction
- Operation up to 90°C
- Low cost

## point-contact general purpose diodes

### HG10

High forward conductance  
Max. average power dissipation 80mW  
Nominal capacitance at -10V 0.2pF  
Operating and Storage temperature range -60°C to 90°C

Type	P.I.V.	Max. D.C. or Mean Forward Current (mA at 25°C)	Min. Forward Current at 1V (mA)	Max. Reverse Current at -50V (µA at 25°C)
*HG1005	100	45	5	50
†HG1006	100	45	5	100
HG1012	75	45	5	100

TYPE APPROVED \*CV 7041 †CV 448 & +CV 7130

## gold-bonded computer diodes

### HG50

Extremely high forward conductance  
Stored charge at 10mA 400pC  
Nominal capacitance at -10V 0.4pF  
Max. average power dissipation 80mW

Type	Min. Breakdown Voltage	Max. D.C. or Mean Forward Current (mA @ 25°C)	Max. Forward Voltage at 100mA	Max. Reverse Current at 25°C (µA @ V)
HG5003	100	100	0.8	25 -50
*HG5004	70	100	0.8	25 -50
HG5008	40	100	0.8	25 -30
HG5085	Transistor base protection diode		V <sub>f</sub> at 100 mA (25°C) ..... 1.0V max. I <sub>g</sub> at -1.0V (45°C) ..... 5µA max. P.I.V. .... 5V Max. DC Current (25°C) ..... 100 mA	

TYPE APPROVED \*CV 7127

## fast recovery computer diodes

### HD18

High forward conductance  
6 Nanosec typical recovery time  
Nominal capacitance at -1V 1.5pF

Type	P.I.V.	Max. Forward Voltage		Max. Reverse Current @ -10V (25°C)
		@ 10 mA	@ 100 mA	
HD1810	50	0.45	0.75	5µA
HD1840	30	0.45	0.70	10µA
HD1841	20	0.45	0.70	20µA
HD1870	15	0.42	0.70	15µA
HD1871	10	0.42	0.70	20µA (@ -5v)

**WRITE NOW** for complete data on the full range of Hughes semi-conductor products, which also includes:—

- Silicon General Purpose and Computer Diodes
- Silicon Power Diodes and Rectifiers
- Voltage Reference Devices
- High Voltage Cartridge Rectifiers
- Voltage Variable Capacitors
- PNP and NPN Silicon Transistors



—or ask for  
a Sales Engineer to call



**HUGHES INTERNATIONAL (U.K.) LTD**

KERSHAW HOUSE, GREAT WEST ROAD, HOUNSLOW, MIDDLESEX

TEL.: HOUNSLOW 5222 M & P HM12

ANOTHER WORLD BEATER IN THE LEKTROKIT RANGE

# LEKTROKIT RACK SYSTEM

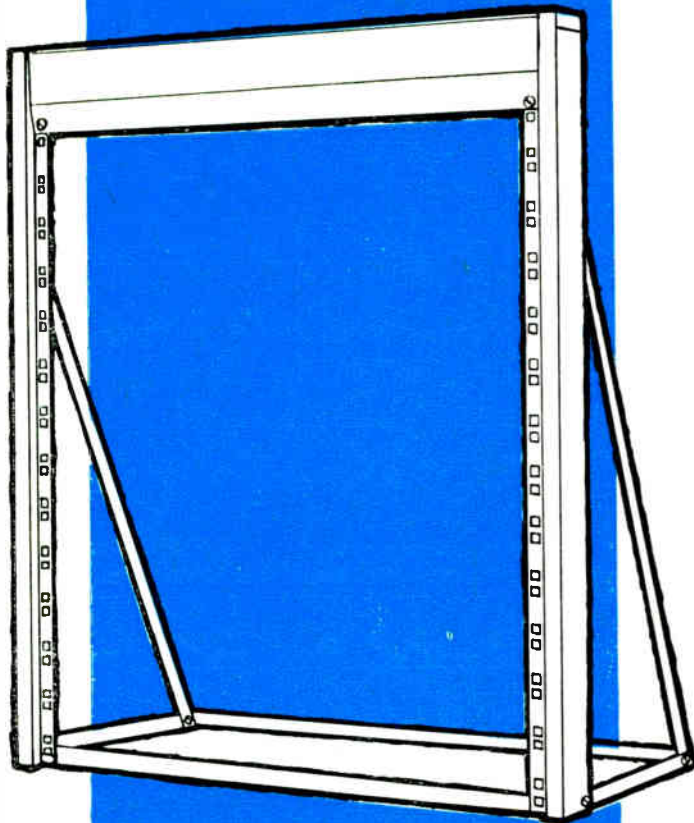

The Lektrokit Rack Construction System is a natural extension of the widely used Chassis Construction System and comprises a range of simple and inexpensive component parts, from which standard equipment racks can be constructed quickly and cheaply.

SPECIAL FEATURES of the Lektrokit Rack System include:

- ★ Assembled racks and trolleys are light in weight but strong and of pleasing appearance.
- ★ Complete versatility – static racks for floor or bench mounting, mobile racks and trolleys, can all be constructed from the same limited range of components.
- ★ Unlimited expansion potential of the assembled racks, laterally as well as vertically.
- ★ Parts are supplied singly or in kit form.
- ★ The components are low priced and can normally be supplied ex-stock.

For full details of the Lektrokit Rack System write for the new illustrated 24-page Rack System Handbook, sent free of charge and without obligation.

Please send my free copy of the  
**NEW RACK SYSTEM HANDBOOK**   
Also send a copy of the  
**CHASSIS SYSTEM HANDBOOK**

Name \_\_\_\_\_

Company \_\_\_\_\_

Address \_\_\_\_\_

Detach and send to :—

# A.P.T

**ELECTRONIC  
INDUSTRIES  
LIMITED**

**CHERTSEY ROAD, BYFLEET, SURREY**

PHONE: BYFLEET 41131/2/3/4 PABX GRAMS: APTRAN, BYFLEET

# Let the

## INDUSTRIAL ELECTRONICS

### READER ENQUIRY SERVICE

# help you to obtain more information

Circle the code numbers of the items in which you are interested. Insert your name and address, etc., in block capitals and post the card to us.

We will communicate with the manufacturers concerned and arrange for the information you require to be sent to you without obligation.

*(No postage stamp is required if posted in Great Britain or Northern Ireland)*

### Is this your own copy ?

Each month INDUSTRIAL ELECTRONICS will bring you news of the latest applications, the most recently announced equipment, produced by the rapidly expanding electronics industries of the world.

It is invaluable to all management and production executives, and engineers, in Industry generally, who need to be informed of the latest developments in electronic aids to industry.

**MAKE SURE OF YOUR COPIES  
USE THE ORDER CARD NOW**

## INDUSTRIAL ELECTRONICS

## READER ENQUIRY SERVICE

FEBRUARY 1963 — For further information circle appropriate number

Editorial code number—		1	2	3	4	5	6	7	8	9	10	11	12	13	14	15	
16	17	18	19	20	21	22	23	24	25	26	27	28	29	30	31	32	33
34	35	36	37	38	39	40	41	42	43	44	45	46	47	48	49	50	51
52	53	54	55	56	57	58	59	60	61	62	63	64	65	66	67	68	69
70	71	72	73	74	75	76	77	78	79	80	81	82	83	84	85	86	87
Advertisement code number—		200	201	202	203	204	205	206	207	208	209	210	211	212	213		
214	215	216	217	218	219	220	221	222	223	224	225	226	227	228	229	230	231
232	233	234	235	236	237	238	239	240	241	242	243	244	245	246	247	248	249
250	251	252	253	254	255	256	257	258	259	260	261	262	263	264	265	266	267

I would also like details of.....

Your Name..... Position held.....

Name of Firm.....

Address.....

Nature of Business.....

PLEASE USE BLOCK CAPITALS

Postage will be paid by Associated Iliffe Press

No Postage Stamp necessary if posted in Great Britain or Northern Ireland

**BUSINESS REPLY CARD**  
Licence No. SE 591

**"INDUSTRIAL ELECTRONICS",  
DORSET HOUSE,  
STAMFORD STREET,  
LONDON, S.E.1**

## INDUSTRIAL ELECTRONICS

FEBRUARY 1963

### SUBSCRIBER'S ORDER FORM

#### Subscription Rates

Home and Overseas £3. 0s. 0d.

USA and Canada \$8.50

Please supply

INDUSTRIAL ELECTRONICS monthly for the next 12 months

I will remit on receipt of invoice

NAME.....

ADDRESS.....

Postage will be paid by Associated Iliffe Press

No Postage Stamp necessary if posted in Great Britain or Northern Ireland

**BUSINESS REPLY CARD**  
Licence No. SE 591

**"INDUSTRIAL ELECTRONICS",  
DORSET HOUSE,  
STAMFORD STREET,  
LONDON, S.E.1**

# Let the **INDUSTRIAL ELECTRONICS**

## **READER ENQUIRY SERVICE**

# help you to obtain more information

### **INDUSTRIAL ELECTRONICS**

### **READER ENQUIRY SERVICE**

**FEBRUARY 1963 — For further information circle appropriate number**

Editorial code number—	1	2	3	4	5	6	7	8	9	10	11	12	13	14	15			
	16	17	18	19	20	21	22	23	24	25	26	27	28	29	30	31	32	33
	34	35	36	37	38	39	40	41	42	43	44	45	46	47	48	49	50	51
	52	53	54	55	56	57	58	59	60	61	62	63	64	65	66	67	68	69
	70	71	72	73	74	75	76	77	78	79	80	81	82	83	84	85	86	87
Advertisement code number—	200	201	202	203	204	205	206	207	208	209	210	211	212	213				
	214	215	216	217	218	219	220	221	222	223	224	225	226	227	228	229	230	231
	232	233	234	235	236	237	238	239	240	241	242	243	244	245	246	247	248	249
	250	251	252	253	254	255	256	257	258	259	260	261	262	263	264	265	266	267

I would also like details of.....

Your Name..... Position held.....

Name of Firm.....

Address.....

Nature of Business.....

**PLEASE USE BLOCK CAPITALS**

Circle the code numbers of the items in which you are interested. Insert your name and address, etc., in block capitals and post the card to us.

We will communicate with the manufacturers concerned and arrange for the information you require to be sent to you without obligation.

*(No postage stamp is required if posted in Great Britain or Northern Ireland)*

### **Is this your own copy ?**

Each month **INDUSTRIAL ELECTRONICS** will bring you news of the latest applications, the most recently announced equipment, produced by the rapidly expanding electronics industries of the world.

It is invaluable to all management and production executives, and engineers, in industry generally, who need to be informed of the latest developments in electronic aids to industry.

**MAKE SURE OF YOUR COPIES  
USE THE ORDER CARD NOW**

Postage will be paid by Associated Iliffe Press

No Postage Stamp necessary if posted in Great Britain or Northern Ireland

**BUSINESS REPLY CARD**  
Licence No. SE 591

**"INDUSTRIAL ELECTRONICS",  
DORSET HOUSE,  
STAMFORD STREET,  
LONDON, S.E.1**



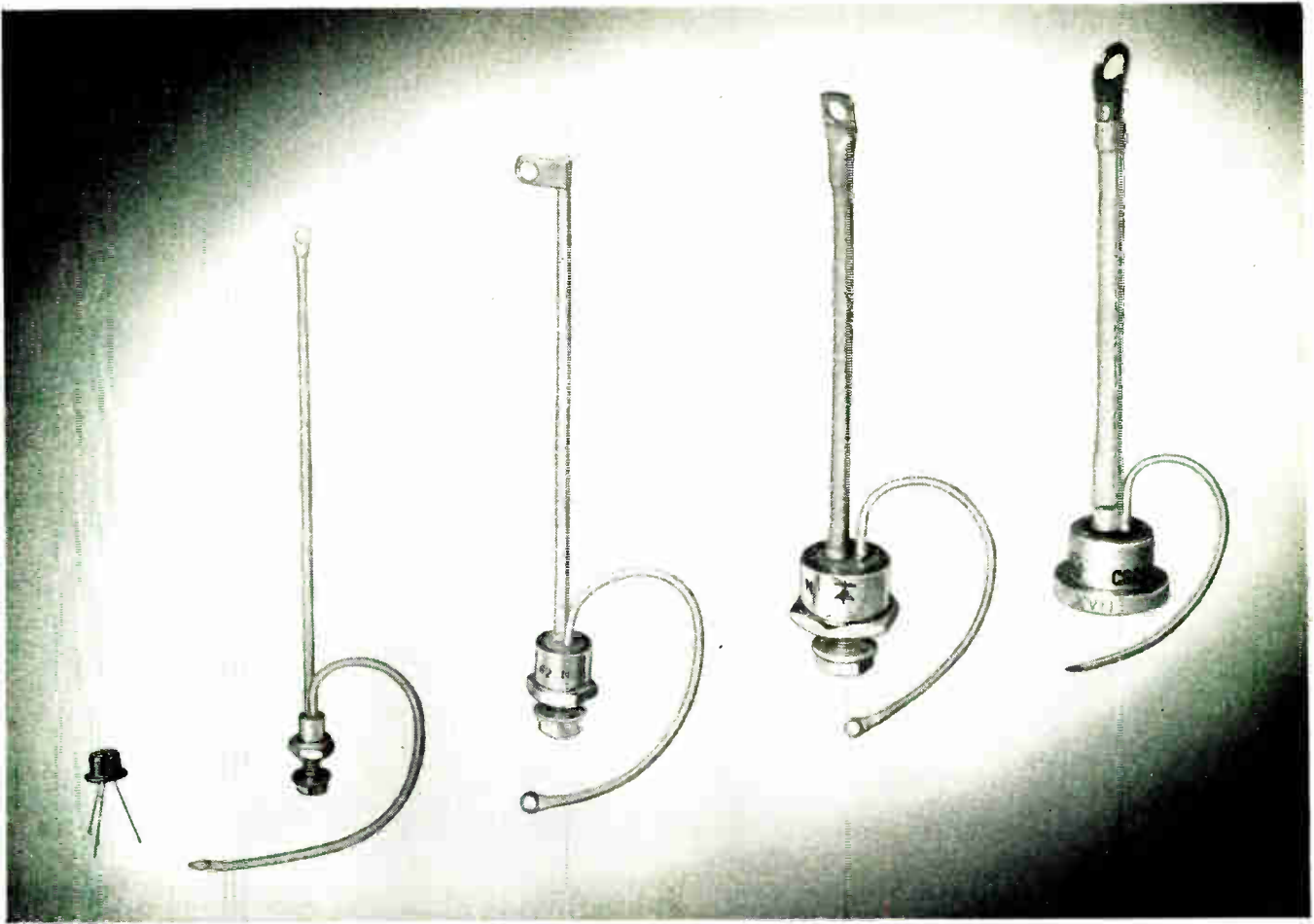

 **WESTINGHOUSE** 

# 'TRINISTOR'

## SILICON CONTROLLED RECTIFIERS

With current outputs of 500 mA, 1A, 10A, 16A, 26A and 70A at voltages of from 25 to 400 volts, there is a Westinghouse 'TRINISTOR' silicon controlled rectifier to suit every application.

For full details write to Dept. I.E. 2/63, Rectifier Division, Semiconductor Department.

**WESTINGHOUSE BRAKE AND SIGNAL CO. LTD**  
82 YORK WAY · KINGS CROSS · LONDON N1 · TERMINUS 6432

**SEE** the advantages of

the  range of digital voltmeters

0 . 4 2 1 8 5

. 1 5 9 9 8

1 . 5 7 3

6 9 . 8

***For full details write to:***

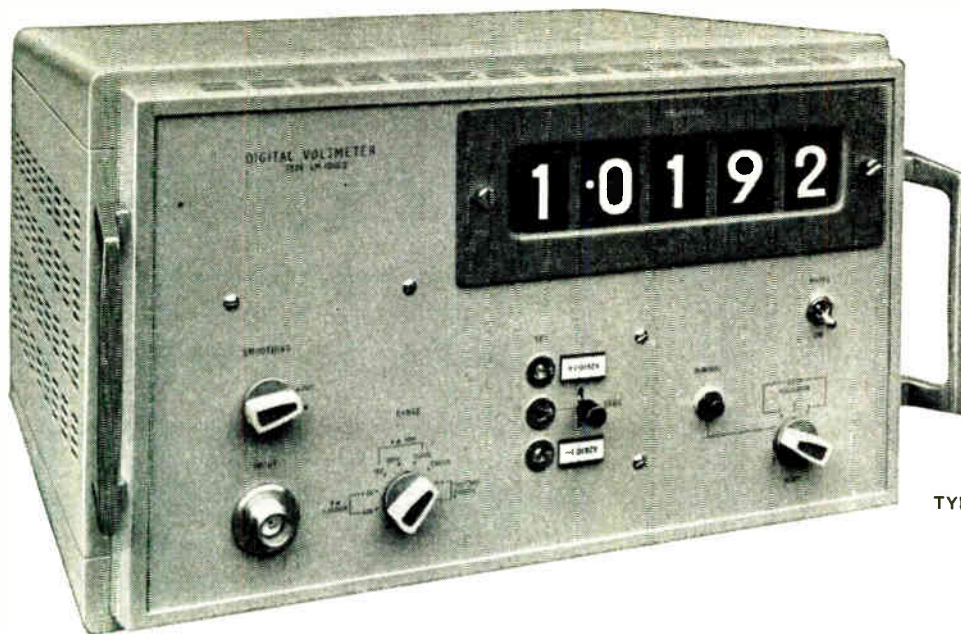

TYPE LM 1010.2

## 6 digit LM 904

Accuracy:  $\pm 0.01\%$  of reading or  $0.003\%$  of range.  
 Range (f.s.): 2.99980—2999.80V in 4 ranges.  
 (Input limited to 1.5 kV).  
 Max. Resolution:  $50 \mu\text{V}$ .

## 5 digit LM 1010.2

Accuracy:  $\pm 0.02\%$  of reading  $\pm 1$  bit.  
 Range (f.s.): 0.15998—1599.9 V in 5 ranges.  
 Max. Resolution:  $20 \mu\text{V}$ .

## 4 digit LM 902.2

Accuracy:  $\pm 0.07\%$  of full-scale or  $\pm 1$  bit.  
 Range (f.s.): 0.1599—1599 V in 5 ranges.  
 Max. Resolution:  $100 \mu\text{V}$ .

## 3 digit LM 901

Accuracy:  $\pm 0.25\%$  of full-scale.  
 Range (f.s.): 0.999 V—99.9 V in 3 ranges.  
 Max. Resolution: 1 mV.

### SOLARTRON'S NEW DIGITAL VOLTMETERS have these advantages:-

Constant percentage accuracy of reading over the entire voltage range—not just at full scale!

Successive approximation techniques using solid state switching to give greater reading speeds (50 per second) and improved reliability.

An input impedance greater than  $1000 \text{ M}\Omega$  on the most sensitive ranges ensures accuracy of reading and permits capacitance transfer techniques for high common mode rejection.

Automatic resolution control and a.c. filtering facilitates use on noisy inputs.

Decimal or binary-coded-decimal print-out signals for use with the Solartron High Speed Printer.

Oven controlled Weston standard cell and sampling resistors to maintain high accuracy.

Co-planar projection displays free from flicker.

New plug-in modular concept gives greater accessibility.

### SOLARTRON LABORATORY INSTRUMENTS LTD.

Cox Lane, Chessington, Surrey · Telephone: LOWer Hook 5252 · Telex: 23842 Chessington · Cables: Solartron, Chess.

M & P S 130

# COAXICON

## Coaxial Connectors by AMP



These high performance RF cable connectors represent AMP precision crimping technique applied to specially designed coaxial plugs and sockets.

**Perfect contact.** Conductor and screen contacts are effected by the well-proved A-MP cantilever beam contact spring which guarantees uniform pressure.

**Controlled crimping.** Conductor, braid and insulation are crimped simultaneously with one stroke of the special A-MP hand tool, at a controlled pressure.

**Efficiency.** The crimping system gives perfect concentricity of conductor and braid. Physical dimensions of plugs and sockets are matched to specific groups of cables, resulting in excellent impedance matching.

**Low Costs.** Application costs are much reduced, as wire stripping is easier and no braid combing is necessary. Attachment is by one stroke — the most efficient and economical system ever devised.

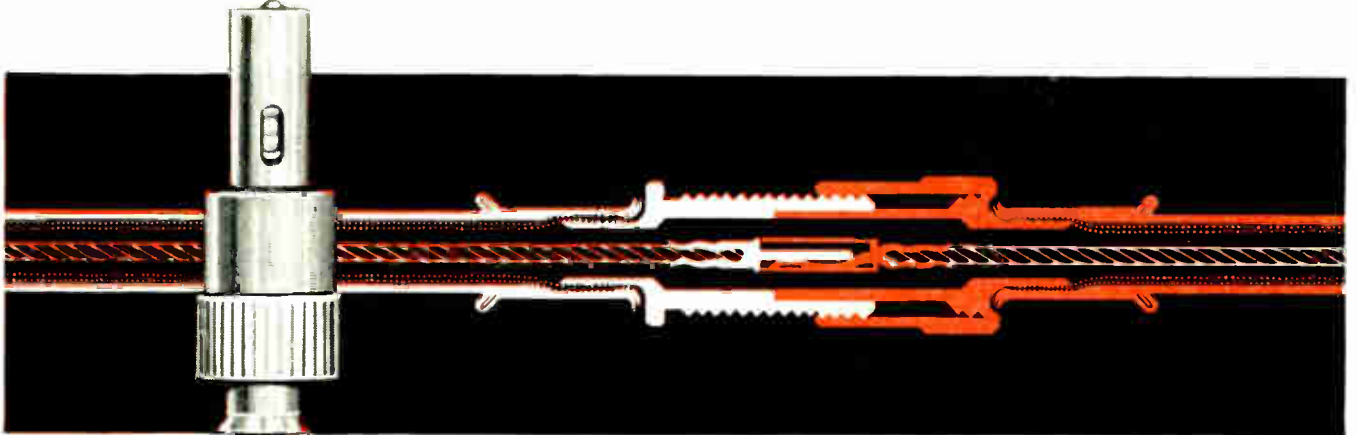

TNC Connector

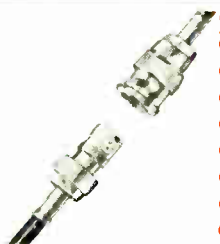

BNC Connector

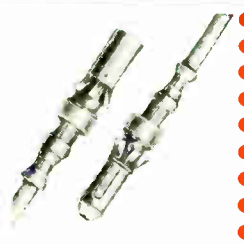

Miniature Pin & Socket

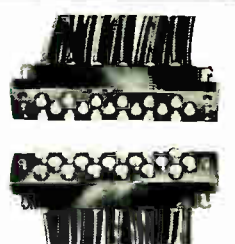

Standard Multi-Way

# AMP

**AIRCRAFT-MARINE PRODUCTS (GT. BRITAIN) LIMITED**

Head Office: AMPLO HOUSE, 87/89 SAFFRON HILL, LONDON, EC1

Tel: CHAncery 2902 (7 lines) Telex: 23513 Cables: AMPLO LONDON TELEX

SOUTH AFRICA DISTRIBUTOR: E. S. MCVITT & SONS (PTY) LTD, 51-57 MILNE STREET, P.O. BOX 417, DURBAN, NATAL  
ASSOCIATED COMPANIES IN USA, AUSTRALIA, CANADA, HOLLAND, FRANCE, GERMANY, ITALY, JAPAN AND MEXICO

AP 22

# INDUSTRIAL ELECTRONICS

## Comment

A great deal of confusion exists about electronics because the word is used with so many different meanings. Originally it was used to convey the meaning that is now more usually denoted by industrial electronics. It was used to describe radio-like devices used for industrial purposes. By radio-like we do not mean that the industrial application was to communications but that the apparatus used valves and circuits of the same nature as those of radio.

After this the purists got hold of the word and decided that it should mean only valves and similar devices. In B.S. 204:1960, electronics is defined as 'that branch of science and technology which deals with the study of the phenomena of *conduction* of electricity in a vacuum, in a gas, and in semi-conductors, and with the utilization of devices based on these phenomena'.

Apart from the final clause this definition represents what might be called the scientific meaning of the word. The final clause covers the most general modern usage of the word. By electronics most people nowadays mean devices utilizing the phenomena of electrical conduction in a vacuum, in a gas or in a semiconductor. It is clear that radio itself is now a branch of electronics.

The wheel has thus come full circle. Electronics is no longer an off-shoot of radio; radio is a part of electronics.

In spite of the clear British Standard definition, it must not be thought that all is now straightforward. Old meanings of words tend to hang on, and in the Electronic Engineering Association, the 'electronic' of its title really means industrial electronics for there is a companion organization called the British Radio Equipment Manufacturers' Association. This is not, however, a strict division between industrial electronics and radio. Here 'radio' really means broadcast receivers and its other aspects come under the electronics heading!

It may well be asked what we ourselves mean by the word, since we use it in our title. The answer is that we use it mainly in the sense of the final clause of the British Standards definition. We are much more concerned with the use of the 'phenomena of . . .' than with the phenomena themselves. We are also very much concerned with the applications of the devices in industry.

Some may say that it is extending the definition unjustifiably to include applications, but we do not think so. Any device is made to perform some function and it is the application which determines the function and the design of the device. Application must thus be the first study of any engineer.

### Telstar Again

We reported last month that the command function in Telstar had failed, with the result that it had become impossible to turn certain apparatus on and off by command signals from the ground in order to conserve the batteries. This affected Telstar's ability to act as a relay station, but not the telemetry apparatus.

It has now been reported that the fault has been repaired and that everything is in proper working order again. This is good news. However, the report implies that active steps were taken to mend whatever went wrong and this is rather hard to believe. It almost implies that Telstar carries a robot serviceman who can be controlled by signals from the ground.

In the absence of any real information

one can only speculate. A common way of guarding against failures is to build in redundancy. This usually means the duplication of parts with arrangements for a changeover from the faulty part to a spare either automatically or by a command signal. This does not seem to have been the case with Telstar, however, for the changeover could surely be effected at once instead of weeks later.

Perhaps the fault was a bad connection which has righted itself as bad connections sometimes do. Perhaps the common remedy of a good hard kick was used! If Telstar had rockets for adjusting its orbit, firing these could have given it the necessary kick.

The appearance of the fault must bring home the importance of reliability in all satellite equipment. Probably in no other application of electronics can a fault be quite so expensive. That satellites are launched at all actually speaks volumes for the reliability obtainable from modern electronic apparatus.

### I.P.P.S.

Elsewhere in this issue we report some of the highlights of the Annual Exhibition of Scientific Instruments organized by The Institute of Physics and the Physical Society, to give it its full name. Until the amalgamation of the two organizations gave it its present cumbersome name, it was the Physical Society's Exhibition, commonly abbreviated to 'Phys. Soc.' We notice that most people still call it that.

This is perhaps a case where initial letters are best and we feel that in the interests of accuracy it is better to call it the I.P.P.S. Exhibition. All that can be said against it is that the initials are unfamiliar, but that always applies to any new abbreviation.

### Algol

Probably most readers would find it hard to define the meaning of this word. It is one which is being increasingly used in computer circles. To say that it is derived from 'algorithmic language' does not help very much for the dictionary merely defines 'algorism' as 'Arabic (decimal) notation'.

Algol is a kind of machine language used by computer programmers. It is based on English words, figures, punctuation marks, and mathematical signs. The programme as written in Algol is not in a form which the average computer can accept; it is not in computer language. But the programme in Algol can be translated into computer language automatically by a machine and it is

easier for a man to write the programme in Algol than in the computer language.

Since a computer is primarily a mathematical machine, Algol is primarily a mathematical language. A sentence in Algol might be  $\text{Absmax}(a)$  size:  $(n, m)$  Result:  $(y)$  Subscripts:  $(i, k)$ ; This means 'The absolute greatest element of the matrix  $a$  of size  $n$  by  $m$  is transferred to  $y$  and the subscripts of this element to  $i$  and  $k$ '.

We hear that the experts in Algol amuse themselves by writing their holiday postcards in it! If this is true it must, as a language, be outgrowing its original mathematical confines.

We hear, too, that other countries use Algol with English words in it, not ones of their own languages. If all we hear is true, Algol might become a universal language, but surely one easier to write than to speak!

### Rent-A-Computer

Most people know that many computer manufacturers have computing centres which provide complete data-processing services for commercial concerns. They may be surprised, however, to learn that there are 117 such centres now operating in Great Britain.

Not all of them are being run on a profit-making basis. Indeed, there is a trend to reduce the charges for computing services in order to attract more companies to use them and become familiar with them.

The latest service is one offered by Elliott-Automation in the form of do-it-yourself workshops, which are to be opened at Borehamwood, Hertfordshire, Newcastle-upon-Tyne and Melbourne, Australia. For a hire fee, which can be as low as £4 an hour in the small hours of the morning rising to a maximum of £8 an hour at other times, one can have the exclusive use of a National-Elliott 803 general-purpose digital computer.

The service is not intended as a replacement for existing ones but as a supplement to them. It is meant primarily for engineers and others engaged on scientific and technical work.

Those who wish to use this do-it-yourself service must naturally know how to operate and programme the computer. Preliminary training courses are, therefore, being arranged and, for an extra fee, the beginner can obtain trained assistance when he first hires time on the computer.

This all sounds a most useful service which ought to be of great help to the many people who only need the aid of a computer occasionally.

*Balancing the armatures of electric hand drills. (Photo by courtesy of Black & Decker Ltd.)*

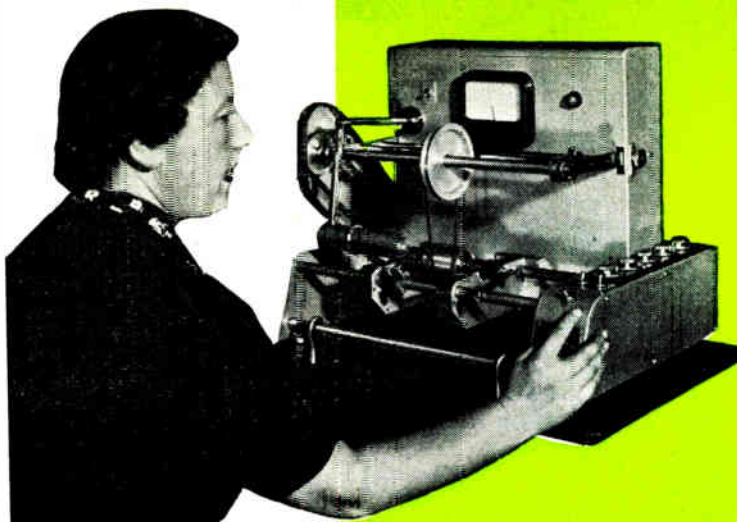

## Dynamic Balancing

**P**RESENT day trends towards ever increasing speeds in rotating machinery emphasize the importance of greater accuracy in balancing. The centrifugal force associated with a given out-of-balance mass in a rotating body increases as the square of the rotational speed. This means that when the speed of a shaft is increased, say, from 1,500 rev/min to 3,000 rev/min, the accuracy of balancing must be increased four times to keep the stress in the bearings and other components due to out-of-balance forces to the same value.

These forces are quite considerable, as can be seen by considering a shaft rotating at, say, 3,000 rev/min; an out-of-balance mass of 2 lb acting at a radius of 15 in. from the shaft axis results in a centrifugal force associated with this out-of-balance mass amounting to as much as 3½ tons. With the smaller rotating bodies, an out-of-balance mass of as little as 1 oz acting at a radius of 1 in. from the shaft axis will exert a force of as much as 15 lb at the same speed.

Simple planar bodies, such as thin flat discs, can be balanced with comparative ease. Referring to Fig. 1, if A is the position of an out-of-balance mass ( $m$ ), then the necessary correction to offset this will be the addition of a similar mass ( $m$ ), at point B diametrically opposite. Assuming that the disc is so thin as to be considered as lying in one plane, then the forces and bending moments are in perfect equilibrium. If, in practice, such a disc existed, normal static balancing would be sufficient. This type of balancing can however be used for flywheels and grinding wheels without any practical risk of vibration.

The situation is however more complicated when considering non-planar bodies. Referring to Fig. 2, it is impossible to balance effectively the out-of-balance mass ( $m$ ) at A by introducing a mass ( $m$ ) at B in a plane further along the body. Static balance can be achieved in this manner but there will still be a small bending moment tending to distort the body even when stationary. Bearing in mind the opening remarks regarding centrifugal forces, this static bending moment will be negligible compared with the large centrifugal forces generated when the body commences to rotate. The directions of influence of these forces are shown by the thick arrows and will naturally be taken by the bearings. The force is an instantaneous one whose direction of action changes as the body rotates; therefore the forces applied to the bearings are cyclical and in phase with the rotation. Thus, as the speed

By **W. G. A. McCORMICK\***

**Highly accurate balancing of rotating parts is essential to prevent vibration. The article describes apparatus which indicates the magnitude and position of the balancing weight which must be added.**

\* Griffin & George Ltd., formerly Dawe Instruments Ltd.

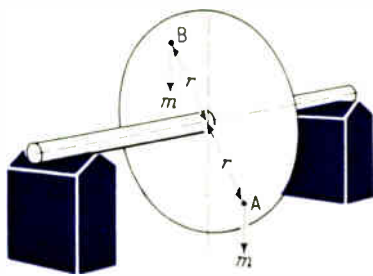

Fig. 1. Simple static balancing in a single plane. An out-of-balance at A, at radius  $r$ , having a mass  $m$ , can be balanced by adding the same mass at B

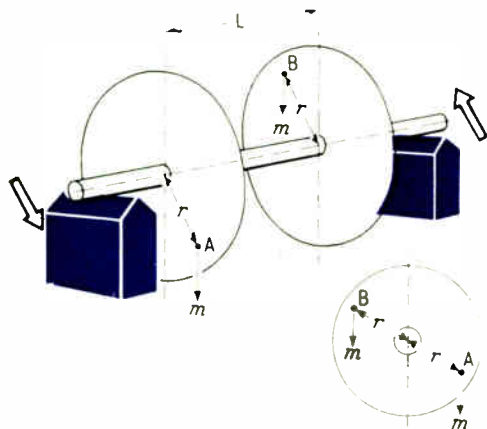

Fig. 2. Dynamic balancing in two planes, showing effects of out-of-balance forces on bearings when rotor is running. Static balancing cannot detect couples caused by dynamic out-of-balance

of rotation varies so will the periodicity of application of the forces to the bearings. This variation can be particularly dangerous if it occurs over the range of the natural frequency of the material since it will excite it violently.

To overcome this problem the body must be tested for balance while rotating, and counter-balancing weights must be attached in the same plane as the out-of-balance masses to be counteracted. In the majority of cases however, since these masses may occur in any plane in the body, this is not a practical proposition and equilibrium is usually achieved by the introduction of counter-balancing weights on two convenient cross-sections. The magnitude and distribution of this counter-balancing is so arranged that forces and bending moments are in satisfactory equilibrium.

Using normal mechanical methods of trial and error, it would take even a skilled operator some time to obtain a close balance, so that where many similar parts are to be balanced, the time factor alone would make mechanical methods completely uneconomical. Development of suitable electronic circuits has rendered this a routine operation which can be carried out by completely unskilled labour after a few minutes' instruction.

A dynamic balancing machine designed by Dawe Instruments Ltd. to achieve this simplicity of balancing is shown in one of the photographs. It illustrates the balancing of generator armatures for the well-known Megger insulation tester which must be accurately balanced if the smooth operation normal to the Megger is to be assured.

Each armature is provided with a ring at each end

having a series of tapped holes. The tray in front of the machine contains a number of slugs of different weight which are screwed into this ring as required, to achieve correct dynamic balancing. A similar problem of dynamic balancing has been solved by Black & Decker Ltd. with the Dawe 1250 balancing machine. This involves the accurate balancing of the drive unit rotor. Since the centrifugal force for an out-of-balance mass increases as the square of the rotational speed and the rotor speeds of small utility tools can be as high as 12,000 rev-min, dynamic balancing of a high order of accuracy is essential.

In the balancing machine used by both the firms mentioned, the workpiece is supported horizontally in V-mountings carried on light cradles, the position of which may be adjusted to suit the length of the body. Fast loading and unloading is thus possible. A belt drive from an electric motor is used to rotate the workpiece. The cradles are free to move in one plane only. Any vibrations caused by unbalance are transferred from the cradles to two electromagnetic pick-ups, one for each bearing support. Due to the light suspension used even a very small unbalance is not appreciably damped.

The electromagnetic pick-ups convert the vibrations into electrical signals proportional to the amplitude of the vibration of the workpiece. These are fed to an amplifier unit and applied to a meter the scale of which can be calibrated to read directly in weight of material to be added or removed to correct the unbalance. The arrangement is such that very minute vibrations will give a reliable reading on the meter. A filter network is included set to pass only those vibrations of the workpiece which occur once per revolution.

The control switches for obtaining readings for amount and angle of unbalance corrections are located adjacent to the workpiece. As unbalance corrections are generally made in two selected transverse planes, one control switch is used to select either the left-hand or right-hand plane of correction and a second switch to select one of two alternative scales of sensitivity. An electrical mixing system is used to ensure that corrections made at one end do not affect the other end.

Balancing generator armatures for the Megger insulation tester. (Photo by courtesy of Evershed & Vignoles Ltd.)

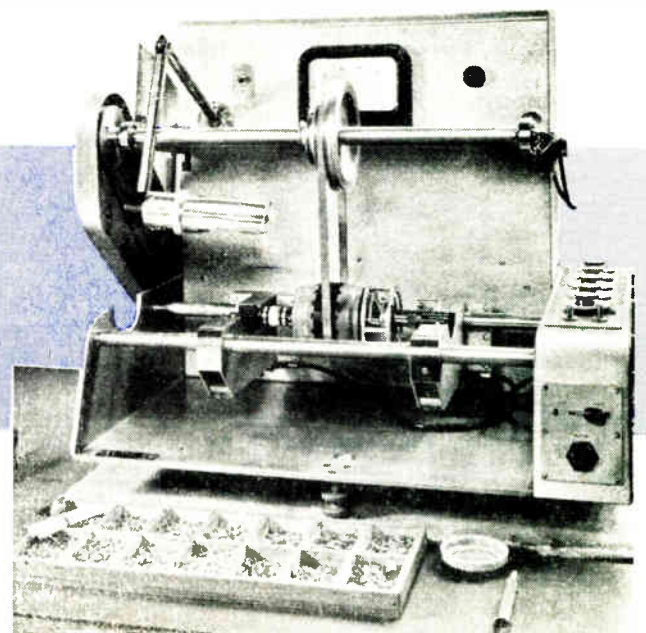



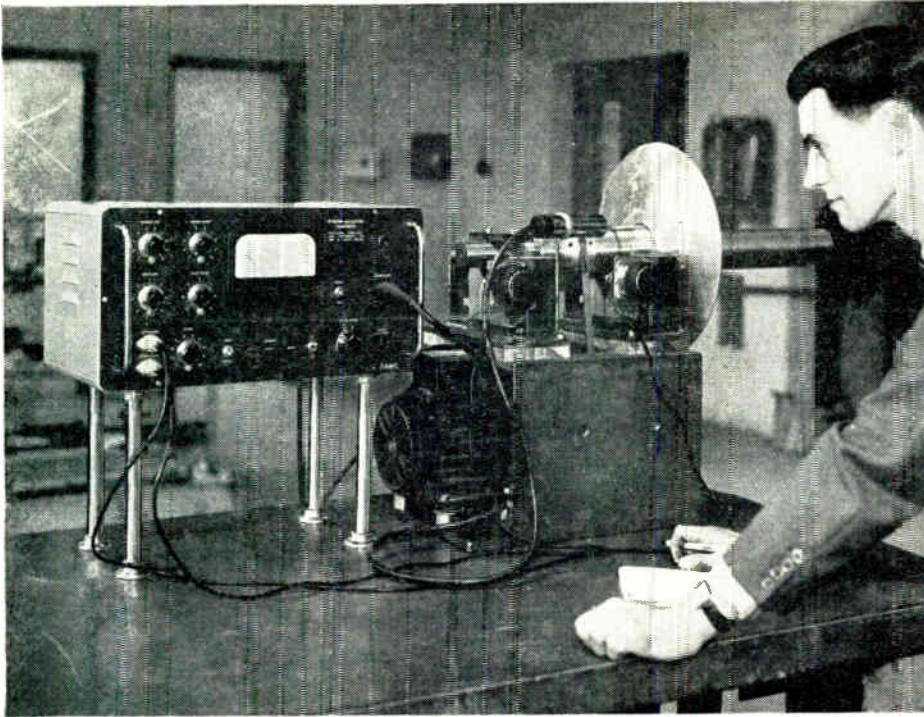

*Use of custom built jig and electronic unit to balance textile spindles. (Photo by courtesy of I.C.I. Terylene Council, Harrogate)*

Signals obtained due to movement of the cradles also trigger a stroboscopic lamp which gives a pulse of light each time the voltage in the pick-up coils changes from negative to positive. Thus the flashing of the lamp is timed by the vibration due to unbalance in the rotating work-piece. The instant of flash each revolution is therefore controlled by the physical point of unbalance on the rotor.

The flashing of the stroboscope is therefore also a function of the rotor r.p.m. and will cause the numbers on a numbered strip attached to the rotor to appear stationary. It follows therefore that if an external stationary pointer is accurately set to indicate a given position on the strip the number

indicated under these conditions will vary for different physical points of unbalance on the rotor and thus provide a means of indicating directly angular location of the unbalance correction.

Great speed of operation is given by the simplicity of loading of this instrument and by the design features which provide for a pre-setting of all controls except those necessary for the operator's use. This design also eliminates the need to reverse the body to balance both ends. A typical time for balancing workpieces between about 4 oz and 10 lb in weight would be about 20 to 30 seconds.

Considerable accuracy is obtained by this method. The

*Portable balancing equipment being used to ascertain unbalance on the grinding wheel in situ. (Photo by courtesy of Prince (Kingston) Engineers Ltd.)*



cradle can vibrate freely, being lightly suspended so that small amounts of unbalance are undamped. The potentials from the pick-ups are also amplified electronically, thus avoiding the errors inherent in mechanical devices. A displacement of 0.00005 in. peak-to-peak movement gives a reading of about 5 per cent of full scale on the meter. The corresponding unbalance in inch-pounds is given approximately by the formula

$$\frac{\text{weight of component in pounds}}{40,000}$$

Assuming that correct out-of-balance forces can be read and corrected to about 1 per cent of the scale, then the maximum out-of-balance force generated in actual running at 3,000 r.p.m. will be about 0.13 per cent of the weight of the body, 3,000 r.p.m. being a fairly high rotational speed even by present-day standards. If a normal operating speed of 1,500 r.p.m. is taken this conservative figure obtained for the maximum out-of-balance force is only 0.03 per cent of the weight of the body. Both these figures are, of course, negligible.

Having obtained a dynamic balance in this way corrections have, inter alia, been made so that the sum of the centrifugal or centripetal forces is zero; i.e.,  $\sum W_r \omega^2 = 0$  where  $W$  is the mass of the element,  $r$  is its radius of gyration and  $\omega$  is the rotational speed. Since a fixed body was assumed,  $\omega$  will be constant for all sections and all elements. Thus,  $\omega^2 \sum W_r = 0$  or  $\sum W_r = 0$ . This is, however, the condition for static balance so that by obtaining dynamic balance static balance has also been automatically obtained. As already shown the reverse is not necessarily true.

While this bench type of machine is suitable for small rotating bodies it is obviously limited to units within the physical capacity of the machine. For larger components a console model (the Dawe Type 1252) is normally used. It operates on the same principle but has a physical capacity to balance workpieces dynamically up to 100 lb in weight on a mass-production basis.

Occasions arise where components are of awkward shape, excessive weight or may require to be balanced in the vertical plane. To provide greater flexibility for such applications the Type 1251 equipment is used. This has

the measuring and sensing units of the Type 1250 but has neither the suspension nor drive, the provision of these being left to the user so that individual requirements in this direction may be catered for. A typical example of the standard Type 1251 unit being used, in conjunction with a custom-built suspension jig, to balance a textile spindle in its own bearing is illustrated in one of the photographs.

The balancing of very large rotors presents particularly difficult problems. Such rotors normally form an integral part of some large piece of equipment and it is advisable to assemble the equipment first and to balance the rotor in situ, to ensure smooth operation of the machine in service.

The balancing requirements under these conditions are somewhat different from those considered above. Accuracy is still of vital importance, but very rapid operation is subsidiary to the need for ease of application under difficult conditions. The Dawe Type 1255 Portable Balancing Equipment consists of an 8½ in. × 13 in. × 12½ in. case (weighing about 19 lb) to which is attached by a cable a moving-coil inertia-type vibration pick-up. When applied to the bearing of a rotating machine, the pick-up provides an electrical signal proportional to the velocity of its vibration. By the use of an integrating network, readings of vibration displacement can also be made. These measurements can be used either for direct investigations on vibration, such as when checking the balance of machines in the factory, or for actual balancing. In the latter case, the size of the meter readings gives an indication of the amount of unbalance present. The position of the unbalance can then be found by triggering the stroboscopic lamp from the pick-up signal and noting the position in which a reference scale on the rotor is frozen. A photograph shows the techniques applied to the balancing of a grinding wheel.

Since sufficient information is seldom available to calculate the exact amount of balance weight required, it is usual to add trial weights opposite the indicated 'heavy' point on the rotor. A skilled operator can frequently obtain dynamic balance in a surprisingly short time. For less experienced men, a systematic balancing procedure has been devised: the readings of bearing displacement with and without trial weights are compared and the amount of correction required to achieve dynamic balance is found from a geometric construction.

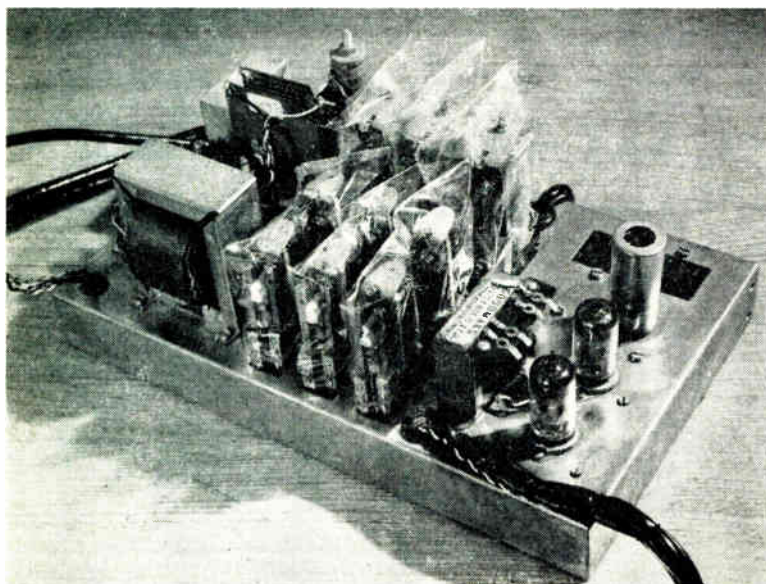

## Relay Dust Covers

*This picture illustrates a simple, low-cost way of protecting relays. Bags made from 'Melinex', I.C.I.'s polyester film, are used by Hartley Electromotives to cover the many relays in their Tape-Writer dictating machine*

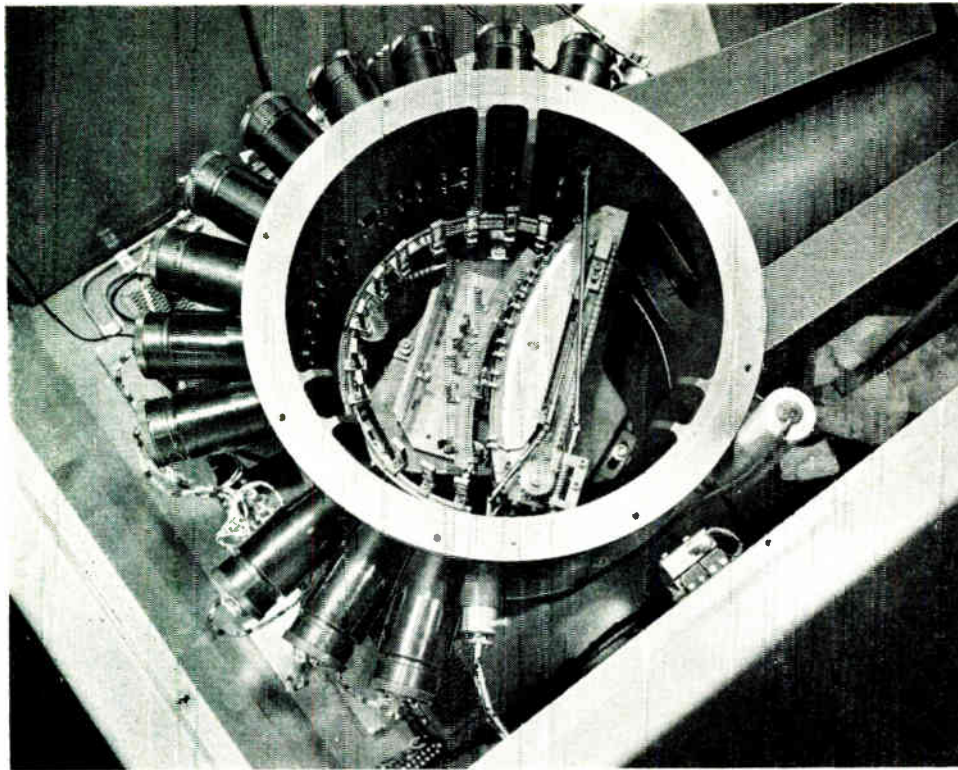

*This illustrates the main chamber of the Polyvac equipment*

In this article is described apparatus for spectrochemical analysis which presents its output in the form of a typed record. It comprises a special spectrometer, electronic measuring apparatus and a computer.

By D. J. WEBB, B.Sc.\*

# The Polyvac Process

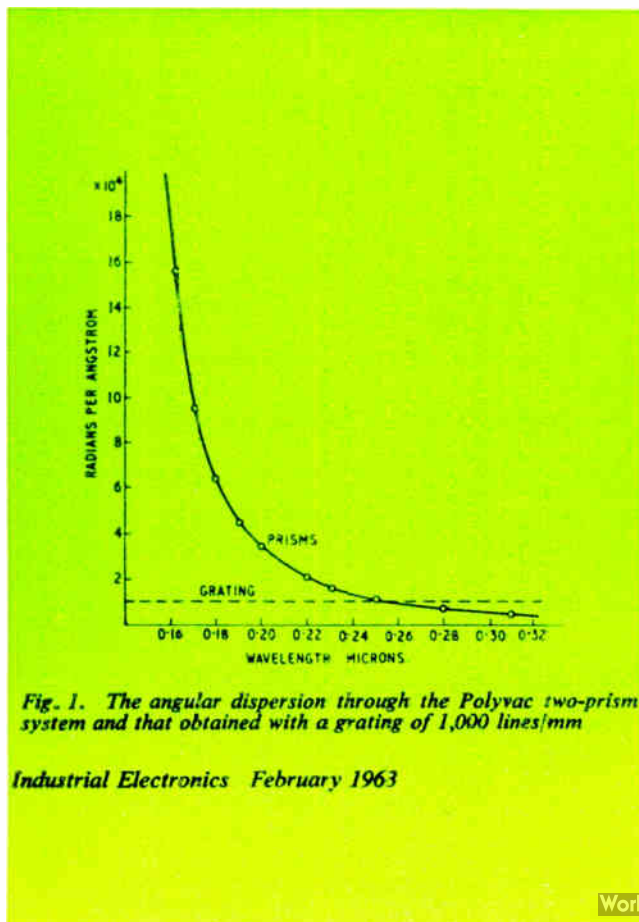
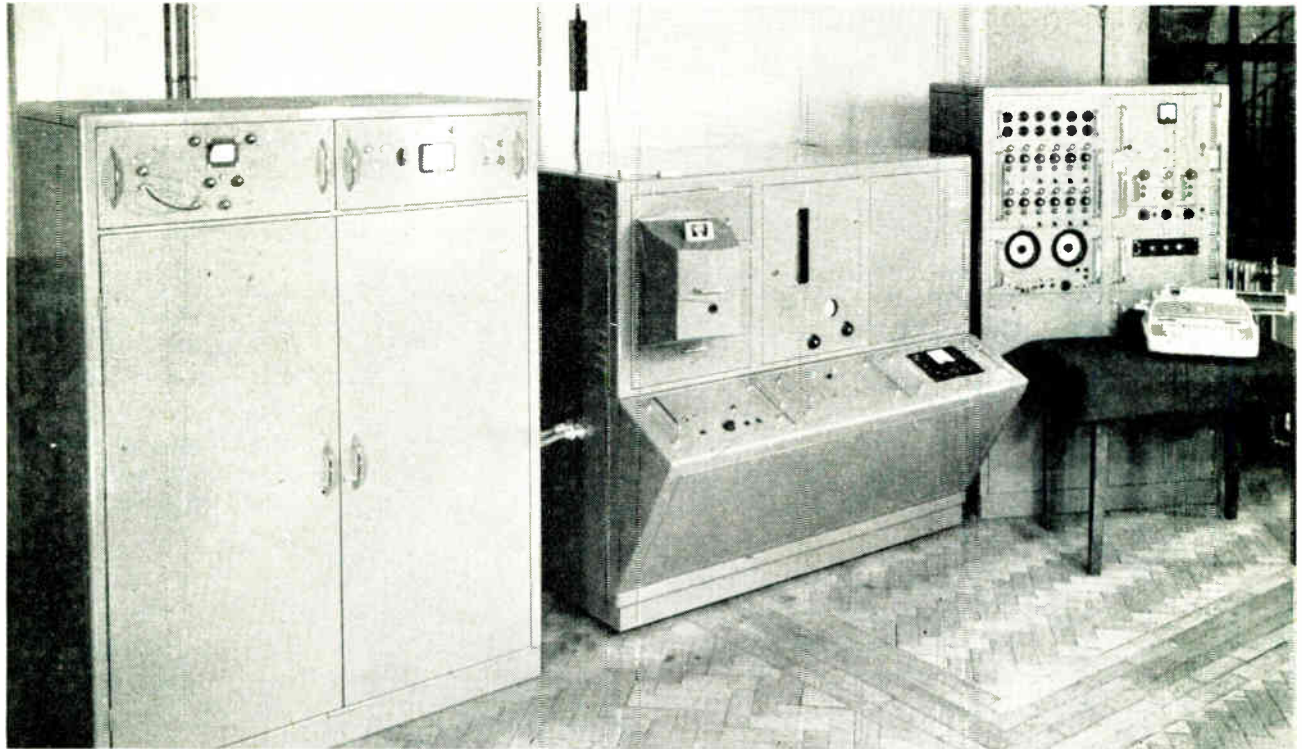

*Fig. 1. The angular dispersion through the Polyvac two-prism system and that obtained with a grating of 1,000 lines/mm*

**S**PECTROCHEMICAL analysis has been used widely in industry for nearly 50 years. Until recently spectrographs, working within the normal range of ultra-violet wavelengths and employing photographic plates for the measurement of the spectrum, have failed fully to meet the requirements of control analysis for some processes. One reason for this failure is that many of the important elements such as carbon, phosphorus and sulphur have their sensitive lines in the wavelength region 1,750 Å–2,000 Å which is absorbed by air. Another reason is that some industries need very high speed analysis which is only possible with photoelectric means of measurement.

The Hilger & Watts Polyvac was designed with these problems in mind. This instrument consists of a source unit, a spectrometer (with its dispersion system in an evacuated chamber) and an electronic measuring console with a computer which gives typed results in the form of direct concentrations. It is unique among instruments of its type in using prisms to disperse the light emitted by the sample and through most of its range the angular dispersion of these two prisms, which are made of fluorite, exceeds that obtained with a diffraction grating of 1,000 lines per mm (Fig. 1). High angular dispersion is of great importance because it reduces the intensity of the background without reducing the intensity of the spectrum lines. On the line-to-background ratio depends the instrument's ability to

\* Hilger and Watts Ltd.



A general view of the complete equipment, showing source unit (left), spectrograph and the control console (right)

detect small concentrations of an element and to discriminate small differences in concentration between samples. The general layout of the optical system is shown in Fig. 2 along with a block diagram of the electronic equipment.

The source unit develops the power required to cause an electric discharge between the specimen to be analysed and a counter electrode rod which is generally silver. This discharge is produced in a chamber flushed with argon because of the light absorption that would take place if air were present.

After the light has been made parallel by a collimator

lens it passes through the two prisms, emerging dispersed to be focused by the camera lens on the focal plane of the instrument. Selected radiations pass through fine slits at this plane and by mirror and prism systems to the sensitive surfaces of a number of photo-electron multiplier tubes. The current outputs from these tubes are proportional to the intensities of the light falling upon them and therefore are functions of the concentration of the elements emitting the spectrum lines.

The whole of the spectrograph is located in a thermostatically-controlled chamber which maintains the interior temperature of the spectrograph constant to within better

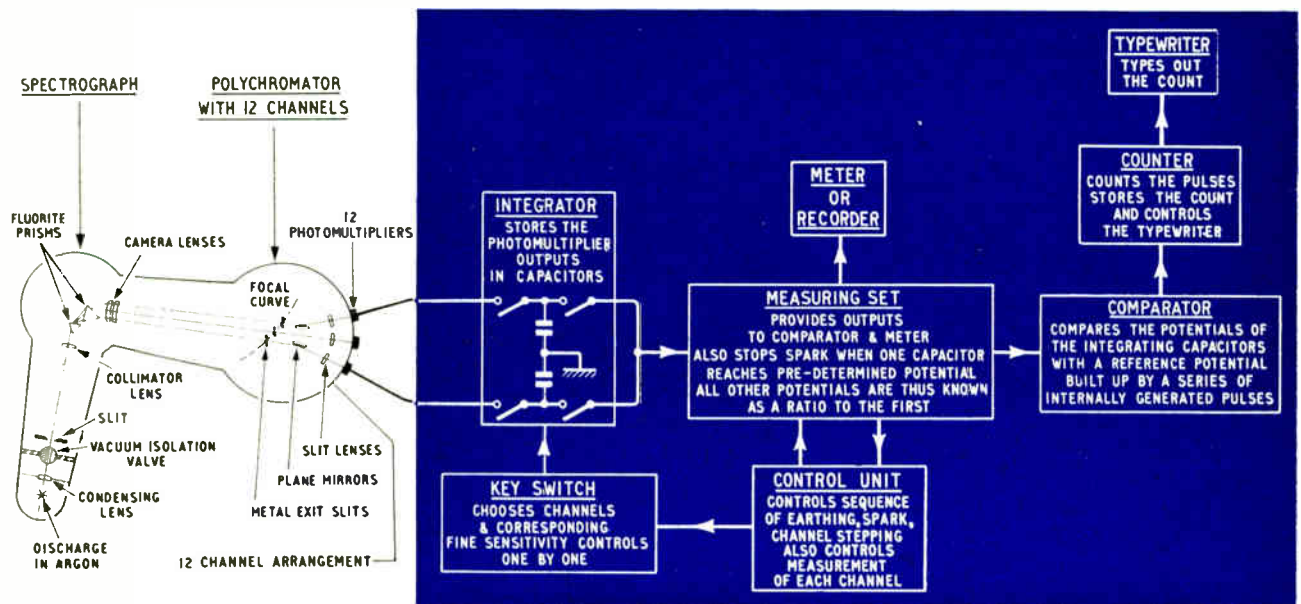

Fig. 2. A simplified schematic drawing of the complete system

than 1/30 °C. This feature is probably the largest single factor contributing to the remarkable stability of the instrument.

### Operation

The sequence of operation is fully automatic once the sample has been mounted in the discharge stand and the start button pressed. The flow of argon to the stand is increased automatically for a short period to flush out all the air before the discharge begins, and the outputs from all the photomultipliers are stored simultaneously in integrating capacitors contained within the electronic console. At the end of the exposure an electronic system measures the voltages acquired by the capacitors and presents them in the form of ratios to the voltage of an internal standard.

The quickest method of presenting results is by automatic typewriter, which eliminates a second operator for recording the results. There is a further saving in time if a computer is fitted. The computer converts the results into percentages of concentration for presentation on the typewriter and there is no need for reference to a calibration curve. The computer also gives automatic correction for interelement interference. It is more fully described later.

Fig. 3 (a), (b) and (c) shows working curves for the elements sulphur, phosphorus and manganese, respectively. These curves are typical of the calibrations obtained.

The Polyvac has a rapid means of correcting small, and inevitable, departures from an original calibration. Controls adjust the response of the measuring amplifier to maintain the readings on standard samples which are sparked from time to time as a check on calibration.

Each photomultiplier has at least one set of controls associated with it and some may have two or more. This is done in order to split up large ranges of concentration into convenient shorter ranges to make better use of the measuring scale and also to enable standardization to be performed independently for different alloy types.

### Applications

The Polyvac has been widely applied to the control of iron and steel production. High-alloy steel presents an interesting problem because it is not possible to assume that the internal-standard element is of constant concentration, which makes it necessary to use a more general method of obtaining the analysis. A method often used is to construct working curves relating intensity to the ratio of the concentration of the elements to that of iron. This leads to the necessity of solving a number of simultaneous equations to obtain the concentrations of the elements. This need of calculation makes the computer even more useful for directly presenting the results as concentrations, instead of readings which have to be converted to concentrations by reference to graphs.

Many of the working curves are in fact straight lines and here there is no difficulty in making the computer direct reading. All that is needed is to subtract (or 'back off') the appropriate amount of signal to make 0% concentration give zero output and then to adjust the sensitivity of the measurement so that, for example, 240 is the reading given by 0.24%, or 2.4%, or 24.0% of the element, depending on the concentration range to be analysed.

However, in the general case the response is a non-linear one, in which event the curve is considered as ten straight lines. This is a good approximation since the curves are always smooth continuous functions of small curvature.

The heart of the computer is a printed-circuit function generator card, one of which is required for each working curve to be dealt with. Its method of operation is best demonstrated by example; for instance, let us suppose that

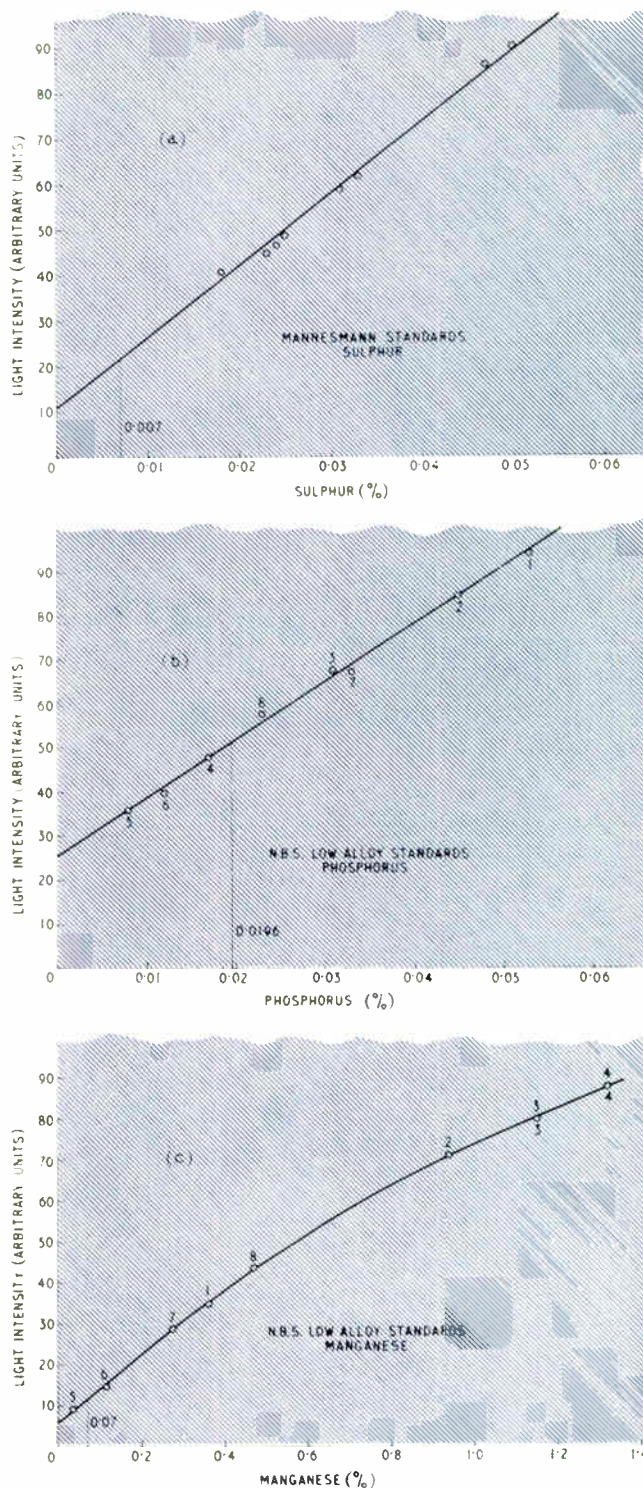
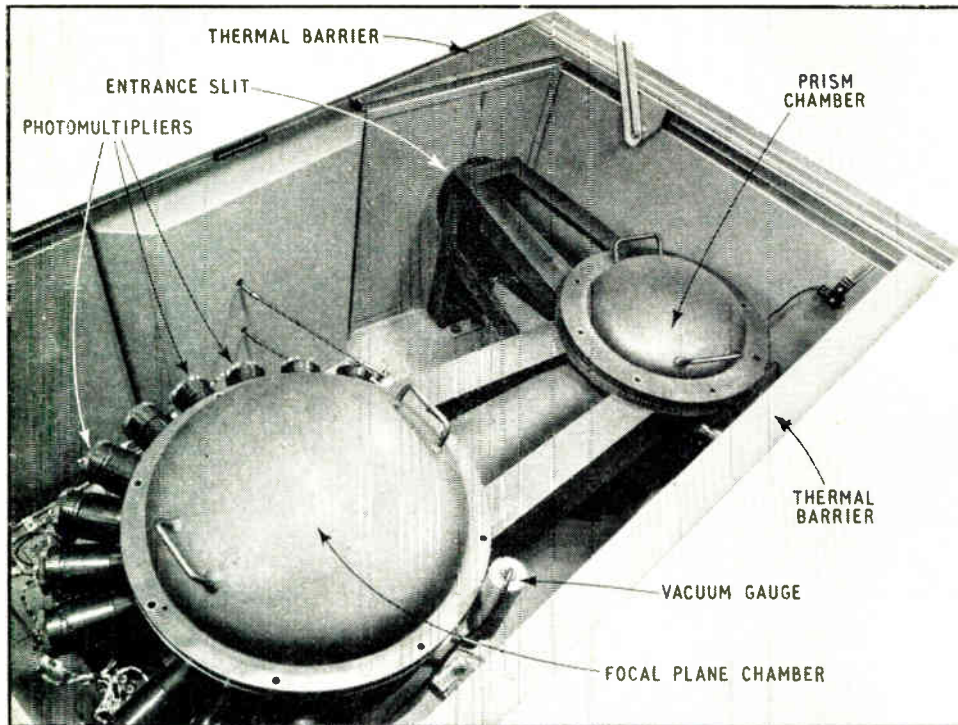

Fig. 3. These diagrams show the working curves for the elements sulphur, phosphorus and manganese. In each case the solid vertical line intersecting the curve indicates the concentration at which the measured intensity equals the background radiation—this is a measure of the line-to-background ratio





*The spectrometer with the covers in place*

the full-scale deflection of the measuring set occurs for 10 volts input. At each level of voltage, 0, 1, 2, 3, etc., the response is adjusted by means of one of ten variable resistors, until the output represents the concentration appropriate to that level of input signal.

As the input signal is increased from zero volts the output current rises linearly with it. At one volt a diode conducts and short-circuits part of the resistance. The response is again linear from one to two volts but at a new rate determined by the setting of the variable resistors. This sequence is repeated again from 2 to 3 volts, and so on. The series of straight lines so produced is arranged to be a series of chords of the working curve, as shown in Fig. 4. The decimal point is selected by means of a change plug and socket and the instrument is now ready to print concentration values directly.

### Third Element Effects

An important facility of the computer is its ability to make corrections for spectrochemical 'third-element' effects.

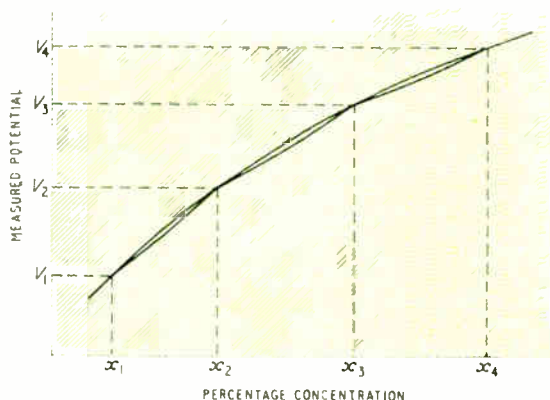

*Fig. 4. The diagram illustrates that a linear response can be obtained by using a series of biased diodes*

As an example, we may take the well-known effect of the presence of the elements manganese and carbon on the determination of sulphur. Both these elements have the effect of enhancing the reading obtained on sulphur. This is normally overcome by preparing tables of corrections to the sulphur concentration for various levels of carbon and manganese.

However, the computer can be arranged to make this correction automatically prior to printing out the sulphur results. To do this the reading order is chosen so that manganese and carbon are read before sulphur. The readings obtained on these elements are stored and used to adjust the sensitivity of the amplifier suitably when the sulphur channel is reached.

The addition of the computer is thus of very real assistance, not only in increasing the speed of the analysis but in eliminating the possibility of error due to the misapplication of the various corrections necessary to the analysis.

In this brief account of the instrument only the more important features have been described. Examples have been taken from the analysis of iron and steel, but the impression should not be gained that this is the only type of analysis that can be done with the instrument. On the contrary, the sensitive lines to be found in the vacuum wavelength region enable the Polyvac to be applied, with advantage, to many other analytical problems.

### INFORMATION WANTED?

If you require further details of products or processes described or advertised in INDUSTRIAL ELECTRONICS you will find it convenient to use the enquiry cards which will be found in the front and back of the journal.

Some of the industrial applications of the cathode-ray oscilloscope are reviewed in this article. These applications include the measurement of the effects of shock and vibration as well as the more conventional stress, torque, pressure, displacement, velocity and acceleration.

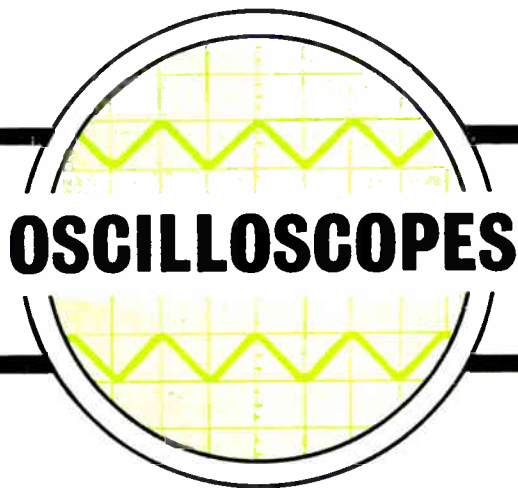

## IN INDUSTRY

By M. DAVIES\*

**A.** C. COSSOR was the first to manufacture a cathode-ray tube in this country, as far back as 1903. It was not until the early 1930s, however, that c.r. oscilloscopes became freely available. Today, after many years of development, and with the aid of specialized auxiliary equipment, the oscilloscope has found its way out of the laboratory and into the workshops of industry, where it enables the mechanical engineer to observe and measure mechanical and physical quantities with an accuracy and flexibility which in many cases cannot be matched by alternative mechanical methods.

In such applications, the physical quantities are normally converted into equivalent electrical signals by means of a transducer, and are displayed by the oscilloscope in the form of a graph. In the simplest form, the quantity to be observed provides, when amplified, the Y-axis or vertical deflection, while a timebase provided by the instrument causes the spot to traverse the screen horizontally at a pre-determined and constant speed.

When the waveform to be examined is cyclic, a small signal is derived from the Y-amplifier and is used to trigger each cycle of the timebase generator. This results in a static presentation on the screen, from which information can be derived about the nature of the mechanical change which is taking place. Because the oscilloscope does not suffer from mechanical limitations in response time, events which occur in extremely small intervals of time may be examined in detail. With an appropriate range of timebase speeds, the time scale can represent anything from several seconds to fractions of a millisecond.

Although work of this kind is often carried out using a general-purpose oscilloscope, instruments are now available which are designed specifically for use by the mechanical and power engineer. Such an instrument is shown in the block diagram of Fig. 1.

Facilities provided by this include those normally found on a good general-purpose oscilloscope together with mechanical triggering facilities, slow sweep speeds and intensity modulation.

### Transducers

Electro-mechanical transducers vary in complexity from the simple wire strain gauge to the sophisticated dynamic

torque transducer: they also follow various schools of thought in the mode of mechanical to electrical conversion. In the resistive strain gauge the fine wire of which it is composed is made to stretch, resulting in a change in resistance which is sensed by an a.c. or d.c. bridge circuit. The unbalance is then amplified. Other systems measure changes in capacitance or inductance, and this may be achieved in several ways. For example, the capacitance or inductance can be made to vary the frequency of a

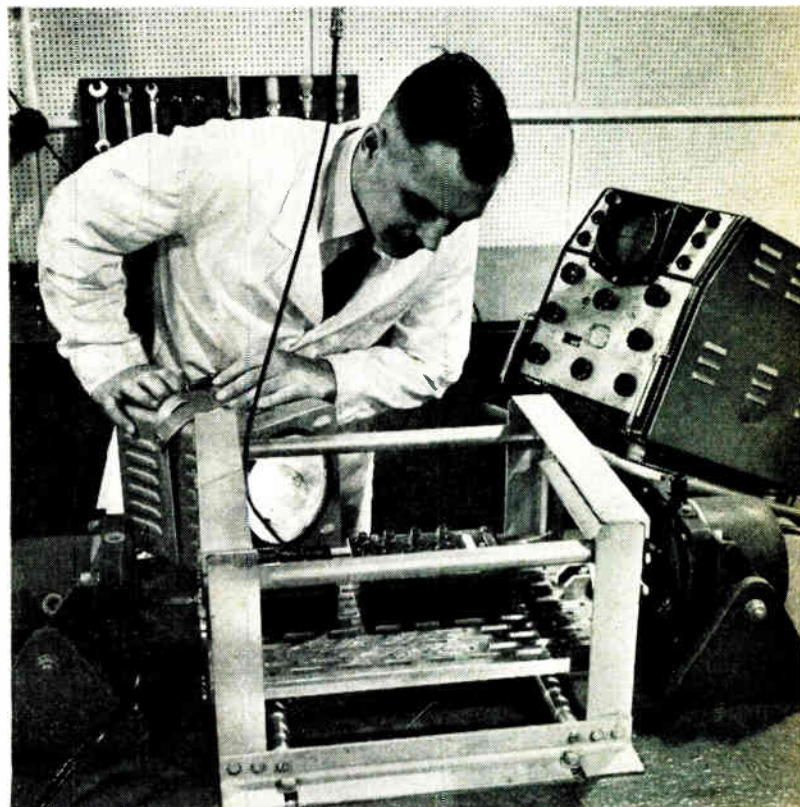

*Cossor Instruments oscillograph Model 1049 being used in vibration testing on Ultra aircraft intercommunication control equipment at the Greenford factory of Ultra Electronics Ltd*

\*Cossor Instruments Ltd.

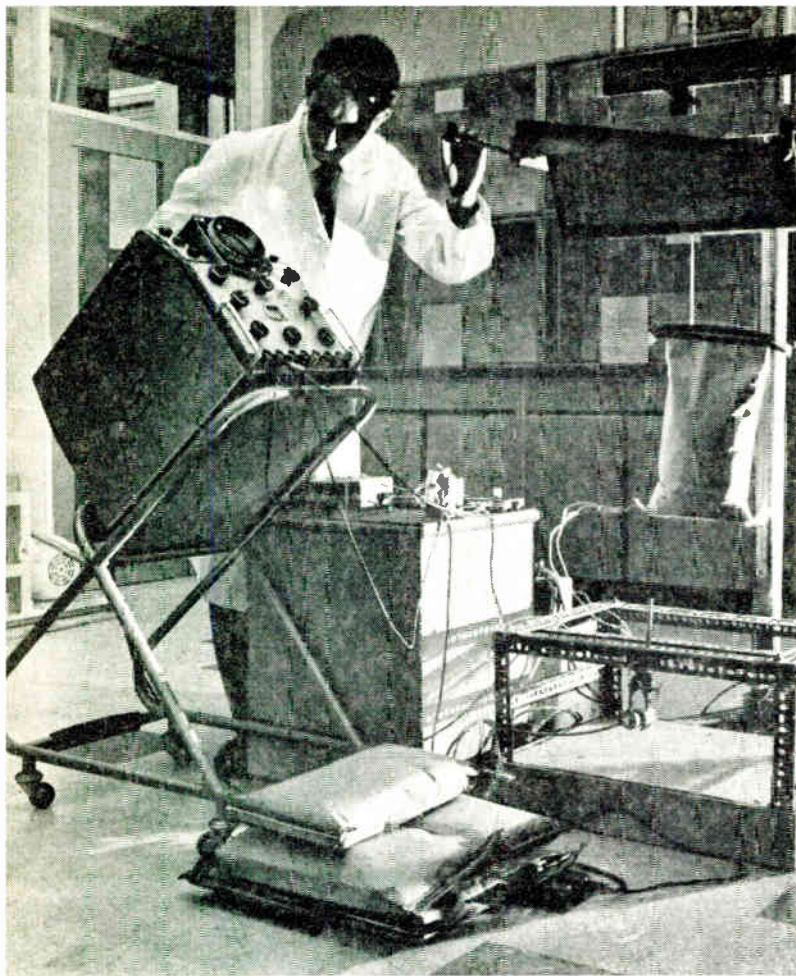

At the new £½ million pound Reed Research and Development Centre at Aylesford, Kent, a Cossor Model 1049 Oscilloscope is used to indicate the strain experienced by the kraft plies of these miniature paper sacks during a drop test  
(Photo by permission of Reed Paper Group)

radio-frequency oscillator, d.c. output being derived from a frequency sensitive circuit; in another method which is applicable to inductive transducers, the inductance is made to vary the amplitude of a carrier-frequency signal; this is in turn converted to a d.c. signal by a phase conscious rectifier. Unlike these systems, which are capable of static calibration, electro-magnetic transducers have outputs proportional to rate of change, so they are suitable only for dynamic measurements. Some use has also been made of photoelectric devices.

In recent years there has been considerable increase in the use of piezoelectric crystals in which applied pressure results in a voltage appearing at the terminals; barium titanate, lead zirconate and pure quartz are among materials currently used. Each of the available systems has its own particular advantages and field of application but it would be beyond the scope of this article to attempt a critical comparison.

Physical quantities which can be dealt with by the foregoing techniques include stress, strain, torque, torsional vibration, pressure, differential pressure, load, displacement, velocity and acceleration. In addition, temperature can be recorded using thermocouples. All of these can be shown in relation to one another on a common timebase, depending

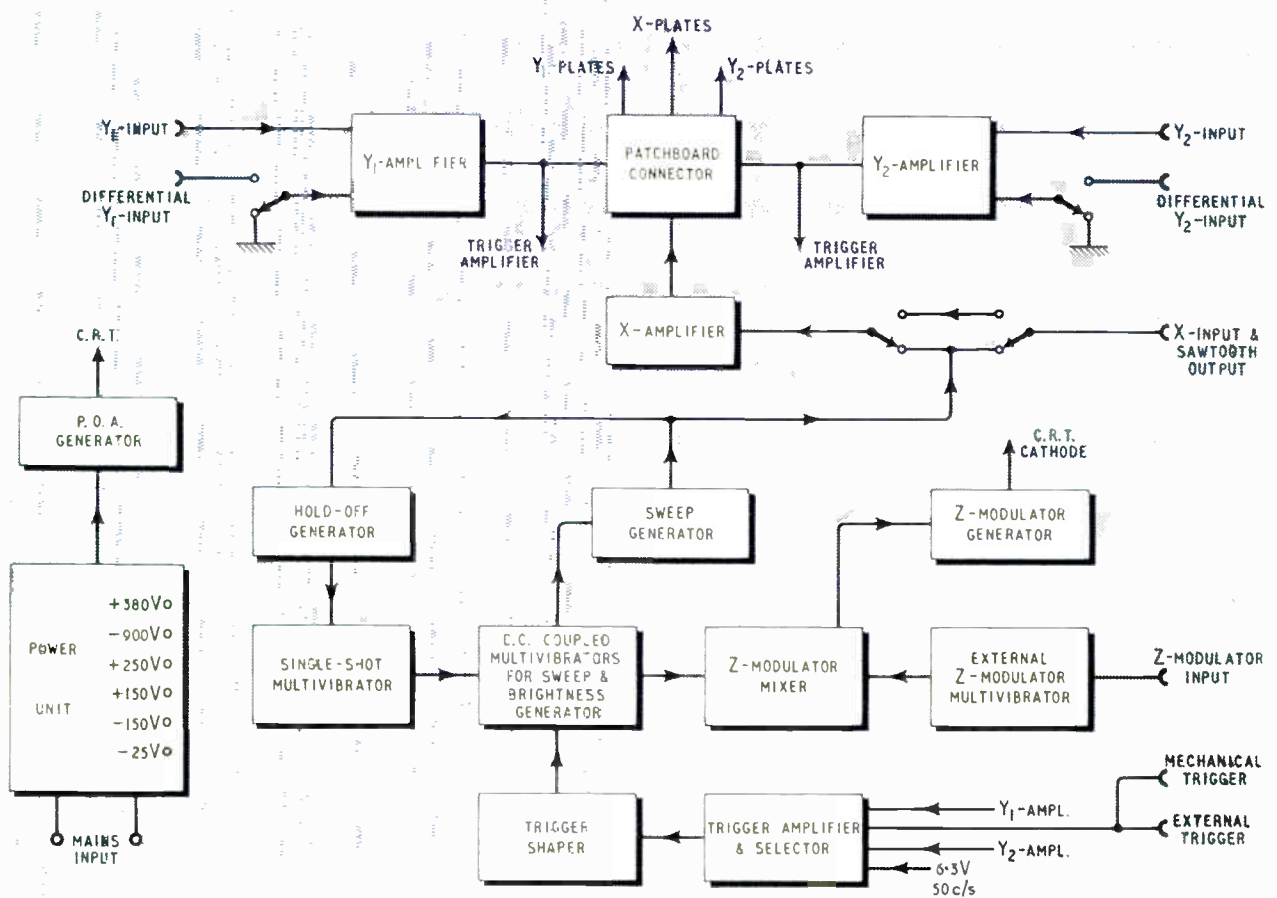

Fig. 1. A schematic diagram of an oscilloscope designed for the industrial engineer



on the number of channels available on the oscilloscope or alternatively as a complex relationship.

An example of this latter technique is in engine indication, when the displayed curve represents pressure-volume or pressure-crank angle. The first Cossor equipment designed specifically for engine indication appeared in 1945. It consisted of a rack of equipment, a capacitance transducer to sense the cylinder pressure and a unit comprising a cam driven from the engine which varied the amount of light falling on a photoelectric cell, to give indication of crank angle. Present-day versions compact the entire electronic system into one small unit which is used with a general-purpose oscilloscope. Pressure is sensed with a quartz transducer which can be incorporated in a standard sparking plug (Fig. 2), and a small inductive transducer driven by the engine produces a waveform which is proportional to true volume. Top dead-centre is shown as a bright mark on the trace, by means of the intensity modulation facility. Recent installations in Germany of equipment manufactured by The Swiss Vibrometer Corporation, have provided press-button control for the operator and a synchronized stroboscope, resulting in an instrument ideally suited to the production test and inspection of diesel engines. The inspector merely makes note of various readings which are later analysed and are the basis of acceptance or rejection on the grounds of performance. At the same time information is provided which is useful if any remedial action is needed in production.

Oscilloscopes are also used as a production and inspection tool, not only for development, in the manufacture of pneumatic and hydraulic equipment. This industry has long been aware of the value of oscillography, and the various applications are too numerous to mention. It is often a simple matter to insert a suitable transducer into the system, and to examine the transient pressures which occur and the side effects introduced by compression and valves. The momentary overshoots are often 30% more than the level indicated by conventional gauges. Ten minutes' inspection of this sort can sometimes reveal more than can be achieved in 12 months of intelligent guesswork. This particular application is a good example of how the oscilloscope's flexible time scale can enable small parts of a transient to be examined in detail; the very wide bandwidth provides a faithful picture of the event. But apart from production tests on equipment, and acceptance tests on bought-out components, many firms are now subjecting the complete installation to a series of tests and photographing the oscilloscope traces. The photographs are stored against the possibility of a later failure, when they provide a considerable reserve of information in a compact form. This practice can be particularly valuable if the failure takes place in some remote part, under conditions which cannot be simulated in the factory. A similar pattern is being followed in the analysis of torque or horsepower; the latest transducers produce an accurate picture of dynamic torque, and are capable of static calibration. On the continent tests of this kind are already coming into use in production inspection.

#### Noise and Vibration

Throughout industry there are applications for the oscilloscope in the inspection of noise and vibration. The transducers most commonly used nowadays are the barium titanate, or lead zirconate crystals, which have a high output and are small in size; the transducer output is fed to the oscilloscope via a cathode follower circuit which provides the necessary high impedance match. Strain gauges and electromagnetic transducers also have their uses, while for some work a simple magnet and coil (e.g. a telephone ear-piece) will give good results. In this last case the movement

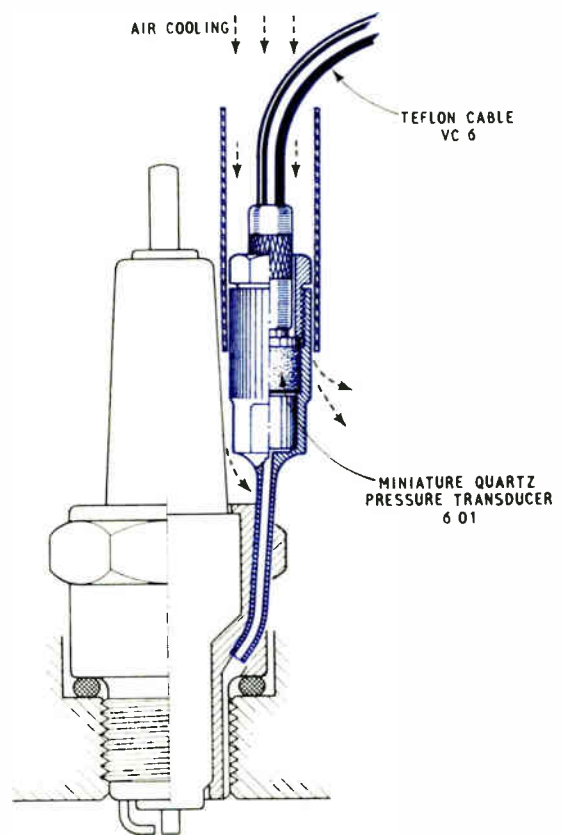
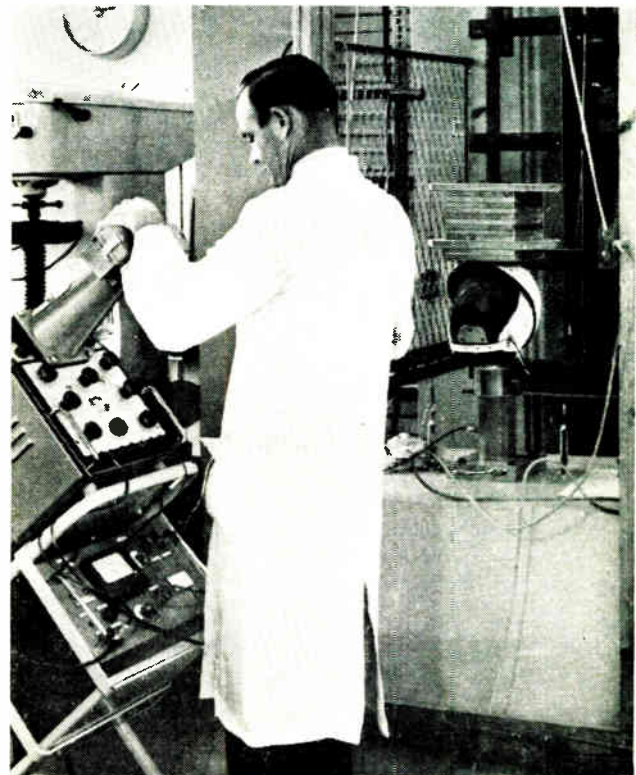
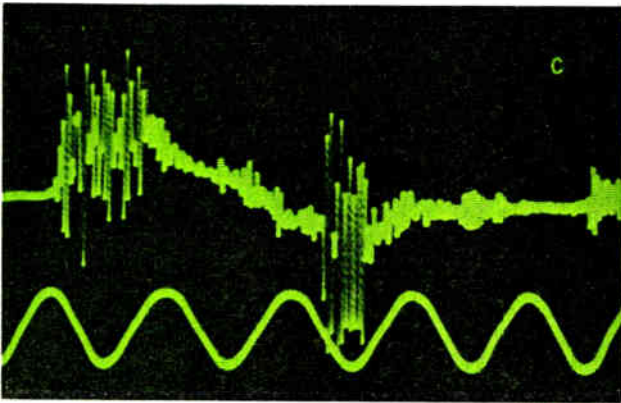
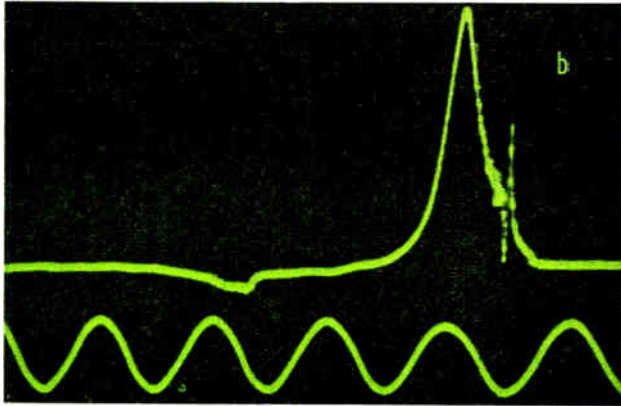
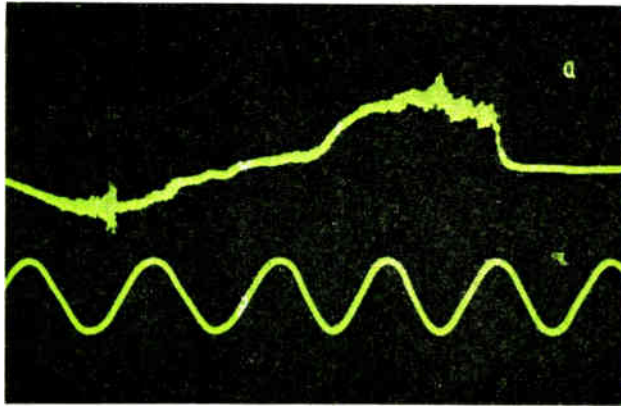

Fig. 2. Transducers are available for many specialized purposes. This crystal transducer is coupled to a standard spark plug for engine indication

At the British Standards Institute's laboratories, Hemel Hempstead, a Cossor Model 1049 Oscilloscope is used to test the effectiveness of various types of crash helmet, under a simulated environment (Photo by courtesy British Standards Institution)





These oscillograms were obtained during the drop testing of a wooden packing case lined with different cushioning materials. They represent the shock experienced by a transducer attached to the contents of the case. In (a) approximate square wave response indicates a good cushioning material and relatively low peak force. In (b) the high peak force indicates 'bottoming'. The oscillogram in (c) shows high frequency ringing of a spring cushioning system which would be difficult to detect by mechanical means. The 50 c/s sine wave on the second channel is in each case for calibration purposes

(Photos by courtesy of Wilmott Packaging Co.)

of a vibrating ferrous component nearby induces a voltage in the coil, and there is no mechanical loading of the system under observation, but, of course, the applications are limited. The tests which can be carried out follow one of three important forms. In the first the oscilloscope displays the output from one or more transducers affixed to apparatus which is in motion, for example, motors, gear-boxes, bearings. The value of this method is greatly enhanced by the use of filters which make possible the analysis of the individual frequencies which may be present.

The second method is an extension of the first, but here the equipment under examination or its component parts is made to vibrate by means of an electromagnetic vibrator fed from a variable frequency oscillator. Accelerometers mounted at various points sense the mode phase and amplitude of vibration, resonance frequencies and nodal points in the assembly—which may be as large as an air-frame. In the third method transducers are used to sense the vibrations which occur when an object is tapped, or dropped and thereby subjected to deceleration forces. This is really an extension of the railway 'wheel tapper's' technique. The applications are innumerable, for example, the system has been used to check the tensioning of bicycle wheel spokes, it has been used to investigate the effectiveness of crash helmets, packing materials, shock absorbers, the pitch of musical instruments, and in tests on man-made fibres. As a production inspection tool the oscilloscope again comes into its own, in that components which are alike will usually produce nearly identical traces and the inspector, who can be completely unskilled, need only look for deviations from the standard pattern.

### Time Measurement

Another technique well suited to oscillography is that of precision timing. As mentioned earlier the timebase in the oscilloscope causes the beam to traverse the tube face at a constant rate; if, therefore, signals are fed to the Y-amplifier at, say, the beginning and end of a function, the distance between them as seen on the tube can be an accurate measure of time. Photoelectric and electromagnetic transducers are often used, the first pulse being used to trigger the timebase cycle. Where it has been necessary to determine the acceleration or deceleration of an object in motion, such as a loom shuttle or a projectile, several pick-ups have been arranged along the path of travel, the outputs from these appear as a series of dots or spikes which are displaced from one another in proportion to the speed of travel. The trace on the oscilloscope is usually photographed and a sine wave of known frequency fed to a second beam provides an accurate time scale which is independent of the oscilloscope timebase.

The field of oscillography has expanded in recent years into every corner of industry. Development work in progress at the present time, both on the oscilloscope itself and on ancillary equipment will allow this most versatile instrument to be applied to an even wider range of observations and measurements than is at present possible.

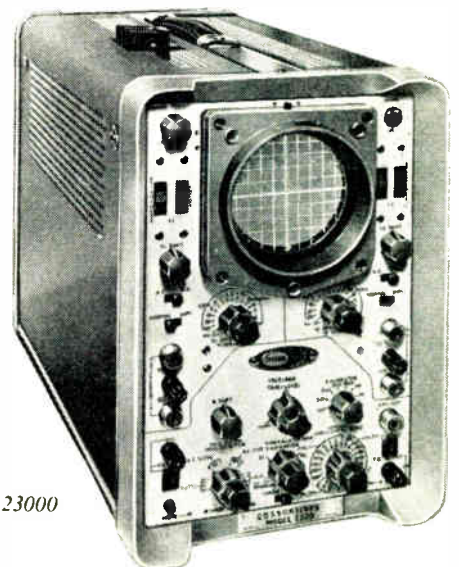

The Cossor Model 23000 Oscilloscope

APPLICATIONS  
ILLUSTRATED

## Leak Detectors

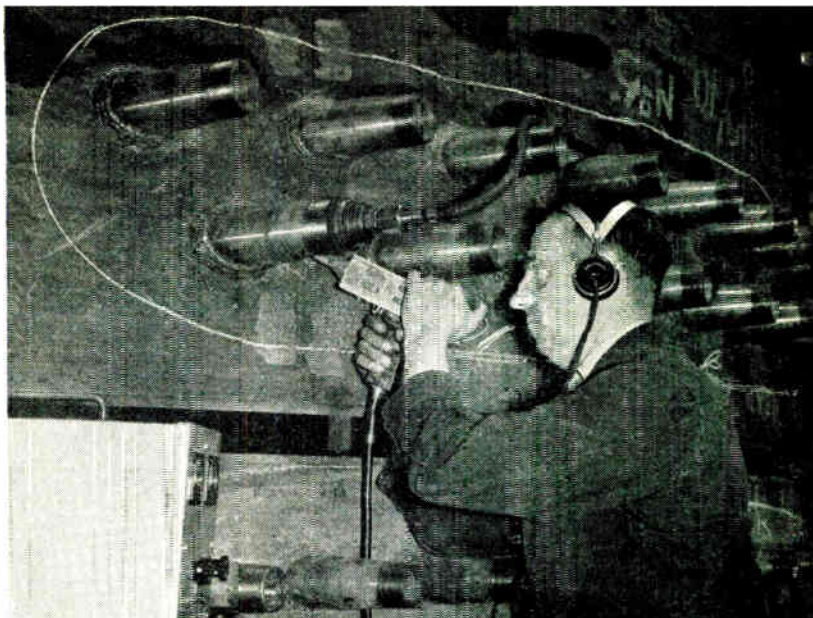

B

**T**HE halogen leak detector presents in a compact and portable form a means of detecting leaks in pressure and vacuum systems which would be imperceptible by any other practicable method. They are not quantitative indicators, but they are so sensitive that they can, for instance, detect a leakage of Arcton (dichloro-difluoromethane) at a rate of 1.5 milligrams per day. For operation, this type of detector relies on an increase in the halogen content of the surrounding air which causes a corresponding increase in the emission of positive ions from a heated platinum electrode.

In the A.E.I. leak detectors illustrated here the sensitive element consists of a pair of concentrically-mounted platinum cylinders. The inner anode cylinder is heated to about 800 °C and the air to be sampled is drawn by a fan through the annular space between the cylinders. Immediately air containing halogen vapour is drawn in ion current flows. The current is amplified and the resulting signal operates an audible-warning device or is displayed on a meter. In a system devoid of a halogen compound a small amount of carbon tetrachloride or trichlorethylene is injected as a 'tracer'.

For further information circle 47 on Service Card

C

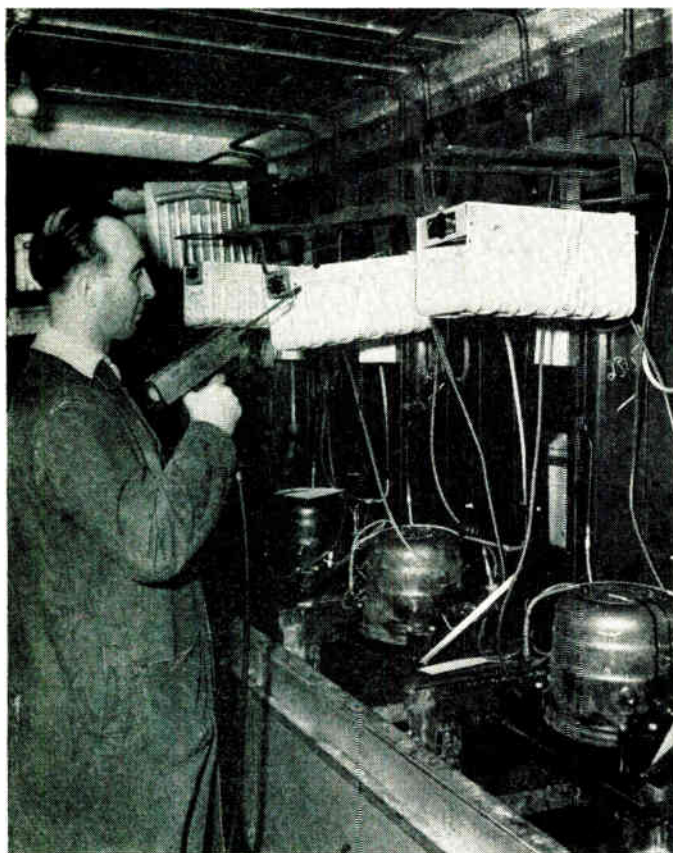

A

(A) Here the A.E.I. type HA leak detector is being used for the production-line testing of refrigerator units. (Photograph by courtesy of the Pressed Steel Co. Ltd.)

(B) Where reliability is all-important—testing the sealing welds on a heat-exchanger shell for a nuclear power station. (Photograph by courtesy of Babcock & Wilcox Ltd.)

(C) Here a leak detector is in use to test an aircraft nose wheel pneumatic system. (Photograph by courtesy of Percival Aircraft Ltd.)

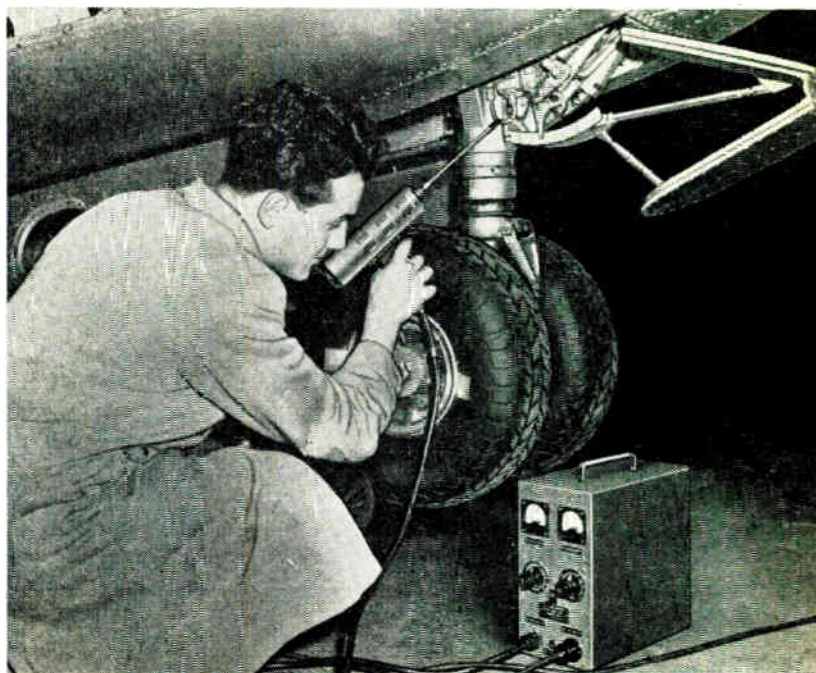

# EQUIPMENT

# review

## 1. Transistor Tester

ONE OF THE latest devices from Taylor Electrical Instruments is the Transistor Tester Model 44 which is economically priced and simple to operate.

It is designed to measure the  $\beta$ ,  $I_{c0}$  and  $\alpha$  characteristics of p-n-p and n-p-n transistors; it also tests semiconductor diodes. It provides a  $V_c$  range from 1.5 to 10.5 V, and  $I_c$  range from 50  $\mu$ A to 1 A full scale, and  $I_b$  range from 10  $\mu$ A to 10 mA; also two  $\beta$  ranges of 0 to 100 and 0 to 200 full scale are provided.

Features of the tester include the facility to vary independently the collector voltage, base current and collector current, and also the ability to test the forward and reverse characteristics of point contact diodes.

A selection of useful d.c. voltage and current ranges are also incorporated in the tester.

The instrument is battery-operated and completely self-contained. — Taylor Electrical Instruments Ltd., Montrose Avenue, Slough, Bucks.

For further information circle 1 on Service Card

## 2. Subminiature Potentiometers

WITH PRINTED circuits in mind, Plessey are marketing a series of subminiature pre-set potentiometers known as Type N. They are available in values from 250  $\Omega$  to 500 k $\Omega$  at a nominal power dissipation of  $\frac{1}{4}$  W. Maximum working voltage is 350 V d.c. Temperature range:  $-55$   $^{\circ}$ C to 100  $^{\circ}$ C.

The 0.1 in. module has a body  $1\frac{1}{4}$  in. long made of glass filled polyester resin. Connecting pins are arranged as shown and the potentiometers may be mounted singly or in banks by means of the fixing holes provided.

Eighteen turns of the leadscrew are required for a complete traverse of the wiper arm. To prevent overwinding, a slipping clutch is incorporated be-

tween the leadscrew and the actuating screw. Operating torque is less than 2 oz in.—The Plessey Co. (U.K.) Ltd., Ilford, Essex.

For further information circle 2 on Service Card

## 3. Circuit Protector

WESTBROOK have announced details of a new circuit protector, Type ICP, which provides in a single unit an on/off switch, a pilot light, a resettable thermal element fuse and auxiliary contacts for a separate alarm.

It is suitable for either a.c. or d.c. circuits in which the full-load current lies between 3 and 12 A. Standard units are available within this range in one-ampere steps and special versions can be supplied which are sensitive to half an amp.

One application is as a starter for small single-phase motors and other

units in which initial current surge can cause overloading.

The ICP will carry 100% of the rated current indefinitely and will open the circuit within 16 min at 125% of the rated current or within 2 sec at 600%. It is designed for operation between 25  $^{\circ}$ C and 55  $^{\circ}$ C.

A safety mechanism prevents manual closure of the contacts while in overload condition. Behind-panel depth: 2.187 in.—G. S. Westbrook Ltd., 50 High Street, Harpenden, Herts.

For further information circle 3 on Service Card

## 4. Improved Alarm System

A NEW Long Range Intruder Alarm System, announced by Photoelectronics, incorporates many improvements on the earlier models from which it has been developed.

The projector optical system has been redesigned for easier alignment and sharper focus, resulting in a 50% increase in beam intensity. This, combined with greater receiver sensitivity, has eliminated setting up problems.

When the beam is interrupted the alarm is set off within 10 msec and continues to ring until the reset button is depressed. Interference with projector, receiver or wiring will immediately set off the alarm relay in the reset unit which is normally located well away from the projector and receiver units.

False alarms are virtually eliminated since, (1) the receiver only responds to light from the projector and (2) failure

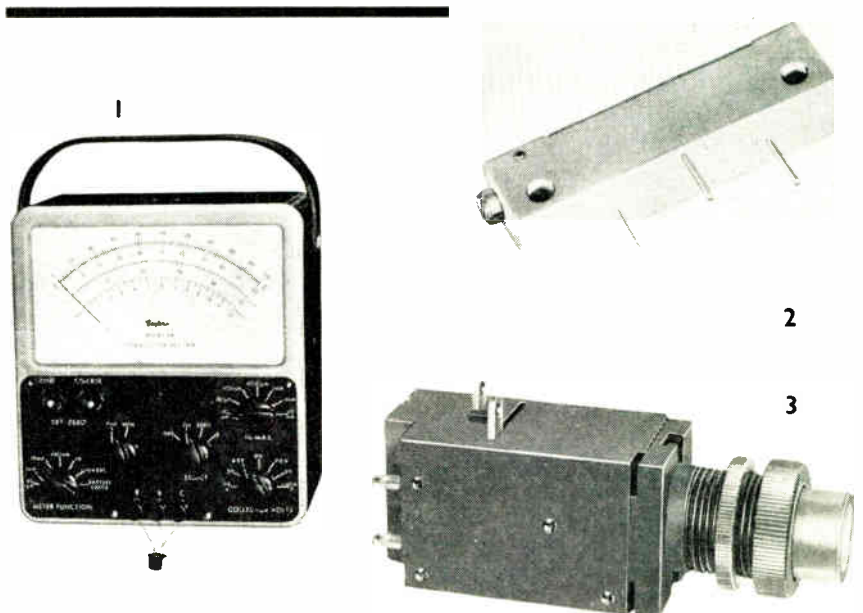

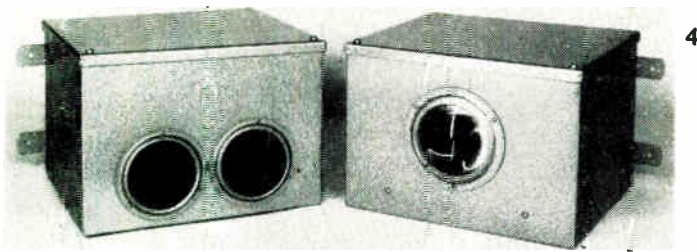

4

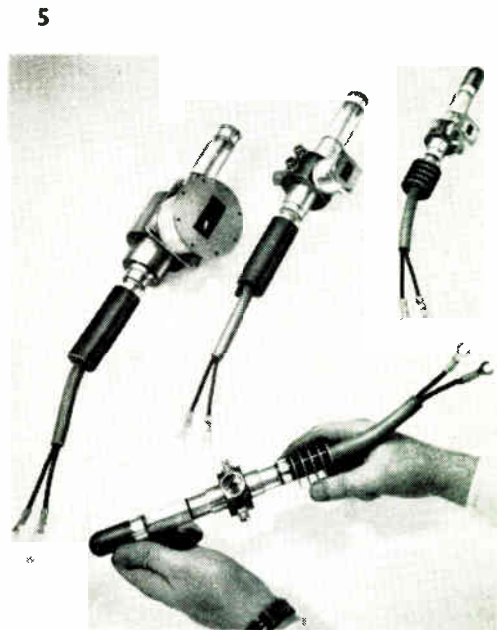

5

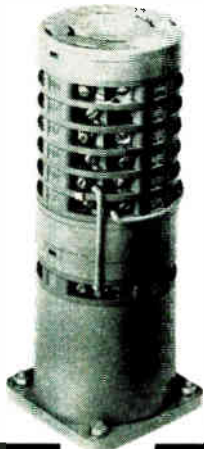

6

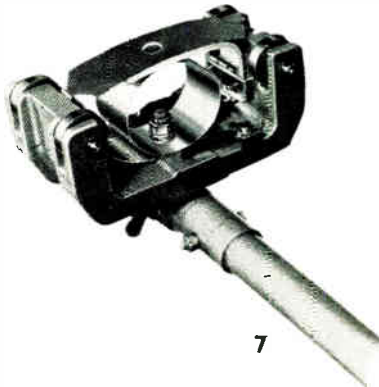

7

of one of the two lamps does not affect the amplitude of the beam, so a lamp defect cannot set off the alarm. 12-V lamps used on a 6-V supply should give at least a year's service. The cost of this system is £75 complete (for the 1,000 ft beam model).—*Photoelectronics (M.O.M.) Holdings Ltd., Oldfields Trading Estate, Oldfields Road, Sutton, Surrey.*

For further information circle 4 on Service Card

### 5. High Power Magnetrons

FOLLOWING FURTHER development of the bombardment type high temperature thoriated tungsten cathode, Ferranti are now marketing four new magnetrons with very high mean power ratings. As illustrated, they are: top left to right, C band (1.5 to 2 MW peak power; 1.5 to 2 kW mean power), X band (1 MW peak power; 1 kW mean power), J band (400 kW peak power; 300 W mean power); bottom, Q band (100 to 150 kW peak power; 100 W mean power).

Tunable versions are under development in which the gun structure is integral with the cathode support, thus leaving the other end of the valve free for a tuning device.

With emission now unlimited even for very small cathodes, the company

is looking into the possibility of extending this high power capability to O band frequencies of up to 70,000 Mc/s. —*Ferranti Ltd., Ferry Road, Edinburgh 5.*

For further information circle 5 on Service Card

### 6. Rotary Switches

**CHILTON SOLENOID** are manufacturing three types of cam-operated rotary switches of very compact design.

The standard versions are intended for use in low-voltage distribution systems of up to 600 V a.c. and can accommodate from 2 to 96 contacts in 36 switch positions with current rating up to 200 amps. The contact bridges are operated by cams which can be arranged to open and close as often as required during rotation. Standard switch angles for three designs range from 10° to 90°.

The A style switches have four double-break silver tungsten contacts in up to 12 banks on a single column; for complex control requirements four columns can be geared together.

The B style switches are medium duty units for simple on-off selection where no heavy power surges are expected.

The C style switches have two

double-break contacts per band; with four 'C' switches in a gear-driven tandem arrangement, as many as 96 contacts can be controlled from one handle.

For remote control applications this range of switches can be supplied as complete units with rotary solenoid drive.—*Chilton Solenoid (U.K.) Ltd., Hungerford, Berks.*

For further information circle 6 on Service Card

### 7. Surface Pyrometer

**THE CAMBRIDGE Instrument Co.** have developed a pyrometer, the Model 49, which will measure surface temperatures of rotating cylinders up to 250 °C with an error of +1 °C at 100 °C (compared with a total immersion reading). The makers claim that this accuracy is independent of the condition of the surface and of its speed over the range 5 to 2,000 ft/min. It is suitable for use on cylinders from 1 to 10 ft in diameter.

The instrument is basically a disc thermocouple mounted at the back of a recess in a flexible phosphor-bronze strip. This assembly is attached to a wheeled cradle and supported by a hoop spring. When the pyrometer is in position the wheels of the cradle rest on the cylinder and the flexible strip

## EQUIPMENT

# review



9

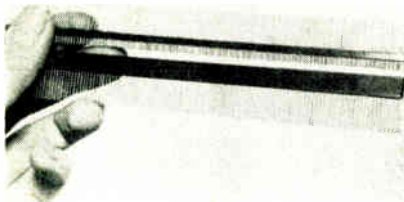

10

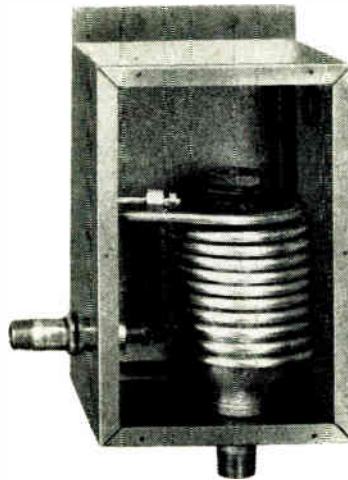

8

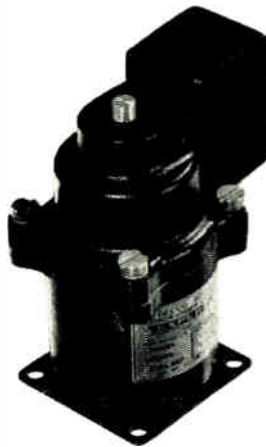

11

12

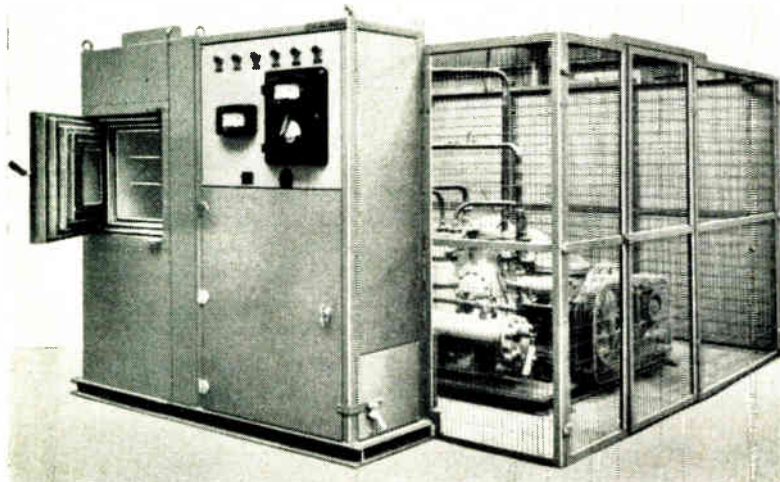

conforms to the surface curvature. The pocket of air trapped in the recess is completely insulated from frictional heat in the strip by a silastomer moulding.

Response time is 75 sec to reach 99% of the final reading. The cradle weighs 7½ lb and the handle 1 lb.—*Cambridge Instrument Co. Ltd., 13 Grosvenor Place, London, S.W.1.*

For further information circle 7 on Service Card

### 8. Fluid Hygrometer

THE PROPERTIES of fluids are often more dependent upon the effective water vapour pressure than upon water content. Hydrodynamics Inc. have accordingly introduced a fluid hygrometer designed to measure equilibrium relative humidity; i.e., moisture condition as opposed to moisture content.

In the form of a sampling chamber 6 by 5 by 9 in., it can be fitted with any of the company's high-resolution detectors and has a tempering coil to damp out temperature variations in the fluid. According to the nature of the process concerned, the hygrometer can be installed on-stream or as a by-pass.

Complete fluid hygrometer systems can be supplied to provide indication, recording or control of moisture condition.—*Hydrodynamics Inc., 949 Selim Road, Silver Spring, Maryland, U.S.A.*

For further information circle 8 on Service Card

### 9. Transistorized Portable Laboratory

WESTBROOK ARE marketing a new multipurpose instrument known as 'The Transistorized Portable Laboratory' TPL-1000 which, they claim, has the accuracy and linearity of a meter standard and will out-perform the individual instruments it replaces. These include a.c. and d.c. voltmeters and ammeters, resistance meters, potentiometers, etc.

The entire instrument maintains calibration against a self-contained  $\pm 0.25\%$  active standard and is stable over the temperature range of 0 °C to 60 °C. Among the components employed are silicon epitaxial planar transistors. One set of penlight batteries gives 1,500 hr operation.—*G. S. Westbrook Ltd., 50 High Street, Harpenden, Herts.*

For further information circle 9 on Service Card

### 10. Microstrip

CANNON ARE marketing a new addition to their Microplug range, known as the 'Microstrip', which

provides 120 contacts on an indicator 6 in. long and 0.070 in. thick ; i.e., with contacts (either Micropins or Microsockets) spaced on 0.050 in. centres. The Micropins are twisted miniature cables 0.250 in. long ; the Microsockets are gold-plated copper tubes with an inside diameter of 0.0225 in.

The strip can be cut up according to the number of contacts required and can be mounted directly on circuit boards with adhesive or embedded in micromodules.

Two versions are available: (i) with contacts fixed in the insulator and fitted with pigtail leads of material to be selected by the customer, (ii) with separate contacts to be crimped to wires by the user, then inserted into the insulator from the rear and fixed in place with an adhesive.—*Cannon Electric (G.B.) Ltd., 168/172 Old Street, London, E.C.1.*

For further information circle 10 on Service Card

## 11. Decco Enclosed Solenoids

NOW AVAILABLE from Expert Industrial Controls are the Decco Miniature and Teen series enclosed push-type solenoids. Although designed for use in the hydraulic and pneumatic industry, they are suitable for many applications in automation.

The sealed die-cast alloy cases are intended both as a protection against mechanical damage and as a heat sink which enables the solenoid to provide, at high cycling rates, a greater force at a lower temperature than when in free air.

The stroke is variable up to  $\frac{1}{2}$  in. and the solenoids can be supplied with or without manual actuating pins, terminal blocks and covers, and cable glands.

The interior of the solenoid is easily accessible for replacement of either the complete unit or the coil.—*Expert Industrial Controls Ltd., Ashby-de-la-Zouch, Leicestershire.*

For further information circle 11 on Service Card

## 12. High-Low Temperature Cycling Cabinet

THE SERIES E-RCHL Rapid Cycling High-Low Temperature Cabinet is the latest addition to the Barlow-Whitney range of environmental test chambers, designed to meet the conditioning tests of M.O.S. Spec. K1007. The temperature can be varied between + 200 °C and -70 °C within 15 to 30 min. depending on the thermal capacity of the charge. The entire cycle, which normally includes a holding time of about 15 min at the upper and lower limits, is automatically controlled

according to the predetermined programme.

The stainless steel chamber (an 18 in. cube, internally) is fitted with an inspection window and viewing light. The programme controller and all associated equipment are conveniently housed in a compartment next to the chamber, while the refrigeration compressors, etc., are situated behind the cabinet.

According to the makers, operating costs are considerably lower than those incurred by the use of separate high and low temperature cabinets.—*Barlow-Whitney Ltd., Coombe Road, Neasden, London, N.W.10.*

For further information circle 12 on Service Card

## 13. Sub-Miniature Elapsed Time Indicator

NOW AVAILABLE in this country is a new Bowmar sub-miniature elapsed-time indicator registering up to 9,999 hours in increments of one hour. Dimensions: length 1.68 in., diameter 0.67 in. Numerals are in matt white on a matt black background and the numeral height is 0.109 in. The adjustable mounting can be made to suit individual requirements.

The unit incorporates a 115-V 400-c/s synchronous motor and a converter can be supplied which will allow it to operate on 24 to 28 V d.c.

When the instrument is in operation, a visual check is provided by means of

an indicator on the face which rotates at 60 r.p.m.—*Miniature Electronic Components Ltd., St. Johns, Woking, Surrey.*

For further information circle 13 on Service Card

## 14. Micro-Amplifier

LESS THAN one-tenth the volume of a matchbox, this amplifier module developed by Sinclair Radionics has a wide range of possible applications, e.g. in miniaturized products employing pre-amplifiers, video and audio amplifiers, etc. It can also be used for pulse amplification.

Despite its small size this amplifier, which uses micro-alloy transistors, has a power gain of 60 dB with a reasonably flat response between 500 c/s and 100 kc/s (3 dB points lying at 150 c/s and 200 kc/s). Power gain at 2 Mc/s is 40 dB. The use of feedback enables the linear range to be considerably extended.

The unit operates equally well with any supply voltage between 1.3 and 9 V, and current drains of 0.5 to 3 mA. It can be supplied with output powers ranging from 0.3 to 10 mW, as required.—*Sinclair Radionics Ltd., 69 Histon Road, Cambridge.*

For further information circle 14 on Service Card

## 15. Automatic Tape Loader

TO FACILITATE maximum utilization of the IBM 7340 Hypertape System, the manufacturers have intro-



13



14



15

duced a programme-controlled Automatic Cartridge Loader. While one cartridge is being processed, another can be pre-stacked in the loader in a maximum cycle time of 30 sec. The second cartridge is then automatically selected as soon as the first has been processed.

This device allows the relevant IBM Data Processing Systems to be used continuously without interruptions due to operator handling of magnetic tape.—*IBM United Kingdom Ltd., 101 Wigmore Street, London, W.1.*

For further information circle 15 on Service Card

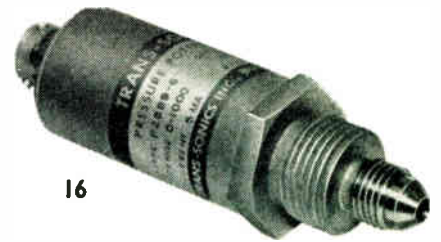

16

## 16. Cryogenic Pressure Detector

A NEW SERIES of pressure detectors for cryogenic applications has been announced by Trans-Sonics, Inc. of U.S.A. With an operating range of  $-320^{\circ}\text{F}$  to  $+160^{\circ}\text{F}$ , the detectors have a temperature-sensitive error of less than 0.005% f.s.d. per  $^{\circ}\text{F}$ .

These units have a time constant of less than 3 milliseconds and their operating life is rated at more than 100,000 cycles. They can withstand a sinusoidal vibration of 50 g to 2 kc/s and 75 g acceleration or mechanical shock in any direction without substantial change in output, thus making them particularly suitable for use in missiles, etc. Maximum weight is  $4\frac{1}{2}$  oz.—*Trans-Sonics, Inc., Burlington, Mass., U.S.A.*

For further information circle 16 on Service Card

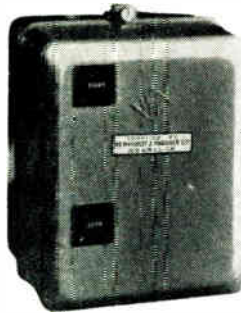

17

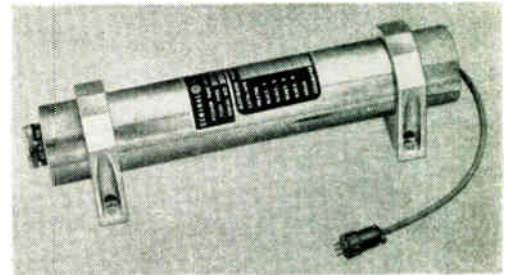

18

## 17. Squirrel-Cage Motor Starters

DEWHURST AND PARTNER are offering two new ranges of squirrel-cage motor starters: the direct-on-line range Type MS, available in a number of ratings up to 60 h.p./400 V, and the Type SMS for star/delta operation in ratings up to 45 h.p./400 V.

The contactors are basic 3-pole units with silver-to-silver contacts with a maximum switching capability of 550 V; up to three auxiliary contacts can be fitted as required. The vacuum impregnated coil is available in three standard ranges: 230–250 V, 396–425 V and 426–455 V.

Overload protection is provided by a temperature-compensated thermal relay with an external reset button; a calibrated scale and moving pointer allow visual adjustment of the setting. The timer in the star/delta range can be readily adjusted to give a delay in the star position of up to 30 sec, depending on the rating.

Both ranges can be supplied in three different forms: (1) in a steel case with local start/stop buttons, (2) in a steel case with two- or three-wire remote

control, (3) open type with two- or three-wire remote control, e.g., for control panels.

As a result of using standardized components the price of these compact and versatile units is comparatively low: from 71s 3d for the 3 h.p. direct-on-line (open form) and from £21 for the 3 h.p. star/delta (in case). As an introductory offer, the makers will deliver any model for 10 days' free trial.—*Dewhurst and Partner Ltd., Conservative Hall, Grove Road, Hounslow, Middlesex.*

For further information circle 17 on Service Card

## 18. Travelling-Wave Tube

A NEW X-BAND travelling-wave tube, now being marketed by International General Electric, is the ZM-3105 suitable for medium noise figure applications such as radar receivers, microwave instrumentation, etc.

This unit, which is convectively cooled, has a minimum output of 10 mW, minimum small signal gain of 35 dB and a noise figure over the range 7 to 12 Gc/s of less than 25 dB.

The metal-ceramic tube is  $11\frac{1}{2}$  in. long, has a diameter of 2 in. and weighs less than 3 lb. It has withstood a 50 g shock test, a 10-day humidity test at 96% r.h. and will operate under a 10 g sinusoidal vibration from 15 c/s

to 2 kc/s and over a temperature range of  $-65^{\circ}\text{C}$  to  $+100^{\circ}\text{C}$ .

The self-contained focusing structure allows considerable flexibility in respect of installation.—*International General Electric Co. of New York Ltd., 296 High Holborn, London, W.C.1.*

For further information circle 18 on Service Card

## 19. Spiral Cut Cable Wrapping

A FAST and economical method of bundling and protecting cables, hoses and harnesses, called 'Spirap' has been developed by A-M.P. This system uses spiral cut plastic tubing: when applied, the tubing tries to return to its original shape and hence grips the bundle firmly and effectively even against severe vibration.

Being in the form of a spiral rather than a continuous sheath, it has no tendency to retain moisture, and since it does not lose its elasticity, Spirap tubing can be re-used as often as required. Wires can be taken off at any point along the wrapping which itself can be colour coded.

Spirap is available in six materials: natural, outdoor and flame retardant polyethylene; natural and outdoor nylon, and 'Teflon'. It comes in three sizes: outside diameters of  $\frac{1}{4}$  in.,  $\frac{1}{2}$  in. and  $\frac{3}{4}$  in. (suitable for bundle diameters from  $\frac{1}{16}$  in. to 4 in.).





19

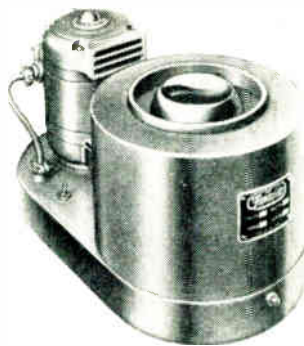

20



21



22

There are three methods of application: (1) a slotted hand tool which enables all diameter tubing to be wrapped quickly and uniformly; (2) a larger 'Handirap' tool, manually or motor driven, for applying the two larger diameter wrappings to long runs of suspended cables; (3) the 'Speedirap' tool which automatically applies two lengths of the larger diameter tubing simultaneously to long cable runs, thus doubling the rate of application. *Aircraft-Marine Products (Great Britain) Ltd., 87-89 Saffron Hill, London, E.C.1.*

For further information circle 19 on Service Card

## 20. Soldering Machine

FRY'S have introduced a new compact dipping unit for bench use in which a continuous 'wave' of clean solder is pumped up through a nozzle, presenting a smooth dross and oxide-free working area. The 'Flow-dipper' can also be used for machine dipping operations and as a mobile unit.

Solder height depends on the pump speed which, once it has been set, remains constant regardless of solder usage. The machine is controlled by two switches: one with an indicator light for the heater, one for the pump unit. The supply voltage required is 200 to 250 V a.c. and the  $\frac{1}{4}$  h.p. motor

has an overhead cut-out with manual reset.

The 'Flowdipper' is 9 in. high with a solder capacity of 45 lb. The working area and depth are respectively 9 sq in. and 1½ in. External finish is in silver-grey hammer.—*Fry's Metal Foundries Ltd., Flowsolder Division, Willow Lane, Mitcham, Surrey.*

For further information circle 20 on Service Card

## 21. High Stability Frequency Generators

CATHODEON ARE now marketing a series of high stability frequency generators, Type SFG.1, in the range 6 to 10 Mc/s. The basic unit is a fundamental plano-convex BT plate in an evacuated glass envelope, contained with its associated oscillator in an oven controlled by a mercury contact thermometer.

Short-term stability is better than  $\pm 5$  in  $10^6$ . Long-term stability is better than  $\pm 1$  in  $10^7$  per week provided the power supply of 115, 200, 220 or 240 V a.c. does not vary more than  $\pm 10\%$ , and the operating temperature is within the specified range of  $-20^\circ\text{C}$  to  $+45^\circ\text{C}$ . The output voltage is 1 V r.m.s. into 75  $\Omega$ . Warm-up time is less than 25 min from  $+15^\circ\text{C}$ .

Dimensions: 19 in. by 3.4 in. by 9.4 in. (excluding front handles). Weight: 9 lb. The price is £80 with

a delivery time of 3 to 4 months.—*Cathodeon Crystals Ltd., Linton, Cambridge.*

For further information circle 21 on Service Card

## 22. Transistorized Electro-Encephalograph

A.E.I. HAVE introduced a transistorized 8-channel electro-encephalograph of considerable flexibility with an overall maximum sensitivity of 1 cm pen deflection for a 10- $\mu\text{V}$  input signal. The three main units, although usually mounted together on a trolley, are individually portable.

The recorder unit is suitable for general scientific and industrial purposes in addition to its function as part of the EEG. Frequency response is 0 to 80 c/s with an input sensitivity per channel of 1 cm pen deflection for a 500-mV input signal. Maximum pen deflection is 2.1 cm peak to peak and the 8-in. wide chart can be driven at 15 different speeds from 0.75 cm/hr to 12 cm/sec. Each d.c. coupled pen driver amplifier is a plug-in unit.

The pre-amplifier unit consists of eight pre-amplifiers and a master control panel, all plug-in units with printed circuitry. There are two associated sub-units: an input switching unit and the 'head' box. On each pre-amplifier a versatile gain control ranges from a nominal figure of 195 up to 50,000 and a frequency-response

switch gives high-frequency cuts of 15% at nominal frequencies of 75, 25 and 15 c/s. Input impedance is not less than 8 M $\Omega$ , and rejection of in-phase signals not less than 1,000:1 at 50 c/s.

A calibration switch on the master control panel provides a selection of calibration voltages from a Mallory cell. The input switching sub-unit caters for 30 electrodes and provides each channel with two 30-position switches enabling any pair of electrodes to be connected to any pre-amplifier input. The power supply unit contains two separate supplies, one for the output amplifiers, the other for the pre-amplifier unit. The mains supply required is 220-240 V a.c., 50 c/s.—*Radio Components Department, A.E.I. Telecommunications Division, 155 Charing Cross Road, London, W.C.2.*

For further information circle 22 on Service Card

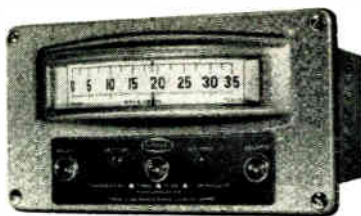

23



24

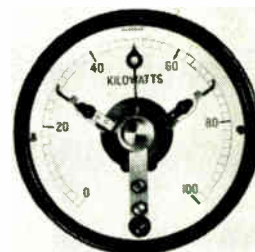

25

### 23. Temperature Indicator/Controller

TYER HAVE announced a new range of fully transistorized temperature indicator/controllers, using plug-in printed circuit boards, which are available with either one or two amplifiers according to whether on-off, anticipatory or modulating control is required.

Switching is effected by the control amplifier, leaving the indicator needle free to show any over-run and ensuring that the unit always tries to control. The plug-in type control relay is rated at 5 A, 250 V a.c. (non-inductive load).

Platinum resistance bulbs are employed as the sensing element, giving a sensitivity of better than 0.2 °C over the range -200 °C to +850 °C. Short ranges within this span can be supplied. Indication is on a 4½ in. scale.

The instrument can be removed from its case without disconnecting any wiring and access is, conveniently, from the front—*Tyer & Co. Ltd., Perram Works, Merrow Siding, Guildford, Surrey.*

For further information circle 23 on Service Card

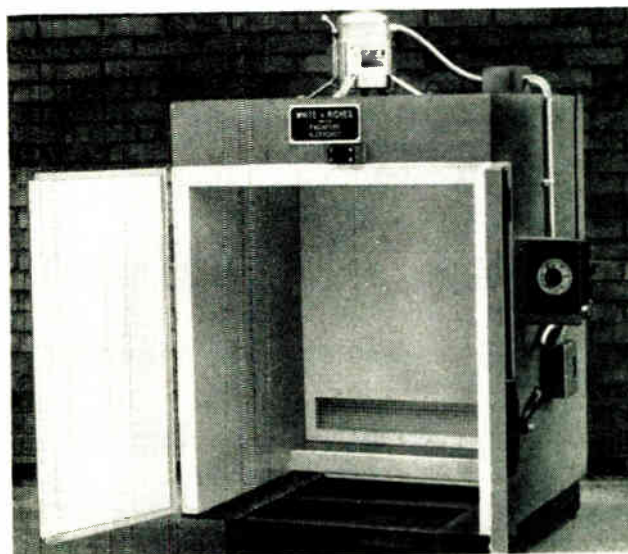

26

### 24. D.C. Neon Indicator

A LOW consumption neon indicator lamp suitable for use in 10 to 30 V d.c. circuits is announced by M.L. Aviation. With a rating of 15 mA at 28 V and a working life of up to 5,000 hr, it is designed to operate between temperatures of -20 °C to +70 °C.

The resin-encapsulated body, which houses a transistorized inverter, is fully screened and proofed against vibration and humidity. The lens can be supplied in red, green or amber either with forward and side illumination or

with illumination restricted to the forward plane only by a matt black bezel.

Length: 3 in. Diameter: ¼ in. Weight: 1½ oz. A ½ in. diameter hole is required for panel mounting.—*M.L. Aviation Co. Ltd., White Waltham Aerodrome, Maidenhead, Berks.*

For further information circle 24 on Service Card

### 25. The Demand Master

A RANGE of long-scale contact-making wattmeters manufactured by Nalder Bros. and Thompson, known as 'The Demand Master', will be of

particular interest to consumers of electricity who pay on a maximum demand basis. Savings in power costs can be made by disconnecting non-essential loads as soon as an impending load increase is indicated.

A built-in damping time of 15 or 20 min allows the necessary load shedding to be accomplished. The contacts can be adjusted to give alarm on conditions of overload and/or underload, or overload and reverse.

This instrument is available in a wide range of versions to suit individual requirements, reading either kW or true kVA (within the limits of

0.75 to 0.99 lagging power factor); diameters are from 6 in. upwards.—*Nalder Bros. and Thompson Ltd., Dalston Lane Works, London, E.8.*

For further information circle 25 on Service Card

## 26. Constant-Temperature Oven

A SPECIAL forced air circulation oven has been designed and manufactured by White and Riches for the Atomic Weapons Research Establishment, Aldermaston. Rated at 5 kilowatts with a maximum temperature of 125 °C it incorporates forced air circulation achieving a uniformity of temperature of  $\pm 2$  °C throughout the charge space.—*White and Riches Ltd., Imperial House, 15 Kingsway, London, W.C.2.*

For further information circle 26 on Service Card

## 27. Low-Noise Subminiature Triode

A LOW-NOISE subminiature triode designed to operate under extreme environmental conditions has been announced by Raytheon Co., of U.S.A.

This high- $\mu$  valve type CK8096 is about 20 dB lower than conventional triodes in microphonic noise output due to reductions of structural resonances within the audio frequency range. Quiescent noise referred to the grid at 10 c/s is  $-130$  dBV per cycle and at 1 kc/s is  $-153$  dBV per cycle.

Built to withstand impact shock of 450 g, acceleration of 1,000 g, and vibration of 10 g over extended periods, the valve has been tested to operate at altitudes of 60,000 ft. It is electrically similar to tube type CK6533WA.—*Raytheon-ELSI, Alpenstrasse, Zug, Switzerland.*

For further information circle 27 on Service Card

## 28. Transistorized Measuring Relay

THE TYPE LCU range of measuring relays, now being produced by Londex, are intended as a robust alternative to contact voltmeters and ammeters, e.g., as load control units in heavy industry.

Three types of unit are available. The LCU/S1 has a single changeover contact which operates at a preset upper limit and resets when the applied signal falls by 0.05 V. The LCU/S2 also has one changeover contact which operates at a high level setting, but in this case it resets at a value determined by a low limit control, variable between 1 V and 10 V. The upper limit, as with the LCU/S1, can be set anywhere between 1.5 V and 10 V. The LCU/D (illustrated) has two changeover contacts, one operating at an upper limit and resetting on

a fall of 0.05 V, the other operating at a lower limit and resetting on a rise of 0.05 V.

The repetitive stability of the operating point(s) is  $\pm 0.05$  V or  $\pm 1\%$ , whichever is the greater. Switching capacity is 3 A at 250 V a.c. Since the input signal must not exceed 10 V r.m.s., each instrument is supplied with an appropriate transformer. Although the signal source is normally a.c., arrangements can be made to accept a d.c. signal.—*Londex Ltd., 207 Anerley Road, London, S.E.20.*

For further information circle 28 on Service Card

## 29. Fast Response Sub-Millimetric Photo-Detector

ALTHOUGH A number of devices can be used to measure radiation in the sub-millimetre band, their use is generally restricted to continuous radiation or wide pulses; i.e., of the order of milliseconds or longer.

However, Mullard have now begun production of a photoconductive detector for wavelengths in the range 0.1 to 8 mm which has a response time of less than 1  $\mu$ sec. This opens up a wide variety of possible applications including, for example, microwave spectroscopy, maser development and weather research.

The cell depends for its operation

on the intrinsic photoconductivity of an indium-antimonide element situated in the field of a superconducting magnet, the whole assembly being immersed in liquid helium and contained by the inner of two concentric Dewar vessels. As an operating temperature of less than 2 °K is necessary to avoid swamping of the photoconductive effect by normal conduction, the boiling point of the liquid helium is lowered from 4 °K to 1.5 °K (approx.) by continuous pumping to a reduced pressure.

The outer vessel contains liquid nitrogen to minimize the rate at which the helium boils away. Approximately 1½ litres of liquid helium are required, giving an operating time of about 8 hr.

In the near future the manufacturers hope to extend the range of the instrument down to 0.01 mm or less by providing a series of doped germanium crystals which will be interchangeable with the present element.—*Mullard Ltd., Mullard House, Torrington Place, London, W.C.1.*

For further information circle 29 on Service Card

## 30. Subminiature Feed-Through

SEAELECTRO CORPORATION announces an addition to their range of subminiature feed-through terminals.

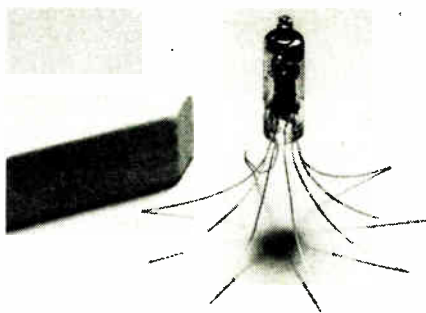

27



28

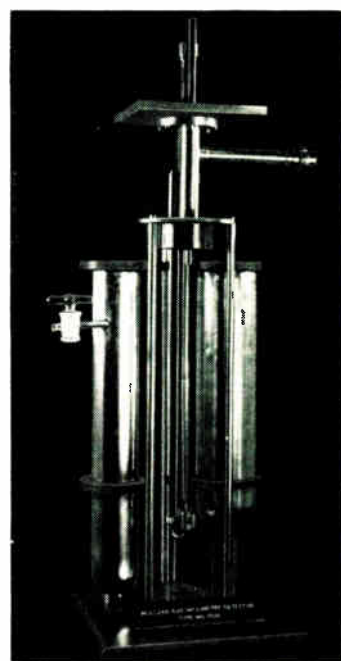

29

30



featuring an extra-short lug length and overall length. It is designed for use in limited space assemblies requiring ultra-compact wiring and connections. This Type FT-SM-62-L3 measures only 0.297 in. overall length, with a lug length above chassis of 0.137 in. Major diameter of the Teflon body is 0.172 in. and minor diameter is 0.148 in. The lug is made of brass, with an electro-plated solder finish. Other plating finishes are available upon order. The lug has a hole-through for wire lead. The Teflon body is available in 10 standard colours.—*Sealectro Corporation, Hershams Factory Estate, Walton-on-Thames, Surrey.*

For further information circle 30 on Service Card

### 31. Improved Digital Voltmeter

DIGITAL MEASUREMENTS have announced a new digital voltmeter, the DM2020, similar to the earlier DM2001, but with an improved performance.

Six ranges are provided, five covering 10  $\mu$ V to 1.9999 kV and the sixth offering an externally-selected scale facility. An illuminated background indicates the polarity of the input signal. Resolution can be reduced from 1 to 2 or 5 digits if required. There are six modes of operation and the total conversion time is 20 msec.

Long-term accuracy is  $\pm 0.05\%$  of any reading or 10  $\mu$ V, whichever is the

greater. Input impedance is greater than 2,000 M $\Omega$  on the two lowest ranges and the external range, and 10 M $\Omega$  on the others.

Dimensions of the bench model: 19½ in. wide, 8½ in. high, 14½ in. deep. Weight: 50 lb. Power supply required: 100 to 125 V or 200 to 250 V, at 50 to 60 c/s. Price: £680.—*Digital Measurements Ltd., 25 Salisbury Grove, Mytchett, Aldershot, Hants.*

For further information circle 31 on Service Card

### 32. Dual Illuminated Switches

DUBESCO HAVE announced a two-light illuminated push-button switch, each half of which can be lighted independently, e.g., to indicate different operational situations. These switches, which match the single-light series in appearance, can be supplied in any combination of the following colours: red, white, blue, yellow and green. Non-illuminated versions are available in opaque black.

The lamps, which are fitted with reflectors, can have ratings from 6 to 60 V. Up to two changeover contacts can be provided on each switch with either momentary (biased) or alternate actions. Switch ratings: 6 A, 230 V a.c. or 250 mA, 250 V d.c. Overall button dimensions are 0.945 in. by 1.890 in.—*Dubesco Laboratories Ltd., 5 Violet Hill, London, N.W.8.*

For further information circle 32 on Service Card



31

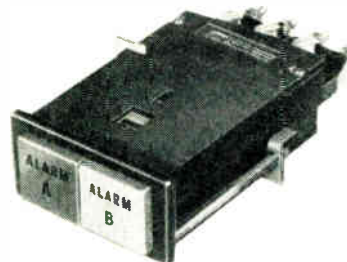

32



33



34

### 33. Miniature Photoelectric Projector and Receiver

THE LATEST Radiovisor plug-in projector and receiver have been designed for application where equipment space is at a premium. These standard units, known as F.P.14/2 and F.R.14/2, are 2½-in. long and only ½-in. diameter and are terminated in a miniature 3-pin plug mating with a socket. Side viewing or end viewing versions are available.

The units are constructed of duralumin and can be fitted with Perspex end caps to reduce the risk of lamp or photocell breakages and to reduce the risk of glass splinters falling on to the product being handled.—*Radiovisor Parent Ltd., Stanhope Works, High Path, London, S.W.19.*

For further information circle 33 on Service Card

### 34. Miniature Photoconductive Cell

THE DEVELOPMENT of a new corrosion-proof plastic encapsulation technique has made it possible for Mullard to produce a miniature cadmium sulphide cell with a diameter of 16 mm and a seated height of only 6.5 mm (compared with 47 mm for the equivalent glass-enveloped cell).

With a cell voltage of 10 V d.c. and an illumination of 54 lux, the nominal cell current of 6.0 mA is sufficient to operate a relay without amplification.

35

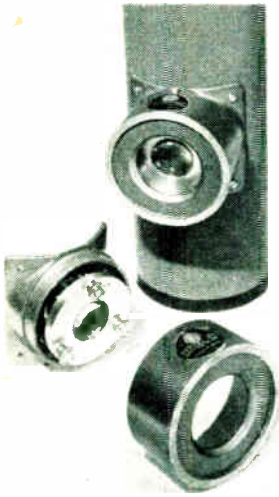

36

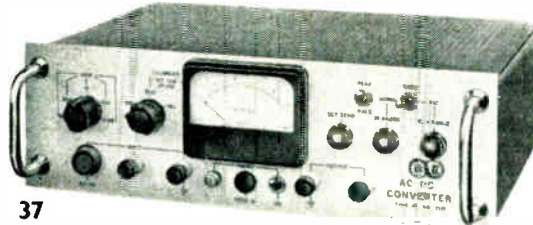
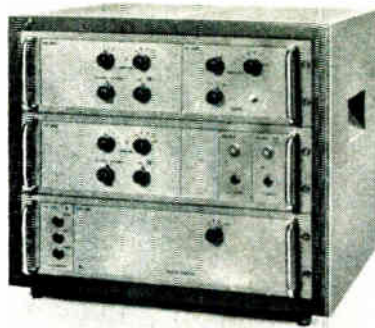

37

Maximum ultimate dark current at 200 V d.c. and 25 °C is 20  $\mu$ A. Peak spectral response is at about 0.7  $\mu$  with adequate response from green to near infra-red. The type number is RPY15. — Mullard Ltd., Mullard House, Torrington Place, London, W.C.1.

For further information circle 34 on Service Card

### 35. Automatic Door Control

AN AUTOMATIC control system which will open a door or gate on the approach of a person or vehicle and close it after a predetermined period can be useful not only for saving time and effort, but also for reducing heat losses in cold weather.

Elcontrol offer a complete set of 'Sentinel' equipment at £67 consisting of two pairs of cast-aluminium housings with light sources and cells, a transistorized relay and a timer which will provide up to 30 sec delay before closing. The standard housings have back pieces curved for bolt or screw attachment to 4-in. diameter pillars (a 2-in. diameter hole is required in each pillar to accommodate rear projection of the units and wiring connections); 3-ft flange-base cast-iron pillar mountings can be supplied at £5 each for applications where free-standing units are required.

The light sources can employ either 6 V 18 W or 12 V 21 W prefocused

bulbs; terminals for 6 V and 12 V supplies are provided in the relay. Lens alignment is carried out by adjusting knurled nuts on a spring loaded mounting. Each unit is water-proof and the glass disc in the cover is bonded to the metal by adhesive to reduce the possibility of shattering as a result of accidental impact. Finish is in hammered bronze.—Machine Automation Division, Elcontrol Ltd., Wilbury Way, Hitchin, Herts.

For further information circle 35 on Service Card

### 36. Modular Units for Nucleonic Instrumentation

A NEW RANGE of modular units announced by Philips allows rapid assembly of instrumentation systems for a wide variety of radiation measurements. Each transistorized unit is designed to perform a basic function such as counting or timing, with either manual or automatic operation.

All the modules generate and accept standardized pulses for starting, stopping and resetting. In manually-operated assemblies, measuring results are presented by moving-coil meters or cold-cathode tubes which are not included in assemblies intended for automatic operation. In this case, the results are converted into pulses for operating the appropriate data-handling equipment.

The illustration shows a typical assembly which will enable isotope decay data to be printed automatically. It consists of a counter, two timers, printer control, two power-supply units and a control unit, to be used in conjunction with a detector, its associated power supply and a printer. One timer controls the counting period while the other controls the interval between measurements.

Only the essential controls are at the front of the modules, with auxiliary controls and most of the sockets at the rear. The panel frame in which the modules are mounted fits a standard 19-in. rack, the width of each module being one-seventh or a multiple of one-seventh of the panel frame width.—Research and Control Instruments Ltd., Instrument House, 207 King's Cross Road, London, W.C.1.

For further information circle 36 on Service Card

### 37. A.C.-D.C. Converter

BLACKBURN are now marketing an a.c. d.c. converter, type BIF 2171, which will convert a.c. voltages into d.c. voltages equivalent to either the peak or r.m.s. value with an accuracy of 0.1%. E.s.d. This unit will deal with input voltages from 1 mV to 1 kV over the frequency range 40 c/s to 30 kc/s.

When used with a Blackburn digital voltmeter, the output filters are short-circuited between each reading, giving a maximum sampling rate considerably in excess of that permitted by normal filter time constants.

To check or re-calibrate the instrument, all that is required is a constant amplitude signal source to be used in conjunction with the internal calibration circuits provided.

Dimensions of the bench model: 5½ in. high, 16¼ in. wide, 12 in. deep. Weight: 26 lb. A standard 19 in. rack-mounting model is also available.—Blackburn Electronics Ltd., Brough, Yorkshire.

For further information circle 37 on Service Card

### 38. 'Megger' Earth Tester

EVERSHED AND VIGNOLES have introduced a new and highly sensitive method of measuring earth resistivity in the 'Megger' Null Balance Earth Tester. Unlike other earth testers its accuracy is not affected by electrode resistance.

The instrument will measure resistances from 0.01  $\Omega$  to 9,990  $\Omega$  in four ranges; measurements are presented in digital form and remain visible until the next test, thus eliminating the possibility of reading errors; accuracy is  $\pm 1\%$ . The effects of soil electrolysis and stray current interference are over-

come by the 'Megger' a.c. generator and its associated circuitry. A guard terminal is provided to ensure accuracy when testing in difficult conditions; i.e., when the spike resistances are high or unbalanced.

The principal applications are: (1) earth electrode resistance measurement, (2) soil resistivity measurement, (3) earth continuity tests, (4) neutral earth loop tests, and (5) direct resistance measurement. This self-contained unit is portable and can be supplied with a complete kit of accessories, including earth spikes.—*Evershed and Vignoles Ltd., Acton Lane Works, Chiswick, London, W.4.*

For further information circle 38 on Service Card

### 39. Flash Light Sources

LUNARTRON ELECTRONICS are producing a range of flash light sources suitable for research purposes. Four examples in this range are:

(1) A general purpose 150-joule, 70- $\mu$ sec flash lamp.

(2) A 'square pulse' source for use as an illuminator for framing cameras.

(3) A spark light source of 0.5- $\mu$ sec duration for shadograph or schlieren photography.

(4) A 2- $\mu$ sec source for photography by reflected light. As illustrated, this 12 by 18 by 12 in. unit is suitable for bench operation; a stand-mounting accessory is available as an extra.—*Lunartron Electronic Ltd., 42 Langley Street, Luton, Beds.*

For further information circle 39 on Service Card

### 40. High Vacuum Variable Capacitor

NOW IN production is the E.E.V. U400/8 high vacuum variable capacitor which extends the existing range of capacitances available to 400 pF.

Twenty-three turns of the tuning shaft cover the range from 10 to 400 pF. The ratio of capacitance to shaft turns is approximately linear over the range from 30 to 400 pF; i.e., after the first two turns from the minimum capacitance position.

Maximum peak r.f. voltage is 8 kV and versions suitable for 10 kV and 12 kV operation are available.—*English Electric Valve Co. Ltd., Chelmsford, Essex.*

For further information circle 40 on Service Card

### 41. R.F. Attenuator

NOW AVAILABLE from Wayne Kerr is an r.f. attenuator suitable for use with any Wayne Kerr-Gertsch frequency meter. The RFA-1 is a waveguide of the below cut-off type with a

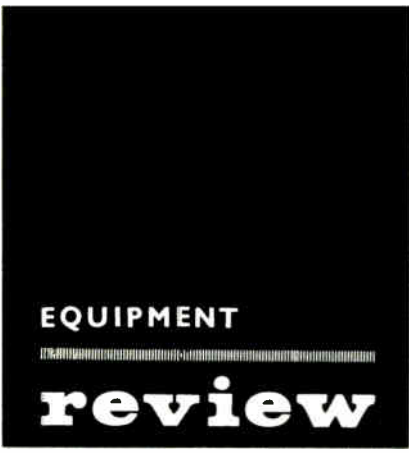

38

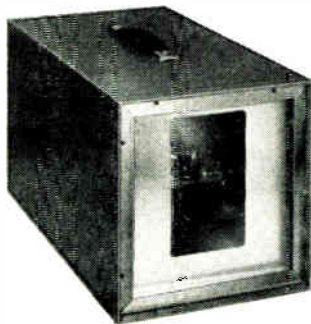

39



40

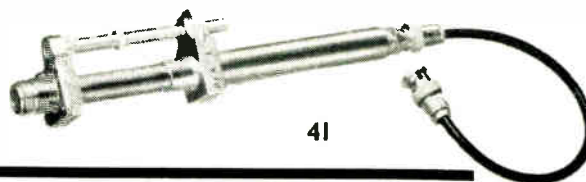

41

linear 3-dB incremental attenuation scale.

Although it is a relative attenuator, it can be calibrated for absolute attenuation levels. Maximum attenuation is 100 dB and minimum insertion loss is approximately 20 dB.—*The Wayne Kerr Laboratories Ltd., New Malden, Surrey.*

For further information circle 41 on Service Card

### 42. U.H.F. Signal Generator

FLANN HAVE announced details of their signal generator Type 501P which has a frequency range of 750 to 3,000 Mc/s. Frequency dial accuracy is  $\pm 1\%$  and frequency stability is 0.005% per  $^{\circ}\text{C}$ .

The instrument consists of five basic parts: stabilized power supply, modulator, klystron cavity, power monitor and piston attenuator. The modulator circuits provide pulse, square and sawtooth waveforms. Klystron tuning is by means of a non-contacting piston. Output from the cavity can be coupled through a removable socket on the panel which provides up to 60 mW.

In the attenuator, the sliding piston carrying the matched pick-up loop and output cable has its longitudinal movement coupled to the dB dial. One division of the attenuator scale is 0.025 dB and the full scale length is 150 in. (0–100 dB).

When the power level is adjusted to read 'set level' and the piston attenuator reads 0 dB, 1 mW of power is available at the output socket at any frequency. The Type 501P is intended for use with standard a.c. mains supplies.—*Flann Microwave Instruments Ltd., 9 Old Bridge Street, Kingston-upon-Thames, Surrey.*

For further information circle 42 on Service Card

### 43. Frequency Standard

BORG have introduced a fully transistorized frequency standard, the Model 1555, for which they quote a 'mean-time-between-failure' rate of more than 10,000 hr.

Dual inner and outer ovens ensure that the temperature of the 5-Mc/s overtone crystal is kept within  $\pm 0.0003^{\circ}\text{C}$ , giving short-term stability of better than 5 parts in  $10^{11}$  and long-

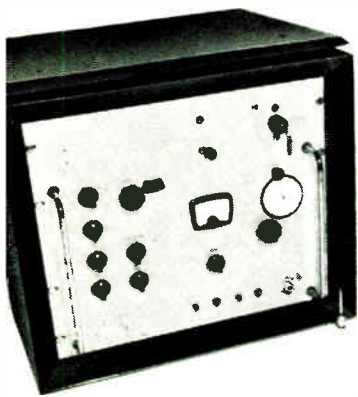

42

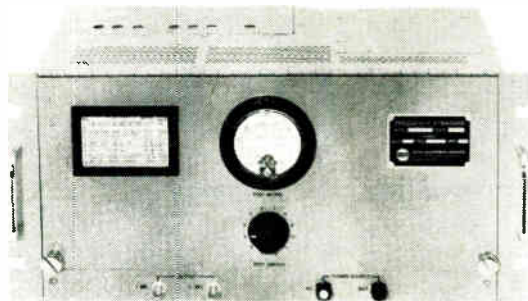

43

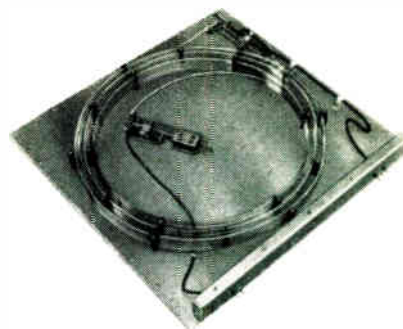

45

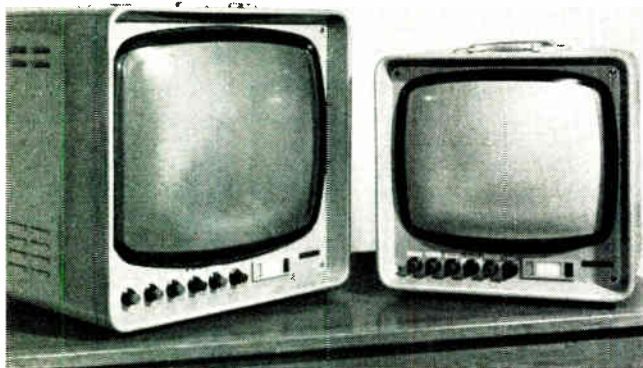

44

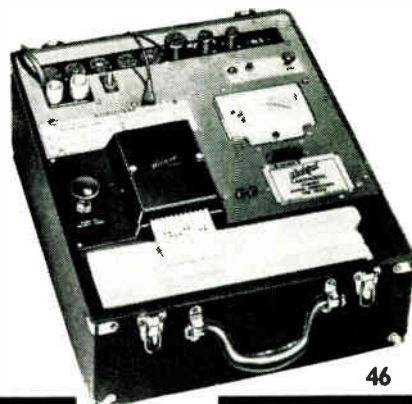

46

term stability of better than 5 parts in  $10^{10}$  per day.

Frequency outputs are located at both front and rear and there is provision for two additional dividers (or multipliers). Dimensions for the standard rack-mounted model are 19 in. by  $8\frac{1}{2}$  in. by  $8\frac{1}{2}$  in. Weight (including self-recharging battery unit for up to six hours stand-by operation): 42 lb. Delivery time: 60 days. *Elliott Bros. (London) Ltd., Microwave and Electronic Instruments Division, Elstree Way, Borehamwood, Herts.*

For further information circle 43 on Service Card

#### 44. Video Monitors

FERGUSON HAVE added two new video monitors to their range of television studio equipment. The facilities offered by these units include manual or automatic line standard selection (405, 525 or 625), remote control of brightness and contrast, and picture centering controls mounted on the front panel.

These monitors use  $110^\circ$  tubes with bonded face-plate construction and short back-to-front dimensions, result-

ing in a shallow cabinet which does not require a separate implosion guard.

As an optional extra, provision can be made for dual video inputs which may be selected either locally or remotely. Basic prices are £215 for the 23-in. model and £198 for the 19-in. version. — *Thorn Electrical Industries Ltd., Thorn House, Upper Saint Martin's Lane, London, W.C.2.*

For further information circle 44 on Service Card

#### 45. Five Millisecond Delay Line

SEAELECTRO are offering a new magnetostrictive delay line, the Deltime 197, which provides a 5-millisecond delay with a p.r.f. of 1 Mc/s. This compact unit is intended primarily for data storage in computer systems.

Maximum input voltage is 16 V at 80 mA and minimum output voltage is 7 mV. Maximum input pulse width at the 10% point is 0.4 to 0.5  $\mu$ sec. Minimum signal/noise ratio for a single pulse is 10:1. The temperature coefficient of delay is 5 p.p.m./ $^\circ$ C.

The Deltime 197 is fully protected against humidity and stray magnetic

fields.—*Seaelectro Corporation, Hershham Factory Estate, Walton-on-Thames, Surrey.*

For further information circle 45 on Service Card

#### 46. Automatic Valve Tester

THE HICKOK Model 123A is a valve tester which makes use of punched card programming; the instrument is supplied complete with 500 selected test cards.

A low signal voltage and fully regulated power supplies enable standard  $g_m$  measurements to be made with 3 to 5% accuracy, while there is also provision for saturation and cut-off tests. With  $g_m$  ranges from 0.5 to 26 mA/V and current ratings from 100  $\mu$ A to 510 mA, this tester will accommodate most types of industrial valve.

There is full overload protection; calibration cards are provided for checking this and also for calibrating the  $g_m$  measuring circuit, fixed bias and power supply voltages, etc.—*Emec Inc., 127 Grace Street, Plainview, L.I., New York, U.S.A.*

For further information circle 46 on Service Card

# THE MINIVAC

---

By A. G. COWLEY\*

Electronic computers are complex devices. For teaching purposes something simpler is adequate and in this article an inexpensive computer simulator is described. It is designed to enable the student to acquire familiarity with computer principles.

IT is generally recognized that computers will revolutionize many aspects of our lives. Already these instruments have considerably affected industrial and business methods in this country. Yet there is still an atmosphere of mystery about these machines which can only be dispelled by wider knowledge of their principles of operation and their potential uses.

Apart from some Universities and Colleges of Technology, there is little provision in our education system for teaching computer concepts. Some educationists feel that there is a need for a simple teaching device which will simulate the operations of a digital computer and illustrate basic principles. An answer to this need may be found in the Minivac which is to be distributed in this country by Clarke & Smith Mfg. Co. Ltd.

The Minivac Teaching Computer is a portable table console unit which is mains operated. The display panel is isolated from the mains and consists of press and slide switches, terminal contacts, light indicators, circuit breaker and a motor indicator control. The switches, which are of a 'break before make' type, are generally used to communicate or store binary information while relays act as memory or control circuits. Binary output is in the form of indicator lights. Limited decimal information is communicated by the small motor-driven rotary switch which can be manually set. Programming is done by means of patch-cord connections to the terminal contacts and these are arranged in sufficient number to allow multiple connections to individual contact points.

It will be seen from the catalogue of display panel details that the basic concept of the Minivac is quite simple and that its size and mechanical mode of operation would preclude consideration of it as a means of speedy calculation. However, these limitations, in comparison with an electronic instrument, can be regarded as strong points in its favour from an educational view. It must be remembered that unfamiliar technical forms tend to raise a mental barrier in many intelligent folk who accept that progress depends upon the wider use of modern techniques. A mind unfamiliar with the binary system would rebel against the statement '11 equals 3' and a person would have greater difficulty in understanding the processes of a computer when he is confused by a maze of electronics housed in a roomful of consoles. The more simple electro-mechanical teaching computer allows a student to assimilate facts and unconventional ideas in a logical fashion.

A comprehensive set of manuals is provided with the Minivac and these do not merely instruct the user in the various modes of operation of the machine. The manuals are important aids to the understanding of computer principles. Informative details are given relating the operation of the Minivac to the methods and purposes of large-scale digital computers.

What then is the range of this equipment? It introduces basic computer circuitry and demonstrates how circuit switching, whether electrical or electronic, can be used as a means of calculation. The student learns by programming the form of instruction circuit which a larger instrument would employ for particular problems. There are a few commercial computers which use patch-cord programming, but the student is informed by analogy of other methods which are employed.

## Input and Output Functions

Push-button switches provide the binary input and the rotary switch the decimal input functions. Storage, memory and processing are combined in the Minivac by

\* Clarke & Smith Mfg. Co., Ltd.



*The Minivac is a computer simulator designed for teaching the principles involved in electronic computers and their programming*



the use of its relays in conjunction with the rotary switch, while secondary storage is provided by slide switches. The memory capacity is limited, of course, but the functioning of the relays or the rotary switching by its motor can be varied according to the programming. In the later version of the equipment, the use of the relays is extended to allow their use as oscillators or automatic control circuits. Binary output is displayed by lights in the customary fashion where the light denotes nought when it is out, one when it is on. Decimal output is indicated by the motor driven rotary pointer. These simple output devices are adequate to display the amount of information which can be handled by the Minivac in its present form and care is taken to illustrate in the manuals the other media such as cards and paper or magnetic tape employed by large computers. In fact, wherever the Minivac uses a particular form of data processing or display both the similarities to and the differences from commercial equipment are amplified or qualified in the manuals. The wired programming, for example, is compared with those computers which use similar methods and those which incorporate permanent wiring of various operations in a stored programme. Similarity of functions of dissimilar components are indicated while comparing the advantages of high-speed operation with the slower visible operation of a teaching computer.

### Logic Circuits

A great deal of study, combined with individual programming, is possible in concentrating on the theme of principles of calculation by computers. The construction of computer arithmetic circuits serves to teach the principles and the introduction of these principles is undertaken in easy stages. However, the Minivac is not confined to binary arithmetic instruction relating to digital computers. A number of experiments in simple Boolean algebra are possible which demonstrate the fundamental logic of a computer. The basis of 'logic circuits' can be simulated with individual programmes and solutions to problems of a logical nature can be presented by the equipment. It should be stressed that this application is limited in its scope due to the size of the instrument. The actual programming takes longer than would be taken mentally solving the logical problem and therefore this aspect of the capabilities of the Minivac must be regarded as instruction in principle and not as a demonstration of speed in the solving of a problem. Nevertheless, the step-by-step method of posing a problem and the understanding of the means by which it is solved are extremely valuable in learning the basis of operation of a high-speed data processing equipment. It rids the student

of misconceptions and is an introduction to logical programme construction.

It is surprising to find that character recognition of the shapes of figures can be demonstrated with the Minivac using its matrix in conjunction with the rotary switch as the decimal output indicator. This illustration of the capability of a machine to recognize characters is rather elementary compared to recognition of characters in magnetic-ink form but it is effective in demonstrating the possibilities of more elaborate machines.

### Simulation

One of the more important applications of computers in the industrial field is to provide automated control of mechanical processes and this automatic arrangement of a sequence of operations can be simulated on the Minivac by an appropriate programme using indicator lights controlled by relays and the motor switch.

The electro-mechanical form of teacher computer, due to its nature, is restricted in the number of binary bits which it can process and although it can copy circuit functions of an electronic computer, it cannot work at great speed. Therefore, it cannot be regarded as a practical proposition as a calculator. Its merit rests on its ability amply to demonstrate the fundamental operations.

Compared with the size and complexity of a large data processing system, the Minivac is a scientific toy but its small size and simplicity are advantageous in the teaching of basic principles. By using mechanical electrical switching to illustrate electronic processes it allows a relatively inexpensive piece of equipment to simulate the operation of computers which cost many thousands of pounds. This substitution of electronic circuits by more simple methods gives a double advantage. It helps the student to acquire an easier understanding by the proven method of 'learning by doing'.

---

### ★ FOR THE BUYER

You must have read about a number of products and processes in this issue of which you would like further details. You can obtain this information very easily by filling in and posting one or more of the enquiry cards to be found inset in the front and back of the journal.

---

# MEASURING TRANSISTOR TIME CONSTANT

Two ways of measuring the collector-base time-constant of an alloy-type transistor operating in the common-base mode are described. The results obtained are compared.

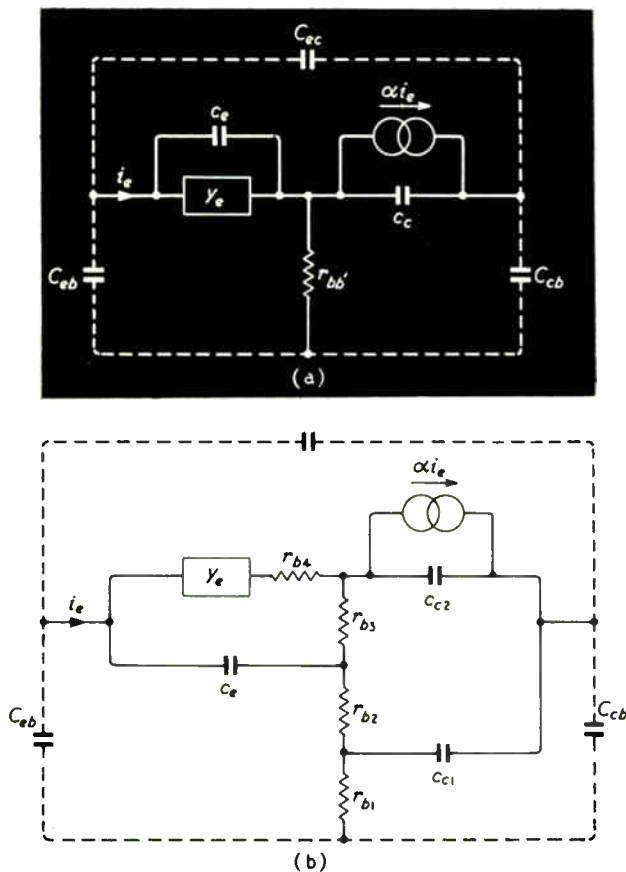

Fig. 1. High-frequency equivalent circuits for common-base connection; (a) simple collector-base circuit; (b) refined collector-base circuit

THE ohmic base resistance and collector capacitance combine to limit the frequency response, switching time and high-frequency power gain of transistors. In the simplest high-frequency equivalent circuit of Fig. 1(a) (after Giacometto<sup>1</sup>) for alloy-type transistors, the base resistance and collector capacitance are represented by single elements  $r_{bb'}$  and  $c_c$  respectively. The latter comprises both depletion-layer and diffusion components; the diffusion component increases with emitter current and decreases with frequency. A more exact equivalent circuit, due to Price and Hyde<sup>2</sup>, is shown in Fig. 1(b). This takes into account to some extent the distributed nature of the base resistance and collector capacitance. There is an additional component of depletion layer capacitance between the collector and base terminals, which is included in  $C_{cb}$ . Although knowledge of this component is desirable, we are only concerned here with the specification of the internal parameters.

In practice the internal collector-base time-constant  $CR$  is of more importance than its constituents, so that a detailed knowledge of the equivalent circuit is not in general required. For Fig. 1(a),  $CR = c_c r_{bb'}$  and for Fig. 1(b),  $CR = c_{c1} r_{b1} + c_{c2}(r_{b1} + r_{b2} + r_{b3})$ . This time constant may readily be measured in the frequency range 1-10 Mc/s using the  $h$ -type neutralizing circuit due to Turner<sup>3</sup>, which is shown in Fig. 2. At balance  $C_n R_n = CR$  if the stray capacitances  $C_{cb}$  and  $C_{cc}$  are ignored. The effects of these capacitances, which should always be made small, are considered in the Appendix. On the basis of the simple equivalent circuit of Fig. 1(a) it is shown that even if  $C_{cb}$  is significant the null condition is still

$$C_n R_n = c_c r_{bb'} \quad (1)$$

for  $C_{cc} = 0$ .

The null is only achieved, however, when a trimmer capacitance  $C'$  is added in parallel with  $R_n$  such that the

\* Formerly in the Department of Electronic Engineering, University College of North Wales, Bangor. Now at Royal Radar Establishment, Malvern.

condition  $C' = C_{eb}C_n(1 + r_e/r_{bb'})/C_c$  is simultaneously satisfied. The effect of  $C_{ec}$  is to change the balance condition to

$$C_n R_n \approx C_c r_{bb'} + C_{ec} r_e \quad (2)$$

at frequency  $f \ll f_a$ , where  $f_a$  is the 3-dB down or cut-off frequency of the internal current transfer operator  $a$ .  $r_e$  is the real part of  $1/y_e$ .

The range of  $CR$  products to be measured is from  $5 \times 10^{-9}$  sec for diffusion (homogeneous base-resistivity) transistors to about  $2 \times 10^{-11}$  sec for drift (graded base-resistivity) transistors. The minimum value of  $CR$  product which can be measured is clearly determined by the minimum values of  $C_n$  and  $R_n$ . If  $R_n$  is made too small, then the series inductance associated with it will cause error; when  $C_n$  is the variable element it will possess a finite minimum capacitance. The maximum value of  $R_n$  is limited by the effect of stray capacitance shunting it.

### Measurement Circuits

#### Variable $R_n$

The use of a biased thermistor as a variable resistor has been discussed in a previous paper<sup>4</sup>. The thermistor part of the circuit, modified to include an uncalibrated trimmer capacitance  $C'$  to nullify the effect of  $C_{eb}$  is shown in Fig. 3. The r.f. value of resistance of the thermistor is determined from the d.c. bridge balance equation

$$R_L + R_n = R_s R_1 / R_2 \quad (3)$$

where  $R_L$  is the d.c. resistance of the decoupling choke  $L$ .

The advantages of the thermistor as a variable r.f. resistor are its small size, with corresponding small values of stray capacitance to ground, small series inductance and the absence of moving contacts. The disadvantages are associated with the d.c. bridge circuit: there are several components involved, together with a stabilized power supply.

Some difficulty is encountered as the balance is approached because of the interaction between variation of  $R_s$  and thermistor d.c. resistance. This can be overcome with a form of self-balancing thermistor bridge with, however, an increase in complexity of the final bridge circuit.

#### Variable $C_n$

The required properties of a variable capacitor for  $C_n$  are (i) linearity; (ii) the terminal to which  $R_n$  is connected should have a small capacitance to ground; (iii) reading accuracy better than 1%. The coaxial assembly of electrodes illustrated in Fig. 4 can be made to satisfy these requirements.

The capacitor consists of a central metal rod  $C$  and two

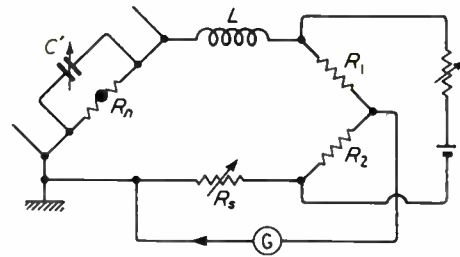

Fig. 3. Details of thermistor sub-circuit in practical version of the circuit of Fig. 2

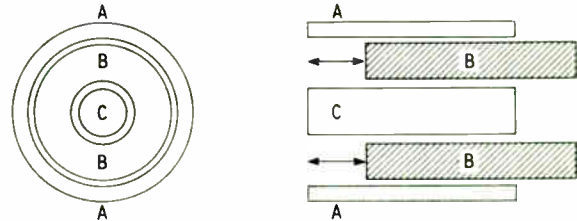

Fig. 4. Schematic cross-section of micrometer capacitor

coaxial metal cylinders  $A$  and  $B$ . The rod  $C$  and outer cylinder  $A$  are fixed concentrically to a disk of Tufnol. The cylinder  $B$  is mounted concentrically between  $A$  and  $C$  to a spring-loaded brass slide, the movement of which is controlled by a micrometer screw thread; the cylinder is insulated from the slide with a second disk of Tufnol.  $B$  can be moved parallel to the central axis while maintaining fixed radial distances between  $AB$  and  $BC$ . In this way only the area between  $AB$  and  $BC$  is changed, and the capacitance variation is linear. The value of the capacitance between  $A$  and  $C$  is approximately  $C_{AB}C_{BC}/(C_{AB} + C_{BC})$ , provided that the capacitance from  $B$  to ground is made small. Here  $C_{AB}$ ,  $C_{BC}$  are the capacitances between  $AB$  and  $BC$ . There is no moving contact since  $B$  is electrically floating, and a suitable micrometer provides the necessary reading accuracy. A high degree of precision machining is required to maintain constant air gaps of 5 mils between  $AB$  and  $BC$  for 500 mils longitudinal movement of  $B$ . The range of capacitance variation is 2–19 pF.  $R_n$  is a  $\frac{1}{4}$ -watt resistor soldered into the end of a tapered brass plug.

Both the thermistor and micrometer capacitor versions were calibrated in situ at the operating frequencies by direct measurement of  $C_n$  and  $R_n$  with an r.f. admittance bridge. The estimated overall accuracy of the thermistor bridge was 2% and of the micrometer bridge, better than 2%.

### Measurements on Alloy-type Transistors

Representative data are given for an R.C.A. drift transistor type 2N247 and a G.E.C. diffusion transistor type GET874. All measurements were made at room temperature with  $V_c = -12$  volts for the 2N247 transistor and  $-6$  volts for the GET874 transistor; the range of frequency was 1–18 Mc/s and of emitter current  $i_E$ , 100  $\mu$ A–10 mA. In all measurements the transistor cases were earthed. The variation of  $C_n R_n$  with frequency at  $i_E = 1$  mA is shown in Fig. 5. In Fig. 6 the dependence of  $C_n R_n$  on emitter current is shown with the frequency held constant at 1 Mc/s

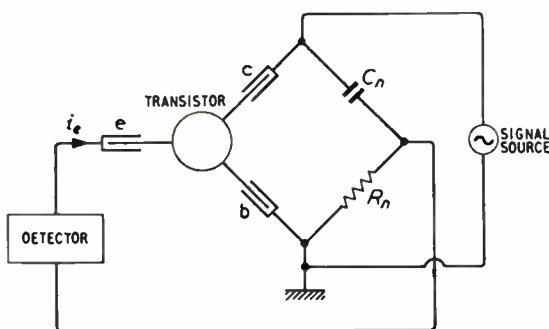

Fig. 2. Basic circuit of the Turner bridge

for the GET874 transistor and 5 Mc/s for the 2N247 transistor.

### Discussion of Results

The approximation made in deriving equation (1) is that  $1 - a \approx 0$ . This condition arises only for  $f \ll f_u$ ; for frequencies approaching  $f_u$  the approximation is not valid so that equation (A3) must be used. It is clear that this equation cannot represent a true null. However, the value of  $C_n R_n$  at the near balance condition appropriate to equation (A3) is greater than that expected from equation (1). This explains the rise in values of  $C_n R_n$  with increasing frequency in Fig. 5. For both transistors there is excellent agreement between measurements obtained using variable  $R_n$  and variable  $C_n$  for frequencies up to 10 Mc/s. At higher frequencies the values of  $C_n R_n$  are somewhat larger using the thermistor bridge. This can be attributed to the effect of the interwinding capacitance of the choke  $L$ , which decreases its effective reactance as the frequency is raised. In consequence the effective r.f. value for  $R_n$  will be less than the d.c. value, and this difference will increase with increasing frequency. Since it is the d.c. value calculated from equation (3) which is used to obtain  $C_n R_n$ , this product rises with increasing frequency.

The collector capacitance includes a component of diffusion capacitance. This capacitance is directly proportional to  $i_E$ ; hence the  $CR$  product and  $C_n R_n$  should increase with  $i_E$ ; this is seen in Fig. 6. At low values of  $i_E$  (large  $r_e$ ) the term  $C_{ce} r_e$  may contribute significantly to the  $CR$  product as in equation (A3), so that  $C_n R_n$  should again rise. This effect is just observed for the type 2N247 transistor which has a low value of  $CR$  product. For the GET874 transistor the  $CR$  product is so large that the effect of  $C_{ce}$  is negligible. The difference in readings at low  $i_E$  for the type 2N247 transistor in the thermistor and cylindrical capacitor bridges is due to the different values of  $C_{ce}$  in the two bridges.

### Conclusion

The good agreement obtained between values of the collector-base time constant in two different circuit arrangements gives confidence in the interpretation of the experi-

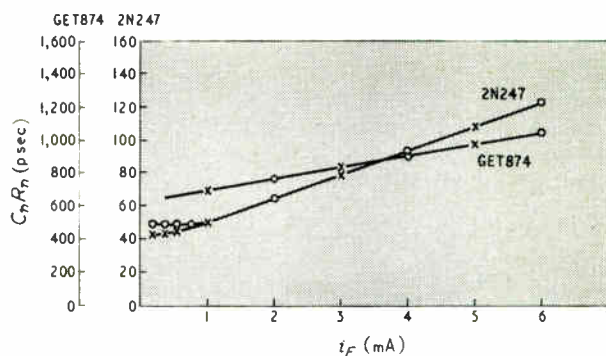

Fig. 6. Dependence of  $C_n R_n$  on  $i_E$  at  $f = 1$  Mc/s (GET874), 5 Mc/s (2N247):  $\circ$ , micrometer capacitor bridge;  $\times$ , thermistor bridge

mental data. It has been shown that the frequency range 1–5 Mc/s is a suitable one for such measurements.

### Acknowledgment

The above work was done in the Department of Electronic Engineering of the University College of North Wales. The author wishes to acknowledge discussions with Mr. F. J. Hyde, the help of Mr. K. Beardsell in making the cylindrical capacitor and the Department of Scientific and Industrial Research for financial support.

### References

- 1 Giacometto, L. J., 'Equipment for Measuring Junction Transistor Admittance Parameters for a Wide Range of Frequencies', *R.C.A. Review*, 1953, Vol. 14, p. 269.
- 2 Price, T. E. and Hyde, F. J., 'Base Resistance and Collector Capacitance of Alloy-Type Transistors', *Proceedings Institution of Electrical Engineers*, 1962, Vol. 109B, p. 115.
- 3 Turner, R. J., 'Surface-Barrier Transistors, Measurements and Applications', *Tele-Tech*, 1954, Vol. 13, p. 78.
- 4 Hyde, F. J. and Price, T. E., 'Measurement of the High-Frequency Base Resistance and Collector Capacitance of Drift Transistors', *Journal of Electronics and Control*, 1959, Vol. 6, p. 347.

### Appendix

#### Effect of Stray Interelectrode Capacitances on the Bridge Balance Condition

##### Emitter-Base Capacitance $C_{eb}$

The effect of  $C_{eb}$  on the balance condition may be determined by converting the delta network comprising  $r_{be}$ ,  $r_{bb}$  and  $C_{eb}$  in Fig. 1(a) to an equivalent star. The modified circuit introduces a resistance in series with  $r_{be}$ , which is insignificant, but  $r_{bb}$  is now shunted by a capacitance  $C_{eb}(1 + r_e/r_{bb})$  where  $r_e = \text{Re}(1/y_e)$ . Hence to produce a null in the circuit of Fig. 2 it is necessary to include a variable capacitor  $C'$  in parallel with  $R_n$ . When the real and imaginary parts of the resultant balance equation are equated it is found that

$$C_n R_n = C_e r_{bb} \quad (\text{A1})$$

$$C' = C_{eb}(1 + r_e/r_{bb}) C_n / C_e \quad (\text{A2})$$

An added trimmer capacitance  $C'$  will therefore increase the sharpness of the minimum when balancing the bridge and ensure that (A1) holds.

##### Collector-Emitter Capacitance, $C_{ce}$

It has been shown<sup>1</sup> that the balance condition is modified by  $C_{ce}$  to

$$C_n R_n \approx C_e r_{bb} + C_{ce}(1 - a)r_{bb} + r_e^2 \quad (\text{A3})$$

which reduces to

$$C_n R_n \approx C_e r_{bb} + C_{ce} r_e \quad (\text{A4})$$

when  $(1 - a) \rightarrow 0$  at low frequency.

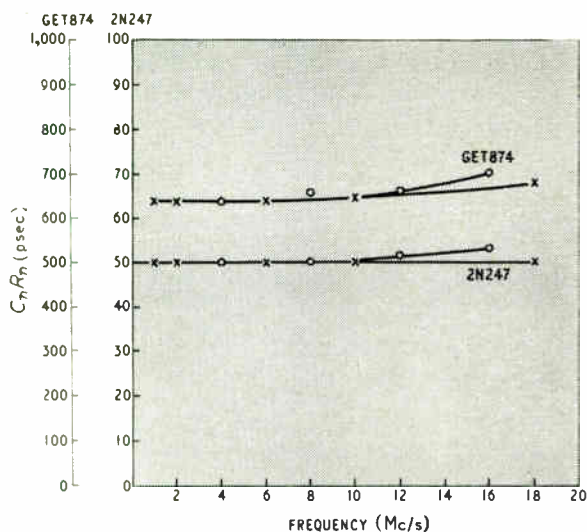
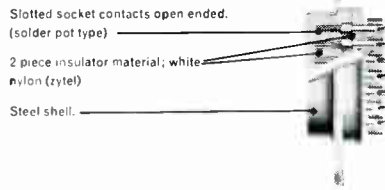

Fig. 5. Variation of  $C_n R_n$  with frequency at  $i_E = 1$  mA;  $V_c = 12$  V for 2N247,  $V_c = -6$  V for GET874.  $\circ$ , micrometer capacitor bridge;  $\times$ , thermistor bridge

# NOW the complete CANNON 'D' subminiature range



Slotted socket contacts open ended. (solder pot type)

2 piece insulator material; white nylon (zylet)

Steel shell.

## THE STANDARD CANNON "D" MINIATURE SERIES D\*

- \* Cadmium Plate with gold iridite finish.
- \* 5 shell sizes with floating mounting bushes if required.
- \* Insert arrangements with 9, 15, 25, 37 and 50 contacts.
- \* Junction shells, potting cups and other accessories available.

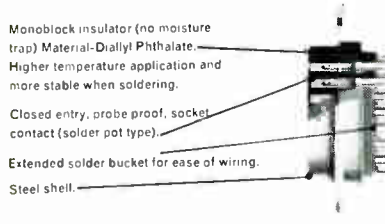

Monoblock insulator (no moisture trap) Material-Diallyl Phthalate.

Higher temperature application and more stable when soldering.

Closed entry, probe proof, socket contact (solder pot type).

Extended solder bucket for ease of wiring.

Steel shell.

## THE CANNON GOLDEN "D" MINIATURE SERIES D\*M INTERMATEABLE WITH STANDARD CANNON "D"

- Also available with snap-in removable coaxial and high voltage contacts. Heavier gauge material (.024) used on the pin insulator shells for greater rigidity.
- \* Cadmium Plate with gold iridite finish.
- \* 5 shell sizes with floating mounting bushes if required.
- \* Insert arrangements with 9, 15, 25, 37 and 50 contacts.
- \* Junction shells, potting cups and other accessories available.

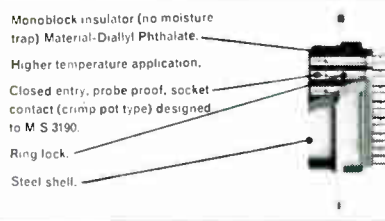

Monoblock insulator (no moisture trap) Material-Diallyl Phthalate.

Higher temperature application.

Closed entry, probe proof, socket contact (crimp pot type) designed to M S 3190.

Ring lock.

Steel shell.

## THE CANNON GOLDEN "D" MINIATURE WITH SNAP-IN REMOVABLE CRIMP-TYPE CONTACTS. SERIES D\*SM INTERMATEABLE WITH D\*M AND D\* SERIES

- Will shortly be available with snap-in removable coaxial and high voltage contacts.
- \* Cadmium Plate with gold iridite finish.
- \* 5 shell sizes with floating mounting bushes if required.
- Insert arrangements with 9, 15, 25, 37 and 50 contacts.
- \* Junction shells, potting cups and other accessories available. Heavier gauge metal (.024) used on the pin insulator shells for greater rigidity.

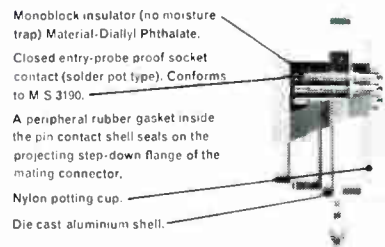

Monoblock insulator (no moisture trap) Material-Diallyl Phthalate.

Closed entry-probe proof socket contact (solder pot type). Conforms to M S 3190.

A peripheral rubber gasket inside the pin contact shell seals on the projecting step-down flange of the mating connector.

Nylon potting cup.

Die cast aluminium shell.

## THE CANNON GOLDEN "D" MINIATURE ENVIRONMENTAL CONNECTOR. SERIES D\*D

- Will shortly be available with snap-in removable crimp type contacts and removable coaxial high voltage contacts.
- \* High altitude sealed application peripheral seal permits partial disengagement of "D" whilst still maintaining seal.
- \* Insert arrangements with 9, 15, 25, 26, 37 and 50 contacts.
- \* 6 shell sizes with floating mounting bushes if required.

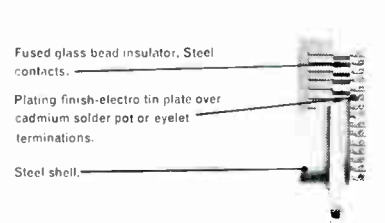

Fused glass bead insulator. Steel contacts.

Plating finish-electro tin plate over cadmium solder pot or eyelet terminations.

Steel shell.

## THE CANNON "D" MINIATURE HERMETICALLY SEALED SERIES D\*M INTERMATEABLE WITH D\*, D\*M, AND D\*SM CONNECTORS.

- These connectors will provide a seal giving maximum leakage rate of 1 micron cubic foot per hour, at a pressure differential of one atmosphere. Available with pin contacts only, in insert arrangements of 9, 15, 25, 26, 37 and 50 way.

Designed especially for missile circuitry and maximum reliability applications, the Cannon "Golden-D" connectors are engineered to deliver superior performance in a sub-miniature size. Supplementing our already famous Standard "D" Subminiature line, the new Cannon "Golden-D" extensions to the range provide comprehensive coverage for a great many new applications.

Wherever maximum reliability is needed in a subminiature multi-contact connector for both military and industrial applications, the new ranges of Cannon "D" Miniature Connectors are highly recommended. Indeed, wherever the application exists for a plug and socket consult CANNON, the world's most experienced and foremost connector manufacturer. For further details of the new range of Cannon "D" Miniature Connectors or of any of our other ranges, write to

CANNON ELECTRIC (Great Britain) Ltd., 168/172 OLD STREET, LONDON, E.C.1. Telephone: CLerkenwell 4954.  
 European enquiries: Cannon Electric International Inc., Bornem, Belgium. Telephone (03) 77.06.14.  
 Scandinavian enquiries:  
 Sweden: AB Gosta Backstrom, Box 12089, Stockholm 12.  
 Denmark: Tage Schouboe 7 Skyttegade, Copenhagen.  
 Norway: Morgenstjerne & Co., Wessels Gate, 6, Oslo.  
 Finland: OY Chester AB, Helsingfors N, Esplanadgatan, 37A, Helsinki.

**CANNON ELECTRIC**  
 (Great Britain) LTD.  
 168/172 OLD STREET  
 LONDON, E.C.1  
 Tel. CLerkenwell 4954





For further information circle 220 on Service Card

**RIST'S**  
**CABLE HARNESSES**  
**SAVE MONEY**  
**AND SPEED**  
**PRODUCTION**

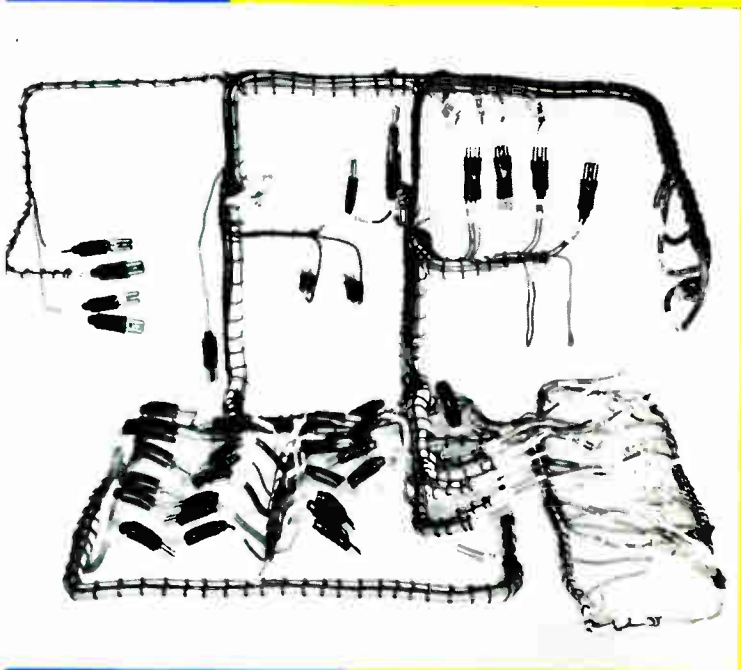

G 61534

**SEND FOR THIS  
LEAFLET NOW!**

**RIST'S WIRES & CABLES LIMITED**

NEWCASTLE · STAFFS

NEWCASTLE, STAFFS World Radio History

A method of designing an interstage correcting network for stabilizing a feedback amplifier is described. The method is illustrated by a practical example.

# FEEDBACK AMPLIFIER STABILIZATION

By S. S. HAKIM, B.Sc., Ph.D., A.M.I.E.E.\*

**I**N an earlier article<sup>1</sup> a method was developed for designing a 2-pole interstage correcting network which would introduce a specified loss into the open-loop gain characteristic of a feedback amplifier so as to realize required gain and phase margins. There it was shown that the admittance  $Y$  of the correcting network and the insertion loss  $\alpha$ , which it produces, are related as follows.

$$Y = Y_t(e^{\alpha} - 1) \quad (1)$$

$$Y_t(e^{\alpha - j\beta} - 1) \quad (2)$$

where  $\theta = \alpha - j\beta$   
 $\beta$  the phase angle associated with  $\alpha$ .  
 $Y_t$  the total admittance measured between the common terminal and the point P of the basic amplifier of Fig. 1 with the correcting network removed from the circuit; that is,  $Y_t$  is equal to the sum of the input admittance of stage  $TR_2$ , the output admittance of stage  $TR_1$ , and the conductance of the interstage biasing resistor.

Next, noting that

$$Y_t = G_t + jB_t$$

and using Equation (2), expressions are developed for the conductance  $G$  and susceptance  $B$  of the admittance  $Y$ . Thus, the  $G$  and  $B$  characteristics are uniquely determined knowing  $G_t$ ,  $B_t$  and  $\alpha$ . The latter characteristic can be used to evaluate the  $\beta$  characteristic as the insertion loss of any 2-pole network is a minimum phase one. Finally either the  $G$  or  $B$  characteristic is used to evaluate the element values of the correcting network.

An alternative method is the following. The specified insertion loss characteristic  $\alpha$  and the conductance characteristic  $G_t$  are approximated with realizable rational functions. Then Equation (1) is used directly to determine the corresponding rational function for the admittance  $Y$  which is finally realized by a passive network. The basic theory of this second method is next developed, followed by a design example.

## Basic Design Equations

In most cases the specified insertion loss characteristic can be closely realized by the approximate straight line

\* Lanchester College of Technology, Coventry.

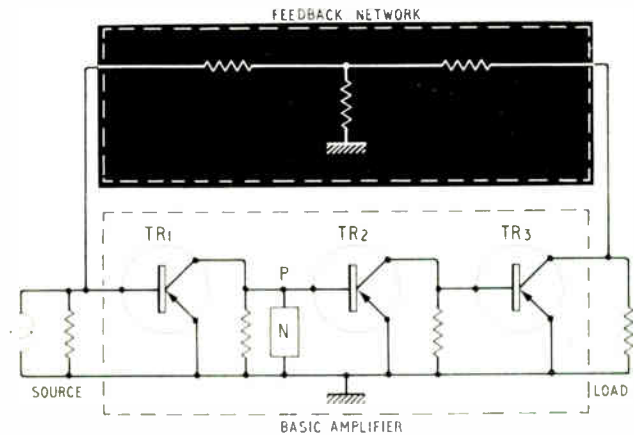

Fig. 1. Transistor feedback amplifier showing correcting network in position.  $N$  is interstage correcting network

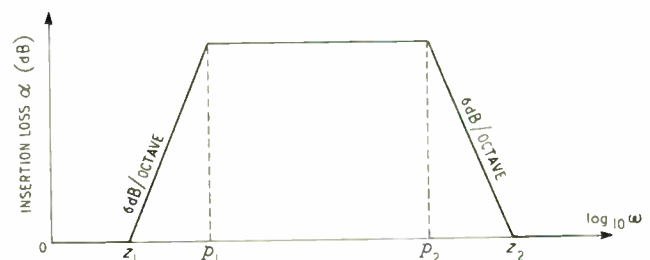

Fig. 2. Approximate straight line representation of insertion loss  $\alpha$

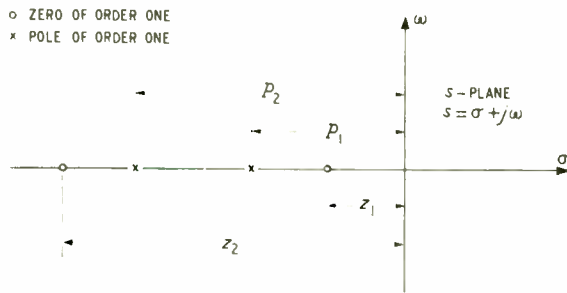

Fig. 3. Pole-zero map of transfer function  $e^\theta$

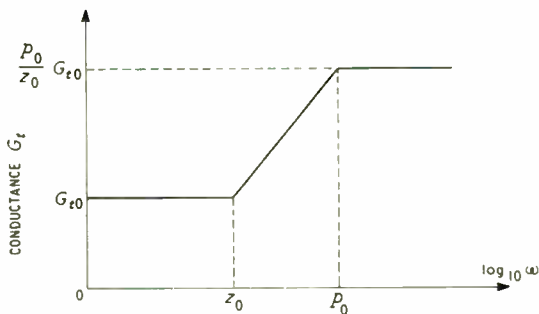

Fig. 4. Approximate straight line representation of conductance  $G_t$

characteristic of Fig. 2 which is defined by the following rational function

$$e^\theta = H \cdot \frac{(1 + s/z_1)(1 + s/z_2)}{(1 + s/p_1)(1 + s/p_2)} \quad (3)$$

where  $s$  is the complex frequency variable, and  $H$ ,  $z_1$ ,  $z_2$ ,  $p_1$  and  $p_2$  are positive real constants. From Fig. 2 it is noted that

$$z_2 > p_2 > p_1 > z_1 \quad (4)$$

and so Equation (3) corresponds to the pole-zero map of Fig. 3. All the poles and zeros are located on the negative real axis of the  $s$ -plane and, therefore, the transfer function of Equation (3) is a minimum phase one as it should be.

However, from Fig. 2 it is noted that the insertion loss  $\alpha$  is zero at zero frequency, and so the constant  $H$  must be equal to unity. It is further observed from Fig. 2 that  $\alpha$  is also zero at infinite frequency in which case it follows from Equation (3) that the constants  $z_1$ ,  $z_2$ ,  $p_1$  and  $p_2$  must be related as follows

$$z_1 z_2 = p_1 p_2 \quad (5)$$

Accordingly, Equation (3) modifies to

$$e^\theta = \frac{(1 + s/z_1)(1 + z_1 s/p_1 p_2)}{(1 + s/p_1)(1 + s/p_2)} = \frac{1 + s(1/z_1 + z_1/p_1 p_2) + s^2/p_1 p_2}{1 + s(1/p_1 + 1/p_2) + s^2/p_1 p_2} \quad (6)$$

from which it follows that

$$e^\theta - 1 = \frac{s(1/z_1 - 1/p_1)(1 - z_1/p_2)}{(1 + s/p_1)(1 + s/p_2)} \quad (7)$$

Next, in the case of a transistor amplifier using common-emitter stages as in Fig. 1, the admittance  $Y_t$  can be closely approximated by the following rational function:

$$Y_t = G_{t0} \cdot \frac{1 + s/z_0}{1 + s/p_0} \quad (8)$$

where  $G_{t0}$ ,  $z_0$  and  $p_0$  are all positive real constants.

From Equation (8) it follows that the conductance  $G_t$  and susceptance  $B_t$  are given by

$$G_t = G_{t0} \cdot \frac{1 + \omega^2/p_0 z_0}{1 + \omega^2/p_0^2} \quad (9)$$

$$B_t = G_{t0} \cdot \frac{\omega(1/z_0 - 1/p_0)}{1 + \omega^2/p_0^2} \quad (10)$$

where  $\omega$  is the angular frequency.

From Equation (9) it follows that  $G_{t0}$  and  $G_{t0} p_0 / z_0$  are the values of the conductance  $G_t$  at zero and infinite frequencies, respectively. In an amplifier using common-emitter stages the conductance  $G_t$  increases with increasing frequency with the result that

$$p_0 > z_0$$

and so Equation (9) corresponds to the approximate straight line characteristic of Fig. 4. Further, the admittance  $Y_t$  of Equation (8) corresponds to the pole-zero map of Fig. 5 and, therefore, the admittance  $Y_t$  can be realized as a resistance-capacitance network. The admittance  $Y_t$  is a minimum susceptance one in that its susceptance characteristic can be determined from its conductance characteristic and vice versa.

Combining Equations (1), and (7) and (8) gives that the admittance  $Y$  of the required correcting network is

$$Y = \frac{G_{t0}(1/z_1 - 1/p_1)(1 - z_1/p_2) \cdot s(1 + s/z_0)}{(1 + s/p_0)(1 + s/p_1)(1 + s/p_2)} \quad (11)$$

If, however,  $z_0$  and  $p_1$  are chosen such that

$$z_0 = p_1 \quad (12)$$

then a pole-zero cancellation takes place, and accordingly Equation (11) reduces as follows

$$Y = G_{t0}(1/z_1 - 1/p_1)(1 - z_1/p_2) \cdot \frac{s}{(1 + s/p_0)(1 + s/p_2)}$$

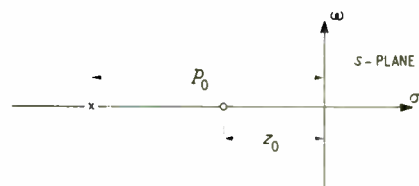

Fig. 5. Pole-zero map of admittance  $Y_t$



Fig. 6. Two-pole correcting network



from which it follows that

$$Z = 1/Y = \frac{1 + s(1/p_0 + 1/p_2) + s^2/p_0p_2}{G_{t0}(1/z_1 - 1/p_1)(1 - z_1/p_2)s} = \frac{1/s + (1/p_0 + 1/p_2) + s/p_0p_2}{G_{t0}(1/z_1 - 1/p_1)(1 - z_1/p_2)} \quad (13)$$

Therefore, the correcting network can be realized by the series LCR network of Fig. 6 having the following element values

$$L = \frac{1}{G_{t0}p_0p_2(1/z_1 - 1/p_1)(1 - z_1/p_2)} \quad (14)$$

$$C = G_{t0}(1/z_1 - 1/p_1)(1 - z_1/p_2) \quad (15)$$

$$R = \frac{1/p_0 + 1/p_2}{G_{t0}(1/z_1 - 1/p_1)(1 - z_1/p_2)} \quad (16)$$

From Equations (14) and (15) it is deduced that the frequency of resonance is equal to  $1/2\pi\sqrt{p_0p_2}$ . Further, all the elements of the correcting network are physically realizable in view of the inequalities of Equation (4).

Equations (5) and (12) impose two conditions on the possible choice of the 2 poles and 2 zeros of the transfer function  $e^{j\omega}$ . However, in spite of this it is still quite possible to choose suitable values for  $z_1$  and  $p_2$  so as to approximate closely to the specified insertion loss characteristic.

### Design Example

In a particular design it was required to introduce the insertion loss characteristic of Fig. 7 into the open-loop response of a transistor amplifier using a cascade of three GET872 transistors, each operated in the common-emitter configuration. Figs. 8 and 9 show the measured conductance  $G_t$  and susceptance  $B_t$  characteristics, respectively, at the point P (see Fig. 1) where the correcting network is to be inserted.

First, consider the  $G_t$  characteristic of Fig. 8. It will be approximated by the rational function of Equation (9). From Fig. 8 one notes that

$$G_{t0} \approx 1.5 \text{ millimho} \quad (17)$$

Next, Equation (9) is forced to pass through two widely spaced points on the conductance characteristic of Fig. 8. For example two such points are the following:

$$f = 0.5, G_t = 4.5 \text{ millimho}$$

and

$$f = 1.25, G_t = 9 \text{ millimho}$$

where the frequency  $f$  is normalized with respect to 1 Mc/s. Substituting these values in Equation (9) and solving for  $z_0$  and  $p_0$  one obtains that

$$\left. \begin{aligned} z_0 &= 0.622 \\ p_0 &= 4.96 \end{aligned} \right\} \quad (18)$$

in which case Equation (9) gives that

$$G_t = \frac{1.5(1 + 12.8f^2)}{1 + 1.6f^2} \text{ millimho} \quad (19)$$

This is shown plotted in Fig. 8 where sufficiently close agreement with the actual conductance characteristic is observed. On the other hand, substituting the values of  $G_{t0}$ ,  $z_0$  and  $p_0$  in Equation (10) one obtains that

$$B_t = \frac{13.3f}{1 + 1.6f^2} \text{ millimho} \quad (20)$$

which is plotted in Fig. 9 where a close approximation to the actual susceptance characteristic is noted too.

Next, it is required to determine the poles and zeros of the transfer function  $e^{j\omega}$  so as to realize the insertion loss characteristic of Fig. 7 and, at the same time, satisfy the conditions

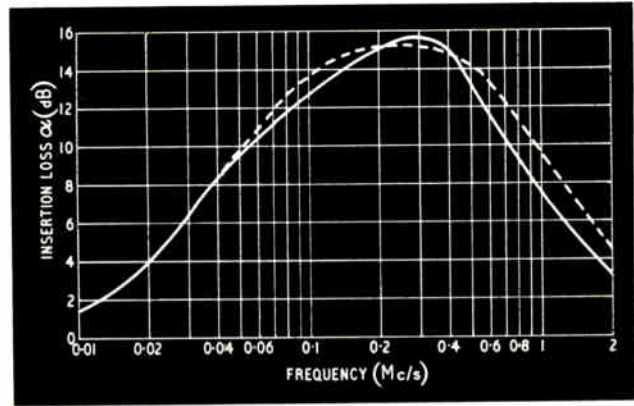

Fig. 7. The insertion loss of the 2-pole correcting network; continuous curve - actual characteristic; dotted curve - Equation (22)

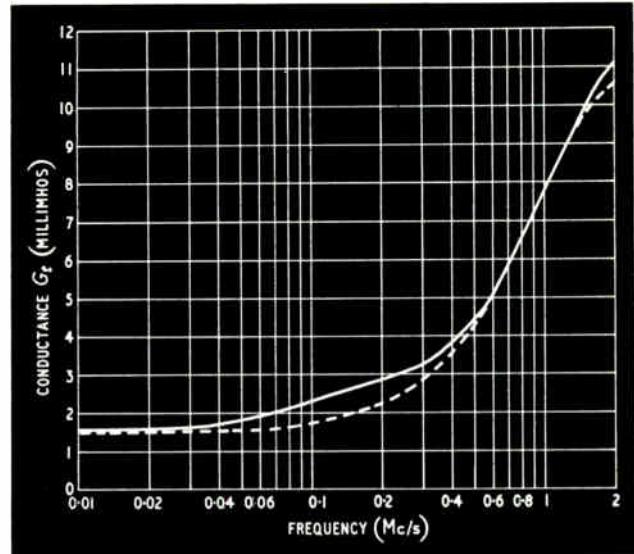

Fig. 8. The conductance  $G_t$  at the amplifier interstage point where the correcting network is to be introduced; continuous curve - actual characteristic; dotted curve - Equation (19)

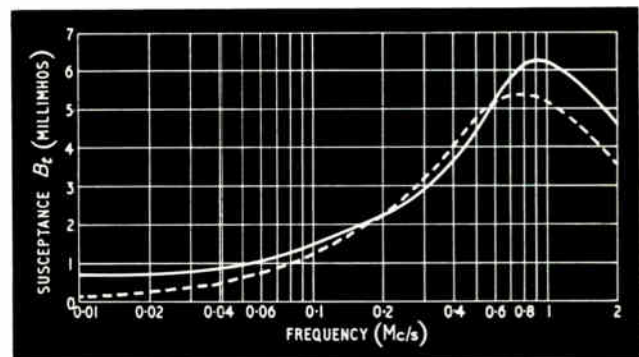

Fig. 9. The susceptance  $B_t$  at the amplifier interstage point where the correcting network is to be introduced; continuous curve = actual characteristic; dotted curve - Equation (20)

of Equations (5) and (12). By a process of trial and error it is found that the following poles and zero positions are acceptable.

$$\begin{aligned} z_1 &= 0.0941 \\ z_2 &= 20.8 \\ p_1 &= 0.622 \\ p_2 &= 3.14 \end{aligned} \quad (21)$$

where Equations (4), (5) and (12) are all satisfied. The resulting insertion loss  $\alpha$  is given by

$$\alpha = 10 \log_{10} \left[ \frac{(1 + 4450f^2)(1 + 0.092f^2)}{(1 + 4f^2)(1 + 102f^2)} \right] \text{ decibels} \quad (22)$$

which is plotted in Fig. 7 where again close agreement with the required insertion loss characteristic is observed.

It is to be pointed out that in the determination of rational functions for  $e^{\theta}$  and  $Y_i$  it may be found that the approximations can be improved by applying Linvill's method<sup>2</sup>.

Finally, using Equations (14) to (18) and Equation (21) and noting that the normalizing frequency is equal to 1 Mc/s,

it is found that the interstage correcting network of Fig. 6 has the following element values:

$$\begin{aligned} L &= 4.9 \mu\text{H} \\ C &= 13,100 \text{ pF} \\ R &= 39.6 \Omega \end{aligned}$$

On the other hand, using the method outlined in reference 1 it is found that the values obtained for the elements of the correcting network are quite close to the values given above. However, generally speaking the method developed in the present article leads to the desired results in a more direct manner.

### References

- <sup>1</sup> Hakim, S. S., 'Feedback Amplifier Stabilization', *Electronic Technology*, January 1962, p. 23.
- <sup>2</sup> Linvill, J. G., 'The Selection of network functions to approximate prescribed frequency characteristics', M.I.T. Technical Report 145, March 1950.

## NEW GLASS FOR ULTRASONIC DELAY LINES

Corning Electronic Components, Inc., in the United States, has recently developed an entirely new glass delay medium with a low temperature coefficient of time delay for the company's solid ultrasonic delay lines. Production of the glass is expected to begin shortly.

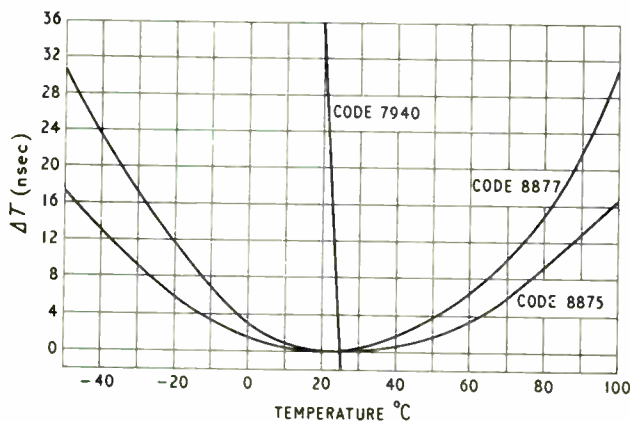

Delay time change with temperature for 100 μsec delay

The new glass, designated Code Glass 8877, provides storage capacity between 3,500 and 4,000 bits. Chief applications will be in delay lines used as buffers and memories in digital computers and processing equipment.

This is the second 'zero t/c' delay medium developed by the company. The previous product, Code 8875 glass, is more stable at operating temperature extremes, but has a smaller storage capacity—about 2,500 bits.

Bit capacity is the product of frequency and delay time. Lines using either of the 'zero t/c' glasses can be operated at frequencies from 1 Mc/s to over 50 Mc/s, with delay times ranging from approximately 500 μsec to about one μsec.

Temperature coefficient of time delay of both glasses is

$0 \pm 1.0$  p.p.m./°C at room temperature. This compares with  $-81.5 \pm 1.5$  p.p.m./°C for Code 7940 fused silica. Fused silica is useful for its lower attenuation coefficient and resultant higher storage capacities, even though it must be temperature controlled.

Variation of the temperature coefficient of time delay with temperature is  $+0.11$  p.p.m./°C<sup>2</sup> for the new glass,  $+0.06$  p.p.m./°C<sup>2</sup> for Code 8875 glass, and  $+0.07$  p.p.m./°C<sup>2</sup> for fused silica.

Digital delay lines, because they are small, light, stable and reliable, have applications in missile and satellite-guidance computers, in high-speed circuits requiring wide bandwidths and stability, in computer circuits requiring storage of high-speed video pulses, and in commercial devices where inexpensive but reliable lines are necessary in quantity.

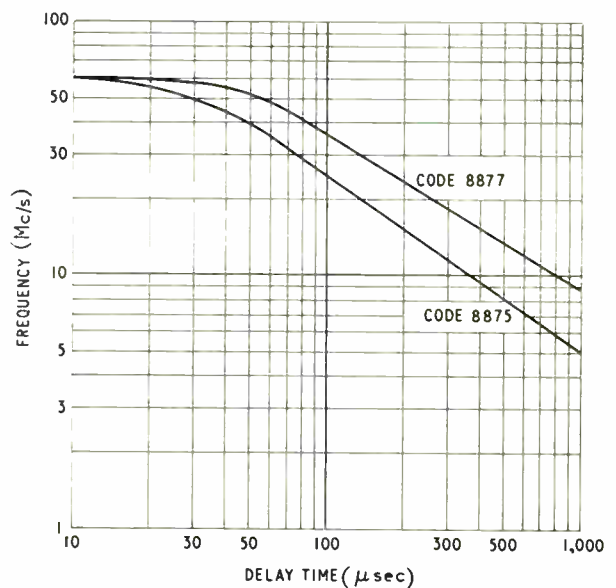

Maximum frequency versus delay time and type of glass

APPLICATIONS  
ILLUSTRATED

**Electronic Undercutters**  
**Automatic Drilling Machine**  
**Effluent Sampler**

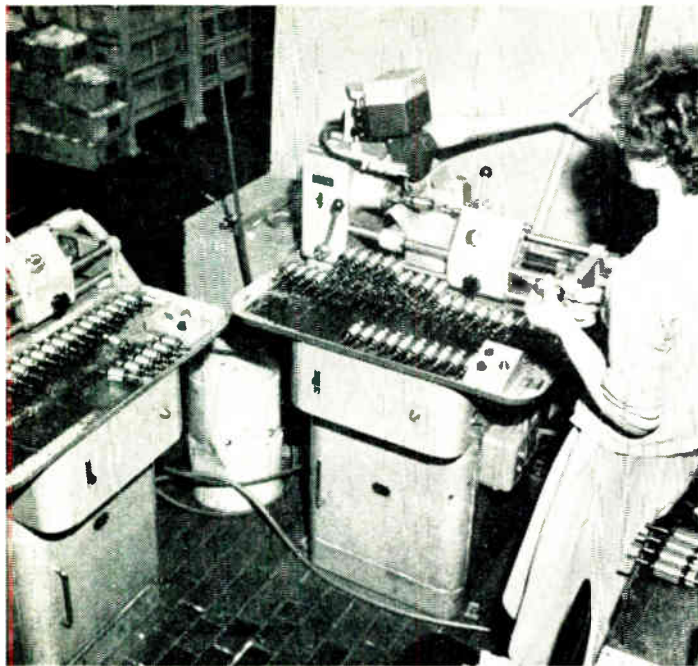

*This is a good example of the reliability of well-designed electronic equipment. The electronically-controlled undercutting machines shown here have been in use for 19 hours a day for 3 years at the Harmondsworth factory of Black and Decker Ltd. These machines are being used to undercut commutators for armatures used in electric drills. One operator can control two machines and process 116 commutators per hour*

**For further information circle 48 on Service Card**

*Illustrated here are two Richmond Tape-Controlled Drilling Machines being worked by a single operator at the Letchworth works of K. & L. Steelfounders and Engineers Ltd. These automatic machines are controlled by punched tape, have a drilling capacity of up to 2in. diameter in mild steel, and have a drilling area of 36in. square*

**For further information circle 49 on Service Card**



*Illustrated here is the Elcontrol portable automatic water sampler being used by the City of Oxford Sewage Disposal Department. Using a 15-day clockwork motor, a transistorized power pack, 12 bottles and 12 electromagnetic pinch valves this device can be used to take up to a total of 12 liquid samples, each at pre-set intervals of 1, 2 or 4 hours. The transistorized power pack produces a 50-V supply from a 6-V battery to operate the electromagnetic pinch valves. By using this technique it is possible to make the instrument sufficiently small to go down a standard manhole*

**For further information circle 50 on Service Card**

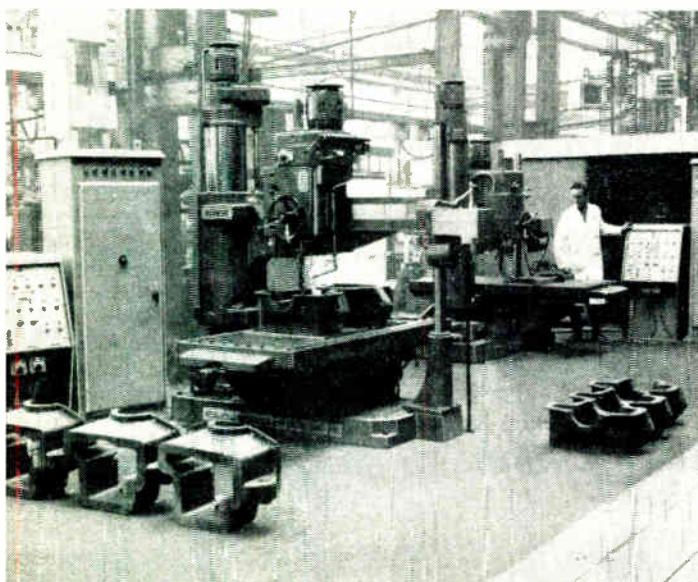

# THE GOONHILLY AERIAL CONTROL SYSTEM

By D. WRAY, B.Sc.(Eng.), A.M.I.E.E.\*

THE aerial adopted by the British Post Office for its satellite communications ground station at Goonhilly Downs, Cornwall, is a massive paraboloid, 85 ft in diameter unprotected by a radome. Since the main purpose of the Telstar experiment was to assess the performance of an active satellite in a wideband communications system, the Post Office took the view that the outcome of the experiment should not be obscured or endangered in its early stages by undue complexities in the ground station equipment, and to this end no attempt was made to track the satellite automatically by a 'lock-on' control system.

Instead, the aerial-tracking is wholly dependent on accurate predictions of the satellite's orbit, the movement of the aerial being controlled by data holes punched into a paper tape. This controlled tracking can be modified to a certain extent by a manual over-ride system should there be the need to trim the movement of the aerial to allow for any slight departure of the satellite from its predicted path.

In contrast, the horn aerial used at the Bell Telephone Laboratories' ground station at Andover, Maine, is less rigid in construction and is housed inside a radome. The American aerial can be controlled in a number of different ways. The normal mode of control requires no preparation of steering data at all, but necessitates three aeri-

\* Post Office Engineering Department.

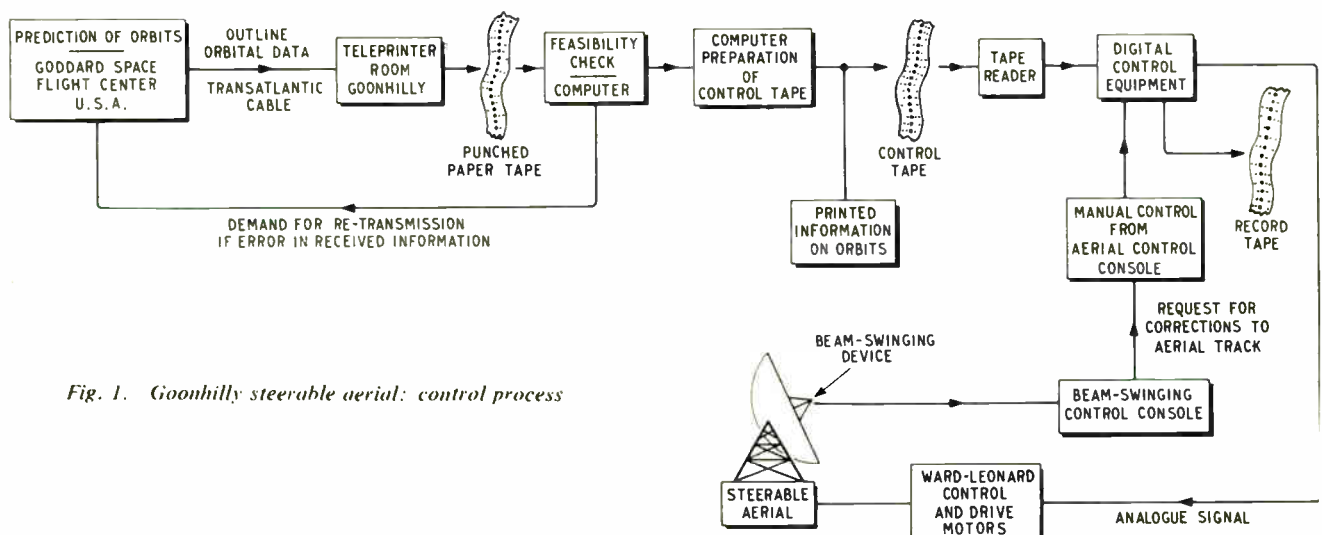
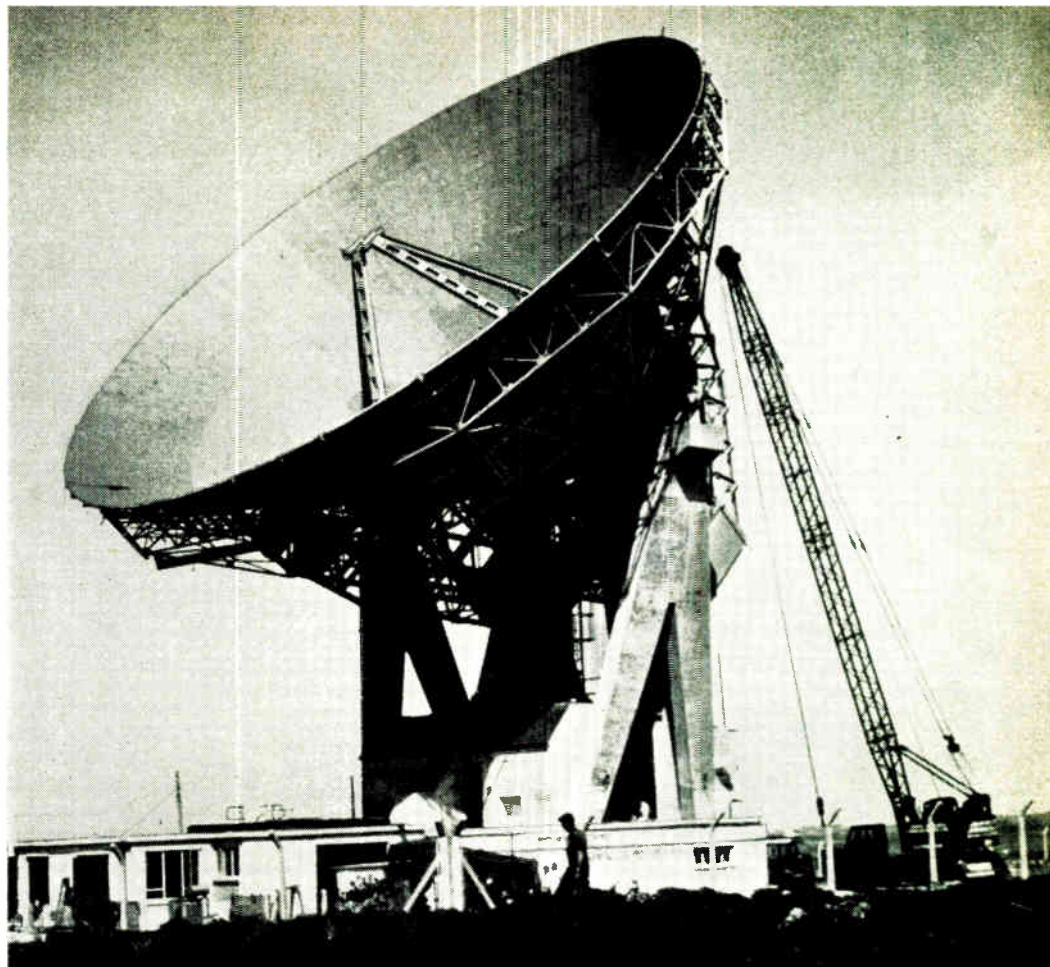

Fig. 1. Goonhilly steerable aerial: control process

When using a satellite for communications, the ground aeri- als have always to be pointed at the moving satellite. This article describes the way in which this is automatically effected at Goonhilly. As a control system it is most unusual in that it operates from predicted data on the satellite's position.



*The Goonhilly aerial during the course of its erection*

tracking the satellite with an increasing order of tracking accuracy. The first of these aeri- als has a wide beam- width, and has four helical elements connected to form a monopulse\* array so that the angle of arrival of the beacon signal from the satellite can be fairly accurately deter- mined. The movement of the second aerial (the 'precision tracker') is controlled by this information, and also has a monopulse facility to refine further the determination of the satellite position; the final horn aerial is slaved to the motion of the precision tracker, and has a sensitive centering system of its own.

The experience of the last few months of working with Telstar has shown that the path of the satellite can be predicted with great accuracy, and that the comparatively simple control system adopted at Goonhilly Downs has proved to be perfectly adequate.

#### **Aerial Steering Requirements**

Although the Telstar and Relay orbits lie to the south of Goonhilly, no restriction has been placed on the direc- tions in which the aerial can point, and it is, in fact, capable of full hemispherical coverage. This is obtained by adopting an elevation-over-azimuth type mounting with a possible azimuthal rotation of  $\pm 250^\circ$  relative to south and an elevation tilt of  $100^\circ$  from horizontal.

To follow satellites with orbital periods of as little as two hours and with perigees of a few hundred miles, the aerial must be able to move at angular velocities of up to two degrees per second in both azimuth and elevation, with an acceleration of  $1.33^\circ$  per second per second. At 4,000 Mc/s the beamwidth of the aerial is about 12 minutes

of arc at the 3-dB points; the permissible tracking error has been restricted to one-third of this, namely four minutes of arc. It is required that this tracking accuracy should be maintained in wind speeds with an hourly mean of 55 m.p.h. and a gust factor of 1.4. In fact, the aerial is mechanically suitable for working in winds averaging 65 m.p.h. and peaking up to 90 m.p.h., but maintaining the same standards of tracking accuracy under these conditions as for lower wind speeds would necessitate much more powerful drive motors, and these were not considered justified in a purely experimental system.

#### **Sequence of Operations**

In experiments on the passive communication satellite, Echo I, the predictions of the orbital path were computed in great detail by the Goddard Space Flight Center (G.S.F.C.)\* and transmitted over teleprinter circuits to the radio stations taking part in the exercise. This was found to occupy a great deal of time, so for the Telstar and Relay experiments the system has been modified so that outline steering data is extracted from the full orbital predictions, and it is this outline data that is sent to the participating ground stations; each ground station has its own small computer that can expand this information into the form most suitable for its own aerial control. The control process adopted is shown in simple diagrammatic form in Fig. 1.

The condensed data sent by the G.S.F.C. to Goonhilly consists of predictions of the satellite's position at one minute intervals, in Universal Time 2, throughout the period of 'mutual visibility'; i.e., the period during which the satellite is in radio contact with both the American and

\* In a monopulse array, the signals received by two or more elements of an aerial spaced a small distance apart, are compared in phase to give an accurate indication of the angle of arrival of the received radio signal. Four elements can give a three-dimensional location.

\* The computing centre of the U.S. National Aeronautics and Space Administra- tion in Greenbelt, Maryland.

Part of the aerial 'dish' showing the supporting structure

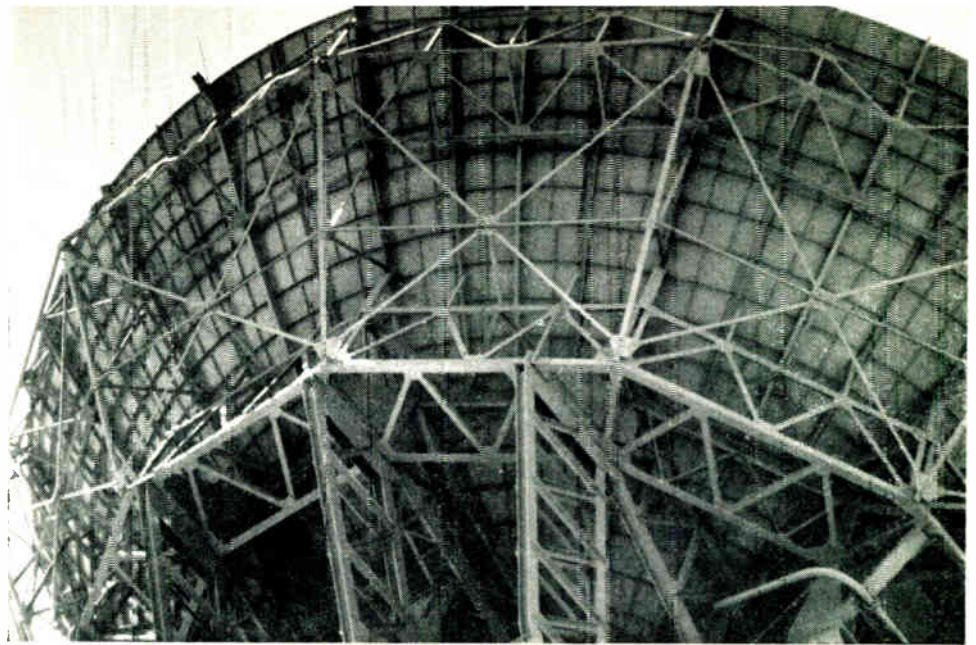

European ground stations. The positional data, as received, is expressed in Cartesian co-ordinates with respect to the centre of the Goonhilly aerial, and is subjected to a feasibility check before further computation. This feasibility check cannot, of course, correct any errors made in the original computation; it is intended primarily for detecting transmission errors. The positional data is in the form of three columns of figures giving the position of the satellite to the nearest hundredth of one kilometre in north, east and vertical co-ordinates, and a fourth column gives a check-sum of these figures. The check programme compares the positional data with the check-sum, looks for any transposition between digits and alphabetical characters, and gives an error indication if these checks fail.

It is then necessary to convert this data into a polar co-ordinate form that is more suitable for the aerial's azimuth and elevation movements and to interpolate steering information between the original one-minute intervals. The aerial drive system requires information every one-fiftieth of a second for smooth control, but to store all this mass of information for a pass that may be more than half-an-hour in duration would necessitate an inordinately long control tape. Interpolation is, therefore, carried out in two stages: a computer processes the information to produce a punched paper-tape carrying the azimuth and elevation bearings of the satellite for every second of the pass, and information about the incremental changes in bearings at one-fifth second intervals; and the digital aerial control equipment contains simple arithmetical facilities that make further linear interpolations at one-fiftieth second intervals. As a result, all the information for one pass can be punched on a 1,000-ft roll of paper tape, usually several days prior to the pass to which it applies. During these co-ordinate conversion and interpolation processes, the computer also makes allowance for the small changes of wave direction that will be caused by refraction

in the atmosphere, and prints out information that is needed by the operational staff, such as the azimuth and elevation at one-minute intervals, the slant range, and the Doppler shift of the 4,080-Mc/s beacon.

Shortly before the start time of a useful pass of the satellite, the appropriate control tape is inserted into a tape reader and the first group of information is read into a store in the control equipment. This information contains, among other things, the time at which the satellite will appear over the horizon, and its azimuth and elevation bearings at this time. This time and bearing data appears on digital displays on the aerial control desk, which is contained in a small control tower that looks out over the site. The aerial is steered under manual control until it has taken up these starting bearings and then switched to automatic control. As soon as there is coincidence between the start time on the control tape and the actual time derived from the station master time equipment, the tape is read in real time and the aerial moves off under its control. During the pass, the aerial control equipment produces another punched tape which records both the required and the actual tracking performance of the aerial. This tape can later be used to produce a complete or selective print out showing how the aerial behaved during the orbit; this is particularly useful when it is necessary to study some interesting or unusual features of the tracking.

The Goonhilly aerial has facilities for making small movements of the axis of the beam relative to the mechanical axis of the parabolic reflector—a technique known as 'beam-swinging'. Just before the aerial moves off under automatic control, a spiral movement is mechanically imparted to the aerial feed, so that although the aerial itself is stationary on its first bearing, it is scanning that region for the satellite's 4,080-Mc/s beacon signal. As soon as the beacon signal is received any discrepancy between the actual bearing of the satellite and the bearing to which the aerial

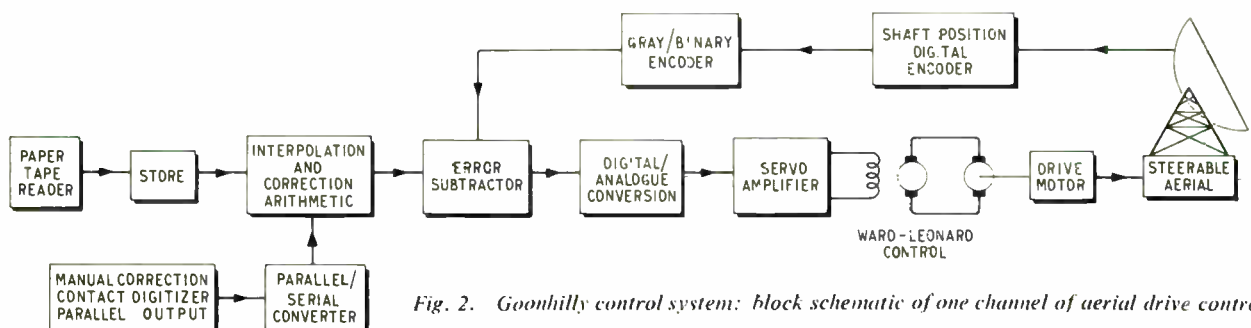
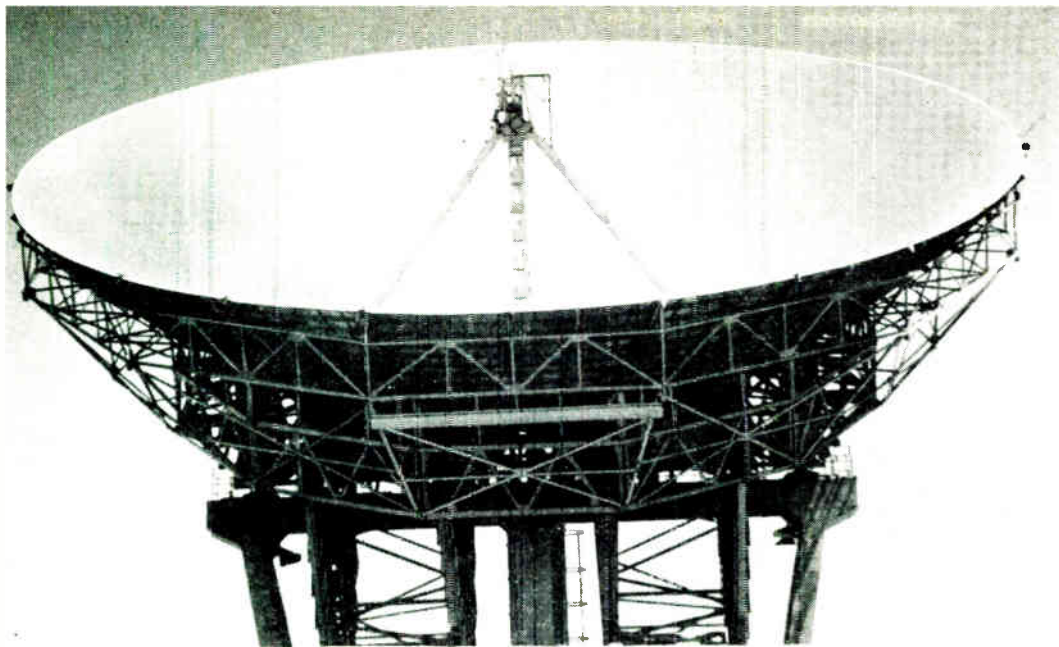

Fig. 2. Goonhilly control system: block schematic of one channel of aerial drive control



*In this view of the dish the aerial elements can be seen on their tripod mounting*

has been set is measured on an oscilloscope and signalled to the operator at the aerial control position. He can make a manual adjustment that sends digital signals to the aerial control equipment so that all subsequent instructions from the control tape are modified by this amount; the spiral scanning motion of the aerial feed is then switched off. To cater for any further small drift that may occur during the pass, the feed unit is given a small conical scan from which further corrections can be signalled to the aerial driver if any subsequent manual adjustments to the control tape instructions are necessary.

#### **Digital Control and Servo Systems**

Automatic control of the Goonhilly aerial necessarily involves a mixture of digital and analogue techniques, for

while the control information from the paper tape and the positional data from shaft encoders on the aerial are in digital form, the speed control over the drive motors is accomplished by a Ward-Leonard system that requires an analogue voltage input. Several stages of code conversion are, therefore, necessary. The system consists of two almost identical channels, one for the azimuth and the other for the elevation motions. A block diagram of one channel only is given in Fig. 2.

Both azimuth and elevation drives come from 100 h.p. Ward-Leonard motor generator sets with a speed range of 720:1. Speed control is determined by the output voltage of transistorized servo amplifiers feeding the fields of the generators. The feedback information for the drive servos is obtained from two optical shaft encoders, one attached

*This photograph shows a close-up of the aerial elements with the control gear for the spiral and conical scans*



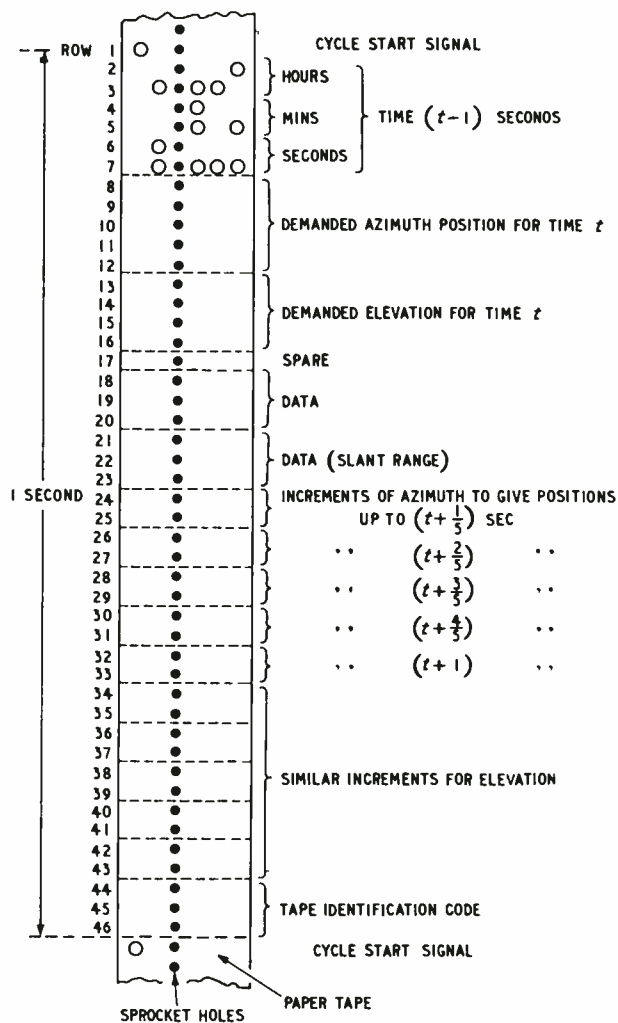

Fig. 3. Control tape

to the central vertical shaft of the aerial for azimuthal movement control, and the other on one of the elevation bearings for elevation control.

The encoders are glass discs, 22 in. in diameter, on which a 16-bit Gray reflected binary code has been photographically reproduced; shaft angles of one-third of a minute of arc can, therefore, be resolved. The azimuth encoder, however, is required to give readings over a  $\pm 250^\circ$  arc; this is achieved by introducing a mechanical switch which is tripped when a  $360^\circ$  clockwise rotation has been completed, thus effectively adding a 17th bit to the code and extending the useful reading angle beyond a single revolution.

Mention was made earlier of the production of a control tape carrying a group of information at one-second intervals. Part of such a tape for a one-second cycle is shown in Fig. 3. It can be seen that 46 characters of a five-hole tape are allocated to each second in time; the first information to be read is in fact the time to which the data refers, or rather the time displaced by one second relative to this data, since the tape is read one second at a time, one second in advance. Following the time code there are the demanded azimuth and elevation bearings, and then several characters allocated to such data as the slant range to the satellite; next comes incremental information for the changes in azimuth and elevation applicable

to the five subsequent one-fifth second intervals, and then a tape identification code. These 46 characters are read at the rate of 1,000 characters per second into a buffer store, and thence pass into a small arithmetic unit known as the interpolator. The demanded angle information is read from the store into an accumulator in the interpolator unit and the first increment is added to this regularly at 20-msec intervals until 200 msec have elapsed when the second incremental value from the tape is repeatedly added for another fifth of a second, and so on with the other increments until the one-second cycle is completed, when the accumulator is cleared and filled with the next bearing demand for the next cycle. The logic operates at a basic clock frequency of 2,000 c/s derived from the 100-kc/s quartz crystal oscillator which is used as the heart of the station master time system.

When driving the aerial under manual control, the tape reader is inoperative, and contact digitizers on the control desk feed digital signals directly into the interpolator. Manual adjustment to automatic control—introduced when the beam-swinging process indicates that the path of the aerial must be adjusted—is achieved by adding similar signals from manually-turned digitizers on to the demanded angle signal in the accumulator.

Following the interpolator is another arithmetical unit, the error subtractor. This compares the continuously changing demands as they appear in the interpolator with the digital indication of the aerial's position. Any difference between the two gives rise to a digital error signal that passes into a digital-to-analogue convertor, from which an analogue error voltage emerges for direct application to the servo amplifiers and the Ward-Leonard generator feed. Since the shaft encoders are marked out in Gray code and the logic operations are conducted in pure binary, a code conversion unit must be inserted between the encoder output and the error subtractor. Further complex code conversions are needed to produce visual displays of the aerial's position in terms of degrees and minutes of arc from the binary form in which it appears on the tape.

Experience in using the aerial and its control system has been confined to the few months since the satellite Telstar was launched on 10th July 1962, and this period has not included any exceptionally bad weather conditions. Over these months, the tracking errors have normally been one minute of arc or less for wind speeds up to 30 m.p.h.; the tracking error has exceeded this figure under heavier wind loading, but usually for only a few seconds at a time. However, a full assessment on the tracking performance of the aerial can only be made when it has been subjected to all that the Goonhilly climate can offer, and the mass of data available on the record tapes has been fully analysed.

Although it is envisaged that the aerial control system will continue to use a control tape covering orbital prediction data, the small correction made to the tracking as a result of beam-swinging indications may be automated in the future to eliminate human intervention in this operation.

#### Acknowledgments

The aerial was designed by Husband & Co., who acted as consulting engineers to the Post Office Engineering Department for this project; the design of the servo and digital control system was in the hands of the Brush Electrical Engineering, A. V. Roe, and Whitworth Gloster Aircraft companies, to the specification of the consulting engineers. The Research Branch of the Post Office Engineering Department were responsible for devising the computer programmes and the control tape format.

The permission of the Engineer-in-Chief of the Post Office to make use of information contained in this article is gratefully acknowledged.



**T**HE history of satellite communication as we know it today can be said to date from October 1945 when A. C. Clarke's original proposals for such links were published in *Wireless World*. The whole matter then remained dormant until 1957 when Sputnik I demonstrated, among many other things, the practicability of one-way communication in the 'down' direction. This was followed in 1959 by the Echo balloon which, as its name implied, could be used as a passive satellite repeater. Moon-bounce experiments had, of course, been carried out some years before Echo had appeared, but these had used radar techniques. Ever-increasing activity in this field culminated in Telstar and its spectacular tests in the middle of 1962.

In November, an international conference on Satellite Communication, held in London under the auspices of the I.E.E., gave a unique opportunity for assessment of the position that has now been reached. It was apparent that in general the planning of communication services had not gone much beyond preliminary studies and the accumulation of data required for prediction of future traffic build-up. In this context two main questions arise—what degree of technical progress has been achieved, and when can an economic public service be expected from satellite links? Clearly economics become more and more predominant as time goes on, and huge capital expenditures will ultimately be involved. Administrations must therefore first determine, as far as possible beyond doubt, the best technical approach before committing themselves to it. The inter-dependence of these two aspects—the technical and what perhaps can best be called the commercial—was also brought out strongly during the conference, and gave additional confirmation of the need to establish sound technical premises before proceeding further.

The process of appraisal is in itself extremely costly. For instance the ground stations installed in Britain and America for satellite working are engineering projects of considerable magnitude and complexity. (They may eventually become part of permanent links for service use, but at present they are operating purely as experimental stations.) A typical example to illustrate these points is the steering control system for the 85-ft diameter aerial at the Post Office station at Goonhilly Downs in the Lizard Peninsula. This system is described in another article in this issue.

The American aerial at Andover is of quite different construction and is shown diagrammatically in Fig. 1. The Goonhilly aerial is of especially robust construction, with no radome, and follows what may be called the Jodrell Bank tradition with a large reflecting dish held in a bridge-like supporting framework. However, one of the most striking facts which emerged at the conference was that, despite these extreme physical differences, the fundamental method of control of these two aerials can be identical. Thus they can both compare demanded and actual position, derived from control tape and shaft encoders respectively, to produce error signal control which is applied finally in analogue form to azimuth and elevation drives. Alternative methods of steering control are possible, and at Andover 'auto-following' by monopulse technique can also be used. Nevertheless it would seem that the predicted position method will continue to be used for 'putting-on' in order to avoid loss of valuable time in preliminary search before acquisition of the satellite 'target'.

The ground communication aerial occupies a key position in being common to both transmission and to reception. The latter is the more difficult in that the power transmitted by the satellite is severely limited, and is radiated from an omnidirectional aerial system. Thus aerial gain and steering accuracy are made as high as possible on the

# Satellite

# Communications

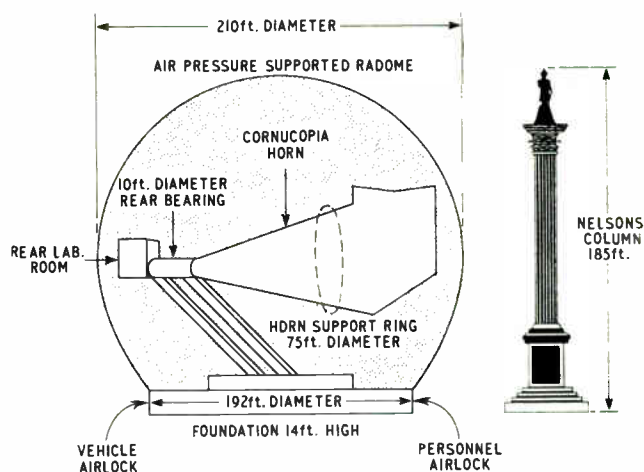

Fig. 1. Main dimensions of radome enclosed aerial—Andover

This article summarizes some of the aspects of satellite communications which were discussed at an I.E.E. Conference. Present satellite uses are shown to be chiefly to obtain data both for communication link design and, by telemetry, for improvement of reliability.

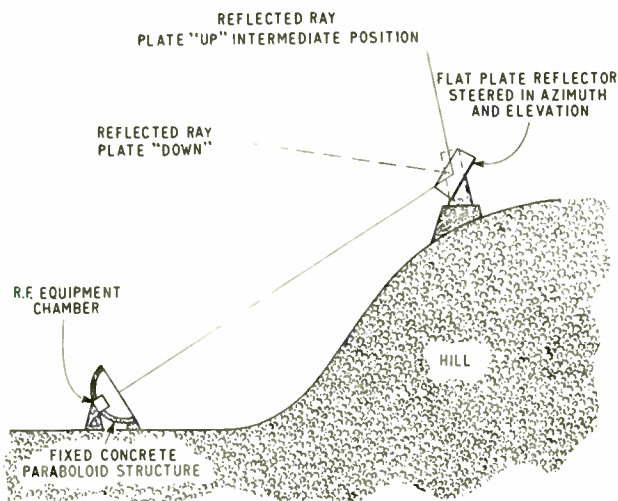

Fig. 2. Greatly simplified aerial proposals

ground in order that the extremely small received signal may be brought to a maximum relative to system noise. The chief contribution to this, from the point of view of overall signal-noise ratio, comes from the input stage of the receiver; and the well-known requirement for minimum noise in the first stage applies with particular force in this case.

These considerations have, in fact, resulted in an identical approach being adopted on both sides of the Atlantic. At both Andover and Goonhilly the receiver input amplifier is a liquid-helium cooled travelling-wave maser with a bandwidth of the order of 25 Mc/s.

It must be accepted that there is no real alternative to these large and expensive stations for carrying out the tasks

on which they are engaged. Nevertheless, in view of the almost prohibitive cost of most development work, it was reassuring to find that two U.K. establishments, R.A.E. and S.R.D.E., were working on 'poor-man's' equipment for use with satellite links. Of particular interest was an R.A.E. proposal for a much simplified aerial arrangement which is illustrated in Fig. 2. The chief feature of this is the transference of the steering function to a secondary reflector plate, which appeared to offer a number of advantages. As the result of the main aerial being fixed it could be made as large as desired at almost negligible increase in cost. The main limitations would be that the coverage is only about two-thirds of the sky, and also the difficulty of finding a site exactly suited to requirements.

As far as the satellite side is concerned the situation is extremely fluid, particularly with regard to choice of orbit. A number of other major decisions have also to be taken, e.g., with regard to point-to-point and multiple-access systems. In the latter a number of two-way channels pass through the one satellite repeater, so that its design becomes quite different from that of a point-to-point repeater of the Telstar or Relay type.

The telemetry equipment carried by Telstar has proved its worth, especially in providing data on which improved reliability can be based. This applies particularly to radiation damage in space which has already been shown to be significant, and which appears to be due to high energy electrons and protons.

It became apparent during the conference that the moon is being used as a passive repeater for much of the long-term research at present being carried out. It provides, gratis, a reflector in an orbit which is entirely predictable and entirely reliable, but the long delay associated with its radio path prevents its use for all but slow-speed traffic. A link using the moon is in operation between Honolulu and Washington.

## MEASUREMENT OF OCEAN TEMPERATURES

A device for determining temperature variations at different depths of water has been developed and produced by EMI-Cossor Electronics Ltd., of Canada. The bathythermograph slug, as the device is known, was originally designed for helping to locate submarines, but it is also of considerable value in gathering oceanographic data.

The conventional method of employing ships to obtain temperature readings is both slow and expensive. By dropping bathythermograph slugs from aircraft, temperature readings over large areas of ocean can quickly be taken.

The bathythermograph package is dropped from the aircraft and, upon hitting the water, the resultant impact releases the slug which, after a delay of one minute, sinks through the water at five feet per second. A temperature-sensitive device within the slug detects changes in sea-water temperature and transmits an acoustic signal.

A standard sonobuoy, which may have been dropped for the purpose or is already floating on the water, detects the signal which modulates the sonobuoy transmitter. After demodulation by the aircraft's receiver, the signal is applied to a translator unit. The output from this unit drives a pen recorder which provides a graph of temperature versus depth.

Power for the electronic circuit is provided by a sea-water-activated battery which remains inert until it makes contact with the water.

For further information circle 51 on Service Card

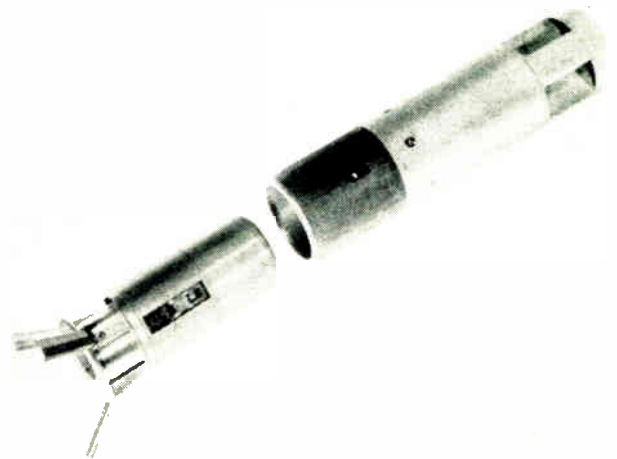

EMI-Cossor Electronics bathythermograph slug

# DUALITY AND TUNNEL DIODES

After a discussion of duality with reference to the tunnel diode, which is a current-operated negative-resistance device, this article shows how tunnel-diode circuits can be derived from gas-tube circuits.

By P. J. LANGLOIS, M.Sc.\*

**N**EGATIVE-RESISTANCE devices are usually divided into two groups; those with 'N'-shaped and those with 'S'-shaped voltage-current characteristics. These are illustrated in Figs. 1 and 2. If the axes of Fig. 2 are interchanged, thus interchanging the effects of voltage and current upon the shape of the curve, the resultant curve takes the 'N' shape of Fig. 1. In this article the 'N' shaped characteristic will be used for both groups, so that the breakdown effect will always be recorded on the ordinate of the graph.

We are concerned with the comparison of certain circuits, which may include negative-resistance devices, where the function of current and voltage are interchanged. Such circuits will be referred to as duals, although strictly speaking duality has a broader mathematical meaning. The current-operated and voltage-operated negative-resistance devices are, in fact, duals.

Here duality of electric circuits and components is examined with particular reference to the tunnel diode, which is a current-operated negative-resistance device. Just as some difficulty has been experienced in thinking in the correct parameters when transistors were first developed, so has there been a similar tendency in tunnel-diode circuitry. In the case of the transistor, there were some attempts to invoke the aid of the duality principle, but in general, there were complications because the transistor is not really the dual of a valve.

In the case of the tunnel diode (current-operated), there are dual (voltage-operated) devices such as the gas tube, and the p-n-p-n diode. By using the principle of duality, much information concerning tunnel-diode circuits can be extracted from circuits designed for voltage-operated devices.

The early part of this article shows how the duals of circuits can be derived, including circuits which are non-planar; i.e., have crossover wires. This method is used to obtain diode circuits from known gas-tube circuits. Finally, the tunnel-diode circuits obtained are analysed. These include two types of multivibrator, a simple ring counter, and a binary counter.

## Principle of Duality

First, consider a planar network, that is a network constructed in one plane with no crossover wires. Such a

network can be represented by two sets of equations based on Kirchhoff's two laws:

- (1) The sum of voltages round a closed loop is zero and
- (2) The sum of currents directed towards a common point is zero.

The simplest loop is one inside which there are no branches. If this type of loop or mesh is used to form equations from Kirchhoff's first law, the coefficient of each variable can have an easily identifiable meaning. Any network can be reduced to a number of these meshes, and a set of equations can be derived:

$$\begin{aligned} Z_{11}I_1 + Z_{12}I_2 + Z_{13}I_3 + \dots + Z_{1n}I_n &= V_1 \\ Z_{21}I_1 + Z_{22}I_2 + Z_{23}I_3 + \dots + Z_{2n}I_n &= V_2 \\ Z_{n1}I_1 + Z_{n2}I_2 + \dots + Z_{nn}I_n &= V_n \end{aligned} \quad (1)$$

An impedance on the diagonal of the matrix (i.e.,  $Z_{pp}$ ) is the total impedance of the isolated mesh P, and an impedance elsewhere (i.e.,  $Z_{xy}$ ) is the impedance common to mesh X and mesh Y, and  $V_x$  is the total voltage from the generators in loop X.

The matrix form of this set of equations is:

$$[Z]_{nn} \cdot [I]_{1n} = [V]_{1n} \quad (2)$$

Similarly, using the second Kirchhoff law,

$$\begin{aligned} Y_{11}V_1 + Y_{12}V_2 + \dots + Y_{1n}V_n &= I_1 \\ Y_{21}V_1 + Y_{22}V_2 + \dots + Y_{2n}V_n &= I_2 \\ Y_{n1}V_1 + Y_{n2}V_2 + \dots + Y_{nn}V_n &= I_n \end{aligned} \quad (3)$$

$Y_{pp}$  is the total admittance between node P and a reference

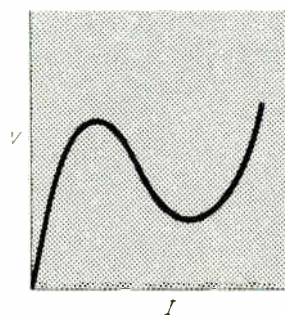

Fig. 1. 'N' characteristics

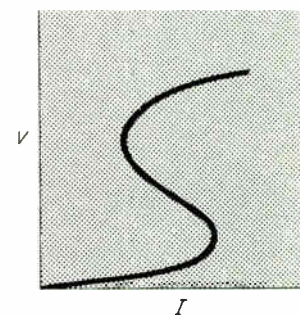

Fig. 2. 'S' characteristics

\* Standard Telephones & Cables Ltd.

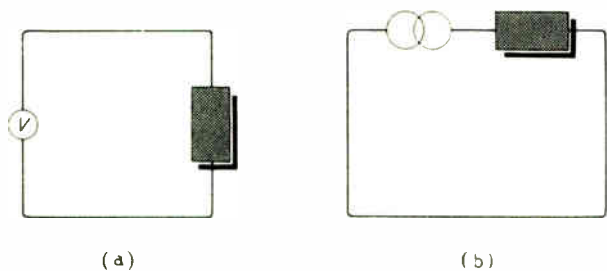

Fig. 3. Simple mesh circuit (a) and simple node circuit (b)

point, where all components not connected to node P are short-circuited to the reference point.  $Y_{ab}$  is the admittance between nodes a and b.

The matrix form is:

$$[Y]_{nn} [V]_{1n} = [V]_{1n} \quad (4)$$

It can be seen from equations (1) and (3) that it is possible to have two networks giving the same numerical matrix in  $[Z]$  or  $[Y]$ . In other words, each network is represented by the same mathematical function, but with the dependent and independent variables interchanged. Such networks are called *duals*.

Identical numerical matrices imply the following pattern similarities:

- (i) The number of branches forming a mesh is the same as the number of branches emanating from a node.
- (ii) The number of nodes is the same as the number of meshes.
- (iii) The disposition of the meshes is the same as that of the nodes.
- (iv) Each component in one network is replaced by its dual component (see below) in the other network.

These properties lead to a simple way of designing the dual of any network.

The five main components used in an electrical network are Resistance, Inductance, Capacitance, Current generator and Voltage generator. From equations (2) and (4), the dual of a simple mesh circuit is a node circuit (Fig. 3). These have equations:

$$Z \cdot I = V \quad (5)$$

or

$$Y \cdot V = I \quad (6)$$

By putting the appropriate components in these equations and comparing them, the following duals result:

- Resistance is the dual of Conductance.
- Capacitance is the dual of Inductance.
- Current generator is the dual of Voltage generator.

The converse is also true.

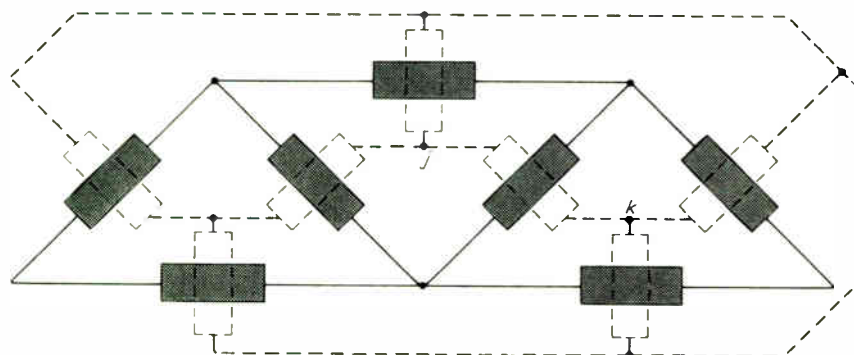

Fig. 4. Obtaining the dual of a circuit. Full lines: original circuit. Broken lines: dual circuit (with dual components)

With these components in mind, the dual of a given network can be found. First, the disposition of the meshes is ascertained. In the dual of each mesh there is a node in the same relative position. It is therefore convenient on paper to draw the nodal point at the centre of each mesh, see Fig. 4. For each component common to meshes such as  $j$  and  $k$ , there is a dual component joining nodes  $j$  and  $k$ . In this way all nodes are joined by the appropriate component duals. It must be remembered that there is also a node corresponding to a mesh current constituting the perimeter of the network.

All discussion so far has assumed a planar network. This limitation can now be explained. In the dual process, each mesh current has been changed to a nodal voltage. In a non-planar network, more than two mesh currents flow through one component. This means that the dual will be connected to more than two nodes, which is impossible.

However, by inserting ideal transformers, a non-planar circuit can be changed to a planar circuit. Several networks have been discussed by Bloch ('The Construction of Planar Networks Dual to Non-Planar Networks', *Proc. Phys. Soc.*, November 1946). One of these methods will now be described, and will be used later to derive a tunnel-diode ring counter.

Kirchhoff's laws for electric circuits apply equally well to magnetic circuits using an ideal magnetic material ( $\mu_r = \infty$ ). In magnetic terms they are:

- (1) The sum of magnetomotive forces round a magnetic path is zero.
- (2) The sum of magnetic flux (or flux change) at a node is zero.

These laws lead to the magnetic circuits of Figs. 5 and 6 respectively, which are mesh and node transformers. Again they are duals, represented by equations of the form:

$$F_1 + F_2 + F_3 \dots = 0$$

i.e.,

$$i_1 + i_2 + i_3 \dots = 0 \text{ assuming } N_1 = N_2 = N_3 \text{ etc. } (7)$$

and

$$d\phi_1 + d\phi_2 + d\phi_3 \dots = 0$$

i.e.,

$$V_1 + V_2 + V_3 \dots = 0 \text{ assuming } N_1 = N_2 = N_3 \text{ etc. } (8)$$

Thus if an electric circuit is coupled to a magnetic circuit, the dual of the electric circuit will be coupled to the dual of the magnetic circuit. It should be remembered that an ideal transformer has no inductive properties. The dual of a real transformer using magnetic circuits need not be another magnetic transformer, but can be a transformer using electrostatic circuits which would then maintain the inductance : capacitance dual.

Consider a crossover wire in a non-planar electric circuit as in Fig. 7. Now, if a suitably polarized 1:1 mesh transformer is inserted in the wire 'cd', it appears as a short-circuit. Since the transformer dictates that whatever current

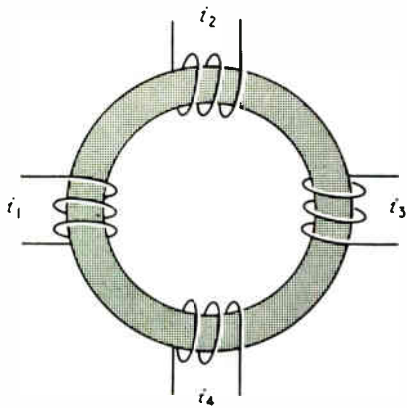

Fig. 5. Mesh transformer

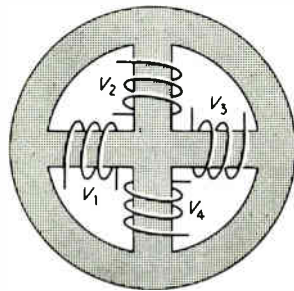

Fig. 6. Node transformer

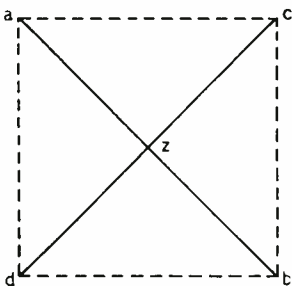
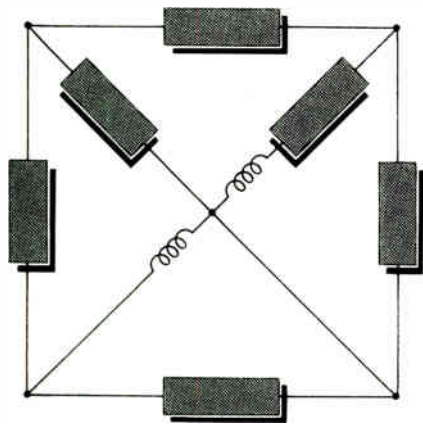
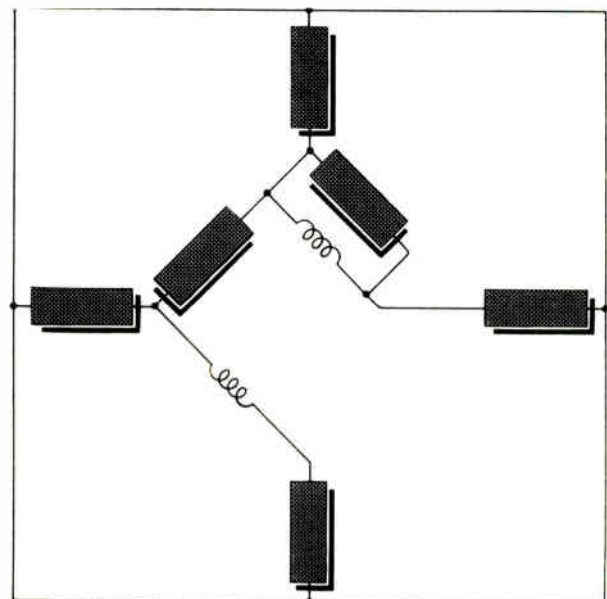

Fig. 7. A crossover wire



Above: Fig. 8. Network with crossover wire and transformer



Right: Fig. 9. Network dual of Fig. 8

enters point 'c' must leave at point 'd', there still appears to be a short-circuit between 'c' and 'd'. The centre point 'z' can be at any potential desired, and further, no current will flow in or out through the point at 'z'. The point 'z' can, therefore, be connected to 'ab' without altering any external circuit conditions. The non-planar circuit, due to the crossover at 'z', has now been changed to a planar circuit with a coupled mesh transformer.

Fig. 8 shows a crossover in a simple network with a mesh transformer. The dual of this is shown in Fig. 9 where the ideal mesh transformer has been changed to an ideal node transformer.

In many circuits, it is impossible in practice to approach the performance of an ideal transformer. However, in some cases, there is a capacitor in the crossover wire, as shown in Fig. 10. The dual circuit is shown in Fig. 11. It can be seen that this is a first-order equivalent circuit of a practical transformer.

From equations (5) and (6), the dual of a non-linear element has the same non-linear characteristic, but with variables interchanged. So far equations (1) and (3) have been used: these have been derived using Kirchhoff's laws and the principle of superposition. The latter assumes a linear relationship between  $V$  and  $I$  in every component. Networks with non-linear elements can be analysed by linear approximation methods. The procedure for deriving the dual of a network containing non-linear elements is therefore the same as for one with linear elements.

### Tunnel Diodes and Voltage-Operated Negative-Resistance Devices

Tunnel diodes have similarly shaped characteristics as voltage-operated negative-resistance devices such as the gas-gap tube and p-n-p-n switch. However, the relative parameters of interest are different. A normalized set of d.c. characteristics is shown in Fig. 12. The curves have been normalized around (a) the peak at breakdown, and (b) the maximum useful operating current or voltage, whichever is appropriate, in the breakdown condition. The idealized switch operates along the X and Y axis. By comparison, the p-n-p-n switch has almost ideal d.c. characteristics. Both the tunnel diode and the gas tube have disadvantages as shown in P, Q and R in Fig. 12. However, the speed of

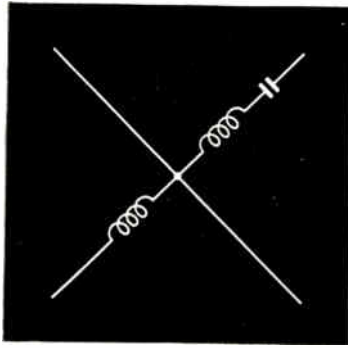

Fig. 10. Crossover wire, ideal transformer and (decoupling) capacitor

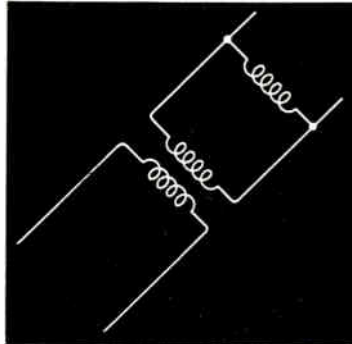

Fig. 11. Dual of Fig. 10

switching and power consumption make the tunnel diode a good component for high-speed digital circuitry.

When finding duals of networks containing gas tubes or p-n-p-n switches, for use with tunnel diodes, it must be remembered that the original circuit was designed specific-

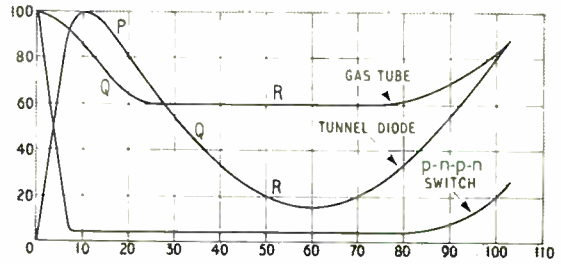

Fig. 12. Normalized d.c. characteristics of some negative-resistance devices

ally for the given component, and therefore took advantage of the merits of its particular characteristic. This may mean difficult practical requirements in the dual circuit.

For example, in circuits containing gas tubes, there are often diodes. Usually, the diode is expected to have reverse and forward impedances of an order of magnitude better than the impedance of the circuit in which it operates, and the knee of the diode should be a second-order effect. This applies equally well to ordinary diodes in tunnel-diode circuits. In practice, owing to the very low voltages used, the knee of the best diode available is a first-order non-linear effect, and the forward impedance characteristic is of the same order of magnitude as the impedance of the circuit in which it operates. For example, the forward resistance of the best diode available for these purposes, the backward diode, has an equivalent resistance of 40 ohms or more under normal working conditions, while the resistance of a tunnel diode before breakdown is only 10 ohms.

(To be continued)

## ELECTRONIC CONVEYOR BELT WEIGHING SYSTEM

Solus-Schall have developed and produced an electronic weighing system for use in conjunction with conveyor belts. Known as 'Transweigh' it is the first system of its type to receive the Board of Trade Certificate of Approval. Transweigh has been ordered for the Sierra Leone Development Co. for one of their iron-ore loading jetties. It is to be incorporated in two conveyor belts, each with a capacity of 3,000 tons/hour.

The system will perform five distinct functions. It will:

1. Indicate the instantaneous rate of flow of ore on each conveyor.
2. Totalize the flow continuously.
3. Record variations in the flow.
4. Print the weight of each load delivered.
5. Enable the batch weight for each hold to be pre-set so that the flow will stop automatically when necessary.

The Transweigh system consists of a weigh carriage, fitted with a resistance type load cell, which slides into position between the conveyor belt rollers, a chart recorder and a tachometer which measures the belt speed. The load cell senses the weight of the ore as it passes overhead and provides a proportional output signal which is fed to the recorder.

For further information circle 52 on Service Card

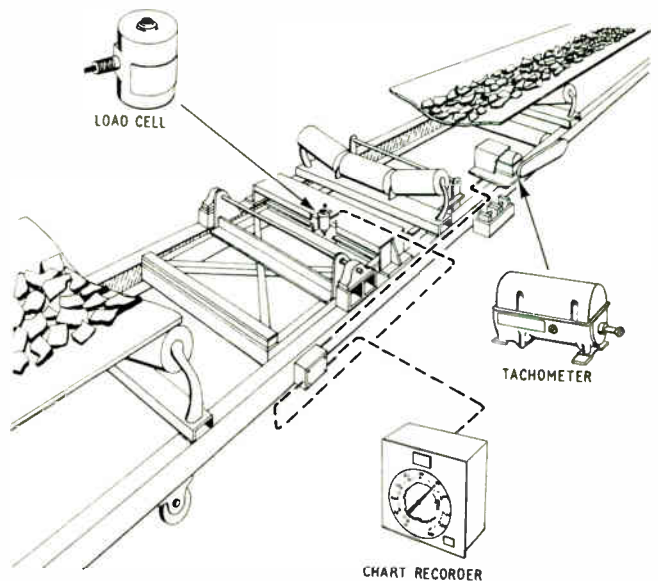

A schematic diagram showing the layout of the Transweigh system as applied to a conveyor belt

A review of some of the interesting items shown at this year's Annual Exhibition of The Institute of Physics and The Physical Society, which was held in London from 14th to 17th January in the Old and New Halls of The Royal Horticultural Society.

# THE 1963

## I.P.P.S. EXHIBITION

FOR this, the 47th Exhibition in the series, the Council of The Institute of Physics and The Physical Society modified the system for the selection of the exhibits—'to preserve and enhance the unique nature of these annual Exhibitions as scientific occasions rather than as opportunities for displays of ordinary commercial products'. As a result of this stricter selection procedure, it proved possible in the limited space to increase the number of manufacturing firms taking part from 91 to 118. The total number of exhibitors was 145 compared with 137 in 1962.

Most of the items shown were prototype in nature and the majority were electronic devices, some of which are described here. Although it is intended that this exhibition should primarily cater for physicists it also caters for almost every facet of engineering, since the majority of developments of the physicist are ultimately connected with practical engineering matters.

### Measurement of Physical Parameters

The problems of the measurement of physical parameters are common to scientist and engineer alike and at the exhibition many devices were shown which have been developed for the measurement of specific physical parameters. One such device is the Baldwin Industrial 'Atomat' Thread Denier Gauge. This is a production-line instrument for the continuous measurement of the diameter or gauge of filaments or threads of material. In this it is arranged that the thread to be measured is fed through a narrow slit of a predetermined unit length in a measuring head. Located above the slit is a Krypton 85 radioactive source and beneath it a detector. With no thread passing through the slit the output current of the detector ionization chamber is at maximum. With thread passing through, the detector output current is reduced because of the energy absorption of the thread. For a given thread material absorption of energy is directly proportional to the mass of material in the slit. Therefore the change in output current from the detector, for a given unit length of thread, is proportional to the diameter of the thread. The detector output current is recorded on a meter and a paper chart. With this instrument diameter measurement accuracies to the order of 0.5% are attained in the range 50 to 300 micrograms per centimetre (47 to 270 denier). Baldwin were also showing an instrument, based on similar principles, for the continuous measurement of fluid density.

For measurements of a different kind—the thickness of materials—a number of devices were shown, most of which are based on the use of ultrasonic energy. Typical of these is an interesting ultrasonic thickness gauge, called

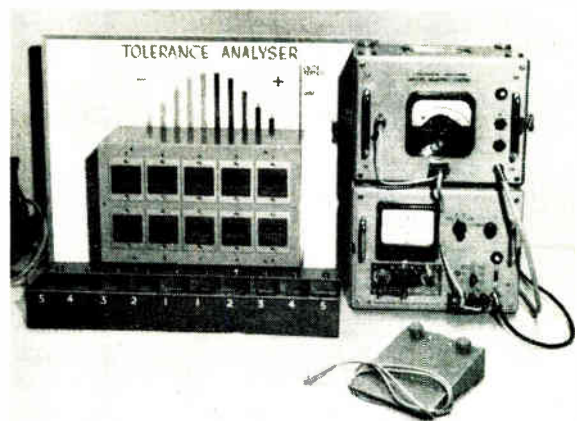

*Aveley Electric demonstrated how by combining a number of standard units it is possible to build a component tolerance analysis system. This picture shows the units in the demonstration: an L.C.R. comparator bridge, a tolerance analyser and an impulse-motor operated histogram chart. Although demonstrated manually this can form part of a completely automatic component testing system handling 60 to 100 items per minute*

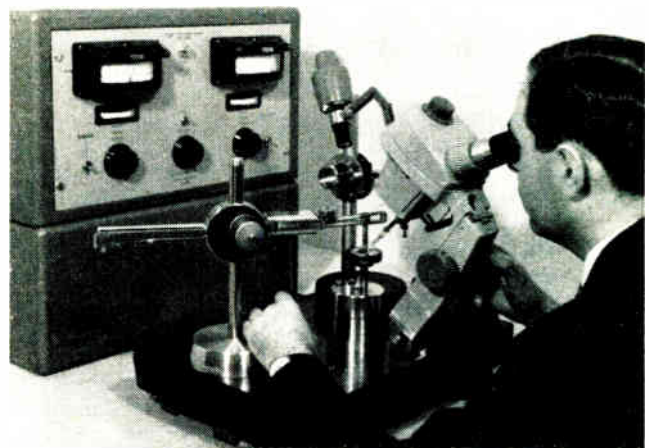

*A thermo-compression bonder shown by G. V. Planer. Comprising a thermostatically-controlled base, a wire feed mechanism, a micro-manipulator and binocular microscope this device can be used to handle wires between 0.0005 in. and 0.01 in. diameter*

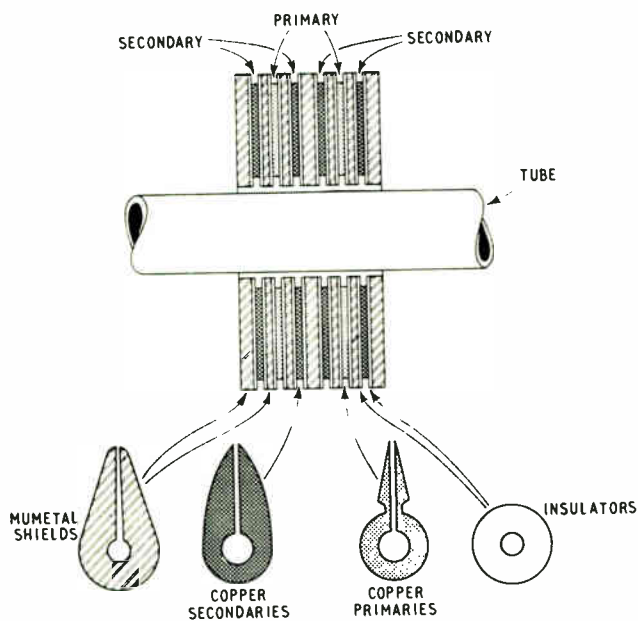

Fig. 1. This shows the construction of the coil of the B.N.F.M.R.A. eddy-current tube tester

the Visigauge 14 type 1109, which was demonstrated by Dawe Instruments. This uses a sweep-frequency oscillator, an ultrasonic transducer and a large-screen c.r.t. When the transducer is placed against the surface of the test material, using a thin film of liquid as a couplant, continuous ultrasonic waves are passed into the material and are reflected from the opposite surface. As the natural resonant frequency of the material varies with thickness a point is reached when the continuously varying signal frequency is equal to the resonant frequency of the part, or a harmonic of it. This results in a considerable increase in the amplitude of the vibrations and produces an increase in anode current of the oscillator valve. The signal resulting from the change of anode current is amplified and applied to the vertical-deflection coil of the c.r.t. and produces a vertical line on the tube. The timebase of the c.r.t. represents the frequency-sweep range. This gauge is suitable for measuring materials in the thickness range 0.006 in. to 2 in. An additional advantage of this type of system is that the coupling for the ultrasonic waves can also be provided by a water column so that measurement can be made on flow line production materials.

Another device demonstrated for production testing by the British Non-Ferrous Metals Research Association is their eddy-current tester for small diameter tubing. This automatically detects small flaws such as the presence of corrosion pits, embedded foreign matter and the like in  $\frac{1}{8}$  in. diameter tubes of wall thickness 0.010 in. In operation the tube is passed through a pair of encircling primary coils energized by a 10-kc/s alternating current. A circumferential flow of eddy-currents is induced in the tube wall. These currents are sensed by secondary coils which are used with a balanced circuit so that the measured signal is zero if the tube within the coil is sound. When there is a fault in the tube the flow of eddy currents is disturbed as the defect passes through the coil and an out-of-balance signal is produced. In the prototype model demonstrated this signal was amplified and used to operate an electromagnetic actuator which operated a tilting platform to feed the tube into a 'reject' tray. To detect a small defect the eddy currents must be confined to relatively short lengths of the tube. To achieve this the coil is constructed with six slotted copper discs magnetically shielded from each other (Fig. 1 shows the construction of this coil).

On the stand of the British Welding Research Association was shown a device designed to measure wire-feed rate accurately and continuously. This overcomes the main disadvantage of slip of the present methods in that the device rides on the wire itself. A knurled spindle connected to a lightweight disc having slots cut in its periphery is turned by the moving wire. The slotted disc interrupts light falling on a photocell to produce a signal which operates a frequency meter. Because the device rides directly on the wire, and the moving parts are light, slip is virtually absent. This apparatus will measure wire speeds of up to 600 in./min.

In addition to these devices many others were shown for such things as the measurement of liquid level, liquid flow, temperature pressure, etc. One of the latest devices developed by S.E. Laboratories is their S.E. 150 transducer for the measurement of absolute pressure only. This is achieved by enclosing one pressure input in an evacuated chamber. The transducer is of the push-pull type where the pressure-sensitive diaphragm acts as the moving core of the two coils. In use the coils are connected into a Wheatstone bridge circuit and the change of inductance of the two coils due to the applied pressure will give a corresponding change in output proportional to pressure. These transducers are available with ranges from 0-15 to 0-500 lb/in.<sup>2</sup> and can operate over the temperature range 70 °C to -50 °C where the combined zero and sensitivity shift is  $\pm 4\%$  of full scale.

### Control and Warning Devices

Transitron demonstrated a full-wave phase-controlled a.c. power supply which was used to accurately control the speed of an a.c. series motor. This is basically a closed-loop circuit comprising a tachogenerator providing a feedback signal to two silicon controlled rectifiers, back-to-back, which are connected in series with the motor. Power to the load is controlled by delaying the point in the a.c. cycle at which the s.c.r.s switch from the 'off' to the 'on' state. The circuit has been used to vary the speed of a 1½ h.p. motor in the range 0 to 6,000 r.p.m. and regulate speed at a pre-set point within the range 100 to 6,000 r.p.m.

Annoying mains-voltage fluctuations commonly occur where a fluctuating load and another, more sensitive load are served by the same supply. A 'flicker correction' circuit demonstrated by the British Electrical and Allied Industries Research Association made it clear that such fluctuations could be eliminated. The device stabilizes the voltage to one load against changes caused by the current drawn by the other. The fluctuations in current cause a corresponding fluctuation in voltage due to the voltage drop across the source impedance of the common supply. By reversing these voltage fluctuations and adding them to

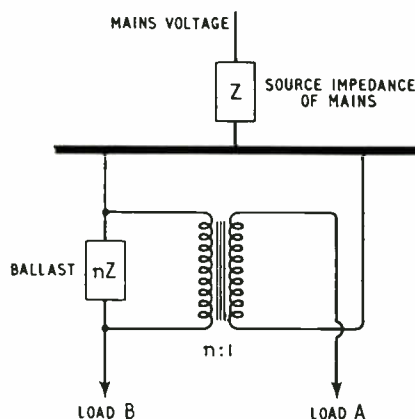
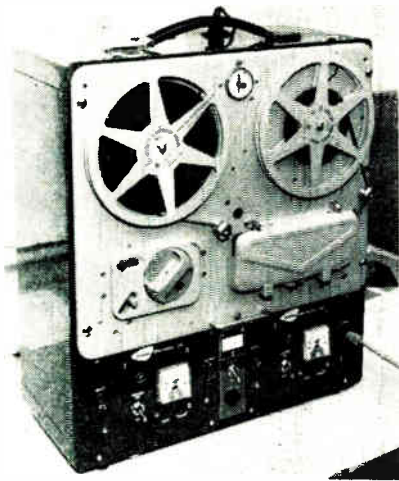

Fig. 2. Given here is the circuit diagram for the E.R.A. flicker corrector





*The Fenlow low-cost d.c. tape recorder. A 2-channel instrument for recording and reproducing on two channels signals between 1 V and -1 V from d.c. to 100 c/s*

the voltage at the common supply point, a completely steady supply voltage can be obtained. This is done by inserting an impedance in the supply to the fluctuating load and transferring the voltage developed across that impedance to the other circuit by a transformer of a suitable ratio. Fig. 2 shows the complete circuit.

Elliotts demonstrated a somewhat different control device—the Swartwout 'Modilog' analogue process-control computer. Unlike most computers this is relatively easy to understand and use. Its object is to receive three separate electrical signals representing physical parameters and, operating as an electronic sliderule, multiply, divide, root or power instantly and provide the answer to the calculation in the form of an electrical signal. The demonstration unit was fitted with a plug-in card marked with the required programme. For input signals *A*, *B* and *C* programme cards are available to perform calculations  $\sqrt{A}$ ,  $A^2$ ,  $A/C$ ,  $AC$ ,  $\sqrt{AC}$ ,  $AB/C$ ,  $ABC$ ,  $\sqrt{(AB/C)}$  and  $3\sqrt{ABC}$ .

Many new warning devices were demonstrated to show that a quite simple electronic device can be used with an associated detector head to provide an audible or visual signal when a quantity being measured reaches a pre-determined value. One of the simplest shown was the Stanley Sealey Instrument Warning Device. This comprises a photoelectric detector head and a separate control unit. In a typical application the detector head is fixed to the glass face of a meter; when the meter pointer passes underneath it, the control unit gives a visual warning signal and operates a pair of changeover contacts to switch external circuits. Several units can be fitted to one or more meters to form the basis of 'on-off' or more complex control and supervisory systems.

### Instruments

The measurement and generation of electrical signals is so much a part of all forms of engineering no review of this exhibition would be complete without a mention of some of the new instruments which were on display.

For the measurement of alternating current Hatfield Instruments were demonstrating their type LE 60 Clip-on Milliammeter. This is a device which can be used to measure alternating current in a conductor without breaking it—a probe clips around the conductor and the current flowing induces an e.m.f. in the coil of the probe which is proportional to the current to be measured. The induced e.m.f. is amplified and displayed on a meter. Currents from

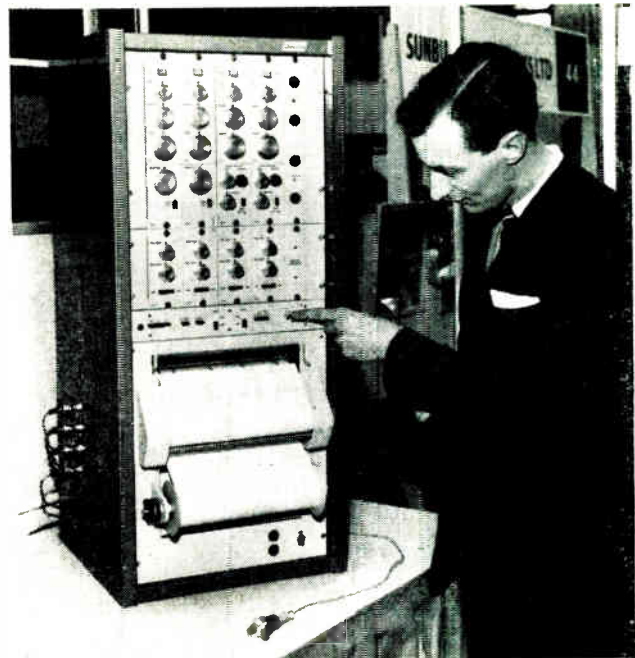

*This completely transistorized instrument comprising a 4-channel pen recorder, each pen having 5 cm excursion, was shown by Devices Ltd. It is available with a number of plug-in units designed to suit various transducers; typically pre-amplifier type D.C.2 has an input sensitivity of 25  $\mu$ V/cm with an input impedance of 3 k $\Omega$*

1 mA to 300 mA full scale can be measured over the frequency range 2 kc/s to 4 Mc/s with an accuracy that is generally better than 3%.

A wide band RC oscillator on the stand of the Admiralty Surface Weapons Establishment gave a foretaste of what low current drain transistors can do for portable instruments. Using ten basic components in a Wien-bridge circuit an RC oscillator has been constructed, to cover the frequency range 16 c/s to 4 Mc/s. in a case about  $4\frac{1}{2} \times 2 \times 1$  in. complete with batteries!

One of the instruments, of a more conventional size, shown by E.M.I. was their WM18 laboratory oscilloscope. This has two independent Y inputs for use separately or differentially. Both inputs have a bandwidth of 25 Mc/s at a maximum sensitivity of 50 mV/cm. A built-in 190-nsec signal delay circuit enables pulse leading edges to be measured. It is provided with voltage and time measurement facilities and a timebase with sweep speeds from 1.5 sec/cm to 50 nsec/cm.

Among the instruments, pulse and waveform generators seem to predominate. Typically, Venner Electronics were showing their TSA648 Pulse Generator which has been developed to fulfil the need for a pulse-forming device on which every parameter can be altered. This is provided with the usual frequency and pulse-width controls but in addition controls are provided for the adjustment of rise-time and fall-time. The frequency range is 10 c/s to 1 Mc/s, delay range 1  $\mu$ sec to 100 msec, pulse-width range 1  $\mu$ sec to 100 msec and rise- and fall-time range 0.1  $\mu$ sec/V to 1 msec/V.

It was generally agreed by visitors and exhibitors alike that this year's exhibition was lively and interesting and had a definite character all of its own. The organizers and exhibitors each in their turn contributed to this 'new look' exhibition which undoubtedly shows that research and development workers are producing new and better devices for the physicist and engineer.



### Personal and Company News

**Sir Harold Bishop, C.B.E., F.C.G.I., B.Sc.(Eng.), M.I.E.E., M.I.Mech.E., F.I.R.E.**, retires on 10th May from his position as Director of Engineering, B.B.C. He will be succeeded by **F. C. McLean, C.B.E., B.Sc., M.I.E.E., S.M.I.R.E.** **M. J. L. Pulling, C.B.E., M.A., M.I.E.E.**, will become Deputy Director of Engineering and **D. B. Weigall, M.A., M.I.E.E.**, Assistant Director of Engineering.

**Pye Telecommunications Ltd.** has concluded a ten-year agreement with the Aircraft Radio Corporation of Boonton. A.R.C. will market Pye communications products in the U.S.A. and Pye have reciprocal rights to manufacture and sell A.R.C. airborne products.

**Sir Cecil Dannatt, O.B.E., M.C., D.Sc.**, is relinquishing all his executive appointments in A.E.I. Ltd., including the vice-chairmanship. He is remaining as a non-executive director and special consultant for another year.

**L. B. Copestick** and **J. E. Crosse**, formerly managing directors of Solartron Research and Development Ltd. and Solartron (Farnborough) Ltd. respectively, have resigned their directorships with the Solartron Group. **L. Malec, M.B.E.**, formerly managing director of Solartron Radar Simulators Ltd., is joining the parent company, Schlumberger, and will be responsible for its electronic interests in Germany.

**H. Faulkner, C.M.G., B.Sc.(Eng.), M.I.E.E., F.I.R.E.**, is retiring from his position as director of the Telecommunication Engineering and Manufacturing Association. The new director is **R. A. Moir, O.B.E., M.C., M.I.E.E.**

**T. F. W. Jackson** has been appointed Regional executive of United Kingdom of Union Carbide International Co. and remains chairman of Union Carbide Ltd., of which company **Ray Wilson** succeeds him as managing director.

**Johnson and Phillips Ltd.** and **European Cables Ltd.** have entered into a treaty of association for the exchange of information on economic, technical and commercial matters.

**John Ayres, M.I.E.E.**, formerly a director of the Simms Motor and Electronics Group, has joined Sears Engineering Ltd.

The businesses of Automatic Control Engineering Ltd. and Hartons Installations Ltd. have been merged. The new company is **A.C.E.-Hartons Ltd.**, Maxim Road, Crayford, Kent (Telephone: Crayford 26211). The chairman is **I. J. Crossthwaite, D.S.O.**, the managing director is **A. J. Matthews** and the deputy managing director **R. Riley**.

**P. L. Sidey, B.Sc., A.R.C.Sc.**, has been appointed director and general sales manager of Advance Components Ltd.

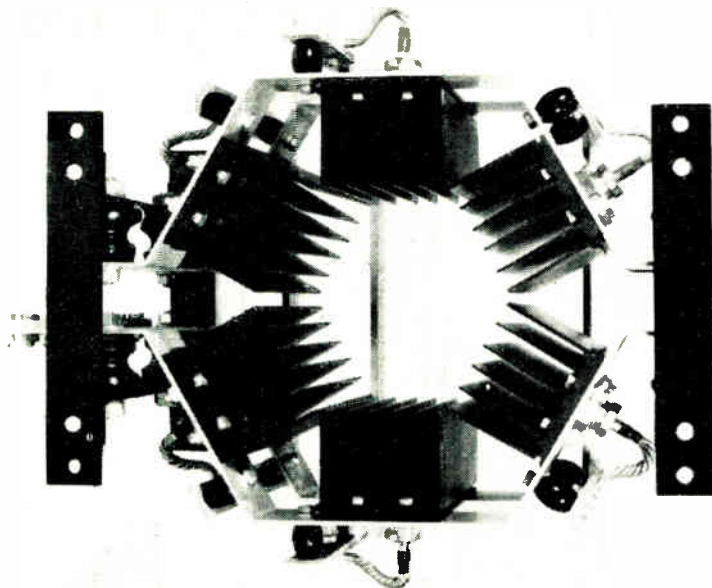

*An unusual mounting arrangement is adopted for high-power silicon rectifiers in order to facilitate cooling. The fan motor is fitted in the centre of the assembly. The rectifiers are International Rectifier Co. (Great Britain) Ltd. types rated at 700 amperes*

**For further information circle 53 on Service Card**

*E.M.I. Gamma Spectrometer GSI can measure and plot the gamma spectrum of any radioactive material. Transistors are used and the apparatus is constructed on a modular system. Alternative mains and battery power-supply units are available*

For further information circle 54 on Service Card

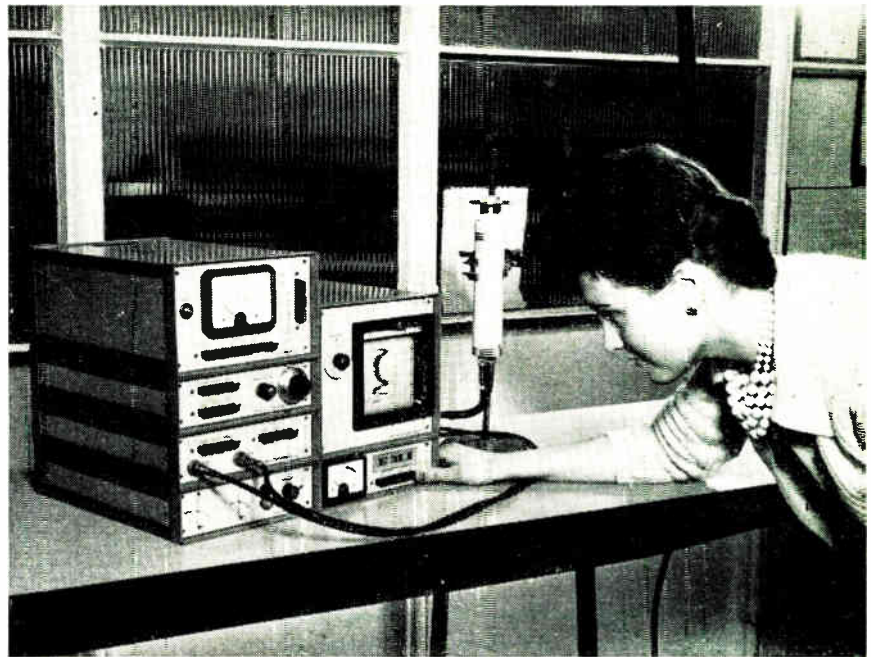

**E. Eastwood, C.B.E., Ph.D., M.Sc., M.I.E.E.**, has been appointed director of engineering and research of Marconi's W.T. Co. Ltd., and **D. G. Smee** becomes Assistant General Manager.

**Colonel E. L. Elford, O.B.E.**, has retired from his position as manager of Marconi's Radar Division and has been appointed a consultant to the company.

**N. H. Searby, C.B.E., Ph.D., B.Sc.(Hons.), M.I.E.E., S.M.I.R.E.**, has been appointed to the board of **Ferranti Ltd.**

**Laurence, Scott & Electromotors Ltd.** are opening a branch office at Prins Hendrikstraat 4, Den Haag, Holland. The manager will be **P. Droppert**.

**Stewart Aeronautical Supply Co. Ltd.** has been appointed sales representative for the Defense Products Division of Fairchild Camera and Instrument Corp.

**T. H. Y. Bonsey** has been appointed director of sales to Aluminium Wire & Cable Co. Ltd.

**George Kent Ltd.** have extended their technical sales facilities at 199-201 High Holborn, London, by the appointment of **R. C. Fletcher** as resident sales engineer.

**M. P. Gaffney** and **K. W. Harrison** have joined the board of **Telephone Mfg. Co. Ltd.** as executive directors. **R. W. Beattie** has been appointed manager of the capacitor division.

Now that **Regentone Products Ltd.** is part of the S.T.C. organization orders and sales correspondence should be addressed to Regent Works, Footscray, Kent (Telephone: Footscray 3333) and service matters to C.R.T.S. Ltd. at the same address.

**G. W. Robinson** has been appointed chief purchasing officer of **Allen West & Co. Ltd.**

**Sir Robert Fraser, O.B.E.**, has become president of the Television Society in succession to **Sir Harold Bishop, C.B.E., M.I.E.E.**

**L. Lewin**, of Standard Telecommunication Laboratories, has been awarded the Annual Microwave Prize by the Institute of Radio Engineers for his paper on the resolution of a class of waveguide discontinuity problems by the use of singular integral equations.

**Advance Components Ltd.** have opened a new engineering laboratory at Hainault, Essex.

**Simmonds Aerocessories Ltd.** has become **Elliott (Treforest) Ltd.** The address of the company is unchanged.

## New Year Honours

### Knighthood

**R. E. Lindsay Wellington, C.B.E.** (Director of Sound Broadcasting, B.B.C.).

### C.B.E.

**A. H. Cooper** (Technical director, E.M.I. Electronics Ltd.).

### O.B.E.

**H. G. Campey** (Head of publicity, B.B.C.).  
**O. J. Crompton** (Director and general manager, British Insulated Callender's Construction Co. Ltd.).

**H. G. Hopkins** (Senior principal scientific officer, Radio Research Station, D.S.I.R.).

**W. S. Melville** (Manager, Military Radar Engineering Department, A.E.I. Ltd.).

### M.B.E.

**H. W. Boutall** (Senior engineer (contracts), I.T.A.).

**A. Cork** (Deputy production manager, E.M.I. Ltd.).

**R. A. Rowden** (Head of field strength section, Engineering Research Department, B.B.C.).

### Electronic Fuel Injection

The Leningrad Fuel Equipment Institute has developed a fuel injection system using electromagnetic valves. These maintain constant fuel pressure and the quantity of fuel injected is controlled by varying the 'open-time' of the valves. The control unit, which produces the pulses operating the valves, includes semiconductors and responds to changes in the engine's operation and changes of speed, gradient, temperature and atmospheric pressure.

It is claimed that the device increases engine power by a third for the same fuel consumption. The electronic system is standard for all vehicles, its programme only being varied for the type of engine.

### Metal-to-Plastic Bonding

Bell Telephone Laboratories have announced a new method of bonding metals to thermoplastics using a single layer of molecules as an adhesive. Long-chain hydrocarbon acids are used for the monolayer. The acid end of the molecule forms a chemical bond with the metal and the hydrocarbon part forms a physical bond with the thermoplastic. When stearic acid is used to bond aluminium to polyethylene, one end of the stearic acid molecule forms aluminium stearate with the metal plate while the other end becomes immersed in the polyethylene.

Tests have shown such bonds to stand up to 600 lb per sq in. tensile-shear stress for months at 100% relative humidity and at 80–120 °F.

### The Society of Acoustic Technology

This is a new society, the inaugural meeting of which was arranged for 17th January 1963. The joint honorary secretaries are Dr. Peter Lord, Royal College of Advanced Technology, Salford, and Dr. H. D. Parbrook, of Liverpool University. Further information can be obtained from Dr. Lord.

### High Magnetic Fields

A conference on the production and application of high magnetic fields will be held at the University of Oxford on 10th–12th July 1963. Arranged by the Institute of Physics and the Physical Society, the conference will cover the generation of high magnetic fields by normal conducting materials and by superconductors, and also the properties of solids in such fields, including optical, magnetic and transport properties.

### Design Course

Four courses are being held in London during 1963 for engineering executives and staff. The executive's course is residential and lasts five days and it deals with design policy as well as design factors. The staff course is also residential and has two five-day periods.

The first executive's course will be 1st–5th April and the staff course will be 4th–8th March and 25th–29th March. The other courses will be in October and November.

Details are obtainable from W. H. Mayall, Industrial Division, for the executive's course, and from Miss Sydney Foott, Education Officer, for the staff course. For both the address is Council of Industrial Design, 28 Haymarket, London, S.W.1.

### Dielectric and Insulating Materials

The Institution of Electrical Engineers is arranging a conference on the theory, properties, testing and uses of dielectric and insulating materials. It will be held in London on 8th–10th April 1964.

### Civil Aviation

A conference on electronic research and development for civil aviation is being held on 1st–4th October 1963 by the Institution of Electrical Engineers.

*Solartron radar simulator type SY 1190 during acceptance tests. It is to be installed at the Central Navigation and Control School, R.A.F. Shawbury. It simulates four of the navigational aids normally found in an airfield control tower; permanent echoes can be introduced, as well as weather and wind effects*

For further information circle 55 on Service Card

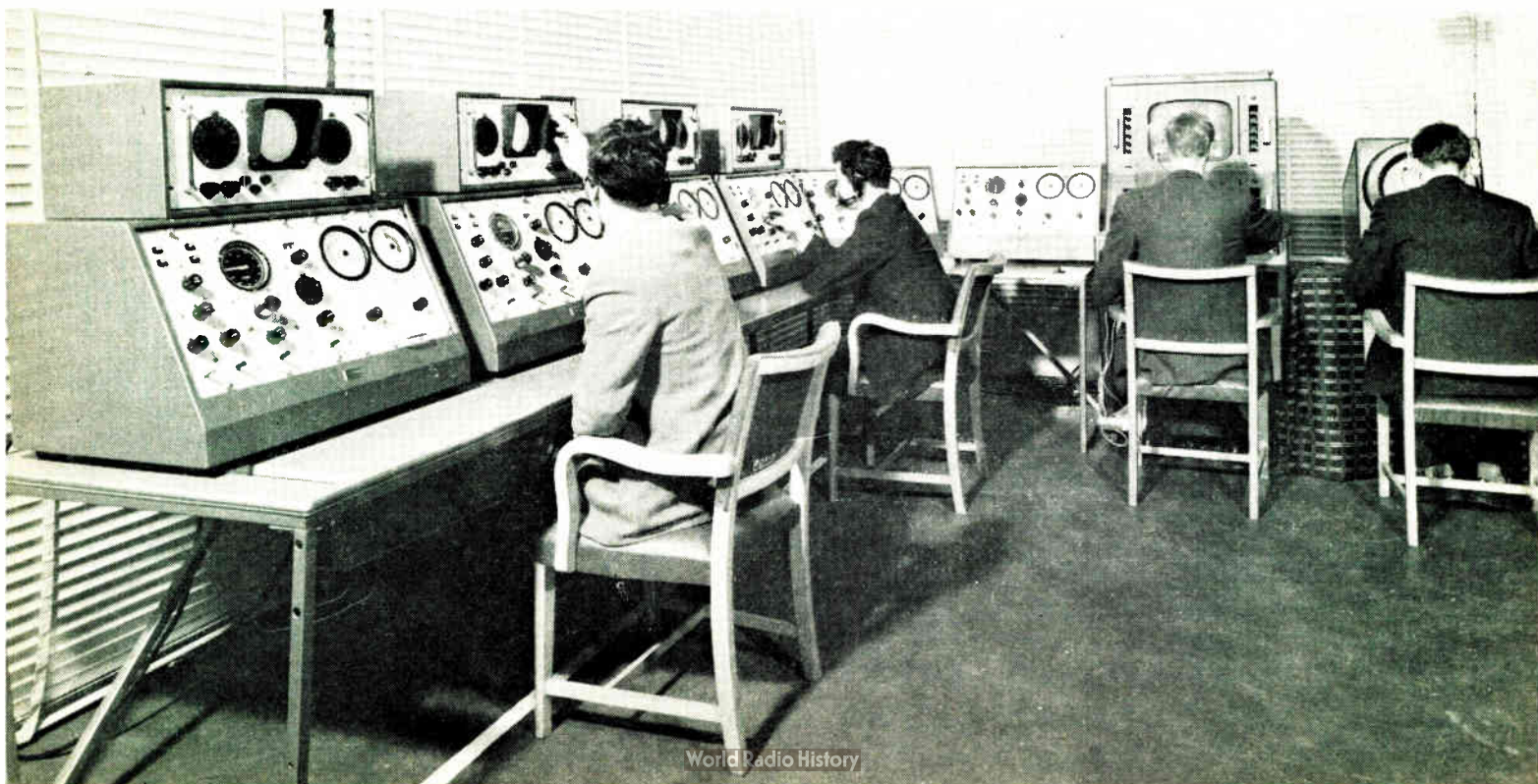

# Correspondence

## Teaching Machines

Sir,—I was interested to see your editorial comment in the December *Industrial Electronics* on teaching machines, because I am taking quite an interest in these, and one of the most necessary things at the moment is to get them more widely known both among those who might use them and those who might make them. As regards the latter, however, the position is that at the moment there are too many manufacturers chasing far too little business, and all of them, in my view, are most liable to take losses for some time to come.

I should like to express an opinion on the last paragraph

of 'Comment'. The bottleneck is not in the design of the machines, which do no more than present information to the student. It is more in constructing the information, or programme as it is called, and especially in the resistance of the teachers to accepting something which they wrongly think will usurp their position.

Secondly, these machines are not electronic, except for the so-called adaptive types which use computer techniques to alter their programmes to suit such skill and experience as they find the student possesses. However, because of their sophistication they will always be expensive, and so in my opinion their use will only be marginal. So I don't think collaboration between electronic engineers, or for that matter any other engineers, and the teachers will get us much further.

What is needed is to sell the idea not of machine design, but of the concept of programmed learning to the teachers, and this is being done by a variety of people, some of them teachers themselves. The main outlet for machines for the time being will anyhow be to industry, for industrial training and re-training.

East Finchley, N.22.

ROBERT WINTON.

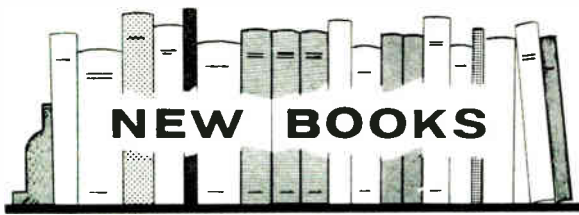

## A Guide to Instrument Design

Produced by the SCIENTIFIC INSTRUMENT MANUFACTURERS' ASSOCIATION in co-operation with the BRITISH SCIENTIFIC INSTRUMENT RESEARCH ASSOCIATION. Pp. 444 + xii. Published by Taylor & Francis Ltd., Red Lion Court, Fleet Street, London, E.C.4. Price 63s.

This is a most unusual and interesting book. Seven different authors have been involved in writing its nine chapters. It is 'an attempt to gather together in one volume the best homilies and instructions on how to design instruments'. One of the aims in producing it has been 'to educate appropriate engineers and scientists in the principles of good design'.

After the introductory chapter on the relation between research, development and production, there is one dealing with general instrument technology, in which the effect of limiting factors is discussed. Then come chapters on mechanical, optical, electronic and nucleonic design. The final chapters cover reliability, intrinsic safety and integrated design.

Most chapters are almost entirely free from mathematics; a little creeps into the discussion of nucleonic instruments; and a great deal into the chapter on optical design. A large amount of this chapter deals with lens aberrations and ray tracing. It is an odd-man-out; it is at a higher technical level than the others as well as being more mathematical and it gives much more specific design information. It is a chapter to which a lens designer might frequently refer.

but it is doubtful if it will greatly help the instrument designer. He is more likely to want, not the general principles which are to be found in any textbook of optics, but general guidance on what is practical in the way of performance and discussions of the merits of alternative ways of obtaining the same results. Most people leave lens design to the specialist, but may well need help to enable them to talk to him intelligently.

The chapter on electronics, for instance, is much more general and the emphasis is placed upon reliability. A few electronic methods are described, but cooling, vibration, accessibility and, even, ergonomics, are treated at greater length.

Nucleonics is dealt with at a level between optics and electronics. Counter and photomultiplier tubes are described and the way in which they operate is explained with the aid of fairly elementary mathematics. It is a good chapter and a useful one and seems to strike just about the right level of exposition.

## Varactor Applications

By PAUL PENFIELD and ROBERT RAFUSE. Pp. 623 + xiv. The M.I.T. Press, Massachusetts Institute of Technology, Cambridge, Massachusetts, U.S.A. Price \$15.

'A varactor is a semiconductor junction diode with a useful nonlinear reverse-bias capacitance.' This definition starts the introductory chapter of the book and as a definition it leaves much to be desired. It does not indicate what quantity is varied to make the capacitance change and it is wrong in insinuating that the property of importance is a *non-linear* variation of capacitance with that quantity. A varactor can, theoretically, have a linear variation of capacitance, although practically it is usually non-linear.

The term 'non-linear capacitance' arises from muddled thinking. An ordinary capacitor has ideally a capacitance which is independent of the voltage across it or the current through it; it has a *constant* capacitance. The reactance of such a capacitor is commonly called linear because the

current through it is a linear function of the voltage across it. A non-linear reactance is one in which the current is a non-linear function of the voltage. This is an accepted usage about which nothing can now be done, but it is nevertheless a poor term for it implies that it is the reactance which varies non-linearly with some quantity. Even if it varied linearly with, say, voltage, the current-voltage relation would still be non-linear.

It is by an extension of this usage that the term 'non-linear capacitance' arises, but this is a term which can hardly be tolerated seeing that it is a stage further removed from the real non-linearity. This sort of expression is at the root of many beginners' difficulties. Beginners do not know the jargon and are apt to understand expressions as meaning what they say by the ordinary rules of the English language. When the expressions do not mean what they say, it is small wonder that difficulties and misunderstandings arise. And they are so unnecessary. All that is needed here is to write 'A varactor is a semiconductor junction diode which has a capacitance which varies with the applied voltage when it is operated with reverse bias'.

The critical reader is thus held up at the very start of the book. The non-critical may well be misled. It is not until p. 68 that one discovers that the quantity which affects the capacitance is, in fact, voltage.

The book has ten chapters and six appendixes. After the introduction, basic concepts are treated and then lossless non-linear reactance devices. The varactor model follows, and in turn frequency converters, parametric amplifiers, pumping, harmonic multipliers, harmonic dividers and large-signal frequency converters and amplifiers.

There is a good deal of mathematics but not much of the difficult kind. As a whole the book seems a most useful one, and is probably the most complete work on the subject that has yet appeared. In spite of its size and price, it is reproduced from typescript, so that the production inevitably leaves much to be desired.

### High Magnetic Fields

Pp 751 + xv. John Wiley and Sons Ltd., Gordon House, Greencoat Place, London, S.W.1. Price 113s.

This book is really the proceedings of the International Conference on High Magnetic Fields which was held at the Massachusetts Institute of Technology from 1st to 4th November 1961. The first part deals with the generation of high magnetic fields, the second with the research programmes, the third with solid-state and low-temperature physics in high magnetic fields, and the fourth and final part covers plasma and fusion physics in high magnetic fields. Each part contains a number of papers; all told there are 88.

From the title of the book one might imagine that it dealt with magnetic fields situated high above the earth, which is in fact a subject of considerable interest. However, what is meant is fields of high intensity and it would have been less misleading to call the book 'Strong Magnetic Fields'.

### The Use of Electronic Valves

British Standard CP1005 (1962). Pp. 71. Published by the British Standards Institution, 2 Park Street, London, W.1. Price 12s. 6d.

'A code of practice on the use of electronic valves, CP1005, was first published in four separate parts. These have now been combined into one document in the revised version of the code issued recently.

The code is intended to give guidance to designers of equipment using electronic valves so that they may obtain optimum performance and life from the valves.'

## Manufacturers' Literature

**Westool 'Sonac'.** This 6-page folder describes some applications of ultrasonic sensing and switching equipment in the coal mining industry, including level control, car and cage positioning and traffic control.

*Westool Ltd., St. Helen's Auckland, Bishop Auckland, Co. Durham.*

**For further information circle 56 on Service Card**

**Radiovisor Timing Equipment.** This 3-page leaflet gives a brief description of six timing units and includes a list of some of the switching operations which they can provide.

**Automatic Lighting Control.** General details of the 'Savelite' range of automatic lighting control systems can be found in this 2-page folder.

*Radiovisor Parent Ltd., Stanhope Works, High Path, London, S.W.19.*

**For further information circle 57 on Service Card**

**Mazda Valve Data.** The 1963 edition of this booklet has 160 pages and offers data on 436 types of valves and c.r.t.s. It is divided into three sections based on availability: 'current', 'obsolescent' and 'obsolete'. A list of equivalents contains over 1,000 fully cross-indexed types including c.r.t.s.

*Thorn-A.E.I. Radio Valves & Tubes Ltd., 155 Charing Cross Road, London, W.C.2.*

**For further information circle 58 on Service Card**

**G-R Electronic Apparatus.** This 12-page booklet provides a sterling price list for General Radio products now available from their subsidiary in Switzerland. It includes full details of import duty, etc.

*Claude Lyons Ltd., Valley Works, Hoddesdon, Herts.*

**For further information circle 59 on Service Card**

**Nucleonic Equipment.** Full technical specifications and price details of a comprehensive range of nucleonic equipment are given in this 70-page catalogue.

*Nuclear Enterprises (G.B.) Ltd., Sighthill, Edinburgh 11, Scotland.*

**For further information circle 60 on Service Card**

**Philips Microvoltmeter.** In this 2-page leaflet details are given of a highly sensitive d.c. microvoltmeter with a measuring range from 10  $\mu$ V to 1 kV. Mention is made of possible applications.

*Research and Control Instruments Ltd., Instrument House, 207 King's Cross Road, London, W.C.1.*

**For further information circle 61 on Service Card**

**Aerialite Products.** This 100-page catalogue describes a very wide range of cables, aerials, accessories, etc. A separate price list is supplied with each catalogue.

*Aerialite Ltd., Castle Works, Stalybridge, Cheshire.*

**For further information circle 62 on Service Card**

**Mallory Cells and Batteries.** The full industrial range of Mallory mercury cells and batteries for instrumentation, voltage reference and general scientific applications is listed in this 10-page brochure which includes details of their construction.

**Voltage Reference Battery.** This 2-page leaflet describes a new mercury battery designed for use as a voltage reference source. It is available either as a single cell 1.35 V unit or as a multi-cell unit with 8 outputs, 0-10.80 V, in 1.35 V increments.

*Mallory Batteries Ltd., Gatwick Road, Crawley, Sussex.*

**For further information circle 63 on Service Card**

**'Squaretrim' Subminiature Potentiometers.** Complete specifications of the Daystrom 218 Series subminiature trimming potentiometers are given in a single page data sheet. These units are  $\frac{3}{4}$  in. square with a range of 10  $\Omega$  to 50 k $\Omega$  and a power rating of 1 W.

*Daystrom, Incorporated, Potentiometer Division, Archbald, Pennsylvania, U.S.A.*

**For further information circle 64 on Service Card**

# CORREX

## CORREACTOR

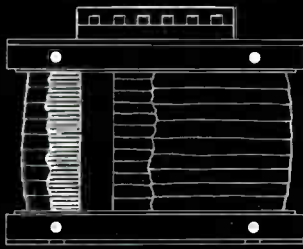

Designed for situations where high percentage regulation is not necessary, the **CORREACTOR** is Phoenix's answer to demand for a general purpose heavy duty component at an economical price. Percentage regulation is between 10% and 85%, load ranges from 125 W to 7 kW single phase.

# CORREX

## A.C.R.

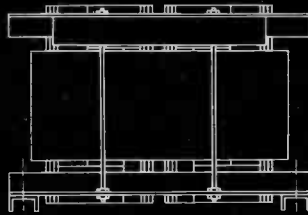

Like the Correactor, the **A.C.R.** comprises three coils about a shell-form core of laminated silicon iron. It has been designed for situations where wider output control range is required and higher power is to be used. Percentage regulation is between 10% and 93%, load ranges from 8 kW to 60 kW single phase.

# CORREX

## TOROIDAL REACTOR

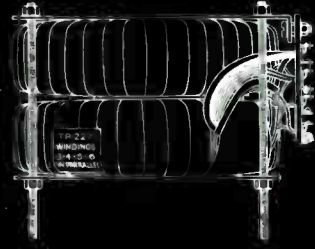

**TOROIDAL REACTORS** are offered specifically for precision installations where higher power gains are called for. Power gains in the order of  $10^5$  are available with toroids. Toroidal Reactors can also be made to customers' own specifications. Maximum percentage regulation is 98% overall. Toroids are powered up to 60 kW single phase.

*All these reactors are designed to operate on D.C. control, which can be varied by only small potentiometers in remote positions. Used in conjunction with CORREX Magnetic Amplifiers, they can be operated from signals on standard equipment down to  $8\mu\text{A}$ . There are no moving parts, so no maintenance is needed.*

## UP TO DATE COMPONENTS FOR STEPLESS CONTROL OF VOLTAGE, POWER, HEAT AND LIGHT IN ANY SITUATION

**RELIABLE  
LONG-LIFE  
DEVICES WITH  
STEADY  
CHARACTERISTICS  
DESIGNED FOR  
PROCESS CONTROL**

# CORREX



## MAGNETIC AMPLIFIERS

*All CORREX MAGNETIC AMPLIFIERS have no thermionic or moving parts. They are all housed in dust-proof cases with streamlined adaptability to any situation. Very little servicing is required. They are aptly suited to the needs of the work-study conscious, modern planners. The compact and sturdy construction of these components and their variety of application make them so: their prices are competitive, too.*

Five components, in the **M. A. 420/430** range, are auto-excited single-ended stages of toroidal construction. They are used as driver stages for Saturable Reactors through variable D.C. output control. Voltage is set by bias control from a small transformer and selenium bridge rectifier.

For instrument and process control amplification, the **M. A. 412** can be used with thermo-couples, photocells etc. This is a two-stage push-pull unit with cascade connection. It has been developed to harmonise in a number of applications with all other CORREX equipment of this kind.

Newest among these Magnetic Amplifiers is the versatile **M. A. 437**, driving a Post Office type 3000 relay at close differential. This is intended to trigger a function on a variable monitored control signal and also from signals too small to drive a conventional relay. Minimum operational signal for the **M. A. 437** is  $80\mu\text{A}$ .

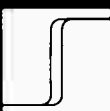

**PHOENIX TELEPHONES LIMITED**  
 GROVE PARK · LONDON, N.W.9.  
 Telephone: COLindale 7243 · Telegrams: PHONOFENIX LONDON, N.W.9.  
**SATURABLE REACTORS      MAGNETIC AMPLIFIERS**  
**TRANSFORMERS & TOROIDS      SPECIALISED CONTROL**  
**EQUIPMENT**

**A.I.D. &  
C.E.G.B.**  
Approved

**CORREX MEANS  
ECONOMY IN  
PLANNING  
AND PRICE** IE2

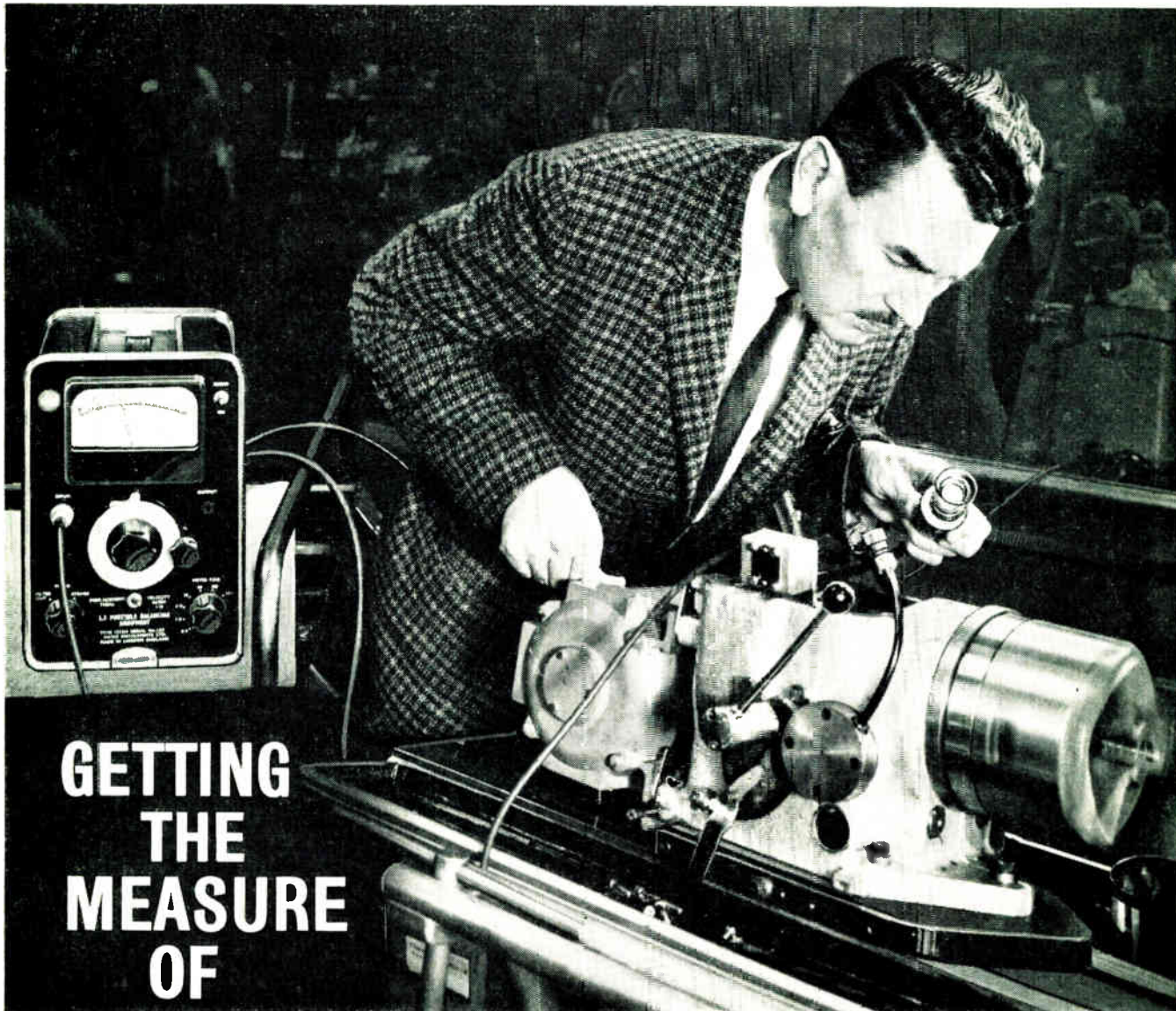

**GETTING  
THE  
MEASURE  
OF**

# **DYNAMIC UNBALANCE**

Dynamic unbalance in rotating or reciprocating machinery is quickly located and measured using the Dawe Type 1255A Portable Balancing Equipment. This is an ideal instrument for checking the overall vibration levels of assembled machines and specifying safe vibration limits. Maintenance engineers find it conveniently light and easy to carry when making routine checks on plant *in situ*. The Dawe range also includes a complete series of Stroboscopes. Send for details today.

**DAWE**

Full technical data from:—

**DAWE INSTRUMENTS LTD., WESTERN AVE., LONDON, W3 Tel: ACO rn 6751**

A member of the *Simms* group of companies



# Electro-Magnetic COUNTERS

## MODEL 442

6 figures — adds or subtracts

Resettable by hand — or non-resettable

Standard Model — up to 500 counts per min

High Speed Model — up to 1000 counts per min

Standard Voltages

DC	12v	24v	48v	110v
AC	115v	230v	50c/s	115v 60c/s

Base or Panel Mounted

Panel size — 1.781 in (45.3 mm) × 1.250 in (31.8 mm)

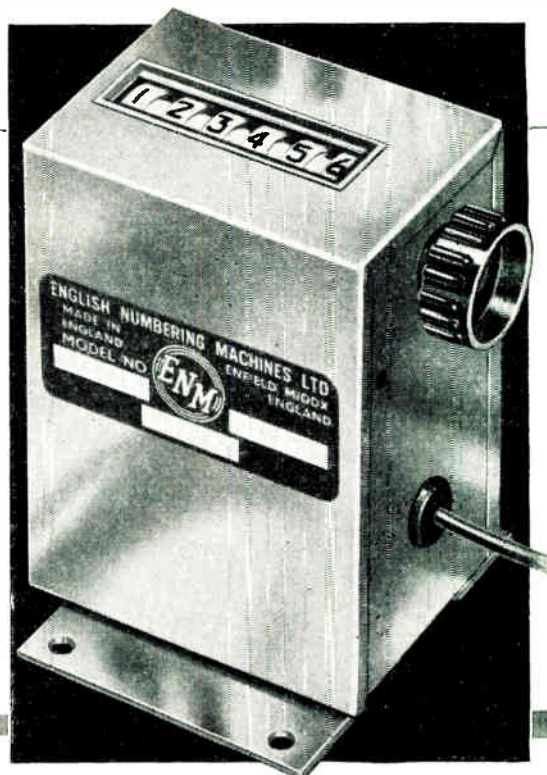

VISUAL OR PRINTING  
ADDING AND SUBTRACTING

## MODEL 443

Adds or subtracts — or adds and subtracts

Manual or Electric Reset, or non-reset

Standard Models — up to 2100 counts per min

High Speed Models up to 3000 counts per min

Standard Voltages

DC	12v	24v	48v	60v	110v
AC	115v	250v	50c/s	115v	60c/s

Panel mounted only

Panel size — 1.812 in (46.0 mm) × 2.75 in (69.0 mm)



Write or telephone HOWard 2611 for fully descriptive literature

# English Numbering Machines Ltd

DEPT E10 QUEENSWAY ENFIELD MIDDLESEX

Tel HOWard 2611

Grams Numgravco Enfield



**WE OFFER  
YOU . . .**

**OUR CATALOGUE**—containing technical information and illustrating typical examples of Cabinets for the Electronic industry and a price list of our standard range.

**OUR TECHNICAL ADVICE** is based on many years experience in the electronic field of cabinet manufacture. We welcome the opportunity to build special cabinets for unusual applications, as well as standard products, especially for customers who consult us at the very outset—this eases many difficulties and results in a more economical and satisfactory product—and an improved delivery date.

**WE OFFER YOU** more than our Catalogue — we offer our experience—products—and reliable service.

WRITE TODAY TO

**Hassett & Harper Ltd**

HASSETT & HARPER LTD. (REGD.) REGENT PLACE BIRMINGHAM 1  
TELEPHONE: CENTRAL 6418

**ADCOLA**  
REGISTERED TRADE MARK  
(Regd. Trade Mark)

**Soldering Instruments and Equipment**

Illustrated

$\frac{3}{16}$ " BIT INSTRUMENT (List No. L64) IN PROTECTIVE UNIT (List No. 700)

ALL VOLT RANGES  
6/7 to 230/50 VOLTS

BRITISH & FOREIGN PATS. & REG. DESIGNS, ETC.

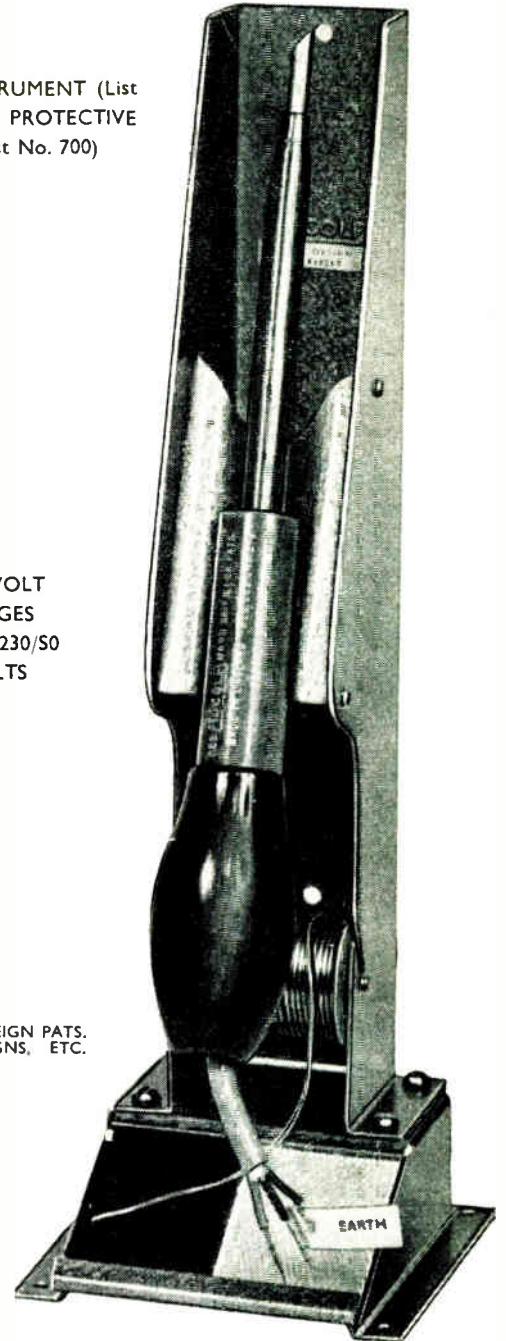

Traditional British Quality and Workmanship  
**ADCOLA PRODUCTS LIMITED**

Head Office, Sales and Service

**ADCOLA HOUSE, GAUDEN ROAD, LONDON, S.W.4**

Telephones MACAULAY 3101 & 4272

Telegrams SOLJOINT LONDON S.W.4

AUSTRALIAN OFFICE: 420 ST. KILDA ROAD, MELBOURNE, S.C.2

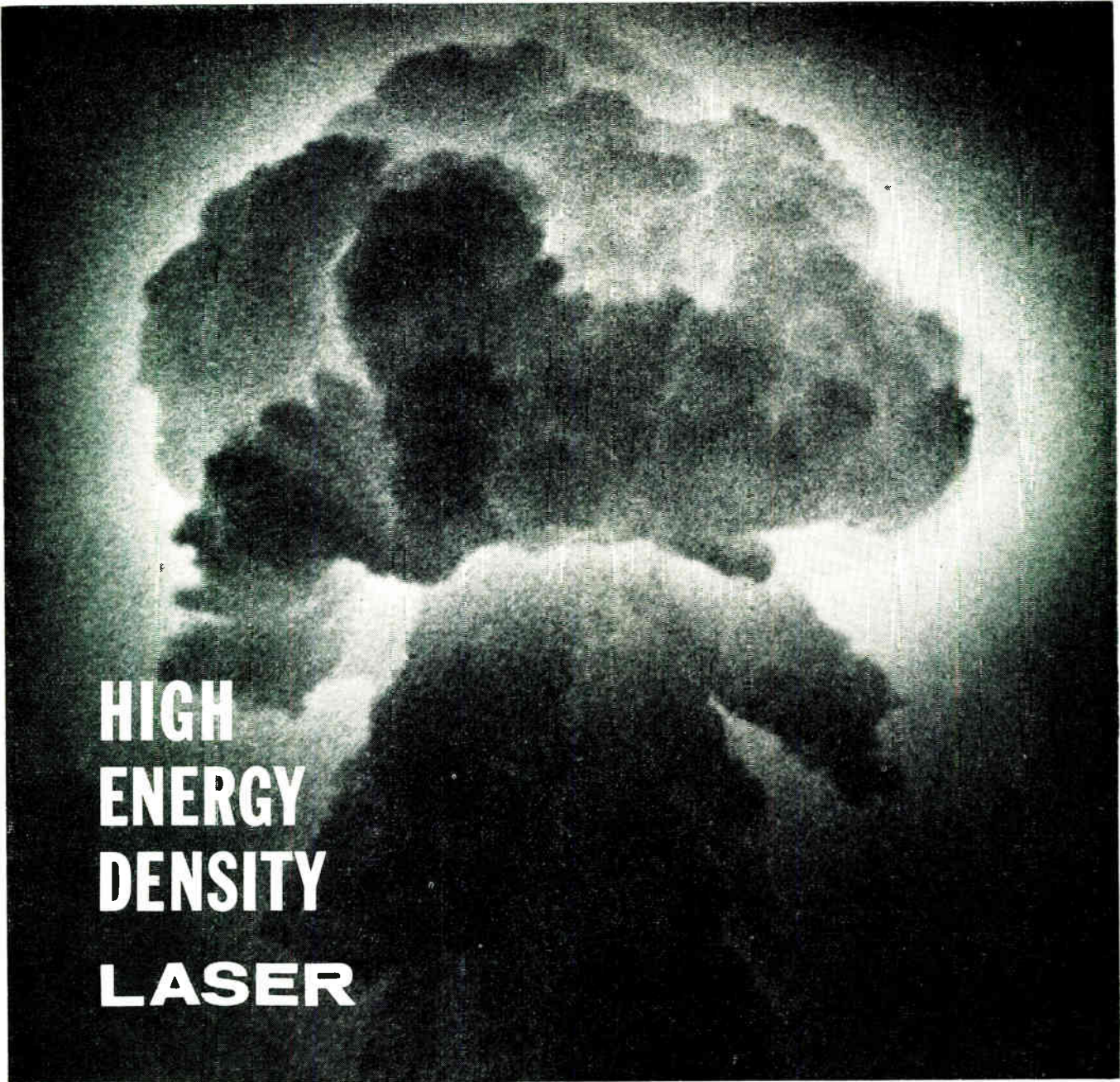

# HIGH ENERGY DENSITY LASER



Energy density approaching that to be found within an atomic explosion can be yours with a **Bradley Laser**.

The type 301, a compact, portable unit, produces single pulses of coherent light in the red region of the visible spectrum with high directivity. The active element is a 2 inch ruby rod having an output energy of 2 Joules, at 6943Å. Concentrating this beam can produce an energy density of  $10^{16}$  Watts/cc.

Our models of greater power and other wavelengths, including the recently introduced 30 Joule model (Type 330), are exciting the interest of forward-looking scientists throughout the world.

Let the Bradley consultancy service throw light on your problems.

**G. & E. BRADLEY, LTD.,** Electral House, Neasden Lane, London, N.W.10. Tel. Dollis Hill 7811



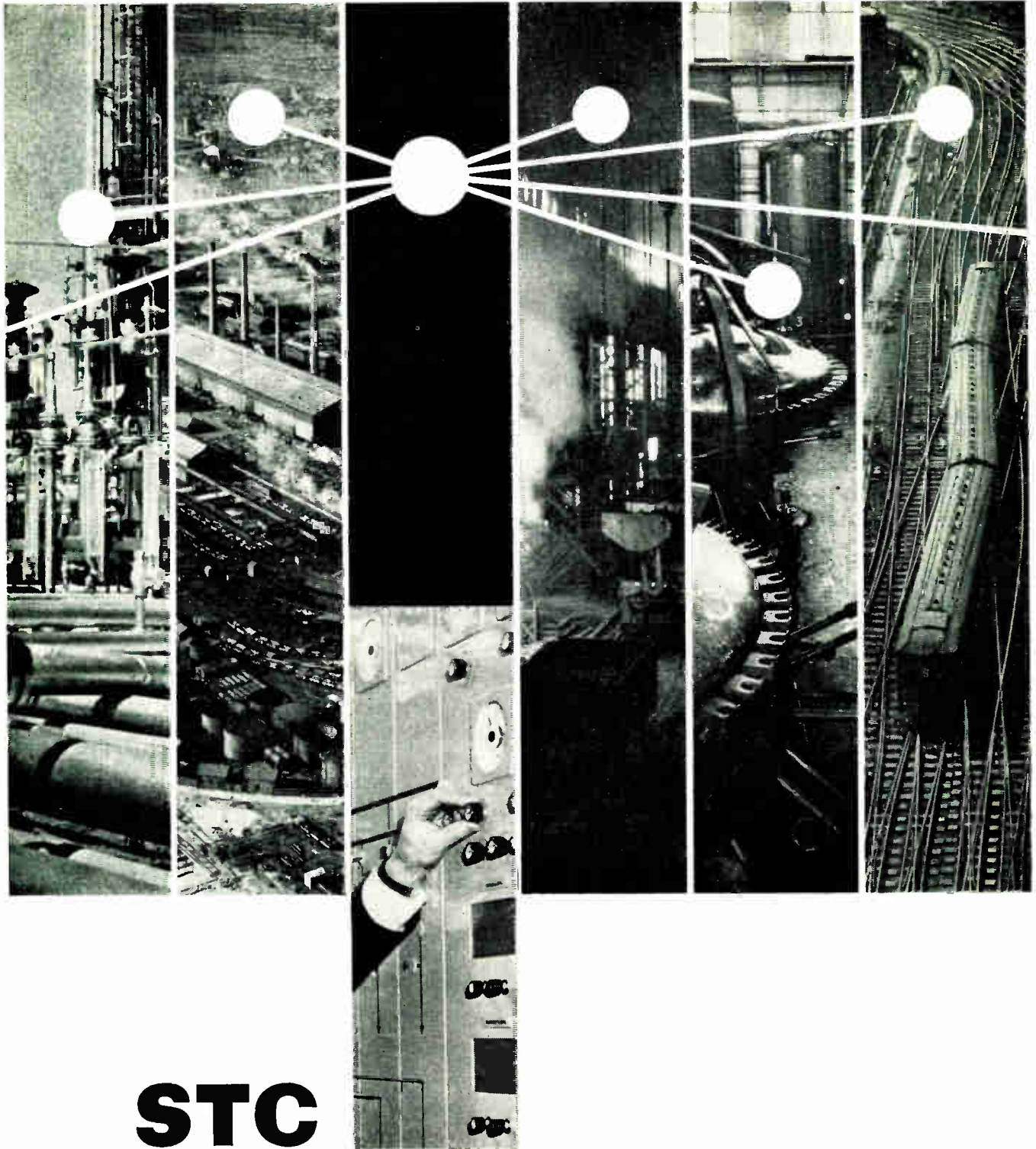

# STC

## DIRECT WIRE CONTROL SYSTEMS FOR INDUSTRY

Write, 'phone or Telex for Brochure D/RC12

63/16R



*Standard Telephones and Cables Limited*  
INTEGRATED ELECTRONIC SYSTEMS DIVISION  
BURLEIGH HOUSE · GREAT CAMBRIDGE ROAD · ENFIELD · MIDDLESEX  
Telephone ENField 5343 · Telex 21409

**ALLSCOTT**

**ECONOMIC  
Electronic  
Supervisory  
Systems**

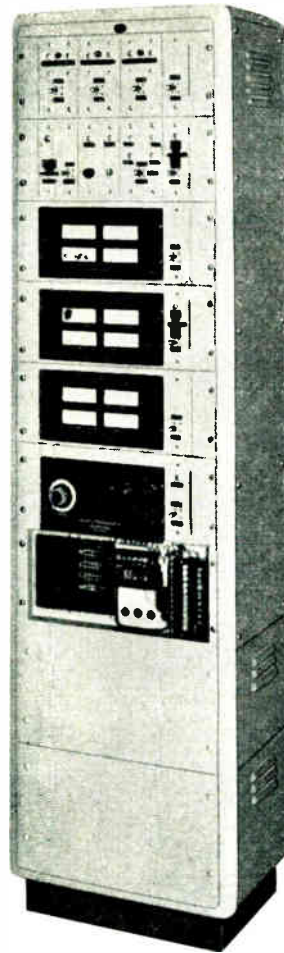

Plant and Instrumentation Engineers can now save cost, space and time in setting-up a wide variety of measurement and control systems

From the extensive range of basic units which includes scanning equipment, timers, discriminators, alarms, detectors, etc. (to name a few), systems can be assembled for numerous applications.

*Applications include —*

- Automatic Inspection**
- Warning and Timing Systems**
- Data Distribution**
- Function Plotting**
- Multi point temperature recording and control**

These are only a few. From the range of standard units a low-cost system for most purposes can be devised

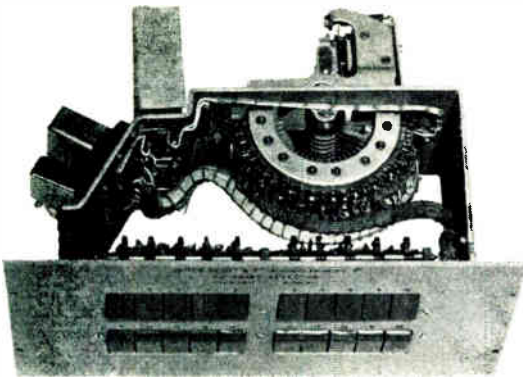

*The illustration is of the basic switch unit in the scanning equipment series—three of these are shown incorporated in the rack*

**Complete Control - Measurement - Warning Systems in compact 'build-up' Units**

**James Scott (ELECTRONIC ENGINEERING) Ltd**

**68 BROCKVILLE STREET,  
CARNTYNE INDUSTRIAL  
ESTATE, GLASGOW, E.2  
TEL: SHETTLESTON 4206**

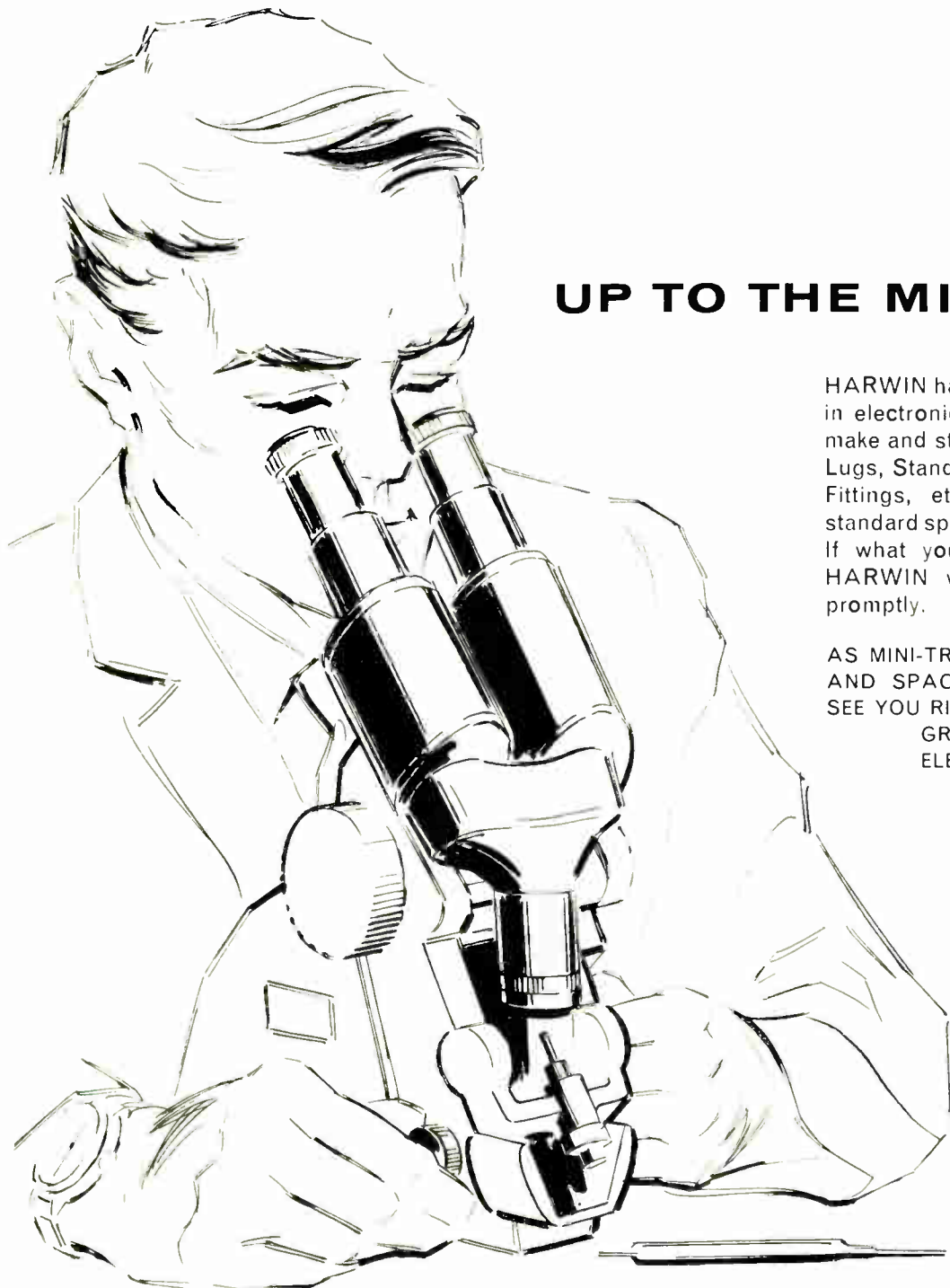

## UP TO THE MINUTE...

HARWIN have been up to the minute in electronic components for years; make and stock miniature Insulators, Lugs, Stand-offs, Brackets, Chassis Fittings, etc., up to and beyond standard specifications. Off the shelf. If what you need does not exist, HARWIN will make it. Precisely, promptly.

AS MINI-TRONIC SAYS 'WHEN TIME AND SPACE ARE TIGHT, HARWIN SEE YOU RIGHT.'

GREAT FOR MINIATURE ELECTRONIC COMPONENTS.



*Telephone or write:*

**HARWIN ENGINEERS LTD., RODNEY ROAD,  
PORTSMOUTH, HAMPSHIRE**

**Telephone: PORTSMOUTH 35555 (4 lines)**

# HARWIN

*For your D.C.  
Control Systems*

**H.E.D**

**TRANSISTORISED**

**PACKAGED**

**UNITS**

**D.C. POWER AMPLIFIERS** type PA-1, PA-2, PA-3

Available in 20 watt or 100 watt output power ratings, these amplifiers require an input of only a few micro-watts. When used in closed-loop systems together with Reference Unit RU-1, they permit regulation of the controlled quantity to within  $\pm 0.5\%$ .

**TYPICAL APPLICATIONS**

- \* Driver Amplifiers for Saturable Reactors
- \* Alternator and Generator output Stabilisation
- \* Remote Position Control Systems
- \* Contactor or Solenoid Operation from very low power levels

**REFERENCE UNIT** type RU-1

A 30 volt 100 mA stabilised direct voltage source, for use as a reference in closed-loop systems. Incorporates electronic short circuit protection.

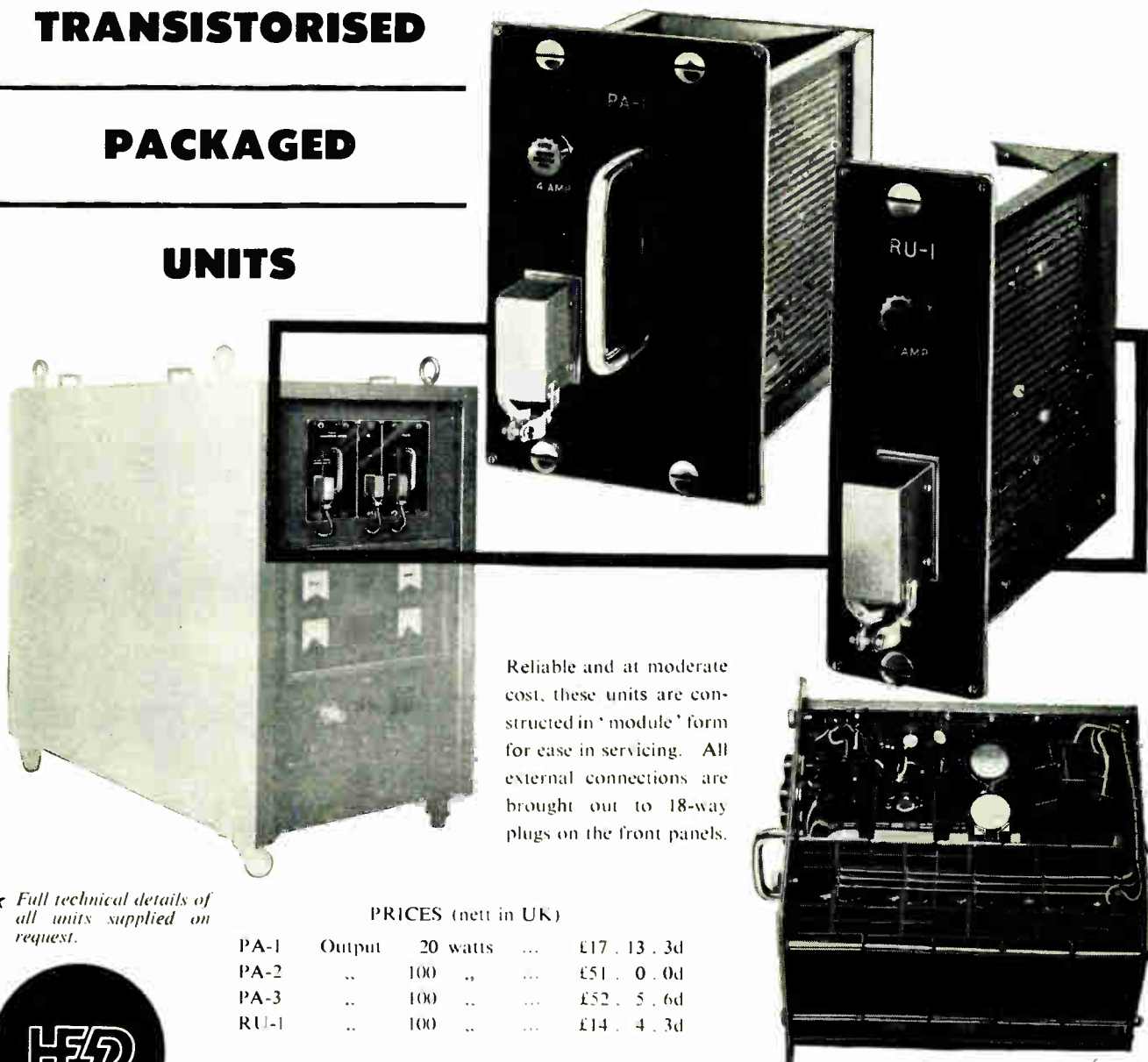

Reliable and at moderate cost, these units are constructed in 'module' form for ease in servicing. All external connections are brought out to 18-way plugs on the front panels.

★ Full technical details of all units supplied on request.

**PRICES** (nett in UK)

PA-1	Output	20 watts	...	£17 . 13 . 3d
PA-2	..	100 ..	...	£51 . 0 . 0d
PA-3	..	100 ..	...	£52 . 5 . 6d
RU-1	..	100 ..	...	£14 . 4 . 3d



**HIRST ELECTRONIC LTD.**

GATWICK ROAD, CRAWLEY, SUSSEX

Telephone: Crawley 25721-2-3-4

# ALL-PURPOSE/PORTABLE

## COSSORSCOPE MODEL 2000

Versatile performance and portability alone make Cossorscope Model 2000 today's most useful oscilloscope for general purpose work in the servicing establishment and research laboratory. Lightweight (34½ lb.) and compact (15 in. x 11 in. x 17 in.), it incorporates two identical Y amplifiers and 2 built-in pre-amplifiers for Y deflection. The sensitivity ranges are ample for use with transistor equipment and low-output electro-mechanical transducers. A d.c. coupled X amplifier of variable gain provides sweep expansion on all time-base ranges and can alternatively be used for X-Y presentation.

Cossor manufacture the most extensive range of oscilloscopes commercially available. Please write for details of instrumentation comprising over 50 different aids to industry.

## SPECIFICATION

**CATHODE-RAY TUBE:** Cossor 4 in. (10 cm) double-gun tube, operating at 1.5 kV with green fluorescence. Blue or long afterglow tubes available to special order. Individual brightness and focus controls provided for each beam.

**Y1 AMPLIFIER:** Frequency response: d.c. to 5 Mc/s, better than -3 dB.

Rise-time: 70 µsec.

Output deflection: not less than 6 cm.

Sensitivity: calibrated 100 mV/cm to 100 V/cm, in steps of 1, 3 and 10. Variable: 3:1 on each range.

Input Attenuator impedance: 1 MΩ, 30 pF on all ranges.

**Y2 AMPLIFIER:** Identical with Y1 amplifier.

**Y PRE-AMPLIFIERS (two):** Sensitivity: 1 mV/cm, bandwidth 10 c/s to 200 kc/s and 10 mV/cm, bandwidth 5 c/s to 1.0 Mc/s, better than -3 dB.

Input impedance: 1 MΩ.

In normal operation, positive input signals deflect both traces upwards.

**TIME-BASE:** 21 calibrated ranges from 3 sec/cm to 1 µsec/cm.

Sweep expansion × 10.

Effectively d.c. coupled bright-up pulse to CRT grid gives uniform brightness along the trace length and sweep bright-up on all ranges.

**TRIGGER:** Four modes of operation: Auto, Fast, Slow, TV Frame. Positive or negative from 50 c/s, internal or external. Adjustable Trig-Level and Trig-Rep., controls permit initiation of scan from any part of the waveform. Range of level control ±30 V for external signals.

Sensitivity: internal 3 mm deflection. External 0.1 V.

Delay: four overlapping ranges cover 4 µsec to 2.5 msec (extendable to 50 msec). Variable control (FINE) is uncalibrated.

**X AMPLIFIER:** d.c. to 1 Mc/s, -3 dB. Variable sensitivity 0.5 V/cm to 2 V/cm.

**CALIBRATION: Voltage.** By internally generated waveform switched through the amplifier. Accuracy ±3%. When input attenuator is accurately set on 0.1 V/cm range, ranges 0.3 V/cm to 100 V/cm are within ±5%.

**Time.** Directly calibrated in time/cm, accuracy ±5% on basic ranges.

High Frequency Time Marker. 50 µsec, ±3% intensity modulation for accurate measurement of pulse rise-time. Synchronized to time-base.

**GENERAL:** Illuminated graticule with variable control. External Z-modulation terminal.

Direct access to Y plates.

Sweep saw-tooth (100 V) available at front panel.

Fittings for attachment of Camera Model 1428 or Model 1458.

**POWER SUPPLY:** Mains. 110 V and 220 V with taps ±5 V, ±10 V, and ±20 V.

Frequency: 50 c/s to 60 c/s.

Consumption: 100 W (approximate).

**SIZE AND WEIGHT:**

Height 15 in. (38.1 cm).

Width 11 in. (27.9 cm).

Depth 17 in. (43.2 cm).

Weight 34½ lb. (15.7 kg).

**OPTIONAL EXTRA:** Probe Model 2005 (for Y1 and Y2 amplifiers).

Input impedance: 10 MΩ, 9 pF.

Attenuation × 10.

*Continuous development may result in minor changes to design.*



# COSSOR

INSTRUMENTS LIMITED

COSSOR INSTRUMENTS LIMITED, THE PINNACLES.





# THE NEW COSSORSCOPE 2000

ELIZABETH WAY, HARLOW, ESSEX, ENGLAND. TEL : HARLOW 26862

17

# THE SOUND OF THE FUTURE IS HERE...

## First issue of a new international quarterly

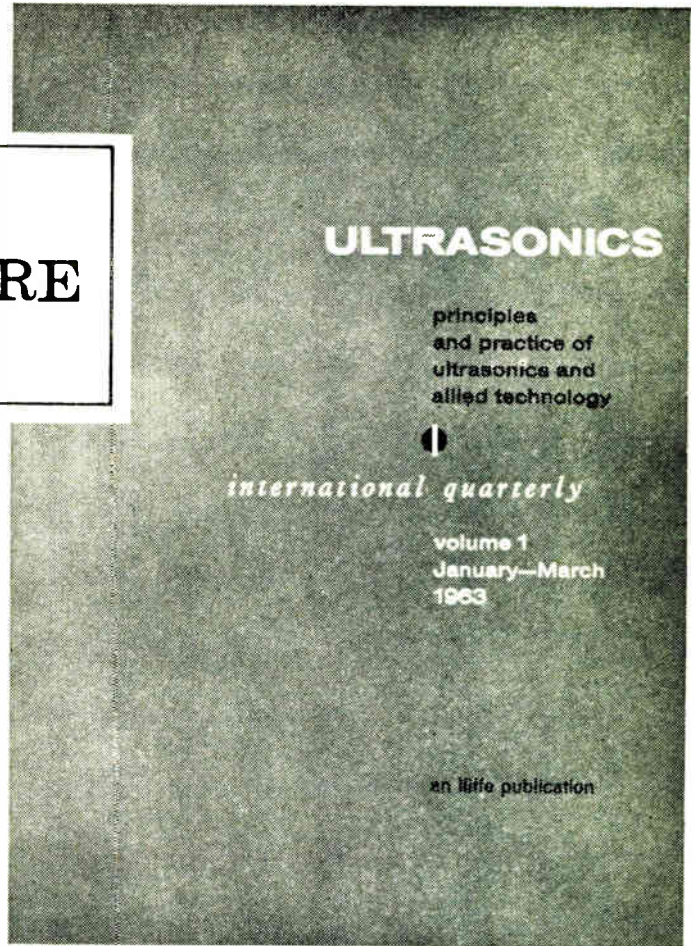

**THE SOUND OF THE FUTURE** is inaudible. But when its high energy is harnessed to the needs of science and industry, this sound can clean, cut, weld, mix, separate, signal, photograph, form, count, measure, probe, test and examine. In fact, ultrasonics is a tool, not of the future, but of *NOW*.

The application of ultrasonics is rapidly extending through industry, research and medicine. Technology too is developing with astonishing speed. Improvements in the energy source, detection and control, invention of new devices and refinements of technique occur with increasing frequency. **ULTRASONICS**, the world's only journal wholly devoted to this important subject, records and interprets all major advances for technologists, designers and research workers in the most diverse fields. The vital service which it provides is guided by editors of international repute supported by a worldwide editorial board and a panel of specialist contributors. **ULTRASONICS** is published quarterly and the first issue is out now. Make sure that you have this essential information from the start.

### BRILLIANT JAN.—MARCH CONTENTS INCLUDE:

- Piezoelectric flexure transducer elements.
- Ultrasonic inspection and evaluation of plastics materials.
- Applications of ultrasonics in the Soviet Union.
- A physical survey of the ultrasonic treatment of Meniere's disease.
- Survey on cavitation effect.
- High energy ultrasonic measurements in liquid.
- Standardization of non-destructive tests.
- Conference Reports from Padua, Copenhagen and London.
- Reviews of ultrasonic equipment.
- Abstracts from foreign literature—notably Russian and Eastern European—detachable for filing.

# ULTRASONICS

Iliffe Industrial Publications Ltd., Dorset House, Stamford St., London, S.E.1.  
Please supply **ULTRASONICS** quarterly from January. I enclose 12 months' subscription of £4.0.0. (U.S.A., Canada \$12.00).

NAME .....

COMPANY .....

ADDRESS .....

DATE ..... I.E.2

A new **ILIFFE** journal

## OUT NOW

—read it from the start

# Let the

## INDUSTRIAL ELECTRONICS

### READER ENQUIRY SERVICE

# help you to obtain more information

Circle the code numbers of the items in which you are interested. Insert your name and address, etc., in block capitals and post the card to us.

We will communicate with the manufacturers concerned and arrange for the information you require to be sent to you without obligation.

*(No postage stamp is required if posted in Great Britain or Northern Ireland)*

### Is this your own copy ?

Each month INDUSTRIAL ELECTRONICS will bring you news of the latest applications, the most recently announced equipment, produced by the rapidly expanding electronics industries of the world.

It is invaluable to all management and production executives, and engineers, in industry generally, who need to be informed of the latest developments in electronic aids to industry.

**MAKE SURE OF YOUR COPIES  
USE THE ORDER CARD NOW**

## INDUSTRIAL ELECTRONICS

## READER ENQUIRY SERVICE

FEBRUARY 1963 — For further information circle appropriate number

Editorial code number—		1	2	3	4	5	6	7	8	9	10	11	12	13	14	15	
16	17	18	19	20	21	22	23	24	25	26	27	28	29	30	31	32	33
34	35	36	37	38	39	40	41	42	43	44	45	46	47	48	49	50	51
52	53	54	55	56	57	58	59	60	61	62	63	64	65	66	67	68	69
70	71	72	73	74	75	76	77	78	79	80	81	82	83	84	85	86	87
Advertisement code number—		200	201	202	203	204	205	206	207	208	209	210	211	212	213		
214	215	216	217	218	219	220	221	222	223	224	225	226	227	228	229	230	231
232	233	234	235	236	237	238	239	240	241	242	243	244	245	246	247	248	249
250	251	252	253	254	255	256	257	258	259	260	261	262	263	264	265	266	267

I would also like details of.....

Your Name..... Position held.....

Name of Firm.....

Address.....

Nature of Business.....

PLEASE USE BLOCK CAPITALS

Postage will be paid by Associated Iliffe Press

No Postage Stamp necessary if posted in Great Britain or Northern Ireland

**BUSINESS REPLY CARD**  
Licence No. SE 591

**"INDUSTRIAL ELECTRONICS",  
DORSET HOUSE,  
STAMFORD STREET,  
LONDON, S.E.1**

FEBRUARY 1963

## INDUSTRIAL ELECTRONICS

### SUBSCRIBER'S ORDER FORM

#### Subscription Rates

Home and Overseas £3. 0s. 0d.

USA and Canada \$8.50

Please supply

INDUSTRIAL ELECTRONICS monthly for the next 12 months

I will remit on receipt of invoice

NAME.....

ADDRESS.....

Postage will be paid by Associated Iliffe Press

No Postage Stamp necessary if posted in Great Britain or Northern Ireland

**BUSINESS REPLY CARD**  
Licence No. SE 591

**"INDUSTRIAL ELECTRONICS",  
DORSET HOUSE,  
STAMFORD STREET,  
LONDON, S.E.1**

# Let the

## **INDUSTRIAL ELECTRONICS**

### **READER ENQUIRY SERVICE**

# help you to obtain more information

**INDUSTRIAL ELECTRONICS**

### **READER ENQUIRY SERVICE**

**FEBRUARY 1963 — For further information circle appropriate number**

Editorial code number—	1	2	3	4	5	6	7	8	9	10	11	12	13	14	15
16	17	18	19	20	21	22	23	24	25	26	27	28	29	30	31
32	33	34	35	36	37	38	39	40	41	42	43	44	45	46	47
48	49	50	51	52	53	54	55	56	57	58	59	60	61	62	63
64	65	66	67	68	69	70	71	72	73	74	75	76	77	78	79
80	81	82	83	84	85	86	87								

Advertisement code number—	200	201	202	203	204	205	206	207	208	209	210	211	212	213
214	215	216	217	218	219	220	221	222	223	224	225	226	227	228
229	230	231	232	233	234	235	236	237	238	239	240	241	242	243
244	245	246	247	248	249	250	251	252	253	254	255	256	257	258
259	260	261	262	263	264	265	266	267						

I would also like details of.....

Your Name..... Position held.....

Name of Firm.....

Address.....

Nature of Business.....

**PLEASE USE BLOCK CAPITALS**

Circle the code numbers of the items in which you are interested. Insert your name and address, etc., in block capitals and post the card to us.

We will communicate with the manufacturers concerned and arrange for the information you require to be sent to you without obligation.

*(No postage stamp is required if posted in Great Britain or Northern Ireland)*

### **Is this your own copy ?**

Each month **INDUSTRIAL ELECTRONICS** will bring you news of the latest applications, the most recently announced equipment, produced by the rapidly expanding electronics industries of the world.

It is invaluable to all management and production executives, and engineers, in industry generally, who need to be informed of the latest developments in electronic aids to industry.

**MAKE SURE OF YOUR COPIES  
USE THE ORDER CARD NOW**

Postage will be paid by Associated Iliffe Press

No Postage Stamp necessary if posted in Great Britain or Northern Ireland

**BUSINESS REPLY CARD**  
Licence No. SE 591

**"INDUSTRIAL ELECTRONICS",  
DORSET HOUSE,  
STAMFORD STREET,  
LONDON, S.E.1**



## K - RELAY

plug-in type

up to 6PDT  
contacts

D.C. operated  
coil

stock delivery

low prices

miniature dimensions

2. 1/8" x 25/32" x 1.3/16"

AGENCIES REQUIRED ; SEVERAL AREAS OPEN

Please ask for literature describing our full range of relays

**H. KUHNKE LTD.**

163 Stanwell Road, Ashford—Middlesex

Telephone: Ashford 2798 Telex: 21577

Telegrams: Kunwith Telex London

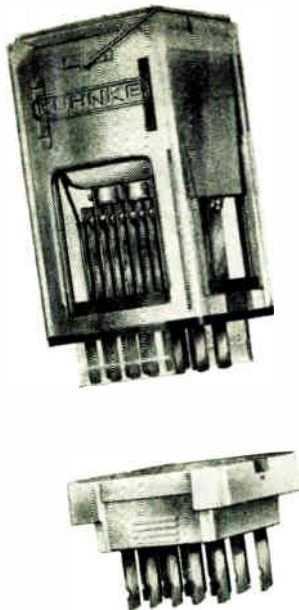

For further information circle 234 on Service Card

An important new book—the first fully  
comprehensive work to appear in this field

# ultrasonic flaw detection in metals

## Theory and practice

B. Banks, A.M.Inst.W., Hon. F.N.D.T.S.

G. E. Oldfield, A.Met., A.I.M.

H. Rawding, A.N.D.T.S.

This book covers what is now one of the more important branches of the new science of non-destructive testing. The use of ultrasonics extends from the examination of material before initial working to the subsequent periodic examination of components and structures after installation to detect flaws caused by such factors as metal fatigue or irradiation. Invaluable to all engineers connected with quality production, and above all, gives the Test Inspectorate the "know-how" which otherwise would take many years of personal experience to acquire.

63s net by post 64s 256pp plus 30pp of plates

obtainable from leading booksellers

Published for WELDING AND METAL FABRICATION by  
**ILIFFE Books Ltd.**

DORSET HOUSE STAMFORD STREET LONDON S.E.1

# SINTERED

## PERMANENT MAGNET MATERIALS

The extensive range of modern permanent magnet alloys has been developed to meet the increasing demands of industry.

Murex Limited specialise in the production of permanent magnets by the powder metallurgy technique. These magnet alloys can be divided into two categories, isotropic and anisotropic. Isotropic alloys show equal magnetic properties in all directions and anisotropic alloys exhibit enhanced properties along certain pre-determined paths.

Permanent magnet alloys currently manufactured by Murex are:—

<b>ALNICO</b> isotropic	Br 7,000	Hc 550	BHmax 1.5
<b>ALCOMAX III</b> anisotropic	Br 11,000	Hc 620	BHmax 4.1
<b>ALCOMAX IV</b> anisotropic	Br 9,500	Hc 725	BHmax 3.5
<b>HYCOMAX</b> anisotropic	Br 8,100	Hc 810	BHmax 2.6
<b>COMALLOY</b> isotropic	Br 10,000	Hc 250	BHmax 1.0

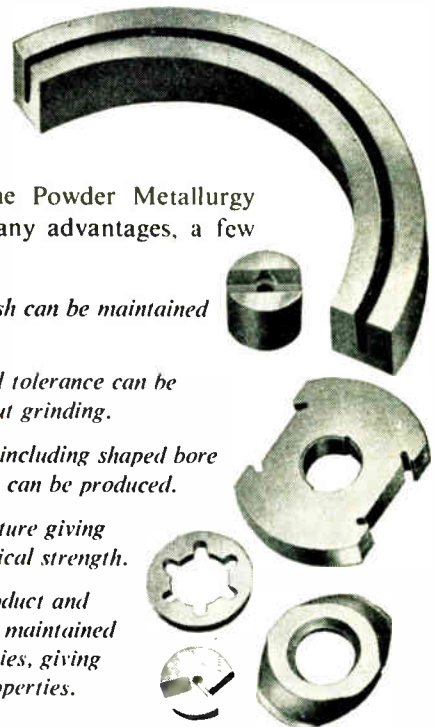

Manufacture by the Powder Metallurgy technique offers many advantages, a few of which are:—

- Good surface finish can be maintained without grinding.
- Close dimensional tolerance can be maintained without grinding.
- Complex shapes, including shaped bore and counterbores, can be produced.
- Fine crystal structure giving increased mechanical strength.
- Uniformity of product and alloy composition maintained over large quantities, giving consistency of properties.

More detailed information on these materials, together with design data and a list of standard shapes and sizes currently available can be provided on request. Technical Personnel are available to advise customers upon the use and application of these materials.

## MUREX LIMITED

(Powder Metallurgy Division)

**Rainham, Essex** Rainham, Essex 3322

Telex 28632 Telegrams: Murex, Rainham-Dagenham Telex.

London Sales Office: Central House, Upper Woburn Place, W.C.1. Tel. EU5ton 8265

**An essential, comprehensive volume . . .**

# AUTOMATIC CONTROL HANDBOOK

Advisory editor  
**G. A. T. Burdett**

This new book fully covers automatic control systems using mechanical, electrical, electronic, hydraulic, electro-hydraulic, pneumatic, nucleonic, pneumatic-hydraulic, electro-pneumatic and temperature operated techniques.

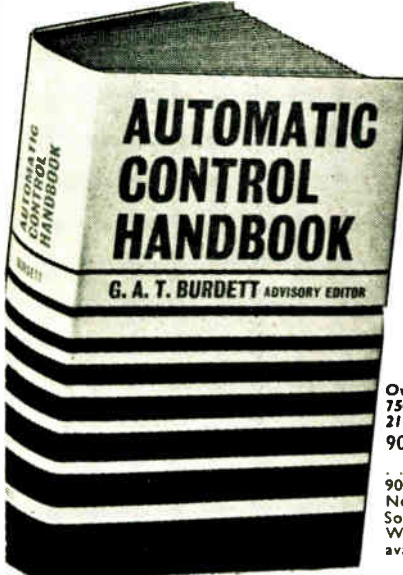

**CONTENTS**  
Electric Motors and Control Systems. Relays and Solenoids. Switching. Electric Servo Systems. Magnetic and Rotating Amplifiers. Voltage Control and Stabilisation. Tubes and Transistors for Electronic Control. Materials, Cables and Wiring. Transducers. Nucleonic Switching and Photoelectric Equipment. Analogue Computers. Mechanical Handling. Lubrication. Temperature Control. Control of Fluids. Hydraulic Power Units and Servos. Pneumatic Control. Gauging and Sizing. Counting Devices. Machine Tool Programming. Gyroscopes. Closed-Circuit Television.

Over 900 pages  
750 diagrams and tables  
21 sections 35 contributors  
90s. from all Booksellers

... or, in case of difficulty, 90s. POST FREE from George Newnes Ltd., Tower House, Southampton Street, London, W.C.2. (Descriptive leaflet available.)

**NEWNES**

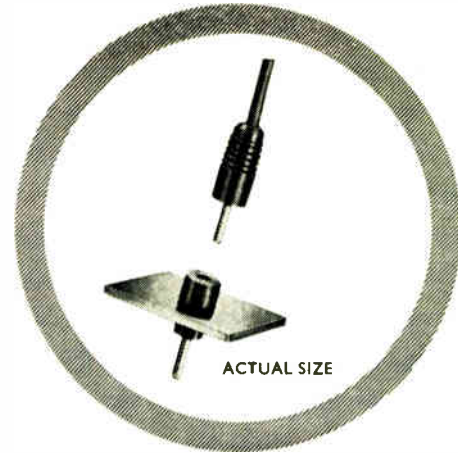

## BARB PLUGS AND SOCKETS

The Oxley plugs and sockets are rapidly assembled connectors of outstanding electrical and mechanical characteristics, the design of the bush making maximum use of the elastic and insulating properties of polytetrafluoroethylene.

The socket tube is a one piece component, heavily silver plated (with an optional gold flash) slit longitudinally to exploit the elastic properties of the insulating bush so providing the necessary retention of the plug under the most arduous conditions.

To fit .156" dia. chassis hole.

Both plugs and sockets supplied: Black, Brown, Red, Orange, Yellow, Green, Blue, Violet, Grey and White. Packed in sealed packets of 100.

Further details supplied on request.

# OXLEY

OXLEY DEVELOPMENTS CO. LTD., ULVERSTON, LANCS.

**A unique new book which will solve the problem of communication**

# SIX-LANGUAGE DICTIONARY OF AUTOMATION, ELECTRONICS AND SCIENTIFIC INSTRUMENTS

OVER 5500

technical terms in English, French, German, Italian, Spanish and Russian

105s net by post 107s 9d  
10" x 8" 732 pp.

from leading booksellers

Compiled by a team of multi-lingual technologists fully conversant with the latest terminology, this new dictionary will enable anyone, whether scientist, engineer or technologist, to read and understand the technical literature on electronics and automation control in any one of the six principal languages of which he already has a basic knowledge.

The scope of the dictionary is indicated by the fact that it contains the equivalents in each language of over 5,500 terms in the basic English glossary. Essential for libraries and professional translators, it is invaluable to everyone who must be familiar with current international developments in the fields of automation and electronics.

Published by **ILIFFE Books Ltd** DORSET HOUSE STAMFORD STREET LONDON S.E.1

# INDUSTRIAL ELECTRONICS

Press date for the March 1963 issue is  
first post 20th February 1963

## CLASSIFIED ADVERTISEMENTS

Advertisement Rates. 6d. per word, minimum charge 6/-, each paragraph charged separately. Remittances payable to "Industrial Electronics", Dorset House, Stamford St., S.E.1. Series discount of 15% is allowed for 12 consecutive insertions.

Box Numbers are available at an additional charge of 2/- to defray cost of registration and postage. Replies should be addressed Box No. 0000, c/o "Industrial Electronics", Dorset House, Stamford Street, London, S.E.1.

Semi-Display advertisements with centralized lines £1/15/- per single column inch, Display advertisements £2/10/- per single column inch—no additional charge for Box Numbers. The Publishers are not responsible for clerical or printers' errors although every care is taken to avoid mistakes.

### SITUATIONS VACANT

**SENIOR ELECTRONICS ENGINEER** required to take charge of project overseas. Candidates must be single and medically fit and in age group 26 to 32 years.

Qualifications: H.N.C. or Fina. City and Guilds Telecoms or equivalent. In addition to technical ability candidates must be capable of dealing with staff, general organisation and administration at field level. Box No. 5183. [2014]

### WANTED

Job, Bankrupt and Frustrated goods, export or other of any description bought. Cash paid at once. No lot too large to handle. Smithgran Trading Co. Ltd., 2 Botolph Alley, London, E.C.3. Telephone Number: M1NCing Lane 9005. [2015]

### BOOKS, ETC.

"**ABACS or Nomograms.**" By A. Giet. Translated from the French by H. D. Phippen and J. W. Head. Most engineers have made use of nomograms at some time in their careers, and are fully alive to the fact that they are a very convenient tool when the same formula has to be solved repeatedly for several sets of variables. It is fair to say, however, that only a small proportion of even those who habitually employ nomograms know how to construct them for their own use. Most of the comparatively small literature on the subject is written for mathematicians and is extremely difficult for the practical engineer to comprehend. This book is essentially practical, and not only demonstrates the many and varied applications of the abac or nomogram, but shows how even those without highly specialised mathematical knowledge may construct their own charts. 35s net from all booksellers. By post 36s from Iliffe Books Ltd., Dorset House, Stamford Street, London, S.E.1.

"**ADVANCED Theory of Waveguides.**" By L. Lewin. Sets out various methods of treating problems arising in work on this complex subject. The author has selected for discussion a number of topics as representative of the field in which the centimetre-wave engineer is engaged, many of the examples being concerned with the rectangular waveguide. 30s net from all booksellers. By post 31s from Iliffe Books Ltd., Dorset House, Stamford Street, London, S.E.1.

"**LONG-WAVE and Medium-wave Propagation.**" by H. E. Farrow, Grad.I.E.E., B.B.C. Engineering Training Department. The main features of propagation at low and medium frequencies, 30-3,000kc/s, and in particular the broadcasting bands 150-285kc/s and 525-1,650kc/s, are explained. There are sections on aerials, ground and sky-waves attenuation due to earth losses, recovery effects, mixed path propagation, synchronized group working, ionospheric reflection, fading and low-power installations. 4s 6d net from all booksellers. By post 4s 10d from Iliffe Books Ltd., Dorset House, Stamford Street, London, S.E.1.

"**LAPLACE Transforms for Electrical Engineers.**" By B. J. Starkey, Dipl.Ing., A.M.I.E.E. A presentation of the theory of the Laplace transformation in which a physical vocabulary rather than a purely mathematical one is used as far as possible in an attempt to attain the utmost simplicity. This method of analysis has become of increasing importance to electrical engineers in many fields during recent years, and the work is designed to provide a thorough treatment of the subject in a language with which they will be familiar. 30s net from all booksellers. By post 31s 2d from the publishers: Iliffe Books Ltd., Dorset House, Stamford Street, London, S.E.1.

Swedish Radio-TV company with growing international market seeks for its further work in

## colour-TV development

a qualified tele-engineer with several years' experience from independent and successful research work.

All the resources of a modern enterprise together with good terms of employment offer the prospect of success and wellbeing at work and leisure.

If you are interested in the post, a short and informal reply with your qualifications, age, salary status, earliest starting date and references will suffice for a first contact, addressed to "Colour TV", Box No. 5179, c/o "Industrial Electronics".

The first comprehensive survey — transmission — reception — servicing

## COLOUR TELEVISION

NTSC System, Principles and Practice

P S Carnt B Sc (Eng) ACGI AMIEE  
and G B Townsend B Sc Inst P MIEE AKC

obtainable from leading booksellers

A comprehensive survey of the British adaptation of the American NTSC system. Introductory chapters are included which will enable the reader to understand the principles of colour measurement and the behaviour of the human eye in relation to colour reception. Most aspects of the transmission and reception of colour signals are discussed, though the emphasis is on the latter. For the service engineer, chapters on fault finding have been included which illustrate the practical approach to colour television. Block diagrams, given as well as full circuits, explain the connection between various component units.

85s net by post 86s 9d 487 pages 233 illustrations

Published by ILIFFE Books Ltd. Dorset House, Stamford Street, London, S.E.1

For further information circle 239 on Service Card

# REDUCE DEVELOPMENT COSTS OF SEMI-CONDUCTOR CIRCUITRY

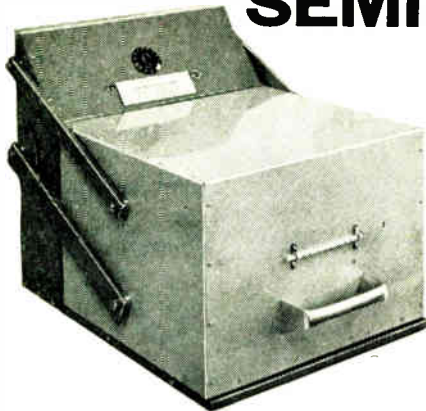

The extensive use of temperature sensitive semi-conductor devices in modern electronic circuitry has demanded the testing in the development stage of these circuits under elevated temperature conditions.

The LAB-OVEN allows a unit under test to remain undisturbed on the base while its temperature is raised to the controlled level or dropped to room ambient. Furthermore, wires for power supplies, test instruments, etc., may extend from the unit, and although these may prevent the oven closing down completely, this will not affect the working temperature, since the unit under test is raised by the thermally insulated platform inside the oven, and the hot air level will be brought down to cover the unit. Moreover, quick changes of components may be effected with a soldering iron without the necessity of removing the test unit, since the hot air trapped inside the oven may be immediately lowered over the test unit.

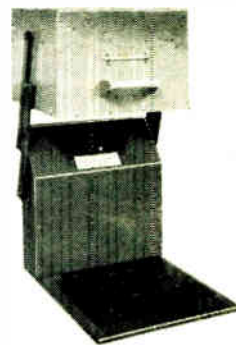

## WITH CONTRONICS LAB-OVEN

### SPECIFICATION OF STANDARD MODEL

Overall size: 19½" deep x 16" wide x 16" high.  
 Oven Cubic Capacity: 1 ft. Cube approx.  
 Temperature Control: Transistorised Thermostatic regulator 25°C.-100°C. plus or minus 1°C.  
 Temperature Gradient: Approximately 2°C.  
 Thermometer: Side fitting mercury thermometer.  
 Heating Element: 275 watt element.

Price £45.0.0 nett.

We shall be glad to advise on your own Control problems, for we design and manufacture Electronic Equipment to customers' specialised requirements. Standard units include:—Photo-electric relays, High-speed Batching Counters, Mis-feed protection Controls, Infra-red alarms, Daylight Intensity Switches, Electronic Tachometers, Proximity relays, Time Delay relays, Sequential Timers.



# CONTRONICS

LIMITED

Blackdown, Nr. Aldershot, Hants. Tel. Deepcut 236

For further information circle 240 on Service Card

## LAPLACE TRANSFORMS FOR ELECTRICAL ENGINEERS

By *B. J. Starkey, Dipl. Ing., A.M.I.E.E.* A presentation of the theory of Laplace transformation in which a physical vocabulary rather than a purely mathematical one is used as far as possible. This method of analysis has become

of increasing importance to electrical engineers in many fields, and the work is designed to provide them with a thorough treatment of the subject in a language with which they will be familiar.

**30s. net** BY POST 31s. 2d.

From leading booksellers, published by **ILIFFE Books Ltd.**, Dorset House, Stamford Street, London, S.E.1

### Index to Advertisers

Adeola Products Ltd. ....	20	Ferranti Ltd. ....	3	Oxley Developments Co. Ltd. ....	30
Aircraft Marine Products Ltd. ....	14	Harwin Engineers Ltd. ....	24	Phoenix Telephones Ltd. ....	17
APT Electronics Industries Ltd. ....	10	Hassett & Harper Ltd. ....	20	Rist's Wires & Cables Ltd. ....	16
Appointments Vacant ....	31	Hirst Electronic Ltd. ....	25	Scott, James, Ltd. ....	23
Bradley, G. & E., Ltd. ....	21	Hughes International (U.K.) Ltd. ....	9	Silentbloc Ltd. ....	4
Cannon Electric Co. Ltd. ....	15	Iliffe Books Ltd. ....	29, 30, 31	Solartron Electronic Group Ltd. ....	12, 13
CIBA (A.R.L.) Ltd. ....	Cover iv	Kuhnke, H., Ltd. ....	29	Standard Telephones & Cables Ltd. ....	5, 6, 7, 22
Contronics Ltd. ....	32	Midland Silicones Ltd. ....	Cover iii	Telequipment Ltd. ....	1
Cossor Instruments Ltd. ....	26, 27	Mullard Equipment Ltd. ....	Cover ii	Ultrasonics ....	28
Dawe Instruments Ltd. ....	18	Murex Ltd. ....	29	Wayne Kerr Ltd. ....	2
English Numbering Machines Ltd. ....	19	Newnes, George, Ltd. ....	30	Westinghouse Brake & Signal Co. Ltd. ....	11
Ericsson Telephones Ltd. ....	8				

Printed in Great Britain for the Publishers, Iliffe Electrical Publications Ltd., Dorset House, Stamford Street, London, S.E.1, by The Chapel River Press Ltd., Andover, Hants. Distributed in U.S.A. by Eastern News Company, 306 West 11th Street, New York, 14



## SILICONE RESIN-BONDED GLASSCLOTH LAMINATES offer:

- excellent dielectric properties over a wide frequency range
- low water absorption
- high arc resistance
- operation up to 250°C.

Available in a wide variety of shapes, the applications of silicone-glass laminates include: printed circuits, coil formers, and supporting or separating materials in all types of electrical equipment.

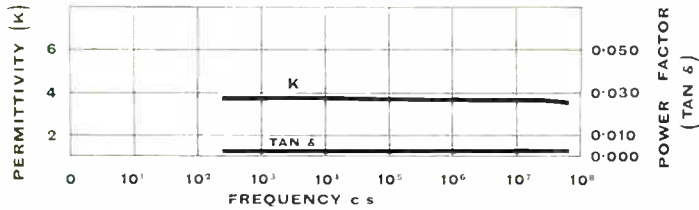

For a guide to the properties and applications of silicone-glass laminates and a list of manufacturers please write for our booklet L18.



**MIDLAND SILICONES LTD** *first in British Silicones*

(Associated with Albright & Wilson Ltd. and Dow Corning Corporation)

68 Knightsbridge, London, SW1 Tel: Knightsbridge 7801

Area Sales Offices: Birmingham, Glasgow, Leeds, London, Manchester. Agents in many countries

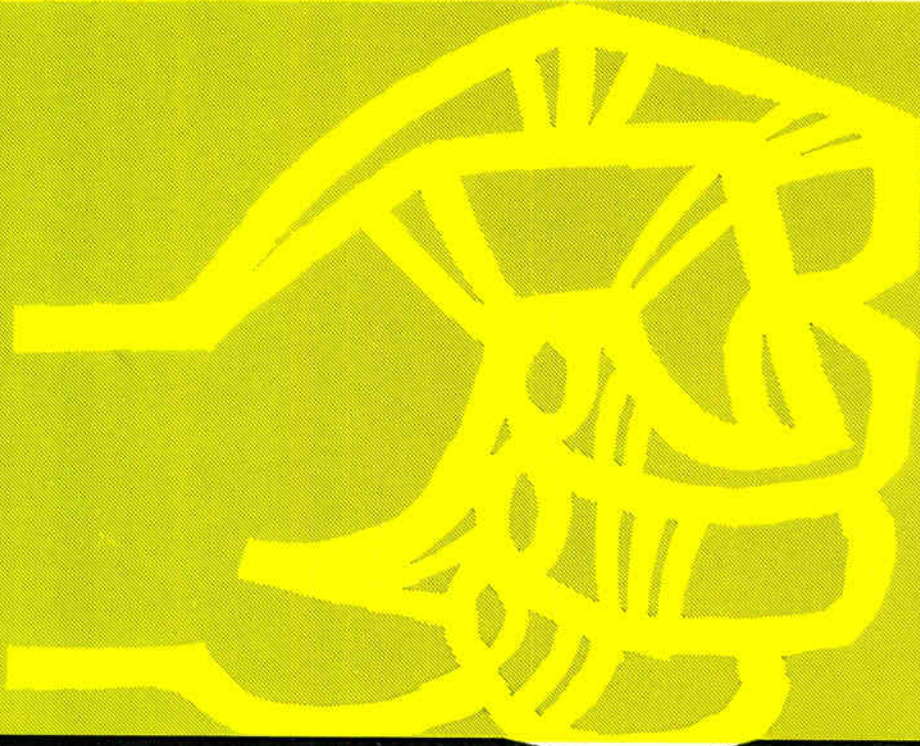

**DOWN**  
WITH DIELECTRIC LOSSES!

For further information circle 202 on Service Card

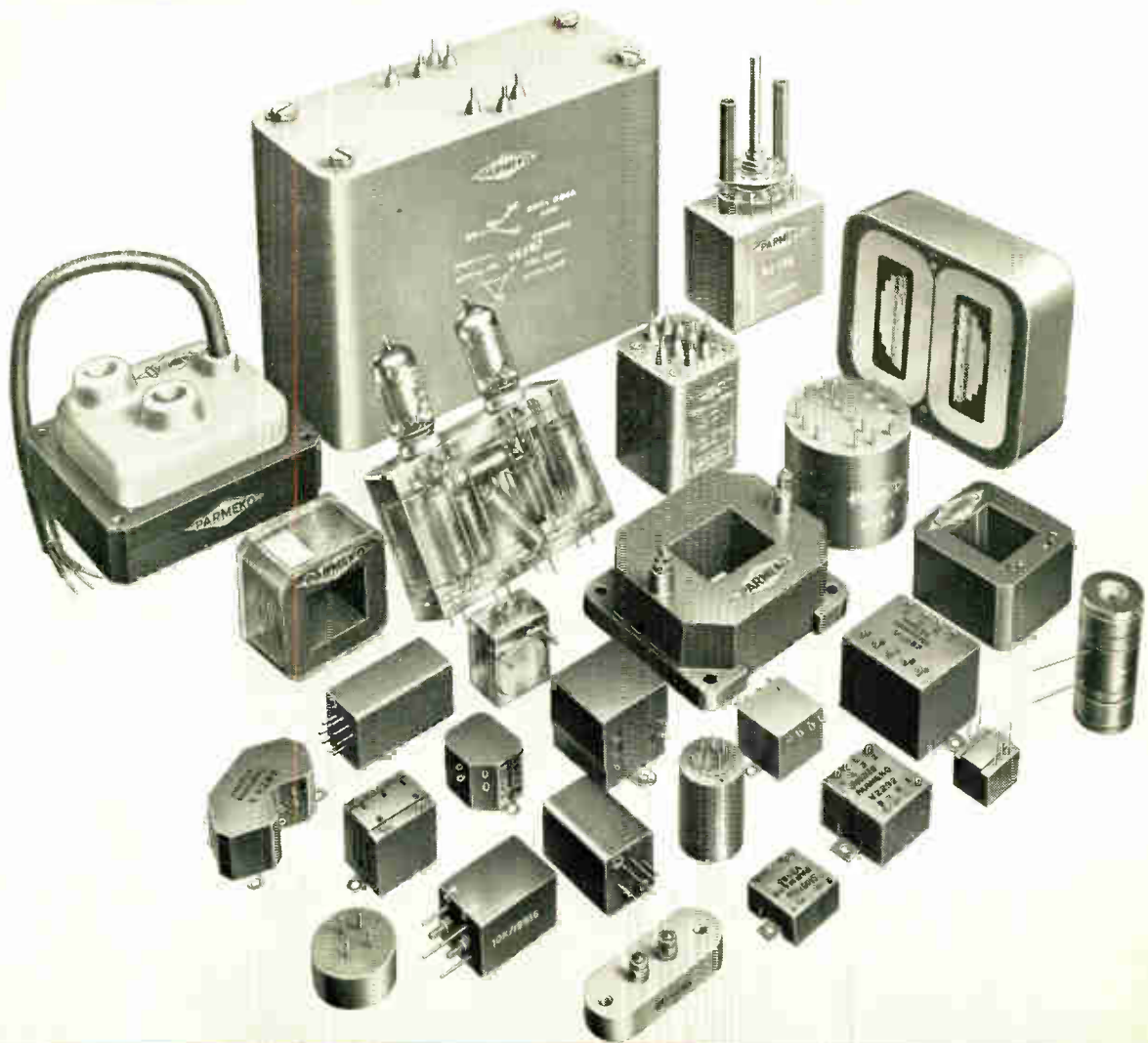

## This great variety . . .

### Araldite epoxy resins are used:

- for casting high grade solid electrical insulation
- for impregnating, potting and sealing electrical windings and components
- for producing glass fibre laminates
- for producing patterns, models, jigs and tools
- as fillers for sheet metal work
- as protective coatings for metal, wood and ceramic surfaces
- for bonding metals, ceramics etc.

... part of the range of radio and electronic components by Parmeko Ltd, Leicester, emphasises the versatility of Araldite epoxy resins for potting and encapsulation. Low shrinkage and the absence of volatiles during the curing process enable a simple casting process to be used, even with units of complicated shape. Components may be fully embedded and no voids are formed.

The resin adheres strongly to metals, ceramics etc., so that brackets, attachments and terminals can be cast *in situ*. The cured resin provides excellent insulation up to very high voltages, gives full protection against moisture or damage, and withstands tropical conditions. By the use of suitable fillers, either a clear or opaque appearance is obtained, without detriment to the electrical properties or the strength of the components.

# Araldite

## EPOXY RESINS

Araldite is a registered trademark

CIBA (A.R.L.) LIMITED, DUXFORD, CAMBRIDGE. TELEPHONE SAWSTON 2121