

MAY 1983
80p

AN ARGUS SPECIALIST PUBLICATION

Hobby Electronics

Project Electronics For Everyone

**POPULAR
COMPUTING**
PROJECTS AND FEATURES

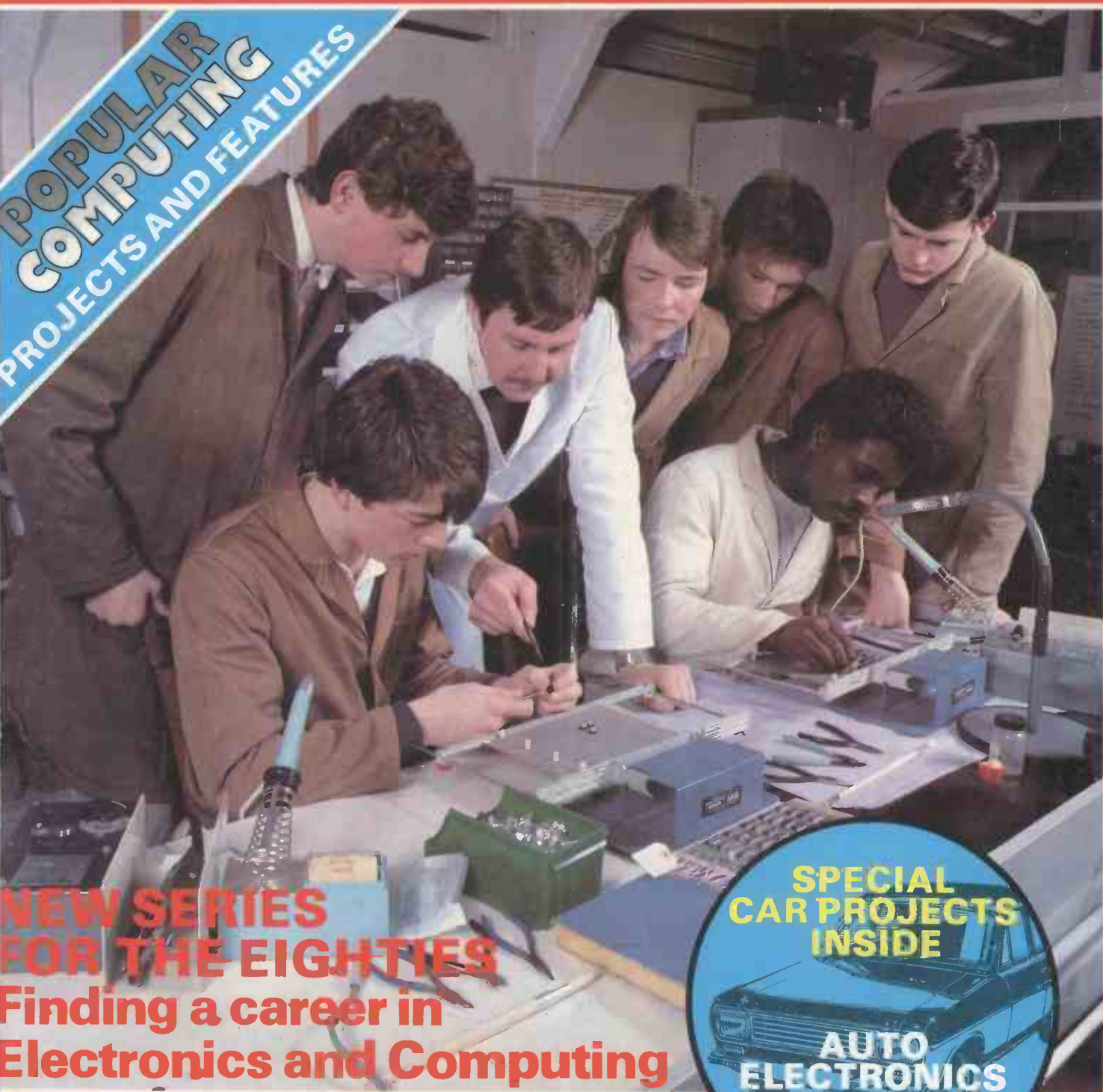

**NEW SERIES
FOR THE EIGHTIES**
Finding a career in
Electronics and Computing

Jupiter Ace Reviewed
Interface for the BBC Micro

**SPECIAL
CAR PROJECTS
INSIDE**

**AUTO
ELECTRONICS
PROJECTS TO
BUILD**

GI' US AN ORDER!

INDEX

A	95	High Voltage Dis
A.0 -	M14	High Voltage Dis
AI -	63	High Voltage Dis
AI.0 -	64	High Voltage Dis
AI.00 -	65	High Voltage Dis
AI.000 -	66	High Voltage Dis
AI.0000 -	67	High Voltage Dis
AI.00000 -	68	High Voltage Dis
AI.000000 -	69	High Voltage Dis
AI.0000000 -	70	High Voltage Dis
AI.00000000 -	71	High Voltage Dis
AI.000000000 -	72	High Voltage Dis
AI.0000000000 -	73	High Voltage Dis
AI.00000000000 -	74	High Voltage Dis
AI.000000000000 -	75	High Voltage Dis
AI.0000000000000 -	76	High Voltage Dis
AI.00000000000000 -	77	High Voltage Dis
AI.000000000000000 -	78	High Voltage Dis
AI.0000000000000000 -	79	High Voltage Dis
AI.00000000000000000 -	80	High Voltage Dis
AI.000000000000000000 -	81	High Voltage Dis
AI.0000000000000000000 -	82	High Voltage Dis
AI.00000000000000000000 -	83	High Voltage Dis
AI.000000000000000000000 -	84	High Voltage Dis
AI.0000000000000000000000 -	85	High Voltage Dis
AI.00000000000000000000000 -	86	High Voltage Dis
AI.000000000000000000000000 -	87	High Voltage Dis
AI.0000000000000000000000000 -	88	High Voltage Dis
AI.00000000000000000000000000 -	89	High Voltage Dis
AI.000000000000000000000000000 -	90	High Voltage Dis
AI.0000000000000000000000000000 -	91	High Voltage Dis
AI.00000000000000000000000000000 -	92	High Voltage Dis
AI.000000000000000000000000000000 -	93	High Voltage Dis
AI.0000000000000000000000000000000 -	94	High Voltage Dis
AI.00000000000000000000000000000000 -	95	High Voltage Dis
AI.000000000000000000000000000000000 -	96	High Voltage Dis
AI.0000000000000000000000000000000000 -	97	High Voltage Dis
AI.00000000000000000000000000000000000 -	98	High Voltage Dis
AI.000000000000000000000000000000000000 -	99	High Voltage Dis
AI.0000000000000000000000000000000000000 -	100	High Voltage Dis

AMBIT SPRING CAT

INDEX

A	95	High Voltage Dis
A.0 -	M14	High Voltage Dis
AI -	63	High Voltage Dis
AI.0 -	64	High Voltage Dis
AI.00 -	65	High Voltage Dis
AI.000 -	66	High Voltage Dis
AI.0000 -	67	High Voltage Dis
AI.00000 -	68	High Voltage Dis
AI.000000 -	69	High Voltage Dis
AI.0000000 -	70	High Voltage Dis
AI.00000000 -	71	High Voltage Dis
AI.000000000 -	72	High Voltage Dis
AI.0000000000 -	73	High Voltage Dis
AI.00000000000 -	74	High Voltage Dis
AI.000000000000 -	75	High Voltage Dis
AI.0000000000000 -	76	High Voltage Dis
AI.00000000000000 -	77	High Voltage Dis
AI.000000000000000 -	78	High Voltage Dis
AI.0000000000000000 -	79	High Voltage Dis
AI.00000000000000000 -	80	High Voltage Dis
AI.000000000000000000 -	81	High Voltage Dis
AI.0000000000000000000 -	82	High Voltage Dis
AI.00000000000000000000 -	83	High Voltage Dis
AI.000000000000000000000 -	84	High Voltage Dis
AI.0000000000000000000000 -	85	High Voltage Dis
AI.00000000000000000000000 -	86	High Voltage Dis
AI.000000000000000000000000 -	87	High Voltage Dis
AI.0000000000000000000000000 -	88	High Voltage Dis
AI.00000000000000000000000000 -	89	High Voltage Dis
AI.000000000000000000000000000 -	90	High Voltage Dis
AI.0000000000000000000000000000 -	91	High Voltage Dis
AI.00000000000000000000000000000 -	92	High Voltage Dis
AI.000000000000000000000000000000 -	93	High Voltage Dis
AI.0000000000000000000000000000000 -	94	High Voltage Dis
AI.00000000000000000000000000000000 -	95	High Voltage Dis
AI.000000000000000000000000000000000 -	96	High Voltage Dis
AI.0000000000000000000000000000000000 -	97	High Voltage Dis
AI.00000000000000000000000000000000000 -	98	High Voltage Dis
AI.000000000000000000000000000000000000 -	99	High Voltage Dis
AI.0000000000000000000000000000000000000 -	100	High Voltage Dis

THE INDEX FROM AMBIT'S SPRING CATALOGUE - AVAILABLE AT YOUR NEWSAGENT OR DIRECT - ONLY 75p, AND INCLUDING 3 x £1 DISCOUNT VOUCHERS

WE CAN DO THAT!

ambit INTERNATIONAL 200 North Service Road, Brentwood, Essex CM14 4SG
Telephone (Consumer Sales/Enquiries) 0277-230909 - Telephone (Industrial Sales/Enquiries) 0277-231616 - Telex 995194 AMBIT G. Data 24hrs (RS232/300baud) 0277-232628 - REWTEL.

- Prices exclude VAT except where otherwise shown. • Postage and Packing 60p per pre-paid order.
- Orders submitted using Ambit Stock Codes will be processed first. • Orders for in-stock items despatched same day (up to 4pm receipt).
- Hours - (consumer sales) 8am-7pm Mon-Sat: (Industrial) 8am-6pm (Mon-Fri).

Hobby Electronics

MAY 1983
Vol 5 No 5

PROJECTS

- ★STALL THIEF 20
Leaves your car burglar sitting in the road.
- ★AERIAL WITHOUT WINGS 27
Converts a car window demister to long and medium wave.
- ★HE AUTO TESTER 28
An all-in meter for car electrics.
- ★BBC MICRO/HEBOT INTERFACE 62
Hobby's personal robot moves faster than ever.

FEATURES

- ★CAREERS IN ELECTRONICS PART 1 12
The first in a major new series.
- FAMOUS NAMES 24
Charles Proteus Steinmetz.
- RADIO RULES 41
Concluding with the Radio Amateurs' Examination.
- ★ACES HIGH 47
Meet the new Jupiter Ace micro computer.
- ★DIY HIFI 52
High quality build-it-yourself loudspeakers reviewed.
- THE ELECTRONIC REVOLUTION 57
Electronics go micro.

SPECIALS

- ★SPECIAL OFFER 10
PCB-maker's kit at 1982 prices.

REGULARS

- Monitor 6
- What's On Next 18
- HE Bookshelf 33
- Buylines 34
- Points of View 36
- Clever Dick 39
- HE Subscriptions 55
- HE Backnumbers 68
- HE PCB Service 71
- HE PCB Printout 72
- Classified Advertisements 73

Editor: Ron Keeley
 Editorial Assistant: Helen Armstrong BA
 Technical Illustrator: Jerry Fowler
 Advertisement Manager: Jolyn Nice
 Divisional Advertisement Manager: Gary Price
 Managing Editor: Ron Harris BSc
 Managing Director: T.J. Connell

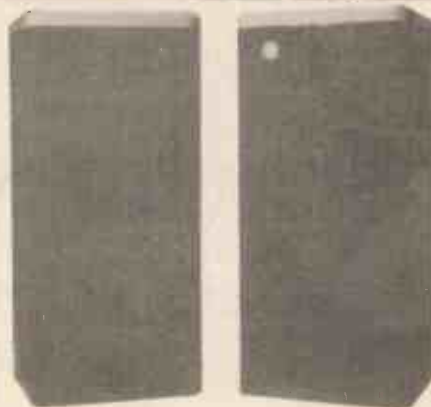

DO IT YOURSELF — page 52



CAREERS IN ELECTRONICS — page 12
 Picture courtesy of British Telecom.



BBC/HEBOT INTERFACE — page 62

Hobby Electronics is normally published on the second Friday of the month prior to the cover date.
 Hobby Electronics, 145 Charing Cross Road, London WC2H 0EE, 01-437 1002. Telex No 8811896. Published by Argus Specialist Publications Ltd.
 Design and Organisation by MM Design and Print Ltd, 145 Charing Cross Road, London WC2H 0EE, 01-437 1002.
 Distributed by S. M. Distribution Ltd, 16/18 Trinity Gardens, London SW9 8DX.
 Printed by QB Ltd, Colchester. Covers printed by Alabaster Passmore.

Notice: The contents of this publication including all articles, designs, plans, drawings and programs and all copyright and other intellectual property rights therein belong to Argus Specialist Publications Limited. All rights conferred by the Law of Copyright and other intellectual property rights and by virtue of International copyright conventions are specifically reserved to Argus Specialist Publications Limited and any reproduction requires the prior written consent of the Company. All reasonable care is taken in the preparation of the magazine to ensure accuracy, but Argus Specialist Publications Ltd cannot be held responsible legally. ©Copyright 1982 Argus Specialist Publications Ltd. Member of Audit Bureau of Circulation.

electronize

AUTO-ELECTRONIC PRODUCTS

KITS OR READY BUILT

ELECTRONIC IGNITION

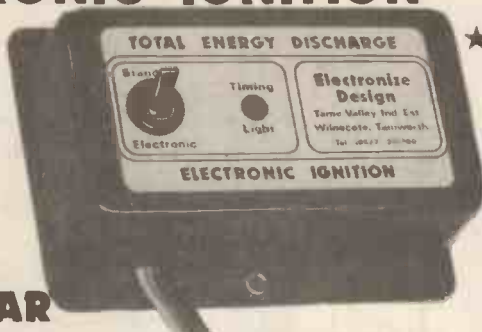

IS YOUR CAR AS GOOD AS IT COULD BE ?

- ★ Is it **EASY TO START** in the cold and the damp? Total Energy Discharge will give the most powerful spark and maintain full output even with a near flat battery.
- ★ Is it **ECONOMICAL** or does it "go off" between services as the ignition performance deteriorates? Total Energy Discharge gives much more output and maintains it from service to service.
- ★ Has it **PEAK PERFORMANCE** or is it flat at high and low revs. where the ignition output is marginal? Total Energy Discharge gives a more powerful spark from idle to the engines max. (even with 8 cylinders).
- ★ Do the **PLUGS and POINTS** always need changing to bring the engine back to its best. Total Energy Discharge eliminates contact arcing and erosion by removing the heavy electrical load. The timing stays "spot on" and the contact condition doesn't affect the performance either. Larger plug gaps can be used, even wet or badly fouled plugs can be fired with this system.

★ Is the **PERFORMANCE SMOOTH**. The more powerful spark of Total Energy Discharge eliminates the 'near misfires' whilst an electronic filter smooths out the effects of contact bounce etc.

Most **NEW CARS** already have **ELECTRONIC IGNITION**. Update **YOUR CAR** with the most powerful system on the market - 3½ times more spark power than inductive systems - 3½ times the spark energy of ordinary capacitive systems, 3 times the spark duration.

Total Energy Discharge also features: **EASY FITTING, STANDARD/ELECTRONIC CHANGE-OVER SWITCH, LED STATIC TIMING LIGHT, LOW RADIO INTERFERENCE, CORRECT SPARK POLARITY** and **DESIGNED IN RELIABILITY**.

★ **IN KIT FORM** it provides a top performance system at less than half the price of competing ready built units. The kit includes: pre-drilled fibreglass PCB, pre-wound and varnished ferrite transformer, high quality 2µF discharge capacitor, case, easy to follow instructions, solder and everything needed to build and fit to your car. All you need is a soldering iron and a few basic tools.

FITS ALL NEGATIVE EARTH VEHICLES

6 or 12 volt, with or without ballast.

OPERATES ALL VOLTAGE IMPULSE TACHOMETERS:

(Older current impulse types need an adaptor).

STANDARD CAR KIT £15-90
Assembled and Tested £26-70

PLUS
P. & P.
£1 (U.K.)

TWIN OUTPUT KIT £24-55
For Motor Cycles and Cars with twin ignition systems
Assembled and Tested £36-45

Prices
include
VAT

PROTECT YOUR CAR WITH AN ELECTRONIZE ELECTRONIC ALARM

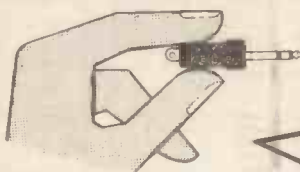

Don't Wait Until
Its too Late ~
Fit one **NOW!**

- ★ **2000 COMBINATIONS** provided by an electronic key - a miniature jack plug containing components which must match each individual alarm system. (Not limited to a few hundred keys or a four bit code).
- ★ **60 SECOND ALARM PERIOD** flashes headlights and sounds horn, then resets ready to operate again if needed.
- ★ **10 SECOND ENTRY DELAY** allows owner to dis-arm the system, by inserting the key plug into a dashboard mounted socket, before the alarm sounds. (No holes in external bodywork, fiddly code systems or hidden switches). Re-closing the door will not cancel the alarm, before or after it sounds, the key plug must be used.
- ★ **INSTANT ALARM OPERATION** triggered by accessories or bonnet/boot opening.
- ★ **30 SECOND DELAY** when system is armed allows owner to lock doors etc.

★ **DISABLES IGNITION SYSTEM** when alarm is armed.

★ **IN KIT FORM** it provides a high level of protection at a really low cost. The kit includes everything needed, the case, fibreglass PCB, CMOS IC's, random selection resistors to set the combination, in fact everything down to the last nut and washer plus easy to follow instructions.

FITS ALL 12 VOLT NEGATIVE EARTH VEHICLES.

SUPPLIED COMPLETE WITH ALL NECESSARY LEADS AND CONNECTORS PLUS TWO KEY PLUGS

CAR ALARM KIT £24-95

PLUS
P. & P.
£1 (U.K.)

ASSEMBLED AND TESTED £37-95

Prices
include
VAT



Access and Visa
Welcome. Write or
Phone Quoting Number

ELECTRONIZE DESIGN

Dept. E · Magnus Rd · Wilnecote
Tamworth · B77 5BY
tel: 0827 281000

MONITOR

Will The Last Person To Leave The House Kindly Put It On Standby . . .

The futurist's dream (one of them anyway): your house at your command. You describe the environment you want, and the computer does the rest. Eventually, not even a computer like the micros we're playing with now, but a little machine totally dedicated to controlling your habitat at the press of a button, nay, at a spoken word. We're not quite there yet, but the incidence of units either specifically designed for controlling household processes, or readily adaptable as such, is definitely increasing. Here are two:

First, from **Electronic and Computer Workshop**, a Universal Microprocessor Timer. Developed originally for industrial and lab use, it comes in kit form suitable for hobbyists. Applications specifically mentioned by ECW include control of house lighting, TV/audio gear, and automatic plant watering.

The timer is based on a pre-programmed TMS 1000 microprocessor, and has a 24-hour clock with four independent relay-controlled outputs. There are 20 daily/weekly functions, entered via a keyboard, and the timer can be set to control any one of the four relay outputs.

Timer functions are set out clearly and simply in the manual, and completed steps are indicated by LEDs and a 12mm seven-segment LED display.

The unit's power supply is stabilised on a separate PCB, and one output control relay is supplied. A total of four relays can be accommodated and relays can be easily obtained.

The kit comes complete with printed panel, to be installed as either a built-in or free standing unit. Price is £58.06 (complete with wooden housing) plus 15% VAT plus £1.50 p&p. Orders and enquiries to **Electronic and Computer Workshop Ltd.**, 171 Broomfield Rd., Chelmsford, Essex CM1 1RY. Tel: (0245) 62149.

Secondly, **Superswitch Electric Appliances** ("Total control at your Fingertips") has come up with the **Command Centre**, a 'revolutionary' new remote control unit for all kinds of electrical appliance.

By transmitting high frequency signals along AC mains wiring the **Command Centre** is capable of remotely operating up to sixteen different appliances. Remote control can be done either manually or programmed to take place automatically up to seven days ahead, with a maximum of 24 automatic programs at one time.

The signals sent by the **Command console** are received by plug-in modules, designed either for appliances or for portable lamps, which are plugged into the ordinary 13 amp household sockets. The two types of module are a safety feature, as one kind is rated for loads up to 13 amps and the lighting one for tungsten lighting up to 400W.

A major feature of the **Centre** is its

ability to check and indicate whether an appliance in another room is on or off when asked. Other features include an 'energy save' key to bring on lamps at one of three brightness levers; manual dimming of lamps; ability to turn on all lamps simultaneously; simple programming on a keyboard that gives tone to tell you that entries have been correctly made; choice of 12 or 24 hour digital clock; simple reviewing and alteration of programs; 9V battery to save programs in case of power failure; ability to turn off up to twelve modules simultaneously; filter modules available in case of any interference to the **Command Centre** from some TV sets; manual override on all modules, and last but not least you can use it as an alarm clock.

The price for a 'starter pack' with the **Command Centre**, and one of each module, is £139.95 inc VAT, no p&p. Contact **Superswitch Electric Appliances Ltd.**, 7 Station Trading Estate, Blackwater, Camberley, Surrey GU17 9AH. Tel: (0276) 34556. **Superswitch**, incidentally, do all kinds of domestic and light industrial timer controllers, dimmer



and time delay switches, remote control switches and units, fan controls and security switches.

Slick Scope Probes

More closely resembling a super executive non-slip-grip-fibretip pen than a conventional scope probe, **Greenpar Connectors'** new range of Posiscan inexpensive miniature oscilloscope probes have been designed for easy and accurate handling on crowded PCBs. The probes come supplied with seven accessories: a BNC adaptor for signal acquisition from a

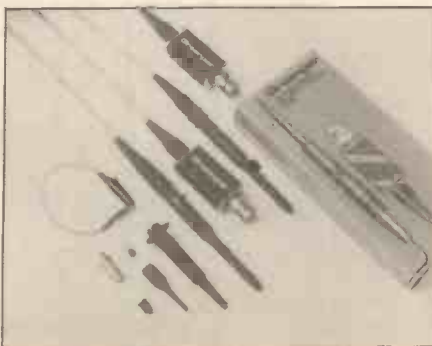

co-ax socket, an IC test tip, a tip insulator, detachable earth lead, spring hook, trimmer tool and a spare probe tip in case of accidental damage to the hardware of original. 1.5 metres of cable is supplied.

The probes are compatible with Hewlett-Packard, Philips and Tektronix accessories. Two types are available: No. 99025, with 10:1 fixed attenuation, and No. 99125, with attenuation switchable from 10:1 to 1:1.

The specifications give, for the 10:1 probe (both models): bandwidth more than 250MHz giving useful bandwidth from 100 to 140MHz with typical 100 to 150MHz scopes; risetime 1.5ns max.; compensation range for scopes of 15 to 50pF input resistance; input capacitance 15pF nominal (17pF for the 99125); input resistance 10MR \pm 1% with scopes of 1MR resistance; for the 1:1 probe (99125 only), bandwidth 5MHz; risetime 70ns; input capacitance 100pF; input resistance equal to scope.

The probes come packed in a new-style card carton with the specification printed on the back. Prices are around £18.00 and £20.00. For further information contact **Greenpar Connectors Ltd.**, Studlands Park Avenue, Newmarket, Suffolk CB8 7EA. Tel: (0638) 668081.

Status Quo Fans Please Note

If you use any number of ICs and find that they come out of their packaging with their legs splayed out, so that they do not match standard IC plugs or rub-down PCB marks, **Aries Electronics** have a tool which will restore proper alignment.

The **Dip-R-Sizer T-516** is designed to take ICs with both .003 or .006 centres. The IC is simply mounted on one side or another of a metal block between a pair of sprung jaws, and the legs squeezed back into specification.

It doesn't look as if the tool would be much help if your 'carpet crawler' has been trodden on or squashed right out of shape, other than giving the legs a final adjustment to the right pitch after a workout with the pliers.

Most useful if you're sharing a workshop or lab, at school for instance, or if you are cannibalising a lot of stuff from old boards. Price is £10.50 inc. VAT and p&p.

Aries Electronics (Europe), Eastways, Witham, Essex CM8 3YQ. Tel. (0376) 519318.

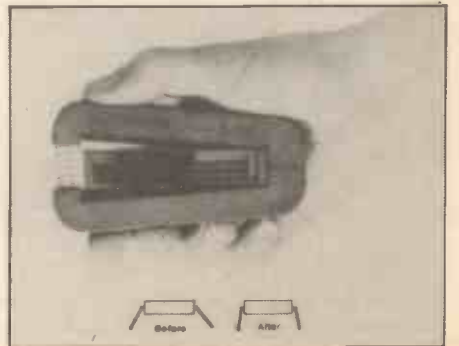

MONITOR

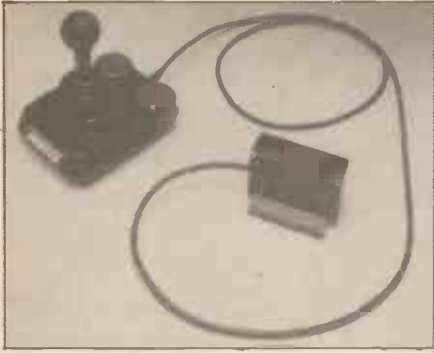

Spectrum Joystick

A self-centering joystick, called the Competition-Pro, is now available for the ZX Spectrum from Kempston Micro Electronics. The compact unit has eight direction commands and two large fire buttons for ease of play without wearing out your hands too quickly. Furthermore a number of software houses are developing games for use with a joystick, and others are on the way. It should also be possible to convert any BASIC program to work with the joystick and a short program is included to show you how to do this.

The joystick has a boxed interface which simply plugs into the expansion port of the Spectrum, with or without the printer.

Price is £25.00 plus £1.00 p&p. Enquire Kempston (Micro) Electronics, 180a Bedford Road, Kempston, Bedford MK42 8BL.

Memories Of A Camel

More memory modules from Camel Products: for the ZX81, a new 64K RAM expansion modules. This comes with a link option to disable RAM in the 0 to 16K range of the ZX81's memory (for use by peripheral cards) and is therefore able to accept an EPROM as an alternative in that part of the map. A 28 pin IC socket can accommodate not only the popular 2716/2732 EPROMs but also the newer 2764 and 27218 devices. These latter give the user 8K and 16K of non-volatile memory respectively.

The cost per byte of the 2764 is already nearly as low as the smaller EPROMs and they are seen as an important trend for ZX81 program storage. Another link option allows slow (450ns) EPROMs to be used with a slightly higher power dissipation.

The unit, named DREAM 81, comes in an ABS case with LED-power indicator and costs £69.95 plus VAT.

Secondly, Camel have introduced a 4K version alongside their 2K MEMIC L CMOS RAM unit. The new MEMIC L 2 offers as much memory as the 2732 and 2532 Eproms (See HE March '83). These units use the latest True CMOS static RAMS which take only a fraction of a uA of current to retain data. An integral

lithium battery supplies the standby power for ten years or so and the current drain is so small that no battery on/off switch is needed.

The use of fast (200ns) RAMs extends system capability by providing a user-definable ROM which can run without wait states in most systems and yet can be reprogrammed at will. This is useful as a soft character generator, for extending language interpreters and operating systems, etc.

The MEMIC unit comes in a moulded black AMS case with a flip-open window for a 24 pin cable connector, the far end of which plugs into the host system's 2716/32 or 2516/32 socket.

Price is £35.95 plus VAT. For information contact Cambridge Microelectronics Ltd., 1, Milton Road, Cambridge. Tel: (0223) 31814.



Never Mind The Voltage, Feel The Heat

Anyone who has access to a digital multimeter can now use it as a wide range temperature measuring instrument using standard type K thermocouples, by adding Graham Bell Instrumentations' DVM/TC Interface Unit.

At considerably lower cost than a dedicated unit, this device has a temperature range of -50° to 1100°C and incorporates automatic cold junction compensation. Thermocouples are attached via a miniature compensated socket. A basic thermocouple and mating plug are supplied as standard with the instrument.

The output of 1mV per degree centigrade is via a 0.75mm coiled lead fitted with 4mm plugs. Long term stability is excellent and the low battery drain allows it to be used for continuous monitoring if necessary. Since the accuracy is not affected by the output loading, it may also be used to interface low output impedance instruments such as chart recorders.

Price is £36.00 plus VAT. For more information and p&p charges contact Graham Bell Instrumentation, PO Box 230, 39 Derbyshire Lane, Sheffield S8 0TH. Tel: (0742) 582370.

A Bit More Scope

The Philips 15MHz PM3207 oscilloscope now incorporates a new CR tube which (like so many advances) is simpler in design yet more reliable than earlier tubes, and gives a sharper and brighter picture. Using their renowned colour TV experience, Philips have used simple internally-mounted permanent magnets to manipulate the electron beam, rather than the conventional electrostatic systems, and two permanently-magnetised wire rings are fitted in the electron gun, giving greater, and better calibrated, deflection sensitivity, more accurate beam centring, stigmatic focussing and more accurate scanning; a higher acceleration voltage is possible than usual in this class of scope, giving a brighter picture.

The choice of display modes includes A+B vertical channel display with separate B channel inversion, and X deflection through the A vertical input channel, for maximum input sensitivity in the X-Y display mode. Automatic triggering is standard; a separate peak-level control ensures a stable picture and the integral TV triggering facility provides automatic changeover from line to frame. Sensitivity is high (5mV), and there is double insulation between line and scope to avoid ground loop problems. The display screen is 8 x 10 cm, weight is 5kg and dimensions are 300 x 130 x 37mm (12 x 5 1/4 x 1 1/2 in). The PM3207 is advertised as meeting all the environmental requirements of a heavy-duty workshop oscilloscope, to standard VDE 0411 (a European standard).

Price is £372.00 from retail outlets, or contact Pye Unicam Ltd., York St., Cambridge CB1 2PX. Tel: (0223) 358866.



MONITOR

Shorts

Stotron are now supplying soldering equipment by **Greenwood**: this includes a high quality 24V 50W soldering station, a cordless Iso-Tip iron powered by long life NiCad batteries (a real boon to anyone who indulges in modifications to their car or bike electrics), which automatically recharges itself overnight in its own, plug-in stand, and accessories including solder-suckers, de-soldering braid and iron-coated long-life soldering tips.

For information on both these ranges contact **Inge Abraham, Stotron Ltd., 72 Blackheath Rd., Greenwich, London SE10 8DA. Tel: 01 691 2031.**

OK Machine and Tool are doing a range of PC board guides and brackets in moulded black plastic, to accommodate boards from 1.02 to 2.55mm (0.040 to 0.100in) thick with an overall length of 106mm (4.12in). Snap-in buttons ensure easy assembly to rack or brackets. The guides give a unique spring action which dampens shock and vibration. The support brackets feature a stabilizing post which permits secure mounting with only one screw. The guides can be bought as a kit (TRs-2) which includes two guides and two mounting brackets. Enquire **OK Industries UK Ltd., Dutton Lane, Eastleigh, Hants SO5 4AA. Tel: (0703) 610944.**

The **Tangerine Users Group** has moved to new premises near Bristol. This goes with an increase in staff, the formation of a new R & D team to extend the Microtan system support, and the eventual setting-up of a monthly meeting centre for members.

By the time you read this, TUG should be well settled in and the disruption caused by the move should be settling down, but if anyone has written and not received a reply, this is the cause.

The new centre is a few miles south of Bristol with easy access to the M4 and M5, and hopefully will make a better meeting place for members.

The new address is: **Tangerine Users**

Group, 1 Marlborough Drive, Worle, Avon BS22 0DQ. Tel: (0934) 21315.

The radio wristwatch shown in our picture uses a **Ferranti Electronics ZX414Z** tuned frequency circuit. The watch is made by **Advance Products UK Ltd., 8A Hornsey St., London N7. Tel: 01 609 0061.** Well, it's a change from the personalised stereo suitcases seen and heard sooft upon our streets...

The **Super Electro** analogue multi-meter from **Elemic** of Italy is now being supplied by **Black Star**. Voltage can be measured to 1000VAC and DC, and current to 30ADC and AC, as well as resistance and capacitance. The **Super Electro** also provides phase sequence detection for three phase systems and a mains and insulation tester. It is based on a high precision moving-coil ammeter, and has coloured scales, an antiparallax mirror and comes complete with a lined protective case, fused test leads and one year guarantee. Sensitivity is 20kR/VDC, accuracy is 1.5% fsd, and there is 50,000V protection on all ranges.

The **Super Electro** costs £39.95 plus VAT from **Black Star Ltd., 9A Crown**

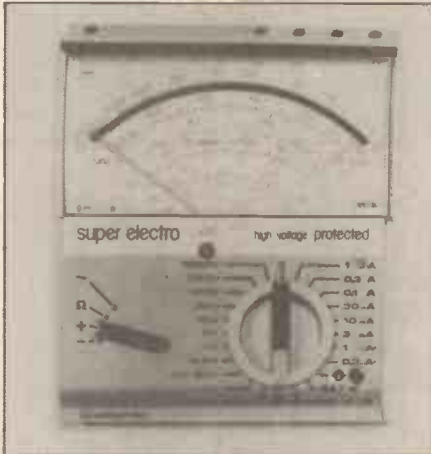

St., St. Ives, Huntingdon, Cambs PE17 4EB. Tel: (0480) 62440.

Sinclair Research is marketing its popular ZX Spectrum micro through a wider chain of retail outlets from mid-February. Selected branches of **Boots, Curry's, Greens** and **John Menzies** will join the former sole distributor, **W.H. Smith**, and **Sinclair's UK distributor, Prism Microproducts**, will be distributing to **John Lewis, House of Fraser, Rank Xerox** and many smaller stores.

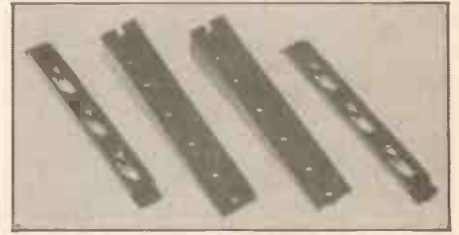

Sinclair expects to be selling twelve to fifteen thousand Spectrums a week in the UK by Easter, and claims sales of its established favourite, the ZX81, of 30,000 a week. Production of the Spectrum is now claimed to be over 50,000 a month and rising, which should cover demand and remove the likelihood of further distribution problems such as **Sinclair** suffered in 1982.

Enquiries about the Spectrum, ZX80 and ZX81 to your local dealer or to **Sinclair Research Ltd., 25 Willis Rd., Cambridge CB1 2AQ. Tel: (0223) 353204.**

All-round tool suppliers **Toolmail** have now issued their new catalogue with prices from February to December 1983. The 128 page catalogue costs £1.00, including postage, and is colour illustrated with over 2000 items, details and prices. Delivery is free and goods are normally despatched from stock within 48 hours. **Toolmail** prefer to buy British tools where possible, and offer a 'no quibble' guarantee on all their lines. The new catalogues each include three £1.00 vouchers redeemable against orders.

Contact **Toolmail (1983) Ltd., P O Box 46, Maidstone, Kent ME15 8EQ. Tel: (0622) 682861.**

Hardware and heatsink suppliers **Dau (UK) Ltd.** and specialist in passive components **Church House Components Ltd.**, of **Bognor Regis**, have combined operations to become **Dau Components Ltd.**, and the address to contact is **70-74 Barnham Rd., Barnham, W. Sussex, PO22 0ES. Tel: Yapton (0243) 553031.**

Look Sharp

Sharp Electronics have announced a series of new products which they will show at the 'Which Computer' show at the NEC, Birmingham in January 1983.

They are launching a pocket computer, the **PC1252**, at the show itself. Running a version of **BASIC** extended from the **PC-1211**, including two-



ONITOR

dimensional arrays and full string handling commands, it has a capacity of 24k ROM and 4.2k RAM. The memory is protected by a battery backup when the machine is switched off, and the PC-1251 works for up to 300 hours on one battery. It has a QWERTY keypad and 24 character LCD, and measures in at approximately 131 x 19 x 9 mm. (5 1/4 x 2 3/4 x 3/8").

Also available for this new computer is the CE-125 integrated printer microcassette recorder: the two machines stacked together are only as large as a one-inch thick A5 paperback.

For the future, Sharp will also be showing their hand-held micro, the PC-1500, for the first time with the new RS232 interface, which will allow the PC-1500 to communicate with other computers either directly or across telephone lines with an acoustic coupler.

The PC-1500 runs BASIC and incorporates 16k bytes of ROM with 3.5k RAM expandable to 11.5k. Optional is an add-on four colour printer cassette interface which offers automatic program, data and calculation printing.

Another Sharp preview will be an innovative ink jet colour printer, capable of printing in seven colours to produce an image of 120 dots per inch, suitable for printouts from high-resolution colour monitors. Further details from Sharp Electronics (UK) Ltd., Sharp House, Thorp Rd., Manchester M10 9BE. Tel: 061 205 2333.

Read and Write

Cassandras among us predict a major and possibly terminal (ouch) conflict between the Printed Word and the Data Store as our main source of ready reference in the future. New software house Ramsoft, however, is backing both horses. It's producing software with full listings published as conventional books.

Ramsoft argue that "you need book length documentation in order to explain the intricacies . . ." (one thing is certain - editors won't go out of fashion while the printed word survives, if only in press releases) . . . of the code and to provide sufficient discussion to enable the reader to take their own programming further. And if you are in the least bit lazy you'll welcome the fact that you can run the programs without laboriously typing in lines and lines of code."

You can't say fairer than that. So far, Ramsoft does tapes to go with the following books: 'The Art of Programming the 1k ZX81', 'The Art of Programming the 16k ZX81' (both by Mike James and S M Gee and published by Babani) and 'The Spectrum Book of Games' (by Mike James, S M Gee and Kay Ewbank), published by Granada, with more titles for the Spectrum, Dragon and BBC Micros coming up from the same publishers in the future.

For more information, contact Ramsoft, P O Box 6, Richmond, N. Yorkshire DL10 4HL.

HE

★★ SATURDAY BARGAINS ★★

EMOS SATURDAY SALES

Starting February 12th we will be open from 10am to 4pm every Saturday to sell our vast range of components at bargain prices. You will easily find us in Daventry on the A45, opposite the John O'Gaunt Hotel.

MIXED BAGS

Lists available

100 Ceramic capacitors	£2.00
30 Axial electrolytics	£2.50
30 Radial electrolytics	£2.50
15 Plastic capacitors	£1.50
20 Transistors - plastic	£1.50

Only brand new and useful values included

SMALL ALUMINIUM ELECTROLYTICS:

Axial Leads:		Radial Leads:	
uF	V	uF	V
1000	6.3	15p	470 16
22	10	05p	1000 25
100	10	05p	220 40
22	16	05p	470 40
470	16	15p	47 50
4.7	25	05p	4.7 63
330	25	15p	100 63
680	25	25p	220 63

LARGE ELECTROLYTICS:

Computer Grade
Made by Sprague or General Electric
Ideal for power supplies
Following values available:-
185,000 @ 15V
300,000 @ 7V
120,000 @ 15V
100,000 @ 30V
71,000 @ 40V
60,000 @ 40V
9,000 @ 50V

Postage and packing
1 or 2 capacitors - £1.00
3 or more - £1.50

Prices - fantastic value at only £2.50 each.

TRANSISTORS

AC 107	30p	BF 115	29p	2N3705	10p
AC 126	30p	BF 194	13p	2N3904	15p
AC 188	27p	BF 197	13p	2N4061	10p
AC 17	66p	BF 198	13p	2N5172	15p
ACY 19	65p	BF 199	15p	2N5179	30p
BC 149	7p	BFR 40	20p		
BC 159	12p				
BC 171	10p	BFX 29	25p		
BC 173	10				
BC 212	9p	BFY 90	60p		
BC 212L	9p				
BC 213L	9p	2N 706	15p		
BC 237	12p	2N1131	20p		
BC 308	13p	2N1132	20p		
BC 327	18p	2N2222A	20p		
BC 337	13p	2N2369A	15p		
BC 558	14p	2N3702	10p		

VOLTAGE REGULATORS

+5V	1A	T0220	40p
+5V	1.5A	T03	140p
-5V	1A	T0330	40p
-5V	1.5A	T03	190p
+6V	0.5A	T0220	35p
+12V	0.5A	T0220	35p
+12V	1.5A	T03	140p
-12V	1A	T0220	40p
-12V	1.5A	T03	190p
+15V	1A	T0220	40p
-15V	1A	T0220	40p
-24V	1A	T0220	70p

P.S.U. COMPONENTS

2N4347 (120V)	150p
2N6258 (250w)	180p
400mW Zeners	5p
723	30p
2N3055	35p

Special Offer

TMS2516JL 8 x 2K EPROM £14.90
TMS4030JL 4K RAM £3.00
8255 P.I.A. £1.90
2N3055 £0.35

Panel mounting 20mm fuseholders 20p
Continental relays 2p c/o 24V or 48V 50p
Heavy duty relays - 5A - 2p c/o 24V 65p
Microswitch - V type - push on terminals 25p

BENCH POWER SUPPLY
See constructional article in February '82 'Practical Electronics'.
Available in kit form or built up.
Prices (inc. VAT p+p):
Kit £44.00 Built £72.00

CMOS

4000	10p	4049	33p	4528	42p
4001	9p	4051	41p	4532	45p
4002	10p	4052	45p	4539	80p
4006	35p	4053	45p	4543	99p
4007	12p	4054	106p	4555	49p
4008	29p	4055	123p	4556	49p
4009	49p	4056	127p	4566	99p
4010	49p	4063	93p	4584	56p
4011	9p	4066	39p	4585	70p
4012	13p	4068	12p		
4013	33p	4069	12p		
4014	67p	4070	19p		
4015	35p	4071	19p		
4016	34p	4072	19p		
4017	59p	4073	19p		
4018	61p	4075	19p		
4019	21p	4076	72p		
4020	37p	4077	19p		
4021	37p	4078	12p		
4022	35p	4081	12p		
4023	10p	4082	19p		
4024	52p	4086	50p		
4025	10p	4089	172p		
4026	125p	4093	18p		
4027	17p	4094	136p		
4028	66p	4095	93p		
4029	39p	4096	93p		
4030	19p	4098	93p		
4031	9p	4502	55p		
4032	95p	4503	59p		
4033	130p	4507	37p		
4034	125p	4508	37p		
4035	40p	4510	69p		
4036	239p	4511	39p		
4038	89p	4512	63p		
4040	36p	4514	99p		
4041	36p	4515	172p		
4042	56p	4516	69p		
4043	61p	4518	69p		
4044	35p	4519	25p		
4045	130p	4520	96p		
4046	85p	4521	80p		
4047	73p	4526	55p		
4048	35p	4527	99p		

74 TTL

7400	9p	7476	29p
7401	9p	7482	55p
7402	9p	7483	62p
7403	10p	7485	69p
7404	10p	7486	26p
7405	13p	7489	140p
7406	24p	7490	17p
7407	24p	7491	47p
7408	12p	7492	23p
7409	22p	7495	34p
7410	12p	7496	57p
7413	14p	74100	72p
7414	15p	74107	19p
7416	16p	74121	30p
7417	16p	74122	27p
7420	13p	74128	20p
7422	17p	74132	28p
7423	23p	74141	73p
7425	23p	74145	35p
7426	23p	74150	45p
7427	15p	74151	32p
7428	15p	74153	49p
7430	12p	74154	40p
7432	15p	74155	32p
7433	19p	74159	65p
7437	17p	74160	38p
7438	15p	74161	32p
7440	10p	74162	69p
7442	26p	74163	69p
7444	55	74164	35p
7445	81p	74165	40p
7446	45p	74174	67p
7447	33p	74175	17p
7448	38p	74182	40p
7450	22p	74185	80p
7451	14p	74191	40p
7453	22p	74192	40p
7454	13p	74195	52p
7460	14p	74199	72p
7470	26p	74221	49p
7472	26p	74284	140p
7473	26p	74298	90p
7474	16p	74366	28p
7475	19p	74368	28p

74LS

LS00	9p	LS85	36p
LS01	9p	LS86	14p
LS02	9p	LS89	20p
LS03	21p	LS93	40p
LS04	21p	LS95	35p
LS05	21p	LS107	40p
LS08	10p	LS109	27p
LS09	10p	LS112	27p
LS10	10p	LS113	27p
LS11	10p	LS114	27p
LS12	10p	LS123	32p
LS13	13p	LS125	20p
LS14	19p	LS138	22p
LS15	22p	LS151	35p
LS20	10p	LS153	35p
LS21	22p	LS156	33p
LS22	22p	LS157	25p
LS26	12p	LS160	32p
LS27	22p	LS163	34p
LS28	12p	LS174	38p
LS30	10p	LS175	36p
LS32	11p	LS181	33p
LS37	11p	LS192	33p
LS40	12p	LS194	31p
LS42	25p	LS195	41p
LS47	32p	LS197	44p
LS51	22p	LS241	49p
LS55	22p	LS242	54p
LS73	27p	LS257	28p
LS74	14p	LS266	16p
LS78	27p	LS298B	70p
		LS374	45p
		LS395	84p

Dept 2D, High March, Daventry, Northants NN11 4HQ
Tel: 03272 5523 Telex: 311245 GRENEL G

Please add 50p per order postage and packing (except where higher is indicated) plus 15% VAT on total. No VAT on overseas orders, postage at cost. Cheques and postal orders made payable to Emos Limited. Send Large S.A.E. for comprehensive catalogue.



SPECIAL OFFER TO HOBBY ELECTRONICS READERS

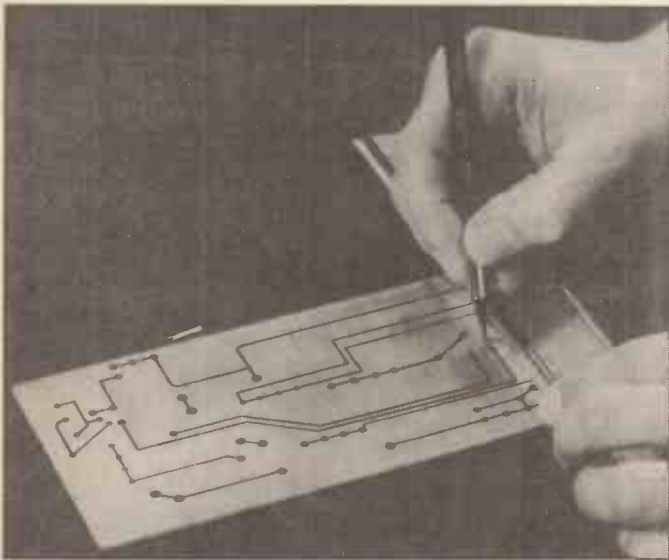
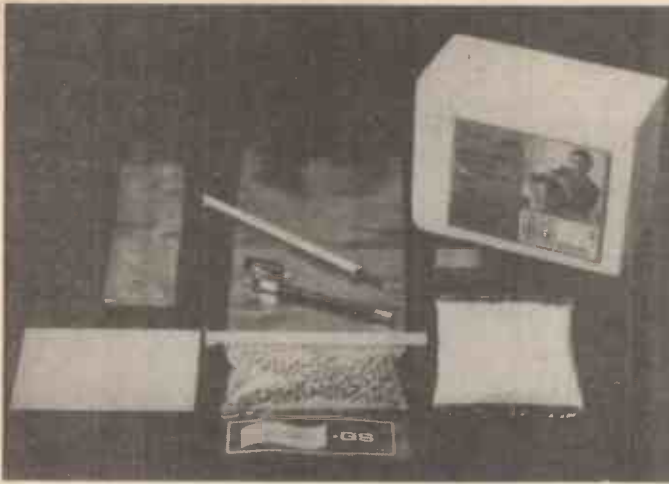

PCB Etch Kit for HE PCBS now available in 1983 at the 1982 price.

*Seno GS PCB Etching Kit

*Etch Resist Pen

*Polyfix Cleaning Block

*Two 6" × 4" single-sided copper-clad boards

ALL FOR £9.50!!

No mess, no fuss.

The Seno GS printed circuit board etching system provides a high level of safety, convenience and efficiency for making one-off PCBs at home or at school. It is unique in allowing the etching process to be carried out in a sealed bag, eliminating the danger and mess associated with open tanks or baths.

The Seno GS kit consists of a sealable etching bag, granulated etch chemicals, leak-proof box and neutraliser. As a special bonus, this offer (available only through Hobby Electronics) includes an etch-resist pen that allows you to draw foil patterns directly onto the copper surface; a polyfix block for cleaning the copper both before and after etching; and, to get you started quickly and with minimum bother, two 6" × 4" single-sided copper-clad boards.

Make the most of the projects in Hobby Electronics by making your own printed circuit boards!

To: HE PCB Kit Offer, Argus Specialist Publications Ltd,
145 Charing Cross Road, London WC2H 0EE.

Please send me:

..... PCB kits @ £9.50
..... Total

Price includes VAT and postage and packaging.
I enclose cheque/postal order, made payable to Argus Specialist Publications Ltd, for.....

OR

I wish to pay by Barclay/Access. Please charge my account number

Signature

Name
(BLOCK CAPITALS)

Address
(BLOCK CAPITALS)

Please note that this offer is valid for the UK mainland only. Allow 28 days for delivery.



*Price includes VAT and postage and packaging; please allow 28 days for delivery.

CRICKLEWOOD ELECTRONICS LTD.

40 Cricklewood Broadway, London NW2 3ET. Tel. 01 452 0161. Tlx. 914977.

Here's a selection from our vast stocks. Full price list free on request. Orders by phone quoting credit card no. or by mail order. Callers welcome. All products first grade franchised source. All in-stock items despatched same day. Official orders welcome from Govt. Depts, schools, etc. Please add 60p p&h + 15% VAT. Overseas orders no VAT but allow £2.00 min p&h. Quantity discounts negotiable.

TRY US NOW - WE'VE GOT WHAT YOU NEED.

RESISTORS		2.2 100 11p	Single sided	2N2905 28p	40411 2.85	BC547A 14p
CARBON FILM		2.2 250 30p	100 x 160 1.55	2N2906A 29p	40412 90p	BC547B 14p
5% HI-STAB		3.3 25 10p	200 x 120 1.30	2N2906B 30p	40822 1.80	BC548A 13p
LOW NOISE		4.7 16 8p	233 x 220 3.99	2N2907 26p	40871 89p	BC548B 14p
10% TO 100M		4.7 25 10p	Doubled sided	2N2915 1.65	40872 89p	BC548C 15p
1/4W E24 2p		4.7 16 8p	100 x 220 2.15	2N2922 3.47	40873 89p	BC549 34p
1/4W E24 2 1/2p		4.7 16 8p	203 x 114 2.21	2N2924 15p	40874 89p	BC549B 34p
1W E12 6p		4.7 16 8p	Z33 x 240 4.55	2N2925 15p	40875 89p	BC549C 34p
2W E12 12p		4.7 16 8p	Developer	2N2926 15p	40876 89p	BC549D 34p
METAL FILM		10 10 16p	above 160 not use	2N3053 27p	40877 89p	BC549E 34p
ULTRA STABLE		10 10 16p	Sodium Hydroxide	2N3054 56p	40878 89p	BC549F 34p
0.4 EXTRA		10 10 16p	150m 2.90	2N3055 60p	40879 89p	BC549G 34p
LOW NOISE		10 10 16p	Prices per metre	2N3056 120p	40880 89p	BC549H 34p
10% TO 100M		22 25 11p	Wire	2N3057 30p	40881 89p	BC549I 34p
2% E24 6p		22 40 14p	Sold connecting	2N3058 30p	40882 89p	BC549J 34p
1% E24 6p		22 63 16p	Wire	2N3059 30p	40883 89p	BC549K 34p
LOW OHMIC		47 25 14p	Main/Speaker	2N3060 30p	40884 89p	BC549L 34p
GLAZED 1/4W		47 40 17p	2N3442RCA 1.85	2N3061 30p	40885 89p	BC549M 34p
As above 2p		47 63 26p	Twin 1 amp 14p	2N3446 4.80	40886 89p	BC549N 34p
E24 11p		100 16 14p	Twin 2 1/2 amp 16p	2N3447 5.09	40887 89p	BC549O 34p
WIREWOUND		100 25 16p	3 Core 2 1/2 amp	2N3448 6.66	40888 89p	BC549P 34p
ON CERAMIC		100 100 22p	3 Core 6 amp 31p	2N3449 11.00	40889 89p	BC549Q 34p
2.5WATT		100 100 22p	3 Core 13 amp	2N3450 11.00	40890 89p	BC549R 34p
0.122 330Ω 28p		100 100 30p	56p	2N3451 11.00	40891 89p	BC549S 34p
4 to 7 WATT		220 10 16p	Screened Cable	2N3452 11.00	40892 89p	BC549T 34p
0.47 to 1.8 33p		220 16 17p	Single 14p	2N3453 2.30	40893 89p	BC549U 34p
10 to 11 WATT		220 16 17p	Stereo 27p	2N3454 2.30	40894 89p	BC549V 34p
10 to 33k 37p		220 16 17p	Mini Single 12p	2N3455 2.30	40895 89p	BC549W 34p
POTS & PRESETS		220 63 30p	Mini Stereo 15p	2N3456 2.30	40896 89p	BC549X 34p
ROTARY POTS		220 100 40p	4 Core 4 Screens	2N3457 2.30	40897 89p	BC549Y 34p
LOW NOISE		470 25 33p	4 Core 1 Screen	2N3458 2.30	40898 89p	BC549Z 34p
1/4W HI-STAB		470 40 33p	8 Core 54p	2N3459 2.30	40899 89p	BC550A 34p
4K7 to 2M 1N 32p		470 63 43p	12 Core 80p	2N3460 2.30	40900 89p	BC550B 34p
4K7 to 2M		1000 16 30p	Aerial Cable	2N3461 2.30	40901 89p	BC550C 34p
LOG		1000 25 38p	100Ω RG58A 35p	2N3462 2.30	40902 89p	BC550D 34p
As above with		1000 40 46p	750 1/4W 28p	2N3463 2.30	40903 89p	BC550E 34p
DP switches		2200 16 40p	3000 Flat 14p	2N3464 2.30	40904 89p	BC550F 34p
As above stereo		2200 16 40p	Round Ribbon	2N3465 2.30	40905 89p	BC550G 34p
(no switch)		2200 16 40p	Cable	2N3466 2.30	40906 89p	BC550H 34p
PRE-SETS PHER		470 25 33p	Prices per foot	2N3467 2.30	40907 89p	BC550I 34p
(DUSTPROOF)		470 40 33p	8 Way 15p	2N3468 2.30	40908 89p	BC550J 34p
ES 1000 to 10MΩ		470 63 43p	10 Way 30p	2N3469 2.30	40909 89p	BC550K 34p
Mini Vertical 15p		1000 16 30p	16 Way 30p	2N3470 2.30	40910 89p	BC550L 34p
Mini Horizontal 15p		1000 16 30p	20 Way 38p	2N3471 2.30	40911 89p	BC550M 34p
Standard Horiz 18p		1000 16 30p	30 Way 55p	2N3472 2.30	40912 89p	BC550N 34p
Standard Horiz 18p		220 10 16p	40 Way 72p	2N3473 2.30	40913 89p	BC550O 34p
Standard Horiz 18p		220 10 16p	50 Way 72p	2N3474 2.30	40914 89p	BC550P 34p
Standard Horiz 18p		220 10 16p	60 Way 72p	2N3475 2.30	40915 89p	BC550Q 34p
Standard Horiz 18p		220 10 16p	70 Way 72p	2N3476 2.30	40916 89p	BC550R 34p
Standard Horiz 18p		220 10 16p	80 Way 72p	2N3477 2.30	40917 89p	BC550S 34p
Standard Horiz 18p		220 10 16p	90 Way 72p	2N3478 2.30	40918 89p	BC550T 34p
Standard Horiz 18p		220 10 16p	100 Way 72p	2N3479 2.30	40919 89p	BC550U 34p
Standard Horiz 18p		220 10 16p	110 Way 72p	2N3480 2.30	40920 89p	BC550V 34p
Standard Horiz 18p		220 10 16p	120 Way 72p	2N3481 2.30	40921 89p	BC550W 34p
Standard Horiz 18p		220 10 16p	130 Way 72p	2N3482 2.30	40922 89p	BC550X 34p
Standard Horiz 18p		220 10 16p	140 Way 72p	2N3483 2.30	40923 89p	BC550Y 34p
Standard Horiz 18p		220 10 16p	150 Way 72p	2N3484 2.30	40924 89p	BC550Z 34p
Standard Horiz 18p		220 10 16p	160 Way 72p	2N3485 2.30	40925 89p	BC551A 34p
Standard Horiz 18p		220 10 16p	170 Way 72p	2N3486 2.30	40926 89p	BC551B 34p
Standard Horiz 18p		220 10 16p	180 Way 72p	2N3487 2.30	40927 89p	BC551C 34p
Standard Horiz 18p		220 10 16p	190 Way 72p	2N3488 2.30	40928 89p	BC551D 34p
Standard Horiz 18p		220 10 16p	200 Way 72p	2N3489 2.30	40929 89p	BC551E 34p
Standard Horiz 18p		220 10 16p	210 Way 72p	2N3490 2.30	40930 89p	BC551F 34p
Standard Horiz 18p		220 10 16p	220 Way 72p	2N3491 2.30	40931 89p	BC551G 34p
Standard Horiz 18p		220 10 16p	230 Way 72p	2N3492 2.30	40932 89p	BC551H 34p
Standard Horiz 18p		220 10 16p	240 Way 72p	2N3493 2.30	40933 89p	BC551I 34p
Standard Horiz 18p		220 10 16p	250 Way 72p	2N3494 2.30	40934 89p	BC551J 34p
Standard Horiz 18p		220 10 16p	260 Way 72p	2N3495 2.30	40935 89p	BC551K 34p
Standard Horiz 18p		220 10 16p	270 Way 72p	2N3496 2.30	40936 89p	BC551L 34p
Standard Horiz 18p		220 10 16p	280 Way 72p	2N3497 2.30	40937 89p	BC551M 34p
Standard Horiz 18p		220 10 16p	290 Way 72p	2N3498 2.30	40938 89p	BC551N 34p
Standard Horiz 18p		220 10 16p	300 Way 72p	2N3499 2.30	40939 89p	BC551O 34p
Standard Horiz 18p		220 10 16p	310 Way 72p	2N3500 2.30	40940 89p	BC551P 34p
Standard Horiz 18p		220 10 16p	320 Way 72p	2N3501 2.30	40941 89p	BC551Q 34p
Standard Horiz 18p		220 10 16p	330 Way 72p	2N3502 2.30	40942 89p	BC551R 34p
Standard Horiz 18p		220 10 16p	340 Way 72p	2N3503 2.30	40943 89p	BC551S 34p
Standard Horiz 18p		220 10 16p	350 Way 72p	2N3504 2.30	40944 89p	BC551T 34p
Standard Horiz 18p		220 10 16p	360 Way 72p	2N3505 2.30	40945 89p	BC551U 34p
Standard Horiz 18p		220 10 16p	370 Way 72p	2N3506 2.30	40946 89p	BC551V 34p
Standard Horiz 18p		220 10 16p	380 Way 72p	2N3507 2.30	40947 89p	BC551W 34p
Standard Horiz 18p		220 10 16p	390 Way 72p	2N3508 2.30	40948 89p	BC551X 34p
Standard Horiz 18p		220 10 16p	400 Way 72p	2N3509 2.30	40949 89p	BC551Y 34p
Standard Horiz 18p		220 10 16p	410 Way 72p	2N3510 2.30	40950 89p	BC551Z 34p
Standard Horiz 18p		220 10 16p	420 Way 72p	2N3511 2.30	40951 89p	BC552A 34p
Standard Horiz 18p		220 10 16p	430 Way 72p	2N3512 2.30	40952 89p	BC552B 34p
Standard Horiz 18p		220 10 16p	440 Way 72p	2N3513 2.30	40953 89p	BC552C 34p
Standard Horiz 18p		220 10 16p	450 Way 72p	2N3514 2.30	40954 89p	BC552D 34p
Standard Horiz 18p		220 10 16p	460 Way 72p	2N3515 2.30	40955 89p	BC552E 34p
Standard Horiz 18p		220 10 16p	470 Way 72p	2N3516 2.30	40956 89p	BC552F 34p
Standard Horiz 18p		220 10 16p	480 Way 72p	2N3517 2.30	40957 89p	BC552G 34p
Standard Horiz 18p		220 10 16p	490 Way 72p	2N3518 2.30	40958 89p	BC552H 34p
Standard Horiz 18p		220 10 16p	500 Way 72p	2N3519 2.30	40959 89p	BC552I 34p
Standard Horiz 18p		220 10 16p	510 Way 72p	2N3520 2.30	40960 89p	BC552J 34p
Standard Horiz 18p		220 10 16p	520 Way 72p	2N3521 2.30	40961 89p	BC552K 34p
Standard Horiz 18p		220 10 16p	530 Way 72p	2N3522 2.30	40962 89p	BC552L 34p
Standard Horiz 18p		220 10 16p	540 Way 72p	2N3523 2.30	40963 89p	BC552M 34p
Standard Horiz 18p		220 10 16p	550 Way 72p	2N3524 2.30	40964 89p	BC552N 34p
Standard Horiz 18p		220 10 16p	560 Way 72p	2N3525 2.30	40965 89p	BC552O 34p
Standard Horiz 18p		220 10 16p	570 Way 72p	2N3526 2.30	40966 89p	BC552P 34p
Standard Horiz 18p		220 10 16p	580 Way 72p	2N3527 2.30	40967 89p	BC552Q 34p
Standard Horiz 18p		220 10 16p	590 Way 72p	2N3528 2.30	40968 89p	BC552R 34p
Standard Horiz 18p		220 10 16p	600 Way 72p	2N3529 2.30	40969 89p	BC552S 34p
Standard Horiz 18p		220 10 16p	610 Way 72p	2N3530 2.30	40970 89p	BC552T 34p
Standard Horiz 18p		220 10 16p	620 Way 72p	2N3531 2.30	40971 89p	BC552U 34p
Standard Horiz 18p		220 10 16p	630 Way 72p	2N3532 2.30	40972 89p	BC552V 34p
Standard Horiz 18p		220 10 16p	640 Way 72p	2N3533 2.30	40973 89p	BC552W 34p
Standard Horiz 18p		220 10 16p	650 Way 72p	2N3534 2.30	40974 89p	BC552X 34p
Standard Horiz 18p		220 10 16p	660 Way 72p	2N3535 2.30	40975 89p	BC552Y 34p
Standard Horiz 18p		220 10 16p	670 Way 72p	2N3536 2.30	40976 89p	BC552Z 34p
Standard Horiz 18p		220 10 16p	680 Way 72p	2N3537 2.30	40977 89p	BC553A 34p
Standard Horiz 18p		220 10 16p	690 Way 72p	2N3538 2.30	40978 89p	BC553B 34p
Standard Horiz 18p		220 10 16p	700 Way 72p	2N3539 2.30	40979 89p	BC553C 34p
Standard Horiz 18p		220 10 16p	710 Way 72p	2N3540 2.30	40980 89p	BC553D 34p
Standard Horiz 18p		220 10 16p	720 Way 72p	2N3541 2.30	40981 89p	BC553E 34p
Standard Horiz 18p		220 10 16p	730 Way 72p	2N3542 2.30	40982 89p	BC553F 34p
Standard Horiz 18p		220 10 16p	740 Way 72p	2N3543 2.30	40983 89p	BC553G 34p
Standard Horiz 18p		220 10 16p	750 Way 72p	2N3544 2.30	40984 89p	BC553H 34p
Standard Horiz 18p		220 10 16p	760 Way 72p	2		

CAREERS IN ELECTRONICS

'83

Charles Harvey

It takes study, but not a higher degree, to work in the high-flying industry of the eighties.

ALTHOUGH electronics is now taught as a subject in many schools, the real courses of electronic education do not properly begin until after leaving school. And then you will find there are a confusingly large number of courses available! Before deciding which one to choose, then, you should ask yourself two very important questions:

What qualifications am I likely to have after leaving school?

Do I want to be a full time student or would it be better to work, and study part time?

The importance of the first question is fairly obvious: the course you will be able to take will depend largely on the qualifications, if any, that you carry away from the school years. But even if you leave with very few formal grades, all is not lost.

Entry to one of the ITECs (Information Technology Centres), set up by the government to teach young people the essentials of electronics and micro-computing, requires no formal qualifications — just an interest and willingness to learn. The courses last up to a year and provide, at the least, a basic understanding of the subject — what you do with it then is up to you!

If you want to find out about ITECs in your area, the information is available from your local Careers Office, who will have all the details at their fingertips — if there is an ITEC nearby.

Young people who are leaving school before reaching the grand old age of 18 should also consider the government's Youth Training Scheme. This starts officially in September 1983, but some schemes are being set up as early as April. They will offer the equivalent of at least three months full-time training,

and up to nine months of relevant work experience; for example, a person might spend a quarter of his or her time at a local college or industrial training centre and the remainder working with an electronics firm in the neighbourhood. Once more, your future after completing the course is left in your own hands.

The Youth Training Scheme organisers hope that they have learned from the experience gained on the Youth Opportunities Programme, and that the new scheme will offer better quality training; however it *is* new, so we will just have to wait and see if it is successful.

Gilt Edged Certificates

Those who leave school with a reasonable range of CSEs (or who pass college selection, in Scotland) could normally aim for a course leading to a City and Guilds Certificate.

The City and Guilds of London Institute, to give it its full title, is an organisation over 100 years old that awards a qualification to crafts men and women in many different industries — catering, building, engineering and needle trades, to mention a few. Their certificates in electronics can be taken full time at many colleges, though most people attend part time on day or block release from a job.

This is where the answer to the second question is needed: full time education is expensive (as every parent knows), but finding an employer who will offer you day or block release from the job will depend on the employment situation in your area. Given the national employment situation, this is likely to be difficult.

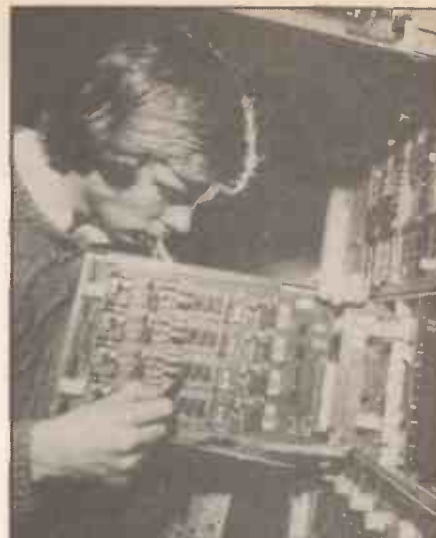

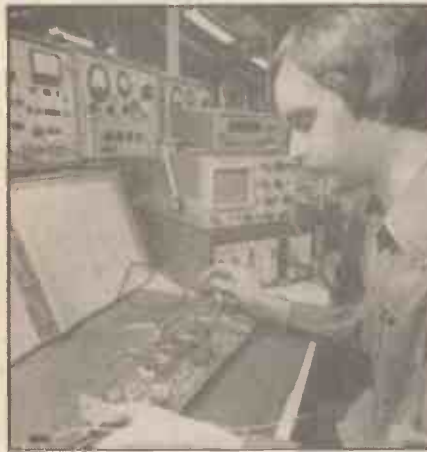

There is no quick and easy solution to the problem, either, unless full time study is a realistic option. Financial assistance is available for some courses, and a few of the options are briefly summarised in Table 1. Many people would prefer employment of any kind, even if not in the electronics industry, to no employment at all — but it's worth considering that any job in an electronics industry (even if its sweeping the floor!) *could* allow you to undertake a City and Guilds course, perhaps leading to a brighter future. Of course the educational qualifications must be met, and entry into the business in this way would be most unusual — but always worth a try if all else fails!

The City and Guilds qualification most relevant to electronics work is the '224 Certificate'. All those who take this course do a 'Part I', which takes about 300 college hours and covers the fundamental knowledge needed (safety, electronic units and systems, transmission, wave forms, electrical supplies and circuits, resistance, magnetism and electrostatics, capacitance and inductance, heat, sound and light, the use of tools and instruments, and a heaped helping of maths, including binary arithmetic). Part II usually takes about 600 hours and contains core subjects which are taken by all students, but then allows the option of specialisation in either Radio/TV or Industrial Electronics. It is also possible to carry on to the Advanced Level (Part III), a specialist option covering TV in greater depth, including video recording systems, information technology, AM/FM radio and audio systems, microcomputer systems, electronic measurement and control systems.

Electronic work is also covered in two other City and Guilds Certificates; the '225', Maintenance Craft Studies in Instrumentation and Control covers the installation, maintenance and repair of instruments used in industrial plants, while Electronic Craft Studies ('232') is for those working in industry and building services, and covers applications of heavy duty electrical engineering as well.

TEChnician Training

As with City and Guilds, part-time study on release from full-time employment is the most common way to gain TEC (Technical Education Council) or SCOTEC (Scottish Technical Education Council) qualifications. The minimum entry level for a TEC course is grade three CSEs in English, Maths and a science subject (or, in Scotland, being able to pass college selection), though some may demand higher entry qualifications. Relevant O-level/O-grade passes in, for example, Maths, Physics or English, usually permit exemptions from Level 1 courses, proceeding directly to Level 2 and finishing the course more quickly.

TEC/SCOTEC Diplomas are usually taken by full-time study and reach the same level, but in a wider range of subjects. Generally if you start at level 1, a TEC/SCOTEC Certificate takes three

years part-time, and a Diploma takes two years full time — but there are exceptions in both cases.

Older readers may remember the Ordinary National Certificate and Diploma courses (ONC and OND); these have now been superseded by the TEC/SCOTEC qualifications and, broadly but not exactly, they are the modern equivalents.

Just as TEC/SCOTEC Certificate and Diploma have replaced the old ONC/OND, so the old Higher National Certificate and Diploma courses (HNC/HND) have been replaced by the TEC/SCOTEC Higher Certificate and Diploma. The usual entry requirements for the higher courses are either a TEC/SCOTEC Certificate of Diploma pass, or an A-level pass together with an attempt at another relevant A-level subject such as Maths, Physics, Electronic Systems etc; two 'highers' or a SCOTEC Certificate or Diploma are usually required in Scotland.

Degrees Of Learning

Again, the usual way of completing a Higher Certificate is by part-time study, while the Higher Diploma is usually taken full-time.

One feature of these qualifications is that they are made up of self-contained units which are devised by the colleges themselves, though approved by the Technical Education Council. As a result, there are often differences between the courses run by different colleges. The TEC recommends that a course should contain some maths, physical science and industrial skills, plus electronic systems, digital techniques, general and communication studies; the range of specialist options usually cover radio, TV and telecommunications subjects. At the higher levels, there are further specialist units dealing in advanced radio/TV, radar, measurement techniques and fault diagnosis, etc. There is even more diversity at the upper levels because the TEC does not lay down such firm guidelines, and colleges are free to develop courses appropriate to the needs of local industry.

For those with two or three good A-levels (or three or four H-levels in Scotland), there are degree courses at Universities, Polytechnics and Scottish Central Institutions. In England and Wales, degree courses last three years normally (four years in Scotland) but 'sandwich' courses, with industrial experience included as part of the degree, will last four years.

For those who do well at degree level — and this means either a First or Second class degree — there is a chance for higher scholastic honours, usually a Master of Science (MSc) or Doctor of Philosophy (PhD) degree. However, competition for the limited number of grants supporting higher degree study is limited, so that even a good degree is not sufficient, alone, to guarantee grant approval.

Another question which every school leaver — indeed, every person in training — will want answered is: what

Table 1

Course	Grants & Finance
ITECs Youth Training Scheme	Government allowance, currently £25.00 pw and fares in excess of £4.00.
Full time City & Guilds and TEC courses	Free tuition if under 18. Only a few authorities (eg Sheffield, ILEA) pay maintenance grants. Fees are payable for over 18s. You may be able to get a discretionary grant from your local authority but it depends where you live. Ask the advice of your local Careers Service, or your local authority's grants department.
Full time Higher TEC Certs/Dips Degree	You can usually get a mandatory grant from your local authority (Scottish Education Dept. in Scotland) regardless of where you live. This covers tuition and is supposed to cover living expenses, though most students find it hard to live on! It is "means tested" — how much you get depends on how much your parents earn; they are expected to make up the difference. There are different rules for mature students.

Table 2

ENTRY	COURSE	AT	COMMENTS	POSSIBLE JOBS
No formal qualifications required	ITEC	ITEC	Practical experience in micro computing and electronics.	Hi-fi servicing, electronic assembly.
No formal qualifications	New "Youth Training"	Further education	Starts Sept '83. Exact details still uncertain but probably includes at least 3 months full training plus relevant work experience.	Not known yet.
Sometimes no formal qualifications but generally CSEs	City & Guilds Cert.	Further education College	Full time course (usually takes two years) or part time, day or block release, usually lasting three years for those in employment; leads to craft certificates.	Hifi servicing, alarm systems installation, etc.
College Selection (Scotland) or grade three CSEs	TEC/SCOTEC Cert./Dip.	FE College	Full time course, usually two-three years, often taken part time by those in employment.	Radio/VTR technician.
TEC/SCOTEC Cert./Dip. At least one A-level pass or two Highers (Scotland)	TEC/SCOTEC Higher Cert./Dip.	FE College or Polytechnic	Full time course usually lasting two years. Often taken part time by those in employment.	Computer service engineer; control & instrumentation engineer.
Two/three good A-levels three/four Highers	Degree	Polytechnic or University or Central Inst. or, occasionally, FE Colleges.	Three years for full time course, four years for sandwich course; four years in Scotland.	Design engineer.



sort of job will my training lead to?

Jobs For The Boys

An attempt to answer this question, in general terms, is made in Table 2, which summarises the various courses mentioned in this article and describes, very roughly, the type of employment which could result. Naturally, whether a job is actually available for you depends on the competition, both locally and nationally; generally electronics graduates and holders of Higher, TEC/SCOTEC qualifications will do better in the hunt for jobs than those without. Below this level the number of jobs available is not so great, compared with the number of people seeking employment, so the competition is much tougher.

Don't Need No Education

You might, by now, have the impression from all this verbiage that the only way into employment in electronics is through a more-or-less specialist course of training. However many employers look rather for a good all-round education in relevant subjects. Some prefer to recruit young people with, say, four O-levels or O-grades, including Maths, Physics and English; or with Maths and Physics at A-level or higher levels in Scotland. As mentioned earlier, it is now possible to study electronics at O- or A-level in many schools, in courses including electronic systems and microcomputers, and any study at school will naturally be advantageous when you later come to select a career in electronics.

HE

THE MEN WHO INVENTED ME WERE
CLEVER ENOUGH TO MAKE ME THINK
IN 'FORTH' (IT'S 10 TIMES FASTER
AND 4 TIMES MORE COMPACT THAN
'BASIC').

YET THEY'RE DUMB ENOUGH TO SELL
ME FOR £89.95!

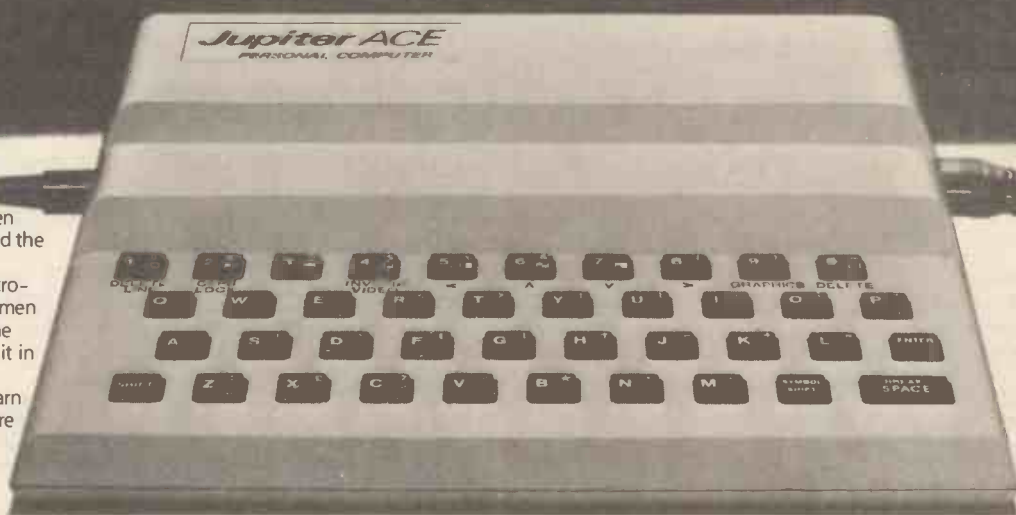

Richard Altwasser and Steven Vickers are the men who invented the Jupiter Ace.

After years of designing micro-computers that use BASIC (both men played a major role in creating the ZX Spectrum), they abandoned it in favour of FORTH.

FORTH is just as easy to learn as BASIC. Yet it's a faster, more compact and more structured language that educationalists and professional programmers alike prefer.

So the Jupiter Ace is the only micro-computer you can buy that is designed around FORTH.

Using it, there's little fear of accidentally 'crashing' programs halfway through and having to start all over again (a common fault with BASIC). The Jupiter Ace's comprehensive error checking sees to that.

The Jupiter Ace has a full-size keyboard, high resolution graphics, sound, floating point arithmetic, a fast, reliable cassette interface, 3K of RAM and a full 12 month warranty.

You get all that for £89.95. Plus a mains adaptor, all the leads needed to connect most cassette recorders and TV's, a software catalogue (35 cassettes available, soon to be 50), the Jupiter Ace manual and a free demonstration cassette of 5 programs

The Jupiter Ace manual is a complete introduction to personal computing and a simple-to-follow course in FORTH, from first principles to confident programming.

Plug-on 16K and 48K memory expansions are also available, at very competitive prices. (There'll be a plug-on printer interface available soon, too.)

It'll take you no time at all to realise how clever Richard and Steven were to design the Jupiter Ace around FORTH. And even less time to realise what a silly price £89.95 is to charge for it.

Technical Information

Hardware
Z80A; 8K ROM; 3K RAM.

Keyboard
40 moving keys; auto repeat; Caps Lock.

Screen
Memory mapped 32 col x 24 line flicker-free display upper and lower case ascii characters.

Graphics
High resolution 256 x 192 pixel user defined characters.

Sound
Internal loudspeaker may be programmed for entire audio spectrum.

Cassette

Programs and data in compact dictionary format may be saved, verified, loaded and merged. All tape files are named. Running at 1500 baud.

Expansion Port

Contains D.C. power rails and full Z80 Address, data and control signals. Can connect extra memory peripherals.

Editor

Allows complete editing and listing of compiled programs.

Please send cheque/postal order to:
Jupiter Cantab, 22 Foxhollow, Bar Hill,
Cambridge CB3 8EP.

Jupiter ACE

Please send me _____ Jupiter Ace microcomputers @ £89.95 (+ £3.95 p. & p.)
Tick here if you require VAT receipt

Name _____

Address _____

010 0183

Available for immediate delivery. Allow 14 days for p. & p. U.K. price only (export price on request).

GET BIG POWER

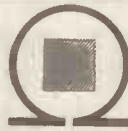
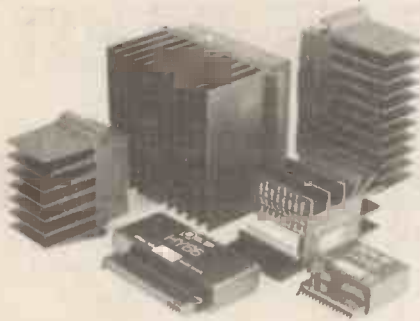

ILP Modular Amplifiers the third generation

Due to continuous improvements in components and design ILP now launch the largest and most advanced generation of modules ever.

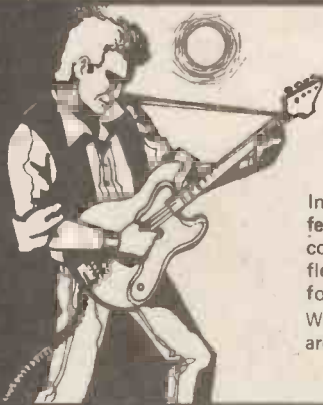

WE'RE INSTRUMENTAL IN MAKING A LOT OF POWER

In keeping with ILP's tradition of entirely self-contained modules featuring, integral heatsinks, no external components and only 5 connections required, the range has been optimized for efficiency, flexibility, reliability, easy usage, outstanding performance, value for money.

With over 10 years experience in audio amplifier technology ILP are recognised as world leaders.



BIPOLAR MODULES

Module Number	Output Power Watts rms	Load Impedance Ω	DISTORTION		Supply Voltage Typ	Size mm	WT gms	Price inc. VAT
			T.H.D. Typ at 1KHz	I.M.D. 60Hz/7KHz 4:1				
HY-8J	15	4-8	0.015%	<0.006%	± 18	76 x 68 x 40	240	£8.40
HY6B7	30	4-8	0.015%	<0.006%	± 25	76 x 68 x 40	240	£9.55
HY6B6A	30 + 30	4-8	0.015%	<0.006%	± 25	120 x 78 x 40	420	£18.69
HY124	60	4	0.01%	<0.006%	± 26	120 x 78 x 40	410	£20.75
HY128	60	4	0.01%	<0.006%	± 35	120 x 78 x 40	410	£20.75
HY244	120	4	0.01%	<0.006%	± 35	120 x 78 x 50	520	£25.47
HY248	120	8	0.01%	<0.006%	± 50	120 x 78 x 50	520	£25.47
HY384	180	4	0.01%	<0.006%	± 45	120 x 78 x 100	1030	£38.41
HY388	180	8	0.01%	<0.006%	± 60	120 x 78 x 100	1030	£38.41

Protection: Full load line. Slew Rate: 15V/ μ s. Rise time: 5 μ s. S/N ratio: 100dB. Frequency response (-3dB) 15Hz - 50KHz. Input sensitivity: 500mV rms. Input Impedance: 100K Ω . Damping factor: 100Hz >400.

PRE-AMP SYSTEMS

Module Number	Module	Functions	Current Required	Price inc. VAT
HY6	Mono pre-amp	Mic/Mag, Cartridge/Tuner/Tape/Aux + Vol/Bass/Treble	10mA	£7.60
HY66	Stereo pre-amp	Mic/Mag, Cartridge/Tuner/Tape/Aux + Vol/Bass/Treble/Balance	20mA	£14.32
HY73	Guitar pre-amp	Two Guitar (Bass Lead) and Mic + separate Volume Bass Treble + Mix	20mA	£15.36
HY78	Stereo pre-amp	As HY66 less tone controls	20mA	£14.20

Most pre-amp modules can be driven by the PSU driving the main power amp. A separate PSU 30 is available purely for pre-amp modules if required for £5.47 (inc. VAT). Pre-amp and mixing modules in 18 different variations. Please send for details.

Mounting Boards

For ease of construction we recommend the B6 for modules HY6-HY13 £1.05 (inc. VAT) and the B66 for modules HY66-HY78 £1.29 (inc. VAT).

POWER SUPPLY UNITS (Incorporating our own toroidal transformers)

Model Number	For Use With	Price inc. VAT
PSU 21X	1 or 2 HY30	£11.93
PSU 41X	1 or 2 HY60, 1 x HY6060, 1 x HY124	£13.83
PSU 42X	1 x HY128	£15.90
PSU 43X	1 x MOS128	£16.70
PSU 51X	2 x HY128, 1 x HY244	£17.07

Please note: X in part no. indicates primary voltage. Please insert "0" in place of X for 110V, "1" in place of X for 220V, and "2" in place of X for 240V.

MOSFET MODULES

Module Number	Output Power Watts rms	Load Impedance Ω	DISTORTION		Supply Voltage Typ	Size mm	WT gms	Price inc. VAT
			T.H.D. Typ at 1KHz	I.M.D. 60Hz/7KHz 4:1				
MOS 128	60	4-8	<0.005%	<0.006%	± 45	120 x 78 x 40	420	£30.41
MOS 248	120	4-8	<0.005%	<0.006%	± 55	120 x 78 x 80	850	£39.86
MOS 364	180	4	<0.005%	<0.006%	± 55	120 x 78 x 100	1025	£45.54

Protection: Able to cope with complex loads without the need for very special protection circuitry (fuses will suffice). Slew rate: 20V/ μ s. Rise time: 3 μ s. S/N ratio: 100dB. Frequency response (-3dB): 15Hz - 100KHz. Input sensitivity: 500mV rms. Input impedance: 100K Ω . Damping factor: 100Hz >400.

'NEW to ILP' In Car Entertainments

C15

Mono Power Booster Amplifier to increase the output of your existing car radio or cassette player to a nominal 15 watts rms.

Very easy to use.

Robust construction.

£9.14 (inc. VAT)

Mounts anywhere in car.

Automatic switch on.

Output power maximum 22w peak into 4 Ω .

Frequency response (-3dB) 15Hz to 30KHz. T.H.D. 0.1% at 10w 1KHz

S/N ratio (DIN AUDIO) 80dB. Load Impedance 3 Ω .

Input Sensitivity and impedance (selectable) 700mV rms into 15K Ω . 3V rms into 8 Ω .

Size 95 x 48 x 50mm. Weight 256 gms.

C1515

Stereo version of C15.

£17.19 (inc. VAT)

Size 95 x 40 x 80. Weight 410 gms.

Model Number	For Use With	Price inc. VAT
PSU 52X	2 x HY124	£17.07
PSU 53X	2 x MOS128	£17.86
PSU 54X	1 x HY248	£17.86
PSU 55X	1 x MOS248	£19.52
PSU 71X	2 x HY244	£21.75

Model Number	For Use With	Price inc. VAT
PSU 72X	2 x HY248	£22.54
PSU 73X	1 x HY364	£22.54
PSU 74X	1 x HY368	£24.20
PSU 75X	2 x MOS248, 1 x MOS368	£24.20

WITH A LOT OF HELP FROM



PROFESSIONAL HI-FI THAT EVERY ENTHUSIAST CAN HANDLE...

Unicase

Over the years ILP has been aware of the need for a complete packaging system for its products, it has now developed a unique system which meets all the requirements for ease of assembly, adaptability, ruggedness, modern styling and above all price.

Each Unicase kit contains all the hardware required down to the last nut and bolt to build a complete unit without the need for any special tools.

Because of ILP's modular approach, "open plan" construction is used and final assembly of the unit parts forms a compact aesthetic unit. By this method construction can be achieved in under two hours with little experience of electronic wiring and mechanical assembly.

Hi Fi Separates

UC1 PRE AMP UNIT: Incorporates the HY78 to provide a "no frills", low distortion, (<0.01%), stereo control unit, providing inputs for magnetic cartridge, tuner, and tape/monitor facilities. This unit provides the heart of the hi fi system and can be used in conjunction with any of the UP Unicase series of power amps. For ultimate hum rejection the UC1 draws its power from the power amp unit.

POWER AMPS: The UP series feature a clean line front panel incorporating on/off switch and concealed indicator. They are designed to compliment the style of the UC1 pre-amp. Performance for each unit which includes the appropriate power supply, is as specified on the facing page.

Power Slaves

Our power slaves, which have numerous uses i.e. instrument, discotheque, sound reinforcement, feature in addition to the hi fi series, front panel input jack, level control, and a carrying handle. Providing the smallest, lowest cost, slave on the market in this format.

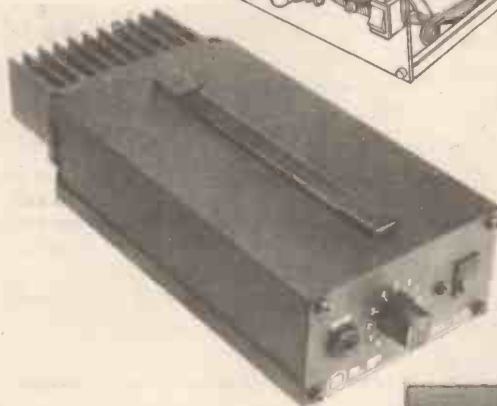
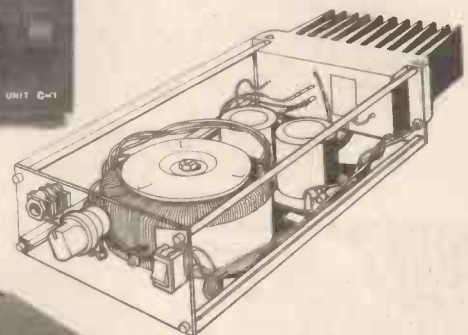

TO ORDER USING OUR FREEPOST FACILITY

Fill in the coupon as shown, or write details on a separate sheet of paper, quoting the name and date of this journal. By sending your order to our address as shown at the bottom of the page opposite, with FREEPOST clearly shown on the envelope, you need not stamp it. We pay postage for you. Cheques and money orders must be crossed and made payable to I.L.P. Electronics Ltd. if sending cash, it must be by registered post. To pay C.O.D. please add £1 to TOTAL value of order.

PAYMENT MAY BE MADE BY ACCESS OR BARCLAYCARD IF REQUIRED

UNICASES

HiFi Separates					Price inc. VAT
UC1	Preamp				£29.95
UP1X	30 + 30W/4-8Ω	Bipolar	Stereo	HiFi	£54.95
UP2X	60W/4Ω	Bipolar	Mono	HiFi	£54.95
UP3X	60W/8Ω	Bipolar	Mono	HiFi	£54.95
UP4X	120W/4Ω	Bipolar	Mono	HiFi	£74.95
UP5X	120W/8Ω	Bipolar	Mono	HiFi	£74.95
UP6X	60W/4-8Ω	MOS	Mono	HiFi	£64.95
UP7X	120W/4-8Ω	MOS	Mono	HiFi	£84.95
Power Slaves					
US1X	60W/4Ω	Bipolar	Power	Slave	£59.95
US2X	120W/4Ω	Bipolar	Power	Slave	£79.95
US3X	60W/4-8Ω	MOS	Power	Slave	£69.95
US4X	120W/4-8Ω	MOS	Power	Slave	£89.95

Please note X in part number denotes mains voltage. Please insert '0' in place of X for 110V, '1' in place of X for 220V (Europe), and '2' in place of X for 240V (U.K.) All units except UC1 incorporate our own toroidal transformers.



Post to: ILP Electronics Ltd., Freepost 4, Graham Bell House, Roper Close, Canterbury CT2 7EP, Kent, England. Telephone: (0227) 54778. Technical: (0227) 64723. Telex: 965780.

Please send me the following _____

Total purchase price _____

I enclose Cheque Postal Orders Int. Money Order

Please debit my Access/Barclaycard No. _____

Name _____

Address _____

Signature _____

COMING SOON TO . . .

Hobby Electronics

HE OSCILLOSCOPE PROJECT

This low cost test equipment project is a must for all electronics enthusiasts. It is a modular design, consisting of an X-Y Oscilloscope plotter and a separate 'Scope Module, containing the Y-Amplifier, Time Base and Trigger circuits.

The projected cost of the two modules is under £79—a price just too good to miss! Designed essentially for audio work and for low-frequency digital test applications, future add-on modules will include a transistor curve-tracer and a 10mV/cm preamplifier of cunning design for the most sensitive audio operators.

Part 1 of the HE Oscilloscope commences in the June '83 issue of Hobby Electronics. A limited number of kits of components will be available through a leading electronics retailer, so be sure to order your copy in advance.

ZX COMPUTER SOUND BOARD

Add sound effects to your Spectrum or ZX81 games program with our ZX Sound Generator Board!

CB RAP LATCH

Keep your eyes on the road keep your hands upon the wheel! Put Safety First with the HE Rap Latch. This simple device means you do not have to hold down the microphone PTT button while talking at length. However, to ensure that the transmitter does not operate for ever, a simple timing circuit first warns that the latch is about to release, then switches the rig back to Receive after a preset time interval.

TRAFFIC LIGHT TOY

A family project that has proved a smash hit (if you'll pardon the expression) with very young drivers.

THE ELECTRONIC REVOLUTION

Our popular informative series concludes with a review of the history of household electrical gadgets.

Please reserve copies of the June issue of

**Hobby
Electronics**

for
Name

Address

.....

.....

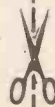

**Hobby
Electronics**

**June issue on sale at
your newsagent
from 13th May.
Place your order now!**

Although these articles are being prepared for the next issue, circumstances may alter the final content.

BI-PAK BARGAINS

TRIACS — PLASTIC

4 AMP — 400v — T0202 — TAG 13SD	1 OFF	10 OFF	50 OFF	100 OFF
40p	£3.75	£17.50	£30.00	
8 AMP 400v — T0220 — TAG 4Z5				
60p	£5.75	£27.50	£50.00	

SLIDER POTENTIOMETERS

Plastic 40mm Travel Mono

SX63 5 x 470 ohm Lin	SX675	+ 47k Lin	
SX64 5 x 1k Lin	SX685	+ 47k Log	
SX65 5 x 22k Lin	SX695	+ 100k Lin	
SX66 5 x 22k Log	SX705	+ 1meg Lin	

ALL AT
50p PER PAK

- SX40 250 Silicon Diodes—Switching like IN4148 DO-35. All good—uncoded. Worth double our price. 45v 75mA £1.25
- SX41 250 Silicon Diodes—General Purpose, like OA200/202 BAX13/16. Uncoded. 30-100v 200mA DO-7 £1.25

OPTO 7-Segment Displays

Brand New 1st Quality LITRONIX DL 707R 14-pin
Red D.3" Common Anode Display 0-9 with right hand decimal point TTL compatible 5v DC Supply. Data supplied.
5 pieces £3 (60p each)
10 pieces £5 (50p each)
50 pieces £20 (40p each)
100 pieces £35 (35p each)
1,000 pieces £300 (30p each)

IN PAKS OF
1,000 pieces £300 (30p each)
THE MORE YOU BUY — THE LESS YOU PAY!

"IRRESISTABLE RESISTOR BARGAINS"

Pak No.	Qty*	Description	Price
SX10	400	Mixed "All Type" Resistors	£1
SX11	400	Pre-formed 1/4-watt Carbon Resistors	£1
SX12	200	1/4 watt Carbon Resistors	£1
SX13	200	1/4 watt Carbon Resistors	£1
SX14	150	1/4 watt Resistors 22 ohm 2m2 Mixed	£1
SX15	100	1 and 2 watt Resistors 22 ohm-2m2 Mixed	£1

Paks SX12-15 contain a range of Carbon Film Resistors of assorted values from 22 ohms to 2.2 meg. Save pounds on these resistor paks and have a full range to cover your projects
*Quantities approximate, count by weight.

"CAPABLE CAPACITOR PAKS"

Pak No.	Qty*	Description	Price
SX16	250	Capacitors Mixed Types	£1
SX17	200	Ceramic Capacitors Miniature Mixed	£1
SX18	100	Mixed Ceramics 1pf-56pf	£1
SX19	100	Mixed Ceramics 68pf-0.5mf	£1
SX20	100	Assorted Polyester/Polystyrene Capacitors	£1
SX21	60	Mixed C280 type capacitors metal foil	£1
SX22	100	Electrolytics, all sorts	£1
SX23	50	Quality Electrolytics 50-1000mf	£1
SX24	20	Tantalum Beads, mixed	£1

*Quantities approximate, count by weight.

IC SOCKETS

The lowest price ever.

Pin	10 off	50 off	100 off
8 pin	85p	£3.50	£6.00
14pin	90p	£3.75	£8.50
16 pin	95p	£4.00	£7.00
28 pin	£2.50	£11.00	£20.00



VOLTAGE REGULATORS T0220

	Positive +	Negative -
	7805 — 50p	7905 — 55p
	7812 — 50p	7912 — 55p
	7815 — 50p	7915 — 55p
	7824 — 50p	7924 — 55p

GUARANTEED TO SAVE YOU MONEY

SX27A	60	Assorted Polystyrene Bead Capacitors Type 9500 Series PPD	£1.00
SX28A	50	Assorted Silver Mica Caps 5.6pf-150pf	£1.00
SX29A	50	Assorted Silver Mica Caps 180pf-4700pf	£1.00
SX30A	50	High Voltage Disc Ceramics 750V min up to 8kV. Assorted useful values	£1.00
SX31A	50	Wirewound 9 watt (arg) Resistors Assorted values 1 ohm-12k	£1.00

AUTO SCREWDRIVER/DRILL
Automatic spiral ratchet. Complete with 2 screwdriver blades, 5 & 6.5mm. 1 screwdriver cross point No. 1 & three drills — 2, 2.8 and 3.65mm — A MUST FOR ALL HOBBY-BUILDERS & CONSTRUCTORS. Order No. ASD/1 £3.50 each.

BARGAINS

SX91	20 x Large .2" RED LED	£1
SX92	20 small .125 Red LED's	£1
SX93	10 Rectangular Green LED's 2	£1
SX94	30 Assorted Zener Diodes 250mw-2 watt mixed voltages all coded. New	£1
SX97	4 Black Instrument Knobs—wired with pointer 1/4" Standard screw Fit size 29 x 20mm.	50p
SX99	20 Assorted Slider Knobs. Black/Chrome, etc.	£1
SX80	12 Neons and Filament Lamps. Low voltage and mains — various types and colours — some panel mounting	£1

SILICON BRIDGE RECTIFIERS

Comprising 4 x 1/2 amp rectifiers mounted on PCB.

VRM — 150 volts IFM — 1.5 Amps
Size: 1 inch square
10 off £1.00
50 off £4.50
100 off £7.50

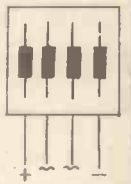

Order No. AS: 4R1 BRect.

BI-PAK'S OPTO 83 SPECIAL

A selection of Large & Small size LED's in Red, Green, Yellow and Clear, plus shaped devices of different types. 7 Segment displays, photo transistors, emitters and detectors. Types like MEL11, FPT100 etc. Plus Cadmium Cell ORP12 and germ. photo transistor OCP71. TOTAL OF 25 PIECES

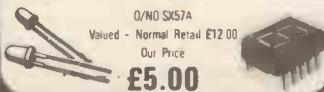

O/N0 SX57A
Valued - Normal Retail £12.00
Our Price
£5.00

1 Amp SILICON RECTIFIERS

Glass Type similar IN4000 SERIES IN4001-IN4004 50 — 500v — uncod.J — you select for VLTS ALL perfect devices — NO duds Min 50v
50 for £1.00 — worth double ORDER NO. SX76

Silicon General Purpose NPN Transistors T0-18 Case Lock fit leads — coded CV7644 Similar to BC147 — BC107 — Z189 ALL NEW! VCE 70v IC500mA Hfe 75-250 50 off 100 off 500 off 1000 off
PRICE £2.00 £3.80 £17.50 £30.00 Order as CV7644

Silicon General Purpose PNP Transistors T0-5 Case Lock fit leads coded CV9507 similar 2N2905A to BFX30 VC 60 IC 600mA Min Hfe 50 ALL NEW! 50 off 100 off 500 off 1000 off
PRICE £2.50 £4.00 £19.00 £35.00 Order as CV9507

SEMICONDUCTORS FROM AROUND THE WORLD

100 A Collection of Transistors, Diodes, Rectifiers, Bridges, SCR's, Triacs, IC's both Logic and Linear plus Opto's all of which are current everyday usable devices.

Guaranteed Value over £10 at Normal Retail Price

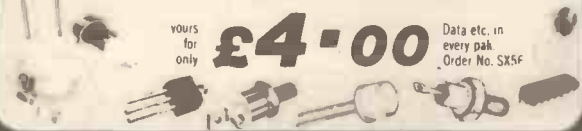

Yours for only **£4.00**

Data etc. in every pak Order No. SX5F

TECASBOTY

The Electronic Components and Semiconductor Bargain of the Year. A host of Electronic components including potentiometers — rotary and slider, presets — horizontal and vertical. Resisto. mixed values 220ohms to 2M2 — 1/8 to 2 Watt. A comprehensive range of capacitors including electrolytic and polyester types plus disc ceramics etcetera Audio plugs and sockets of various types plus switches, fuses, heatsinks, wire, nuts/bolts, gromets, cable clips and lyes, knobs and P.C. Board. Then add to that 100 Semiconductor devices in a Fantastic Parcel. No rubbish all identifiable and valued in current catalogues as well

Price —
Our Fight Against Inflation — Beat the Budget Down with Depression

JUST £6.50.
O/N0. SX85

PROGRAMMABLE UNIJUNCTION TRANSISTOR "PUT" case T0105 plastic MEU22 Similar to 2N6027/76028 PNP Silicon
Price: 1-9 10-49 50-99 100+ Normal Retail Price £0.35 each
Each: 20p 18p 15p 13p

SX33A	6 small (min) (SDST/SPDT Toggle Switches 240V 5amp	£1.00
SX35A	6 Rocker Switches 250V 2A	£1.00
SX32A	12 Assorted Jack & Phone plugs, sockets and adaptors, 2.5m, 3.5mm and standard sizes	£1.00
SX71	50 BC108 "Fallouts" Manufacturers out of spec on volts or gain You test.	£1.00
SX72	A mixed bundle of Copper clad Board Fibre glass and paper. Single and double sided. A fantastic bargain	£1.00

REGULATED VARIABLE Stabilised POWER SUPPLY

Variable from 2.30 volts and 0.2 Amps. Kit includes — 1 — VPS30 Module, 1 — 25 volt 2 amp transformer, 1 — 0.50v 2" Panel Meter, 1 — 0.2 amp 2" Panel Meter, 1 — 470 ohm wirewound potentiometer, 1 — 4k7 ohm wirewound potentiometer. Wiring Diagram included Order No. VPS30 KIT £25.00

MINIATURE FM TRANSMITTER
Freq: 95-106MHz, Range: 1/4 mile Size: 45 x 20mm Add: 9v batt.
Not licenced in U.K. ONLY £5.50
Ideal for: 007-M15-FBI-CIA-KGB etc.

SX38	100 Silicon NPN Transistors—all perfect Coded mixed types with data and eqvt sheet. No rejects. Retail value.	£3.00
SX39	100 Silicon PNP Transistors—all perfect. Coded mixed types with data and eqvt. sheet. No rejects. Fantastic value.	£3.00
2N3055	The best known Power Transistors in the World — 2N3055 NPN 115w. Our BI-PAK Special Offer Price: 10 off 50 off 100 off £3.50 £16.00 £30.00	

BD312 COMPLIMENTARY PNP POWER TRANSISTORS: TO 2N3055. Equivalent MJ2955 — BD312 — T03 SPECIAL PRICE £0.70 each 10 off £6.50



MORE BARGAINS!

SX51	60 metres PVC covered Hook-up wire single and stranded. Mixed colours.	£1
SX58	25 Assorted TTL Gates 7400 Series. 7401-7460.	£1
SX59	10 Assorted Flip Flops and MSI TTL	£1
SX60	20 Assorted Slider Potentiometers	£1
SX62	40 Assorted Pre-Sets Hor/Vert etc.	£1
SX79	10 Reed Switches — glass type 3 Micro Switches — with lever	£1

BI-PAK

Send your orders to Dept. HE5 BI PAK PO BOX 6 WARE HERTS SHOP AT 3 BALDOCK ST., WARE, HERTS
TERMS: CASH WITH ORDER. SAME DAY DESPATCH. ACCESS, BARCLAYCARD ALSO ACCEPTED TEL (0920) 3182, GIRO 388 7006
Add 15% VAT AND 75p PER ORDER POSTAGE AND PACKING



Use your credit card. Ring us on Ware 3182 NOW and get your order even faster. Goods normally sent 2nd Class Mail.
Remember you must add VAT at 15% to your order Total. Postage add 75p per total order.

Stall-Thief

Andy Armstrong

Our 'invisible', noiseless anti-theft device simulates an ignition fault, frustrating a thief in his attempt to make off with your motor.

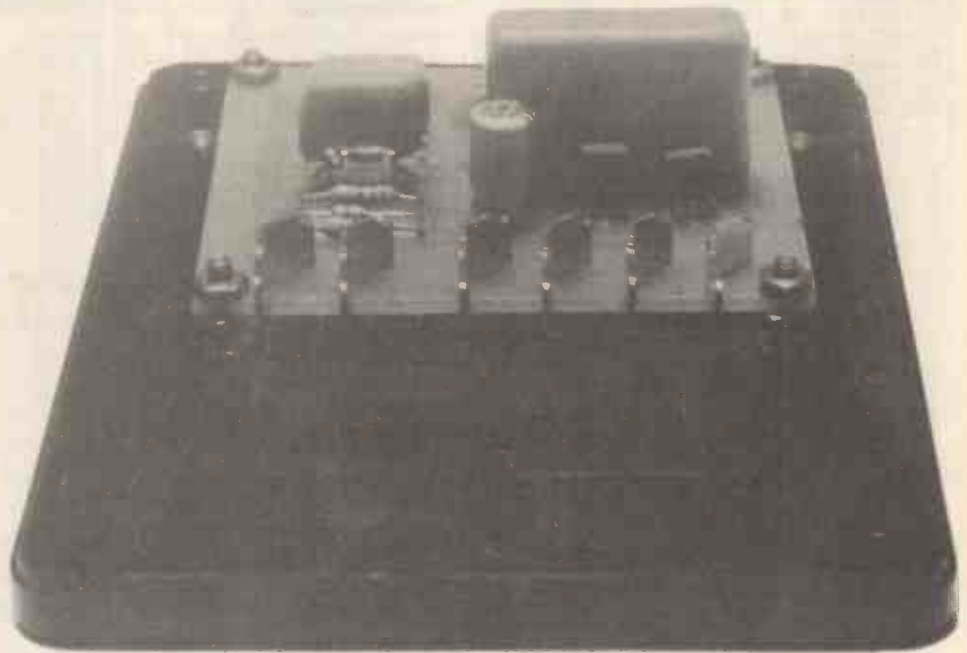

THIS is a gadget which should discourage any thief in his right mind from stealing your car! Sure, you may say, but a thief can get around any disabling device in a few minutes. This one, however, doesn't appear to be an anti-theft device; instead, it makes the car seem to be at fault.

When the car engine is started (possibly not at the first try) it will run for a few seconds, and then cough and die. Further attempts at starting will be met with the same results.

This particular system has the added advantage that it is automatically reset when the ignition is switched off, and that the method of deactivating it is very unusual. Thus, you cannot forget to protect your car, and any prospective thief has little chance of bypassing the system.

Obviously, the device can simply be removed, so it needs to be installed where it won't easily be found — there are some suggestions about this further on. The unit does its job by periodically shorting the contact breaker, and preventing a spark from being generated. Typically, it is shorted out for about two seconds in every ten seconds; this is adequate to stop a cold engine, though one could probably continue driving if the car was thoroughly warmed up and moving reasonably fast.

This brings us to a WARNING: though the circuit is designed not to bring the car to a halt on a fast road, it is preferable to avoid even the slightest risk of this. Therefore, the anti-theft unit — and, indeed, anything which could stop the ignition system from working — must be built and fitted with reliability in mind. (The

same applies to commercial devices like electronic ignitions).

The Circuit

IC1a and b form a bistable which always powers up with pin 4 high and pin 3 low; this occurs because C1 takes longer to charge than C2. Resistors R4 and R5, in series with pins 6 and 1 respectively, are to prevent the capacitor's discharge currents from damaging the CMOS input protection diodes (built into the chip) when the unit is switched off, ie when the ignition is switched off.

IC1c and d form an oscillator, which is enabled while pin 13 is held high. This oscillation has an uneven mark to space ratio, so that the

engine is allowed to function most of the time, but is periodically halted. The timing has been chosen so that someone trying to restart the engine immediately after it has stopped would meet with (temporary) success.

The oscillator works in the following manner: when the power is switched on both C3 and C4 are uncharged; therefore at the moment of switch-on, pin 12 will be at logic 0. This causes pin 11 to be at logic 1 and hence pin 10 to be at logic 0. This state persists while the lower end of C4 charges towards logic 1 via R9.

This same voltage will appear on pin 12 via R8, so that after it passes about half the power supply voltage, pin 11 falls towards logic 0, causing pin 10 to rise to logic 1.

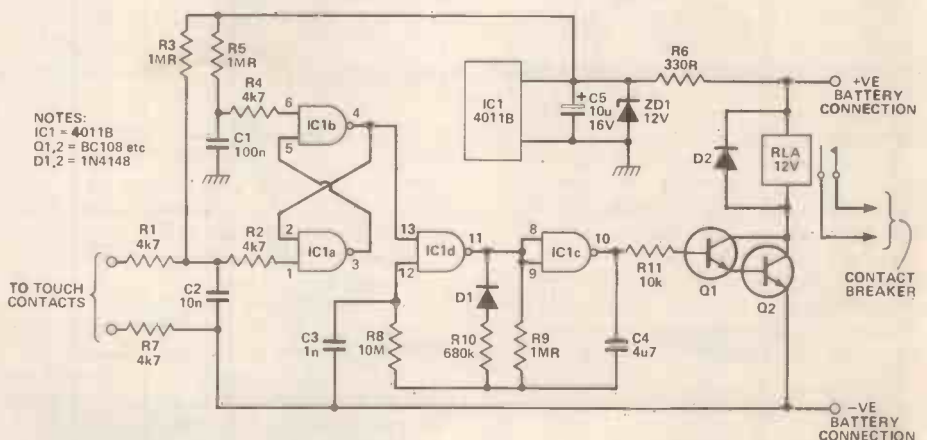

Figure 1. The Stall-Thief circuit; Vcc connects to pin 14 of the IC and 0V goes to pin 8.

How It Works

The Stall Thief is powered from a point in the car's electrical system which is switched on by the ignition switch. When power is applied, the bistable output is at logic 0 and 1 this enables the oscillator, which is set up to produce an asymmetric waveform. The waveform is 'low' for most of the oscillator period, so that the relay driver is turned off and the car may be started — briefly!

However, when the oscillator

output is 'high' (for about two seconds in every ten), the relay is energised so that the contacts short out the ignition coil contact breaker, effectively simulating a fault in the ignition system.

The Stall Thief is disabled by touching the concealed switch contacts; this takes the bistable output to logic 0, disabling the oscillator and preventing the relay from operating.

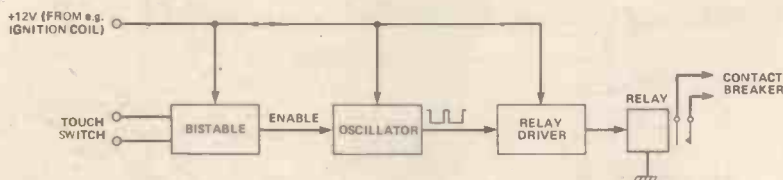

In this condition, transistors Q1 and Q2, which form a Darlington pair, are turned on, thus closing the relay and preventing the engine from functioning.

You will observe, now, that the voltage on the lower end of C4 is about half the supply voltage higher than the top end, which has just been raised virtually to the full supply voltage. The voltage on C4 is thus outside the limit of the supply rails and will therefore discharge, partly via R8 and the input protection diodes on IC1d pin 12, but mostly via R9 and R10/D1. This is why R8 is such a high value — so that this discharge current is small enough to be ignored, compared with the current through R9 and R10.

The voltage on C4 therefore discharges into IC1d pin 11, towards logic 0, with a time constant given approximately (neglecting R8) by C4, and R9 in parallel with R10 (since D1 is conducting in this condition). This time constant is about 25% of the charging time constant set by C4, R9 because R9 is in parallel with R10 is approximately 520k.

When the voltage on pin 12 falls below half the supply voltage, the logic gates switch into the state they had when first switched on, thus taking the voltage on the lower end of C4 outside the supply rails in the other direction, until it charges back up to half supply via R9 (see Figure 2).

This cycle repeats until the owner of the vehicle touches both of the "touch plates"; this switches the flip-flop (IC1a and IC1b) into the other state, setting pin 4 at logic 0. This disables the oscillator, causing pin 11 to go to logic 1 and pin 10 to logic 0. Thus the relay is permanently de-energised and the engine runs normally.

Spiking the Noise

The purpose of C3 may not be immediately obvious; it's there to

prevent stray noise pick-up onto the high impedance of pin 12, from causing spurious operation of the gate. The time constant of R8 and C3 is much shorter than that of R9, R10 and C4, so that C3 has no appreciable effect on the oscillator frequency.

Since car electrical systems may have substantial voltage spikes on them, the CMOS power supply is protected by R6, D2 and C5; were these components omitted from the design, the delicate CMOS would probably fail at an inconvenient moment!

Some constructors may wonder at the use of a Darlington pair of transistors to drive the relay — so a word of explanation. Even buffered CMOS cannot properly be asked to source much more than 1mA (hence the value of R11), and a transistor in saturation cannot be assumed to have a gain greater than ten. Therefore if only one transistor were used, a current of only 10mA would be available to drive the relay if the transistor were saturated. What would happen, in practice, would be that some unlucky constructors would find that the relay did not pull in, or that the transistor burned out because it was not properly switched on and thus was dissipating too much power.

Construction

The construction of the board is simply a matter of following the overlay. The CMOS IC should be installed last, after a visual inspection to check that the rest of the components have been installed correctly.

Veropins can be used for the connections to the board, though the 0.25in push-on connector blades used on the prototype are to be preferred.

The relay is separate from the board for two reasons: the first is that, while a particular PCB mounting relay may not be hard to obtain, many people may have a 12V relay in their junkboxes. The second reason is that

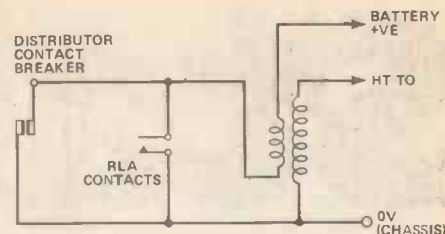

Figure 2. The circuit of a typical ignition system; the Stall-Thief relay contacts short out the distributor contact breaker intermittently, interrupting the ignition timing.

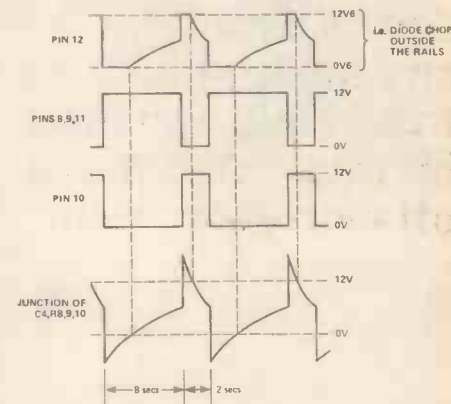

Figure 3. Waveforms produced at various points in the Stall-Thief circuit when the oscillator consisting of IC1d,c is enabled (logic '1' on pin 13).

Parts List

RESISTORS

(All 1/4 watt 5% carbon)

R1,2,7	4k7
R3,5,9	1MR
R6	330R
R8	10M
R10	680k
R11	10k

CAPACITORS

(All polyester unless noted)

C1	100n
C2	10n
C3	1n
C4	4u7
C5	10u
	ceramic
	16VDC radial electro

SEMICONDUCTORS

IC1	CD4011B
	quad-NAND
Q1,2	BC108
	or similar
D1,2	1N4148
	or similar
ZD1	BCY88C12V

MISCELLANEOUS

RLA..... see Buylines
PCB; case (see text); 6 x 1/4" PCB-mounting connector blades; wire, solder, nuts and bolts etc.

BUYLINES page 34

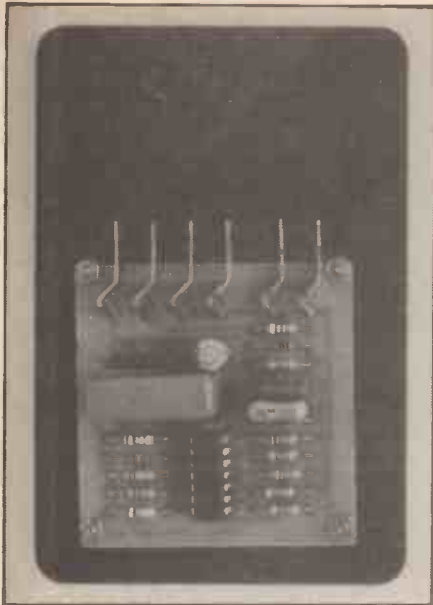

it may, under some circumstances, be preferable to mount the relay near to the distributor or coil, and mount the rest of the works elsewhere, for example behind the dashboard.

The choice of relay is, to some extent, important. The contacts need to be rated for the current (at least 5A), and also need to open, when de-energised, to at least as wide as the contact breaker gap, to avoid breakdown. Some suitable types are described in *Buylines*.

Once the unit is built it should be tested before installation. Connect up the relay and then connect the board to a 12V power supply. The relay should switch on for about two seconds out of each ten. If it does not do so, check the voltage across the relay coil; if this reaches at least 10V for the two seconds and still the relay does not switch, then it is unsuitable.

If there is no voltage on the relay at all, check the logic levels (after switch-on, before operating the touch contacts!). A wrong or indeterminate logic level should point to the short circuit, wrong component etc.

Once the relay has been made to switch, slightly moisten your finger and place it briefly across the two blades waiting to be connected to the touch terminals: the relay should switch no more. Finally, it is a good idea to varnish the board to avoid condensation problems.

Installation

Many of the details of installation may be left to the individual constructor, as the space available in different cars needs different methods.

The first decision to make is whether to mount the relay separately or not. If there is little concealment for the whole unit under the bonnet, it is preferable to mount the relay near the wiring channels, and connect it to the contact breaker in as unobtrusive a way as possible. In this case, a small

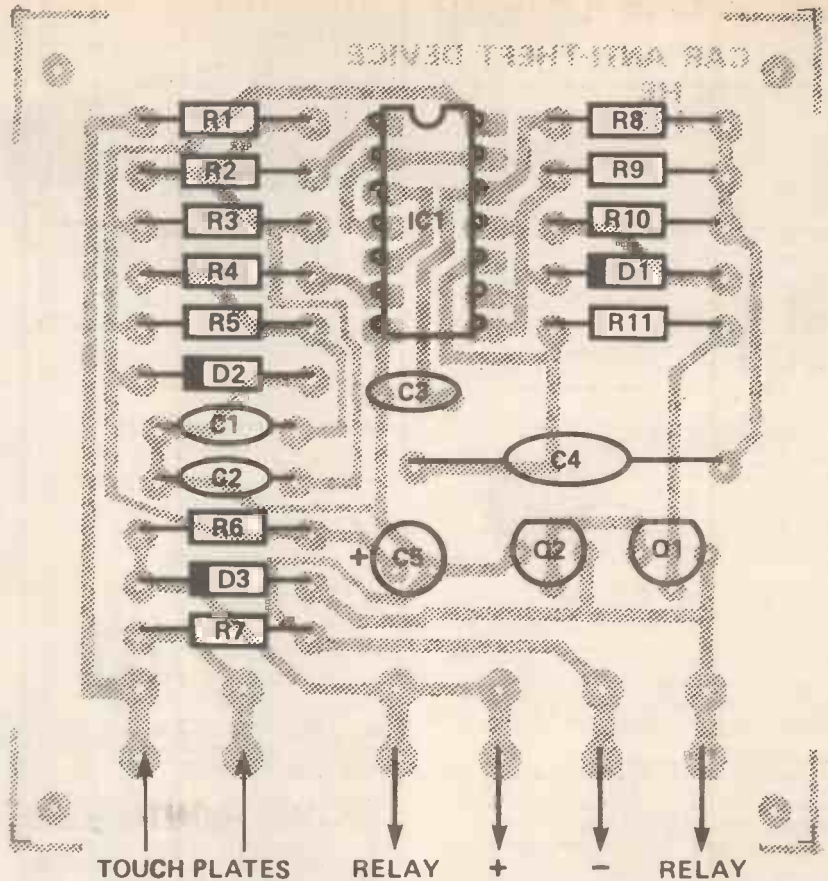

Figure 4. The component overlay; 1mm PCB connector pins may be used instead of the push-on connectors, but are not as secure.

plastic box just large enough to take the PCB and push-on connectors is required. This may be mounted in a convenient place behind the dashboard and wires run to the relay. If the area under the bonnet is sufficiently untidy, so that an extra plastic box would not be noticed, then the whole thing can be mounted in one place, with twisted wires leading to the touch contacts. For this option, a larger plastic box would be required.

In any event, the PCB should be mounted to the lid by four 6BA or M2.5 bolts, and a slot cut in the box to allow cable entry. If the relay is mounted separately, it must be securely bolted down; if it is mounted in the plastic box it may be easier to use double-sided adhesive pads on two faces to mount the relay. (Note: for a reliable fixing, the surfaces must be thoroughly clean.)

Since the wires from the relay to the ignition system must be soldered at the relay end, special care should be taken; these connections should be sleeved, preferably with heatshrink sleeving (a 2kW electric fan heater shrinks it a treat!). These wires should also be fixed in place using self-adhesive aluminium cable clamps, readily available from car accessory shops.

The wiring to the contact breaker should be kept short to reduce the amount of extra ignition interference radiated, and on grounds of reliability. Depending on circumstances, a "piggy back" connector to the coil or distributor, or a tap-in connector to

the wire between the two, should be used. Take care not to put tension on the wiring, to avoid the risk of it pulling off while you are driving!

Touch contacts

The suggested technique for making these is to use plastic washers, of the type used for transistor mounting, to put two bolts into the underside of the dashboard, but insulated from it. If these bolts are more than a few inches apart, it is most unlikely that any one would touch both at once by chance, so your secret Stall Thief would be safe.

When the unit is fixed in place and connected to its touch contacts, it should be wired up to the battery. Assuming a negative earth, the -ve terminal should be connected to chassis and the +ve terminal to any positive supply which is switched off by the ignition switch (eg the +ve terminal of the coil). For +ve earth cars, this procedure must, of course, be reversed.

Operation

Simple! Switch on the ignition, then touch both bolts without touching any other metalwork (if your hands are exceptionally dry you may need to lick your fingers but normally there should be no problems). The car can then be started and driven as usual.

Your local tea-leaf, on the other hand, will not know about this and will be stalled in his attempt to steal your motor.

GOING FOR A SONG!

GOING FOR A SONG - Are you a buyer for a factory, school, shop, club, etc? If so, please telephone or write for our sale list - over 1,000 tons of stock is being sold off at much below cost, simply because we must clear our big store this year. You will be amazed at the very low prices. Here are two examples:

LOT 1. is a parcel of approximately 1 million $\frac{1}{4}$, $\frac{1}{2}$ & 1 watt resistors. All uniformly packaged and front labelled in boxes ideal for retail display or self service racking. Normal stock valuation £8,000, offered at £950 the lot.

LOT 2. 1000 miniature encased relays - p.c.b. mounting - 2 change-over contacts 9 - 15V coil - very low current (700 ohm), normal stock valuation based on a similar relay R.S. price £2.56 each is £2,500. Parcel offered for £600.



8 POWERFUL MODEL MOTORS
(all different)
for robots, meccanos, drills, remote control planes, boats, etc. £2.95.

12 volt MOTOR BY SMITHS

Made for use in cars, etc. These are series wound and they become more powerful as load increases. Size $\frac{3}{4}$ " long by $\frac{3}{8}$ " dia. They have a good length of $\frac{1}{2}$ " spindle - Price £3.45.

Ditto, but double ended £4.25.
Ditto, but permanent magnet £3.75.



EXTRA POWERFUL 12v MOTOR

Made to work battery lawnmower, this probably develops up to $\frac{1}{4}$ h.p., so it could be used to power a go-kart or to drive a compressor, etc, etc. £7.95 + £1.50 post.
(This is easily reversible with our reversing switch - Price £1.15).

SET OF 12v MOTORS!

Set of four 12 volt motors to drive passenger locomotive - £29.50.
With address where to buy other parts.

WATERPROOF HEATING WIRE

60 ohms per yard, this is a heating element wound on a fibre glass coil and then covered with p.v.c. Dozens of uses - around water pipes, under grow boxes in gloves and socks. 23p a metre.

THERMOSTAT ASSORTMENT

10 different thermostats. 7 bi-metal types and 3 liquid types. There are the current stats which will open the switch to protect devices against overload, short circuits, etc., or when fitted say in front of the element of a blow heater, the heat would trip the stat if the blower fuses; appliance stats, one for high temperatures, others adjustable over a range of temperatures which could include 0 - 100°C. There is also a thermostatic pod which can be immersed, an oven stat, a calibrated boiler stat, finally an ice stat which, fitted to our waterproof heater element, up in the lid could protect your pipes from freezing. Separately, these thermostats could cost around £15.00 - however, you can have the parcel for £2.50.

POPULAR PROVEN PROJECTS

3 Channel sound to Light - with fully prepared metal case	£14.95
Ditto - made up	£26.00
Big Ear, listen through walls	£9.50
Robot controller - receiver / transmitter	£7.50
Ignition kit - helps starting, saves petrol, improves performance	£13.95
Silent sentinel Ultra Sonic Transmitter and receiver	£9.50
Car Light 'left on' alarm	£3.50
Secret switch - foos friends and enemies alike	£1.95
3 - 30v Variable Power Supply	£13.80
2 Short & Medium Wave Crystal Radio	£3.99
3v to 10v Mains Power Supply Kit	£1.95
Light Chaser - three modes	£17.50
Mullard Unilex Hi Fi stereo amplifier with speakers	£16.75
Radio stethoscope - fault finding aid	£4.80
Mug Stop - emits piercing squawk	£2.50
Morse Trainer - complete with key	£2.99
Drill control kit	£3.95
Drill control kit made up	£6.95
Interrupted beam Kit	£2.50
Transmitter Surveillance Kit	£2.30
Radio Mike	£6.90
FM receiver kit - for surveillance or normal FM transmissions	£3.50
Seat Belt Reminder	£3.00
Car Starter Charger Kit	£14.00
Soil heater for plants or seeds	£16.50
Insulation Tester - electronic megger	£7.95
Battery Shaver or Fluorescent from 12v	£6.90
Matchbox Radio - receives Medium wave	£2.95
Mixer Pre-amp - disco special with case	£16.00
Aerial Rotator - mains operated	£29.50
Aerial direction indicator	£5.50
40 watt amp hi-fi 20hz 20KHz	£9.50
Microvolt multiplier - measure very low currents with ordinary multimeter	£3.95
Pure Sine Wave Generator	£6.75
Linear Power output meter	£11.50
115 Watt Amplifier 5Hz - 25KHz	£13.50
Power Supply for one or two 115 watt amps	£17.50
Stereo Bass Booster, most items	£8.95

INSTRUMENT BOX



Instrument box with key. Very strongly made (plywood sides with hard board top and bottom). With black grained effect, vinyl covered, giving a very pleasing appearance. Internal dimensions $12\frac{1}{2}$ " long, $4\frac{1}{4}$ " wide, 6" deep. Ideal for carrying your multi range meter and small tools and for keeping them in a safe place. £2.30. Post paid if ordered with other goods, otherwise add £1.

LIGHTING & POWER CABLES

Copper clad, PVC sheathed. Made by Volex to B.S.		
1.5mm single	per 100 metres	£2.30
1.5mm flat twin	per 100 metres	£4.50
1.5mm flat 3 core & E	per 100 metres	£5.50
4mm single	per 100 metres	£3.45
6mm flat 3 core	per 100 metres	£32.00
16mm flat twin & E	per 100 metres	£54.00

If not collecting, add 50% carriage.

SUB MINIATURE MOVING COIL SPEAKER OR MICROPHONE



Beautifully made permanent magnet type, this is only 0.8" dia, and 0.4" thick (approx). Impedance approximately 350 ohms, voice coil sealed with dust cover. Ex-equipment. £1.15 each, or 10 for £10.

THIS MONTH'S SNIP

SUPER BARGAIN JUST ARRIVED: The AMSTRAD Stereo Tuner.

This ready assembled unit is the ideal tuner for a music centre or an amplifier, it can also be quickly made into a personal stereo radio - easy to carry about and which will give you superb reception.

Other uses are as a "get you to sleep radio", you could even take it with you to use in the lounge when the rest of the family want to view programmes in which you are not interested. You can listen to some music instead.

Some of the features are: long wave band 115 - 270 KHz, medium wave band 525 - 1650KHz, FM band 87 - 108MHz, mono, stereo switch, AFC switch, tuning meter to give you spot on stereo tuning, optional LED wave band indicator, fully assembled and fully aligned. Full wiring up data showing you how to connect to amplifier or headphones and details of suitable Fit aerial (note ferrite rod aerial is included for medium and long wave bands. All made up on very compact board. This comes packed in a special container, which you can use as a temporary case if you want to make it quickly into a carry about personal stereo.

Offered at a fraction of its cost: **only £6.00** + £1.50 post + insurance.

TANGENTIAL BLOW HEATER

2.5 Kw quiet, efficient instant heating from 230/240 volt mains. Kit consists of blower as illustrated, 2.5 Kw element, control switch and data all for £4.95. post £1.50.



MINI-MULTI TESTER Deluxe pocket size precision moving coil instrument, jewelled bearings - 2000 o.p.v. mirrored scale. 11 Instant range measures:

	DC volts 10, 50, 250, 1000,
	AC volts 10, 50, 250, 1000,
	DC amps 0 - 100 mA.

Continuity and resistance 0 - 1 meg ohms in two ranges. Complete with test prods and instruction book showing how to measure capacity and inductance as well. Unbelievable value at only £6.75 + 60p post and insurance.

FREE Amps-range kit to enable you to read DC current from 0 - 10 amps, directly on the 0 - 10 scale. It's free if you purchase quickly, but if you already own a Mini-Tester and would like one, send £2.50.

J. BULL (Electrical) Ltd.

(Dept. HE), 34 - 36 AMERICA LANE, HAYWARDS HEATH, SUSSEX RH16 3QU. Established 30 YEARS

MAIL ORDER TERMS: Cash, P.O. or cheque with order. Orders under £10 add 60p service charge. Monthly account orders accepted from schools and public companies. Access & Barclay orders accepted day or night. Haywards Heath (0444) 454563. Bulk orders: write for quote. Delivery by return. Shop open 9.00 - 5.30, mon to Fri, not Saturday.

3 CHANNEL SOUND TO LIGHT

Now supplied with fully prepared metal work and p.c.b.
You'll have it going in an evening.

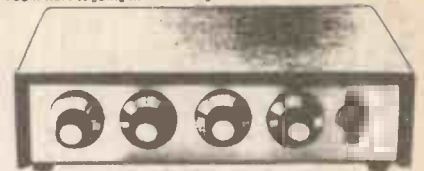

Complete kit of parts for a three channel sound to light unit controlling over 2000 watts of lighting. Use this at home if you wish but it is plenty rugged enough for disco work. The unit is housed in an attractive two tone metal case and has controls for each channel, and a master on/off. The audio input and output are by $\frac{1}{8}$ " sockets and three panel mounting fuse holders provide thyristor protection. A four pin plug and socket facilitate ease of connecting lamps. Special price is £14.95 in kit form or £25.00 assembled and tested. Case & Metal Chassis No. Fully punched and prepared.

PANEL METERS & INSTRUMENTS

Singal meter, 200VA	£1.15
Volt meter 0 - 200 volts, $2\frac{1}{4}$ " round	£1.75
Milli-amp meter, 500ma $2\frac{1}{4}$ " round	£1.15
-amp meter, hot wire scaled, 0 - 9 amps	£2.30
Ammeter, $2\frac{1}{2}$ " round, centre zero, 500ma	£1.75
Charger panel meters, $1\frac{1}{4}$ " dia, scaled 3 amp	.75
Panel meter, $1\frac{5}{8}$ " square, scaled Vu	£1.15
Panel meter, Amstrad, 40mm sq. centre zero, scaled 1, 2, 3	.75
Edgeways panel, 3", 0 - 25ma, ex-GPO	£2.30

SUPER HI-FI SPEAKER CABINETS

Made for an expensive Hi-Fi outfit - will suit any decor. Resonance free. Cut-outs for $6\frac{1}{2}$ " woofer and $2\frac{1}{2}$ " tweeter. The front material is Dacron. The completed unit is most pleasing. Supplied in pairs, price £6.99 per pair (this is probably less than the original cost of one cabinet) carriage £3.00 the pair.

GOODMANS SPEAKERS

$6\frac{1}{2}$ " 8 ohm 25 watt £4.50. $2\frac{1}{2}$ " 8 ohm tweeter. £2.50. No extra for postage if ordered with cabinets. Xover £1.50.

DITTO but for 8" speaker and 4" tweeter. £7.50 + £3.50.



VENNER TIME SWITCH

Mains operated with 20 amp switch, one on and one off per 24 hrs, repeats daily automatically correcting for the lengthening or shortening day. An expensive time switch but you can have it for only £2.95. These are without case but we can supply a plastic base £1.75 or metal case £2.95. Also available is adaptor kit to convert this into a normal 24 hr. time switch but with the added advantage of up to 12 on/off's per 24 hrs. This makes an ideal controller for the immersion heater. Price of adaptor kit is £2.30.

50 THINGS YOU CAN MAKE

Things you can make include: Multi range meter, Low ohms tester, A.C. amps meter, Alarm clock, Soldering iron minder, Two way telephone, Memory jogger, Live line tester, Continuity checker, etc. etc., and you will still have hundreds of parts for future projects. Our 10kg parcel contains not less than 1,000 items - panel meters, timers, thermal trips, relays, switches, motors, drills, taps, and dies, tools, thermostats, coils, condensers, resistors, neon, earphone/microphones, nicad charger, power unit, multi-turn pots and data on the 50 projects.

POTS FOR ONLY £11.50 plus £3.00 post.

EXTRACTOR FANS

Mains operated - ex-computer.
Woods extractor $4\frac{1}{4}$ "x 4" Muffin 115v.
5" - £5.75, Post £1.25 £4.50. Post 75p.
6" - £6.95, Post £1.25 $4\frac{1}{4}$ "x 4" Muffin 230v.
5" Plannair extractor £5.75. Post 75p.
£6.50. Post £1.25.

ROTARY WAFER SWITCHES

5 amp silver plated contacts. $\frac{1}{8}$ " shaft. $1\frac{1}{4}$ " dia. wafer. Single wafer types, 29p each, as follows:

1 pole 12 way	2 pole 6 way	3 pole 4 way
4 pole 3 way	6 pole 2 way	4 pole 3 way

Two wafer type, 59p each, as follows

2 pole 12 way	4 pole 5 way	4 pole 6 way
6 pole 2 way	8 pole 3 way	12 pole 2 way

3 wafer types 99p each.
9 pole 4 way 6 pole 5 way 6 pole 6 way
12p 3 way 18p 2 way

EXTRA POWERFUL 12v MOTOR

Made to work battery lawnmower, this probably develops up to $\frac{1}{4}$ h.p., so it could be used to power a go-kart or to drive a compressor, etc, etc. £6.90 + £1.50 post.
(This is easily reversible with our reversing switch - Price £1.15).

MINI MONO AMP

on p.c.b., size $4\frac{1}{4}$ "x 2" approx. Fitted volume control and a hole for a tone control should you require it. The amplifier has three transistors and we estimate the output to be 3W rms. More technical data will be included with the amplifier. Brand new, perf. a.c. collection, offered at the very low price of £1.15 each, or 10 for £10.00.



Charles Proteus Steinmetz

Ian Sinclair

An experimenter and teacher who took the guesswork out of electrical design.

YOU CAN BE FORGIVEN if you've never heard of Charles Steinmetz, because neither his name nor his achievements are well known on this side of the Big Pond. Nevertheless, his contribution to electricity, and hence to electronics, has had a profound influence on us all, making possible advances that we now take for granted. Of all the Famous Names we have looked at so far, that of Steinmetz seems at first glance least connected with modern electronics, because most of his work was concerned with large electric motors, but, as often happens, a piece of research which expands useful knowledge often affects work which is carried out years later, and in an entirely different field.

Steinmetz was born in Breslau, Germany, in 1865 (the town is now called Wroclaw, and has been part of Poland since the occupation of Eastern Europe by the USSR after the Second World War). He was christened Karl August Rudolf, and was handicapped from birth by a severe spinal deformity, which may have had the effect of turning him to academic studies at times when his classmates were playing football. His education progressed to the Technical High School in Berlin — a type of institution which never became rooted in this country — and from there, in 1892, to University, where he started to make a name for himself as a brilliant researcher and equally as a committed Social Democrat. It was this second activity which drew him to the attentions of the ruling authorities, and it's ironic to think that if he were active in his home town right now, the Polish authorities would probably take the same line.

After several brushes with the Government, he emigrated, like so many others at the time, to the USA to find freedom of expression and action. Shortly after arriving, he anglicised his names to Charles Proteus — Proteus having been a college nickname.

His reputation as a researcher had preceded him, and he was employed almost at once by the firm of Eickemeyer and Osterheld, an electrical manufacturing company with interests in electric motors, transformers and power transmission. Once established, he founded a small research laboratory which soon became very well known in

the industry. It was at this laboratory that he discovered the effect of magnetic hysteresis.

Hysteresis Lesson

Now magnetic hysteresis isn't a subject you learn about nowadays unless you have specialised interests. It was once included as a topic in A Level physics courses, but was dropped several years ago because it didn't fit in with the new methods of teaching physics, and in particular with the modern system of units. This is a pity, because it deprives a lot of students of their first glimpse of real-life physics, as distinct from the neat and tidy

world of theory. Let me explain the subject in outline.

When you stretch a spring, its length increases, and the amount of force that you need to keep the spring stretched depends on how far you have stretched it. Unless you stretch the spring too far, it will always return to its original length when you release it. This simple fact was discovered by Hooke in the seventeenth century, and is called Hooke's Law. A lot of laws in physics are like this one — one quantity is proportional to another, so that a graph of the extension of a spring for example, plotted against the stretching force, is a straight line (Figure 1). This type of relationship is called linear.

If you over-stretch the spring, however, its length is permanently changed, and the graph of extension plotted against force looks more complicated. The graph now has two lines, one for increasing force, the other for decreasing force (Figure 2). A shape of this type is called a 'hysteresis' curve, and it implies, in this example, that the spring does not return to its original length.

Until Steinmetz investigated the magnetization of iron, everyone assumed that when a coil of insulated wire was wrapped round a piece of iron, and an electric current passed through the wire, then the magnetism of the iron would depend on the amount of current through the wire, and the relationship would be linear, or almost so. They expected, in other words, that a graph of magnetic strength plotted against current would be a straight line. By the late 1880s, it was becoming obvious that this assumption just could not be sustained. There was, for example, no way in which the performance of an electric motor could be predicted using these simple ideas about magnetism, and the magnetism of the iron in the motor was the only missing link in the theory. The only way that a manufacturer could get data on the likely performance of a new electric motor design was to build a prototype and test it! At a time when the uses of electricity, and in particular the uses of electric motors, were expanding rapidly, this was unsatisfactory, rapidly becoming intolerable because the use of AC in power transmission, strongly urged by many engineers, demanded the use of transformers — and there was no theory

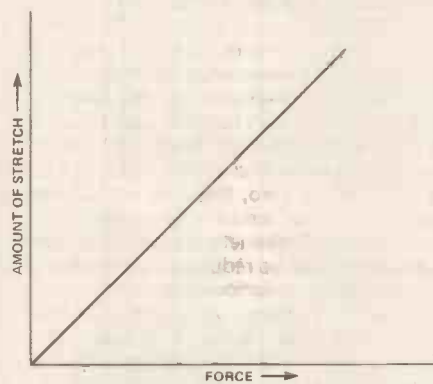

Figure 1. The graph for stretching a spring — providing you don't overstretch it!

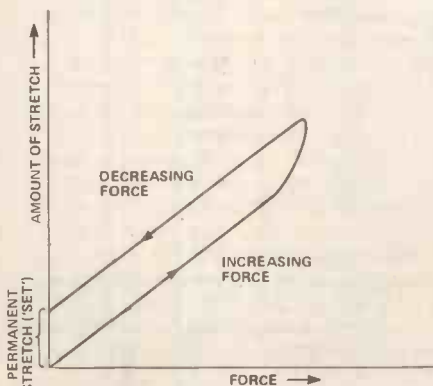

Figure 2. The 'hysteresis' graph shape that results from overstretching.

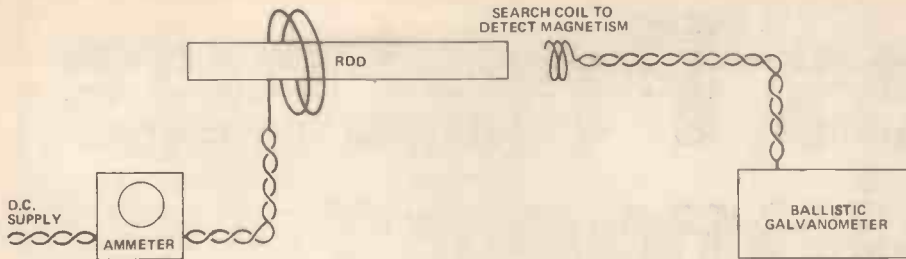

Figure 3. The Steinmetz apparatus, simplified. The rod was magnetized by the current flowing in the large coil, and the amount of magnetism detected by the smaller coil in conjunction with a ballistic galvanometer.

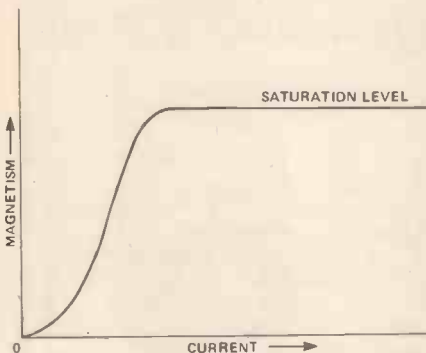

Figure 4. The first part of the magnetizing curve for iron.

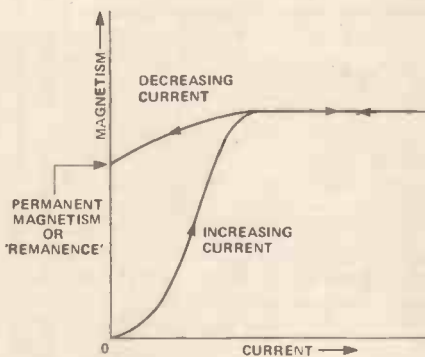

Figure 5. The hysteresis effect — as current is reduced from the saturation level, a different curve is traced, and with zero current, the iron remains magnetized.

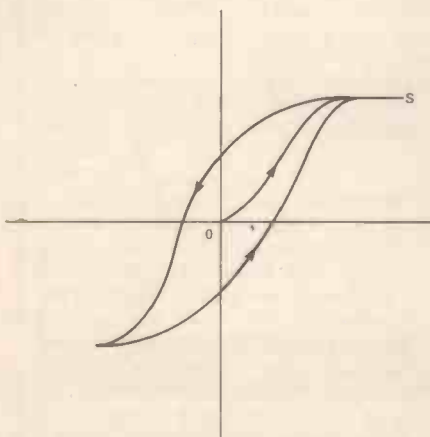

Figure 6. The complete hysteresis loop — the first part, marked OS, is seen only when starting with completely demagnetized material and is never traced again in the course of a measurement of this kind.

governing the design of the most important part of a transformer, its magnetic core.

Round the Bend

Steinmetz set to work investigating the magnetism of iron and its alloys, using the type of equipment illustrated in Figure 3. The details have been omitted, but the principle was that a measured current was passed through the coil surrounding the magnetic specimen, and the strength of the magnetism measured (by a system which Steinmetz had devised). The measurements enabled him to draw a graph of magnetic strength (what we would now call the flux density) against the current flowing in the coil (proportional to what we now call magnetizing force). He started with completely demagnetized iron, and found that as the current increased, the magnetic strength also increased, following a curved graph line shaped rather like an 'S', to a maximum magnetic strength, which he termed 'magnetic saturation' (Figure 4). When the current was reduced, however, a different set of graph points was obtained, so that the graph for decreasing current followed a different path. This path (Figure 5) showed that when the current was reduced to zero, the iron remained magnetized (the amount is called the 'remenance'). Steinmetz found that the magnetism could be reduced to zero only by reversing the direction of the current in the coil and holding it at some definite value, called the 'coercive force'. By taking the value of the reversed current to the amount that caused the magnetism to saturate again he produced the now-familiar hysteresis curve for iron (Figure 6).

The consequences of this work were enormous. The area inside the loop-shaped curve is proportional to the amount of energy that has to be used to magnetize and demagnetize the material, and this energy causes the iron to become hot. Previously, it had been thought that the heating of electric motors and transformers was due only to the current flowing through the wires (and to eddy currents), but Steinmetz's work clearly showed that the magnetic material was as much to blame. He went on to show that the shape and size (area) of the hysteresis curve could be greatly affected by the composition of an iron alloy, and even more importantly, on its previous treatment, such as heating, previous magnetization, mechanical strain, and so on.

For the first time, electric motors could be designed and perform to specification, and transformers could be wound which would not overheat. The way was open for the invention of magnetic recording by Poulsen, and subsequent research which led to the discovery of ferrite materials such as are now used for coil cores and for aerials in pocket radios. Even if Steinmetz had done nothing more on this work, he would have deserved to be remembered, and his classic paper of 1892 is well worth reading in reprint form.

It Doesn't Add Up . . .

He contributed much more, however. When he arrived in the USA, he was amazed and dismayed to find that engineers, brought up in the British tradition, were almost incapable of making elementary calculations on alternating current circuits, and he undertook, virtually singlehanded, to raise the level of mathematical education to the standard which by then was common on the European continent, Britain excepted. He invented a new method of expressing AC calculations (the j-vector method) which is still in use, and, finding that engineers didn't understand it or even appreciate its advantages, he set about writing, in 1897, a textbook of Engineering Mathematics which did more to improve the education of engineers than any other single step in the decade.

Steinmetz's reputation by that time was such that when General Electric purchased the firm of Eickemeyer and Osterheld, Steinmetz was regarded as the main asset, and the most valuable single part of the deal. His work for GE included a new theory of transients (voltage pulses) which resulted in greatly improved ways of protecting transmission lines against switching surges and lightning strikes. The same theory was later used by the early workers on radar to predict the action of pulses in their circuits. Always an experimenter as well as a brilliant theorist, Steinmetz designed a pulse generator, for testing lines, which would even nowadays be regarded as something special — 100kV at 10kA for 1ns! This giant insulation-cracker was used to test lines for transient behaviour — and one nanosecond is as transient as you can get.

He continued working for GE, living in their bachelor accommodation surrounded by dozens of pet small animals of every kind, and a hothouse full of his special joy, orchids. He appears to have been idolised by his fellow-workers as that very rare type, a near-genius who was at the same time a very warm and friendly personality, and who would help anyone to the best of his ability. He died in 1923, having amassed no fortune, won few of the glittering prizes that most academics covet, and not even honoured by having his name used for a unit or a device. The admiration of his colleagues, and the increasing value of his contributions to electrical science were reward enough for Charles Steinmetz, and perhaps this article may serve to make his well-deserved US reputation rather better known over here.

THE PROJECT KITS

I.C.
TRANSISTORS
CAPACITORS

TOOLS
RESISTORS
HARDWARE

CASES
KITS

MAGENTA

Make us your No. 1 SUPPLIER OF KITS and COMPONENTS for H.E. Projects. We supply carefully selected sets of parts to enable you to construct H.E. projects. Kits include ALL the electronics and hardware needed. Printed circuit boards (fully etched, drilled and roller tinned) or Veroboard are, of course, included as specified in the original article, we even include nuts, screws and I.C. sockets. PRICES INCLUDE CASES unless otherwise stated. BATTERIES ARE NOT INCLUDED. COMPONENT SHEET INCLUDED. If you do not have the issue of H.E. which includes the project — you will need to order the instruction reprint at an extra 45p each.

Reprints available separately 45p each + p. & p. 40p.

STEREO VOICE OVER UNIT April 83 £17.52
OPTIONAL MIC PRE AMP April 83 (no case) £4.28
AUTO POWER DOWN April 83 no case £8.05
PHASE FOUR Dec 82 £18.71
STEREO NOISE GATE Dec 82 £15.35
TAPE/SLIDE SYNCHRONIZER Dec 82 £21.73
BIG EAR Dec 82 less pipe parts £8.21
MICROAMMETER ADAPTOR Dec 82 £4.98
ODOMETER Nov. 82 £14.98
DIANA V.C.O. Nov 82 £4.89
CB SQUELCH UNIT Oct 82 £9.19
'JUNIOR' SLOT CAR CONTROLLER Sept 82 £5.80 less case.
ZX INTERFACE BOARD Sept 82 inc edge con £11.33.
T.V.I. FILTER July 82 £5.33
AUTO WAM June 82 £18.98 inc case or £12.28 less case.
AUTO GREENHOUSE SPRINKLER June 82 £15.38 less pump and power supply (12V 2A).
TELEPHONE TIMER June 82 £33.42 less power supply (suitable type below).
POWER SUPPLY DESIGN 12V 500mA June 82 £9.98
ECHO REVERB UNIT May 82. Less case £33.98. Economy case WB3 £3.78 extra.
DIGITAL THERMOMETER May 82 excluding case + bezel £18.90
AUDIO SIGNAL GENERATOR May 82 £20.98.
CABLE TRACKER May 82 £9.98
DIGITAL CAPACITANCE METER. Apr 82 £21.37
SIGNAL TRACER Apr 82 £3.86
BIKE ALARM Apr 82 £11.74
DIGITAL DICE Mar 82 £7.29
BICYCLE SIREN Mar 82 £10.89
NOISELESS FUZZBOX Feb 82 £10.45
MASTHEAD AMPLIFIER Feb 82 £14.74
DRUM SYNTHESIZER Dec 81. Full kit £21.37
GUITAR HEADPHONE AMPLIFIER Dec 81 £3.72
IN CAR CASSETTE POWER SUPPLY Dec 81 £4.77
SCRATCH FILTER Nov 81 Mono £5.82 Stereo £8.98
LED VU METER Nov 81 less case £4.87
SIMPLE STYLUS ORGAN Nov 81 less case £4.98
METRONOME Nov 81 £12.71
TELEPHONE BELL REPEATER Oct 81 £13.87

Med linking wire extra 14p metre
COMBINATION LOCK Oct 81 less solenoid £18.65
BABY ALARM Oct 81 £8.70, Fig 8 linking wire 7p metre
'DIANA' METAL LOCATOR Sept 81 £34.60
REACTION TESTER GAME Sept 81 £12.81
VARIABLE BENCH POWER SUPPLY Aug 81 £26.98
ULTRASOUND BURGLAR ALARM July 81 £19.98
ELECTRONIC DOOR BUZZER July 81 £5.98
ELECTRONIC METRONOME July 81 £4.99
CONTINUITY CHECKER June 81 £5.71
ENVELOPE GENERATOR June 81 £17.98
AUDIO MIXER June 81 £5.33
PUBLIC ADDRESS AMPLIFIER March 81 £19.48. Extras - horn speakers £8.83 each, PA MIC £4.40
FUZZBOX March 81 £10.98
WINDSCREEN WIPER CONTROLLER March 81 £8.20
STEAM LOCO WHISTLE March 81 £12.98
PHOTOGRAPHIC TIMER March 81 £3.50
HEARTBEAT MONITOR Feb 81 £24.98
TWO-TONE TRAIN HORN Feb 81 £5.60 less case
medium wave radio Feb 81 £8.20
BENCH AMP Jan 81 £10.80
NICAD CHARGER Jan 81 £8.20
CHUFFER Jan 81, less case £7.53
BATTERY CHARGE MONITOR Dec 82 £5.77
MEMORY BANK — MINI SYNTHESISER Nov & Dec 80 £29.98
TRANSISTOR TESTER Nov 81 £8.54 inc test leads
GUITAR PRE-AMP Nov 80 £8.65 case (diecast) extra £2.29
INTRUDER ALARM Oct 80 £20.98
TOUCH SWITCH Sept 80 £2.75 less case & contacts
GUITAR PHASER Sept 80 £16.28
SOUND OPERATED FLASH TRIGGER July 80 no sct £5.33
FOG HORN June 80 £8.64
SPEED CONTROLLER FUM M/C April 80 £17.55 (less case)
DIGITAL FREQUENCY METER April 80 £39.98
GUITAR TUNER Nov 79 £12.82
CAR ALARM Feb 79 £12.81

SOLDERING / TOOLS

ANTEX X5 SOLDERING IRON 25W £5.48
SOLDERING IRON STAND £1.98
SPARE BITS. Small standard, large, 65p each. For X5 + X25
SOLDER. Handy size. 99p
SOLDER CARTON £1.84
DESOLDER BRAID 69p
HEAT SINK TWEEZERS 29p
DESOLDER PUMP £6.48
HOW TO SOLDER LEAFLET 12p
LOW COST CUTTERS £1.69
LOW COST LONG NOSE PLIERS £1.68
WIRE STRIPPERS & CUTTERS £2.69
PRECISION PETITE
12V P.C.B. DRILL £11.67
DRILL STAND £7.98
GRINDING STONE 50p
GRINDING WHEEL 50p
SAW BLADE 85p
BRASS WIRE BRUSH 50p
BURR 50p
VERO SPOT FACE CUTTER £1.49
PIN INSERTION TOOL £1.98
VEROPINS (pk of 100) 0.1" 52p
MULTIMETER TYPE 1 (1,000 opv) £5.48
MULTIMETER TYPE 2 (20,000 opv) with transistor tester. Very good £14.75
CROCODILE CLIP TEST LEAD SET. 10 leads with 20 clips 99p

RESISTOR COLOUR CODE
CALCULATOR 21p
CONNECTING WIRE PACK TYPE ED. 11 colours 49p
ILLUMINATED MAGNIFIERS
Small 2" dia. (5x mag.) £1.14
Large 3" dia. (4x mag.) £2.40
CAST IRON VICE £2.98
SCREWDRIVER SET £1.98
POCKET TOOL SET £3.98
DENTISTS INSPECTION MIRROR £2.85
JEWELLERS EYEGLASS £1.50
PLASTIC TWEEZERS 69p
PAIR OF PROBES WITH LEADS (cc) 77p



20,000 opv. Includes transistor tester. AC + DC volts. DC current. 4 very useful resistance ranges. We've used it and we like it.

SPEAKERS. Miniature, 8 ohm 87p
64-75 ohm 89p
CRYSTAL EARPIECE 85p
MONO HEADPHONES £2.96
TELEPHONE PICK-UP COIL 72p
MIN. BUZZERS. 6V, 50p, 9V. £1-10.
12V, 65p
MAGNETIC EARPIECE 15p
STEREO HEADPHONES £4-35
F.M. AERIAL 99p

VEROBOARD 0.1" COPPER STRIPS 10 strips 24 holes £1.20 per 5 24 strips 24 holes 78p 24 strips 50 holes 89p 36 strips 37 holes 89p 36 strips 50 holes 99p Terminal pins 0.1" 62p/100	PP3 CLIPS 10p PP5 CLIPS 11p	PANEL METERS 50uA: 100uA; 1mA, 1A, 25V, 100uA-0-100uA; 5A. AU £4.38 each. State value.
EUROBREADBOARD £8.20 S-DEC BREADBOARD £3.98 BIMBOARD 1 BREADBOARD £8.98 VEROBLOC BREADBOARD £4.20		

Q MAX PUNCHES
1" - £2.98; 1.5" - £3.08
1.5" - £3.17; 2" - £3.24

HELPING HANDS JIG £6.30
Heavy base. Six ball and socket joints allow infinite variation of clips through 360°. Has 2 1/2" diameter (25 x) magnifier attached, used and recommended by our staff.



JUNIOR HACKSAW
SPARE BLADES 29p/5
ABRAFRAME HACKSAW (cuts all directions) 87p
SPARE BLADES 36p/2
QUICKTEST (Quick connect mains block). £8.99

30 SOLDERLESS BREADBOARD PROJECTS

Book by R. A. Penfold

Clear verobloc layouts and circuit diagrams. Includes: fuzz box, radio, metronomes, timers, transistor checker, switches, etc. Introduction gives basic information on components including resistors, capacitors, I.C.s, transistors, photocell etc. Ideal for beginners as well as those with some experience. Complete kit including verobloc, book, and components.

(Less batteries) £24.74 OR (Less book) £22.50
or (Less verobloc) £20.25 OR BOOK ONLY £2.75

BOOKS

ADVENTURES WITH MICROELECTRONICS

Similar to 'Electronics' below. Uses I.C.s. Includes dice, electronic organ, doorbell, reaction timer, radio, etc. Based on Bim-board 1 bread board. Adventures with Microelectronics. £2.55
Component pack £29.64 less battery.

SEMICONDUCTOR DATA BOOK Newnes £5.90
ELECTRONIC PROJECTS FOR HOME SECURITY ELECT. PROJECTS IN PHOTOGRAPHY £3.36
110 ELECT. ALARM PROJECTS £3.36
MODEL RAILWAY PROJECTS £5.36
BASIC ELECTRONICS. Theory & practice £7.98
BEGINNERS' GUIDE TO BUILDING ELECT. PROJECTS £1.50

by Tom Duncan

ADVENTURES WITH ELECTRONICS

An easy to follow book suitable for all ages. Ideal for beginners. No soldering, uses an S-Dec breadboard. Gives clear instructions with lots of pictures. 16 projects—including three radios, siren, metronome, organ, intercom, timer, etc. Helps you learn about electronic components and how circuits work. Component pack includes an S-Dec breadboard and all the components for the projects. Adventures with Electronics £2.40. Component pack £18.98 less battery.

MORE PROJECT KITS — SIMILAR STYLE TO H.E.

INSTRUCTIONS INCLUDED (SEPARATELY 45p EACH)
PLEASE QUOTE REF. NO. WHEN ORDERING

B1 PEST CONTROL 'Ultrasonic cat scarer' £7.65	B11 IN SITU TRANSISTOR TESTER £5.98
B2 COMPONENT TESTER £8.88	B12 WEIRD SOUND EFFECTS GENERATOR £5.98
B4 GUITAR NOTE EXPANDER £17.98	B13 AUDIBLE VISUAL METRONOME £5.98
B6 CAMERA OR FLASH GUN TRIGGER Infra red system £12.61	B14 ELECTRONIC DICE £5.71
B6 SIMPLE INFRA RED REMOTE CONTROL £17.20	B16 MINI EGG TIMER £4.34
B7 0-12V POWER SUPPLY £17.98	B18 LED JEWELLERY — Cross brooch £2.77 Star brooch £9.91 Spiral brooch £7.98
B9 SOUND TO LIGHT — single channel £8.42	
B10 THREE CHANNEL SOUND TO LIGHT £21.44	

MORE KITS AND COMPONENTS IN OUR LISTS
FREE PRICE LIST
Price list included with orders or send sae (9 x 4)
CONTAINS LOTS MORE KITS, PCBs & COMPONENTS

1982 ELECTRONICS CATALOGUE
Illustrations, product descriptions, circuits all included. Up-to-date price list enclosed. All products are stock lines for fast delivery. Sends 80p in stamps or add 80p to order.
MORE H.E. PLUS E.E. and E.T. PROJECT. KITS IN THE PRICE LIST

MAGENTA gives you FAST DELIVERY OF QUALITY COMPONENTS & KITS. All products are stock lines—and are new & full specification. We give personal service & quality products to all our customers—HAVE YOU TRIED US?

MAGENTA ELECTRONICS LTD
HX36, 135 HUNTER ST., BURTON-ON-TRENT, STAFFS.
DE14 2ST. 0283 65435. MON-FRI 9-5. MAIL ORDER ONLY
ADD 45p P&P TO ALL ORDERS. PRICES INC VAT

ACCESS and BARCLAYCARD (VISA)
ORDERS ACCEPTED BY PHONE OR POST.
SAE ALL ENQUIRIES.

Prices inc. VAT
OFFICIAL ORDERS WELCOME
OVERSEAS. Payment must be in sterling.
IRISH REPUBLIC and BFPO: UK PRICES.
EUROPE: UK PRICES plus 10%.
ELSEWHERE: write for quote.

Aerial Without Wings

Andy Armstrong

A novel device that converts a rear-window demister into an effective car radio aerial for medium or longwave reception.

ARE YOU fed up with car aerials that corrode and won't work properly, or which are broken off by vandals? Or perhaps you simply dislike the idea of drilling rust-trapping holes in your beautiful bodywork!

If you listen to long or medium wave radio in your car, then your troubles may be over. This simple gadget will transform a rear window demister into a long and medium wave aerial; it will also work for FM reception, though not so well because of directional effects.

Circuit, What Circuit?

All you need to build the device is a couple of capacitors and a bifilar wound coil. The circuit, such as it is, is shown in Figure 1.

The demister, like any length of wire, straight or not, will act as an aerial, but normally the radio frequency voltages induced in the wire are shorted to earth, either directly or through the battery (which presents virtually zero impedance to high frequencies).

The effective part of the circuit is the bifilar-wound coil, L1, which presents a high impedance to radio frequency signals, allowing them to be tapped off to the car radio aerial input via C1. The 1nF capacitor, C2, is there to bypass to earth any transients (spikes) which are often present on a car's electrical system.

But what, you ask, is a "bifilar

coil"? Well, it is simply two coils (like a 'pair' of scissors, there must be two 'halves') wound on a common former for the same number of turns with the same gauge wire, and *in the same direction*. The dots at the ends of the coil, in the circuit, indicate either the start or the finish of each winding; it doesn't matter which, as long as both ends are the same (this is the so-called 'dot convention' which is the standard way of indicating the polarity of transformers etc.).

Saturation Tactics

Whenever a current flows in a coil (or in any wire, for that matter), a magnetic field is set up around the conductor. If the current is DC, however, and if the coil is wound on an iron or ferrite core, the magnetic flux rapidly reaches 'saturation', beyond which further increases in current have very little effect.

Therefore the high frequency AC will have no effect, either, and since inductance is largely dependent on variations in the magnetic flux density, DC flowing through an iron or ferrite-cored inductor has a drastic and undesirable effect on the inductance.

Bifilar-wound coils prevent this; since the coils, when connected as shown in Figure 1, are passing the same DC in opposite directions, the magnetic fields in each half are of opposite polarity and therefore cancel

out. Thus only the flux due to the AC has any real presence, and the value of the inductance can be accurately predicted.

Construction and Installation

To make the coil, you simply need to wind two strands of thick wire (preferably 1.2mm² enamelled copper wire, but ordinary 13A household cable will do) on a toroid or pot former for between 13-20 turns, taking care to wind them together and in the same direction. Obviously the number of turns is not too critical within this range, so there is some room for experiment here! C2 can be soldered across the ends of the coil but the other capacitor cannot be so conveniently mounted, so after soldering to the appropriate coil-end, it must be securely fixed to part of the car body using a plastic cable tie. Alternatively, it could be strapped across the body of the toroid or pot former with a longer plastic cable clip, which can also be used to secure the whole assembly to the car chassis.

As with all constructions to be used in a motor, the soldered connections must be very secure lest they vibrate themselves loose, and all bare wires should be covered with insulating sleeving, preferably of the heat-shrinking variety.

The completed device should be installed as close as possible to the demister, to avoid interference pickup, and is connected to the radio aerial input via a long length of low capacitance car aerial cable, available from most good motor accessory shops. Do not be tempted to use ordinary co-ax, as the high inherent capacitance of this type of cable will prevent correct operation.

Next the car radio aerial trimmer must be adjusted for best reception; this can usually be done without dismantling the radio, and the location of the trimmer will be explained in the car radio installation instructions. And, finally, it may be necessary to improve the interference suppression, either by replacing the existing suppression components or adding extra ones (again, these should be available from an accessory shop). So here's wishing you happy motoring, and easy listening pleasure. Your car aerial is now off the wing!

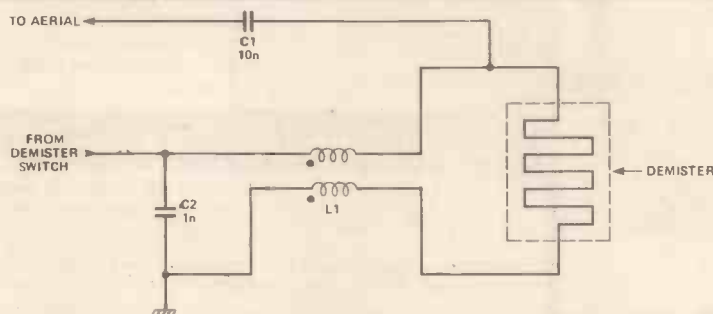

Figure 1. The Circuit: dots signify the starting points of the two windings.

Parts List

CAPACITORS (polyester)

C1 10n
C2 1n

MISCELLANEOUS

L1 see text
Pot core or toroid (see Buylines);
1.2mm² wire; car aerial cable;
motor car with rear window demister and car radio.

BUYLINES page 34

This handy little test gadget will help you sort out all those little things that go wrong in automotive electrics. With this, you can check voltage drops, on and off charge battery voltages and resistances.

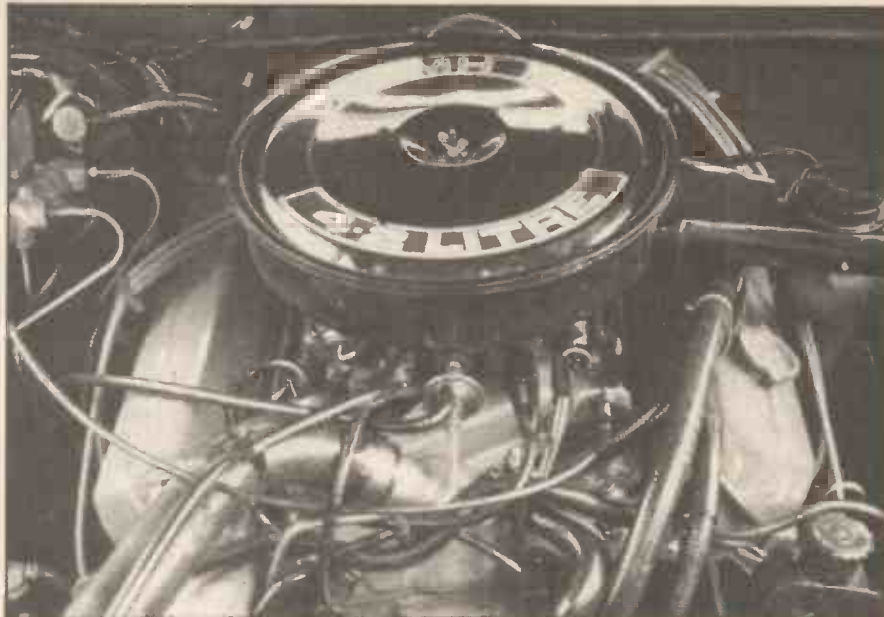

HE Auto Tester

Graeme Teesdale

BUDDING MECHANICS are very often bamboozled by the electrics of a modern motor vehicle. An automotive or electronic type multimeter, with its combination scales all crammed together, simply adds to the confusion. This project was developed to make fault-finding a little easier by providing simple LED indication of 'set' points in voltage or resistance.

In a vehicle, voltage drop in cables of more than 0V5 can bring problems. The Auto Tester provides a clear indication of voltage drops less or greater than 0V5. The battery system, to perform up to scratch, must deliver at least 12V on load and the battery should have a terminal voltage of more than 13V5 when charging.

Resistances encountered in vehicles tend to have fairly well defined limits. Many devices have resistances under 10 ohms, a few range up to 150 ohms. Thus the first resistance 'set' point is at about 150 ohms. Much higher resistances are encountered in HT suppressors, etc. Generally, these are around 10k or 15k. Trouble can occur if they go faulty and exhibit a high resistance, generally greater than 50k. Thus, two other 'set' points for resistance are at 10k and 50k.

The unit was housed in a small, conveniently-sized box; the PCB designed for the unit will just fit comfortably into several different types on the market. Four indicator LEDs are provided: a POLARITY indicator, followed by one for each of the three set points in voltage and resistance. Two pushbuttons select which 'mode' you wish to use — VOLTS or OHMS.

Where battery polarity is unknown, or in instances where the Auto Tester may be incorrectly connected, the POLARITY LED will light when the red, or positive, input lead is connected to the battery negative.

Protection against input overvoltage damage has been incorporated, so that voltage inputs of greater than

15V are clamped to avoid damaging the IC.

The Auto Tester, unlike most multimeters, will not be damaged if a DC voltage is applied to the input when it is being used in the resistance mode.

The unit is powered from a PP3 9V battery and the circuit is based around the commonly available, low cost LM324 or uA324 quad op-amp. The battery will likely last its shelf life (probably a year or more) as consumption is only ever momentary, when you take a reading!

Auto Testing

The clearest way of seeing how this circuit works is to break it down into simplified sections. The Auto Tester performs three main functions: voltage drop measurement, 12/13.8V measurement and resistance measurement. In addition, an indication of reverse polarity connection is provided along with input overvoltage protection.

The whole circuit is built around an LM324 (or uA324) quad op-amp, IC1. Three op-amps from this are arranged as comparators and one as an amplifier. Let's look at the voltage drop measurement stage first. This portion of the circuit is shown in Figure 1 (only the relevant components are included).

When PB1 is pressed, power is supplied to IC1 via D3 (note that R1, LED1, R2 and ZD2 play no part here). RV1, R3 and R4 form a voltage divider across the input of IC1a, which is arranged as an amplifier, while IC1d is set up as a comparator.

If the input leads are then

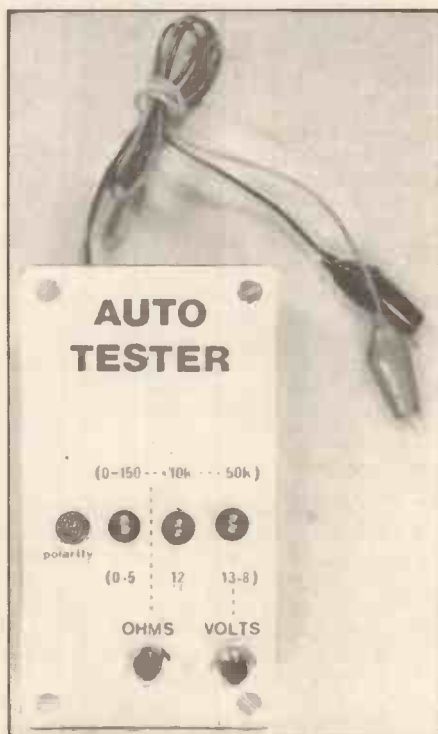

HE Auto Tester showing the front panel and crocodile clips.

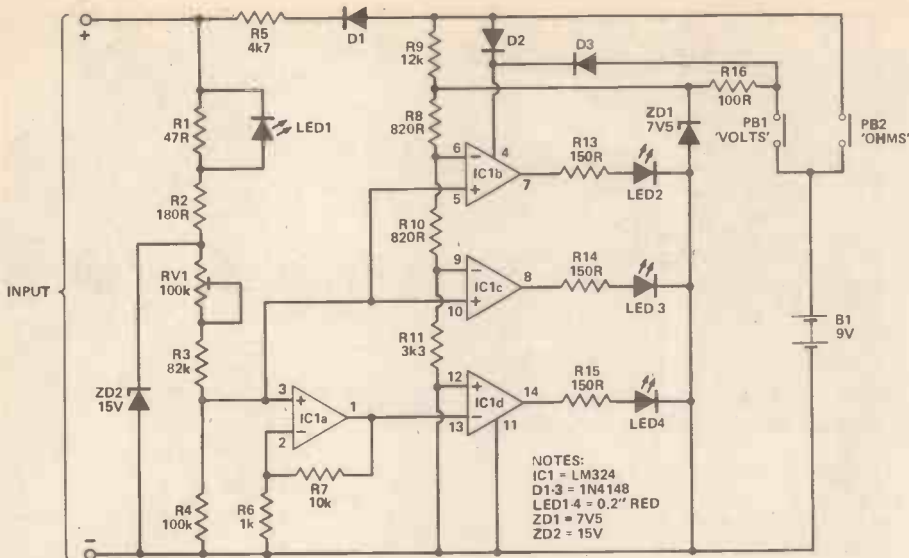

Figure 1. The Auto Tester circuit.

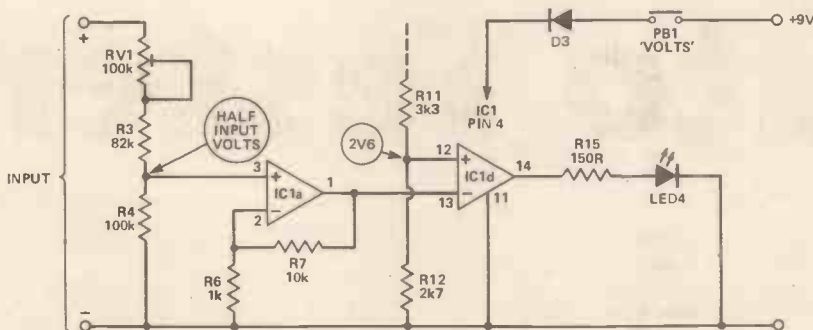

Figure 2. Voltage drop measurement.

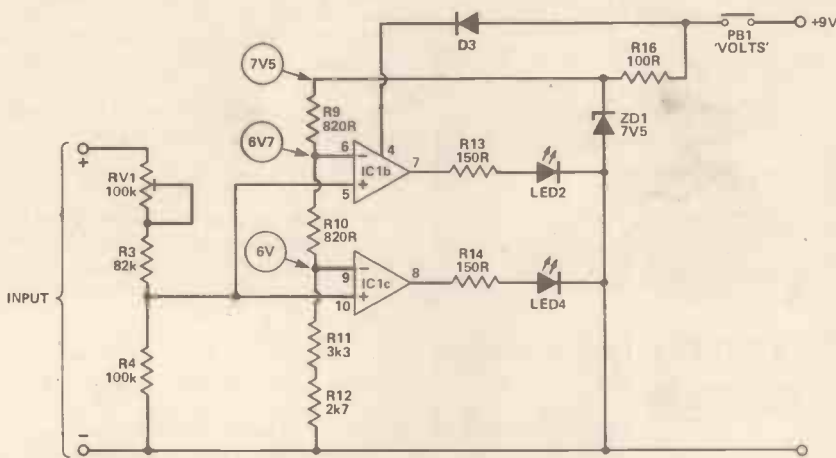

Figure 3. 12V and 13V8 measurement.

connected across a cable having a voltage drop of less than half a volt, say 0V2, the voltage appearing at the non-inverting input of IC1a will be about 0V1 (half the input volts) due to the divider action of RV1, R3 and R4. RV1 is set to provide this division ratio of about two, while IC1a provides a gain of 10, and thus the output will be 1V. This is lower than the 2V6 on the non-inverting input of IC1d and thus its output will be driven high, lighting LED4.

If the voltage drop on the cable you have connected the input leads across reaches a little over a half a volt, say 0V55, the voltage on the non-inverting input of IC1a will be about 0V275. The voltage on the output of IC1a, and thus the inverting input of IC1d, will be 2V75 which exceeds the 2V6 on IC1d's non-inverting input. The output of IC1d will thus go low and LED4 will extinguish, warning you of excessive voltage drop in the cable.

Note that, when performing voltage

drop measurements, the positive lead must be connected at the end of the cable closest to the positive terminal of the vehicle battery!

When the input leads are open circuit and PB1 is pressed, D1 will be forward biased as it is connected to the 7V5 rail (from ZD1) via R8. Thus, something a little under 7V will appear at the 'top' of RV1, and about 3V5 at pins 3, 5 and 10 of IC1. This will drive the output of IC1d low, and LED4 will be unlit. It won't change the condition of either IC1c or IC1d, so LEDs 2 and 3 will also be unlit. Thus, nothing happens if you press PB1 ('VOLTS') when the leads are not connected to anything.

Let us look at the other voltage measurements now. This section of the circuitry is shown in Figure 2, where IC1b and IC1c are connected as comparators. Each has its inverting input connected to the voltage divider R9, 10, 11 and 12. This voltage divider is supplied from a regulated 7V5, derived by ZD1 and R16, thus battery voltage variations will not affect circuit operation, provided the battery voltage doesn't fall to 8V or less.

IC1b and IC1c have their non-inverting inputs connected together and these are attached to the input voltage divider. When PB1 is pressed, power is supplied to IC1 via D3, as before. With no input voltage, the outputs of IC1b and c will both be low and LEDs 2 and 3 will be unlit. When the input leads are connected to a voltage a little over 12V, the voltage on pin 10 of IC1c will be a little over 6V. This will drive the output of IC1c high, lighting LED3. When the input voltage rises above about 13V5, the voltage on the pin 5 of IC1b will be a little over 6V7, driving the output of IC1b high, now lighting LED2 also.

Resistance

Look at resistance measurement now (for this explanation, refer to the complete circuit diagram, Figure 3). As before, R1, LED1, R2 and ZD2 play no part here.

When PB2 is pressed, power is supplied to IC1 via D2; some current is also supplied to the resistive divider network, R9, 10, 11, 12, by R8. This establishes a different set of voltages on the three comparator inputs. Pin 6, IC1b will now have about 3V8 on it, pin 9, IC1c about 3V on it and pin 12, IC1d about 1V3 on it.

When the leads are connected to a resistance, current will be supplied to the resistance via D1 and R5. Say the resistance is 100 ohms; about 1mA8 will be driven through it because there is about 8V5 on the cathode of D1 and 8.5 divided by 4800 ohms gives about 1mA8. Thus, there will be a voltage drop across the 100 ohms of resistance of about 0V18. About 0V09 will appear on pin 3, IC1a, and the output of IC1a will drive the inverting input of IC1d to about 0V9 which is less than the 1V2 on IC1d's non-inverting input. Thus the

output of IC1d will be high, lighting LED4. If the resistance across the input is, say, 180 ohms, the voltage across the input leads will be about 0V32. About 0V16 appears on pin 3, IC1a and 1V6 on pin 13, IC1d. The output of IC1d will therefore go low, and LED4 will not light.

If the resistance across the input terminals is between 150 ohms and 10k, say 5000 ohms or so, then the voltage across it will be about 4V. The voltage on pin 10, IC1c will be about 2V, which is less than that on pin 9 and the output of IC1c will be low and LED3 will be unlit. If the resistance across the input leads is about 15k, say (such as a spark plug suppressor resistor), then the voltage across the input will be about 6V4 and the voltage presented to pin 10, IC1c will be about 3V2. This is above the 3V on pin 9 and the output will thus go high, turning on LED3.

If the resistance across the input leads is about 50k, then the voltage across the input will be about 7V8. The voltage on pin 5, IC1b will be about 3V9 and the output of IC1b will therefore be high, turning LED2 on. Note that LED3 will also be on as the voltage on pin 10, IC1c is above that on pin 9 and IC1's output will be high also. Thus, for all resistances above 50k (including an open circuit) LED2 and LED3 will light.

Parts List

RESISTORS

(All 1/4 watt 5% carbon)

R1.....	47R
R2.....	180R
R3.....	82k
R4.....	100k
R5,12.....	4k7
R6.....	1k
R7.....	10k
R8.....	12k
R9,10.....	820R
R11.....	3k3
R13,14,15.....	150R
R16.....	100R

POTENTIOMETERS

RV1.....	100k
	min. trimpot

SEMICONDUCTORS

IC1.....	LM324
	quad-op amp
LED1,2,3,4.....	0.2" red LEDs
D1, 2, 3.....	1N4148 etc.
ZD1.....	7V5 Zener
ZD2.....	15V Zener

MISCELLANEOUS

PB1,2.....push-to-make switches
PCB; box approx. 52 x 30 x 100mm;
PP3 battery plus clip; 2 x alligator clips and leads; wire, solder, nuts and bolts etc.

BUYLINESpage 34

Poles Apart

Followed that so far? Alright, let's look at the reverse polarity indication. The relevant portion of the circuit is shown in Figure 4.

If the input leads are transposed while trying to measure voltage, ZD2 will conduct as a diode in the forward direction (as shown by the arrow), passing current through LED1, which will turn on. It will also pass some current through R1, but that's immaterial. R1 is there so that current can pass to RV1 when the leads are correctly connected, otherwise no current would pass through LED1 as it would appear as a reverse-biased diode.

If you reverse the input leads while attempting to measure voltage drop, LED1 will only come on if the voltage drop is above about 1V3 or so. Thus, it is important to watch lead polarity when measuring voltage drop in cables.

Overtension protection is provided by ZD2. Why have it? Well, if a battery cable comes adrift and you're attempting to measure voltages while the motor is running, the generator/alternator can quite easily deliver outputs of 20V or so; this can possibly destroy the LM324. In addition, it is not unusual to get inductively-produced voltage 'spikes' on the supply lines in a vehicle, which can also destroy the IC. If a voltage of greater than 15V appears on the input leads to the Auto Tester, ZD2 will ensure that the voltage delivered to the LM324 does not exceed 15V.

The various voltages and resistances given here can vary by ± 10% or so without grossly affecting

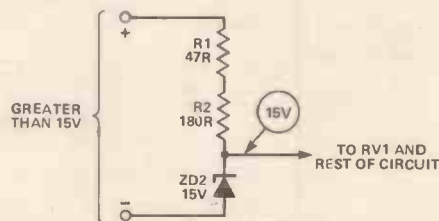
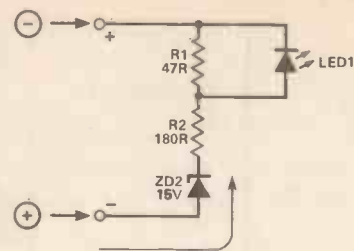

Figure 4 (top). Reverse polarity indication.

Figure 5 (bottom). Overtension protection.

your interpretation of readings. What you are after, after all, is a 'ballpark' measurement which will indicate if all is well, or not.

Construction

The project PCB has been designed to fit into almost any of the small general purpose boxes available. These are generally all-plastic or plastic cases with a light gauge aluminium 'lid'. The design will suit those boxes measuring 52 x 100mm or a little larger.

Before assembling the components to the board, check that it has no

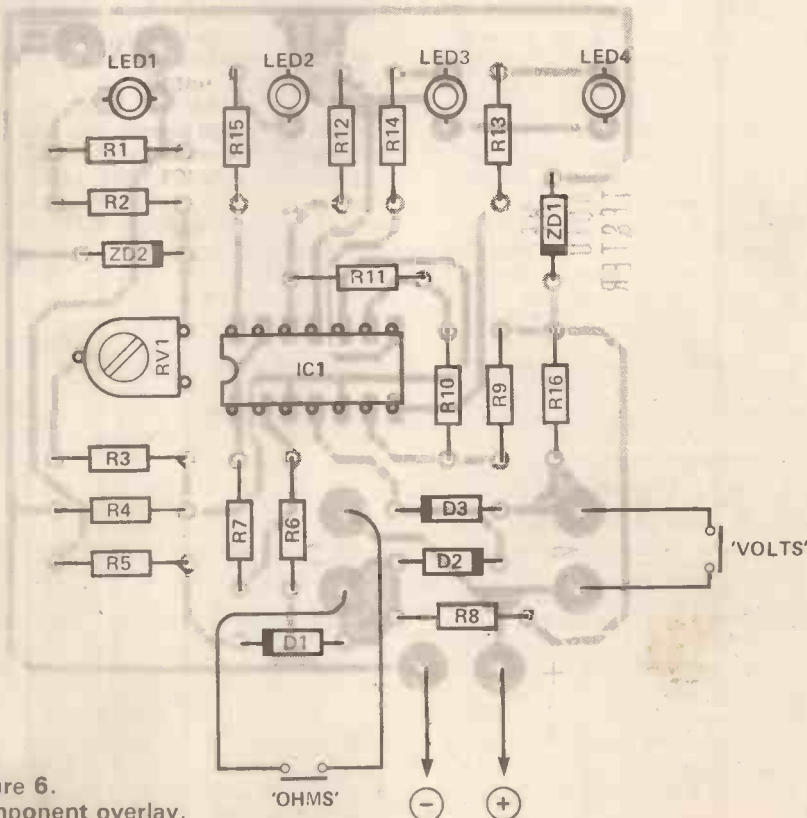

Figure 6. Component overlay.

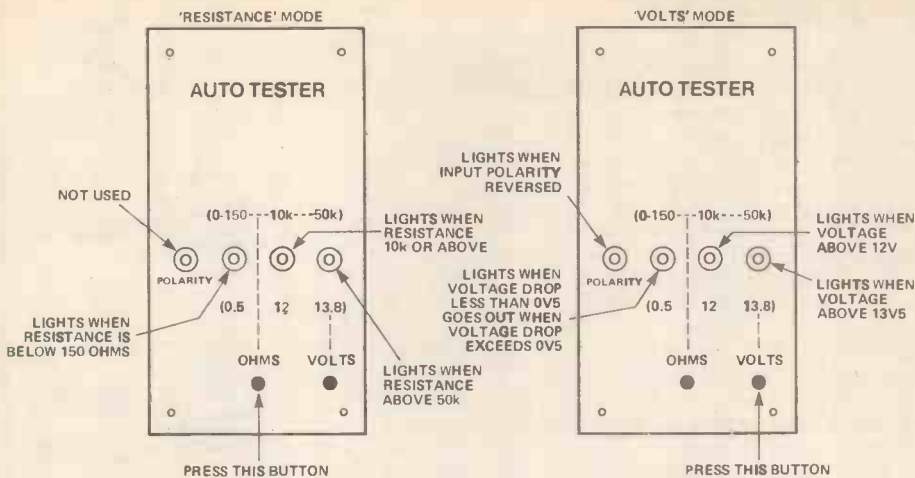

Figure 7. Operating the Auto Tester in Resistance and Voltage modes.

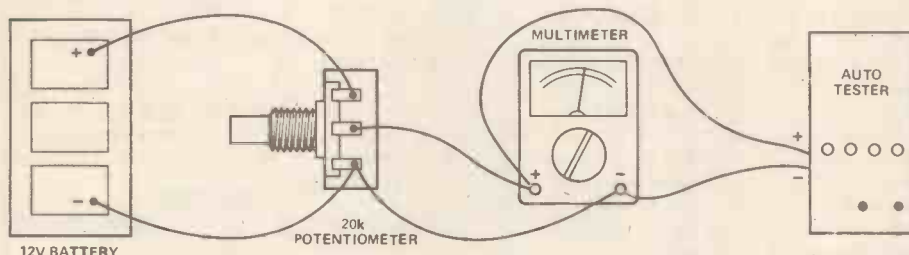

Figure 8. Test setup for calibrating the Auto Tester.

breaks or shorts between tracks, particularly between the IC pins. Also check that components like RV1, the Zener diodes and LEDs have the correct lead hole sizes drilled. The board can be mounted by soldering the two pushbutton switches directly to the board and letting the board hang from their leads — it's quite a robust arrangement. If you're going to do this, see that the holes for PB1 and PB2 are drilled the right size.

Next, check that the board fits inside the box. Make sure you orient the board correctly when you do this. If the board doesn't fit in without jamming you may have to carefully trim a little off one or both sides with a file until it fits properly. If it doesn't fit at all, get a bigger box.

Mark out and drill the front panel, or lid, of the box and fit the four LED mounts. Once the board is ready to go, commence assembly by soldering all the resistors in place, then the diodes D1, 2 and 3, followed by the

two Zener diodes (make sure you get all the diodes in the correct way round).

If you're mounting the board to PB1 and PB2, solder these in place now, making sure their mounting 'shoulders' are level. Insert the four LEDs next, but don't solder them in place; make sure you orient them correctly and don't trim off their leads. Temporarily mount the board to the front panel of the case, push the LEDs into position and then solder and trim their leads. De-mount the board from the panel and fit IC1, RV1, the battery clip lead and the two input leads. Now you're ready for testing. But first, check *everything* carefully. See that the IC, all diodes and LEDs are correctly orientated, according to the component overlay.

Testing the Unit

Fit a 9V, PP3 battery, short the input clips together and press the VOLTS

button: the OV5 LED should come on. If not, check component orientations, then resistor values. Fix any faults, and once you have that corrected, try again. When you get the OV5 LED to light, unclip the input leads and it should go out.

To calibrate the unit, you'll need to get hold of a multimeter, a well charged 12V battery and a 20k potentiometer. Hookup the circuit shown here and adjust the potentiometer to give a 12V reading on the multimeter. Press the VOLTS button and adjust RV1 so that the '12V' LED just lights. Then, reset the potentiometer to get a 0V5 reading, or a little more, on the multimeter. The 'OV5' LED should just light; if it doesn't, vary the potentiometer slightly until it lights. If the 'OV5' LED lights when the multimeter reads more than $\pm 0V1$ from 0V5, then you may have to change the value of R12. Increase it if the voltage is low, decrease it if the voltage is high. Just take the next highest or next lowest resistor value; you're only after a rough indication, after all.

Set the potentiometer fully 'up' (fully clockwise); if the battery is well charged, then the multimeter should read 13V5 or above and the '13V8' LED should turn on, along with the '12V' LED. Now, reverse the Auto Tester input leads. The POLARITY LED should come on.

If you can't get the proper indications, check with the multimeter that you are getting 7V5 (within $\pm 0V3$) across ZD1 when you press the VOLTS button. Also check the voltages on pins 6, 9 and 12 of IC1 when you press the VOLTS button and see they are close to those given in the circuit description.

If all is well, proceed with testing the OHMS mode. Disconnect the 12V battery, then set the multimeter to read resistance (should be the X1 scale). Adjust the potentiometer until the multimeter reads about 100 ohms. Press the OHMS button and the '0-150' LED should come on. Turn the potentiometer until that LED goes out and keep turning till the '10k' LED turns on; it should turn on when the multimeter reads somewhere in the vicinity of 10k.

With the Auto Tester leads open circuit, both the '10k' and '50k' LEDs should turn on.

You are now ready for use. Happy fault-finding!

BEASTIES

BY AH

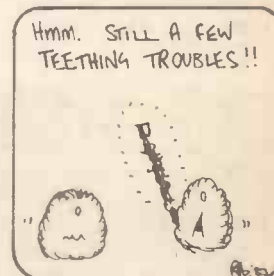
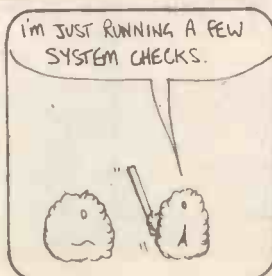

74 SERIES	74136 28p	74131 13p	74LS244 3p	4041 40p	CA3019 9p	M43712 25p	M2A152 8p	E4	2N3702/3 10p	BRIDGE RECTIFIERS	TIL321/2 130p
7400 11p	74141 56p	74LS12 13p	74LS245 70p	4042 40p	CA3046 70p	MB3730 40p	2N419C 190p	MJE340 50p	2N3704/6 12p	TIL330 140p	
7401 11p	74142 176p	74LS13 15p	74LS251 30p	4043 40p	CA3048 220p	MC1310P 50p	2N423E 130p	MJE2955 90p	2N3706/7 10p	TIL750 200p	
7402 11p	74143 200p	74LS14 25p	74LS253 30p	4044 40p	CA3059 26p	MC1445 25p	2N424E 130p	MJE3305 70p	2N3773 200p	DISPLAYS	
7403 12p	74145 40p	74LS20 13p	74LS255 150p	4076 40p	CA3080E 28p	MC1458 35p	2N426E 300p	MPF102 30p	2N3819 200p	1A50V 19p	
7404 12p	74147 75p	74LS22 13p	74LS259 55p	4078 15p	CA3088 20p	MC1495L 35p	2N427E 580p	MPF103/4 30p	2N3823 30p	1A100V 20p	
7405 15p	74150 50p	74LS23 15p	74LS259 55p	4081 14p	CA3089 20p	MC1496 70p	2N428E 400p	MPF104 30p	2N3866 90p	1A400V 25p	
7406 15p	74151A 36p	74LS26 14p	74LS260 22p	4082 15p	CA3090A 400p	MC3340P 120p	2N434E 200p	MPSA12 30p	2N3904 15p	1A600V 30p	
7407 18p	74152 30p	74LS27 13p	74LS261 50p	4086 40p	CA3130 40p	MC3403 65p	2N435E 150p	MPSA13 50p	2N4007 65p	2A50V 30p	
7408 14p	74154 200p	74LS28 14p	74LS266 20p	4089 125p	CA3140E 10p	MC3508 80p	2N4413 70p	MPSA13 50p	2N4037 65p	2A100V 35p	
7409 14p	74155 36p	74LS32 13p	74LS276 30p	4094 90p	CA3150 10p	MNE221A 600p	2N4426 27p	MPSA13 50p	2N4037 65p	DL704 Red 140p	
7410 14p	74156 40p	74LS37 14p	74LS283 40p	4095 75p	CA3161E 150p	NE531 140p	2N4426 27p	MPSA13 50p	2N4037 65p	DL707 Red 140p	
7411 16p	74157 30p	74LS38 14p	74LS288 90p	4096 70p	CA3162E 45p	NE531 140p	2N4426 27p	MPSA13 50p	2N4037 65p	FND507 90p	
7412 16p	74159 75p	74LS40 12p	74LS299 150p	4097 290p	CA3189E 30p	NE531 140p	2N4426 27p	MPSA13 50p	2N4037 65p	FND507 90p	
7413 16p	74161 40p	74LS42 30p	74LS321 150p	4098 90p	CA3240E 110p	NE531 140p	2N4426 27p	MPSA13 50p	2N4037 65p	FND507 90p	
7414 18p	74161 40p	74LS42 30p	74LS321 150p	4099 125p	CA3240E 110p	NE555 16p	2N4426 27p	MPSA13 50p	2N4037 65p	FND507 90p	
7416 18p	74162 40p	74LS51 14p	74LS323 160p	4500 575p	CM7202 20p	NE555 46p	2N4426 27p	MPSA13 50p	2N4037 65p	FND507 90p	
7417 18p	74163 40p	74LS55 14p	74LS324 160p	4502 60p	DAC1408-B E2	NE555 46p	2N4426 27p	MPSA13 50p	2N4037 65p	FND507 90p	
7420 14p	74164 45p	74LS73 18p	74LS325 60p	4503 46p	DAC0800 200p	NE555 120p	2N4426 27p	MPSA13 50p	2N4037 65p	FND507 90p	
7421 18p	74166 45p	74LS74 16p	74LS353 60p	4505 40p	DA C 0808 200p	NE566 155p	2N4426 27p	MPSA13 50p	2N4037 65p	FND507 90p	
7422 20p	74166 45p	74LS75 18p	74LS363 140p	4507 35p	RAT388 195p	NE567 140p	2N4426 27p	MPSA13 50p	2N4037 65p	FND507 90p	
7423 18p	74166 45p	74LS76 18p	74LS364 140p	4508 130p	ICL7106 70p	NE570 410p	2N4426 27p	MPSA13 50p	2N4037 65p	FND507 90p	
7425 18p	74170 120p	74LS83 36p	74LS365 30p	4510 45p	ICM721568 E18	NE571 400p	2N4426 27p	MPSA13 50p	2N4037 65p	FND507 90p	
7427 18p	74172 250p	74LS86 16p	74LS365 30p	4511 45p	ICM721568 E18	NE571 400p	2N4426 27p	MPSA13 50p	2N4037 65p	FND507 90p	
7428 18p	74173 50p	74LS86 16p	74LS365 30p	4512 48p	ICM721568 E18	NE571 400p	2N4426 27p	MPSA13 50p	2N4037 65p	FND507 90p	
7430 14p	74174 55p	74LS90 22p	74LS365 30p	4513 48p	ICM7555 80p	NE571 400p	2N4426 27p	MPSA13 50p	2N4037 65p	FND507 90p	
7432 18p	74176 40p	74LS92 30p	74LS367 30p	4515 110p	LC17120 300p	NE571 400p	2N4426 27p	MPSA13 50p	2N4037 65p	FND507 90p	
7433 22p	74177 45p	74LS96 40p	74LS374 55p	4516 55p	LC17130 325p	NE571 400p	2N4426 27p	MPSA13 50p	2N4037 65p	FND507 90p	
7437 22p	74178 40p	74LS96 40p	74LS375 46p	4518 40p	LF347 150p	NE571 400p	2N4426 27p	MPSA13 50p	2N4037 65p	FND507 90p	
7438 22p	74180 40p	74LS107 20p	74LS377 70p	4520 50p	LF351 48p	NE571 400p	2N4426 27p	MPSA13 50p	2N4037 65p	FND507 90p	
7440 15p	74181 115p	74LS109 27p	74LS390 45p	4521 90p	LF353 95p	NE571 400p	2N4426 27p	MPSA13 50p	2N4037 65p	FND507 90p	
7441 55p	74182 40p	74LS112 20p	74LS393 45p	4526 60p	LF356P 95p	NE571 400p	2N4426 27p	MPSA13 50p	2N4037 65p	FND507 90p	
7442A 30p	74184A 90p	74LS113 20p	74LS399 160p	4527 60p	LF357 110p	NE571 400p	2N4426 27p	MPSA13 50p	2N4037 65p	FND507 90p	
7443 70p	74185 90p	74LS114 22p	74LS467 90p	4532 70p	LM10C 325p	NE571 400p	2N4426 27p	MPSA13 50p	2N4037 65p	FND507 90p	
7445 50p	74186 470p	74LS122 25p	74LS540 90p	4534 40p	LM307 45p	NE571 400p	2N4426 27p	MPSA13 50p	2N4037 65p	FND507 90p	
7446A 36p	74188 250p	74LS123 34p	74LS610 91p	4536 270p	LM308 45p	NE571 400p	2N4426 27p	MPSA13 50p	2N4037 65p	FND507 90p	
7448 46p	74190 45p	74LS124 90p	74LS626 150p	4538 90p	LM308N 75p	NE571 400p	2N4426 27p	MPSA13 50p	2N4037 65p	FND507 90p	
7451 15p	74191 45p	74LS125 74p	74LS628 150p	4543 70p	LM310 120p	NE571 400p	2N4426 27p	MPSA13 50p	2N4037 65p	FND507 90p	
7453 15p	74193 45p	74LS132 34p	74LS670 120p	4553 245p	LM310 120p	NE571 400p	2N4426 27p	MPSA13 50p	2N4037 65p	FND507 90p	
7454 15p	74194 40p	74LS133 25p	74LS687 40p	4555 36p	LM318 150p	NE571 400p	2N4426 27p	MPSA13 50p	2N4037 65p	FND507 90p	
7460 15p	74195 40p	74LS136 25p		4556 36p	LM318 150p	NE571 400p	2N4426 27p	MPSA13 50p	2N4037 65p	FND507 90p	
7470 30p	74197 40p	74LS139 27p		4560 120p	LM319 215p	NE571 400p	2N4426 27p	MPSA13 50p	2N4037 65p	FND507 90p	
7472 25p	74198 80p	74LS145 70p		4569 270p	LM324 30p	NE571 400p	2N4426 27p	MPSA13 50p	2N4037 65p	FND507 90p	
7474 18p	74199 80p	74LS147 100p		4572 30p	LM324 30p	NE571 400p	2N4426 27p	MPSA13 50p	2N4037 65p	FND507 90p	
7475 22p	74221 55p	74LS148 75p		4583 90p	LM324 30p	NE571 400p	2N4426 27p	MPSA13 50p	2N4037 65p	FND507 90p	
7476 25p	74251 45p	74LS151 40p		4584 36p	LM324 30p	NE571 400p	2N4426 27p	MPSA13 50p	2N4037 65p	FND507 90p	
7478 15p	74273 120p	74LS153 40p		4585 75p	LM381A 180p	NE571 400p	2N4426 27p	MPSA13 50p	2N4037 65p	FND507 90p	
7481 120p	74278 140p	74LS154 30p		4600 90p	LM382 120p	NE571 400p	2N4426 27p	MPSA13 50p	2N4037 65p	FND507 90p	
7482 65p	74279 140p	74LS155 30p		4609 24p	LM382 120p	NE571 400p	2N4426 27p	MPSA13 50p	2N4037 65p	FND507 90p	
7483A 36p	74283 50p	74LS156 35p		4610 24p	LM384 140p	NE571 400p	2N4426 27p	MPSA13 50p	2N4037 65p	FND507 90p	
7484 65p	74284 160p	74LS157 25p		4611 11p	LM386 90p	NE571 400p	2N4426 27p	MPSA13 50p	2N4037 65p	FND507 90p	
7485 60p	74290 75p	74LS158 30p		4612 11p	LM387 120p	NE571 400p	2N4426 27p	MPSA13 50p	2N4037 65p	FND507 90p	
7486 18p	74293 80p	74LS160 38p		4613 20p	LM388 95p	NE571 400p	2N4426 27p	MPSA13 50p	2N4037 65p	FND507 90p	
7489 170p	74298 100p	74LS161 38p		4614 48p	LM389 150p	NE571 400p	2N4426 27p	MPSA13 50p	2N4037 65p	FND507 90p	
7490A 20p	74361 150p	74LS162 38p		4615 40p	LM391 95p	NE571 400p	2N4426 27p	MPSA13 50p	2N4037 65p	FND507 90p	
7491 36p	74365 30p	74LS163 38p		4616 20p	LM393 100p	NE571 400p	2N4426 27p	MPSA13 50p	2N4037 65p	FND507 90p	
7492A 25p	74366 35p	74LS164 40p		4618 48p	LM394 300p	NE571 400p	2N4426 27p	MPSA13 50p	2N4037 65p	FND507 90p	
7493A 36p	74367 36p	74LS165 50p		4619 25p	LM394 300p	NE571 400p	2N4426 27p	MPSA13 50p	2N4037 65p	FND507 90p	
7495A 36p	74368 30p	74LS166 55p		4620 48p	LM394 300p	NE571 400p	2N4426 27p	MPSA13 50p	2N4037 65p	FND507 90p	
7496 36p	74376 100p	74LS167 50p		4621 40p	LM394 300p	NE571 400p	2N4426 27p	MPSA13 50p	2N4037 65p	FND507 90p	
7497 90p	74393 90p	74LS174 40p		4622 45p	LM394 300p	NE571 400p	2N4426 27p	MPSA13 50p	2N4037 65p	FND507 90p	
74100 80p	74490 95p	74LS175 40p		4623 13p	LM394 300p	NE571 400p	2N4426 27p	MPSA13 50p	2N4037 65p	FND507 90p	
74107 22p		74LS181 90p		4624 32p	LM394 300p	NE571 400p	2N4426 27p	MPSA13 50p	2N4037 65p	FND507 90p	
74109 25p		74LS181 90p		4625 13p	LM394 300p	NE571 400p	2N4426 27p	MPSA13 50p	2N4037 65p	FND507 90p	
74112 170p		74LS182 36p		4626 80p	LM394 300p	NE571 400p	2N4426 27p	MPSA13 50p	2N4037 65p	FND507 90p	
74116 50p		74LS183 36p		4627 20p	LM394 300p	NE571 400p	2N4426 27p	MPSA13 50p	2N4037 65p	FND507 90p	
74118 55p		74LS189 36p		4628 40p	LM394 300p	NE571 400p	2N4426 27p	MPSA13 50p	2N4037 65p	FND507 90p	
74119 60p		74LS193 36p		4629 45p	LM394 300p	NE571 400p	2N4426 27p	MPSA13 50p	2N4037 65p	FND507 90p	
74120 60p		74LS194 36p		4630 15p	LM394 300p	NE571 400p	2N4426 27p	MPSA13 50p	2N4037 65p	FND507 90p	
74121 25p		74LS195 36p		4631 125p	LM394 300p	NE571 400p	2N4426 27p	MPSA13 50p	2N4037 65p	FND507 90p	
74122 30p		74LS196 45p		4633 125p	LM394 300p	NE571 400p	2N4426 27p	MPSA13 50p	2N4037 65p	FND507 90p	
74123 36p		74LS197 45p		4634 140p	LM394 300p	NE571 400p	2N4426 27p	MPSA13 50p	2N4037 65p	FND507 90p	
74125 30p		74LS240 55p		4635 45p	LM394 300p	NE571 400p	2N4426 27p	MPSA13 50p	2N4037 65p	FND507 90p	
74126 30p		74LS241 55p		4636 275p	LM394 300p	NE571 400p	2N4426 27p	MPSA13 50p	2N4037 65p	FND507 90p	
74128 36p											

Bookshelf

THE HE BOOKSHELF is the easiest way to build up your library of electronics books. Order today to have these top titles delivered **DIRECT TO YOUR DOOR.**

52 PROJECTS USING IC741 £1.25
More than 50 ways of using the ubiquitous IC741.

50 (FET) FIELD EFFECT TRANSISTOR PROJECTS £1.75
Contains a wide range of projects, all based on Field Effect Transistors.

COUNTER DRIVER AND NUMERICAL DISPLAY PROJECTS £1.75
Features many varied projects using numerical displays, counter and driver ICs.

RADIO CIRCUITS USING IC's £1.35
All you need to know about using IC's for AM or FM reception.

IC LM3900 PROJECTS £1.35
Provides the ground work for simple and more advanced uses of IC LM3900.

PRACTICAL CONSTRUCTION OF PRE-AMPS, TONE CONTROLS, FILTERS AND ATTENUATORS £1.45
Contains practical designs for use with home constructed equipment or commercial modules.

BEGINNERS GUIDE TO MICROPROCESSORS AND COMPUTING £1.75
Basic introduction to binary arithmetic, micro-processor operation and machine language programming.

IC 555 PROJECTS £1.95
The 555 timer users 'Bible'!

CHOOSING AND USING YOUR HI-FI £1.65
Concise information for all hi-fi enthusiasts.

ELECTRONIC GAMES £1.75
Amusing electronic games which can easily and inexpensively be constructed by the enthusiast.

ELECTRONIC HOUSEHOLD PROJECTS £1.75
Packed with circuits for projects that can be used in or around the home.

A MICROPROCESSOR PRIMER £1.75
A painless approach to understanding computers and computing.

REMOTE CONTROL PROJECTS £1.95
Practical information about many applications of remote control.

ELECTRONIC MUSIC PROJECTS £1.75
Many practical circuits for less complex items of electronic music equipment.

ELECTRONIC TEST EQUIPMENT CONSTRUCTION £1.75
How to build and use a wide range of test equipment for the hobbyist.

POWER SUPPLY PROJECTS £1.75
Packed with circuits for building various kinds of power supply.

SINGLE IC PROJECTS £1.50
Easy to construct projects based around a single IC.

PRACTICAL COMPUTER EXPERIMENTS £1.75
Build and examine a number of basic computer circuit elements.

ELECTRONIC PROJECTS USING SOLAR CELLS £1.95
A range of practical applications using silicon solar cells.

V MOS PROJECTS £1.95
Contains a number of varied and interesting projects using VMOS power FETs.

DIGITAL IC PROJECTS £1.95
Simple and advanced digital ICs.

INTERNATIONAL TRANSISTOR EQUIVALENTS GUIDE £2.95
Find possible equivalents for a popular user-orientated selection of modern transistors.

HOW TO USE OP-AMPS £2.25
All you need to know about Op-Amps, a source book of circuits and design calculations.

AUDIO PROJECTS £1.95
Clear information on how to build pre-amps, mixers, power amps, tone controls etc.

To receive your books you have only to fill in the form below and send it, together with your payment, to the address stated.

Please allow up to 21 days for delivery. This offer applies only within the U.K. Prices may be subject to change without notice.



SEND TO: HE BOOKSHELF, 513 London Road, Thornton Heath, Surrey CR4 6AR.

I am enclosing my Cheque/Postal Order/
for: (delete as necessary)

£..... (Made payable to A.S.P. Ltd)



OR Debit my Access/Barclaycard
(delete as necessary)



--	--	--	--	--	--	--	--	--	--	--	--	--	--	--	--	--	--	--	--

Please use **BLOCK CAPITALS** and include post codes.

Name (Mr/Mrs/Miss)

(delete accordingly)

Address

.....

.....

.....

.....

Signature

Date

Books Required

Price

Add 75p p&P

0.75

Total Payment

£

BUYLINES

BBC/HEBOT Interface

A complete kit of parts and components for the project is being supplied for £24.00 by Kelan (Hobbyboard) Ltd., North Works, Hookstone Park, Harrogate, North Yorkshire. The PCB is available separately from our PCB Service—see page 71.

Aerial Without Wings

A suitable toroid for this project is available from Neosid Small Orders 1982, PO Box 86, Welwyn Garden City, Herts AL7 1AS, for just £1.10, including P&P.

Stall Thief

The 0.25" PCB-mounting push-on connector blades used on the prototype are not absolutely necessary, but they do give a firmer, more reliable connection. They are not stock items and will have to be ordered specially; identification is easy if you quote the RS Components stock number—533-229. Alternatively, 0.1" PCB pins may be used, but make sure your soldering is secure!

The relay is not critical, as long as it is a 12V type, 200R coil with contacts rated at 5A or better; the open-contact gap should be wider than 5mm for reliable operation.

Component cost, excluding the PCB, relay and connector blades, should be around £2.00.

Check List

RESISTORS

(All 1/4 watt 5% carbon)
4 x 4k7; 2 x 1M; 1 x 10M; 1 x 680k; 1 x 2M2; 1 x 330R; 1 x 10k.

CAPACITORS

1 x 100n; 1 x 10n; 1 x 1n; 1 x 4u7; 1 x 10u 16V electrolytic.

SEMICONDUCTORS

1 x CD4011B; 2 x 1N4148; 2 x BC 108 or similar.

MISCELLANEOUS

1 x 12V/200R relay, contacts rated 5A or better; PCB; 6 x 0.25" connector blades or 0.1" PCB pins; optional case; wire, solder, nuts and bolts etc.

Auto-Test

All the components and parts for this useful project are stock by most suppliers—Greenweld Electronics, for example. The cost ought to be under £3.00, excluding the case and PCB.

Check List

RESISTORS

(All 1/4 5% carbon)
1 x 47R; 1 x 180R; 1 x 82k; 1 x 100k; 2 x 4k7; 1 x 1k; 1 x 10k; 1 x 12k; 2 x 820R; 1 x 3k3; 3 x 150R; 1 x 100R.

POTENTIOMETERS

1 x 100k miniature trimpot.

SEMICONDUCTORS

1 x LM324; 3 x 0.2" (5mm) LEDs; 3 x 1N4148 or similar; 1 x BZY88C7V5; 1 x BZY88C15V.

MISCELLANEOUS

2 x push-to-make switches; PCB; case; 52 x 30 x 100mm approx; PP3 battery + clip; 2 x alligator clips and leads; wire, solder, nuts and bolts etc.

BEASTIES

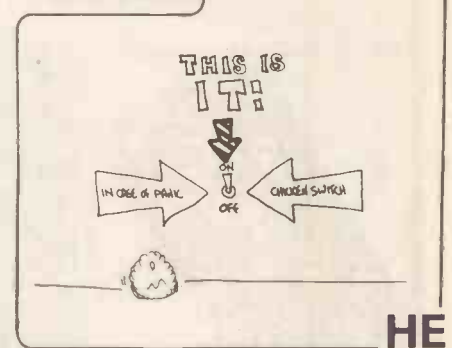

Do you know anybody who can build a Digital Pulser for only £18.00? *

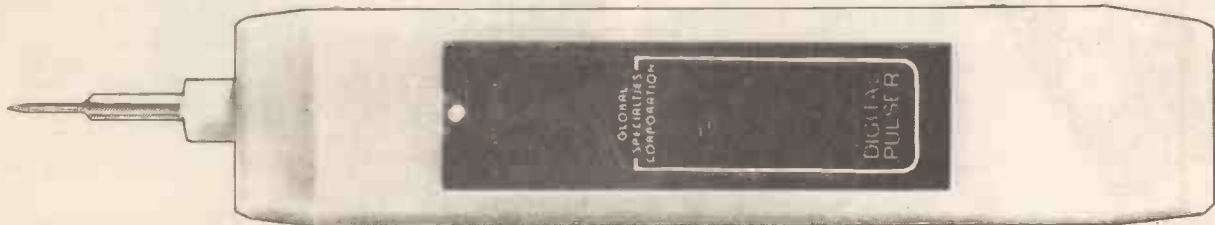

The answer is yes — its YOU!

With GSC's new DPK-1 kit, you can build a sophisticated portable test instrument for stimulus/response testing. It automatically delivers just the right signal for whichever logic family you're using — and it's equally suited to single pulses or pulse trains at a frequency of 100 per second. The fully featured DPK-1 kit includes all components, leads, circuit board and case — and is supplied complete with detailed assembly instructions and an operating manual. Get rid of your digital hang-ups; send off for a DPK-1 straight away.

Easy to follow
Instruction
Manual
with every
Kit

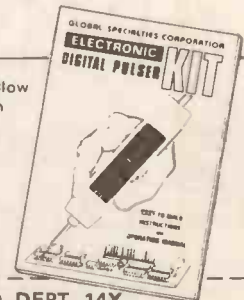

GLOBAL SPECIALTIES CORPORATION



G.S.C. (UK) LIMITED DEPT. 14X
UNIT 1, SHIRE HILL INDUSTRIAL ESTATE
SAFFRON WALDEN, ESSEX CB11 3AQ
Telephone: Saffron Walden (0799) 21682
Telex: 817477

GLOBAL SPECIALTIES CORPORATION (UK) LIMITED, DEPT. 14X
Unit 1, Shire Hill Industrial Estate, Saffron Walden, Essex CB11 3AQ

DIGITAL PULSER KIT DPK-1	£22.42 (inc. P & P & 15% VAT)	Quantity Reqd.	For FREE catalogue tick box <input type="checkbox"/>
-----------------------------	----------------------------------	-------------------	------------------------------------------------------------

Name _____ Address _____

I enclose PO/Cheque for £ _____ or debit my

Barclaycard/Access/American Express. No. _____ exp date _____

Goods despatched within 48 hours.

Step-by-step fully illustrated assembly and fitting instructions are included together with circuit descriptions. Highest quality components are used throughout.

Sparkrite

BRANDLEADING ELECTRONICS
NOW AVAILABLE IN KIT FORM

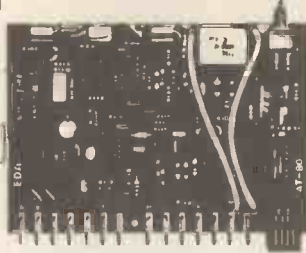
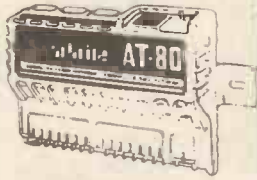

AT-80 Electronic Car Security System

- Arms doors, boot, bonnet and has security loop to protect fog/spot lamps, radio/tape, CB equipment
- Programmable personal code entry system
- Armed and disarmed from outside vehicle using a special magnetic key fob against a windscreen sensor pad adhered to the inside of the screen
- Fits all 12V neg earth vehicles
- Over 250 components to assemble

VOYAGER Car Drive Computer

- A most sophisticated accessory
- Utilises a single chip mask programmed microprocessor incorporating a unique programme designed by EDA Sparkrite Ltd
- Affords 12 functions centred on Fuel, Speed, Distance and Time
- Visual and Audible alarms, warning of Excess Speed, Frost/Ice, Lights-left-on
- Facility to operate LOG and TRIP functions independently or synchronously
- Large 10mm high 400ft-L fluorescent display with auto intensity
- Unique speed and fuel transducers giving a programmed accuracy of + or - 1%
- Large LOG & TRIP memories, 2,000 miles 180 gallons 100 hours
- Full Imperial and Metric calibrations
- Over 300 components to assemble
- A real challenge for the electronics enthusiasts!

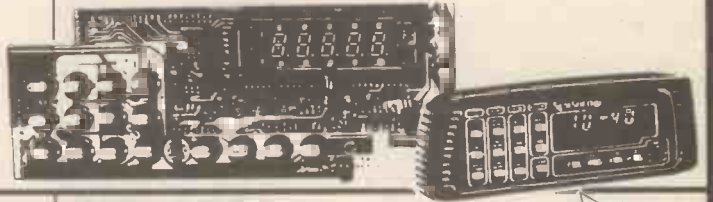

SX1000 Electronic Ignition

- Inductive Discharge
- Extended coil energy storage circuit
- Contact breaker driven
- Three position changeover switch
- Over 65 components to assemble
- Patented clip-to-coil fitting
- Fits all 12v neg. earth vehicles

TX1002 Electronic Ignition

- Contactless or contact triggered
- Extended coil energy storage circuit
- Inductive Discharge
- Three position changeover switch
- Distributor triggerhead adaptors included
- Die cast weatherproof case
- Clip-to-coil or remote mounting facility
- Fits majority of 4 & 6 cyl. 12V. neg. earth vehicles
- Over 145 components to assemble.

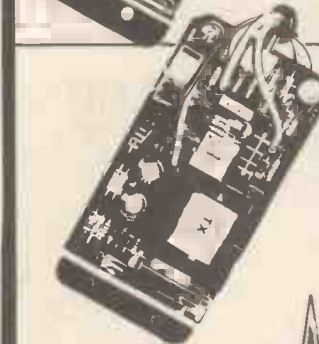
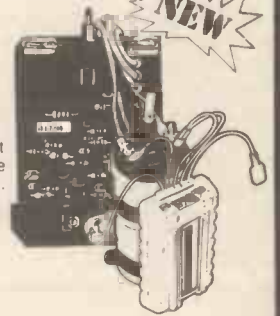

SX2000 Electronic Ignition

- The brandleading system on the market today
- Unique Reactive Discharge
- Combined Inductive and Capacitive Discharge
- Contact breaker driven
- Three position changeover switch
- Over 130 components to assemble
- Patented clip-to-coil fitting
- Fits all 12v neg. earth vehicles

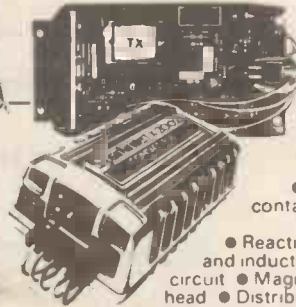

TX2002 Electronic Ignition

- The ultimate system
- Switchable contactless
- Three position switch with Auxiliary back-up inductive circuit
- Reactive Discharge
- Combined capacitive and inductive
- Extended coil energy storage circuit
- Magnetic contactless distributor trigger head
- Distributor triggerhead adaptors included
- Can also be triggered by existing contact breakers
- Die cast waterproof case with clip-to-coil fitting
- Fits majority of 4 and 6 cylinder 12v neg. earth vehicles
- Over 150 components to assemble

All SPARKRITE products and designs are fully covered by patents in the UK and USA.

SPECIAL OFFER

"FREE" MAGIDICE KIT WITH ALL ORDERS OVER £45.00

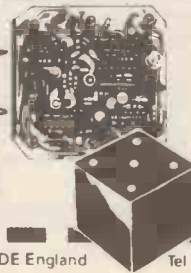

MAGIDICE Electronic Dice

- Not an auto item but great fun for the family
- Total random selection
- Triggered by waving of hand over dice
- Bleeps and flashes during a 4 second tumble sequence
- Throw displayed for 10 seconds
- Auto display of last throw, 1 second only
- Muting and Off switch on base
- Hours of continuous use from PP7 battery
- Over 100 components to assemble

SPARKRITE 82 Bath Street, Walsall, West Midlands, WS1 3DE England

Tel (0922) 614791 Allow 28 days for delivery

	SELF ASSEMBLY KIT
SX 1000	£12.95
SX 2000	£19.95
TX 1002	£22.95
TX 2002	£32.95
AT 80	£32.95
VOYAGER	£64.95
MAGIDICE	£9.95

PRICES INC. VAT POSTAGE & PACKING

NAME _____ HE5
ADDRESS _____
I ENCLOSE CHEQUE(S)/POSTAL ORDERS FOR
£ _____ KIT REF _____
CHEQUE NO _____



BRANDLEADING BRITISH ELECTRONICS

CUT OUT THE COUPON NOW!

POINTS OF VIEW

Feel like sounding off?

Then write to the Editor stating your Point of View!

Audio Analyser

We have received several queries about this project, which regrettably has had more than its fair share of mistakes.

The entire file has been passed back to the designer with instructions to sort it out, quickly. Meanwhile, we ask all readers who've had a problem with this project to be patient — it will be unravelled. One problem with electronics is that components can vary quite widely from their paper specification, and because of this, individual prototypes can work perfectly, when 99% of other models built to the same design will fail to work properly (or at all); conversely, sometimes a model which has been built perfectly with all the proper components will be the 1% which will never work until half the components have been changed . . . the electron is still a mysterious animal, despite the confidence with which we shunt it around.

Apropos of that, let me add that the Telephone Timer (HE June/July '82), which has turned a few hairs grey, is under similar surveillance, but at present we are not sure where the author is. . . . On a more minor note, we are looking again at Big Ear (HE December '82) to find out why a few people have had minor but persistent problems with it. We haven't abandoned you, and the answer will eventually appear. Now on with the show . . .

Missing Designer

Is Mr. Peter Walton, who sent us a Selective Caller project a few months ago, out there? We would like a word with him, but don't have his address. Please write.

Alarm Alarm

Dear Sir,
I am building your Low Cost Alarm system, from HE December '82. I have all the parts for the alarm, but I do not have PCBs and the window foil and terminals. If you do not have these components I would like to know where I can get them.
Yours faithfully,
Stephen Herron,
Newtownabbey,
Co. Antrim,
N. Ireland.

Up until now there has not been a made-up PCB available for the Low Cost Alarm; but there is now. See the PCB Service page in this issue. We

don't of course stock components of any kind (not now, not ever, never — we have enough trouble with ETI stealing our personal store) but the foils and switches for this project are, of course, available from the source mentioned in Buylines: in this case, Maplin Electronics.

Siren Call

Dear Sir,
Project: Low Cost Alarm system, HE December '82.

1) AWD. Greenweld (1982/3 catalogue) do not seem to supply the siren as described in the text, parts list and photo.

Could you please suggest an alternative supplier, and full specification, if possible? (This AWD sounds very good, with a warbling tone, only 0mA75,95dB at 1m, and very compact, as per photo.)

2) PCB. Is this going to be available?
Many thanks,
Dr. K.D.E. Whiting,
Hatfield,
Herts.

This AWD is on the RS components catalogue as 249-413 — ask your local dealer to order it for you. As for the PCB, it's now available, as from this month.

Projects From The Past

Dear Sir or Madam,
I have two problems I wish you could solve for me:

1) HE September '79 page 23 Starburst. I bought your ETI Print made PCB, fitted components, wired up, tested and got no result. The ICs are working, and so are the LEDs (tested before wiring boards together, ie LEDs). Somebody made a hash of component layout on page 26, they even managed to get the power supplies back to front. Did they make a mistake in values for R7 to R11?

2) HE October '81 Pages 51 and 52 Touch Lamp. As is my practice, I am trying to fit this lot into a small box, could you tell me what relay you used, name and shop or agent?
Yours faithfully,
V. Hogg,
Hayes,
Middx.

Yes, the 0V and +9V notation should be swapped around on the PCB layout on page 26 — an easily-spotted error.

The values for R7 to R11 should produce reliable switching provided you are using the specified transistor. However, if you think this is the

source of the problem, reduce the values to around 18k (don't go lower than 10k).

A relay was not specified for the Touch Switch but any 6 to 12V, 100R coil relay with single changeover contacts rated at 10A or so will suit; just be careful with the counting and wiring. Such relays are available from almost any mail order supplier advertising in HE.

This also seems a good time to remind all our readers that technical enquiries such as this one cannot be answered personally unless an SAE is enclosed, and although we try to be prompt, especially with enquiries about projects under construction, your Hobby Electronics has to come first — so you may have a long wait. But don't feel you are alone — designers have all the problems constructors have, and then some . . .

Shed A Little Light

Dear Sir,
I have been working on a light sensitive switch project based on one of your circuits but have a problem with operation during daylight.

I want the switch to operate on artificial light, eg car head-lights, but not daylight. Is there a light sensitive component suitable and if so where can it be obtained?

F S Robertson,
Kelso,
Scotland.

You could attack this problem in one of three ways: a) you could mount your light receptor in a recess or cowling so that it would get a minimum of normal daylight but would pick up a headlight beam pointed at it b) you could use a logic circuit of some kind which would pick up a simple pattern of flashes from the headlights c) you could opt for a commercial infra-red or ultra-sonic remote control and sensor combination — which would do the job, but is of course a completely different solution from using a light-sensitive switch.

We don't know of any light receptor which will distinguish between headlights and daylight without the kind of help described here. Does anybody else have any suggestions?

Not Beaten Yet

Dear Sir,
In HE December '81 you had a DIY Drum Synthesiser. Have you any of the aforementioned drum synth circuit boards left, and if so could you please quote me a price?

S Hallam,
Horsley Woodhouse,
Derbyshire.

All our projects are DIY unless you can con a friend or relation in building them for you! Perhaps one day we'll design a robot that builds itself . . .

Unfortunately we don't do a PCB for the drum synth, but you can try contacting Bewbush Audio, 26 Hastings Road, Pound Hill, Crawley, Sussex and asking for information.

Getting Into Phase

Dear Sir,
Could you please send me your latest price list and catalogue on the HE Phase One unit and any other musical effects.
A Brandon,
Winsford,
Cheshire.

I think you mean Phase Four, the HE Phaser Unit. If not, you're in the wrong store! There is no kit for Phase Four, but the PCB is still available from our PCB Service. For other effects, consult the Cumulative Index in HE January '83 — we can always supply back issues or copy articles of old projects, but we can only supply the PCBs as listed in the most recent issue, ie this one. Any help? Phase Four, for anyone else who wants to check it out, is in HE December '82, and features a custom-designed case supplied by Newrad Instruments.

Time To Switch On

Dear Sir,
AS a regular reader of HE, I wonder if you could publish a timer project for switching mains appliances on and off. The application I have in mind is to switch my hi-fi on to record a certain radio programme while I'm out. When the programme is over, the timer should also switch the system off. A repeat function for recording the same programme each day (holidays, etc.) would also be useful, and a smart case and digital display would make the unit fit in well with hi-fi equipment, etc.

Great mag, keep up the good work.
J. Jezard,
Tonbridge,
Kent.

There are a number of timers already on the market which will switch a mains socket on and off at preset times. However, these are relatively expensive and do not include the extra facilities you mention. So we have started work on a design for such a timer and hope to publish one in the future. In the meantime, you might like to take a look at your central heating switch — some have an external mains outlet socket which is switched on and off with the heating. Of course, you'd have to switch off the heating system first to avoid wasting energy by warming an empty house!

Raiders Of The Lost Hobby . . .

Dear Sirs,
Having been a keen reader of HE for some time I have noticed how back numbers of the magazine soon become objects of great demand among friends and colleagues, and this leads to permanent gaps in one's collection! I am in fact in need of issues from November and December 1980 and February 1981 or more specifically the excellent articles in the series on Digital Electronics by Ian Sinclair.

Could you please advise me how to obtain these if they are still available?
J P Sheppard,
Cheltenham,
Gloucestershire.

Yes indeed. Shall I refer this reader once again to our Backnumbers page, "not in every Hobby, but in most of them"? We can't always supply the whole magazine, glossy cover and all, but we can always supply copies of the articles.

Another award-winning idea! Introduce your friends and colleagues to our Backnumbers page. And our Cumulative Index (HE January '83). Then they can see not only what they've been missing, but how to get their hands on it without raiding your collection . . .

Batteries In The Breeze

Dear Sir,
I have been an avid reader of your magazine for some months. In November I leave for Kimbali which is in the Pacific. For some time now I have been trying to find out how I can use a normal car alternator driven by a form of windmill to top up a 12V storage battery during the day and possibly run limited lighting at night.

I would be grateful if you could help me on this subject in any way.
M J Maddison,
Cleethorps,
S. Humberside.

This is essentially a mechanical problem which we can't really advise on but the basic answer is something like this: bearing in mind that car alternators are negatively earthed, if you can take the negative line from the metalwork of the alternator, or whatever it is mounted on, and the positive from one of the larger tags on the back of the unit, you can connect up the battery.

You will then have to calculate how fast the alternator needs to turn to charge the battery. A tickover speed, in a normal car engine, the alternator will only just be charging the battery, if at all. You can calculate the tickover speed of the alternator by physically measuring the diameter of the pulley wheel on the alternator, and the one on the engine, dividing the engine pulley by the alternator pulley and multiplying the lot by the number of revs per minute at which the car engine ticks over. Then triple this figure and you will have the

RPM needed from the alternator to charge the battery at a reasonable rate.

The alternator can be driven by a simple pulley and belt drive straight from the wind vane, but the gear ratio between the pulleys will have to be such that the alternator is not turning too slowly to charge, or so fast that the act of charging slows down the windvane to the point of uselessness.

You would have to discover this by experimentation, as much depends on the speed and strength of the wind. It is best if you use the battery for the experimenting, with an ammeter on it to show how fast (or not) it is charging.

Into Electronics — Minus!

Dear Sir,
I would be obliged if you could let me know if you have a copy of 'Into Electronics Plus' from 1979, and if so the price.
K Edwards,
Barrow-in-Furnace,
Cumbria.

Sorry! IEP really is out of print now. However, if you're eager, you could consult our wonderful Cumulative Index (HE January '83) and obtain copies of all the Into Electronics articles. See the Backnumbers page for further details . . .

Microtrainer Manual

Dear Sir,
Ref: Hobby Electronics Vol. 4, No. 6, June 1982: HE Microtrainer, page 62. In the above article you refer to RCA's 'User Manual for the CDP1802 COSMAC Microprocessor'. Can you supply me with the address to write to for this publication, please? Your assistance would be much appreciated.
Many thanks.
P V Haviland,
Lichfield,
Staffs.

The supplier of this manual at the time was none other than Technomatic Ltd., of 17 Burnley Rd., London NW10 1ED, who supplied the HE Microtrainer. Try them.

Component Copies

Dear HE,
I would like to know how much it would cost to obtain photocopies of your series of articles 'Into Electronic Components', which I think started in August '81. I would like to know the cost of the whole series except for parts 8 and 9.
C K Williams,
Bracknell,
Berks.

'Into Electronic Components' did indeed begin in HE August '81. As for copies, if you inspect page 68 of this issue, you'll find our Backnumbers service. If the back issue isn't available, we can supply a photocopy; they like the Backnumbers, cost £1.25 each.

IT'S HERE!



**ONLY
35p!**

Buying or selling?
Now's the time to
take a look.

★ **LATEST** computers featured and their performance assessed by Home Computing Weekly's team of resident experts.

★ Tested program listings for all the populars including BBC, ZX80, ZX81, Spectrum, Atari, VIC-20, Oric and others.

★ The **LATEST** news and views on personal computers.

★ Inside information for the computer enthusiast.

★ News coverage like you've never seen before.

★ Over five pages of software reviews each week.

OUT NOW AND EVERY TUESDAY

Don't be left without — cut along dotted line and give this coupon to your newsagent.

Dear Newsagent,
Every Tuesday, please reserve me a copy of



Name:

Address:

.....
.....

Thank You



Clever Dick

As the month of May rolls around again Clever Dick, who is himself usually quite merry, is rolling around, still.

The CD I-Spy award of the month goes to an observant reader in Glasgow. And who said there are no more surprises in the world?

Dear CD,
First of all, this is a neatly written, amusing, original letter (November, page 53).

I have written to help you with your material problem (you mean you didn't know you have a material problem?)! I refer, of course, to the letter from D.C. Holmes (September page 31 AND November page 21) and the letter from R. Einstein (November page 53 AND December page 51). Is there any reason for this? Perhaps they are relatives of someone in the HE offices?

Although I considered writing to the editor about his Points of View, where one duplicate appeared, he seems to give out very few (none) of those famous blue and gold delights that are the dream of every HE reader.

I like HE very much, but how about more Veroboard projects? Keep up the good work.

Steve Morton,
Glasgow.

PS Any reader following this letter without the aid of the issues mentioned may wonder what I'm going on about.

At first I wondered what you were going on about, too... but your report is entirely accurate. Those letters were duplicated, much to our editor's horror. When I mentioned it to him he put his head in his hands and sobbed loudly for two minutes (he does this at least once a day), then promised to look into it. In the meantime one of those fabled "blue and gold delights" is winging its way towards you courtesy of the editor and High Speed British Post.

And who said the age of miracles was past?

Since we have been presenting more practical projects in HE, we have adopted a policy of putting most projects on PCB, since this makes construction much more reliable and, in general, PCB layouts are not as vulnerable to the dreaded 'gremlins'. However, projects will continue to be developed on Veroboard where this medium is appropriate — that is, not too complicated and difficult to build up correctly.

Now here's a man with a problem or three

Dear Clever Dick,
I have been taking your excellent magazine for a number of years and although electronics is a subject I find fascinating, I have never tried building one of your projects. However, necessity seems to be driving me to do so. Let me explain.

Since I have lived at my present address about twelve years, I have suspected that the television signal from the Mendip hills is somewhat weak, due to the position of a hill between it and me. However, I have been able to run three monochrome TV sets reasonably well off three separate aerials on the roof. The pictures have been a bit snowy, but not too bad.

Last week I thought I'd spoil myself and buy a colour portable set for the bedroom, but when I got it home it would not work on its own set-top aerial. When connected to one of the rooftop aerials it worked, but hardly satisfactorily. So, I removed one of my aerials from the roof and connected it by a short lead directly to the set, pointing the aerial out the window in the direction of the transmitter. This produced the best picture yet.

From the above experiments I conclude that the signal is very weak indeed and that the long lead is very noisy, so I have a poor signal-to-noise ratio, as it were. I propose to build the TV Masthead Amplifier (February '82 issue) and put up a higher mast also, but all this raises a few questions in my mind:

If I put up two aerials side by side, and connect them together, will this improve my signal-to-noise ratio?

Will the Masthead Amplifier drive four TV sets, or can the output from one amp be fed to the input of another?

Can I simply join the serials together by soldering the inner wires together, and the outer braids together? If not, what is the best way to run three sets from one lead?

The Masthead Amp is said to amplify the signal by 18 times and to run from any voltage between 10V and 24V; does it give best amplification on the higher voltage?

Is it worth making a power supply? If not, what batteries would you suggest? What is the current consumption?

Can you suggest a book that would

explain about fitting aerials?

Since my colour set isn't yet working, do I need a colour license? What's a binder?

G.H. Wakefield,
Weston-super-Mare.

PS The hill that weakens my signal is called Bleadon Hill. I think the name is quite fitting, don't you?

If you pronounce the words "Bleadon Hill" slightly differently, it also describes my reaction to this letter, which raises a few questions in my mind, too. Like, why does he need four TV sets, for example? Never mind, some questions are better not answered (ignorance is quite pleasant) and I suspect this is one of them.

Yes, you can connect two aerials side by side (better one on top of the other), provided they are accurately positioned and linked by what is called a 'phasing harness'. The precise positioning of the aerials and the matching harness are both to ensure that the signals are in phase so that they add, rather than subtract.

If you are determined to run four TV sets you can do so from a single aerial using a suitable distribution system. Rather than the methods you propose (you can't simply connect aerials together and hope for the best) you can use four separate Masthead Amplifiers connected to the one aerial by appropriate impedance matching transformers.

The amplification provided by the OM355 device, which is at the heart of the Masthead Amplifier, is dependent on the supply voltage and the gain will be higher (27dB) at 24V than at 12V (23dB). Typically, the device will draw about 35mA from the supply and if you really do want four of them (!) you may as well build a 24VDC power supply capable of supplying around half an amp or so.

A suitable book, which will answer all your questions in detail, is "Long Distance Television Reception (TV-DX) For the Enthusiast" by Roger W. Bunney. It is published by Bernard Babani (Publishing) Ltd. and is available through the Hobby Electronics Bookshelf. The principles of long-distance reception are equally applicable to fringe area reception.

Finally, I cannot comment on your legal position but if you need information on this or further answers to your ten thousand questions, contact the Engineering Information Service, Broadcasting House, London W1A 1AA.



7 HUGHENDEN
ROAD, HASTINGS,
SUSSEX. TN34 3TG
Telephone:
HASTINGS (0424)
436004

ELECTRONIC KITS

Post & Packing 50p for KS kits, 75p for UK kits, £1.00 for Cabinets. Send 20p S.A.E. for Catalogue of our extensive range of kits & Cabinets. Trade, Educational & Export enquiries welcome

 KS 100 Mini VHF Super-regenerative receiver 88-108 MHz 9V D.C. £5.27 inc VAT	 KS 200 Mini F.M. transmitter 88-108 MHz 9V D.C. (Not licenceable in U.K.) £7.37 inc. V.A.T.	 UK 108 Miniature F.M. transmitter. Not licenceable in U.K. £9.46 inc. V.A.T.
 KS 370 2 Tone Siren, output 10W at 4 ohm, 6W at 8 ohm, 100 DBM £5.27 inc VAT	 UK 875 Capacitive Discharge Electronic Ignition £21.84 inc VAT	 UK 150 Amplifier Output Voltmeters (Mono & Stereo) £9.46 inc VAT
 UK 114/U 20W Integrated Circuit Amplifier, req 32V D.C. power £8.42 inc VAT	 UK 232 Antenna Amplifier for AM/FM £5.27 inc VAT	 UK 502/U MW-LW Radio Receiver £7.37 inc VAT
 KS 272 6 Chan High Power VU Unit 300W per chan £16.79 inc VAT	 UK 11/W Electronic Siren (ready assembled) 12V DC £10.52 inc VAT	 KS 142 LED VU Display 0.3V-1.3V, 5 12V D.C. £9.12 inc VAT
 UK 233 Car Radio Antenna Amplifier for AM/FM £5.27 inc VAT	 UK 558 600MHz Prescaler £28.42 inc VAT	 KS 238 3 channel microphone operated sound to light, 300W per channel, 240V A.C. £11.58 inc. V.A.T.
 KS 240 3 channel sound to light, output 3 x 1KW 240V £13.70 inc VAT	 KS 250 3 channel chase light, 1KW per channel, 240V A.C. £10.52 inc. V.A.T.	 KS250 12V-0.5A stabilized power supply £7.37 inc. V.A.T.
 KS 490 Nicad battery charger, 10-20-45-150 mA, 15V D.C. max 240V A.C. £8.42 inc. V.A.T.	 UK 380 Digital tuning indicator £37.88 inc. V.A.T.	 KS 420 Digital D.C. voltmeter, 999mV-999V, 0.5V D.C. £17.89 inc. V.A.T.
 KS 300 Westminster chimes, (Big Ben) £9.48 inc. V.A.T.	 UK 562 Transistor end diode tester £14.73 inc. V.A.T.	 KS 165 Dusk Switch 9V D.C. Switches 240V 5A max £12.63 inc VAT
 3005-00 Instrument Cabinet H 54mm, W 82mm, L 145mm £5.27 inc VAT All Aluminium	 3005-70 Instrument Cabinet, H 68mm, W 263mm, D 216mm £11.58 inc VAT All aluminium	 3003-00 Heat Sink Box, H 78mm, W 72mm, L 143mm £5.00 inc VAT

ELECTRONI-KIT

FX-COMPUTER

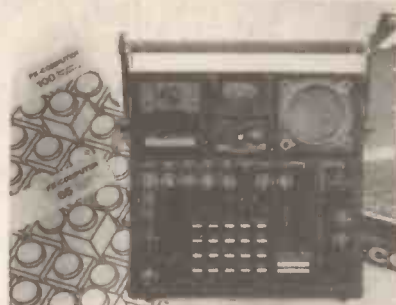

Teach-Yourself Computer and Electronics Construction Kit

A complete introduction to the "How, Why and What" of Computers and Electronics in the most practical way ever devised

THE KIT IS BATTERY-OPERATED AND COMPLETELY SELF-CONTAINED. NO TELEVISION OR OTHER EQUIPMENT IS REQUIRED. VERY EXTENSIVE MANUALS ARE INCLUDED

Ministry of Science and Technology, Japan — Prize Winning Product

The **FX-COMPUTER** is the ideal introduction to the study and understanding of computers and electronics. The kit offers remarkable versatility because the components are interchangeable and circuits are constructed by simply plugging specified components into the board provided in accordance with the instruction manuals. You quickly understand the principles involved and new circuits can be easily devised, built and dismantled. No soldering or wiring is involved, no tools are required; the components themselves complete the circuits.

No previous knowledge is required — very extensive educational manuals have been provided by English experts in computers and electronics. Working through the manuals you will soon be able to write programmes and "run" them and understand how computers work.

The following are just a few of the programmes in the Computer Manual (there are too many to list here) and also a few of the projects in the Electronics Manual:

How to instruct the Computer and Store Information into Memories. Use of different Instructions and Programming Techniques. Adding, subtracting, multiplying, dividing, averaging, counting up, counting down, etc. — in Decimal and Hexadecimal. Converting Hexadecimal to Decimal, storing Random Numbers. Games: Tennis, Catch-the-Rat, Gun Fight, Slot Machine, etc. Using the Computer as a Musical Organ, storing and playing-back tunes, etc. **OVER 100 PROGRAMMES SHOWN IN THE COMPUTER MANUAL PLUS EXPLANATIONS AND DEMONSTRATIONS OF ALL TECHNICAL TERMINOLOGY.**

Electronic Components and How they Work — batteries, conductors, resistors, capacitors, diodes, transistors, lamps, photo-electric devices (CdS cell is included in the kit), oscillators, burglar alarms, control systems, organ, lie detector, etc., etc. **OVER 65 PRACTICAL WORKING PROJECTS SHOWN IN THE ELECTRONICS MANUAL.**

All this is in **ONE** kit, costing about the same as the cheapest "Basic" ordinary Computer

The price is only £69.95 plus £3.00 P&P (overseas rates quoted on request)

TRADE & EDUCATIONAL ENQUIRIES WELCOMED

Send cheque/PO/Access/Barclaycard to **DEPT. HEFX. Electroni-Kit Ltd**
It's not JUST a computer!

ELECTRONI-KIT LTD.
388 ST. JOHN STREET
LONDON, EC1V 4NN (01-278 0109)

RADIO RULES

Helen Armstrong

Just one more step before you launch into space—the Radio Amateur's Examination!

By the time you read this you should, thanks to Radio Rules, be well on your way to being your own radio expert, which means that you will be nearly ready to face the final hurdle in becoming a radio amateur — the Radio Amateur's Examination, better known as the RAE.

Radio amateurs have a far wider choice of wavebands, and far more range and power to play around with, than CBers (who, until recently, weren't even legal) and the idea that members of the public should be allowed to transmit anything at all without a mass of official controls is a very recent one in the UK. CB radio has been around in some other countries, notably the USA, for a long time. But even in these places, the amateur has to pay for his greater freedom in what and where he transmits by proving that he or she is capable of running a station without interfering with other transmissions. So radio amateurs have to pass a fairly demanding exam.

The original justification for licensing amateurs to transmit was to encourage them to train themselves as radio technicians and operators in case they were needed in times of emergency or war, and the license states to this day that an amateur radio station is 'part of the self-training of the Licensee in communication by wireless telegraphy'. This is also a tribute to the develop-

ment work done on radio by amateurs in its early days, as you will doubtless remember from "The Birth of Broadcasting" (HE February '83).

Amateur radio is more a pastime for people who are interested in radio and its whys and wherefores, than for those who simply want to communicate with friends without finding a callbox. That said, the RAE, although it aims to establish that the would-be amateur is competent to operate a station, is a straightforward examination for anyone reasonably familiar with the subject. The change, three years ago, from straight essay-type examination to multiple-choice questions has, despite initial grumbles and teething troubles, produced much the same percentage of passes as before.

This has sometimes led to complaints from the old school that today's amateurs can hardly hold a screwdriver, let alone construct their own transceivers — but amateur radio is more likely to encourage a lively interest in radio if people can enter it at a level where, once they understand the principles and can keep their hardware properly tuned, they can get out on the airwaves and learn the rest 'live'. Indeed, the arrival of CB, far from rendering the amateur obsolete as had been glumly forecast in some quarters, has given more people than ever a taste of radio; as CB is very limited, many of

these then go on to extend their knowledge and mastery of radio and become amateurs — the number of people sitting the RAE and joining the Radio Society of Great Britain (RSGB) is increasing dramatically year by year.

Terms and Conditions

But it's not enough to know about radio. The first part of the RAE deals with the conditions governing amateur radio licenses, and if you fail this, you fail completely. You have to know the rules before you'll be let loose. Although phrased in legalistic lingo which may be puzzling even to people used to reading paragraphs of equations, the radio rules are fairly straightforward and largely a matter of commonsense.

Cast your mind back to the first part of "Radio Rules" back in HE April '82, and you will recall that Amateur License A is the full radio licence which allows you to use amateur bands below 144MHz, as well as those above, and to transmit Morse Code (CW). Not many people opt for Morse now. A separate Post Office examination has to be taken for this. Most amateurs hold Licence B.

Your transmitter, receiver, test equipment and log are in fact a radio station, which is licensed to be set up permanently at a named address, or in any other 'temporary location'; longer-term removals have to be notified as



Finding Out

For information about the RAE, you should contact the Home Office Amateur Radio Licencing Division, Waterloo Bridge House, Waterloo Rd., London SE1 8UA for a free copy of their booklet *How to Become A Radio Amateur*, which will tell you the up to date licence conditions along with a lot of other useful information. For full details of the exam, and sample questions, write to the City and Guilds of London Institute (who actually run the exam) at 76 Portland Place, London WC1N 4AA.

To get hold of the *Radio Amateurs' Examination Manual*, which contains all (or most of) the

technical background and information needed to take the extra (although it ought to be used as a basis for wider study if you are going to master the subject properly, and not just as the sole source), contact the Radio Society of Great Britain at Alma House, Cranbourne Rd., Potter's Bar, Herts EN6 3JW, tel. (0707) 59015. They will also take applications to sit the RAE. The exams are usually held twice a year, in May and December, but there have been so many applications that there may be three sittings in 1983. Membership of the RSGB currently stands at around 38,000 after

rising a lot in the last five years. They publish a monthly magazine, will help members with technical queries and publish a range of useful textbooks which are, of course, cheaper to members than non-members. You don't have to be a member to take the RAE, but it pays somebody starting out in the hobby to be in touch with the main meeting-point for amateurs.

The RAE is like most other exams — to pass it, you learn the radio rules. Once you have passed and been certified safe to be let out on your own, the door is open to the real spirit of amateur radio.

'alternative premises'. The station can be operated by a pedestrian (colloquially known as portable operation) or from a private vehicle (colloquially and officially known as mobile operation — although I have yet to see one being operated from a bicycle, and operators using a hand-held mike while driving have occasionally been stopped by the police for illegally driving with one hand!). Mobile operation is increasingly popular, and there are many transceivers and aerials designed specifically for use from a car.

You must not, however, use the station in a sea-going area (at sea or in an estuary, dock or harbour) or from an aircraft or public transport vehicle (although special aircraft and mobile licenses are obtainable where appropriate).

Section 1 of the license states that you are licensed to send in radio telegraphy (which covers both voice transmissions and Morse, although voice transmissions are also called telephony) personal messages in plain language about things in which you or your contact are personally involved, but you may not discuss business or exchange messages on anyone else's behalf. This is designed to prevent the amateur bands from being used for commerce or propaganda rather than stop you from sending greetings on behalf of a friend. The RAE Manual's section on operating procedures states "It should be a golden rule never to discuss religion, politics or any other matter which may offend the person to whom one is talking or anyone who may be listening" — but this is only a guideline, not, as some people think, a statement of law. You are definitely not allowed to transmit "grossly offensive, indecent or obscene" messages, however.

License the also permits the transmission of facsimile signals (radio-encoded pictures), radio teleprinter signals, video (amateur television) and test and other signals relating directly to these and not in any secret code. This doesn't of course preclude the 'codes' and abbreviations once common in radio, especially in Morse, where they were used for the sake of brevity and extra clarity, and especially to get around any language barriers in international calls.

Emergency Services

Amateur operators may be (and often are) called out to help the police or other emergency services. In parts of the country groups exist which practice working as a team or network—this is known as a Raynet group—and they hold communications exercises as well as taking part in real emergency work.

Generally the only person permitted to use a station was the license-holder or another licensee under his supervision. Now a pre-war custom, the sending of greetings messages by non-licensed people under occasional conditions, is being revived after long agitation by the RSGB, but this has not yet been incorporated in the licensing rules.



QSL cards are exchanged by amateurs as a record of contacts made. These two are from Yugoslavia and Mallorca, with their national code letters.

Transmission by anyone using a false license number is likely to be promptly spotted and reported by another station! No kind of recording may be transmitted except for certain test messages and tones, and nothing that infringes copyright (which means, in effect, anything published, or otherwise copyrighted) or anything misleading — jokes on the air are alright, but not if they could remotely be mistaken for a distress call.

It's also a requirement of the license that you should be able to receive on the same wavebands on which you are transmitting, so that messages can be returned. On the other hand, listening in to the wrong thing is out: under Section 5 of the Wireless Telegraphy Act, it is an offence to deliberately receive unauthorised messages, and disclosing anything about them to 'unauthorised persons' is an offence under the Official Secrets Act. This includes police transmissions, so don't tell me your hifi amplifier picks them up!

Some of the most important license conditions concern the prevention of interference and keeping broadcasts within the right frequency bands. Section 3 states that a satisfactory method of frequency stabilisation must be used, and that there must be equipment on hand capable of checking that the station is operating correctly. And Section 4 makes it clear that the maintenance of the radio and morse equipment in a state which doesn't interfere with other transmissions is an absolute requirement of the license, not just a social duty. The Notes to the license give examples of when aerials may give rise to interference, or (another kind of interference entirely) when they may be in danger of fouling aircraft, or power lines, and the limitations imposed.

Sections 10, 11 and the footnotes say that the station must be available for inspection at all reasonable times, and that it can be closed down at any time. This is normally only done in a case of

national emergency, but the license itself can be revoked (and the operator prosecuted) if the terms of the license are broken.

To further aid keeping track of transmissions, you must keep a detailed log of calls and contacts made. This comprises, basically, the date of the call, opening and closing of operation and the address of any temporary premises (or the geographical location, for mobile operation), the times, frequencies and call-signs of each contact made and classes of emission, including those used for CQ and test calls. The log must be signed by any other amateur using the station.

Signing On

The license is specific about the use of a callsign. It must be broadcast at the beginning and end of each period of sending, and every 15 minutes otherwise. Extra identification letters

Safety in

Don't give a new meaning to the old expression 'over and out'! Consult the Radio Society of Great Britain's safety recommendations for amateur radio stations. A serious amateur radio station usually consists of several pieces of equipment, very often in various stages of construction, modification, testing or repair. Any piece of electrical equipment carries some danger from electric shock, but doubly so when it's being connected and re-connected. Following this comprehensive list of safety precautions will effectively remove the danger of serious shocks. Here is a summary of them:

Equipment should be turned on and off from one master switch; everything should be connected to a good, tested earth (not, as formerly, a water mains, as many now have plastic sections); wire and terminals should be thoroughly insulated (there is often a temptation to leave temporary terminals open and live); capacitors of more than 0.01uF (100n) should have a bleeder resistor across their terminals that will ensure rapid discharge; capacitors with low leakage should be stored with their terminals short-circuited, as they can otherwise build up a static charge (you can get a serious shock from a large capacitor) and better, capacitors in use should be discharged with a 'wandering earth lead', an insulated lead with some bare strands at the end, connected to a permanent earth; all equipment should have conspicuous indicator lamps to show that it is live (apart from the safety factor, it does equipment no good to leave it switched on when not in use and unattended); double-poled switches should be used for

are prescribed for mobile, temporary or pedestrian use, and for the main geographical areas of the British Isles — GW for Wales, GM for Scotland, and so on. At a temporary location, a brief address must be included.

Probably the most familiar aspect of non-broadcast radio to people who know nothing at all about it is the 'phonetic alphabet', where letters of the alphabet are replaced by distinctive words beginning with the same letter. The alphabet published by the RSGB is recommended rather than prescribed, and there are common variants, but the examiners will want the versions published! The phonetic alphabet is used to make important messages clearer in bad reception conditions, and it's generally better if you can stick to well-known versions, otherwise the point is lost. In any case, it's stated that the words used must not be "objectional or facetious". The alphabet as given in the Radio Regulations, Geneva, 1976, is



QSL cards from Poland and France.

printed in the footnotes to the license.

Sections 12, 13 and 14 and 15 summarise the terms under which the license is issued, the most important being that the licensee shall pay up every year, and that the terms of the license may be varied by the Secretary of State in a general announcement in the press or via the BBC.

Section 16c and the following notes contain information about how the rest of the rules should be interpreted and various other important information, such as the correspondence address at the Home Office. It also harks back to Section 2, which briefly draws our attention to the fact that radio rules are international, in effect, whatever the local variations. It refers to the International Telecommunications Convention of 1973 and various other sets of international regulations. The Government in its turn has to abide by radio rules when broadcasting at home or overseas.

Practical Procedure

Apart from the Home Office license conditions, the RSGB issues its own advice for operators as to proper operating procedure, to ensure clear and trouble-free communication.

Quite a large chunk of the advice is for Morse operators, including a detailed list of 'Q' codes, and calling patterns for establishing a contact, making, and ending a transmission, and an RST code table, giving the standard notations for describing the quality of a transmission. The use of the Q and RST codes, as well as the phonetic alphabet, has spilled over into voice radio. The original purpose of codes was to increase both the brevity and the clarity of transmissions, but brevity is not generally important in voice radio and the use of abbreviations has become more a matter of jargon than necessity.

Amateur jargon can be quite incomprehensible to the non-initiated (although never as colourful and obscure as CB jargon). The RSGB is

tending to discourage the use of jargon and CW codes, but it would be a pity if jargon disappeared altogether as the use of patter is one of the charms of radio.

Contacting other Stations

When trying to establish a contact with another station — known as 'calling' — it is important to get your call out as quickly and as clearly as possible. Give the callsign of the station you are calling once or twice, depending on conditions, and then your own callsign at least twice, using the phonetic alphabet. If there is no response from the station you are calling, call again, putting the emphasis on your own callsign, but don't keep calling continuously. Leave it till later or (if you are mobile) until you are closer to the station.

Likewise, CQ (general) calls can be repeated several times, giving your callsign clearly, but no information is needed other than 'calling and standing by', and you should listen for a few moments between each call. Don't keep on and on calling CQ on the same channel if you get no response in a reasonable time — either listen around to see if another exchange is about to finish, or try another channel.

Once the contact is made, the stations should spell out their callsigns until they are sure that both have been received correctly. After that, callsigns only need to be given every fifteen minutes, so that in good operating conditions a normal telephone-style conversation can be held; if reception is down a bit the words 'break' or 'over' give an additional signal when one operator has finished talking. Give both callsigns again in phonetic alphabet when signing off; this also helps other stations listening in, who may wish to call.

Incidentally, if you have trouble remembering callsigns, write your contact's callsign down at the beginning of the exchange if you can; this saves a repeated 'What was your callsign again?' and 'G3 Yankee what was it?' every time callsigns are exchanged, which is all too common.

When transmitting to a group or 'net' give your callsign at the beginning of each transmission, to let the group and other listeners know who is talking. You can also pass the call on to the next person to speak, if you are taking turns.

It is not necessary to continually list the other callsigns in the group, but some groups have the practice of letting one member act as 'master of ceremonies', repeating the callsign when one member has finished and passing the call on to another member of the group.

It is helpful also to say briefly what you are about to do if you are changing channel, have just arrived on a channel or are signing off for the time being.

An important part of any exchange, especially long distance ones, where the signal strength of either operator is likely to be below maximum, is to give a signal strength report. In CW, a code known as the RST code (readability/signal strength/tone) is used. There are

Shack

switching mains on and off, and the correct fuses should be installed on the equipment side of the switches.

A mains circuit breaker, such as a micro-switch, should be used to switch off metal-cased equipment automatically when the lid or other service hatch is opened; test probes and lamps should be insulated; a rubber mat should be used on the floor if the floor is at all damp.

Equipment should be switched off before adjusting, and insulated tools used. If any adjustments must be made while the gear is live, one hand only should be used, and the other hand kept in a pocket; headphones should never be worn while adjusting live equipment, and metal-cased gear like microphones and morse keys need to be properly earthed; meters with metal adjustment screws are not safe to use on high-voltage equipment.

A check needs to be kept for unexpected live projections from equipment, especially where metal screws are used on control knobs; aerials should never be connected to the mains or any other high voltage source; where they are connected through a capacitor, an RF choke should be provided.

The full recommendations are given in detail in the RAE Manual.

BEASTIES

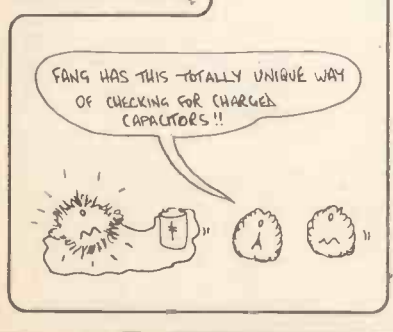

five levels of readability, from unreadable to perfectly readable, and nine levels each for signal strength and tone from one to nine. For operating proficiency certificates and awards given by the RSGB the minimum signal report needed is RST339, or RS33, which are the minimum practical signals.

In other parts of the world, sections of the amateur bands are reserved for certain classes of operator using particular modes of transmission (eg CW or radio teleprinter (RTTY)). There, it is illegal to fail to observe these restrictions; not so from the UK, but we should still adhere to them at all times as a courtesy — this is only common sense, as are most of the rules of procedure.

It is only common sense not to attempt to call a station which is clearly trying to establish a call elsewhere, for instance, no matter how badly you want to make a contact with a station in that particular location; not to call CQ continuously if you are getting no reply; not to interrupt an established exchange; not to hold conversations on channels such as S20 (145.5MHz) which are so normally used for calling.

If you contact somebody on a channel which he has been working, move off again once the exchange is finished; don't use long-distance bands (DX) for local calls while they are open for long-distance communication, and when conditions are unusually good for long-distance contacts, keep your calls short — there will be queues of other operators hoping to pick up some rare QSL cards, waiting to speak to the same stations you are speaking to.

Repeaters and Satellites

Over the last ten years, a number of unmanned transceivers, mounted on masts at high geographical points, have



QSL cards from Finland and the USSR.

been set up. These receive VHF or UHF transmissions from portable or mobile stations on an input channel and retransmit them on a different output frequency within the same band, but with greater power. Thus the range of low-powered equipment can be doubled or better.

These relay stations are known as repeaters and have their own call signs (eg GB3PI near Peterborough, the 'Cambridge repeater', one of the first to be opened). They can more than double the range of low-powered equipment without the use of extra power or better aerials. To prevent continuous operation of the repeater by one caller, or when not in use, the repeater is usually designed to be switched on and off remotely: on by means of a 1750Hz tone (toneburst) transmitted by the caller, or by the user's carrier on the

input channel at the beginning of each transmission, and off automatically after, say, one minute — a limit known as 'time out'.

Repeaters only respond to an accurate FM signal and if the accessing signal becomes inadequate, the repeater will switch itself off. After each over, the repeater will wait for a minute or two, and then broadcast a signal in Morse to show that it is free for use.

There are also satellites for amateur use which play a similar role to repeaters, only at a greater power and over a longer distance. The first one was launched in 1961 and others have gone up periodically since. They are known as OSCARs (for Orbiting Satellite Carrying Amateur Radio), each with its own code number. They are transponders, which accept single sideband, radio teleprinter or Morse signals (for preference, although any mode is acceptable) over certain wavebands, and retransmit them on another band. At the moment they can transpond from 432 to 144MHz, 144 to 432MHz and 144 to 28MHz. Unlike repeaters, the satellites are continuously operational and require no special signal to access them.

To transmit to the satellites, a power level of 80 to 100W ERP is needed, normally provided by a transmitter of 10 to 15W output with antenna gain of 10dB, and the antenna must be in line of sight with the transmitter and, for best results, capable of following it.

Alright on the Night

There are a number of ways to learn enough about radio to take the Radio Amateurs Examination successfully. The only essential rules are: know what is in the syllabus (it helps to be familiar with the Radio Amateur's Examination Manual), and make sure you both learn the theory and get as much practical

Below: a set of RAE-style papers. Samples can be obtained from the Home Office.

PAPER 1

- Having written to inform the necessary officials of your intention to set up a station at alternative premises, the minimum time which must elapse before the station may be operated at these premises is:
 - the same day
 - one week
 - ten days
 - one month
- An amateur sending and receiving station for wireless telegraphy may be used by:
 - the licensee and family aged over 14 years
 - the licensee and husband/wife
 - the licensee only
 - the licensee and holders of Amateur Radio Certificates when under the supervision of the licensee
- The amateur's licence and log book is liable to inspection by:
 - a person acting under the authority of the Secretary of State at any reasonable time
 - a person acting under the authority of the Secretary of State at any time
 - officials of the Radio Society of Great Britain at any reasonable time
 - the local police, on receipt of complaints, at any time
- The purposes for which an amateur wireless station may be used includes the use of the station for sending to other licensed amateur stations:
 - messages in plain language which are remarks of a business nature providing these are known to both the sending and receiving stations
 - any third party messages which may appear necessary in times of national disaster
 - messages to amateur wireless stations in general
 - details pertaining to the commercial equipment used by the operating station
- In the terms of the Amateur Licences A and B, the term "UK" shall mean only:
 - England, Ireland, Scotland and Wales
 - England, Northern Ireland, Scotland and Wales
 - the United Kingdom of Great Britain, Northern Ireland, the Isle of Man and the Channel Islands
 - the United Kingdom of Great Britain and Northern Ireland

- The maximum bandwidth for J3E transmissions is chosen so as to:
 - not exceed 25 kHz
 - not exceed 2.5 kHz
 - be within the narrowest possible frequency
 - not exceed 1/25 th of the frequency being used
- When constructing an aerial in the proximity of an overhead power cable, precautions must be taken to the satisfaction of:
 - the station owner
 - the local police
 - the Home Office
 - the owner of the power cable
- Particular care will have to be taken to minimise the risk of interference to others when aerials are sited:
 - in a loft
 - close to overhead power lines
 - less than 20ft above the ground
 - within 50yds of an airplane boundary
- To reduce multi-borne interference when using an end-fed antenna one must ensure that:
 - the mains earth is used
 - a good, short low resistance connection to a cold water tap is used
 - no earth connection is used
 - a good, short low resistance connection to an earth spike is used
- To comply with the License regulations pertaining to non-interference, the Licensee shall conduct tests on his equipment:
 - weekly
 - from time to time
 - on the receipt of new equipment
 - on receiving complaints from any other user of wireless telegraphy

PAPER 2

- Many VHF and UHF repeaters have a pause between the end of audio transmission and the generation of a tone, usually "R" or "T". The reason for this is:
 - it takes time for the repeater to switch from transmit to receive mode
 - to give the opportunity for other stations to use the repeater
 - to identify the repeater
 - to give the operator time to switch from transmit to receive mode
- Using the recommended radio telephony phonetic alphabet Q2MUR would be sent as:
 - Qolt 2 Mike Uniform Radio
 - Qolt 2 Mexico Uniform Radio
 - Qolt 2 Mike Uniform Romeo
 - Qolt 2 Mexico Uniform Romeo
- In a series tuned circuit with an inductance of 400µH and a capacitance 144pF, the resonant frequency will be:
 - 16.3kHz
 - 663 kHz
 - 0.0663 MHz
 - 6.63 MHz
- The effective capacitance between terminals A and B is:

 - 1400 pF
 - 600 pF
 - 285 pF
 - 560 pF

experience as you can. One without the other is likely to leave you high and dry. You might get through on theory alone if you are very good at memorizing things, but it will be a lot harder unless you actually have 'hands on' experience of radio equipment — inside and outside the chassis.

Obviously the candidate with an electrical or electronics background has an immediate advantage in that he is already schooled in an understanding of how electronic devices work; he will still need to be thoroughly familiar with the actual syllabus to pass. But how does the complete novice with perhaps only a little physics, or not even that much to start with, get the knowledge?

Probably the best way is a structured course in a class with other candidates. In this way you will get the benefit not only of the teacher's experience but those of other hopefuls with varying experiences and see more than one approach, perhaps even with more than one teacher.

To find a local radio course, first try radio journals and popular radio magazines — the RSGB's "Radio Communication" (RadCom) for instance. Also, check with your local public library or main district library, which should have lists of activity clubs and also local institutes which do courses of various kinds. Look for local radio or electronics clubs, or local RSGB groups. Quite apart from attending club talks and meeting other amateurs, if there are enough candidates locally then you can apply to the principle of any local college to have a course set up, though you may have to find your own teacher, or an instructor that the college is satisfied with. The college year starts in September, so you will have to find this out well in advance, in time for the RAE, which is usually held twice a year, at various locations around the country.

If you cannot find any kind of local

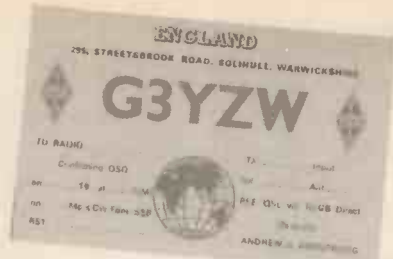

QSL cards from the UK and the Faroe Islands.

course, there are correspondence courses, and private students are also often successful. Try contacting other amateurs in the area — consult the RSGB's Amateur Radio Call Book; again, a local library might help — you are likely to find one or two who would gladly advise you and share their experience.

Three years ago, the RAE switched from question-and-answer to multiple choice, but do not assume that this will make the exam easy. You will still have to know your practical circuit diagrams and be able to do straightforward calculations. It is helpful and speeds things up if you have a calculator, although you can get by quite adequately on normal arithmetic as long as you have a grasp of equations (which a calculator won't help you with anyway). All the symbols used in the

exam are British Standard 3939, and are laid out in the RAE Manual — you are less likely to be misled if you know these thoroughly.

The rules of thumb for the exam are also simple: assuming you know your stuff, and even if you *don't*, do two things; read all the instructions on the paper carefully, and give yourself time to tackle all the questions. Time taken to make sure you are doing the right thing is never wasted. If you can't do a question, leave it and go on to the next. You can always come back to it. With a multiple choice exam, don't leave any question unanswered — who knows, but you might pick the right answer by accident or inspired guesswork! This compensates for the factor in the old-style exam, where some marks were allocated for part-questions finished, even if the whole answer was not right. There is always a luck factor in exams — this will never make the difference between a good and a bad candidate, but may make the difference between gaining and not gaining your licence first time around. And it costs money to take the exam, so never give up the paper while the exam is still in progress!

The RAE is not a competitive exam — you have only to reach a certain standard to pass, regardless of how many other people pass or fail.

Make sure you are familiar with everything on the syllabus. However ill prepared you may feel, make sure you have an overall acquaintance with the subject before you try swatting up on special subjects — not only are you more likely to get through the exam that way, but it will stand you in better stead afterwards.

HE

5) CURRENT, mA

SECONDS

The frequency and RMS value of the current represented by this sine wave is:

- 16 Hz 70.7 mA
- 11 Hz 35.4 mA
- 16 Hz 35.4 mA
- 33 Hz 70.7 mA

6) The current gain of a transistor used in a common collector (emitter follower) connection is 50. The external emitter resistance to ground is 10K ohms. The device input resistance will be approximately:

- 500K ohms
- 200 ohms
- 5000 ohms
- 5M ohms

7) A transistor amplifying with an efficiency of 50% or less is likely to be operating in:

- class A
- class AB
- class B
- class C

8) If the input frequency to the mixer stage of a radio receiver is 1.8 MHz and the required intermediate frequency is 470 kHz, the local oscillator frequency should be tuned to:

- 470 kHz
- 1800 kHz
- 2270 kHz
- 2740 kHz

9) Fig 1

In Fig 1, a single sideband generator, what label should be given to the box marked?

- unbalanced modulator
- balanced modulator
- buffer amplifier
- voltage controlled attenuator

10) In Fig 1, what is the purpose of the two components marked A and B:

- to switch frequency bands
- to switch from transmit to receive
- to provide upper and lower sidebands
- to allow for repeater frequency shift

11)

A 30 MHz half wave dipole has an input impedance of about 80Ω when the length L and height H are:

L metres	H metres
a) 5	2.5
b) 2.5	5
c) 2.5	2.5
d) 5	5

12) In the Yagi directional aerial arrangement shown below, the director is of length:

- A/2
- A
- more than A/2
- less than A/2

13) Tropospheric propagation is usually the major mode for:

- frequencies below 30 MHz for local communications
- frequencies above 50 MHz for long distance communications
- frequencies above 1 GHz
- frequencies above 50 MHz for line-of-sight communications

14) In order to measure the peak envelope power by the "two tone" test method, the following equipment is needed:

- an audio oscillator generating two tones, a dummy load and an oscilloscope
- a dummy load and an audio oscillator generating two tones
- an audio oscillator operating at two known frequencies

15) A milliammeter M having a full scale deflection of 5 mA is to be used as a voltmeter measuring up to 250 V, the circuit needed will be:

**HOBBY HERALD
HAS ALL THE
LATEST NEWS
FOR THE
ELECTRONICS
HOBBYIST**

When you need to update yourself with all that is available in the "Do-it-yourself" market, then you need the Hobby Herald.

Packed with product information essential to the electronics enthusiast, this new electronics catalogue lists over 60 exciting products ranging from All Purpose Cutters to Verobloc, the solderless breadboard. All products are available throughout the U.K. from over 200 stockists.

HOBBY HERALD

Alternatively ordering products through the Herald is simplicity itself, and you can pay by either cheque, Barclaycard or Access. So make sure you get your copy of Hobby Herald by ringing **(04215) 62829.**



BICC-Vero Electronics Ltd.
Industrial Estate,
Chandlers Ford, Hampshire,
SO5 3ZR

BICC vero

CALL IN AND SEE FOR YOURSELF

AUDIO ELECTRONICS

ALL PRICES INCLUDE VAT

TEST EQUIPMENT CENTRES ALL MODELS ON DISPLAY OPEN SIX DAYS A WEEK

RETAIL • MAIL ORDER • EXPORT • INDUSTRIAL • EDUCATIONAL

DIGITAL MULTIMETERS (UK C/P Free)



ALL MODELS 3 1/2 DIGIT UNLESS STATED

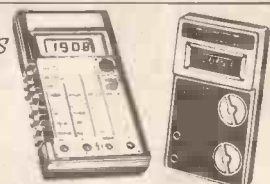

- HAND HELD** ■ With free carry case
- KD25C=13 range 0.2A DC 2 meg ohm £24.95
 - KD30S=16 range 10A DC 2 meg ohm £29.95
 - KD30C=26 range 1A AC/DC 20 meg ohm £34.95
 - KD55C=28 range 10A AC/DC 20 meg ohm £39.95
 - 6D10=22 range 10A AC/DC 20 meg ohm £34.40
 - 7D30= As 6D10 but 0.1% basic £41.30
 - KD615=16 range 10A DC 2 meg plus Hfe tester £39.95
 - 189M 30 range 10A AC/DC 20 meg plus Hfe tester £69.95
- HAND HELD AUTO RANGE**
- DM2350=21 range 10A AC/DC 20 meg ohm (Miniature) £49.95
 - HD30 16 range 0.2A AC/DC 2 meg ohm £41.95
 - HD30/B As above plus cont. buzzer £44.50
 - HD31 22 range 10 AC/DC 2 meg ohms plus cont. buzzer £58.95
 - +Optional carry case £2.95

BENCH MODELS

- TM353=27 range LCD 2A AC/DC £86.25
- TM355=29 range LED 10A AC/DC £86.25
- TM351=29 range LCD 10A AC/DC £113.85
- 2001 28 range LCD 10A AC/DC plus 5 range Cap. Meter with case £108.00
- TM451 4 1/2 digit LCD every facility (0.02%) £171.00
- 1503a 4 1/2 digit LCD every facility (0.05%) £171.00
- 1503Ha 0.03% basic version of above £189.00
- *Optional carry case £6.84

ALWAYS BARGAINS IN EQUIPMENT FOR CALLERS

FREQUENCY COUNTERS



- PFM200A 200 MHz hand held pocket 8 digit LED £67.50
- 8110A 8 digit LED bench 2 ranges 100 MHz £77.00
- 8610B 9 digit LED bench 2 ranges 600 MHz £113.85
- 8000B 9 digit LED 3 ranges 1 GHz £178.00
- TF040 = 8 digit LCD 40 MHz £126.50
- TF200 = 8 digit LCD 200 MHz £166.75
- +Optional carry case £6.84
- Prescalers - extended range of most counters
- TP600 600 MHz £43.00
- TP1000 1 GHz £74.00

SIGNAL GENERATORS



- FUNCTION: All sine/square/triangle/TTL etc
- TG100 1 Hz - 100 KHz £90.00
 - TG102 0.2 Hz - 2 MHz £166.75
- PULSE**
- TG105 Various facilities 5 Hz - 5 MHz £97.75
- AUDIO** - Multiband Sine/Square
- LAG27 10 Hz to 1 MHz £90.85
 - AG202A 20 Hz to 200 KHz (List £94.50) £83.50
- RF**
- SG402 100 KHz to 30 MHz (Last few) £59.95
 - LSG17 100 KHz to 150 MHz £79.35

ELECTRONIC INSULATION TESTER

- YF 501 500 V/0-100m with carry case £63.00

MULTIMETERS

- (UK C/P 65p)
- C7081 50K/V 21 ranges. Range doubler 10A DC. SPECIAL PRICE £15.95
 - ETC5000/5001 21 ranges. 50K/V. Range doubler. 10A DC. £16.50
 - TMX500 23 ranges 30K/V. 12A DC plus cont. buzzer. £23.95
 - NH56R 20K/V. 22 range pocket £10.95
 - EU102 14 range 2K/V pocket £5.95
 - 830A 26 range 30K/V. 10A AC/DC overload protection, etc. £23.95
 - 360TR 23 range 100K/V. Large scale 10A AC/DC plus Hfe £36.95
 - AT120 18 range 20K/V. Deluxe plus Hfe tester £17.50
 - ST303TR 21 range 20K/V plus Hfe tester £16.95
 - YN 360TR 19 range 20K/V plus Hfe tester £13.95

VARIABLE POWER SUPPLIES (UK C/P £1.00)

- PP241 0/12/24V. 0/1A £35.00
- PP243 3 amp version £59.95
- PS 1307S 8/15V 7 amp twin meter £24.95

DIGITAL THERMOMETER

- TH301 LCD -50 C to +750 with thermocouple £68.43

AC CLAMP METER

- ST300 0/300A: 0/600 VAC. 0/1 Kohm 9 ranges With carry case (UK C/P 65p) £28.50

LOGIC PROBES

- LP10 10 MHz £28.50
- LDPO76 50 MHz with carry case and accessories £71.30

OSCILLOSCOPES



- Full specification any model on request. SAE by post.
- 'HM' Series HAMEG; 'SC' THANDAR; 'CS' Series TRIO; '3' Series CROTECH**
- SINGLE TRACE**
- 3030 15 MHz 5mV. 95mm tube plus component tester C/P £3.00 £177.10
 - SC110A = Miniature 10 MHz battery portable Post free £171.00
 - HM103 15 MHz 2mV. 6 x 7 display plus component tester C/P £3.00 £181.70
 - +Optional carry case £6.84 AC adaptor £6.69
 - Nicads £12.50
- DUAL TRACE (UK C/P £4.00)**
- NM203/4 Dual 20 MHz plus component tester £303.60
 - CS1562A Dual 10 MHz (List £321.00) £269.50
 - 3131 Dual 15 MHz - component tester £276.00
 - CS1566A Dual 20 MHz All facilities (List £401.35) £349.50
 - NM204 Dual 20 MHz plus component tester sweep delay. £419.75
 - CS1820 Dual 20 MHz with extra facilities (List £508.30) £485.00
- OPTIONAL PROBE KITS**
- X1 £7.95 X10 £9.45
 - X1 - X10 £10.50 X100 £16.95

HIGH VOLTAGE METER

- Direct reading 0/40 KV. 20K/Volt. (UK C/P 65p) £23.00

DIGITAL CAPACITANCE METER

- 0.1 pF to 2000 mfd LCD 8 ranges DMG613 £52.75 (Carry case £2.95)

TRANSISTOR TESTER

- Direct reading PNP, NPN, etc. TC1 (UK C/P 65p) £21.95

AUDIO ELECTRONICS

Cubegate Limited

301 EDGWARE ROAD, LONDON W2 1BN, TEL: 01-724 3564
ALSO AT HENRY'S RADIO,
404/406 EDGWARE ROAD, LONDON W2, TEL: 01-723 1008

FREE CATALOGUE! SEND LARGE SAE (UK 20p)

Order by Post with CHEQUES/ACCESS/ VISA or you can telephone your orders. An order despatched within 3 days unless advised.

HIGH FLYING ACE

Mike Lord



HE's micro-master reviews the first personal computer to use FORTH, a fast and efficient high-level language, as its 'mother tongue'.

IN INTRODUCING THE ACE, Steven Vickers and Richard Altwasser have broken away from the tradition of offering more hardware (RAM, sound, colour etc.) for your money. Instead, they have decided to innovate in terms of software by choosing FORTH for the ACE's 'natural' language rather than the various extended BASICs used by their competitors.

Because of this, any review of the ACE must begin by looking at FORTH itself, and considering its advantages and disadvantages as a programming language.

FORTH

FORTH is not a new language. It was originally developed over ten years ago.

Since then it has attracted a steadily growing band of enthusiastic supporters, most of whom use it for 'real' applications such as controlling machinery or — recently — for writing fast action moving games.

FORTH was originally developed as an alternative to machine code for use on small microcomputers with a limited amount of memory and where BASIC-like languages were often too slow for the job. The result therefore lies between machine code and BASIC in terms of both speed and ease of use.

Unlike BASIC programs, which are essentially a numbered list of commands, FORTH programs are built up by defining new commands, starting with the elementary low level operations, then using these in more complex commands, and so on until you

end up with a single command that defines the whole program.

In FORTH terminology, a 'command' is known as a 'word', and consists of a descriptive name followed by a definition of what the word is to do. The definition is usually in terms of other FORTH words, although you can use a machine language routine where speed is really critical. As each word definition is entered, it is added to a 'dictionary', and that word can then be used in the definition of new words. This probably sounds confusing to someone who hasn't encountered FORTH before, but the basic principle is quite simple. If you were to enter:

```
: HI 125 100 BEEP ;
```

then the colon at the start of the line tells the computer that you are defining a new word — called HI — and the semi-colon at the end signals the end of the definition. The definition of this word is therefore:

```
125 100 BEEP
```

BEEP is a pre-defined word, one of about 140 FORTH words held permanently in the ACE's ROM, and it makes a sound using the ACE's internal loudspeaker. The two numbers define the frequency and duration of the note. Having entered the new word definition, it will be placed in the ACE's dictionary, and now the ACE will understand the word HI as an instruction to produce a short, sharp, tone. In fact, just typing in the word HI will now produce the tone, since if you enter any line that doesn't start with a colon, then FORTH assumes that you want it acted upon immediately. This is an extremely important feature that lets you test out new words as you develop them.

We could now enter a second word definition:

```
: LO 250 100 BEEP ;
```

to produce a lower note, and then play the two notes one after the other by entering:

```
HI LO
```

Having added the two words to the dictionary, we can use them in a further definition:

```
: TUNE HI HI LO LO HI ;
```

so that the new word TUNE will play a sequence of 5 notes.

In this way, a FORTH program is gradually built up by defining new words to perform ever more complex tasks, but by taking it one step at a time, you can construct your program in a logical and ordered manner.

Looping and Choosing

To let you program for alternative courses of action, FORTH has an IF-THEN-ELSE construct similar to that found in advanced versions of BASIC. BEGIN-UNTIL and BEGIN-WHILE-REPEAT allow you to repeat actions until (or while) a particular condition is met, in much the same manner as BBC BASIC's REPEAT-UNTIL. And if you want to repeat an action a defined



Ace comes with a power pack, cassette leads, programming manual and demonstration tape.

number of times, FORTH provides a DO-LOOP construct which behaves like BASIC's FOR-NEXT. There is, however, no equivalent to the BASIC GOTO command. This seems at first like a serious omission to anyone used to programming in BASIC, but once you get used to FORTH you find you can always use IF-THEN-ELSE, BEGIN-UNTIL or BEGIN-WHILE-REPEAT to achieve the same result but in a much more elegant fashion.

Stack It

One area where FORTH differs considerably from most other computer languages is in its use of a 'stack' to hold the values being worked on. Most languages use named 'variables' to hold values, so that the BASIC statement:

```
LET A = 27 + 33
```

tells the computer to add 27 to 33, then store the result in an area of memory reserved for the variable named 'A'. You can also use named variables in FORTH, but the values actually being worked on at any time will usually be held in a special area of memory known as the 'Stack'. This is best thought of as a pile of values; a new value can be added to the top of the pile — making the pile higher — or a value can be taken off the top of the pile — making it shorter. All of FORTH's fundamental operations, like addition, multiplication etc., work on the values present on the top of the stack. The '+' operator, for example, takes the top two values off the stack, adds them together, then puts the result back onto the top of the stack.

When the computer sees a number in the line you have entered, it puts that value onto the top of the stack. For example, if you look back at our definition of the word HI, what it was really telling the computer to do was to first put the value 125 onto the stack, then put the value 100 on top of that, then execute the pre-defined word BEEP, which takes the top two numbers from the stack to give the frequency and length of the note to be produced.

Similarly, the line:

```
27 33 +
```

will place the values 27 and 33 onto the stack, then replace them by the single value 60. This way of writing may seem backwards at first (and — indeed — it is

known as 'reverse Polish') but you soon get used to it.

There are two main reasons why FORTH was designed around the use of a stack. The first is that it saves memory space because values are kept in RAM only as long as they are needed, and — more importantly — because the program doesn't need to contain the names of the variables (at least as long as the values are being kept on the stack). The second advantage is that your programs run more quickly because the computer doesn't have to search through a 'variables storage area' to find the one you want.

DIY FORTH

FORTH is really a 'Do It Yourself' language. Although it has about 140 pre-defined words compared to the 90 or so keywords in most versions of BASIC, they nearly all correspond to very elementary operations, and you have to add your own definitions to do anything that is even slightly complex.

Take arrays for example. In BASIC, a simple DIM statement will set up an array so that you can then refer to an element of it by just using a subscripted variable such as A(27). But FORTH has no equivalent to the DIM statement or the subscripted variable; you have to write special words that will let you handle data in array form, or — more precisely — you have to define a routine that can be used to set up arrays, and another to let you refer to an individual element of an array. At the end of the day you will be able to handle arrays of data at least as well as you could in BASIC, but you will have taken longer to get there.

Similarly, if you want to handle strings, you must first define some string handling words.

Fast FORTH

Where FORTH really scores is in doing fairly simple tasks very quickly. And, because it is much nearer to machine code than BASIC, you have much more control over what the computer is actually doing. Indeed, to program successfully in FORTH you need to be much more aware of how the computer works than you do with most other languages, and pay much more attention to the possible side effects of

what you are doing. For example, FORTH arithmetic is usually done using 16-bit words that can take integer values from -32768 to 32767. But there is no check to see if a result has overflowed, so that it will quite happily add 30000 to 30000 and say that the result is -55361. FORTH enthusiasts will say, of course, that if you really want the + operator to check for overflow then you can easily define a new version of the word that does just that.

ACE FORTH

There is a standard for the FORTH language, known as FORTH-79, and the version provided on the ACE sticks very close to it. The main differences are the addition of words to handle floating point numbers, plotting, the sound generator, and I/O ports. There are also some differences in the way programs are entered and edited.

The Hardware

The ACE comes in a white vacuum-formed plastic box about the same width as the Spectrum but deeper, held together with plastic rivets along the sides and back. A label on the underside of the box warns that there are no 'user serviceable' parts inside, and indeed the case is fixed together in such a way that you can't take it apart without splitting the plastic. This is a pity, because I am sure that many people who would be attracted to the ACE would be enthusiastic (and knowledgeable) enough to want to get at the hardware to make minor 'improvements'.

On the model received for review, the quality of the case was poor. The edges where it had been cut from the mould were rough, there were a couple of noticeable dimples on the top surface, and the holes in the case for the TV, Ear, Mic and Power sockets did not line up properly. Worse, the bottom part of the case was bowed so that it flexed whenever you pressed on a key, and the keytops sometimes caught underneath the case top. Hopefully these were just teething problems with the first models.

Two PC board edge connectors are provided at the back for add-ons. One of these is to take memory extension and/or I/O ports. It is believed that the other is for a possible colour display add-on.

The keyboard has the same layout as on the Spectrum, even having the same awkwardly positioned Symbol Shift key, and also lacks a proper space bar. But, because FORTH doesn't use keywords in the same way that Spectrum BASIC does, there is a blessed simplicity about the key legends. Generally, each key is only used to give upper or lower case characters — governed by using the SHIFT key, or a special symbol such as '<', which is obtained with the Symbol Shift key. The keys are black with easily read white markings.

As on the Spectrum, the keytops are all formed from a single rubber moulding which collapses as you press on a key, but the ACE's keys feel much

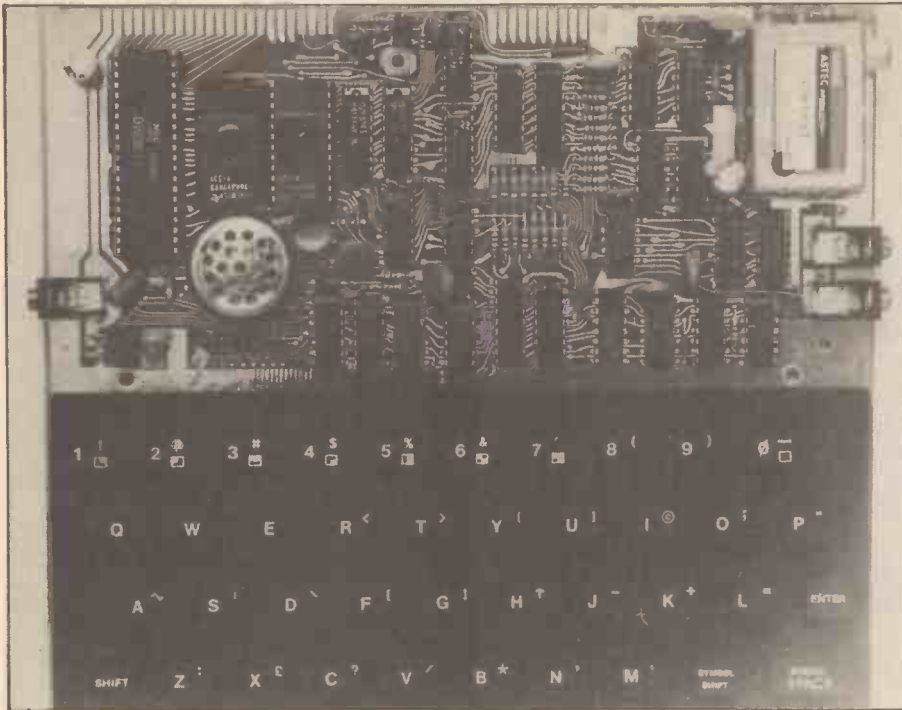

The view inside the ACE; the chip count totals around 30 ICs!

firmer and need to be pressed much more deliberately. You can't type quickly on the ACE — the keyboard just won't let you — so the auto-repeat feature is useful.

On Screen

The TV display is crisp and stable but is in black and white only. There are 24 lines of 32 characters each, and in typical fashion the bottom line is reserved for use as an input buffer. Characters are normally displayed in white on a black background, although you can make any character appear in black on white. Both upper and lower case letters are available, as well as 16 'chunky' graphics characters. The character codes used are basically ASCII with a few additions such as the copyright symbol and '£' as well as '\$' and '#'. As is common practice for most low cost computers, the characters are formed from an 8 x 8 array of pixels. The dot patterns for the whole character set are held in a special area of RAM (they are copied from ROM into the RAM when power is applied), which means that you can re-define any or all of them to make your own shapes in much the same way as you can on the Spectrum or the BBC computer. A PLOT command uses the chunky graphics characters to give a low resolution (64 x 46) plotting capability similar to that on the ZX81. Because you can define your own characters, each as an 8 x 8 pixel array, you can theoretically draw shapes with an overall resolution of 256 x 192 pixels, but in practice you wouldn't use this facility for drawing shapes larger than the space of a few characters on the screen. There is no equivalent to the high resolution plotting modes available on the Spectrum, Dragon or BBC machines.

The ACE has an internal loudspeaker, and a BEEP command to drive it, but you are limited to one note at a time and can only vary the pitch and duration.

The cassette tape interface works at a respectable 1500 baud (about 6 seconds for 1K bytes). You can save to tape either the dictionary of new word definitions that you have entered, which is effectively your program, or a defined area of memory. A VERIFY command lets you see if what is on tape is the same as what is in memory. On the model under test, a very high level was needed from the recorder when loading; reminiscent of the old ZX81, but otherwise the system worked reliably.

Internal Matters

Inside the case is a bit of a shock to anyone used to Sinclair's 'The fewer parts the better' philosophy; almost 30 ICs have been packed in. Obviously in starting up a new company from scratch Vickers and Altwasser could not afford the time or cost of developing a custom integrated circuit like the ULA used to replace handfuls of TTL chips in the Spectrum, just as they didn't invest in the tooling for an injection moulded case.

The central processor is, of course, the one we can't seem to get away from: the Z80A. The Operating System software, FORTH, and the standard character set dot patterns have all been squeezed into an 8K byte ROM. 3K bytes of RAM have been fitted, which may seem a lot compared to the 1K of the ZX81, but 1K is used to hold the dot patterns when the machine is running, and almost the whole of another 1K is used for the TV display file, and yet more for working space, stacks, and System Variables, so you are left with well under 1K bytes to hold your program and data. Some form of memory expan-

ACE BOUNCER

This program was written as an exercise in using FORTH and to get some idea of how fast a FORTH program will run. It moves a star around the screen, bouncing it off the four edges.

Similar programs written in BASIC will make a complete circuit of the screen in about one or two seconds. This FORTH version runs at about the same speed, but only because it has been deliberately slowed down by the 100 5 BEEP command in the word GO. Without this restraint, the star moves so fast that you can only see momentary glimpses of it as it flashes around the screen!

```

10 VARIABLE HPOS
10 VARIABLE VPOS
1 VARIABLE HVEL
-1 VARIABLE VVEL
: NEWPOS @ DUP 0= IF 1
HVEL ! THEN DUP 31 = IF -1 HVEL !
THEN HVEL @ + HPOS ! VPOS
DUP 0= IF 1 VVEL ! THEN DUP 22 =
IF -1 VVEL ! THEN VVEL @ + VPOS !
:
: WIPE VPOS @ HPOS @ AT
SPACE:
: PRINTNEW VPOS @ HPOS AT
42 EMIT ;
: GO CLS BEGIN 100 5 BEEP WIPE
NEWPOS PRINTNEW 0 UNTIL ;

```

sion is essential for any but the simplest application.

The 181 page manual provided with the ACE is excellent, both as an introduction to FORTH and as a guide to using the ACE. It was written by Steven Vickers, and is in the same light but very informative style as his previous Sinclair manuals. One interesting chapter, *Extending the ACE*, gives much more information on how to add I/O ports or memory than is usual in a computer manual, including the circuit for a simple I/O port and examples of software to drive it.

In Conclusion

The ACE represents a brave attempt to get away from the cliché of colour — BASIC — games machine personal computers, but in the long term will probably suffer from the lack of investment in a professional looking case and the absence of colour or true high resolution graphics. Now that FORTH is becoming available as an optional language for other computers such as the Spectrum and ORIC, many people may prefer to spend the extra to get the more powerful and flexible machines. The ACE will probably appeal most to those who have a limited budget and are interested in programming simple control type applications. But even these potential buyers might prefer the combination of a ZX81 with a cheap 16K RAM pack and FORTH on cassette, which adds up to about the same as an ACE.

ROBOTICS FANS!!! LOOK!!



ONLY
£4.95

"BIG TRAK" MOTORIZED GEARBOX

These units are as used in the "Big Trak" computerized vehicle, and offer the experimenter in robotics the opportunity to purchase the electro-mechanical parts required in building remote controlled vehicles. The unit comprises:

- a) 2 x 3V motors, linked by a magnetic clutch, thus enabling turning of the vehicle;
- b) A gearbox contained within the black ABS housing reducing the final drive speed to approx 50rpm.

Data is supplied with the unit showing various options on driving the motors, as well as a direction controller circuit, enabling the unit to turn right, left or go straight ahead.

2N3055

SCOPII

Made by Texas — full spec devices, 60p each; 10 for £4; 25 for £9; 100 for £34; 250 for £75; 1000 for £265.

COMPUTER SOFTWARE

We now sell a range of tapes and books for DRAGON 32, SPECTRUM, ZX81, BBC and VIC20. Send s.a.e. for list stating for which computer required, or call in our shop.

SIMON GAME

Simon is back again. Another supply of ready built PCB's for this flashing light/pulsating tone computerised game is now with us. Supplied tested and working with speaker and instructions. £4.95.

COMPUTER BATTLESHIPS

Probably one of the most popular electronic games on the market. Unfortunately the design makes it impractical to test the PCB as a working model, although it may well function perfectly. Instead we have tested the sound chip, and sell the board for its component value only (PCB may be chipped or cracked), SN76477 sound IC; TMS1000 u-processor; batt clips, R's, C's etc. Size 160 x 140mm. Only £1.50. Instruction book and circuit 30p extra.



LIE DETECTOR

Not a toy, this precision instrument was originally part of an "Open University" course, used to measure a change in emotional balance, or as a lie detector. Full details of how to use it are given, and a circuit diagram. Supplied complete with probes, leads and conductive jelly. Needs 2 41V batts. Overall size 155x100x100mm. Only £3.95 worth that for the case and meter alone!

GREENWELD

443A MILLBROOK ROAD, SOUTHAMPTON SO1 0HX
All prices include VAT — just add 50p post. Tel (0703) 772501

ELECTROSUPPLIES

WHOLESALE & TRADE COUNTER
BOWNESS MILL, SHAWCLOUGH ROAD,
WATERFOOT, ROSSENDALE, LANCS. TEL:
ROSENDALE 215556
RETAIL SHOP

6A TODD STREET, MANCHESTER (next to
VICTORIA STATION) TEL: 061-834 1185

Teletext Panels

Main Board, and information, untested.....£15 set

200 MHz frequency counter kits

Kit contains 2 PCB's one for main component and one for displays. 8 digit. All parts except case (using the ICM 7216B chip).....£45 set

Stereo Cassette Deck

Complete with pre-amplifiers.....£14.95 + £1.50 P&P

AY-3-8500	200p	LM 319	200p	NE 562	350p	TDA 1327	
AY-5-3507	200p	LM 324	35p	NE 565	120p	TDA 2524	
AY-5-4007	200p	LM 339	60p	NE 566	160p	TDA 2530	300p
CA 758	150p	LM 380	85p	NE 5018	700p	TDA 2540	350p
HA 1156	150p	LM 1458	50p	NG 5553	120p	TDA 2541	350p
IGH 8510KA	1000p	LM 2901	80p	NG 5554	12p	TDA 256073	350p
ICL 7103	400p	LM 3401	80p	TBA 810P	80p	TDA 2571A	325p
ICL 7106	750p	LM 3900	55p	TDA 1001A		TDA 2581	225p
ICL 7109	800p	MC 1310	150p	TDA 1003A	220p	TDA 2611A	
ICL 80388M	300p	MC 1312		TDA 1004	300p	TDA 3310	
ICL 8048	1000p	MC 1327		TDA 1008	300p	TDA 3950	
ICL 8049	1000p	MC 1349		TDA 1050	250p	Computer ICs	
ICL 8260		MC 1357	80p	TDA 1071		2732	450p
ICM 7205IPG	900p	MC 1456	80p	TDA 1170	200p	4116	80p
ICM 7211	400p	MC 1488	150p	TDA 1190	200p	2114	90p
ICM 7212	300p	MC 1489	200p				
ICM 7216B	1800p	MC 1495	320p				
ICM 7216C	1800p	MC 1496	80p				
ICM 7216D	1800p	MM 53100N	200p				
ICM 7217C	700p	MM 57105	200p				
ICM 7218	700p	NE 536T					
ICM 7235A	400p	NE 540L					
IM 5600	150p	NE 543K	200p				
LF 155T		NE 541					
LF 355T	100p	NG 550	90p				
LF 356H	100p	NG 555	16p				
LF 357H	100p	NG 556	40p				
LM 310	150p	NG 558	100p				
LM 311	80p						

Call in the shop for lists and a browse. We feel sure you will be pleasantly surprised at the stock we keep.

ALL PRICES INCLUDE VAT
PLEASE ADD 50p P&P

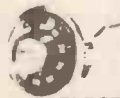

NOW
REDUCED
TO £3.95

ELECTRO DIAL

Electrical combination lock for maximum security—pick proof. One million combinations! Dial is turned to the right to one number, left to a second number, then right again to a third number. Only when this has been completed in the correct sequence will the electrical contacts close. These can be used to operate a relay or solenoid. Overall dia 65mm x 60mm deep. Only £3.95.

FERRIC CHLORIDE

New supplies just arrived — 250mg bags of granules, easily dissolved in 500ml of water. Only £1.15. Also abrasive polishing block 95p.

STABILIZED PSU PANEL

A199 A versatile stabilised power supply with both voltage (0-30V) and current (20mA-2A) fully variable. Many uses inc bench PSU, Ni-cad charger, gen, purpose testing. Panel ready built, tested and calibrated £7.75. Suitable transformer and pots £6.00. Full data supplied.

REED RELAYS

Manufacturers rejects — DIL and other PCB mounting types. SP, DP and 4P — make, break and c/o contacts. Not tested, so may be only partially working or o/c etc, so very low price — pack of 10 assorted £1; 25 £2.00; 100 £7.00.

TELESCOPIC AERIALS

As used in Sinclair microvision, 9 section 100-610mm. Only 95p.

IN4148 — BEST PRICE EVER

Supplied in packs of 100, by Toshiba £2 per pack; 3 packs £5.50; 10 packs £15; 25 packs £32; 100 packs £115.

COMING SOON . . .

MORE COMPUTER GAMES PCB'S
— MICROVISIONS, ALPHIE,
AVENGER, INTRUDER, AND
STARBIRD



Bigger and Better

the colourful Wilmslow Audio brochure
— the definitive loudspeaker catalogue!

Everything for the speaker constructor — kits, drive units, components for HiFi and PA.

50 DIY HiFi speaker designs including the exciting new dB Total Concept speaker kits, the Kef Constructor range, Wharfedale Speakercraft, etc.

Flatpack cabinet kits for Kef, Wharfedale and many others.

- ★ Lowest prices — Largest stocks ★
- ★ Expert staff — Sound advice ★

- ★ Choose your DIY HiFi Speakers in the comfort of our ★
two listening lounges
(Customer operated demonstration facilities)

- ★ Ample parking ★

Send £1.50 for catalogue

(cheque, M.O. or stamps — or phone with your credit card number)

- ★ Access — Visa — American Express accepted ★
also HiFi Markets Budget Card.



0625 529599

35/39 Church Street, Wilmslow, Cheshire SK9 1AS



Lightning service on telephoned credit card orders!



LITESOLD ARE OFFERING A COMPLETE SOLDERING KIT FOR ONLY



Contains all you need to solder/de-solder any electronics project:

LITESOLD LC18H 240v high performance iron, made to professional standards in our own works, fitted with 3.2mm bit. 2 alternative bits, 1.6 and 2.4mm. Reel of 3 metres 18 swg flux-cored solder. Stainless steel tweezer. 3 soldering aids. Reel of 1.5 metres de-soldering braid. Packed in clear PVC presentation/storage wallet. Superb present — ideal for beginner or expert.

SK18H KIT SPECIAL PRICE £14.55 inc. VAT & P.P. (normal resale value £18.45 inc.) LC18H IRON only £6.00 (normally £7.39)

Spares, accessories and after-sales service available from us. 16-page colour catalogue — 60p. Send cheque/P.O. to LITESOLD or ring for Access/Barclaycard sales.

Spencer Place, 97/99 Gloucester Road, Croydon CR0 2DN, Surrey. Tel: 01-689 0574.



LITESOLD

LIGHT SOLDERING DEVELOPMENTS LTD.

Send for my CATALOGUE ONLY 75p

(plus 25p post/packing)

My all-inclusive prices quoted in the Catalogue are the lowest. All below normal trade price — some at only one tenth of manufacturers quantity trade.

See my prices on the following:

CAPACITORS . . . ELECTROLYTIC; CAN, WIRE END, TANTALUM, MULTIPLE, COMPUTER GRADE, NON POLAR, PAPER BLOCK, CAN, POLY, MICA, CERAMIC. LOW AND HIGH VOLTAGE, RESISTORS. 1/8th WATT TO 100 WATT; 0.1% TO 10% CARBON, METAL AND WIRE WOUND + NETWORKS. FANS, BATTERIES, SOLENOIDS, TAPE SPOOLS, VARIABLE CAPACITORS AND RESISTORS, TRIMMERS, PRESETS, POTS . . . SINGLE, DUAL, SWITCHED, CARBON, CERMET AND WIREWOUND, SINGLE OR MULTITURN, ROTARY AND SLIDE. DIODES, RECTIFIERS, BRIDGES, CHARGERS, STYLII, SOCKETS, PLUGS, RELAYS, TRANSISTORS, IC'S, CLIPS, CRYSTALS, ZENERS, TRIACS, THYRISTORS, BOXES, PANELS, DISPLAYS, LED'S, COUPLERS, ISOLATORS, NEONS, OPTO'S, LEADS, CONNECTORS, VALVES, BOOKS, MAGAZINES, TERMINALS, CHOKES, TRANSFORMERS, TIMERS, SWITCHES, COUNTERS, LAMPS, INDICATORS, BELLS, SIRENS, HOLDERS, POWER SUPPLIES, HARDWARE, MODULES, FUSES, CARRIERS, CIRCUIT BREAKERS, KNOBS, THERMISTORS, VDR'S, INSULATORS, CASSETTES, METERS, SOLDER, HANDLES, LOCKS, INDUCTORS, WIRE, UNITS, MOTORS, COILS, CORES, CARTRIDGES, SPEAKERS, EARPHONES, SUPPRESSORS, MIKES, HEATSINKS, TAPE, BOARDS and others.

Prices you would not believe before inflation!

BRIAN J. REED

TRADE COMPONENTS

ESTABLISHED 26 YEARS

161 St. Johns Hill, Battersea, London SW11 1TQ

Open 11 am till 7 pm Tues. to Sat. Telephone: 01-223 5016

For a detailed booklet on remote control — send us 30p and S.A.E. (6" x 9") today.

HOME LIGHTING KITS

These kits contain all necessary components and full instructions & are designed to replace a standard wall switch and control up to 300w. of lighting.

TDR300K Remote Control Dimmer £14.30

MK6 Transmitter for above £ 4.20

TD300K Touchdimmer £ 7.00

TDE/K Extension kit for 2-way switching for TD300K £ 2.00

LD300K Rotary Controlled Dimmer £ 3.50

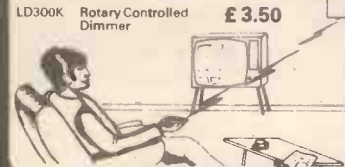

DVM/ULTRA SENSITIVE THERMOMETER KIT

This new design is based on the ICL7126 (a lower power version of the ICL7106 chip) and a 3 1/2 digit liquid crystal display. This kit will form the basis of a digital multi-meter (only a few additional resistors and switches are required—details supplied), or a sensitive digital thermometer (-50°C to +150°C) reading to 0.1°C. The basic kit has a sensitivity of 200mV for a full scale reading, automatic polarity indication and an ultra low power requirement—giving a 2 year typical battery life from a standard 9V PP3 when used 8 hours a day, 7 days a week



Price £15.50

3-NOTE DOOR CHIME

Based on the SAB0600 IC the kit is supplied with all components, including loudspeaker, printed circuit board, a pre-drilled box (95 x 71 x 35mm) and full instructions. Requires only a PP3 9V battery and push-switch to complete. AN IDEAL PROJECT FOR BEGINNERS. Order as XK102 £5.00

XK113 MW RADIO KIT

Based on ZN414 IC, kit includes PCB, wound aerial and crystal earpiece and all components to make a sensitive miniature radio. Size: 5.5 x 2.7 x 2cms. Requires PP3 9V battery. IDEAL FOR BEGINNERS. £5.00

COMPONENT PACKS

- PACK 1 650 Resistors 47 ohm to 10 Mohm — 10 per value £4.00
- PACK 2 40 x 16V Electrolytic Capacitors 10µF to 1000µF — 5 per value £3.25
- PACK 3 60 Polyester Capacitors 0.01 to 1µF/250V — 5 per value £5.55
- PACK 4 45 Sub-miniature Presets 100 ohm to 1 Mohm — 5 per value £2.90
- PACK 5 30 Low Profile IC Sockets 8, 14 and 16 — pin — 10 of each £2.40
- PACK 6 25 Red LEDs (5mm dia.) £1.25

MINI KITS

MK1 TEMPERATURE CONTROLLER/THERMOSTAT

Uses LM3911 IC to sense temperature (80°C max.) and triac to switch heater. 1KW £4.00

MK2 Solid State Relay

Ideal for switching motors, lights, heaters, etc. from logic. Opto-isolated with zero voltage switching. Switches without triac £2.60

MK3 BAR/DOT DISPLAY

Displays an analogue voltage on a linear 10 element LED display as a bar or single dot. Ideal for thermometers, level indicators, etc. May be stacked to obtain 20 to 100 element displays. Requires 5-20V supply. £4.50

MK4 PROPORTIONAL TEMPERATURE CONTROLLER

Based on the SL441 zero voltage switch, this kit may be wired to form a "burst fire" power controller, enabling the temperature of an enclosure to be maintained to within 0.5°C. Max. load 3KW £5.55

MK5 MAINS TIMER

Based on the ZN1034E Timer IC this kit will switch a mains load on (or off) for a preset time from 20 mins. to 35 hrs. Longer or shorter periods may be realised by minor component changes. Max. load 1KW. £4.50

LCD 3 1/2 DIGIT MULTIMETER

16 ranges including DC voltage (200 mv-1000 v) and AC voltage, DC current (200 mA-10 A) and resistance (0-2M) + NPN & PNP transistor gain and diode check. Input impedance 10M. Size 155x88x31 mm. Requires PP3 9v battery. Test leads included ONLY £29.00

ELECTRONIC LOCK KIT XK101

This KIT contains a purpose designed lock IC, 10-way keyboard, PCBs and all components to construct a Digital Lock, requiring a 4-key sequence to open and providing over 5000 different combinations. The open sequence may be easily changed by means of a pre-wired plug. Size: 7 x 6 x 3 cms. Supply: 5V to 15V d.c. at 40uA. Output: 750mA max. Hundreds of uses for doors and garages, car anti-theft device, electronic equipment, etc. Will drive most relays direct. Full instructions supplied. ONLY £10.50

Electric lock mechanisms for use with latch locks and above kit £13.50

DISCO LIGHTING KITS

DL 1000K This value-for-money kit features a bi-directional sequence, speed of sequence and frequency of direction change, being variable by means of potentiometers and incorporates a master dimming control. £14.60

DLZ100K A lower cost version of the above, featuring unidirectional channel sequence with speed variable by means of a pre-set pot. Outputs switched only at mains zero crossing points to reduce radio interference to a minimum. Only £8.00

Optional opto input DLA1 Allowing audio ("beat") —light response. 60p

DL3000K This 3 channel sound to light kit features zero voltage switching, automatic level control & built in mic. No connections to speaker or amp required. No knobs to adjust — simply connect to mains supply & lamps. (1Kw/Channel) Only £11.95

Have you got our FREE ORANGE CATALOGUE yet? NO?! Send S.A.E. 6" x 9" TODAY!!

It's packed with details of all our KITS plus large range of SEMICONDUCTORS, including CMOS, LS TTL, linear, microprocessors and memories, full range of LEDs, capacitors, resistors, hardware, relays, switches etc.

We also stock VERO and Antex products as well as books from Texas Instruments, Babani and Elektor.

ALL AT VERY COMPETITIVE PRICES.

ORDERING IS EVEN EASIER — JUST RING THE NUMBER YOU CAN'T FORGET FOR PRICES YOU CAN'T RESIST.

5-6-7 8-9-10

and give us your Access or Barclaycard No. or write enclosing cheque or postal order. Official orders accepted from schools, etc.

Answering service evngs & weekends

ALL PRICES EXCLUDE VAT

Open 9am to 5pm (Mon to Fri) 10am to 4pm (Sat)

FAST SERVICE · TOP QUALITY · LOW LOW PRICES

No circuit is complete without a call to —



TK ELECTRONICS
11 Boston Road
London W7 3SJ



TEL: 01-567 8910 ORDERS
01-579 9794 ENQUIRIES
01-579 2842 TECHNICAL AFTER 3PM

THERE IS NOT much doubt that English-made loudspeakers are the finest in the world — without any disrespect to our American cousins or the latter-day Samurai. When it comes to "Zen and the Art of Loudspeaker Construction", the British speak little but work marvels. But not on the cheap. A really first class pair of 'speakers almost requires a mortgage, and even a decent pair won't leave much change from a month's pay. You will therefore understand my interest when I was offered the chance to review a pair of self-assembly 'speakers from Wilmslow Audio!

The range offered by Wilmslow is very large. Almost every major British manufacturer is represented, including top names such as Kef, Celestion, Chartwell, and Jordan Watts. In the High Street, prices for such 'speakers range from the barely affordable to "Oh my god", so the great attraction of self-assembly 'speakers has to be the opportunity to acquire a good set at an equally good price.

Hifi Hype

It's always easy to buy an argument, amongst hifi buffs, as to which components of a hifi system are the most critical; it depends really on who you talk to and on the degree of difficulty involved in engineering particular elements.

Amplifiers, for example, are no longer much of a challenge in the normal line of hifi equipment, so that any manufacturer worthy of the name ought to be able to produce an amp that is capable of around 50 watts per channel with 0.1% distortion and a frequency

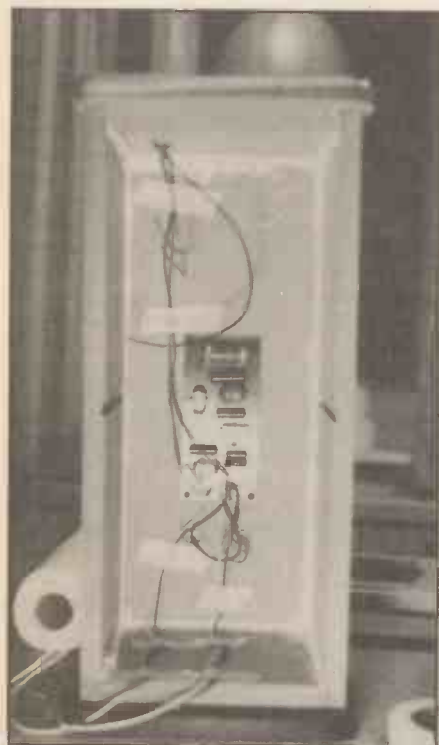

At this stage the cabinet has been assembled (note the lines of bathroom sealant around the inside of the joints). The crossover board has been screwed to the rear panel and the leads taped out of the way.

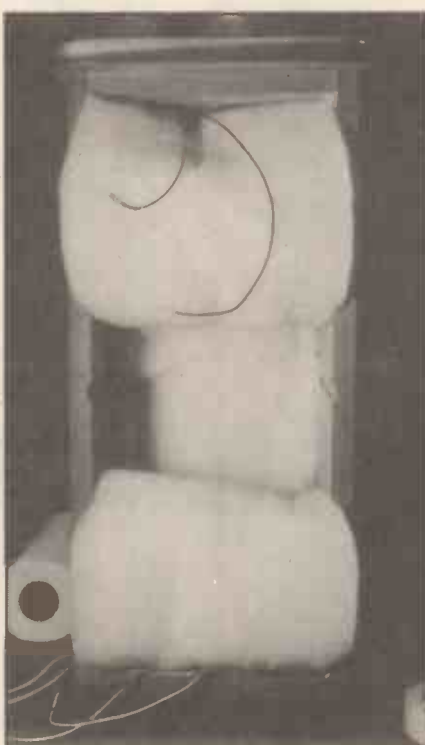

The two sections of acoustic wadding are rolled up and placed inside the cabinet, then teased out to fill the entire space.

D.I.Y.

Barry Foster

With self-assembly loudspeakers for your money with



what you like depends on what you hear. On the other hand, what you like to hear will decide where you will spend most of your hifi budget.

Briefly, the quality of the turntable, arm etc. will determine the bottom limit of distortion and the upper limit of frequency response (assuming that the amplifier is up to the mark). The 'speakers may also contribute to distortion but, more importantly, set the bottom limit of the frequency response.

So if, like me, you are a person who puts more store by meaty, beefy bass than in crisp clean highs at the upper limit of hearing, the loudspeaker becomes the most important element in the hifi system. Thus a self-assembly kit provides the means to spread your budget to the best advantage, while at the same time allowing you to acquire a first class set of 'speakers at a moderate

HIFI

speakers you get more
without sacrificing quality.



price and leaving cash in hand to outlay on other items.

Questions and Answers

Price is not all, however, if performance does not follow, so the question must be asked: how good are self assembly 'speakers'?

The answer, reassuringly, is — very good indeed! The kit chosen for review was the modestly priced dB12W kit, designed for amplifiers between 15 and 75 watts, and provided the assembly instructions are followed with reasonable care, they will produce results as good as any store-bought items of comparable size and design.

In a Nutshell

The dB12W kit is second from the top in Wilmslow's dB kit range. It is designed

for amplifiers in the range 15-75 watts and is given a five star assembly rating, meaning that no woodworking or electronic skills are required. The dimensions of each cabinet are 540 x 255 x 230mm, and they are designed for stand mounting some 300mm off the floor and, ideally, at least two feet away from walls. The units are described as medium sensitivity infinite baffle 'speakers, and contain three drivers and a pre-assembled three-way crossover board (which is the only component not manufactured in the UK).

The lower driver is a specially designed 6½in 'lower bass' unit, which, together with the 6½in mid/upper-bass driver, gives a surprisingly good response for a unit of its size; the transient response is sharp, without any trace of soggy. The treble driver is a 1in soft-domed tweeter, dilled with ferrofluid, which produces accurate highs all the way to the top.

They are perhaps a little too strong on mid-range 'presence' for my taste, but a little bass and treble equalisation easily compensates. When boosted slightly, the bass is always clear and distinct, even though the speakers are floor-mounted rather than set up on stands as

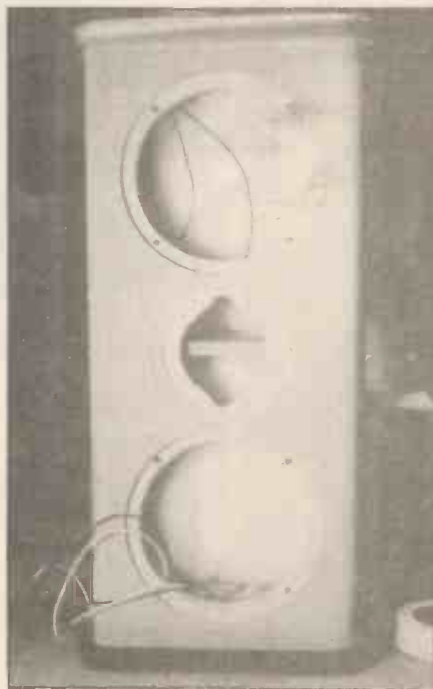

The central 'shelf' (visible through the tweeter opening) is installed next, then the front baffle-board is glued into place. The wires are led out through the openings, ready to connect up to the driver units.

recommended. Likewise, the highs are crisp and clean and the stereo image, though the room does not permit ideal placement, is well separated.

The next question, of particular interest to hifi nuts who may not also be DIY buffs is: how easy are they to assemble? The answer is once more agreeable; putting together the dB12W 'speakers occupied a leisurely Saturday afternoon, with plenty of time to watch "World of Sport" while the glue dried!

The cabinets are constructed from a material described as 'MDF', which looks like very high density chipboard to me; in any event, it certainly lives up to the makers claim that "It machines cleanly and accurately without the ragged edges associated with chipboard components". The side and top panels are prefinished solid African Walnut which, together with the simple but reliable construction method described later, give the finished units a solid appearance, not at all like a 'homemade' unit.

Doing It Yourself

The speakers arrived, in bits, in two weighty cardboard boxes, and when unpacked formed an impressive if confusing array of high-density chipboard panels, foam-shrouded driver units, printed circuit boards, black acoustic foam, white wadding, and glossy brown African walnut panels. The instructions were roughly copied and seemed not altogether comprehensive, though in the end they proved adequate (remember the Golden Rule — when in doubt read the instructions!).

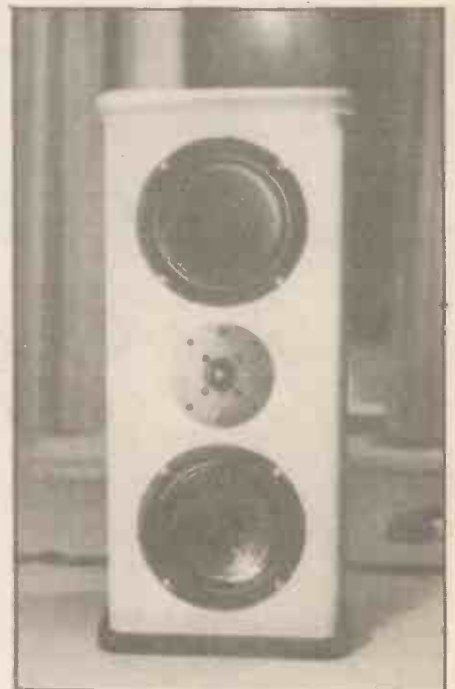

Nearly complete, the driver units have been screwed into place. The bass and mid-upper units are physically very similar, and must be checked carefully to make sure they go in the right openings (bass at the bottom).

Tools required to assemble the kit are minimal: a pair of cross-head screwdrivers, a tube of woodworking glue, a roll of masking tape, a damp cloth to remove excess glue, a small power or hand drill with a 1/8in bit and a small hammer.

My initial doubts about the instructions were soon resolved. These said, in effect, "apply glue to the relevant surfaces, slap the panels together and hold them in place with masking tape while they dry". What? No screws, clamps or wood presses? No, not one; the panels are so finely and accurately machined that the box can be assembled virtually free-standing, the precision joints providing sufficient rigidity to hold the whole thing in place. The masking tape gives a slightly tighter and more securely sealed joint, but mostly seems to be for insurance (and assurance for the doubting constructor).

The remainder of the construction is equally simple, as illustrated by the accompanying photographs; there are one or two points worth noting, though.

One of the secrets of obtaining good clean bass response is to ensure that the cabinets are completely airtight; the slightest leak and your prized 'speakers will wheeze like a bagpipe with a hole in it — and sound almost as appealing! The trick I used was to seal the inside of each joint with a liberal bead of ordinary bathroom waterproof sealant, of the type sold in most DIY shops. This ensures that the panels are completely airtight (watertight, too). The front

baffle-board cannot be sealed this way, however, so I applied a thin line of glue to the outside of the joint, carefully wiping off the excess with the damp cloth. These steps are perhaps not necessary if you take due care to secure the joints, but the cost and effort is minimal for a guaranteed result!

The pre-assembled crossover board can be mounted anywhere within the cabinet, as long as the leads will reach from the PCB to the drivers. I found it odd that these mounting holes were not pre-drilled, as this would have simplified the construction considerably, but apparently Wilmslow have found that people have different ideas about locating the crossover board within the cabinet. Personally, I don't see that it matters.

I had some slight difficulty with the construction at two stages only: the foam gasket in which the mid-range and bass drivers sit has to be cut up and rearranged around the flange to clear the bolt holes; then I found that the tweeter did not want to sit firmly in its milled rebate, apparently because the centrally mounted shelf was blocking it. Fortunately, the glue had not yet dried so I was able to move the shelf backwards, secure the tweeter, then gently knock the shelf forward into position.

The only items with which I was just slightly unhappy were the banana sockets supplied for connecting up the 'speakers to the amplifier. While they have proved adequate, so far, I would

have preferred solid spring-clip connectors for that extra measure of security.

Finally, though, when the dB12W kit was completed and booming out "The Wall" at top volume (the neighbours had been warned!), minor problems and quibbles were blasted into insignificance.

There is one other cautionary note which, however, applies to most makes of 'speakers, rather than the dB12W kit in particular. Like most modern loudspeakers, the dB12Ws are fronted by an acoustically transparent foam grille, which nicely complements the polished woodwork and looks at home in most decorative schemes. But the family cat seems to find the foam totally irresistible, preferring it to all other scratching posts!

The dB12W kit is priced at £108 including VAT, with postage and insurance £4.50 extra. Other self-assembly kits in the range go from the dB4C, at £35.95, up to the Jordan System 4, which is priced at £330 and requires considerable woodworking skills (or, as Wilmslow put it, "Built any good sideboards lately?"). There are many types in between and it is worth checking the Wilmslow catalogue before coming to a decision.

Write to Wilmslow Audio Ltd, 35/39 Church Street, Wilmslow, Cheshire SK9 1AS, or telephone Wilmslow (0625) 529599.

HE

HEMMINGS ELECTRONICS LTD

Electronic Components & Microcomputers

16 BRAND STREET, HITCHIN, HERTS, SG5 1JE

Telephone: (0462) 33031

Shop opening hours
Mon to Fri 9am to 5.30pm
Sat 9am to 5.00pm
Wed Closed

TERMS OF BUSINESS — Professional quality electronic components brand new and fully guaranteed. Mail order by return of post. Cash, Cheque, Postal Order or Bankers Draft with order payable to HEMMINGS ELECTRONICS LTD. Access or Barclaycard available using our 24 hour answerphone service. Monthly Credit Accounts available on request to government and educational authorities. Industrial customers wishing to open a credit account are required to furnish a bank reference and two trade references. Postage and packing add 45p to all orders under £10. All prices are exclusive of VAT. Please add 15% to total including p&p. No VAT on export orders or books.

COMPUTER ICs 6502 350p 6522 340p 6800 290p 6802 345p 6809 845p 6809E 1350p 6809E 1295p 6810 120p 6821 160p 6821E 215p 6840 390p 68540 580p 684 1295p 6845 795p 6850 140p 6852 250p 6854 680p 6875 490p 8127A 120p 8128 740p 8195 90p 8197 90p 8198 90p 8035L 340p 8039L 290p 8060A 360p 8085A 450p 815 450p 8212 155p 8216 100p 8224 160p 8228 195p 8238 250p 8243 210p 8251 300p 8253 450p 8255 280p 8259 450p 8275 450p 8279 450p 75451 65p 75452 65p 75491 70p 75492 70p AY-3-1015D 300p AY-5-1013A 300p MC1408 290p MC1488 55p MC1489 55p MC3459 265p Z80ACPU 350p Z80APD 300p Z80ACT 300p Z80DART 750p	MEMORIES 2708 220p 2114L 90p 2906 210p 2532 380p 4116 75p 4164 500p 6116P3 390p 6116L P3 450p LINEAR ICs AY-3-1270 725p AY-3-1350 350p AY-3-8910 435p AY-3-8912 620p AY-5-1230 450p 740 70p 741 8 pin 25p 741 14 pin 25p 7415 55p 747 65p 748 35p CA3080E 70p CA3130E 75p LA4422 295p LF355 80p LF356 90p LF357 100p LM309A 280p LM307 50p LM308A 95p LM311N 66p LM324 35p LM339 50p LM345 75p LM358 60p LM380 95p LM381 150p LM393 90p LM399 95p MC1310P 210p MC1455 66p MC1456 135p MC1458 35p MC3242A 630p MC3302 95p MC3340 120p MC3401 65p MC3403 70p MC3456 107p MC3480 580p MC3901 280p NE555 55p 555 CMOS 95p NE556 55p NE555 155p NE567 140p SN76023 180p TA7205A 125p TA7205A 125p TBA560Q 160p TBA750 280p TBA820 95p	TRANSISTORS BC107 120p BC107B 150p BC108 120p BC108B 120p BC109 120p BC109B 150p BC109C 150p BC147 90p BC157 90p BC158 90p BC177 25p BC178 25p BC179 25p BC182 100p BC182A 100p BC182B 100p BC183A 100p BC183C 100p BC184 100p BC184C 100p BC212 100p BC212A 100p BC212B 100p BC213A 100p BC213C 100p BC214 100p BC237A 120p BC237C 120p BC238 120p BC238A 120p BC238B 120p BC238C 120p BC239 120p BC250A 150p BC250B 150p BC250C 150p BC250D 150p BC250E 150p BC250F 150p BC250G 150p BC250H 150p BC250I 150p BC250J 150p BC250K 150p BC250L 150p BC250M 150p BC250N 150p BC250O 150p BC250P 150p BC250Q 150p BC250R 150p BC250S 150p BC250T 150p BC250U 150p BC250V 150p BC250W 150p BC250X 150p BC250Y 150p BC250Z 150p BC250AA 150p BC250AB 150p BC250AC 150p BC250AD 150p BC250AE 150p BC250AF 150p BC250AG 150p BC250AH 150p BC250AI 150p BC250AJ 150p BC250AK 150p BC250AL 150p BC250AM 150p BC250AN 150p BC250AO 150p BC250AP 150p BC250AQ 150p BC250AR 150p BC250AS 150p BC250AT 150p BC250AU 150p BC250AV 150p BC250AW 150p BC250AX 150p BC250AY 150p BC250AZ 150p BC250BA 150p BC250BB 150p BC250BC 150p BC250BD 150p BC250BE 150p BC250BF 150p BC250BG 150p BC250BH 150p BC250BI 150p BC250BJ 150p BC250BK 150p BC250BL 150p BC250BM 150p BC250BN 150p BC250BO 150p BC250BP 150p BC250BQ 150p BC250BR 150p BC250BS 150p BC250BT 150p BC250BU 150p BC250BV 150p BC250BW 150p BC250BX 150p BC250BY 150p BC250BZ 150p BC250CA 150p BC250CB 150p BC250CC 150p BC250CD 150p BC250CE 150p BC250CF 150p BC250CG 150p BC250CH 150p BC250CI 150p BC250CJ 150p BC250CK 150p BC250CL 150p BC250CM 150p BC250CN 150p BC250CO 150p BC250CP 150p BC250CQ 150p BC250CR 150p BC250CS 150p BC250CT 150p BC250CU 150p BC250CV 150p BC250CW 150p BC250CX 150p BC250CY 150p BC250CZ 150p BC250DA 150p BC250DB 150p BC250DC 150p BC250DD 150p BC250DE 150p BC250DF 150p BC250DG 150p BC250DH 150p BC250DI 150p BC250DJ 150p BC250DK 150p BC250DL 150p BC250DM 150p BC250DN 150p BC250DO 150p BC250DP 150p BC250DQ 150p BC250DR 150p BC250DS 150p BC250DT 150p BC250DU 150p BC250DV 150p BC250DW 150p BC250DX 150p BC250DY 150p BC250DZ 150p BC250EA 150p BC250EB 150p BC250EC 150p BC250ED 150p BC250EE 150p BC250EF 150p BC250EG 150p BC250EH 150p BC250EI 150p BC250EJ 150p BC250EK 150p BC250EL 150p BC250EM 150p BC250EN 150p BC250EO 150p BC250EP 150p BC250EQ 150p BC250ER 150p BC250ES 150p BC250ET 150p BC250EU 150p BC250EV 150p BC250EW 150p BC250EX 150p BC250EY 150p BC250EZ 150p BC250FA 150p BC250FB 150p BC250FC 150p BC250FD 150p BC250FE 150p BC250FF 150p BC250FG 150p BC250FH 150p BC250FI 150p BC250FJ 150p BC250FK 150p BC250FL 150p BC250FM 150p BC250FN 150p BC250FO 150p BC250FP 150p BC250FQ 150p BC250FR 150p BC250FS 150p BC250FT 150p BC250FU 150p BC250FV 150p BC250FW 150p BC250FX 150p BC250FY 150p BC250FZ 150p BC250GA 150p BC250GB 150p BC250GC 150p BC250GD 150p BC250GE 150p BC250GF 150p BC250GG 150p BC250GH 150p BC250GI 150p BC250GJ 150p BC250GK 150p BC250GL 150p BC250GM 150p BC250GN 150p BC250GO 150p BC250GP 150p BC250GQ 150p BC250GR 150p BC250GS 150p BC250GT 150p BC250GU 150p BC250GV 150p BC250GW 150p BC250GX 150p BC250GY 150p BC250GZ 150p BC250HA 150p BC250HB 150p BC250HC 150p BC250HD 150p BC250HE 150p BC250HF 150p BC250HG 150p BC250HH 150p BC250HI 150p BC250HJ 150p BC250HK 150p BC250HL 150p BC250HM 150p BC250HN 150p BC250HO 150p BC250HP 150p BC250HQ 150p BC250HR 150p BC250HS 150p BC250HT 150p BC250HU 150p BC250HV 150p BC250HW 150p BC250HX 150p BC250HY 150p BC250HZ 150p BC250IA 150p BC250IB 150p BC250IC 150p BC250ID 150p BC250IE 150p BC250IF 150p BC250IG 150p BC250IH 150p BC250II 150p BC250IJ 150p BC250IK 150p BC250IL 150p BC250IM 150p BC250IN 150p BC250IO 150p BC250IP 150p BC250IQ 150p BC250IR 150p BC250IS 150p BC250IT 150p BC250IU 150p BC250IV 150p BC250IW 150p BC250IX 150p BC250IY 150p BC250IZ 150p BC250JA 150p BC250JB 150p BC250JC 150p BC250JD 150p BC250JE 150p BC250JF 150p BC250JG 150p BC250JH 150p BC250JI 150p BC250JJ 150p BC250JK 150p BC250JL 150p BC250JM 150p BC250JN 150p BC250JO 150p BC250JP 150p BC250JQ 150p BC250JR 150p BC250JS 150p BC250JT 150p BC250JU 150p BC250JV 150p BC250JW 150p BC250JX 150p BC250JY 150p BC250JZ 150p BC250KA 150p BC250KB 150p BC250KC 150p BC250KD 150p BC250KE 150p BC250KF 150p BC250KG 150p BC250KH 150p BC250KI 150p BC250KJ 150p BC250KL 150p BC250KM 150p BC250KN 150p BC250KO 150p BC250KP 150p BC250KQ 150p BC250KR 150p BC250KS 150p BC250KT 150p BC250KU 150p BC250KV 150p BC250KW 150p BC250KX 150p BC250KY 150p BC250KZ 150p BC250LA 150p BC250LB 150p BC250LC 150p BC250LD 150p BC250LE 150p BC250LF 150p BC250LG 150p BC250LH 150p BC250LI 150p BC250LJ 150p BC250LK 150p BC250LL 150p BC250LM 150p BC250LN 150p BC250LO 150p BC250LP 150p BC250LQ 150p BC250LR 150p BC250LS 150p BC250LT 150p BC250LU 150p BC250LV 150p BC250LW 150p BC250LX 150p BC250LY 150p BC250LZ 150p BC250MA 150p BC250MB 150p BC250MC 150p BC250MD 150p BC250ME 150p BC250MF 150p BC250MG 150p BC250MH 150p BC250MI 150p BC250MJ 150p BC250MK 150p BC250ML 150p BC250MM 150p BC250MN 150p BC250MO 150p BC250MP 150p BC250MQ 150p BC250MR 150p BC250MS 150p BC250MT 150p BC250MU 150p BC250MV 150p BC250MW 150p BC250MX 150p BC250MY 150p BC250MZ 150p BC250NA 150p BC250NB 150p BC250NC 150p BC250ND 150p BC250NE 150p BC250NF 150p BC250NG 150p BC250NH 150p BC250NI 150p BC250NJ 150p BC250NK 150p BC250NL 150p BC250NM 150p BC250NN 150p BC250NO 150p BC250NP 150p BC250NQ 150p BC250NR 150p BC250NS 150p BC250NT 150p BC250NU 150p BC250NV 150p BC250NW 150p BC250NX 150p BC250NY 150p BC250NZ 150p BC250OA 150p BC250OB 150p BC250OC 150p BC250OD 150p BC250OE 150p BC250OF 150p BC250OG 150p BC250OH 150p BC250OI 150p BC250OJ 150p BC250OK 150p BC250OL 150p BC250OM 150p BC250ON 150p BC250OO 150p BC250OP 150p BC250OQ 150p BC250OR 150p BC250OS 150p BC250OT 150p BC250OU 150p BC250OV 150p BC250OW 150p BC250OX 150p BC250OY 150p BC250OZ 150p BC250PA 150p BC250PB 150p BC250PC 150p BC250PD 150p BC250PE 150p BC250PF 150p BC250PG 150p BC250PH 150p BC250PI 150p BC250PJ 150p BC250PK 150p BC250PL 150p BC250PM 150p BC250PN 150p BC250PO 150p BC250PP 150p BC250PQ 150p BC250PR 150p BC250PS 150p BC250PT 150p BC250PU 150p BC250PV 150p BC250PW 150p BC250PX 150p BC250PY 150p BC250PZ 150p BC250QA 150p BC250QB 150p BC250QC 150p BC250QD 150p BC250QE 150p BC250QF 150p BC250QG 150p BC250QH 150p BC250QI 150p BC250QJ 150p BC250QK 150p BC250QL 150p BC250QM 150p BC250QN 150p BC250QO 150p BC250QP 150p BC250QQ 150p BC250QR 150p BC250QS 150p BC250QT 150p BC250QU 150p BC250QV 150p BC250QW 150p BC250QX 150p BC250QY 150p BC250QZ 150p BC250RA 150p BC250RB 150p BC250RC 150p BC250RD 150p BC250RE 150p BC250RF 150p BC250RG 150p BC250RH 150p BC250RI 150p BC250RJ 150p BC250RK 150p BC250RL 150p BC250RM 150p BC250RN 150p BC250RO 150p BC250RP 150p BC250RQ 150p BC250RR 150p BC250RS 150p BC250RT 150p BC250RU 150p BC250RV 150p BC250RW 150p BC250RX 150p BC250RY 150p BC250RZ 150p BC250SA 150p BC250SB 150p BC250SC 150p BC250SD 150p BC250SE 150p BC250SF 150p BC250SG 150p BC250SH 150p BC250SI 150p BC250SJ 150p BC250SK 150p BC250SL 150p BC250SM 150p BC250SN 150p BC250SO 150p BC250SP 150p BC250SQ 150p BC250SR 150p BC250SS 150p BC250ST 150p BC250SU 150p BC250SV 150p BC250SW 150p BC250SX 150p BC250SY 150p BC250SZ 150p BC250TA 150p BC250TB 150p BC250TC 150p BC250TD 150p BC250TE 150p BC250TF 150p BC250TG 150p BC250TH 150p BC250TI 150p BC250TJ 150p BC250TK 150p BC250TL 150p BC250TM 150p BC250TN 150p BC250TO 150p BC250TP 150p BC250TQ 150p BC250TR 150p BC250TS 150p BC250TT 150p BC250TU 150p BC250TV 150p BC250TW 150p BC250TX 150p BC250TY 150p BC250TZ 150p BC250UA 150p BC250UB 150p BC250UC 150p BC250UD 150p BC250UE 150p BC250UF 150p BC250UG 150p BC250UH 150p BC250UI 150p BC250UJ 150p BC250UK 150p BC250UL 150p BC250UM 150p BC250UN 150p BC250UO 150p BC250UP 150p BC250UQ 150p BC250UR 150p BC250US 150p BC250UT 150p BC250UU 150p BC250UV 150p BC250UW 150p BC250UX 150p BC250UY 150p BC250UZ 150p BC250VA 150p BC250VB 150p BC250VC 150p BC250VD 150p BC250VE 150p BC250VF 150p BC250VG 150p BC250VH 150p BC250VI 150p BC250VJ 150p BC250VK 150p BC250VL 150p BC250VM 150p BC250VN 150p BC250VO 150p BC250VP 150p BC250VQ 150p BC250VR 150p BC250VS 150p BC250VT 150p BC250VU 150p BC250VV 150p BC2
--------------------------------------------------------------------------------------------------------------------------------------------------------------------------------------------------------------------------------------------------------------------------------------------------------------------------------------------------------------------------------------------------------------------------------------------------------------------------------------------------------------------------------------------------------------------------------------------------------------------------------------------------------------------------------------------------------------------------------------------------------------------------------------	---------------------------------------------------------------------------------------------------------------------------------------------------------------------------------------------------------------------------------------------------------------------------------------------------------------------------------------------------------------------------------------------------------------------------------------------------------------------------------------------------------------------------------------------------------------------------------------------------------------------------------------------------------------------------------------------------------------------------------------------------------------------------------------------------------------------------------------------------------------------------------------------------------------------------------------	---------------------------------------------------------------------------------------------------------------------------------------------------------------------------------------------------------------------------------------------------------------------------------------------------------------------------------------------------------------------------------------------------------------------------------------------------------------------------------------------------------------------------------------------------------------------------------------------------------------------------------------------------------------------------------------------------------------------------------------------------------------------------------------------------------------------------------------------------------------------------------------------------------------------------------------------------------------------------------------------------------------------------------------------------------------------------------------------------------------------------------------------------------------------------------------------------------------------------------------------------------------------------------------------------------------------------------------------------------------------------------------------------------------------------------------------------------------------------------------------------------------------------------------------------------------------------------------------------------------------------------------------------------------------------------------------------------------------------------------------------------------------------------------------------------------------------------------------------------------------------------------------------------------------------------------------------------------------------------------------------------------------------------------------------------------------------------------------------------------------------------------------------------------------------------------------------------------------------------------------------------------------------------------------------------------------------------------------------------------------------------------------------------------------------------------------------------------------------------------------------------------------------------------------------------------------------------------------------------------------------------------------------------------------------------------------------------------------------------------------------------------------------------------------------------------------------------------------------------------------------------------------------------------------------------------------------------------------------------------------------------------------------------------------------------------------------------------------------------------------------------------------------------------------------------------------------------------------------------------------------------------------------------------------------------------------------------------------------------------------------------------------------------------------------------------------------------------------------------------------------------------------------------------------------------------------------------------------------------------------------------------------------------------------------------------------------------------------------------------------------------------------------------------------------------------------------------------------------------------------------------------------------------------------------------------------------------------------------------------------------------------------------------------------------------------------------------------------------------------------------------------------------------------------------------------------------------------------------------------------------------------------------------------------------------------------------------------------------------------------------------------------------------------------------------------------------------------------------------------------------------------------------------------------------------------------------------------------------------------------------------------------------------------------------------------------------------------------------------------------------------------------------------------------------------------------------------------------------------------------------------------------------------------------------------------------------------------------------------------------------------------------------------------------------------------------------------------------------------------------------------------------------------------------------------------------------------------------------------------------------------------------------------------------------------------------------------------------------------------------------------------------------------------------------------------------------------------------------------------------------------------------------------------------------------------------------------------------------------------------------------------------------------------------------------------------------------------------------------------------------------------------------------------------------------------------------------------------------------------------------------------------------------------------------------------------------------------------------------------------------------------------------------------------------------------------------------------------------------------------------------------------------------------------------------------------------------------------------------------------------------------------------------------------------------------------------------------------------------------------------------------------------------------------------------------------------------------------------------------------------------------------------------------------------------------------------------------------------------------------------------------------------------------------------------------------------------------------------------------------------------------------------------------------------------------------------------------------------------------------------------------------------------------------------------------------------------------------------------------------------------------------------------------------------------------------------------------------------------------------------------------------------------------------------------------------------------------------------------------------------------------------------------------------------------------------------------------------------------------------------------------------------------------------------------------------------------------------------------------------------------------------------------------------------------------------------------------------------------------------------------------------------------------------------------------------------------------------------------------------------------------------------------------------------------------------------------------------------------------------------------------------------------------------------------------------------------------------------------------------------------------------------------------------------------------------------------------------------------------------------------------------------------------------------------------------------------------------------------------------------------------------------------------------------------------------------------------------------------------------------------------------------------------------------------------------------------------------------------------------------------------------------------------------------------------------------------------------------------------------------------------------------------------------------------------------------------------------------------------------------------------------------------------------------------------------------------------------------------------------------------------------------------------------------------------------------------------------------------------------------------------------------------------------------------------------------------------------------------------------------------------------------------------------------------------------------------------------------------------------------------------------------------------------------------------------------------------------------------------------------------------------------------------------------------------------------------------------------------------------------------------------------------------------------------------------------------------------------------------------------------------------------------------------------------------------------------------------------------------------------------------------------------------------------------------------------------------------------------------------------------------------------------------------------------------------------------------------------------------------------------------------------------------------------------------------------------------------------------------------------------------------------------------------------------------------------------------------------------------------------------------------------------------------------------------------------------------------------------------------------

SAVE £4.25 by receiving a FREE magazine binder when you subscribe to

Hobby Electronics

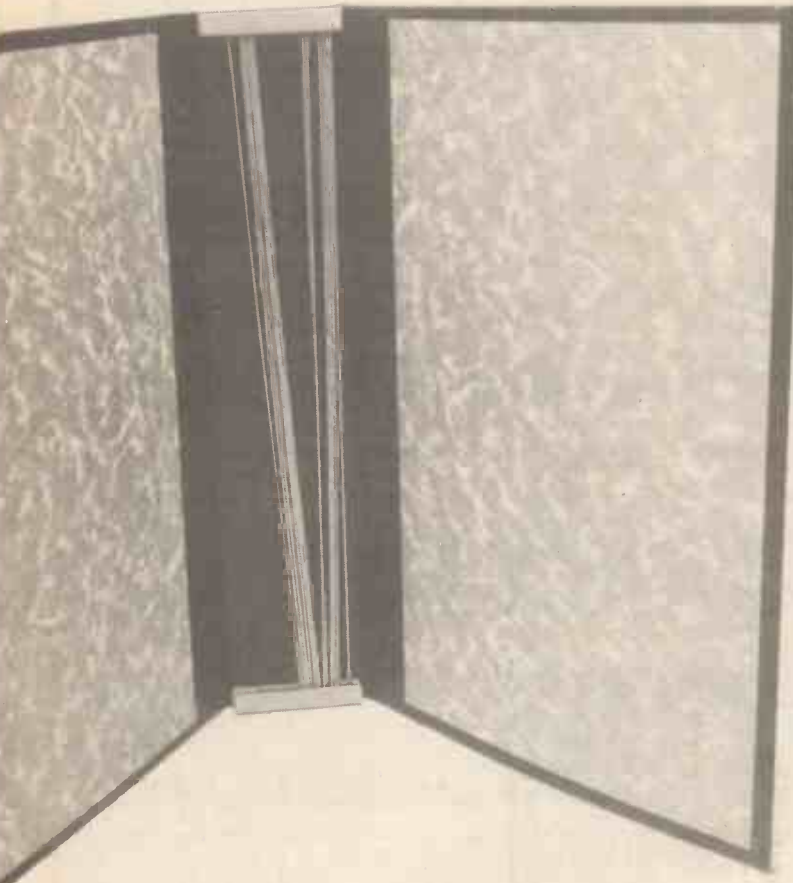

It's true, by subscribing to Hobby Electronics you will not only receive your personal copy direct to your door for a whole year but also have a superb A S P magazine binder in which to keep your copies AND IT'S FREE!

All you have to do to receive your FREE binder is book a new subscription or renew an existing subscription to Hobby Electronics before 30th April 1983. What could be simpler? Normally priced at £4.25, these attractive binders will hold approximately 12 issues of Hobby Electronics.

Not for you any longer the chore of having to track down dogeared copies of your favourite magazine, instead you will merely go to your bookshelf and they will be waiting for you in pristine condition.

Don't miss out on this outstanding offer — subscribe today and receive your FREE binder within 14 days of your order being received.

SPECIAL OFFER

Cut out and SEND TO :

**Hobby
Electronics**
513, LONDON ROAD,
THORNTON HEATH,
SURREY, CR4 6AR
ENGLAND.

Please send my free binder and
commence my personal subscription to
with the issue

**SUBSCRIPTION
RATES**
(tick as
appropriate)

£11.95 for 12 Issues
UK
£13.95 for 12 Issues
overseas surface
£26.90 for 12 Issues
Air Mail

I am enclosing my (delete as necessary)
Cheque/Postal Order/International Money

Order for £.....
(made payable to ASP Ltd)

OR

Debit my Access/Barclaycard*
(*delete as necessary)

Insert card no.

Please use **BLOCK CAPITALS** and include post codes.

Name (Mr/ Mrs/ Miss)
delete accordingly

Address

.....

.....

.....

Signature

Date

THE ELECTRONIC REVOLUTION: THE ELECTRONIC AGE

For better or for worse, the Atomic Age began on 16th July, 1945. The Electronic Age dawned just two years later with less of a bang, though with equally significant after-effects.

John Biggins



IT IS VERY RARELY indeed that the birth of a new era can be located exactly on a particular day. The explosion of the first atomic bomb on 16th July 1945 at Almagordo, New Mexico is the twentieth century's most obvious candidate for the title of a day which changed the world for ever. But there have been a few others, and the events of 23rd December 1947 at the Bell Laboratories certainly give that date a strong claim to be one of history's great turning points. On that day the world's first transistor was made to work.

Some inventions creep up upon the world rather than burst upon it. Faraday's magnetic induction demonstration in August 1831 took a good half-century to turn into even the beginnings of an electric power industry while wireless dawned so gradually that we cannot even say with any certainty who transmitted the first signal. Some inventions like television were eagerly awaited for decades before anyone could produce a workable system, while other like radio-telephony lay around for years before anybody realised what could be done with them.

But the transistor fell into none of these categories. Its birth that day represented the pinnacle of nearly thirty years' concentrated research by some of the most talented physicists in the world, all labouring with the conscious aim of constructing a solid-state analogue of the

wireless valve. And over the previous three years, Bell Labs alone had invested several million dollars and some of its best researchers in the project. Nor were the implications of the event lost on those present. No one had much idea of the sort of world that the transistor would have produced thirty-five years later but all those who were there seem to have been conscious that something out of the ordinary had happened and that things would never be the same again. In the event it took a decade for the transistor to be perfected and built into electronic technology, but when this happened it pushed the science of electronics into an age of exponential growth which has done more to change the world in the last generation than steam did in the two centuries before that.

Like its near-contemporary the atom bomb, the transistor is a classic case of development not by technological push, but by demand-pull. The state wanted the bomb and the corporations wanted the transistor for their own purposes, and both were prepared, whether the project turned out to be feasible or not, to invest any amount of money and time and research talent towards achieving it.

The idea of a solid-state transducer was almost as old as wireless itself. In fact, wireless wave detection began with a primitive semi-conductor, the coherer,

and continued for many years afterwards with another form of the semi-conductor in the shape of the crystal detector. Looking back, you might almost see the half-century of thermionic valve development following Fleming's diode of 1904 as a blind alley in electronics history. Valves came in largely to make up for the deficiencies of the crystal detector: its fragility, its need for constant delicate adjustment and above all its puny current output. Valve manufacture began by having access to all the resources and experience of the light-bulb industry out of which it had accidentally sprung, and the valve's versatility as oscillator, detector or amplifier led to its dominating radio from about 1919 onwards.

Closing the Valve

Valve design became remarkably sophisticated between the Wars in the hands of specialists like Philips of Eindhoven and the Second World War produced great advances in miniaturisation. But even in the 1930s it was beginning to be apparent that the law of diminishing returns applied to valve development as to everything else. Research and development could reduce some of the valve's many drawbacks, but could never abolish them: its size, its fragility, the expense of its manufacture, its large power requirement, its need for cooling (40 gallons of water per minute for some of the giant transmitter valves of the mid-1920s) and its highly unpredictable life-span. For these reasons interest in semi-conductors never died away, despite the apparent death of the crystal receiver some time after 1930. For one thing, pure undirected speculative research went its own sweet way during the 1920s and 1930s. Physicists like Pohl at Göttingen University carried on a long pre-1914 tradition of research into the electrical properties of crystals, though this was sometimes more by accident than by design: as in Pohl's case, where Germany's ruined economy in the years after 1918 prevented him from getting hold of liquid oxygen to study gas conductivity and obliged him to look at solids instead.

Most of this research was quite innocent of any immediate practical application but, at the back of it, the idea of a solid-state analogue to the valve was never far away. One Lilienfeld patented a crystal amplifier in Germany in 1925, though none was ever built and argument goes on to this day as to whether the thing would ever have worked if it had been. All experimenters had to grapple with terri-

fying problems in getting crystals pure enough to experiment with, but gradually some substances began to emerge as front-runners. Copper oxide was in common use as a rectifier during the early 1930s, and in 1935 Oskar Heil attempted to build a field-effect amplifier by passing a current through a slab of the stuff forming one side of a capacitor: an idea which was to be taken up again by Bell after 1945, but which was eventually beaten by electron retention at the slab's surface. Embedding an electrode in a crystal to modulate the current passing through it was the obvious next step, and in 1938 Pohl and Hilsch in Germany announced that they were confident of soon being able to use this technique with a potassium bromide crystal to produce the long-sought successor to the triode valve.

Enter Germanium . . .

The war which broke out the following year brought most German research to a halt. But in the end it was the war's demands which forced development of the transistor ahead once more, and in particular the development by the Allies, circa 1942, of centimetric radar. Ordinary wireless valves had too high a capacitance to detect the returning signal, so the crystal detector was brought out of retirement: this time in the form of a silicon crystal touched by a tungsten cat's whisker. It worked, but not very well. So germanium was investigated as a substitute. The Massachusetts Institute of Technology and about forty other US research institutions got to work on the problem, and by late 1943 germanium detectors were available which could handle up to 150 volts.

When the war ended the research team at Bell Labs, Brattain, Barden and Shockley, were tinkering once more with the field-effect transistor, though this time as part of a vast programme aimed at producing reliable solid-state equivalents of the valve. The field-effect approach was eventually defeated by the surface retention which had beaten Heil a decade earlier. But point-contacts with a germanium crystal turned out to be far more promising. It was a semi-conductor of this type, soon to be christened the transistor, which was successfully tested at Bell Labs two days before Christmas 1947. The more familiar junction transistor followed soon afterwards and the first public demonstration was given at the end of June 1948.

Contrary to later legend, Bell was anxious from the very first to get the transistor as widely used as possible as soon as possible. To this end it was prepared to grant manufacturing rights at very favourable terms. For the first few years, though, there were few takers. Up until the spring of 1953 in fact the main optant was the hearing-aid manufacturer Raytheon which was not too concerned about sound quality so long as it could get miniature, low-power amplifiers. Wireless, television, the telephone manufacturers and (strangely enough) the military showed very little interest at first. True, apart from its size and its low power

requirement the transistor offered few immediate advantages over valves. The first generation were noisy, expensive (about eight times the price of an equivalent valve in 1950), limited in the voltages they could tolerate and limited in their frequency response. Manufacturing methods were often astonishingly haphazard by the standards of a generation later, not so much designing a batch of transistors to fit a desired range of characteristics but rather making the batch and then sifting out those transistors which measured up to the requirements. And there was always the problem of minute traces of impurity left in the crystals, known collectively as 'sudden-deathium', and the reason for the failure of many early semi-conductors. But above all these difficulties there was the attitude of the industry itself. Though interested in solid-state devices, the engineers of the great American and European electronics firms were men who had grown up with valves from their earliest youth. For this reason they tended to regard the transistor as a mere valve-substitute until well into the 1950s, by which time it was establishing itself as a technology in its own right and developing the sub-technology of small-scale integrated circuitry which was to lead to the micro-chip in the early 1970s. This conservatism may have had a great deal to do with the electronics industry's great migration to the Far East from the late 1950s onwards.

The thing that really made the transistor's fortunes, though, was the providential development, at about the same time, of the digital computer. But unlike the transistor the computer was not propelled into an eagerly waiting world by a massive research programme. Instead it crept up on the human race almost unawares.

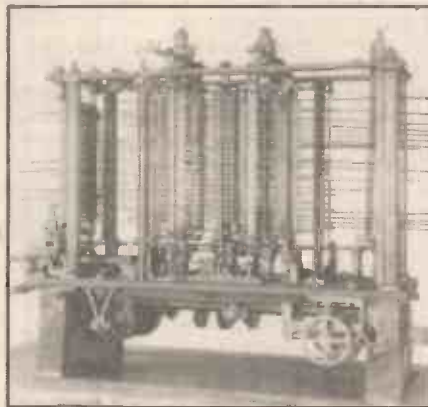

Babbage's "Analytical Engine" was perhaps the earliest computer — a machine designed specifically for performing mathematical calculations.

(British Crown Copyright, Science Museum, London.)

The idea of calculating by machine was scarcely a new one in the late 1940s when the electronic computer began to dawn upon the public consciousness. The abacus, Napier's bones, the slide rule (remember the slide rule?), Pascal's calculator and the Burroughs comptometer were all attempts — more or less unsatisfactory — to rid calculation of some of that mind-numbing drudgery involved in

projects like the one, about 1840, which had an entire company of Prussian army engineers scribbling away for six months to calculate the curvature of a single lens. In 1833 the mathematician Charles Babbage had designed (but not built) his Analytical Engine: the world's first project for an analogue computer with input, output and some sort of memory. At the very end of the nineteenth century the increasing demands of each successive US census had produced a number of increasingly elaborate card-processing machines to deal with the returns. But true computers required an accuracy far beyond the reach of even early twentieth century precision engineering, and in the mid-1930s the valve began to be built into electronic analogue calculating machines at Harvard University and Bell Labs.

As with the transistor, the demands of the Second World War pushed development forward and began the transition from calculator to true computer. Not only the Manhattan atomic bomb project but also ballistic trials required calculations of an unheard-of complexity, far beyond the capacity of human beings working unaided. And in this area the Harvard Mark 1 electronic calculator was able to score a notable triumph in 1942 when it predicted — correctly, as it turned out — that the German army would never get anywhere with the electrically powered long-range gun which it was trying to build. Meanwhile, across the Atlantic, the Enigma code-breaking operation required the building of a succession of increasingly powerful electronic cipher-machines at Bletchley Park. On a more mundane level, the vast complexity of modern armed forces led to the development of electronic personnel selectors in an effort to sort out the right man for the job from among the millions available. Evelyn Waugh's novel *Sword of Honour* mentions one of these latter contraptions installed in a War Department office in London circa 1943. And beyond the strictly technical considerations of electronic systems design, the war led to the first concentrated, systematic study of operational logic, information flow and decision-making: all areas essential to the creation of artificial intelligences after the war was over.

. . . And the Computer

The value of electronic calculation was so evident by the time the war ended that the US Government was keen to sponsor the building of the first true electronic analogue computer ENIAC at the University of Pennsylvania in 1946. The previous year John von Neumann had suggested the use of the binary system for electronic calculation, and after Cambridge University's EDSAC in 1947 all computers went over to digital operation. Meanwhile Pennsylvania University was building ENIAC's successor EDVAC with the first magnetic core memory, and computers were moving outside the field of strictly scientific calculation with the US Air Force's Whirlwind flight-simulator. Likewise the universities and government departments lost their monopoly of computer ownership in 1952 when GEC ac-

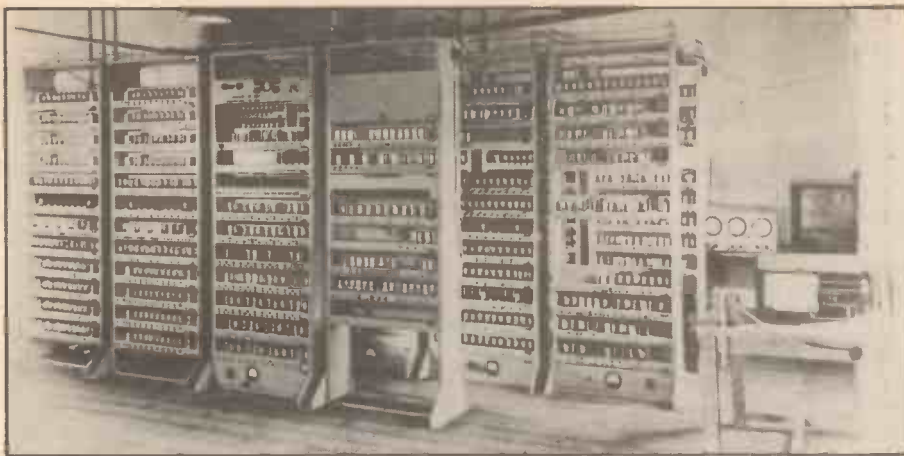

More than a hundred years after Babbage, the ESDAC I computer was built in Cambridge. It was no smaller, but a lot faster!

quired its Univac I, the first computer in the world to be owned by a private firm.

The trouble with these early computers was their sheer size and unreliability. Bell's Model V in 1944 contained over 9,000 valve relays and fifty pieces of teletype equipment. It weighed ten tons and took up over a thousand square feet of floor-space. Heat dispersal from these forests of valves was a major problem and power requirements were vast. ENIAC used 130kW and is said to have dimmed lights over half of Philadelphia when it was switched on. Above all, down-time was huge, given the number of valves, their unreliability and the difficulty of getting at them to replace them. When it arrived on the scene at the end of the 1940s the transistor was the answer to the computer builder's prayers, with its miniscule size, cool operation, low power requirement and — post 1953 or thereabouts — long life. From about 1955 onwards the valve began to be ousted by the transistor in computer construction, and as the transistor took over the computer began to move out into the world.

At the end of the 1940s the experts had confidently predicted that a country like Britain would never need more than two or three computers to serve all its needs while the USA itself would only re-

quire a hundred at most. But as is the way with these things, the increase in supply created its own demand. As the computer became smaller and cheaper it was found that more and more previously manual administration jobs could be handed over to the machine: not just censuses and scientific calculation, but banking and payrolls and stock control and police records. From then on it began to affect the lives of every one of us. Computer and transistor were the twin foundations of the post-1945 electronic age, and neither could really have existed without the other.

The miniaturization of electronics made possible by the semi-conductors, and the durability and low power consumption which they brought with them, caused another great leap forward (or upward) in the second half of the 1950s. After all, where would space exploration be if it relied upon valves? The nasty blow dealt to American prestige by the launching of the Sputnik in October 1957 led directly to the race to the Moon. But so far as this century is concerned its most important consequence may turn out to have been the birth of space communications. As early as 1928 the German rocket pioneer Hans Oberth had suggested space relay stations in geosynchronous orbit 22,300 miles above the

Earth, though in this case he proposed beaming messages up and down by heliograph because of the limited power available from the transmitters of the day. And this idea was taken up again by Arthur C. Clarke in 1945. But it was not until the late 1950s that the idea came anywhere near realisation when the United States launched its first Echo communications relay satellites.

These were passive reflectors: mere balloons of metallised PVC which were supposed to act as mirrors for microwave signals. They were not particularly successful and it was not until July 1962 that the first active relay satellite, Telstar I, was put into orbit, powered by solar cells and capable of redirecting TV signals for that part of the day when it was above the horizon. Geosynchronous orbit followed with the Syncom series of satellites launched from February 1963 onwards. By 1980, upwards of fifty communications satellites were in orbit with a further fifty planned. The tariffs demanded by the international Intelsat corporation were too high at first for more than a minimal amount of direct TV broadcasting via satellite, but from the mid-1970s onwards US television networks and Third World governments alike began to see the advantages of a satellite-based TV system. And not only the advantages of satellite TV but also the benefits of secure telephone communications and computer data links of a hitherto unimaginable speed and purity. Again, once the transistor made it possible people began to think of needs they had never felt before.

Getting Taped

This kind of self-sustaining growth, with new developments creating demand and demand calling forth new developments, has been particularly noticeable in the world of home entertainment over the past eight-odd years. Wireless and television we all know about, of course. But what about recorded music? After all, one of radio's first and greatest conquests in the late 1920s was its absorption, for a time at any rate, of the gramophone: previously a scratchy, faint-sounding, clockwork instrument, but transformed by the valve, the wireless loudspeaker and electric drive into a robust, reliable means of entertainment. The great success story of the age, however, was the tape recorder. The idea of recording sound on magnetic steel wire had been suggested as far back as 1888. But it was ten years before the Danish inventor Valdemar Poulsen took out a US patent on his Telegraphone. This operated by means of clockwork-driven spools passing wire through a magnetising/de-magnetising coil at a rate of 7 feet per second. It was hailed as a major new discovery when it appeared on the market and Poulsen set up the American Telegraphone Company to sell it, but in the end the idea came to nothing. The machine's frequency response was too poor for use as anything except an office dictaphone and the wire suffered from an incurable tendency to twist and stretch — as well as occasionally snapping and slashing around at high speed until the spools

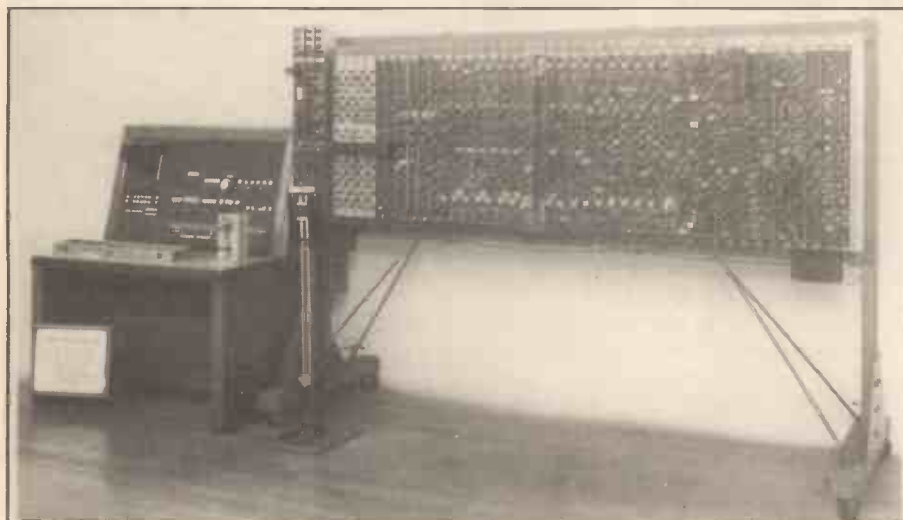

The ACE computer, built in 1950, still used valves, though less of them than its predecessor ESDAC.

(Lent to the Science Museum by National Physical Laboratories)



Pulsen's "Telegraphone" was patented in the US in 1898 and used mainly as a dictaphone. "Hifi" had yet to be invented!

(British Crown Copyright, Science Museum, London.)

could be stopped. (Wire recording was eventually used for aircraft flight recorders, because of its robustness, but it was decidedly not bound for the entertainment industry.) All the same, interest never died away completely and post-1918 AEG, Bell, 3-M and the US Naval Research Laboratories were all looking into the idea.

In 1928 the German researcher Pflumer abandoned wire in favour of paper tape coated with iron oxide. Meanwhile the Magnetophon company, also in Germany, worked on plastic-based tape. The Blattner system — used by the BBC for studio recording from 1934 onwards — favoured steel tape which had the disadvantage of having to be cut with shears and spot-welded into splices which went through the heads with a deafening clatter. But during the early 1930s magnetic tape recording was upstaged by the photo-optical system developed for the talking films.

Interest picked up once more during World War II, and the German Magnetophon system began to pull ahead of its nearest American rival Brush. It was strongly sponsored by the German Propaganda Ministry, who found its acoustic accuracy and the portability of the tapes very useful for broadcasting speeches by the Nazi leadership at times and places which would puzzle Allied intelligence. The result was that by 1945 Magneto-



The modern tape recorder was developed in Germany during World War II, when it was used to replay and broadcast speeches by the Nazi leaders.

(Photo, Science Museum, London.)

phon tape recorders were way ahead of anything that the Allies could produce, with a frequency response of up to 10kHz. American scientists were highly impressed by German recorders captured at the end of the war, and after several years' work to perfect tape-coatings tape recorders began to appear on the US domestic entertainment market. Meanwhile, small battery-powered tape recorders came to replace wax-disc machines in radio outside broadcasting, doing away with the need for a technician to sit beside the machine while it was recording with a camel hair brush to get rid of the swarf thrown up by the needle. The only technological developments which stood between the tape recorder and a mass pre-recorded music market were the compact cassette to do away with the need for threading the tape (introduced by Philips in 1963), and CrO₂ tape (launched by DuPont five years later). Once these were achieved, hifi came to be a feature of most households with any pretensions to civilisation.



The "Walkman" and similar cassette players probably represent the ultimate in personal hifi.

Once sound recording on magnetic tape had become an established technology it was only natural that people should begin to think of some better means of recording TV programmes than merely pointing a cine-camera at the screen. It is odd to remember, though, that video recording is an idea as old as television itself. In 1930 the Baird Television Company had tried to market shellac video discs with its 'Televisor' receivers: no great problem in theory, since all the disc had to do was to vary the output of a neon lamp shining through a Nipkow disc onto the back of a ground glass screen. The Baird discs turned out to be even less of a success than the Televisor itself and sank without trace after a few months. It was not until 1951 that the Crosby Laboratories developed a video recorder which could register a TV signal magnetically: in this case along the length of a tape running past at over eight feet per second. This method gave tolerable picture quality but was so greedy of tape — something like three miles for a half-hour programme — that the idea never made it outside the laboratory. The first commercially usable video system came in 1956 when the American Ampex Corporation brought out a recorder which entered each picture

frame transversely on a two-inch-wide tape. A similar system was taken up by the BBC under the acronym VERA in the same year, and between them these two video systems dominated broadcast TV for the next twenty years, even though they were both about the dimensions of two wardrobes stuck together, and used tape spools the size of bicycle wheels. They gave a very good picture, but they and the later, smaller, versions of the studio VTR were clearly out of the question for the home user.

Helical scanning was developed by Sony in the mid-1960s as a compromise between tape width, speed and picture quality. It opened the way to a consumer video market but for some reason — perhaps because people were still absorbing hifi sound recording — it failed to catch on until the late 1970s when TV addicts in the USA began to appreciate the domestic VTR's time-shifting capabilities. Suddenly the market exploded as it became profitable for the Japanese electronics industry to tool up for mass production of domestic video recorders. The American film industry began its belated shift towards producing for TV and video first and the traditional movie theatre second. Meanwhile cable TV, satellite TV and the prospect of fibre-optic cable TV were starting to follow the way cut by the VTR in fragmenting TV audiences to the point where people now speak of 'narrowcasting' as the dominant home entertainment form of the 1980s.

It is only just over a century and a half since Faraday made his historic demonstration of electro-magnetic induction and only just over a century since Britain got its first public electricity supply. During that time electricity has advanced from being a barely understood and not particularly useful scientific freak to a point where it is the lifeblood of our civilisation. A great many of its innovations have merely helped us to cope with difficulties which we would never have had in the first place without those same innovations — the pocket calculator and the photocopier are the two examples which come readiest to mind — but good thing or not, the technology was there, and so it happened. The only safe prediction now, in Anno Domini 1982, is that we are only seeing the beginning.



A PAM transistor radio dating from 1956. As today, the physical size was determined by the need for a relatively large loudspeaker.

(British Crown Copyright, Science Museum, London.)

NEW Elemic

DIGITAL 9

DC VOLTS 100V-1000V
+ 0.5% + 1 digit
10MΩ

Range: Accuracy: Input Resistance:
AC VOLTS 100V-1000V
+ 0.8% + 1

Range: Accuracy: Input Impedance:
DC CURRENT 100mA-10A
(20A for 1 minute)
+ 0.5% + 1 digit
10MΩ/100F

Range: Accuracy: AC CURRENT 100mA-10A
(20A for 1 minute)
+ 0.5% + 1 digit
10MΩ/100F

Range: Accuracy: RESISTANCE 10-20MΩ
+ 0.5% + 1 digit
20MΩ + 0.8% + 1 digit

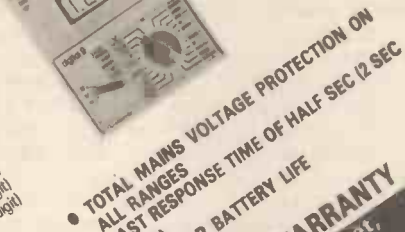

Only £58.95
(price excl VAT)
UK CARRIAGE £1.00

- TOTAL MAINS VOLTAGE PROTECTION ON ALL RANGES
- FAST RESPONSE TIME OF HALF SEC (2 SEC 20MΩ)
- 2000 HOUR BATTERY LIFE
- DIODE TEST

ONE YEAR WARRANTY
Supplied complete with fused test case, deluxe protective carrying case, instruction manual and digital multimeters available. Send off for details

DTM DISTRIBUTION
4 Sandy Lane,
Stockton Heath
WARRINGTON
Cheshire WA4 2AY
Tel: 0825 66521

FREE

STEINEL VOLT CHECK

Lightning ELECTRONIC COMPONENTS

THE CHOICE IS YOURS — CALL AT OUR NEW SHOWROOM OR USE OUR VERY FAST MAIL ORDER SERVICE.

EITHER WAY WE'LL KEEP YOU HAPPY *****

Furthermore we promise if any part ordered by mail fails to please just return within 7 days for a full refund.

For a vast selection of electronic components & equipment of all kinds. Here is just a selection of our stocks. Many more items listed in our catalogue available now 70p post paid.

RESISTORS
W 5% C.F. 1R to 10M 2p each 100 for £1.00
W 5% C.F. 10R to 1M 2p each
W 5% C.F. 10R to 820K 5p each
W 1% M.F. 10R to 680K 5p each 100 for £3.00
100 off prices one value only no mixing

CAPACITORS
Min Plat: 18pF to 47pF 5p Disc: .01uf 50V 8p (100 for £5)
56pF to 220uf 6p Ceramics: .1uf 50V 10p (100 for £5)
Ceramics: 270pF to 1000pF 7p
1200pF to 4700pF 8p Variable 0 to 500pF 9p
100 off any one type less 30%

POTENTIOMETERS
Presel 1W Horiz 8p
1W Vert 11p
Sid Range Pot 25p
Single S Switch 50p
Dual Gang 75p

TRANSISTORS
R2010B 2.60
AC12B 0.24 TIP29A 0.39
AF117 0.52 TIP29C 0.45
BC107 0.10 TIP30A 0.39
BC107C 0.12 TIP30C 0.45
BC108 0.10 TIP31A 0.39
BC108C 0.12 TIP31C 0.45
BC109 0.10 TIP32A 0.39
BC109C 0.13 TIP32C 0.45
BC182L 0.10 TIP33C 0.85
BC184L 0.10 TIP34C 0.85
BC212L 0.10 TIP35C 1.85
BC212L 0.10 TIP36C 1.90
8D112 0.80 TIP41A 0.45
8D112 0.59 TIP41C 0.48
BD115 0.59 TIP42A 0.45
BD124 1.58 TIP42C 0.48

V. REGULATORS (FIXED)
+Ve 100mA 78L05 78L12 -78L15 31p LM317K 1.5 Amp £3.35
+Ve 100mA 78L05 78L12 78L15 59p LM338K 5 Amp £4.70
+Ve 1 Amp 7805 7812 7815 80p LM390K 10 Amp £11.90 (Met)
+Ve 1 Amp 7905 7912 -7915 65p L723 14 DIL £0.46
L723 123 7099 £0.60

V. REGULATORS (VARIABLE)
1.5 Amp £3.35
5 Amp £4.70
10 Amp £11.90 (Met)
14 DIL £0.46
123 7099 £0.60

FOTO COATED RESIST BOARD — High quality fibre glass laminate pre-coated with positive photo resist. For small batch production of PCB's.
1mm single sided 12" x 18" £8.80
1.6mm Single sided 1.53
100 x 160mm Euro 1.83
203 x 114mm 3.60
203 x 228mm 3.60
467 x 305mm 8.10
1.6mm Double sided 100 x 160mm Euro 1.70
203 x 114mm 2.10
203 x 228mm 4.10
Fotodeveloper concentrate £2.42
Chemical Dishes 12" x 10" £1.80
Acetate Sheet £0.20
Transfer Pack 5 assist sheets £2.50
Ferric Chloride rock £1.20
Plastic Tonges £0.95
Diao Pen £0.88

BD240A 0.60 TIP110 0.82
BD241A 0.60 TIP115 0.82
BF180 0.30 TIP121 0.99
BF199 0.18 TIP126 0.99
BF244B 0.29 TIP141 1.20
BF257 0.30 TIP142 1.20
BFR39 0.24 TIP146 1.25
BFR40 0.24 TIP147 1.25
BFR64 3.00 TIP2055 0.57
BFR73 0.26 TIP2955 0.69
BFR80 0.26 TIS43 0.30
BFR80 0.25 TIS43 0.30
BFW14 0.25 TIS90 0.28
BFY53 0.21 2N1309 0.60
BFY90 0.85 2N3053 0.22
BLY93A 14.20 2N3054 0.48
BU125 2.25 2N3055 0.48
BU208A 2.00 2N3904 0.14
MPSA05 0.20 2N373 2.25
MPSA06 0.21 40673 0.92
MJ15003 4.05 40871 1.05
MJ15004 5.04 40872 1.05

PANEL METERS
Until now panel meters have proved an expensive part of your project. Now available this new quick fit type.
32mm Square Meter



The following Diarranges
50uA - 100uA - 500uA - 1mA
5mA - 10mA - 50mA - 100mA
500mA - 1A - 5A - 25V - 50V
ONLY £1.95 each

Postage & Packing 50p per order (free over £10) Please add VAT at 15%. Telephone orders welcome by Access or Barclaycard

LIGHTNING ELECTRONIC COMPONENTS
Showroom & Mail Order Distribution Centre at:—
18 Victoria Road, TAMWORTH, Staffs B79 7HR
Telephone 0827-65767.

OPTO ELECTRONICS

LEDS

- 3mm, 5mm, Rectangular Diffuse Gravestone:
- Red - 8p
- Orange - 8p (not Gravestone)
- Yellow - 10p
- Green - 10p
- 3mm Red Battery Status - 20p
- 5mm Red Flasher - 40p
- 5mm Bi Colour Red/Green - 50p
- 3+5mm Red Constant Current - 20p
- 3 or 5mm Mounting Clips - 2.5p

INFRA RED EMITTERS

- 3mm TIL32 Type - 40p
- 5mm TIL38 Type - 40p
- IRL60 Mini Radial - 30p
- IRL80 Side Looker - 40p

INFRA RED SENSORS

- 3mm TIL78 Type - 40p
- 5mm BP103B (Trans) - 45p
- Pin Diode (Side Looker) - 85p
- NORP12 (Resistor) - 75p
- LPT100 (Transistor) - 40p

DISPLAYS

- DL304/307 - 75p
- DL704 - 90p
- DL500/507 - 85p
- DL527/528 - £1.50
- DL0727 (Orange) - £2.00
- DL0747 (Orange) - £1.00
- DL6304/307 (Green) - 80p
- RB61000 - £1.60
- 4 Digit 0.5" Clock - £2.00
- 9 Digit Calculator - 50p
- DL1414 Intellegent - £12.50

OPTICAL ISOLATORS

- IL74 (6 pin) - 60p
- ILD74 (8 pin) - 99p
- ILQ74 (16 pin) - £2.25
- 4N26 (6 pin) - 53p

STARTER KIT

- 5 each, 4 colours, 3,5mm, Rectangular Gravestone Leds
- 2 each, TIL38, 78, Photo Diode/2 each, ILD74 ISOL
- 2 each, DL307, 704, 500/1 x 9 Digit Calculator Stick
- £10

For full details of our extensive Opto range a 52 page catalogue is available at £1 .25 including P&P & VAT or free with order £10 or over in value.

SYNCHRO SERVICES

DICKEN HOUSE,
ORCHARD LANE,
HARROLD, BEDFORD
TELEPHONE: (0234) 720575
TELEX: 825744

TERMS — All prices exclusive of VAT and are subject to availability plus 60p P&P.



BBC Micro/ HEBOT Interface

Owen Bishop



Hobby Electronics' maestro of the micros describes a versatile interface which joins the HEBOT II to the BBC Microcomputer, Model A or Model B, or which can be used for any other imaginable purpose!

UNTIL NOW, the only way to command our friendly robot has been by using a ZX81 computer. Now we add to the list of the controllers of HEBOT, by publishing another interface; this one lets you operate HEBOT from the keyboard of the BBC Microcomputer. The interface plugs into the 1MHz socket, which is found on both Model A and Model B.

The interface has exactly the same facilities as that published in November 1982, for the ZX81. It has an eight-bit data output for controlling the motors, the pen, the lights and the horn, and it has a 4-bit data input for reading the touch sensors. It also supplies the power needed for operating the circuitry of HEBOT, including its motors and solenoid. The ZX81 supplied 10V (or thereabouts), this being the output from the ZX mains adaptor, while the BBC Microcomputer has a nominal 12V output which can supply up to 1A25, and this is more than enough for HEBOT. Readers who already have HEBOT need not worry that the power supply from this interface is 12V, rather than the 10V which little HEBOT has been used to receiving from the ZX81.

Powertran Ltd. who supply the HEBOT II kit, assure me that the motors and solenoid are in fact rated for 12V operation, though they work just as well on 10V. You might find that HEBOT nips around the room a little faster when connected to the BBC Microcomputer! The other components in HEBOT are able to work just as well with a 12V supply as with a 10V supply, though his eyes may glow that bit brighter and his voice may become that bit stronger. So it looks as if an invigorated HEBOT will soon be evident!

It is worth noting that this interface could also be used to control any other device instead, provided it works with an eight-bit TTL input and a four-bit TTL output.



HEBOT Meets The Micro

The interface provides an eight-bit data output and a four-bit data input, and consists of three parts: the Decoder, which decodes signals on the address and to the control lines; the Latches, in which data from the computer is temporarily stored in send on to HEBOT; and the input Data Buffers, which receive data from HEBOT and pass it on to the micro when asked.

The BBC micro, in common with most others, has 16 address lines; the upper 8 of these are decoded internally to produce an output which goes by the remarkable name of FRED. Normally the voltage level on FRED is 'high', but when any of the

256 addresses in the range &FC00 to &FCFF is written to or read from, FRED stops feeling 'high' and feels rather 'low' instead. This leaves only the lower 8 lines (A0 to A7) to be decoded at the interface. The circuit diagram, Figure 1, shows how these are decoded by a number of simple logic gates. The address allotted to HEBOT is &FCF0, which is '1111 1100 1111 0000' in binary; FRED takes care of the '1111 1100' and the interface takes care of the '1111 0000'.

Writing Home to HEBOT

The final gates in the chain take the state of the Read/Write (R/W) line into account. When the micro wants

Figure 1. The full circuit of the BBC/HEBOT Interface.

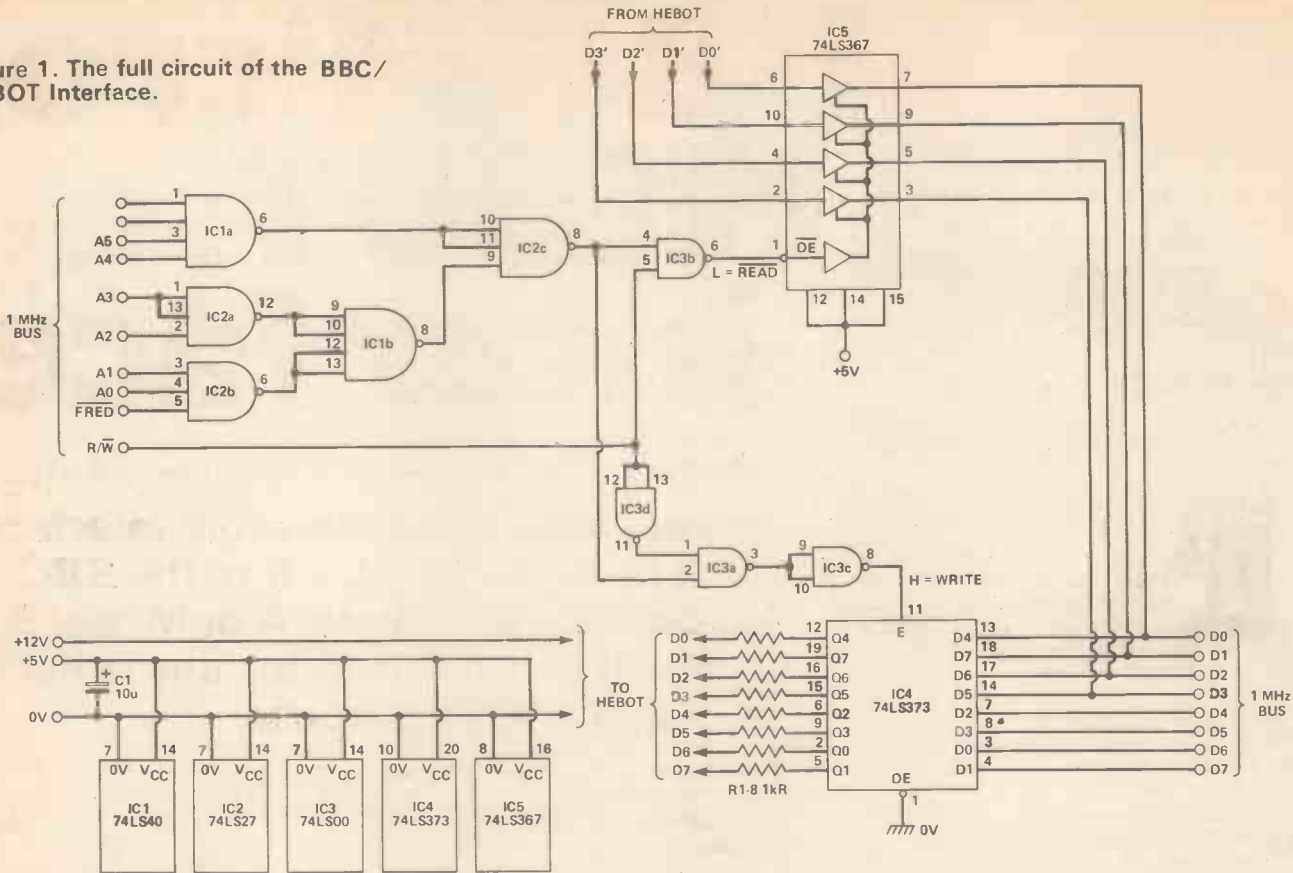
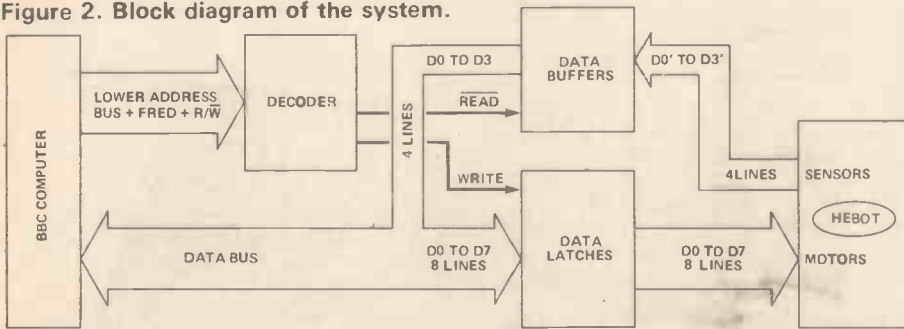

Figure 2. Block diagram of the system.



to write to HEBOT, this line is taken low, consequently the output at pin 8 of IC3 (which we have called 'WRITE') goes 'high'. It is not possible to detect this high pulse by using a voltmeter, for it lasts only a fraction of a microsecond, however it is long enough to trigger the latches of IC4. The output of each latch assumes the state which is present on its data input line at the instant that WRITE goes high, and this output level is fed to HEBOT through resistors R1 to R8. Once latched, the output remains unchanged, even though the data itself is no longer present on the data bus. Indeed, the micro may be writing different data to other parts of its memory but HEBOT's data remains held at the latches, giving HEBOT plenty of time to respond, and it remains unchanged until a new set of data is written to the latches.

When the micro wants to read data from HEBOT's sensors, it addresses HEBOT at &FCF0, as before, but this time the R/W line is taken 'high'. The result is that the output of IC3 at pin

6 goes low. We call this line 'READ', and when READ goes low, it enables the data buffers of IC5. In their disabled state these buffers have what is called a 'high impedance output'; in other words, there is a very high resistance (several hundred thousand ohms) between the buffer output terminal and the data line. In effect, then, the buffer is disconnected from the data line and cannot supply data to it.

When the buffers are enabled, they have normal TTL output characteristics: if a buffer is receiving a high input from one of the sensor circuits of HEBOT, the corresponding line of the data bus is made high; if the sensor circuit has a low output, that line is low. There are only four sensor outputs from HEBOT, so only the lower four lines of the data bus are connected to the buffer IC. A hex buffer (74LS367) was chosen in preference to a quadruple IC (74LS125) since it has only one enable input shared between the four buffers we are using, whereas the

74LS125 has a separate enable input for each buffer, making the wiring more complicated.

It is feasible to wire up the other two buffers to provide a six-bit data input to the micro, if you like. If you are thinking of giving HEBOT one or two additional sensors, take their outputs to pins 12 and 14 of IC5, connect the buffer outputs (pins 11 and 13) to D4 and D5 and join the other enable input (pin 15) to pin 1. You will also need to remove the track which at present connects pins 12, 14 and 15 to the +5V rail.

Construction

The interface is built on a double-sided PCB; most of the wiring is on the under side of the board, but the power rails and a few linking tracks are on the upper side.

If you are making your own board, take special care that the two designs are exactly registered with each other on opposite surfaces of the board. There are some 'tight squeezes' in certain parts of the board; also there are 28 points at which the tracks on the upper and lower surfaces must be connected and pads are provided in the design where these connections are to be made. Drill a hole through the board in the centre of one of the pads; if registration is correct, the drill should pass through the centre of the pad on the opposite surface. Pass a 1mm terminal pin through the hole and solder it to the pads on both surfaces of the board. If you want to make a more professional job of the board, you can use the special

'through-PCB' pins which are obtainable from some suppliers, but you need three proper terminal pins at the points where the power supply cable is to be connected.

The ICS can be soldered directly to the board, thus saving cost, though it is advisable to use sockets since it is often useful to be able to remove an IC when tracing faults. Do not insert the ICs until all the wiring has been completed and the preliminary wiring checks described below have been undertaken.

Connections To The Board

The interface is joined to the micro by a 34-way ribbon cable. At the micro end, the cable is terminated in a 34-way Speedbloc connector, which must have a central key in order to mate with the socket on the micro. Speedbloc connectors are of the insulation-displacement type and are very quick to attach to the cable, but a vice is essential for this. You also need an adaptor tool (which is inexpensive) but if you lack the equipment, it is far simpler to purchase the cable with the connector already attached to one end (see *Buylines*).

Note that the diagrams of the 1MHz bus in the BBC Microcomputer System User's Guide are incorrect — at least, those in my copy (issued late

PARTS LIST

RESISTORS

(All 1/4 watt 5% carbon)

R1-R8 1k

CAPACITORS

C1 10u
25V axial electrolytic

SEMICONDUCTORS

IC1 74LS40

dual 4-input NAND gate

IC2 74LS27

triple 3-input NOR gate

IC3 74LS00

quad 2-input NAND gate

IC4 74LS373

octal D-type latch

IC5 74LS367

hex bus driver, three-state output

MISCELLANEOUS

PCB; 3 x 14-pin IC sockets, 1 x 16 pin IC socket; 1 x 20-pin IC socket; 3 x 1mm terminal pins; 25 x through-PCB pins, or 1mm terminal pins; ABS case, approx 150mm x 80mm x 5mm; 34-way Speedbloc cable-mounting socket; 34-way ribbon cable, approx 60cm; 16-way ribbon cable, at least 1m; wire, solder, nuts and bolts etc.

BUYLINES

A complete kit of components and parts for the BBC-HEBOT Interface is available from Kelan (Hobby-board) Ltd., North Works, Hookstone Park, Harrogate, North Yorkshire for £24.00.

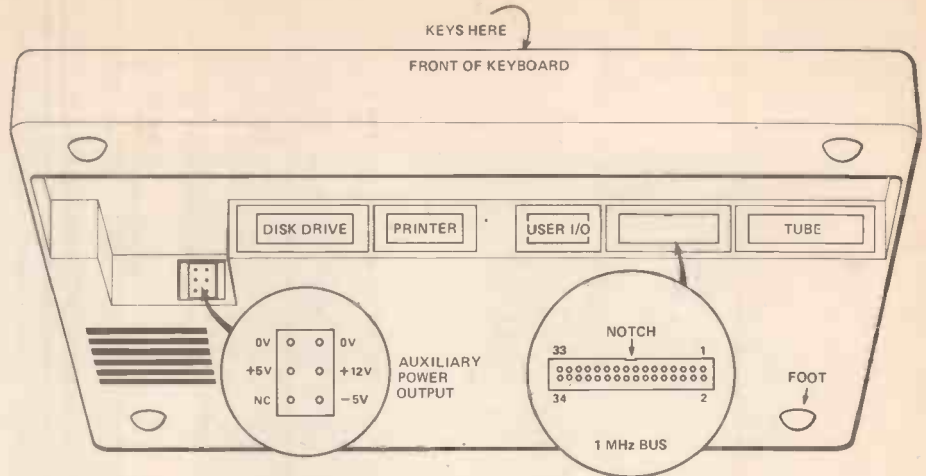

Figure 3. Schematic view of the connectors underneath the BBC Micro.

1982) are! The diagram of the various sockets on pg. 499 suggests that the 1MHz bus has 26 pins, yet a simple count shows it to have 34. The diagram on pg. 503 shows 34 pins, provided that one ignores the rather odd 0V and +5V pins which do not exist on the 1MHz socket itself. The next error is that the numbering of pins in the two drawings is inconsistent; in this article we adopt the numbering shown on pg. 503, beginning with pin 1 at the bottom (a 0V line) and ending with pin 34 at the top (address line A7). Once again, we ignore the spurious 0V and +5V pins. On this reckoning the pin numbering on pg. 499 is wrong in orientation, as well as in magnitude, and should be as shown on the diagram we publish here. (We have now learned that recent issues of the Guide have been corrected—Ed.) It is essential to understand the pin numbering system before you attach the Speedbloc plug and solder the cable to the interface board.

Table 1 shows that HEBOT uses only 18 of the 34 lines available at the 1MHz bus port. Certain of the lines may be cut short at the interface end of the cable, as shown in Figure 4 but make sure that the cuts are clean, so that there are no thin filaments of wire protruding from the cut insulation to cause a short-circuit with an adjacent wire. The same consideration applies when you solder the wires to the board; make certain that all the strands of each wire go through the hole. Examine your work with a lens when you have finished, looking for single strands lying on the top surface of the board and pull off any that you see.

Power Supplied

The power supply for the interface and for HEBOT is provided from an outlet on the underside of the keyboard. This is marked 'Auxiliary Power Output' and has a special six-way socket normally used to provide power to the disk drive. The drawing shows which pins to connect, so make sure that you get the orientation

Line no.	Name	Function	* = used for HEBOT
1	0V		
2	R/W	Read/write strobe	
3	0V		
4	1MHzE	1MHz clock	
5	0V		
6	NMI	Non-maskable interrupt	
7	0V		
8	IRO	Interrupt request	
9	0V		
10	FRED	Negative strobe FC00-FCFF	
11	0V		
12	JIM	Negative strobe FD00-FDFF	
13	0V		
14	RST	System reset	
15	0V		
16	ANALOG IN	Analogue input	
17	0V		
18	D0	Data bus, least sig. bit	*
19	D1	Data bus	*
20	D2	Data bus	*
21	D3	Data bus	*
22	D4	Data bus	*
23	D5	Data bus	*
24	D6	Data bus	*
25	D7	Data bus, most sig. bit	*
26	0V		
27	A0	Address bus, least sig. bit	*
28	A1	Address bus	*
29	A2	Address bus	*
30	A3	Address bus	*
31	A4	Address bus	*
32	A5	Address bus	*
33	A6	Address bus	*
34	A7	Address bus, most sig. bit of lower byte	*

Table 1. Correct pin numbering and function for the 1MHz bus.

BBC 1MHz BUS	HEBOT CABLE	POWER LINES
LINE 2 R/W	BLACK D4	BLUE 0V
10 FRED	BROWN D2	RED +5V
18 D0	RED D3	GREY +12V
19 D1	ORANGE D7	
20 D2	YELLOW D6	
21 D3	GREEN +12V	
22 D4	BLUE +12V	
23 D5	VIOLET 0V	
24 D6	GREY 0V	
25 D7	WHITE D5	
	BLACK D3*	
27 A0	BROWN D0*	
28 A1	RED D2*	
29 A2	ORANGE D1*	
30 A3	YELLOW D1	
31 A4	GREEN D0	
32 A5		
33 A6		
34 A7		

Table 2. Summary of the input and output connections of the Interface.

correct. You need a three-way cable of about the same length as the ribbon cable; connect the other ends of the wires to the three terminal pins marked 0V, +5V and +12V on the interface board.

The board also provides connections for the 16-way cable that goes to HEBOT, and this has the same order of pins as in the ZX81 version. If you already have a HEBOT tethered to the

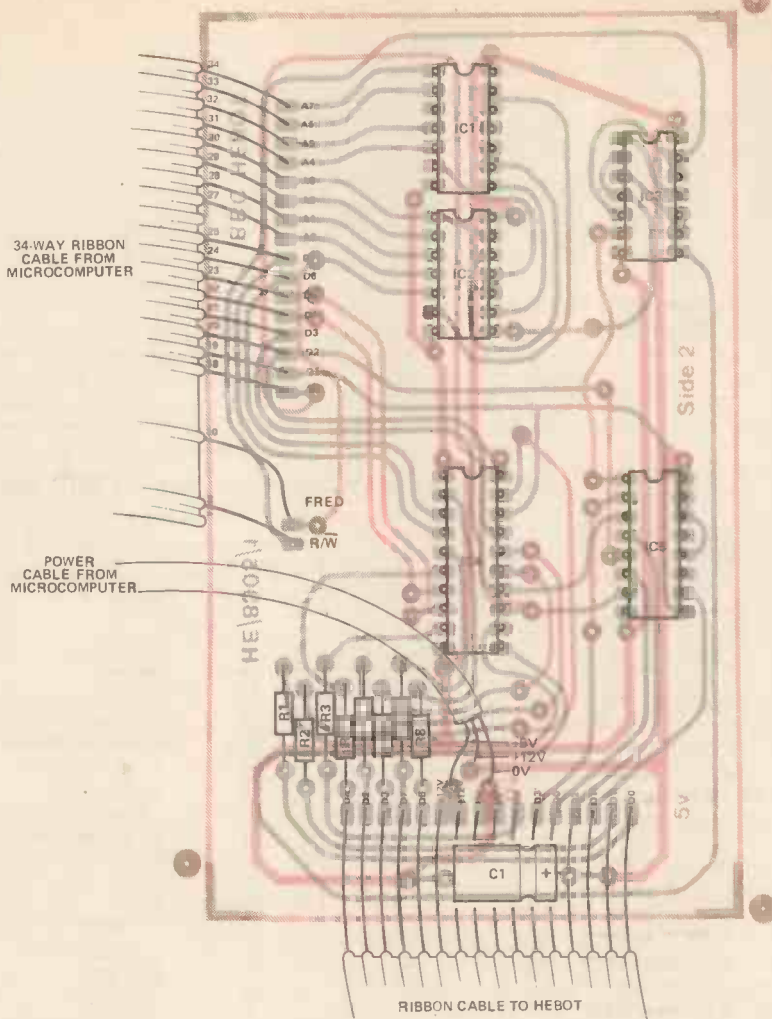

Figure 4. The component overlay; the component-side tracks of the double-sided board are shown in red.

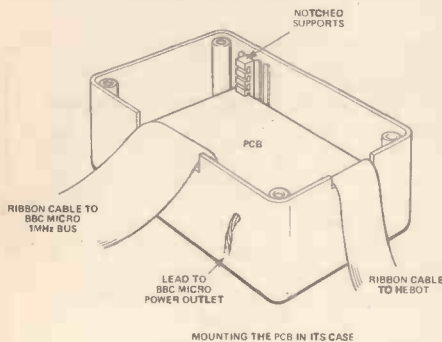

Figure 5. The PCB fits neatly into a standard case, but slots must be cut and filed for the ribbon cables.

other end of the cable, do not connect it until the wiring has been tested as described in the next section. If you are beginning with a new cable, solder this to the interface board and strip its wires at the other end, but do not solder it to HEBOT until testing is complete.

There are many ways of enclosing the interface; the simplest method is to mount it in an ABS box of convenient size. Certain types of box

have notched strips which slide in grooves on the inner side of the walls, and this board is of the correct size to slip easily into one of these boxes. Before putting the board in the box, though, cut slots for the cables, as shown in the drawing, and bore a hole for the power cable.

Checking The Wiring

There are only five ICs but there are many connections between them, the micro and HEBOT, so it is well worth while making a systematic check for short-circuits and faulty joints before you attempt to plug the interface into the micro. Use a multimeter to check that there are no short circuits between adjacent wires of the micro cable, working your way along the row of pads where the cable is soldered to the board. Similarly, test for short-circuits where the HEBOT cable is joined to the board.

(Alternatively, a variety of PCB-interconnecting plug and socket systems are available which will result in a much neater and safer project. However, they have not been specified for the Interface for reasons of cost, so we'll leave this detail in the

hands of the dedicated constructor.

Next, insert the ICs in their sockets then, using the multimeter as before, check all the connections from the input cable to the terminal pins of the ICs and all connections between the ICs themselves. You are a maestro of the soldering iron if you do not discover at least *one* dry joint which could ruin the operation of the interface. Similarly, check the power connections and, finally, check that there is no short-circuit between the 0V and +5V line (the interface takes only 45mA at +5V, so this is well within the capability of the micro's power output rating).

Testing On The Micro

Insert the Speedbloc plug into the 1MHz socket on the underside of the micro and insert the power plug into the power output socket; have a multimeter handy, set to a voltage scale to read up to +5V. Temporarily connect the negative probe of the meter to the 0V line of the interface — the pin to which the 0V supply line is soldered will do. Arrange the further end of the HEBOT cable on the table so that the bared ends are spread widely apart, with no chance of them touching each other! If you have not yet soldered the HEBOT cable to the board, it will not be as easy to perform the tests, but you should be able to manage by making connections as required to the far ends of resistors R1 to R8, or to the pads for DO' to D3'.

When all is ready, switch on the TV set or monitor, then switch on the micro. If it fails to display its customary legend on the screen ("BBC Computer. . .") or the usual bleep from the loudspeaker is not heard, switch off immediately; you have probably still got a short to one of the address or data lines. Go back and retest the interface, but *thoroughly* this time!

As explained in the section on addressing, the interface is placed at address &FCF0 (64752 in decimal), and we treat the interface as a single byte in memory, writing data into it or reading data from it. To test output to the interface, first type:

H = &FCO

then press 'Return'. This sets variable H to the address of the interface (better to refer to it as the address of HEBOT, since eventually HEBOT will be attached to the interface). Next type:

?H = &FF

then press 'Return'. This command uses the Indirection Operator, '?', as explained on pg. 409 of the User's Manual, to write 'FF' into HEBOT's address. In binary, 'FF' is '1111 1111', so we shall expect that all 8 outputs of the latch IC will now be 'high'. Use the testmeter to measure the voltage at the HEBOT cable end for all of lines

D0 to D7, but do not expect to read +5V, even though we often equate 'high' with this voltage. In practice, anything over +2V is 'high' to a TTL IC! Now key in:

```
?H = &O
```

then press 'Return'. There is no need to repeat 'M = &FCFO' unless you have switched off the micro or inadvertently pressed 'Break'. After this, all the outputs D0 to D7 should be low, (less than OV8). If any line fails to go 'high' on the first command and 'low' on the second, switch everything off and re-examine the board for faults, concentrating particularly on the faulty line.

For a final check on output, try writing other values to the HEBOT address. For example, if you key '?H = &AA' you are sending the bit pattern '1010 1010', ie the even numbered data outputs are 'low' while the odd-numbered ones are 'high'. Now to test the input side. The command for this is:

```
PRINT ?H
```

then press 'Return'. It is handy to set up one of the user-defined function keys to do this. The command causes a decimal number representing the input state of all eight data lines to be printed on the screen. Thus the values printed normally range from 0 (0000 0000, all lines 'low') to 255 (1111 1111, all lines 'high').

However the output from HEBOT is present on only the lower four data lines so when reading from HEBOT, there is nothing connected to the upper four data lines. A line with no input reads as 'high' so D7 to D4 always produce '1111'. Thus the range of values obtained by testing HEBOT lies between 240 (1111 0000) and 255. If all of the lines D0' to D3' are left unconnected, then all lines are effectively high, and '255' appears on the screen. Now connect line D0' to the OV rail and key the command again. You should see '254' this time, for the data input is '1111 1110'. Try various other input combinations, grounding one or more lines of D0'-D3'! If you convert the number on the screen to its binary form, the '0's correspond with a grounded data input.

Interference

You may find that sometimes the value you get on the screen is lower than expected. In particular, it may be 16 less than expected. This is due to a 'low' appearing on data line D4. Now, this cannot be coming from the interface in the normal way, for the interface has no output to line D4 or any of the upper lines.

This 'low' is due to electromagnetic interference between adjacent wires in the cable, and becomes more evident the longer the cable; it would have improved matters if the 1MHz bus had had grounded (OV) lines alternating with each data line and address line. The diagram on pg. 505 of the BBC Manual shows that there

are such grounded lines on part of the bus (between lines carrying control signals), but not on the part carrying data and addresses. Grounded lines would have shielded wires from this interference and though the lack of shielding does not matter normally (for most interfaces would be sending firm data along every line of the bus), with this interface the upper four lines are left 'floating' and prone to pick up any interference which is around.

Fortunately it is no problem to program the micro to ignore the upper four data lines completely, as in line 90 of Program 1. In transmission of data to the interface, interference does not occur, for none of the lines are 'floating'.

If, in the tests above, you find that any combination of the lower four data inputs does not produce the corresponding figure on the screen (ignoring odd effects of interference on the upper four lines), switch off and re-examine the interface board, especially the line which is giving trouble. Assuming that all now appears to be in working order, switch off, and make the connections to HEBOT.

Programming HEBOT

The tables on pg. 11 of the November 1982 issue of HE summarises the ways of commanding HEBOT and reading from the sensors, and exactly the same arrangement of data lines is used in this interface. The programs in that issue are in Sinclair BASIC; here we list equivalent programs in the BBC BASIC, which differs in a number of respects from Sinclair BASIC. The first program is the 'walk and avoid' routine, in which HEBOT moves forward, eyes flashing menacingly until it runs into an obstacle. Muttering under its breath (or rather, tooting vociferously on its speaker) it backs away, turns left and then proceeds in a forward direction again. Those of you who have seen the pond animal, *Paramecium* (or any of its relatives), alive under the microscope, will know just how HEBOT behaves with this program.

The second program allows you to type in a sequence of commands and then run the program so that HEBOT carries them out in order; the micro has plenty of memory to spare so a very large number of movements can be programmed if you wish. You can use a variant of this program to make HEBOT draw a pattern on a sheet of paper, or with a little ingenuity, you could program HEBOT to dance to music produced by the micro's sound generators. The routine can be repeated or not, as selected by your entry at the beginning of the second phase.

With the 16K of the Model A or the 32K of the Model B at your disposal, there is massive scope for programming HEBOT. It can learn how to run a maze. Or it can be allowed to wander around the room at random, bumping into objects and memorising their positions; this information, stored in the computer can be used to build up a map of the room, for display on the screen. Another project is to program HEBOT to write its own signature on a large sheet of paper. It can learn to write too; you type a message in at the keyboard and HEBOT writes it out on paper. These are only a few suggestions of things that HEBOT can be programmed to do.

On pg. 435 of the User's manual, Aunty Beeb takes on her most severely admonitory tone and threatens dire results if we 'insist' on addressing HEBOT directly, instead of using Aunty's OSBYTE calls. Sorry, Aunty, but this programmer *insists* (as you put it) on addressing HEBOT directly. As you point out in an afterthought, the required OSBYTE routine is not available before ROM release 1.0, so many of our readers have no other option but direct addressing! And those lucky few who eventually use the Tube would really not find it all that difficult to modify their program accordingly.

Apple owners take heart - we will shortly be publishing an interface for you!

```
PROGRAM 1: "Walk and Avoid"
10 REM ** HEBOT's MOVE **
20 HEBOT = &FCFO:REM HEBOT's address
30 Collision = FALSE:REM Not colliding yet
40 Motion = 5: REM forward
50 ?HEBOT = Motion:REM HEBOT to move
60 PROCdelay(2):REM move for .2 secs
70 ?HEBOT = Motion + 16:REM move and flash lights
80 PROCdelay(2):REM for .2 secs
90 Sensors = ?HEBOT AND 15:REM test sensors
100 IF Sensors <> 0 THEN 140:REM in collision!
110 IF Collision = TRUE THEN 180
120 Emergency = INKEY(50):REM any key pressed?
130 IF Emergency > 0 THEN ?HEBOT = 0:STOP:ELSE 50
140 IF Sensors > 6 THEN 190
150 Motion = 10 + &R:REM to back and sound horn
160 Collision = TRUE:REM in collision
170 GOTO 50:REM to move back
180 Collision = FALSE:REM reset flag
190 ?HEBOT = 8:REM turn left
200 PROCdelay(1):REM turn for 1 sec
210 GOTO 40:REM to move forward again
300 DEF PROCdelay(secs)
310 TIME = TIME + secs * 100
320 REPEAT
330 UNTIL TIME = secs * 100
340 ENDPROC
```

```
PROGRAM 2: "Recorded Moves"
10 REM ** Recorded moves **
20 HEBOT = &FCFO:REM HEBOT's address
30 %&O8 = 32:REM set 'Caps lock' mode
40 data = 0:REM HEBOT stopped
50 ?HEBOT = data
60 motions = "S"
70 last motions = "S"
80 INPUT "How many moves?";moves
90 DIM(moves)(moves)
100 DIM(times)(moves)
110 PRINT:PRINT "HEBOT is under your control."
120 PRINT "Use keys F, B, R, L, or S."
130 FOR J = 1 TO moves
140 TIME = 0
150 PRINT "Key move no. ";J
160 motions = GETS:REM wait for key
170 IF motions = last motions THEN 160:REM no change of key
180 IF motions = "S" THEN data = 0:GOTO 240:REM stop
190 IF motions = "F" THEN data = 6:GOTO 240:REM forward
200 IF motions = "B" THEN data = 10:GOTO 240:REM back
210 IF motions = "L" THEN data = 9:GOTO 240:REM left
220 IF motions = "R" THEN data = 6:GOTO 240:REM right
230 GOTO 160:REM invalid key pressed
240 ?HEBOT = data:REM instruct HEBOT
250 moves(J) = data:REM store move
260 times(J) = TIME:REM store time
270 last motions = motions
280 NEXT J
290 PRINT "Press S to stop HEBOT"
300 IF GETS <> "S" THEN 290
310 ?HEBOT = 0:REM stop HEBOT
320 times(moves) = TIME
330 PRINT:INPUT "How many repeats?";repeats
340 FOR K = 1 TO repeats
350 PRINT "Repetition no. ";K
360 FOR J = 1 TO moves
370 PRINTTAB(16) "Move no. ";J
380 TIME = 0
390 ?HEBOT = moves(J)
400 REPEAT
410 UNTIL TIME = times(J)
420 NEXT J
430 NEXT K
440 PRINT:PRINT "That's all!"
450 END
```

Two HEBOT programs in BBC BASIC.

YOUR OWN TELEPHONE SYSTEM

Miniature 10 Way Manual Exchange with simple instructions. (Require the addition of 10 resistors, 9 diodes, 50V power supply and a bugger)

RECONDITIONED TELEPHONES

Push Button Trimphones £15 + £.80 p&p 2 for £28 + £2.50

Push Button 746 £13.50 + £1.80. 2 for £25 + £2.50

Recent Style Dial Phones £4.75 + £1.80. 2 for £9 + £2.50. 5 for £20 + £5

Seconds (in good working order)

Class A (not too bad) £3.50 + £1.80. 5 for £15 + £5.

Class B (grotty) £2.50 + £1.80. 5 for £9 + £5.

FREE on request — Leaflet "D.I.Y. Telephone Systems and Automatic Exchange Design".

HIGH QUALITY TEMP. GAUGE 0³ — 120°C Remote sensor on 38" capillary, panel mounting dial 55mm. dia. **ONLY £2.50**

16A 240V RANCO THERMOSTAT Wide control range (low room temp. to over boiling point) Sensor on 22" capillary. **£2.30**, including control knob.

RANCO THERMAL CUT-OUT 100°C 15A 240V. Sensing coil on 41in. capillary panel mounting with reset button **£1.20**

BUY ONE EACH OF ABOVE FOR £5.50

GEARED Synchronous motor, 8 r.p.m., 240V A.C. 3 Watt **£2**

SOLENOID GAS VALVE. 240V A.C. 5 P.S.I. suitable for non-corrosive fluids. **£2.20**



L.E.M. SERVICES
22 Emscote Road,
Warwick,
Warwickshire

ADD 50p P&P ORDERS OVER £7.50 POST FREE
unless stated otherwise

ALL ITEMS — MONEY BACK IF NOT DELIGHTED

TECHNICAL TRAINING IN ELECTRONICS, TELEVISION AND AUDIO

IN YOUR OWN HOME — AT YOUR PACE

ICS can provide the technical knowledge that is so essential to your success, knowledge that will enable you to take advantage of the many opportunities open to the trained man. You study in your own home, in your own time and at your own pace and if you are studying for an examination ICS guarantee coaching until you are successful.

City & Guilds Certificates

Radio Amateurs

Basic Electronic Engineering (Joint C&G/ICS)

Certificate Courses

TV and Audio Servicing
Radio & Amplifier Construction
Electronic Engineering* and Maintenance
Computer Engineering* and Programming
TV, Radio and Audio Engineering
Electrical Engineering,* Installation and Contracting

*Quality for IET Associate Membership



Approved by CACC



Member of ABCC

POST OR PHONE TODAY FOR FREE BOOKLET

Please send me your FREE School of Electronics Prospectus.

Subject of Interest _____

Name _____

Address _____



Post to: Dept G262
ICS School of Electronics
160 Stewarts Road
London SW8 4UJ



01-622 9911
(All Hours)

ELECTROVALUE

Understandably
Britain's most popular
and relied-upon
suppliers of

SEMI-CONDUCTORS

I.C.s

COMPONENTS

COMPUTING EQUIPMENT
TOOLS, BOXES, CONNECTORS
and much, much more

THE LATEST PRICE LIST TELLS ALL

Large S.A.E. brings your FREE copy by return
GOOD PRICES - GOOD SERVICE - DISCOUNTS

Send for yours now to:

ELECTROVALUE LTD.

Head Office, Mail Order Dept and Shop

289 St. Judes Road, Englefield Green, Egham, Surrey TW20 0HB

Telephone Egham (STD 0784; London 871 33603; Telex 264475

Also in Manchester for personal shoppers at:

680 Burnage Lane, Burnage, Manchester M19 1NA - Telephone 061-432 4945

Computing Shop -

700 Burnage Lane, Manchester - Telephone 061-431 4866

COMPETITION-PRO JOYSTICK

PRECISION GAME CONTROL!



ONLY £25.00 inc. VAT

PLUS £1.00 P + P

For **ZX SPECTRUM**
Complete with stylish interface unit simply plug in for instant arcade action

Outstanding Features

- Super strong nylon and steel construction, built to last
- A total of 8 directions plus 2 large fire buttons
- Arcade proven moulded leaf switches ensure incredible reliability
- Complete with self contained boxed interface which simply plugs into the Spectrum expansion port (with or without printer)
- Easily programmed in BASIC or M/C.

These arcade games, designed exclusively for the Joystick by leading software houses, are now available for Spectrum:

Time Gate	M/C	48K	£6.95	Spooky Man	M/C	16K	£4.95
Meteoroids	M/C	16K	£6.95	Cosmos	M/C	16K	£4.95

Watch this space for new software! Available only from:

KEMPSTON

MICRO ELECTRONICS

Dept HE5 180a Bedford Road, Kempston, Bedford MK42 8BL

BACKNUMBERS

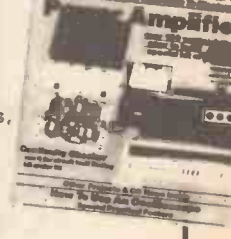
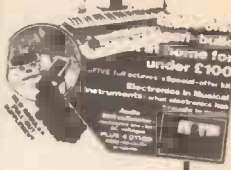

February 1980
 Passion Meter, Win Indicator, Short Circuit Special, Kit Review Special, Into Electronics Construction Part 1.

May 1980
 MiniClocks, 5080 Preamp, Model Railway Track Cleaner, 5080 Loudspeakers, Loudspeaker Crossover Design, Radio Controlled Model Survey.

June 1980
 Microbe Radio Control System, Egg Timer, Two Watt Amplifier, Fog Horn, Short Circuits, LEDs and LED Displays.

July 1980
 Sound-Operated Flash Trigger, 18 + 18 Car Stereo Booster, Hazard Flasher, Electronics in Photography, Electronic Espionage, Piezo Electricity.

August 1980
 EquiTone Car Equaliser, Pass-The-Loop Game, Gaztec Gas Detector, OP-Amp Checker, In-Car Entertainment Survey, Introducing Microprocessors.

September 1980
 MicroMixer, Reaction Tester, Guitar Phaser, Development Timer, Teletext Explained, Into Digital Electronics Part 1.

October 1980
 Kitchen Timer, Tug 'o' War Game, Light Dimmer, Freezer Alarm, Intruder Alarm, Temperature-Controlled Soldering Iron.

January 1981
 Car Rev-Counter, Bench Amplifier, Sound-Into-Light Converter, Chuffer, Electronic Games reviewed.

February 1981
 Heartbeat Monitor, High-Impedance Voltmeter, Medium Wave Radio, Two-Tone Train Horn, Audio Signal Generator.

March 1981
 Public Address Amplifier, Windscreen Wiper Controller, Bicycle Speedometer, Photographic Timer, Microcassettes.

April 1981
 Pre-Amplifier Part 1, Super Siren, Guitar Tremolo, Russian Roulette Game, Doorbell Monitor, Anatomy of a Space Shuttle.

May 1981
 Electronic Organ, Voice-Operated Switch, Infra-Red Controller, Pre-Amplifier Part 2, Audio Millivoltmeter.

June 1981
 Power Amplifier Part 1, Continuity Checker, Envelope Generator, Early Radio, Gadgets, Games and Kits Supplement.

July 1981
 Burglar Alarm, Doorbuzzer, Treble Booster, Electronic Aids for the Disabled, Power Amplifier Part 2.

August 1981
 Electronic Ignition, Thermometer, Electronic Organ (final part), RPM Meter, Bench Power Supply, Radio Control Survey, Into Electronic Components Part 1.

All of the 1980 issues, except January and April, are still available together with the remaining issues from 1981.

All backnumbers cost £1.25 each. For those of you who only want copies of articles, we do offer a photocopying service. Each copy costs £1.25 and information as to its title and publication date should be given. Ordering backnumbers and photocopies could hardly be easier, just fill in the coupon, cut it out and send it to:

**Hobby Electronics,
 145 Charing Cross Road,
 London WC2H 0EE**

Please remember to mark your envelope with the service you require, **BACKNUMBERS** or **PHOTOCOPIES**, otherwise our mailroom won't like you.

**HOBBY ELECTRONICS
 BACKNUMBER ORDER FORM**

Please send me the following items:

NAME

ADDRESS

.....

.....

.....

Back issues at £1.25 each

I enclose £.....

Cheques and Postal Orders should be made payable to ASP Ltd.

**HOBBY ELECTRONICS
 PHOTOCOPY ORDER FORM**

Please send me the following items:

NAME

ADDRESS

.....

.....

Photocopies of in the

..... issue at £1.25 each

I enclose £.....

Cheques and Postal Orders should be made payable to ASP Ltd.



Universal NI-CAD, battery charger. All plastic case with lift up lid. Charge/Test switch. LED indicators at each of the five charging points.

Charges:- PP3 (9V), U12 (1.5V penlite), U11 (1.5V "C"), U2 (1.5V "D"), Power:- 220-240V AC, Dims:- 210 x 100 x 50mm. Knock down price only while stocks last.

Only £6.00
Order No. MW 398

Multitester & Transistor Tester
DC volts 0-1v-5v-2.5v-10v-50v-250v-1000v ±3%
AC volts 0-10v-50v-250v-1000v ±3%
DC current 0-50uA-2.5mA-25mA-0-25A ±3%

Resistance:
Minimum 0-2-2-200-200k ohms
Midscale 20-200-20k-200k ohms
Maximum 2k-20k-2m-20m ohms

As a transistor tester:
Leakage current 0-150uA at Z1k range
0-15mA at X10 range
0-150mA at X1 range

±3%
Only £11.95
Order No. HT 320

±5%

PLEASE ADD 15% VAT & £1 P&P

ENFIELD ELECTRONICS 208 BAKER ST., ENFIELD, MIDDX. Tel: 01-366 1873

SWITCHES SWITCHES SWITCHES

vast stocks of high quality approved switches normally only sold to industry now available to the hobbyist at bargain prices.

Example: Miniature Toggles:-

S.P. [ON-ON] @ £0.51 each)
S.P. [ON-OFF-ON] @ £0.54 each) For full product list, send s.a.e.
D.P. [ON-ON] @ £0.72 each)
D.P. [ON-OFF-ON] @ £0.78 each)

****SPECIAL OFFER**** 1 off each only £3.00 including p/p & VAT. Send cheque or P.O. to:

SELECT COMPONENTS LTD
STAMFORD HOUSE, STAMFORD NEW ROAD
ALTRINCHAM, CHESHIRE WA14 1BL

TALK TO THE WHOLE WORLD

Study now for the **RADIO AMATEUR'S EXAMINATION**

We have had 40 years successful experience in training men and women for the G.P.O. Transmitting licence.

FREE R.A.E. brochure without obligation from:-

British National Radio & Electronics School
READING, BERKS. RG1 1BR

Name

Address

HE/5/817 BLOCK CAPS PLEASE

VARIABLE VOLTAGE POWER SUPPLIES

1 - 30v 1.6A	£38.75	0 - 30v 1.6A	£39.99
1 - 30v 3A	£42.99	0 - 30v 3A	£44.50
1 - 30v 5A	£45.75	0 - 30v 5A	£47.80
1 - 30v 10A	£56.99	0 - 30v 10A	£58.99

MULTIRAIL POWER SUPPLIES FOR MICROS ETC.

5v 5A, - 5v 1A, 12v 1A, - 12 1A, 24v 1A	£34.50
-----------------------------------------	--------

(5V HAS CROWBAR OVERVOLTAGE PROTECTION)

CONSTANT VOLTAGE/CONSTANT CURRENT SUPPLY

1 - 32V/100mA - 5A	£55.90
--------------------	--------

HIGH EFFICIENCY SWITCHING POWER SUPPLY

2 - 32V 4A Max	£52.99
----------------	--------

OTHER SUPPLIES FOR MICROS

5v 3A	£25.99	5v 5A	£28.99	5v 10A	£35.99
12v 1A	£12.45	12v 3A	£27.95		

(ALL THE ABOVE HAVE CROWBAR OVER VOLTAGE PROTECTION)

C.B. RADIO E.T.C. POWER SUPPLIES

1 - 15v 3A	£27.99	1 - 15v 5A	£34.99
- 2 - 15v 3A	£29.99	- 2 - 15v 5A	£35.99

SWITCHMODE P.S.U. 5v 5A £35.75

NICAD CONSTANT CURRENT CHARGER FOR ALL DOMESTIC BATTERIES £18.99

S.A.E. FOR LISTS

ALL THE ABOVE SUPPLIES ARE FULLY STABILISED AND OVERLOAD PROTECTED. ALL PRICES ARE INCLUSIVE AND INCLUDE CARRIAGE

EDWARDS ELECTRIC
UNIT 3, MILL LANE, CHURCH STREET, BRIDGWATER, SOMERSET TA6 5AT

LEARN BASIC ELECTRONICS

with our PPG FUN KITS

Four LEARNING courses plus 50 KITS to prove your knowledge.

Send for catalogue to:

ELECTROMECH LTD
51a Meldreth Road, Shepreth, Royston, Herts SG8 6PS
TEL: 0763 61372

It's easy to complain about advertisements.

The Advertising Standards Authority. ✓
If an advertisement is wrong, we're here to put it right.

ASA Ltd, Brook House, Torrington Place, London WC1E 7HN.

RECHARGEABLE BATTERIES AND CHARGERS

PRIVATE OR TRADE ENQUIRIES WELCOME
FULL RANGE AVAILABLE SEND SAE FOR LISTS
£1.45 for booklet "Nickel Cadmium Power"

- NEW ALL BRITISH MULTI CHARGER
- NEW SEALED LEAD RANGE AVAILABLE

SANDWELL PLANT LTD
2 Union Drive, Boldmere, Sutton Coldfield, West Midlands
021-354 9764 After hours 0977 616913

GOT YOUR LATEST COPY YET???

Our 72 page fully illustrated catalogue includes special offer lists, order forms, and pre-paid envelopes and lots lots more. To obtain your copy of Marco Trading's latest catalogue send 35p plus 26p postage to:

Marco Trading, Dept HB2, The Maltings, High Street, Wem, Shropshire, SY4 5EN. Tel: 0939 32763



MAIL ORDER - WHOLESALE - RETAIL

ALARMS



FREE CATALOGUE!

OUR GREAT NEW ILLUSTRATED CATALOGUE IS PACKED WITH INFORMATION ON SUPERB QUALITY, PROFESSIONAL BURGLAR ALARM EQUIPMENT



AT UNBEATABLE PRICES!



SEND S.A.E. OR PHONE **NOW**

FOR YOUR COPY



THIEF CHECK BURGLAR ALARM D-I-Y SYSTEM



**A.D. ELECTRONICS
DEPT. HE3
217 WARBRECK MOOR
AINTREE LIVERPOOL
L9 0HU/051 523 8440**

ETESON ELECTRONICS



15b Lower Green,
Poulton-le-Fylde,
BLACKPOOL,
Lancs FY6 7JL

Tel: (0253) 885107

We are only small, but our aim is to please, and our stock range is growing all the time. If any of the following interests you:-

**TRANSISTORS - DIODES - CMOS - TTL - TTL LS - LINEAR ICs -
RESISTORS - POTENTIOMETERS - CAPACITORS - VEROBOARD -
VEROBOXES - INSTRUMENT CASES - TRANSFORMERS - FUSES -
GSC BREADBOARDS - SOLDERING IRONS - ETC, ETC.**

Please send a stamped addressed envelope or call in for a copy of our 16-page price list.

MAKE YOUR OWN P.C.B's.



DIRECT ETCH KIT

COPY DIRECT FROM MAGAZINE or OWN DESIGN

Simple system - Complete kit containing PCB, Pattern Transfer & Etch Resist Sheets, Tray & Etchant, Copper Cleaning Block, Gloves & full instructions. **£15.60**

Price inclusive of VAT & carriage. Please allow 21 days for delivery. Cheques, PO's or signed Access orders welcomed.



a division of
KELAN ENGINEERING Ltd
Hookstone Park
Harrogate, N. Yorks

complete P.C.B. workshop

HB/PC1

MASTER ELECTRONICS NOW! The PRACTICAL way!

This new style course will enable anyone to have a real understanding of electronics by a modern, practical and visual method. No previous knowledge is required, no maths, and an absolute minimum of theory.

You learn the practical way in easy steps mastering all the essentials of your hobby or to start or further a career in electronics or as a self-employed servicing engineer.

All the training can be carried out in the comfort of your own home and at your own pace. A tutor is available to whom you can write personally at any time, for advice or help during your work. A Certificate is given at the end of every course.

You will do the following:

- Build a modern oscilloscope
- Recognise and handle current electronic components
- Read, draw and understand circuit diagrams
- Carry out 40 experiments on basic electronic circuits used in modern equipment
- Build and use digital electronic circuits and current solid state 'chips'
- Learn how to test and service every type of electronic device used in industry and commerce today. Servicing of radio, T.V., Hi-Fi and microprocessor/computer equipment.



New Job? New Career? New Hobby? Get into **Electronics** Now!

FREE!
COLOUR BROCHURE

Please send your brochure without any obligation to

I am interested in:

HE/5/821

NAME _____

COURSE IN ELECTRONICS as described above

ADDRESS _____

RADIO AMATEUR LICENCE

OTHER SUBJECTS _____

MICROPROCESSORS

LOGIC COURSE

POST NOW TO:

BLOCK CAPS PLEASE

British National Radio & Electronics School Reading, Berks. RG1 7BR

PCB FOIL PATTERNS

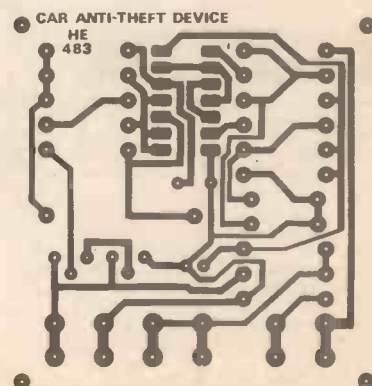
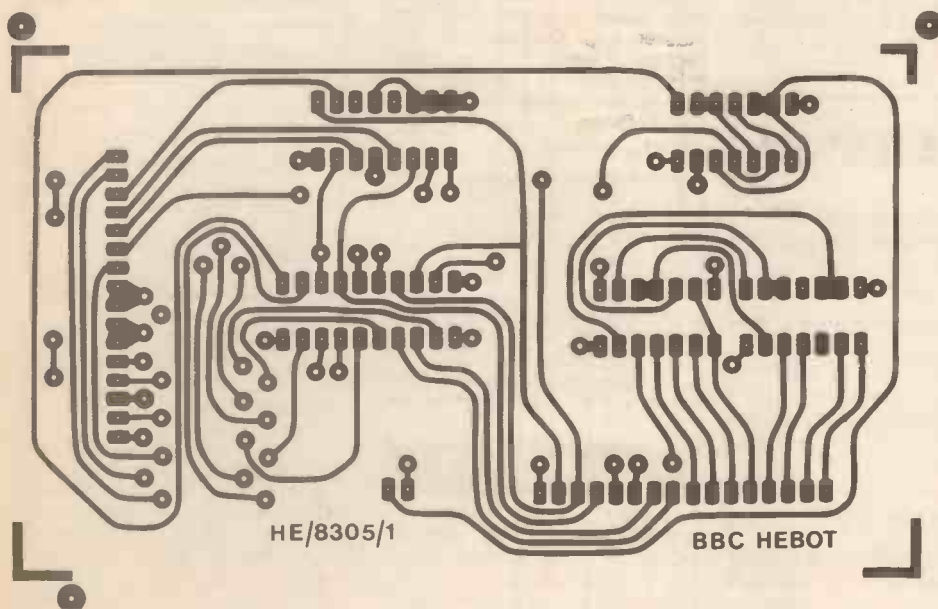
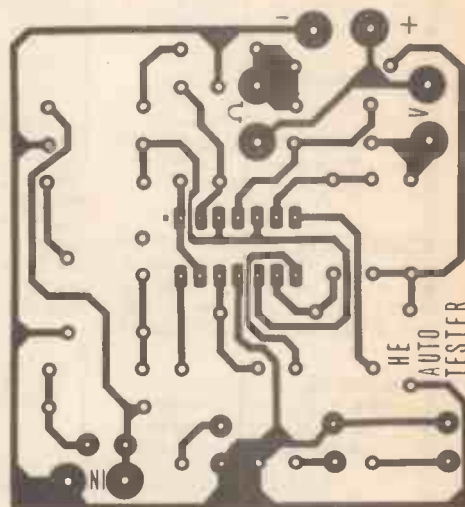
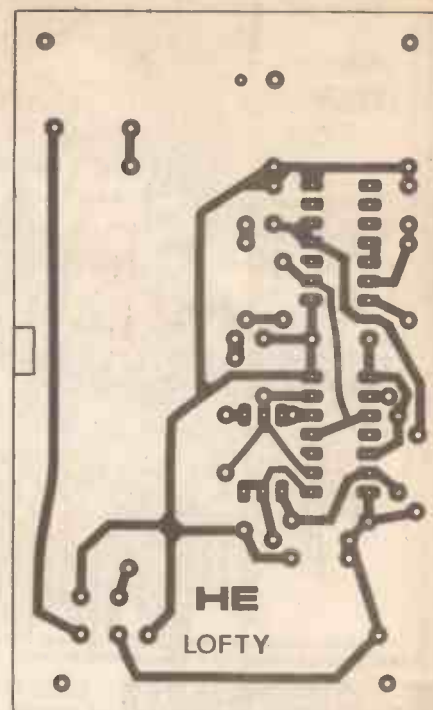
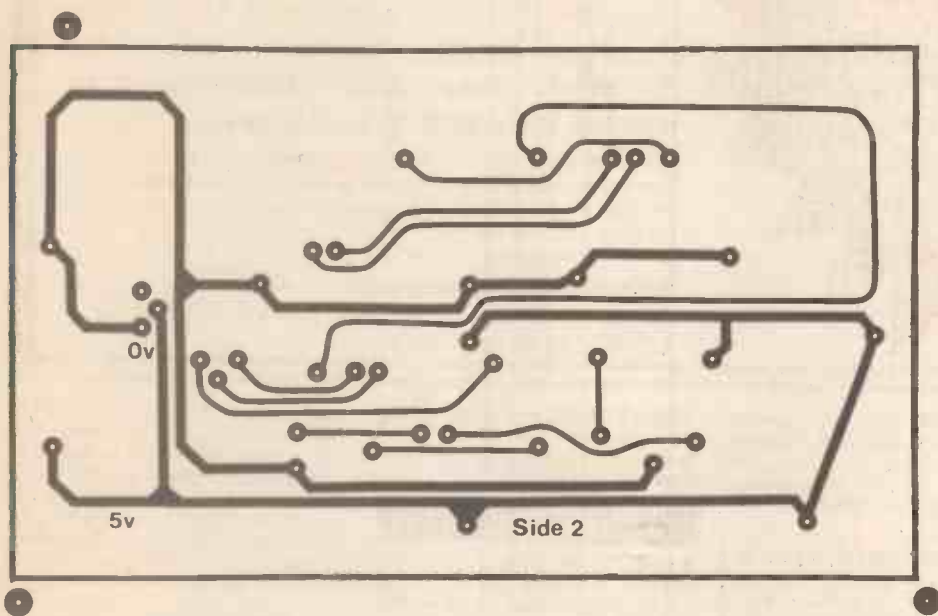

Top right; the HE Lofty' PCB, which was not published with the project.
 Middle right; the Auto-Tester PCB.
 Bottom right; the foil pattern for the Stall-Thief.
 Above top; the component side tracks for the BBC/HEBOT Interface.
 Above, the main foil pattern.

BARCLAYCARD

VISA

CLASSIFIED

THE PATH TO
SUCCESSFUL SALES!

01-437 1002
Ext 213

FOR SALE

SLIM COMBINATION — Stainless steel pen, & quartz L.C.D. watch, uses 'Parker' refill, instructions. Only £3.99. (spare battery 50p) Two for only £5.99! Tait's Mail Order (Dept. HE) 31 Lime Grove, Addlestone, Surrey.

KIA return an AD No 6 100 Watt fibreglass power-amplifiers + to 3 heatsinking... (£19.95p) — Ready to play + data... Post advert + £6.95p — 8 Cunliffe Road, Ilkley.

ACORN ATOM 12K + 12K PSU, VIA, LEADS, MANUAL software, including CHESS, INVADERS. Excellent condition. £180 — Crayford 528264

POWERFUL SW Medium FM portable radio, only £14.95 p + p £2.55. Sharland Enterprises, 7 Mountview, Mill Hill NW7 3HT.

L.C.D. PENWATCH 5 — Funchon S/Steel takes Parker refills. Guaranteed only £2.99 + 35p p + p spare battery. Add 50p Ashley Sales, 7 Beverley Gardens, St Albans, Herts AL4 9BJ.

COMPONENTS

BUMPER BOX OF BITS

WOW!! We've got so many components in stock, we can't possibly list them all!! — So buy a box, in it you'll find resistors, capacitors, displays, switches, panels with transistors, diodes, IC's, etc., coils, pots... and so on. All modern parts — guaranteed at least 1000 items. Minimum weight 10lbs. ONLY £8.50 inc.

ELECTRONICS WORLD
1F Dews Road Salisbury Wilts SP2 7SN
COMPONENTS

ELECTRONICS components shop in **MAID-STONE, KENT!** Thyronics Control Sys'tems, 8 Sandring Road, Maidstone, Kent. Maidstone 675354.

ALL NEW COMPONENTS

C-MOS 4012-8p, 4017-25p, 4019-14p, 4022-32p, 4023-12p, 4024-20p, 4025-12p, 4049-18p, 4071-12p, 4076-28p, 4081-10p, 4518-28p, 4520-26p, 4528-34p, 4557-140p, NE567-38p, SPX6-20p, 314A223-4p, TTL 7400-6p, 7404-8p, 7412-8p, 7419-14p, 7414-20p, 7416FJ-12p, 7495-24p, 74L592-24p.

30p P&P order under £6. No VAT
V Bansal, 14 Davigdor Road, Hove,
Sussex BN3 1QD. Tel (0273) 732419

DIGITAL WATCH REPLACE-MENT parts. Batteries, displays, backlights etc. Also reports, publications, charts. S.A.E. for full list. Profords, Copnersdrive, Holmergreen, Bucks HP15 6SGE.

WAVEBANDS

Auto Electronics,
103 Coventry Street,
Kidderminster
Tel: (0562) 2179

Brand new components by return post or ring with Access/Barclaycard number for same day despatch.

All manufacturers guaranteed new stock. All at most competitive prices. Catalogue available only 50p. All prices inclusive of VAT.

BOOKS & PUBLICATIONS

HOBBY ELECTRONICS MAGAZINE. Opportunity to purchase volumes one to four. Mint condition. Offers? Crayford 526380.

ELECTRONICS BOOKS. International publishers. Lowest rates. Ask list. Business promotion. 376 Lajpatrai Market Delhi India.

ADVERTISEMENT RATES

Semi-Display (min 2 cms)

1-3 insertions £7.50 per cm

6-11 insertions £7.00 per cm

12+ insertions £6.50 per cm

Lineage 26p per word (min 15 words)

Box Nos. £2.50

Closing date 2nd Friday of the month preceding publication date.

All advertisements in this section must be prepaid. Advertisements are accepted subject to the terms and conditions printed on the advertisement rate card (available on request)

Send your requirements and cheque/P.O. to:

HOBBY ELECTRONICS CLASSIFIED
ADVERTISING, 145, CHARING CROSS RD,
LONDON WC2H 0EE

SPECTRUM journal Microzine 9k cassette £1 payable S. Brown 86 Bronson Road London SW20 8DY

KITS

ELECTRONIC kits for sale: Morse Practice £4.10, Dice £8.10. SAE for details. Bee Micro, 33 Bevendean Crescent, Brighton, E Sussex.

PRINTED CIRCUITS. Make your own simply, cheaply and quickly! Golden Fotolac light-sensitive lacquer — now greatly improved and very much faster. Aerosol cans with full instructions, £2.25. Developer 35p. Ferric chloride 55p. Clear acetate sheet for master 14p. Copper-clad fibreglass board, approx. 1mm thick £1.75 sq. ft. Post/packing 75p. White House Electronics, Castle Drive, Praa Sands, Penzance, Cornwall.

HAVEN HARDWARE

ZX81 £49.90. Inverse Video £4.50. Repeating Keymodule £5.95. ZX Spectrum software: Repulsor fruit machines and Solitar £4.95 each. Mancala and Patience £5.95 each. Jupiter Ace £89.90. Inverse Video £4.95.

Access taken. SAE for details.

HAVEN HARDWARE
4 Asby Road, Asby, Workington,
Cumbria Tel: 094-686 627
Agency enquiries welcome

EQUIPMENT

EQUIPMENT

BURGLAR ALARM EQUIPMENT. Please visit our 2,000 sq. ft. showrooms or write or phone for your free catalogue. C.W.A.S. Ltd. 100 Rooley Avenue, Bradford BD6 1DB. Telephone 0274-308920.

BURGLAR ALARM EQUIPMENT: As used in the trade for DIY. JN Security Centre, 176 Sydenham Road, London SE26 5JZ. Tel 01-778 1111 Showroom open six days.

HIGH POWER MERCURY ION LASER, emits green/red light. Easily built by the amateur constructor. Ideal school project etc. comprehensive kit of plans, including source of all materials. £5.25 + 25p p&p. Lastertech, 31 Mill Brow, Chaderton, Lancs.

CENTURIUM ALARMS

We manufacture, you save £ £ £'s

Send s.a.e. or phone for our Free list of professional D.I.Y. Burglar Alarm Equipment and accessories. Discount up to 20% off list prices, eg. Control Equipment from £15.98, Decoy Bell Boxes from £5.95 inc.

TRADE ENQUIRIES WELCOME

0484-21000

or 0484 35527 (24 hr. ans.)
CENTURIUM ALARMS (ETI)

265 Wakefield Road, Huddersfield
HD5 9BE, W. Yorkshire
Access & Visa
Orders Welcomed

TELEQUIPMENT. Type 55D scope dual beam separate XY amp etc. Slight screen burn otherwise perfect. Sensible offers 01-428 6089

U.V. Light exposer unit for use in prep. of Photo-resist P.C.B's. Attractive wooden construction with exposer area of 250 x 150mm. Case 350x250x95mm 240V operation. Only £37.00 p&p. Send cheque to V.E.P. Ltd., 5 Hewens Road, Uxbridge, UB10 0FR.

AERIAL AMPLIFIERS Improve weak television reception. Price £6.70. S.A.E. for leaflets. Electronic Mailorder, Ramsbottom, Lancashire BL0 9AGH.



MULLARD SPEAKER KITS

Purposefully designed 40 watt R.M.S. and 30 watt R.M.S. 8 ohm speaker systems recently developed by MULLARD'S specialist team in Belgium. Kits comprise Mullard woofer (8" or 5") with foam surround and aluminium voice coil. Mullard 3" high power domed tweeter. B.K.E. built and tested crossover based on Mullard circuit, combining low loss components, glass fibre board and recessed loudspeaker terminals. **SUPERB SOUNDS AT LOW COST.** Kits supplied in polystyrene packs complete with instructions. 8" 40W system — recommended cabinet size 240 x 216 x 445mm
Price £14.90 each + £2.00 P & P.
5" 30W system — recommended cabinet size 160 x 175 x 295mm
Price £13.90 each + £1.50 P & P.

Designer approved flat pack cabinet kits, including grill fabric. Can be finished with iron on veneer or self adhesive vinyl etc.
8" system cabinet kit £8.00 each + £2.50 P & P.
5" system cabinet kit £7.00 each + £2.50 P & P.

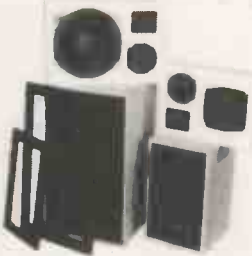

STEREO CASSETTE TAPE DECK MODULE.

Comprising of a top panel and tape mechanism coupled to a record/play back printed board assembly. Supplied as one complete unit for horizontal installation into cabinet or console of own choice. These units are brand new, ready built and tested.
Features: Three digit tape counter. Autostop. Six piano type keys, record, rewind, fast forward, play, stop and eject. Automatic record level control. Main inputs plus secondary inputs for stereo microphones. Input Sensitivity: 100mV to 2V. Input Impedance: 68K. Output level: 400mV to both left and right hand channels. Output impedance: 10K. Signal to noise ratio: 45dB. Wow and flutter: 0.1%. Power Supply requirements: 18V DC at 300mA. Connections: The left and right hand stereo inputs and outputs are via individual screened leads, all terminated with phono jacks (phono sockets provided). Dimensions: Top panel 5 1/2" x 11 1/2". Clearance required under top panel 2 1/2". Supplied complete with circuit diagram and connecting diagram. Attractive black and silver finish.
Price £26.70 + £2.50 postage and packing.
Supplementary parts for 18V D.C. power supply (transformer, bridge rectifier and smoothing capacitor) £3.50.



LOUDSPEAKERS

15" 100 watt R.M.S. (HI-FI, P.A., DISCO, BASS GUITAR) Die cast chassis, 2" aluminium voice coil, white cone with aluminium centre dome. 8 ohm imp., Res. Freq. 20Hz., Freq. Resp. to 2.5KHz., Sens. 97dB (As photograph). Price: £32.00 + £3 carriage.

12" 100 watt R.M.S. (HI-FI) Die cast chassis. 2" aluminium voice coil. Black cone. 8 ohm imp., Res. Freq. 20Hz., Freq. Resp. to 4.5KHz. Sens. 95dB. (As photograph). Price: £23.50 + £3 carriage.

8" 50 watt R.M.S. (HI-FI, P.A.) 1 1/2" aluminium voice coil. White cone. 8 ohm imp. Res. Freq. 40Hz., Freq. Resp. to 6KHz. Sens. 92dB. Also available with black cone fitted with black metal protective grille. (As photograph). Price: White Cone £8.90. Black cone/grille £9.50 P&P £1.25.

12" 85 watt R.M.S. McKENZIE C1285GP (LEAD GUITAR, KEYBOARD, DISCO) 2" aluminium voice coil, aluminium centre dome, 8 ohm imp., Res. Freq. 45Hz., Freq. Resp. to 6.5KHz., Sens. 98dB. Price: £22.00 + £3 carriage.

12" 85 watt R.M.S. McKENZIE C1285TC (P.A., DISCO) 2" aluminium voice coil. Twin cone. 8 ohm imp., Res. Freq. 45Hz., Freq. Resp. to 14KHz. Price £22 + £3 carriage.

15" 150 watt R.M.S. McKENZIE C15 (BASS GUITAR, P.A.) 3" aluminium voice coil. Die cast chassis. 8 ohm imp., Res. Freq. 40Hz., Freq. Resp. to 4KHz. Price: £47 + £4 carriage.



OMP 80 LOUDSPEAKER

The very best in quality and value. Ported tuned cabinet in hardwearing black vinyl with protective corners and carry handle. Built and tested, employing 10in British driver and Piezo tweeter. Spec: 80 watts RMS; 8 ohms; 45Hz 20KHz; Size: 20in x 15in x 12in; Weight: 30 pounds.
Price: £49.00 each. £90 per pair
Carriage: £5 each. £7 per pair

BK ELECTRONICS

Prompt Deliveries
VAT inclusive
prices
Audio Equipment
Test Equipment
by
Thandar
and
Leader

1K.WATT SLIDE DIMMER

- Controls loads up to 1KW
- Compact size
4 3/4" x 1 3/16" x 2 1/2"
- Easy snap in fixing through panel/cabinet cut out
- Insulated plastic case
- Full wave control using 8am triac
- Conforms to BS800
- Suitable for both resistance and inductive loads

Innumerable applications in industry, the home, and discos theatres etc.
Price: £11.70 each + 50p P&P (Any quantity)



KEYBOARDS



MEMBRANE KEYBOARDS manufactured from a tough polycarbonate film mounted on 1mm glass fibre printed circuit board assembly incorporating silver plated contacts.

16 way numeric keyboard Standard keyboard providing 0-9 and A-F functions.
Size: 100mm x 100mm x 2mm. Price: £5.99 + 35p p&p
Alpha Numeric Keyboard Full size 55 key non encoded keyboard with the commonly required functions in a Dweny array. Matrix output via a 16 pin DIL socket.
Size: 350mm x 100mm x 2mm. Price: £13.99 + 50p p&p



BSR P256 TURNTABLE

- P256 turntable chassis
- S shaped tone arm
- Belt driven
- Aluminium platter
- Precision calibrated counter balance
- Antiskate (bias device)
- Damped cueing lever
- 240 volt AC operation (Hz)
- Cut-out template supplied
- Completely manual arm.

This deck has a completely manual arm and is designed primarily for disco and studio use where all the advantages of a manual arm are required.
Price: £31.35 + £2.50 P&P



OMP POWER AMPLIFIER MODULES

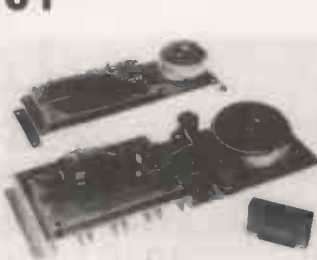

100 WATT R.M.S. AND 300 WATT R.M.S. MODULES

Power Amplifier Modules with integral toroidal transformer power supply, and heat sink. Supplied as one complete built and tested unit. Can be fitted in minutes. An LED Vu meter is available as an optional extra.

SPECIFICATION:
Max Output Power: 110 watts R.M.S. (OMP 100)
310 watts R.M.S. (OMP 300)
Loads: Open and short circuit proof. 4-16 ohms.
Frequency Response: 20Hz — 25KHz ±3dB.
Sensitivity for Max. Output: 500mV at 10K (OMP 100) 1V at 10K (OMP 300)
T.H.D.: Less than 0.1%
Supply: 240V 50Hz
Sizes: OMP 100 360 x 115 x 72mm
OMP 300 460 x 153 x 66mm
Prices: OMP 100 £31.50 each + £2.00 P&P
OMP 300 £88.00 each + £3.00 P&P
Vu Meter £6.50 each + 50p P&P

Matching 3-way loudspeakers and crossover

Build a quality 60watt RMS system 8ohms
Build a quality 60 watt R.M.S. system.

- ★ 10" Woofer 35Hz-4.5KHz
- ★ 3" Tweeter 2.5KHz-19KHz
- ★ 5" Mid Range 600Hz-8KHz
- ★ 3-way crossover 6dB/oct 1.3 and 6KHz

Recommended Cab-size 26" x 13" x 13"
Fitted with attractive cast aluminium fixing es-cuteons and mesh protective grills which are removable enabling a unique choice of cabinet styling. Can be mounted directly on to baffle with or without conventional speaker fabrics. All three units have aluminium centre domes and rolled foam surround. Crossover combines spring-loaded loudspeaker terminals and recessed mounting panel.
Price £22.00 per kit + £2.50 postage and packing. Available separately. prices on request.



12" 80 watt R.M.S. loudspeaker.
A superb general purpose twin cone loudspeaker. 50 oz. magnet. 2 aluminium voice coil. Rolled surround. Resonant frequency 25Hz. Frequency response to 13KHz. Sensitivity 95dB. Impedance 8ohm. Attractive blue cone with aluminium centre dome.
Price £18.49 each + £3.00 P&P.



PIEZO ELECTRIC TWEETERS - MOTOROLA

Join the Piezo revolution. The low dynamic mass (no voice coil) of a Piezo tweeter produces an improved transient response with a lower distortion level than ordinary dynamic tweeters. As a crossover is not required these units can be added to existing speaker systems of up to 100 watts (more if 2 put in series). **FREE EXPLANATORY LEAFLETS SUPPLIED WITH EACH TWEETER.**

TYPE 'A' (KSN2036A) 3" round with protective wire mesh, ideal for bookshelf and medium sized Hi-fi speakers. Price £4.29 each.

TYPE 'B' (KSN1005A) 3 1/2" super horn. For general purpose speakers, disco and P.A. systems etc. Price £4.99 each.

TYPE 'C' (KSN6016A) 2" x 5" wide dispersion horn. For quality Hi-fi systems and quality discos etc. Price £5.99 each.

TYPE 'D' (KSN1025A) 2" x 6" wide dispersion horn. Upper frequency response retained extending down to mid range (2KHz). Suitable for high quality Hi-fi systems and quality discos. Price £7.99 each.

TYPE 'E' (KSN1038A) 3 1/4" horn tweeter with attractive silver finish trim. Suitable for Hi-fi monitor systems etc. Price £4.99 each.

TYPE 'F' (KSN1057A) Cased version of type 'E'. Free standing satellite tweeter. Perfect add on tweeter for conventional loudspeaker systems. Price £10.75 each.
P&P 20p ea. (or SAE for Piezo leaflets).

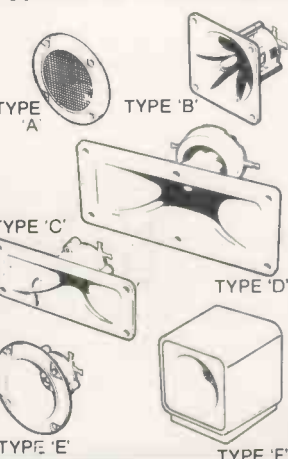

B.K. ELECTRONICS

37 Whitehouse Meadows, Eastwood, Leigh-on-Sea, Essex SS9 5TY

★ SAE for current lists. ★ Official orders welcome. ★ All prices include VAT ★ Mail order only ★ All items packed (where applicable) in special energy absorbing PU foam. Callers welcome by prior appointment. please phone 0702-527572.



100 FREE PROGRAMS

FROM SILICA SHOP — WITH EVERY PURCHASE OF AN

ATARI 400

800



ATARI PRICES REDUCED!
 We at Silica Shop are pleased to announce some fantastic reductions in the prices of the Atari 400/800 personal computers. We believe that the Atari at its new price will become the U.K.'s most popular personal computer and have therefore set up the Silica Atari Users Club. This club already has a library of over 500 programs and with your purchase of a 400 or 800 computer we will give you the first 100 free of charge. There are also over 350 professionally written games and utility programs, some are listed below. Complete the reply coupon and we'll send you full details. Alternatively give us a ring on 01-301 1111 or 01-309 1111.

ATARI 400 with 16K	£159
ATARI 400 with 48K	£228
ATARI 800 with 48K	£349

400/800 SOFTWARE & PERIPHERALS

Don't buy a T.V. game! Buy an Atari 400 personal computer and a game cartridge and that's all you'll need. Later on you can buy the Basic Programming cartridge (£35) and try your hand at programming using the easy to learn BASIC language. Or if you are interested in business applications, you can buy the Atari 800 + Disk Drive + Printer together with a selection of business packages.

Silica Shop have put together a full catalogue and price list giving details of all the peripherals as well as the extensive range of software that is now available for the Atari 400/800. The Atari is now one of the best supported personal computers. Send NOW for Silica Shop's catalogue and price list as well as details on our users club.

THE FOLLOWING IS JUST A SMALL SELECTION FROM THE RANGE OF ITEMS AVAILABLE:

ACCESSORIES Cables Cassettes Diskettes Joysticks Le Stick - Joystick Misc. Supplies Paddles	ADVENTURE INT Scott Adams Adv No 1 Adventureland No 2 Pirate Adv No 3 Mission Imp No 4 Woodoo Cast No 5 The Count No 6 Strange Ody No 7 Mystery Fun No 8 Pyramid of D No 9 Ghost Town No 10 Saw Island 1 No 11 Saw Island 2 No 12 Golden Voy Angle Worms Deflections Galactic Empire Galactic Trader Lunar Lander	ADVENTURE Mountain Shoot Rearguard Star Flite Sunday Golf	AUTOMATED SIMULATIONS Crush Crumble Cmp Datstones of Ryn Dragons Eye Invasion Orion Rescue at Rigel Ricochet Star Warrior Temple of Apsah Upper Reaches Aps	BOOKS Basic Ref Manual Compute Atari DOS Compute Bk Atari Compute Magazine De Re Atari DOS Utilities List DOS2 Manual Misc Atari Books OS System Listing Wiley Manual	BUSINESS Calculator Database Managmt Decision Maker Graph-It Invoicing Librarian Mort & Loan Anal Nominal Ledger Payroll Personal Finl Mgmt Purchase Ledger Sales Ledger Statistics 1 Stock Control Telelink 1 VisiCalc Weekly Planner Word Processor	CRYSTALWARE Beneath The Pyramid Fantasyland 2041 Galactic Quest House Of Usher Watersloo World War III	DYNACOMP Alpha Fighter Chompelo Crystals Forest Fire Intruder Alert Monarch Moonprobe Moving Maze Nominoes Jigsaw Rings of The Emp Space Tilt Space Trap Stud Poker Triple Blockade	EDUCATION from APX Aligcalc Atlas of Canada Cubbyholes Elementary Biology Frogmaster Hickory Dickory Inst Comptg Dem Lemonade Letterman Mapware	EDUCATION from ATARI Conv French Conv German Conv Italian Conv Spanish Energy Czar European C & Caps Hangman Invite To Prog 1/2/3 Kingdom Music Composer	Maths-Tac-Toe Metric & Prob Solvg Mugwump Music Terms/Notatn Musical Computer My First Alphabet Number Blast Polycalc Presidents Of U.S. Quiz Master Starware Stereo 3D Graphics Three R Math Sys Video Math Flash Wordmaker	EMIL SOFTWARE British Heritage Cribbage/Dominos Darts European Scene Jig Hickory Dickory Humpty Dumpty Jumbo Jet Lander Snooker & Billiards Submarine Commdr Super Cubes & Tilt Tournament Pool	ENTERTAINMENT from APX Alien Egg Anthill Attank Avalanche Babel Blackjack Casino Block Buster Block Em Bumper Pool	ENTERTAINMENT from ATARI Asteroids Basketball Jax-O Jukebox Lookahead Memory Match Midas Touch Minotaur Outlaw/Howitz Preschool Games Pro Bowling Pushover Rabbitz Reversi II Salmon Run 747 Landing Simul Seven Card Stud	Castle Centurion Checker King Chinese Puzzle Codecracker Comedy Diskette Dice Poker Dog Daze Domination Downhill Eastern Front Galahad & Holy Grl Graphics/Sound Jax-O Jukebox Lookahead Memory Match Midas Touch Minotaur Outlaw/Howitz Preschool Games Pro Bowling Pushover Rabbitz Reversi II Salmon Run 747 Landing Simul Seven Card Stud	Sleazy Adventure Solitaire Space Chase Space Trek Sultans Palace Tact Trek Terry Wizards Gold Wizards Revenge	Jawbreaker Mission Asteroid Mouskattack Threshold Ulysses/Golden Fl Wizard & Princess	PERIPHERALS Centronics Printers Disk Drive Epson Printers Program Recorder RS232 Interface Thermal Printer 16K Memory RAM 32K Memory RAM	PROGRAMMING AIDS from Atari Assembler Editor Dismbler [APX] Microsoft Basic Pascal [APX] Pilot (Consumer) Pilot (Educator) Programming Kit	SANTA CRUZ Basics of Animation Bobs Business Display Lists Graphics Machine Kids 1 & 2 Horizontal Scrolling Master Memory Map Mini Word Processor Page Flipping Player Missile Gr Player Piano Sounds Vertical Scrolling	PERSONAL INT from APX Adv Music System Banner Generator Blackjack Tutor Going To The Dogs Keyboard Organ Morse Code Tutor Personal Fitness Prg Player Piano Sketchpad	SILICA CLUB Over 500 programs write for details
-------------------------------------------------------------------------------------------------------------------------	--------------------------------------------------------------------------------------------------------------------------------------------------------------------------------------------------------------------------------------------------------------------------------------------------------------------------------------------------------------------------------	------------------------------------------------------------------------------	-----------------------------------------------------------------------------------------------------------------------------------------------------------------------------------------------	------------------------------------------------------------------------------------------------------------------------------------------------------------------------------------------------------------	--------------------------------------------------------------------------------------------------------------------------------------------------------------------------------------------------------------------------------------------------------------------------------------------------------------------	---------------------------------------------------------------------------------------------------------------------------------	--------------------------------------------------------------------------------------------------------------------------------------------------------------------------------------------------------------------------------------	--------------------------------------------------------------------------------------------------------------------------------------------------------------------------------------	-----------------------------------------------------------------------------------------------------------------------------------------------------------------------------------------------	-------------------------------------------------------------------------------------------------------------------------------------------------------------------------------------------------------------------------------------------------------------------------------	-----------------------------------------------------------------------------------------------------------------------------------------------------------------------------------------------------------------------------------------	------------------------------------------------------------------------------------------------------------------------------------------------------	--------------------------------------------------------------------------------------------------------------------------------------------------------------------------------------------------------------------------------------------------------------------------------------	---------------------------------------------------------------------------------------------------------------------------------------------------------------------------------------------------------------------------------------------------------------------------------------------------------------------------------------------------------------------------------------------------------------------------------------	----------------------------------------------------------------------------------------------------------------------------------------------	-------------------------------------------------------------------------------------------------------------	-------------------------------------------------------------------------------------------------------------------------------------------------------------------------	------------------------------------------------------------------------------------------------------------------------------------------------------------------------	------------------------------------------------------------------------------------------------------------------------------------------------------------------------------------------------------------------------------------------------------------------------	---------------------------------------------------------------------------------------------------------------------------------------------------------------------------------------------------------	--------------------------------------------------------------

FOR FREE BROCHURES - TEL: 01-301 1111

For free brochure and reviews on our range of electronic products, please telephone 01-301 1111. To order by telephone, just quote your name, address, credit card number, and order requirements and leave the rest to us. Post and packing a FREE OF CHARGE in the UK. Express 24 hour delivery available at an additional charge.

- **SHOP DEMONSTRATION FACILITIES** - we provide full facilities at our shop in Sidcup, Monday to Saturday, 9am to 5pm (closing Thursday 1pm, Friday 8pm).
- **MAIL ORDER** - we are a specialist mail order company and are able to supply goods direct to your door.
- **MONEY BACK UNDERTAKING** - if you are totally unsatisfied with your purchase, you may return it to us within 15 days. On receipt of the goods in satisfactory condition, we will give you a full refund.
- **PART EXCHANGE SECOND-HAND MACHINES** - we offer a part exchange scheme to trade in many makes of T.V. games for personal computers.
- **COMPETITIVE PRICES** - our prices, offers and service are very competitive. We are never knowingly undercut and will normally match any lower price quoted by our competitors.
- **HELPFUL ADVICE** - available on the suitability of various computers.
- **AFTER SALES SERVICE** - available on all computers out of guarantee.
- **VAT** - all prices quoted above include VAT at 15%.
- **CREDIT FACILITIES** - we offer credit over 12, 24 or 36 months, please ask for details.

SILICA SHOP LIMITED
 Dept HE 05831-4 The Mews, Hatherley Road, Sidcup,
 Kent DA14 4DX Telephone 01-301 1111 or 01-309 1111

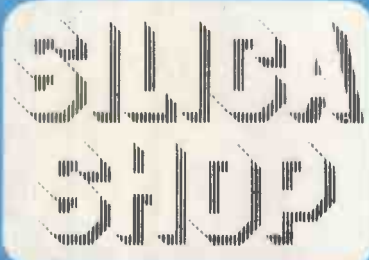

FREE LITERATURE

I am interested in purchasing an Atari 400/800 computer and would like to receive copies of your brochure and test reports as well as your price list covering all of the available Hardware and Software.

Name

Address

.....

Postcode

HE 5 83