

Hobby Electronics

SEPTEMBER 1982

ISSN 0142-6192

70p

Project Electronics For Everyone

MODEL PROJECTS

Three-Aspect Lights Controller



HE 'Junior'
Slot - Car Controller

PLUS...

RADIO RULES • MONITOR
BREADBOARDS • MICROTRAINING

POPULAR
COMPUTING
ZX Interface
Project

NICADS: UK's LOWEST PRICES

AMBIT'S NEW CONCISE COMPONENT CATALOGUE IS OUT NOW -

Available at your newsagent or direct, for 70p inc.

Ambit's new style catalogue continues to lead the market with low prices, new items, info, 3 £1 discount vouchers. In a recent supplier survey, we were one of only two suppliers listed in all categories!

There's a few examples of some super low prices

78XX 1A	37p
BC237/8/9	8p
3SK51	54p
10MHz XTALS	£2
8 Pole 10.7MHz XTAL filters	£14.50
2GHz coax relay	
150W	£10.95

All the "usual" stuff at rock bottom prices + Toko coils, crystal and ceramic filters, micrometals toroids, Fairite ferrites, Alps switches, OKI LSI, Piezo sounders, RF, IF Modules + Kits etc.



RECHARGEABLE UP TO 400 TIMES PER CELL!

CAPACITY	TYPE	1-9	10-49
500 mAh	AA	80	74
2200 mAh	C	2.35	1.99
1200 mAh	D	2.14	2.06
4000 mAh	D	3.05	2.85
110 mAh	PP3	3.70	3.50

Price on the page

CMOS	
4000	0.11
4001	0.11
4002	0.12
4007	0.13
4008	0.50
4008AE	0.80
4009	0.25
4010	0.30
4011AE	0.24
4011	0.11
4013	0.25
4015	0.50
4016	0.22
4017	0.40
4019	0.38
4020	0.55
4021	0.55
4022	0.55
4023	0.15
4024	0.33
4025	0.15
4026	1.06
4027	2.06
4028	0.50
4029	0.55
4030	0.35
4035	0.67
4040	0.50
4042	0.50
4043	0.50
4043AE	0.93
4044	0.60
4046	0.60
4047	0.68
4049	0.24
4050	0.24
4051	0.55
4052	0.55
4053	0.55
4054	1.30
4055	1.30
4056	1.30
4059	5.75
4060	0.75
4063	1.15
4066	0.30
4067	4.30
4068	0.16
4069AE	0.14
4070	0.16
4071	0.16
4072	0.16
4073	0.16
4075	0.16
4076	0.55
4077	0.18
4078	0.18
4081	0.12
4082	0.18
4093	0.30
4099	0.80
4175	0.80
4502	0.60
4503	0.50
4506	0.70
4507	0.37
4508	1.50
4510	0.55
4511	0.45
4512	0.55

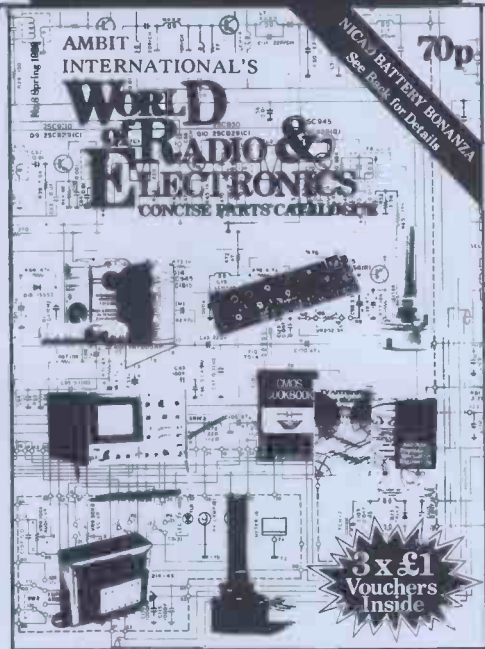

NICAD BATTERY BONUS! See back for details 70p

3 x £1 Vouchers Inside

Prices shown EXCLUDE VAT. Access/Barclaycard may be used with written or telephone orders, official MA details on application. E & EO. POSTAGE and PACKING 50p per order

74125N	0.40	74153N	0.55	74170N	1.25
74126N	0.40	74154N	0.55	74173N	1.10
74128N	0.65	74155N	0.55	74174N	0.75
74132N	0.50	74156N	0.55	74175N	0.75
74136N	0.65	74157N	0.55	74176N	0.75
74141N	0.45	74159N	1.90	74177N	0.75
74142N	1.85	74160N	0.55	74178N	0.90
74143N	2.50	74161N	0.55	74179N	1.35
74144N	2.50	74162N	0.55	74180N	0.75
74145N	0.75	74163N	0.55	74181N	1.22
74147N	1.50	74164N	0.55	74182N	0.70
74148N	1.09	74165N	0.55	74184N	1.20
74150N	0.79	74166N	0.70	74185N	1.20
74151N	0.55	74167N	1.25	74188N	3.00

74190N	0.55	74LS74N	0.16	74LS248N	1.35	74C76	0.48
74191N	0.55	74LS75N	0.22	74LS249N	1.35	74C83	0.98
74192N	0.55	74LS76N	0.20	74LS251N	0.35	74C85	0.98
74193N	0.55	74LS78N	0.19	74LS253N	0.35	74C86	0.26
74194N	0.55	74LS83N	0.40	74LS257N	0.40	74C89	2.68
74195N	0.55	74LS85N	0.60	74LS258N	0.37	74C90	0.80
74196N	0.55	74LS86N	0.14	74LS259N	0.60	74C93	0.80
74197N	0.55	74LS90N	0.32	74LS260N	0.50	74C95	0.94
74198N	0.85	74LS91N	0.28	74LS266N	0.22	74C107	0.48
74199N	1.00	74LS92N	0.31	74LS273N	0.70	74C151	1.52
74221N	1.00	74LS93N	0.31	74LS275N	3.20	74C154	2.26
74246N	1.50	74LS95N	0.40	74LS279N	0.35	74C157	1.52
74247N	1.51	74LS96N	1.20	74LS280N	2.50	74C160	1.05
74248N	1.89	74LS107N	0.25	74LS283N	0.42	74C161	1.05
74249N	0.11	74LS109N	0.20	74LS290N	0.50	74C162	1.05
74251N	1.05	74LS112N	0.20	74LS293N	0.40	74C163	1.05
74265N	0.66	74LS113N	0.20	74LS295N	1.50	74C164	0.80
74273N	2.67	74LS114N	0.19	74LS298N	0.76	74C165	0.84
74278N	2.49	74LS122N	0.35	74LS365N	0.32	74C173	0.72
74279N	0.89	74LS123N	0.35	74LS366N	0.34	74C174	1.05
74283N	1.30	74LS124N	1.80	74LS367N	0.32	74C175	1.05
74284N	3.50	74LS125N	0.24	74LS368N	0.35	74C175	1.08
74285N	3.50	74LS126N	0.24	74LS373N	0.70	74C193	1.08
74290N	1.00	74LS132N	0.42	74LS374N	0.70	74C195	1.08
74293N	1.05	74LS133N	0.24	74LS375N	0.40	74C200	4.52
74297N	2.36	74LS136N	0.20	74LS377N	0.85	74C221	1.06
74298N	1.85	74LS138N	0.30	74LS378N	0.65	74C901	0.38
74365N	0.85	74LS139N	0.30	74LS379N	0.60	74C902	0.38
74366N	0.85	74LS145N	1.20	74LS384N	2.50	74C903	0.38
74367N	0.85	74LS151N	0.30	74LS385N	2.50	74C904	0.38
74368N	0.85	74LS153N	0.27	74LS386N	2.05	74C905	5.64
74390N	1.85	74LS154N	0.98	74LS390N	0.68	74C906	0.38
74393N	1.85	74LS155N	0.35	74LS393N	0.61	74C907	0.38
74490N	1.85	74LS156N	0.37	74LS395N	2.10	74C908	0.84
		74LS157N	0.30	74LS396N	1.99	74C909	1.52
		74LS158N	0.30	74LS398N	2.75	74C910	3.62
		74LS160N	0.37	74LS399N	2.30	74C914	0.86
		74LS161N	0.37	74LS445N	1.40	74C918	0.98
		74LS162N	0.37	74LS447N	1.95	74C925	4.32
		74LS163N	0.37	74LS490N	1.10	74C926	4.32
		74LS164N	0.40	74LS668N	1.05	74C927	4.32
		74LS165N	0.80	74LS669N	1.05		
		74LS166N	0.80	74LS670N	1.70		
		74LS168N	0.70				
		74LS169N	0.85				
		74LS170N	0.80				
		74LS173N	0.80				
		74LS174N	0.40				
		74LS175N	0.40				
		74LS176N	0.40				
		74LS177N	0.40				
		74LS178N	0.40				
		74LS179N	0.40				
		74LS180N	0.40				
		74LS181N	0.40				
		74LS182N	0.40				
		74LS184N	0.40				
		74LS185N	0.40				
		74LS188N	0.40				

Processors	
8080AFC/2 £7.30	
8212	2.30
8214	3.50
8216	1.95
8224	3.50
8251	8.21
8255	5.40

RAM	
2102	1.70
2112	3.40
2114 2	1.49
4027	5.78
4116 2	1.59
4116 3	1.49
4864P	12.50
6116P 3	9.00
6116P 4	11.25
8264	12.50

74CXX	
74C00	0.20
74C02	0.20
74C04	0.20
74C08	0.20
74C10	0.20
74C14	0.20
74C20	0.20
74C30	0.20
74C32	0.20
74C42	0.80
74C48	1.03
74C73	0.50
74C74	0.50

Z80 series	
Z80A	£3.75
Z80ADRT	7.50
Z80APIO	3.50
Z80ASIO/1	11.00
Z80ASIO/2	11.00
Z80ASIO/9	9.00
Z80CTC	4.85
Z80ACTC	4.50
Z8001	65.00

PROM	
2708	2.00
2716	£3.00
2532	0.04
2732	£4.00

Hobby Electronics

SEPTEMBER 1982
Vol 4 No 9

PROJECTS

★ HE 'JUNIOR'	9
<i>A low-cost method to improve a slot-car's performance.</i>	
POPULAR COMPUTING	
ZX INTERFACE BOARD	14
<i>Eight bits of input and output for ZX computers</i>	
MICROTRAINING	25
<i>First steps to using the HE Micro Trainer.</i>	
★ BREADBOARDS	34
<i>Designing and building tone controls.</i>	
* MODEL RAIL SIGNAL LIGHTS.	39
<i>Three-aspect signal project.</i>	
PROJECT: MUSIC	
AUDIO ANALYSER	57
<i>Concluding our audio spectrum analyser project.</i>	

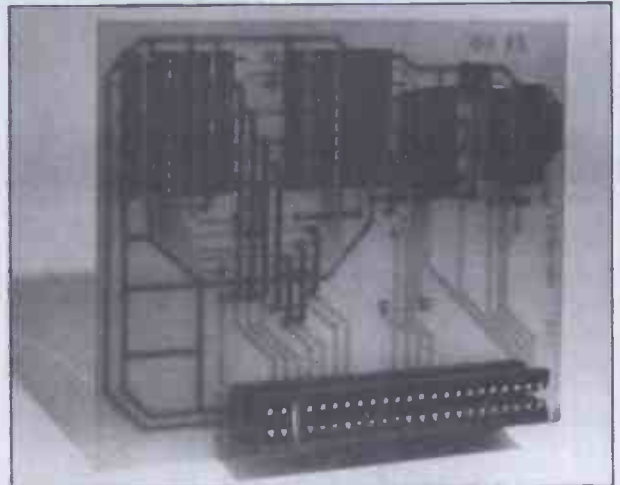

FEATURES

INTO RADIO	
RADIO RULES	20
<i>The classes of radio power.</i>	
★ FAMOUS NAMES	37
<i>Sir Edward Appleton.</i>	
GADGETS, GAMES AND KITS	
TESTON AUTO-RANGE DVM	47
<i>Hands-off meter reviewed.</i>	
★ PLANNING ON SUCCESS	49
<i>Get your projects working — first time!</i>	

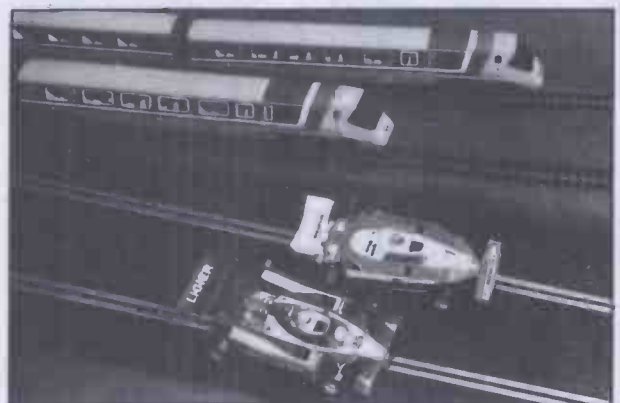

REGULARS

Monitor	6
Whats On Next	18
Points of View	31
Buylines	33
Subscriptions	33
Clever Dick	54
Breadboard Exhibition	53
HE Bookshelf	45
Backnumbers	60
PCB Printout	62
PCB Service	64
Classified Advertisements	65



Editor: Ron Keeley
 Editorial Assistant: Paul Coster BSc
 Advertisement Manager: Gary Price
 Managing Editor: Ron Harris BSc
 Managing Director: T.J. Connell

Hobby Electronics is normally published on the second Friday of the month prior to the cover date.
 Hobby Electronics, 145 Charing Cross Road, London WC2H 0EE, 01-437 1002. Telex No 8811896. Published by Argus Specialist Publications Ltd.
 Design and Organisation by MM Design and Print Ltd, 145 Charing Cross Road, London WC2H 0EE, 01-437 1002.
 Distributed by S. M. Distribution Ltd, 16/18 Trinity Gardens, London SW9 8DX.
 Printed by QB Ltd, Colchester. Covers printed by Alabaster Passmore.

Notice: The contents of this publication including all articles, designs, plans, drawings and programs and all copyright and other intellectual property rights therein belong to Argus Specialist Publications Limited. All rights conferred by the Law of Copyright and other intellectual property rights and by virtue of international copyright conventions are specifically reserved to Argus Specialist Publications Limited and any reproduction requires the prior written consent of the Company. All reasonable care is taken in the preparation of the magazine to ensure accuracy, but Argus Specialist Publications Ltd cannot be held responsible legally. © Copyright 1982 Argus Specialist Publications Ltd. Member of Audit Bureau of Circulation.

Beginners' luck

30% OFF
10 selected kits
for first-time
builders



Shortwave
Listener's
Receiver

With Heathkit, you're all set for a great deal. And not just big savings.

Whichever kit you choose, you'll find it easy to build. Simple, but detailed instructions take you through every stage. Everything is included. Even the solder you need

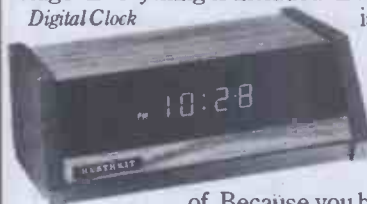

Digital Clock

is there. Follow the steps and you'll end up with a hand-crafted, well-designed piece of equipment. One you'll be proud

of. Because you built it yourself.

There are 10 great kits to start you off. An interesting choice of a digital clock to a metal locator, including a short wave listener's receiver, windspeed and direction indicator, digital readout electronic scale and five more useful kits.

All at 30% off to first-timers. Send for your catalogue right now for a start.



Windspeed and Direction
Indicator

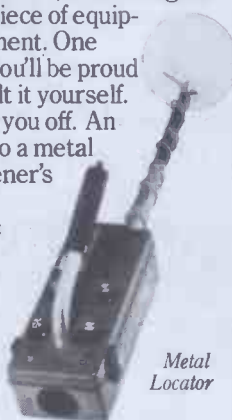

Metal
Locator

To Heath Electronics
(UK) Limited, Dept (HE9)
Bristol Road, Gloucester GL2 6EE.

HE9

To start me off, please send me a copy of the Heathkit catalogue. I enclose 28p in stamps.

Name _____
Address _____

HEATH You build on our experience
HEATHKIT

BI-PAK

BI-PAK's COMPLETELY NEW CATALOGUE

Completely re-designed. Full of the type of components you require, plus some very interesting ones you will soon be using and of course, the largest range of semiconductors for the Amateur and Professional you could hope to find.

There are no wasted pages of useless information so often included in Catalogues published nowadays. Just solid facts i.e. price, description and individual features of what we have available. But remember, Bi-Pak's policy has always been to sell quality components at competitive prices and **THAT WE STILL DO.**

BI-PAK'S COMPLETELY NEW CATALOGUE is now available to you. You will be amazed how much you can save when you shop for Electronic Components with a Bi-Pak Catalogue. Have one by you all the time—it pays to buy BI-PAK.

To receive your copy send **75p** plus 25p p&p.

8 Bit MICROPROCESSOR

National INS8080AN 40 Pin DIL N. Channel Silicon GATE MOS TECHNOLOGY As used in National's N8080 Micro Computer Family
Instruction Cycle Time 2 μ S
Supplied with functional Block Diagram
BRAND NEW — NOT seconds or reclaims
100% perfect ORDER NO. SX8080
Normal Sell price £4.50 each
Our BI-PAK Special Price **only £2.00**
SO HURRY — LIMITED STOCKS

40 Pin IC Socket to fit SX8080 Offer price
ORDER NO. 1609 **30p**

5 watt (RMS) Audio Amp

High Quality audio amplifier Module. Ideal for use in record players, tape recorders, stereo amps and cassette players, etc. Full data and back-up diagrams with each module.

Specification:
● Power Output 5 watts RMS ● Load Impedance 8-16 ohms ● Frequency response 50Hz to 25 KHz—3db
● Sensitivity 70 mw for full output ● Input Impedance 50k ohms ● Size 85 x 64 x 30mm ● Total Harmonic distortion less than 5%

BI-PAK'S give away price

£2.25
each.

You could not Build one for this price.

MW398 NI-CAD CHARGER

Universal Ni-Cad battery charger. All plastic case with lift up lid. Charge/Test switch. LED Indicators at each of the five charging points.

Charges: — Power: —
PP3 (9V) 220-240V AC
U12 (1.5V penlite) Dims: —
U11 (1.5V "C") 210 x 100 x 50mm
U2 (1.5V "D") **£6.95**

POWER SUPPLY DUA PRICE £3.25

Power supply fits directly into 13 amp socket. Fused for safety. Polarity reversing socket. Voltage switch. Lead with multi plug.
Input: — 240V AC, 50HZ Output: —3, 4.5, 6, 7.5, 9 & 12V DC Rating: —300 ma MW88

TRIACS — PLASTIC

4 AMP — 400v — T0202 — TAG 136G.	
1 OFF	10 OFF 50 OFF 100 OFF
40p	£3.75 £17.50 £30.00
8 AMP 400v — T0220 — TAG 425	
60p	£5.75 £27.50 £50.00

2N3055 The best known Power Transistors in the World — 2N3055 NPN 115w.
Our BI-PAK Special Offer Price:
10 off 50 off 100 off
£3.50 £16.00 £30.00

BD312 COMPLIMENTARY PNP POWER TRANSISTORS TO 2N3055
Equivalent MJ2955 — BD312 — 103
SPECIAL PRICE £0.70 each
10 off £6.50

5T21 SCREWDRIVER SET

6 precision screwdrivers in hinged plastic case. Sizes: — 0.8, 1.4, 2, 2.4, 2.9 and 3.8mm **£1.75**

5T31 NUT DRIVER SET

5 precision nut drivers in hinged plastic case. With turning rod. **£1.75**

5T41 TOOL SET

5 precision Instruments in hinged plastic case. Crosspoint (Phillips) screwdrivers: — H 0 and H 1 Hex key wrenches: — 1.5, 2 and 2.5mm **£1.75**

5T51 WRENCH SET

5 precision wrenches in hinged plastic case. Sizes: — 4, 4.5, 5, 5.5 and 6mm. **£1.75**

BUY ALL FOUR SETS 5T21-5T51 and get

HEX KEY SET FREE

HEX KEY SET ON RING.

Sizes: 1.5, 2, 2.5, 3,

4, 5, 5.5 and 6mm.

Made of hardened steel.

HX/1. **£1.25**

TECASBOTY

The Electronic Components and Semiconductor Bargain of the Year. A host of Electronic components including potentiometers — rotary and slider, presets — horizontal and vertical. Resistors of mixed values 22ohms to 2M Ω — 1/8 to 2 Watt. A comprehensive range of capacitors including electrolytic and polyester types plus disc ceramics etcetera. Audio plugs and sockets of various types plus switches, fuses, heatsinks, wire, nuts/bolts, gromets, cable clips and ties, knobs and P.C. Board. Then add to that 100 Semiconductors to include transistors, diodes, SCR's opto's, all of which are current everyday usable devices. In all a Fantastic Parcel. No rubbish all identifiable and valued in current catalogues at well over £25.00. Our Fight Against Inflation

Price —
— Beat the Budget
— Down with Depression

JUST £6.50.
Oino SX85

Send your orders to Dept. HE9
BI-PAK PO BOX 6, WARE HERTS
SHOP AT 3 BALDOCK ST
WARE HERTS.



Use your credit card. Ring us on Ware 3182 NOW and get your order even faster. Goods normally sent 2nd Class Mail. Remember you must add VAT at 15% to your order Total. Postage add 75p per Total order

THE PROJECT KITS

I.C.s
TRANSISTORS
CAPACITORS

TOOLS
RESISTORS
HARDWARE

CASES
KITS

MAGENTA

Make us your No. 1 SUPPLIER OF KITS and COMPONENTS for H.E. Projects. We supply carefully selected sets of parts to enable you to construct H.E. projects. Kits include ALL the electronics and hardware needed. Printed circuit boards (fully etched, drilled and roller tinned) or Veroboard are, of course, included as specified in the original article, we even include nuts, screws and I.C. sockets. PRICES INCLUDE CASES unless otherwise stated. BATTERIES ARE NOT INCLUDED. COMPONENT SHEET INCLUDED. If you do not have the issue of H.E. which includes the project — you will need to order the instruction reprint at an extra 45p each.

Reprints available separately 45p each + p. & p. 40p.

- T.V. I FILTER July 82 £4.98
SUNBURN TIMER — TANOVER July 82 £8.99
- AUTO WAH June 82 £17.89 inc case or £11.48 less case.
AUTO GREENHOUSE SPRINKLER June 82 £14.38 less pump and power supply (12V 2A).
TELEPHONE TIMER June 82 £31.24 less power supply (suitable type below).
POWER SUPPLY DESIGN 12V 500mA June 82 £9.79.
- ECHO REVERB UNIT May 82. Less case £31.82. Economy case WB3 £3.76 extra
DIGITAL THERMOMETER May 82 excluding case + bezel £15.80
LIGHT SEEKER May 82 £4.99
AUDIO SIGNAL GENERATOR May 82 £19.69
CABLE TRACKER May 82 £9.37
DIGITAL CAPACITANCE METER Apr 82 £19.98
- SIGNAL TRACER Apr 82 £3.61
BIKE ALARM Apr 82 £10.98
DIGITAL DICE Mar 82 £8.82
BICYCLE SIREN Mar 82 £10.18
NOISELESS FUZZBOX Feb 82 £9.77
SOUND SWITCH Feb 82 £8.31
MASTHEAD AMPLIFIER Feb 82 £13.74
DRUM SYNTHESIZER Dec 81. Full kit £19.98
- GUITAR HEADPHONE AMPLIFIER Dec 81 £3.48
IN CAR CASSETTE POWER SUPPLY Dec 81 £4.46
SCRATCH FILTER Nov 81 Mono £5.44 Stereo £8.40
LED VU METER Nov 81 less case £4.56
SIMPLE STYLUS ORGAN Nov 81 less case £4.74
METRONOME Nov 81 £11.88
TELEPHONE BELL REPEATER Oct 81 £12.78
Med Linking wire extra 14p metre
COMBINATION LOCK Oct 81 less solenoid £17.43
BABY ALARM Oct 81 £8.14, Fig 8 linking wire 7p metre
'DIANA' METAL LOCATOR Sept 81 £32.25
POWERPACK Sept 81 £9.58
- REACTION TESTER GAME Sept 81 £11.98
VARIABLE BENCH POWER SUPPLY Aug 81 £25.35
ULTRASOUND BURGLAR ALARM July 81 £18.67
ELECTRONIC DOOR BUZZER July 81 £5.65
ELECTRONIC METRONOME July 81 £4.67
CONTINUITY CHECKER June 81 £5.34
ENVELOPE GENERATOR June 81 £16.85
AUDIO MIXER June 81 £4.99
PUBLIC ADDRESS AMPLIFIER March 81 £1821, Extras — horn speakers £6.83 each, PA MIC £4.40
FUZZBOX March 81 £10.35
WINDSCREEN WIPER CONTROLLER March 81 £7.67
STEAM LOCO WHISTLE March 81 £12.26
PHOTOGRAPHIC TIMER March 81 £3.28
HEARTBEAT MONITOR Feb 81 £23.40
TWO-TONE TRAIN HORN Feb 81 £5.24 less case
MEDIUM WAVE RADIO Feb 81 £7.67
BENCH AMP Jan 81 £10.10
NICARD CHARGER Jan 81 £7.67
CHUFFER Jan 81, less case £7.04
BATTERY CHARGE MONITOR Dec 80 £5.40
MEMORY BANK — MINI SYNTHESISER Nov 80 £28.40
TRANSISTOR TESTER Nov 81 £8.12 inc test leads
GUITAR PRE-AMP Nov 80 £5.65 case (diecast) extra £2.29
INTRUDER ALARM Oct 80 £19.61
TOUCH SWITCH Sept 80 £2.57 less case & contacts
GUITAR PHASER Sept 80 £15.22
SOUND OPERATED FLASH TRIGGER July 80 no skt £4.99
FOG HORN June 80 £6.21
SPEED CONTROLLER FOR R/C April 80 £16.41 (less case)
DIGITAL FREQUENCY METER April 80 £39.35
DIGI-DICE Jan 80 £10.97
GUITAR TUNER Nov 79 £11.99
CAR ALARM Feb 79 £12.07

SOLDERING / TOOLS

- ANTEX X5 SOLDERING IRON 25W £5.48
SOLDERING IRON STAND..... £2.40
SPARE BITS. Small standard, large, 65p each. For X5 + X25
SOLDER. Handy size..... 99p
SOLDER CARTON..... £1.84
DESOLDER BRAID..... 69p
HEAT SINK TWEEZERS..... 29p
DESOLDER PUMP..... £6.48
HOW TO SOLDER LEAFLET..... 12p
LOW COST CUTTERS..... £1.69
LOW COST LONG NOSE PLIERS..... £1.68
WIRE STRIPPERS & CUTTERS..... £2.69

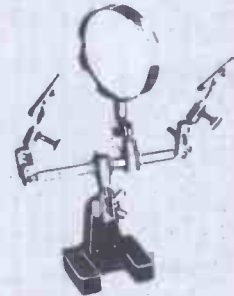

HELPING HANDS JIG £6.30

Heavy base. Six ball and socket joints allow infinite variation of clips through 360°. Has 2 1/2" diameter (25 x) magnifier attached, used and recommended by our staff.
VERO SPOT FACE CUTTER... £1.49
PIN INSERTION TOOL..... £1.98
VEROPINS (pk of 100) 0.1"..... 52p
MULTIMETER TYPE 1 (1,000 opv)..... £6.66
MULTIMETER TYPE 2 (20,000 opv) with transistor tester. Very good..... £14.75
CROCODILE CLIP TEST LEAD SET. 10 leads with 20 clips..... 99p

RESISTOR COLOUR CODE

- CALCULATOR..... 21p
CONNECTING WIRE PACK TYPE ED. 11 colours..... 49p
ILLUMINATED MAGNIFIERS
Small 2" dia. (5x mag.)..... £1.14
Large 3" dia. (4x mag.)..... £2.40
CAST IRON VICE..... £2.98
SCREWDRIVER SET..... £1.98
POCKET TOOL SET..... £3.98
DENTISTS INSPECTION MIRROR..... £2.85
JEWELLERS EYEGLASS..... £1.50
PLASTIC TWEEZERS..... 69p
PAIR OF PROBES WITH LEADS (cc)..... 77p

- SPEAKERS. Miniature, 8 ohm..... 87p
64-75 ohm..... 89p
CRYSTAL EARPIECE..... 65p
MONO HEADPHONES..... £2.95
TELEPHONE PICK-UP COIL..... 72p
- MIN. BUZZERS. 6V, 50p. 9V. £1.10.
12V. 65p.
MAGNETIC EARPIECE..... 45p
STEREO HEADPHONES..... £4.35
F.M. AERIAL..... 49p

- | | | |
|--|--------------------------------|---|
| VEROBOARD 0.1" COPPER STRIPS
10 strips 24 holes..... £1.20 per 5
24 strips 37 holes..... 78p
24 strips 50 holes..... 89p
36 strips 37 holes..... 89p
36 strips 50 holes..... 99p
Terminal pins 0.1"..... 52p/100 | PP3 CLIPS 10p
PP9 CLIPS 11p | PANEL METERS:
50uA; 100uA; 1mA,
1A, 25V, 100uA-0-
100uA; 5A. AU
£4.98 each. State
value. |
|--|--------------------------------|---|
- EUROBREADBOARD..... £8.20
S-DEC BREADBOARD..... £3.98
BIMBOARD 1 BREADBOARD..... £8.98
VEROBLOC BREADBOARD..... £4.20

MULTIMETER TYPE 2 - £14.75

20,000 opv. Includes transistor tester. AC + DC volts. DC current. 4 very useful resistance ranges. We've used it and we like it.

BOOKS

- SEMICONDUCTOR DATA BOOK Newnes £5.90
ELECTRONIC PROJECTS FOR HOME SECURITY £3.35
ELECT. PROJECTS IN PHOTOGRAPHY £3.35
110 ELECT. ALARM PROJECTS £5.35
MODEL RAILWAY PROJECTS £1.95
BASIC ELECTRONICS. Theory & practice £7.98
BEGINNERS GUIDE TO BUILDING ELECT. PROJECTS £1.50

ADVENTURES WITH MICROELECTRONICS

Similar to 'Electronics' below. Uses I.C.s. Includes dice, electronic organ, doorbell, reaction timer, radio, etc. Based on Bimboard 1 bread board.
Adventures with Microelectronics..... £2.55
Component pack £29.64 less battery.

ADVENTURES WITH ELECTRONICS

by Tom Duncan

An easy to follow book suitable for all ages. Ideal for beginners. No soldering, uses an S-Dec breadboard. Gives clear instructions with lots of pictures. 16 projects—including three radios, siren, metronome, organ, intercom, timer, etc. Helps you learn about electronic components and how circuits work. Component pack includes an S-Dec breadboard and all the components for the projects.
Adventures with Electronics £2.40. Component pack £17.98 less battery.

ADVENTURES WITH DIGITAL ELECTRONICS

New book by Tom Duncan in the popular 'Adventures' series. This book of entertaining and instructive projects is designed for hobbyists, and students. It provides a stepping stone to the microprocessor.
The first part deals with the properties of some basic ICs used in digital electronics.
The second part gives details of how to build eight devices — shooting gallery, 2 way traffic lights, electronic adder, computer space invaders game etc.
For each project there is an explanation of 'how it works' and also suggestions for 'things to try'.
No soldering — all circuits built on 2 Bimboard 1 breadboards.
Adventures with Digital Electronics book £3.25. Component pack £42.50 ref ETD. All the components needed including 2 breadboards and hexadecimal keyboard. Available less breadboards £29.98 ref ETD. Both less battery.

MORE PROJECT KITS — SIMILAR STYLE TO H.E.

INSTRUCTIONS INCLUDED (SEPARATELY 45p EACH)
PLEASE QUOTE REF. NO. WHEN ORDERING

- B1 PEST CONTROL 'Ultrasonic cat scarer' £5.98
B2 COMPONENT TESTER £8.38
B3 ENLARGER TIMER — relay output £26.99
B4 GUITAR NOTE EXPANDER £16.87
B5 CAMERA OR FLASH GUN TRIGGER Infra red system £11.98
B6 SIMPLE INFRA RED REMOTE CONTROL £16.38
B7 0-12V POWER SUPPLY £16.99
B8 SOIL MOISTURE MONITOR £4.23
B9 SOUND TO LIGHT — single channel £7.97
B10 THREE CHANNEL SOUND TO LIGHT £19.98
- B11 IN SITU TRANSISTOR TESTER £6.73
B12 WEIRD SOUND EFFECTS GENERATOR £5.68
B13 AUDIBLE VISUAL METRONOME £5.98
B14 ELECTRONIC DICE £5.71
B15 2K RAM PACK Less case for ZX81 £13.34
B16 MINI EGG TIMER £4.14
B17 AUDIO EFFECTS UNIT FOR WEIRD SOUNDS £12.71
B18 LED JEWELLERY — Cross brooch £2.77 Star brooch £9.71 Spiral brooch £7.50

MORE KITS AND COMPONENTS IN OUR LISTS
FREE PRICE LIST
Price list included with orders or send sae (9 x 4)
CONTAINS LOTS MORE KITS, PCBs & COMPONENTS

1982 ELECTRONICS CATALOGUE

Illustrations, product descriptions, circuits all included. Up-to-date price list enclosed. All products are stock lines for fast delivery.
Sends 80p in stamps or add 80p to order.

MORE H.E. PLUS E.E. and E.T.I. PROJECT KITS IN THE PRICE LIST

MAGENTA gives you FAST DELIVERY OF QUALITY COMPONENTS & KITS. All products are stock lines and are new & full specification. We give personal service & quality products to all our customers—HAVE YOU TRIED US?

MAGENTA ELECTRONICS LTD

HQ28, 135 HUNTER ST., BURTON-ON-TRENT, STAFFS,

DE14 2ST. 0283 65435. MON-FRI 9-5. MAIL ORDER ONLY
ADD 45p P&P TO ALL ORDERS PRICES INC VAT

ACCESS and BARCLAYCARD (VISA) ORDERS ACCEPTED BY PHONE OR POST.
SAE ALL ENQUIRIES.

Prices inc. VAT
OFFICIAL ORDERS WELCOME
OVERSEAS. Payment must be in Sterling.
IRISH REPUBLIC and BFPO: UK PRICES.
EUROPE: UK PRICES plus 10%.
ELSEWHERE: write for quote.

MONITOR

Have A Good Time

The cost of Casio's latest quartz digital watch works out at less than ½p per day, based on a retail price of £5.95 and a five year life from the lithium battery! The timing facilities of the F10 include continuous hour, minute, second and date display, together with indicators for am/pm and day of the week. The calendar is automatic, but needs adjustment for leap years. The standard F10 has a black resin case and strap though if you fancy something with a little more class, the B815, priced at £9.95, is identical except for the traditional stainless steel case and bracelet.

For something a little different, Casio have come up with the MM400 watch. It has a normal daily alarm, another which can be set up to a week ahead, and a third with a monthly cycle; each alarm has a different melody! The LCD readout shows hour, minute, second, date and day, plus indicators showing which alarms are set. It also features a stopwatch function accurate to 1/1000th of a second. The MM400 has a stainless steel bracelet and case, and a recommended retail price of £34.95 at any High Street Casio stockist.

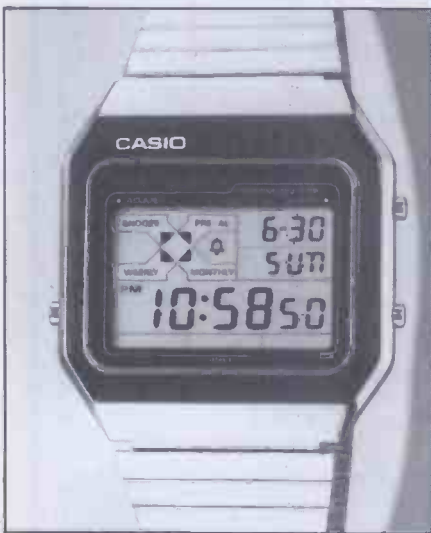

Would'n You Like One?

A new range of stabilised power supplies (right), specially designed for the UK market, are being released by Telecomms, the exclusive distributors of SHF Electronic products.

The range will be of particular interest to both CB and electronics enthusiast. There are five models, from a 2A unit for standard 40-channel CB rigs up to a 12A heavy duty supply. The prices are very attractive, ranging from £11.90 to £49.95, retail. The cases are made from a toughened nonconductive material and have been designed to be safer and more pleasing to the eye than conventional metal-cased units. Nice picture, too!

SHF Electronic supplies are distributed by Telecomms, 189 London Road, North End, Portsmouth; Tel. 0705 660036.

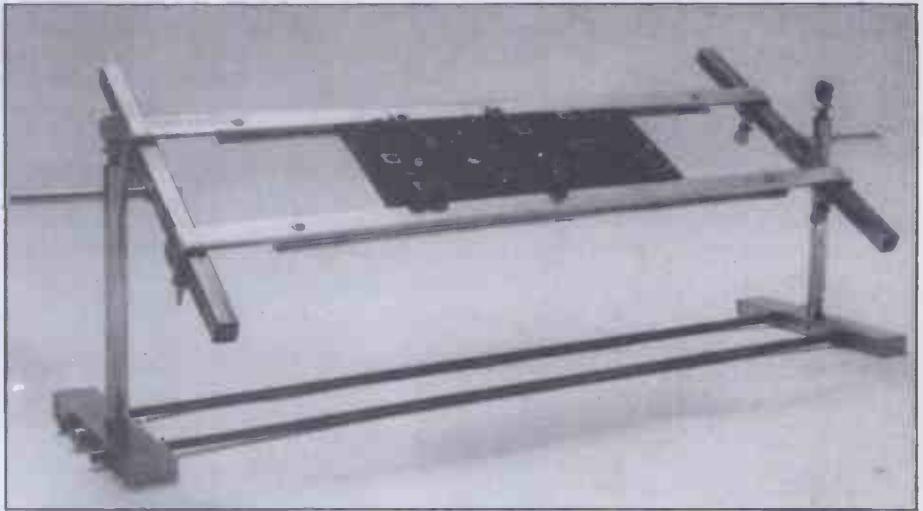

PCB Jig

No, it's not a new dance, simply two additions to the Carlton Nichol range of PCB holders/assembly-jigs.

The CNC 16 (above) will hold any board of up to 420 x 205 mm. The PCB is clamped between two easily adjustable rails and this also gives it the useful facility for holding a number of smaller boards, rather than one large one. A clip-on foam pad is also available, enabling components to be inserted in the board before soldering.

The CNC 10 holder is designed to take boards up to 203 x 203 mm, held between two rails and locked in position by means of a single, central clamp. When in position, the PCB may be rotated through 360° and locked at any angle. The holder can be folded flat, for storage, simply by loosening one bolt.

These products are available directly from the manufacturer, Carlton Nichol and Co. Ltd., Goldkey Industrial Estate, Kelvedon, Essex. The CNC 16 is priced at £21.75 and the foam pad is £6.90; the CNC 10 costs £16.10 and an optional pad is £5.63. These prices included VAT, but £1.50 should be added to cover postage.

Displays On Show

A new range of high quality, reliable, low cost displays (below) from Liton have just been launched by Stotron Ltd. They feature high brightness, low power drain and wide angle visibility, and are compatible with ASCII and EBCDIC codes.

The ten-step bar graph is available in either red or green with a bar point size of 1.5 x 5 mm. The clock display has a red colour filter for better contrast.

Further details are available from

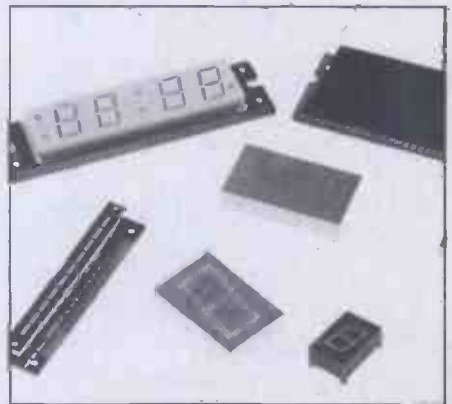

MONITOR

Stotron Ltd, 72 Blackheath Road, Greenwich, London SE10 8DA, or 'phone 01 691 2031.

Call For The Doctor

This one is for serious computer buffs. Normally, faults in memory chips are very difficult to locate as the usual methods, using a 'scope or logic probe, are not well suited to the job. The **Microdoctor**, an intelligent device from **Dataman Designs**, is designed specifically for the purpose.

It is an intelligent device for fault finding on computers or microprocessor based equipment generally, with the capability of performing a series of programmed tests on the memory chips of any computer to which it is attached and printing out the results. In addition, unknown systems can be memory-mapped, with the contents printed out in HEX or in ASCII; any device in the memory or I/O space can be read from or written to.

The Microdoctor is Z80 based and is supplied with a free Z80 disassembler, allowing it to produce a listing in HEX or ASCII of the contents of any ROM in a Z80 system. As it stands, the Microdoctor is applicable to microprocessor systems, and disassemblers for other popular MPUs will soon be available at low cost.



The Microdoctor costs £339.25, including VAT and carriage, from **Dataman Designs**, Lombard House, Cornwall Road, Dorchester, Dorset DT1 1RX. Tel. 0305 68066.

Logic Logged Here

Fault-finding on digital circuitry is not one of the easier tasks in electronics, and any assistance is generally very welcome. Enter **Global Specialities**, with a new 16-pin logic monitor.

The **IM-2A (above)** is specifically designed to monitor dual-in-line packaged integrated logic circuits. It has a built-in LED display which gives rapid, simultaneous readout of the static and dynamic states of eight, 14 and 16-pin ICs. Connection to the circuit under test is via a 610 mm long cable and a 16-pin 'Proto Clip' test probe. Using the **LMA-9** optional cable, up to 16 independent points can also be monitored.

The front panel mode switch selects either TTL, CMOS or variable threshold logic levels; the thumb-wheel control selects threshold from +1V to +9V, allowing the **LM-2A** to monitor practically all non-standard logic levels, and the

external voltage sense line used in the CMOS mode ensures that the 70% threshold for CMOS is accurately met. All inputs are 1MΩ impedance and protected to $\pm 26V$.

The **LM-2A** measures 30 x 81 x 150 mm and weighs in at 0.3 kg. The case is high-impact plastic, and the unit is supplied complete with the 16-way cable terminated in the IC test clip.

The suppliers are **Global Specialities Corporation**, Shire Hill Industrial Estate, Saffron Walden, Essex CB11 3AQ; tel 0799 21682 for further information.

Catalogue News

Finding sources of electronic components and hardware is one of the electronics hobbyist's greatest problems. Of course, our super Electronic Supplies Directory which will appear in the October issue, will help, but beyond that, a good catalogue collection is essential.

A new 28 page release, from specialist suppliers **Roadrunner Electronic Products**, features a wide range of circuit board and enclosure accessories. The Roadrunner 'solder-wrap' wiring system is highlighted, together with their extensive range of prototyping boards, connectors and electronic production accessories.

For further information, contact **Roadrunner Electronic Products Ltd.**, 116 Blackdown Rural Industries, Haste Hill, Haselmere, Surrey GU27 3AY. Tel. 0428 53850.

Another recent arrival was the latest catalogue from **Rapid Electronics**, who have considerably extended their product range. New additions include a wider range of linear devices, with data sheets, more capacitors, PCB transformers and tools. The total stock line now covers over 2000 items at prices that are "the most competitive in the industry", backed by a return post service.

Copies of the catalogue are available free with orders over £10 or by sending 45p to **Rapid Electronics**, Hill Farm Industrial Estate, Boxted, Colchester, Essex CO4 5RD. Tel. 0206 36412.

Calculator With A Difference

The **Hioki 3208**, from **Dorman Smith Instrumentation**, combines the functions of a powerful scientific calculator and a digital multimeter in one compact unit.

The mV ranges cover AC and DC voltage, ohms, low-power ohms for in-circuit testing, and it has current measuring capability up to 200 mA in two ranges. A single key converts the meter reading into scientific notation, for instant calculations.

The unit is supplied complete with tester probes, and a battery, giving 100 hours of continuous operation. It is available by mail order for £72.50, direct from **Dorman Smith Instrumentation**, Blackpool Road, Preston PR2 2DQ. Tel. 0772 728271.



Bradley Marshall Ltd

OF EDGWARE ROAD
SPECIALIST ELECTRONIC COMPONENT DISTRIBUTORS
Tel: 723-4242

PROBABLY THE LARGEST STOCK OF ICs & TRANSISTORS IN THE SOUTH TRY US FIRST

LARGE RANGE OF ACCESSORIES

Plugs
Sockets
Audio Connectors
Veroboards
IC Sockets
Soldering equipment
Screw drivers
(BAHCO)
Sifam Knobs
etc.

LARGE RANGE OF

ICs
Transistors
Capacitors
Diodes
Triacs
Thyristors
Opto
Resistors
Potentiometers
Fuses
Bridges
Please send S.A.E. for list.

SPECIAL OFFER

STEINAL
MULTICHECK
£7-50
+ VAT

Normal price £10-26

BUY WITH ACCESS BARCLAYCARD A/EXPRESS DINERS

Just phone we do the rest

MAIL ORDER FASTER SERVICE

PHONE 723-4242

16, 24, 40 WAY
RIBBON CABLE
£1.10; £1.40; £2.20
metre

Header plugs 14 way,
16 way, 24 way, 40 way

BAHCO TOOLS SIDE CUTTERS

2132 £7-10
2112 £9-40

END CUTTERS

2211 £10-43

PLIERS

2411 £6-75
2415 £6-78

ICE MULTIMETERS

Microtest 80 £16-60
Supertest 680 R £32-00
Supertest 680E £24-50

EXPERIMENTER BREADBOARD'S

EXP 325 EXP 600
EXP 350 EXP 650
EXP 300 EXP 4B

LOGIC PROBES

LP1 £31-00
LP2 £18-00

EXPERIMENTER KITS

PB6 £9-20
PB100 £11-80

PLEASE REMEMBER To ADD 15% VAT

BRADLEY MARSHALL LTD FOR

Crimson Elektrik
PROFESSIONAL AMPLIFIER MODULES

PRICE LIST —
ELECTRONIC MODULES & ASSEMBLIES — APRIL 1981

CODE	DESCRIPTION	Less VAT	INC VAT	WT
		£	£	(Kg)
CE 608	Power Amplifier Module	18.26	2.74	21.00
CE 1004	Power Amplifier Module	21.30	3.20	24.50
CE 1008	Power Amplifier Module	23.90	3.60	27.50
CE 1704	Power Amplifier Module	30.43	4.57	35.00
CE 1708	Power Amplifier Module	30.43	4.57	35.00
CE 3004	Power Amplifier Module	42.60	6.40	49.00
BD 1	Bridge Driver Module	7.13	1.07	8.20
TR 80	Toroidal Transformer 80VA	18.00	2.70	20.70
TR 150	Toroidal Transformer 150VA	20.07	3.01	23.08
TR 250	Toroidal Transformer 250VA	25.43	3.81	29.24
TR 250Q	Toroidal Transformer (low noise)	33.20	4.98	38.18
B 6	Bridge Rectifier (6 amp)	0.99	0.15	1.14
B12	Bridge Rectifier (12 amp)	1.80	0.27	2.07
C4700/40	Reservoir Capacitor and Clip	1.91	0.29	2.20
C4700/63	REservoir Capacitor and Clip	2.40	0.36	2.76
C4300/63	Reservoir Capacitor and Clip	2.60	0.39	2.99
CPS 80	Power Supply	22.82	3.42	26.24
CPS 80D	Dual Power Supply	27.63	4.14	31.77
CPS 150	Power Supply	25.86	3.88	29.74
CPS 150D	Dual Power Supply	31.65	4.75	36.40
CPS 250	Power Supply	32.03	4.80	36.83
CPS 250D	Dual Power Supply	39.43	5.91	45.34
TS 70	Thermal Switch 70°C	1.92	0.29	2.21
HS 50	50mm Heatsink	1.60	0.24	1.84
HS 100	100mm Heatsink	2.60	0.39	2.99
HS 150	150mm Heatsink	3.65	0.55	4.20
FM 1	Fan Mounted on 2 x HS 100	32.13	4.82	36.95
FM 2	Fan Mounted on 2 x HS 150	36.10	5.42	41.52
CPR 1X	Pre-Amplifier Module	31.30	4.70	36.00
MC 2	Moving Coil Pre-Pre-Amplifier Module	20.00	3.00	23.00
REG 1	Regulated Power Supply	8.09	1.21	9.30
TR 6	6VA Mains Transformer	2.87	0.43	3.30
XO 2	2 Way Crossover Module	17.39	2.61	20.00
XO 3	3 Way Crossover Module	26.09	3.91	30.00
MU 1	Muting Circuit for XO 2 or XO 3	8.35	1.25	9.60
CK 1010	Complete Pre-Amplifier Kit	78.26	11.74	90.00
CK 1040	Complete 40 Watt Power Amplifier Kit	103.48	15.52	119.00
CK 1100	Complete 100 Watt Power Amplifier Kit	129.56	19.44	149.00
MC 2K	Add On Moving Coil Kit	21.74	3.26	25.00
PSK	Pre-Amplifier Power Supply Kit	17.39	2.61	20.00

SOLE DISTRIBUTION BRADLEY MARSHALL LTD OF EDGWARE RD
325 EDGWARE RD, LONDON W21 BN
TEL: 01-723 4242

TECHNICAL TRAINING IN ELECTRONICS, TELEVISION AND AUDIO

IN YOUR OWN HOME — AT YOUR PACE

ICS can provide the technical knowledge that is so essential to your success, knowledge that will enable you to take advantage of the many opportunities open to the trained man. You study in your own home, in your own time and at your own pace and if you are studying for an examination ICS guarantee coaching until you are successful.

City & Guilds Certificates

Radio Amateurs

Basic Electronic Engineering (Joint C&G/ICS)

Certificate Courses

TV and Audio Servicing

Radio & Amplifier Construction

Electronic Engineering* and Maintenance

Computer Engineering* and Programming

Microprocessor Engineering*

TV, Radio and Audio Engineering

Electrical Engineering,* Installation

and Contracting *Qualify for IET Associate Membership



Approved by CACC



Member of ABCC

POST OR PHONE TODAY FOR FREE BOOKLET

Please send me your FREE School of Electronics Prospectus.

Subject of Interest _____

Name _____

Address _____



Post to: Dept 262Y
ICS School of Electronics
160 Stewarts Road,
London SW8 4UJ



01-622 9911
(All Hours)



Constructor Series Speakers

IT'S
SO
EASY

Have fun, save money, building a Kef design with a Wilmslow Audio CS Total kit. No electronic or woodworking knowledge necessary and the end result is a proven top-quality design that you'll be proud of.

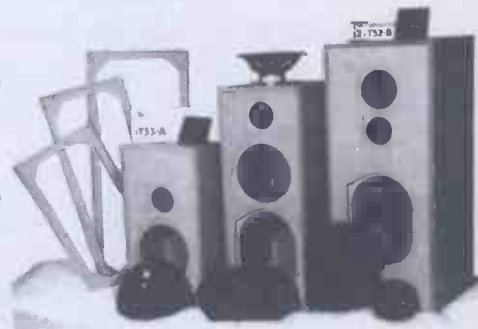

Each kit contains all cabinet components, accurately machined for easy assembly, speaker drive units, crossovers, wadding, grille fabric, terminals, nuts, bolts, etc.

The cabinets can be painted or stained or finished with iron-on veneer or self adhesive woodgrain vinyl.

Easy foolproof assembly instructions supplied. Set of constructor leaflets sent free on receipt of large S.A.E.

Prices: CS1 (As 101) £110 pr. inc. VAT, plus carr./ins. £ 5.50
CS1A (simplified LS3/5A) £103 pr. inc. VAT, plus carr./ins. £ 5.50
CS3 (as 103.2) £129 pr. inc. VAT, plus carr./ins. £10.00
CS5 (as Carlton II) £192 pr. inc. VAT, plus carr./ins. £15.00
CS7 (as Cantata) £250 pr. inc. VAT, plus carr./ins. £18.00



0625 529599

35/39 Church Street, Wilmslow, Cheshire SK9 1AS

1982 Catalogue — £1.50 post free

Lightning service on telephoned credit card orders!



HE 'Junior' Slot-Car Controller

Jonathan Scott



Put more zap in your slot-car's zip with our economy model controller

IN their May issue, this year, our cousins at Electronics Today International presented a super, souped-up Slot Car Controller project, providing (amongst other things) fuel tank simulation and controlled overshoot. In the course of developing that project, fierce argument raged around the authors' household, some arguing for the 'no-holds-barred' approach — the method ultimately adopted by ETI — while others argued for 'cost effectiveness'.

If you are a dedicated slot car fanatic, with hundreds of pounds invested in your layout, then you've probably already built the ETI Super Controller. On the other hand, if you're not sure that you are a fanatic, or you have just bought a layout, say, then this cost-effective approach, the HE 'Junior', is the one for you. It is relatively simple to construct, cheap, and easy to get going. It is basically a replacement for whatever you are using to power your set now. It offers operation from AC or DC, car battery, model train transformer, door-bell transformer or a range of typical project transformers or power supplies. It gives independent protected supplies for each lane,

adjustable for most car set types available.

In addition, we're giving tips for optimising your set and ideas for layouts. These should be sufficient to turn a simple rig into a first-class slot car racing set-up.

Theory And Practice

In practice, the basic rheostat in series with the track (car) system is not at all a bad compromise. For a given control setting, the car accelerates fairly rapidly towards a final speed. This is because torque is proportional to current (in the permanent magnet motors used) and current is at maximum when the car is standing still; as the engine RPM increase so does the back EMF, or rather the internal EMF of the engine, which represents the mechanical-power output in the mathematical model of the engine. As this rises, the voltage drop across the control resistance decreases, and so does the current, the torque and the acceleration (Figure 1). This gives a very car-like performance for a minimum of parts. The final speed is fixed by the minimum DC path resistance, the available supply voltage and the

amount of friction and other losses in the car. Overall performance includes cornering ability, which is affected by the car weighting and wheel type and condition. Attention to these factors will effectively 'tune' the car.

If you think you have a two-car set with one car better than the other, the chances are that checking the above points will reveal a silly fault in one of them. You can end up, after some tinkering, with two improved cars. Let us go through a typical tuning-up of a small car, such as those in the cheaper sets. We will start at the car and end up at the controller.

Firstly, the wheels. It is important to check that these do not have some wobble or severe out-of-roundness. The tyres should be slightly rough, so that they grip, and fairly flat at the point of contact with the track, so that they do not bounce when the wheel rotates quickly. See that the tyre is fitted straight, if you have removable tyres, and that the wheels are squarely mounted on the axles.

Next, it is worth opening the car up. Check that the axles and cogs are free of dust and carpet fluff. A very small touch of light machine oil on bearings and cogs is a good idea,

though not absolutely necessary. Do not oil the tyres or any exposed bit of the car. See that the cogs mesh neatly and fairly silently. On an expensive car, these things should be in order already.

Now let's look at the brushes. These are, in our experience, the most vulnerable point in the car. Brush friction usually accounts for 90% of car performance problems. The brushes should be clean and dust free. There will be some unravelling of the braid, this is good. The ends of the brushes seem to benefit from a bit of 'combing', done with a small jeweller's screwdriver, a scribe or scalpel. About three to five millimetres of combed braid is nice. Finally, the shape of the brushes is important. There are several ways to bend the brush, and you should experiment to see which is better. We used the down-and-then-straight pattern (See Figure 2).

Next, the minimum rheostat resistance is important. Some controllers have such high resistive leads that the series resistance never gets below an ohm or two. If you have a protected voltage source this is a disadvantage.

Finally, the supply potential is vital. If it is too high, the control becomes too critical and it is too hard to get just the right amount of power. It cannot be too low, of course, as you would not get anywhere near enough power to realise maximum speed without crashing — which takes out all the skill. As well, if the supply is not regulated, one car can interact with the other; an extreme case is when one car suddenly 'shutting down' causes such a surge that the other spins off the track (it can happen!).

One further factor is worth discussing, with respect to the car: weighting, and this is an area where you are going to have to experiment for yourselves. Most cars have spaces inside the plastic shells where nuts or other pieces of metal can be secured with a little Blutac, or similar adhesive, to add weight. Weight will reduce the acceleration for a given power, but it will increase wheel adhesion on the road. It will also change the handling, possibly making spinouts more likely, and reduce the period of time required between brush realignments. In our experience, a couple of 2BA or similar nuts in a small car, near the middle and low down, are quite beneficial if you have adequate power, as with our controller.

The Supply

As we have said, all that is necessary to achieve quite adequate performance is a voltage supply for each car. It needs to be the right voltage, and the cars should not interact with each other via the supply. The HE 'Junior' is a simple supply that meets these standards. It is versatile in that it will operate from whatever source of voltage you have available; it simply needs to deliver at least three volts

more than the cars need (average) and to be able to supply the maximum current, typically 0A5 to 1 A per car.

If you think you have a two-car set with one car better than the other, the chances are that checking the above points will reveal a silly fault in one of them. You can end up, after some tinkering, with two improved cars. Let us go through a typical tuning-up of a small car, such as those in the cheaper sets. We will start at the car and end up at the controller.

Firstly, the wheels. It is important to check that these do not have some wobble or severe out-of-roundness. The tyres should be slightly rough, so that they grip, and fairly flat at the point of contact with the track, so that they do not bounce when the wheel rotates quickly. See that the tyre is fitted straight, if you have removable tyres, and that the wheels are squarely mounted on the axles.

Next, it is worth opening the car up. Check that the axles and cogs are free of dust and carpet fluff. A very small touch of light machine oil on bearings and cogs is a good idea, though not entirely necessary. Do not oil the tyres or any exposed bit of the car. See that the cogs mesh neatly and fairly silently. On an expensive car, these things should be in order already.

Now let's look at the brushes. These are, in our experience, the most vulnerable point in the car. Brush friction usually accounts for 90% of

car performance problems. The brushes should be clean and dust free. There will be some unravelling of the braid, but this is good. The ends of the brushes seem to benefit from a bit of 'combing', done with a small jeweller's screwdriver, a scribe or scalpel. About three to five millimetres of combed braid is nice. Finally, the shape of the brushes is important. There are several ways to bend the brush, and you should experiment to see which is better. We used the down-and-then-straight pattern (see Figure 2).

Next, the minimum rheostat resistance is important. Some controllers have such high resistive leads that the series resistance never gets below an ohm or two. If you have a protected voltage source this is a disadvantage.

The Circuit

The complete circuit is shown in Figure 3. It is basically a crude series voltage regulator, based on the 723 variable regulator IC, that supplies power to the rheostat in the hand controller. The rheostat is in series with the motor in the car, via the track connections. The voltage supplied to the controller and car can be preset anywhere between about 3 V and 12 V.

The circuit is designed to be powered from a variety of sources — bell transformer, car battery, plugpack, model train transformer or conventional 240 VAC to 15 V/1-2 A

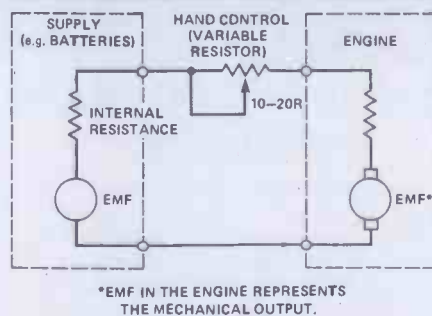

Figure 1. A circuit model of a slot car set-up.

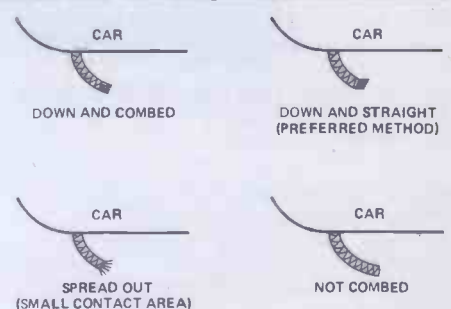

Figure 2. Various brush arrangements.

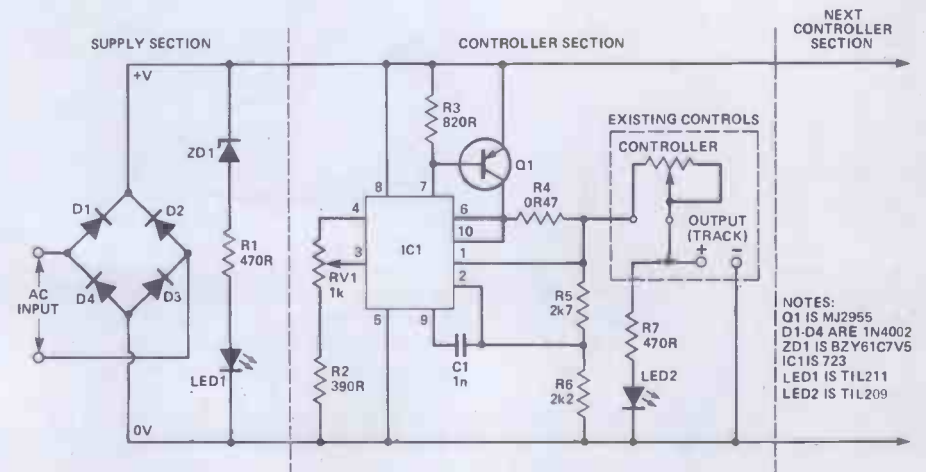

Figure 3. Circuit diagram of one controller; note that the components in the Supply Section are required for one board, only.

Parts List

RESISTORS

(All ½ watt 5% carbon, unless noted)

R1,7	470R
R2	390R
R3	820R
R4	OR47
	1 watt
R5	2k7
R6	2k2

POTENTIOMETERS

RV1	1k
	miniature vertical preset

CAPACITORS

C1	1n
	disc ceramic

SEMICONDUCTORS

D1-D4	1N4002
	rectifier diodes
ZD1	BZX61C7V5
	zener diode
LED1	TIL211
	0.2" green LED
LED2	TIL209
	0.2" red LED
IC1	LM123
	10 pin TO-100 regulator (see
	Buylines)
Q1	MJ2955
	silicon PNP power transistor

MISCELLANEOUS

Case (see **Buylines**); PCB; terminal block; nuts, bolts, wire, solder etc.

BUYLINES page 33

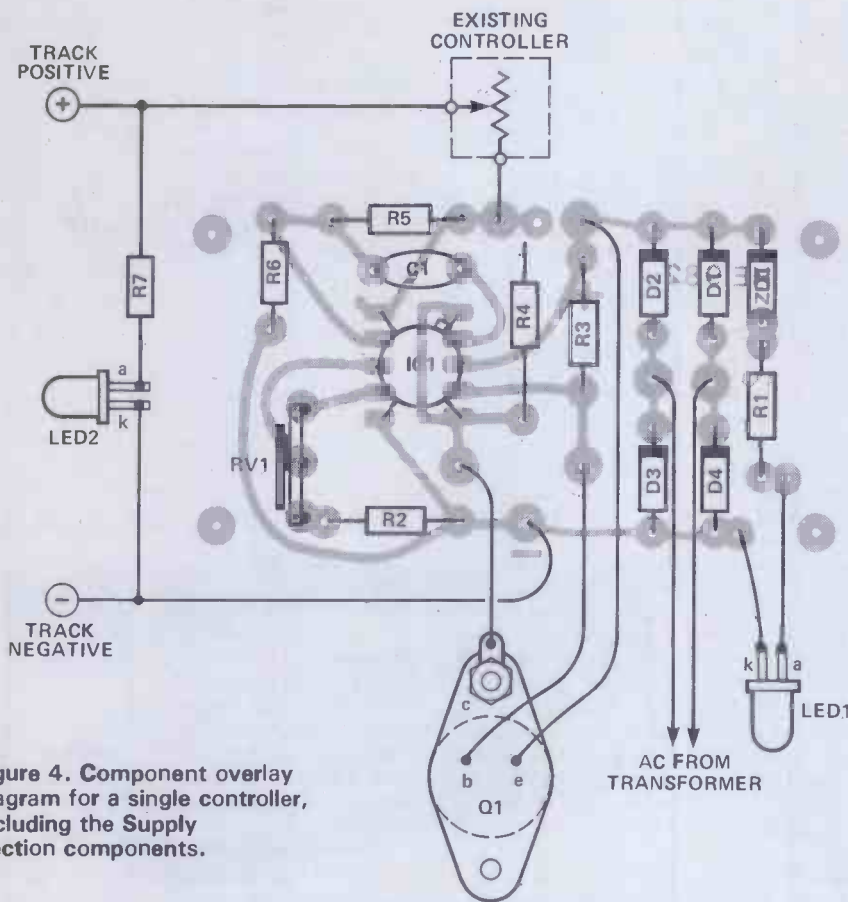

Figure 4. Component overlay diagram for a single controller, including the Supply Section components.

transformer — whatever is available. If the source is AC, such as that direct from a transformer secondary, the diode bridge rectifier formed by D1-D4 rectifies this, supplying unfiltered DC to the circuit. These four diodes may be deleted if the unit is run from a DC supply, or they may be left in, provided the DC exceeds the voltage required by the car by about four volts. Leaving D1-D4 in place has the advantage that the device can be run off AC at any time, and when running it off a DC supply it can be connected either way round as polarity doesn't matter and no possible damage can be caused by accidental reverse polarity connection.

To indicate that a supply of sufficient voltage is connected to the circuit, ZD1, R1 and LED1 make a simple indicator. When the supply voltage between the +V and 0 V rails is high enough to overcome the zener voltage plus the voltage drop across LED1 and R1 at a current of a few milliamps, LED1 will light. You need to produce a minimum of approximately 10 V between the + V and 0 V rails. Note that, while this is sufficient for the IC regulator circuit to operate, it may not be enough for some slot car sets. For those that require 12 VDC, at least 14 V between the +V and 0 V rails will be required. An AC input of up to 24 VAC (RMS) may be used.

Following the rectifier and indicator sections of the circuit is the regulator, which consists of IC1, Q1 and associated components. Each lane in

the slot car set should be supplied with a separate regulator circuit to ensure that one lane does not interfere with the operation of the other, especially in the event of a short circuit due to a crash or a fault, etc. Two regulator sections may be run from a single rectifier section.

The 723, IC1, controls the base current of Q1 to deliver the required voltage to the hand controller, except when the external circuit (controller and car motor, via the track) attempts to draw current above about 1A2. In this case, the 723 reduces the voltage supplied to the external circuit to prevent possible damage.

The output voltage is set by RV1. By adjusting this preset control, the voltage delivered to the controller and external circuit may be varied anywhere between about 3 V and 12 V maximum. This should be adjusted to suit the particular slot car set you are using by setting its position so as to deliver a suitable amount of acceleration to the car when the hand controller is set full on.

LED2 indicates that a voltage is reaching the track. This is useful to check correct operation and for detecting shorts on the track.

Construction

Construction of the HE 'Junior' is relatively straightforward. You will require one PCB for each lane, though some components will not be required on any but the first board. Further lanes will simply demand a larger box

and a repeat of the wiring of the first board, less ZD1, R1 and LED1. The component layout for a single-lane board is shown in Figure 4.

The first step is to drill the box. We used a cheap metal box, but if you want it to look particularly good, or if it will have to withstand nasty knocks, a diecast aluminium or extruded box of sufficient size can be used, although it will add to the cost. The advantage of a metal box is that the front panel doubles as a heat sink.

Drill the MJ2955 mounting holes and the LED mounting holes first. The only other hardware preparation is for the PCB mounting screw holes and those for the wires and the terminal block.

After drilling, assemble the boards. The first should have *all* components fitted. It is best to include D1 to D4 even if you have a DC supply, as the unit cannot, then, be connected the wrong way round, and can still be used with AC if required. The diodes should only be omitted if the DC supply is too low to tolerate the voltage drop across them, ie below 12 V, on average (omitting the diodes will allow it to run on around 10 V). It

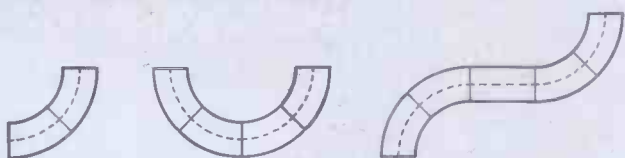

Figure 5. Rational constructs.

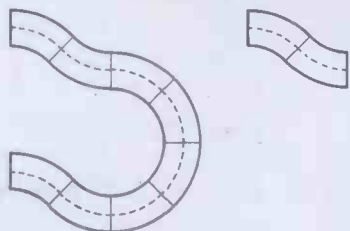

Figure 7. Zig-zags cancel out.

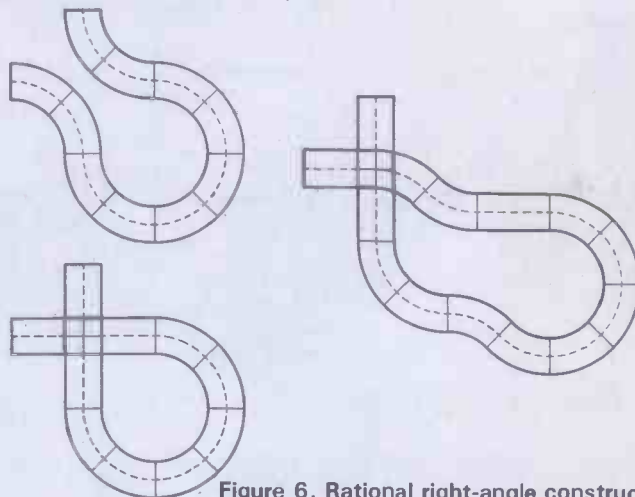

Figure 6. Rational right-angle constructs.

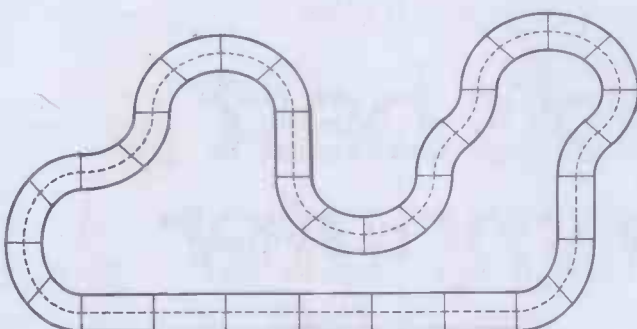

Figure 8. HE's Grand Prix track



should also be noted that the supply will have to be a bit higher if the car set is a 12 V type — around 15 V at least.

Fit all the components as shown in the overlay, starting with the resistors and finishing with the IC. Take care with the IC orientation. Once the board is assembled, connect the off-board wiring as shown. The current limiting resistors, R1 and R7, are mounted behind the LEDs themselves. For the output leads to the tracks and the controllers, we used an ordinary plastic terminal block, as these are cheap. Once the assembly is complete, label the supply and track LEDs, on the panel.

Testing

The HE 'Junior' is so simple that it does not require much setting up. After completing the assembly and wiring it up to your controllers and to the tracks, you should be 'on the road' immediately. The only adjustment that needs to be made is the setting of RV1, which controls the output voltage as mentioned in the circuit description. For safety, make a trial run with RV1 set for minimum voltage, first!

The Track

When it comes to track, there are three factors worth mentioning which may influence your choice if you have yet to purchase it. These factors are: range of pieces available, flexibility and width. If you are going to buy a cheap set, and let's face it, that is the

most economical approach, you will have to accept that the track comes in fixed quantities; probably multiples of what it takes to make up one loop or a small figure-8. However, you can get a good selection of 45° curves and straights, not to mention two cars and controllers, and fences, etc, for under £25 in some places. For this, plus one of our controllers, you can get a really good set-up, and for a bit more you get a really fantastic set.

Laying Out

In designing a layout, the main problem is not to find a shape which is particularly interesting, but one which is fair, or equal, for both lanes, as well as 'rational'.

A layout is said to be *rational* if it fits together *exactly*. For this to happen, there *must* be no uncanceled irrational constructs. Even if you are lucky enough to have a range of bits, it is quite a challenge to sort out a fair and rational track.

First, let us define some terms. A 'construct' is any group of track section. It does not necessarily meet up to form a closed loop, but is usually a familiar shape which can often be found in layouts. A rational construct is one which replaces a section of an oval track — either a right angle, a single straight section, or a combination of these.

To explain this, consider Figure 5. The right angle turn introduces a one-unit displacement along and one unit down. The U-bend introduces a two-unit shift along and no shift down.

The S-bend introduces three along, and two down. These are all rational constructs in the system of track used here — that is, one where straights are exactly one radius of curvature long, as is common. The constructs in Figure 6 are all equivalent to a right angle, and are thus rational.

The zig-zag in Figure 7 is irrational, but the construct next to it is rational, as the zig-zags clearly cancel out.

Some constructs favour one lane. For instance, in a plain 180° bend, the outside lane is longer, and thus you might expect it to take longer to negotiate. If there are fences it may be faster, as the car can bounce off them and thus allow greater speed without accident.

Experiment will determine how each construct favours lanes. Once you have an idea of each construct and how it favours lanes, you can assemble them into a fair layout. Even though a completely flat layout will inevitably have one lane longer on the outside, it can be made fair by the addition of constructs to favour the worse lane — such as zig-zags at the ends of long straights.

If you are really getting involved, you can devise a catalogue of constructs. We developed a computer program for checking rationality and a layout plotting routine, and here is an optimal layout (Figure 8) which uses all the track from two cheap figure-eight sets.

Our thanks to Hornby Hobbies, who supplied the pictures featured in this article.



"...the quality of the colour display is excellent". Popular Computing Weekly.

"The graphics facilities are great fun". Personal Computer World.

"...the Spectrum is way ahead of its competitors". Your Computer.

"The world's best personal computer for under £500."

Chris Sinclair

Sinclair ZX Spectrum 16K RAM £125, 48K RAM £175.

This is the astonishing new ZX Spectrum – a powerful professional's computer in everything but price!

There are two versions – 16K or a really powerful 48K. Both have a full 8 colours, sound generation, a full-size moving-key keyboard and high-resolution graphics. Plus established Sinclair features such as 'one-touch' keyword entry, syntax check and report codes!

Key features of the Sinclair ZX Spectrum

Full colour – 8 colours plus flashing and brightness-intensity control.

Sound – BEEP command with variable pitch and duration.

Massive RAM – 16K or 48K.

Full-size moving-key keyboard – all keys at normal typewriter pitch, with repeat facility on each key.

High resolution – 256 dots horizontally x 192 vertically, each individually addressable for true high-resolution graphics.

ASCII character set – with upper- and lower-case characters.

High speed LOAD & SAVE – 16K in 100 seconds via cassette, with VERIFY and MERGE for programs and separate data files.

The ZX Printer – available now

The printer offers ZX Spectrum owners the full ASCII character set – including lower-case characters and high-resolution graphics.

Printing speed is 50 characters per second, with 32 characters per line and 9 lines per vertical inch.

ZX Microdrive – coming soon

Each Microdrive will hold up to 100K bytes on a single interchangeable microflop – with a transfer rate of 16K bytes per second. And you'll be able to connect up to 8 ZX Microdrives to your ZX Spectrum – they're available later this year, for around £50.

How to order your ZX Spectrum

BY PHONE – Access, Barclaycard or Trustcard holders can call 01-200 0200 for personal attention 24 hours a day, every day.

BY FREEPOST – use the coupon below. You can pay by cheque, postal order, Access, Barclaycard or Trustcard.

EITHER WAY – please allow up to 28 days for delivery. And there's a 14-day money-back option, of course. We want you to be satisfied beyond doubt – and we have no doubt that you will be.

sinclair ZX Spectrum

Sinclair Research Ltd,
Stanhope Road, Camberley, Surrey,
GU15 3PS. Tel: Camberley (0276) 685311.

To: Sinclair Research, FREEPOST, Camberley, Surrey, GU15 3BR.				Order
Qty	Item	Code	Item price £	Total £
	Sinclair ZX Spectrum – 16K RAM version	100	125.00	
	Sinclair ZX Spectrum – 48K RAM version	101	175.00	
	Sinclair ZX Printer	27	59.95	
	Printer paper (pack of 5 rolls)	16	11.95	
	Postage and packing: orders under £100	28	2.95	
	orders over £100	29	4.95	
			TOTAL £	

Please tick if you require a VAT receipt
 *1 enclose a cheque/postal order payable to Sinclair Research Ltd for £.
 *Please charge to my Access/Barclaycard/Trustcard account no. Please print.

 *Please delete/complete as applicable.
 Mr/Mrs/Miss _____
 Address _____

FREEPOST – no stamp needed. Prices apply to UK only. Export prices on application. HEL 809

ZX Interface Board

Mike Lord

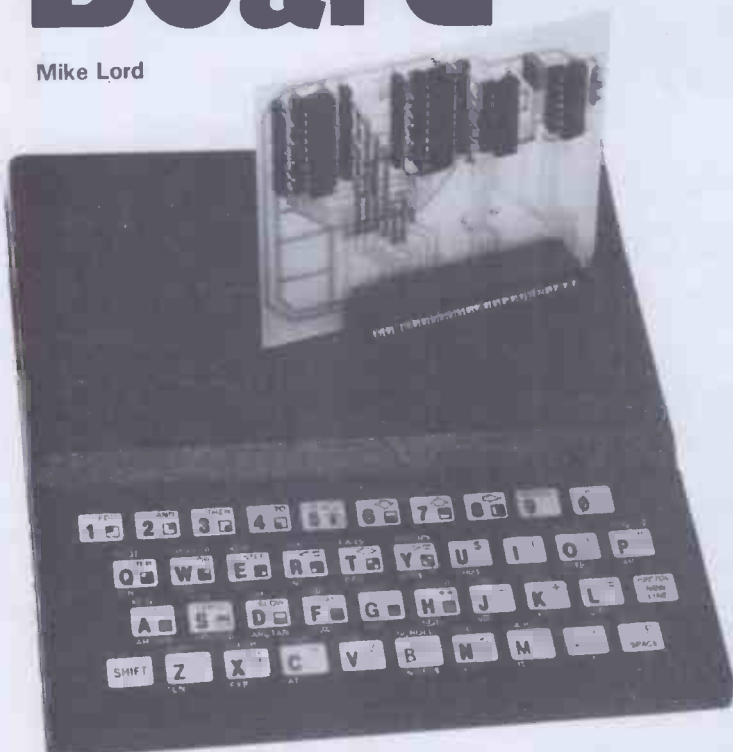

Last month's article gave a generalised description of techniques for interfacing external circuits to the Sinclair ZX81 and Spectrum. This month we present a practical circuit, an Input / Output interface board which can be built to work with either the ZX81 or the Spectrum.



As discussed last month, I/O interfaces for the ZX81 are best designed to look like normal memory ('Memory Mapped I/O'). For the Spectrum, on the other hand, it makes more sense to use the Z80's I/O address space ('I/O Mapped'). We have therefore designed the PCB so that the circuit can be constructed as either a Memory Mapped or an I/O mapped interface.

Whichever version is built, it will give you eight separate TTL level outputs, which can be controlled by the ZX, to drive LEDs, relays or whatever you will. There are also eight TTL inputs to the board, and the ZX can examine the states of signals applied to these inputs.

The ZX81 version of the board is designed to work with the basic (1K RAM) ZX81, and also with the ZX printer and the Sinclair 16K RAM pack. It should also be compatible with most ZX81 add-ons offered by other firms except for those which use memory addresses in the range 8192 to 16383.

The Spectrum version will also work with the ZX printer and — as far as we can tell from the limited information available at this time — will be compatible with future Sinclair add-ons such as the Microdrive and RS232 interface.

Circuit Description

The circuit for both versions of the

board are shown in Figure 1. In the ZX81 (Memory Mapped) version, IC4 and IC3c, IC3d monitor the states of the ZX address lines A13, A14, A15, and also the ZX \overline{MREQ} line. When A13 is high (logic '1'), and A14, A15 and \overline{MREQ} are all low, then the output, pin 11, of IC3d will go low. This will happen whenever the ZX81 accesses any memory address in the range 8192 to 16383. At the same time, the ZX81 \overline{ROMCS} line is pulled high through D1, to disable the unwanted 'echo' of the ZX81 8K ROM which would otherwise appear at these addresses.

For the Spectrum (I/O Mapped) version, IC4, D1 and R1 are not fitted, and IC3d is connected so that its output, pin 11, goes low when address line A5 and the Spectrum \overline{IORQ} lines are both low.

In either case, pin 11 of IC3d going low enables IC3a and IC3b so that during a ZX 'write' operation, when WR goes low, the output, pin 6, of IC3b goes low. Similarly, during a ZX 'read', the output of IC3a's pin 3, will go low.

Both versions of the board do respond to a wide range of ZX addresses rather than to a single address. This has been done for simplicity, since to reduce the number of addresses that the board would

respond to would mean adding more gates to monitor the states of more of the ZX's address lines. In both cases, the address decoding provided is adequate to allow the I/O board to work properly both with the computer and with Sinclair add-ons.

The eight board outputs are via PL1 and PL2 from the outputs of the 8-bit latch, IC1. The eight inputs to IC1 are connected to the ZX data bus lines D0-D7, so that when IC3b pin 6 pulses low the data present on D0-D7 is clocked into the latches. It will be held there until another ZX 'write' operation, to a suitable memory or I/O address, updates it.

IC2 contains 8 'tri-state' buffers. The inputs to these buffers are connected to the I/O board input points on PL3 and PL4. The output of each buffer is connected to one of the ZX data bus lines, but normally has no effect because the IC2 outputs are held open-circuit by a 'high' input to pins 1 and 19. When, however, the ZX does a 'read' operation from a suitable memory or I/O address, so that pin 3 of IC3a goes low, the output circuits of the buffers are enabled, transferring the information

present at IC2 inputs to the ZX data bus lines.

Construction

Refer to the component overlay, **Figure 2**. Begin by adding wire links in the positions shown. You should end up with 15 links (including the strap a-b) for the memory mapped version, or 16 (including straps a-c and d-e) for the I/O mapped board. Insulating sleeves should be fitted over the wire for the longer links, which might otherwise be liable to bend and touch each other.

Newcomers to the art of electronic circuit building may be interested to learn an old trick for making neat sleeved-wire links. It involves taking a piece of solid cored (not stranded) plastic insulated tinned copper wire about 18" (457.2 mm) long and carefully — without nicking the conductor — stripping a short length of insulation from each end. You then grip one bare end firmly in a vice or a pair of pliers. Then, holding the other bare end with the pliers, pull firmly until the wire suddenly stretches. Stretching the wire this way straightens it, and removes most of its 'spring'. It also breaks the wire free from the inside of the insulation and reduces its diameter slightly, so that what was insulation now becomes the correct sized sleeving.

Next, solder in D1 and R1 — but only if you are making the ZX81 (Memory Mapped) version of the board. Note that D1 must be fitted the right way round, with the broad coloured band away from the edge of the board. Now fit and solder the IC sockets and then C1. The pins of the IC sockets are fairly close together, so make sure that you don't leave any unwanted solder 'bridges' between adjacent pins.

Parts List

RESISTORS

R1 470R
¼ watt, 5%

CAPACITORS

C1 100n
polycarbonate

SEMICONDUCTORS

IC1 74LS273
TTL octal D type flip-flop
IC2 74LS244
TTL octal tri-state buffer
IC3 74LS32
TTL quad 2-input OR
IC4 74LS00
TTL quad 2-input NAND

MISCELLANEOUS

20-pin DIL socket (2); 14-pin DIL socket (2); 23+23 way ZX edge connector socket, polarising key in position 3; 23+23 way ZX connector, matching socket; 10-pin 0.1" PCB plug (4); 10-way 0.1" socket housing (4); crimp terminal for socket housing (24); PCB, wire, solder, etc.

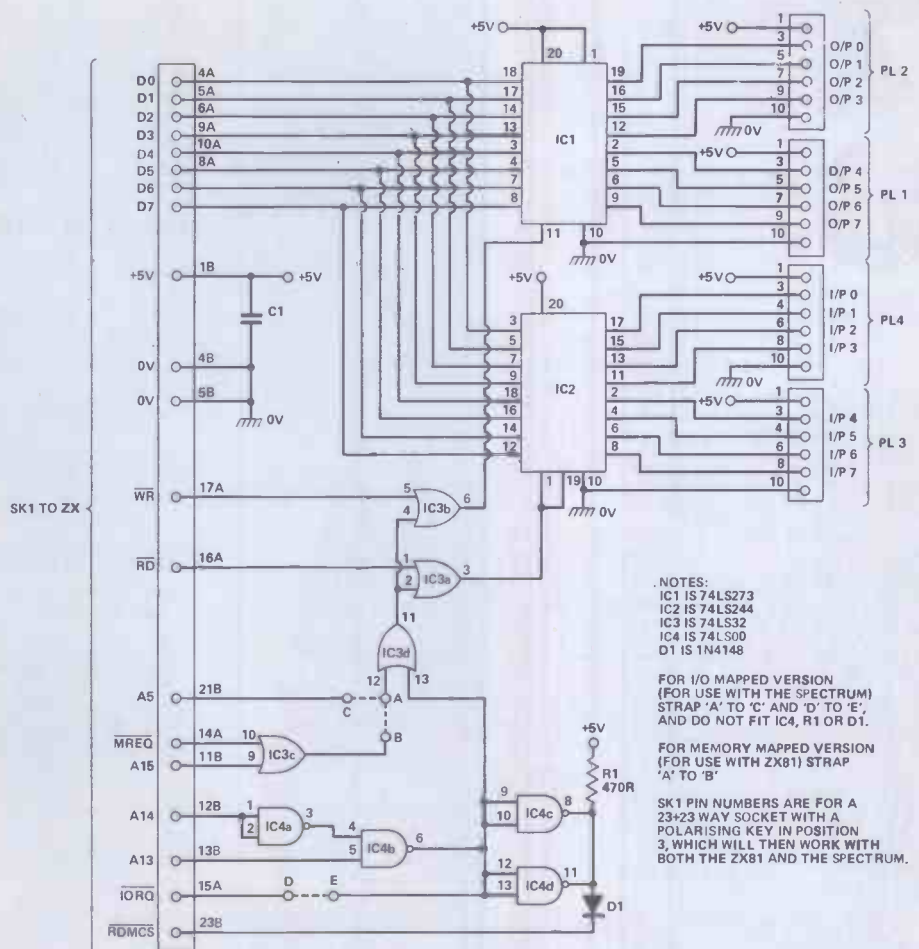

Figure 1. The circuit diagram shows both versions; note the links required to fit the board for one or the other.

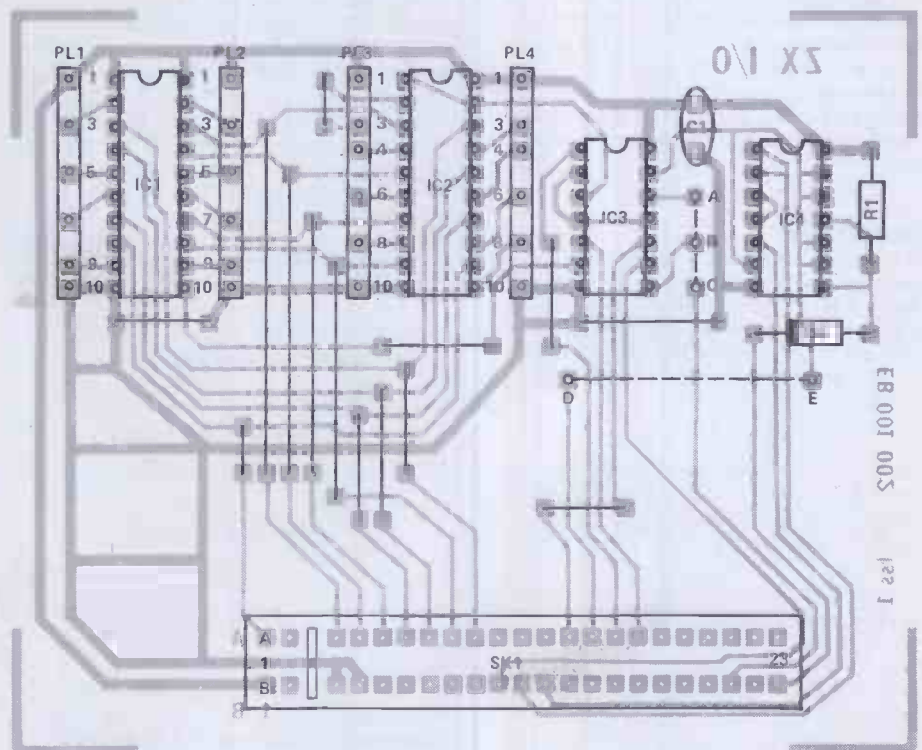

Figure 2. The component overlay diagram.

The four Input / Output connectors, PL1-4, can now be soldered in, but before doing so pull out the metal pins from the positions for which there is no corresponding hole in the PCB. The plastic moulding and the long ends of the plug pins should be on the component side of the board, the short ends of the pins should go through the board to be soldered on the track side.

The 23 + 23 way ZX socket can now be fitted so that the body of the connector is on the component side of the board, as close to the board as it will go. Tack-solder a couple of the corner pins first, then make sure that the socket is exactly perpendicular to the board before proceeding. For mechanical soundness, each pin of the socket should be soldered to its PCB pad, even though there may be no track going to that pad. Make sure that no solder bridges are formed between adjacent pads or tracks.

If you want to use other add-ons such as the ZX81 16K RAM pack, then a 23 + 23 way double-sided PCB plug must be fitted, projecting at right-angles from the track side of the I/O board. Each connection pad on this plug must be soldered to the corresponding 'tail' of the 23 + 23 way socket. Again, take care to avoid solder bridges, and make sure that the plug is positioned so that it is exactly perpendicular to the PCB and in line with the 23 + 23 socket.

Note that although the Spectrum actually has a 28 + 28 way plug, the wanted connections lie within the scope of a 23 + 23 way ZX81 connector and—if the polarising key is fitted—in the correct positions to suit both machines.

Finally ICs 1, 2 and 3 (and IC4 for the ZX81 version) may be fitted into their sockets, making sure that they are oriented with the semi-circular depressions in the IC mouldings pointing towards the top edge of the board as shown in Figure 2, and that all pins are properly engaged in their sockets.

Testing It

The first, and most important, test is to plug the board onto your computer and check that the computer itself still operates properly! If all is OK, we can test the input side of the board by first keying one of the instructions:

```
PRINT PEEK 8192
(for the ZX81 version);
```

TABLE 1

254	IF I/P 0 (PL4 PIN3)	IS CONNECTED TO 0V
253	1 " " 4 " "	" " "
251	2 " " 6 " "	" " "
247	3 " " 8 " "	" " "
239	4 (PL3 PIN3) " "	" " "
223	5 " " 4 " "	" " "
191	6 " " 6 " "	" " "
127	7 " " 8 " "	" " "

Testing the inputs to the board; the result is '255' if all inputs are logic 1.

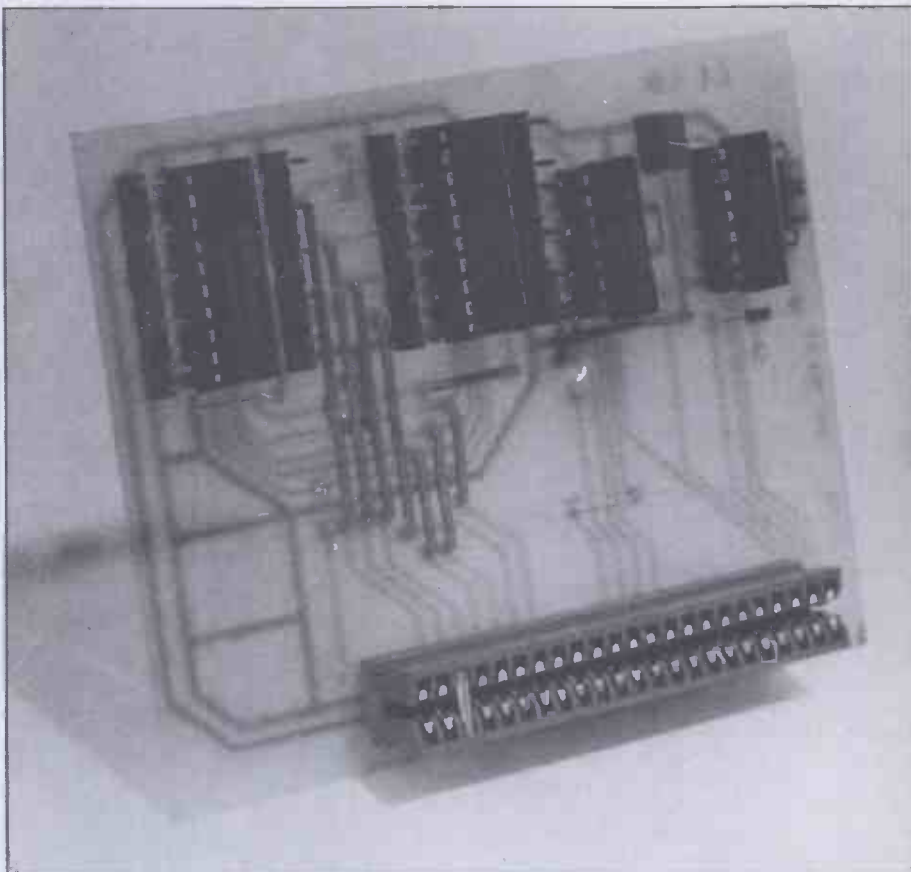

```
PRINT IN 65503
(for the Spectrum board).
```

The correct answer is 255 (not 42!), as all eight inputs to IC2 are, for the moment, open circuit and therefore look to the I/O board as logic '1's.

Repeating the instruction with a temporary connection between 0V (PL3 pin 10 is a suitable point to make connection to the 0V rail) and one of the inputs (PL3 or PL4 pin 3, 4, 6 or 8) should give the results shown in Table 1. Only one input should be connected to 0V at any one time for this test.

Now for the output. Connect a DC voltmeter, switched to its 5 or 10 volt range, between 0V and o/p 0 (PL2 pin 3). Now key in one of these instructions;

```
POKE 8192,0
(for the ZX81 version);
```

```
OUT 65503,0
(for the Spectrum version).
```

TABLE 2

n =	1 FOR	O/P 0 (PL2 PIN3)
2	" " 1 " "	5
4	" " 2 " "	7
8	" " 3 " "	9
16	" " 4 (PL1 PIN3)	5
32	" " 5 " "	5
64	" " 6 " "	7
128	" " 7 " "	9

Testing the outputs; each will go high (between 2V5 and 5V) when the corresponding value of 'n' is POKEd or OUTput to the latch.

This should result in a voltage reading of between 0V and 0V4. Then input:

```
POKE 8192, 1 or
```

```
OUT 65503,1
```

which should make the voltage change to between 2V5 and 5V.

The other seven outputs can then be tested, in turn. For each one, POKE 8192,0 or OUT 65503,0 should give less than 0V4, while POKE 8192,n or OUT 65503,n should give between 2V5 and 5V, where n is a number corresponding to a particular output, as shown in Table 2.

Programming

Considering the output half first, we have eight separate TTL level outputs which can each be set to give a logic '1' or '0' level by a program command which loads a suitable value into the 8-bit latch, IC1. The value will affect all eight lines simultaneously so, if we want to change just one output, we

TABLE 3

O/P SET TO '1'	DECIMAL VALUE
0	1
1	2
2	4
3	8
4	16
5	32
6	64
7	128

Each output is set by loading a decimal value, as shown above.

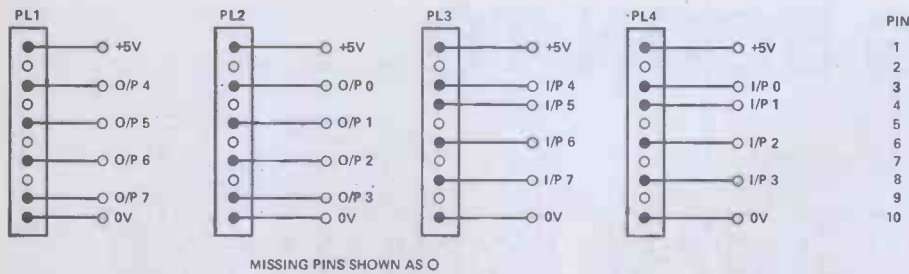

Figure 3. The I/O connectors. PL1 and 2 carry the output lines; PL3 and 4 carry the inputs.

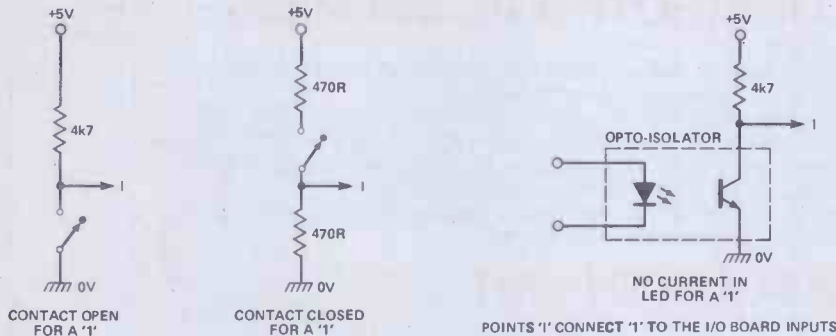

Figure 4. Inputs to the I/O board; points 'I' connect to the board inputs.

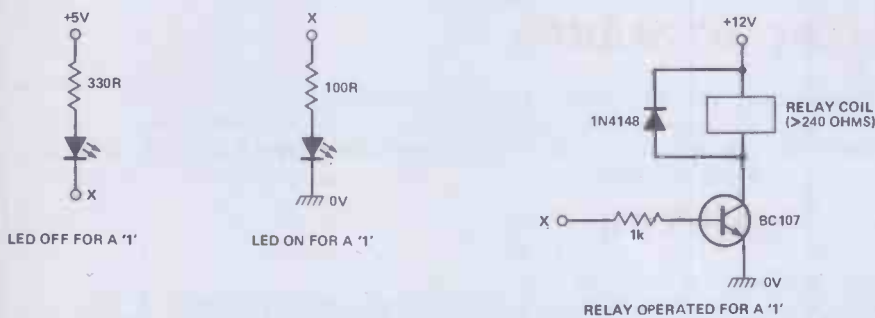

Figure 5. Outputs from the I/O board; points 'X' connect to the output pins.

must remember to load a value which — as well as affecting the output we want to change — will also preserve the previous states of the other seven outputs.

This value can be calculated by considering the eight output lines as individual bits on an 8-bit byte, o/p 0 being the least significant bit and o/p 7 the most significant, and converting the result to decimal. To do this, add together the values from Table 3 corresponding to the wanted '1' level outputs. For example, if we wanted to set outputs 2 and 5 to '1', and the other 6 lines to '0', the value to be loaded into the latch would be 00100100 binary, or $4 + 32 = 36$ decimal, and the correct BASIC instruction would be;

POKE 8192,36
(for the ZX81) or

OUT 65503,36
(for the Spectrum).

If we wanted to then change output 2 to a '0' without affecting the other lines, then the appropriate instruction

would be: POKE 8192,32 or OUT 65503,32.

Alternatively, we could let the computer do the hard work by inserting the following lines near the beginning of our program:

```
LET OP0 = 1
LET OP1 = 2
LET OP2 = 4
LET OP3 = 8
LET OP4 = 16
LET OP5 = 32
LET OP6 = 64
LET OP7 = 128
```

Then, to set, say, o/ps 1, 5 and 7 to '1', use the program line:

POKE 8192, (OP1 + OP5 + OP7)

or

OUT 65503, (OP1 + OP5 + OP7)

Spectrum programs could use the BIN function, which takes an 8-bit binary number expressed as a string of '1's and '0's and converts it to the decimal equivalent. For example:

OUT 65503,BIN 10100010

Now for Input. The combined states of the 8 inputs applied to the I/O board are read by the ZX as a single decimal number in the range 0 to 255. For example, if a '1' were applied to inputs 0 and 7, and '0' to the other six inputs, then the variable X would be given the value 129 by a ZX BASIC instruction of the form:

LET X = PEEK 8192
(for the ZX81) or

LET X = IN 65503
(for the Spectrum).

The following routine can then be used to sort out the states of the eight individual inputs;

```
DIM I(8)
FOR J = 1 TO 8
LET I(J) = X - 2 * INT (X/2)
LET X = INT (X/2)
NEXT J
```

This routine will give each of the eight array elements I(1) to I(8) the value '1' or '0', depending on the logic level applied to the individual I/O board inputs.

Using It

The whole point of an I/O board is that it will be connected to other equipment, and to this end the board described here has four 10-way plugs (PL1-4) fitted to it. As shown in Figure 3, PL1 and PL2 each carry four of the output lines, as well as 0V and +5V rails. PL3 and PL4 each have four of the input lines, and also the 0V and +5V connections. Leads can be soldered to the pins of the plugs or — more professionally — the mating sockets shown in the components list can be used; note that these consist of a shell moulding with separately supplied contacts.

The I/O board inputs can, of course, be connected directly to TTL or 5V CMOS outputs, and switch or relay contacts can be easily interfaced as shown in Figure 4, which also shows how a LED-phototransistor opto-isolator could be used to sense signals that it may not be possible to connect to the computer's 0V rail.

LEDs or low power relays can be driven from the board's output lines, as shown in Figure 5. In all cases, the total amount of current drawn from the +5V rail on pin 1 of PL1-4 should be not more than about 50 mA, as it is being provided by the regulator in the ZX, which runs hot enough anyway!

Note also that any large or inductive loads such as motors or relay coils should have interference suppressors fitted to cut down the risk of noise pulses upsetting the computer. For this reason it is advisable to isolate any large loads with a relay or opto-isolator, so that high voltage or heavy current circuits are completely separate from the computer. This will also reduce the chance of high voltages getting accidentally connected to your valuable ZX!

COMING SOON TO . . .

Hobby Electronics

DIRECTORY OF ELECTRONIC SUPPLIES

Hobby Electronic's October issue features the largest, most comprehensive survey of electronic components and hardware ever published.

The Directory consists of three large pull-out wall charts showing 40 categories of components, hardware and information for the electronics constructor. More than 60 company names and addresses are listed separately, with comments on product lines, specialities and services, and mentioning any items not covered in the charts.

With all this information presented so efficiently, the October issue of Hobby Electronics is a *must for all* electronic enthusiasts.

CB SQUELCH UNIT

Stamp out noise!

This device is the companion to our Stereo Noise Gate, also under preparation for October, but designed to eliminate CB receiver noise when the channel is open. If you find noise annoying, this easy-to-build and economical unit will sooth your nerves!

CIRCUIT MAKER

A complete kit for making PCBs at home, using the photographic process, has recently been released by Electrolube Limited. In October, Owen Bishop reports on his experiences with the photo-resists, the light frames and the bags of ferric chloride. His conclusions? See for yourself in the October issue of Hobby Electronics!

HEBOT II

Remember the HEBOT?

Way back in November 1979 we published one of the first ever mobile robot projects, which we christened HEBOT. It proved to be enormously popular and, judging by the mail we still receive, reader's enthusiasm for simple robotics has not decreased over the years!

HEBOT has long since 'passed on' but now, in conjunction with Powertran Ltd., we are proud to present its successor.

HEBOT II is a very similar animal — er, robot — but using today's more sophisticated circuitry and operating under the control of a microcomputer. Like the original, it is a 'turtle' robot, propelled by two large, independently controlled rubber wheels which enable it to perform a wide variety of movements. Obstacle-sensors allow it to explore its environment, discovering the limits of movement or the shape of a room, or it can draw patterns or graphs using a pen, which presses down on command. Its blinking eyes and on-board beeper can be programmed to communicate with the operator, eg to indicate that it has finished a task.

The projected cost of this educational and inspirational robot is under £100, and it is initially intended to be controlled via a Sinclair ZX81 microcomputer — though future developments will open still greater possibilities. Look out for HEBOT II in the November issue of Hobby Electronics.

Please reserve copies of the October issue of

Hobby
Electronics

for

Name

Address

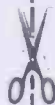

Hobby
Electronics

October issue on sale at
your newsagent
from 10th September.

Place your order now!

Although these articles are being prepared for the next issue, circumstances may alter the final content.

The Logic Probes

Spend Less

Test More

LP-1 Logic Probe

The LP-1 has a minimum detachable pulse width of 50 nanoseconds and maximum input frequency of 10MHz. This 100 K ohm probe is an inexpensive workhorse for any shop, lab or field service tool kit. It detects high-speed pulse trains or one-shot events and stores pulse or level transitions, replacing separate level detectors, pulse detectors, pulse stretchers and pulse memory devices.

All for less than the price of a DVM

£31.00*

Model LP-3 illustrated

LP-2 Logic Probe

The LP-2 performs the same basic functions as the LP-1, but, for slower-speed circuits and without pulse memory capability. Handling a minimum pulse width of 300 nanoseconds, this 300 K ohm probe is the economical way to test circuits up to 1.5 MHz. It detects pulse trains or single-shot events in TTL, DTL, HTL and CMOS circuits,

replacing separate pulse detectors, pulse stretchers and mode state analysers.

(Available in kit form LPK-1 £12.50)

£18.00*

Model LP-3 illustrated

LP-3 Logic Probe

Our LP-3 has all the features of the LP-1 plus extra high speed. It captures pulses as narrow as 10 nanoseconds, and monitors pulse trains to over 50 MHz. Giving you the essential capabilities of a high-quality memory scope at 1/1000th the cost.

LP-3 captures one shot or low-rep-events all-but-impossible to detect any other way.

All without the weight, bulk, inconvenience and power consumption of conventional methods.

£49.00*

Model LP-3 illustrated

The New Pulser DP-1

The Digital Pulser: another new idea from G.S.C. The DP-1 registers the polarity of any pin, pad or component and then, when you touch the 'PULSE' button, delivers a single no-bounce pulse to swing the logic state the other way. Or if you hold the button down for more than a second, the DP-1 shoots out pulse after pulse at 1000 Hz. The single LED blinks for each single pulse, or glows during a pulse train. If your circuit is a very fast one, you can open the clock line and take it through its function step by step, at single pulse rate or at 100 per second. Clever! And at a very reasonable price.

£51.00*

Model LP-3 illustrated

The logic probes shown are all suitable for TTL, DTL, HTL and CMOS circuits.

GLOBAL SPECIALTIES CORPORATION



G.S.C. (UK) Limited, Dept. 1411
Unit 1, Shire Hill Industrial Estate,
Saffron Walden, Essex CB11 3AQ.
Telephone: Saffron Walden (0799) 21682.
Telex: 817477.

G.S.C. (UK) Limited, Dept 1411, Unit 1, Shire Industrial Estate, Saffron Walden, Essex CB11 3AQ.

Prices include P.&P. and 15% VAT

LP-1	£37.38	Qty	LP-2	£22.42	Qty	LP-3	£58.08	Qty	DP-1	£60.95	Qty	LPK-1	£15.52	Qty
------	--------	-----	------	--------	-----	------	--------	-----	------	--------	-----	-------	--------	-----

Name _____ Address _____

I enclose Cheque/P.O. for £ _____ or debit my Barclaycard/Access/
American Express card no. _____ exp date _____

FOR IMMEDIATE ACTION — The G.S.C. 24 hour, 5 day a week service.
Telephone (0799) 21682 and give us your Barclaycard, Access, American Express
number and your order will be in the post immediately.

For FREE
catalogue
tick box

RADIO RULES

Ian Sinclair

Radio Frequency Power Amplifiers.

THE SAMPLE examination papers for the Radio Amateur's exam don't mention valves — though they do mention a number of topics that aren't covered to any great extent in the manual. Yet the fact is that the output power permitted to be used on the most popular amateur bands cannot easily be achieved using transistors. The good ol' fashioned valve is still the only way of ensuring that you have a beefy signal, without spending your whole income on the output stage! Unless you have some understanding of valve operation, then, the higher power stages of transmitters are going to be a bit of a mystery to you, and that doesn't sound like a good idea to me! So, for the benefit of those whose hair has not yet turned gray, let's look at the low-down on high-vacuum devices.

A valve relies for its action on electrons moving across a vacuum. Only electrons are involved, because holes can't exist outside a solid crystal, so the action of the valve resembles that of the N-channel MOSFET rather than that of a bipolar transistor, and there is no valve-type device which corresponds to the P-channel MOSFET. The electrons are emitted from a hot material, the cathode, which is cylindrical in shape and is heated by a wire filament, the heater (Figure 1). The cathodes of the smaller valves use a non-conducting (at room temperature) white material (the oxide cathode) which becomes an electron-emitting conductor when it is heated to a temperature of around 700°C, when it glows a dull red. Larger transmitting valves work with large currents and voltages, enough to damage a coating of this type, so that a filament of tungsten, either pure or coated with thorium, is used and carries out the tasks of both heater and cathode.

Electrons released into the vacuum of the valve from a hot cathode will, obeying the law that unlike-charges attract, move to anything that is at a more positive voltage than the cathode. Surrounding the cathode, then, is a metal cylinder, called the anode, which is maintained at a positive voltage of anything from 100 V to 25kV, depending on valve size and power, so as to pull electrons away from the cathode at high speed. This electrode corresponds to the drain of the MOSFET.

A valve with only a cathode and an anode is a diode and can be used for rectification, though nowadays we use valves as rectifiers only for very high voltages, like the 100 kV supplies used in X-ray work. But if we add a third electrode, called a grid, between the cathode and the anode, it can control

the flow of electrons and make the valve a useful amplifier or oscillator. The grid is usually a coil of wire held on metal posts between the cathode and the anode, but very much closer to the cathode (Figure 3). When the voltage on the grid is the same as the cathode voltage, electrons will pass through between the wires, practically unaffected by the grid, and will reach the anode. If the grid voltage is made negative, however, the electrons will be repelled from the grid wires and the space immediately around the wires, reducing the number of electrons that can reach the anode. At some particular negative voltage on the grid, this repulsion effect will be so strong that no more electrons will reach the anode and in this state, the valve is said to be 'cut off'. Therefore, a varying voltage on the grid, which must be biased so that its starting voltage (with no signal) is

suitable (usually negative), will cause a varying anode current, just as a varying gate voltage on a FET causes a varying drain current.

The important difference is that the valve can operate at much higher power levels. If we try to operate semiconductors at high power, we have a problem conducting away the heat which is generated inside the material, as electrons and holes flow through it. Heat is also generated in a valve, of course, but most of it is released at the anode and the anode is made of a metal which can withstand much higher temperatures than a semiconductor junction made of silicon. In addition, the valve can dissipate heat by radiation through its glass envelope (as used in the smaller valves) or even by making the anode part of the outside of the valve and 'finning' it, so that it can be air-cooled, or by forming a water-jacket

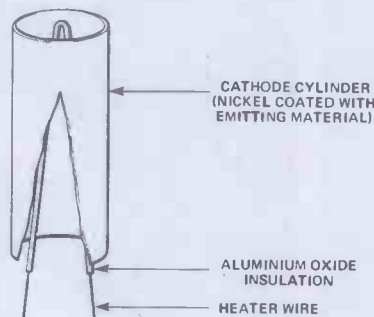

Figure 1. The cathode and heater of a valve. The heater is insulated from this type of cathode.

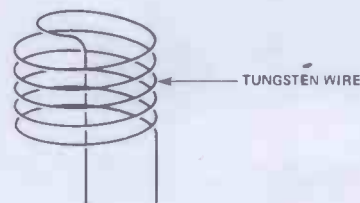

Figure 2. A tungsten filament, acting as combined heater and cathode, for the larger types of transmitting valve.

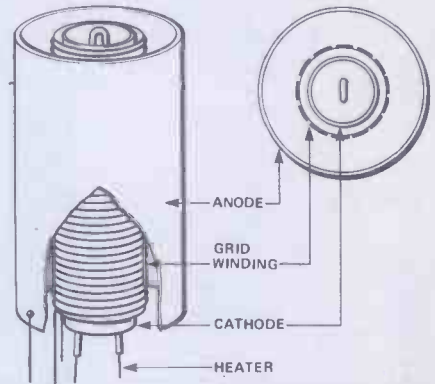

Figure 3. Arrangement of cathode, grid and anode in a small transmitting valve.

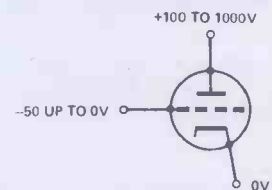

Figure 4. Valve symbol (triode) with typical voltage ranges (heater not shown).

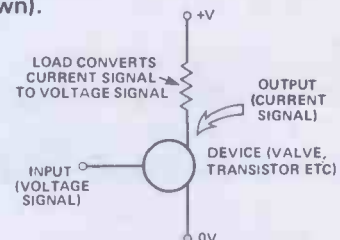

Figure 5. The principle of using a load to convert current signals to voltage signals.

around the anode so that it can be cooled like the cylinder-block of a car.

For powers of more than 100W, then valves are simpler and more reliable than transistors and in countries where high powers (several kilowatts) are permitted and used, valves are unchallenged.

Classes

No, it's not like the Post — first-class or pigeon. Class of operation means the way that we use a device, valve or transistor, to amplify signals; and it's important. There are three main classes of operation, termed (imaginatively) A, B and C, and you need to understand them thoroughly because all three are used in radio circuits.

Before we start, let's clear the way by making sure that we know what's involved in an amplifier. What it does is straightforward enough — create a high-power signal under the control of a low-power signal. An amplifier is an 'enlarger' of signals, using electrons instead of light.

The electronic devices, valves or semiconductors, that we used for constructing amplifiers do not, by themselves, amplify signal voltage. Rather, they create a *current* signal at the output, from a voltage signal (low current) at the input. What we usually need, however, is a voltage signal at the

output, and to convert current signals into voltage signals we need a load — something that obeys Ohm's law so that the voltage across the load is proportional to the current through it. Audio amplifiers use a resistor or loud speaker as load, but radio frequency amplifiers use a tuned circuit which, at the frequency of resonance, behaves like a resistor for AC signals, but as a resistor of a very different and lower value for DC bias currents. We've looked at this point previously, when we dealt with tuned circuits and their dynamic resistance. Now: what distinguishes one class of operation from another is the way in which the load and the amplifying device work together.

Class A

Class A is the most familiar operating class because it's used so extensively for audio amplifier circuits — the ones that most of us cut our teeth on. In a Class A circuit, the transistor or valve never cuts off and is never saturated. In other words, the biasing and the signal amplitude will be arranged so that a change in the voltage of the input will *always* cause a change in the current at the output. For a silicon transistor, this means that the bias voltage between base and emitter must never fall much below 0V6 and the collector voltage

must not fall much below the base voltage; a typical audio Class A amplifier is shown in Figure 6. With no signal input, the collector voltage is around half the supply voltage and the signal amplitude, when a signal is applied, must never cause the output voltage to reach either the supply voltage or earth level.

Radio frequency amplifiers working in Class A are similar — but different. To start with (Figure 7) the load will be a tuned circuit or a choke (inductor) rather than a resistor. Since the DC resistance of such a load is small, the normal no-signal voltage on the collector will be equal to the supply voltage and when a signal is applied, the voltage at the collector will be below supply voltage on one half of the cycle and above it on the other half. The restrictions are the same though — the current must never cut off and the collector voltage must never go as low as the base voltage, give or take a fraction. Using Class A for a radio-frequency amplifier produces what is called 'linear amplification', meaning that a graph of the amplifier signal current output plotted against the signal voltage at the input is a straight line. This is the type of amplifier that is needed for FM or single-sideband (SSB) signals, as we shall see later. One very important feature of a linear amplifier stage like this is that the DC current is constant — the amplifier takes the same amount of current from the supply when a signal is being amplified as it does when there is no signal and this makes decoupling and supply filtering a lot easier.

The trouble with the Class A amplifier is its low efficiency. Like the horse which is eating its head off even when it is not working, the Class A amplifier is taking current from the supply even when there is no signal, so that the ratio of power output from the amplifier to the DC power taken from the supply (confusingly called the power input) is low — always less than 50%. This ratio implies that a Class A stage will always run hot if it is handling more than a few milliwatts.

Class B

The Class B amplifier operates rather differently. To start with, the amplifying device is biased back, almost to cut off. This means that current flows mainly for the positive half-cycles of the signal (assuming a NPN transistor or valve) only. This type of stage can be usefully employed in audio amplifiers only in the form of balanced pairs (the push-pull circuit) so that one transistor handles the positive half-cycles and the other transistor handles the negative half-cycles. This is the basis of push-pull Class B circuits which, at one time, used transformers for splitting the signal into two opposite phases and recombined the phases later, but which now always deal with the two half-cycles directly by using a PNP and NPN transistor in series combination (Figure 10).

Radio frequency amplifiers can make more effective use of Class B amplifiers because they can use a load

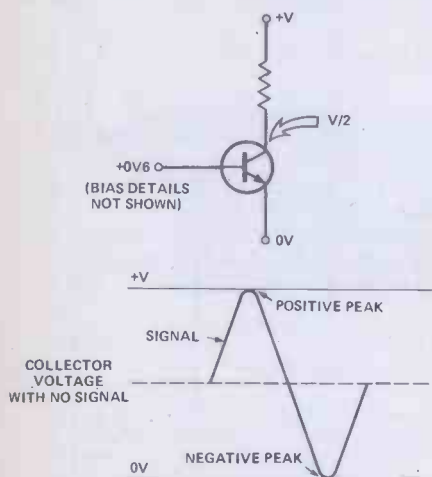

Figure 6. Class A bias — the collector voltage, when there is no signal input is at around half of supply voltage.

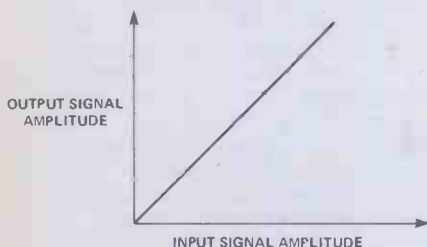

Figure 8. Linear amplification — the graph of output plotted against input is a straight line.

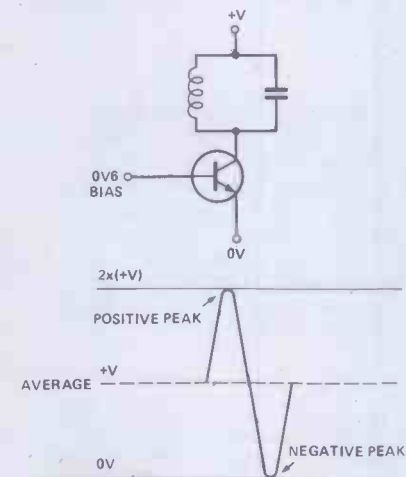

Figure 7. Adapting Class A to radio frequencies. The load is tuned circuit, and the no-signal collector voltage is equal to supply voltage.

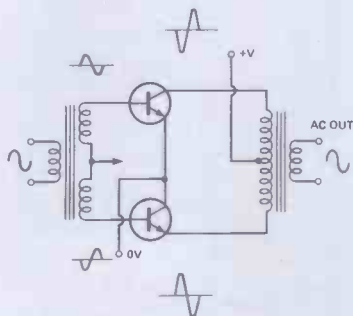

Figure 9. An old-fashioned audio push-pull stage, which can use Class B bias because the two output transistors each use half of the signal wave.

which is a tuned circuit. A tuned circuit reacts to short duration electrical pulses as a bell reacts when it's struck — it rings! A suddenly applied voltage across a parallel tuned circuit (Figure 11) will charge the capacitor, which will then discharge through the inductor, which re-charges the capacitors . . . and so on, with the cycle continuing until the energy of the original pulse has been dissipated in the resistance of the circuit. A tuned circuit will, in fact, produce a continuous signal at its resonant frequency with only a little help — it needs just enough signal at the right frequency to compensate for what is being lost in the resistance. It's like a swing — once you get it going, it needs only a very small amount of effort to keep it going.

A Class B tuned amplifier depends on this; the transistor or valve needs to conduct only for part of a cycle to keep a complete cycle going. Providing that the Q-factor of the tuned circuit is not too low, this works well and the Class B amplifier can be used for near-linear amplification. In many cases, however, the tuned circuit is loaded by other amplifier stages and has a low Q, so that the bias current has to be increased to obtain more linear operation. This need not necessarily be to the extent that is used in a Class A stage, and such arrangements are called Class A-B amplifiers.

The Class B amplifier has much higher efficiency than the Class A amplifier, meaning that a greater proportion of the power taken from the supply is converted into signal power (up to 80%), but it also means that the current is taken from the power supply in pulses, making smoothing difficult and requiring very good decoupling if these pulses are not to affect other stages in the circuit.

Class C

Class C amplification carries the "ringing" principle to its logical conclusion by biasing the transistor or valve so far into cut-off that the device conducts only on signal peaks (Figure 13). Unless the load has a high-Q, this will distort the signal considerably and so Class C amplification is used mainly for power stages of conventional AM transmitters. The fraction of the signal wave for which the transistor or valve conducts is called the 'conduction angle', and is given in degrees. If we imagine a complete cycle as being 360°, then the fraction of the wave for which the Class C stage conducts is given by the conduction angle divided by 360° so that a 30° conduction angle would mean that the transistor or valve was passing current for only one twelfth of the cycle, a lot less than the half cycle (180° conduction angle) of the Class B amplifier. The main advantage of Class C is its very high efficiency — the DC power that is taken from the supply is only slightly more than the AC signal power at the output, so that Class C is particularly useful for high-power stages which do not need linear amplification. Such power amplifiers need to be carefully designed,

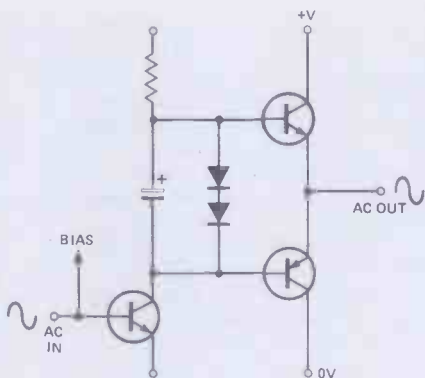

Figure 10. The more modern type of series Class B audio circuit — each transistor conducts alternately.

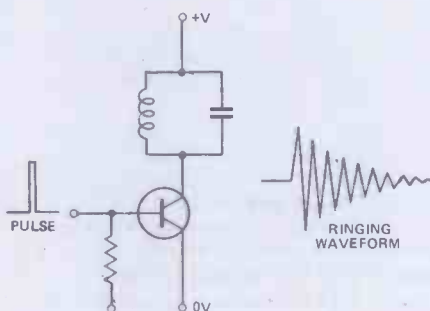

Figure 11. A ringing circuit. The pulse causes the transistor to conduct briefly — but the tuned circuit continues to oscillate even after the transistor has cut off. By feeding a small portion of the output back to the base of the transistor, this circuit can be made to oscillate, as described in an earlier part of this series, or it can be used as the basis of a Class C radio frequency amplifier.

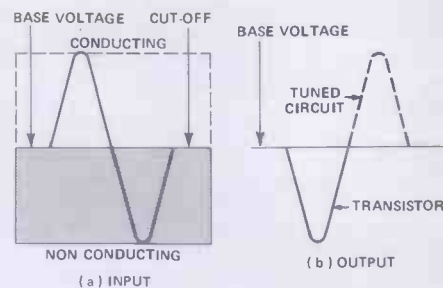

Figure 12. Using Class B for radio frequency — the tuned circuit contributes half of the output; this is possible only if the Q is fairly high.

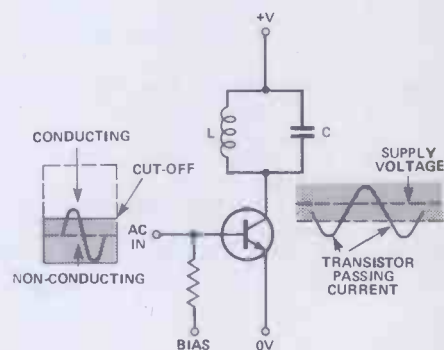

Figure 13. Class C radio frequency amplification. The transistor conducts for only a small portion of the input cycle and the tuned circuit contributes the remainder. Class C amplifiers are the most efficient, but the distortion they introduce means they can only be used for radio frequency amplification.

however, because the large pulse currents which flow for very short times will cause feedback to other parts of the circuit, and radiate from the supply leads! It is good practice to feed a Class C stage from a separate supply and to have a large decoupling capacitor across the Class C stage, between the 'cold' end of the load and earth. Large capacitance, in this respect, means about 100nF or less, depending on the frequency at which the stage is being operated. Electrolytics, which usually have rather large RF resistance, are quite definitely unsuitable.

Frequency Multipliers.

Up till now, we've been considering the best ways of obtaining, from an amplifier, a reasonable copy of the input signal but with higher power. Another problem that is tackled by

surprisingly similar methods is that of obtaining a signal which is *not* a good copy but is, in fact, a different frequency! A frequency multiplier is an amplifier which is deliberately made to distort the shape of the sinewave so that harmonics appear. These harmonics are at multiples of the input frequency (twice, three times, and so on) and any one of them can be selected by using a tuned circuit so that it is amplified to a much greater extent than the others. By using an amplifier with low bias, such as a Class C stage, and with a load which is tuned to a multiple of the input frequency, we can produce an output which is a signal at the frequency to which the load is tuned. (Figure 15).

This circuit is useful because we can use crystal oscillators operating at comparatively low frequencies to generate outputs at VHF. We can, for example, multiply the frequency of an

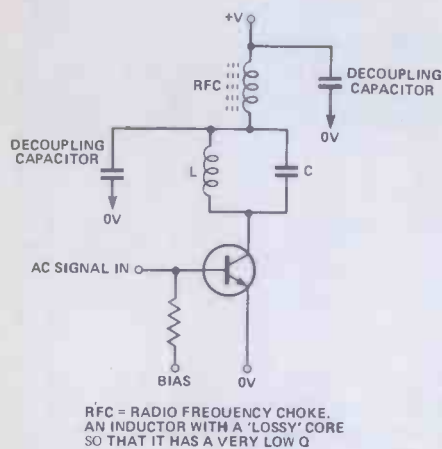

Figure 14. Decoupling a Class C circuit.

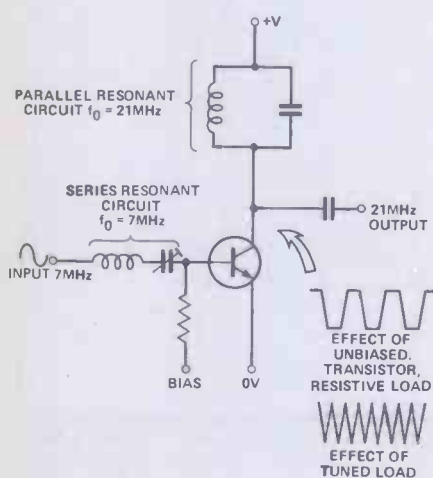

Figure 15. Frequency multiplication – the transistor output would be a square wave but for the tuned circuit, which rings at a harmonic of the input frequency so that, each time the transistor conducts, the result is in the correct phase to maintain oscillation.

8 MHz crystal to 144 MHz, using several stages of multipliers. The amounts of multiplication that are used are mainly x2 and x3, though x4 is possible for low-power stages.

Frequency Limitations

An ideal amplifier stage design would be one that could be used at all frequencies – but there's no such animal. What we do in practice is to use different designs for different parts of the frequency range. Just to complicate matters, there are several effects which combine to restrict the highest frequency that an amplifier can operate at and we have to be aware of all of them, if we are to make wise choices for components and circuits.

One of the most important limiting effects is stray capacitance. Any two points in a circuit which are not directly connected will have some stray

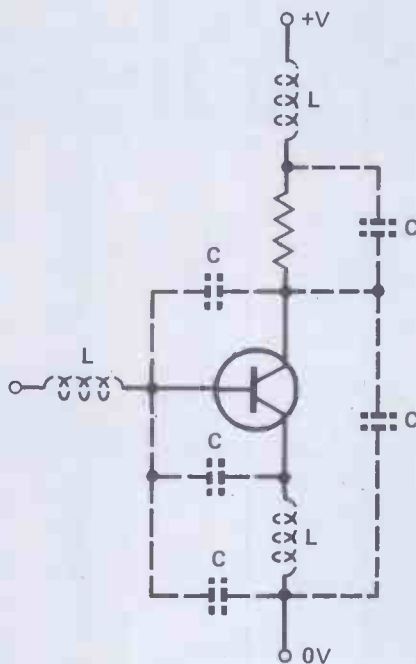

Figure 16. Stray capacitance and inductance around an amplifying stage. Each length of wire has some inductance, and there will be stray capacitance between any two points at different voltage.

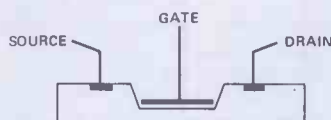

Figure 17. A FET, illustrating why transit time of electrons is important.

capacitance between them and this invisible capacitance is as real in its effect as a capacitor soldered in place. Stray capacitance can even exist between two bits of metal that are connected together because, when a radio frequency wave moves along a strip of metal, some points will be at high voltage and some at low voltage, so there can be capacitance between them.

The second effect is stray inductance. Any length of wire has an inductance and, though the inductance of a few centimetres of wire is very small, even this will be significant if we are using UHF signals. Finally, the transistors and valves that we use as amplifying devices can't operate at frequencies above the limit set by the speed of their current carriers (eg electrons).

That last one needs some explanation; suppose you imagine a FET

in which electrons move from the source to the drain and are controlled by a gate (Figure 17). Suppose, also, that the voltage on the gate is a sine wave at a high frequency, perhaps 10 MHz. Now a 10 MHz signal means that one complete cycle takes 100 nS and one quarter of a cycle takes 25 nS. What's the significance of this? Think of the movement of the electrons; if an electron starts moving from the source when the wave on the gate is at its positive peak, then it has to get past the gate before 25 nS has elapsed. If it doesn't, it will be slowed down or even repelled because the gate voltage will, by that time, have reversed. As it happens, we can make the gate and the source very close to each other, so that even with the slow speed of electrons in semiconductors, it's possible to operate FETs at fairly high frequencies, certainly more than 10 MHz – but only if the FET has been designed with its gate very close to the source. A similar effect occurs in valves and is called 'transit time'. The limitation here is that it's impossible to get the grid really close to the cathode without risking them touching, particularly when the electrodes expand due to heat.

Transistors suffer from another effect, 'charge storage', meaning that the base of a NPN transistor, which conducts because of hole movement, will fill up with electrons while the transistor is switched on and it takes some time to clear these electrons when the transistor is switched off.

Whatever the cause, we have to choose amplifying devices that will cope with the frequencies that we want to use. This may, for example, mean using transistors in common-base circuits rather than in common-emitter circuits.

For audio amplifiers, there are no serious frequency limitations. Even power amplifier transistors now have good frequency responses, provided we use modern transistor designs. The limitations caused by the effects of stray capacitance, along with the use of resistor loads have very little effect at audio frequencies.

In tuned-load amplifiers, the stray capacitance can actually be made part of the tuned circuit and becomes a problem only when we use such high frequencies that the stray capacitance is larger than the total capacitance that we need! At such frequencies, we are also up against the frequency limitations of the device itself and the effects of stray inductance, so that specialised constructional techniques are needed when we work at 400 MHz or above. Ultimately, if we want to use frequencies above 1 GHz (1000 MHz), we have to use pulsed devices such as klystrons and magnetrons to generate signals, and linear amplification eventually becomes out of the question.

We've now dealt with a lot of pieces of circuitry – oscillators, amplifiers and basic component theory – so we're ready to start putting the bits together to see how they are used in radio receivers and transmitters. We'll kick off next month, then, with the AM superhet receiver. Out.

HE

Rapid Electronics

Tel: 0206 36412
Hill Farm Industrial Estate
Boxted, Colchester
Essex CO4 5RD



CONNECTORS

DIN	Plug	Skt	Jack
2 pin	9p	9p	2.5mm
3 pin	12	10p	3.5mm
5 pin	13p	11p	Standard
Pin/DIN	10p	12p	Stereo
1mm	12p	13p	4mm

UHF (CB) Connectors
PL259 Plug 40p Reducer 14p
SO239 square chassis act 38p
SO239S round chassis socket 40p
IEC 3 pin 250V/6A
Plug chassis mounting 38p
Socket free hanging 60p
Socket with 2m lead 120p

CAPACITORS

Polyester. Radial leads. 250V, C280 type.
0.01, 0.015, 0.022, 0.033 6p; 0.047, 0.068, 0.1
7p; 0.15, 0.22 3p; 0.33, 0.47 13p; 0.68, 20p; 1u
2p
Electrolytic. Radial or axial leads.
2200/40V 110u; 4700/40V 160p; 2200/63V
140p; 4700/63V 230p
Polyester. Miniature Siemens PCB
1N, 2N, 3N, 4N, 7, 6N8, 10N, 15N 7p; 22N, 33N,
47N, 68N 8p; 100N 9p; 150N 11p; 220N 13p; 330N
20p; 470N 26p; 680N 29p; 1u 33p; 2u2 50p
Tantalum bead
0.1, 0.2, 0.33, 0.47, 1.0 @ 35V 12p; 2.2, 4.7,
10 @ 25V 20p; 15/16V 30p; 22/16V 27p;
33/16V 45p; 47/16V 27p; 47/16V 70p; 68/16V
40p; 100/10V 90p
Ceramic disc. 22p-0.01u 50V 3p each
Mullard miniature ceramic plate 480p
1.8p to 100pF 6p each
Polystyrene. 5% tolerance
10p-1000p 6p; 1500-4700p 8p; 6800-0.012u
10p
Trimmers. Mullard 809 Series
2-10pF 2Z; 2-22pF 30p; 6.5-66pF 35p

BRIDGE RECTIFIERS

1A50V	22	6A 100V	80
1A400V	35	6A 400V	95
2A200V	40	VM18, DIL	
2A400V	45	0.9A 200V	50

POTENTIOMETERS

Rotary. Carbon track Log or Lin 1K-2M2
Single 32p; Stereo 85p; Single switched 80p;
Slide 60mm travel single Log or Lin 5K-500K 83p
each
Preset. Submin. Iron. 100 ohms-1M 7p each
Cermat precision multiturn. 0.75W 1in 100 ohms
to 100K 88p each

REGULATORS

78L05	30	LM309K	120
78L12	30	LM317K	350
78L15	30	LM317T	120
7805	40	LM323K	350
7815	40		
7805	65	LM723	40
78L12	65	LM338K	475
78L15	65	78H05	
7805	65	5A5V	560
7812	45		
7815	45		

BOXES

Aluminium	70p	Plastic	
3 x 2 x 1in	85p	with lid + screws	
4 x 3 x 1 1/2in	100p	3 x 2 x 1 1/2in	55p
4 x 3 x 2in	120p	4 1/2 x 3 1/2in	88p
6 x 4 x 2in	150p	7 x 4 x 2in	160p

NEW CATALOGUE

Our latest catalogue has just been released containing over 2000 stock lines all at extremely competitive prices backed by Rapids return of post service. Stocks include Denco coils, tools, Verocases, data sheets etc. etc. Send 45p for your copy now (sent free of charge with all orders over £10).

TRANSFORMERS

Please add carriage charges to our normal post charges
Miniature mains
606V, 909V, 120/12V all @ 100mA 100p each
PCB mounting. Miniature
3VA 0-5, 0-8 @ 0.25A; 0-9, 0-9 @ 0.15A;
0-12, 0-12 @ 0.12A 200p each
6VA 0-6, 0-6 @ 0.5A; 0-9, 0-9 @ 0.3A; 0-12,
0-12 @ 0.25A 220p each
High quality. Split bobbin construction
8VA 0-6, 0-6 @ 0.5A; 0-9, 0-9 @ 0.4A; 0-12,
0-12V @ 0.3A 220p each
12VA 0-6, 0-6 @ 1A; 0-9, 0-9 @ 0.8A, 0-12,
0-12 @ 0.5A; 0-15, 0-15 @ 0.4A 295p (plus
40p carriage)
25VA 0-6, 0-6 @ 1.5A; 0-9 @ 1.2A; 0-12, 0-12
@ 1A; 0-15, 0-15 @ 0.8A 330p each (plus 60p
carriage)
50VA 0-12, 0-12 @ 2A, 0-15, 0-15 @ 1.5A
440p each (plus 75p carriage)

TRIACS

400V 4A	50
400V 8A	65
400V 16A	85
BR100	25

SCRs

TC145	70
C106D	30
400V 8A	70
400V 12A	90

FREE RESISTORS!

Yes that's right! Its giveaway month at Rapid! On all orders over £15 received we give you 100 1W 5% resistors absolutely free of charge. Free pack contains 10 each of 10 different popular values. Offer expires 30th September 1982. Please mention this magazine.

VERO WIRING PEN

Pen + spool 310p
Spore spool 75p
Combs 6p
Pen insertion
Tool 162p

RESISTORS

1W 5% Carbon film E12 series 4.70-10M 1p each
1W 5% Carbon film E24 series 4.70 to 4M7 2p each
1W 1% Metal film E24 series 100-1M 6p each

PANEL METERS

Size 60 x 46 x 35mm
0-50uA 0-500mA
0-100uA 0-1A
0-500uA 0-50V AC
0-1mA VU
0-10mA 0-300V AC
0-50mA 0-25V DC
0-100mA 0-30V DC
All 45p each

DIODES

BY127	12	*1N4001	3
0A47	10	1N4002	5
0A90	8	1N4006	7
0A91	7	1N4007	7
0A200	8	1N5401	15
0A202	8	1N5404	16
1N914	4	1N5406	17
*1N4148	2	400mW zen	6
B2X61	-	Series zeners 1.3W	
4V7-39V	-	15p each	

PCB MATERIALS

Afac transfer sheets - please state type (e.g. DIL pads etc) 45p
Dalo etch resist pen 100p
Fibre glass board 3.75" x 8" 80p
Ferric Chloride 250ml bottle 100p

LINEAR

ICL7621 180
ICL7622 120
ICL8038 320
LM324 200
LM383 100
LM723 80
LM709 25
*741 14
748 -35
9400CJ 860
AY-3-1270 350
AY-3-8910 600
AY-3-8912 625
CA3046 60
CA3080 65
CA3089 215
CA319AD 375
CA3190 40
CA3192 125
*CA3140E 50
CA3161E 100
CA3189 290
*CA3240E 110
ICL7106 795
ICL7611 95

TRANSISTORS

BC548 10
BC549 10
BC157 10
BC158 10
BC159 8
*BC128 25
BC126 25
BC187 22
BC188 22
AD142 120
AD143 80
AD161 40
AD162 40
AF124 60
AF126 50
*BC182L 8
AF186 70
AF239 75
BC107 10
BC107B 12
*BC108 9
BC109B 12
BC108C 12
*BC109 9
BC109C 12
BC114 22
BC115 22
BC117 22
BC119 35
BC137 40
BC139 40
BC140 30
BC141 30
BC142 25
BC143 25
BC147 8
BC148 8
BC149 9

SWITCHES

Submin toggle
SPST 50p SPDT 60p DPDT 85p
Miniature toggle
SPDT 90p SPDT centre off 90p
DPDT 90p DPDT centre off 100p
Standard toggle SPST
36p DPDT 48p
Miniature DPDT slide 12p
Push to make 12p Push to break 22p
Rotary type adjustable stop
1P12W 2P6W 3P4W all 50p each
DIL switches
4 SPST 80p 6 SPST 80p 8 SPST 100p

HARDWARE

PF3 battery clips 6p
Red or black crocodile clips 6p
Black pointer control knob 15p
Pr Ultrasonic transducers 350p
*6V Electronic buzzer 60p
*12V Electronic buzzer 65p
*RBT270 Piezo transducer 70p
*64mm 64 ohm speaker 70p
*64mm 8 ohm speaker 70p
20mm panel fuseholder 25p

SOLDERING IRONS

Antex CS 17W Soldering iron 450p
2.3 and 4.7mm bits to suit 210p
CS 17W element 60p
Antex NS 25W Soldering iron 490p
3.3mm and 4.7mm bits to suit 85p
Solder pump desoldering tool 40p
Spare nozzle for above 10p
100mm 122swg solder 70p

OPTO

*3mm red 8 *5mm red 8
*3mm green 12 *5mm green 12
*3mm yellow 12 *5mm yellow 12
Clips to suit 3p each
Rectangular TL32 40
*red 12 TL78 40
green 17 TL111 60
yellow 17 ORP12 85
TL139 40 TL100 90
2N577 45 Dual color 90
Seven segment displays
Com cathode Com anode
DL704 0.3" 95 DL707 0.3" 95
*FN5000 0.5" FN5057 0.5"
TL1313 0.3" 100 TL1312 0.3" 105
TL1322 0.5" 115 TL1311 0.5" 115
LCD; 3 1/2 digit 580p 4 digit 620p

CMOS

*4017 38
4018 38
4019 25
4020 50
4022 12
4006 50
4007 15
4008 48
4009 24
*4011 11
4012 15
*4013 25
4014 50
4016 50
4017 20

LS TTL

LS150 11
LS01 11
LS02 11
LS03 12
LS04 12
LS05 13
LS08 12
LS09 12
LS11 12
LS12 12
LS13 22
LS14 38
LS15 12
LS20 12

TTL

*7401 11
7402 11
7403 12
7404 13
7405 15
7406 24
7407 25
7408 24
7409 14
7410 14
7411 16
7412 18

VERO

Size *1 matrix
2.5 x 1
2.5 x 3.75
2.5 x 5
3.75 x 5
VB board
Veropins per 100
Single sided
Double sided
Spot face cutter
Pin insertion tool

SOCKETS

*8 pin
*14 pin
*16 pin
18 pin
20 pin
22 pin
28 pin
32 pin
40 pin
48 pin

CRYSTALS

100kHz 290
1MHz 370
1.008M 370
1.8432 370
2.0M 270
2.4576M 220
3.2768M 240
4.0M 170
4.194M 150
4.433M 125

★ Same day despatch ★ Competitive prices
★ Top quality components ★ In-depth stock

MicroTraining

Paul Kelly

Concluding the main part of our MicroTrainer project.



In the first article of this series we described the general principles of microprocessor operation, using the 1802 as a particular example. In this issue, we continue with a detailed description of the 1802 instruction set, and a discussion of simple programming techniques using these instructions. Then we should have laid the foundations for aspiring designers of control systems, so that in future articles we may concentrate on the applications aspects of microprocessing. We also said, at the outset of the MicroTrainer series, that we were not aiming to produce experts in machine code programming, but rather to encourage the use of microprocessors in a wide range of hobbyist applications, and we believe the average hobbyist will be well able to produce his own useful designs with only a basic understanding of machine code software.

Instructions Executed

A microprocessor operates by sequentially fetching data bytes from an external random access memory (this includes ROM) and interpreting each one as an instruction to perform specific operations on data stored in either internal registers or in external memory. The task that a microprocessor system performs is determined almost entirely by the particular sequence of instructions held in the memory, known as software or, more simply, a program. A particular microprocessor, such as the 1802, is distinguished by the set of instructions available, and by the functions of a closely related set of internal registers, as well as its peculiar hardware features.

We have already given a table of 1802 instructions and a representation of the register set (June '82 issue) and to supplement this, the internal architecture of the 1802 has

been drawn in Figure 1 and the instruction set is reproduced here as Table 1. This information is also available in the RCA programming manual. The architecture of the 1802 reveals some of the 'hidden' registers (eg the instruction holding registers I and N) as well as the user accessible registers, but a description of the MPU's operation at this level is beyond the scope of this article.

The instruction set can be subdivided into broad categories, which we will look at in turn. The categories are: register operations, memory references, logical operations, arithmetic operations, branch and skip instructions, control instructions and input/output instructions.

Register Instructions

The 1802 register set includes a bank of 16, 16-bit registers, each of which can hold 2 bytes of data or one 16-bit address. The instructions that operate on these registers show that they are primarily intended for use as memory address pointers for subsequent instructions. Here are the register instructions:

INC	R(N)	Increment register N.
DEC	R(N)	Decrement register N.
IRX		Increment register X.
GLO	R(N)	get low byte of register N and place in accumulator.
PLO	R(N)	put accumulator in low byte of register N.
GHI	R(N)	get high byte of register N, place in accumulator.
PHI	R(N)	put accumulator in high byte of register N.

These are the only instructions which specifically alter the contents of the 16-bit registers (some instructions have a 'register auto-increment/decrement' addressing mode,

however). In order to set-up a sixteen bit address in any of the registers, data must be fetched from memory via the accumulator, one byte at a time. An example will best illustrate this (the prefix '\$' and suffix 'H' both denote hexadecimal):

```
LDI $40 ;load accumulator with 40H
PHI R5 ;R5.1 = 40H
LDI $E0 ;load accumulator with E0H
PLO R5 ;R5.0 = E0H
```

At the end of this sequence of instructions, register 5 will hold the address 40E0H. The LDI instruction has been described earlier in the series. Two other instructions, INC & DEC, provide a quick means of changing this address to adjacent or nearby memory locations, eg two INC instructions will advance R5 to address 40E2H.

Each of the register instructions is a single-byte op-code which can be found in the instruction table. Clearly, since these instructions can be applied to any of sixteen registers, there must be sixteen possible codes in each case. Happily, these codes can easily be worked out by, firstly, looking up the first digit of the hex op-code and then using the register number as the second hex digit. For example, the instruction 'DEC' has a quoted op-code of '2N' where 'N' is the register number, so that 'DEC R9' has the op-code '29H'. In fact, any of the 1802 instructions which make use of the 16-bit registers can be worked out in this way.

Memory Reference

These instructions allow transfers of data bytes between the accumulator and memory locations. You have already met the two-byte instruction LDI (Load Immediate), wherein the byte stored after the op-code is copied into the accumulator. There are four other instructions that will also load data from memory into accumulator, and which illustrate the different addressing modes of the MPU:

Memory Immediate mode (LDI): has been described already.
 Register Indirect (LDN): the memory byte pointed to by register N is loaded into the accumulator.
 Indexed Addressing mode (LDX): the memory byte pointed to by the index register R(X) is loaded into the accumulator.
 Register Indirect with auto-increment (LDA): as Register Indirect but the register is automatically incremented by one after loading the data byte.
 Indexed Addressing with auto-increment (LDXA) — as with Indexed Addressing but the index register is automatically incremented after the load operation.
 All but the LDI instruction are a single byte.

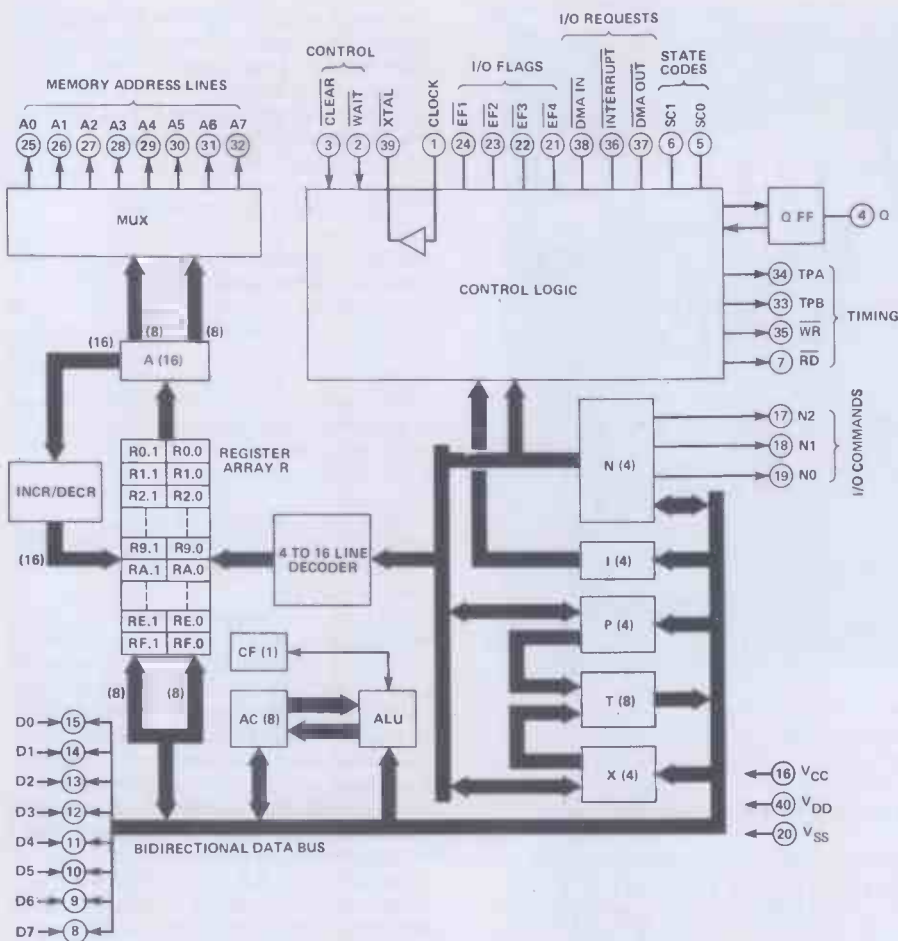

Figure 1. The 'internal architecture' of the 1802 microprocessor.

The immediate mode of addressing allows data to be placed in the program during writing, as an alternative to setting up an address pointer and then loading the data byte from elsewhere in memory. Register Indirect and the very similar Indexed Addressing modes are the most powerful and often used; they permit several data blocks within memory to be speedily accessed, using the large number of address registers available. The auto-increment addressing modes are useful when a program is operating on a large array of data stored successively in memory, where the improved execution time is a virtue.

There are two instructions which allow storage of the accumulator in memory; STR uses Register Indirect addressing and STXD is Index Addressed with auto-decrement.

The instructions described so far provide a flexible system for transferring data between memory locations and the main 1802 registers. A few of these instructions (eg STXD) may, for the moment, seem obscure, however they come into play in more advanced programming techniques.

Logic Operations

Most readers will be familiar with the logic functions 'OR', 'AND' and 'Exclusive OR' (EX-OR) which operate on two single-bit operands to produce a single bit result. The 1802 has logic instructions, of this form, which operate on a memory byte and the

IDL	00	Wait for interrupt or DMA request	SHLC	7E	Shift left with carry (accumulator)	RET	70	Return from interrupt or subroutine	LDX	F0	Load accumulator via index register
LDN	0N	Load accumulator, via register N	SMBI	7F	Subtract with borrow, immediate data from accumulator	DIS	71	Return from interrupt with interrupts disabled	OR	F1	Logic OR, memory with accumulator, via index register
INC	1N	Increment register N	GLO	8N	Load accumulator with low order byte of register N	LDXA	72	Load accumulator, via index register, and increment index register	AND	F2	Logic AND, memory with accumulator, via index register
DEC	2N	Decrement register N	GHI	9N	Load accumulator with high order byte of register N	STXD	73	Store accumulator in memory, via index register, and decrement index register	XOR	F3	Logic XOR, memory with accumulator, via index register
BR	30	Branch always	PLO	AN	Store accumulator in low order byte of register N	ADC	74	Add with carry, via index register, to accumulator	ADD	F4	Add memory to accumulator, via index register
BQ	31	Branch if Q = 1	PHI	BN	Store accumulator in high order byte of register N	ADC	74	Add with carry, via index register, to accumulator	SD	F5	Subtract accumulator from memory, via index register
BZ	32	Branch if accumulator is zero	LBR	CO	Long branch always	SDB	75	Subtract with borrow, accumulator from memory, via index register	SHR	F6	Shift right accumulator
BPZ	33	Branch if positive or zero	LBQ	C1	Long branch if Q = 1	SHRC	76	Shift right with carry (accumulator)	SM	F7	Subtract memory from accumulator, via index register
B1	34	Branch if EF1 = 0	LBZ	C2	Long branch if accumulator is zero	SMB	77	Subtract with borrow, memory from accumulator, via index register	LDI	F8	Load accumulator with immediate data
B2	35	Branch if EF2 = 0	LBPZ	C3	Long branch if positive or zero	SAV	78	Save T register in memory, via index register	ORI	F9	Logic OR, accumulator with immediate data
B3	36	Branch if EF3 = 0	NOP	C4	No operation (long skip never)	MARK	79	Push X, P registers on stack, via index register	ANI	FA	Logic AND, accumulator with immediate data
B4	37	Branch if EF4 = 0	LSNQ	C5	Long skip if Q = 0	REQ	7A	Reset Q flag to zero	XRI	FB	Logic XOR, accumulator with immediate data
BRN	38	Branch never	LSNZ	C6	Long skip if accumulator not zero	SEQ	7B	Set Q flag to one	ADI	FC	Add to accumulator, immediate data
BNQ	39	Branch if Q = 0	LSMI	C7	Long skip if minus	ADCI	7C	Add with carry, immediate data to accumulator	SDI	FD	Subtract accumulator from immediate data
BNZ	3A	Branch if accumulator not zero	LSKP	C8	Long skip always	SDBI	7D	Subtract with borrow, accumulator from immediate data	SHL	FE	Shift left accumulator
BM	3B	Branch if minus	LBNQ	C9	Long branch if Q = 0				SMI	FF	Subtract from accumulator, immediate data
BN1	3C	Branch if EF1 = 1	LBNZ	CA	Long branch if accumulator not zero						
BN2	3D	Branch if EF2 = 1	LBMI	CB	Long branch if minus						
BN3	3E	Branch if EF3 = 1	LSIE	CC	Long skip if IE = 1						
BN4	3F	Branch if EF4 = 1	LSQ	CD	Long skip if Q = 1						
LDA	4N	Load accumulator, via register N, then increment register N	LSZ	CE	Long skip if accumulator zero						
STR	5N	Store accumulator in memory, via register N	LSPZ	CF	Long skip if positive or zero						
IRX	60	Increment index register	SEP	DN	Set program counter to register N						
OUT	6N	(N = 1, 7) Transfer via index register to output device N, then increment index register	SEX	EN	Set index register to						
***	68	Illegal instruction									
INP	6N	(N = 9, F) Transfer to accumulator from input device (N-B), then store via index register									

Table 1. The instruction set of the 1802.

A	B	A,B
0	0	0
0	1	0
1	0	0
1	1	1

TRUTH TABLE
A AND B

A	B	A+B
0	0	0
0	1	1
1	0	1
1	1	1

TRUTH TABLE
A OR B

A	B	A⊕B
0	0	0
0	1	1
1	0	1
1	1	0

TRUTH TABLE
A EX-OR B

0	0	1	0	1	1	1	1
0	0	0	0	0	1	0	0
0	0	0	0	0	1	0	0

(2FH) AND (04H) = 04H

0	0	0	0	0	0	0	0
0	0	0	0	0	1	0	0
0	0	0	0	0	1	0	0

(2FH) OR (04H) = 2FH

0	0	1	0	1	1	1	1
1	1	1	1	1	1	1	1
1	1	0	1	0	0	0	0

(2FH) EX-OR (FFH) = E0H

Table 2. Above, the truth tables for AND, OR and Exclusive-OR functions. Below; AND, OR and Exclusive-OR operations performed on a data byte.

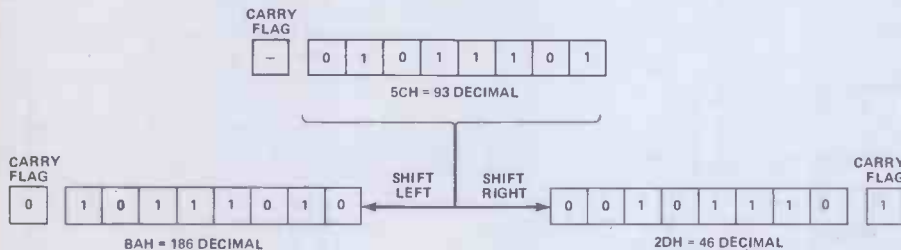

Table 3. A shift left is equivalent to 'multiply by two' and shift right performs 'divide by two'.

accumulator byte to produce a result in the accumulator, doing so on a bit-by-bit basis. For each of these functions, there is an instruction (to fetch the memory byte) in Immediate Addressing mode and an instruction in Indexed Addressing mode. The need for these instructions in a control system is obvious, however they have an important but not so apparent second use, that of 'bit manipulation'. For example, suppose the accumulator had the initial value of B7H and then we executed the instruction ANI \$0F (AND Immediate) the result would be 07H, in the accumulator. The effect has been to mask the first four bits of the data byte. Looking at the 'AND' function analytically, we can say that the effect of a logic zero in a particular bit of one operand has the effect of resetting, to logic zero, the state of the corresponding bit in the other operand. This can be used for testing the state of an individual bit within a byte (you shall see what is meant by this later). For example, ANI \$04 will mask out all but bit 2 of the accumulator data (04H = 00000100 binary). Table 2 shows that the 'OR' function has a bit-setting capability, whilst the 'Exclusive Or' function may logically invert bits.

The remaining logical operations fall in to the category of Shifts and Rotates, and are single operand functions operating on the accumulator. 'SHL' (Shift Left), for example, causes all the bits of accumulator data to move one place left (bit 0 becomes bit 1 etc); for example, after SHL, 01011101 becomes 10111010. A few calculations should convince you that

this operation is equivalent to a 'multiply by two' (but see Table 3, if in doubt), and the primary use of such an instruction is to permit arbitrary multiplications and divisions, in conjunction with the arithmetic functions (Subtract and Add). Similarly, the Shift Right instruction, 'SHR', is, in effect, a 'divide by two'. Note that the MSB, in the case of SHL, and LSB in the case of SHR, are shifted out of the accumulator into the one-bit carry-flag, CF. The setting of the carry-flag indicates that the division or multiplication by two is not quite right; it may be looked upon as an arithmetic carry (multiplication) or as a remainder (division). At the other end of the accumulator, a zero is copied in during shift operations.

There are two other instructions (RSHL, RSHR), 'ring shifts' or 'rotates', in which the previous state of CF, rather than a zero, is shifted into the 'trailing' end of the accumulator. In conjunction with ordinary shifts, these instructions allow the shift operation to be extended to multiple byte words.

Arithmetic Operations

The 1802 has only two basic arithmetic operations, Add and Subtract, and they are as simple as you might guess. The only difficulty is when the result goes above FFH or below 00H. A useful model, here, is to consider the accumulator a 'binary' bicycle mileometer. For example, when adding 07 to FD the accumulator counts up to FF then cycles back through 00, finally arriving at the value of 04 after seven

counts. Similarly during subtraction, the accumulator counts down to 00 then switches back to FF and continues to decrement. In both cases, the carry flag indicates that the result has 'overflowed' or 'underflowed'. If you look at the other Add and Subtract instructions in Table 1 you will find that there are instructions for 'accumulator subtracted from memory' as well as 'memory subtracted from accumulator' (the result always falls in accumulator) together with Add and Subtract with Carry/Borrow instructions (again, to cope with multiple-length arithmetic) all of these instructions use the two basic addressing modes of memory, Immediate and Indexed.

Branch instructions

Theoretically, any program could be written with a sequential string of arithmetic, logic and transfer instructions. However, if you consider programs that require operations to be performed many thousands of times over, this prospect becomes plainly ridiculous. Branch instructions allow program control to be transferred to a new address by directly altering the program counter, rather than the usual increment after each instruction. The simplest branch instruction is 'BR\$XX' where 'XX' is the byte following the op-code. In executing this instruction, the byte 'XX' is copied into the low-order byte of the program counter, so that execution continues with the instruction found at that address. The example below shows how a repetitive loop can be set-up using this branch instruction.

```
0000H 1F      INC  RF
           ;increment register 'F'
0001H 30 00  BR   $00
           ;branch back to 0000H
```

Normally, loops are constructed to terminate when certain conditions are set, and so a number of Conditional Branch instructions are provided. Conditions, such as the state of the carry flag or whether the accumulator is zero, are tested by the Branch instruction and a branch takes place only if the condition is met, otherwise execution continues with the next instruction. Suppose, for example, we wished to increment the 'F' register 100 times:

```
0000 F8 64 LDI   $64
           ;100 = 64H
0002 A1      PLO   R1
           ;initialise counter with one hundred
0003 1F      INC   RF
           ;increment RF
0004 21      DEC   R1
           ;decrement counter
0005 81      GLO   R1
           ;bring count into accumulator for testing
```

0000	F8	20	LDI	\$20	;load 20H in accumulator	002E	52	STR	R2	;set last digit to zero
0002	B2		PHI	R2	;put in high byte of R2	002F	22	DEC	R2	;R2 = 207AH
0003	F8	77	LDI	\$77	;load 77H	0030	02	LDN	R2	;load third digit (tens of minutes)
0005	A2		PLO	R2	;put in low byte of R2	0031	FC	ADI	\$01	;add 1
					;2077H is centre screen address	0033	52	STR	R2	;put back in display
0006	F8	00	LDI	\$00	;"0"	0034	FF	SMI	\$06	;subtract 6 to test if greater than 5
0008	52		STR	R2	;store in memory pointed to by R2	0036	3A	BNZ	P0	;go to delay loop if less than 60 minutes
0009	12		INC	R2	;R2 = 2078H	0038	52	STR	R2	;set to zero if 6
000A	F8	00	LDI	\$00	;"0"	0039	22	DEC	R2	;R2 = 2079H; ";"
000C	52		STR	R2	;	003A	22	DEC	R2	;R2 = 2078H
000D	12		INC	R2	;R2 = 2079H	003B	02	LDN	R2	;fetch second digit (hours)
000E	F8	3A	LDI	\$3A	;"3"	003C	FC	ADI	\$01	;add 1
0010	52		STR	R2	;	003E	52	STR	R2	;put in display
0011	12		INC	R2	;R2 = 207AH	003F	FF	SMI	\$0A	;subtract 10 to test for 9 hours
0012	F8	00	LDI	\$00	;"0"	0041	32	BZ	P1	;go to P1 if hours greater than 9
0014	52		STR	R2	;	0043	02	LDN	R2	;if not, load hours digit again
0015	12		INC	R2	;R2 = 207BH	0044	FF	SMI	\$03	;subtract to test if 3 hours
0016	F8	00	LDI	\$00	;"0"	0046	3A	BNZ	P0	;if not, go back to delay loop
0018	52		STR	R2	;display now shows "00:00"	0048	22	DEC	R2	;R2 = 2077H
0019	F8	7B	LDI	\$7B	;start of delay loop	0049	02	LDN	R2	;load first digit (tens of hours)
001B	A2		PLO	R2	;sets R2 to point to last digit of display	004A	FF	SMI	\$02	;subtract to test if 20 hours
001C	F8	00	LDI	\$00	;	004C	3A	BNZ	P0	;if not go to delay loop
001E	A5		PLO	R5	;	004E	52	STR	R2	;if 23 hours, set tens to zero
001F	F8	0F	LDI	\$0F	;	004F	12	INC	R2	;R2 = 2078H
0021	B5		PHI	R5	;0F00H sets the delay period	0050	02	STR	R2	;set hours to zero
0022	25	LO	DEC	R5	;start of loop LO	0051	30	BR	P0	;go to delay loop
0023	95		GHI	R5	;load accumulator with high byte of R5	0052	52	STR	R2	;set hours to zero
0024	3A	25	BNZ	L0	;go back if not zero	0053	22	DEC	R2	;R2 = 2077H
0026	02		LDN	R2	;fetch last digit	0054	02	LDN	R2	;fetch first digit (tens of hours)
0027	FC	01	ADI	\$01	;add 1	0055	FC	ADI	\$01	;add 1
0029	52		STR	R2	;put in display	0057	52	STR	R2	;put in display
002A	FF	0A	SMI	\$0A	;subtract 10 to test if greater than 9	0058	30	BR	P0	;go to delay loop
002C	3A	19	BNZ	P0	;go back if not zero					

Table 4. A simple program to simulate a 24-hour clock. The timing is set by the data byte loaded in lines 001CH to 0021H; 0F00H gives a delay of approximately one minute, and may be adjusted for more accurate timing.

```
0006 3A 03 BNZ $03
      ;branch to 0003 if count not yet
      zero
0008 .....
      next instruction
```

Notice that loop counters are usually decremented to zero rather than incremented from zero, because it is easier to test a zero condition than a content of 64H. Besides loops, conditional branches are used to transfer control to different sections of a program, according to certain conditions. If, for example, a control system required the illumination of an LED in the event of an 'underflow' following the subtraction of two variables, then a conditional branch 'BM' (Branch if Minus) immediately following the Subtract instruction could transfer control to a section of code designed to light the LED.

There are other Branch and Conditional Branch instructions that permit a program counter jump to anywhere within the memory system. These are 'long branches' and have a two-byte address, following the opcode, which is copied into the accumulator, eg LBR \$A007. Obviously these take longer to execute, and take up more memory space.

The Skip instructions of the I802 may be considered a luxury, in that they can always be replaced by one or more Branch instructions simply by writing the program in a slightly different way. An example of the skip instructions is:

```
0005 CE LSZ
      ;long skip if zero (skip 2 bytes)
0006 ...
0007 FC 01 ADI 01
      ;add 1
0009 C4 NOP
      ;continue
000A ...
```

The instruction to add one to the accumulator is executed only if the accumulator was non-zero.

Control Instructions

There are two instructions, in this group, that we are particularly concerned with, namely SEP and SEX (no comments, please!). As described in earlier issues, these two instructions define a particular 16-bit register as program counter and index register, respectively.

Often, large programs will contain sections of code which occurs many times, and it is useful to be able to condense this code into one routine or 'subroutine' to which control can be transferred from various points in the program. The greatest difficulty with this scheme is finding a method of storing the address of the program counter before control is transferred to the subroutine so that, when the subroutine has completed, control can be returned to the correct point in the main program. How this is achieved with the I802 is outlined below:

```
0000 F8 10 LDI $10
      ;load immediate, 10H.
0001 B1 PHI R1
      ;store in high byte of register 1.
0002 F8 00 LDI $00
      ;load immediate, 00H
0003 A1 PLO R1
      ;store in low;byte of R1; R1 now
      points to subroutine.
.....
0030 D 1 SEP R1
      ;go to subroutine; program counter
      is now R1.
.....
0050 D 1 SEP R1
      ;go to subroutine.
.....
```

```
OFFF D 0 SEP R0
      ;return to main program; program
      counter is now R0; R1 increments
      to 1000H.
1000 .....
      ;start of subroutine
.....
.....
100F C 0 LBR OFFF
      ;long branch to OFFF;
```

Note that it is necessary to reset the subroutine pointer (register R1) to the subroutine address (1000H) before returning to the main program because, since it is the program counter, R1 is automatically incremented after each instruction. A return at, say, 100FH would leave R1 pointing to 1010H. Instead, a jump is made to the address just before the start of the subroutine; control is returned to R0 and R1 automatically increments to 1000H. The other catch is that the subroutine must not use R0, else the return address will be lost!

It is possible to have many subroutines, each with a different pointer register, for as many registers as you can spare; it is also possible to nest subroutines (call a subroutine from a subroutine) provided that careful track is kept of the registers used. Often, each subroutine will have its own data space in memory, and this can be quickly accessed by a subroutine by reserving a register to point to this data area and defining it as the index register (SEX), on call.

Much of this may seem very academic, but it is a necessary requirement before useful programs can be written. We'll finish, however, by listing a quite complex practical program (Table 4). The comments should prove a sufficient explanation.

Next time we will look at the largely hardware-orientated instruction, so far omitted, when we discuss I/O interfaces.

THE CASE FOR



It's the chance every constructor wants



POWER AMPS



P.S.U.'s



**PRE-AMP
MODULES**

It's something you have always wanted....something to build your equipment into that's smart, modern, strong, adaptable to requirement and not expensive. The 'UniCase' is yet another triumph of I.L.P. design policy. It presents totally professional appearance and finish, ensuring easier and better assembly to make it equal to the most expensive cased equipment. The all-metal 'UniCase' is enhanced by precision aluminium extruded panels engineered for speedy and perfect aligned assembly within a mere five minutes. Designed in the first case to accommodate I.L.P. power amps with P.S.U.'s, the range will shortly be extended to house any other modular projects.

WHAT WE DO FOR CONSTRUCTORS

Our product range is now so vast we cannot possibly hope to show it all in our advertisements without overcrowding or abridging information to the point of uselessness. So we have devised a solution which we invite you to take advantage of without delay. ALL YOU NEED DO IS FILL IN AND FORWARD THE COUPON BELOW TO RECEIVE OUR NEWEST COMPREHENSIVE I.L.P. CATALOGUE POST FREE BY RETURN. It gives full details of all current I.L.P. products for the constructor together with prices, full technical and assembly details, wiring and circuit diagrams etc. and it's yours, FREE. You don't even have to stamp the envelope if you address it the way we tell you.



FREEPOST 6
GRAHAM BELL HOUSE, ROPER CLOSE, CANTERBURY CT2 7EP
Telephone Sales (0227) 54778 Technical Only (0227) 64723 Telex 965780

FREEPOST
Mark your envelope clearly **FREEPOST 6** and post it **WITHOUT** a stamp to I.L.P. at address above. We pay postage when your letter reaches us.

Did you know

I.L.P. are the world's largest designers and manufacturers of hi-fi audio modules?

I.L.P. pioneered encapsulated power amps and pre-amps for enhanced thermal stability, mechanical protection and durability?

There are **TWENTY** power amplifiers from 15 to 240 watts RMS including the very latest super-quality Mosfets to choose from?

TWENTY pre-amp modules allow you to incorporate exciting professional applications to your equipment never before available to constructors and experimenters?

I.L.P. are suppliers to the B.B.C., I.B.A., N.A.S.A., British Aerospace, Marconi, Racal, Ferranti, G.E.C., Rolls Royce etc?

Goods are despatched within 7 days of your order reaching us and covered by our 5 year no-quibble guarantee?

SEND COUPON
(NO STAMP NECESSARY)
**FOR YOUR FREE
I.L.P. CATALOGUE
AND OPEN UP
TO A
NEW WORLD OF
QUALITY & VALUE**

To: **I.L.P. ELECTRONICS LTD.**
PLEASE SEND ME I.L.P. CATALOGUE,
POST PAID BY RETURN

I HAVE/HAVE NOT PREVIOUSLY
BUILT WITH I.L.P. MODULES

Name: _____

Address: _____

I.L.P. products are available also from Henry's, Marshall's, Technomatic & Watford.

TTLS 7400 11p 7401 11p 7402 12p 7403 12p 7404 12p 7405 12p 7406 20p 7407 20p 7408 14p 7409 14p 7410 14p 7411 18p 7412 18p 7413 18p 7414 20p 7415 20p 7416 20p 7417 20p 7420 15p 7421 20p 7422 20p 7423 20p 7424 20p 7425 20p 7426 28p 7427 22p 7428 22p 7430 14p 7431 22p 7432 22p 7433 22p 7437 25p 7438 25p 7440 15p 7441 15p 7442A 32p 7443 80p 7445 50p 7446A 60p 7447A 36p 7448 45p 7451 15p 7453 15p 7454 15p 7460 17p 7470 25p 7472 25p 7473 25p 7474 25p 7475 30p 7476 30p 7480 50p 7481 100p 7482 70p 7483A 38p 7484 66p 7485 90p 7486 200p 7490A 20p 7491 20p 7492A 25p 7493A 24p 7494 36p 7495A 36p 7496 40p 7497 80p 74100 80p 74107 22p 74109 24p 74116 50p 74118 60p 74119 80p 74120 80p 74121 25p 74122 40p 74123 48p 74125 48p 74126 48p 74128 36p 74132 45p 74136 28p 74141 55p 74142 200p 74145 50p 74147 80p 74178 70p 74151A 50p 74151B 40p 74154 50p 74155 40p 74156 40p 74157 30p 74159 70p 74161 48p 74162 48p 74163 48p 74164 48p 74165 48p 74166 48p 74170 120p 74172 275p 74173 60p 74174 55p 74175 45p 74176 40p 74177 45p 74178 80p 74180 40p 74181 115p 74182 60p 74184A 90p 74185 90p 74186 500p 74188 250p 74190 48p 74191 48p 74192 48p 74193 48p 74194 48p 74195 48p 74196 48p 74197 48p 74198 85p 74199 85p 74221 55p 74221 55p 74273 140p 74278 10p 74283 125p 74290 100p 74293 100p 74365 50p 74366 50p 74367 50p 74368 50p

74390 75p 74393 100p 74490 95p 74LS SERIES 74LS00 12p 74LS01 11p 74LS02 12p 74LS03 12p 74LS04 12p 74LS05 12p 74LS08 12p 74LS09 12p 74LS10 13p 74LS11 13p 74LS12 13p 74LS13 20p 74LS14 34p 74LS15 15p 74LS20 12p 74LS21 12p 74LS22 12p 74LS23 12p 74LS24 12p 74LS28 14p 74LS30 12p 74LS32 14p 74LS37 15p 74LS38 15p 74LS42 30p 74LS47 36p 74LS51 14p 74LS55 15p 74LS73 18p 74LS74 16p 74LS75 18p 74LS78 18p 74LS83 38p 74LS85 50p 74LS86 18p 74LS87 18p 74LS92 32p 74LS93 24p 74LS95 40p 74LS96 50p 74LS107 40p 74LS108 27p 74LS112 25p 74LS113 25p 74LS114 22p 74LS122 20p 74LS123 22p 74LS124 22p 74LS125 24p 74LS126 25p 74LS132 40p 74LS133 30p 74LS136 25p 74LS138 25p 74LS139 30p 74LS145 70p 74LS147 160p 74LS148 75p 74LS151 70p 74LS153 70p 74LS154 90p 74LS155 32p 74LS156 36p 74LS157 27p 74LS158 30p 74LS168 40p 74LS169 40p 74LS181 36p 74LS182 36p 74LS184 40p 74LS185 40p 74LS186 40p 74LS187 40p 74LS188 40p 74LS189 40p 74LS190 40p 74LS191 40p 74LS192 40p 74LS193 40p 74LS194 40p 74LS195 40p 74LS196 40p 74LS197 40p 74LS198 40p 74LS199 40p 74LS200 40p 74LS201 40p 74LS202 40p 74LS203 40p 74LS204 40p 74LS205 40p 74LS206 40p 74LS207 40p 74LS208 40p 74LS209 40p 74LS210 40p 74LS211 40p 74LS212 40p 74LS213 40p 74LS214 40p 74LS215 40p 74LS216 40p 74LS217 40p 74LS218 40p 74LS219 40p 74LS220 40p 74LS221 40p 74LS222 40p 74LS223 40p 74LS224 40p 74LS225 40p 74LS226 40p 74LS227 40p 74LS228 40p 74LS229 40p 74LS230 40p 74LS231 40p 74LS232 40p 74LS233 40p 74LS234 40p 74LS235 40p 74LS236 40p 74LS237 40p 74LS238 40p 74LS239 40p 74LS240 40p 74LS241 40p 74LS242 40p 74LS243 40p 74LS244 40p 74LS245 26p 74LS251 36p 74LS253 36p 74LS257 36p 74LS258 36p 74LS259 60p 74LS260 82p 74LS266 20p 74LS273 60p 74LS279 35p 74LS283 40p 74LS298 90p 74LS323 175p 74LS324 150p 74LS343 120p 74LS352 80p 74LS353 80p 74LS363 140p 74LS364 140p 74LS365 30p 74LS366 30p 74LS367 30p 74LS368 30p 74LS369 30p 74LS370 30p 74LS371 30p 74LS372 30p 74LS373 30p 74LS374 30p 74LS375 45p 74LS376 45p 74LS377 60p 74LS378 60p 74LS390 60p 74LS393 45p 74LS399 160p 74LS400 75p 74LS41 75p 74LS40 140p 4000 SERIES 4000 10p 4001 10p 4002 10p 4003 10p 4004 50p 4005 15p 4006 15p 4007 24p 4008 24p 4009 24p 4010 11p 4012 16p

4013 23p 4014 48p 4015 45p 4016 20p 4017 36p 4018 45p 4019 25p 4020 15p 4021 48p 4022 45p 4023 32p 4024 32p 4025 15p 4026 90p 4027 22p 4028 45p 4029 50p 4030 20p 4031 12p 4032 90p 4034 140p 4035 60p 4036 275p 4037 50p 4038 27p 4039 48p 4040 48p 4041 50p 4042 44p 4043 48p 4044 48p 4045 48p 4046 48p 4047 50p 4048 50p 4049 24p 4050 24p 4051 45p 4052 60p 4053 50p 4054 90p 4055 90p 4056 90p 4057 90p 4058 45p 4059 45p 4060 55p 4061 80p 4062 75p 4063 14p 4064 14p 4065 14p 4066 14p 4067 14p 4068 14p 4069 14p 4070 14p 4071 14p 4072 14p 4073 14p 4074 14p 4075 14p 4076 48p 4077 18p 4078 16p 4079 15p 4080 15p 4081 15p 4082 15p 4083 90p 4084 90p 4085 75p 4086 75p 4087 340p 4088 90p 4089 150p 4090 24p 4091 90p 4092 75p 4093 75p 4094 75p 4095 75p 4096 75p 4097 75p 4098 90p 4099 100p 4100 100p 4101 50p 4102 180p 4103 180p 4104 180p 4105 180p 4106 40p 4107 40p 4108 40p 4109 40p 4110 40p 4111 40p 4112 40p 4113 40p 4114 40p 4115 40p 4116 40p 4117 40p 4118 40p 4119 40p 4120 40p 4121 40p 4122 40p 4123 40p 4124 40p 4125 40p 4126 40p 4127 40p 4128 40p 4129 40p 4130 40p 4131 40p 4132 40p 4133 40p 4134 40p 4135 40p 4136 40p 4137 40p 4138 40p 4139 40p 4140 40p 4141 40p 4142 40p 4143 40p 4144 40p 4145 40p 4146 40p 4147 40p 4148 40p 4149 40p 4150 40p 4151 40p 4152 40p 4153 40p 4154 40p 4155 40p 4156 40p 4157 40p 4158 40p 4159 40p 4160 40p 4161 40p 4162 40p 4163 40p 4164 40p 4165 40p 4166 40p 4167 40p 4168 40p 4169 40p 4170 40p 4171 40p 4172 40p 4173 40p 4174 40p 4175 40p 4176 40p 4177 40p 4178 40p 4179 40p 4180 40p 4181 40p 4182 40p 4183 40p 4184 40p 4185 40p 4186 40p 4187 40p 4188 40p 4189 40p 4190 40p 4191 40p 4192 40p 4193 40p 4194 40p 4195 40p 4196 40p 4197 40p 4198 40p 4199 40p 4200 40p

LINEAR ICs AN103 200p AY1-0212 600p AY1-1313 688p AY1-1320 320p AY15050 140p AY1-1350 400p AY3-8910 I 550p AY3-8912 650p AY5-4007D 520p CA3028A 120p CA3019 80p CA3046 70p CA3048 225p CA3059 300p CA3060 350p CA3080E 72p CA3086 48p CA3089 200p CA3090AQ 375p CA3130E 90p CA3140 50p CA3180E 100p CA3181E 140p CA3182 450p CA3189E 300p CA3240 120p CA3280G 200p DAC1408-8 200p HA1366 300p HA1385 270p ICL7106 850p ICM7216B 18 ICM7217 700p ICL8038 300p ICM7555 40p LC7120 400p LC7130 400p LF347 150p LF351 48p LF353 100p LF356P 92p LF357 120p LM1010C 350p LM301A 27p LM310 120p LM318 200p LM319 225p LM324 30p LM334Z 100p LM335Z 140p LM339 50p LM348 75p LM358P 60p LM377 175p LM380 75p LM381AN 180p LM382 120p LM386 95p LM387 120p LM389 95p LM391 150p LM393 100p LM394 100p LM709 35p LM710 50p LM711 70p LM733 70p LM741 18p LM747 70p LM748 35p LM7917 200p LM3302 90p LM3300 50p LM3303 95p LM3311 130p LM3914 200p LM3915 200p LM3916 225p LM13600 110p M51513L 300p M51516L 500p MB3712 250p MB3730 400p MC1310P 150p MC1445 325p MC1458 36p MC1495L 350p MC1496 70p MC3340P 120p MC3403 75p MC30398 725p MM5160 620p MN6221A 6p ME531 150p NE555 20p NE556 40p NE558 130p NE566 155p NE567 140p NE570 375p NE571 375p PLEB534A 500p PLQ24 500p RC4136 60p RC4151 200p S568 240p SAD102A 1250p SFF9634A 80p SL490 350p SN74647 500p SN7488 500p SN7695 500p SR8515 750p TA7120 30p TA7204 250p TA7205 250p TA7222 200p TA7310 200p TA621 275p TB8651 200p TA8200 200p TA8210 200p TA8220 200p TA8250 200p TA8950 300p TC2420 350p TCA940 175p TDA1170 300p TDA1008 220p TDA1012 520p TDA1024 120p TDA1034H 250p TDA1170 300p TDA2002V 325p TDA2003 325p TDA2006 320p TLO64 150p TLO71/B1 25p TLO72/E2 25p TLO74 100p TLO84 200p TLO94 200p UA1170 70p UAA170 100p UA2240 150p UDN6118 320p UDN6184 320p ULN2003 100p UPC6575 400p UPC6592H 300p UPC1155H 300p XR2206 300p XR2207 600p XR2211 675p XR2216 675p ZN414 225p ZN419C 150p ZN423E 95p ZN424E 135p ZN426E 350p ZN427E 625p ZN428E 500p ZN1034E 200p ZN1040E 200p ZN423A 800p

VOLTAGE REGULATORS FIXED PLASTIC 1A +ve -ve 5V 1A 7805 45p 7905 80p 12V 1A 7812 50p 7912 55p 15V 1A 7815 50p 7915 50p 18V 1A 7818 55p 7918 60p 24V 1A 7824 55p 7924 60p 5V 100mA 78L05 30p 79L05 60p 12V 100mA 78L12 30p 79L12 60p 15V 100mA 78L15 30p 79L15 60p

OTHER REGULATORS LM309K 1A 5V 135p 78GKCC 600p LM317K 325p 78H05KC 550p LM317T 1A Adj 125p 78MG72C 140p LM337T 1.40p 78GUC 200p LM323K 3A 5V 500p 78GUC 225p LM723 150mA Adj 37p 78HGKC 700p TL494 400p TL497 300p 78S40 300p LM305AS 250p

OPTO-ELECTRONICS OS577 45p ORP60 120p OC7P1 180p ORP61 120p ORP12 120p TIL78 55p

OPTO-ISOLATORS ILD74 130p TIL111 90p MCT26 100p TIL112 90p MCS2400 190p TIL113 90p ILO74 240p TIL114 90p

LEDS 0.125" TIL220 Red 10p TIL22 8p TIL209 Red 9p TIL228 Yel 14p TIL21 7p Rectangular 12p TIL212 Ye 14p LEDs (R, G, Y) 570p TIL216 Red 18p NS85881 600p

DISPLAYS TIL312/3 110p 301FS 200p TIL321/2 130p DL704 140p TIL330 140p DL707 Red 140p 7750/60 200p

DRIVERS RFD327 30p 3363 30p BFR40 25p TIP29A 35p BFR79 25p TIP29C 35p BFR96 180p TIP30A 35p BFC29 40p TIP31A 40p BFX30 27p BFX45/5 47p BFX86/7 27p BFX88 27p

* MICROTRAINER *

(as described in June/July/Aug issue)

- Hobbyists can now learn and explore the workings of microprocessors. This project opens the mystical field of computers to enthusiasts.
- A truly low cost teaching aid useful for training centres, schools and industries. In fact a short step towards developing new ideas and systems. Gives effective insight into micros to engineers, technicians, etc. not directly involved in the computer field.

Complete Kit£64 + £1 p&p
8V 1.8A PSU£7 + 70p p&p
1802 Ref£7.00

ACORN ATOM

Basic Built 8K + 2K£135
Expanded 12K + 12K£180
8K + 5K + Colour Card£175
 (p&p £3/unit)

3A5V PSU£26 + £2 p&p
 Send for detailed Atom list

MICRO TIMER

The programmable clock/timer is a 6502 based dedicated micro computer with memory and 4 digit 7 segment displays to form an extremely versatile timing device with following features:

- 24 hour 7 day timer
- 4 completely independent switch outputs
- 4 digit 7 segment display output to indicate real time turn-off times and reset times
- Individual outputs to day of week, switch and status LEDs
- Data entry through a simple matrix pad

Further details on request

Complete Kit£56 + £1 p&p
PSU£7 + 70p p&p
 Construction details supplied

SWITCHES	DIGITAST SWITCHES	VERO BOARDS
Toggle Switches	1xP	2.5" x 5" 90p
Summirature	Push to break (R, G, B)	2.5" x 3.75" 80p
SFST 60p, SPOT 85p, DPOT 70p	Push to make (Black)	3.75" x 17" 145p
Rotary Switches	Slide Switch DPDT	3.75" x 3.75" 90p
IP120w, 2Pw, 3Pw, 4Pw, 55p	Square PCB Switch	3.75" x 11" 110p
		Vero Block £3.90

LOW PROFILE DIL SOCKETS BY TEXAS	WIRE WRAP SOCKETS BY TEXAS	FOR FAST DELIVERY JUST PHONE
8 pin 10 18 pin 15p 24 pin 24p	8 pin 25 pin 18 pin 50p 24 pin 70p	01-452 1500/450 6597
14 pin 10p 20 pin 18p 28 pin 26p	14 pin 35p 20 pin 60p 28 pin 80p	MINIMUM ORDER £5
16 pin 11p 22 pin 22p 40 pin 30p	16 pin 40p 22 pin 65p 40 pin 100p	

TRANSISTORS	TIP33C	2N3054	68p	3N140	120p	ZENERS
ADP16/2 25p	TIP34A 90p	2N3055	48p	3N141 110p	2.7V-33V	
BC107/8 13p	TIP34C 120p	2N3056	140p	3N201 110p	400mW 9p	
BC109 14p	TIP35A 120p	2N3057	240p	3N204 120p	1W 15p	
BC117 20p	TIP35C 140p	2N3058	250p	3N205 75p		
BC106C 12p	2N3502 120p	2N3503 120p	140p	3N206 250p		
BC172 12p	2N3504 120p	2N3505 120p	140p	3N207 120p		
BC177 12p	2N3506 120p	2N3507 120p	140p	3N208 120p		
BC178 12p	2N3508 120p	2N3509 120p	140p	3N209 120p		
BC179 12p	2N3510 120p	2N3511 120p	140p	3N210 120p		
BC182/3 12p	2N3512 120p	2N3513 120p	140p	3N211 120p		
BC184 11p	2N3514 120p	2N3515 120p	140p	3N212 120p		
BC187 30p	2N3516 120p	2N3517 120p	140p	3N213 120p		
BC193 30p	2N3518 120p	2N3519 120p	140p	3N214 120p		
BC197 30p	2N3520 120p	2N3521 120p	140p	3N215 120p		
BC214 12p	2N3522 120p	2N3523 120p	140p	3N216 120p		
BC237 16p	2N3524 120p	2N3525 120p	140p	3N217 120p		
BC337 16p	2N3526 120p	2N3527 120p	140p	3N218 120p		
BC338 16p	2N3528 120p	2N3529 120p	140p	3N219 120p		
BC461 25p	2N3530 120p	2N3531 120p	140p	3N220 120p		
BC477/8 30p	2N3532 120p	2N3533 120p	140p	3N221 120p		
BC516/7 40p	2N3534 120p	2N3535 120p	140p	3N222 120p		
BC547B 18p	2N3536 120p	2N3537 120p	140p	3N223 120p		
BC548C 9p	2N3538 120p	2N3539 120p	140p	3N224 120p		
BC549C 18p	2N3540 120p	2N3541 120p	140p	3N225 120p		
BC557B 18p	2N3542 120p	2N3543 120p	140p	3N226 120p		
BC559C 18p	2N3544 120p	2N3545 120p	140p	3N227 120p		
BC619 18p	2N3546 120p	2N3547 120p	140p	3N228 120p		
BC70 18p	2N3548 120p	2N3549 120p	140p	3N229 120p		
BC771 2 22p	2N3550 120p	2N3551 120p	140p	3N230 120p		
BD131 2 75p	2N3552 120p	2N3553 120p	140p	3N231 120p		
BD138 40p	2N3554 120p	2N3555 120p	140p	3N232 120p		
BD140 40p	2N3556 120p	2N3557 120p	140p	3N233 120p		
BD189 60p	2N3558 120p	2N3559 120p	140p	3N234 120p		
BD232 95p	2N3560 120p	2N3561 120p	140p	3N235 120p		
BD233 75p	2N3562 120p	2N3563 120p	140p	3N236 120p		
BD235 85p	2N3564 120p	2N3565 120p	140p	3N237 120p		
BD241 60p	2N3566 120p	2N3567 120p	140p	3N238 120p		
BD242 60p	2N3568 120p	2N3569 120p	140p	3N239 120p		
BD243 60p	2N3570 120p	2N3571 120p	140p	3N240 120p		
BD244 60p	2N3572 120p	2N3573 120p	140p			

POINTS OF VIEW

Feel like sounding off? Then write to the Editor stating your Point Of View!

The most interesting Point of View, this month is from Mr. A.G. Meakins, who comments on writing style of certain points mentioned in "Scaling the HiFi Heights" (HE January issue).

Unimpressed

Dear Sir,

Your cover puts H.E. as having "a down to earth approach to electronics", but it's a pity you don't impress this on your writers, who use long words like "parameters" when "limits" would do.

In *Scaling the HiFi Heights*, your writer should come down to earth. When he states that £400 is the lowest starting point, he is way off target. I would suggest that, for most HE readers, that would be the extreme top limit.

Another piece of pie in the sky that comes from his pen is the wattage of the amplifier. I have a room of 1200 cubic feet, my amplifier is 14 W per channel and with the volume control at 30%, I can comfortably fill my room with ample power left to take the peaks. Perhaps your writer destroyed his hearing in a disco, when young.

A.G. Meakins
Richmond,
Surrey.

First, this letter was attached to a late return of our Reader Survey, also from the January issue. We have since changed our masthead slogan but not, we hope, our approach.

Every article which appears in HE is carefully edited to ensure that it can easily be understood. However, this must not be overdone; an article consisting entirely of words of one syllable would not only be an insult to our readers, it would also be boring and, most likely, inaccurate because it is not always possible to find a 'short word' to substitute for a long one. Remember that electronics is a technical subject, that certain words have very precise meanings and, therefore, cannot be changed.

In fact, the word 'parameter' is one for which there is no suitable substitute. It means "... a constant in the case considered but varying in different cases." (C.O.D.). In general usage, a parameter is a factor by which a device or property is defined or measured, for example the small-signal parameters which define transistor operation under certain conditions. A limit is a border or boundary line or point, and not the same thing at all.

The suggestion that £400 is the top limit of spending for HE readers is an example of a limit that is somewhat

arbitrary. True, it is a lot of money, but a system costing this much or more is not out of the question. It is possible to build up a very expensive hifi over a period of years buying units one at a time. Also, the figure was mentioned as the lowest total "... for serious sound pursuit." and considering that it is possible to spend over £1000 on audio gear, a £400 system only just qualifies as hifil

For example, a 14 W per channel amplifier, while adequate for normal listening, would not satisfy a dedicated hifi fanatic. It has to be said that opinions on listening levels are extremely subjective (one man's pleasure is another's pain), nevertheless, all other factors (type of programme material, the size of the room and acoustic treatment, the efficiency of the speakers etc) being equal, a large amplifier will come closer to reproducing the original dynamic range of music, at comfortable levels, than a small amp. This, after all, is the goal of hifi - accurate reproduction of the original music.

Finally, it's worth pointing out that concert musicians, sitting in the middle of an orchestra which can produce sound peaks of up to 100 dB SPL, do not usually destroy their hearing. There is no reason why these levels, accurately reproduced, should destroy the hearing of a listener in the middle of his lounge room. What the neighbours think is another question!

No Kitting

Dear Sir,

I have been trying to get you by phone to ask about the LED VU Meter project from the November '81 issue. I was wondering if the kit you did for it included the integrated circuit U267B Bargraph Driver.

If so, could you please send a full kit for the VU Meter and when I receive it I will send on the money.

S. Harvey,
Cleethorpes,
South Humberside.

Sorry, but we do not sell kits or component parts for HE projects except, of course, the printed circuit boards which are advertised in each issue. However, there are companies who supply kits for our projects and they usually advertise in the magazine. One of them should be able to help you.

This reply should also answer S.N. Heider of Dextridge, Livingstone, West Lothian, who wrote with a similar enquiry.

Trying to 'phone us is not a good idea - we cannot, unfortunately, accept

telephone enquiries because of the time involved. There simply aren't enough hours in a day! One other thing; most companies would want to see the colour of your money before sending the goods.

'Diana' Hunted

Dear Sir,

Please will you let me have a copy of your article, from the September 1981 issue of *Hobby Electronics*, on the *Diana Metal Detector*. I work at Plessey Radio at Cowes, here on the Isle of Wight, as a test engineer. Our librarian has contacted on my behalf our local libraries, Portsmouth and Southampton libraries and, finally, the British Museum, for a copy of the issue but all without success.

I hope you will be able to assist me.
G.M. Store,
Ryde,
Isle of Wight.

The quickest and easiest method for obtaining most back issues of HE is to write to our Backnumbers Department - see the advertisement in this or any recent issue. It certainly beats chasing around libraries and museums.

Meanwhile, interested readers might like to know that the add-on VCO for 'Diana' has been finalised and will appear in the near future.

Into Electronics Lost

Dear Sir,

Recently a friend loaned me one of your books, 'Into Electronics Plus', published in 1979. I found it of great interest and wondered if you could advise whether it is still possible to obtain a copy, and the price.

Three years since publication is a long time, I realise, but if a copy could be located I would very much appreciate it.

D. C. Holmes,
Bury St. Edmunds,
Suffolk.

Regretably, this book is no longer available. It has been 'out of print' for some time. However, you might find 'Electronics - It's Easy' a suitable alternative; it provides a slightly less detailed, broader introduction to electronics. It is available from our Specials Department, 513, London Road, Thornton Heath, Surrey CR4 6AR, for £4.95 including p&p; don't forget to ask for it by name!

LOOK

Kit includes tape transport mechanism, ready punched and back printed quality circuit board and all electronic parts, i.e. semiconductors, resistors, capacitors, hardware, top cover, printed scale and mains transformer. You only supply solder and hook-up wire.

Featured in April issue P.E. Reprint 50p. Free with kit.

Self assembly simulated wood cabinet — Only £4.50 + £1.50 p&p.

£32-95
+ £2.75 p&p.

ELECTRONICS ONLY!

Ideal for updating your existing cassette. Includes pcb diagram, all semiconductors, IC's, Capacitors, resistors. **£18-95** + £1.40p&p

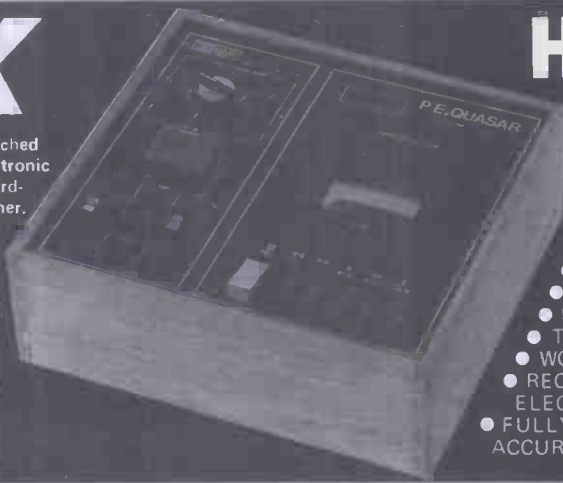

HI-FI STEREO CASSETTE RECORDER KIT

- NOISE REDUCTION SYSTEM
- AUTO STOP
- TAPE COUNTER
- SWITCHABLE E.O.
- INDEPENDENT LEVEL CONTROLS
- TWIN V.U. METER
- WOW & FLUTTER 0.1
- RECORD PLAYBACK I.C. WITH ELECTRONIC SWITCHING
- FULLY VARIABLE RECORDING BIAS FOR ACCURATE MATCHING OF ALL TAPES

STEREO AMPLIFIER KIT

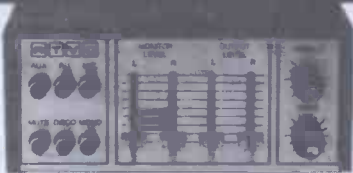

- Featuring latest SGS/ATES TDA 2006 10 watt output IC's with in-built thermal and short circuit protection.
- Mullard Stereo Pre-amplifier Module.
- Attractive black vinyl finish cabinet, 9" x 8 1/4" x 3 1/4" (approx).
- 10+10 Stereo converts to a 20 watt Disco amplifier.

To complete you just supply connecting wire and solder. Features include din input sockets for ceramic cartridge, microphone, tape or tuner. Outputs - tape, speakers and headphones. By the press of a button it transforms into a 20 watt mono disco amplifier with twin deck mixing. The kit incorporates a Mullard LP1183 pre-amp module, plus power amp assembly kit and mains power supply. Also features 4 slider level controls, rotary bass and treble controls and 6 push button switches. Silver finish fascia with matching knobs and contrasting cabinet. Instructions available, price 50p. Supplied FREE with kit.

£16-50

+ £2.90 p&p.

Suitable for 4 to 8 ohm speakers
40Hz - 20KHz
P.U. 150mV, Aux. 200mV,
Mic. 1.5mV.

Tone controls

Distortion
Mains supply

8" SPEAKER KIT Two 8" twin cone domestic speakers. £4.75 per stereo pair plus £1.70 p&p, when purchased with amplifier. Available separately £6.75 & £1.70 p&p.

125W HIGH POWER AMP MODULE

KIT: **£10-50** BUILT: **£14-25**
+ £1.15 p&p + £1.15 p&p.

The power amp kit is a module for high power applications - disco units, guitar amplifiers, public address systems and even high power domestic systems. The unit is protected against short circuiting of the load and is safe in an open circuit condition. A large safety margin exists by use of generously rated components, result, a high powered rugged unit. The PC board is back printed, etched and ready to drill for ease of construction and the aluminium chassis is preformed and ready to use. Supplied with all parts, circuit diagrams and Instructions.

ACCESSORIES: Suitable mains power supply kit with transformer: £7.50 plus £3.15 p&p.
Suitable LS coupling electrolytic: £1.00 plus 25p p&p.



SPECIFICATIONS:

Max. output power (RMS): 125W.
Operating voltage (DC): 50 - 80 max.
Loads: 4 - 16 ohms.
Frequency response measured @ 100 watts: 25Hz - 20KHz.
Sensitivity for 100 watts: 400mV @ 47K.
Typical T.H.D. @ 50 watts, 4 ohms: 0.1%.
Dimensions: 205 x 90 and 190 x 36 mm.

HI-FI SPEAKERS AT BARGAIN PRICES

GOODMANS TWEETERS

8 ohm soft dome radiator tweeter (3 1/4" sq.) for use in up to 40W systems; with 2 element crossover.

£3.50 each (p&p £1) or £5.95 pair (p&p £2).



35 WATT MICRO 2-WAY SPEAKER SYSTEM

Unit comprises one 50w (4" app.) Audax soft dome tweeter HD100. And one 5" Audax bass/midrange 35w driver HIFIJSM. Complete with 2 element crossover. Total impedance of system 4 ohms.

£7.95

PER SET + £2.70 p&p.



P.E. STEREO TUNER KIT

This easy to build 3 band stereo AM/FM tuner kit is designed in conjunction with Practical Electronics (July 81 issue). For ease of construction and alignment it incorporates three Mullard modules and an I.C. IF. System.

FEATURES: VHF, MW, LW Bands, interstation muting and AFC on VHF. Tuning meter. Two back printed PCB's. Ready made chassis and scale. Aerial: AM - ferrite rod, FM - 75 or 300 ohms. Stabilised power supply with 'C' core mains transformer. All components supplied as to P.E. strict specification. Front scale size: 10 1/2" x 2 1/2" approx. Complete with diagram and instructions.

£17-95

Plus £2.50 p&p.

Self assembly simulated wood cabinet sleeve to suit tuner only. Finish size: 11 1/2" x 8 1/2" x 3 1/4". **£3.50** Plus £1.50 p&p.

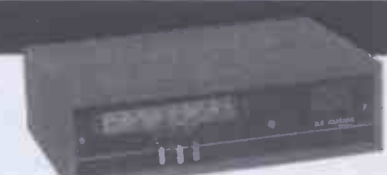

SPECIAL OFFER! TUNER KIT PLUS:

• Matching I.C. 10 watt per channel Power amp kit. • Mullard LP1183 built pre-amp, suitable for ceramic pick-up and aux. inputs. • Matching power supply kit with transformer. • Matching set of 4 slider controls for bass, treble and volumes. **£21.95** + £3.80 P&P.

PRACTICAL ELECTRONICS

CAR RADIO KIT SERIES II



2 WAVE BAND, MW - LW

• Easy to build. • 5 push button tuning. • Modern design. • 6 watt output. • Ready etched and punched PCB. • Incorporates suppression circuits.

All the electronic components to build the radio, you supply only the wire and the solder, featured in Practical Electronics. Features: pre-set tuning with 5 push button options, black illuminated tuning scale. The P.E. Traveller has a 6 watt output neg. ground and incorporates an integrated circuit output stage, a Mullard IF Module LP1181 ceramic filter type pre-aligned and assembled, and a Bird pre-aligned push button tuning unit.

Suitable stainless steel fully retractable aerial (locking) and speaker (6" x 4" app.) available as a complete kit. **£2.50/pack + £1.50 p&p.**

£12-95

+ £2.00 p&p.

BIRD AUDIO STEREO CAR RADIO BOOSTER

To boost your car radio or radio cassette to 15W r.m.s. per channel.

£9-95

+ £1.50 p&p.



TV SOUND TUNER KIT

£11-45

+ £1.50 p&p.

As featured in E.T.I. December '81 issue. Kit of parts including PCB, UHF tuner and selector switch with all components excluding case.

• Transformer £1.50 + £1.50 p&p (p&p free on transformer if ordered with kit). • Ready built LP1183 Module for simulated stereo operation. **£1.95 + 75p p&p.**



MONO MIXER AMP



50 WATT Six individually mixed inputs for two pick ups (Cer. or mag.), two moving coil microphones and two auxiliary for tape, tuner, organs, etc. Eight slider controls - six for level and two for master bass and treble, four extra treble controls for mic. and aux inputs. Size: 13 1/2" x 6 1/2" x 3 1/4" app. Power output 50 watts R.M.S. for use with 4 to 8 ohm spkrs. **£39-95** Attractive black vinyl case with matching fascia & knobs. Ready built. + £3.70 p&p.

All mail to:
21E HIGH STREET, ACTON, W3 6NG.
Note: Goods despatched to U.K. postal addresses only. All items subject to availability. Prices correct at 30/8/82 and subject to change without notice. Please allow 7 working days from receipt of order for despatch. RTVC Limited reserve the right to update their products without notice. Send S.A.E. for full list.

ALL CALLERS TO: 323 Edgeware Road, London W2. Tel: 01-723 8432. 9.30 - 5.30, closed all day Thurs. Prices include VAT. Telephone or mail orders by ACCESS are welcomed.



BUYLINES

IN THE constant search for new ways to ensure Hobby readers get the best deal when buying components, we are in the process of re-thinking Buylines. Next month, we will be presenting a comprehensive survey of component suppliers and hope to provide a special ordering service to supplement this page. For this month, though, we are introducing an improved system for finding sources of hard-to-get items, as well as attempting to produce more accurate estimates of building costs. We would be interested to know what you think of the changes.

Signal Lights

Not much here to trouble the constructor. The TTL ICs can all be obtained from Watford or Technomatic. Remember, it's a good idea to use sockets just in case you have to replace any faulty chips; most companies sell the complete DIL socket range at a reasonable price, so why not buy a few as spares?

The three differently coloured LEDs — red, amber (yellow) and green — can be

bought from Rapid and TK, or for a wide range of shapes try Ace Maitronix.

The only source we can find for one-off 1/8 watt resistors is Maplin, though most suppliers sell 1/4 watt types that will do just as well.

Cost is £2.60 for the junction module and £3.50 for the main module (inclusive of PCBs).

'Junior' Slot Car

It was quite difficult finding a source for the low value (OR47) 1 watt resistor. This was due to the fact that most companies sell these values in 2 1/2 watt packages only. However, Greenweld came to the rescue and they can also supply the unusual 10 pin metal can 723 regulator IC (LM123). An alternative source for this IC is ElectroValue.

The MJ2955 is stocked by most people, but the cheapest source we found was Ambit, whose quoted price is 25% lower than their nearest competitor!

The best case for your controller will depend on your particular slot-car set-up.

However, Newrad do a range of high quality low-cost cases, should you find no room on your present layout. Cost excluding the case, should be about £5 for each board with rectifiers and indicators.

ZX PCB

Quite a useful little board, this, though you may be unfamiliar with a couple of the components. The low-power Schottky ('LS') TTL integrated circuits are stocked by both Technomatic and Watford, though most other retailers sell them at widely differing prices. The appropriate DIL sockets can be bought from either Bi-Pak or Greenweld.

The only supplier of the exact SIL plug-pin strip was Ambit, though Maplin do a 6-way and 4-way version making up the required 10-way strip.

Finally, the edge plug and matching connector (double sided) are to be found in the RS range (codes 468-709 and 467-021 respectively) and must be ordered from your supplier. These are 43-way connectors with the polarising pin at position 7, and must be carefully sawn to convert them to 23-way, with the polarising pin at position 3. You may be able to find other sources for the edge connector, probably not with the matching plug, but it's worth looking around. Cost of the board, using the specified components, will be £8 — plus the edge connector/plug combination of your choice.

Subscriptions

Do yourself a favour. Make 1982 the year you start to take Hobby Electronics, regularly. Delivered fresh every month.

SUBSCRIPTION ORDER FORM

Cut out and SEND TO :
Hobby Electronics Subscriptions
513, LONDON ROAD,
THORNTON HEATH,
SURREY,
ENGLAND.

Please commence my personal subscription to Hobby Electronics with the issue.

SUBSCRIPTION RATES

(tick as appropriate)

- £10.75 for 12 issues U.K.
- £12.75 for 12 issues overseas surface
- £25.70 for 12 issues Air Mail

I am enclosing my (delete as necessary)
Cheque/Postal Order/International Money
Order for £.....
(made payable to A.S.P. Ltd)
OR
Debit my Access/Barclaycard*
(*delete as necessary)



.....

Please use BLOCK CAPITALS and include post codes.

Name (Mr/Mrs/Miss)

delete accordingly
Address

.....

Signature

Date

Breadboards

Design and build your own tone controls.

JUST one project for this month's Breadboard, but it's a winner — high performance tone controls in a simple arrangement that you can modify for any application. The controls are based on a standard op-amp circuit, using the TL081. This has high impedance FET inputs and a high slew rate, enabling it to operate over a wide band of frequencies. The circuit also allows you to experiment with different component values.

Talking of experimenting, we are offering £5 to any reader whose design is original and/or ingenious enough for publication. All you need to supply is a circuit diagram, a breadboard layout and a brief description of how the circuit works plus any ideas for modifications or experiment. Put them all in an envelope marked 'Breadboards' and addressed to us — remember to enclose an SAE if you'd like the contents returned.

Gain Controlled

It is just about thirty years since the publication of the first practical circuit for varying bass and treble independently within a single network, without using switches. It is known as a Baxandall circuit, after its inventor, and is still used, more or less modified, in most audio equipment.

The simplest way to understand how the circuit (Figure 1) operates is to look at what's happening to the gain of the op-amp at different frequencies. The gain is controlled by the feedback resistance from pin 6 to pin 2 of IC1, via the tone control network consisting of RV1, R2, R3, C3 and RV2, R5, C4, and R3 again.

At very low frequencies, capacitors C2, 3 and 4 may be compared to very large resistances. To all intents and purposes, they are open circuit and the gain is dependent on the values of the resistors only, and mainly on RV1. At low frequencies, the gain will be maximum (boost) when RV1 is maximum, and minimum (cut) when RV1 is minimum, as indicated in Figure 1. At higher frequencies, however, the impedance of C3 decreases, so that the effective value of RV1 is reduced and at mid-frequencies, the gain is about one (unity gain).

At still higher frequencies, the impedance of the capacitors decreases further until, at some frequency, RV1 is effectively shorted out by C3. The gain, then, will depend on the setting of RV2, as indicated in the circuit diagram.

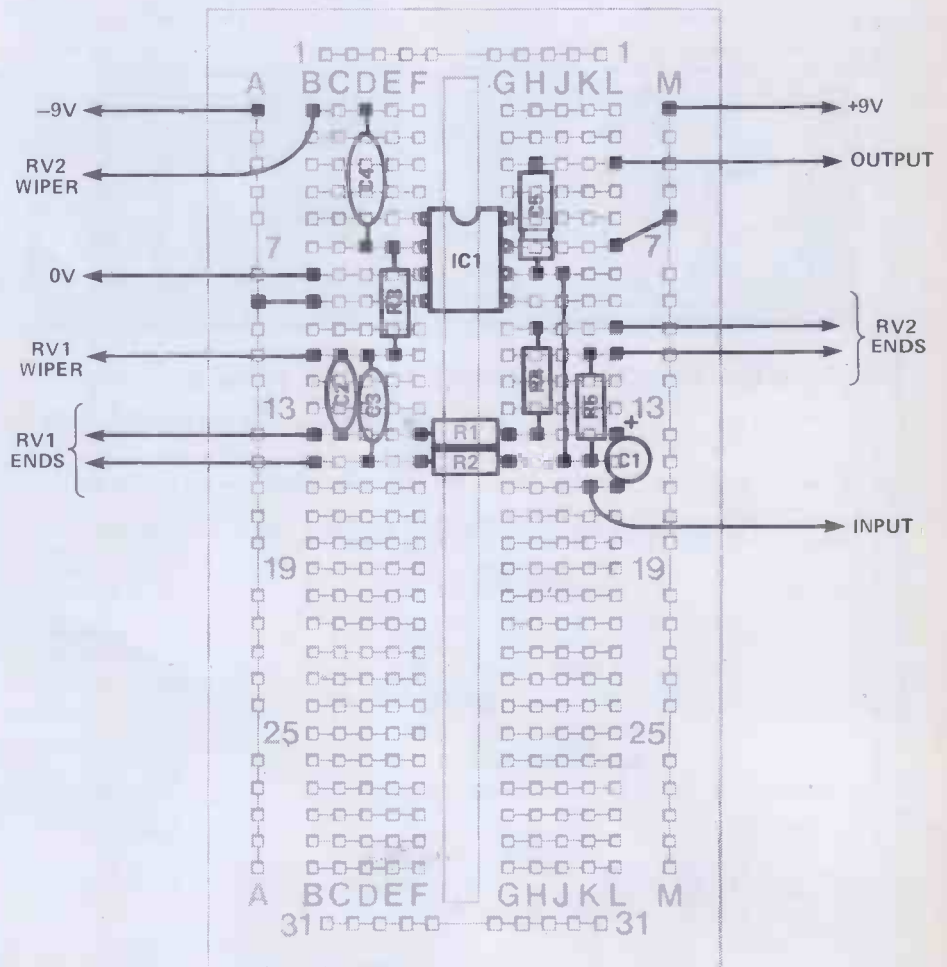
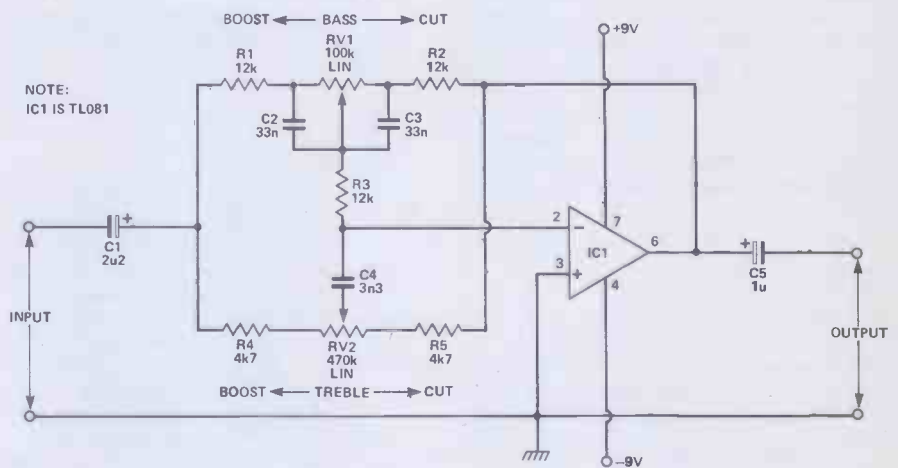

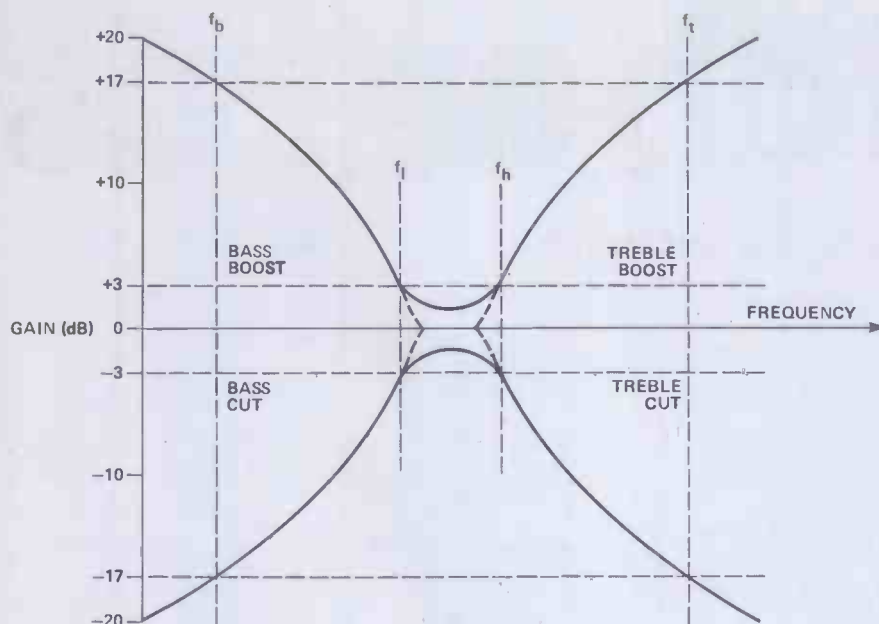

Table 1

1. Choose the upper and lower corner frequencies, f_h and f_l , and the maximum boost/cut (gain, A_v) required.

2. Select values for RV1 and R3.

$$3. R1 = R2 = \frac{RV1}{A_v}$$

$$4. C2 = C3 = \frac{1}{(2\pi)(f_l)(R2)}$$

$$5. R4 = R5 = \frac{R2 + 2R3}{A_v}$$

$$6. C4 = \frac{1}{(2\pi)(10)(f_h)(R5)}$$

7. $RV2 \geq 10(R2 + R5 + 2R3)$

Alternatively, to set the maximum boost/cut at frequencies f_b and f_t , use:

$$4. C2 = C3 = \frac{1}{(2\pi)(10)(f_b)(R2)}$$

$$6. C4 = \frac{1}{(2\pi)(f_t)(R5)}$$

Example:

1. Design a bass and treble tone control with a gain of 10 (± 20 dB) and corner points at 500 Hz and 2 kHz.

2. Let $RV1 = 50k$, let $R3 = 10k$.

$$3. R1 = R2 = \frac{RV1}{A_v} = \frac{50k}{10} = 5k$$

$$4. C2 = C3 = \frac{1}{(2\pi)(f_l)(R2)} = \frac{1}{(2\pi)(500)(5k)} = 63n$$

$$5. R4 = R5 = \frac{R2 + 2R3}{A_v} = \frac{5k + 20k}{10} = 2k5$$

Preferred value = 2k7

$$6. C4 = \frac{1}{(2\pi)(10)(f_h)(R5)} = \frac{1}{(2\pi)(10)(2k)(2k7)} = 2n9$$

Preferred value = 2n7

7. $RV2 \geq 10(R2 + R5 + 2R3) \geq 10(5k + 2k7 + 20k) \geq 277k$

Therefore, choose $RV2 = 500k$.

Alternatively, to set the maximum boost/cut at $f_b = 60$ Hz and $f_t = 12$ kHz:

$$4. C2 = C3 = \frac{1}{(2\pi)(10)(f_b)(R2)} = \frac{1}{(2\pi)(10)(60)(5k)} = 53n$$

Preferred value = 56n.

$$6. C4 = \frac{1}{(2\pi)(f_t)(R5)} = \frac{1}{(2\pi)(12k)(2k7)} = 4n9$$

Preferred value = 4n7

Shaping Up

The three factors which determine the response curve of a tone control (Figure 3) are the slope of the curve, the maximum boost/cut, and the frequencies at which the curve breaks away from the flat — the 3 dB or 'corner' points. These parameters are all set by selecting the appropriate values for the tone control network. The full design procedure is quite complicated but, as is usually the case, a simplified 'rule-of-thumb' method gives the right results! One of the most important simplifications is that, in the circuit, $R1 = R2$, $R4 = R5$ and $C2 = C3$.

At low frequencies, with all capacitors effectively open circuit, the gain is more or less equal to $RV1/R2$; a value for $RV1$ is simply selected and $R2$ calculated to give the required boost/cut. The values used here give a maximum gain of approximately 8 (18 dB) at low frequencies.

At high frequencies, the capacitors are all effectively short circuits and the gain is set by $RV2$, provided it is higher than 10 times $(R2 + R5 + 2R3)$, but the maximum gain is approximately equal to $(R2 + 2R3)/R5$. Here, the value of $R2$ has already been found, $R3$ is merely selected and $R5$ calculated for the required amount of gain. Again, the values have been chosen to give a maximum gain, at treble frequencies, of 18 dB.

All that remains is to set the low and high frequency corner points, which we will refer to as f_l and f_h ; these are determined by the values of $C3$ and $C4$, respectively.

The value of $C3$, for any desired f_l , is equal to $1/(2\pi)(f_l)(R2)$. Another useful characteristic of this circuit is that the bass corner frequency is always about ten times the frequency, f_b , at which the boost/cut is maximum; the value of $C3$ in our circuit puts the bass corner at 400 Hz, so the maximum effect is at 40 Hz. To select a value of $C3$ to give maximum boost/cut at a desired frequency, simply multiply the selected f_b by ten to find the corner frequency which is used in the equation.

Similarly, the point at which the treble boost/cut is maximum, f_t , is ten times the treble corner frequency, and the value of $C4$ which will give a particular corner frequency is $1/(2\pi)(10f_h)(R5)$. To find the value of $C4$ which gives a desired f_t , simply substitute for $10f_h$ in the formula. The values in our circuit place the treble corner at 1 kHz and give maximum effect at around 10 kHz.

Finally, remember that $RV2$ must be chosen to be greater than $10(R2 + R5 + 2R3)$. The values of $RV1$ and $R3$ are then chosen; any close to those used in our circuit will do. Remember also that $R1 = R2$, $C2 = C3$ and $R4 = R5$.

These rule-of-thumb formulas are summarised in Table 1; using them, the tone controls can be re-designed to give a selected amount of boost and cut at any desired frequency.

Sir Edward Appleton

Ian Sinclair

A pioneer of radio and radar who won a Nobel prize for his work on the ionosphere.

You don't have to be a student of radio history to have heard of the Appleton layer — but the fact remains that a lot of people who ought to know the name, just don't. Edward Appleton was born in Bradford in 1892, and started his academic career, after conventional schooling, at St. John's College, Cambridge. In 1920 he became assistant demonstrator in Experimental Physics in that most famous of all laboratories, the Cavendish, where his own particular interest was in the propagation of radio waves, following the work of Heaviside and Kennelly in 1901. The situation at that time was that everyone knew that radio waves could be used to send messages over very large distances, but no-one could show, with any real proof, why this should be so.

By the end of the 18th Century, Oliver Heaviside had put forward the theory that the intense radiation from the Sun, which is a nuclear furnace that no-one protests about, was splitting atoms in the low-pressure air at the outer fringes of our atmosphere. These split atoms are electrically charged and can move fairly freely (they get the name 'ions' from an ancient Greek word meaning "wanderer" but even at the low pressures a hundred miles or so above the Earth, these ions are still sufficiently close to each other to affect a radio wave.

Ionic Effects

The effect depends on the radio wavelength. A radio wave will pass fairly easily between metal objects which are spaced by a distance equal to several wavelengths, but when the objects are closer than a wavelength apart, they act to reflect the wave. Heaviside's theory was that the spacing between the charged particles would be close enough to act as reflectors of radio waves, certainly for wavelengths down to 10 metres.

The idea had been strongly supported by the American physicist, Kennelly, but few other people took very much notice until Marconi succeeded in doing what so many had said was impossible — transmitting a radio signal across the Atlantic. This made many engineers and physicists, who had scoffed at Heaviside, pay rather more attention to his ideas, and it started a rush to find and measure these reflecting layers.

Appleton had the idea of using a method which was direct, elegant, and which used what nowadays would be called "state-of-the-art" technology. In doing so, he

devised the essential principle of radar and the principle was simple! A burst of radio waves could be beamed directly upwards, and the time for it to be reflected back could be measured. Since radio waves travel in space at the same speed as light (around 300 million metres per second) the distance that the waves had travelled to the reflecting layer and back could be precisely measured.

Trouble With Time

The trouble with direct, simple and elegant methods is that they are usually extremely difficult to carry out! The snag, in this particular example, was how to measure the time which, from rough calculations, looked as if it would be about 300 microseconds. Measuring a time period as short as that wasn't

exactly a routine matter in 1923, and Appleton solved it by turning to new technology — the cathode-ray tube.

He saw that the electron beam could be moved rapidly across the screen by using changing voltages on the deflection plates, and if the deflecting voltage is a sawtooth shape, then the speed of the spot across the screen is practically constant. Even better, its value can be calculated from the size of the deflection plates and their distance from the screen, thus the position of a spot can be used to represent time from some starting position.

Appleton's Layers

Appleton's classic 1923 measurements showed that there were several layers of reflecting particles, labelled D, E, and F, above the atmosphere, at heights ranging from 50 to 400 km. The shorter wavelengths that penetrated the lower layers of this "ionosphere", as it was called, were reflected higher up in the F-layer, which from then onwards was called the Appleton layer. The F-layer is about 100 miles above the surface of the Earth and, during the day, actually consists of two layers; a thin F1 layer, and a higher, more strongly ionised F2 layer. At night, the F1 layer rises to the F2 level and reflects wavelengths down to 10 m (around 30 MHz), so providing the excellent short-wave conditions that we experience at night. These days, the heights of the layers are monitored continually — using methods very similar to Appleton's — by weather research stations all over the world, and ionospheric predictions are available for anyone who is occupied with short-wave transmission. The main UK ionospheric station is at Slough.

Appleton's brilliant research work eventually led him to London, where he became Wheatstone Professor of Physics, and subsequently back to Cambridge as Jacksonian Professor of Natural Philosophy (Physics). At the outbreak of war in 1939, he was attached to the Department of Science and Industry (they associated the two, in those days!) to work on radar research, along with the pioneers of television, from EMI, and of shortwave transmission, from Marconi. He was awarded the Nobel prize in 1947, for his work on the ionosphere, and became Vice-chancellor of Edinburgh University in 1949, a post which he held for several years. He died in 1965 after a brilliant career which covered some of the most exciting developments in electronics, and with his name immortalised in the Appleton layer. **HE**

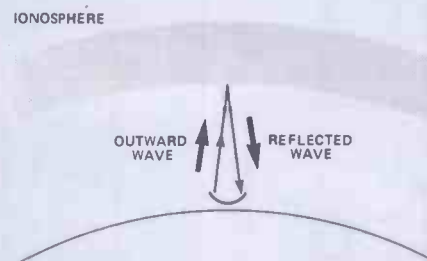

Figure 1. The Appleton experiment. This was an early use of the principle of radar to measure the distance of the Appleton and other layers from the surface of the earth.

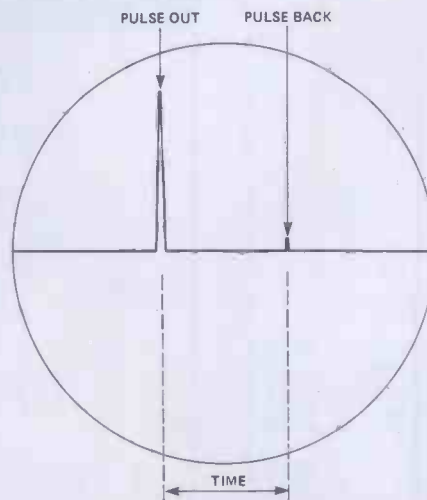
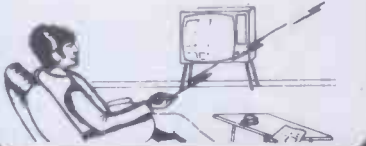

Figure 2. An oscilloscope display used to measure the distance. With a constant speed timebase, distance along the screen represents time, which in turn represents distance travelled by the wave.

HOME LIGHTING KITS

These kits contain all necessary components and full instructions & are designed to replace a standard wall switch and control up to 300w. of lighting.

- TDR300K Remote Control Dimmer **£14.30**
- MK6 Transmitter for above **£ 4.20**
- TD300K Touchdimmer **£ 7.00**
- TDE/K Extension kit for 2-way switching for TD300K **£ 2.00**
- LD300K Rotary Controlled Dimmer **£3.50**



DISCO LIGHTING KITS

DL 1000K
This value-for-money kit features a bi-directional sequence, speed of direction change, being variable by means of potentiometers and incorporates a master dimming control. **Only £14.60**



DL2100K
A lower cost version of the above, featuring unidirectional channel sequence with speed variable by means of a pre set pot. Outputs switched only at mains zero crossing points to reduce radio interference to a minimum.

Optional opto input DLA1
Allowing audio ("beat") —light response. **Only £8.00 60p**

DISPLAYS

COX87A 0.5" dual, c.a. Red **£1.80**
DL340M 0.1" 4-Digit c.c. **£4.50**
FND 500 0.5" c.c. **85p**
FND 507 0.5" c.a. **85p**



MP463 4-digit 0.5" multiplexed c.c. **£2.20**
LED Clock Display

Liquid Crystal Display, 3 1/2 digit, 0.5" digits, d.i.l. package **£6.00**

KL901 9-digit, 7-seg. 0.1" c.c. LED calculator display with red filter **55p**

TRIACS

- 400v Plastic case (Texas) 3AT1C206D **49p**
 - 8AT1C226D **58p**
 - 12AT1C236D **85p**
 - 16AT1C 246D **96p**
 - 25AT1C263D **190p**
- 6A with trigger Q4006LT **85p**
8A isolated tab TXAL2288 **65p**
Diac **18p**
Dpto isolated triac MOC3020 0.1 A/400v .. **110p**

LCD 3 1/2 DIGIT MULTIMETER

16 ranges including DC and AC voltage, DC current and resistance+NPN & PNP transistor gain and diode check. Input impedance 10M. Size 155x88x31mm. Requires PP3 9v battery. **ONLY £31.00**

TRANSISTORS

- BC108 **8p**
- BC109 .. **15p**
- BC182 **8p**
- BC182L .. **8p**
- BC212 **9p**
- BC327 .. **12p**
- BC337 .. **13p**
- BFY50 .. **20p**
- TIP31A .. **40p**
- TIP32A .. **40p**
- 2N3055 **45p**
- 2N3442 .. **45p**
- 115w 140v .. **90p**
- 2N3819 N ch fet **20p**

VMOS POWER FETS

- VN10KM 0.5A/60v **52p**
- VN66AF 2A/60v **88p**

REMOTE CONTROL

Published remote control systems tend to be quite complex requiring difficult-to-get components and a well-equipped lab to get them to work. If this has put you off making your own system we have just the kits for you. Using infra-red, our KITS range from simple on/off controllers to coded transmitter/receivers with 16 on/off outputs or three analogue outputs for controlling, e.g. TV or Hi-Fi systems. The kits are easy to build and simple to set up—and they are extremely versatile, controlling anything from garage doors to room lighting just by adding the required output circuits, i.e. relays, triacs, etc. If you can design your own system we stock a wide range of remote control components at very competitive prices. We have compiled a booklet on remote control, containing circuits, hints, data sheets and details of our remote control kits and components. So don't control yourself—SEND US 30p and a stamped addressed envelope for your copy TODAY!



24 HOUR CLOCK/APPLIANCE TIMER KIT

Switches any appliance up to 1kW on and off at preset times once per day. Kit contains: AY-5-1230 IC, 0.5" LED display, mains supply, display drivers, switches, LEDs, triacs, PCBs and full instructions.



- CT1000K Basic Kit **£14.90**
- CT1000K with white box (56/131 x 71mm) **£17.40** (Ready Built) **£22.50**

DVM/ULTRA SENSITIVE THERMOMETER KIT

This new design is based on the ICL7126 (a lower power version of the ICL7106 chip) and a 3 1/2 digit liquid crystal display. This kit will form the basis of a digital multimeter (only a few additional resistors and switches are required—details supplied), or a sensitive digital thermometer (-50°C to +150°C) reading to 0.1°C. The basic kit has a sensitivity of 200mV for a full scale reading, automatic polarity indication and an ultra low power requirement—giving a 2 year typical battery life from a standard 9V PP3 when used 8 hours a day, 7 days a week.



Price **£15.50**

FREE SHORT FORM CATALOGUE — send SAE (6" x 9"). We also stock Vero, Books, Resistors, Capacitors, Semi-Conductors etc.

FAST SERVICE - TOP QUALITY - LOW LOW PRICES

No circuit is complete without a call to—

TK

ELECTRONICS HE
11 Boston Road
London W7 3SJ

ALL PRICES EXCLUDE VAT

Add 55p postage & packing +15% VAT to total. Overseas Customers: Add £1.75 (Europe), £4.50 (elsewhere) for p&sp. Send S.A.E. for further STOCK DETAILS. Goods by return subject to availability. 9am to 5pm (Mon to Fri) 10am to 4pm (Sat)

OPEN



TEL: 01-567 8910 ORDERS
01-579 9794 ENQUIRIES
01-579 2842 TECHNICAL AFTER 3PM

THE IC-MAN BEAT THESE PRICES

TOP QUALITY FULL SPEC QUICK DELIVERY GUARANTEED

TTL N Series	LS	OTHER	MAIL ORDER ONLY
7406	18p	74LS14	25p
7414	25p	74LS136	15p
7425	20p	74LS153	25p
7427	16p	74LS154	62p
7430	14p	74LS161	33p
7432	18p	74LS164	35p
7437	18p	74LS175	35p
7442	25p	74LS245	71p
7476	30p		
7492	30p		
7493	30p		
74107	18p		
74136	25p	LM339	45p
74151	35p	75452B	40p
74153	35p	75453	50p
74160	50p		
74161	33p		
74164	40p		
74174	40p		
74175	40p		
74180	30p		
74192	40p		
74193	42p		
74194	45p		

NEW BY TOM DUNCAN
ADVENTURES WITH DIGITAL ELECTRONICS **£2.80** post free no VAT

EVER POPULAR
ADVENTURES WITH MICRO-ELECTRONICS **£2.80** post free

THE IC-MAN, DEPT HE, 60 HILLCREST
BALDOCK, HERTS SG7 6NF

PRICES plus 15% p & p 40p

RECHARGEABLE BATTERIES AND CHARGERS

PRIVATE OR TRADE ENQUIRIES WELCOME

FULL RANGE AVAILABLE SEND SAE FOR LISTS. **£1.45** for Booklet "Nickel Cadmium Power" plus Catalogue. Write or call:

* NEW SEALED LEAD RANGE AVAILABLE *

SANDWELL PLANT LTD.
2 Union Drive, Boldmere
Sutton Coldfield, West Midlands
021-354 9764

After hours 0977 84093

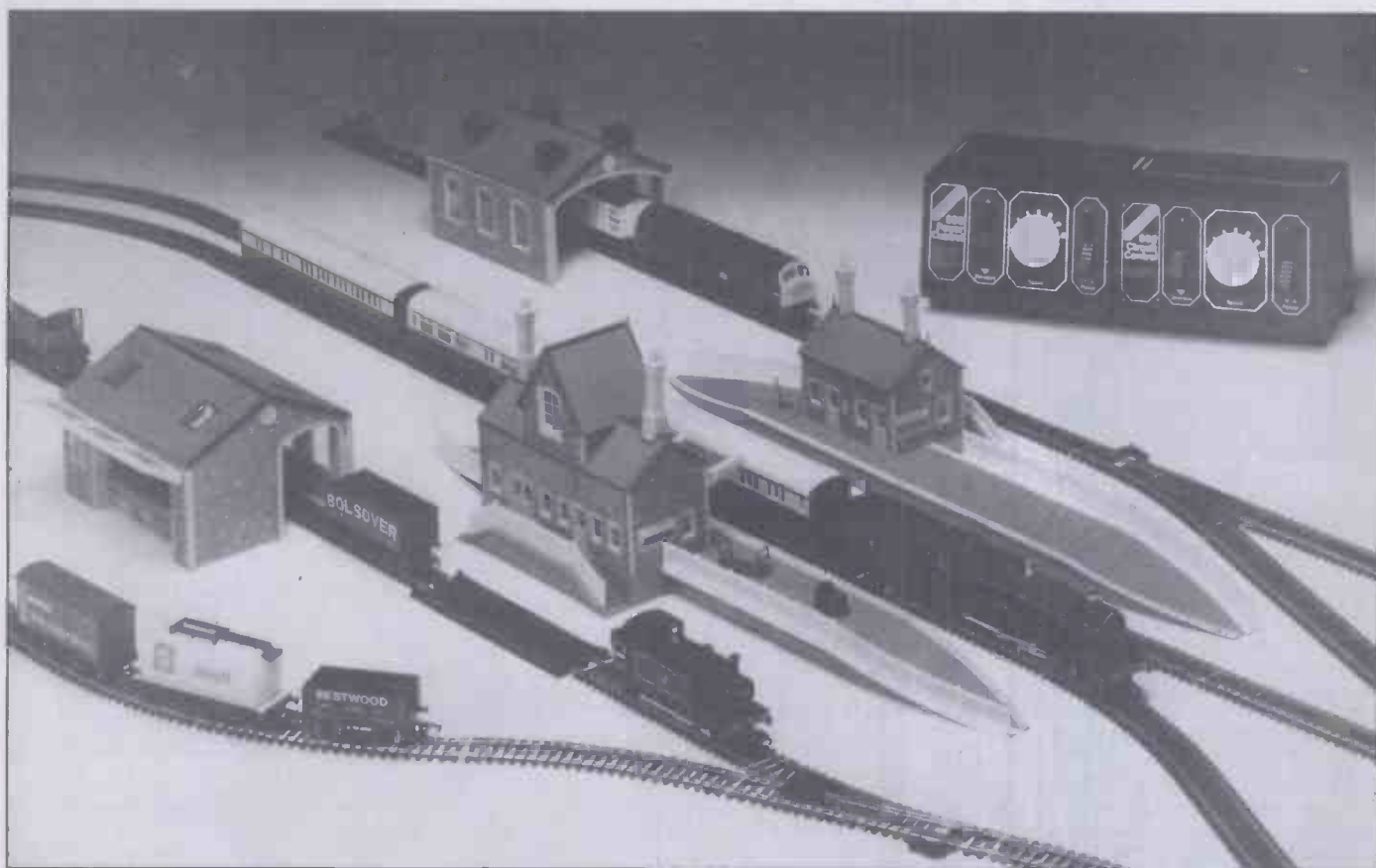

Three-Aspect Signal Lights

Just the right lights for a realistic model rail set-up.

RAILWAY signal lights are intended to indicate whether or not the way ahead is clear. In the simplest case a colour signal, either a red or a green light, shows if it is safe for a train to proceed into the next section of track. As soon as the train passes a green signal, the light changes to red.

This was the first type of signal system to replace the older semaphore signals; today, they are used only in a few isolated cases. With three-aspect signalling, an additional amber light indicates that the line ahead is clear but that the *next signal* is set to red — danger ahead! More common still, these days, is the four-aspect system, where a second amber light is used. A display of two amber lights indicates two clear sections before the next red signal, allowing the driver to adjust his speed accordingly (regular commuters can observe the system from almost any British Rail platform — if the trains are running!).

Signalling a simple junction, where a

branch line leaves the main line, requires an extra arm to the signal; this is positioned on the signal stand, on the same side as the branch and shows a row of four or five white lights, together with a green or an amber light, when the points are set for the branch line. A green or amber signal alone indicates that the points are set for a straight-through run.

In the real world, these signals are controlled by track circuits which detect the position of a train on the line. The axles span electrically isolated sections of rail, thereby completing a circuit to indicate its location. Of course, the settings of points and level crossings also control the signals.

Prototypes and Models

In the prototype, failsafe requirements lead to considerable circuit redundancy — backup units in case one should fail — but for model railways, the basic functions of a three-aspect signalling system can be provided quite simply.

The electronics of the system consist of two circuit modules. The basic Track Module controls one set of signal lights for one section of track; it responds to the location of the train and the settings of any points, level crossings etc in that section of track. The second module is a Junction Module, required to drive the white lights of a branch line indicator and to control the Track Modules either side of the junction.

For the signal lights, it is easy to use Light Emitting Diodes (LEDs) which, conveniently, are available in red, yellow (amber) and green. There are several methods that can be used to detect the position of a train; one of the simplest and most reliable is to use small bar magnets attached under the locomotives at axle height, and magnetically operated reed switches positioned on the track between the rails. Model points do not usually provide a signal suitable for driving the circuits but, with a little ingenuity,

INPUTS		OUTPUT
A	B	A·B
0	0	1
1	0	1
0	1	1
1	1	0

NAND
OUTPUT = NOT (A AND B)

INPUTS		OUTPUT
A	B	A+B
0	0	1
1	0	0
0	1	0
1	1	0

NOR
OUTPUT = NOT (A OR B)

Table 1. Truth tables for NAND and NOR gates.

microswitches can be attached to the points to give suitable inputs to the modules.

The Track Module

The circuit diagram of Figure 1 is for a single Track Module; a model layout will need one of these for each set of lights. The circuit itself is quite simple (though as we shall see, the interaction of two or more modules becomes slightly more complicated!). The 'brain' of the circuit is the bistable flip-flop consisting of NAND gates IC1c and IC1d (truth tables for both NAND and NOR gates are shown in Table 1). Switches SW2 and SW3 are the magnetic reed switches which close momentarily when the locomotive passes over them.

When SW2 closes, pin 5 of IC1c is taken to 0V (logic 0 or 'low') for just a moment, so that the output at pin 6 goes high (logic 1, +5V). This high is coupled to pin 2 of IC1d and, since its pin 1 input is already held high through R6 and R7, pin 3 goes low. This is coupled back to the other input of IC1c at pin 4, ensuring that output stays high. Thus the momentary low on pin 5 is 'latched' by the flip-flop and it will maintain this state, which indicates that there is a train in the section controlled by the module.

When the train leaves the section of track, SW3 closes and pin 1 of IC1d goes low for a moment; this is coupled to pin 4 of IC1c and, since pin 5 is being held high through R4, R5, the output at pin 6 goes low. This is fed back to the pin 2 input, maintaining the high output on pin 3. So, the new state is latched in and this indicates to the following circuitry that the train has cleared the section.

Resistors R4 and R6 provide the +5V to ensure that the inputs are normally high. The other components, R5, C1 and R7, C2, provide interference suppression which works satisfactorily even in the presence of high frequency track cleaning systems. The value of R6 has been chosen to provide a 'power-on-reset'.

When the power is first switched on, both C1 and C2 conduct heavily so that both plates of the capacitors are momentarily at 0V. They soon begin to charge up but, because R6 is more than twice the resistance of R4, C2 will take more than twice as long to reach full charge. In fact, the voltage on C2 will still be at logic 0 level when C1 is fully charged. Thus at power-on, a low pulse is effectively applied to pin 1 of IC1d and a high pulse to pin 5 of IC1c. As previously described, these are the conditions for the flip-flop to be reset to 'track clear', thus making sure that all

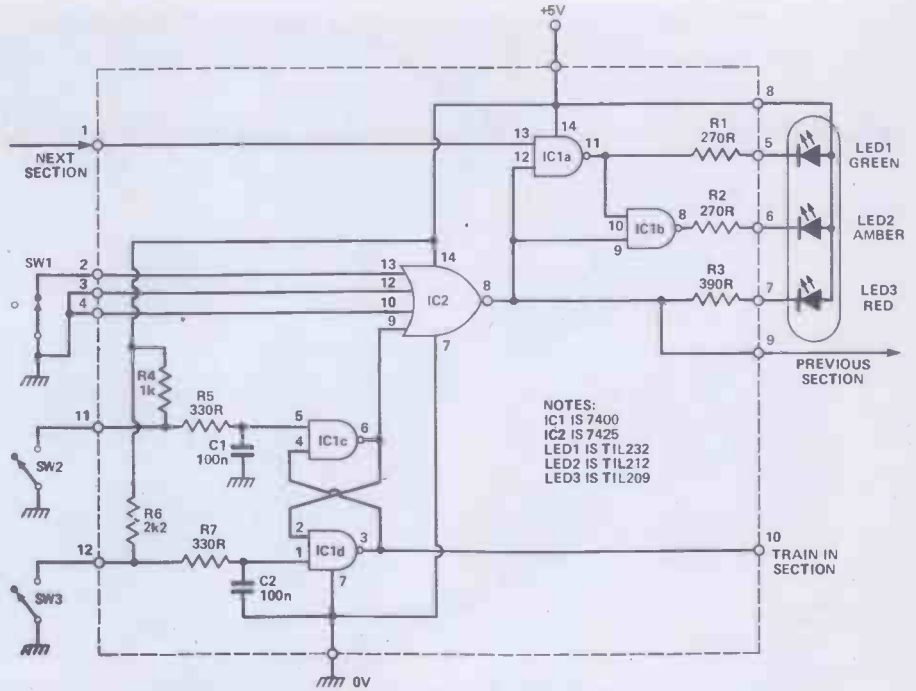

NOTES:
IC1 IS 7400
IC2 IS 7425
LED1 IS T1L232
LED2 IS T1L212
LED3 IS T1L209

Figure 1. Circuit diagram of the Track Module.

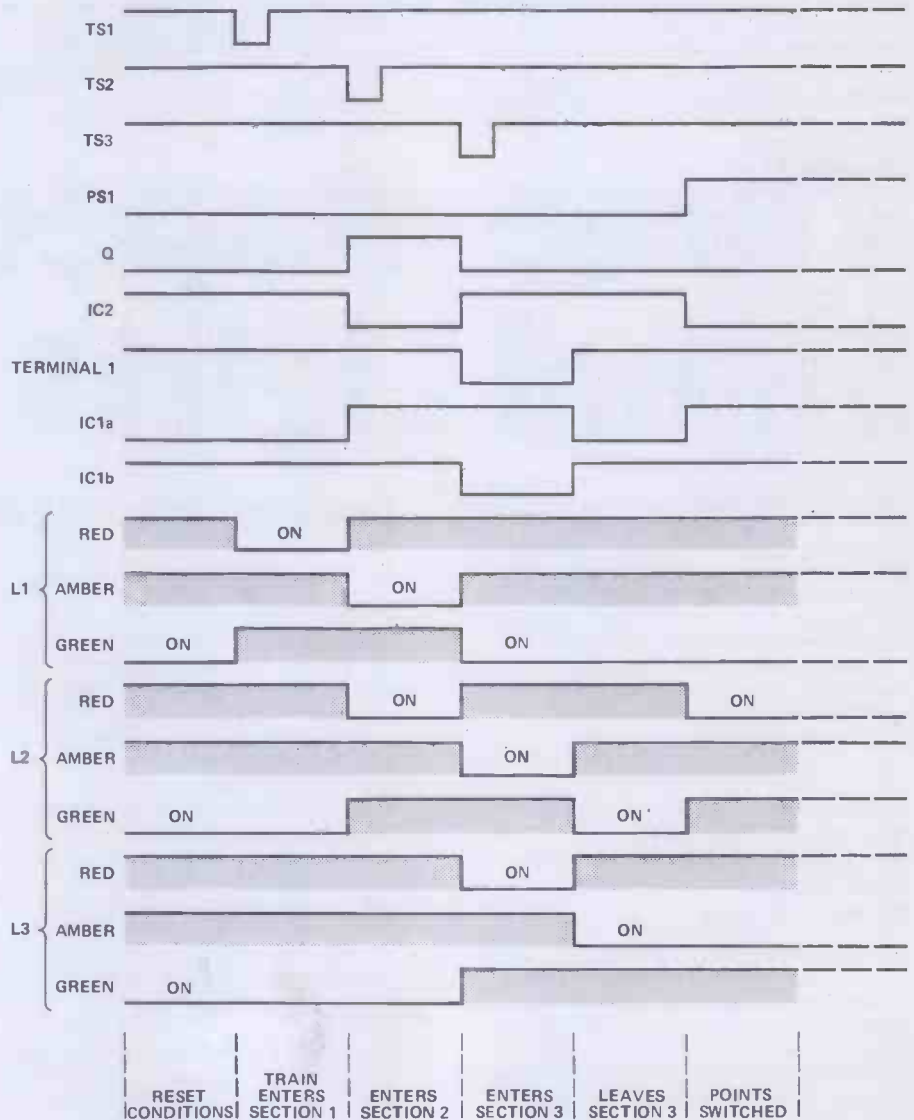

Figure 3. Timing diagram for "Keeping Track".

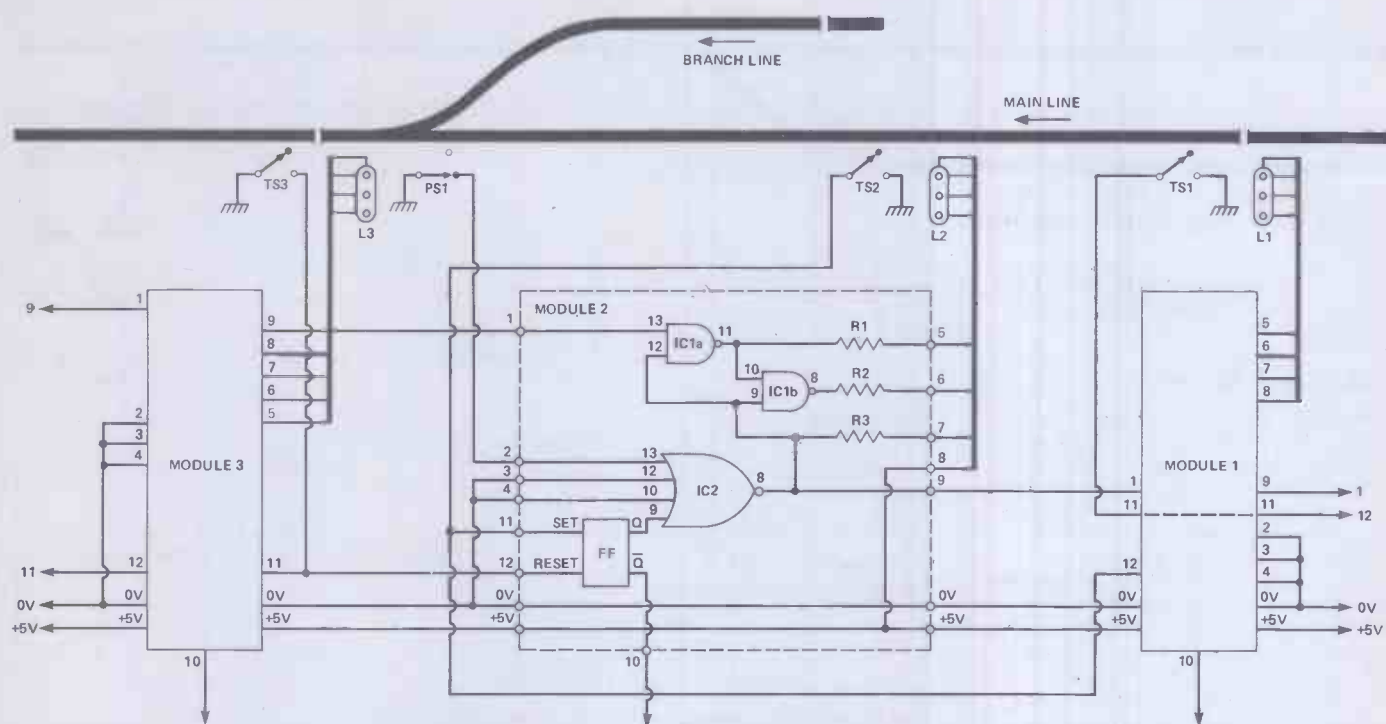

Figure 2. Combines Module circuit and track layout diagram; note that the flip-flop has been drawn here in standard 'block' form.

signal lights are green when the system is first turned on. It will probably be necessary to adjust the value of R6 to suit a particular layout and power supply; a little experimenting should soon determine the correct value.

If the flip-flop is the brain of the circuit, the quad-input NOR gate IC2 is its 'heart'. Its output at pin 8 directly drives the red signal light, LED3, and indirectly controls the other two lights. As shown in Figure 1, two of the inputs are wired directly to 0V, one to 0V via the normally closed points switch SW1, and the fourth is connected to the pin 6 output of the flip-flop. When all four inputs are low, the output will be high and the LED is biased off, with +5V on both the anode and cathode. However, when the flip-flop is triggered by a train entering the section, pin 9 of IC2 goes high, pin 8 goes low and LED3 turns on. The result is the same if SW1 is opened (indicating that the points are set against an oncoming train), since the internal circuit of the TTL gate puts a high on any open circuit input.

If the section of track monitored by a module does not contain a set of points, then terminal 2 should also be wired to 0V. The other two inputs, at module terminals 3 and 4, are available for other switch functions within a section of track, eg for level crossing indication, etc.

Keeping Track

To understand how the remainder of the circuit works, it is easier to look at the interaction between several modules, controlling two or more sections of line, and to trace the logic sequence as a train passes through. The composite circuit diagram of Figure 2 shows the internal circuit of the module controlling Section 2 of a length of line, together with the outlines and ter-

minals of the adjacent modules. The internal circuit has been simplified by drawing the flip-flop as a block with SET and RESET inputs, and Q and \bar{Q} outputs, in standard notation; however, its operation is exactly as described earlier. The timing diagram, Figure 3, will be helpful in tracing the action of the sequential logic.

First, though, we should establish the starting conditions. After a power-on reset, all inputs to IC2 are low and the red LED is turned off. The output from Module 2 terminal 9 is a high, indicating that the section is clear. Similarly, the terminal 9 output from Module 3 is high. Therefore, the inputs to NAND gate IC1a are both high; its output will be a low and the green light, LED1, turned on. The gate IC1b has a high input from IC2 and a low from IC1a so its output will be high and the amber light, LED2, is turned off. The logic conditions are the same for Modules 1 and 3.

What happens, then, when a train leaves Section 1 and enters Section 2? First, Track Switch one (TS1) closes for a moment and the Q output of the flip-flop goes high. This forces the output of IC2 to a low and the red LED of L1 comes on. This low is also applied to the terminal 1 input of Module 1, indicating that there is a train in Section 2. At the same time, the \bar{Q} output of the flip-flop goes low, and this point (terminal 10) can be wired back to a current limiting resistor and LED on a track layout panel near the controller, to indicate train movements.

At this point the inputs to IC1a are: a high from IC2 and a low from the terminal 1 input (because Section 3 is still clear). Therefore, the output of IC1a goes high, turning off the green LED. The inputs to IC1b are: a high from IC1a and the low from IC2. The output stays high and the amber stays off.

The lights change again as the train leaves Section 2; now L3 will show red and the terminal 9 output of Module 3 will go low. However, TS3 is also connected to the terminal 12' input of Module 2 so when it closes, as the locomotive passes, it resets the flip-flop with the Q output low and the \bar{Q} output high. With all inputs low, IC2 goes high, turning off the red LED. The inputs to IC1a, now, are a high from IC2 and the low from terminal 1, so its output will stay high and the green LED, off. However, the inputs to IC1b are both high, its output is low and the amber LED is turned on — indicating that Section 2 is clear but that L3 is showing red.

When the train clears Section 3, eventually, the same sequence takes place within Module 3; its terminal 9 output goes low so that IC1a now goes low, turning on the green light.

The low input from IC1a forces IC1b output to a high, turning off the amber light; LED3 simply remains, off.

The only other operation is when the points are set for the branch to join the main line. Points switch PS2 is normally closed, maintaining the low on that input to IC2. When it is opened, the internal TTL circuitry take the input high, forcing the output to a low and turning on the red LED. The low to the inputs of ICs 1a and 1b forces their outputs high, so that both the green and amber lights are held off until the points are reset.

Junction Module

The function of the second circuit module is to control the signal lights indicating a branch leaving the main line, and to connect the Track Modules on either side of the junction, according to the setting of the points. The composite diagram, Figure 4, shows the internal circuit of a junction module and

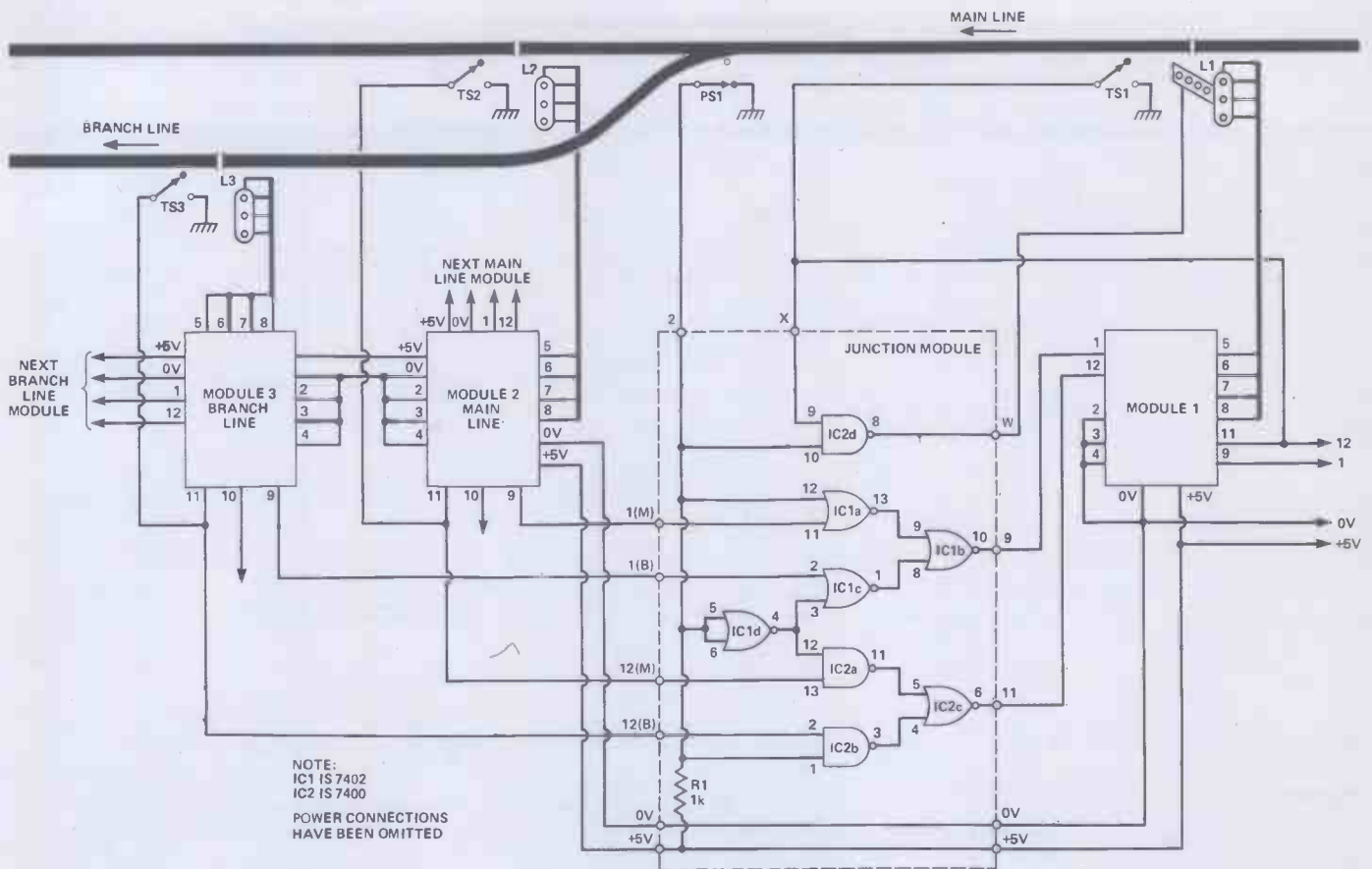

Figure 4. Combined Junction Module circuit and track layout diagram.

its connections to the Track Modules. It is most easily understood with the aid of the timing diagram Figure 5, which traces the logic sequence of trains passing through the junction, and with the truth tables of the NAND and NOR gates.

We can assume, at the start, that all signals are showing green, ie, all Track Modules are in their reset condition, and that the points are set for a straight-through run. The inputs and outputs of the Junction Module are as follows: the inputs to IC2d are a high (since TS1 is open) and a low (from PS1, which is closed); therefore its output is high and the branch lights are turned off.

Both terminal 9 outputs from Modules 2 and 3 are high (tracks clear) and these force the outputs of ICs 1a and 1c to low: IC1b output, therefore, will be high, sending a 'track clear' signal to Module 1. Similarly tracing the logic levels through ICs 1d, 2a, b and 2c will show that the input to the reset terminal of Module 1 is high, as it should be.

Now, a train moving along the track will momentarily close TS1, triggering the Module 1 flip-flop and switching L1 to red. The input to IC2d from TS1 also goes low, but this has no effect.

Normally, in a straight section of track, Module 1 is reset by the train passing over TS2; in this case, however, it is reset via the Junction Module. When TS2 closes, it takes one input of IC2a low for a moment, forcing



the output to go high. With both its inputs high, IC2c will go low, providing the reset pulse to terminal 12 of Module 1 and turning off the red LED of L1.

At the same time, terminal 9 on Module 2 has gone low, taking one input of IC1a with it; the other input is a low from PS1, so the output will go high, forcing IC1b output low; this turns on the amber LED of signal L1. Finally, when the train clears Section 2, terminal 9 goes high, IC1a goes high and IC1b goes high, turning off the amber light in L1 and turning on the green.

Now let's see what happens when a train takes the branch line. First, the points must be set, opening PS1; both inputs to IC2d go high, so its output goes low, turning on the branch line indicator. At the same time, all inputs connected to PS1 will change state (including those to ICs 1c and 2a, which

are via inverter IC2d). These changes switch the logic to accept inputs from Module 3, rather than from Module 2.

As a train passes over TS1, signal L1 will turn to red, as before. A side-effect of TS1 closing is that the branch line indicator lights turn off for an instant.

The train now moves through Section 1 and takes the branch line, which we have called Section 3. As it does, TS3 closes, turning L3 to red and putting a low on one input of IC2b, so that its output is forced high. The other input of IC2c is being held high by PS1, via ICs 1d and 2a, therefore IC2c will go low, putting a reset pulse on terminal 12 of Module 1 and turning off its red LED. Simultaneously, terminal 9 of Module 3 has gone low; IC1c now has two low inputs (the other is held low by PS1 via IC1d), so its output goes high, forcing IC1b high and thus turning on the amber LED in L1 via

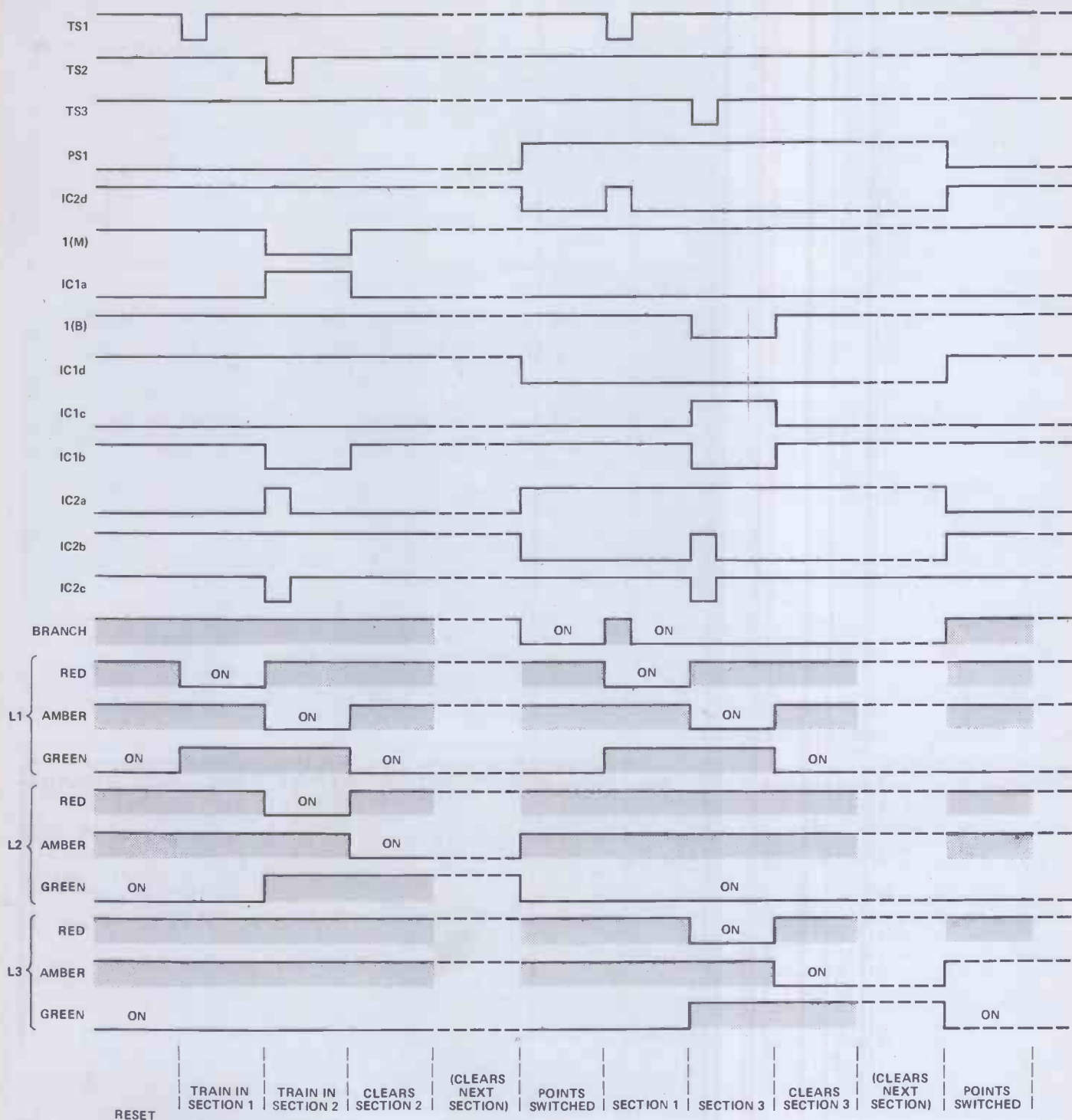

Figure 5. Timing diagram for tracing the Junction Module operation.

Module 1.

A similar sequence of logic will set L1 to green when the train finally clears Section 3. The timing diagram, Figure 5, shows this sequence as well as that which results when the points are reset.

These circuits, although very simple by themselves, can be quite complicated in their interactions, as we have just seen! Everything depends on the timing of the various switch closures, together with the conditions which resulted from the last operation. Timing diagrams are essential for understanding circuits of this kind.

In fact, if the timing of the switch closures (which trigger the logic changes resulting in the appropriate signal lights) are not correct, the system will not produce the right results. The track switches must be positioned very carefully, at the start of each section of line, to produce the desired signals. Another small trap, which should not normally be of any bother, is that a set of points cannot be changed until the train has cleared the section controlled by the branch indicator. In other words, the points cannot be set for the branch line, in our example, until the train has cleared Sec-

tion 2. Otherwise the amber light on L1 will not clear.

Construction and Layout

The component overlay diagrams for a Track Module and for a Junction Module are shown in Figures 6 and 7, respectively. Full sized PCB patterns are reproduced on the PCB Printout page.

The construction is quite straightforward and should not give any difficulty. The ICs are all TTL, so no special handling procedures are needed except for normal care not to overheat them or bend the pins. The composite circuit diagrams, Figures 2 and 4,

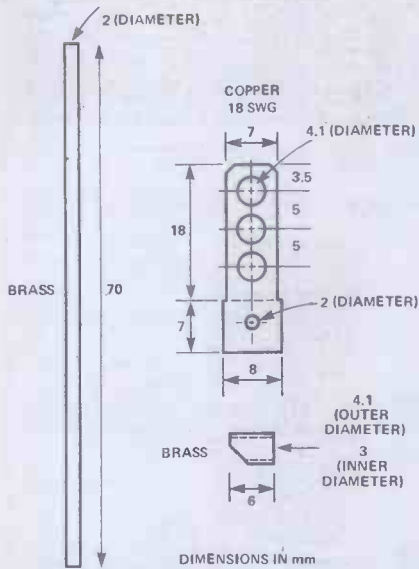

Figure 8. Mechanical details of a simple signal stand.

Parts List

Track Module

RESISTORS

(All 1/4 watt 5% carbon)

R1,2	270R
R3	390R
R4	1k
R6	2k2
R5,7	330R

CAPACITORS

C1,2	100n
	C280 polyester

SEMICONDUCTORS

IC1	7400
	TTL quad 2-input NAND
IC2	7425
	TTL dual 4-input NOR
LED1	TIL232
	green 0.2" LED
LED2	TIL212
	orange 0.2" LED
LED3	TIL209
	red 0.2" LED

MISCELLANEOUS

SW1	SPST switch
	track switch - see text
SW2	SPST switch
	points switch - see text

PCB; signal stands (see text);
wire, solder etc.

Junction Module

RESISTORS

(All 1/4 watt 5% carbon)

R1	1k
----	----

SEMICONDUCTORS

IC1	7402
	TTL quad 2-input NOR
IC2	7400
	TTL quad 2-input NAND

MISCELLANEOUS

SW1	SPST switch
	points switch - see text

BUYLINES page33

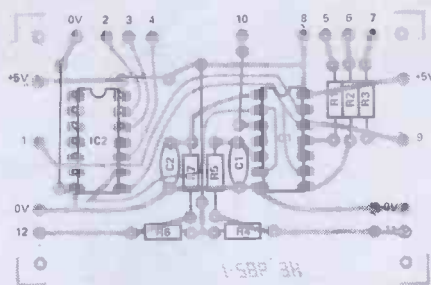

Figure 6. Component overlay for the Track Module.

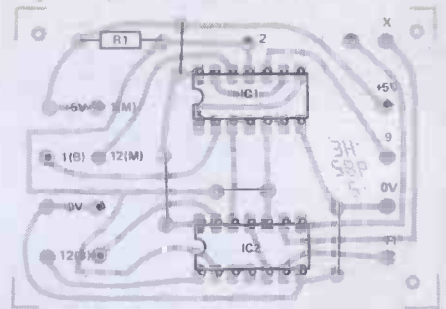
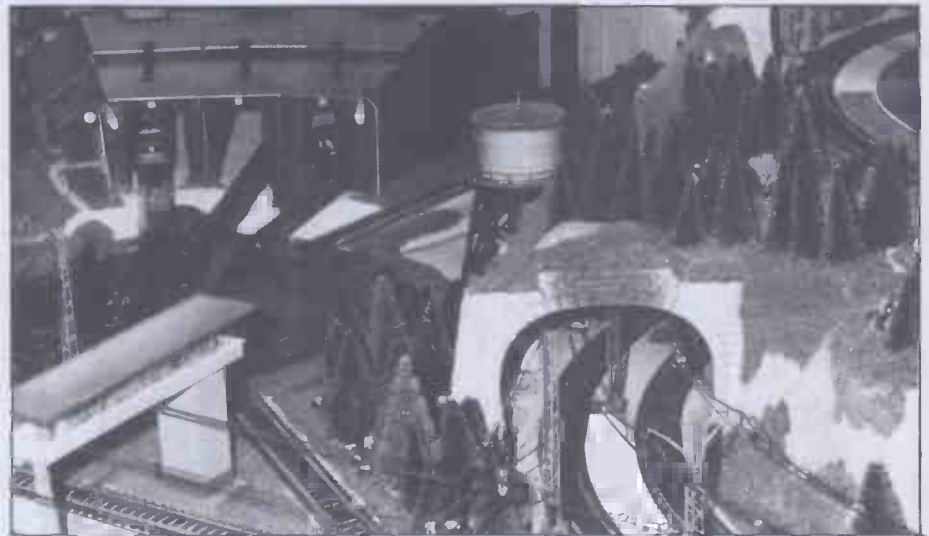

Figure 7. Component overlay for the Junction Module.



should be used as a guide to positioning the track switches and signal stands. The modules are most conveniently mounted under the track layout and connected together, as shown in Figures 2 and 4, by lengths of four-way ribbon or multicore cable. The connections to the signal lights can also be made with four-way cable.

In a track layout as shown in Figure 2, there would normally be another signal stand on the branch line, near its junction with the main line. To connect another control module into the system at this point, simply wire it in parallel with the four-way module bus. However, point switch PS2 must now be a two-way type, with the change-over terminal connected so that terminal 2 of the new module is connected to 0V when the points are set for the branch line to join.

Power Supply

All the circuit modules are powered from +5V, which can easily be derived using a three-terminal 5V regulator; a suitable circuit to operate from a smoothed DC supply of 12-15V appeared in the June issue of Hobby Electronics, this year. Each module will draw approximately 50 mA, so the source must have the capability to supply this current, times as many modules as there are in the layout.

Signal Stands Alone

Many model signals currently available use miniature coloured incandescent bulbs, but these are rather expensive

and draw considerable current. Dedicated modellers might, therefore, be interested in Figure 8, which shows the details of a signal stand especially designed for 3mm LEDs.

The bracket holding the LEDs is cut from 18SWG copper, bent at right angles and soldered to the post. The light shields are formed from brass tubing with an inside diameter of 3mm to take the LEDs, and the post is cut from 2mm tubing. These parts are all available from model shops and you can, if you wish, add to the construction with a ladder and safety rails made from tinned copper wire.

The connections to the LEDs should be made with appropriately colour coded wire-wrap wire (!), which is thin enough so that four or more leads can be fed up the post and through a small hole in the bracket. The connections can be covered by a cowling made from thin card, lightly glued in place.

The only other question which remains to be answered is: what to use for the branch line indicator lights? Unfortunately, white LEDs are not available! Well, one suggestion is to use low current miniature light bulb and fibre optic filaments to simulate the line of lights. However, the solution to this problem, as with many other practical problems in modelling, depend on particular set-ups and individual ingenuity. That, after all, is half the fun!

Photo Credits. Our thanks to: Hornby Hobbies for the photo on page 39 and C.J. Freezer (Editor, Model Railways) for the picture on page 42.

Bookshelf

THE HE BOOKSHELF is the easiest way to build up your library of electronics books. Order today to have these top titles delivered **DIRECT TO YOUR DOOR.**

62 Projects Using IC 741

62 PROJECTS USING IC741 £1.25
More than 50 ways of using the ubiquitous IC741.

Beginners Guide to Microprocessors and Computing

BEGINNERS GUIDE TO MICROPROCESSORS AND COMPUTING £1.75
Basic introduction to binary arithmetic, micro-processor operation and machine language programming.

Remote Control Projects

REMOTE CONTROL PROJECTS £1.95
Practical information about many applications of remote control.

Electronic Projects Using Solar Cells

ELECTRONIC PROJECTS USING SOLAR CELLS £1.95
A range of practical applications using silicon solar cells.

50 (FET) Field Effect Transistor Projects

50 (FET) FIELD EFFECT TRANSISTOR PROJECTS £1.75
Contains a wide range of projects, all based on Field Effect Transistors.

IC 555 Projects

IC 555 PROJECTS £1.95
The 555 timer users 'Bible'!

Electronic Music Projects

ELECTRONIC MUSIC PROJECTS £1.75
Many practical circuits for less complex items of electronic music equipment.

VMOS Projects

VMOS PROJECTS £1.95
Contains a number of varied and interesting projects using VMOS power FETs.

Counter Driver and Numerical Display Projects

COUNTER DRIVER AND NUMERICAL DISPLAY PROJECTS £1.75
Features many varied projects using numeral displays, counter and driver ICs.

Choosing and Using Your Hi-Fi

CHOOSING AND USING YOUR HI-FI £1.65
Concise information for all hi-fi enthusiasts.

IC Projects for Beginners

DIGITAL IC PROJECTS £1.95
Simple and advanced projects based on digital ICs.

Radio Circuits Using IC's

RADIO CIRCUITS USING IC'S £1.35
All you need to know about using IC's for AM or FM reception.

Electronic Games

ELECTRONIC GAMES £1.75
Amusing electronic games which can easily and inexpensively be constructed by the enthusiast.

Power Supply Projects

ELECTRONIC TEST EQUIPMENT CONSTRUCTION £1.75
How to build and use a wide range of test equipment for the hobbyist.

International Transistor Equivalents Guide

INTERNATIONAL TRANSISTOR EQUIVALENTS GUIDE £2.95
Find possible equivalents for a popular user-orientated selection of modern transistors.

IC LM3900 Projects

IC LM3900 PROJECTS £1.35
Provides the ground work for simple and more advanced uses of IC LM3900.

Electronic Household Projects

ELECTRONIC HOUSEHOLD PROJECTS £1.75
Packed with circuits for projects that can be used in or around the home.

Digital IC Projects

SINGLE IC PROJECTS £1.50
Easy to construct projects based around a single IC.

How to Use Op Amps

HOW TO USE OP-AMPS £2.25
All you need to know about Op-Amps, a source book of circuits and design calculations.

Practical Computer Experiments

PRACTICAL COMPUTER EXPERIMENTS £1.75
Build and examine a number of basic computer circuit elements.

Audio Projects

AUDIO PROJECTS £1.95
Clear information on how to build pre-amps, mixers, power amps, tone controls etc.

A Microprocessor Primer

A MICROPROCESSOR PRIMER £1.75
A painless approach to understanding computers and computing.

To receive your books you have only to fill in the form below and send it, together with your payment, to the address stated.

Please allow up to 21 days for delivery. This offer applies only within the U.K. Prices may be subject to change without notice.

SEND TO: HE BOOKSHELF, 513 London Road, Thornton Heath, Surrey CR4 6AR.

I am enclosing my Cheque/Postal Order/ for: (delete as necessary)

£..... (Made payable to A.S.P. Ltd)

OR Debit my Access/Barclaycard (delete as necessary)



--	--	--	--	--	--	--	--	--	--	--	--

Please use **BLOCK CAPITALS** and include post codes.

Name (Mr/Mrs/Miss)
(delete accordingly)

Address

.....

.....

Signature Date

Books Required	Price
Add 75p p&p	0.75
Total Payment	£

ELECTRONICS IS A FINE HOBBY

VELLEMAN-KIT



In less than a year we have become well-known for our varied and interesting range of electronic kits and our efficient service.

Graded by difficulty, the kits are of high quality, well packaged and have applications covering a wide field.

The range includes kits using microprocessors, infra-red systems, power supplies, dimmers, motor control units, amplifiers, sound and light units, digital counters, timers, VU's and many, many more.

New kits are:

- K2580 — electronic powerswitch dimmer.....£9.34
- K2581 — stereo volume and tone control.....£11.27
- K2582 — stereo audio input selector.....£11.27

The Velleman 'top ten' are:

- K1682 — Microprocessor timer£48.37
 - K1771 — FM Oscillator£5.45
 - K1798 — Stereo VU using LED's£16.91
 - K1823 — 1 amp Power supply£6.99
 - K2544 — Complex sound generator£8.28
 - K2569 — Three tone chime.....£6.56
 - K2575 — Microprocessor doorbell.....£15.53
 - K2577 — Motor speed control£7.57
 - K2578 — Eprom programmer.....£207.00
 - K2579 — Start stop timer£6.21
- (prices include VAT)

SEND FOR FREE ILLUSTRATED CATALOGUE OF COMPLETE RANGE

VELLEMAN (U.K.) LIMITED

P.O. Box 30, St. Leonards-on-Sea, East Sussex, TN37 7NL, England. Telephone: 0424 753246.



ENQUIRIES FROM RETAILERS INVITED

MASTER ELECTRONICS NOW!

The PRACTICAL way!

This new style course will enable anyone to have a real understanding of electronics by a modern, practical and visual method. No previous knowledge is required, no maths, and an absolute minimum of theory.

You learn the practical way in easy steps mastering all the essentials of your hobby or to start or further a career in electronics or as a self-employed servicing engineer.

All the training can be carried out in the comfort of your own home and at your own pace. A tutor is available to whom you can write personally at any time, for advice or help during your work. A Certificate is given at the end of every course.

You will do the following:

- Build a modern oscilloscope
- Recognise and handle current electronic components
- Read, draw and understand circuit diagrams
- Carry out 40 experiments on basic electronic circuits used in modern equipment
- Build and use digital electronic circuits and current solid state 'chips'
- Learn how to test and service every type of electronic device used in industry and commerce today. Servicing of radio, T.V., Hi-Fi and microprocessor/computer equipment.

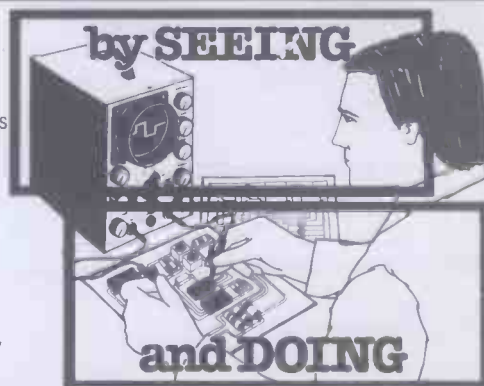

New Job? New Career? New Hobby? Get into Electronics Now!

FREE!
COLOUR BROCHURE

Please send your brochure without any obligation to

I am interested in:

NAME _____

COURSE IN ELECTRONICS as described above

HE/9/821

ADDRESS _____

RADIO AMATEUR LICENCE

MICROPROCESSORS

OTHER SUBJECTS _____

LOGIC COURSE

POST NOW TO:

BLOCK CAPS PLEASE

British National Radio & Electronics School Reading, Berks. RG1 7BR

Hands Off!

Paul Coster

Hobby's hardworking editorial assistant was happy to come to grips with this handy auto-ranging multimeter. Read on for his hard-hitting comments . . .

ABOUT the most surprising feature of the Teston LCD multimeter is its size. For a meter that auto-ranges, measures AC and DC and has a continuity checker (with tone generator), to fit into your hand, is pretty impressive. The complete package, available from Stotron, is supplied with test leads, carrying strap, test clip, current shunt and soft case. There is also a small folded sheet — entitled (optimistically) 'Instruction Manual' — which describes each range and how to use it. However, despite this lack of a decent manual, the meter was easy to use and very good value for the facilities offered.

Its full title is the ISI-Teston DM 2350 and it is an auto-ranging digital multimeter with only three scale-select buttons; current, voltage and resistance. A small switch, — push-to-changeover, selects AC/DC or ohms/lo ohms (more about this later). The meter is powered from two AAA batteries and protected against overload by a 200 mA fuse. It is cased in grey plastic with a clear 10mm display. Input impedance was a creditable 10 megohms on both AC and DC voltage ranges; rising to 100 M on the 200 mV DC range. Accuracy on all ranges was also good, at better than 1% (the highest resistance range is quoted at 2%, but our unit was well within this). Overload protection is provided by an external fuse and special FET circuitry — the meter also 'bleeps' to warn of a dangerously high input.

Wide Ranging

The DM2350 has five DC and four AC voltage ranges. The DC scale extends down to 200 mV FSD, which makes possible measurements as low as 100µV. Maximum DC input is 1000 volts, accurate to better than 1% of the reading. The AC scale is not quite as sensitive but is adequate for most purposes. The range is 2-600 volts, with a resolution on the lower range down to 1mV. This would have been excellent for audio measurements, except for the narrow frequency response — 40 to 500 Hz (though, in fairness, this is common to just about all comparable



meters) — and the inductive pick-up which results from using non-screened test leads; its easy enough to make your own screened lead's, however.

Both the AC and DC ranges worked well — it was possible to switch between AC and DC without plugging the test leads into different sockets — and the AC frequency limitations were not a major drawback (just use 440 Hz instead of 1 kHz as a test frequency).

There are two resistance scales, one for normal measurements and one for taking readings with components 'in circuit'. This latter facility is extremely useful for measurements around silicon junction components — silicon diodes and transistors etc — since the low output (0V4) is not sufficient to activate them. Both scales read up to 2 M, with the out-of-circuit range going down to 1 ohm resolution. Accuracy was found to be better than 1% on all ranges. An additional feature on both these ranges is that the tone generator can be used to indicate continuity. By connecting the leads between any two points in a circuit (power off!), and switching to resistance, the meter will bleep if a direct path is 'made' (a DC resistance of less than 1 ohm).

The two current scales are the only ones that do not auto-range, simply because both have a single limit of

200mA. This meant the sensitivity suffered (only 100 uA resolution) and very low current readings — quiescent supply in CMOS circuits etc — were not possible. However, this did not seem too important in the tests carried out and with the 10 A shunt fitted, the extended range made up for the deficit. The current scales were slightly less accurate at just over 1%, but, since most current readings will vary from device to device, higher accuracies are not so important. More significantly, the DM2350 compares favourably with its competitors in this particular respect.

Getting To Grips

Using this multimeter was a sheer delight, with the push-button controls and auto-ranging capability enabling one-handed operation — you can twiddle knobs and take readings simultaneously! In fact, the only aspect I found slightly annoying (as did the editor!) was the bleep every time a range was automatically switched. It's a good idea for continuity testing — indeed, vital — and as an overload warning signal, but does get a bit irritating after a while. Perhaps something less piercing is called for?

So, bearing in mind the comments on frequency response and current sensitivity, I found this meter had a lot to recommend it. The simple operation and auto-ranging facility made it a real pleasure to use and, for anyone thinking about buying professional test gear — hobbyists and engineers alike — it's worth including on your shortlist.

The price for the complete package of meter, test leads and case etc is £56.93 (all inclusive). Further details can be obtained from Stotron Limited, Haywood Way, Ivyhouse Lane, Hastings, East Sussex.

HE

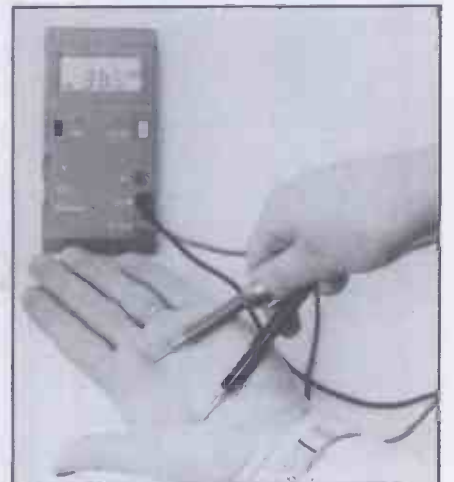

INTRODUCING TWO NEW HANDHELD DIGITAL MULTIMETERS

200 μ A — 10 AMP AC-DC

MODEL 6010

DC accuracy 0.5%

£29.95
plus VAT

MODEL 7030

DC accuracy 0.1%

£35.95
plus VAT



SPECIFICATION 6010 & 7030

- BATTERY:** Single av dry cell
- BATTERY LIFE:** 200 hours
- DIMENSIONS:** 170 x 89 x 38mm
- WEIGHT:** 400g inc battery
- MODE SELECT:** Push button
- AC DC CURRENT:** 200 μ A to 10A
- AC VOLTAGE:** 200mV to 750V — 6 Ranges
- DC VOLTAGE:** 200mV to 1000V — 5 Ranges
- RESISTANCE:** 200 Ω to 20M Ω — 5 Ranges
- INPUT IMPEDANCE:** 10M Ω — 6 Ranges
- DISPLAY:** 3 $\frac{1}{2}$ Digit 13mm LCD
- O/LOAD PROTECTION:** All ranges
- OTHER FEATURES:**

- Auto polarity. Auto zero. Battery-low indicator.
- Strong ABS plastic case with tilt stand.
- Battery and test leads included.
- Optional carrying case.

Please add 15% to your order for VAT. Postage & Packing is free of charge. Trade enquiries invited.

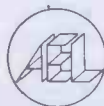

ARMON ELECTRONICS LTD.

Cottrell House, 53-63 Wembley Hill Road, Wembley, Middlesex HA9 8BH, England

Telephone: 01-902 4321 (3 lines)

TELEX No. 923985

AITKEN BROS.

ELECTRONIC COMPONENTS AND TEST EQUIPMENT

35, HIGH BRIDGE, NEWCASTLE
UPON TYNE NE1 1EW TEL: 0632 326729



SAFGAN OSCILLOSCOPES — 5 mV/div sensitivity. Choice of Bandwidth 10, MHz, 15 MHz, 20 MHz. 1S/div-100n S/div. Calibrated timebase. Solid trigger with bright line auto, normal and TV. XY facility. Z modulation. Calibration output. Bright and clear display. Portability. • Model DT410-10 MHz £205.85. Model DT415-15 MHz £217.35. • Model DT420 20 MHz £228.85. Send S.A.E. FOR FULL spec.



THANDAR PDM35 3 $\frac{1}{2}$ DIGIT L.E.D. DIGITAL POCKET MULTIMETER. • DC volts (4 ranges) 1mV to 1000V. • AC volts 1V to 500V • DC current (6 ranges) 1nA to 200mA • Resistance (5 ranges) 1 Ω to 20 meg. Ω . £39.95. • AC adaptor £5.95. • carrying case £3.65 • MN1604 Battery £1.57.



THANDAR TM354 3 $\frac{1}{2}$ DIGIT LCD DIGITAL POCKET MULTIMETER • DC volts 1mV to 1000V • AC volts 1V to 500 V AC rms • DC current 1 μ A to 2A • Resistance 1 Ω to 2 M Ω • Diode check • Basic accuracy \pm (0.75% of reading + 1 digit) • Battery life typically 2000 hrs • leads inc. • £45.94 • 40KV Probe £34.95 • Universal test lead set £12.95.



THANDAR TM352 3 $\frac{1}{2}$ DIGIT LCD DIGITAL POCKET MULTIMETER • DC volts: 100 μ V to 1000V • AC volts: 1V to 1000V • DC current: 100 nA to 10A • Resistance 1 Ω to 2 M Ω • Diode check • hFE measurement • Audible continuity check • Basic accuracy \pm (0.5% of reading + 1 digit • Battery life 150 hrs + • £57.44 inc. leads • Battery • Universal test lead set £12.95 • 40 KV probe £34.95



THANDAR SC110 SINGLE TRACE LOW POWDER 2" OSCILLOSCOPE • Bandwidth DC to 10 Mhz • Sensitivity: 10mV/div to 50 V/div. • Sweep speeds: 0.1 μ secs / div to 0.5 secs/div. • Power requirements 4-10 V DC 4 'C' cells • Size & weight 255x150x40mm : 800gms £159.85 a truly portable and superb instrument • Carrying case £8.86 • AC Adaptor £5.69 • Nicad Batt. pack £8.63 • x1 probe £9.78 • x10 probe £11.50 Complete range of Thandar instruments available from stock S.A.E. for CAT. & prices.



G.S.C. SOLDERLESS BREADBOARDS • Accepts all components with leads up to .033" • Replaceable nickel-silver spring clip contacts. • Combines bus strip with board • Unlimited expansion • .3" and .6" centre channels • Three free experimental circuits with every purchase

	Centre Channel	Strip Length	Strip Width	Points	Tie Term	Clips	Cpty.	i.c.	Price
EXP-600	15mm	152mm	61mm	550	110	3	28pin		£7.25
EXP-300	8mm	152mm	53mm	550	110	6	14pin		£8.82
EXP-48	n/a	152mm	25mm	160	32	n/a			£2.65
EXP-650	15mm	91mm	91mm	270	54	1	40pin		£4.14
EXP-350	8mm	91mm	53mm	270	54	3	14pin		£3.62
EXP-325	8mm	48mm	53mm	130	26	1	22pin		£1.84

Please send S.A.E. for catalogue listing complete range of G.S.C. Instruments and Boards.



SABTRONICS LCD MULTIMETER MODEL 2033. • DC volts 100 μ V-1000V Accuracy + .5% • AC volts 100 μ V-1000 V Accuracy \pm 1% • DC current 10 μ A-2A Accuracy \pm 1% • AC current 10 μ A-2A Accuracy \pm 1% • Resistance 1 Ω to 20 M Ω Accuracy \pm 1% • £42.27. • Please send 30p for full Sabtronic catalogue and price list



TMK 500 MULTIMETER • 30 kopv. • AC volts 2.5 10 25 100 250 500 1000V • DC volts 0.25 1 2.5 10 25 100 250 1000 • DC current 50 μ A 5MA 50MA 12 amp • Resistance 0-6K 60K, 60 meg. • Decibels -20 to + 56 d/b • Buzzer continuity test • Size 160x110 x65 • Batteries and leads inc. £26.95



YN360 TR MULTIMETER • AC volts 10 50 250 1000 • DC volts 0.1, 0.5, 2.5, 10v 150v 250v, 1000v. • DC current 50 μ A 2.5 MA, 25MA, 250 MA • Resistance 0-2K 20K 2M Ω , 20 M Ω . • Transistor check • DB -10db -- +22db £16.95

DESOLDERING TOOL £6.45



SCHOOLS, COLLEGES, UNIVERSITIES SUPPLIED. PHONE OR SEND YOUR ACCESS OR BARCLAYCARD NUMBER.

PRICES INCLUDE VAT. PLEASE ADD 75p POSTAGE TO ORDERS UNDER £10.00

Planning on Success

Vivian Capel

First-time success with a project depends on careful planning and execution. Here's how to go about it ...

WE'VE ALL done it; spent long hours with a hot soldering iron and bags of components, seeing a once bare PCB gradually filling up, mounting switches and controls, lettering the control panel, wiring up, and finally coming to the moment of truth, the switch-on.

Perhaps for the first time, a moment's anxiety — will it work? What will happen if it doesn't? With an accelerating pulse rate, we turn the switch. Our worst fears are realised, nothing happens, or perhaps there is some sign of activity but nothing like what it should be. Worst still, maybe a tiny curl of smoke drifts upward from some undetermined component on the board!

From satisfaction at having completed the project, we are plunged into gloom and despondency. With growing despair we make haphazard checks on this and that, but can find no cause. Sooner or later we switch off, wishing we had taken up pigeon fancying instead of electronics. Of course, with or without help, we may get the thing going eventually but, even if not, it isn't long before some new circuit fires our imagination and we are making out our shopping list of components. This one will be different — it's bound to work first time. Hope springs eternal. . .!

If you have ever built a project and that, or something like it, has never happened to you, you are either fortunate or careful — or both. Sometimes, getting a project working satisfactorily can take as long if not longer than building it in the first place. So what can be done about it?

Prevention vs Cure

As the old saying has it, "prevention is better than cure" and that is certainly true with project-building. The foundations for a "work-first-time" are laid from the start. First of all, we must have a sound design and layout, and if the project is one that is published by a reputable electronics magazine there should be no worries on that score. If it is one of your own designs then obviously you are well qualified to handle any problems that may turn up. However, most projects are built from published circuits by constructors who differ in technical competence. Some may have only a hazy idea of how the circuit works, in which case fault-finding, should it be necessary, could pose problems. Careful building of a good design is the only sure guarantee of success.

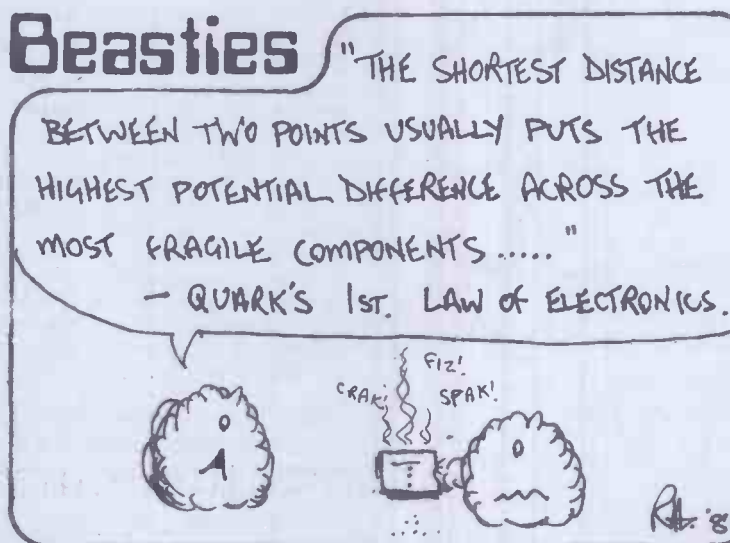

Sometimes a constructor will modify some part of the published design in order to improve its performance or to add or change some feature or facility; this is where caution *must* be exercised. In most cases, performance will have been optimised by the original designer and further improvements are unlikely, other than by going beyond the original framework of design. Almost any circuit *can* be improved, but only if one is prepared to make it a lot more complex and expensive!

Modifications to change some facility to one more in keeping with one's own requirements are legitimate, but you need to be sure of what you are doing. It is often better to construct it as designed, get it working, then modify it afterward. At least you know then, where you are and where the trouble lies if problems should arise. The section it is planned to modify can be built on a temporary basis, with components not permanently fixed and soldered into place.

Construction

In the majority of cases, the design is constructed as published, without alteration, and success then depends on the quality of construction, and the components.

There are a number of common construction errors which are frequently responsible for many faults and which we will now discuss. Most published designs include a PCB pattern that can be copied and etched, but some use a Veroboard layout.

With the custom-designed PCB, care must obviously be taken in copying, masking and etching and, especially where fine circuit tracks and/or spacings are involved, a careful examination with a magnifying glass should be made to see that all the copper has been etched away between tracks and that no etching solution has encroached on to a track due to faulty masking. The larger areas of spacing or conductor are usually fault-free, unless something has gone radically wrong with the etching.

Veroboard has its drawbacks, but can be very useful for many small applications where high currents are not involved. However, although the constructor is spared the task of copying and etching, rather more care is needed in the actual construction. For example, cuts are required in certain places along the tracks and all these should be inspected through a magnifying glass, however clean they appear to the naked eye. Another pitfall in making track cuts is their position. Errors can easily occur and the wrong track or position cut. To avoid this, count the number of holes along the track from the nearest end and place the cutting tool on the hole while you count back again to the edge. Then, select the right track by counting in from the edge, moving the tool to the track so counted and, as before, count back to the edge to double check. The tool should thus finish up on the correct hole. Now make the cut without removing the tool or, if for some reason it must be taken off, at least make a

definite mark with it so that the position can be identified.

Components

A problem that frequently arises is that components of the specified type or value are not available. The choice is, therefore, between waiting an indefinite period in the hope that the required part will be obtained, or substituting something else. Substitutions can be made providing they are of a type which is equal or superior to that specified.

In the case of resistors, carbon composition types are the cheapest and used for general applications where nothing else is required. Other types have particular characteristics which may be important in the particular circuit. High stability carbon film resistors generally have improved characteristics, with about double the value-stability when not in use and some four times the stability of composition resistors when operated at full power rating; generated noise is about a third, the maximum operating voltage is higher and the temperature coefficient is less, but amount depends on the value.

Metal oxide resistors have even better characteristics than the carbon high-stab types, with particularly low self-noise generation — about a tenth of the high-stab value — and a lower temperature coefficient; value-stability is some four times better at full rating, but the voltage rating is lower than either composition or film resistors.

Metal-film resistors generate about three times as much noise as the oxide types, but are still better than the carbons. They excel in temperature stability, being some two-and-a-half times lower than the oxides, but they have the lowest maximum voltage rating. Another type is the thick-film metal glaze resistor. This combines the low noise properties of metal-oxide with the stability of metal-film and is also the smallest, for a given wattage; it is also the most expensive!

Thus, the choice depends on the use, and the designer has taken this into consideration when specifying a certain component. However, if a substitute must be made, then another type with similar characteristics can be chosen.

The wattage rating of resistors should not be lower than that specified but can, with advantage, be higher. This will improve reliability but will take up more room, so where close packed components are involved, larger sizes could be difficult to accommodate.

Resistance values are always given in the preferred E12 range, which advances in 20% increments. There is also an E24 range which increases in 10% steps; these are less common but may occasionally be specified (see Understanding Component Values, in HE June '82 issue). Usually, if a particular type of resistor is stocked by a supplier, all the values in the range will be held. Sometimes particular values may go out of stock, but the value can usually be made up by connecting two others in series or parallel, using Ohm's Law to calculate the values.

The same is true of capacitors, where the type of dielectric is determined by the application. Polyester is a good general purpose material; polycarbonate has a low temperature coefficient and so is desirable when stability at temperature extremes is required; polystyrene has a very high insulation resistance, of the order of a hundred times greater than most others, while polypropylene is best for pulsed voltages and AC operation. Large values require electrolytics, but these have a high leakage factor, so where this is important, tantalum capacitors, with about a third of the leakage, should be used. They are smaller, and also nearly three times the price of electrolytics.

The voltage rating of all capacitors should exceed the voltage across them, under all operating conditions, by a comfortable margin. Reliability is improved if higher voltage ratings than specified are used, but this usually means larger components.

At the low capacitance end of the scale there are polystyrene, silver-mica and ceramic capacitors. Ceramics are commonly used, but silver-mica types have better temperature stability in circuits where the value must be constant. As they have a positive temperature coefficient (whereas ceramics are negative), the required value is sometimes made up by paralleling one of each type in critical circuits, to improve the temperature stability.

With diodes and transistors, there are often equivalents of another make which can be satisfactorily used, but

not if the circuit is designed to take advantage of some particular property possessed by a certain device. There will be some cases where a listed equivalent may not work as well! If a transistor is specified with a suffix letter, A, B, or C, this should not be ignored. The suffix refers to the gain grouping — lowest for the A types and highest for the Cs. Many circuits are designed for a specific gain, and will not function correctly with any other.

Although seemingly simple, diodes cannot be substituted without consideration of the characteristics. If a germanium type is called for, do not think that a silicon diode will do. Germanium has a lower forward voltage drop, and this may be needed in a circuit involving low voltages. Also, a point-contact diode has a low capacitance which makes it suitable for high-frequency circuits, and so could not be successfully changed for a junction diode.

Integrated circuits are more specialized and substitutions cannot usually be made without circuit modification, unless the replacement is a direct equivalent of another make. The only room for manoeuvre, here, is that some ICs come in differently packaged versions, and one may be available while another is not. Of course this could upset the PCB connections!

Mounting Components

Assuming all the components, or suitable alternatives, are to hand, and the PCB is prepared, the next stage is to mount them. Some constructors like to mount the parts one at a time and solder

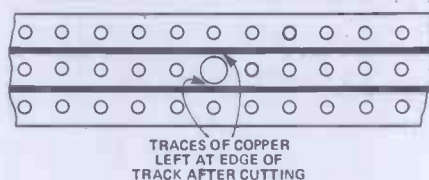

TRACES OF COPPER LEFT AT EDGE OF TRACK AFTER CUTTING

Figure 1. When cutting Veroboard tracks, ensure that no fine copper bridges are left at the edge of the cut.

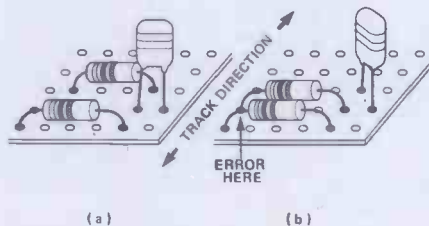

Figure 2. Check that component wires are all going to the right holes. It is easy to make mistakes, as can be seen by comparing (a) and (b).



Figure 3. When a component straddles several holes on a matrix board count the number as it is fitted. It is not so easy to check when the part is in place.

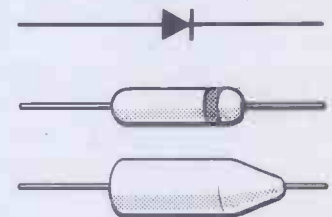

Figure 4. The easy way to remember the connections to a diode; the band marks the straight line of the symbol (the cathode) and with power diodes, the taper points in the same direction as the arrow.



Figure 5. Transistors can be fitted more easily, and errors reduced, by cutting the wires to unequal lengths. The emitter wire is left full length, the base is cut shorter and the collector the shortest. They are inserted in the same order.

each one, while others prefer to mount them all, retain them by bending the wires, then solder all at once. The latter method has some advantages in that any mistake can be rectified without unsoldering, and it is usually quicker to do all the soldering operations together.

Whichever method is followed, it is a good practice to leave all the semiconductors to last, mounting and soldering the passive components first. Thus, the transistors or ICs will not be repeatedly subjected to conducted heat from the iron as associated components are soldered in. In the case of ICs, it is wise to use sockets rather than solder the device directly in to the circuit. Not only does this remove any possibility of damage by heat but it facilitates changing the device, should it prove faulty. Furthermore, suppliers are more inclined to change a faulty IC if the pins are unsoldered.

There is always the likelihood of component wires being inserted in the wrong holes — even in a PCB, but especially with Veroboard, where all holes are in rows. Take special care with this, and where the component straddles several holes, count them! After getting the first hole right, it is easy to put the other wire in, say, the second instead of the third hole along.

Watch that you have the correct resistor values, because some colours are difficult to distinguish on small components; red and orange, for example, can easily be mistaken. In particular, make sure that you are reading the colour code from the right end! There are four values, especially, that can be easily mistaken. A 270k,

(red-violet-yellow) can be mistaken for a 4k7, (yellow-violet-red), while a 1k2, (brown-red-red) could be thought to be a 220 ohm (red-red-brown) and, of course, vice-versa in both cases.

When mounting capacitors, it is a good practice to fit them with their values uppermost, or where they can be read. While not affecting the working of the circuit, it will help with component identification should the circuit need servicing later. Ensure that all electrolytics and tantalum capacitors are wired in with the correct polarity; this is another very easy error to make, so check when fitting and also afterward.

The same is true of diodes; some constructors find difficulty in remembering which way diodes are marked. An easy method is to regard the band, at one end, as the straight line used to depict the cathode in the diagram. In the case of power diodes, the tapered end is also the cathode and can be remembered as the end to which the 'arrow' in the diagram is pointing.

Care is likewise necessary in fitting transistors, and double-checking is necessary to make sure they are wired correctly. Difficulty is sometimes experienced in getting all three of the wires in their holes at the same time without any slipping out, so here is a tip which aids this operation and also reduces the possibility of incorrect fitting. Cut the wires to unequal lengths by leaving the emitter as it is, cutting the base somewhat shorter and the collector the shorter still. Now fit the longest wire in its hole first, followed by the next and finally the shortest; Each

one being longer than the next, it stays put in its hole, without coming out. When all are in place, bend, solder and crop off the excess. If the habit is established of fitting the emitter first and collector last, correct insertion is almost guaranteed!

In the case of ICs we have the problem of being able to insert them, in the PCB or in their holders, the wrong way round. Not only are there two ways of plugging in an IC, but the identification is not at all clear. A dot at one end marks 'pin one', but it is often no more than a shallow depression, so watch out for this; it is all too easy, when turning the board over and working on both sides, to get it wrong. It is a good idea, when preparing the board initially, to put a mark either with paint or a marking pen, at the site of all ICs on the 'pin one' end. Then, when assembling or changing them later, the chance of a mistake is reduced.

As to the actual mounting, fit components fairly close to the board so that surplus wire is minimised. Shorts can occur between wires of adjacent vertically mounted components, so make sure that these are well spaced. Also ensure that vertical components are seated firmly on the board, otherwise they may lean over and touch. Transistors should have short leads — but not too short, they may be damaged by heat, when soldering, and future servicing may be hampered.

Checking Components

Is it necessary to test components before they are fitted? With many, this should not be necessary; resistors, for example, are very rarely faulty from new, other than obvious physical defects such as loose end-caps or wires. Also, it is most unusual for a value to be outside the rated tolerance. Wire-wound resistors could be checked, as occasionally one is found to be open circuit.

Electrolytic capacitors should be tested for leakage, as any held in stock by the suppliers for any length of time can develop high leakage currents. Resistance, when measured with an ohmmeter, should be well above a megohm, although it will be lower if measured reverse-connected (note that the positive lead of the meter is actually of negative polarity when switched to ohms).

Diodes should be tested before fitting. Cases of new diodes being open circuit are certainly not unknown, and in at least one case a power diode was found with reversed polarity! This could have been disastrous had it not been checked before fitting. To test, connect the ohmmeter across the diode with the positive lead to a cathode (band or rounded end) whereupon a reading of from a few hundred to a thousand ohms should be obtained. Then reverse the meter leads to obtain a very high or infinite reading.

It is prudent to check transistors, and this can also be done with an ohmmeter and a resistor. For NPN devices, connect the positive-marked meter lead (which is actually negative) to the

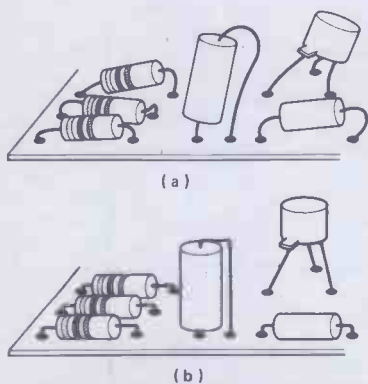

Figure 6 (a). Untidy fitting with wires left too long, leading to possible shorts; (b) the same layout wired neatly, as it should be.

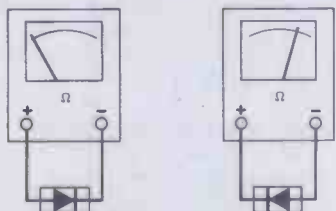

Figure 7. Testing diodes; with the meter positive to the anode, the ohms reading should be very high. When the cathode is connected to the meter positive, the reading should be around 1,000 ohms.

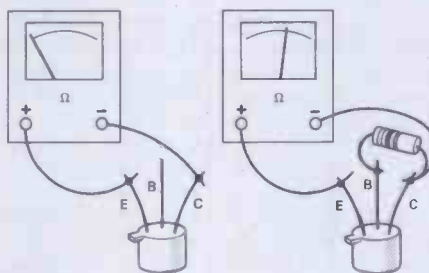

Figure 8. Checking a NPN transistor with a meter; with positive to emitter and negative to collector, there should be very high or infinite reading. Connecting a 10k resistor between base and collector should give a reading much less than 10k. Reverse the polarity for PNP device.

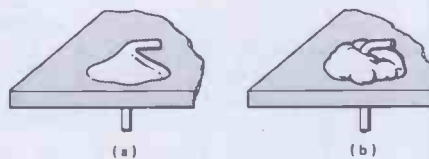

Figure 9 (a). A good soldered joint is smooth and rises gradually from the track; (b) a bad joint is lumpy, curls under at the base and dips inward toward the wire, but not all bad joints have all these features.

emitter and the negative-marked lead to the collector; there should be no reading. Now connect a resistor of about 10k from the base to collector. A reading of around 10k should be obtained; the actual reading depends on the gain of the transistor and the value of the resistor, which can be any value from 10k to 33k. If the reading is a little higher than the value of the resistor, you are looking at the base/emitter junction, through the resistor, which means that the collector is open circuit. If you get no reading at all, the emitter is open circuit; a low reading before connecting the resistor means either the device is short circuit or is reversed polarity. Try reversing the meter leads; if the reading is still low, it is definitely shorted, but if it now gives normal results, the polarity is wrong and you actually have a PNP transistor! For testing PNP transistors, connect the positive meter lead to the emitter. As new transistors have been found to be shorted, open, and with wrong polarity, it is by no means a waste of time to do this!

If constructing is your hobby, and you regularly build circuits, it is recommended that you equip yourself with a transistor tester such as the Eagle TT 145 or similar instrument, as well as the obligatory multimeter. You will then be able to measure gain, leakage, polarity, and be able to match up transistors for complementary circuits.

Soldering

Quite a number of faults are due to soldering defects so take care; the symptoms they produce can be quite baffling. Firstly, always ensure the work is clean; handling the board can leave greasy deposits that resist the solder but a clean-off with a spot of meths will get rid of most of the grease. Apply the iron to the work with a little solder on the bit to facilitate the flow of heat and, after a second or two, introduce the solder, which should melt on the joint itself. Wait another couple of seconds until the solder can be seen to be flowing freely, then remove the iron. Do not carry the solder to the work on the iron, and do not try to 'paste' it on like applying putty.

After the board (or the section you are working on, if it is a large one) is completed, examine every joint with a magnifying glass, scanning across the board in strips to ensure none are missed. With Veroboard this is easy, as you only have to run along each track in turn. Every joint should be smooth with a gradual rise from the copper and a smooth taper to the component wire. Any sudden rises, hollows around the wire, or blobby looking lumps of solder spell bad joints. Re-heating with the iron for a few seconds will, in most cases, put things right.

Another possibility is the presence of tiny whiskers of solder between tracks. So, when scanning the board for doubtful joints, examine the spaces between close running tracks; with the Vero, examine every space! A further potential cause of trouble is the wire

cropped off from components; pieces can lodge in all sorts of places and escape detection so, when cutting the surplus wire, hold the board so that it falls away onto the bench, then gather them up and dispose of them before they find their way into trouble. Likewise screws, washers or other items of hardware that may be dropped into the works when assembling. If it seems to have disappeared, don't take the easy way out and fit another; search for the truant, even if it means upending the project and shaking it. Wandering screws can be responsible for all kinds of future problems.

Fault-finding

If all the above suggestions are carried out during the building, the chances of non-operation at first switch-on are greatly reduced. However, it can still happen, so what do we do then? The most likely causes in order of probability are: soldering faults, including damage to components by soldering; PCB faults; incorrect assembly or use of wrong components; defective transistors or ICs; defective passive components.

As can be seen from this list, construction faults are still the most likely in spite of your precautions, so a careful visual check over the whole thing is the best first step. It is surprising how obvious errors can be sitting there, looking right at you, yet pass unobserved. So do not take anything for granted; check everything again.

If this fails to reveal the cause of the trouble, use the multimeter to check voltages. The absence of a voltage will, in many cases, indicate where the fault lies. Sometimes a voltage will be present but incorrect, such as a full supply voltage on a transistor collector. This suggests zero current due to no forward bias on the base, an open circuit emitter junction or transistor.

Actual voltage readings depend entirely on the type of circuit, but a few basic rules are: the collector of a NPN device must be positive when measured from the emitter, usually by several volts; if the emitter does not go directly to chassis or earth, it will be slightly positive, usually by less than one volt; the base should be 0V6 more positive than the emitter, in the case of silicon transistors. If the device is used as a gate or switch it may be biased off, normally, in which case the voltage would be high on the collector and low or zero elsewhere.

Check all the supply points to the ICs, measuring on the actual pins, but be careful! Use fine pointed meter prods to avoid bridging two adjacent pins, as this might put supply voltage where it shouldn't be, with disastrous effects. Measure the voltages on the circuit side of stabilizers and across zener diodes, to ensure that they are working properly.

With PNP devices, the collector voltage will be negative and the base 0V6 negative with respect to emitter. For germanium transistors, the voltage difference will be 0V15.

If voltage readings fail to show up the cause of the trouble, we will have to delve deeper. Try to establish what parts of the circuits are working. How this can be done depends on the function of the circuit and what it is supposed to do. Usually, the circuit is intended to operate on some sort of signal, whether audio, RF, DC control or digital pulses, and respond in some way by amplifying, triggering, controlling another circuit or an electro-mechanical device.

It may be possible to determine whether the input signals are present or, if this is uncertain, suitable signals may be produced by other means. Disturbance testing has long been used by professional engineers as a quick check; this can be as simple as scratching a test prod on the input pin, thereby producing pulses that extend into the RF spectrum. If this produces some response at the output, even if not the required result, it shows that the circuit is working to some extent.

The main thing is to work systematically, not hopping from one point to another, hoping to alight on the trouble by chance. Establish the area of the fault by eliminating those parts of the circuit that appear to be working, and concentrate on the doubtful ones. It is not unlikely that more than one fault exists and that possibility must always be considered.

Resistance readings with, of course, the equipment switched off, can often be illuminating. Measurements to earth from points that normally carry no voltage sometimes show up short-circuits that would not otherwise be revealed.

The IC will probably come under suspicion, at some point. Unlike transistors, it cannot be tested out of the circuit before fitting, so when the other components in the affected part of the circuit have been absolved, attention naturally turns to the IC. Many circuits use several of the same type in which case, if they have been fitted by means of sockets, a swap can easily be made to see if that makes any difference. If faulty, it means that, now, some other part of the circuit will not work.

It is a good idea to keep a few spares of the cheap, commonly used ICs, as it is with general-purpose transistors and a selection of resistors and capacitors. All told, the cost of a small stock is very little but can be well worth while when chasing faults or experimenting.

Although publishers of the original circuit will, in most cases, offer what suggestions they can in response to a letter for help (and provided an SAE is enclosed — Ed.), servicing at a distance, without being able to make tests and observe results is rarely satisfactory; they will often suggest things you will have already tried.

However, if care is taken in the initial construction, and systematic tests made in the event of trouble arising, the fault should eventually be localised. Although it may be irritating at the time, it will add to your experience — and make the next project that much easier!

BRITAIN'S LEADING EXHIBITION FOR ELECTRONICS ENTHUSIASTS

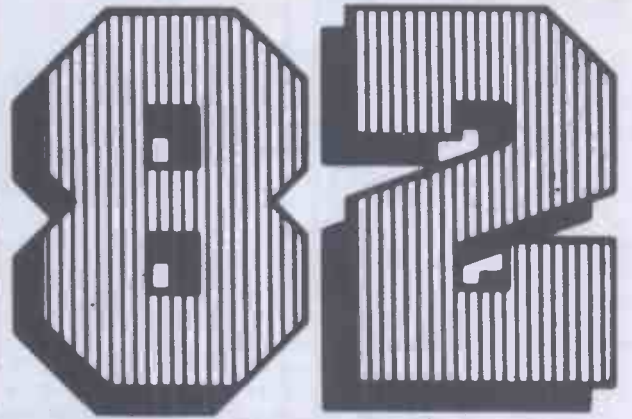
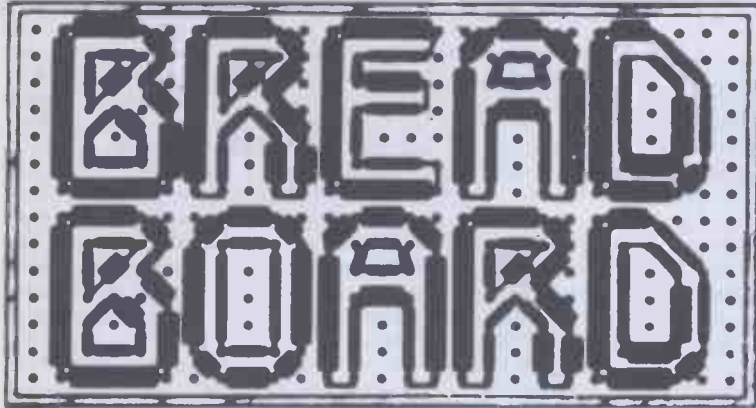

10-14 NOVEMBER 1982 at:
ROYAL HORTICULTURAL SOCIETY'S NEW HALL
GREYCOAT ST, WESTMINSTER, LONDON SW1.

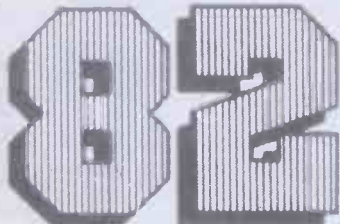
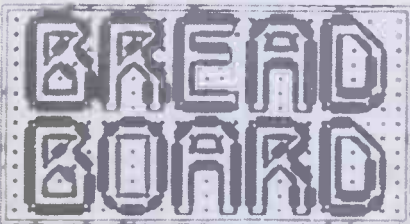

**MORE
COMPREHENSIVE
THAN EVER BEFORE:**

- ★ COMPUTERS
- ★ LOGIC
- ★ KITS
- ★ AUDIO
- ★ TEST GEAR
- ★ COMPONENTS
- ★ RADIO
- ★ C.B.
- ★ DEMONSTRATIONS
- ★ MUSIC
- ★ GAMES
- ★ LECTURES
- ★ MAGAZINES
- ★ BOOKS
- ★ SPECIAL OFFERS

SPECIAL TICKET OFFER

For the fifth consecutive year BREADBOARD is back with even more to offer electronics enthusiasts.

This is the best opportunity to update yourself on all the latest equipment, ideas and developments.

COME AND SEE THEM IN ACTION.

Book your tickets now at this special low rate.

50^p OFF BOOK NOW

(OFFER ENDS SEPTEMBER 30th)

SPECIAL ADVANCE BOOKING PRICE
ADULTS £1.50 — STUDENTS/SENIOR CITIZENS £1.

PLEASE SEND tickets @£1.50 and tickets @£1.
I enclose cheque/P.O. for.....

NAME.....
ADDRESS.....
.....
.....

Send to: BB 82, Argus Specialist Publications Ltd.,
145 CHARING CROSS ROAD, LONDON WC2H 0EE.

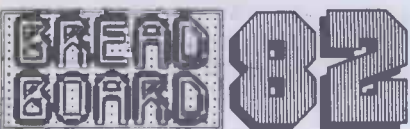

THE EXHIBITION YOU CAN'T AFFORD TO MISS

Clever Dick

Nostalgia is a wonderful thing ... why, it seems like only yesterday when I first had the chance to parade my journalistic talents before an unsuspecting public. Since that epic day, way back in August 79, I've stood firm against overwhelming odds (and editors!) to continue to answer your questions. I hope you appreciate it! But now for this month's offerings, the first of which had me working overtime!

*Dear CD,
How good is your memory? Can you remember if any faults appeared in the Envelope Generator project published in the June '81 issue of Hobby?*

I'm at the point of filing the project for future reference (ie finishing it!) so I'd be grateful for any advice.

Also, am I right in assuming that if I use a BC183L in place of a BC183, then the leadout wire configuration is changed?

Your replies will a) cure my insomnia and b) prevent hair loss (due to me tearing it out!)

*Kevin McKeourn,
Cirencester,
Gloucs.*

PS Have you ever thought of publishing an auto-wah project?

PPS The sounds I can get with your effects hooked up to my penny whistle and chime bar set-up are amazing!

I hope you realise that my memory is very good ... in fact, it's excellent! So, I can tell you, categorically, that the Envelope Generator was without errors — check your unit again. As you say, changing the BC183 for a BC183L will mean wiring the leads differently. However, this is not the only component that must be correctly oriented, so make sure all the others are right.

Can't say I've ever thought of publishing anything (not even my memoirs), but the editor tells me that HE did an Auto-Wah in June 82, though it was designed with guitarists in mind. Maybe it's time for you to move onto something a little more musically adventurous — dustbin lids perhaps?

*Dear CD,
I like playing with TV games and hand held electronic games but I haven't got one of my own. I'm sure that your team could come up with an idea. I mostly like playing with TV games, please please I am only 10 and am not trying to scrounge a binder.*

*David Ovington,
Camberley,
Surrey.*

PS Is the Digi-Die in the January 80 issue a Digital Dice?

Surprising how many young HE-men seem to spend most of their time playing games. In my day ... ah, but that's another story. Anyway, "our team", as you call them, is working on such a project at this very moment — after their tea-break of course — so you should see it within this noble tome in the near future.

As for the Digi-Die, it displays the numbers on seven LEDs arranged like the spots on a standard die and it is digital since it deals with logic signals or binary digits.

*Dear CD,
Re: HE OCTOBER 1981 — BABY ALARM*

Unfortunately you have neglected to print the track breaks in the Veroboard layout for this project. Please can you either send me a diagram of the breaks or print them in the next issue.

*Paul Brade,
Herne Bay,
Kent.*

Unfortunately you have neglected to enclose a SAE, which must accompany letters enquiring about Hobby projects. Of course, if you were a regular reader you'd know that already. You'd also know that we published the answer to your question in 'Your Letters' March 82. So now you know ... eh? I still haven't told you where the breaks are supposed to be — well, since you did say 'please': the breaks were merely to prevent the mounting bolts shorting any of the tracks. Omit the bolts (use double sided adhesive pads) and you've solved the problem. Happy now? Good.

Stop me if you've heard this one — letters to Hobby Electronics must include a SAE if they require a personal reply. You're right, it's not a joke and you've probably heard it before, but if it means one less letter using up the precious time of our back-room boys (as some of you like to call them), then it's worth repeating. So, I will: letters needing written replies must include a SAE. However, just to be awkward, letters to my own honourable personage don't need a SAE because questions will usually be answered through the magazine. Indeed, in an effort to allow others to share the limelight, letters I receive WITH a SAE are usually passed to the Technical Queries department, leaving me to concentrate on giving my all for readers of this page. Aren't I good to you?

*Dear CD,
I am writing in the hope that you may be able to answer the following question:*

Is it possible to receive an electric

shock from a 12V car battery?

I have asked several people the same question and they all said yes. This leaves me puzzled however, as I wouldn't have thought it possible, since 12V doesn't seem to be a harmful voltage level.

I would be most grateful for any information on this matter as I would prefer to use a battery for low voltage equipment thus eliminating the need for mains connections to power supplies etc.

*Wm. Lumsden,
Glasgow.*

Interesting one, this, because it really boils down to 'What is an electric shock?' The truth of the matter is that reactions to a shock vary greatly between individuals. Some are almost unshockable, while others jump at the smallest things (small rodents included!). However, I diverge, the answer to your question is no — unless the voltage has been stepped up. In fact as the potential gets higher, assuming the current is not limited, the more dangerous the possible shock.

More to the point, though, if you build a proper PSU then the whole issue becomes irrelevant. They're a lot easier to carry around and a lot cheaper!

*Dear CD,
Please, Please, Please, Please, Please, Please, Please can I have a binder. The pages of my March '82 issue have already fallen out. You'd better, or you'll have my mum to deal with (my, you should see her). Secondly, how about a digital, I repeat digital voltmeter (DC). I've looked in many magazines and haven't seen one. I think that ones with meters in are useless! As your loyal and faithful servant would indeed love a binder. Yours sincerely, loyalty (or loyalty?),
F. Woodroffe.*

PPS Where can I get a book about building experimental circuits on Verobloc?

PPPS Sorry about the punktchewayshun but I came 28th out of 31 in English.

Faced with all that, what can a peace-loving man (or woman) do but send a binder — so, that's where this month's blue and gold delight is going. Regarding the question about a DC digital voltmeter, you'll be happy to hear that one was printed last month. Also, you need look no further than our 'Breadboards' page, for a source of circuits to experiment with. Oh, and, incidentally, you're punctuation wasn't that bad, just your spellig!

HE

Send for my CATALOGUE ONLY 75p

(plus 25p post/packing)

My VAT and post/packing inclusive prices are the lowest. All below normal trade price – some at only one-tenth of manufacturers quantity trade.

See my prices on the following:

CAPACITORS . . . ELECTROLYTIC; CAN, WIRE END, TANTALUM, MULTIPLE, COMPUTER GRADE, NON POLAR, PAPER BLOCK, CAN, POLY, MICA, CERAMIC. LOW AND HIGH VOLTAGE, RESISTORS. 1/8th WATT TO 100 WATT; 0.1% TO 10% CARBON, METAL AND WIRE WOUND + NETWORKS. FANS, BATTERIES, SOLENOIDS, TAPE SPOOLS, VARIABLE CAPACITORS AND RESISTORS, TRIMMERS, PRESETS, POTS . . . SINGLE, DUAL, SWITCHED, CARBON, CERMET AND WIREWOUND, SINGLE OR MULTITURN, ROTARY AND SLIDE. DIODES, RECTIFIERS, BRIDGES, CHARGERS, STYLII, SOCKETS, PLUGS, RELAYS, TRANSISTORS, IC'S, CLIPS, CRYSTALS, ZENERS, TRIACS, THYRISTORS, BOXES, PANELS, DISPLAYS, LED'S, COUPLERS, ISOLATORS, NEONS, OPTO'S, LEADS, CONNECTORS, VALVES, BOOKS, MAGAZINES, TERMINALS, CHOKES, TRANSFORMERS, TIMERS, SWITCHES, COUNTERS, LAMPS, INDICATORS, BELLS, SIRENS, HOLDERS, POWER SUPPLIES, HARDWARE, MODULES, FUSES, CARRIERS, CIRCUIT BREAKERS, KNOBS, THERMISTORS, VDR'S, INSULATORS, CASSETTES, METERS, SOLDER, HANDLES, LOCKS, INDUCTORS, WIRE, UNITS, MOTORS, COILS, CORES, CARTRIDGES, SPEAKERS, EARPHONES, SUPPRESSORS, MIKES, HEATSINKS, TAPE, BOARDS and others.

Prices you would not believe before inflation!

BRIAN J. REED
TRADE COMPONENTS

ESTABLISHED 25 YEARS

161 St. Johns Hill, Battersea, London SW11 1TQ

Open 11 am till 7 pm Tues. to Sat. Telephone: 01-223 5016

EXPO DRILLS

KITS TOOLS ACCESSORIES



The Expo Pin Chuck and Wishbone Drill Sharpener are a must for all small engineering. The Pin Chuck comes complete with three Steel Collets and Tommy Bar, and the Wishbone with Eye Glass Gauge, Stone, and four Collets in attractive presentation box, competitively priced at £4.60. Incl. VAT, for the Pin Chuck, and £7.00. Incl. VAT, for the Wishbone, available from ourselves or any good Model Shop.



Why not send 35p for our illustrated Leaflet of Small Precision Drills, Burrs, Reamers, Grinder & Polisher, from 0.6mm to 3.0mm.

EXPO (DRILLS) LTD Unit 10, Sutanum Works
Titchfield, Hants Tel Titchfield (03294) 41752

ELECTRONIC IGNITION

Makes a good car
better



Buy NOW!
7% PRICE INCREASE
EFFECTIVE 1st. OCT.

TOTAL ENERGY DISCHARGE electronic ignition gives all the well known advantages of the best capacitive discharge systems.

PEAK PERFORMANCE — higher output voltage under all conditions.

IMPROVED ECONOMY — no loss of ignition performance between services.

FIRES FOULED SPARK PLUGS no other system can better the capacitive discharge system's ability to fire fouled plugs.

ACCURATE TIMING — prevents contact wear and arcing by reducing load to a few volts and a fraction of an amp.

SMOOTH PERFORMANCE — immune to contact bounce and similar effects which can cause loss of power and roughness.

PLUS

SUPER POWER SPARK — 3½ times the energy of ordinary capacitive systems — 3 times the power of inductive systems.

OPTIMUM SPARK DURATION 3 times the duration of ordinary capacitive systems — essential for use on modern cars with weak fuel mixtures.

BETTER STARTING — full spark power even with low battery.

CORRECT SPARK POLARITY unlike most ordinary C.D. systems the correct output polarity is maintained to avoid increased stress on the H.T. system and operate all voltage triggered tachometers.

L.E.D. STATIC TIMING LIGHT for accurate setting of the engine's most important adjustment.

LOW RADIO INTERFERENCE fully suppressed supply and absence of inverter 'spikes' on the output reduces interference to a minimal level.

DESIGNED IN RELIABILITY an inherently more reliable circuit combined with top quality components — plus the 'ultimate insurance' of a changeover switch to revert instantly back to standard ignition.

IN KIT FORM

it provides a top performance electronic ignition system at less than half the price of competing ready-built systems. The kit includes everything needed, even a length of solder and a tiny tube of heatsink compound. Detailed easy-to-follow instructions, complete with circuit diagram, are provided — all you need is a small soldering iron and a few basic tools.

AS REVIEWED IN

ELECTRONICS TODAY INTERNATIONAL June '81 Issue
and EVERYDAY ELECTRONICS December '81 Issue

FITS ALL NEGATIVE EARTH VEHICLES,
6 or 12 volt, with or without ballast

OPERATES ALL VOLTAGE IMPULSE TACHOMETERS
Some older current impulse types (Smiths pre '74) require an adaptor —
PRICE £2.95

STANDARD CAR KIT £ 14.85

Assembled and Tested £ 24.95

TWIN OUTPUT KIT £ 22.95

For MOTOR CYCLES and CARS with twin ignition systems
Assembled and Tested £ 34.70

PLUS
£1.00
U.K.
P. & P.
Prices
Include
VAT.

ELECTRONIZE DESIGN

Dept. E, Magnus Road, Wilnecote,
Tamworth, B77 5BY

Phone: (0827) 281000



VISA

Now our name means more, than ever before.

If the name BICC-Vero sounds only half familiar, that's not the only difference you're going to notice.

Because not only have we added to our name we've also added to our technology. Building upon our well established industrial product range and incorporating the very latest ideas and techniques to ensure that you too are working at a state-of-the-art standard.

But you will of course still recognise the old favourites. Products like Veroboard, which pioneered in so many ways, today's thriving pastime of electronics.

Bigger means better in other respects. Being part of the giant BICC-Vero Electronics Group ensures that we're a major force in electronics technology. Our R and D scope is enlarged, and our supply and distribution facilities improved.

And because we're professionals we appreciate the very real professionalism of the hobbyist market - and service it accordingly.

Yes, we're sure you'll notice the difference. As well as that pleasantly familiar personal touch.

BICC-VERO ELECTRONICS LTD.

Industrial Estate, Chandlers Ford, Eastleigh, Hampshire SO5 3ZR.
Tel: Chandlers Ford (04215) 62829.

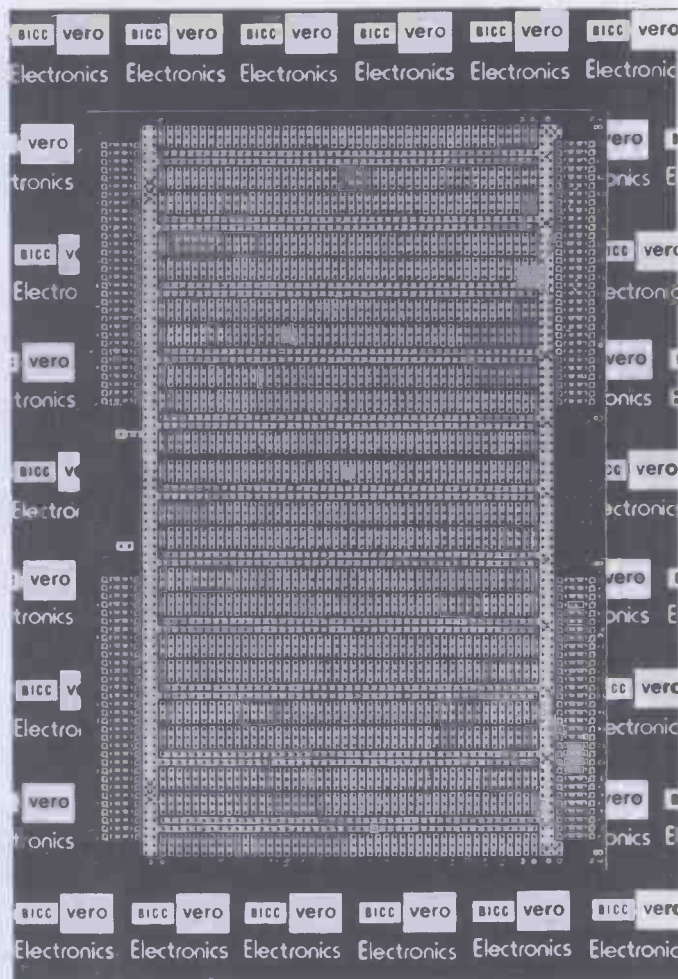

SUMMERTIME SALE!!

DEDUCT 20% OFF ALL ORDERS OVER £10 FROM THIS ADVERT

All prices include VAT - Just add 50p post

1982/3 CATALOGUE

Bigger! Better!! Buy one!!!

Only 75p inc. post - Look what you get!!!

- Vouchers worth 60p
- 1st class reply paid envelope
- Wholesale list for bulk buyers
- Bargain List with hundreds of surplus lines
- Huge range of components
- Low, low prices

Sent free to schools, colleges etc.

'COMPUTER BATTLESHIPS'

Probably one of the most popular electronic games on the market. Unfortunately the design makes it impractical to test the PCB as a working model, although it may well function perfectly. Instead we have tested the sound chip, and sell the board for its component value: SH76477 sound IC; TMS1000 u-processor; batt clips, R's, C's etc. Size 160 x 140mm. Only £1.50. Instruction book and circuit 30p extra.

'STARBIRD'

Gives realistic engine sounds and flashing laser blasts - accelerating engine noise when module is pointed up, decelerating noise when pointed down. Press contact to see flash and hear blast of lasers shooting. PCB tested and working complete with speaker and batt clip (needs PP3). PCB size 130 x 60mm. Only £2.95.

COMPONENT PACKS

K503 150 wirewound resistors from 1W to 12W, with a good range of values. £1.75. K514 100 silver mica caps from 5pF to a few thousand pF. Tolerances from 1% to 10% £2.00. K520 Switch pack - 20 different, rocker, slide, rotary, toggle, push, micro, etc. Only £2.00.

MIXED LED PACK

All new full spec by Micro, Fairchild, etc. Red, Yellow, Green, Amber, Clear, 3mm & 5mm. Pack of 50 assd £3.95; 250 £15.

1000 RESISTORS £2.50

We've just purchased another 5 million preformed resistors, and can make a similar offer to that made two years ago, at the same price!!! K523 - 1000 mixed 1/4 and 1/2W 5% carbon film resistors, preformed for PCB mntg. Enormous range of preferred values. 1000 for £2.50; 5000 £10; 20k £38.

COPPER CLAD BOARD

K522 All pieces too small for our etching kits. Mostly double sided fibreglass. 250gm (approx. 110 sq ins) for just £1.00.

PANELS

Z521 Panel with 16236 (2N3442) on small heat sink, 2N2223 dual transistor, 2 BC108, diodes, caps, resistors, etc. 65p.
Z527 Reed relay panel - contains 2 x 6V reeds, 6 x 25030 or 25230, 6 x 400V reeds + Rs. 50p.
Z529 Pack of 6x-computer panels containing 74 series ICs. Lots of different gates and complex logic. All ICs are marked with type no. or code for which an identification sheet is supplied. 20 ICs £1.00; 100 ICs £4.00.



ELECTRO-DIAL

Electrical combination lock for maximum security, absolutely pick-proof!! One million combinations!! Dial is turned to the right to one number, left to a second number, then right again to a third number. Only when this has been completed in the correct sequence will the electrical contacts close. These can be used to operate a relay or solenoid etc. Overall dia 65mm x 60mm deep. Finished in bright chrome. With combination the price is £9.95. Also available without combination, but instructions are provided on how to find it. Takes about 20 mins. £2.95.

It's easy to complain about advertisements.

The Advertising Standards Authority. ✓
If an advertisement is wrong, we're here to put it right.

ASA Ltd, Brook House, Torrington Place, London WC1E 7HN.

GREENWELD

443F Millbrook Road, Southampton, SO1 0HX

Audio Analyser

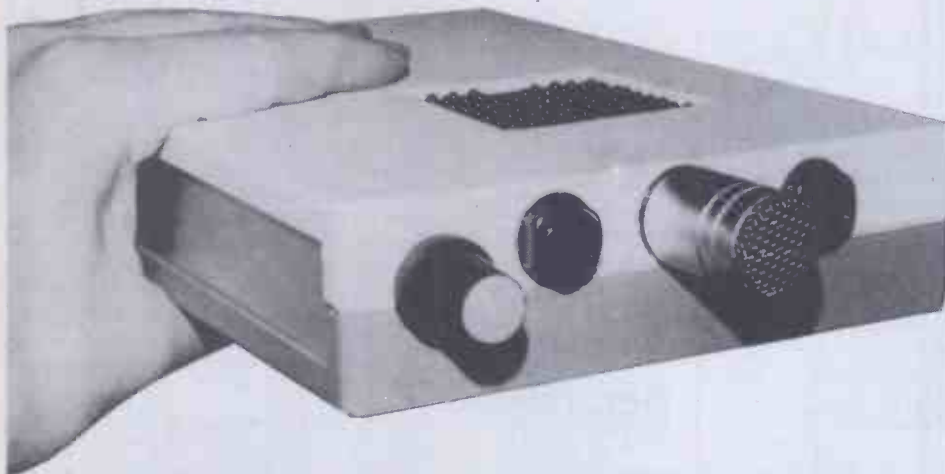

Concluding the Audio Spectrum Analyser project with the method of construction and setting up.

CONSTRUCTION of this project is not for the faint-hearted! To make this project handheld has meant using two fairly dense PCBs, so you can put away your gas-fired soldering irons and pliers; delicacy, finesse and a steady hand are required. Use an iron with a small bit and make sure you don't leave huge blobs of solder that bridge the PCB tracks. IC sockets are not just recommended; we insist upon them. Fit the components to the boards in the usual way, filter board first, taking great care to observe component polarity where this is important. Don't miss out any of the wire links; and *don't* try to finish it all in one evening — or two. Time 'saved' during construction will be wasted on fault-finding, later!

The nice men who designed the 4017 didn't put its sequential outputs 'sequentially' on the IC pins and this often leads to tricky PCB layouts when using the IC. Fortunately we can cheat, because all we need in this project is to look at each of the 10 channels separately — so long as they appear on the right display columns it doesn't matter what the actual order is. This is why the filters don't run in sequence down the PCB — it's purely for convenience.

To avoid the use of a double-sided PCB for the display matrix, a rather cunning technique has been adopted. Solder in one row of LEDs only and cut off one pin only — the ones whose solder pads are linked by copper tracks. Now solder a length of tinned copper wire to the pad indicated, bend it over so it touches the other LED pins about $\frac{1}{4}$ " away from the board, then solder all the pins to it and trim them off. Then do the next row, and so on. Mistakes made here will be almost impossible to correct later, so check that every LED in every row is the right way round before you solder it. The most certain method is to use Figure 2; flats, dots and 'one leg is shorter than the other' can all lead you astray.

The case used was a Vero type 1 (reference number 202-21034), external size 205 x 140 x 40 mm; a fair bit of work with a sharp chisel is required to make everything fit, though. The vertical slot guides at both ends of both case halves should be removed, plus all the PCB mounting pillars in the grey (bottom) half and the outer set of four pillars in the white (top) half. Everything mounts on the top half except the on/off switch, which is fitted in the side aluminium panel.

The two PCBs are bolted together with stand-off pillars and have a number of wire links between them. The easiest way to do this is to solder lengths of tinned copper wire to the relevant pads of the display board and cut them down slightly to different lengths, gradually increasing as you move down the board (Figure 3). Then you can insert the longest link onto the

filter board, move the two closer together, insert the second and so on, until they're all through.

Assembly starts by test-fitting the display board and making a hole for the display. It's a good idea to glue a piece of red plastic or polarising filter behind it to improve the contrast of the LEDs. Fix the pillars to the display board and screw into the case — the transistors and tantalum capacitors will probably have to be bent over to give clearance. Now slide the main board over the wires, as described above, solder all the links and trim them. Now the wiring for the off-board components can be completed.

We found the cheapest way of getting an electret mic element was to buy a cheap electret cassette recorder mic (about £3) and cut the end off it. Do this very carefully as you mustn't damage the insulation on the internal wiring; you'll need it to link the mic to

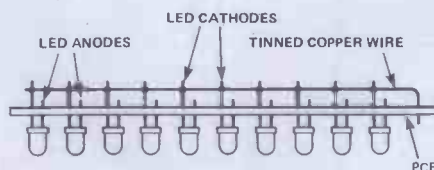

Figure 1. Wiring the LED matrix; it is best to check all the LEDs before soldering them in, because replacing one will be very difficult once the boards are assembled.

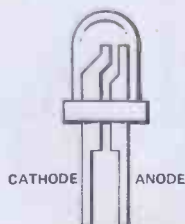

Figure 2. Pin connections of a LED.

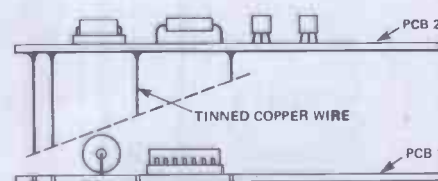

Figure 3. Fitting the links between the two boards.

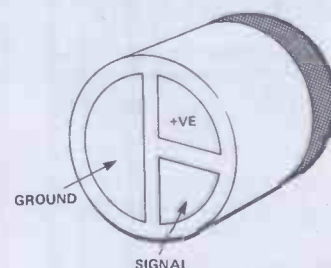

Figure 4. Connections to an electret microphone.

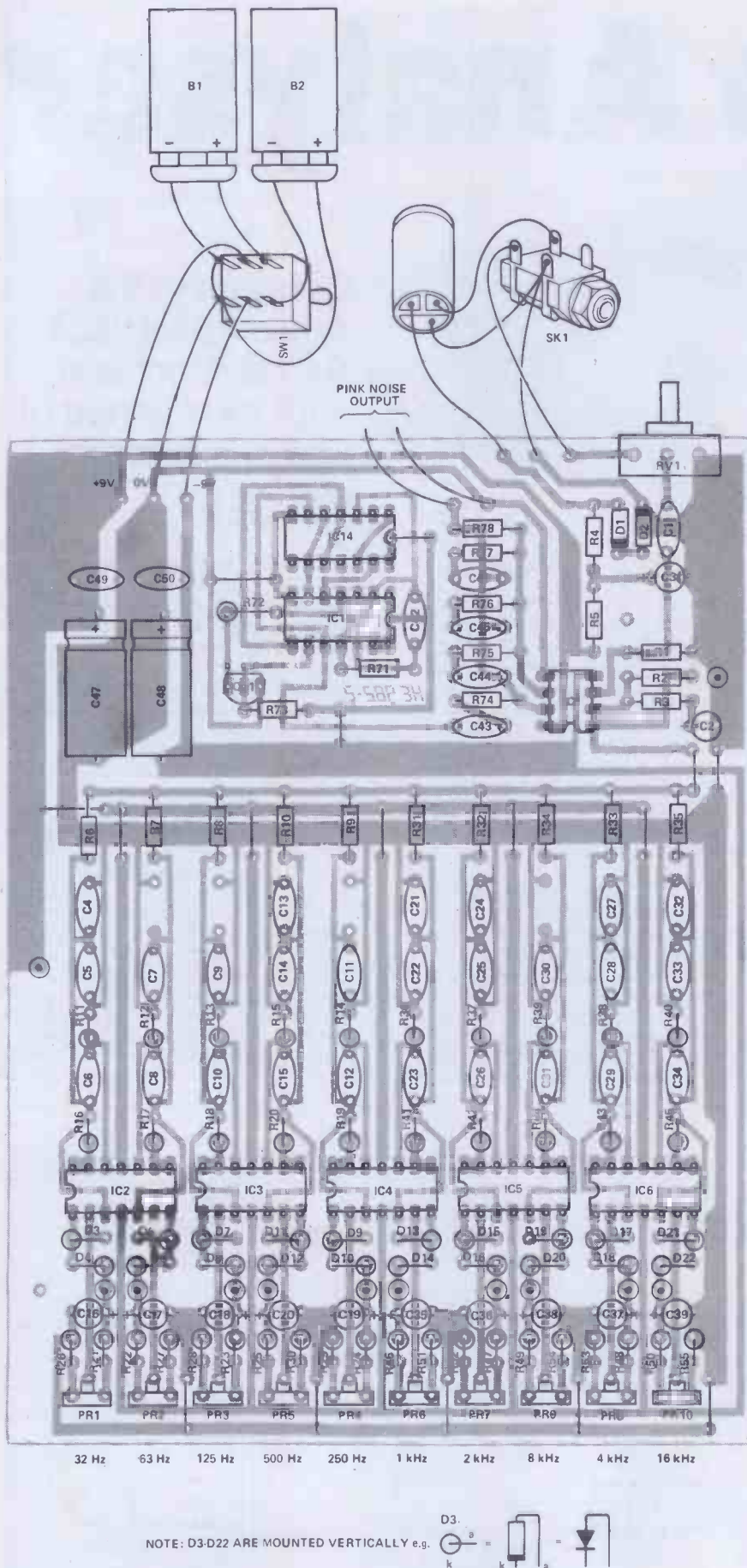

Figure 7. The filter board component overlay.

the PCB. Glue the mic into a suitable-sized hole cut in the end of your case and connect it to the PCB as shown on the overlay; the existing battery terminals of the mic will tell you which are the positive and negative supplies, while the third wire is the signal connection (probably screened by the earth wire). If you don't feel your constructional abilities are up to this, just plug a mic into the external jack socket; not as compact but much easier.

If choosing an alternative case, bear in mind that you'll want easy access to the batteries; the current consumption of the unit is quite high and you'll either have to replace your alkalines regularly or, if you've been sensible, recharge the Nicads.

Anyone who attempts to improve on our PCB design is on his own. Anyone who attempts to build the circuit on Veroboard will be recommended for committal to a mental institution.

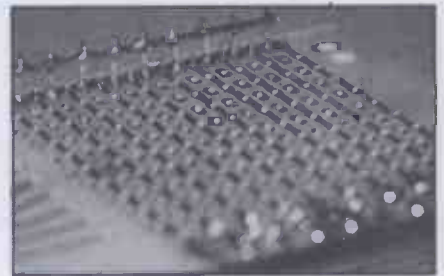

Figure 5. View of the LED display from the foil side.

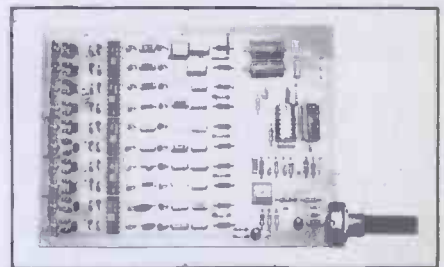

Figure 6. The completed display board.

Setting up and Use

The unit can be set up using either the built-in pink noise generator or, better still, with a sine wave oscillator. Adjust PR10 to about 75% of its travel (wiper towards the clockwise direction). With the unit switched on and the sine wave oscillator connected to the external input, by sweeping the oscillator frequency, each column should come up in sequence. Adjust the sine wave frequency and the analyser level control until the 16 kHz column is peaking at a column height of about eight LEDs.

Now, using the same amplitude and without touching the level control, adjust the signal generator frequency until the 8 kHz column peaks and adjust PR9 to give the same height. Repeat this adjustment for each of the filters. Due to component tolerances the actual peak of a filter may not

Parts List

NOTE: The parts list published last month contained several errors and these are corrected here.

RESISTORS (All 1/4 watt 5% carbon)

R1,2	220k
R3	2k2
R4,5,6,9	15k
R6-10,31-35,72	10k
R11-15,21-25,36-40,46-50,78	1M
R16-20,41-45	220R
R26-30,51-55,68,76	100k
R56	680k
R57	6k8
R58-67	47k
R68	100k
R69	15k
R70	430R
R71	27k
R73	4k7
R74	180k
R75	18k
R77	390k

POTENTIOMETERS

RV1	47k log carbon
PR1-10	220k min horiz preset

CAPACITORS (All metallised Polycarbonate unless noted)

C1,13,43,49,50	100n
C2,3,41	10u 16V tantalum bead
C4,5,7	1u0
C6	56n
C8,10	27n
C9,11	270n
C16-20,35-39	2u2 35V tantalum bead
C12	6n8
C14	18n
C15	3n9
C21,22	39n
C23	1n5
C24	33n
C25,32,33	2n2
C26,44	820p ceramic disc
C27	12n
C28	3n3
C29	470p ceramic disc
C30	10n
C31	180p ceramic disc
C34	100p ceramic disc
C40	22n
C42	1n
C45	2n7
C46	5n6
C47,48	220u 16V axial electrolytic

SEMICONDUCTORS

IC1	LF353 dual BIFET op-amp
IC2-6	TL064 quad lo-power op-amp
IC7	4011 CMOS quad 2-input NAND
IC8,9,10	4016 CMOS quad analogue switch
IC11	LM3915 bargraph driver
IC12	4017 CMOS decade counter/divider
IC13	4070 CMOS quad EX-OR
IC14	4006 CMOS 18-stage shift register
Q1-11	BC184L silicon NPN transistor
D1-22	1N4148 signal diode
LED1-100	high efficiency red LED (see Buylines)

MISCELLANEOUS

SK1	1/4" jack socket with break contacts
MIC1	electret microphone (see Buylines)
PP3 battery clips (2 off); IC sockets (13 off); case; wire; solder; PCBs, etc.	
Buylines	page 33

correspond exactly to its nominal centre frequency. The 16 kHz filter has the greatest loss which is the reason for starting with it near its maximum gain.

If a sine wave oscillator isn't available, connect the pink noise output to the external input and adjust the presets to give an even response across the 10 channels. Each column should be approximately the same height; due to the nature of noise, the top of the columns may jump up and down slightly and this should be averaged out by eye. If one of the columns appears dimmer than the rest, replace the transistor that drives that column; if only a single LED appears dim then it must be replaced but as we've pointed out, the method of construction make this a bit tricky. It's a good idea to either buy good quality LEDs or test them individually for duds before commencing construction.

To measure a room set-up, feed the pink noise into the hi-fi or PA system via a cable from the listening position and adjust the graphic equaliser controls until a flat response is indicated.

A final point; the microphone used must be fairly flat or its frequency response will affect the measurements you're making. If you use one with a limited bandwidth it's possible to use the presets to compensate; however, to do this properly you'll need to play the pink noise into the mike via a sound system/location you already know to be flat.

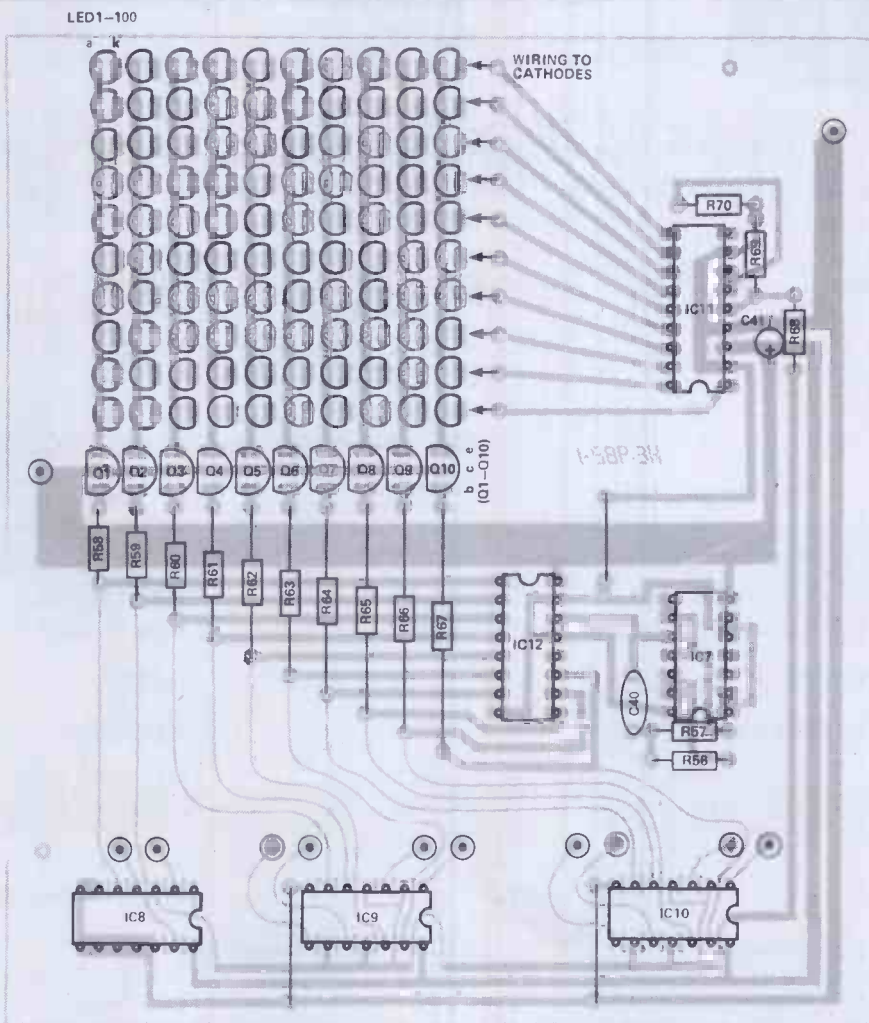

Figure 8. Display board component overlay.

NOTE: CIRCLED PADS INDICATE LINK-WIRES BETWEEN THE PCBs (SEE TEXT)

BACKNUMBERS

February 1980

Passion Meter, Win Indicator, Short Circuit Special, Kit Review Special, Into Electronics Construction Part 1.

May 1980

MiniClocks, 5080 Preamp, Model Railway Track Cleaner, 5080 Loudspeakers, Loudspeaker Crossover Design, Radio Controlled Model Survey.

June 1980

Microbe Radio Control System, Egg Timer, Two Watt Amplifier, Fog Horn, Short Circuits, LEDs and LED Displays.

July 1980

Sound-Operated Flash Trigger, 18 + 18 Car Stereo Booster, Hazard Flasher, Electronics in Photography, Electronic Espionage, Piezo Electricity.

August 1980

EquiTone Car Equaliser, Pass-The-Loop Game, Gaztec Gas Detector, OP-Amp Checker, In-Car Entertainment Survey, Introducing Microprocessors.

September 1980

MicroMixer, Reaction Tester, Guitar Phaser, Development Timer, Teletext Explained, Into Digital Electronics Part 1.

October 1980

Kitchen Timer, Tug 'o' War Game, Light Dimmer, Freezer Alarm, Intruder Alarm, Temperature-Controlled Soldering Iron.

January 1981

Car Rev-Counter, Bench Amplifier, Sound-Into-Light Converter, Chuffer, Electronic Games reviewed.

February 1981

Heartbeat Monitor, High-Impedance Voltmeter, Medium Wave Radio, Two-Tone Train Horn, Audio Signal Generator.

March 1981

Public Address Amplifier, Windscreen Wiper Controller, Bicycle Speedometer, Photographic Timer, Microcassettes.

April 1981

Pre-Amplifier Part 1, Super Siren, Guitar Tremolo, Russian Roulette Game, Doorbell Monitor, Anatomy of a Space Shuttle.

May 1981

Electronic Organ, Voice-Operated Switch, Infra-Red Controller, Pre-Amplifier Part 2, Audio Millivoltmeter.

June 1981

Power Amplifier Part 1, Continuity Checker, Envelope Generator, Early Radio, Gadgets, Games and Kits Supplement.

July 1981

Burglar Alarm, Doorbuzzer, Treble Booster, Electronic Aids for the Disabled, Power Amplifier Part 2.

August 1981

Electronic Ignition, Thermometer, Electronic Organ (final part), RPM Meter, Bench Power Supply, Radio Control Survey, Into Electronic Components Part 1.

All of the 1980 issues, except January and April, are still available together with the remaining issues from 1981.

All backnumbers cost £1.25 each. For those of you who only want copies of articles, we do offer a photocopying service. Each copy costs £1.25 and information as to its title and publication date should be given. Ordering backnumbers and photocopies could hardly be easier, just fill in the coupon, cut it out and send it to:

**Hobby Electronics,
145 Charing Cross Road,
London WC2H 0EE**

Please remember to mark your envelope with the service you require, **BACKNUMBERS** or **PHOTOCOPIES**, otherwise our mailroom won't like you.

HOBBY ELECTRONICS BACKNUMBER ORDER FORM

Please send me the following items:

NAME

ADDRESS

Back issues at £1.25 each

I enclose £.....

Cheques and Postal Orders should be made payable to ASP Ltd.

HOBBY ELECTRONICS PHOTOCOPY ORDER FORM

Please send me the following items:

NAME

ADDRESS

Photocopies of in the

..... issue at £1.25 each

I enclose £.....

Cheques and Postal Orders should be made payable to ASP Ltd.

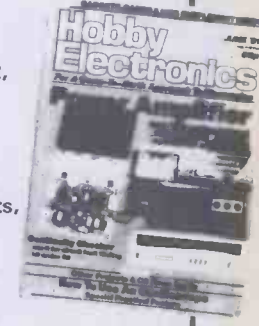
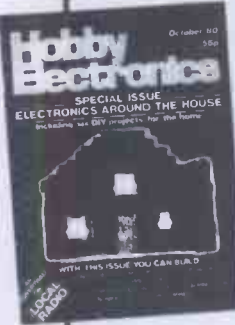
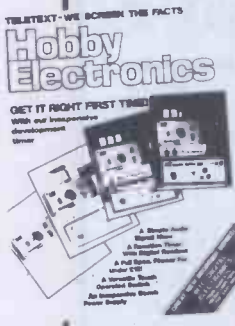
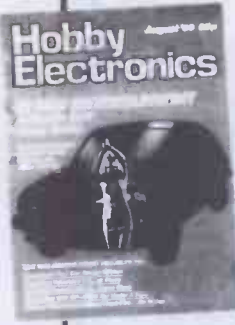

Lightning

**ELECTRONIC COMPONENTS
NEW SHOWROOM NOW OPEN * * * ***

For a vast choice of electronic components & equipment of all kinds:— Here is just a selection of our stocks.

TRANSISTORS	CMOS ICs	LINEAR ICs	74LS TTL ICs
BC182L 10	4000 14	LM301AN 26	74LS00 12
BD124(M) 1-58	4001 14	LM380N 75	74LS04 15
BFR39 24	4011 15	LM381N 1-45	74LS08 15
BFR64 3-00	4013 34	LM386N 90	74LS10 15
BFR79 26	4017 42	LM387N 1-18	74LS13 29
BLY93A 14-20	4022 65	MC1458 47	74LS20 15
MJ15003 4-05	4046 74	NE555 20	74LS30 18
MJ15004 6-04	4049 30	NE565 60	74LS374 24
TIP41C 48	4066 35	TBA120 90	74LS107 40
TIP42C 48	4070 25	TBA440 2-52	74LS154 85
2N3055 48	4093 38	TBA800 85	74LS244 80
2N3773 2-25	40106 55	741 (8 pin) 18	74LS386 28
40673 90	4511 67	555 20	

V.Regulators (Fixed)	V.Regulators (Variable)
78L05 — 78L12 — 78L15 0-31	LM317K 1.5 Amp. 3-35
79L05 — 79L12 — 79L15 0-59	LM338K 5 Amp 4-70
7805 — 7812 — 7815 0-60	LM396K 10 Amp 11-00
7905 — 7912 — 7915 0-66	L723 14 DIL 0-45

MANY more types listed in our catalogue — AUDIO POWER TRANSISTOR SPECIALISTS — LIST AVAILABLE FOR BULK BUYERS — S.A.E.

CATALOGUE ONLY 70p Post Paid.
Listing:— Resistors, Coaxials, Semiconductors, Tracs, Switches, Relays, Cases, Connectors, PCB Equipment, Vero Products, Test Equip, Tools, Books, Denco Coils, Transformers, PLUS MUCH MORE for the keen constructor. Don't delay send today. (Slight delays on new catalogues at the moment as we are awaiting second print)

BARGAIN PACKS	£1-10	12 Asstd Presets	0-50
12 Asstd Panel Mounted Pots	65	30 Asstd Silver Mica Caps	90
20 Asstd Electrolytic Caps.	1-10	5 Asstd Relays	1-10
7 Asstd Blob Boards	20	30 Asstd C296 Polyester	60
1 50pF Trimmer Capacitor	20	250 Asstd Preformed Resistors	75
30 Asstd Min Ceramic Caps	1-10	8 Asstd Switches, Micros, Slide Lever Key, push, Toggle, Excellent Value at 90p	60
9 Asstd CD4000 Type CMOS	60		
10 Black & Red Croc Clips			

THE LIGHTNING PROMISE — Mail order despatched within 24 Hours. Callers welcome. If any part ordered by mail fails to please just return within 7 days for refund.

Postage & Packing 50p per order (FREE OVER £10). PLEASE add VAT at 15%
Telephone orders welcome by Access & Barclaycard
Showroom and Mail Order Distribution Centre at:—
18, Victoria Road TAMWORTH Staffs. B79 7HR.
Telephone 0827-65767

DESOLDERING TOOL Now everyone can afford one of these superb, blue anodised aluminium high pressure hand desoldering tools at nearly half our normal price. Normal Price £8.50 + VAT. With this ad £3.95 + VAT. Spare Teflon screw-in noses 75p + VAT.

JAPANESE TRANSISTORS Equivalents available for most types. Please call, phone or write.
LOW COST VERSATILE MULTIMETER
THE MIGHTY MINI MULTI-TESTER 2,000 ohms per volt. DC & AC Voltage ranges: 10v, 50v, 250v, 1000v. DC current ranges 100mA. Resistance ohms x 10 x 100db from —10db to +22db. Mirror arc scale, overload protected, complete with battery, test leads & instructions. Usual price £8.65 + VAT; with this Ad: £4.95 + VAT.

ORDER FORM
Name:

Address:

..... Desoldering tools at £3.95 = £

..... Spare Teflon noses at 75p = £

..... Mighty Mini Testers at £4.95 = £

Postage, packing and insurance at 60p per one device, 25p for each additional device

Sub total £

Add 15% VAT £

I enclose cheque no/P.O. no. £

Alternatively please credit my VISA/ACCESS No.

Signature

This offer applies to UK only. Please allow 7-10 days delivery. Overseas customers please do not add VAT but allow to cover postage. TRADE ENQUIRIES WELCOME.

CRICKLEWOOD ELECTRONICS LTD.
40 Cricklewood Broadway, London NW2 3ET. Tel: 01-452 0161

Goodmans Fane Richard Allan Celestion Altai

Multimeters & Accessories
UK P/P 65p or £1.00 for two
KRT 100 12 range pocket 1K/volt £4.95
NH55 10 range pocket 2K/volt £5.95
NH56R 22 range pocket 20K/volt £10.95
YW360TR 19 range plus hfe test 20K/volt £14.95
ST303TR-21 range plus hfe test 20K/volt £17.95
TMK500 23 range plus 12 adc plus cont. buzzer £23.95



High Quality Speakers
8" 25W to 50W
10" 25W to 100W
12" 30W to 200W
15" 100W to 250W
18" 100W to 350W

CROSSOVERS
2 way 100W 8 ohm
3 way 100W 8 ohm
4 way 80W 8 ohm

Power Amplifier Modules 100W to 200W

PIELO ELECTRIC TWEETERS
PIEZO HORN TWEETERS
Up to 100 watts each. No a/c over required. Flared Horns. Mid range Flared Horns in stock now. Large range of speakers, public address equipment, microphones, mixers, ham equipment. Heavy chromed Floor Stand. Boom Arm. Echo Chamber. Analogue Echo Chamber.

Stockists of leading makes of Disco Units & Lighting Equipment.
CITRONIC, FAL, TK, ICE, OPTIKINETICS, PLUTO.
SEND LARGE SAE FOR LIST
ALLOW 10 DAYS FOR DELIVERY

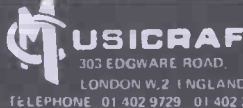

**CAMBRIDGE LEARNING
SELF-INSTRUCTION COURSES**

**A PRACTICAL DIGITAL ELECTRONIC KIT FOR
★ LESS THAN £20 ★**



**SUITABLE FOR BEGINNERS
NO SOLDERING!**

Learn the wonders of digital electronics and see how quickly you are designing your own circuits. The kit contains: seven LS TTL integrated circuits, breadboard, LEDs, and all the DIL switches, resistors, capacitors, and other components to build interesting digital circuits; plus a very clear and thoroughly tested instruction manual (also available separately). All this comes in a pocket size plastic wallet for only £19-90p inc VAT and p&p. This course is for true beginners:

- needs no soldering iron.
 - asks plenty of questions, but never leaves you stuck and helpless.
 - teaches you about fault-finding, improvisation, and subsystem checking.
 - the only extra you need is a 4 1/2V battery (Ever Ready 1289, or similar), or a stabilised 5V power supply.
- Using the same breadboard you may construct literally millions of different circuits.

DIGITAL COMPUTER DESIGN £8.50 NEW!

An up-to-date course on the design of digital computers — from their individual logic elements and from integrated circuits. You are first shown the way in which simple logic circuits operate and then, through a series of exercises, arrive at a design for a working machine.

This course, as well as our beginners' theory course, Digital Computer Logic and Electronics, supports the practical Superkit series.

GUARANTEE No risk to you. If you are not completely satisfied, your money will be refunded upon return of the item in good condition within 28 days of receipt.

CAMBRIDGE LEARNING LIMITED, UNIT 98 RIVERMILL SITE, FREEPOST, ST IVES, CAMBS, PE17 4BR, ENGLAND.
TELEPHONE: ST IVES (0480) 67446. VAT No 313026022

All prices include worldwide postage (airmail is extra — please ask for prepayment invoice). Giro A/c No 2789159. Please allow 28 days for delivery in UK.

-SUPERKIT(S) @ £19.90
-DIGITAL COMPUTER DESIGN(S) @ £8.50
-DIGITAL COMPUTER LOGIC AND ELECTRONICS @ £6.00

I enclose a *cheque/PO payable to Cambridge Learning Ltd for £..... (*delete where applicable)

Please charge my:

*Access / American Express / Barclaycard / Diners Club Eurocard / Visa / Mastercard / Trustcard

Expiry Date..... Credit Card No

Signature.....

Telephone orders from card holders accepted on 0480 67446

Overseas customers (including Eire) should send a bank draft in sterling drawn on a London bank, or quote credit card number.

Name.....

Address.....

Cambridge Learning Limited, UNIT 98 Rivermill Site, FREEPOST, St Ives, Huntingdon, Cambs, PE17 4BR, England. (Registered in England No 1328762).

HE PCBs

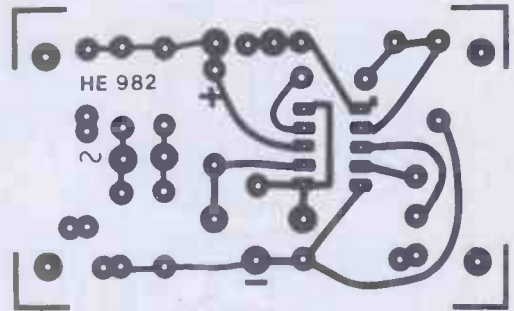
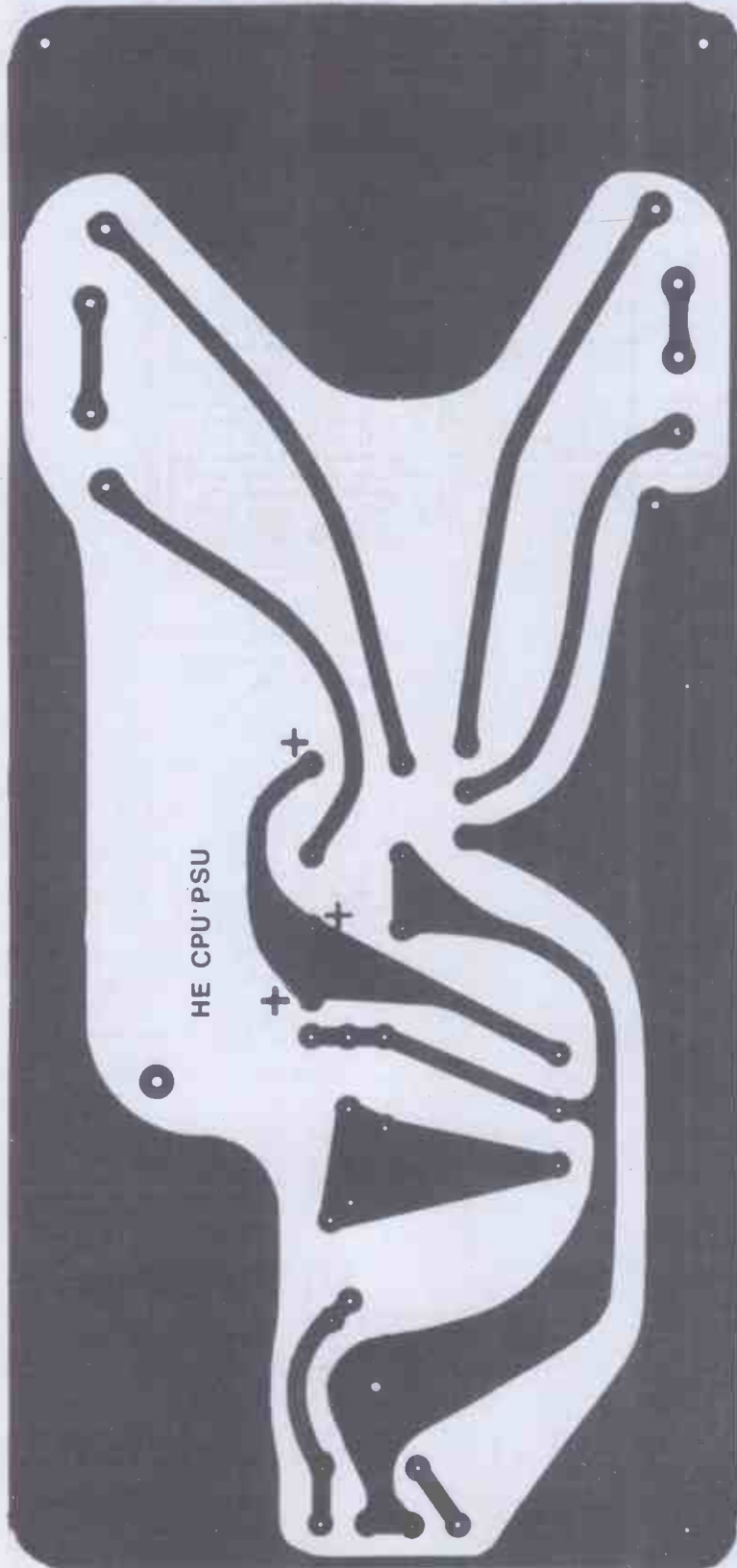

Above: The PCB pattern for the 'Junior' Slot Car and (below) the foilside pattern for the ZX PCB.

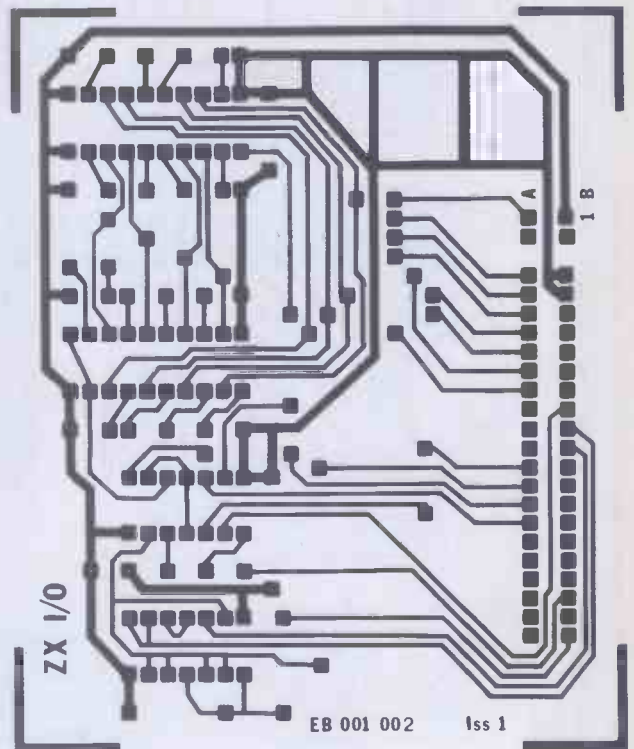

Computer PSU

We apologise to all those readers who attempted to build the Computer PSU featured in the July issue. As you probably realised, the PCB pattern was shown half size but we omitted to say this in the caption – sorry! The full size foil pattern is shown on the left.

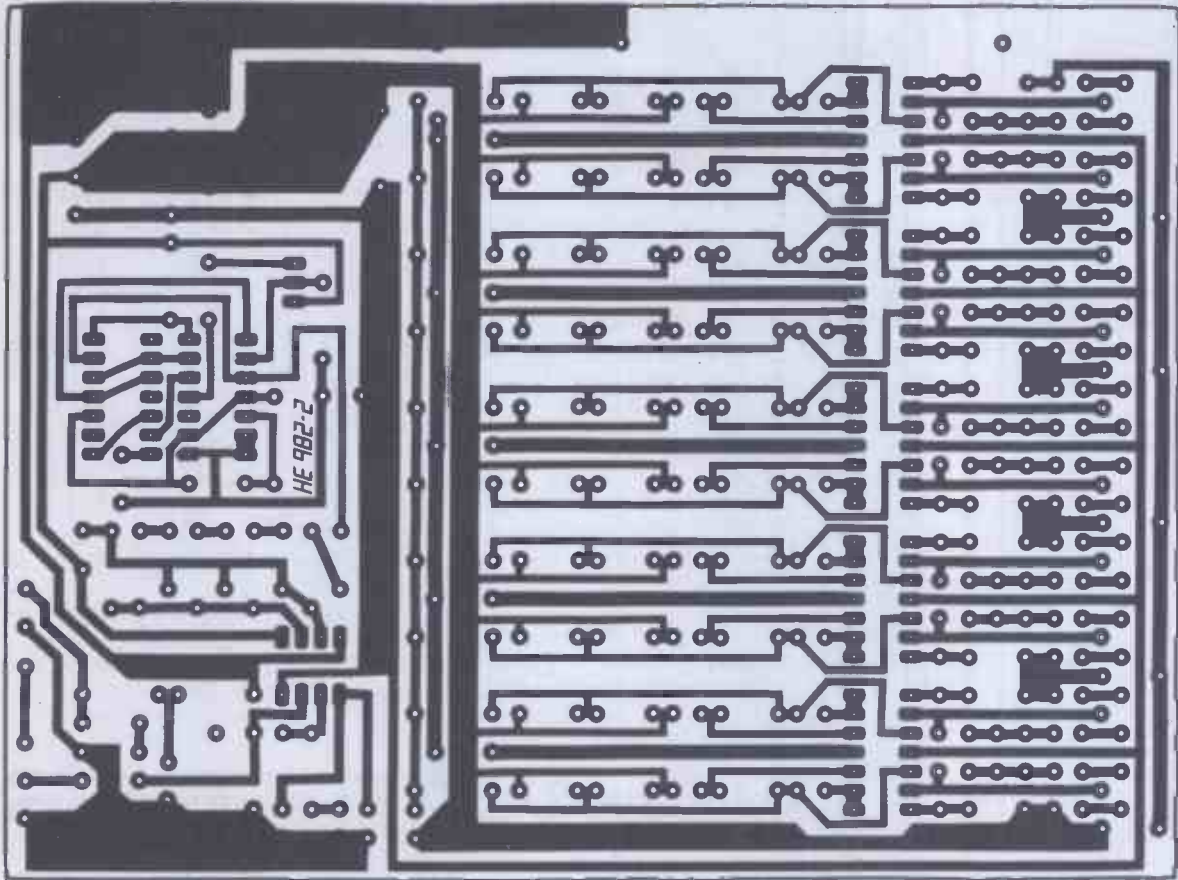

The two PCB foil patterns for the Audio Analyser. The display board (left) is fixed on top of the filter board (above).

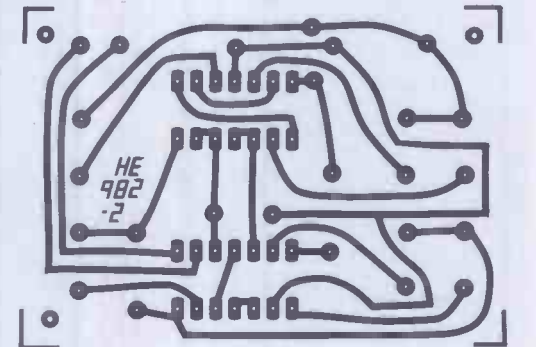
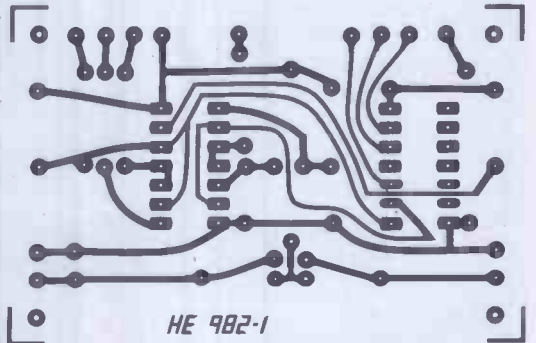
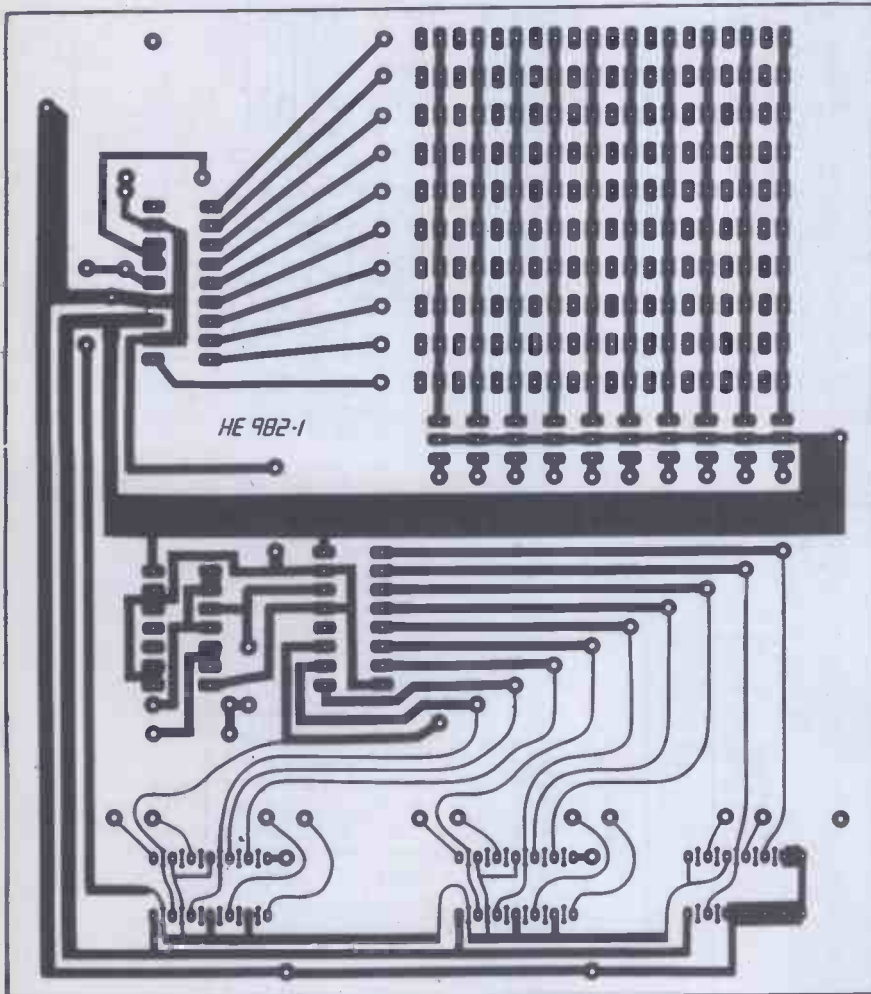

Above: The two foil patterns for the Signal Lights; uppermost is the signal module and below that the junction module board.

BARCLAYCARD
VISA

CLASSIFIED

THE PATH TO
SUCCESSFUL SALES!

01-437 1002
Ext 213

ADVERTISEMENT RATES

Semi-Display (min 2 cms)

1-3 insertions **£6.00** per cm

4-11 insertions **£5.50** per cm

12+ insertions **£5.00** per cm

Lineage 21p per word (min 15 words)

Box Nos. **£2.00**

Closing date 2nd Friday of the month preceding publication date.

All advertisements in this section must be prepaid. Advertisements are accepted subject to the terms and conditions printed on the advertisement rate card (available on request)

Send your requirements and cheque. P.O. to:

HOBBY ELECTRONICS CLASSIFIED
ADVERTISING, 145, CHARING CROSS RD,
LONDON WC2H 0EE.

THE SCIENTIFIC WIRE COMPANY

PO Box 30, London, E.4. 01-531 1568

ENAMELLED COPPER WIRE

SWG	1 lb	8 oz	4 oz	2 oz
8 to 34	3.30	1.90	1.00	0.50
35 to 39	3.52	2.10	1.15	0.85
40 to 43	4.87	2.65	2.05	1.46
44 to 47	8.37	5.32	3.19	2.50
48 to 49	15.96	9.58	6.38	3.69

SILVER PLATED COPPER WIRE

14 to 30	6.63	3.95	2.28	1.50
----------	------	------	------	------

TINNED COPPER WIRE

14 to 30	3.97	2.41	1.39	0.94
----------	------	------	------	------

10 x 10 mtr reels 3 amp PVC cable mixed colours 5.00.
Prices include P & P vat. Orders under £2 add 20p.
SAE for list of copper and resistance wire. Dealer enquiries welcome.

H.E. ORGAN KITS £99.50 inc. p&rp. 61 note keyboards £32.00. 13 note paddle boards £25.00 inc. p&rp. A.T. Hawkins, 23, Blenheim Road, St. Albans, Herts. AL1 4NS.

TECHNICS organ; double manual, bass pedals, 12 rhythms, voices upper and lower. Cost £976. 5 months old £650; includes headphones Bench music and cover. Tel. 0978-822141

KIA RETURN AN AD No 1: . . . FREE — Quality — Capacitor Pak!! . . . Post this ad + S.A.E. (12½p) NOW to 8 Cunliffe Rd, Ilkley, LS29. KIA — REPAIR — AMPS — FAST!

ZX81 with 16K RAM pack and number of cassettes, £80 ono. Almost complete Hebot, £40 ono. Video space invaders £40 ono. Peter Aziz, 38A Portland Road, Bishops Stortford, Herts. Tel. 0279 55683.

COPPER CLAD PCB 3p per square inch. Single sided 2p. Brand new 7 segment displays bargain 45p. PCB containing eight 7 segment display bulb after 2nd display to form DP £3.50. All displays tested. IC's on PCB 7p each. 100 resistors free on orders above £10.00 Worth £1.00. p&rp 30p. Free above £2.75. G. Dickinson, 4, Station Cottages, Kippax, Leeds.

PCB DESIGN SERVICE — for cost of artwork mail circuit diagram to 39A New Road, Clonfield, PO8 0NR.

TELETEXT (Oracle/Ceefax) add-on adaptors for your existing television. Only £149.95 inclusive. Also Prestel. Fantastic colour graphics for microcomputers. Avon Office Services (HE), FREEPOST, Bristol, BS10 6BR. (0272) 502008 anytime.

SOLAR CELLS 3" dia. 900mA at 0.45V £7.59. Price lists 75p. Edencombe Ltd., 34 Nathans Road, Wembley, Middx. HA0 3RX

SCOOP PURCHASE — TELEPHONES

Black G.P.O. type for extension use. As new only £4.75 each, Carriage £1.75. 2 for £12.00 Carriage paid.

HAVE YOU SEEN THE GREEN CAT?

1000s of new components, radio, electronic, audio at unbelievably low prices. Send 40p and receive list and FREE Record Speed Indicator. Try a JUMBO pack, transistors, caps, resistors, pots, switches, radio and electronic devices. Over £50 worth for £11 plus carriage £2.50.

MYERS ELECTRONICS, Dept HE1, 12/14 Harper Street, Leeds LS2 7EA. Tel: 452045. Callers Welcome.

WORKBENCHES, secondhand a Ex-ITT TV factory. Open or cubicle style. Need space. Details: 042 486 3464.

SECURITY SYSTEM KITS . . . All components and full instructions. Send large S.A.E. for latest catalogue of advanced projects for car, caravan and home. **COMPU-TECH SYSTEMS**, Worstead Lab's, N. Walsham NR28 9SA. Tel. (0692) 405600.

BURGLAR ALARM EQUIPMENT. Please visit our 2,000 sq. ft. showrooms or write or phone for your free catalogue. C.W.A.S. Ltd. 100 Rooley Avenue, Bradford BD6 1DB. Telephone 0274-308920.

KWIKMAIL ELECTRONICS Bargain Components. Send S.A.E. for list or £1 for sample. Super bag. I.C.'s, Capacitors, Resistors, and more. 135 Tany's Dell, Harlow, Essex.

AMAZING ELECTRONICS PLANS. Lasers, Super-powered Cutting Rifle, Pistol, Light Show, Ultrasonic Force Fields, Pocket Defence Weaponry, Giant Tesla, Satellite TV Pyrotechnics, 150 more projects. Catalogue £1 — From Plancentre, 46, Bye Street, Ledbury, HR8 2AA.

ELECTRONIC GAMES. Build your own microchip games from our detailed circuits. S.A.E. for details. GHT Ltd. PO Box DR95, Dover, Kent CT16 1UL.

LONDON SCHOOL OF ELECTRONICS Full time/part time courses in analogue and digital electronics and electronic design. City and Guild courses also available. Fees: Full-time £1300 pa. Part time £350 for 6 months. £500 for 9 months. Please apply to London School of Electronics, 67-83 Seven Sisters Road, London N7. Tel. 263-5937.

ELECTROLYTIC capacitor tester/reforming units, instructions, mains/test leads, £12, Phone (0743) 59492 after 6.30pm

PSU's 5V5A £25.99, 1-2V—27V 1-2A with voltmeter £24.99. (with toroidal transformers). Fully fused and protected. Top brand VHS video cassettes. E120 £7.65, E180 £8.10. Prices include p&rp. Mail order only. Edwards Electrics, 30 St. James Square, London SW1.

MANUFACTURERS surplus new components, I.C.s, transistors, diodes, capacitors, resistors, etc. 100 assorted £1.25 post free. U.H.A. Ltd., 62 Wellington Road South, Stockport, SK1 3SU.

STEREOPOWER 200 watt poweramps (100 + 100W protected) 4 x TO3 outputs — MJ3001 fibreglass, case + controls + D.I.N. sockets. Boxed £11.95. A. Law, 8 Cunliffe Rd (Over Incatile) Ilkley LS29 9D2

POCKET COMPUTERS FROM THE SPECIALISTS
 SHARP PC-1500 PC-1211 CASIO FX-702P
 Hardware Software Books Consumables
 IN STOCK NOW CE-155 (8K RAM) £79.95
 Trade in your PC1211 for a PC1500
 Send for a free copy of "THE ELKAN FILE". Full of "Top Secret" information. See us on Prestal - page 258 2022
ELKAN ELECTRONICS
 FREEPOST (no stamp required) 28 Bury New Road, Prestwich, Manchester M25 6LZ. Tel: 061 773 8714

SPECIAL OPENING OFFER, 1000 ITEM COMPONENT PACK! Sockets, Presets, Diodes, Pots, Knobs, Resistors, Capacitors—: Discs, Polyesters, Plates, Electrolytics, HV-Caps, Insulators, Hardware, Etc. **JUST £10 + £3.83 P&P/VAT. TOTAL £14.03.** Also 60 (approx) Electrolytics pack (good values) £1.20 + £1.04 P&P/VAT. TOTAL £2.24. 100 Mini Discs £1.50 + 80p P&P/VAT. TOTAL £2.30
 Ideal gifts for experimenters & hobbyists. Callers welcome, Lists 50p, free with orders. Letchworth Electronic Components, Spirella Building, Bridge Road, Letchworth, Herts., SG6 4ET. Tel. (04626) 70354.

CENTURION ALARMS

We manufacture, you save £££'s
 Send s.a.e. or phone for our Free list of professional D.I.Y. Burglar Alarm Equipment and accessories.
 Discount up to 20% off list prices, e.g. Control Equipment from £15.98, Decoy Bell Boxes from £5.95 inc.

TRADE ENQUIRIES WELCOME
 0484-21000
 or 0484 35527 (24 hr. ans.)
CENTURION ALARMS (HE)
 1265 Wakefield Road, Huddersfield HD5 9BE, W. Yorkshire
 Access & Visa Orders Welcomed

PARAPHYSICS JOURNAL (Russian translations); Psychotronic Generators, Kirliano-graphy, gravity lasers, telekinesis. Details: S.A.E. 4x9" Paralab, Downton, Wilts.

PRINTED CIRCUITS. Make your own simply, cheaply and quickly! Golden Fotolac light-sensitive lacquer - now greatly improved and very much faster. Aerosol cans with full instructions, £2.25. Developer 35p. Ferric Chloride 55p. Clear acetate sheet for master 14p. Copper-clad fibreglass board, approx. 1mm thick £1.75 sq. ft. Post/packing 75p. White House Electronics, Castle Drive, Praa Sands, Penzance, Cornwall.

FIND-A-FRIEND through FIND-A-FRIEND'S new confidential, inexpensive service. Your ideal friendship/relationship - all ages - countrywide. SAE/Telephone: FIND-A-FRIEND (HE), Temple House, 43-48 New Street, Birmingham B2 4LH. 021-429 6346.

BUILT TRANSMITTERS £2.90 88-110 MHz
 FM range 150 yds. Refund guarantee (unlicensable). P. Faherty, 37, College Dr., Ruislip.

ELECTRONICS component shop in MAIDSTONE, KENTI Thyronics Control Systems, 8 Sandling Road, Maidstone, Kent. Maidstone 675354.

DIGITAL WATCH REPLACEMENT parts. Batteries, displays, backlights etc. Also reports, publications, charts. S.A.E. for full list. Profords, Copnersdrive, Holmergreen, Bucks HP15 6SGE.

AERIAL AMPLIFIERS Improve weak television reception. Price £6.70. S.A.E. for leaflets. Electronic Mailorder, Ramsbottom, Lancashire BL0 9AGH.

AD INDEX

Aitken Bros.....	48
Ambit.....	IFC
Armon Electronics	48
Bic Vero	56
Bi-pak.....	4
B K Electronics	BC
BNRS	46
Bradley Marshall	8
Brian J Reed	38
Cambridge Learning.....	61
Cricklewood.....	61
E.D.A. Sparkrite	OBC
Electronize Design	55
Expo	55
Global Specialties Corporation.....	19
Greenweld	56
Heath Electronics.....	4
ICS	8
ILP.....	29
J. Baker	38
Lightening.....	61
Magenta	5
Musicraft.....	61
Rapid Electronics	24
RTVC	32
Sandwell Plant.....	38
Sinclair Research	13
Technomatic	30
T K Electronics	38
Velleman (UK)	46
Watford Electronics	36
Wilmslow Audio	8

USE HOBBY ELECTRONICS CLASSIFIED

(21p per word, minimum 15 words. Box Nos. £2.00 extra or £6.00 per single column centimetre - all prepaid).

Just write the details on the form below and send it with your cheque, made payable to A.S.P. Ltd, to Hobby Electronics Classified, 145 Charing Cross Road, London WC2 0EE

1.	2.	3.	4.	5.
6.	7.	8.	9.	10.
11.	12.	13.	14.	15.

Please place my ad in the next available issue of Hobby Electronics:

Name

Address

Tel. No.

I enclose my cheque/P.O. for the value of £



MULLARD SPEAKER KIT

A PURPOSELY DESIGNED 40 WATT R.M.S. 8 OHM SPEAKER SYSTEM RECENTLY DEVELOPED BY MULLARD'S SPECIALIST TEAM IN BELGIUM. Kit comprises a Mullard® Woofer with foam surround and aluminium voice coil, Mullard 3" high power dome tweeter, B.K.E. built and tested crossover, based on Mullard circuit combining low loss components, glass fibre board and recessed loudspeaker terminals. Recommended cabinet size 240 x 216 x 445 mm. A superb sound at a relatively low cost. Complete with instructions. Price £14.90 + £1.50 p&p per kit.

New 5" 30 watt mini version of above now available. Recommended cabinet size 180 x 155 x 295 mm. Price £13.90 + £1.00 p&p per kit.

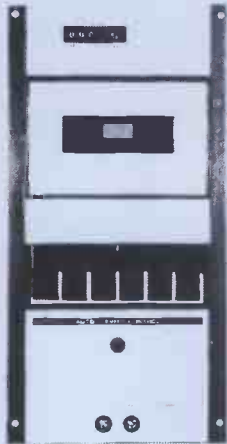

STEREO CASSETTE TAPE DECK MODULE. Comprising of a top panel and tape mechanism coupled to a record/play back printed board assembly. Supplied as one complete unit for horizontal installation into cabinet or console of own choice. These units are brand new, ready built and tested.

Features: Three digit tape counter, Auto-stop. Six piano type keys, record, rewind, fast forward, play, stop and eject. Automatic record level control. Main inputs plus secondary inputs for stereo microphones. Input Sensitivity: 100mV to 2V Input Impedance: 68K. Output level: 400mV to both left and right hand channels. Output Impedance: 10K. Signal to noise ratio: 45dB. Wow and flutter: 0.1%. Power Supply requirements: 18V DC at 300mA. Connections: All terminated with phono plugs (phono sockets provided). Dimensions: Top panel 5 1/2" x 11 1/4". Clearance required under top panel 2 1/2". Supplied complete with circuit diagram and connecting diagram. Attractive black and silver finish. Price £26.70 + £2.50 postage and packing. Supplementary parts for 18V D.C. power supply (transformer, bridge rectifier and smoothing capacitor) £3.50.

6 piano type keys

NEW RANGE QUALITY POWER LOUD-SPEAKERS (15", 12" and 8"). These loudspeakers are ideal for both hi-fi and disco applications. Both the 12" and 15" units have heavy duty die-cast chassis and aluminium centre domes. All three units have white speaker cones and are fitted with attractive cast aluminium (ground finish) fixing escutcheons. Specification and Price: -

15" 100 watt R.M.S. Impedance 8ohm 59 oz. magnet, 2" aluminium voice coil. Resonant Frequency 20Hz. Frequency Response to 2.5KHz. Sensitivity 97dB. Price £32 each. £2.50 Packing and Carriage each.

12" 100 watt R.M.S. Impedance 8 ohm, 50 oz. magnet, 2" aluminium voice coil. Resonant Frequency 25Hz. Frequency Response to 4KHz. Sensitivity 95dB. Price £23.70 each. £2.50 Packing and Carriage each.

8" 50 watt R.M.S. Impedance 8 ohms, 20 oz. 1 1/2" aluminium voice coil. Resonant Frequency 40Hz. Frequency Response to 6KHz. Sensitivity 92dB. Also available with black cone fitted with black metal protective grill. Price: White cone £8.90 each, Black cone/grill £9.50 each. P & P £1.25 each.

PIEZO ELECTRIC TWEETERS - MOTOROLA

Join the Piezo revolution. The low dynamic mass (no voice coil) of a Piezo tweeter produces an improved transient response with a lower distortion level than ordinary dynamic tweeters. As a crossover is not required these units can be added to existing speaker systems of up to 100 watts (more if 2 put in series). **FREE EXPLANATORY LEAFLETS SUPPLIED WITH EACH TWEETER.**

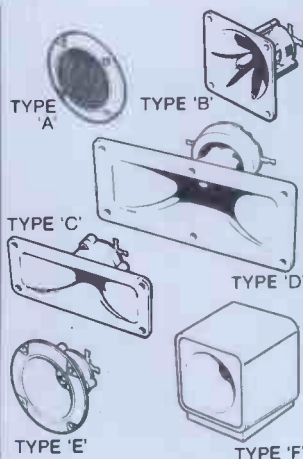

TYPE 'A' (KSN2036A) 3" round with protective wire mesh, ideal for bookshelf and medium sized Hi-fi speakers. Price £3.45 each.

TYPE 'B' (KSN1005A) 3 1/2" super horn. For general purpose speakers, disco and P.A. systems etc. Price £4.35 each.

TYPE 'C' (KSN6016A) 2" x 5" wide dispersion horn. For quality Hi-fi systems and quality discos etc. Price £5.45 each.

TYPE 'D' (KSN1025A) 2" x 6" wide dispersion horn. Upper frequency response retained extending down to mid range (2KHz). Suitable for high quality Hi-fi systems and quality discos. Price £6.90 each.

TYPE 'E' (KSN1038A) 3 1/2" horn tweeter with attractive silver finish trim. Suitable for Hi-fi monitor systems etc. Price £4.35 each.

TYPE 'F' (KSN1057A) Cased version of type 'E'. Free standing satellite tweeter. Perfect add on tweeter for conventional loudspeaker systems. Price £10.75 each. U.K. post free for SAE for Piezo leaflets).



1000 MONO DISCO MIXER

A superb fully built and tested mixer/pre-amp with integral power supply. 4 inputs 2 turntables (ceramic cartridge). Aux. for tape deck etc., plus Mic. with override switch, all with individual level controls. Two sets of active tone controls (bass and treble) for Mic. and main inputs. Master volume control. Monitor output with select switch and volume control. Outputs Main 750 mV Monitor 500 mV into 8 ohms. Supply 220/240V AC50/60Hz Size 22 1/2" x 4 1/2" x 2 1/2" price £39.99 + £2.50 P&P

1K.WATT SLIDE DIMMER



- Controls loads up to 1KW
- Compact size 4 1/4" x 13" x 2 1/2" 16
- Easy snap in fixing through panel/cabinet cut out
- Insulated plastic case
- Full wave control using Bamp triac
- Conforms to BS800
- Suitable for both resistance and inductive loads

Innumerable applications in industry, the home, and discos/theatres etc.

Price: £11.70 each + 50p P&P (Any quantity)

BSR P256 TURNTABLE

P256 turntable chassis • S shaped tone arm • Belt driven • Aluminium platter • Precision calibrated counter balance • Anti-skate (bias device) • Damped cueing lever • 240 volt AC operation (Hz) • Cut-out template supplied • Completely manual arm. This deck has a completely manual arm and is designed primarily for disco and studio use where all the advantages of a manual arm are required.

Price: £28.50 + £2.50 P&P



POWER AMPLIFIER MODULES



100 WATT R.M.S. AND 300 WATT R.M.S. MODULES

Power Amplifier Modules with integral toroidal transformer power supply, and heat sink. Supplied as one complete built and tested unit. Can be fitted in minutes. An LED Vu meter is available as an optional extra.

SPECIFICATION:
Max Output Power: 110 watts R.M.S. (OMP 100) 310 watts R.M.S. (OMP 300)
Loads: Open and short circuit proof. 4 16 ohms.
Frequency Response: 20Hz - 25KHz ±3dB.
Sensitivity for Max. Output: 500mV at 10K (OMP 100) 1V at 10K (OMP 300)
T.H.D.: Less than 0.1%
Supply: 240V 50Hz
Sizes: OMP 100 350 x 115 x 72mm
OMP 300 460 x 153 x 66mm
Prices: OMP 100 £29.99 each + £2.00 P&P
OMP 300 £89.00 each + £3.00 P&P
Vu Meter £6.50 each + 50p P&P

Matching 3-way loudspeakers and crossover

Build a quality 60watt RMS system 8ohms
Build a quality 60 watt R.M.S. system.

- ★ 10" Woofer 35Hz-4.5KHz
 - ★ 3" Tweeter 2.5KHz-19KHz
 - ★ 5" Mid Range 600Hz-8KHz
 - ★ 3-way crossover 6dB/oct 1.3 and 6KHz
- Recommended Cab-size 26" x 13" x 13"
Fitted with attractive cast aluminium fixing escutcheons and mesh protective grills which are removable enabling a unique choice of cabinet styling. Can be mounted directly on to baffle with or without conventional speaker fabrics. All three units have aluminium centre domes and rolled foam surround. Crossover combines spring-loaded loudspeaker terminals and recessed mounting panel.
Price £22.00 per kit + £2.50 postage and packing. Available separately, prices on request.

12" 80 watt R.M.S. loudspeaker.
A superb general purpose twin cone loudspeaker. 50 oz. magnet, 2" aluminium voice coil, Rolled surround. Resonant frequency 25Hz. Frequency response to 13KHz. Sensitivity 95dB. Impedance 8ohm. Attractive blue cone with aluminium centre dome.
Price £17.99 each + £2.50 P&P.

BK ELECTRONICS

Prompt Deliveries
VAT inclusive prices
Audio Equipment
Test Equipment
by
Thandar
and
Leader



GENERAL PURPOSE 4 1/2" MINI SPEAKER

General purpose full range loudspeaker, ideal for mini systems etc.

- Rolled fabric surround
- Twin cone
- 8ohm impedance
- 15 watt RMS
- 1" voice coil
- 13oz magnet
- Frequency range 50/15000Hz

Price: £6.90 each + 75p P&P



B.K. ELECTRONICS

37 Whitehouse Meadows, Eastwood, Leigh-on-Sea, Essex SS9 5TY

★ SAE for current lists. ★ Official orders welcome. ★ All prices include VAT. ★ Mail order only. ★ All items packed (where applicable) in special energy absorbing PU foam. Callers welcome by prior appointment, please phone 0702-527572.



Step-by-step fully illustrated assembly and fitting instructions are included together with circuit descriptions. Highest quality components are used throughout.

Sparkrite

BRANDLEADING ELECTRONICS

NOW AVAILABLE IN KIT FORM

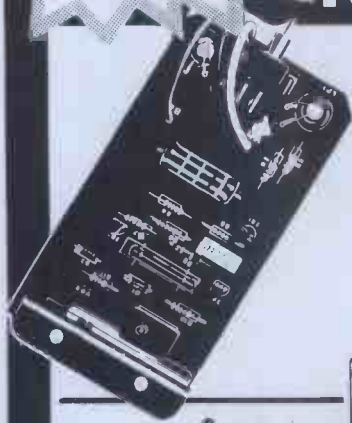

SX1000 Electronic Ignition

- Inductive Discharge
- Extended coil energy storage circuit
- Contact breaker driven
- Three position changeover switch
- Over 65 components to assemble
- Patented clip-to-coil fitting
- Fits all 12v neg. earth vehicles

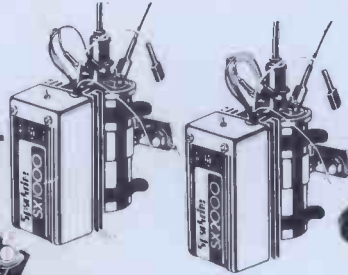

SX2000 Electronic Ignition

- The brandleading system on the market today
- Unique Reactive Discharge
- Combined Inductive and Capacitive Discharge
- Contact breaker driven
- Three position changeover switch
- Over 130 components to assemble
- Patented clip-to-coil fitting
- Fits all 12v neg. earth vehicles

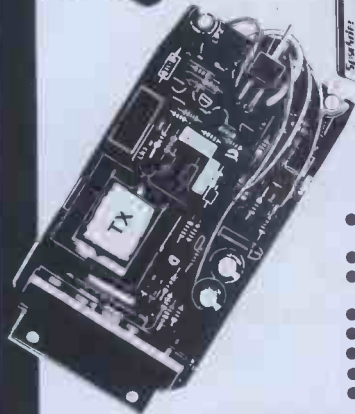

TX2002 Electronic Ignition

- The ultimate system ● Switchable contactless. ● Three position switch with Auxiliary back-up inductive circuit.
- Reactive Discharge. Combined capacitive and inductive. ● Extended coil energy storage circuit. ● Magnetic contactless distributor triggerhead. ● Distributor triggerhead adaptors included.
- Can also be triggered by existing contact breakers.
- Die cast waterproof case with clip-to-coil fitting ● Fits majority of 4 and 6 cylinder 12v neg. earth vehicles.
- Over 150 components to assemble

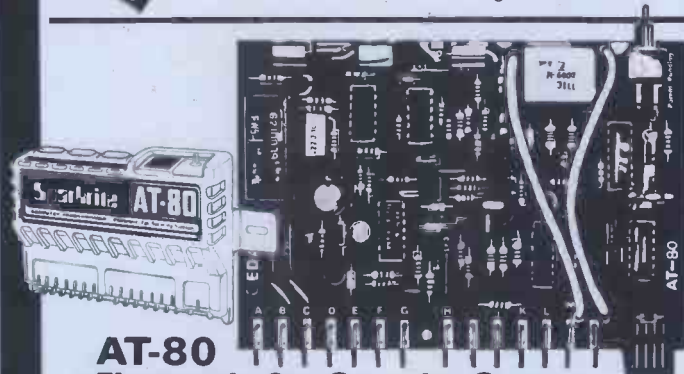

AT-80 Electronic Car Security System

- Arms doors, boot, bonnet and has security loop to protect fog/spot lamps, radio/tape, CB equipment
- Programmable personal code entry system
- Armed and disarmed from outside vehicle using a special magnetic key fob against a windscreen sensor pad adhered to the inside of the screen ● Fits all 12V neg earth vehicles
- Over 250 components to assemble

VOYAGER Car Drive Computer

- A most sophisticated accessory. ● Utilises a single chip mask programmed microprocessor incorporating a unique programme designed by EDA Sparkrite Ltd. ● Affords 12 functions centred on Fuel, Speed, Distance and Time. ● Visual and Audible alarms warning of Excess Speed, Frost/Ice, Lights-left-on. ● Facility to operate LOG and TRIP functions independently or synchronously.
- Large 10mm high 400ft-L fluorescent display with auto intensity. ● Unique speed and fuel transducers giving a programmed accuracy of + or -1%. ● Large LOG & TRIP memories. 2,000 miles. 180 gallons. 100 hours. ● Full Imperial and Metric calibrations. ● Over 300 components to assemble. A real challenge for the electronics enthusiast!

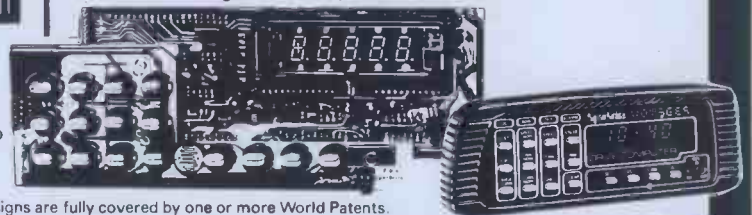

All EDA-SPARKRITE products and designs are fully covered by one or more World Patents.

EDA SPARKRITE LIMITED 82 Bath Street, Walsall, West Midlands, WS1 3DE England. Tel: (0922) 614791

	SELF ASSEMBLY KIT	READY BUILT UNITS
SX 1000	£12.95	£25.90
SX 2000	£19.95	£39.90
TX 2002	£29.95	£59.90
AT. 80	£29.95	£59.90
VOYAGER	£59.95	£119.90
MAGIDICE	£9.95	£19.90

PRICES INC. VAT. POSTAGE & PACKING

NAME _____ HE882
ADDRESS _____

I ENCLOSE CHEQUE(S)/POSTAL ORDERS FOR

£ _____ KIT REF. _____

CHEQUE NO. _____
24 hr. Answerphone
PHONE YOUR ORDER WITH ACCESS/BARCLAYCARD
SEND ONLY SAE IF BROCHURE IS REQUIRED
Allow 28 days for delivery

BRANDLEADING BRITISH ELECTRONICS

CUT OUT THE COUPON NOW!