

17th JANUARY 1962

VOL. 133

NUMBER 3449

THE ORIGINAL
'DO-IT-YOURSELF'
MAGAZINE

HOBBIES *weekly*

FOR ALL
HOME CRAFTSMEN

MUSICAL INSTRUMENTS YOU CAN MAKE

Also in this issue :

BONUS PLAN —
COFFEE TABLE

COLLECTORS' CLUB
— LATEST ISSUES

ANGLING WITH
PLASTIC BAITS

TRANSISTORS FOR
SPEAKER STAGES

DISC BREAK —
THE SHADOWS

FULL-SIZE
FRET PATTERNS

ETC. ETC.



Up-to-the-minute ideas

Practical designs

Pleasant and profitable things to make

World Radio History

5^D



NELSON'S Dockyard, situated in English Harbour on the southern coast of the island of Antigua in the West Indies, has been popularly so named from the fact that it was once the headquarters of one of England's greatest sailors, Lord Nelson.

English Harbour was first occupied by the Royal Navy in 1725; and from that date until 1899, when it was abandoned by the Navy, it has been used by many

of the famous British Admirals of the time either as their headquarters or for the purpose of refitting their ships. The dockyard and surroundings lands were taken over by Government of Antigua in 1906.

Following the departure of the Royal Navy, the buildings, suffering from neglect and the ravages of nature, steadily deteriorated and were almost a mass of ruins when in 1951 the Society of the Friends of English Harbour was formed. The Society had as its objects the raising of funds for the restoration and preservation of the Dockyard both as an historic monument and as a centre for ocean-going yachts.

By the judicious expenditure of funds raised, Nelson's Dockyard lives again. Visitors from all over the world enjoy its peace and splendour. To commemorate the restoration special stamps were issued last November.

* * *



Russian issues commemorating the 22nd Congress of the Communist Party



The Sierra Leone set issued in commemoration of the recent Royal visit includes four values. Design details:

3d. red, black and white — 'The Royal Charter granted to the Sierra Leone Company in 1799'.

4d. violet, black and white — 'King's Yard Gate'.

6d. orange, black and white — 'View of the old House of Representatives'.

1s. 3d. blue, black and white (illustrated) — 'Royal Yacht Britannia'. All values depict the Queen.



The 3d. and 6d. values of the Gambian set commemorating the same event show an outlined map indicating the position of Gambia in relation to the rest of West Africa. The 2d. and 1s. 3d. values show a single palm leaf, surmounted in the top right-hand corner by the St. Edward's crown.

Next week's articles will feature many more of the latest stamp issues.

Advertisers' Announcements

CEYLON

Current set 2 cts. to 50 cts. 12 values 2/- set. Current Pair Rs. 5/- and Rs. 10/- (Cat 14/-) 5/- pr. Post free in each case.

May we send you our world-wide discount approvals? (3d. postage please).

THE PRIORY STAMP COMPANY
(Dept. H/1), 86 Pauntley Road, Mundeford, Christchurch, Hants.

SPECIAL NEW YEAR OFFER: British (Castle Set) 2/6, 5/-, 10/- and £1 values. Send only 1/- P.O. and request to see our Selected Approval Books, post free. — White Stamps, Dept. 25, Eastleigh, Hampshire.

50 STAMPS FREE to applicants for fine stamps on approval. Discounts and Post Paid. — McKendrick (H), 9 Nethercourt Farm Road, Ramsgate, Kent.

100 DIFFERENT stamps free! Request ½d. upwards discount approvals. — Bush, 53 Newlyn Way, Parkstone, Dorset.

-MODERN COMPLETE USED SETS-
BULGARIA '61 UNIV-SPORTS (6) 2/6
CHINA '55 SCIENTISTS (4) 9
CZECHO. '55 WILD LIFE (5) 1/9
'58 MUSHROOMS (5) 1/3 '58 AUTOS (6) 1/9
HUNGARY '55 TRANSPORT (7) 2/3
'61 ZOO (10) 5/6 '61 HORSES (7) 4/9
LIBERIA '58 AIRMAILS (10) 4/-
MONGOLIA '61 BIRDS (7) 4/9
C.V.O. · LISTS FREE · POSTAGE 3d. EXTRA
G. DOWE, 21 DUKES RD, BRAINTREE, ESSEX.

STAMP ENCYCLOPEDIA + 100 PICTORIALS FREE! Request ½d. upwards Approvals. — A. Bateman, 1099 York Road, Searcroft, Leeds 14 (Postage 6d.).

Each week provision will be made on these pages for advertisers' offers. Classified rate 6d. per word prepaid. Display rates on application.



Stamp Collector's Corner

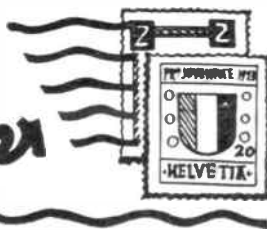

If you were asked how many different countries or colonies had issued triangular stamps, what would you reply? You would no doubt recall that The Cape of Good Hope has, because I expect when people heard that you collected stamps they asked you 'Have you any triangular Capes?'

Most people know that the triangular stamps came from the Cape and that they are very valuable, but not quite so many realise the reason why the stamps were made in this shape. The idea was that a stamp should be produced which was obviously different from those in use by other countries at that time (1853). It was realised that the native postmen would not be able to read so they had to be able to recognise that the stamp had been bought in Cape Colony. The stamp

at that time was only intended for use for inland postage, but was later used for all posts.

It was designed by Charles Bell, the surveyor-general and engraved by William Humphreys. It is only the penny and fourpenny stamps of 1861 which became very valuable because they were printed in the wrong colours. Most of the Cape triangular stamps are certainly worth having but the two mentioned fetch from £600 to £1,750. At least they are catalogued at that, but the price they would fetch would depend so much on their condition that one cannot give a definite figure.

By the way, all Cape triangulars were demonetized from 1st October 1900. This means that although the last issue of triangular stamps was in 1864 (after that all stamps issued were the more usual rectangular), the triangular could

be used for defraying the cost of posting a letter until 1st October 1900. After that, if anyone used such a stamp on a letter the recipient would have to pay just as though no stamp had been used.

After the Cape stamps would you remember that the Union of South Africa issued a triangular stamp, 4d. value, in 1926? Unlike the other South African stamps these are printed in English for the whole sheet. Then another sheet would all be in Afrikaans, so that it is not possible to obtain two stamps together, one in English and the other in Afrikaans, as you can with other

TRIANGULARS

By L. P. V. Veale

issues of the time. This stamp only survived for one year, being replaced by the stamp bearing the picture of the Kaffir Kraal.

In 1943 the Health stamps of New Zealand (the 1d. plus 1d.) bore the portrait of Princess Margaret and the 2d. plus 1d. carried a portrait of H.M. Queen Elizabeth II as Princess.

Now where do we go? To Newfoundland, for in 1857 she issued her first set of stamps, only one value, the 3d., being a triangular. The design had the words 'St. Johns Newfoundland' on the two sides and 'Postage threepence' along the bottom, the centre being taken up with heraldic flowers of the United Kingdom on an engine turned background.

One of the Indian native states issued in 1935 a triangular stamp for government service. This was a 1 anna three pies value and the lettering has been made to fit into the design very well, the centre being a shield supported by two fish.

These, then, are the chief colonial postage stamps made in the shape of a triangle, but there are quite a number of foreign countries using this shape. Many of these stamps can be purchased quite cheaply so that there is no reason why you should not have one at least in your collection. The two from New Zealand which we have already mentioned could be purchased for less than a shilling.

Of the foreign countries with triangulars Liberia is easily the top scorer. The first she had was in 1894 and is illustrated. Compare the wording in this with that on the Cape stamp. The '5 cents' seems to weigh down on the picture. The main fault seems to be that they have tried to get too much into the

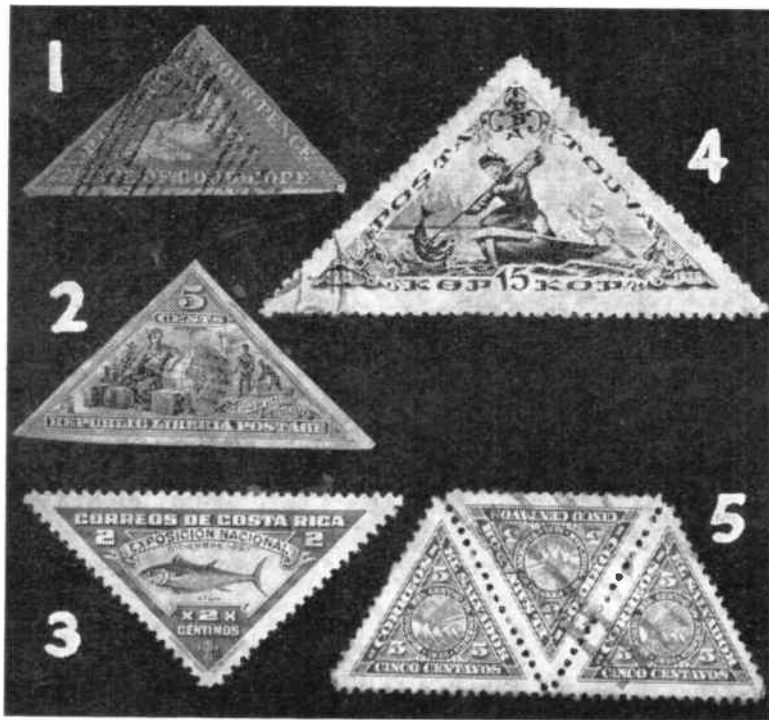

1. Cape triangular. 2. Liberia issue of 1894. 3. Costa Rica (tunny fish) 4. North Mongolia. 5. Three triangulars from Salvador.

● Continued on page 259

LOUDSPEAKER STAGES

WHEN a receiver or amplifier is built for use with a loudspeaker, there is a choice of two types of output stage. The simplest has a single transistor, which conducts over the whole range of the audio cycle, and this is referred to as a 'Class A' stage. Class A output stages are easy to build, do not require very many components, and give quite reasonable volume. They may, in fact, be designed to give an output of 2 watts or more, and in this form they are often used in car radio receivers employing transistors.

When a large output is required, the current demands of a Class A stage become heavy, and it is no longer economical to run the set from very small dry batteries.

In the second type of output stage, two transistors are used, so arranged that each one conducts during different halves of the audio cycle. This is termed 'Class B' or 'Push-Pull'. Push-pull output stages of this kind are economical to run, while giving good volume, and are often provided when loud results are necessary, with small dry batteries.

Class A output

The simplicity of the Class A, or single transistor output stage, makes it well worth while in many receivers. If an

An amplifier and output stage of this kind is shown in Fig. 19, component values being for an OC71 in the first position, and XC101 in the output. The XC101 has a white marking to show the Collector, the centre lead being the Base, and the remaining lead the Emitter.

in this circuit, but the XC101 is particularly suitable. Fig. 13 gave suitable values for an OC72 or similar transistor.

Base voltage

As previously described, the manner in which a transistor works depends largely on the base voltage. In Fig. 19, the base of the first transistor is connected to battery negative through the 47K resistor, and to battery positive through the 10K resistor. As a result, the base takes up a certain intermediate voltage, and the two resistors are chosen to assure that this voltage is correct. With the output stage, the 12K and 2.2K resistors provide the base voltage.

If the base voltage, with a particular transistor, is too much positive, amplification falls. If the base is too negative, the transistor may pass a heavy current and be damaged. Somewhere between these extremes lies the correct base voltage. With particular named transistors, such as the OC71, XC101, and others which have been given for particular circuits, it is possible to choose a pair of fixed resistors which will be satisfactory for any transistor of the appropriate type number.

Surplus transistors, especially those of

By 'Radio Mech'

The choice of loudspeaker, and method of coupling this item, have been

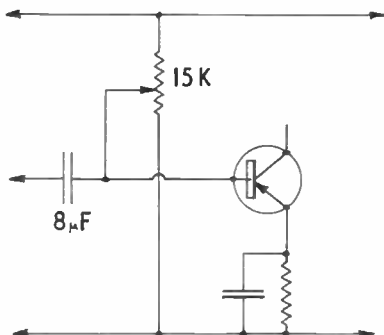

Fig. 20—Means of adjusting base voltage

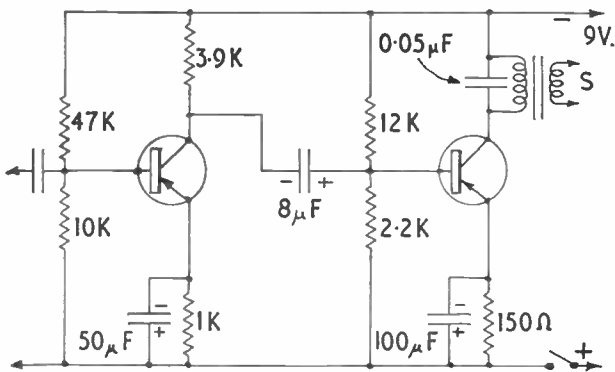

Fig. 19—Amplifier and output stage

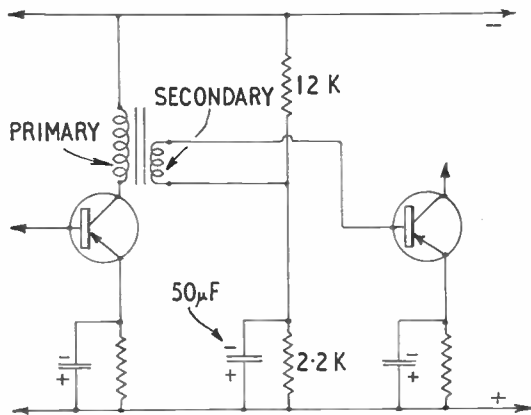

Fig. 21—Transformer coupling between stages

efficient loudspeaker is used, ample volume for all ordinary domestic listening purposes may be obtained.

The very large Class A output stages, as used in car radio sets, require so much current that an accumulator is almost essential. This type of circuit will be described later. Such output stages can, however, be designed so that they use much less current, and running from dry batteries is then in order.

A miniature speaker may be used, and can be used without a transformer, as in Fig. 16. A miniature speaker with transformer is also in order or a larger speaker, if size is not important. The first transistor coupling circuits so far described, or to a single transistor amplifier. Several suitable circuits for this purpose have appeared.

It is possible to use other transistors

very low cost, are often very variable in performance. Many are surplus rejected by various makers, because the characteristics are not quite correct. This arises from small irregularities in manufacture.

It can thus be seen that some surplus transistors may not give the best possible results, because they would work more satisfactorily with a different base voltage. This difficulty can be overcome by

feeding the base from a pre-set potentiometer, as in Fig. 20. This can be about 10K to 15K or so for a small output stage, and 25K or 50K for an earlier amplifier.

The potentiometer is first set so that the slider is fairly near the positive battery line. A normal signal should be available, and the loudspeaker should be connected in the usual way. The slider is then moved slowly towards the negative tag, until reproduction is at its best.

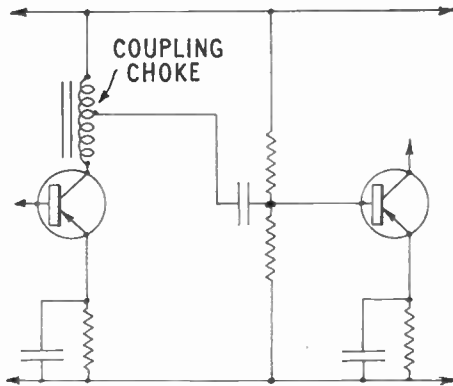

Fig. 22—An auto-transformer or tapped choke coupling

The slider must not be turned too near the negative tag, for the reasons already described.

When the potentiometer is correctly adjusted, this will allow any transistor to give the best results of which it is capable.

Transformer coupling

The amplification obtained from a pair of transistors can be increased by using a transistor coupling transformer, as shown in Fig. 21. This transformer has a fairly large number of turns on its primary, and fewer turns on its secondary. That is, it has a step-down ratio.

The first transistor can operate more satisfactorily, because the primary has a high impedance, yet does not waste battery voltage (as with a resistor). The small secondary is also better able to provide the current drive needed by the second transistor. As a result, the overall amplification is a good deal greater.

Miniature transformers of this type are available for pocket sets. The ratio depends to some extent on the transistors, but is frequently something around 5:1. One way of assuring proper results is to obtain two transistors, and a transformer, for use together. Another method is to refer to the best collector impedance load for the first transistor, and the best base impedance load for the second. The first figure is divided by the second, and the square root of the result is found.

This is the correct transformer ratio.

If Fig. 21 is compared with circuits using condenser coupling, it will be seen that a transformer can be added to most circuits. The resistors which originally fed the base are now connected to the transformer secondary.

A spare loudspeaker transformer with several primary tapplings, like that in Fig. 15, may be used for coupling, in a somewhat similar way. The secondary (intended for speaker connections) is

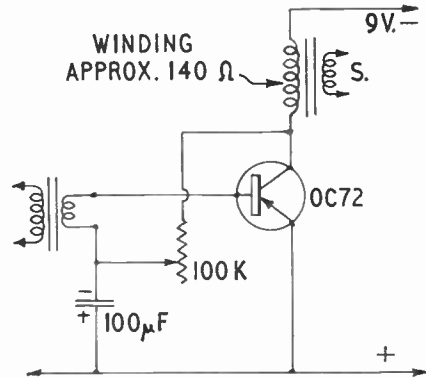

Fig. 23—Another type of output stage

not used. The full primary is connected from collector to battery negative, as in Fig. 22.

The lead from the coupling condenser is then tried on various tapplings. The actual result is similar to that obtained with a separate secondary, except that part of the primary acts as secondary. Such an arrangement is known as an 'auto-transformer' or tapped choke.

Transformer or auto-transformer couplings are very useful when the maximum possible amplification is required from very few transistors, and when space is available for the transformer. In many receivers, transformer coupling is used before the stage which drives the loudspeaker.

Push-pull output stages are often used, as mentioned, and these require a centre-tapped transformer. As a centre-tapped transformer can be used with a single output transistor as well, by ignoring one connection, this type of component can be obtained if there is any possibility that a push-pull output stage will be built later.

A 60mW stage

The maximum output of amplifiers used with a loudspeaker is often given in watts (W) or Milliwatts (mW). One Watt = 1,000mW. It is thus possible to compare the maximum output of one stage with that of another, if the outputs are given in watts or milliwatts.

A battery-operated valve receiver using a 3S4 or similar output valve, with a 67½V. H.T. battery, would be capable of a maximum output of about 0.18W or 180mW. This, which is given as a guide, would be the maximum power when the receiver is operating as loudly as possible, but not so loudly as to cause distortion from overloading.

The sensitivity of the ear is such that apparent loudness is not proportional to energy, but is nearly proportional to

the logarithm of the energy. That is, a sound which seems, for example, two or three times as loud as another sound is actually very many times more powerful.

In addition to this, the typical valve receiver mentioned would probably be set at much below maximum possible volume for normal listening. For this reason, and because of the ear sensitivity just described, transistor output stages giving only 25mW to 50mW or so can do very well, for normal loudspeaker listening indoors.

As previously mentioned, the efficiency of the loudspeaker has a great effect on the volume. For example, a 50mW signal operating a good-quality, efficient speaker may sound just as loud as a 200mW signal which is operating a very small or inefficient speaker.

A method of using an OC72 so as to obtain an output of about 60mW is shown in Fig. 23. This is a very simple arrangement, and would do very well for a receiver which is not of miniature type, and which can thus have a reasonably large loudspeaker.

The winding in the collector circuit should have a direct current resistance of 120 to 140 ohms, and the impedance load should be 140 ohms. A speaker of appropriate type may be connected directly, as explained for Fig. 16. With speakers of another impedance, the

● Continued on page 260

NOVELTY BAND INSTRUMENTS

By S. H. Longbottom

YOU may not be a musician but that is no reason why you should not start a novelty band, making your own instruments from a few odds and ends to be found about the home. No doubt your friends will be only too keen to assist.

In a band, one group of instruments plays the melody, usually the violins or trumpets in a symphony orchestra, while the percussion section usually deals with the rhythm. Other instruments supply harmony, colour and effects. We do not propose making anything so difficult as a violin but we can make bells, chimes and whistles to provide the tune along with drums to make the rhythm. And it is really surprising what can be done in this respect with commonplace objects.

In Fig. 1 you will see a small range of differently sized flower pots which give a bell-like note when tapped. Wash out some pots, ensuring that there are no

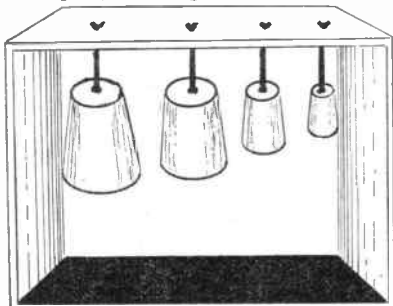

FIG 1

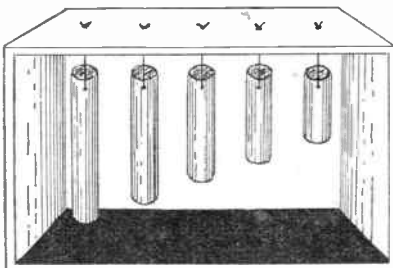

FIG 2

cracks, and test by striking with a pencil. You will require four or more pots of different sizes for this instrument and these are suspended from the top of a frame as shown. Alternatively, they can be suspended from a rod if you can provide a convenient holder. Tie the pots upside down with a large knot on the

inside of the hole with the other end tied by a knot on the outside of the frame.

If the drainage holes are very large you may use a soft washer on the inside. All you then need is a stick or a small wooden hammer for striking the pots. Larger pots give the lower notes while smaller ones give the higher ones.

A set of chimes

Chimes can be made from lengths of brass rod or tubing about $\frac{1}{2}$ in. in diameter. Tuning is similar to the flower pots. A set of these chimes can be made by cutting the rods as shown in Fig. 2. You will find it better to drill small holes through the tops of the rods for fitting the string which is ultimately tied through holes as shown. It is also an advantage to file a small groove at the tops of the rods to keep the string in position. A wooden rod will be suitable as a striker.

If you cannot obtain flower pots or brass tubing you may still make a set of chimes by using an assortment of nails, say from 6 in. downwards, tied to a thin cord which is attached through holes to a similar frame. The nails should hang freely like washing on a line. Remember you can always adjust the tuning of a note by cutting off a portion from the end, or you may cut down 6 in. nails to make a set. Use another nail as a striker.

The xylophone

Another interesting instrument to make is a one-octave marimba or xylophone as shown in Fig. 3. One octave is a full range of notes from low doh to high doh without the intermediate sharps or flats.

This is a more ambitious project of course but still not too difficult to make.

You will first require a frame as shown in Fig. 4. This should be made from $\frac{1}{2}$ in. square material prepared to the dimensions indicated with screwed or nailed joints.

For the bars you will need a 7 ft. length of pine or deal, which must be thoroughly dry. This should be cut as follows, the letters indicating the note: C 12 in.; D 11 $\frac{1}{2}$ in.; E 11 in.; F 10 $\frac{3}{4}$ in.; G 10 $\frac{1}{4}$ in.; A 9 $\frac{3}{4}$ in.; B 9 $\frac{1}{2}$ in.; C 9 in.

These lengths, although reasonably accurate, should be taken as a guide for the notes shown. It is advisable to first cut the 12 in. length for the lower C and compare with the note C on a piano

or a tuning fork. A little may be rasped off for finer tuning and the other notes are then made to correspond.

After cutting the bars lay them on the top of the table so that they taper correctly and are the same distance apart. Now place the frame centrally on top of the bars, drawing guide lines along the outside and inside of the frame. Remove the frame and lay a piece of cord or felt between the guide lines, tacking to each bar and leaving a surplus at each end for fixing to the frame.

Take the set of bars, now attached to the cords, i.e., one down each side, turn over and tack the ends of the cords to the frame. You may also find it advisable to add further tacks between bars. Note that the bars must rest on these strips of felt or cord if they are to produce a nice resonant note. A small

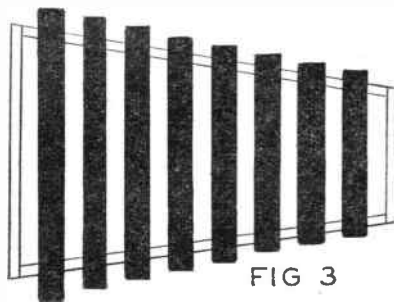

FIG 3

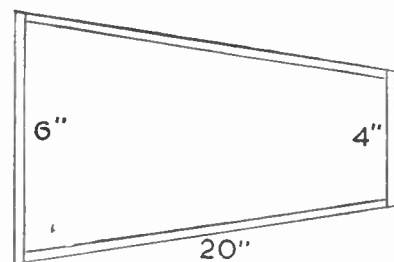

FIG 4

mallet will make an excellent striker for a clear note but if you prefer a softer note you may cover the end of the mallet with felt.

Some novel methods of making drums and a recorder will be described in further articles along with a popular tune for playing on the marimba or recorder.

...ab evenly on the paper in
...ht and hang to dry under
...to know if you could re-
...to go over the wallpaper
...wish to make some plan
...on the space
...mitter? (R.P. — Wolverhampton.)
...Channel 10 would

Replies to Readers

...reality
...safety is a brush polisher
...V. and 15V
...more.)
...ully,
...to charge a 12V. battery, as a
...was made by fixing
...board over a stool

Defective Windowsill

PLEASE advise me on repairing a badly worn windowsill. During heavy rainfall, rain seeps through and makes the wall very damp. I do not wish to remove the windowsill if it is avoidable. (S.F. — Liverpool).

ASSUMING your windowsill is of Astone or cement, to fulfill its function it should have a gentle slope away from the window and be flat — i.e. — no hollow where rain can collect. When worn it should be rendered with a $\frac{3}{4}$ in. thickness of cement concrete, equal parts of sand and cement. Roughen up the surface first to provide a key for the concrete, by gentle chipping with a cold chisel. Dampen with water, then trowel on the concrete. Level off lengthwise then slope outwards. Quite a gentle slope will suffice, and a straightened slip of wood will, if drawn over the surface, do the job satisfactorily. If the wall surrounding the window has suffered from damp, repoint the brickwork with some of the cement concrete.

* * *

Heating for Chemistry

WILL you inform me how I can use my bunsen burner? Unfortunately we are not connected to the gas supply. Do you suppose I should use a cask of liquid gas, or can I make gas by means of a chemical? (J.M. — Portadown).

THE only means of using your bunsen burner without a supply of mains gas is by using a Calor gas bottle. This however, would be expensive for the work to be undertaken. For experiments in which heat is required, you might use a spirit lamp.

* * *

Solid Fuel from Paper

IS there any way of turning old newspapers and magazines into a solid fuel that could be stored away? I was thinking of making papier mâché, then soaking it in creosote or something like that. (C.J. — Ilford).

WITHOUT a beating engine, the making of papier mâché is very unsatisfactory, shredding and tearing under water being essential for good results. A compromise would be to shred and tear as fine as possible by hand, and pulp with water in a bowl, using a

potato masher. Short 'logs' can then be made from this by ram-moulding in a short length of drainpipe. Stack the 'logs' to dry thoroughly. Creosote can be used, but care should be taken not to have the paper 'logs' excessively im-

All queries must be addressed to the Editor, 'Hobbies Weekly', Dereham Norfolk. Enclose stamp for reply and Readers' Reply Coupon.

pregnated. Otherwise they will blaze too fiercely. Standing them on end in a very shallow layer of creosote, so that capillary absorption may take place, is safer. A more expensive but safer way, and which also would bind the paper and prevent disintegration during handling or storage, is to soak the logs as above in a solution of resin in methylated spirit — ratio one ounce resin; 10 fluid ounces meths. In both cases allow to dry thoroughly before use.

Fire Torches

I HAVE been making fire torches for the youth club of which I am a member. We use the torches mainly for lighting purposes when the club has a barbeque or firework display. The method I used was to get lengths of wood, probably brush handles, cut up, then bind one end of each torch with quite a lot of rags, tying each rag on as it was wrapped round, then soaking them in paraffin. The trouble is, the torches don't burn long enough — as soon as the rag is burnt out, the torch goes out. Is there a method of using tar which will enable the torch to burn longer? (W.S. — Wirral).

TAR is indeed an easy solution to this torch problem, but it should first be thinned with kerosene (ordinary lamp paraffin) so as to permit penetration of the rags. A more efficient torch may be made by screwing a tin to the top of the torch handle and packing this with asbestos wool saturated with kerosene. The asbestos wool acts as a wick, and as the flame only burns at the top of the tin, too rapid consumption of the fuel is prevented. Since the asbestos wool constitutes an indestructible wick, it is only necessary to pour on more kerosene when the torch goes out. But be sure the container has adequately cooled before re-charging.



COFFEE TABLE

Here are instructions for making up the Coffee Table, detailed drawings for which are printed on the following centre pages. To preserve this plan for future reference it is suggested that the centre pages be extracted by lifting the wires which bind the magazine.

THE coffee table illustrated overleaf would make a colourful addition to any home. A polystyrene pad let into the centre of the table allows for the incorporation of a display of artificial flowers, the arrangement and variety of which can be changed from time to time.

The obvious advantage of this type of floral decoration is that there is no soil or water to spill over the sitting room floor, particularly when dusting and cleaning. The flowers are firmly pushed into the honeycomb-type pad which holds them securely.

The construction of the table is straightforward and the handyman should experience no difficulties in producing a first class article. The table top (A) can either be made from a Hobbies veneered panel or cut from plywood and covered with 'Waverite'. These materials are available from

Hobbies Ltd, Dereham, Norfolk, or at any branch.

Note that a centre opening 6 in. by 4 in. is cut from piece A. Piece D is cut and glued to the underside of A beneath this hole. The 'step' accommodates a pad of expanded polystyrene insulation board, a material now freely available from hardware and builders' merchants and in some large stores. This should not be glued in as a replacement pad will probably be needed after considerable use.

The legs C and ends of rails B are now halved together and glued and screwed from the insides of legs C. Once assembled these sections are glued to the underside of A in the position shown and crossrails are added where indicated for extra strength.

Whether your choice of finish is paint or polish, remember that the secret of a good finish is in the cleaning and preparation of all parts.

Hobbies **BONUS**
PLAN

COFFEE TABLE WITH A DIFFERENCE

HOBBIES VENEERED PANEL. OAK, WALNUT OR SAPELE. ALTERNATIVELY GLUE WARERITE TO 1/2 IN. PLYWOOD.

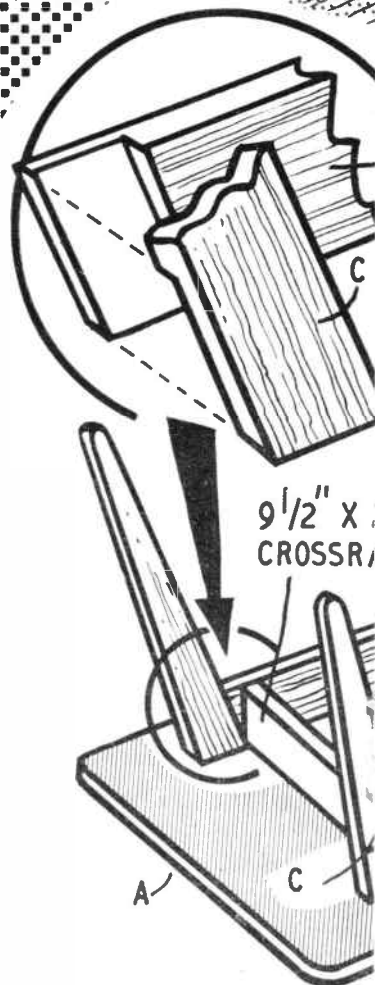
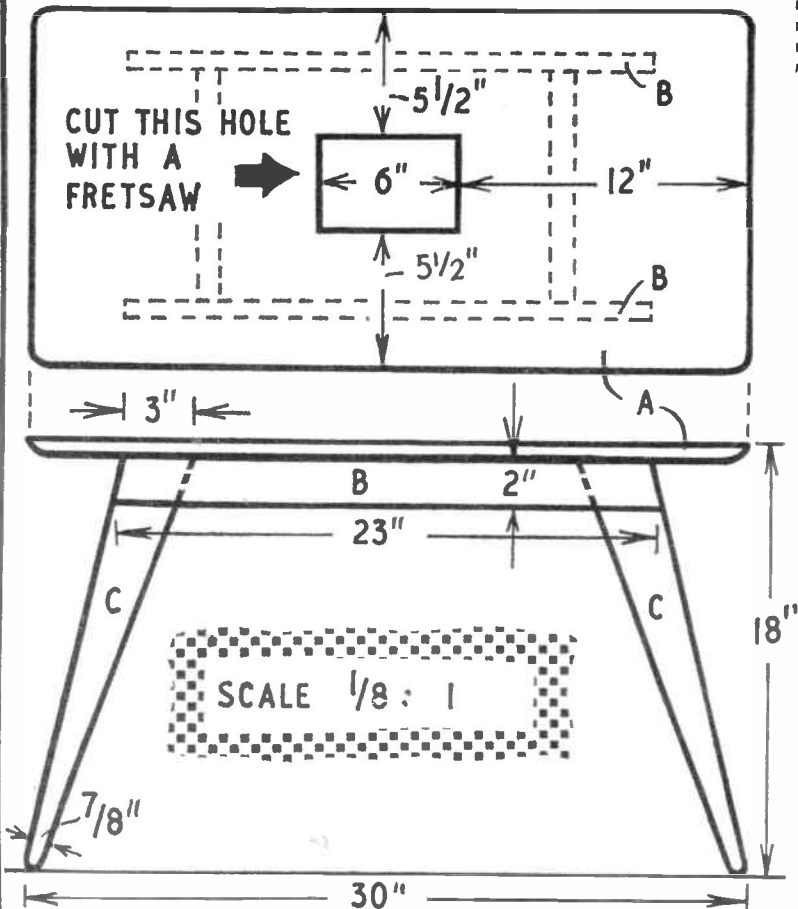

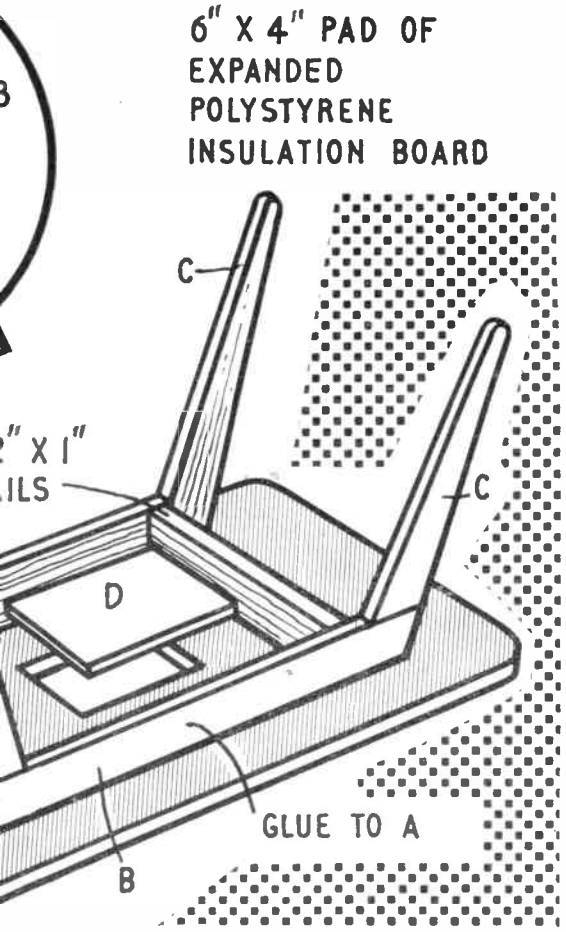
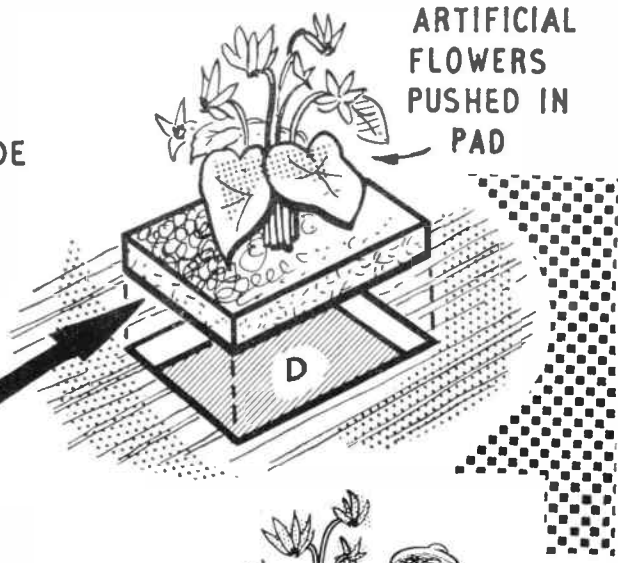
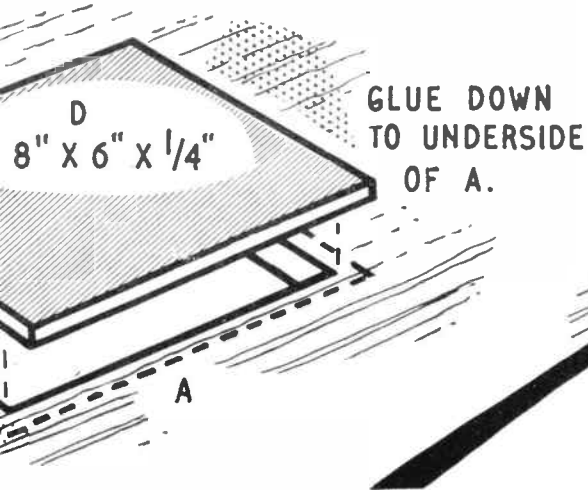

Use **CASCAMITE**
‘One Shot’
Resin Glue
for all Wood Gluing



Obtainable in:
3½-oz., 7-oz.,
and 18-oz. tins,
Stocked by: Ironmongers, Builders' Merchants, etc.

Manufactured by:
LEICESTER, LOVELL & CO. LTD. North Baddesley, Southampton

DISC BREAK

THE SHADOWS

IN April 1958 two young Geordies arrived in London with suitcases, gramophone, guitars, .£6. 10s. and very little else — apart from a burning desire to make a name for themselves in show-business.

The obvious starting place, decided Bruce Welch and Hank B. Marvin, was the famous 'Two 1's' coffee bar in Soho, the breeding ground for so many young singers.

The boys from Newcastle found that skiffle in a coffee bar did not provide a short cut to success. 'Often', adds Bruce, 'we felt like packing up and going home.' While they were playing at the 'Two 1's,' Bruce and Hank recorded for Columbia with 'The Five Chesternuts', a group led by Peter Chester, son of comedian Charlie Chester. Titles were *Teenage Love* and *Jean Dorothy* (now deleted).

They also met up with Jet Harris, who is now leader of 'The Shadows'. He had been touring with Tony Crombie's 'Rockets' but sat in occasionally with Bruce and Hank. As they were playing one night, Tony Meehan, not long left school, walked into the room and joined in on drums.

This was the first meeting, during the

late summer of 1958, of the four boys who were later to become famous as 'The Shadows', the supporting group to Britain's top teenage star, Cliff Richard, as successful recording artists in their own right, and as a top-of-the-bill theatrical act. Originally they were known as 'The Drifters'. But when their recording of *Feelin' Fine* and *Don't be a Fool With Love* (Columbia 45-DB4263) was released in the States there was a

The teenage twins who made a hit with 'One Little Robin' will be featured next week.

clash of names with an American group. So 'The Drifters' became 'The Shadows,' a name picked by Jet.

As 'The Shadows' they have lived up to their name, accompanying Cliff Richard wherever he goes and on his many hit records. They have appeared with him in the film *Expresso Bongo*, at the Royal Command Performances in Manchester in 1959 and London in 1960, and during a six-month season at the London Palladium.

The last six months of 1960 put 'The Shadows' on top of the world. Their recording of *Apache* and *Quatermass's Stores* (45-DB4484), released in July, saw them emerge as disc stars in their own right. *Apache* reached No. 1 position in the British Top Ten and won for them a Silver Disc for sales exceeding 250,000. Readers of the 'New Musical Express' chose it as Best British Disc of the year in the annual poll. Their next recording, *Man of Mystery* and *The Stranger* (45-DB4530) also quickly made its mark in the Hit Parade.

'The Shadows' have also had outstanding success as composers of some of Cliff's hit records. Bruce had a hand in *Please Don't Tease*, Bruce and Hank wrote *Thinking Of Our Love, I Love You*, and *You and I*, while Hank and Jet penned *Gee Whiz, It's You and She's Gone*.

Leader of the group, JET HARRIS, was born on 6th July 1939 in Kingsbury, London. He was christened Terry but his prowess as a sprinter at school — at 15 he set up a record for the 100 yards by clocking 10.8 secs. — earned him the nickname 'Jet'. He is a great-great-nephew of the famous music hall entertainer Vesta Tilley.

His interest in music began with a clarinet and he played double bass before changing to bass guitar. Jet played with 'The Vipers', Tony Crombie and 'The Most Brothers' before joining 'The Shadows'.

BRUCE WELCH, rhythm guitar, was born at Bognor Regis on 2nd November 1941. While at school in Newcastle he and Hank played in a skiffle group called 'The Railroaders'.

HANK B. (for Brian) MARVIN, lead guitar, was born in Newcastle on 28th October 1941. He was nicknamed 'Hank' to avoid confusion with two of his friends who were also called Brian. At 15 he bought a banjo from a schoolmaster and changed to guitar when his father gave him a 16 gn. model for a birthday present in 1957.



● Continued on page 259

CAMPING Notes

by Ed Capper

I CAN just hear all of you saying: 'This is a fine time to write an article on camping. It's the middle of winter; all our gear is stowed away...'

That, my friends, is just the point. Have you stowed away your equipment correctly? Was your tent thoroughly dry before you folded it neatly away? If not, you can expect mould. Perhaps it would be just as well if you had a quick inspection — now!

What is mould? Tents and other canvas equipment are made from vegetable fibre. Next to foodstuffs, vegetable fibre is the most perishable thing known.

We owe our knowledge of canvas mould and fungi to pioneer Elkanah Healey, who opened his first factory for waterproofing canvas at Warrington as far back as 1868. Healey discovered that it was the cellulose covering on the fibres that was eaten away by mould. After much experimenting he concocted a solution of copper into which he dipped his canvas goods. In short, he 'copper-plated' the fibres, making them resistant to water.

This copper plating accounts for the

characteristic green colour associated with waterproofed canvas. Nowadays with modern progress, dyes can be incorporated with the copper plating to allow us to purchase tents and equipment in many colours.

Mildew and stains

If mildew or mould has started to attack your gear it can be arrested by sponging off with warm water. On no account, add a detergent to the water. The action of detergents is to form an extra coating on the fabric threads which prevents the normal expansion and contraction of the thread. In short, it throttles the threads, preventing their normal 'breathing' action.

If you have a bad stain, such as grease, use warm water again and 'knead' the material to loosen the grime. A weak solution of 'Lux' can be used but try and remove the stain by kneading alone.

A bad attack of mould will need stern measures. Cut away the affected part, clean the surround and repair it with a kit called 'Patchkit', manufactured by Grangersol Ltd. The patch should be

cut 1 in. larger all round than the hole. The solution is applied and when tacky the patch should be applied and smoothed down firm. The repair should then be left for as long as possible, weighted down to keep it flat. If you place the patch on the inside of the tent it will not be so conspicuous.

I hope none of you have found mould on your gear. Remember, the wise camper waterproofs his equipment at the beginning of each winter before stowing it away. And don't stow away canvas gear in polythene bags. The inside of the bags will sweat, the moisture will collect on your gear and then you really will have mould.

The Roster Board

Every camping party has an easy-going chap who never complains. And what happens? This poor fellow finishes up doing all the chores. The rest of you clear your conscience by saying: 'Oh well, he likes doing all the odd jobs...'

But, is it quite fair? Why not make up a roster card, and fill it up at the beginning of your camp, so that everyone does their fair whack of the chores. A pukka job can easily be made from plywood, painted with blackboard paint and marked with chalk. And don't forget to work out a free day for each member of the party, if possible.

● Continued from page 251

TRIANGULAR STAMPS

space at their disposal. The more simple design looks much better.

Costa Rica, as the next illustration shows, had a triangular stamp with the design inverted. That was a 1937 issue. Lithuania in 1932 had various triangular designs. The 5c and 10c showed a map of the country but the wording is so small that without a glass it is difficult to read.

Tannu Tuva or North Mongolia issued some very large pictorial stamps bearing the English words 'Postage', 'Air Mail', 'Registered'. The postmark, a very nice, neat mark just on the edge of the stamp, is quite enough in itself to make anyone suspicious. Further, it is not very likely that a small country, small that is in size of population likely to write letters, would want issues of stamps in 1926, again in 1927, 1932, 1933, and separate types for airmail and registration in 1934. The stamp is shown here rather as a warning than anything else. It may be cheap, but is not very likely to become of any value. The Mozambique Company, which was

responsible for the administration for a large part of Portuguese East Africa, also issued a number of triangular stamps, probably for the same reason as North Mongolia.

Spain, Salvador, Obock, Uruguay, Nicaragua, Ecuador, Netherlands, Roumania, Estonia, Austria, Bolivia, Dominica, Monaco and Russia are some of the other countries which have triangular stamps. We illustrate three of the examples of Salvador, just to show another different shape and also to indicate how they are joined in a sheet.

Now probably you would like to possess a triangular stamp or two, purely for the pleasure of ownership. If you buy a slightly damaged Cape of Good Hope it should not cost many shillings, but remember that as it is damaged it will not increase in value. But it is worth having as a 'space filler'. You could get good specimens of either the South Africa or the New Zealand for a shilling or so and they will in time probably appreciate a bit in value.

● Continued from page 258

THE SHADOWS

TONY MEEHAN, drums, was born in Hampstead on 2nd March 1943. He was only ten years old when he became interested in playing drums. By the time he was 13, Tony had his first job with a band in a dance hall at Willesden, London. He also played timpanis with the London Youth Orchestra.

Unlike the others he was never short of work, playing cabaret at places like 'Churchills' and the 'Stork Club'. He also played with Jet in the Vipers group.

Tony is interested in arranging, which he studies, and besides drums also plays guitar and bass. His hobbies include psychology and psychiatry.

A project for the family man will be featured next week. It will consist of a special low chair for nursing baby — comfortable and with a handy drawer.

MAKE SURE OF YOUR COPY

WITH ROD & LINE

AMONGST the new things which crop up these days in the way of fishing tackle I think one of the most promising — and I say this after using them for some considerable time — are the 'Plastifol' range of baits and lures which cover both sea and freshwater fishing.

MODERN BAIT OF PLASTIC By 'Kingfisher'

Taking that most popular freshwater bait, the maggot, first of all, I've been using one for over a year and it's still as good as new after catching plenty of good fish. When these lures first appeared on the market I was convinced that they would be of no use in still water but I was pleasantly surprised when I caught fish in lakes with them.

No re-baiting

I'm not trying to say that they are better than the natural maggot but they are proving to be as good. There is also the fact that whereas you have to change your bait once a maggot has been bitten with the 'Plastifol' maggot it has no effect and you just carry on fishing after you've unhooked your fish.

The makers of these baits or lures have copied the real creature exactly and this applies both to looks and feel. They can be obtained both in the natural colour and in about four other colours. They are exceptionally good for dace fishing as it so often happens that this fish will take the natural maggot, suck it dry and let go before you hardly know that it has been on. You then have to reel in and put on another maggot. But with the 'Plastifol' all you have to do is reel in and cast again, thus saving no end of time. This is important when the dace are willing to feed.

Such baits are ideal for fishing on fly tackle as it is virtually impossible to throw them off the hook, when casting.

The next item which I found to be good was the 'Plastifol' tadpole. This is so

lifelike that you almost expect it to turn into a frog whilst looking at it. The same colour as the natural, it also has the exact shape so that the thin, flexible tail wiggles about as it goes through the water.

A belated delicacy

My second cast with one of these secured a perch of 2½lbs. These are a lure which every angler should carry. Thousands of tadpoles are eaten every year by many species of fish and in fact my perch fell to one when tadpoles had long since grown into frogs. Probably the perch thought it a rather belated delicacy and well worth taking! I fished it with a sink-and-draw motion, which is very effective both for perch and pike.

For many years I used the green cabbage caterpillar for chub fishing and always found them good but in recent years they seem to have become scarce, perhaps due to the use of modern insecticides. However, early last year a 'Plastifol' caterpillar came on the market and this really pleased me as I could give it a trial with the chub to see how successfully it would fox this wily fish.

It did. My best chub to date on the caterpillar is a fish of 3½lbs. This was fished by straight swimming the stream with a very small shot two foot from the lure. I should add that if you like to use a fly rod when chub fishing this bait is ideal as it is so light in weight.

There are quite a number of other

lures available but space limitations prevent me mentioning them in detail. I can say a few words about the fishing of them, however. Do not expect these lures to go down and catch the fish for you. Remember all the time that they have no life — movement has to be imparted either by the angler or by the current. Develop a technique of using them on your own particular water as I have done.

A happy experience

It is a fact that the day I took my best roach the fish were not biting at all and there were about 40 anglers on this particular water that day, using natural maggots. The fish showed no inclination to feed on anything at all. I changed my spot after five hours and went to another where there were two anglers who said they had been there since nine o'clock in the morning and hadn't had a bite. The time then was four in the afternoon but before five-thirty when I had to leave I had seven roach, the best being 1½lbs. That satisfied me, as the other two anglers, using natural maggots and fishing only five yards from me, still hadn't had a bite when I packed up.

"Plastifol" PLASTIC MAGGOTS



Have smell to attract the fish
A PERFECT BAIT.
Coarse fish and trout take them.

ULTRA SOFT PLASTIC, they look and feel NATURAL in 4 COLOURS.
CAN BE USED REPEATEDLY
DO NOT COME OFF THE HOOK

Ask your dealer for a TRIAL PACKET.
4 in 4! postage 3d BROWNING'S LTD.
69 Aberdeen St HULL - Yorks.

● Continued from page 253

LOUDSPEAKER STAGES

transformer ratio can be found as already explained.

A meter is initially included in the negative lead to the stage, and the 100K potentiometer is adjusted until the collector draws 33mA. This current is too large for miniature batteries, but it is easily within the capacity of normal cell batteries. This is another reason why the stage is suitable for ordinary size portables, etc, but not for miniature

pocket sets.

The amplifier can be operated from an earlier stage, with the transformer coupling described. If a 45:1 transformer is used, with a high output type crystal pick-up, this will give full volume from the stage, for record playing, without any other amplifier. The circuit is particularly specified for the OC72.

The use of transistors in power output stages will be described next week.

***NOW** the most advanced range of finishes **EVER!**



HUMBROL

In handy 1/2 oz tinlets 9d Economy size tin 2 oz 1/6d

Here's a first class family of fine finishes, something for every job the handyman tackles.

THE HUMBER OIL COMPANY LTD
MARFLEET - HULL



The **STRONGEST** handy glue

STILL ONLY

1/2 a large tube

MANY MODELS from ONE TIN!



Pyruma, plastic and ready to use from its tin, can be fashioned into the widest variety of models imaginable. Buildings for your model railway set, houses, ship models, animals and figures, ashtrays and plaques — all of which when set or baked to stone-hardness can be finished in natural colours. Get the Pyruma Model Instruction book — see Coupon — and start making things like those shown below.

SANKEY'S PYRUMA PLASTIC CEMENT

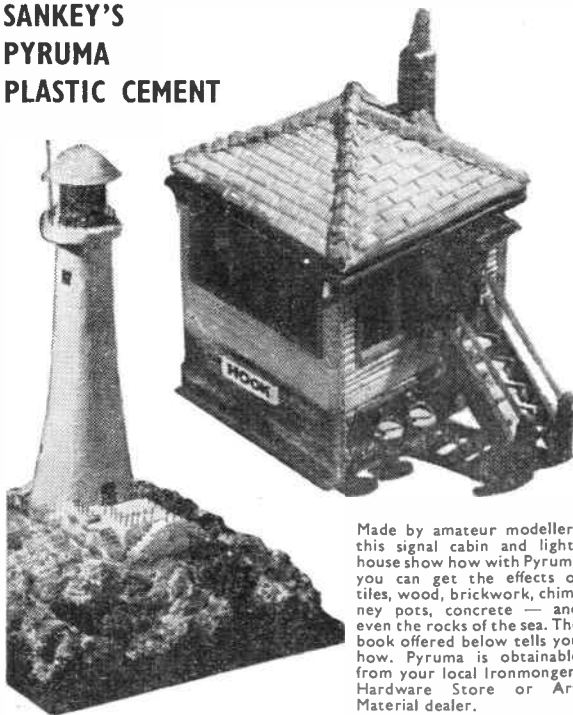

Made by amateur modellers this signal cabin and lighthouse show how with Pyruma you can get the effects of tiles, wood, brickwork, chimney pots, concrete — and even the rocks of the sea. The book offered below tells you how. Pyruma is obtainable from your local Ironmonger, Hardware Store or Art Material dealer.

POST THIS BOOKLET COUPON TO-DAY

To **J. H. SANKEY & SON, LTD** (Dept. HW)
ILFORD, ESSEX

I enclose P.O. 6d. (not stamps) for a copy of Pyruma Modelling instruction Booklet, post free to:

NAME
ADDRESS

(BLOCK LETTERS PLEASE)



A NEW RANGE OF JOHNSON DO-IT-YOURSELF OUTFITS

Here's excitement! The new Johnson range of "Do-it-yourself" outfits makes it so easy to develop and print your films at home.

These outfits contain everything you need. They range from sets for the beginner, to outfits for the more advanced enthusiast. And full instructions go with every outfit.

Prices from £1-17-6 to £5-12-6.



FOR CONFIDENCE
IN PHOTOGRAPHY

Get it
NOW!



THE ANNUAL WITH A THOUSAND HAPPY HOURS

From branches, news-agents, stockists or send 2/6 (including postage) to

HOBBIES LTD, 99 DEREHAM, NORFOLK

BRASS, COPPER, DURAL, ALUMINIUM, BRONZE

ROD, BAR, SHEET, TUBE, STRIP, WIRE
3,000 STANDARD STOCK SIZES

No quantity too small List on application

H. ROLLET & Co. Ltd.
6 CHESHAM PLACE, LONDON, S.W.1
Also at
Liverpool, Manchester, Leeds, Birmingham

IT'S EXCITING. IT'S PROFITABLE. Paint designs. Flowers. Anything. Even beginners' ideas can sell for £25/£60. Inexhaustible demand. Details free. POPULAR ART SERVICES (HW). CLUN, SALOP.

HOMEWORKERS required to make up and machine simple household goods. Experience unnecessary. Good pay. Regular work. S.A.E. for details to Dept. 28, Arnold, 10 Shelley Road, Worthing, Sussex.

YOUR PORTRAIT DRAWN, in black and white, by professional artist. Enclose photograph, 5/- each including postage, packing and returned photograph. Cash with order. — W. M. Oldhamstead, "Locarno", Thames View, Langden Hills, Essex.

TRANSISTOR POCKET RADIOS



ONLY 32/6
no more to pay

months off 8d. battery. Should last a lifetime, anyone can assemble it in an hour or two with our easy plan. Complete set of parts incl. mini. speaker, carrying case — everything, only 32/6 — 2/6 P. & P. C.O.D. 2/6 extra. (Parts can be bought separately.) Limited period — order before it's too late — DEMONSTRATIONS DAILY.

CONCORD ELECTRONICS
(Dept H.W.1) 210 Church Road, Hove, Sussex

ENJOY WRITING? Then write for Profit. Send for "Writers' Handbook" (free) detailing countless opportunities for beginner or experienced. — Writers' Ring (HW), 5 Edmund Street, Birmingham.

54 page Edition WHERE'S THAT CAR FROM?

Price 1/- (Postage 4d.)

Entirely new! Brief Guide to
INN SIGNS

Price 1/6 (Postage 4d.)

Of all Booksellers
OR

RALEIGH PRESS, Exmouth, Devon

PERSONAL COLUMN LTD, Falcon House, Burnley, Lancs. Pen Friend — all hobbies. Correspondents in almost every Country. All ages. S.A.E. for details.

LEARN

RADIO & T/V SERVICING
for your OWN BUSINESS/HOBBY

● by a new exciting no-maths system, using practical equipment recently introduced to this country
FREE Brochure from:—

RADIOSTRUCTOR
DEPT. G81, READING, BERKS.

17/1/62

LET 'Plasticine'



HELP YOU DO-IT-YOURSELF Regd. Trade Mark
Special Trial Offer. We will send 4 lb. 'Plasticine' (any colour) with booklet 'Plasticine Modelling for Amateurs' Post free: 10/- U.K. only.
Harbutt's Plasticine Ltd, Bathampton, Bath



No. 2 Corner
Cramp

Made of cast iron.
Will take mouldings up to 4 ins.

30/-
(post free)

HOBBIES LTD (DEPT. 99), DEREHAM, NORFOLK

A TIDY RACK FOR TIN TACKS

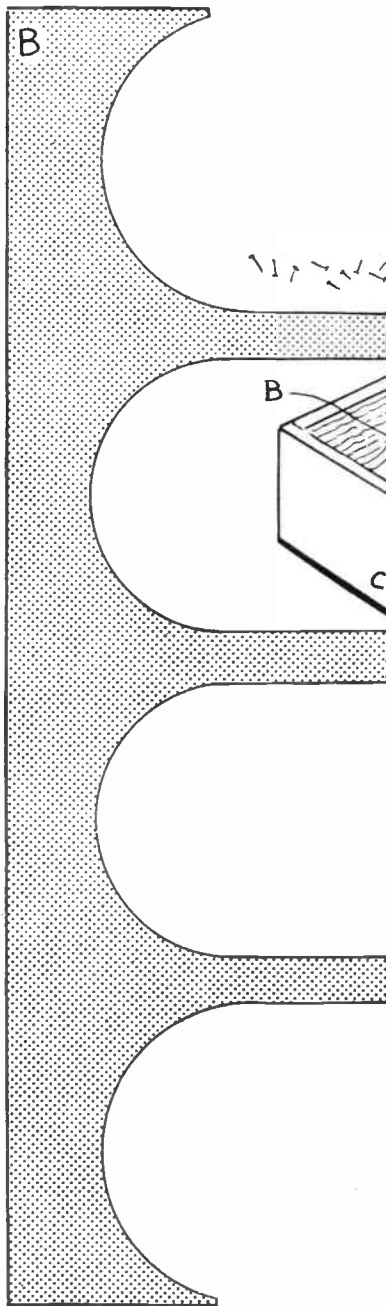
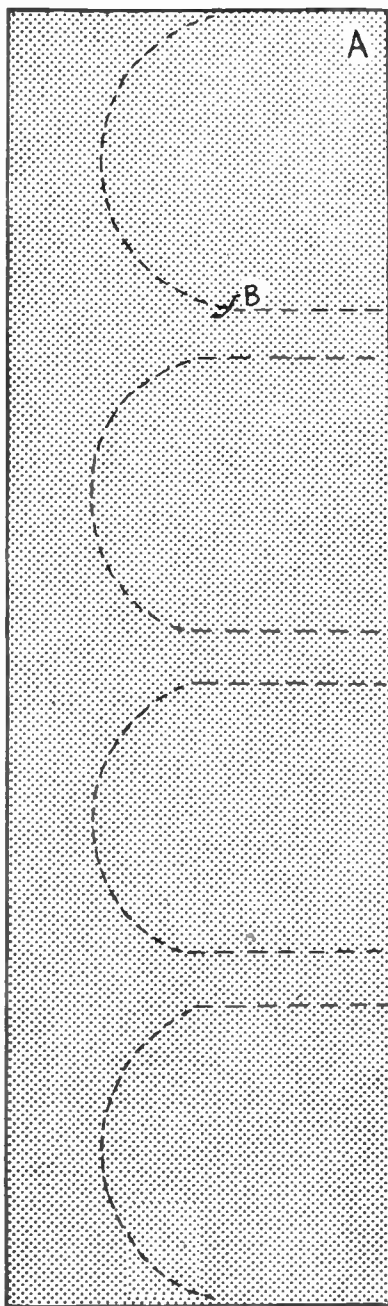

MAKE up this useful box for your fretpins, panel pins or tin-tacks. Cut two each of pieces A, B and C, and three of D from $\frac{1}{4}$ in. wood using a fretsaw. Glue together pieces A and B in pairs to form the sides. Pins the ends C in position, and glue the spacers D across as shown. Line the compartments with thin plywood glued in position. (M.p.)

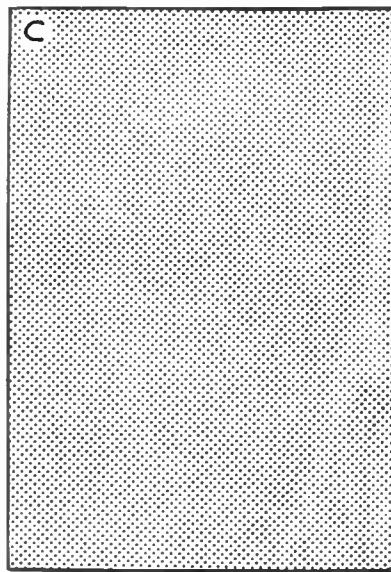
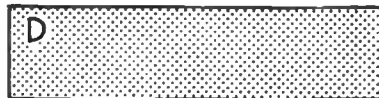
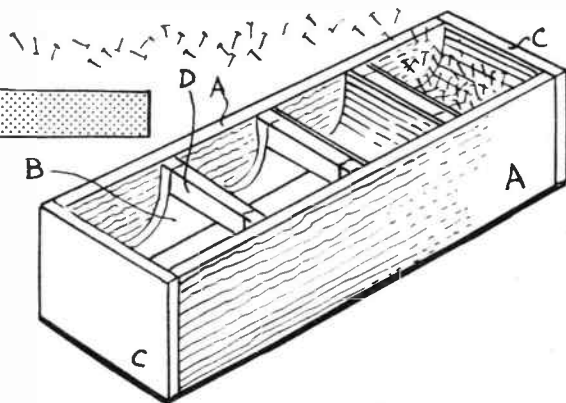

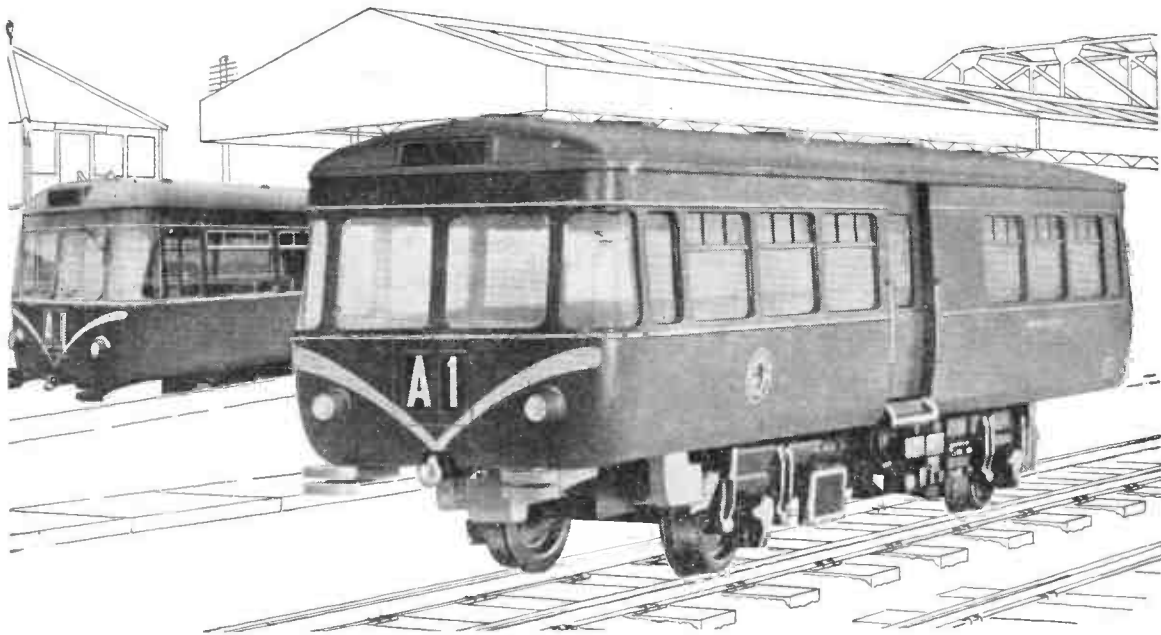

Just like the real thing!

Believe it or not, the nearer one is the Airfix model of the Railbus, built to fit all 00 gauge systems (Kit 3/-). Behind it is a picture of the real thing.

That's how wonderfully realistic Airfix models are. Close attention to every detail gives them their faithful-to-the-original look—makes them true collector's pieces. And every Airfix series is to a constant scale. This means Airfix models look proportionally right, one against another, because they *are* right! You can't beat Airfix for realism—or value.

AIRFIX

Constant Scale Construction Kits

From Model & Hobby Shops, Toy Shops, and F. W. Woolworth

There are over 140 Airfix models from 2/- to 10/6.

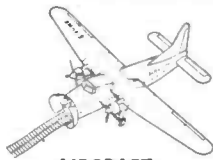

AIRCRAFT

Bristol Superfreighter 7 6

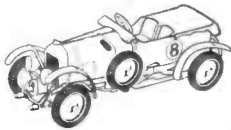

VINTAGE CARS

1930 Bentley 2/-



MODEL FIGURES

Lifeguard 2/-

BRITISH WARSHIPS

H.M.S. Cossack 2/-



STOP PRESS!

Latest Airfix Production

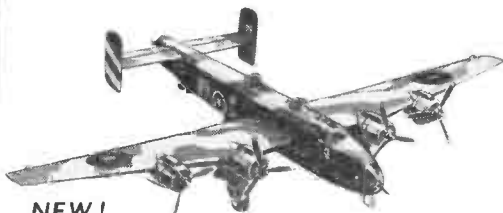

NEW! HALIFAX Mk III

This magnificent 1/72 scale model of the Handley-Page 'Halifax' has a 163" wingspan, retractable undercarriage, rotating turrets, movable control surfaces and a complete set of transfers.

110 part kit . . . 7/6

ALSO NEW H.M.S. 'NELSON' Another in the Airfix Warship Series. This famous ship is reproduced in magnificent detail, overall length 14'

134 part kit . . . 6/-