

18th JULY 1962

VOL. 134

NUMBER 3475

THE ORIGINAL
'DO-IT-YOURSELF'
MAGAZINE

HOBBIES *weekly*

FOR ALL
HOME CRAFTSMEN

RECORD STORAGE UNIT

Also in this issue:

PATTERNS FOR
PROFITABLE PROJECTS

COLLECTORS' CLUB:
LATEST ISSUES

USEFUL JOBS FOR
DOWEL RODS

THREE ARTISTES IN
DISC BREAK

PHOTO FAULTS
AND REMEDIES

MODEL RAILWAY
ACCESSORIES

A TUNING UNIT

ETC. ETC.

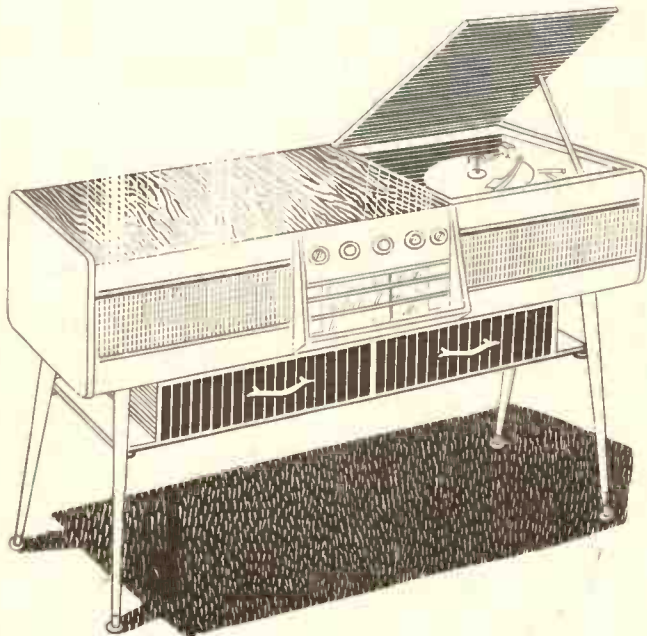

**ADD THIS NEAT ARRANGEMENT
TO YOUR RADIOGRAM**



Up-to-the-minute ideas
Practical designs
Pleasant and profitable things to make

5^D



★★★★★★★★★★★★★★★★★★
 ★ NOTE TO ★
 ★ CORRESPONDENTS ★
 ★ All correspondence on any sub- ★
 ★ ject covered in this magazine ★
 ★ must be addressed to: The Editor, ★
 ★ Hobbies Weekly, Dereham, Nor- ★
 ★ folk. If a reply is required, queries ★
 ★ should be accompanied by a ★
 ★ stamped addressed envelope and ★
 ★ reply coupon inside back cover. ★
 ★★★★★★★★★★★★★★★★★★

MOST breeds of poultry are well described in this set of 50 cigarette cards issued by John Player in 1931, listed at 5s. 0d. But as this is an extensive subject, a few additional notes are, perhaps, called for.

Dunghill or common barnyard fowls are supposed to be a mixture of many breeds. They are of many different colours, sizes, and shapes. The cocks usually have large combs and wattles.

Cards in Circulation

POULTRY

Game fowls much resemble common ones in form, but they are generally a little smaller, and have more delicate legs. They are also stronger and more courageous. The cocks are very quarrelsome, and will fight until they die. On this account they were much used for the cruel sport of cock-fighting, which is still a favourite amusement in the East Indies and in Spanish America.

Dorking fowls were first raised in the town of Dorking in Surrey. They are of large size, good shape, and when of pure blood are white, but many are now seen speckled with black or grey. They always have five toes on each foot, instead of four like most other fowls. Sometimes the cocks have double combs.

Poland fowls, supposed to have been first brought from Poland, are black, and have instead of a comb a crest of feathers on the head, which is sometimes so large as to hang over their eyes.

Black Spanish fowls were first brought from Spain. They are quite large, with black feathers, which are very dark on the lower parts, and have lead-coloured feet and legs. Their combs are large, and often hang over on one side. They have a white patch of bare skin behind the ears.

Chinese and Malay fowls include Shanghais, Cochin Chinas, Chittagongs, and Brahmputras. The Shanghais, which came from China, greatly resemble the Cochin Chinas, which were brought from the country of that name. They are larger than common fowls, and are awkward in shape, having long bony

legs and short wings and tail. Some are yellow or cinnamon coloured, some black, some white. The Cochin Chinas are usually reddish-brown.

The Chittagongs or Malays were first brought to this country from Malacca. But they probably got their name from Chittagong in India. They are large, with heavy feathered legs, and are usually brown streaked with yellow or white. The Brahmputras, named from the river Brahmputra in India, are large grey fowls.

Hamburg fowls, sometimes called Bolton Greys, are very pretty, silvery-

white speckled with black. Bantam fowls are named from the town of Bantam in Java, but they were first brought from India.

Besides these, there are many fancy breeds of fowls, which are kept chiefly as curiosities. Among them are the creepers, with short legs; the Persian or rumpless fowls, without tails; the Friesland, frizzled, or crisped fowls, with feathers turned towards their heads; the silky or Merino fowls, covered with a kind of down instead of feathers; and the negro, with black comb, wattles, legs, and feathers.

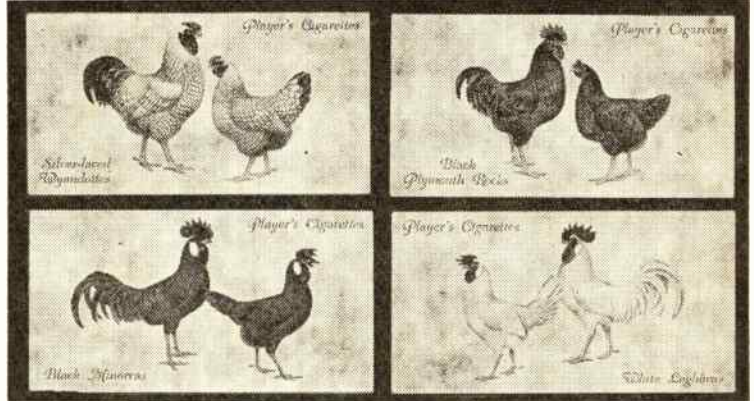

New Stamp Series:

FAMOUS FRENCHMEN

A new series of stamps depicting famous Frenchmen was released by France on 4th June. The one illustrated (30 centimes) commemorates Gustave Charpentier (1860-1956). Others in the series are: 30 centimes, Denis Papin (1647-1714); 20 centimes, Edme Bou-chardon (1698-1762); 45 centimes, Edouard Estaunie (1862-1942), and 50 centimes, Hyacinthe Vincent (1862-1950). All bear a surcharge varying from 5 to 20 centimes.

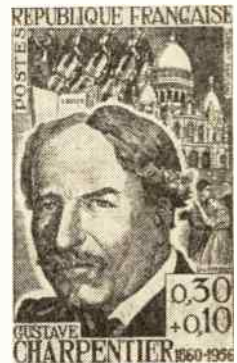

HONG KONG COMMEMORATIVES

TO commemorate the centenary of the issue of the first postage stamps of Hong Kong in 1862, a special issue of three values was released by the Government of Hong Kong on 4th May. The new stamps include a portrait of Her Majesty the Queen with the St. Edward's Crown and a reproduction of the statue of Queen Victoria which stands in Victoria Park, Causeway Bay, Hong Kong.

The colours are: 10 cents: red and black. 20 cents: blue and black (illustrated). 50 cents: drab yellow and black. The stamps will remain on sale for a period of three months or until stocks are exhausted, whichever is the earlier. The Hong Kong dollar is equivalent to 1s. 3d.



The Colony of Hong Kong is situated at the mouth of the Canton River on the south-east coast of China next to the province of Kwangtung. In January 1841 the island was occupied by British forces partly as a reprisal for the treatment of British merchants in Canton, and partly as a base from which trade with China could be conducted free from interference. The cession was confirmed by the Treaty of Nanking in August 1842, and part of the mainland and various islands were added to the Colony by the 1860 and 1898 Conventions of Peking.

Hong Kong was attacked by the Japanese in December 1941, and fell on Christmas Day after 18 days' fighting. The ensuing occupation lasted for 3½ years.

The statue of Queen Victoria shown on the stamps was unveiled on 28th May 1896. During the Japanese occupation it was removed to Japan, where it suffered much damage and, although the Japanese originally intended that it should be melted down due to a shortage of metal, it was recovered from Osaka in 1946. After repair, the statue was placed in a new park at Causeway Bay, which was appropriately named Victoria Park.



RUSSIAN MATCH LABELS

Latest 'Adverts' Set Issued February 1962

YOUTH STAMPS OF WEST GERMANY

With the Youth Stamps 1962 the Deutsche Bundespost will start the series of surcharge stamps for the benefit of young people, which are planned to be issued henceforth every year. On each of the four values a butterfly is represented.

Details are:

- 7+ 3 Pfennigs, Apollo.
- 10- 5 Pfennigs, Camberwell Beauty.
- 20+ 10 Pfennigs, Small Tortoise-shell.
- 40+ 20 Pfennigs, Scarce Swallow Tail.

The stamps will be on sale up to and including 31st October 1962. They will remain valid for prepayment of mail up to and including 31st December 1963. They may be exchanged, free of charge, at their real postage value for valid postage stamps during the first quarter of 1964.



AUSTRIA — JOHANN NESTROY COMMEMORATIVE



THE centenary of the death of Johann Nestroy, the second of the three great playwrights of Viennese popular drama of the nineteenth century, was on 25th May, when this special stamp was issued. He was born in Vienna in 1801, and though he had studied law, he became an actor. He wrote eighty-two dramatic works: parodies, farcical comedies, and popular plays featuring Viennese life — plays full of dramatic verve, and including wonderful parts that he had written for himself and the brilliant ensemble around him.

USEFUL JOBS FOR DOWEL RODS

DOWEL rods are made in a variety of diameters and, apart from their normal use for jointing, can be utilized for many useful household accessories.

In one illustration, we show two clothes airers, each of which can be made from dowel rods. By modifying the sizes, you may make large or small editions for practical usage, or tiny ones for children's toys. Any increase in size warrants, of course, the use of stronger rods.

By S. H. Longbottom

The old fashioned airer shown is, perhaps, one of the easiest of all jobs for the handyman, being made in sections involving two uprights and two or three dowel rods for rails to carry the clothes. The airer may have two or three sections which are fastened together by means of simple, webbing hinges tacked to the uprights.

In Fig. 1 you will see that we have provided for a substantial airer having three rails 15 in. apart. For this we suggest $1\frac{1}{2}$ in. square uprights and $\frac{3}{8}$ in.

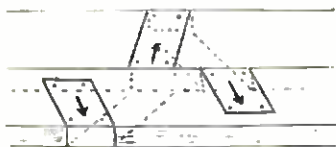
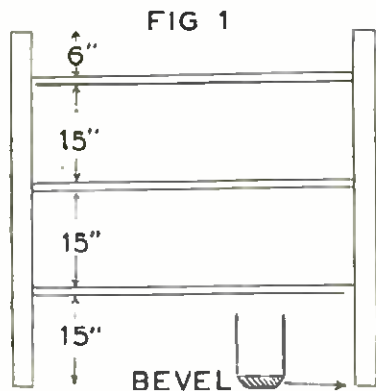

FIG 2

dowel rod to make a really good job. The foot of each upright is neatly bevelled, while the top is rounded. Lay all the uprights on the floor with their ends squared together, then measure off the distances for the holes. This is a far quicker method, and more accurate than marking each one individually. After drilling the requisite number of holes in each upright, cut the dowel rods to the required size, allowing for the thickness of the uprights.

The rods may be glued into the holes and reinforced if necessary with brass or copper pins through the uprights. Use waterproof glue, since the airer may be subject to wet clothes. The hinging is done by means of two lengths of carpet binding. Steel hinges rust, and are unsuitable since wet clothes may be stained with 'ironmould'. Take a piece of binding, fold over the end, and back in the position shown in Fig. 2. Pass this under the adjoining section, wrap round and back to the other. A hinge is re-

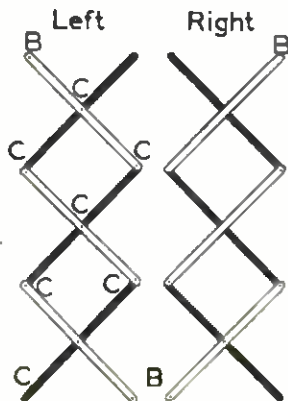

FIG 3

quired at both the top and bottom. Use 1 in. tacks for fastening.

A more recent design of airer is also shown, and the main advantage of these is that they store away easily. In practice, you will find that we cannot make them as wide unless we sacrifice some rigidity, and the following instructions are for a small but substantial airer. Should you prefer a larger version the width can easily be modified by employing longer dowel rods, but remember to compensate by using a thicker diameter. You will require the



following parts:

- A 12 arms 14 in. by 1 in. by $\frac{3}{8}$ in.
- B 2 dowels 12 in. by $\frac{3}{8}$ in.
- C 9 dowels 11 $\frac{1}{2}$ in. by $\frac{1}{2}$ in.
- D 1 dowel 10 $\frac{1}{2}$ in. by $\frac{1}{2}$ in.
- E 2 ft. 14 in. by 1 $\frac{1}{2}$ in. by $\frac{3}{8}$ in.

FIG 4

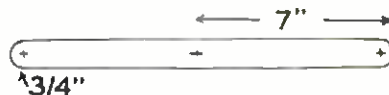

FIG 5

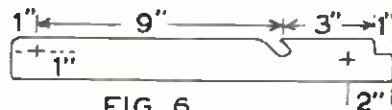

FIG 6

The arms are shown in Fig. 4, and there is a $\frac{3}{8}$ in. hole in all the arms — at the centre and $\frac{1}{2}$ in. from each end. Round off both ends. The feet are shown in Fig. 6, allowing for a stop notch to hold the last dowel of the airer. The feet are joined together by dowel rod D at the front, and centres for the holes are as shown. The stop notch is made by boring a $\frac{1}{2}$ in. hole, and then cutting out the waste. You may also attach a small turnbutton to keep the bottom dowel B firmly in position.

The dowel rods are cut as stated, and it will be wise to drill $\frac{1}{8}$ in. holes in the

ends $\frac{3}{8}$ in. deep. The dowels should be screwed to the arms by means of $1\frac{1}{4}$ in. brass roundhead screws, and if you will now refer to Fig. 5 you will see that we have included a washer between the arms to ensure easy working, also one on the outside.

Fig. 3 shows the assembly of the arms for the left and right sides, and it is best to start with the left. Dowels B (12 in. by $\frac{3}{8}$ in.) are the first and last, while dowels C are in between. The arms indicated in black are on the inside.

When the airer is completed, it will stand approximately 28 in. high, and will fold away to a 4 in. thickness. If a larger size is required, any modifications should be proportionate.

Another useful, miniature airer, can be made quite easily by using two coat-hangers and a few dowel rods. Cramp the hangers together, drill holes for $\frac{3}{8}$ in. rods — cut to suitable length — and glue in the rods. The wire hangers can be retained for suspending the airer.

We also show a bath rack which can

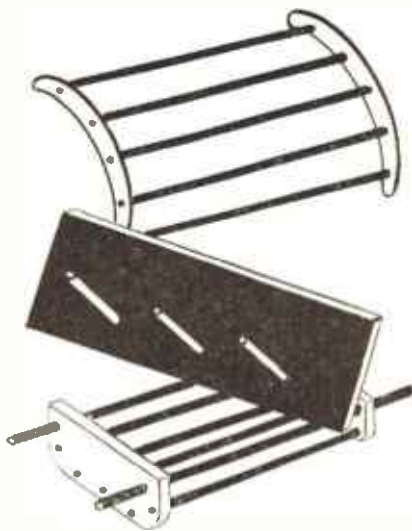

be quickly made from two suitably shaped endpieces and some dowel rods. Two of the dowel rods are longer than the others to permit the rack to rest on the sides of the bath.

Another simple device is an accessory for gardeners. All you require is a length of 2 in. by 1 in. material with holes bored at determined intervals to accommodate various garden tools. The advantage of such a rack is that dowel rods do not rust in the dampest of garden sheds, and the accessory will last indefinitely if the rods are glued firmly in position. The rods are best inserted at an angle.

Convenient shelves for the greenhouse or shed can also be made from dowel rods. I find that these, being open, permit air to circulate all round, and do not interrupt free drainage for pots and seedpans. All you need is a pair of 2 in. by 1 in. endpieces cut as long as required, and connected by a few substantial dowel rods. The endpieces are then screwed to the wall or supported by shelf brackets in the usual manner.



BEAUTIFUL Timi Yuro, twenty-one-year-old husky voiced singer from Chicago, has got something new as was shown in *Hurt*, her first record to be released here. To a swooning string accompaniment Timi croons, coaxes, sings, sobs . . . and scores a big success.

Timi, who was born Rosemarie Yuro in Chicago on 4th August 1940, was nicknamed Timi by her schoolmates in Los Angeles when Momma and Poppa Yuro opened an Italian restaurant there nine years ago. They gave Timi the job of cashier and let her sing to the custom-



ers while they ate their spaghetti. Timi sang so well (in Italian and Spanish) that she was given five years' operatic training.

Soon her voice came to the notice of a Liberty Records scout. A recording contract followed — and now success. Timi's ambitions? To go on singing 'pops' — and to go on making her pet pasta dish, lasagna.

DEL SHANNON



The latest photograph of Del Shannon just released



THE Latin-beat ballad *In The Night* introduced twenty-one-year-old newcomer, Ronnie Gallant. Born in Georgetown, S. Carolina, on 7th July, 1940, Ronnie developed his singing ability at the age of seven, and was encouraged by his parents to join a local gospel group in which he eventually became featured singer.

When he was fourteen he joined a local rock 'n' roll group, the Rays. After several years of success in their home state, the group went hopefully to New York, hitting the headlines there when they won first prize for four consecutive weeks at New York's Apollo Theatre Amateur Night.

Yet it was Ronnie Gallant who was singled out from the group for a Warner Bros. recording contract.

PRINTING AND ENLARGING

ALTHOUGH you may have obeyed all the rules of composition and produced what can be a good picture it may still be marred by stains, spots, veiled highlights, muddy blacks or other faults. So we must continue our aim of improvement by analysing the processing technique. This will not only produce better pictures but also save a considerable amount of expensive material.

By S. H. Longbottom

The average amateur takes far too many liberties in processing. He either does not heed the maker's instructions packed with the printing paper or ignores much of the advice given in textbooks. A simple example of this is the handling of paper itself. A thorough rinse is always recommended before a print is transferred from the developer to the fixer. If you refuse to observe this simple fact you are almost sure to attract stains.

Contact paper will stain very easily if handled by the fingers so the remedy is to use a pair of tweezers. Both contact and enlarging papers attract brown stains if handled by fingers slightly damped with developer while other stains will appear if the surface is not covered by the solution. Uneven development is responsible for white patches and streakiness and stains will appear if the print is rinsed but then insufficiently covered with hypo, or if the bath is exhausted. All this is due to carelessness which can be avoided by a little commonsense.

Correct measurements

See that you have sufficient developer and fixer in your dishes and another dish for a water rinse or a stop bath. A pair of tweezers will not only help you to handle the paper without contamination but is also useful for keeping the print beneath the surface of the solution — apart from the fact that you avoid any chemical irritation to the skin. A glass rod or print paddle will keep the prints below the surface in the fixing bath.

I know that the quickest way to prepare a fixing bath is to fill a dish with water and add some salts. I have done this myself. But this is not the correct way and sometimes we have to pay for the consequences. If the fixing bath is too strong and the prints are left in while

attending to others in the developer they are liable to bleach and have the appearance of being under-exposed. If the bath is too weak it will not fix them at all and in both cases we have wasted time and material.

So there must be no more guesswork in connection with the solutions. A small polythene measure is inexpensive and you must prepare your solutions carefully, adding the correct weight to the prescribed volume of water. Incidentally, it is easier to prepare fixing solution in bulk — say double strength — and add water when required. Developing solutions should be kept in well-stoppered bottles. With age stock, undiluted solutions will oxidize and only produce muddy prints; if kept in too cold a place the metal content will crystallize, causing deterioration and lost efficiency.

It is a sound plan to filter all developers made up from powder. A funnel is another cheap accessory and if one is placed in the neck of a clean stock bottle the prepared solution can be quickly filtered. Place a small pearl button in the funnel so that it covers the top of the tube part and then add a wad of saturated cotton wool. The button will prevent the wool from entering the tube and blocking the drainage. You will be surprised at the amount of dirt and sediment extracted.

Temperatures vary from day to day. You will find that most makers of the materials recommend development at a temperature of 68°F. There are sound reasons for observing this temperature and you are recommended to invest in a thermometer. In winter a cold solution will not possess the same efficiency for hydro-quinone does not act as well at lower temperatures and you will lose contrast. If the temperatures are too high you will get the reverse. An adjustment can be made by standing the measure of prepared solution in hot or cold water.

Use forceps

Do not handle the prints with your fingers — use forceps. Good, fresh developer and hypo prepared to the prescribed proportions and sufficient in quantity in the dish will avoid a lot of staining troubles. And remember that solutions should be filtered, kept in well stoppered bottles, used once and discarded. Finally, remember to aim at constant temperatures.

Once you have eliminated such guesswork and become methodical you will find an improvement in your work but we still have to consider faults in the equipment. These will be considered in more detail in our next feature on this subject.



"I'D LIKE YOU TO KNOW I'M IN HERE DOING A WOOD SCULPTURE — NOT CHISELLING SOMEONE!"

RECORD STORAGE UNIT

IF your radiogram has insufficient record storage space you can add to it quite simply by providing a drawer unit as suggested on the front page. The size will of course depend upon the radiogram and it may be necessary to make one drawer instead of two. Make sure when deciding upon the measurements that you allow room for the largest size record you are likely to use.

The drawer unit can be made from $\frac{1}{2}$ in. material, with the bottoms of the drawers cut from $\frac{1}{4}$ in. plywood. The wood used should, if possible, match the radiogram or be stained to give the same effect. The addition of gleaming polished brass handles will give the finishing touch.

The diagram in Fig. 1 shows the main construction. The base on which the unit is built should fit nicely between the legs of the radiogram. Make up the carcass as shown, using $\frac{1}{2}$ in. plywood faced with a suitable veneer.

The drawer construction is indicated in Fig. 2. Note that each side is made in two pieces to provide a groove in which the runners will fit. You will see the runners illustrated in Fig. 1. The bottom of the drawer can be $\frac{1}{4}$ in. plywood or $\frac{1}{2}$ in. hardboard.

Finish off the drawer by fixing the front which is shown in Fig. 3, and con-

sists of $\frac{1}{2}$ in. wood. The handle shown is Hobbies No. 715A, costing 1s. 9d. each (postage 6d. extra), from Hobbies Ltd, Dereham, Norfolk.

Clean up when completed and finish with french polish or varnish. The unit is supported by four large screweyes, one inside each leg, and a roundhead screw driven up through each from underneath. (M.h.)

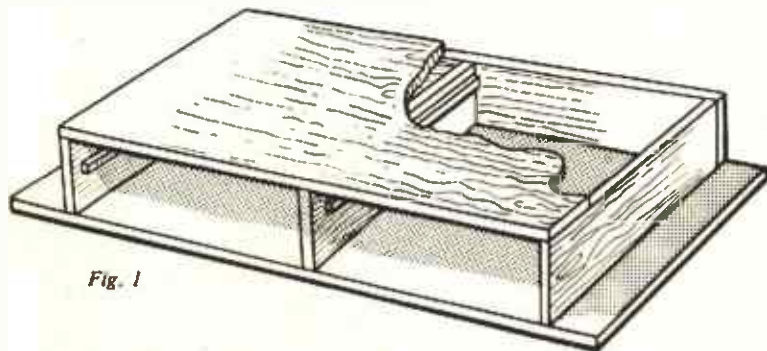

Fig. 1

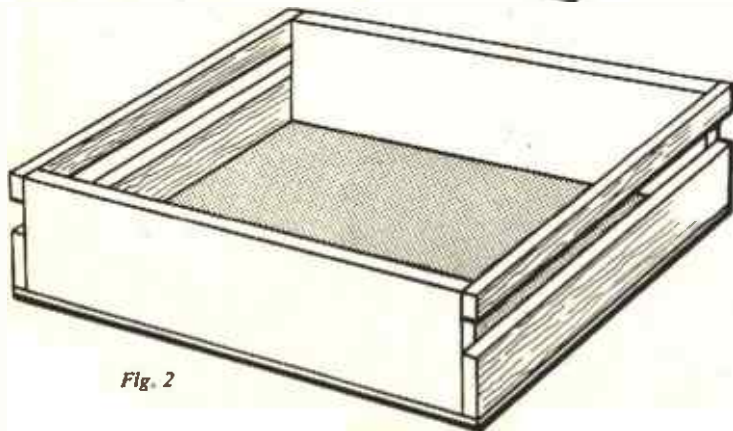

Fig. 2

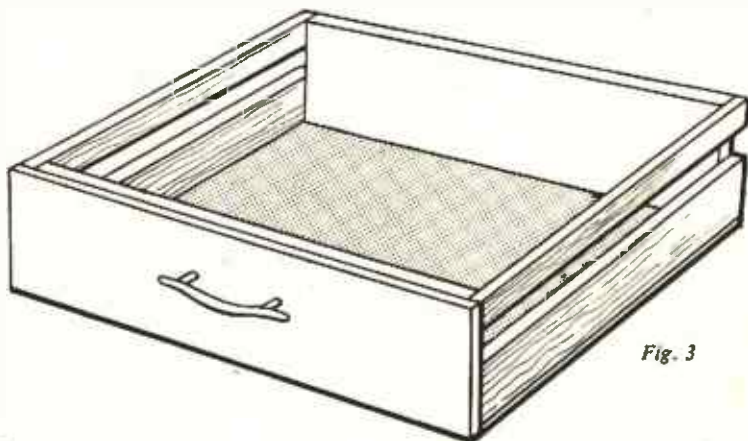

Fig. 3

HOW TO MAKE BUILT-IN FURNITURE

By Mario Dal Fabbro

HERE are step-by-step instructions for constructing 102 'built-in' projects. Each piece is designed to be made with standard grades and sizes of wood, using ordinary woodworking tools.

Designs range from a simple telephone shelf to an entire storage wall with roll-away beds, and include such diverse pieces as bookshelves, desks, cabinets, bars, room-dividers, cupboards, sink-units, headboard units, workbenches, radio cabinets, tables and chests.

The projects have been planned to help the homeowner to make the most of wall recesses, attics, or space beneath a sloping ceiling. Detailed building instructions are well backed by clear illustrations and comprehensive materials lists.

Published by John Murray, Albemarle Street, London. Price 30s.



**BONUS
PLAN**

PROFITABLE PROJECT

*MATCHBOX HOLDER

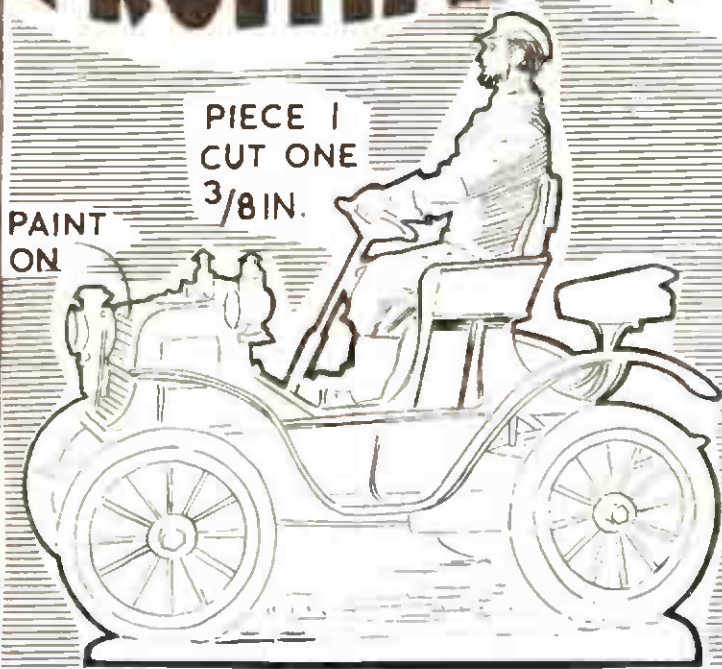

PIECE 1
CUT ONE
 $\frac{3}{8}$ IN.

PAINT
ON

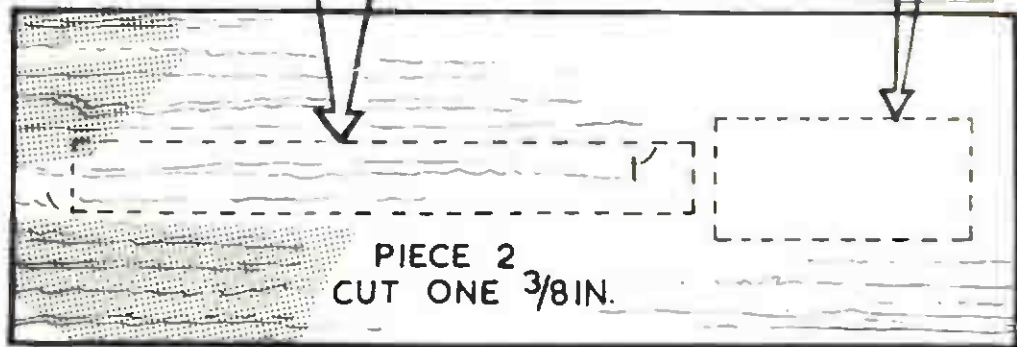

PIECE 2
CUT ONE $\frac{3}{8}$ IN.

TS
RS

PIECE B.
CUT ONE $\frac{3}{8}$ IN.

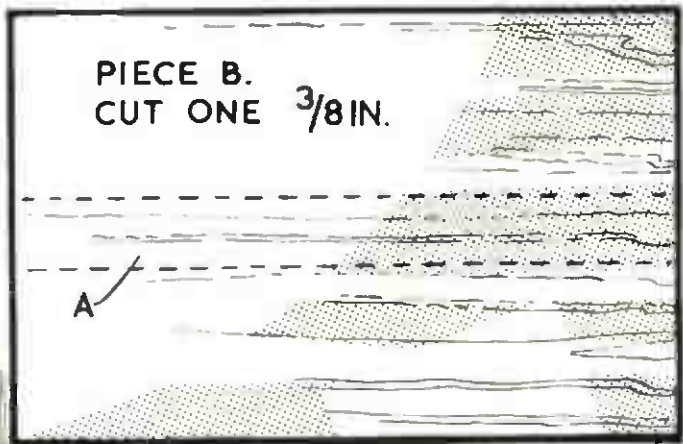

PIECE A
CUT ONE
 $\frac{3}{8}$ IN.

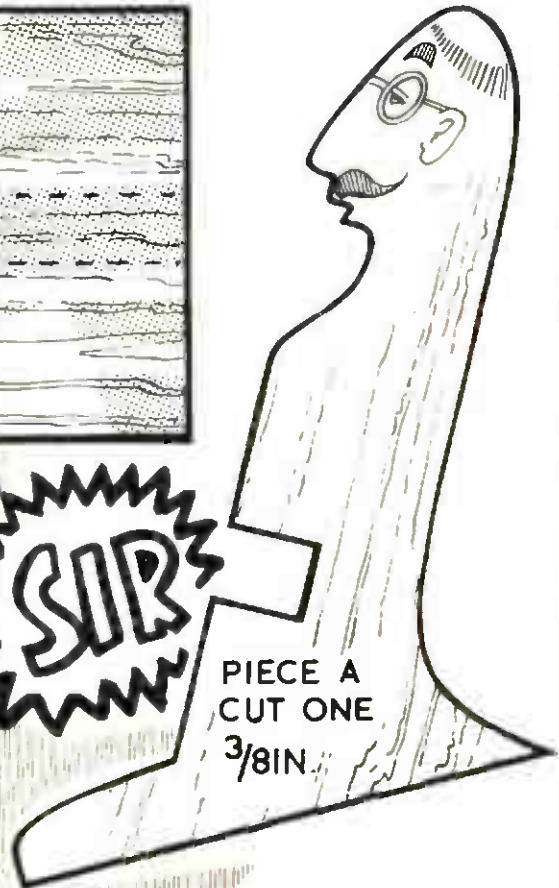

MATCHBOX

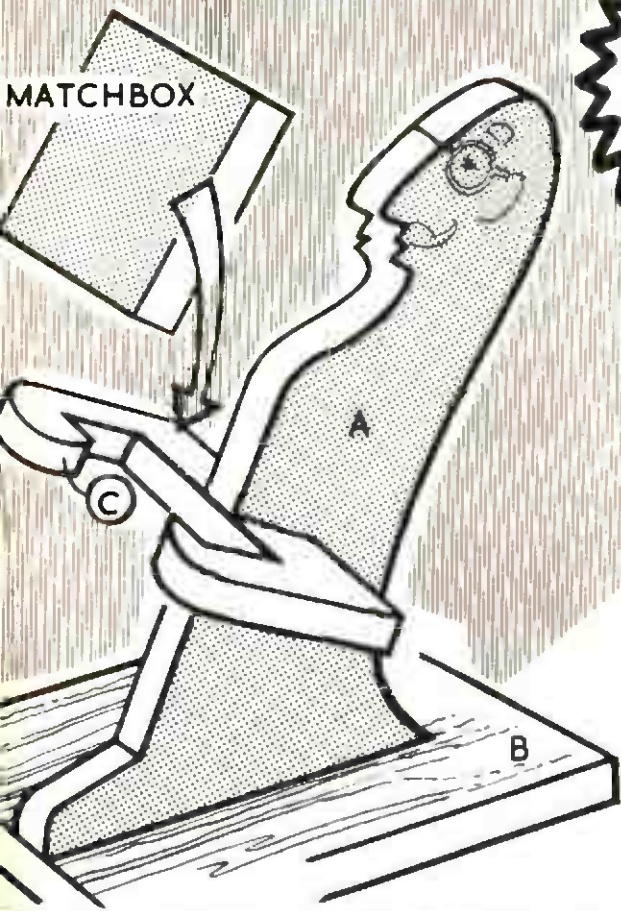

PIECE C
CUT ONE

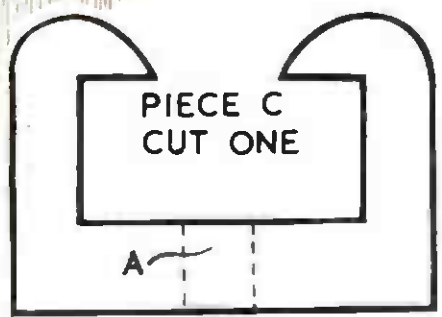

ONE HOBBIES GD6 WOOD
PANEL. PRICE 1/8
NEEDED FOR EACH
PROJECT.

NEW Thoughts on

RAILWAY MODELLING



I AM trying, in this series, to bring to your notice those things that you would normally not think about. I find that one tends to concentrate on the railway and forget some of the smaller things that are part and parcel of a layout. I know that some of you will only be concerned with running trains, but a model railway that has all the little refinements will be admired when others are just a vague memory. In short, aim

for a railway model and not just a train set.

Now, every model railway will need buffer stops at the end of sidings, etc, and these can take one of two forms, either built up from rail or else made from old sleepers. The latter type are very easily built, and our material in the main is card. I have given you designs or drawings for buildings in the past, and you have had to cut out windows, etc, and you have had small pieces left over, I am sure. Here is a chance to use them.

I would say, in passing, that the model railway hobby teaches you never to throw away anything that could have a possible use later on. If you want to

stay happy with the domestic side of the family, keep the scraps and pieces in a box or similar container — never leave them lying about.

To get back to the buffer stops, I make these from scraps of thick card, and scribe the lines on with a dry ball point

MORE LINESIDE ACCESSORIES

By F. A. Barrett



SLEEPER BUILT BUFFER STOP



NOT TO SCALE

COAL MERCHANTS STAITHES

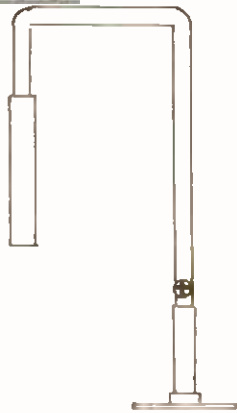

WATER STANDPIPE



BALLAST BIN



SCALE OF FEET

pen. Press hard to get a good deep line. When you cut out the parts, leave some of the planks longer than others. This looks good and is authentic. The centre of the thing is filled with a block of wood, rough on the top. The actual bar that meets the buffers of the engines or trucks is of thick card. Paint the whole job with black matt, inside the walls as well. The buffer bar can be red or white, and the wooden block should be covered with either green or brown flock or compound to simulate earth or grass. To make it look really good put a few patches of green flock around the bottom to represent weeds or grass. The lamp, which is quite a feature, can be made up from $\frac{1}{8}$ in. square wood, with paper top and handle. These lamps, by the way, have many uses. They can be used on locomotives, brake vans, and scattered around the railway at stations and other places. You can purchase buffer stops ready made, and the rail built type are most common.

Water cranes are used a lot on railways where there are steam locomotives, and these can be made from dowel to the pattern shown in the drawing. The actual pipe that goes into the tanks of locos can be made from Systoflex, which you can get from most radio or electrical shops. It is a sleeving that covers bare wires in radio circuits. The wheel used by the engine man can be part of an old toy, or a part from a plastic kit, or you could draw it on transparent material, or shape it up from wire.

In the goods yard one sees coal

merchants, and they usually keep the coal in what are known as staities. We can model these once again from card, in a similar manner to the buffer stops. Use thick card, scored, and with uneven tops to the planks. Put a floor in the thing, and these can be made up singly or in rows of three or so with a dividing wall between. A nameboard over the top is made from two uprights of $\frac{1}{8}$ in. strip-wood, with a length of card glued across. Paint matt black, and put in some coal, either real, or the plastic form that you can obtain from Hobbies branches.

Along the tracks one sees ballast bins for the convenience of platelayers, so that they can make good any faults in the track. We can make these with thinnish card to the design shown. You will need to make up two sides, a back and a front. The sides and back will have overlays which are stuck on to the actual sides. A floor is put in. Cut a block of wood shaped so that it slopes to the front, and paint the whole thing with concrete paint. When dry glue some loose ballast or sand to the block of wood.

One way you are able to represent ballast is to get some really coarse sandpaper, cut a small piece to fit, glue this on to the wood block, and paint it dark grey. Sandbins will have a finer grade of sandpaper, not painted.

Advertisement hoardings can be made from a piece of card with legs of $\frac{1}{8}$ in. square wood. A piece of $\frac{1}{8}$ in. by $\frac{1}{8}$ in. wood can be put along the top and bottom of the card, and if you are using more than one advert you can divide the front with $\frac{1}{8}$ in. strips of wood. Paint to choice. The adverts can be purchased from Hobbies Branches, or you could cut them from magazines.

One thing that is rarely modelled is the G.P.O. pillar box. I know that you can buy these quite cheaply, but they are also easy to make. You will need a piece of dowel of a suitable size, with a piece of paper wrapped round the bottom for a height of 1 ft., and two more narrow strips, one at the top, the other about 1 ft. down. The actual top is a disc of

HAMMANT AND MORGAN POWER UNITS

I WROTE about electrification in a recent article, and mentioned Power Packs that you could use on your layout, writes F.A.B. The power packs put out by Messrs. Hammant and Morgan are among the best in the world. The range is vast, and they have packs which may be used on all types of railways.

One of the great advantages with their units is that they are of the 'add to' type, which means to say you can add further units as your railway grows. You can start with the H & M Clipper which is a power unit of 1 amp rating, with a built in speed controller. This has three outputs — 12 volts controlled, 12 volts uncontrolled, and 16 volts A.C. You can then purchase a Multipack D.C. Control Unit which plugs into the Clipper, and you have another controller. Cost of the Clipper is 39s. 0d., and the extra Control Unit 27s. 0d. You could, of course, purchase the H & M Duette which is dual-control power unit of 2 amp capacity. This gives you two independent 1 amp controlled circuits, and there is provision for adding another controller when needed.

All the power units are fitted with thermal cut-outs, which guard the system against burn-outs on short circuits. There are many other units in the range such as meter units, flash switch units, selector switch units and the famous Variwave Control which provides pulse power for slow running control.

Many of my readers will know about the S.M.3 Solenoid Motor for the operation of points. Now this is an excellent job. It can be mounted either above or below the baseboard, has a positive lock, and is fitted with an automatic cut-off switch so that it can be used with or without a flash switch. There is also means of using a built-in switch for separate circuit switching if desired, such as for indicator light, signal, or for any other means. The price of the solenoid motor is 9s. 0d. I have used several of these and they are excellent in every way. They are available from branches of Hobbies Ltd.

thick card glued on. Paint the box red, with the bottom black. The slot for letters can be drawn on with indian ink, and a small piece of paper glued on for the label.

A very useful material for our job is bristle, such as is used to make yard brooms. With it I have fashioned porters brooms, shovels, picks, and countless other little things that you cannot purchase, but which are easily made, and look authentic. Porters brooms are fashioned from a piece of wood for the brush part, with a piece of bristle for the handle. These brooms are wider than the domestic sort, so that if you want to model the latter all you need to do is make the head shorter.

Shovels are small pieces of very thin card for the blade, glued to a piece of bristle for the handle.

Pickaxes are made from two pieces of bristle, one bent to the shape of the pick, and the other straight for the handle.

If you want a little touch of glamour on your railway, near a station, or in the garden of a house, you can build up an archway over which you can trail pieces of sea fern, and dot this with small blobs of paint in a suitable colour to represent a rose arbour. The framework can be made from bristle. I know that some of you will say that you would rather make such a thing from wire, soldered, but unless you are proficient with an iron I would not risk it.

A final point I would like to make this week. When you are near a railway, on a station, or on a train, look around you, and if you see something outstanding, or something that you want to copy, either make a rough sketch or else, if you have a camera, photograph it for future reference. If you are able to measure it, so much the better. You will then be able to make a better model.

In my next article I shall be dealing with freight rolling stock, and will tell you how to make your own, and details of a jig that will help you to make up goods bodies in an easy way.

FOR YOUR LAYOUT



Horby-Dublo 4-6-0 'Ludlow Castle' locomotive and tender (3 rail) fitted with ring field motor. Price £4. 5s. 2d.

A RADIO TUNING UNIT

THIS simple tuner can be used for a number of purposes, and covers the medium wave band. It has a tapped coil, as shown in Fig. 1. There is no need to follow the coil details exactly, as a slight change in the diameter of the insulated tube, or the number of turns, or wire gauge, will not be important. The coil is wound on a $1\frac{1}{2}$ in. diameter cardboard or Paxolin tube, the tube being about $2\frac{1}{2}$ in. long. For the winding, 28 s.w.g. enamelled wire is used. The wire is fixed at A by passing it through two small holes, the free end

the coil is finished at D; the end again being anchored by passing it through holes. A touch of cement will help hold the loops and ends, if needed, but the whole winding must not be covered with

By 'Radio Mech'

adhesive, varnish, wax, or anything of this kind. Where connections are to be made, the enamel is scraped off. There

will be the metal frame of some condensers, but will easily be seen. If the panel and baseboard are somewhat larger than required for the coil and condenser, this will allow other parts to be assembled on the same base and panel, when making a receiver.

The tuner can be used in several ways, some of which are as described here.

Wavetrapp

A wavetrapp will reduce the strength of a troublesome local or other station, and so reduce or prevent interference with the desired station. It is particularly useful with simple receivers, which do not have sharp tuning. If a wavetrapp is required, take a short lead from C on the tuner to the aerial terminal of the receiver. Connect the aerial to B on the tuner. The tuner coil should be clear of the receiver coil, and preferably at right angles to it. Tune in the offending station on the receiver, and adjust the tuner for

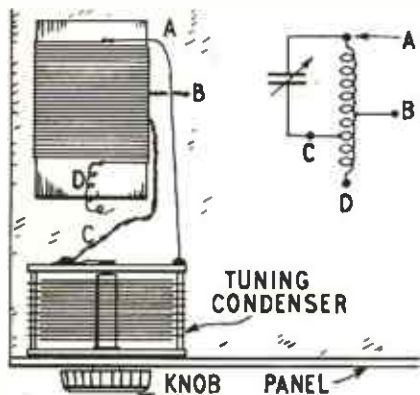

Fig. 1—The Tuning Unit

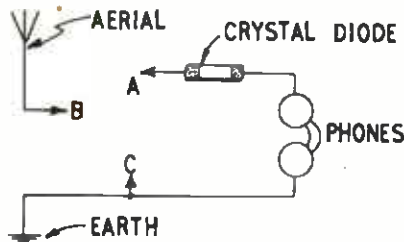
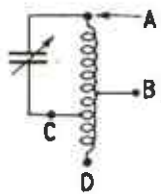

Fig. 2—Using the tuner for a crystal set

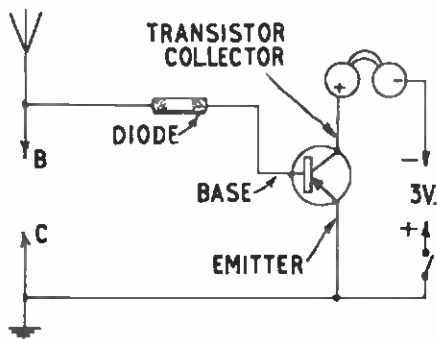

Fig. 3—A 1-Transistor Receiver

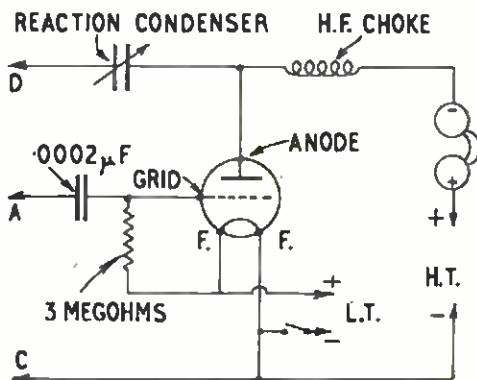

Fig. 4—A 1-Valve Receiver

being left a few inches long, and 60 turns are then wound on closely, side by side. The loop B is then made, by twisting the wire for 1 in. or so. Winding is then continued until a further 30 turns have been added, and loop C is then made, about 3 in. long, to reach the tuning condenser. A further 35 turns are wound on, and

are 125 turns in all, and they are in the same direction throughout.

A $0.0005\mu\text{F}$ (500pF) tuning condenser is fitted to a small panel, as in Fig. 1. Two small screws will hold the coil. Lead A is taken to the fixed plates of the tuning condenser, and loop C goes to the moving plates tag or terminal. This

minimum volume. The station should be much reduced in strength. The tuner is then left, tuning normally on the receiver.

Crystal Set

If a crystal diode and phones are added, the tuner will do well for a crystal

set. The crystal diode should be of reliable make, or results may be very weak. The usual kind of medium or high resistance headphones are satisfactory. Connections are shown in Fig. 2. The crystal diode goes to A, and earth line to C. A normal out-door aerial can be taken to B. For a short, indoor, or poor aerial, results will be improved if the aerial is taken to A. An outdoor aerial can also be connected to D, which will give slightly sharper tuning. A crystal set should give sufficient phone volume from one or two local stations. After dark, some overseas stations may be heard, if the aerial is good, but only at low volume.

Transistor set

A very simple transistor receiver can easily be arranged, as shown in Fig. 3. If the transistor is in proper working order, this will give a considerable increase in volume, compared with the crystal set. Connections are made as shown. If the aerial is very short, it can be taken to A on the coil. Results will be best when the diode is connected in one particular way. So an experiment should be made, by disconnecting the diode, and reversing it, to see if this gives best volume. An audio amplifier type transistor is used, and a small 3V. (2 cell) dry battery. A switch is added in one battery lead. This switch can be fitted to the panel.

1-valver

With a few extra components, a 1 valve receiver can be made, and this can bring in a surprising number of stations, even with a poor aerial, or in a locality where an earth cannot be provided. Fig. 4 shows the circuit. The reaction condenser is $.0003\mu\text{F}$ or $.0005\mu\text{F}$, and it is fitted to the panel, and has a control knob. Its moving plates tag is connected to lead D, and its fixed plates tag is wired to the valveholder anode tag.

The $.0002\mu\text{F}$ condenser is a small fixed component, mica or paper. The value of the resistor is not very important, but around 3 megohms will be satisfactory. The $.0002\mu\text{F}$ condenser goes from A to valveholder grid, and the resistor is connected from grid to filament positive. A high frequency choke is wired from anode to phones. With some phones this choke can be omitted, because the phone windings act as a choke. If reaction is found to be satisfactory without

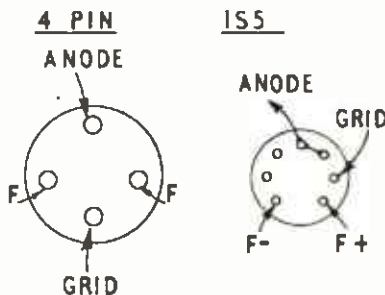

Fig. 5—Valve pins

the H.F. choke, it is not needed. The phones can be of the same kind as were used with the crystal set. For high tension, about 45V. will be sufficient. Two 22½V. batteries, in series, may be used, or a 67½V. or similar H.T. battery. The valve may be an old 4-pin type, which can work well in this circuit. Valves of this kind, still found in old 2-volt battery receivers, include the HL2, HL210, 210HF, 210HL, PM1HL, HL2K, and many similar types. In the 1-valver, the filament of the 2-volt valve can be run from a 1½V. dry battery, so an accumulator is not needed. The valve fits a 4-pin British holder. If a valve is to be purchased, the IS5 is available cheaply as surplus. Equivalents of the IS5 are the

1FD9, and DAF91, which can be used instead. These valves require a B7G miniature holder. For filament, a 1½V. dry battery is used. Very many other valves could also be fitted, but they may need a different type of holder, or connections to the pins may not be the same as for the IS5. The valve pins are shown in Fig. 5. With the 4-pin valves, the anode pin stands a little clear of the other pins. The IS5 uses a 7-pin holder, as mentioned, and it should be noted that Fig. 5 shows the valve pins, or underside of the holder. The valve has a screen grid (pin 4). As this is not wanted, it is joined to the anode (pin 5), and both together act as anode. It is quite in order to use the valve with a separate screen grid supply. To do this, use pin 5 as anode, and wire pin 4 directly to H.T. positive.

C is the earth line of the receiver (if an earth is used), and is also taken to C on the coil (moving plates of tuning condenser). The aerial lead is taken to B.

An on/off switch is provided in one low tension (1½V. battery) lead. Small dry batteries can easily be carried on the baseboard.

When using the tuner for a receiver, it may be found more convenient to fit an insulated strip, with four terminals, to the rear of the baseboard. Aerial, Earth, and Phone connections can then be made to these terminals.

The reaction condenser should be slowly closed, from minimum capacity, until the set is nearly oscillating, or until a required station has been brought up to sufficient volume. This condenser does not make very much difference with powerful stations, but has a great effect on the results obtained with weak, distant stations. It should not be turned beyond the point where oscillation begins, as this may cause interference to other receivers, and will in any case give less satisfactory reception.

Chemistry

Send S.A.E. for leaflets:
H. Storer, 67 Clopton Road,
Birmingham 33

LEARN RADIO & ELECTRONICS the NEW Practical Way! Latest system of experimenting with and building radio apparatus — 'as you learn'. FREE Brochure from: Dept. H.W.10, Radiostructor, Reading.

IF you have taken a lot of care in making a musical box, be sure to make it worthy by including the best Swiss movement — a RÜEGE. Prices from 14/9. Wide range includes a charming Dancing Ballerina. Many tunes to choose from. Send for details in free booklet 'Profitable Leisure' HOBBIES LTD, DEREHAM, NORFOLK.

BUYING OR SELLING?

Classified advertisements on this page are accepted at a cost of 6d. per word prepaid. Use of a Box No. is 1/- extra. Send P.O. with advertisement to *Hobbies Weekly*, Advert. Dept., Dereham, Norfolk. Rates for display advertising on application.

BRASS, COPPER, DURAL, ALUMINIUM, BRONZE

ROD, BAR, SHEET, TUBE, STRIP, WIRE
3,000 STANDARD STOCK SIZES

No quantity too small List on application

H. ROLLET & Co. Ltd.

4 CHESHAM PLACE, LONDON, S.W.1

Also at

Liverpool, Manchester, Leeds, Birmingham

FOR MODEL MAKERS

THE 'MIGHTY MIDGET' electric motor, only 1½ in. high. Runs at 10,000 R.P.M. from a 4½ V. torch battery. Minute current consumption. Complete with pulley, price 11/-, postage 6d. **MODEL BOAT PROPELLER**, 3 blades, shaft, pulley, and 5½ in. long stern tube, to run off above 'Mighty Midget'. Price 7/3, plus 6d. postage. **HOBBIES LTD.** (Dept. 99), DEREHAM, NORFOLK.

UNDER 21? Penfriends anywhere — details free. Teenage Club, Falcon House, Buryley.

PAINT FOR PLEASURE AND PROFIT. Send for free exciting brochure 'Make Art Pay'. Popular Art Services, Clun, Shropshire.

ENJOY WRITING? Then write for Profit. Send for 'Writers' Handbook' (free) detailing countless opportunities for beginner or experienced. — Writers' Ring (HW), 5 Edmond Street, Birmingham.

BE A LIGHTNING CALCULATOR

ARE you good at mathematics? If your reply is 'No', do not worry, because now, with the aid of an attractively coloured set of specially numbered 'die' cubes, you are going to become a mental wizard who will add up large irregular sums with the rapidity of lightning. The set of five cubes must first be shaken up in a cup by a friend of yours, and then thrown out on to the table. When you have hardly glanced at the cubes, you will be able to announce the total in thousands, hundreds, and units. Much later, when he has completed the sum on paper, your friend will be able to confirm your mathematical ability. The experiment may be repeated once or twice again, if you wish.

You can easily make up the cubes. If five miniature toy bricks, measuring approximately $\frac{3}{4}$ in. square, are not available to serve your needs, you will have to cut out the cubes yourself. Take great care to achieve regularity of form and finish off the wooden blocks afterwards by thoroughly smoothing their faces, using fine glasspaper. Paint your homemade cubes in various gay colours. When the paint is quite dry, wash the cubes in warm water with detergent to remove traces of grease, rinse well in cold water, dry the cubes carefully, and number their various faces, as follows, by painting or writing on the figures in Indian ink.

Cube (1)	264	660	462
	165	363	561
Cube (2)	672	870	177
	474	771	375
Cube (3)	349	448	943
	745	844	547
Cube (4)	754	556	358
	952	853	259
Cube (5)	486	288	387
	981	585	189

You will now be wondering how the calculation may be rapidly accomplished. The secret is simple. As soon as you see the upturned faces of the scattered cubes, begin to add up the final DIGITS of the five numbers. The resulting sum will tell you the last two digits in the grand total of the big numbers. To obtain the first two digits of this answer, you merely subtract the small sum you actually calculated from the key number: FIFTY. If your little number comes to less than ten, then it must be prefixed by a nought when you announce your final total.

Let us imagine that the five cubes indicate the numbers: 264, 474, 547, 358, and 981. Immediately you add up the last digits. The total will be 24. This

number gives you the end two digits in the grand total of the big numbers. To obtain the first digits, subtract twenty-four from fifty. Thus your answer will be 2,624. Add up the five numbers properly, and check this rapidly calculated answer.

Another example will make the technique absolutely clear. Let us now imagine that the five cubes indicate the

numbers: 660, 771, 943, 952, and 981. The sum of the last digits will be 7, which is, of course, less than ten. Therefore, you must prefix the seven with a nought, to obtain the last digits of the grand total, thus: 07. Subtract seven from fifty, and you can quickly obtain the complete final total of 4,307. Check this yourself. Practise a little before you demonstrate to your friends. (A.E.W.)

A Bathroom Tidy For Toothbrushes

MEASURE off full-size pattern for side pieces (A) to dimensions shown and cut four of these from either clear perspex or fretwood of $\frac{1}{4}$ in. thickness.

The $2\frac{1}{4}$ in. square pieces (B and C) may be squared-off directly on to $\frac{1}{4}$ in. material. Measure out the four mortice-slots in piece C and the tooth-brush slots in piece B. Cut these pieces and the slots in them with the fretsaw.

Chamfer edges where sides fit together as detailed in Fig. 2. Round-off edges of base piece D to the section indicated in

Fig. 1. Glue piece C to piece D, then apply glue to edges and tenons of side pieces, and assemble.

Piece B may either be permanently glued to the top, or fitted as a removable lid so toothpaste may also be stored inside the stand. Make certain that all parts are cut, assembled and cleaned-up true, and finish the article with bright paint (or polish up plastic parts.)

Write or print identification panels against brush holders for each member of the family — as suggested by 'His' and 'Hers' on the finished article. (T.S.R.)

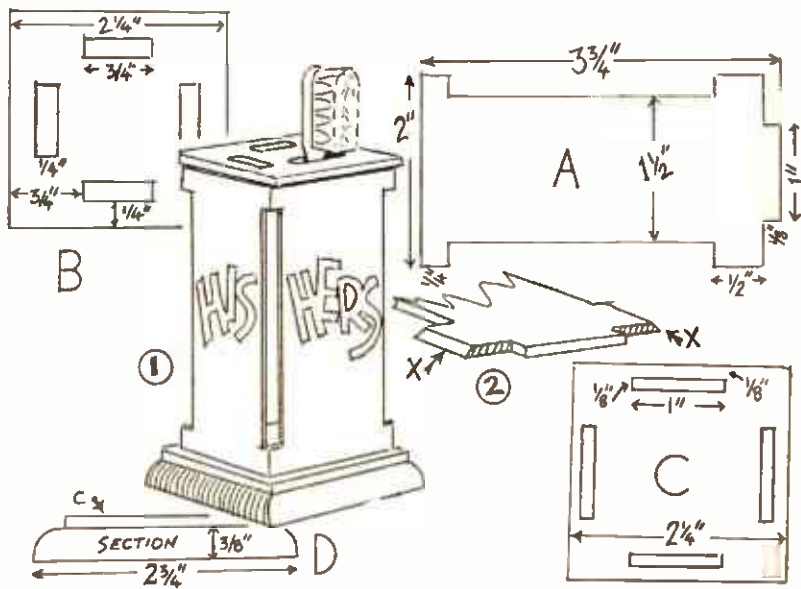

First of a series

THE JIGSAW ALPHABET

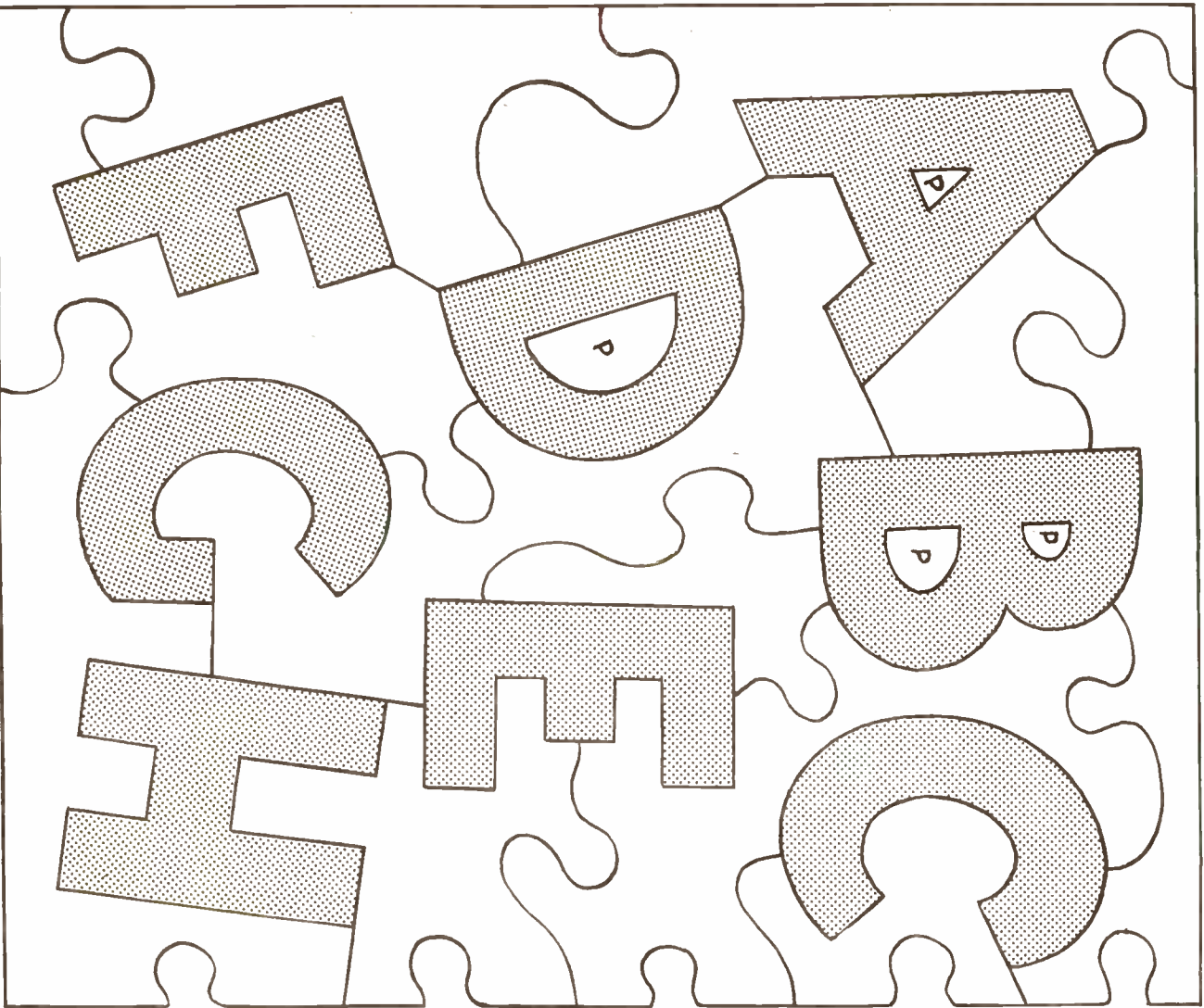

255

letters with bright enamels, and paint the rest of the jigsaw pale grey or cream. (M.p.)

complete jigsaw. Mark out the pattern on to $\frac{1}{4}$ in. plywood, and cut out with a fretsaw. Note that the pieces marked P are not cut, but painted on. Colour the

THIS simple jigsaw will be a help to the youngster just starting school. It will be continued in later editions of *Hobbies Weekly*, and will make one

Printed by BAIRDING + MANSSELL, LTD., London and Wisbech, and Published for the Proprietors, HOBBS LTD., by HORACE MARSHALL & SON, LTD., Temple House, Tallis Street, E.C.4. Sole Agents for Australia and New Zealand: Gordon & Gotch (A's.in.) Ltd. For South Africa: Central News Agency Ltd. Registered for transmission by Canadian Magazine Post.

READER'S REPLY
HW
JULY
1962

'LOG CABIN' CLOCK

Kit No. 3018

This Kit contains design with instructions, panels of selected wood and a reliable 30-hour movement, 28/-, plus 2/6 postage.



HOBBIES LTD (Dept. 992) DEREHAM, NORFOLK

WANTED

PRIVATE CHRISTMAS CARD AGENTS

(SPARE TIME)

MAKE EXTRA MONEY FOR CHRISTMAS BY BECOMING A SPARE TIME AGENT FOR ONE OF THE LARGEST FIRMS IN THE BRITISH ISLES, WHO HAVE BEEN OPERATING FOR OVER 50 YEARS

WE SUPPLY:

- FREE SAMPLE BOOK
- FREE STATIONERY
- SEND ALL GOODS POST FREE
- PAY HIGHEST COMMISSION AVAILABLE
- LARGE RANGE OF ATTRACTIVE DESIGNS TO PLEASE ALL TASTES

Write at once for further details of this money making offer. You incur no obligation by doing so.

GARRICK CARD CO., (Dept. 8)
MILLER STREET, PRESTON, LANCS.

AT HOME ON THE RANGE

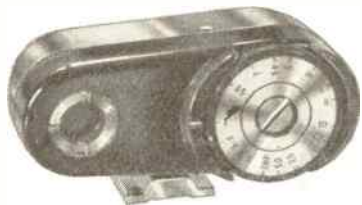

You'll be quite at home with the Johnson-Wray Optical Rangefinder, it's so easy to use and it fits almost every camera. You get perfect focusing every time, with every shot needle sharp! This beautifully made rangefinder has the largest possible viewing window that shows a bright, clear image. To find the range you just turn the milled wheel until a secondary yellow image is super-imposed in the viewing window. Then read off the distance and set your focus. Easy! Price. 43/10. Ask to see it at your photographic shop.

JOHNSONS
OF HENDON LTD
FOR CONFIDENCE IN PHOTOGRAPHY

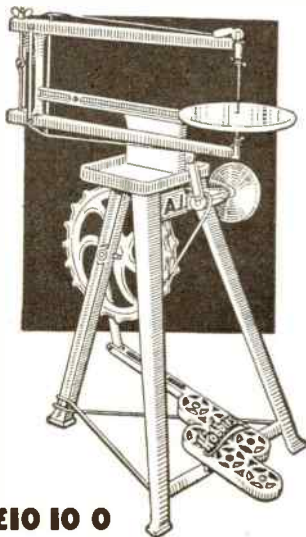

£10 10 0

'A.1' TREADLE SAW

A sturdy machine with cast metal legs, metal table, wooden arms, special saw tension action etc. Easy to treadle, smooth running and rigid. Provides a factory at home for the handyman — a machine for profit and pleasure.

THE 'MARVEL' BENCH MOTOR-DRIVEN SAW

To meet modern needs. Just plug in and switch on from any house lighting point. For either A.C. or D.C. mains, with 230/250 volt motor, flex, switch, etc.

£13 10 0

Also a Bench Machine without motor for 97/6.

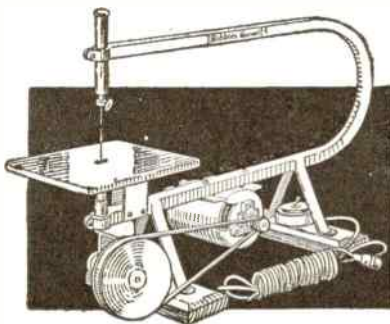

FAMOUS MACHINES AVAILABLE ON EASY PAYMENTS

A system is now in operation whereby a machine may be despatched carriage paid after the initial down payment, and subject to the completion of a simple form of Agreement. The slight additional cost over cash price is to cover extra clerical work, books, interest charges, etc. It is impossible for us to allow this system to apply in any part of Ireland, or anywhere outside Great Britain.

Agreement Forms are obtainable at any Hobbies Branch, where machines may be seen, and money paid each month. Or, you can do the business through Hobbies Head Office at Dereham, Norfolk, sending your instalments there.

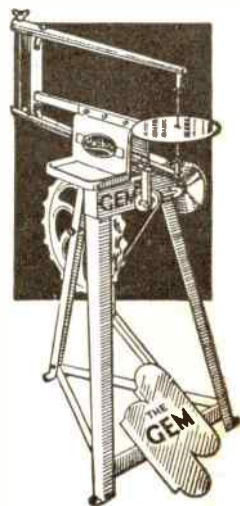

THE 'GEM'

£6 12 6

A lighter machine with pressed metal legs, but easy running and a reliable worker. Sound value and a machine for all kinds of work. Spare blades, instructions, and designs are included with each.

Hobbies Ltd (Dept. 99) DEREHAM NORFOLK