

6th JUNE 1962

VOL. 134

NUMBER 3469

THE ORIGINAL
'DO-IT-YOURSELF'
MAGAZINE

HOBBIES *weekly*

FOR ALL
HOME CRAFTSMEN

*FREE design for
making this novelty . . .*

Also in this issue:

**RAFTS FOR FUN
IN THE WATER**

**LATEST STAMPS
AND LABELS**

**PHOTO COPYING
WITH YOUR CAMERA**

**A RUSTIC TABLE
FOR THE GARDEN**

**MAKE A RAILWAY
COALING STAGE**

**A HOUSEHOLD
STEPLADDER**

**FRETWORK PLAN
ETC. ETC.**

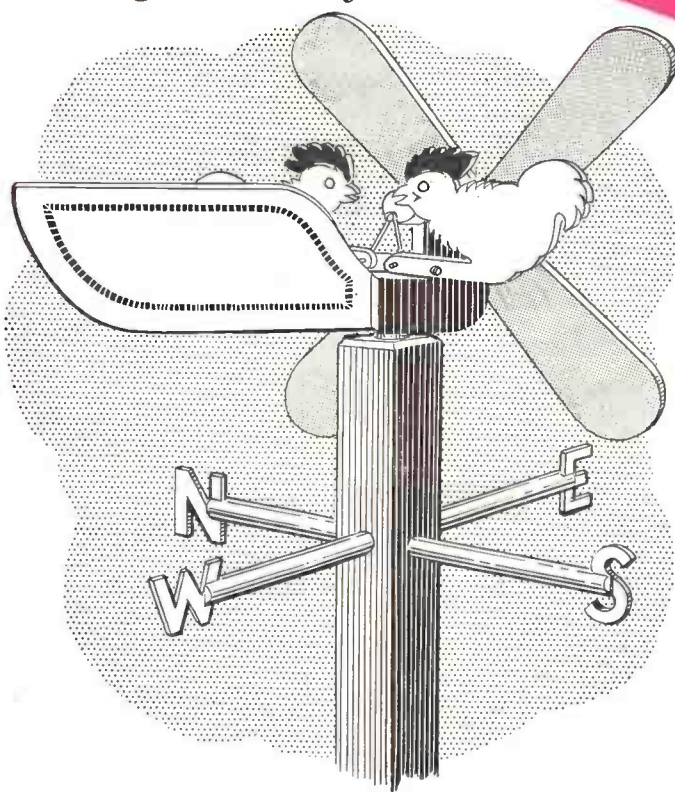

WIND VANE

Up-to-the-minute ideas

Practical designs

Pleasant and profitable things to make

World Radio History



5^D



Stamp Collector's Corner

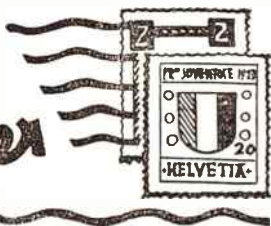

WITH all the changes that are taking place in Africa it is certain that every stamp enthusiast should look at his collection and try to fill in the gaps that may exist.

The Union of South Africa, that is the union of Natal, Cape of Good Hope, Transvaal and the Orange Free State, took place in 1910. The stamp illustrated was issued on 4th November 1910 to commemorate the opening of the first Union Parliament at Cape Town by the Duke of Connaught. Notice that the inscriptions are in English and Dutch and that in the corners we can see the arms of the four states comprising the Union. Stamps of the pre-union colonies were demonetized on 1st January 1938 so until that date one could, for example use a Cape of Good Hope stamp in any part of the Union. Subsequently only Union of South Africa stamps would prepay postage.

In 1913 a full set of stamps from ½d. value to £1 was issued, the ½d., 1d., and 1½d. are slightly different from the values of 2d. and above. The difference is that on the three low values there is included the word 'revenue' in the lowest scroll. The watermark was the springbok's head—one per stamp. But with the next set, which was issued in 1926, the watermark was springbok's head (multiple) which would mean that each stamp would have more than the one head, possibly one and the part of another. These would not of course be central—not quite so easy to spot as when there is just the one central item to look for. This multiple watermark continued in use until 1959 when it was changed for the Union coat of arms. The 1926 set introduced another novelty. The stamps were inscribed alternately in

English and Afrikaans. In this case it is preferable to collect the stamps in horizontal pairs.

Does it give you considerable satisfaction to find differences in stamps which at first sight appear to be of the same design? If you do enjoy this then you will find that the stamps of South Africa are going to reward your sharp eyes, for many of the early low values have slight differences. Take, for example the illustration of the pair of the penny value. This is black and carmine and the perforation is 14½ x 14. But if you can find one perforation 13½ x 14, then you have a very nice pair catalogued at £5.

In 1930 the design was redrawn and the word 'Suidafrika' was in one word, not with a hyphen as in the illustration. Also there is a difference in the two ornaments immediately below the 'S' and last 'a' of Suidafrika. In 1933 the same design was printed in grey and carmine and there are different shades of this to look for. So you see there is plenty of scope for finding differences between the quite common stamps. So often one reads of differences in the valuable stamps that it is a welcome change to be able to afford to buy duplicates so that one can have a lucky dip. Magnifying glasses should come out and a thorough search

Union of South Africa, commemorating the first Union Parliament



A penny pair (left) showing 'Suid-Afrika' with hyphen and (right) the 1936 'Gold mine' pair (the large size)

be made for varieties in these lower priced stamps.

In 1926 S. Africa issued a triangular stamp very similar to the Cape triangular of 1853. Although this stamp was issued in both English and Afrikaans they are on separate sheets so that it is not possible to have one set-tenant; nevertheless it is desirable to have a specimen of each printing in your collection.

Now South Africa has issued a considerable number of commemorative stamps and the Voortrekker Memorial Fund derived great benefit from these. In 1933 there appeared four stamps of postal value ½d., 1d., 2d., and 3d. with a face value of 1d., 1½d., 3d. and 4½d. respectively. The additional amount realised on their sale was set aside for the National Memorial Fund. The designs

1—THE SOUTH AFRICAN STORY

By L. P. V. Veale

were ½d. Church of the Vow, 1d. Cradocks Pass, 2d. Voortrekker, and 3d. a Voortrekker Woman. As the centenary was to be celebrated on the 16th December 1938 a special commemorative envelope was issued. It was designed by W. H. Coetzer and showed an ox waggon drawn by eight pairs of oxen.

This envelope was carried on a special ox-waggon post which left Cape Town on 8th August 1938. It travelled 1,705 miles and took four months, seven days to do it. The route took it through such historic places as Slagter's Nek, the site of the last struggle between the British and the Dutch in 1816, and which battle led to the Great Trek of 1836. It also went through Bulhoek, the supposed birthplace of President Kruger, through Bloemfontein to Vegkop, where the trekkers had their first encounter with the Matabele, and on to Pretoria. The prepared envelopes which were carried on this ox waggon were very large. The reason for this is that not only does it carry a very large design but also it should have four pairs of stamps stuck on—that is if it has the full set.

Normally one should put stamps in an album as far as possible in chronological order but in the case of South Africa this does not give the best arrangement. Take for example the 1½d. gold mine stamp. It was first issued in 1936 This was the full size specimen. Another stamp of quite similar design but not quite so large was issued in 1941, while the very small stamp of the same design

● Continued on page 147



This beautiful set of Russian match labels depicting pigeons, which has just been released, will doubtless be regarded as one of the year's major issues. Mr Gevergeieff says in a letter 'They are limited and won't last long.' Order from your dealer now

'EUROPA' STAMPS FROM CYPRUS

TO commemorate the occasion of Cyprus becoming a member of the Council of Europe, the Cyprus

Government issued a special three value series of 'Europa' stamps.

The design, which is common to all three values includes the word 'Europa'. The colours are as follows:

10 mils — Mauve for background and white for doves.

40 mils — Cobalt for background and white for doves.

100 mils — Apple-green for background and white for doves.



This stamp appeared from Denmark on 10th May 1962 to mark the 'Centenary of the Abolition of the Mill Monopolies'

● Continued from page 146

THE SOUTH AFRICAN STORY

came out in 1948. Surely these three pairs of stamps would look better if they all appeared together with the dates of issue written clearly below them.

The year 1935 brought us the Silver Jubilee set of four values ½d., 1d., 3d. and 6d. Although each stamp has the name in English and Afrikaans on it yet they should be collected in pairs as alternate stamps have the position of the inscriptions reversed. As an illustration of how important it is that the stamps should be joined in pairs let us look at the catalogue values of the stamps as a pair and as two singles. Separate specimens of the 3d. are quoted at 12s. 6d. whilst a pair would be 40 shillings.

Now the Silver Jubilee stamps provide anyone with an excellent exercise for sharp eyes. There are so many varieties to be found. One of the most important is the cleft skull variety. As its name in-

dicates it is a stamp which has a scratch from the top of the skull to the chin, just in front of the ear.

In 1937 five values were issued to commemorate the coronation of King George VI and Queen Elizabeth on 12th May; they were printed in photogravure by the government printer in Pretoria. Look carefully at the King's head and the colour inside the frame. You may very likely find one of the many varieties. Quite a number of these stamps show white lines and smudges, particularly in this coloured portion. The explanation of these blemishes is that two cylinders were used in the printing of the interior part of the design. One cylinder was very good while the other was full of the minor flaws. A separate cylinder was used for each of the frames.

The South African story will be continued in another issue.

Advertisers' Announcements

100 DIFFERENT stamps free! Request ½d. upwards discount approvals. — Bush, 53 Newlyn Way, Parkstone, Dorset.

101 STAMPS FREE: many pictorials, (catalogued 12s.6d.). Request approvals—postage 4½d. — W. H. Westlake, Clawton, Holsworthy Devon.

FRIENDS' WORLD. International Pencil Association, (H.B.) Postbox 708, Calcutta, India, offers world-wide congenial pen friends.

20 LARGE ANIMALS 9d., sent with discount approvals. — Globalmix, 12 Haslow Place, Blackpool.

HAVE FUN WITH A RAFT

IF rafts are used within their capacities they can give quite a lot of good fun, but more must not be expected of them than they can do. Remember, a raft is not a boat and has not the sharp prow and other characteristics which make a real vessel readily manageable in currents and winds. Thus, rafts can be easily caught by the flow of a stream, and too vigorous movements on the part of the passenger may cause them to tilt up.

But if you accept these limitations, rafts on shallow rivers and ponds, especially if near where you are camping, can give hours of sport, the fun being added to if you are in bathing kit and ready for an occasional plunge.

The simplest possible raft is shown in Fig. 1. This is merely a number of approximately equal-length logs lashed side by side to the cross-members A. The longer the pieces and the more of them used, the greater the buoyancy of the final craft. As far as possible use single lengths of cord for the lashings (one to each cross-piece), the cord being taken at the intersection of the members as shown in the inset sketch. This type of lashing is standard for all times when spars at right angles have to be joined, and it is continually cropping up in raft making.

This kind of raft usually rides low in the water and the passenger must balance well in the centre of it and distribute his weight equally. Nevertheless, it can yield much entertainment.

The 'Outrigger'

The floating log was probably man's first idea of a boat, but he was not long in discovering that unless there was

some lateral support his vessel rolled over. Thus there came the 'outrigger'. To this day it features in many native vessels, which in themselves are little more than hollowed-out tree trunks. The outrigger is an arm protruding from the vessel at right angles and having on its end a small float, the arrangement giving in effect a boat of a width equal to the length of the arm.

Using this method, any fairly heavy log that does not ride too low in the water can be made into a reasonable passenger-carrier as shown in Fig. 2. Four spars are required as A, and the longer these are, the more stable will be the log. Also needed is a shorter piece of wood B, to act as the outrigger float. The spars are lashed above and below the main log and float as indicated, the rope being taken right round the bigger pieces and over the smaller in a larger version of the lashing shown in Fig. 1. For holding everything tight, the length of rope which is taken horizontally round the lashings is important in this case.

To complete the raft, a seat can be fastened at a point between the outrigger spars. Two blocks of wood secured to the log sides will act as foot rests. This type of raft incidentally, falls into the category of the 'catamaran'.

Use a barrel

Comic papers always show people floating away in a barrel. But they are not so far from the mark as a really good raft can be made from a closed barrel of sufficient size, and floating horizontally in the water. The safe weight such a barrel will support can be roughly gauged by multiplying the capacity in

gallons by nine, this giving the permissible load in pounds.

The trouble with a barrel alone is, of course, that it rolls over if anyone sits astride it, but this characteristic can be stopped by fitting with an outrigger frame as shown in Fig. 3. The barrel is kept in position by the lashing A, which goes right round and is fastened to the cross parts B. In fitting the frame, adjustment has to be made so that the barrel under load floats at the same level as the outrigger logs. This means that the frame has to be generally lashed at a position higher than the centre of the barrel ends, but everything depends on the size of the barrel.

The long spars D, are any suitable lengths you can find, but as with the log raft, the longer they are the greater the final stability of your craft. Also, the end floats must not be too small, although the further they are from the barrel, the less need be their size.

Although the first feeling with this sort of craft is to sit astride the barrel to propel it, more fun can be obtained by sitting the other way, that is, facing one of the floats and putting your feet on a near cross spar. Using a paddle, it is then quite possible to send the raft through the water as shown by the arrow. If desired, a board could be lashed across the main members just in front of B as a foot rest, though if B is long enough, the ends of this will do quite well for the feet.

Petrol tin raft

The next one is a really good proposition. It is constructed with standard petrol tins and will carry quite a heavy person well out of the water. If the tins are only required for a limited time, as, say, during a camp, it might be possible to borrow these from a nearby garage, especially if the firm concerned has done any of your transporting. With reasonable care, the tins are not in any way damaged by incorporating them in the craft.

Twelve tins are required, and these are laid out in two rows of six each, with their filling caps towards the top. All the caps, incidentally, must be securely screwed down. Four spars, A and B in Fig. 4, are then required to go along the full length of the upper sides and four more as C, D, E and F to go at right angles. These spars must be firmly lashed together into the framework shown, before dealing with the tins, the square lashing again being used at all points of intersection.

Now take six of the tins and lash them

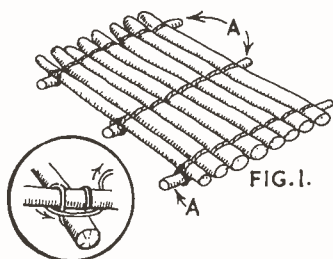

FIG. 1.

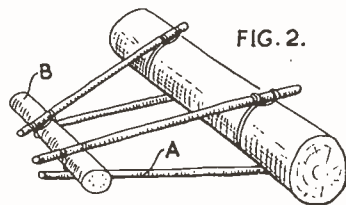

FIG. 2.

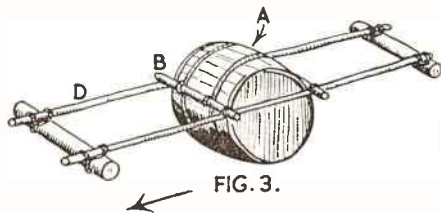

FIG. 3.

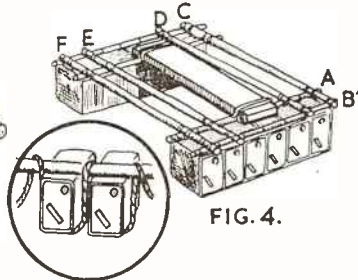

FIG. 4.

AN EFFICIENT POND NET

AFTER obtaining his first microscope, a youngster will soon want to collect specimens for examination. Tiny insects and other minute creatures abound in our ponds, lakes and streams, and provide a most interesting study under the microscope.

To collect these specimens, a pond net is essential; and this can be made from easily obtainable materials at a very

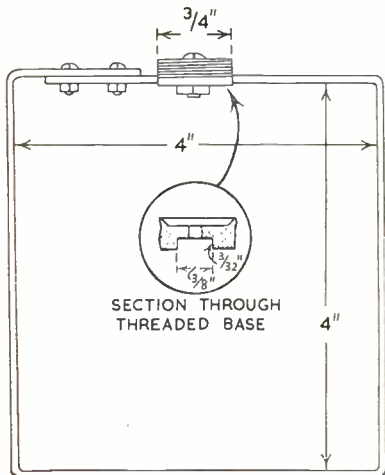

Fig. 1

small cost. The one described is made detachable, so that other accessories can be attached to the same rod when necessary.

The frame to carry the net is made from a piece of brass valance rail used for curtain railways. Obtain a length of rail 18 in. long by $\frac{3}{8}$ in. wide by $\frac{3}{32}$ in. thick and bend it into a 4 in. square as shown in Fig. 1. Drill two $\frac{1}{8}$ in. diameter holes and bolt the ends together. In the centre of the side where the ends are joined bore a $\frac{3}{32}$ in. hole. If tapping gear

is available it is better to drill a smaller hole and tap to take a bolt $\frac{3}{32}$ in. in diameter.

From a hardware store obtain a brass towel rail bracket as shown in Fig. 2 to take a $\frac{3}{8}$ in. diameter rail. Remove the threaded sleeve and cut off the threaded section from the bracket. The bracket is no longer required. Drill a $\frac{3}{32}$ in. hole down the centre of the threaded stud and cut a slot on one end $\frac{1}{8}$ in. wide and $\frac{3}{32}$ in. deep to take the frame for the net. Bolt the frame to the stud with a $\frac{3}{32}$ in. bolt, and if the hole in the frame, as shown in Fig. 3, has been threaded, lock it with a nut on the inside.

The screwed ferrule is fitted to a $\frac{7}{8}$ in. diameter handle 4 ft. 6 in. long, and this

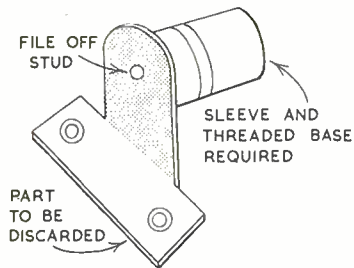

Fig. 2

must be a drive fit leaving the threaded portion exposed just sufficient to screw on the frame. A small handle about $2\frac{1}{2}$ ft. long can also be made, and will be found very useful.

The net is made from the top 9 in. of a lady's nylon stocking. The double seam is threaded over the brass frame, which is then bolted together. It may be neces-

sary to slightly enlarge the hole in the seam but this should be sewn up afterwards. At the other end a hem is formed and a strong piece of tape attached so that it can be tied round the top of a small glass bottle about 1 in. in diameter and 3 in. long. Well varnish the handles.

In use the net is swept through the water or dragged slowly through weeds in the pond. It is removed from the water and the microscopic organisms will have been washed into the bottle which is tied to the net. The catch can be examined with a hand lens and if the

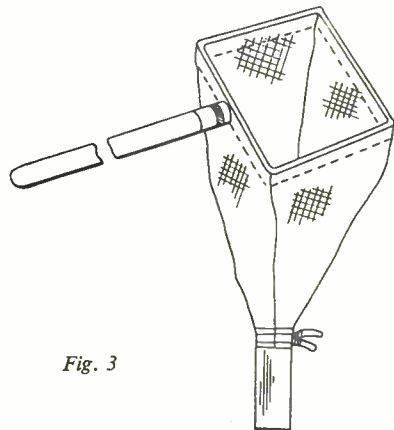

Fig. 3

specimens are required they can be placed in screw top jars and taken home for a detailed examination under the microscope.

(C.F.)

● Continued from page 148

HAVE FUN WITH A RAFT

HAC PRODUCTS

Will readers please note that the correct address of HAC Short-Wave Products, suppliers of kits for Short Wave Receivers, is

44 OLD BOND STREET,
LONDON, W.1

Recent advertisements of this firm have inadvertently carried the old address at 11 Old Bond Street. Customers who have had no reply to recent correspondence should therefore note the reason and make renewed application to 44 Old Bond Street, as their letters may not have been forwarded.

under one of the ends as shown by the inset sketch. A continuous piece of cord is used, and is taken alternately under a tin and over a spar. The tins must be pulled together as tightly as possible so as to form, as nearly as they can, a solid block. And to get this ideal condition it might be found advisable to take a horizontal lashing round a complete set, passing the cord through the handles which, as well as anything else, will prevent any tendency it might have to ride up.

Finally, lash a board (or boards) across the centre, as shown, to give the passenger a riding position. In this type

of raft, the longer the longitudinal spars, the more stable the whole arrangement will be; but of course they must not be so long as to introduce any undue springiness. The vessel is propelled by paddling in the space left between the central boards and longitudinal spars.

One final word. Make your rafts as near the water in which they are to float as possible, as while they are perfectly firm when supported by the water, they are not so easy to carry without disturbing the lashings. If there is any lifting to be done, get as many persons to help as possible, so that they can all take the weight of various parts together. (E.)

WHAT DO YOU KNOW ABOUT

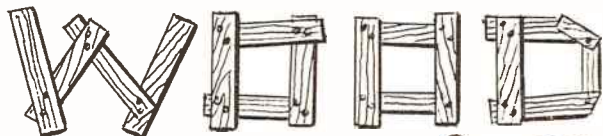

asks Ed Capper.

NOWADAYS the word 'deal' has come by common usage to mean collectively, the various softwoods which we import. The word however, originally meant a measurement of firwood of not more than 3 in. thick, 7 in. or more wide, and 6 ft. or more long. To be used correctly today, the word deal should only refer to the timber known as European Redwood or Red Deal. All the same it is one of the best known timbers in the world.

Softwoods, used mainly for building and construction work, are derived from coniferous, needle-leaved trees. Their opposites, the hardwoods, come from the broad-leaved trees of the temperate and tropical forests and are used mostly in the furniture trade.

Softwood forests extend in a belt across the Northern Hemisphere, running from North America to Scandinavia, Russia and Siberia, and Northern Europe. At the same time softwood areas are found in hardwood areas but mostly they are growing at high altitudes above the tropical level.

Although the terms 'softwood' and 'coniferous wood' are mostly used collectively it should be remembered that some coniferous woods can be hard and heavy, such as pitch pine. On the other hand there are a few woods of the broad-leaved variety that are both light and soft, such as obechi. However, by

far the majority of softwoods are from coniferous trees.

Surprisingly enough, there are not many varieties of species of softwoods in any one forest — four at the most. This, together with the uniform size of the trees and the fact that the natural growth of a conifer tree gives it a single main stem, usually straight, makes it a fairly easy tree to take from the forest. On the other hand, very many different species of trees are found growing in the hardwood range in tropical forests, thus making their extraction more difficult.

It has been said that the rapid growth of early civilization was due in no small part to the plentiful and easily found supply of timber. In Great Britain, forests of any great extent have long since disappeared and the importation of wood is one of the biggest industries in the country.

A softwood importing trade was in existence here even before the Great Fire of London. In fact, the Fire really set the importing business going in a big way for as much timber as could be



found quickly was needed for rebuilding the City of London.

The main sources were, of course, Central and Northern European countries. A few years later the Napoleonic Wars cut off these supplies and we had to look elsewhere. A natural source was from our newly won colonies in North America and from that day we have continued to obtain our largest supplies from this area.

When a tree or limb is felled the wood is very waterlogged. This moisture begins to evaporate immediately and after a short period the wood begins to shrink. This shrinkage is not consistent in all directions; furthermore wood has a blotting-paper texture and is capable of soaking up water long after it has dried.

It is vital, therefore, that the skill in using and marketing wood is consistent with the ability to control these various changes in its life. All wood must be dried to a certain extent before use and the exact state of dryness is determined by the final use to which the wood will be put.

A KEY 'BANGER'

AN old key with a hollow 'stem', a blunted nail, some string and a match head or percussion cap will make a simple banger that will keep a boy amused for an hour or two. Select a nail that will fit snugly into the space inside the key stem and cut off the point with a hacksaw.

When the nail is inserted inside the key, its head should protrude for about $\frac{1}{2}$ in. Tie the ends of an 18 in. length of strong string to the top and bottom of the key, so that the completed banger may be suspended by the resulting loop in a horizontal position.

To 'charge' the banger you may either use toy percussion caps trimmed down with scissors, or fragments of the chemical material from a red-top match

pared away with a penknife. If you use a match, be careful not to ignite the material by friction as you wield the knife.

Employ the nail 'detonator' as a ram rod to push the mild explosive charge down into the tube of the key and press the nail firmly into position. Do not be tempted to load your banger with material scraped from more than one match. The suggested amount of material will be quite sufficient.

Fire the device by first suspending the key, as described, and then swinging it hard against a wall, in such a manner that the detonator head strikes the stonework. The faster the key is moving on impact with the wall, the greater will be the bang as the detonator tip compresses and fires the charge. (A.E.W.)

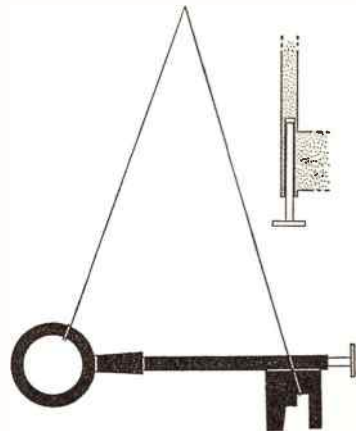

NOVELTY WIND VANE

THE FIGHTING COCKS

OUR design for this novelty wind vane incorporates two cockerels who move up and down most realistically in a fighting attitude when the propeller of the vane is rotated by the wind. It makes a pleasing novelty for the garden, being especially interesting for the children.

Hobbies kit contains all the wood, wire, round rod, stripwood and washers to make the vane and the letters. The post is not, of course, supplied with the kit.

Most parts are full size on the design sheet, and they should be traced and transferred to the appropriate thicknesses of wood by means of carbon paper. For piece 1 the main shape is given full size, but note that the length of the vane has to be extended to make the overall size 15 in. When all the parts have been marked out on to the wood they can be cut out with the fretsaw and cleaned up with glasspaper.

Waterproof glue

In all stages of the assembly waterproof glue such as Cascamite One-Shot should be used, and because the novelty will be subject to all kinds of weather, the finish should also be carefully applied. Initially it would be advisable to treat with a wood preservative such as Cuprinol. Then after under-coating, two coats of exterior grade paint should be given for good protection.

All details are given by means of diagrams on the design sheet and should be consulted in conjunction with these instructions. Glue the pieces 2 on either side of piece 1 and piece 3 is then fixed across centrally as shown in diagram A. Screws can be added here for extra strength.

The wire axle (9) which takes the propeller, goes through the centre of the vane assembly, which must be drilled accordingly so as to make the axle a fairly loose fit. Note that the axle is flattened at one end and tightly inserted into pieces 4, which have been glued together with the grains running in oppo-

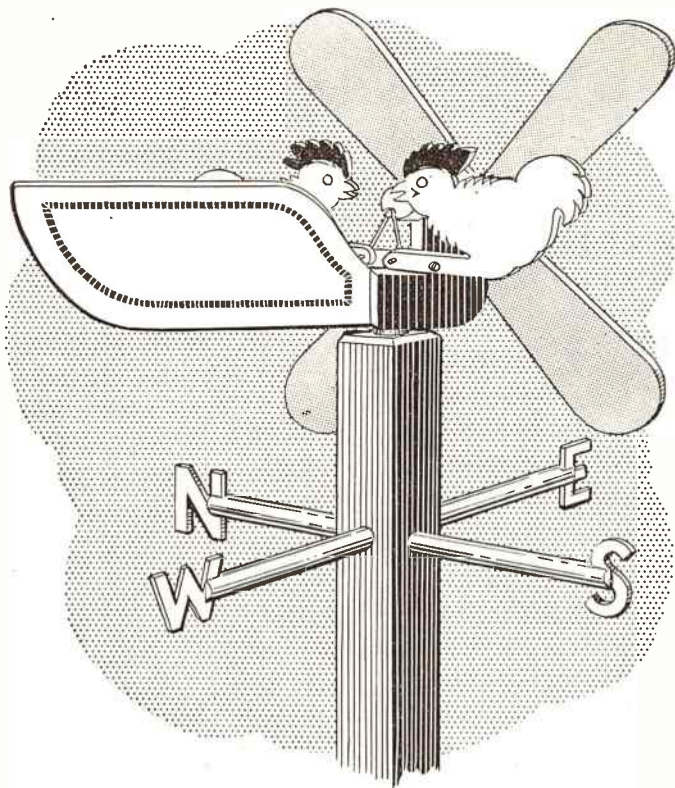

site directions. Don't forget to insert the washers (W) in the correct positions when assembling the axle.

The supports for the propeller blades (pieces 6) are shaped from $\frac{3}{8}$ in. square stripwood and halved together as shown in the detail (B). Note from the drawing the angle of slope, and fix the pieces together by gluing. A hole is then drilled centrally to take the axle.

Now add the blades (7) of the propeller, feathering the edges rather than leaving them square. Pins or screws can be added for additional strength.

Pivot the birds in position with round-head screws and facing inwards, of course, as seen in diagram A. Connect them finally to the driving wheel (4) by means of the wire links (8). These links are pivoted to the driving wheel by means of a roundhead screw and washer. The length of the links and the exact pivoting position of the birds is a matter of trial and error to obtain an easy and satisfactory action.

Nail pivot

A pivot for the vane can be made by drilling a fairly substantial nail into the

top of the post and filing off the head. Add a couple of washers and then drill a hole in the underside of the vane which should then pivot nicely on the nail.

The arms of the N.E.W. and S. points are $\frac{3}{8}$ in. diameter round rod and the appropriate letters are cut from $\frac{1}{4}$ in. wood and glued into slots in the ends of the rods. The positioning of the post will, of course, be determined by a compass reading.

★
★ **A KIT FOR 9s. 11d.** ★
★ **Hobbies Kit No. 3469 for making** ★
★ **this attractive and novel Wind** ★
★ **Vane contains appropriate panels** ★
★ **of wood, stripwood, round rod,** ★
★ **wire, washers, screws, etc. Kits,** ★
★ **price 9s. 11d., from Hobbies** ★
★ **branches and stockists or direct** ★
★ **from Hobbies Ltd, Dereham,** ★
★ **Norfolk (post 2s. extra)** ★
★
★

MAKE COPIES WITH YOUR OWN CAMERA

ANYONE who owns a camera can make copy photographs. Letters, diagrams, photos of which the negatives have been lost, stamps, coins, pages of books needed for future reference; all these can be copied in every detail in a matter of a few seconds. Naturally, the better the camera and its lens, the better will be the copy pictures, but even simple box cameras can be used provided that the negatives are not enlarged too much. A print size of at least postcard from a conventional 3½ in. by 2¼ in. negative should be possible from most cameras, however old or inexpensive they might be.

In order to approach the subject close enough to obtain a reasonably large image on the film, it is necessary to clip a supplementary lens over the camera lens. You can buy one from any photographic dealer for a few shillings, and the clip mount suitable for your model camera

By
A. E. B.

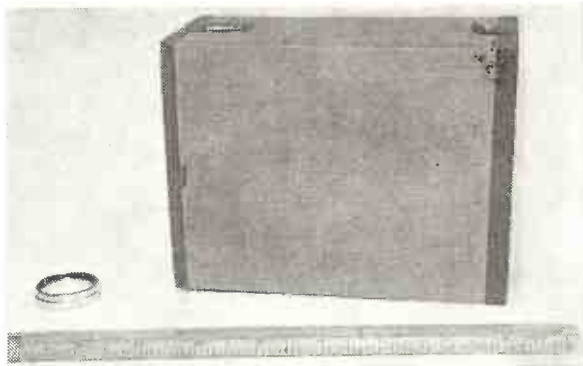

The only requirements

intermediate distances are also given. Remember, all distances are measured from the face of the subject to the plane of the film in the camera.

With a fixed-focus camera, only one working distance is possible for each strength of supplementary lens, and that must be found by conducting a simple experiment. Fit the supplementary in place, open the shutter of the empty camera to the 'Time' setting, and open or remove the camera back. Fix a strip of tracing paper, the same width as the film, tightly across the guide rollers with strips

width and height of this visible area for future reference. At such close ranges the viewfinder is hopelessly inaccurate, both for aiming the camera and determining the area covered, so it should be ignored.

When making copies use a fairly slow film, for example Ilford FP3, Adox RB 17 or Agfa Isopan F, as these give results of the highest quality and improved sharpness. This film is also quite suitable for ordinary outdoor snapshots in average light, so you can keep the same one in the camera all the time and mix the subjects up just as you please.

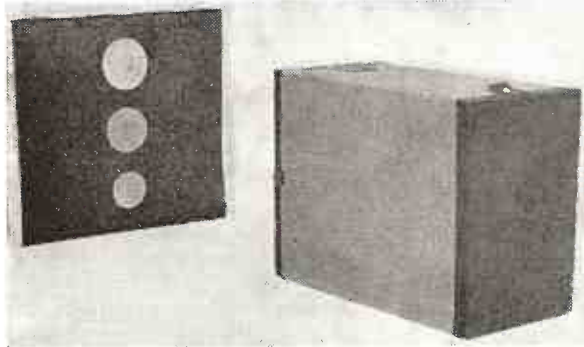

The set-up for photographing coins



Copy of a postal cover

may be had at the same time. A No. 1 supplementary lens is suitable for very large original subjects, the No. 2 for medium-sized ones, while the No. 3 is best for smaller items such as a group of coins or stamps or the page of a book. In addition you will need a ruler.

If your camera has a focusing lens, you can make use of the chart supplied with the supplementary lens. This gives a list of camera lens scale settings for various working distances. For example, with a No. 2 supplementary, when the working distance is 12½ in. the scale must be set to 3 ft., and when the distance is 19½ in. it must be set to infinity. All the

of adhesive tape.

Cover your head and the back of the camera with a cloth and move the camera backwards and forwards in front of a brightly illuminated sheet of newspaper. By watching the tracing paper screen, you will easily be able to determine the distance from the camera to the newspaper which gives the sharpest image. Measure and make a note of it, for that is the range at which the camera will always be used.

While you are doing this, you can also see from the tracing paper screen just how much of the subject will be included in a negative. Measure and note the

The subject matter must be propped up vertically in front of the camera and at the correct distance. You could cut out a plywood easel, rather like a book end in shape, to support the original. The easel should have black paper stuck on with tape to form a background for small light-coloured items, and white paper for dark ones. The subjects can then be attached to the background with tape or stamp hinges fitted out of sight.

Heavy subjects, such as coins, are best mounted by applying a spot of rubber cement to their backs and to the back-

● Continued on page 153

A TABLE FOR YOUR GARDEN

THIS useful table is semi-rustic in appearance and makes an attractive addition to the garden. It is very solid and substantial and if well made will last for many years. It can be used for outside meals during the summer and can safely be left outside during the winter.

The measurements are shown in the plan and side view (Fig. 1), the overall width being 42 in. and height about 28 in. to 30 in. The top and feet are made up separately and then attached to the column.

The diagram in Fig. 2 indicates how the top is made up from seven boards 6 in. wide and 1 in. thick. They are held together by cross battens of 2 in. by 1½ in. wood. The diagram shows, of course, the underside of the top.

Fig. 3 shows how the feet are made up from 3 in. by 1½ in. pieces 24 in. long. They are halved together and slotted into the centre column.

Make the centre column from a branch or trunk of a tree about 6 in. diameter. If the bark is adhering firmly it can be left in place, otherwise it should be stripped clean. Lay the feet across the bottom and mark their positions

AN ATTRACTIVE FITMENT WITH A RUSTIC APPEARANCE

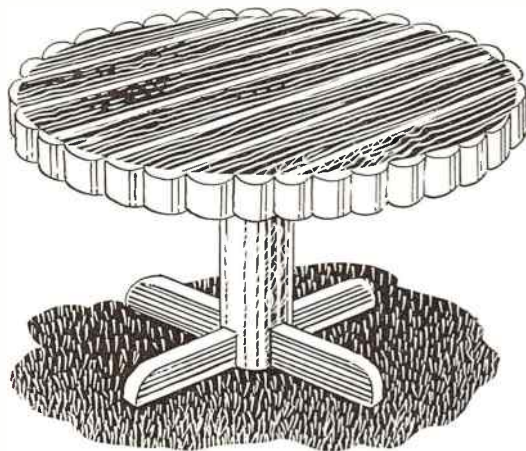

before cutting. Cut down with a saw to the required depth and clean out with a chisel.

The top is edged with small half logs with or without bark, nailed all round. The diameter of the logs should be about 2 in. to 3 in.

Finally place the top in position on the centre column and secure with three ½ in. diameter dowels, or four large nails. It will be advisable to drill the top to suit the nails to obviate splitting.

Finish off by giving two coats of clear

wood preservative for protection against the elements. This treatment should be repeated each year. (M.h.)

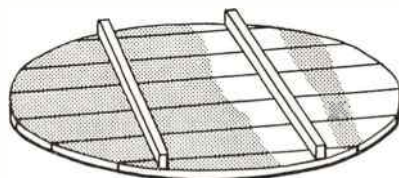
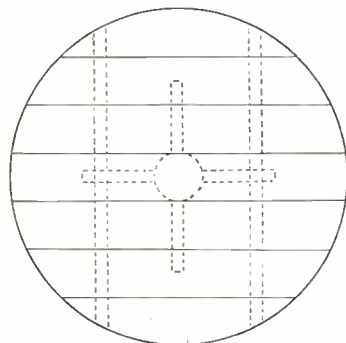
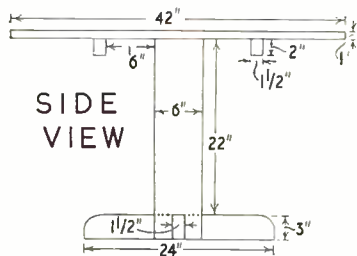

Fig. 2



PLAN

Fig. 1

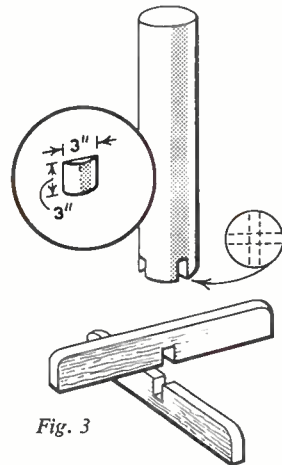

Fig. 3

Continued from page 152

MAKING COPY PHOTOGRAPHS

ground. When both patches are dry, the two should be pressed into contact. The rubber cement can be peeled off with a dry fingertip later. Books may be held open by securing them to stout cardboard with rubber bands.

It is important to line up the lens with the centre of the subject, both horizontally and vertically. If necessary, either the easel, or more frequently the camera, will have to be raised up on one or two books to achieve this.

Use the smallest lens opening on your camera, generally marked $f/16$ or $f/32$, and take care not to shake the camera while exposing. The most satisfactory method is to hold a black card almost touching the lens while you open the shutter to

'Time', remove the card when the camera is stationary, replace the card after the appropriate interval, and then close the shutter. There is then little risk of movement spoiling the picture.

Using the films mentioned earlier, and a 100 watt pearl bulb 3 ft. from the subject, the average exposure will be in the region of 5 seconds at $f/16$ or 10 seconds at $f/32$. That the process is capable of producing some fine results can be seen from our copy of an interesting postal cover. All the details, however lightly toned and fine, are captured without difficulty. The hobbyist and practically everyone else will find many applications for photographic copying.

NEW Thoughts on

RAILWAY MODELLING

THERE are many types of coaling stage used on railways today, depending upon the amount of coal needed, the type of engines that use it, and the size of the locomotive depot where it is housed.

The larger type under review here is one where the coal is transported in the truck to the top of a concrete tower, and then dumped into the large open mouth, the truck returning empty to track level when the job is completed. The locomotives run under this tower, and the coal is dropped into the tender or bunker, being weighed in the process.

Our coaling stage is a large concrete structure with a lift for the trucks. You will have a lot of fun making it work, either by hand, or by a cheap electric motor. The drawings, will have to be enlarged with your scale rule.

are going to use this as a bearing. Get two wheels, they do not have to be the same, but I think you will know the usual flanged wheel in the range, push the boss through the side from the *inside* of the stage walls, and glue in place. Make sure that the two wheel centres line up when the job is assembled as you have to put a shaft or handle through these afterwards.

You can then assemble your stage, but leave off the back middle section so that you have access to the shaft above. The back part should be left off if you are making the electric model as well, but in both cases put strips of wood down the side of the opening left, and along top and bottom so that you will have something to glue to when you put the back in place.

Your next job is to make the runners up which the truck runs, or at least the hoist platform. These are best made of 00 gauge running rail, and you should get bull head section, available at all model railway shops. Here is where you will have to do some soldering. I will tell you how the thing works and perhaps you will know what is to be done. The platform or hoist has to be made up from wood (you will see this in the drawing) and at the top and bottom of the sides are placed two wheels that run in the rail. The wheels I used on my model were in fact brass ships deadeyes, which were just the right size.

Failing this you could use two beads at each position so that the rail comes between the two beads. Get your pulleys or beads first, and then set the distance between your front and back runner to suit. You will want this space to be just a little wider than the centre of the deadeyes, that is the groove in the centre, so that when the hoist is moving it only touches on one of the runners. If it is tight you will not get the thing to move at all. When you have determined the width draw out the lines that the two runners are to take, and do this on a piece of wood. Drive in a row of pins along each of these lines and then after bending your rail to shape put the front one in position, making sure that the part of the rail that is to face the gap does so, and then drive in more pins to hold this in position. Do the same with the back rail. Assuming that you have bent and cut the side supporting pieces these can now be soldered into place.

MAKING A COALING STAGE

By F. A. Barrett

Make up the main structure from thick card using the same method as described for the locomotive shed.

Mark out one side and either pin the two together or else cut one side and then use this as a template for the other side. The other sides are made up in sections. The lower pieces are delicate cuts, as they look like two legs with a thin strip between them. You could make this part of strips of wood. The parts above these are easy, merely being rectangles of card, in one of which a hole is cut to receive the truck. Above this are two smaller pieces, and the roof goes on the top. Make a piece to fit in the bottom for the floor and reinforce the whole structure with stripwood where possible but leave the opening clear for the truck.

Before you stick any parts of the model together you must decide if you want the thing to work. If you merely want a static model, you can go ahead with the assembly. If you want the model to work by hand you must carry out two further operations. At the top of the shaped sides you will have to drill a hole near the top about 1 in. down and in the middle, the size to take the boss of a Meccano wheel with the setscrew removed. We

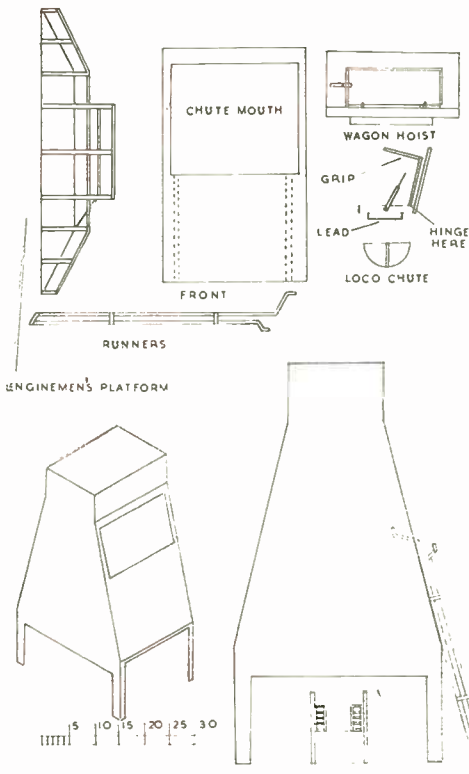

When you have finished one side, do the other, but note that these parts are 'handed', that is to say you must make one right, and one left. When all that is done you can then solder the cross members in place. Wash the parts with hot water to remove flux.

You will have to drill small holes in the cross members so that you can fix them to the coaling stage front, and you will see in the drawing the location of the runners. The hoist platform should next be made to the drawings, and for this you will have to use wood. You will see that a short piece of track will have to suit the type you are using. To accommodate the hoist a hole will be cut in the baseboard to allow it to fit in and the tracks will have to line up with the track on the platform. A sprung retaining bar will be fitted to the back of the hoist, the idea of this being to hold the coal wagon in position on the track whilst it is being hoisted, and to hold it there whilst the wagon is turned over in the top of the coaling stage. The underside of the hoist platform will have to be weighted with a piece of lead nailed underneath, to counterbalance the wagon hoist when the coal has gone. The pulleys will have to engage in the runners, and make sure that your hoist runs up and down freely.

Two small pieces of rail with a small hole drilled each end are used to haul up the hoist. These are pinned in the centre of the hoist platform, and the other end fasten some cord. Make sure that when the hoist platform is at the bottom the two small pieces of rail lie flat and out of

the way of the wagons. They must of course lie to the back of the platform, and the cord (cable) will then be clear of any vehicle.

The ramp used by the enginemens to load up their engines can be made from a solid block of wood, with side supports of thin stripwood. The ladders that go to the upper platforms can be pieces of signal ladder, purchased at any model shop and the platforms are made from pieces of card.

The under shoots that actually load the coal into the engines can be made from either pieces of suitable sized dowel split in half, or else from half round beading. In either case the detail is put on with thin strips of paper.

Now to powering the model. For a hand powered model get a Meccano handle of the right length and get someone to drill two small holes at each end and in line with the cords from the hoist. Put the handle through the bosses of the two wheels which we are using as bearings. A bush each end outside the stage with a set screw in each will hold the handle in place. Tie the cords to the handle through the holes and then turn until the hoist rides up the runners, and there you are.

As a refinement you could alter the top front piece of the coaling stage by cutting small rectangles and putting a Meccano rod across the opening so formed with a small free running pulley wheel over which the cords would run. In any case this method should be used for the electric powered model. For this you will need to make a small plat-

form on which to put the assembly. This should be of wood, so that you can screw the components to it. You will need a small electric motor — one of the 'Mighty Midget' motors supplied by Hobbies Ltd. would be ideal — a Meccano rod or axle, a couple of bearings, a pulley, some wire, and some sort of resistance to slow the speed of the motor down. This can be a variable resistance or a fixed one, and you will also need a change-over switch.

You will see from the sketch that the Meccano rod is supported on a couple of brackets with a bearing to hold it in place at each end. There is a pulley in the middle which is driven by an elastic band connected to the pulley on the motor. Keep your assembly as neat as possible. It has to fit the bottom of the coaling stage, on the floor in fact.

Fasten the cords to each end of the shaft, one each side of the driving pulley and belt (it would be better to drill a small hole at each end to take the cord if you can) pass the cords through the hole in the cover up over the pulleys at the front and down to the hoist platform.

Before testing the working of the hoist set the resistance to the slowest speed, set your switch for lift, and then gradually increase the speed until the hoist slowly moves up the runners. Check that when the top pulleys on the hoist reach the top of the first part that they follow the track into the opening in the mouth of the stage. The other hoist pulleys should ride up the outer track until the whole hoist with truck has turned over. At the maximum tilt put a block of wood inside the stage to touch the back of the hoist platform. When the hoist has dumped the coal into the hopper reverse your switch and it should come down to the track level again. If it doesn't then you will have to experiment with more weight until it comes down smoothly and rests in its right position. Paint the inside of the stage black and the platform for the enginemens and the hoist also in the same colour. Fix your back wall in place and paint the outside of the stage in concrete colour, and then smear the surface, especially the front, with black paint. Put it on almost dry, or with a dry brush, or you can rub soot into the surface. Make it look like a coal stage!

The platelayer's hut is easy to make in card, scored from top to bottom with a dry ball point pen to represent planks of wood. The chimney is a strip of wood covered with brick paper, with a piece of dowel pushed in the top for a pot. Paint the hut matt black, and put it alongside your track.

Next time I shall describe some aspects of electrification, how to connect up your controllers to the tracks, sectionalizing, and lighting some of your models.

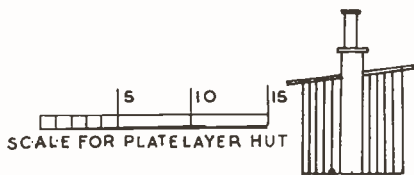
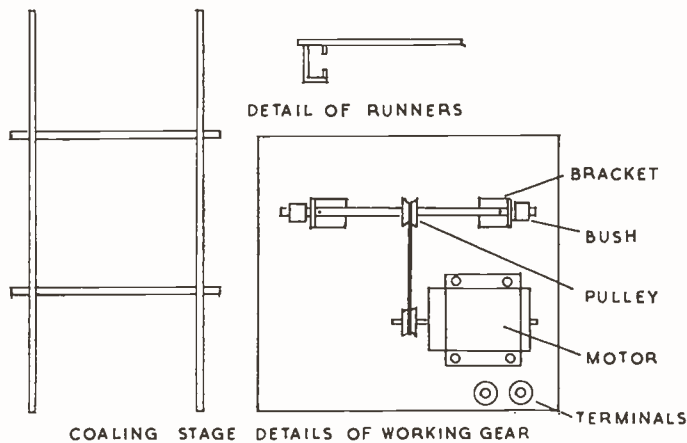

A HOUSEHOLD STEPLADDER



housings is well worth while to ensure that all the treads will fit tightly into place.

The treads

The steps or treads can be dealt with next. Each one is 5 in. wide, but their lengths will vary and must be determined by direct measurement. First mark out

too difficult the cross pieces can be glued and screwed to the uprights instead. Fig. 5 explains the construction, the exact width being taken off the ladder itself.

By J. H. Parry

and cut the housings in the top step to take the upper ends of the strings, and lightly nail temporarily in place. Open out the base to 20 in. and nail a scrap strip of timber across. The exact length of each tread can now be measured and the treads cut. The ends should be slightly bevelled to allow for the tapering of the ladder and here again a slide bevel comes in useful. The back edges should also be bevelled flush with the back edges of the strings but this can be left until the frame has been assembled if preferred.

The whole frame is now glued together, using a good quality waterproof glue, and two 2 in. oval nails all driven through the strings into the ends of the treads. Similarly, fix the top step and remove the scrap piece previously nailed across the base. Test for squareness and cut out the cross hinge support, bevelling its upper edge so that it fits snugly under the top step. Then glue and screw it in position.

The back frame

For a really first class job, the back frame should be mortised and tenoned together but if this is considered to be

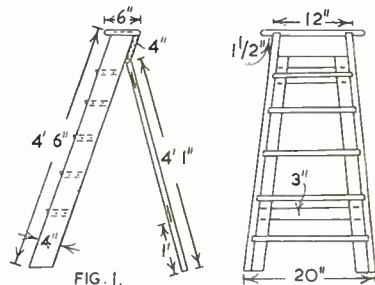

FIG. 1.

FIG. 2.

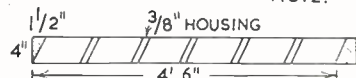

FIG. 3.



FIG. 4.

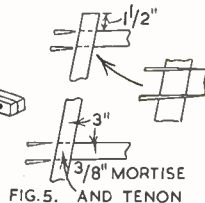

FIG. 5. AND TENON

Notice how two thin wedges are driven into each joint with a spot of glue and afterwards sawn and planed to the level of the uprights.

When the back frame has been assembled it is attached to the ladder with a pair of 2 1/2 in. steel butt hinges and 3/4 in. countersink screws. Finally fit a strong cord of suitable length to prevent the legs opening more than about 3 feet.

NO household is complete without a stepladder, so essential for decorating and countless other jobs around the home. The one described here, calling for no special woodworking skill in its making, is strong and sturdy and with a reasonable amount of care in construction can be relied upon to last a lifetime.

One inch planed timber is used throughout and a good quality well seasoned hardwood is recommended. Figs. 1 and 2 give the main dimensions and it will be seen that the ladder is narrowed towards the top for extra stability.

Begin with the sides or strings and mark out as shown in Fig. 3. Make the housings the exact width of the treads to ensure a tight fit and cut them 3/8 in. deep. First mark the bevel at one end by following the measurements given, then mark out the positions of the housings into which the treads will fit. A useful though not essential tool for this job is a slide bevel. To ensure that all the housings are cut to the same depth of 3/8 in., use the simple depth gauge shown in Fig. 4. This consists of two strips of timber overlapping the ends of the saw and screwed or bolted together so that the saw cannot enter any deeper than 3/8 in. A little care when cutting the

CLOTHES PEG FIRE ALARM

A SPRING-TYPE clothes peg, two drawing pins and a pellet of wax, will make an effective trigger device to set off a rousing fire alarm. Press the drawing pins well into the wooden peg 'prongs' in such a manner that the heads may be squeezed together by the powerful spring. Attach insulated copper wires to the drawing pins and join up these wires, in series, with a loud tone electric bell and a suitable battery.

To 'set' the alarm, wedge a wax pellet between the peg prongs, below the draw-

ing pins, so that the pin head 'switch' is kept open to break the circuit. Heat from a burning match held near the peg trigger should be sufficient to melt the wax and cause the pins to be drawn together. Immediately the circuit will be completed and the bell will ring.

If you wish to employ the alarm as a safeguard in your home or workshop, let the peg trigger be situated or suspended upon its wires near the potentially inflammable material you wish to protect. (A.E.W.)

A Built-in Milk Box

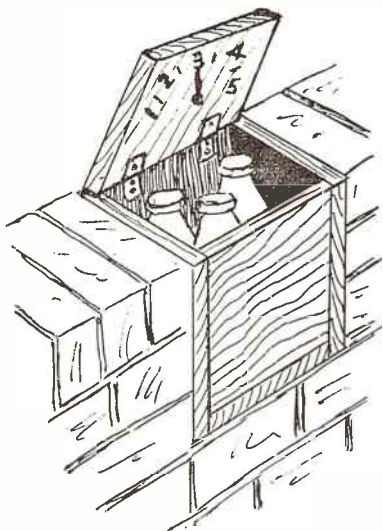

I MADE the useful milk box shown in the drawing for two reasons. Firstly, tits were becoming a nuisance by pecking away the aluminium foil cap and drinking my milk. Also, my wall needed repairs at a point where I could see I could build-in a box quite conveniently.

First, measure the length of your milk bottles, so that you will know what depth to construct the box. Also, measure the diameters of the bottles to ascertain what length you will need to hold, say, up to six bottles. The width of the box will of course, be 9 in. the same as the length of a brick.

Use 1 in. thick planed timber for the box itself. It will be sufficient to simply nail it together. Nails, driven through from the inside of the box into a joint between layers of brickwork will keep the box firmly in position. A lid should be made, also from 1 in. thick timber and hung with a pair of brass butt hinges inside, as shown.

Underneath the lid a simple indicator is made, to let the milkman know how many bottles you require. It consists of a metal pointer, screwed centrally to the lid and the numbers, indicating pints and half-pints, painted on at suitable intervals.

If you are away all day and do not collect the milk until evening, here is a useful tip during hot weather. Stand a container in the bottom of the box, half-filled with water. This, combined with the shade obtained by the box, will ensure your milk keeps fresh through the hottest day.

(E.C.)

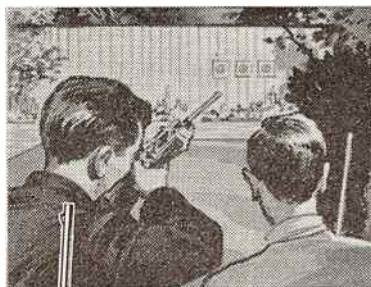

Really worth waiting for!



With a BSA Meteor or Airsporter Air Rifle, you learn how to handle an air rifle safely. A real rifle — BSA precision engineered. With telescopic sight for super accurate aiming. Yes, a BSA Air Rifle is really worth saving for.

Send postcard for free illustrated folders today.

BSA METEOR



Meteor and Airsporter
AIR RIFLE

shoot with **SAFETY**

BSA GUNS LTD., SHIRLEY, SOLIHULL, WARWICKSHIRE.

Miscellaneous Advertisements

IT'S EXCITING. IT'S PROFITABLE. Paint designs. Flowers. Anything. Even beginners' ideas can sell for £25/£60. Inexhaustible demand. Details free. **POPULAR ART SERVICES (HW), CLUN, SALOP.**

ENJOY WRITING? Then write for Profit. Send for 'Writers' Handbook' (free) detailing countless opportunities for beginner or experienced. — Writers' Ring (HW), 5 Edmund Street, Birmingham.

LEARN RADIO & ELECTRONICS the NEW Practical Way! latest system of experimenting with and building radio apparatus — 'as you learn'. FREE Brochure from: Dept. H.W.10, Radiostructor, Reading.

MAKE a complete oxy-acetylene welder from bits and pieces. New parts amount less than £1. Gas from chemicals. Ideal for home repairs, handicrafts, e.g. glass and wire ornaments, etc. Send 2s. 6d. for building instructions, diagrams, welding hints. — 'Dresdecca', The Harrow Way, Basingstoke, Hants.

TRANSISTORS — OC 17, 6s. 6d.; OC 72, 8s.; Components for Speaker Two 70s.; Soldering irons; Portable 30 watt 18s. 6d.; Henley 25 watt 27s.; 65 watt 35s. C.W.O. — S.A.E. with enquiries. — Starres, 4 Yew Walk, Partington, Manchester.

COLLECTORS, ETC. Hobbies and Designs from 1903; weighing 240 lbs. Bargain, £12.0.0. 23 Wellington Road, Forest Gate, London, E.7



No. 2 Corner Cramp

Made of Cast iron. Will take mouldings up to 4 ins.

30/-
(post free)

HOBBIES LTD (DEPT. 99), DEREHAM, NORFOLK

FOR PERMANENT RESULTS... MODEL IT IN

Plastone

—the self-hardening modelling material. *Regd. Trade Mark.*
Send for sample tin and booklet 4/9 (including postage) to Sole Manufacturers—
Harbutt's Plasticine Ltd., Bathampton, Bath, Somerset.

...wab evenly on the paper in...
 ...to know if you could...
 ...to go over the wallpon...
 ...wish to make some plan...
 ...mitter? (R.P. — Wolverhampton).
 ...on the...
 ...Channel 10 world...
Replies to Readers
 ...rectif...
 ...mercy is a brush posit...
 ...V. and 15V...
 ...more.)
 ...fully...
 ...to charge a 12V. battery, as ch...
 ...was made by fixing...
 ...board over a stou...

Discoloured Keys

THE keys of my organ have become very dull and yellowish, through age. Could you please tell me any method of restoring their original white-shine? (D.S. — Kinlochleven).

TREATMENT of the keys depends upon the material of which they are made. For example, if the keys are of ivory they can be cleaned by washing them with a dilute solution of oxalic acid, and following by washing with warm water. If, however, the keys are made of celluloid or some form of plastic, the stains can be removed by washing with a dilute solution of acetone. Another plan is to use an abrasive such as finely powdered pumice powder applied on a damp rag, rubbing lightly until the stains are removed. Then repolish with any good wax polish.

* * *

Illuminated Quiz Game

IHAVE attempted to make a Criss Cross Quiz game, but cannot figure out how the noughts and crosses light up separately. I hope you will be able to help me. (R.H. — Salford).

SO that either a nought or cross may be shown, each section needs two lamps; one to illuminate the nought shape, and one the cross shape. These separate shapes, with lamps, have to be set back, and so positioned that either symbol will show at the front, according to which lamp is lit. All lamps can have a common return lead. A switch is required in the second lead to each lamp.

* * *

Clouds of Black Smoke

CAN you provide me with a formula which on ignition would cause a lot of smoke? (S.W. — Hayes End).

WHERE it is required to produce black smoke, there is a simple method. Dissolve about 5 grams of camphor in 80 c.c. of methylated spirit, and then stir in 10 c.c. of genuine oil of turpentine (not turpentine substitute). Saturate pieces of cotton wool with this solution, and allow to dry. On igniting them, black smoke is evolved.

* * *

Battery Player on Mains

IHAVE been running a Philips transistorised record player from 240V. A.C. Mains by using transformer-rectifier, secondary winding giving 0-12V. D.C. Normal running of power for this record player is from four 1½V. dry U.2 batteries, total 6V. Recently a loud hum, drowning the normal sound even of the record, is heard. Could this be a mains hum, and if so, how can I suppress it? (D.E. — Nottingham).

THE equipment should not be run from a higher voltage than that for which it was designed. The hum could be caused by the rectifier, but if the voltage obtained from the mains unit is up to normal, this is not very likely. In these circumstances, the breakdown of one of the large capacity condensers which are fitted in parallel with the supply, in the amplifier, is most probable. These can be tested by substitution. See that leads carrying A.C. are not near pick-up or amplifier input circuits.

* * * * *

Painting a Canvas Canoe

IHAVE re-covered my canoe hull with 15 ounce canvas and the deck with 12 ounce. Could you please tell me if I should treat the canvas with any preparation before painting. The canvas is stretched quite tight, and I have not used any form of dope. (R.W. — Keighley).

PAINT used on the canvas of your canoe may be a marine grade or a good household quality. No undercoating is necessary, and you should not apply too great a thickness of paint, as then it would be liable to cracking. The woodwork, of course, will be treated with marine varnish.

* * *

Reactivating Silica-gel

COULD you please tell me how to re-activate silica-gel? How quickly will it absorb moisture and become de-activated? (S.D. — Corby.)

TO re-activate the gel, heat it in an oven for an hour at about 150 degrees Centigrade. De-activation point cannot be assessed unless moisture exposure level is known, but the gel may be made self-indicating by laying on the gel a slip of filter paper soaked in a solution of 1 gram cobalt chloride in 3 c.c. of water, the cobalt chloride soaked paper having been dried and heated until it turns blue. De-activation point is indicated by the paper turning red.

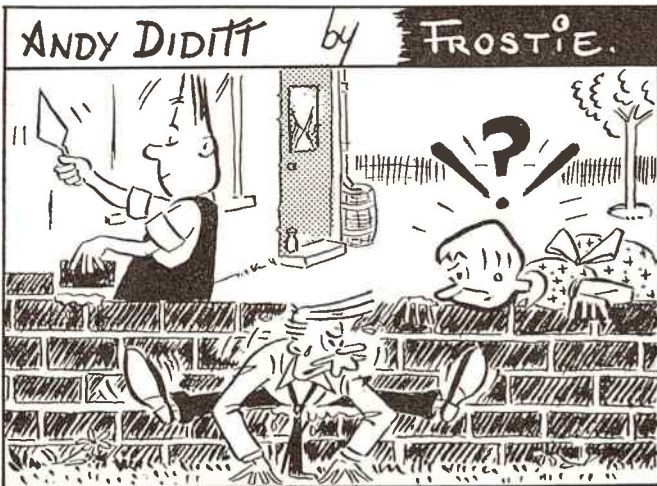

"ALL I SAID TO HIM WAS - 'IF YOU'RE THINKING OF BUILDING A DIVIDING WALL HERE IT WILL HAVE TO BE OVER MY DEAD BODY!'"

ASHTRAY STAND

THIS easy-to-make smoker's stand is constructed from two pieces A and one piece B cut from $\frac{1}{2}$ in. wood. The two pieces A have a 1 in. diameter hole to take the piece of 1 in. round rod C which is about 22 in. long. The piece B has a 3 in. circle removed to take a small metal or plastic ashtray. All parts are of course cut out with a fretsaw. (M.p.)

A JOB FOR THE FRETSAW

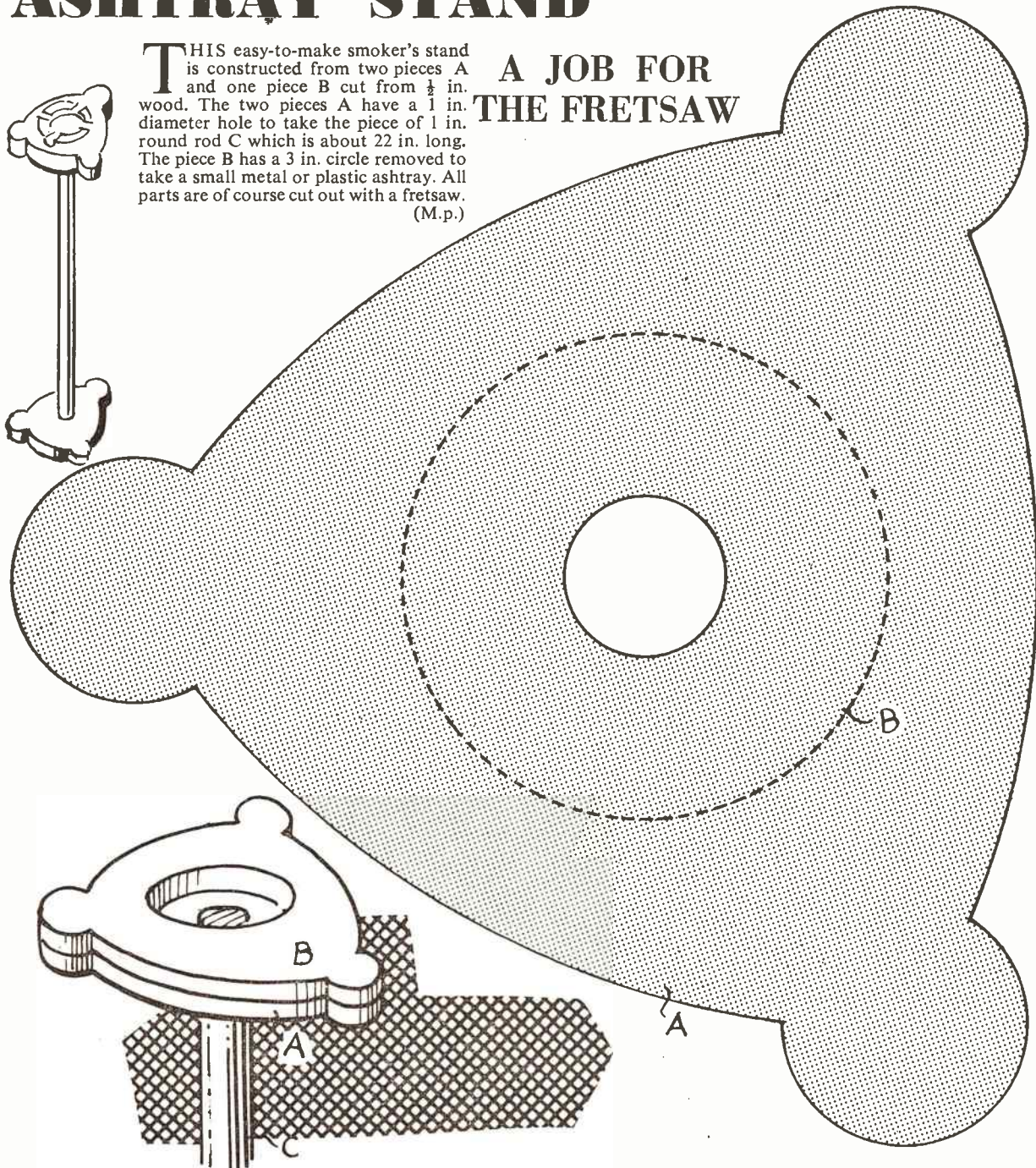

YOU CAN DEPEND ON THESE

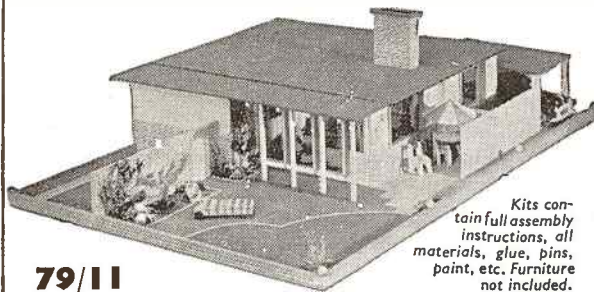

Kits contain full assembly instructions, all materials, glue, pins, paint, etc. Furniture not included.

79/11

THE 'CELEBRITY'—RTA 7

Size 36 in. x 24 in. Five main rooms including lounge with dining recess. Gardens, car port, service area, sun trap, etc. Flat roof lifts off for easy access to each room

ALL PARTS PRE-CUT

ALL READY TO PUT TOGETHER

For the 'Royal' and 'Celebrity' Dolls' Houses, Hobbies have prepared kits with all parts cut to size and shape, ready for you to put together and finish. These are ideal for the man who wants to make a really excellent Doll's House — in a hurry!

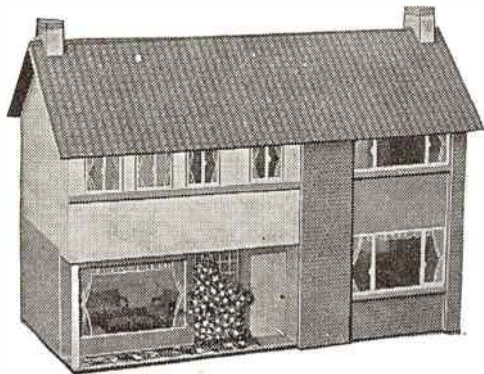

THE 'ROYAL'—RTA 6

Size 26 in. x 12 in. x 19 in. high. Double door opening at back. Modern lounge, hall entrance, kitchen/dining room, 2 bedrooms, bathroom and landing. **98/6**

TO HOBBIES LTD (DEPT. 99), DEREHAM, NORFOLK
 PLEASE SEND KIT No. RTA.....
 NAME
 ADDRESS.....

 P.O. or cheque for.....enclosed

Now you can paint the pushbutton way with—

**YUKAN
 EASY
 SPRAY
 ENAMEL**



YUKAN is new, a Pushbutton spray kit, trigger actioned if desired, with its own power supply and 16 ozs. enamel. No need for brushes or thinners. Ideal on most surfaces, Yukan produces a high gloss finish that can't be bettered any other way. Excellent quality and durability.

Available in the following range of hard gloss colours: white, cream, light green, green, light blue, royal blue, grey, yellow, red, maroon, pink, black, orange. Also flat off-white and white primer.

*In pushbutton spray can 14/3 each Carriage paid 16/-
 Separate Trigger Handle 4/3 Carriage paid 5/-
 Or Special offer: Complete trigger action kit, 18/6 carriage paid.
 Please state colour and enclose cheque/P.O. for total amount to:*

**YUKAN, Dept. H.W. • 307 Edgware Road
 London W.2.**

MAKE YOUR OWN

GUITAR

Kit 3209

All wood (including partly shaped neck) full-size plan, six strings, etc.

59/6

(Post free)

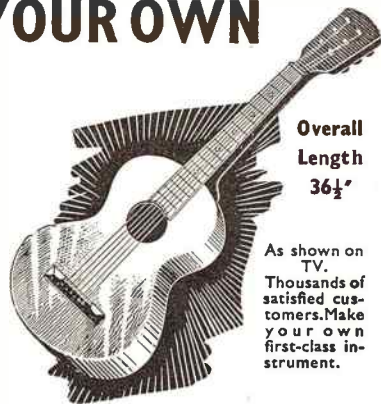

Overall Length 36½"

As shown on TV. Thousands of satisfied customers. Make your own first-class instrument.

UKULELE

Kit No. 3260

Contains all wood, wire, strings, etc., for full-size instrument **24/11** Post 2/-

To Hobbies Ltd., Dept 99, Dereham, Norfolk. Please send Kit No.....
 P.O. for enclosed
 Name
 Address



From branches, etc., or by post

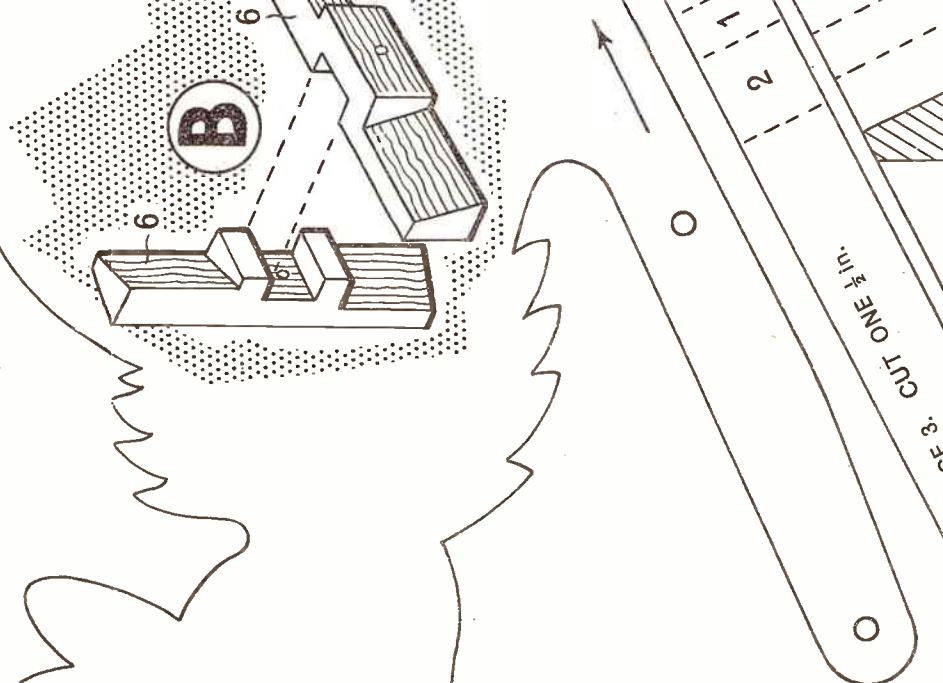
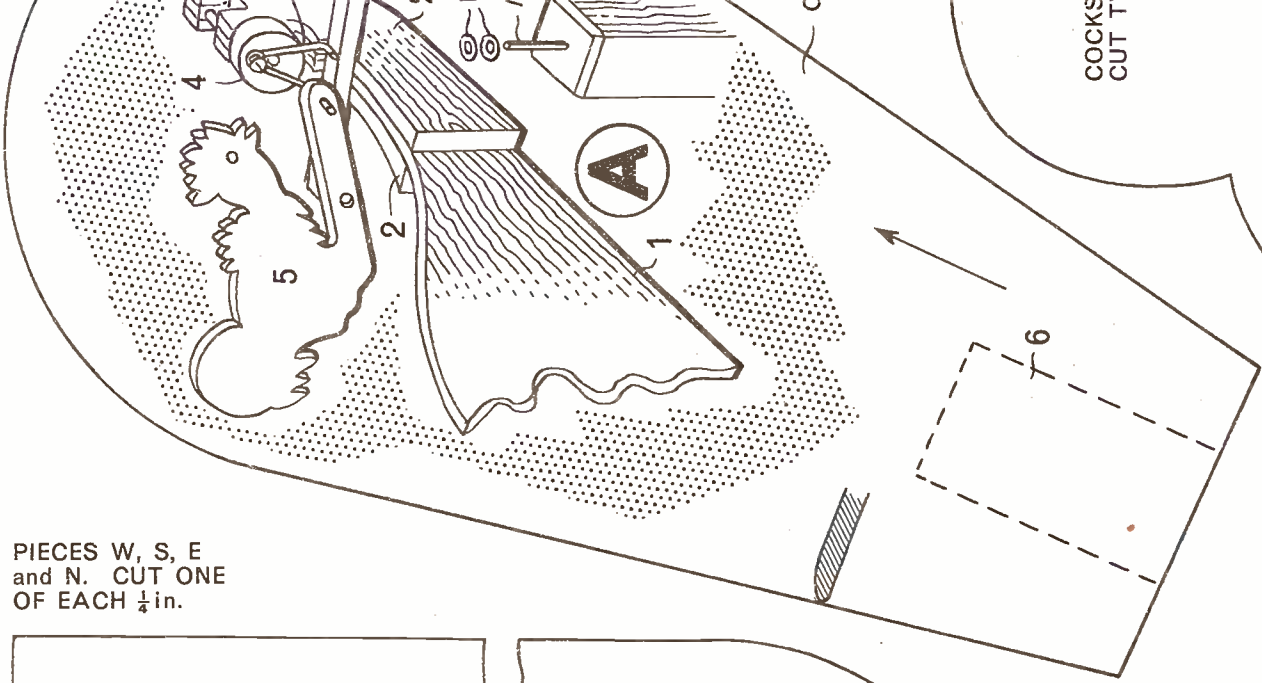

PIECES W, S, E
and N. CUT ONE
OF EACH $\frac{1}{4}$ in.

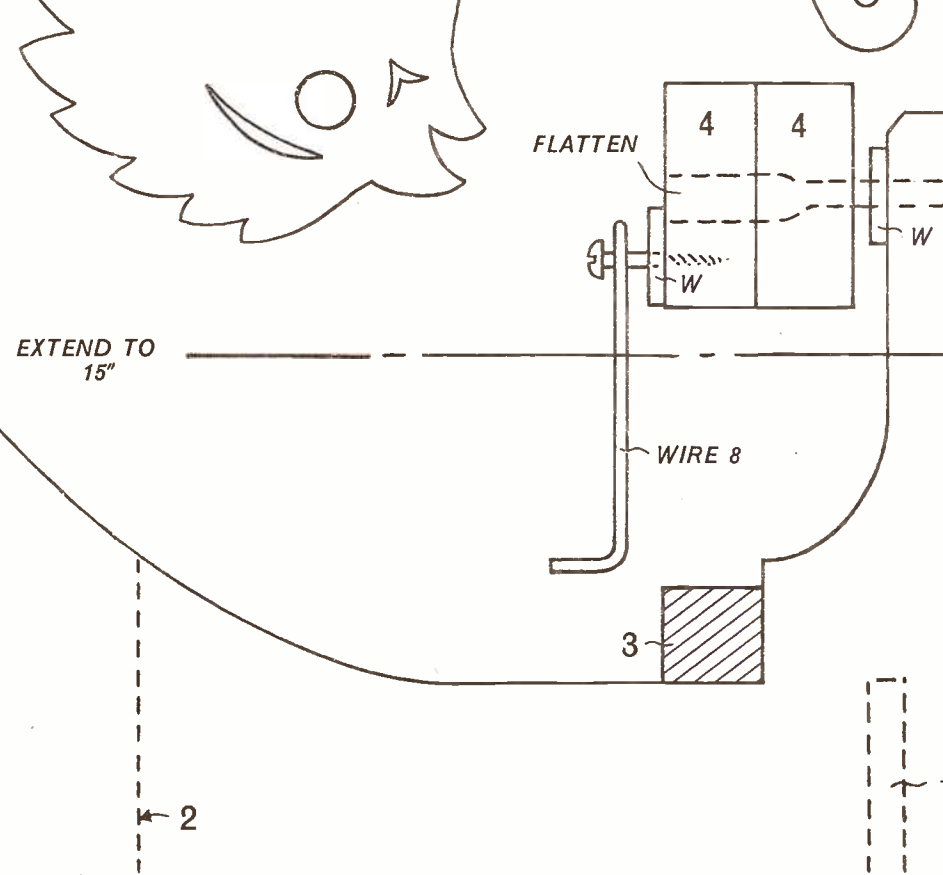
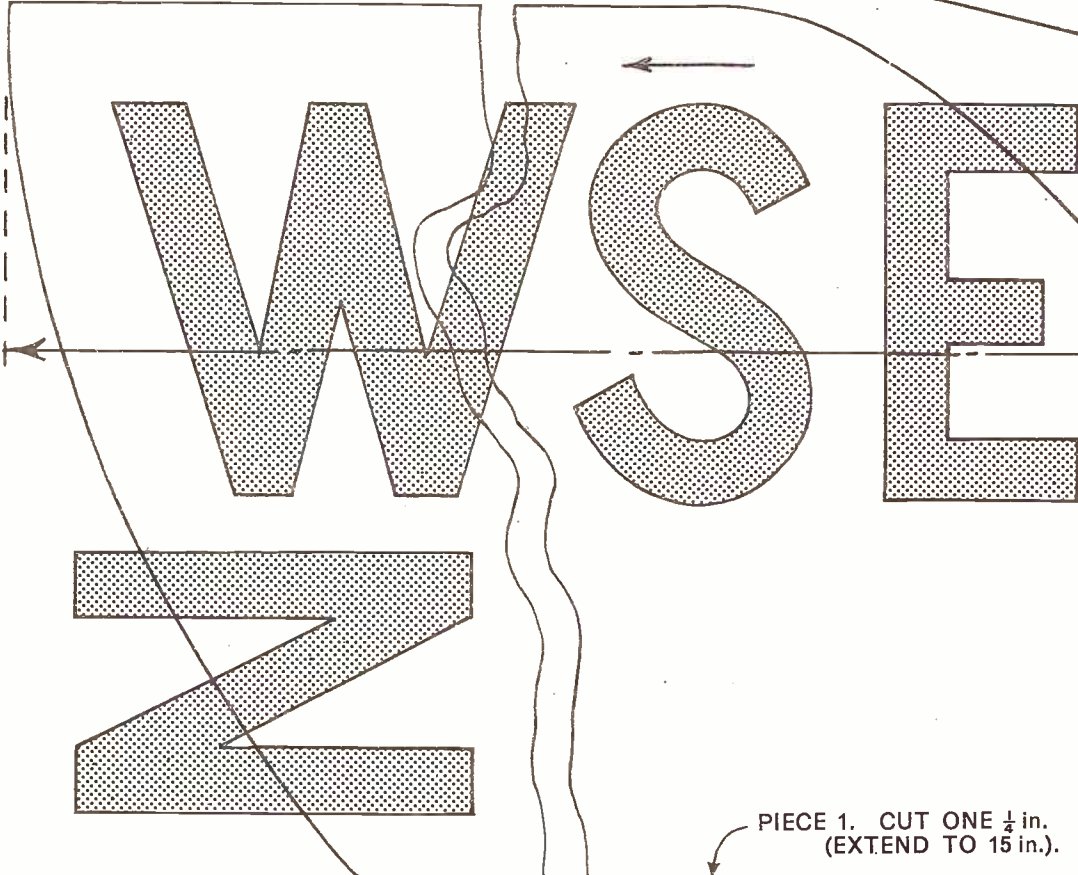

**NOVELTY WIND VANE
THE "FIGHTING COCKS"**

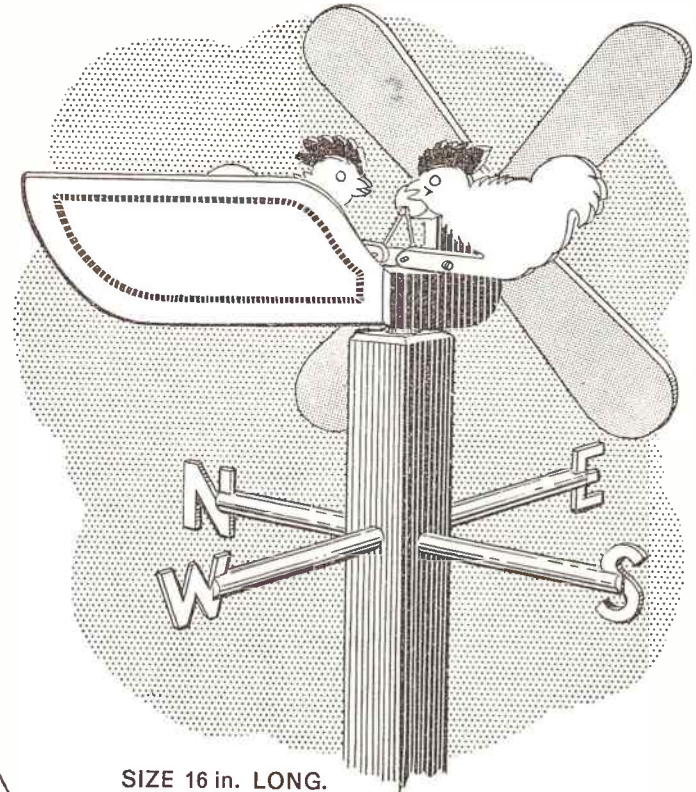

SIZE 16 in. LONG.

A KIT OF MATERIALS FOR MAKING THIS DESIGN IS SUPPLIED BY HOBBIES LIMITED, DEREHAM, NORFOLK. PRICE ON APPLICATION.

Use **CASCAMITE**
"One Shot"
Resin Glue
for all Wood Gluing



- Mixed & use cold
- Waterproof type
- Gap-filling and non-staining

Obtainable in:
3½-oz.; 7-oz.
and 18-oz. tins.

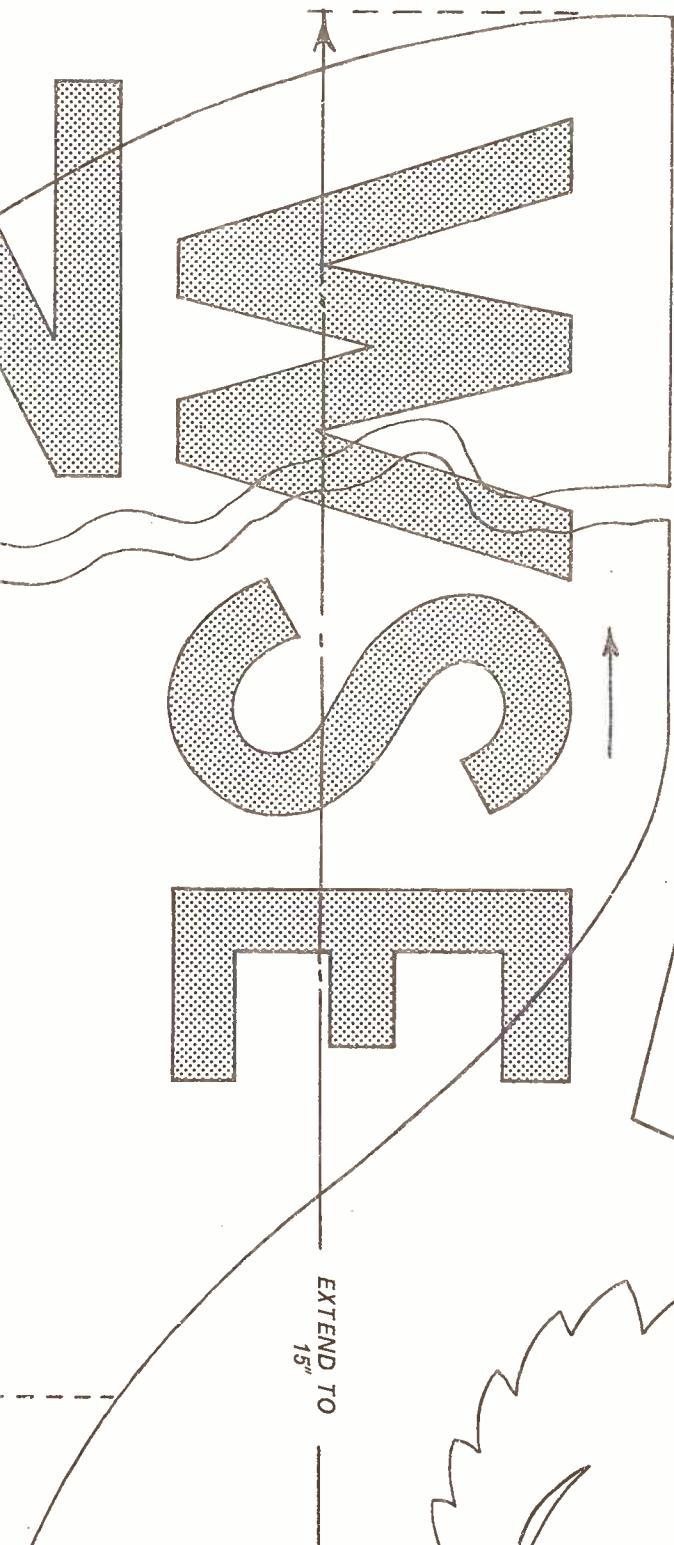

PIECES W, S, E
and N. CUT ONE
OF EACH ¼ in.

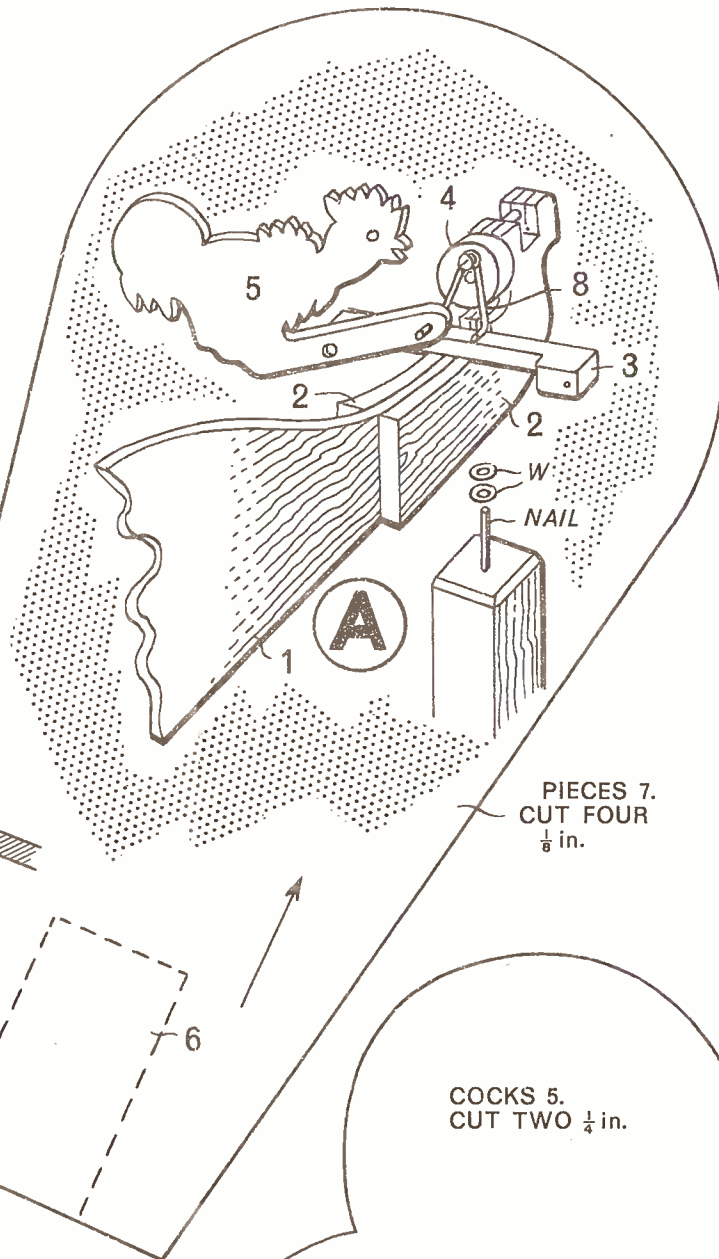

PIECES 7.
CUT FOUR
⅛ in.

COCKS 5.
CUT TWO ¼ in.

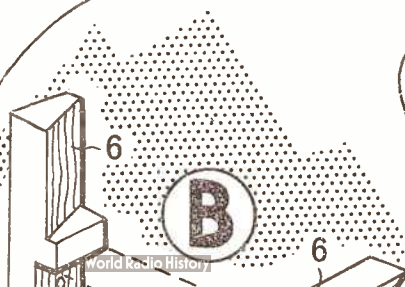

Use **CASCAMITE**
 'One Shot'
 Resin Glue
 for all Wood Gluing

● Mixed & use cold ● Waterproof
 ● Gap-filling and non-staining
 Stocked by: Ironmongers, Builders
 Manufactured by:
LEICESTER, LOVELL & CO. LTD. North

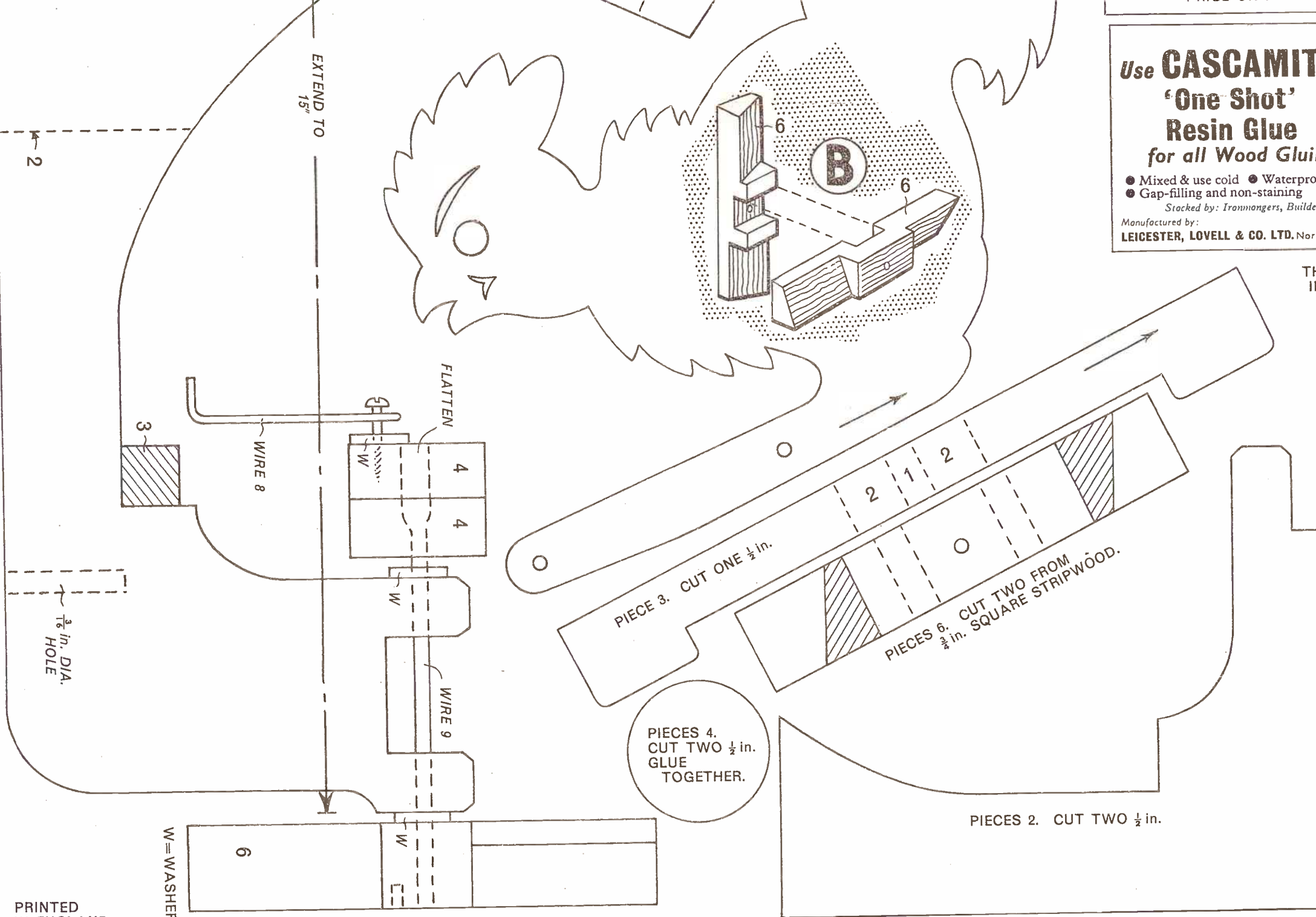

PRINTED IN ENGLAND.

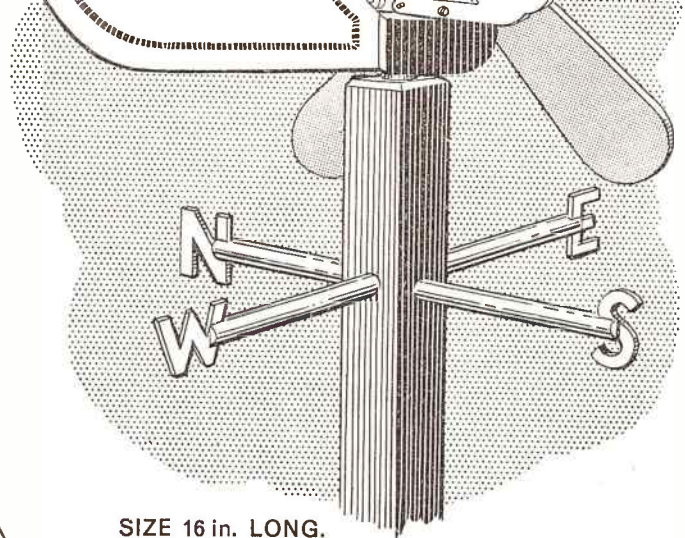
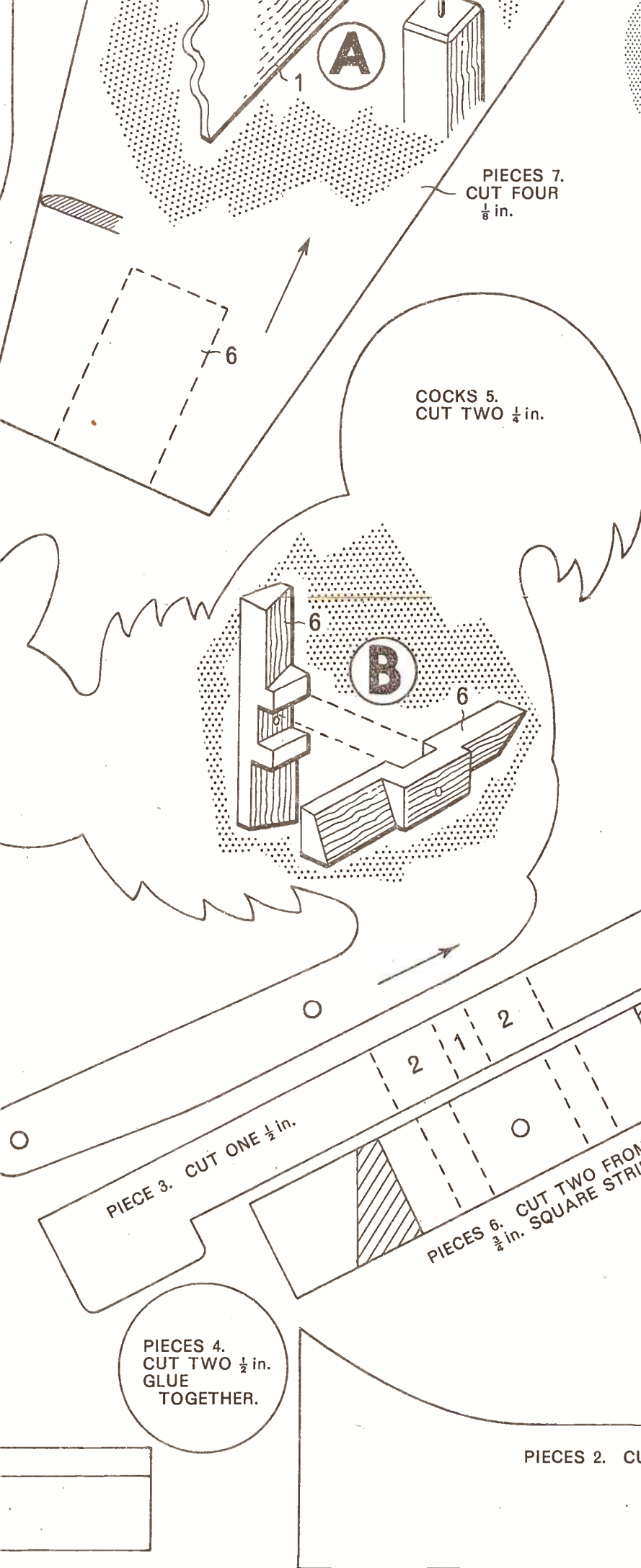

SIZE 16 in. LONG.

A KIT OF MATERIALS FOR MAKING THIS DESIGN IS SUPPLIED BY HOBBIES LIMITED, DEREHAM, NORFOLK. PRICE ON APPLICATION.

Use CASCAMITE
'One Shot'
Resin Glue
 for all Wood Gluing



Obtainable in:
 3½-oz.; 7-oz.
 and 18-oz. tins.

Stocked by: Ironmongers, Builders' Merchants, etc.

Manufactured by:
LEICESTER, LOVELL & CO. LTD. North Baddesley, Southampton

THE ARROWS INDICATE DIRECTION OF GRAIN OF WOOD.