

7th MARCH 1962

VOL. 133

NUMBER 3456

THE ORIGINAL
'DO-IT-YOURSELF'
MAGAZINE

HOBBIES *weekly*

FOR ALL
HOME CRAFTSMEN

*FREE design
in this issue*

Also in this issue:

LATEST STAMPS
ILLUSTRATED

COLD WEATHER
ANGLING TIPS

HOW TO MAKE
A PHOTOMETER

DISC BREAK
PERSONALITIES

MORE RAILWAY
MODELLING TIPS

AN ILLUMINATED
CORNER FITMENT

PATTERNS FOR A
FUSE HOLDER

ETC. ETC.

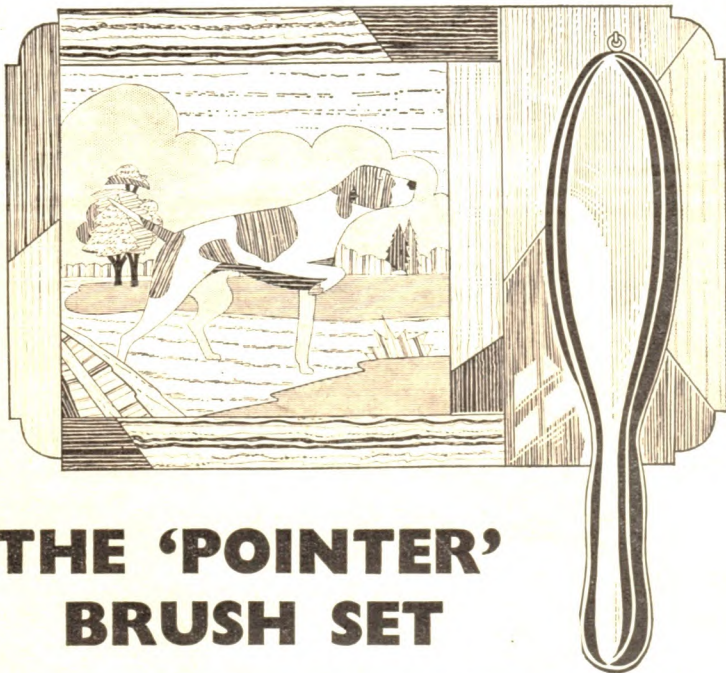

THE 'POINTER' BRUSH SET

A CHARMING DECORATIVE PLAQUE



Up-to-the-minute ideas

Practical designs

Pleasant and profitable things to make

5^D



Stamp Collector's Corner

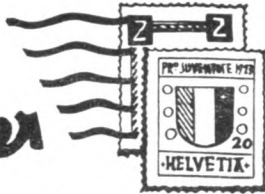

IN the last article we discussed birds, and this time we want to go on to the beasts that are seen in the stamp album.

Nearly everyone is interested in pictures of animals, and the stamp designers are well aware of this fascination, so they give as many as possible. After all, the idea is to sell the stamps. Some countries make quite a lot of money out of the sales, while others only issue stamps as they are necessary for postage.

Now these designs have to be executed very carefully. Because of television everyone is well aware of the form of these animals, and a mistake would soon bring scorn. There was a case in 1866 when Newfoundland issued a stamp showing a seal with paws. Immediately everyone was up in arms, and said 'Fancy drawing a seal with paws; everyone knows they have flippers!' Public opinion was such that the stamp had to be redrawn for the next issue. But now one wonders if it was a mistake after all, because there is a seal which has paws, although it must be admitted that it is a rare one.

Colour also has to be carefully considered. For instance, Fiji issued a 5d. stamp in 1938 which showed sugar-cane. The frame was in scarlet and the

centre in blue. The result was that many came out with the criticism 'Fancy sugar cane in blue'. So in October 1940 a fresh stamp appeared with the sugar-cane in

FEATURING WILD BEASTS By L. P. V. Veale

green. Incidentally, the former stamp is now quite a nice possession, catalogued at 30s. 0d., while the latter is only 10d.

Twenty-five different designs

Generally speaking there are more animals shown on the stamps of the British Colonies than on those from foreign countries. Chile, however, produced a sheet of twenty-five stamps of the 60c value, each with a different design; nineteen of these were animals and the other six were plants. This means that in order to have the set of the Chilean stamps, you have to have twenty-five 60c stamps. I wonder what happens at the post office if you want a special design? Are you allowed to have

the stamp from the centre of the sheet or do you have to wait your turn for the one you want? Do you ask for a 60c lizard or, say, a 60c penguin?

It is difficult to judge which country has the best stamp zoo. Australia with her 1937 and now her 1959 sets must come fairly well up in the list, and North Borneo is another region with some very interesting specimens.

The present trend seems to be to produce a whole set of stamps all of which are on the same subject, such as the set from the ill-fated island Tristan da Cunha, each stamp showing a fish. There are also the ships of the 1954 set for the Falkland Islands Dependencies. This does, of course, make it easier for the thematic collector, but it also means that one loses a lot of the fun in searching out the various stamps that one wants to make up a thematic collection.

Suppose we go on to specific animals instead of generalizations, and make a start with the big ones. There are only two species of elephant that occur on stamps. The African is admirably shown on the stamp from the French Cameroons. It is the largest, and may attain a height of 12 ft. The tusks are enormous, and are the main source of ivory. This beast is also shown on the 4d. of the 1954 set from South Africa (see illustration). It gives a very fine view of the head; and notice the ears, for these are so much larger than those of the Asiatic specimen which can be seen on the next stamp, which is the 5c of the 1909 issue from North Borneo. This stamp is very useful, as there is a man shown which gives a clue to the size of the beast. A comparison of the two stamps will make the differences clear, such as size of ears and tusks.

French Equatorial Africa presents us with a very good picture of the Black Rhinoceros. Notice in the illustration the two horns and how the skin folds, giving the appearance of armour plating.

The next animal to be considered — the lion — is not herbivorous by any means. How many people would recall that we have had quite a number of lions on the stamps of Great Britain? In 1911 and 1912 we had the two 1d. stamps, one with the lion unshaded and then the lion shaded. Then in 1924 we had the 1d. and the 1½d. of the British Empire Exhibition, and the same again in 1925. If we accept heraldry we have the 2s. 6d. and 5s. 0d. of the 1939 issue, and the £1 of 1951. For a really beautiful picture of a lion we should turn to the 6d. of the 1954 set from South Africa. There is also a good one on the 20c of the 1954 issue from Kenya, Uganda, and Tanganyika.

North Borneo in 1909 issued a stamp showing a tapir, an animal somewhat



● Continued on page 363

NEW ISSUES FROM POLAND



A NEW set of three perforated stamps, commemorating 1,000 Years of Polish Mining Industry, was issued on 4th December. The stamps show:

2.50 zl. — the emblem of The International Congress of the Mines Con-

structors — held in Warsaw in 1958. 60 gr. — the seal of Bytom (old Polish town) from the fourteenth century.

40 gr. — the emblems of kopasyni family of 1284, the first miners in the Upper Vistula Region.

The new perforated stamp shown on right value 60 gr. commemorates the 5th World Trade Union Congress in Moscow. It was issued by Poland, on 20th November. It features the Emblem of the Congress



The new set of 3 perforated stamps shown above commemorate the 15th anniversary of UNICEF, issued by Poland on 11th December

● Continued from page 362

FEATURING WILD BEASTS

like a pig in shape, with a long snout. As you can see from the illustration the front of the body is black, and the rest is white. They are harmless animals, eating vegetable matter, and they live a solitary life.

Where would you find bats on a stamp? Have a look at any of the Centenary stamps of Hong Kong, and in the margins you will see a number of them, but they are very small. What is a bongo? Well, you can see one on the 1921 1c stamp from Liberia, and the same country has a picture of a kudu. These two animals are somewhat similar. They are both antelopes living in Africa around the equator. The gnu lives further south, and a picture can be seen on the 1s. 0d. stamp of South Africa. These stamps should be collected in pairs if at all possible, as one is printed in English, and the next one to it is

printed in Afrikaans.

Bears do not appear on very many stamps, but there is the great favourite polar bear on the stamps of Greenland (see illustration). This animal may weigh anything up to 1,600 lb., as much as ten men. Its food is, of course, fish and seals.

Well, we could go on for a very long time on animals, but we must finish with a few words about monkeys and apes. The proboscis monkey which is shown on the 4c 1939 State of North Borneo has a very curious appearance due to the nose which gives it its name. It stands about 2 ft. 6 in., and has a very long tail. The 10c of the 1939 set from North Borneo (see illustration) has a fine face of the orang-utan which may grow to 5 ft. 6 in. high. It has very long arms and rather short and weak legs. So it is not surprising that it moves about mainly in the trees, particularly as it is a vegetarian.

Advertisers'

Announcements

(Readers are asked to seek their stamp and label requirements from addresses advertised in this magazine.)

BRITISH COMMONWEALTH APPROVALS. Fraction Catalogue. Plus 25% discount. — S. Herbert, 75 Shooters Drive, Nazeing Essex.

100 DIFFERENT stamps free! Request 4d upwards discount approvals. — Bush-53 Newlyn Way, Parkstone, Dorset.

FOR SALE — NEWFOUNDLAND STAMPS! 100 fine NFLD stamps \$1.00 — 1,000 \$9.00 — 2,000 \$15.00 — 50 all different \$2.00 — 100 all different \$6.00 order now from **HARRY PHILLIPS SALES, BONAVISTA-2K, NEWFOUNDLAND, CANADA.**

FREE! Stamps catalogued 15/- to approval applicants. 3d. postage. — Pattle, "Pattlesden", Rattlesden, Bury St. Edmunds, Suffolk.

LARGE bundles of World's Stamps, including high values, pictorials, complete sets, to clear regardless of catalogue. Fantastic value in 10s. and £1 lots. Satisfaction guaranteed. (Sample 5/-) post 6d. Jeanne Exall, 66, Ridgeway, Southborough, Tunbridge Wells, Kent. (Old British Empire Stamps purchased.)

EUROPA GERMAN 1/5 set, other items E.C.W.O., S.A.E. — Stamp Supplies, 15 Queens-hill Avenue, Leeds 17

WITH ROD & LINE

FISHING in winter sets up all manner of problems even to the experienced angler. To the not so experienced things may almost look to be impossible.

Now although fish are regarded as cold-blooded creatures this is not strictly true. They are cold-blooded by comparison with ourselves, for example, but they are certainly a little warmer than the water. It follows then that as the cold of winter chills the surface of the lake or river then the fish will go deeper to find the warmer layer of water.

In lakes they may get into the mud on the bottom, and stay there until conditions are more to their liking. The more hardy of the fish will not hibernate entirely and so if the right places are searched there is always the chance of taking one or two of them.

Most of us have heard that fish will not be caught if there is an east wind. This is recognized as a cold wind and in still water it ruffles the surface and really chills it. As it continues to blow, more and more of the surface of the water becomes exposed to this chilling effect. In a shallow lake this affects the fish far more quickly than would be the case in a deep one. Trees, too, offer quite a protection and therefore you have to do your fishing in deeper and

less exposed waters if you want to catch anything.

In the river you must look for the deeper and well-protected lay-bys. Fish such as pike and perch, made hungry by the colder weather, will be on the prowl for food and during the bitterly cold spell we had in the North just before Christmas I fished a lake which was half

COLD WEATHER ENTICEMENTS By 'Kingfisher'

frozen over. With only a depth at the most of four feet I knew it would be useless fishing for anything except pike so I used spinning tackle and found the pike really ravenous and I didn't have to make many casts before being taken. This turned out to be quite a good pike day for me.

This spinning at least keeps you nice and warm and is preferable to sitting over a live-bait or trying to find one or two roach.

The rivers and streams are usually a far better proposition to fish than still water at this time of the year unless you have floods to contend with.

Fishing the quiet lay-bys calls for groundbaiting in order to encourage the fish to feed. The cold will have made them lethargic and perhaps although hungry they will be too much in the state of a sort of hibernation to feed greedily. Your groundbait can be just the thing to rouse them from this state and make them feed madly for a couple of hours during the day.

There is no need to get up in the middle of the night for your fishing. The best time is the hours from mid-day to about three in the afternoon.

Very often we get an hour or two of sunshine. Although it will have no warming effect on the surface of the water I always incline to the idea that the sun's rays travel through water and carry their heat through it as through a window. The fish down below can feel this, so that the falling groundbait plus that little extra warmth can be sufficient to do the trick.

One problem is keeping yourself warm in such weather and you should be suitably clad for the job. It is always colder near the water. An extra pair of socks will help keep your feet warm and for this reason when you buy a pair of Wellington boots you should get them large enough to take these extra socks.

A great help after the first hour at the waterside is a flask of hot coffee. This, I think, is far better for keeping you warm and its effect lasts much longer than tea. If made with milk I think it is even better still as it has more 'body' to it.

A flask of hot soup is also fine. A hot bath when you get home makes a perfect ending. You'll feel really good after it.

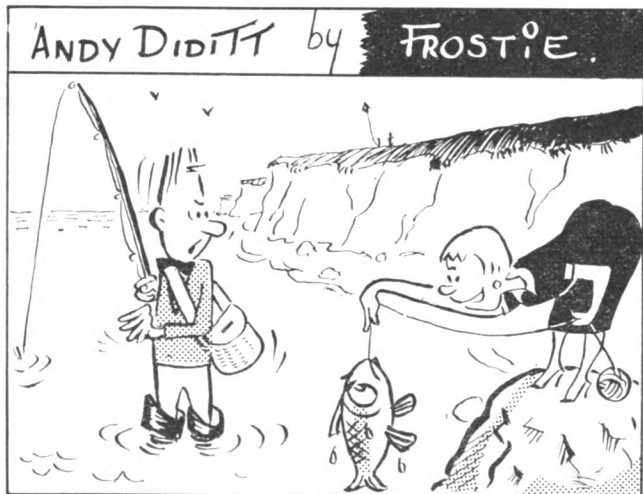

"IS THIS WHAT YOU'RE AFTER, ANDY?"

1962

FRETWORK COMPETITION

Have YOU sent your entry yet?
Remember it is FREE: No entrance fee.

£200 IN PRIZES

Also a grand silver CHALLENGE CUP which the winner holds for a year, and retains a replica as a permanent memento.

Closing date for this competition is 30th April.

All entries must be made from Hobbies Design No. 3434 which was given free in 'HOBBIES WEEKLY' issue of 4th Oct., 1961. Designs are available price 1/- from HOBBIES LTD, Dereham, Norfolk.



AT Woodford Golf Club's social evening the band had just played *The Queen* when club member Paul Cave went up to pianist Mrs Gladys Mills and told her: 'More people should hear you play.' He gave her a telephone number to ring and Mrs Mills thought it was one more engagement for the band.

She made the call — and as a result found herself booked to appear in the Billy Cotton Show on B.B.C. Television and to make a record for E.M.I.'s Parlophone label. All of which left the genial Mrs Mills — superintendent of the typing department at the Paymaster-General's Office in London — bewildered to say the least.

THE GENIAL MRS MILLS

'Glad' is pictured here looking as happy as one of her popular medleys. And isn't that a smiling Geoff. Love in the background?



* * *

IS SPIKE CONTEMPLATING SEWER-SIDE!

Caught in the act — Spike Milligan preparing to go underground for his morning stroll. Unusual but not altogether unexpected, since Spike has made a new Goon-type all singing and talking record entitled, 'Sideways through the sewers of the Strand'. It's on Parlophone 45-R4839, backed with 'I'm walking out with a mountain'. Both tracks are from his November LP, 'Milligan Preserved'



'Of course,' she explains, 'I was really thrilled to pieces by it all. But at the same time I must admit that I was flabbergasted and overwhelmed by the whole thing.'

Mrs Mills — 'call me "Glad", everyone else does' — was born in Bletchley, Buckinghamshire, and moved with her parents to Loughton in Essex, when she was about 12. Ask her if she has at any time set her sights on a career as a professional pianist and she will unhesitatingly reply: 'No. I have always liked to entertain people, mind you. But a show-

business career has never entered my head.'

Mrs Mills — she is in her early forties — still lives in Loughton. Husband Gilbert Mills — whom she married in 1947 — was a regular in the Royal Marines and now works as a maintenance engineer at London University. She still has her band — The Astoreons.

To Mrs Mills — she has fair hair, blue eyes and readily admits to being 'something under 16 stone' — laughter is very important. That is why she lists as her favourite artists, Harry Secombe, Norman Wisdom and Hattie Jacques, or anyone who makes her laugh. She admires also the work of the late Charlie Kunz.

Her first record for Parlophone — *Mrs Mills Medley* — was released in December. On 45-R4856 she played an essentially happy bunch of good old ones such as *The Sheik of Araby*, *Baby face*, *Somebody stole my gal*, *Ma, he's making eyes at me*, *Swanee*, *Ain't she sweet*, *California here I come and I want to be happy*.

The 'Pointer' Brush Plaque

THIS delightful picture in wood serves a dual purpose. Apart from its practical use as a decorative wall plaque, it has been designed to incorporate a clothes brush, and thereby also serves as a brush set. The subject of the picture, a handsome pointer dog, will be particularly acceptable to animal lovers.

Overall dimensions of the plaque are 13½ in. wide by 8½ in. deep, and other applications for its use will suggest themselves. For instance, it could be used purely as an attractive hanging or standing picture. Others may like to arrange a hanging plant in the position occupied by the brush, whilst the design could also be used for the incorporation of pipe racks or small shelves.

All the veneers which go to make up the picture are contained in Hobbies kit, which also includes the backing panel and a clothes brush.

Make a start by tracing the shape of the backing board A from the design sheet on to ¼ in. plywood, and cut it out neatly with a fretsaw. Now position the design sheet on the backboard, and

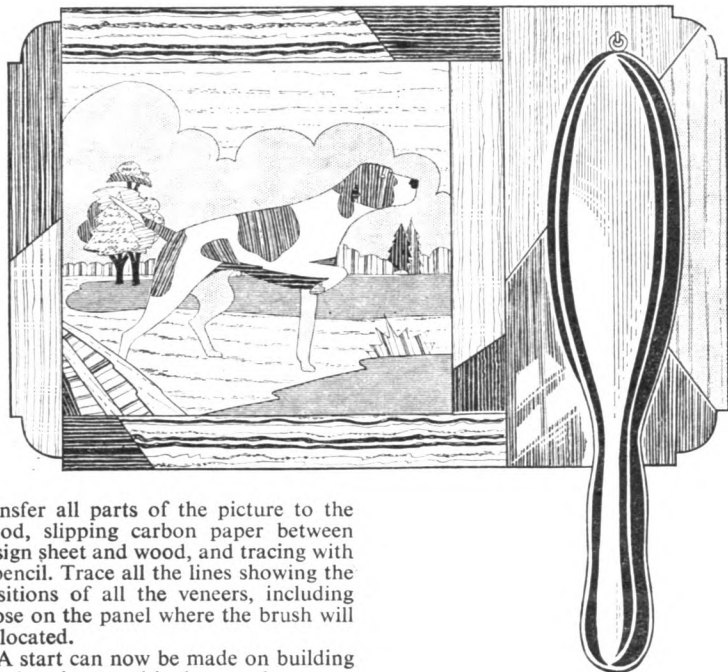

transfer all parts of the picture to the wood, slipping carbon paper between design sheet and wood, and tracing with a pencil. Trace all the lines showing the positions of all the veneers, including those on the panel where the brush will be located.

A start can now be made on building up the picture with the wood veneers. The method recommended in this instance is to complete the dog panel first, and apply the border veneers and decorative side panel afterwards. When cutting the veneers, take particular note where arrows are shown indicating the direction of the grain.

Fig. 1 shows the application of the obeche veneer which forms the top of the sky piece. Note that allowance is made for a slight overlap (about ¼ in.) around all edges of the veneer. The sky shape is transferred on to the veneer, again by means of carbon paper, with due allowance for the overlap already mentioned. Cut out the shape (to include overlap) with a sharp knife. Spread adhesive thinly but evenly on the back of the veneer, and also on the position it will take on the backboard.

Press the veneer down firmly in place, taking particular care at the corners to ensure there is no lifting.

Now prepare the veneer for the adjoining piece of sky from the harewood. Trace the exact shape where it will adjoin the obeche veneer already fixed. This time, however, leave an overlay only on the sides and at the bottom. Cut out the shape carefully, place it in position on the backboard where it will lay over, of course, the overlap which was allowed on the previous veneer. Hold the harewood firmly in position, and using a sharp knife, cut through the obeche overlap all round the top edge where the veneers will meet (Fig. 2). Peel away the unwanted overlap of the obeche veneer from the backboard (Fig. 3), and the two veneers should now make a perfect fit. Glue the harewood veneer in position as previously described, and carry on in like manner for the rest of the picture, adding adjoining veneers as indicated. In all cases allow an overlap where applicable to each shape, and cut this away when adding the next veneer. This method, using each shape as a template, should ensure a perfect join every time.

Note that where no indication is

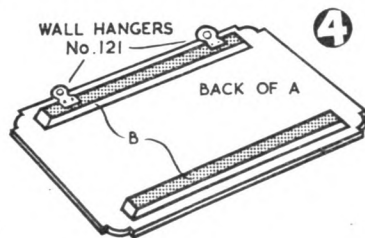
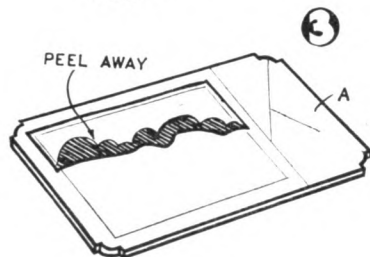
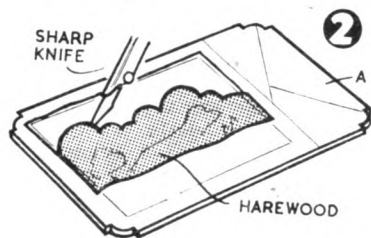
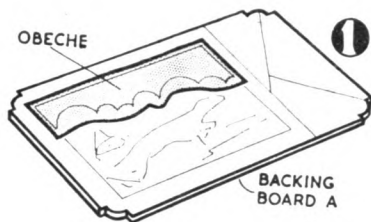

given on the design sheet for some of the tiny insets of veneer, the type to use can be gained from the finished picture.

Having completed the dog panel, there should be left an overlap of the various veneers all round. The same template method is now employed in adding the various border veneers. Cut them to exact shape, position them, and cut away the unwanted portions of overlapping veneers already on the back-board. Then glue the border veneers in place. Similarly complete the veneer work by adding those which are indicated for the brush panel.

The finished picture will, necessarily, be a bit bumpy and uneven, and to obtain an even surface it is essential to scrape and glasspaper. A very satisfactory method is to use the edge of a piece of glass for careful scraping until a fair level has been obtained. Then finish with a glasspaper block. Work down from medium to fine grade until the surface is perfectly smooth. On the success of this smoothing, the beauty of the completed picture will largely depend.

A word of caution is, perhaps,

necessary. Be careful not to apply too much pressure with the scraper or glasspaper, so as to damage the veneers. When as flat a surface as is possible has been attained, the picture is ready for polishing. Apply white wax with the finger tips, rubbing well into the veneers. Then go over lightly with a duster, and give a rub down with a fine grade glasspaper. It will be necessary to change the paper about frequently because the wax will fill it up. Repeat this process of waxing, polishing, and glasspapering until such time as a high gloss finish is obtained. Remember that the more work you put into this operation, the more lasting will be the effect, and the more satisfaction gained from your work.

Alternatively, after levelling the surface, the grain on the face of the picture can be filled, and it should then be smoothed down and finished with two coats of clear varnish, rubbing down in between.

The pieces B shown in Fig. 4 act as supports for the picture. As shown on the design sheet they are 11½ in. by 1 in. cut from ½ in. wood. The ends should be

A KIT FOR 18/6

All the wood and veneers for making the 'Pointer' Brush Set are contained in Hobbies Kit No. 3456, which also includes the brush and fittings. Kits from branches, etc, price 18/6 or direct from Hobbies Ltd, Dereham, Norfolk (post 2/6 extra).

bevelled slightly. Glue to the back of the panel A in the positions indicated by dotted lines on the design sheet. It will be appreciated that when the wall hangers No. 121 are screwed to the top strip, they will not be seen when the article is hung. The hook for holding the brush is screwed in from the front where indicated on the design sheet. A screweye is inserted in the brush for hanging purposes. An attractive edging to the panel will be obtained by painting in black after filling with woodfiller.

Handy Tools from Clothes Pegs

THE common household peg can be modified in many ways to make useful tools, some of which are shown in our illustration.

For example, there is a small hand-grip or vice which will be found extremely useful for cutting, filing or shaping small parts for models. All you require is a ½ in. nut and bolt with a wing nut and a small washer at each side. A small hole for the bolt is drilled through the 'legs' of the peg. The material you are working can be fastened in position as convenient — either in the

centre of the legs or at the tips. The peg is held by the hand, resting on the bench. You may find it better to rasp the inside of the 'legs' to ensure a firm grip.

We also show how you can make a useful compass from a peg similarly treated, using a screw for tightening the 'legs'. This instrument will be found useful for describing large circles for discs of plywood. A pencil is inserted between the 'legs' where necessary according to the measurements of the required radius, and the screw tightened. A pin is also inserted in the head to

make the central pivot.

In the third example we show how two pegs can be used for making a handy holder for the artist or photographer. The base is a piece of hardboard and a screw passes through this to fasten a peg in the vertical position. Another peg is fitted between the legs but this needs another screw for tightening the legs as previously described. A flower or other object is then placed between the 'legs', where it will be held firmly in position. In this instance we recommend the addition of strips of foam rubber on the internal sides of the 'legs'.

Finally we show how a pair of dividers can be made. A wing nut fastener is again used but pins are inserted in the ends of the legs after trimming away about ½ in.

Sometimes you may need an odd wooden bead replacement to act as a foot or buffer for a box and here again you will find that the humble peg can be of assistance. All you have to do is to cut off and use the rounded head.

These handy tools are quickly made and we would strongly recommend the preparation of the handy grip, which is a really useful accessory. Not only can this small vice be used for shaping but also for applying pressure to small objects which have been glued — and the cost is almost negligible. (S.H.L.)

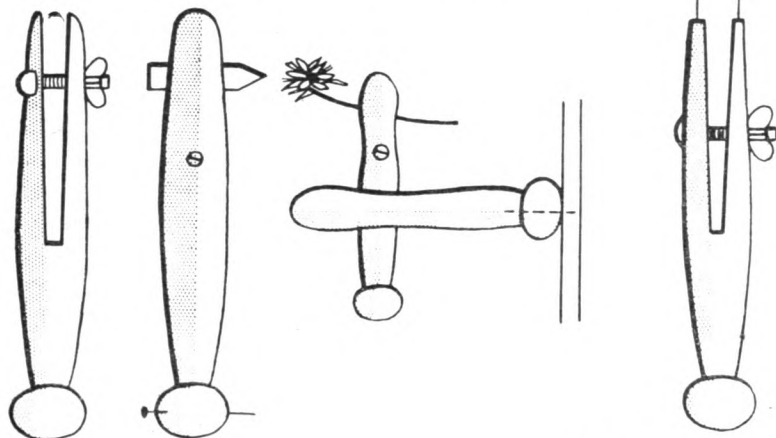

NEW Thoughts on

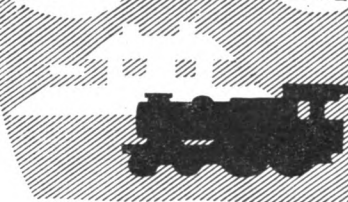

RAILWAY MODELLING

WE have described details of track laying, and we have covered the aspect of scenic modelling of tunnels, etc, and in this issue I propose to give you some details of bridges for your railway layout.

Of course, there are many types of bridges — girder, brick, timber trestle, concrete and countless combinations. It is impossible to cover the construction of every type but I will give you as complete a picture as possible of those you should be most interested in.

Naturally, bridges will carry the tracks over a river, or over other tracks or roads, etc, or will carry roads over tracks, as the case may be. I am sure that most of you will agree that a model railway without at least one bridge would be lacking in interest, to say the least, and it should be the aim of every modeller to include a couple in his layout somewhere. Bridges can be bought ready made. In my last article I told you of a couple of excellent bridges by Tri-ang. If you require a good girder bridge, there is a kit for one by Airfix. This is naturally in plastic, and is very detailed and very good value.

Illustrated is a flying girder bridge, and also a smaller brick built bridge which can be adapted to suit almost any site.

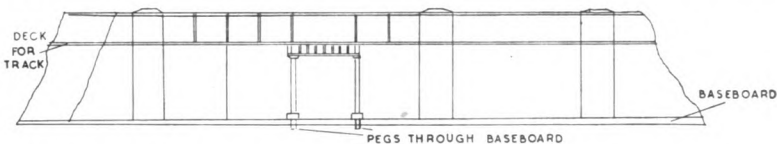

FLYING GIRDER BRIDGE

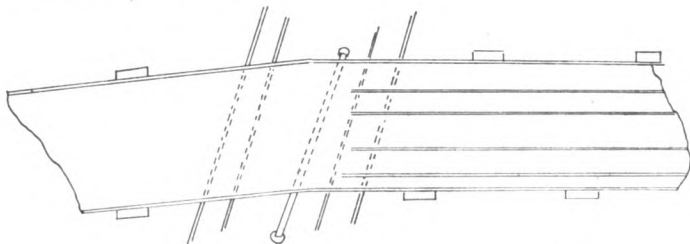

The flying girder bridge is very useful as it is possible with this type to carry a set of tracks over a lower one. The start of the bridge incline can run alongside tracks and it will then rise up and eventually cross the other tracks. This scheme can be used for tracks of almost any radius, and is therefore eminently suitable for any of the proprietary brands such as Tri-ang, Trix, Hornby-Dublo, etc.

TWO TYPES OF BRIDGES

By F. A. Barrett

If you are modelling in the smaller scales naturally it can be used by altering the dimensions to suit. The sloped approaches to the bridge are made to suit

the type of scenery that the line is running through and to suit the tracks.

The deck for the tracks will have to be made from something strong, which will not readily warp. I recommend plywood or one of Hobbies wood panels, and failing these, hardboard. Make the supports for it from blocks of wood, as shown in the drawing. The sides of the slope leading up to the bridge can be covered in thick cardboard suitably covered with brick or stone paper. As an alternative it could be finished to represent concrete, with Humbrol paint from their scenic colour range.

The girder work can be made up in several ways, but here I would use cardboard again. Use a Bristol board for preference as this is a nice smooth board, and does not tend to get fluffy. The overlays should be made from the same card, the thin strips being cut with a sharp model-makers' knife with a steel rule for a straight edge. For a bridge to the OO gauge dimensions I would cut strips $\frac{1}{16}$ in. wide. Mark the positions

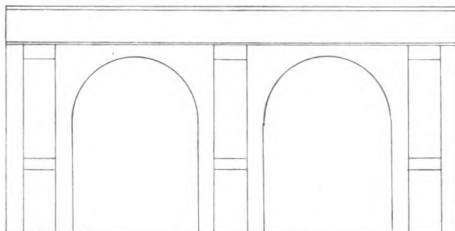

SMALL BRICK BRIDGE

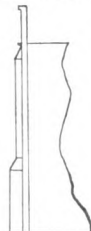

for these on the card sides with a pencil and a square and then glue them into position, and also glue the top and bottom strips in place, and you should have a nice neat job.

For the flying girder you can also use a strip of card with a strip of card along the top and the usual side webs. The R.S.J.'s or columns can be made of dowel, with a strip of paper glued round the bottom to form the thick support. Make the columns longer than the actual height so that you can push the bottoms into holes drilled into the base-board. This will make the whole structure more secure, and will prevent possible trouble at a later date.

The whole structure should then be painted with shellac, or French polish. It stiffens up the structure and makes a

good base for the subsequent painting in dark green or dark grey. Don't forget to show the smoke on the bridge left by the engines when passing through, also the underside of the bridge should also be painted matt black for the same reason.

If you want to make your bridge really authentic you should show the girders on the underside of the track base. These run lengthwise, in other words the same way as the tracks above run, and there would be about eight of them. These could be made up from three pieces of card, or you could use strips of thin wood, say $\frac{1}{8}$ in. square.

The smaller brick built bridge could be used for tracks over a road or river, and also would be suitable to carry a road over the railway. The method of construction is again cardboard, or at least that is what I use. I find it is easy to cut and very strong, but you will need to get some that is about $\frac{1}{16}$ in. thick. The bridge can be covered with brick paper, and I would select a type of weathered brick for this. It looks much better than, say, a red brick. The deck of the bridge can be made of ply or hardboard and the supports are pieces of wood, cut to suit the site.

It would be best to cut two sides for the bridge, and then shellac them, as mentioned previously. When dry, cover them with the brick paper making sure that you have the paper on square, that is to say, so that the line of bricks along the top of the side is level. Whilst this is drying, cut your strips of card for the overlays, the buttresses, and the strips along the top. Next cover the buttresses with brick paper, again making sure that they are square, and when these are dry they can be glued into position on the bridge sides. The top coping strip can then be glued into position, together with any other embellishments, and these should be painted a stone or concrete colour. The sides then can be put

ROVEX SCALE ACCESSORIES

I HAVE received another batch of new products from Messrs Rovex Scale Models Ltd, both for the OO enthusiast and the TT3 man, writes F.A.B. The new Super 4 Track with hand operated points for OO gauge is ideal in every way. It looks good, it works excellently, and as is usual, by setting the point you also set the power for the way in which the train will run. This can be converted to electric operation by the addition of a small point motor.

The Super 4 Track has been responsible for the introduction of the 'Clip-Fit' accessories. A single track level crossing, hand operated, is a lovely little model in plastic and can be fitted anywhere on the track. It clips into the sides of the track, and locks into position. Altogether a good buy at 6s. 7d.

Another new line is the R.488 uncoupling ramp. This is also a 'Clip-Fit', and a very useful item at 1s. The R.487 power connecting clip is also a good item. It incorporates a television

interference suppressor, and sells for 1s. 8d. The beauty of it is that you do not have to buy special terminal rails etc. I have also had a new buffer stop which again fits anywhere on the layout, and the price is a modest 1s.

All of these 'Clip-Fit' items can be used on Series 3 track as well as Super 4, and represent grand value.

Now for TT3. The T.99 2-6-2 'Prairie' Tank Locomotive is priced at 48s. 2d. and what a wonderful little loco it is, perfect in every detail. It runs beautifully, and this is a design that is always very popular with model railway fans. Also in TT gauge is an excellent model of a signal gantry. This has four signal arms, two facing each way, and also employs the 'Clip-Fit' facility so that fitted to Tri-ang tracks it becomes a rigid structure. But it is an easy matter to mount the gantry in a free standing position for other TT track users.

This range is one of the finest on the market, and I congratulate the designers on their skill.

into position on the framework of the bridge, i.e. the deck glued and nailed to the blocks forming the piers. You will then need some thinner card from which to cut pieces to fit and curve round the inside of the arches. When you have them correct, cover with brick paper, and finally glue into position.

To add a little touch of realism when you have fixed your bridge down to the baseboard, add a few light touches of green paint round the bottom of the bridge supports where they rest on the baseboard and put a little flock powder on the wet spots. This will then give the appearance of growing grass.

If you are making a road bridge remember to make it wide enough to carry the traffic that would normally proceed over it, and remember to put in the pavements where applicable. These are represented on the model with thin strips of card, and they can be scored with a ruler and dry ball point pen to represent the paving stones and the kerbs. Or you can get a paper that is an excellent copy of paving stones. I should of course point out that the papers I have mentioned are only available in OO scale, so if you are using a different scale you will have to revert to the do-it-yourself method outlined above.

FOR YOUR LAYOUT—TWO NEW SETS FROM AIRFIX

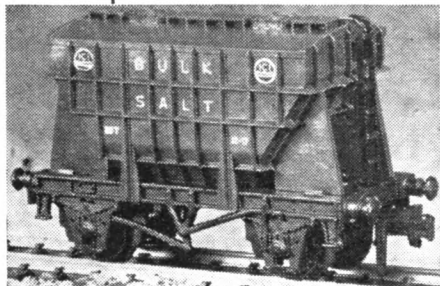

Hornby-Dublo I.C.I. Bulk Salt Wagon.
Price 7/1d.

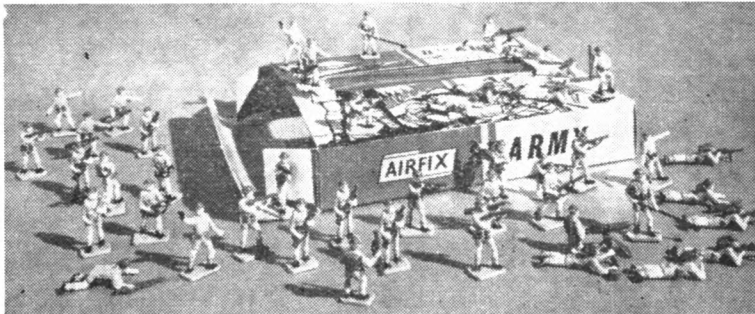

Eighth Army figures in action. Each box contains 48 figures to HO and OO scale. Another set to the same scale depicts the French Foreign Legion in action. Price each set 2/-

Mainly for Modellers

WE now come to the study of what, on the early ships, has always been the part of the hull to carry the main decorations.

Prior to about 1500, typical of the carrack, the largest type of sailing ship of the period, was the round stern. Most reconstructions of the *Santa Maria*, which shows a square tuck, are, therefore, wrong for this type of vessel. This round stern persisted into the sixteenth century in smaller vessels after the introduction of the square tuck (or stern) for the larger types.

The first half of the sixteenth century saw the addition of extra decks at the stern, each deck projecting over the stern post as much as some 20 ft. This addition of decks resulted in extra counters and galleries, and by 1600 the general rule in large ships was to have two counters and galleries. To support the floors of these quarter galleries curved brackets of timber were used.

The next step was the closing in of

some of the galleries, leaving part of the forward end open. With the *Prince Royal* of 1610 we see the lower galleries and sternwalk glazed in. This was carried further in the *Sovereign of the Seas*, the stern of which was completely glazed in and some two thirds of the galleries.

WOODEN SHIP BUILDING—18

By 'Whipstaff'

In English ships this glazing in of the stern and galleries, because of the lines of the windows, gave a vertical effect. On the other hand the Netherlands modified the open lower gallery and discontinued the upper one. This became the low box-like stern we have in

Dutch vessels of the period with a taffrail above on which it became usual to paint or carve in low relief a coat of arms or symbolic painting denoting the ship's name.

Up to late in the sixteenth century the taffrail in English ships carried the Royal Arms only, but with the arrival of the Stuarts carving began to be used extensively, and framing of the windows and brackets were so decorated. Carvings also appeared in panels and spaces where there were no windows. On the Continent the designs of the curved sterns and galleries became very elaborate, even to the point of being, to English eyes, very bizarre.

From about 1580 there began to be a gradual reduction in the height of the stern. The high sterns of the Tudor period proved to have serious defects, both in structure and in affecting the seaworthiness of the ship.

Half way through the seventeenth century the English ship builders developed a basic design for the stern which lasted, with small variations, for some considerable time. The vertical appearance given by the window lines, etc, began to be replaced by curves. The length of the galleries was reduced, giving eventually an elliptical effect, and the gallery brackets radiated above and below.

The upper galleries were made smaller in size and flanking carvings, after the Dutch style, were introduced on the quarter pieces of the stern. As with the designs on seals the artist would disturb the figures of the carvings to fit them into the shapes left by the designer.

When the early type of stern was closed in the main shapes of the stern timbers were not altered, so that later, when open walks were again introduced, it was only necessary to remove the outside windows.

Windows were glazed with panes of a diamond shape, set in lead frames. They were made to open outwards, but later, possibly about the reign of Queen Anne, glass manufacture had improved so much that ground glass came into use, and was puttied into the frames. On large ships the stern windows were usually made in a double sash, but those in the quarter galleries were usually permanently fixed.

In the largest vessels of the late seventeenth century there were seven windows in each tier, and this became the standard practice into the nineteenth century. Up to the end of the seventeenth century gun ports, known as chase ports, were cut under the windows for guns to fire astern. Above the windows the taffrail carried the Royal Arms carved in low relief and flanked by carved figures on either side, and finished off

● Continued on page 372

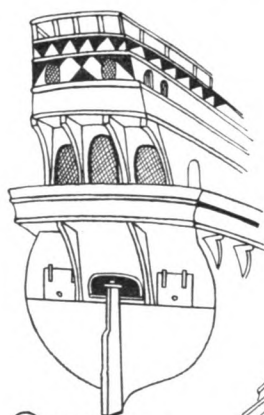

1 ELIZABETHAN GALLEON

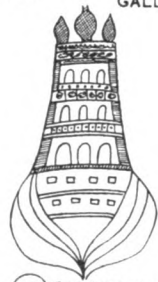

3 FRENCH WARSHIP 1637



2 VENETIAN CARRACK

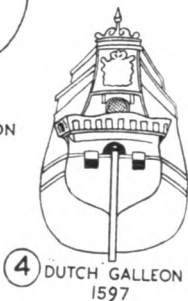

4 DUTCH GALLEON 1597

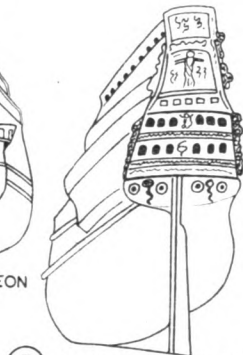

5 STERN OF "SOVEREIGN OF THE SEAS" FROM "WHIPSTUFFS" SCALE MODEL

HEAR ALL CONTINENTS

With H.A.C. Short-Wave Receivers

Suppliers for over 18 years of radio S-W Receivers of quality.

One-Valve Kit, Price 25/- Two-Valve Kit, Price 50/-

Improved designs with Denco coils. All kits complete with all components, accessories and full instructions. Before ordering, call and inspect a demonstration receiver, or send stamped addressed envelope for descriptive catalogue.

(H.A.C.) Short-Wave Products (Dept. 22), 11 Old Bond Street, London, W.1.

No. 1 MITRE-CUTTING TOOL AND CORNER CRAMP

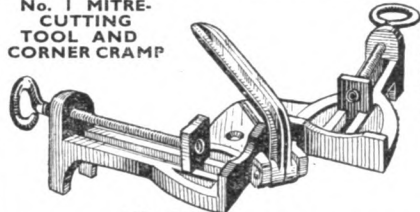

Will cut mitres on moulding and similar work up to 4 ins. wide. (post free) **55/-**

WOOD MITRE BOX

Made of selected hardwood. Size 9 ins. long. (postage 1/6) **5/6**

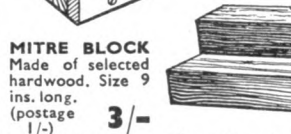

MITRE BLOCK
Made of selected hardwood. Size 9 ins. long. (postage 1/-) **3/-**

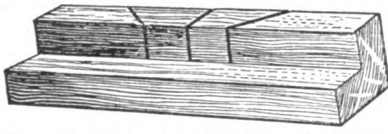

HOBBIES LTD (DEPT. 99), DEREHAM, NORFOLK

for holding
POWER



SECCOTINE

REGD

There's nothing like real SECCOTINE! For over sixty years Seccotine has been indispensable to every handyman. For sheer adhesive power buy Seccotine with the efficient new "pop-on" seal and open-nozzle tube ready for use.



STILL ONLY
1/3
PER TUBE

Sole Manufacturers — **McGAW, STEVENSON & ORR LTD., BELFAST**

STOP SMOKING

You can overcome the Smoking habit in 3 days, or money back. Safe, pleasant, permanent. The only scientific way. **No Will Power necessary.** 'Conquered the habit in 2½ days.'—F.C. 'Within 2 days I was free.'—W.G. Complete Course 7/6 Details 2d. Sent under plain cover.

NATURE REMEDIES, (H166), 28 Dean Road, London, N.W.2.
Established 1928

ENJOY WRITING? Then write for Profit. Send for 'Writers' Handbook' (free) detailing countless opportunities for beginner or experienced. — Writers' Ring (HW) 5 Edmund Street, Birmingham.

PERSONAL COLUMN LTD, Falcon House, Burnley, Lancs. Pen Friend — all hobbies. Correspondents in almost every Country. All ages. S.A.E. for details.

PERSONS with sewing machines required at once. Regular work. Send S.A.E. for details to Dept. 28, Arnold 10, Shelley Road, Worthing, Sussex.

LEARN RADIO & ELECTRONICS the NEW Practical Way! Very latest system of experimenting with and building radio apparatus — 'as you learn'. **FREE Brochure** from: Dept. H.W.10, Radiotractor, Reading.

IF you have taken a lot of care in making a musical box, be sure to make it worthy by including the best Swiss movement — a **REUGE**. Prices from 14/9. Wide range includes a charming Dancing Ballerina. Many tunes to choose from. Send for details in free booklet 'Profitable Leisure'. **HOBBIES LTD, DEREHAM, NORFOLK**

GLASS CUTTERS FOR THE HANDYMAN



With its six-wheel 'turret' this tool is just the thing for the handyman. It has a strong composition handle.

PRICE 2/9, postage 4½d.



Cuts circles 1½ in. to 10 in. diameter. Can also be used for straight cuts. The tool is housed in a pivot, the top of which serves as a thumb rest and adjuster nut lock. It has three cutting wheels.

PRICE 8/6, postage 6d.

HOBBIES LTD (Dept. 99), DEREHAM, NORFOLK

Illuminated Corner Fitment

A NEAT telephone shelf with concealed lighting is a space-saving fitting which will brighten a dark corner, especially in a small hall. An added feature is the illumination provided for a pot plant on the top shelf.

By A. Liston

Each of the three triangular shelves is made of $\frac{1}{2}$ in. thick chipboard. They are 18 in. long on the sides which touch the walls, so that two shelves can be cut from an 18 in. square of chipboard with one diagonal cut from corner to corner. If necessary, the lower shelf can be dispensed with altogether and dimensions can be altered to suit individual requirements.

(A). A 6 in. square box frame of 2 in. by $\frac{1}{4}$ in. wood (B) is pinned and glued together, and a porcelain or plastic lampholder is screwed inside its rear face. A hole should be drilled in the frame at this point to take the flex out to the rear of the frame. A $5\frac{1}{2}$ in. square of quarter round beading (C) is pinned and glued inside the frame $\frac{1}{4}$ in. from the top, so that the $5\frac{1}{2}$ in. square of $\frac{1}{4}$ in. thick glass (D) is level with the top of the frame. The beading may have to be cut away at one point to clear the lampholder, but this depends on the type which is being used.

The flex is attached to the lampholder and the complete frame is screwed in position in the hole cut for it in the upper shelf (E). It should now project approximately $\frac{3}{8}$ in. above and below this shelf.

A 12 in. by 3 in. strip of plywood with curved ends (F) is pinned in front of the

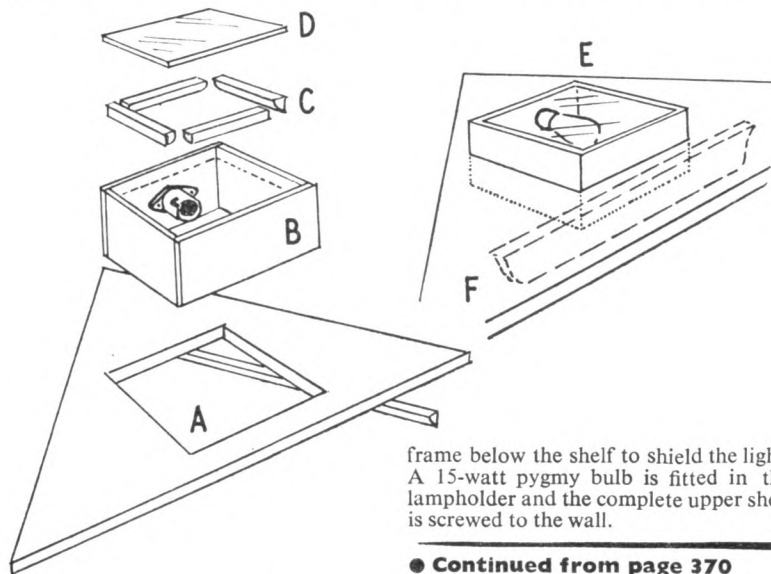

frame below the shelf to shield the light. A 15-watt pygmy bulb is fitted in the lampholder and the complete upper shelf is screwed to the wall.

● **Continued from page 370**

All shelves rest on supports made from 16 in. lengths of quarter round moulding, two to each shelf. These supports are first screwed to the wall, using wall plugs. The lowest pair, which support the shelf for the directory, are 24 in. above floor level. The middle pair are placed 6 in. above this to take the telephone shelf, and the upper pair are 15 in. above the telephone shelf.

The two lower shelves are screwed to their supporting strips, then the light fitting in the upper shelf is constructed. This is done by first cutting a 6 in. square in the top shelf, 2 in. from its front edge

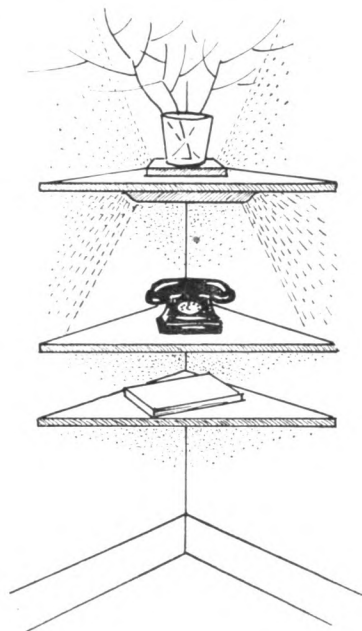

If the light flex is to run down the wall, the least obtrusive position is in the angle of the walls. The corners of the lower shelves may be cut away at the back to allow the flex an unobstructed run. A torpedo switch may be incorporated in the flex just below the telephone shelf.

An attractive finish for the chipboard is two coats of emulsion paint, either matching or contrasting with the walls, and protected by a coat of varnish.

WOODEN SHIP BUILDING

above usually with a floral design. In single deck vessels the quarter galleries gradually disappeared, to be replaced by carved badges.

In our sketches are shown the stern developments from Elizabethan times to the Stuarts. Introduced during the reign of Elizabeth I, the projecting galleries extending along each quarter gradually went out of fashion, as did the carrying of these galleries round the stern to form a stern walk. This outside gallery survived up to the building of the *Royal*

Prince of 1610, and then died out for the best part of a century, all ships having a closed glazed stern.

The earlier ships had the rudder head cut off below the counter, the horizontal tiller passing through a large opening called a helm port. But around 1700 the rudder was introduced with the head carried up into the counter, and thus entirely inside the ship. This meant a smaller helm post which could more easily be closed with canvas against the weather.

MAKING PHOTOMETERS

VARIOUS forms of photo-electric meters to show the exposure required can be made quite easily. Similar meters can also be used to help find the exposure when enlarging.

Two circuits are shown in Fig. 1. The selenium cell may be round or rectangular, and it produces current according to the light falling on it. This gives a reading on the meter, which thus shows light intensity, or the exposure required for a successful photograph.

For high sensitivity (ability to measure dim light) the meter must be sensitive, with a full-scale reading of $50\mu\text{A}$ (microamperes) or $100\mu\text{A}$. Such meters are available new, or as surplus, or as indicators in aircraft and other instruments.

Sensitivity may be reduced by adding a series resistor as also shown in Fig. 1. The same cell and meter can then measure strong light (outdoor scenes) as well as poor light (interiors). A push switch can short out the resistor. The meter then covers high degrees of illumination, until the push is depressed.

A cell about 40 mm. by 22 mm., with a

Directional angle

For maximum sensitivity (indoor use) the cell can be behind an opening, or glass. The meter must then be held in such a position that a very bright area, such as a window, does not throw light on the cell, or the reading will be incorrect.

By F. G. Rayer

Many photometers have a grille similar to that in Fig. 2. This reduces the angle of light falling on the cell to about that of the camera lens. The meter is then less affected by light sources outside the picture area.

The grille can be made by drilling rows of holes in $\frac{1}{8}$ in. thick ebonite or similar material. If the holes are not very numerous, the light reaching the cell is much reduced. If the grille is attached to

level, facing upwards, so that light falls upon it, and the meter pointer is visible. The cell should be behind a small opening, so that small parts of the image may be sampled.

A sensitive meter is necessary, and the enlarger should have condenser illumination, a high-intensity lamp, and a lens preferably not smaller than $f/3.5$. If these points are overlooked, the meter reading will be too small.

The reading should be taken from a representative area of the projected image. With a given paper and developer the meter may be calibrated directly in exposure times. It is also satisfactory to use a numbered scale, and prepare a table showing exposures.

Illumination and brightness

Some surplus meters are calibrated in 'Lux', which is a continental unit equal to 0.093 lumen/sq. ft. That is, 1 lumen per sq. ft. equals 10.76 Lux.

The term 'lumens per sq. ft.' is the same as 'Foot Candles'. If a surface 1 sq. ft. in area is arranged so that every point is 1 ft. from a light source of 1

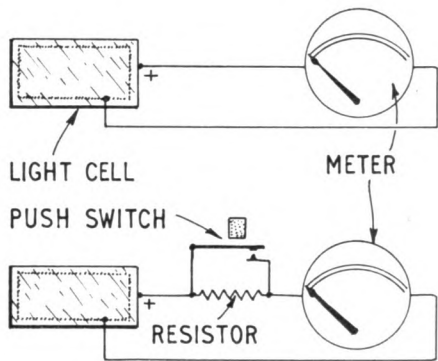

Fig. 1—Photo-electric meter circuits

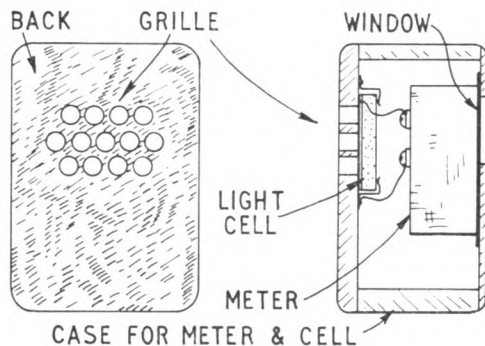

Fig. 2—How to construct the Photometer

$50\mu\text{A}$ meter, will read up to about 1/500th sec. at $f/5.6$, with a 6.8K (6,800 ohm) resistor, and employed with 30°Sch. film. With a given cell and meter, sensitivity can be reduced by increasing the value of the resistor, until bright sunlight gives a full-scale reading. This will do well for outdoor use.

The sensitivity of a given cell and meter cannot be increased. The ability of the photometer to give a reading with dim light depends on using a large cell, and a sensitive meter. For general purposes, the 40 mm. by 22 mm. cell will do well.

small hinges, this will give a two-range photometer. When the grille is closed over the cell, sensitivity is reduced, and the meter can be used outside. With the grille opened so that the cell is fully exposed, the meter may be used indoors.

If this method is used, continue to drill holes until the meter just reads full-scale out-of-doors in full sunlight.

Fig. 2 shows one way to make the photometer. The cell is held with small clips, the back being positive. If the meter pointer tries to move the wrong way, simply reverse the leads.

The cell should be at nearly baseboard

candle power, as in Fig. 3, the amount of light falling on the surface is 1 lumen.

Brightness is the amount of light leaving a surface. This depends on the intensity of the illumination, and the type of surface, as light-toned surfaces reflect much more than dark-toned surfaces.

Brightness (or luminance) is generally expressed in Foot-Lamberts. A ft.-lambert is the brightness of a diffusing surface, so illuminated that it emits one lumen from each sq. ft. of area.

It should be noted that the illumination of a surface by a light source does not fall in proportion to the increase in

distance, but in proportion to the square, or increase in area. This is shown in Fig. 4, which is an experiment easily made with stout cards.

The light passing through the 1 sq. ft. opening illuminates 4 sq. ft. on the second card. Doubling the distance of an object from the light source thus reduces the illumination of that object by four.

Meter readings

For photographic purposes, the meter is often held to show the subject brightness (ft.-lamberts). This is termed a 'reflected light' reading.

Another method is to hold the cell facing the source of illumination. This

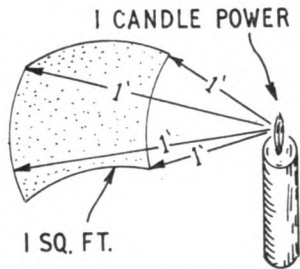

Fig. 3—Diagram showing the lumen

gives a much higher reading, and is called the 'incident light' reading.

The difference between reflected light reading and incident light reading will be very great for dark subjects, but much smaller for light-toned or reflective subjects. For an average portrait, the reflected light will be about one-twentieth the incident light. If illumination is so poor that it is impossible to get a reflected light reading, it is thus possible to take an incident light reading, divide by twenty, and give this exposure.

Exposure value scale

Reducing the lens aperture by one stop makes necessary a 'doubling in exposure time. For example, $\frac{1}{4}$ sec. at $f/4$, $\frac{1}{2}$ sec. at $f/5.6$, 1 sec. at $f/8$, and 2 sec. at $f/11$ would all give the same result, in terms of exposure, or light reaching the film.

Modern 'Exposure Values' run from about 2 to 18. Any exposure value number, as marked on a modern camera or meter, represents a particular exposure. For example, exposure value 6 could be any of the lens apertures and shutter speeds just given.

Reducing the exposure value by 1, multiplies exposure by 2. Similarly, each time 1 is added to the exposure value, the exposure is halved. If exposure value 6 is 1 sec. at $f/8$, then the exposure value 5 is 2 sec. at $f/8$, while exposure value 7 is $\frac{1}{2}$ sec. at $f/8$, and so on.

If the camera has an exposure value

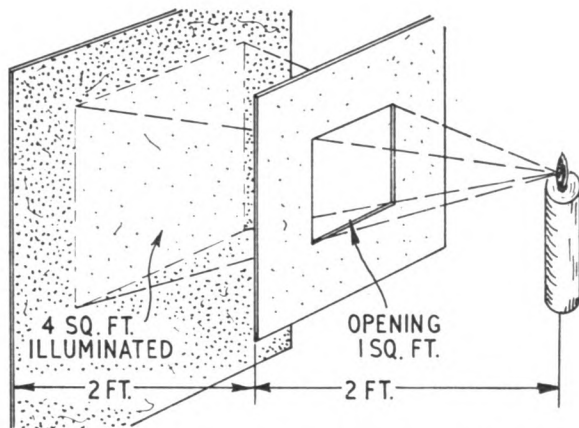

Fig. 4—How illumination changes with distance

scale, it is handy to have this type of scale on the photometer. It is then only necessary to set the camera indicator to agree with the meter reading.

Calibration

If the meter is a surplus one, calibrated in Lumens, Lux, or ft.-lamberts, these can be changed to give readings for incident or reflected light.

A home-made meter, with no scale, can be calibrated in exposure values, or in shutter speeds and lens apertures. If a ready-made photometer can be borrowed, direct this meter and the home-made meter at various subjects in turn, and mark the home-made meter scale to agree with that of the ready-made meter.

Another method is to use the detailed lighting conditions and exposures set out by film makers, to calibrate the

meter. Or the table below can be used to give exposure values for HPS film. For other films or further exposure values, double the exposure for each 3° Sch. reduction in film speed, or when reducing the exposure value by 1, as explained. Use a 100-watt pearl domestic lamp, without shade or reflector, and direct the meter at this.

Lamp to meter Distance	Exposure Value
4 $\frac{1}{4}$ in.	18
6 in.	17
8 $\frac{1}{2}$ in.	16
12 in.	15
17 in.	14
24 in.	13
34 in.	12
48 in.	11
68 in.	10
96 in.	9

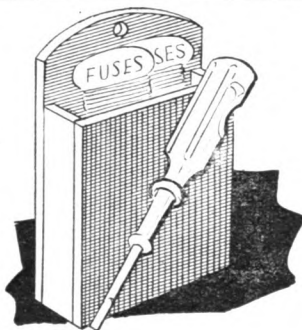

PATTERNS OPPOSITE

THE sketch shows a small box for fuse cards, complete with a special 'Stripmaster' screwdriver. No need to search high and low for these essential items which seem to have a habit of disappearing just when needed.

A HANDYMAN'S FUSE HOLDER

Cut one each of pieces A and B, two of piece C and two of piece D, all from $\frac{1}{4}$ in. wood. All the pieces may be cut with a fretsaw. Glue them all together as indicated by the sketch and by the dotted lines on the various pieces.

The screwdriver is held in place quite simply by inserting a large screweye in the centre of piece B. Hang the tidy in the cupboard next to the meter and fuse boxes. The 'Stripmaster' screwdriver can be obtained from Hobbies Ltd, Dereham, Norfolk, and from any branch or stockist, price 3s. 6d. (postage 6d.). (M.p.)

HANDYMAN'S FUSE HOLDER

CUT OUT WITH
A FRETSAW

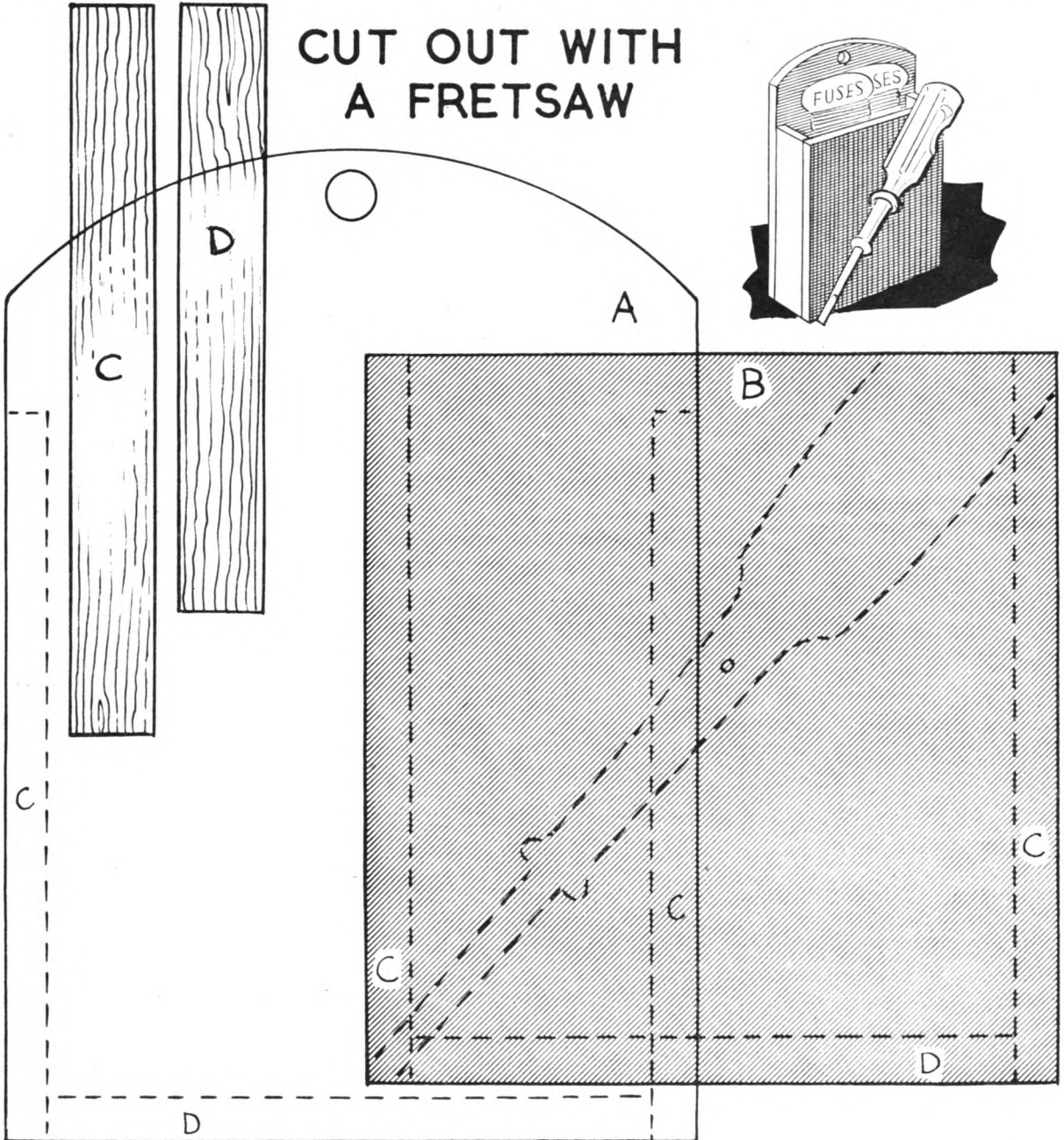
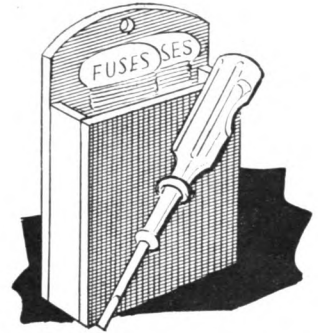

YOU CAN DEPEND ON THESE

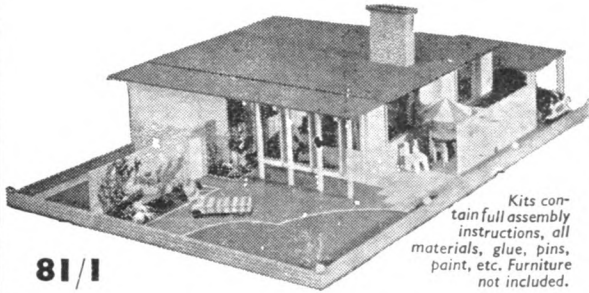

Kits contain full assembly instructions, all materials, glue, pins, paints, etc. Furniture not included.

81/1

THE 'CELEBRITY'—RTA 7

Size 36 in. x 24 in. Five main rooms including lounge with dining recess. Gardens, car port, service area, sun trap, etc. Flat roof lifts off for easy access to each room

ALL PARTS PRE-CUT

ALL READY TO PUT TOGETHER

For the 'Royal' and 'Celebrity' Dolls' Houses, Hobbies have prepared kits with all parts cut to size and shape, ready for you to put together and finish. These are ideal for the man who wants to make a really excellent Doll's House — in a hurry!

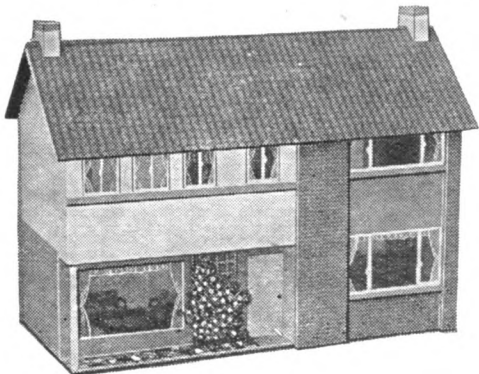

THE 'ROYAL'—RTA 6

Size 26 in. x 12 in. x 19 in. high. Double door opening at back. Modern lounge, hall entrance, kitchen/dining room, 2 bedrooms, bathroom and landing.

99/11

TO HOBBIES LTD (DEPT. 99), DEREHAM, NORFOLK

PLEASE SEND KIT No. RTA.....

NAME

ADDRESS

.....

.....

P.O. or cheque for..... enclosed

If your hobby is working in wood
ARCOY PRODUCTS make ideal tools for you.

ARCOY RABBETTER

For use with any Portable Drill. A boon for all workers in wood. It rebates for panelling, etc. It slots for drawers. It strips for laths. It tongues, grooves and fillets.

PRICE £22.6

Moulding cutters for use with rabbetter £13.6 each.

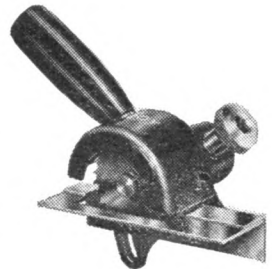

ARCOY POWER PLANE

Combines the handiness of the normal smoothing plane with the efficiency of the planing machine. Will never split wood, lift fibres or tear. Depth of cut adjustable from 0- $\frac{1}{16}$ in.

PRICE £16.10.0

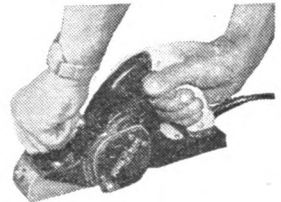

ARCOY DOVETAILER

With the aid of any $\frac{1}{2}$ in. capacity power tool you can produce joints at $\frac{1}{4}$ in. pitch in timber up to 9 in. in width in any combination of thicknesses from $\frac{1}{8}$ in. to 1 in. in five minutes!

PRICE £66.3

Housing Joint Attachment

PRICE £1.11.9

Multi-Pitch Attachment

PRICE £2.16.6

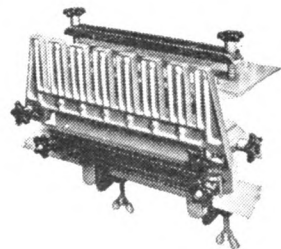

If you have difficulty in obtaining
ARCOY PRODUCTS, write for **FREE literature to: ARCOY PRODUCTS**
KNOWSLEY RD., BOOTLE, LIVERPOOL 20

