

16th AUGUST 1961

VOL. 132

NUMBER 3427

THE ORIGINAL
'DO-IT-YOURSELF'
MAGAZINE

HOBBIES *weekly*

FOR ALL
HOME CRAFTSMEN

Also in this issue:

PATTERNS FOR
PHOTO FRAMES

COLLECTORS' CLUB
AND LETTER RACK

DISC BREAK

MODELLING A
CLIPPER SHIP

RECIPES FOR
WINE MAKING

TEA TRAY FOR
AN ARMCHAIR

ETC. ETC.

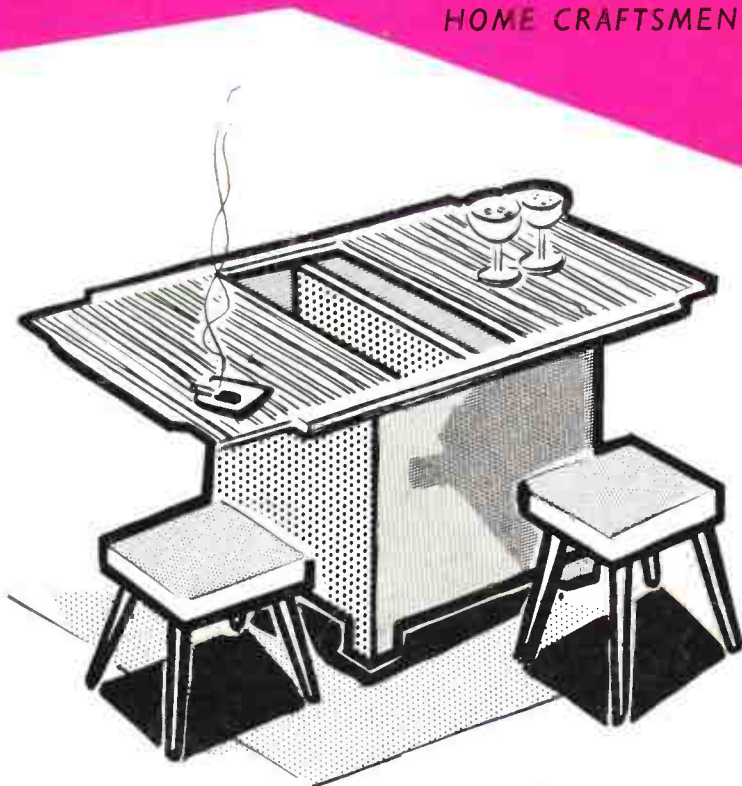

Instructions
for making

COCKTAIL CABINET (WITH SLIDE-AWAY TRAYS)



Up-to-the-minute ideas

Practical designs

Pleasant and profitable things to make

5^D



THE old guns had smooth bores — that is, the inside of their barrels were bored out smooth. These would not shoot a ball very far nor very straight, and in time it was found that guns could be made to shoot truer and further if little channels or grooves were cut on the inside of the barrels. Guns whose bores are cut with these grooves

this was apt to throw it out of the right line of flight; but the rifle ball, being made to turn in exactly the same way during its flight, goes much truer and straighter. As it is commonly pointed like a cone, it also cuts through the air more easily, and therefore, goes much further.

Pistols came into use soon after muskets. They are mentioned as being used in France in the middle of the sixteenth century by troops called pistoliers.

The Museum of Artillery in Paris has two 'revolving pistols' made more than two centuries ago. But the clumsiness of these instruments hindered their general adoption.

The first marked improvement in revolving pistols was made by the American Samuel Colt, who in 1836 made the pistol which is named after him, and since that time others have made revolving pistols, but they are all much like the Colt. It has but one barrel, behind which is a cylinder usually with six chambers. The chambers are loaded with metal cartridges, containing the powder, ball, and percussion powder, much like those used in the Springfield rifle. The Remington and the Smith & Wesson revolving pistols differ but little from Colt's, and use the same kind of cartridge.

THE STORY OF FIREARMS—2

are called rifles. The grooves, which vary in shape, size and number in different kinds of rifles do not run straight from one end of the barrel to the other, but are made with a twist, so that they usually turn round the barrel once in its length.

When the gun is fired the ball has to follow the grooves in passing out of the barrel, and this gives it a twist which makes it spin after coming out of the barrel, and always in the same way. In the smooth-bore gun the round bullet used in it would also spin sometimes; but the motion was not always the same, and

A BARBADOS COMMEMORATIVE



The 4-cent value of Barbados Deep Water Harbour Commemorative Issue (6th May). Colour: 4 cents orange and black, 8 cents blue and black, 24 cents black and red. The design, which is common to all values, features the Amigoni portrait of Her Majesty the Queen and a view of the new harbour at Bridgetown, the capital.

MINIATURES IN BRASS

BRASS miniatures are made in great variety. In the animal group are elephants, lions, tigers, kangaroos, etc. I have a lovely model of three pandas. It came from Germany and cost me a packet of early English stamps.

The latest brass miniature on the market is an axe, 6 in. long by 2 in. wide. Mine cost 12s. 6d. Collectors usually keep these novelties in glass cabinets. But they may be displayed on shelves or elsewhere in the home.

Among household effects we find kettles, pots and pans, urns, vases trays, gongs, etc. Transport enthusiasts are not forgotten. I have seen coaches, cars, aircraft and even rockets.

Some of the older models produced about 30 years ago are naturally collectors pieces. They include Buckingham Palace, Big Ben, The Houses of Parliament, The Pyramids, The Taj Mahal, etc.

Look through your albums and you'll find many of the above models depicted on stamps and labels. Check your back numbers of *Hobbies Weekly* for illustrated articles on these topics. Axes are featured on stamps and labels, too.

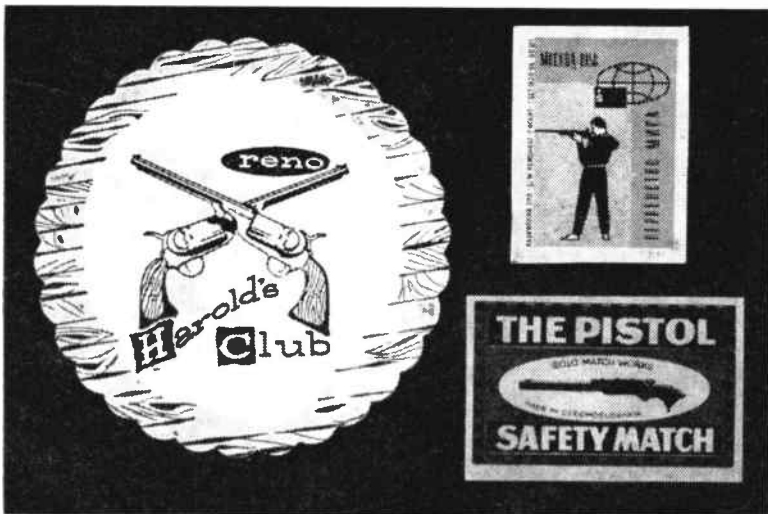

★ ★ ★ ★ ★ ★ ★ ★ ★ ★ ★ ★ ★ ★ ★ ★
 ★ Next week's free design will be for ★
 ★ a decorative 3-D picture in wood, ★
 ★ incorporating a pot plant. ★
 ★ MAKE SURE OF YOUR COPY ★
 ★ ★ ★ ★ ★ ★ ★ ★ ★ ★ ★ ★ ★ ★ ★ ★

A COLLECTOR'S LETTER RACK

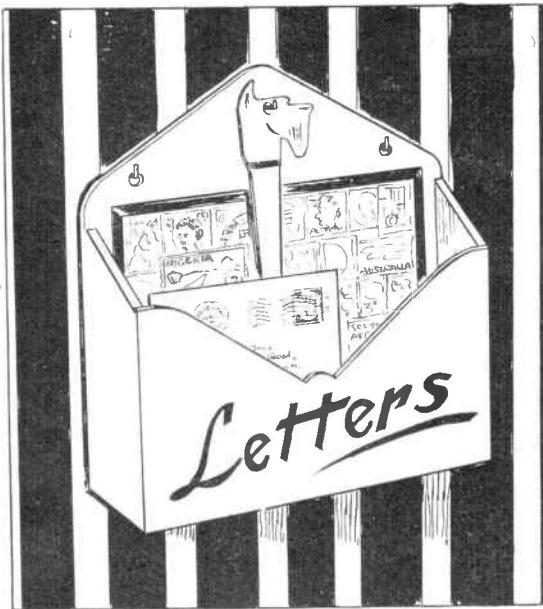

ENTHUSIASTIC stamp collectors who exchange specimens with fellow readers of 'Collectors' Club' and regularly receive correspondence from all over the world, will appreciate this serviceable letter-rack. As the illustration shows, this rack resembles a large, open envelope into which the incoming mail is placed, and has a panel

insert with a colourful display of world-wide postage stamps. Other hobbyists could decorate the rack with cigarette cards or match-box labels, according to their interests. The attractive letter opener, for which a pattern is given, is a serviceable accessory, hung in a convenient position on the rack. Cut parts A and B with a fretsaw to the patterns given in Fig. 1, using fretwood or plywood of $\frac{1}{8}$ in. thickness. Cut two of D and one of C to provide a base and end members of $\frac{1}{4}$ in. or $\frac{3}{8}$ in. wood. Glue and nail these together to make the 'envelope' rack. Drill two holes in the top 'flap' for hanging on the wall. Clean up with fine glasspaper, then paint. The overall colour is white, or a touch of colour mixed into your white paint for a pleasant pastel shade. The wording 'Letters' can be hand-painted red or blue. The display insert E is a piece of card

$7\frac{1}{4}$ in. by $5\frac{1}{4}$ in. on which the stamps or labels are mounted. Bind the board with paper or plastic tape along its edges.

The stamps are stuck on permanently with glue, so valuable issues are not used. Queen Elizabeth, Airmails, Overseas, Commemoratives, and Pictorials series all provide interesting specimens. Arrange the colours to make an attractive design. Stamps may be uniformly spaced or 'staggered' as desired. The panel is finally covered with clear acetate sheeting.

A small hook is required for hanging the paper-knife. A panel-pin hammered into the rack at the position shown and the end bent up makes a small 'square' hook.

For the letter-opener, obtain a piece of perspex of about $\frac{1}{8}$ in. thickness and $5\frac{1}{2}$ in. long. Follow the graph sketch to obtain the full-size pattern shown in Fig. 2. Cut out with a fretsaw after boring the hole for the 'eye' of the 'Scottie dog'. Lubricate the blade and perspex whilst cutting out, to prevent jamming when the blade gets hot. File a 'knife edge' of the blade indicated at X. Features to the dog's head and a collar are painted on both sides with plastic enamel. (T.S.R.)

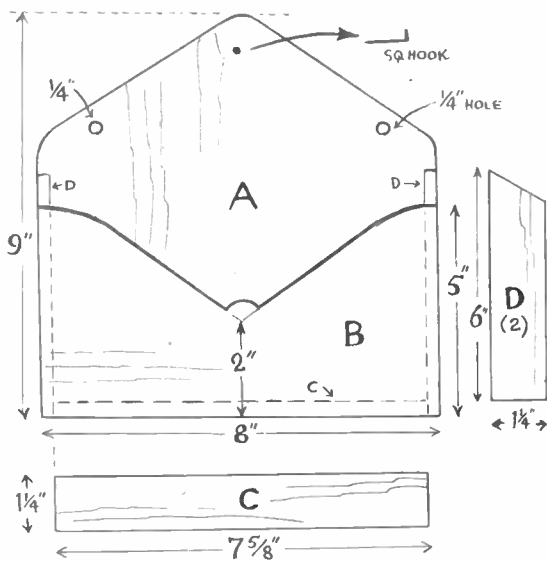

Fig. 1.

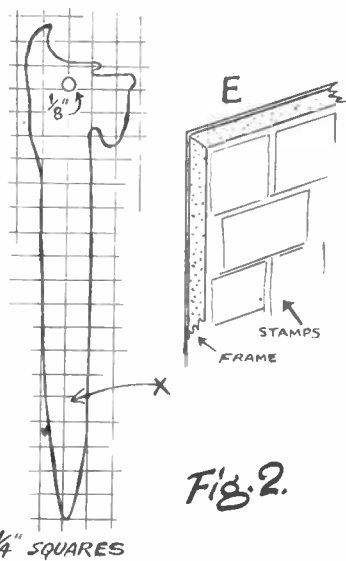
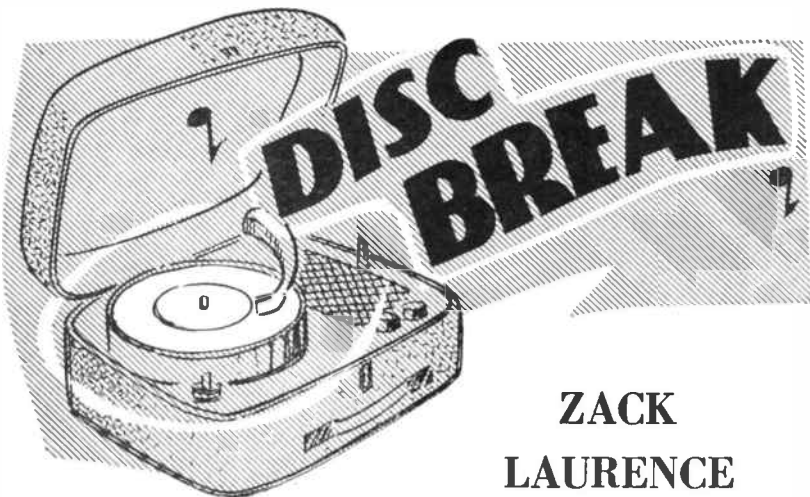

Fig. 2.



ZACK LAURENCE

ZACK Laurence, 16-year-old Parlophone pianist, has his mother to thank for starting him on a musical career. Born in Hackney on 30th June, 1945, Zack has been playing the piano since he was seven.

'It was all my mother's idea', he says. 'She was always determined that I should be musical in one way or another. At first it was dancing lessons when I was five, but after a year I lost interest. Once when I was taking part in an amateur show I was so frightened that I ran off the stage and wouldn't go back again.'

'Next came the violin, but that never meant anything either. Still my mother kept on trying. There has always been a piano in the house and she decided that I would have to learn to play it.'

Reluctantly, for his ambition was to be a fireman, Zack began his scales and arpeggios. He improved so rapidly that by the time he was 10 he won a scholarship to the Guildhall School of Music, where he studied for two years.

But while he was expected to train as a classical pianist his interest turned more towards pops. 'It wasn't that my heart was not in classical music, but I felt that I wanted to play my own notes instead of the written ones. The times I was told off for introducing my own variations into a piece by Mozart! In fact, the only occasions when I played straight were during exams.'

From the time he was 12, Zack was playing in charity shows and at 13 he took part in a Carroll Levis Show. In the same year he was introduced to music publisher Dick James, who arranged for Zack to make a test recording for Parlophone's A and R manager, George Martin. But Zack was out of luck — for Russ Conway was then consolidating his position as the country's leading pop pianist.

Another eighteen months went by and then Zack's go-ahead uncle arrived from America, heard him play and arranged for him to appear at a concert at the Nuffield Centre. This resulted in another meeting with Dick James, a second recording test — and his first Parlophone disc, *Magic Fingers* and *Zsa Zsa* (45-R4752), two numbers he composed when he was 12.

Zack is regarded as having the talent for a bright show-business future and has already been signed by a music publishing company to produce a minimum of eight numbers a year.

But he is staying at school to take his G.C.E. at 'A' level in history and economics — 'I would like to have something to fall back upon, just in case,'

he says.

In the future, he says, 'I think I might take singing lessons — at the moment my voice sounds like a croaking frog, only worse. Then I would like to try writing a show and I also want to do musical arrangements, something I am studying now.'

Musically, Zack's tastes range from classical music to modern jazz, with a special admiration for the playing of Art Tatum. Other interests include reading, especially the works of Dickens, and translating foreign books and papers into English.'

The story of Zack's career can well be illustrated with appropriate stamps and labels.

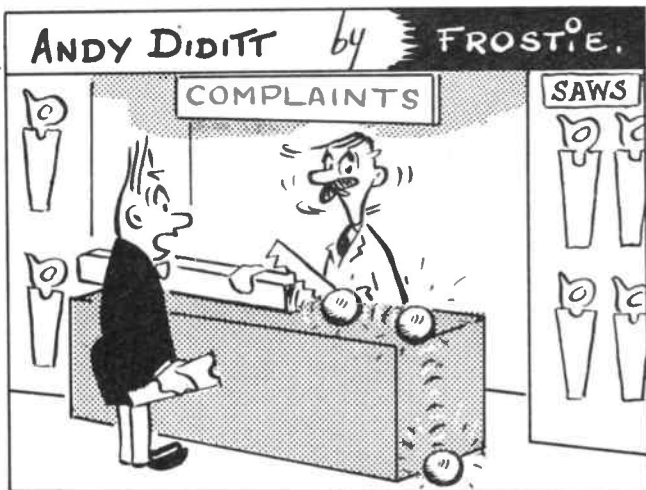

"SEE WHAT I MEAN? IT WONT CUT ANYTHING SQUARE!"

Illustrated on front page

Sliding-top Cocktail Cabinet

DESIGNED as a cocktail cabinet, this unit with twin slide-away top trays, can if desired be used instead as a workbox or a magazine rack, for its central portion comprises a deep set box base. Twin seats or tables, which are optional, can be made so that they tuck away under the extended flaps of the trays when closed. This design should find favour in homes where space is limited.

The cabinet is designed in the simple, straight-line pattern so popular in contemporary homes today, and its construction will, therefore, be found quite simple.

Ply or hardboard

The first thing to tackle is the making of the square box base. This is made in the conventional way from $1\frac{1}{2}$ in. square planed wood, covered with a skin of hardboard or plywood. Cross members should be fitted, the lower ones being rebated into the corner uprights, as shown in the cutaway part in the illustration. The top cross members can be simply screwed into the tops of the upright, as the ply or hardboard covering will keep the whole base firm and rigid.

A bottom piece should be fitted into position, again of ply or hardboard. A suitable size for the finished base would be 18 in. square, with a similar height.

Next, purchase a length of single-channel moulding, of the type with a

groove to take hardboard. Cut this, and fit it with glue along the top edges of the two top cross members of the box base with the grooves facing inwards, of course. When fitted, the ends of the channelling should extend beyond the length of the box base by around 10 in.

By E. Capper

Next cut a partition piece of $\frac{1}{2}$ in. plywood, and fit it centrally into the box base. The top of this partition piece should be cut to fit around the channelling and the top cross member of the box base, whilst its top edge should finish level with the bottom of the groove in the channelling (see partition detail).

It is essential that the partition piece is fitted exactly central inside the base, for when the sliding trays are in their closed position their two ends will rest along the top edge of the partition. Hold the partition with glue and panel pins through from the outside of the ply or hardboard skin.

The trays are next made from two sheets of hardboard glued together. The top sheet is cut to slide between the inside edges of the channelling, whilst

the lower sheet is cut larger, to slide along the groove cut in the channelling (see detail). First cut the sheet that goes into the groove, and then the sheet that will locate between the channel edges, finally gluing them together.

Do not make either of the hardboard sheets a tight fit, but cut them to a length so that they come together when in the closed position, halfway across the top edge of the partition piece, the other end finishing flush with the end of the channelling. Both of these details are shown in enlarged drawings.

Fit tray stops

Below each sliding tray is fitted a length of $\frac{1}{2}$ in. square wood, held with panel pins and glue. This prevents each tray from over-riding its closed position. This is shown in the tray stop detail.

Below the further ends of the trays hand grips are fitted. These are made from 1 in. quarter moulding, glued and pinned to fit easily between the inside edges of the channelling.

The twin seats or tables that stow away under the flaps of the cabinet are, of course, optional. They need not be elaborate in construction. Make them with straight $1\frac{1}{2}$ in. square legs, and a top piece of $\frac{1}{2}$ in. plywood. If to be used as seats the top should be covered with foam rubber. Alternatively legs of the screw-on type (available from Hobbies) which will make construction that much more simple.

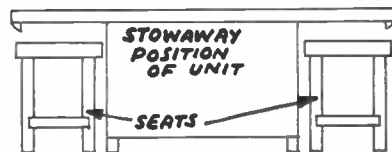
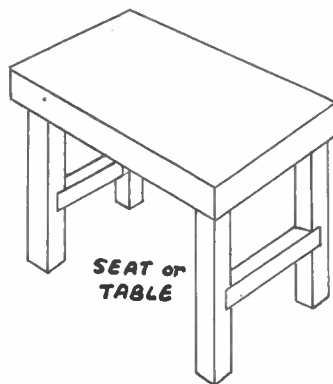
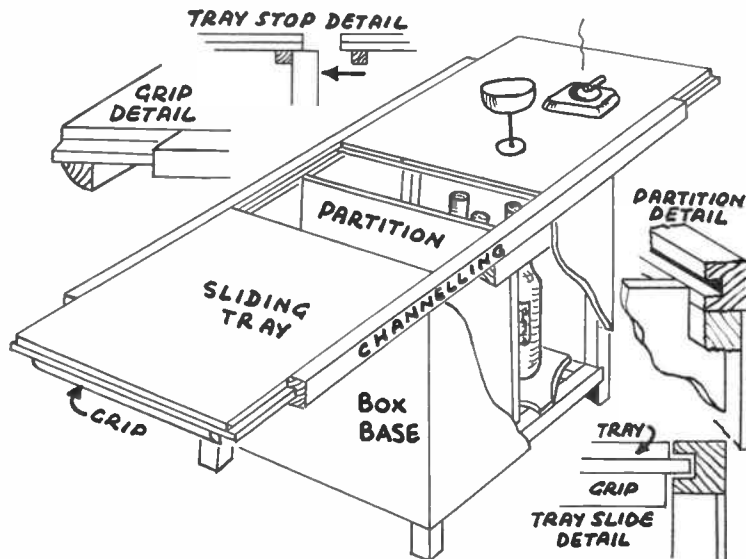

Mainly for Modellers

IN previous articles I have detailed the full ship rig to enable our readers to rig their models correctly in detail. We now have two clipper type ship kits, Hobbies 2186 *The Cutty Sark* and 3234 *The Tea Clipper*. To help our readers in building these two models I am in the present series detailing the various items of deck furniture, etc, which can be modelled to add realistic detail.

I certainly recommend a visit to the *Cutty Sark* now preserved in dry dock at Greenwich, London. Readers will better appreciate the beauty of these vessels. Any time spent in viewing the hull from all angles will not be wasted. The full beauty of her lines will be understood, and it will help the modeller to aim at perfection. To stand on the deck and look aloft at the towering masts and spars, and the delicate tracery of the rigging against the sky always makes me realize that the full rigged sailing ship is

On models to the scale of Hobbies two kits I suggest that the deck piece is sanded down a little to allow for covering with Bristol board. The amount sanded off should leave the deck the same thickness specified in the plan after adding the Bristol board.

CLIPPER SHIP MODELLING—1 By 'Whipstaff'

This will give a fine smooth surface, and when shellaced and dry it should be painted over with artist's oil colour burnt umber, and immediately wiped off. This will give the deck a nice light tone similar to the actual ship's decks.

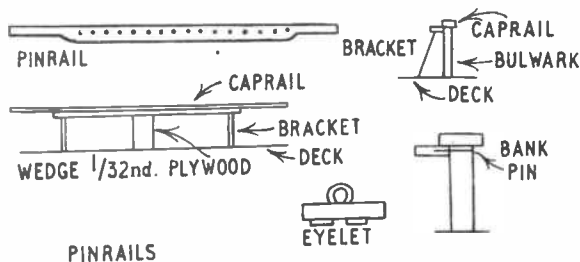
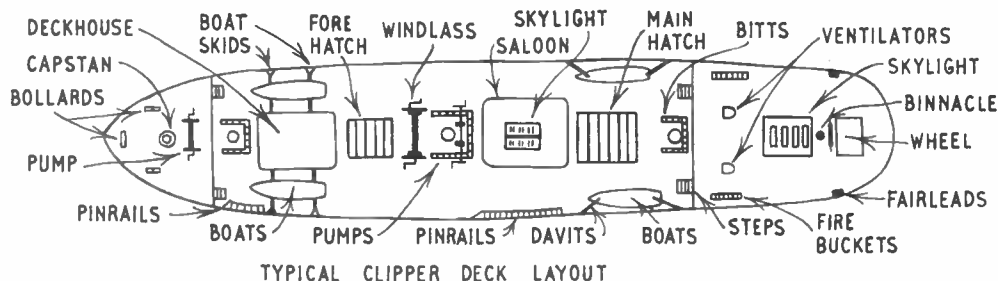

look right and in scale it is better left out.

It is a great help if a photograph or a good illustration the same size as the finished model is available. You only model then the details that are clearly seen in the picture. This, however, is an ideal not often possible, and we have to rely on our own judgment.

Pinrails are essential for correct rigging of the model, but need to be strong and to scale. This is not easy on the size model we are discussing, but it can be done.

I make pinrails for this size of model from $\frac{1}{8}$ in. plywood. They are $\frac{5}{16}$ in. wide, and $\frac{1}{8}$ in. at the widest point to take the shrouds. They must have the additional support of brackets, as on the actual ship. To place these in position when gluing you will need tweezers. I use two pairs—flat-nosed stamp collectors', and a pointed-nosed pair.

In this type of fitting you make the length sufficient to accommodate the number of shrouds for which each pinrail is designed plus the backstays, and drill the holes accordingly. For example, on our *Tea Clipper* models there are five shrouds and seven backstays on the main mast. Therefore, if fitting pinrails

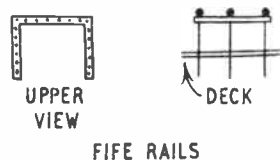

instead of channels, you would drill twelve holes to accommodate the rigging. In this particular model you can either leave the channels as in the design or fit pinrails instead. The channels were used on early *Tea Clippers*. Later ships like the *Cutty Sark* had the shrouds set up to pinrails inside the bulwarks.

In order to strengthen the pinrails, which have to take the strain of tightening your shrouds and backstays to keep them taut, I pin and rivet them as in the

● Continued on page 311

one of the most beautiful creations of man's handiwork, and thoughts naturally move to wondering what it felt like to be up aloft trying to take in sail in rough weather.

In the sketch I have shown the main deck layout of a clipper ship. It will vary slightly from ship to ship, but in our present series I shall show the main details of the *Cutty Sark* and the average *Tea Clipper* details.

All bulkheads can be improved by covering with Bristol board, and any necessary details to be painted on these can be done before gluing in place.

We will now commence to make those small fittings that can make so much difference to our models. If you cannot model the smaller details well, do not worry. Add only those that you are satisfied with. I always consider that unless a small fitting can be modelled to

CLOSE-UP WITH BOX CAMERAS

CLOSE-UP photography is a fascinating aspect of the hobby which is denied users of simple box cameras having, perhaps, only a casual interest. Such cameras are not designed to focus any closer than about 6 ft., but this can be remedied quite inexpensively and no special photographic skill is called for.

All that is required is a supplementary lens sometimes called a 'portrait attachment'. These can be purchased for a few shillings, but a cheaper plan is to use discarded spectacle lenses. Provided that the centre of the lens is not badly scratched, it does not matter if the edges are chipped. The only point to remember is that the lens must be the convex or magnifying type, and not a concave one, which would have the opposite to the desired effect.

Having obtained a suitable lens, attach it centrally to the camera in front of the existing lens with strips of Sellotape round the edge. The camera can now be taken much closer to the object to be photographed, and the exact distance must next be found. If the camera is loaded, take out the film, and open or remove the back. A focusing screen must be used to observe the effect of the additional lens. This can be a

piece of ground glass or a strip of greaseproof paper of the same width as the film wound on a spool, and loaded into the camera in the same way as a film ready for exposing. Ordinary glass can be ground on one side by rubbing with wet abrasive paper or by rubbing

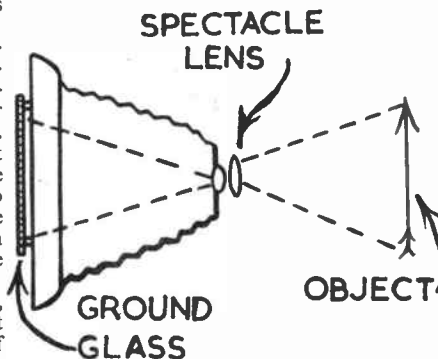

two pieces of glass together with wet kitchen scouring powder in between, until one face is evenly ground all over.

Set the camera to the B or T setting as used for time exposures, and place the focusing screen in the exact position normally occupied by the film during

exposure. If using glass, ensure that the ground surface is facing towards the inside of the camera. Aim the camera at any brightly lit object, and open the shutter. The inverted image of the object can then be observed on the screen, and the camera should be moved until satisfactory definition is obtained. This image is exactly what would normally be recorded on the negative if an exposure were made. Make a careful note of the distance from the object to the lens as this will remain constant for that particular lens. If other lenses are available, repeat the process with these, and note the lens-to-object distance each time for future use.

To approach the object more closely, use a lens of shorter focal length, and before making an exposure, measure the noted distance accurately to ensure a sharp negative.

These instructions are intended primarily for users of simple fixed-focus cameras, which always work at a small aperture. Users of more elaborate cameras should focus the lens to infinity, and use as small an aperture as possible — in any case not more than $f/8$ — to prevent distortion of the negative image caused by an uncorrected supplementary lens. (J.H.P.)

● Continued from page 310

CLIPPER SHIP MODELLING

sketch with lill (or bank pins), drilling the holes with a fine twist held in a pin vice. This, together with the bracket supports, makes a strong enough unit to hold your rigging. One word of warning — do not use balsa cement for any joint which has to take the pull of the rigging, as it eventually parts company. I use Casco Impact for this purpose, and have also had success with Certofix. For all wood joints in the hull, etc, I use Casco One Shot.

To attach the shrouds and backstays we need eyes, and these are made from fine wire or ordinary pins with the heads cut off. These are fitted to the pin-rails, and the ends riveted over. A spot of Impact glue on each one will give added strength.

Fife rails can be fitted at the positions shown on the deck layout. The rails can be made of thin celluloid, or plastic for preference, painted to represent mahogany. The pillars and stanchions supporting them are of bamboo dowel,

or better still use ordinary pins. The heads can form the knobs at the top of the stanchions, and the pins can then be driven well into the deck to give a secure hold. Drill the deck first with a No. 74 twist drill, and they will drive home easily.



'Tea Clipper'

Hobbies Limited Kit No. 3234 26/-
(post 2/3 extra)

What's Where in London

The BP guide to shops and services
by Denys Parsons, M.Sc., A.R.I.C.

THIS book will answer almost every question of 'Where can I get it?' put by Londoners and visitors to London.

Want a pen-knife with 100 blades? Want a fat man's outfitter? Want a wine glass repaired? Want to buy carding cloth? Want to buy rattlesnake meat? This book lists sources for these and many hundreds of similar queries.

In a city as vast as London you might spend months or even years tracking down the spot where to get an old barometer repaired, where to get a stuffed otter on hire, where to buy kangaroo soup, a skeleton, dry ice, and hundreds of other queer items.

This book should prove of great interest to collectors of various hobbies, whether they are Londoners or not. Indeed, it will be fascinating reading to all those with an inquiring mind.

Published by Kenneth Mason Publications Ltd, 167 Victoria Street, London, S.W.1 — Price 6s. 0d.

PHOTO FRAMES SHOULD SUIT THEIR SUBJECT

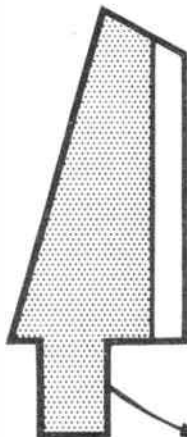

CUT TWO TO OUTLINE AND ONE TO SHADED AREA $\frac{1}{8}$ IN.

THIS END IS STANDARD ON ALL FRAMES

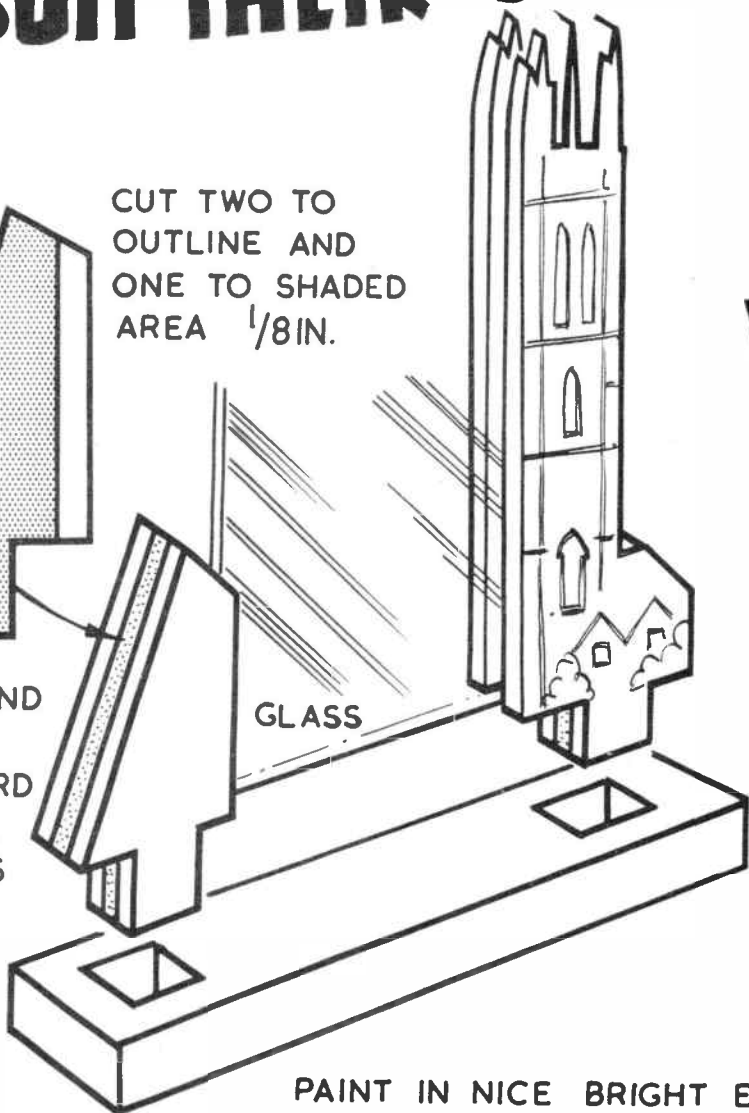

PAINT IN NICE BRIGHT ENAM

N
C
V
A
A
S

A BROADLAND
SNAP



A ZOO
PHOTO

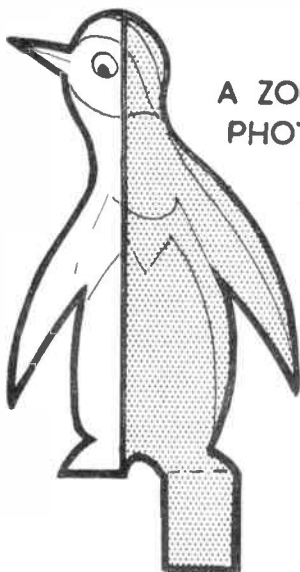

FOR AN
ARCHITECTURAL
STUDY

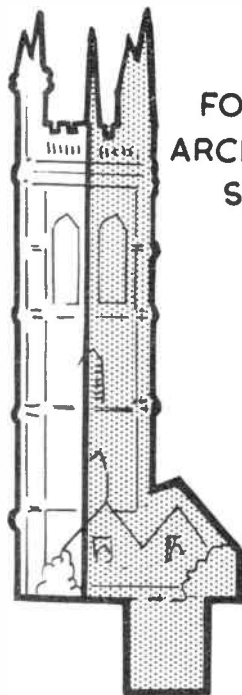

FOR THAT VISIT TO
LONDON
SNAPSHOT



IN EACH CASE
CUT TWO OF EACH
PIECE TO OUTLINE
FROM 1/8 IN.
AND ONE OF EACH
SHADED PIECE
1/8 IN. &
GLUE BETWEEN
AS IN THE
DETAIL

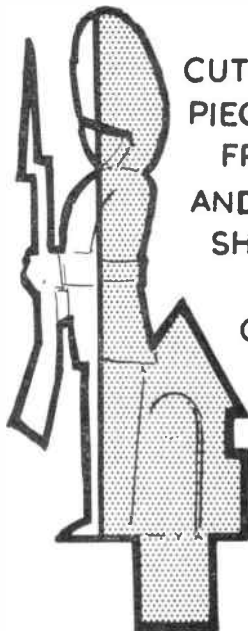

NO DOUBT
OUR READERS
WILL BE
ABLE TO
ADD TO THESE
FEW
SUGGESTIONS

DETAILS



PRINTED IN ENGLAND

CURIOSITIES OF LOW PRESSURE

SUSPEND two apples from cords tied to a horizontal pole supported between two chair backs. The apples should hang at equal heights above the floor and they should be about 2 in. apart. You must now try to cause the apples to swing away from each other by blowing through the gap between them. Try as you will, the feat cannot be done, because the harder you blow, the more the apples will press closer together.

By A. E. Ward

This odd trick of nature is explained by the fact that the pressure within a gas or liquid in motion is less than the pressure exerted by the same gas or fluid at rest. The pressure in the high-speed stream of air created by your forcibly expired breath was much lower than static atmospheric pressure, which pushed the apples together into the fast air stream. The same principle will enable you to blow a flame towards yourself.

Strike a match and wait until the flame is really burning well. Hold the matchbox upright a short distance in front of your lips and support the ignited match on the opposite side of the matchbox barrier. When you blow hard against the box, the match flame will bend back towards you. The fast flow of air which you direct at the box is deflected outwards to form a low-pressure zone into which atmospheric air flows and pushes the flame.

A drinking straw may be adapted to illustrate the action of a motor-car carburettor which supplies a fine spray

of petrol particles to the engine cylinders. Almost cut the straw into two parts, by making a scissors cut across the middle. Bend the straw to form a pair of short tubes at right angles to each other. Hold the apparatus with one of the tubes pointing downwards and flatten the end of the horizontally held tube which 'touches' the vertical tube, by giving the straw a pinch.

Dip the lower tube into a tumbler filled with water and blow hard into the wide open end of the upper tube. A fine spray of water droplets and air will be blown away from you, accompanied by

a furious hissing sound. The device works because atmospheric pressure, acting upon the surface of the water in the drinking glass, pushes the liquid up through the immersed straw and into the fast air stream, where pressure is low. In a motorcar, a similar arrangement causes a mixture of air and 'atomized' petrol to flow into the engine.

Pressure in a stream of water is less than atmospheric pressure, that is why, at the fairground, a showman can 'balance' ping pong balls upon water jets, to serve as targets for his rifles. Air pressure prevents the balls from falling. It is also possible to support a ping-pong ball, or a balloon, upon the airstream produced by a vacuum cleaner nozzle converted as a 'blower' and directed upwards. If you use a balloon it should be weighted with a small nail or bolt.

Attach a string to a ping-pong ball, using a blob of melted candle grease or sealing wax. Turn on the water tap in the kitchen and hold the end of the string while you press the ball against the column of water. The ball will 'stick' to the water and you will feel quite a tug on the string as atmospheric pressure pushes the ball into the low-pressure stream of water.

Apples floating in a bowl of water will be pushed together by the comparatively still water around them if water is allowed to fall into their midst from a tap. Here it is the difference in pressures exerted by still and moving water which is demonstrated. The important scientific principles illustrated by these experiments will help to explain many ingenious technical achievements, ranging from scent and insect sprays to the major component of the lift exerted by the air on aeroplane wings.

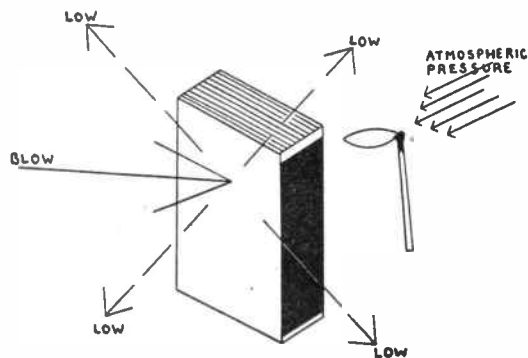
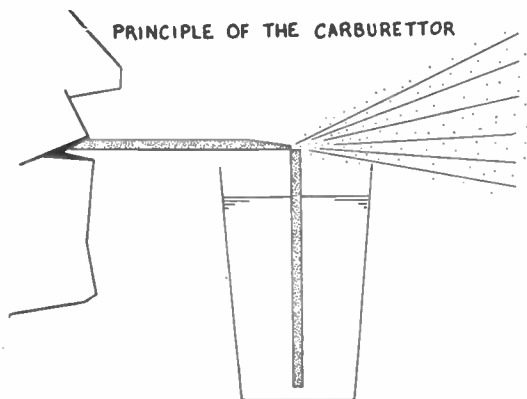
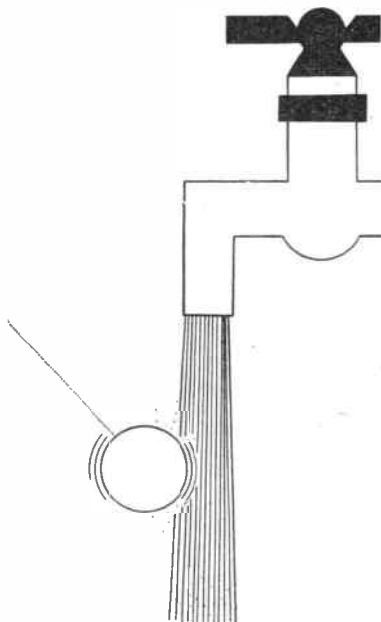

Model Engineer Exhibition

16—26 August

11 a.m. — 9 p.m.

now held at

Central Hall
Westminster

finest collection of precision built models
in the world.

PHOTOGRAPHERS!

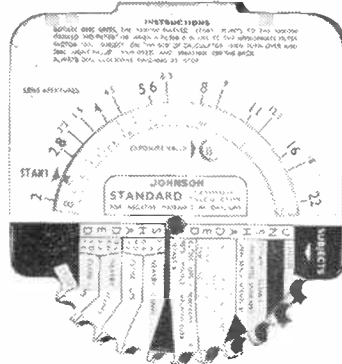

Get the right exposure every time!

Do your pictures ever come out over-exposed or under-exposed? You need a Johnson Standard Daylight Exposure Calculator! It's only 4/6d. With this calculator, you just 'dial' for the correct exposure. It's easy! You 'dial' the sort of subject you are photographing, the light conditions, the weather, and the speed of the film you are using—then read off the exposure details. Other calculators for colour cine, artificial light, and flash are also available. Ask your local photographic shop about Johnson calculators.

JOHNSONS
OF HENDON LTD

There's always a big demand.
Make sure of your copy
NOW!

STILL ONLY
2/-

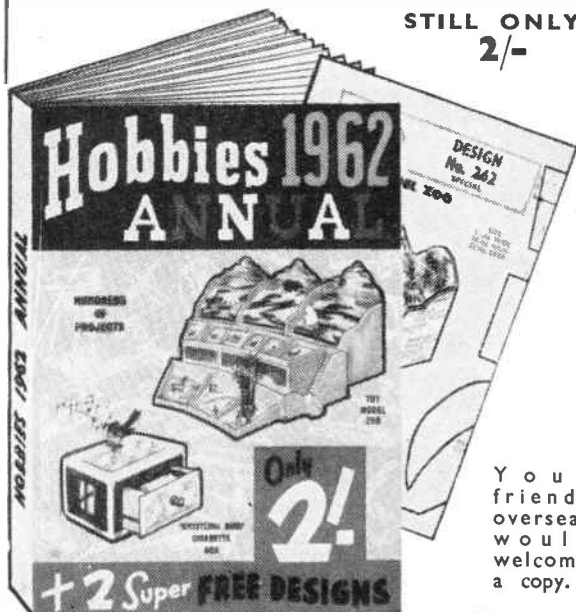

Your friends overseas would welcome a copy.

HOBBIES 1962 ANNUAL

180 pages packed with hundreds of exciting projects and interesting information for the handyman, hobbyist modeller and home craftsman.

GIVEN FREE WITH EACH COPY

Large designs for making a sensational novelty — the 'WHISTLING BIRD' CIGARETTE BOX, and a grand TOY MODEL ZOO. Each worth the price of the Annual.

Obtainable now from Hobbies branches, stockists, newsagents, bookstalls, etc. or by post direct (6d. extra for postage).

To Hobbies Ltd., Dept. 99, Dereham, Norfolk

Please send.....copy/copies Hobbies 1962 Annual containing two free plans

Name

Address

.....

.....

P.O. for.....enclosed

MAKING DESIGNS WITH CUT PAPER

LET'S make some cut-outs from folded paper. They are ever so attractive, and can be further decorated by attaching pieces of differently coloured or silver paper at the back, and which will be seen through the openings. And as we don't wish to invite trouble by blunting the household scissors, we will describe how to make some really sharp cutting tools, even

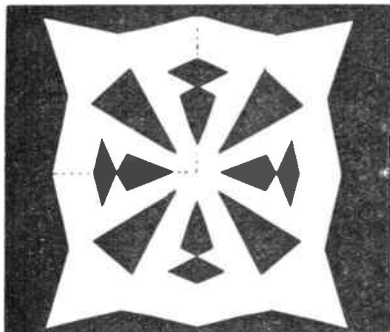
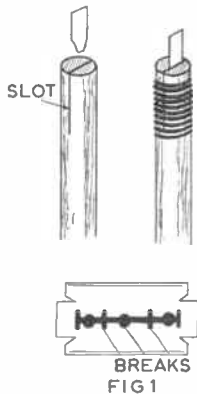

Fig. 3—The paper is folded in four and cut as shown by the dotted lines.

better than scissors, because they will permit you to cut out fine — and sometimes awkward — parts of the design. If you cannot make these simple tools we would recommend a pen nib trimmer, usually sold by a good stationer.

If you will refer to Fig. 1 you will see that we make a really keen set of trimmers from an old razor blade and pieces of dowel rod. Break off a few pieces of the blade to the slot, as shown in the diagram, and insert the broken end into a dowel rod — about the length of a pen holder — which has been slotted down the centre with a fine saw.

This slot should be about 1 in. deep. Bind with a length of thin strong string.

You may use any kind of paper, either white or coloured, remembering that the former will permit extra colouring if you wish, while other colours at the back will increase the decorative value.

It will probably be best to plan a simple design in pencil after folding a square, or circle, of paper, as shown in

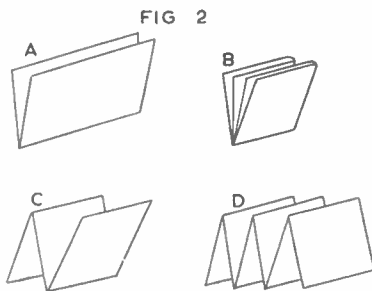
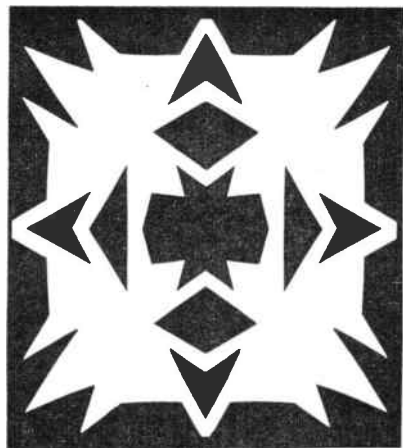

Fig. 2, but note that there are several ways of folding, each of which will alter the finished design. If the paper is folded in half, as at A, the two halves produce a symmetrical design after cutting. You may make another fold, cutting again as at B. Alternatively, you may fold into quarters at the start before cutting the design; you may fold as at C or D, each producing a different



result, although your basic pattern may be the same.

You may cut out silhouette type pictures or motifs for book covers or illustrations, or start an album of cut-outs which will require mounting. In any case do be careful to make a good job of mounting, applying only a minimum of glue to the back. Place the cut-out face down on a sheet of newspaper, applying a few dabs of adhesive here and there. Then apply the coloured backing. A further application of glue will make the motif ready for mounting, when it should be pressed down firmly with a clean cloth.

You will also find these little cut-outs most attractive for greetings cards, notebooks, and for decorating bookcovers. You should modify the shape of the basic piece of paper to match the shape of the cover it is to decorate. (S.H.L.)

A fascinating story of the Saw

PETER D'A. JONES and E. N. Simons have drawn material from many different parts of the world in this study of the saw, covering its evolution as a primitive flint implement in pre-historic times to the highly specialized components of machine tools serving present-day industry.

At each stage the saw is seen as a master tool, exerting a vital influence on social and economic development. The spread of civilization in many lands was materially affected by the progress of sawing techniques; in building ships, in clearing forests, in constructing fortresses and places of worship. The great monuments of Egyptian, Greek, and Roman, medieval and renaissance civilizations owed much to the existence of

effective stone-cutting saws, and it would be difficult to over-estimate the contribution of the circular saw and the band-saw to the impetus of the Industrial Revolution.

The types of saw most favoured during each historical period are here examined in detail and the book concludes with a review of the main varieties in use today, and description of manufacturing methods, particularly as applied by the world's oldest saw-makers, Spear & Jackson Ltd of Sheffield, now celebrating their second century.

Published by Newman Neame Ltd, 50 Fitzroy Street, London, W.1 — Price 21/-.

NYLON · P.T.F.E

BRASS · COPPER · BRONZE
ALUMINIUM · LIGHT ALLOYS
ROD, BAR, SHEET, TUBE, STRIP, WIRE
No Quantity too Small List on Application

H. ROLLET & Co. Ltd.

6 Chesham Place, S.W.1 BELGRAVIA 4300
ALSO AT LIVERPOOL, BIRMINGHAM
MANCHESTER, LEEDS

LEARN

RADIO & T/V SERVICING for your OWN BUSINESS/HOBBY

● by a new exciting no-maths system, using practical equipment recently introduced to this country
FREE Brochure from:—

RADIOSTRUCTOR

DEPT. G81, READING, BERKS. 16/8/61

Completely new 54-page Edition
WHERE'S THAT CAR FROM?

Price 1/- (Postage 4d.)

Of all Booksellers

or

RALEIGH PRESS, Exmouth, Devon

LEARN WATCHMAKING. — YOU can learn this fascinating trade through our unique, easy to follow home study course. Modern in every respect. You learn Swiss and American movements and you are doing profitable repair jobs within the first few lessons. A business of your own, an excellent source of extra income, a good retirement supplement. The future belongs to the man who prepares for it. Highly illustrated lessons, tools, supplies, instruction by experts, easy tuition payments. Watchmakers are in demand in all countries. Write for free details. No obligation. — **COMMONWEALTH CORRESPONDENCE SCHOOLS LTD.** Dept. H2; 2125 AVENUE ROAD, SUITE 205, TORONTO 12, ONT., CANADA.

EARN EXTRA MONEY with your sewing machine by making cushion covers. Profitable and interesting. Regular work guaranteed. Apply Dept. 28. Arnold Company, 10 Shelley Road, Worthing, Sussex.

LEARN RADIO & ELECTRONICS the NEW Practical Way! Very latest system of experimenting with and building radio apparatus — 'as you learn'. FREE Brochure from: Dept. H.W.10, Radiostructor, Reading.

100 DIFFERENT stamps free! Request 1d. upwards discount approvals. — Bush, 53 Newlyn Way, Parkstone, Dorset.

ENJOY WRITING? Then write for profit. Send for 'Writer's Handbook' (free) detailing countless opportunities for beginner or experienced. — Writers Ring (HW), 5 Edmund Street, Birmingham.

BUILD your own electric guitar in one hour. Screwdriver only required. Thin line cutaway full-size body. Reinforced neck, built-in Vox pick-up and controls, 9 gns., plus 5/- carriage or 20/- and eight payments of 23/-. — Musicland, 88 Broadway, Bexleyheath, Kent.

PROFITABLE LEISURE. Learn to draw/paint flowers, birds, doodles, etc. Waiting markets. Profitable. Fascinating. Exciting. Booklet, specimens, free. — Popular Art Services (HW), Clun, Shropshire.

GLASGOW

DO YOU KNOW?

HOBBIES LTD. have a branch at

328-330 ARGYLE STREET

where the manager and staff are always willing to give you the benefit of their experience with any of your handicraft problems. Why not pay a visit?

MODERN CABINETS FOR MODERN HOMES

Kit No.

3144

72/-
(carriage paid)

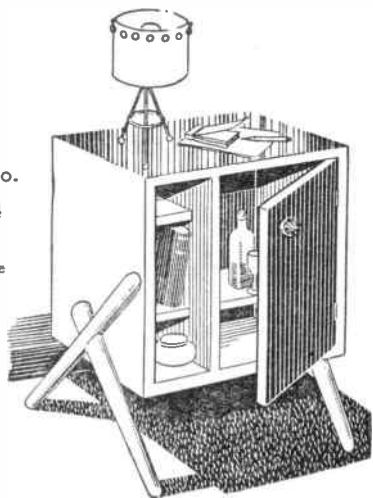

27 ins.
high
18 ins.
wide

IDEAL AS A BEDSIDE CABINET

Kit contains selected planed wood, dowel rod, handle, hinges, design sheet and instructions, etc.

Send for free copy of 'Profitable Leisure'

HOBBIES LTD. (Dept. 99) **DEREHAM NORFOLK**

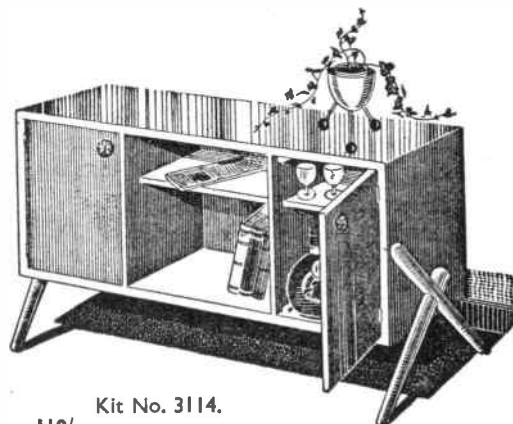

Kit No. 3114.

110/-
(carriage free)

FOR THE LOUNGE

This cabinet is a really outstanding piece of work. Size 3 ft. long, 27 ins. high. Kit contains selected planed wood, hinges, handles, design sheet with instructions.

TREE WINES

TREES can play an important part in the manufacture of home-made wines. To many of us, it is not looked upon as a suitable subject for our experiments in wine making but there are a large number of splendid drinks that can be produced from the various parts of trees, including the leaves, buds, flowers and even the sap.

Oak leaf wine is probably the best known, and there are two distinct types. One is made in the spring from young leaves while the other makes use of the old leaves just before they fall in the autumn.

By A. F. Taylor

The young leaves picked in the spring when the tree is bursting with activity is considered to produce a better brew than the more mature crop that is ready in the autumn, but that is a matter of personal opinion. Try both recipes and see which you like best.

Oak Leaf Wine (Spring)

Some people recommend picking the leaves just as they have opened in the spring while others name the last week in June or the first week in July as being the best time.

1 gal. Oak Leaves
4 lb. Sugar
2 Oranges
2 Lemons
1 gal. Water
 $\frac{1}{2}$ oz. Yeast

Remove the dust from the leaves by washing well in cold water. Cut the peel from the lemons and oranges so as not to include any of the white pith, which will make it bitter, and add to the leaves. Pour over this a gallon of boiling water and allow to steep for a day. Then bring to the boil and simmer for about a quarter of an hour. Strain through butter muslin, stir in the sugar until dissolved and add the juice of the lemons and oranges.

When the temperature has fallen to blood heat (98°F) add the yeast, which has previously been dissolved in a little of the liquid. Let this ferment until the gas bubbles have practically ceased, then strain without disturbing the sediment and put into bottles, corking lightly at first.

Young oak buds may be mixed with

the young leaves as a slight variation of the above recipe.

Oak Leaf Wine (Autumn)

1 gal. Oak Leaves
3 Oranges
 $\frac{1}{2}$ oz. whole Ginger
4 lb. Sugar
1 gal. Water
 $\frac{1}{2}$ oz. Yeast

Pick the leaves in late September or early October when they are beginning to turn yellow. They will need washing well in cold water. Put the leaves in an earthenware jar, pour over them the boiling water and allow to stand for three days before straining through butter muslin. Well bruise the whole ginger by hammering it and put this with the grated rind of the oranges, their juice and the sugar and boil gently for half an hour. Add the yeast when the liquid has cooled to blood heat, ferment for fourteen days and bottle as in the previous recipe.

Walnut Leaf Wine

Perhaps not so well known, this is quite good and easy to make.

1 large handful Walnut Leaves
1 lb. Raisins
3 lb. Sugar
1 gal. Water
 $\frac{1}{2}$ oz. Yeast

After rinsing the leaves in cold water put them in a bowl or earthenware jar, pour on the boiling water and leave to soak for twenty-four hours. Then strain, add the sugar and stir until dissolved. Chop up the raisins and add these to the mixture, then add the yeast and leave to ferment for 21 days. Bottle up as usual and store in a cool place.

Lime Wine

One of the joys of a walk through the countryside in early summer is the scent of lime trees in full flower, and the wine made from them is equally delightful. The flowers are pulled from the tree when they are fully open and preferably on a sunny day. They are then dried in the sun for a few days, which is supposed to bring out the flavour to the full.

1 pint Lime Flowers
 $\frac{3}{4}$ lb. Raisins
3 $\frac{1}{2}$ lb. Sugar
1 gal. Water
 $\frac{1}{2}$ oz. Yeast

The flowers are first put into a saucepan with the water, brought to the boil and then allowed to simmer for thirty

minutes. Strain, add the raisins chopped up into small pieces together with the sugar, and when the temperature has fallen to blood heat (98°F) mix in the yeast.

Let this ferment for fourteen days, then bottle up in the usual manner.

Birch Sap Wine

This is a wine that has been made for centuries in the Scandinavian countries.

1 gal. Birch Sap
1 Orange
1 Lemon
3 lb. Sugar
 $\frac{1}{2}$ oz. Ginger
 $\frac{1}{2}$ oz. Yeast

A little care is needed when gathering the sap so as not to damage the tree in any way. A gallon is a good allowance to expect from one tree, and it may take a week or two to gather this amount. March is the correct time to gather the sap and it is best done when the weather is cold.

First drill a small hole (about $\frac{1}{4}$ in. diameter) in the trunk of the tree about 15 in. from ground level. The depth of the hole should be from 1 in. to 1 $\frac{1}{2}$ in. according to the size of the tree trunk. A tube is then inserted in the hole and this can be glass or a hollow wood stick such as a piece of elder stem with the pith extracted. Do not use a metal tube because it is liable to affect the flavour of the resulting wine.

The sap is allowed to drip into a glass or earthenware bowl (not metal) and boiled each day until you have collected enough for your requirements. Put this into a bottle and cork up tightly.

The wine is made by first thinly cutting off the peel from the orange and lemon, then boiling it gently in the sap and the crushed ginger for about half an hour. Any liquid lost by evaporation is made good by adding water. While still hot dissolve the sugar and then add the yeast when it has cooled to 98°F. Allow to ferment in a warm temperature until most of the gas bubbles have ceased to rise to the surface. Strain through muslin, put into bottles and cork up.

Carefully decant after three months without disturbing the sediment, and cork tightly. Sometimes the corks are wired down and the bottles stored on their sides until ready to sample after at least six months.

This last recipe can be varied by adding $\frac{1}{2}$ lb. raisins and leaving out the ginger, or you can use two lemons instead of the orange and lemon. Using the same recipe, you can substitute either walnut or sycamore for the birch sap.

You may also like to try peach leaf wine. Although not classed as a tree, a very good wine is made from grape vine leaves.

ARMCHAIR TEA TRAY

CUT two pieces A from $\frac{3}{8}$ in. plywood, cutting out the pattern with your fretsaw. The tray is made up as shown in the exploded diagram and should be about 15 in. by 9 in. It consists of the frame mitred together and made from tray moulding or stripwood, a piece of Warerite and a base of $\frac{1}{4}$ in. plywood.

All are glued together in the order shown, but the pieces A must first be screwed to the plywood base and the screws countersunk slightly. These pieces will of course be spaced according to the width of the chair arm. Clean up and paint in suitable colours. (M.p)

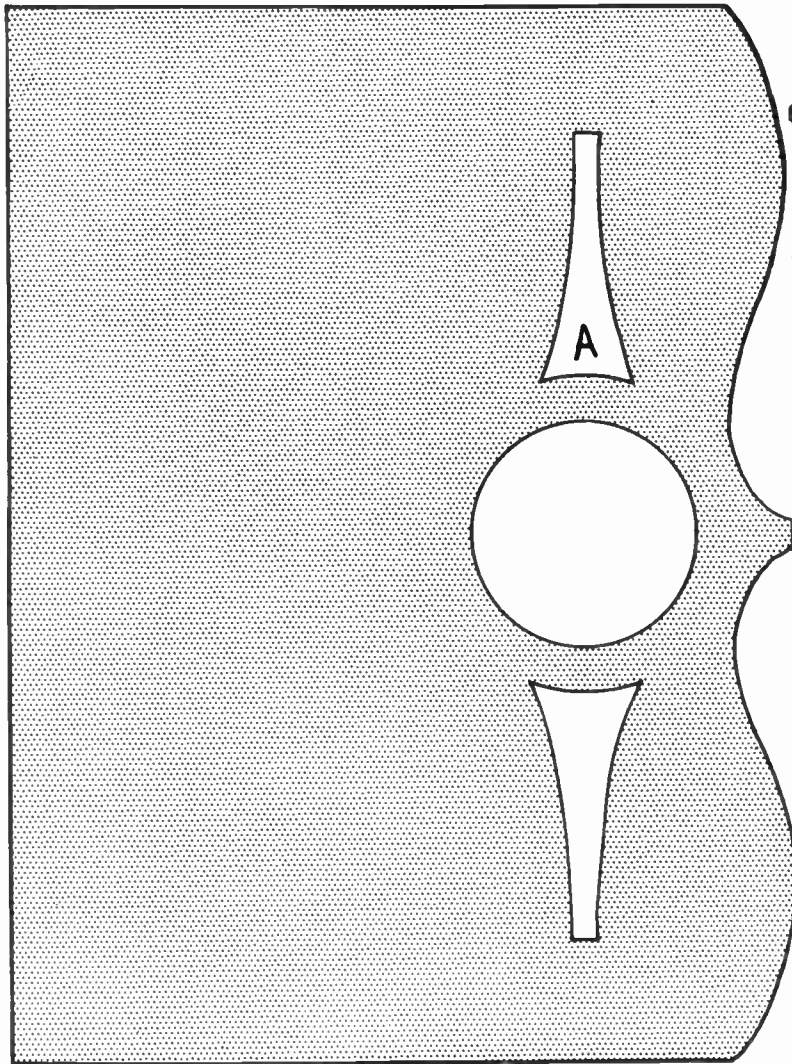
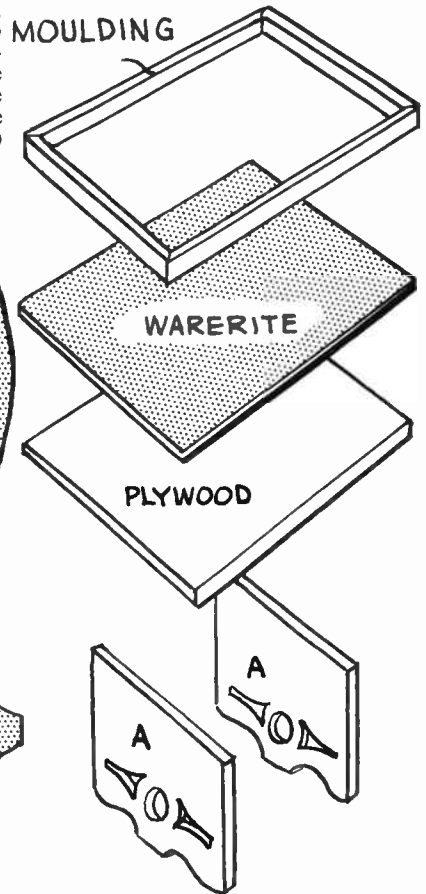

USE
YOUR
FRETSAW

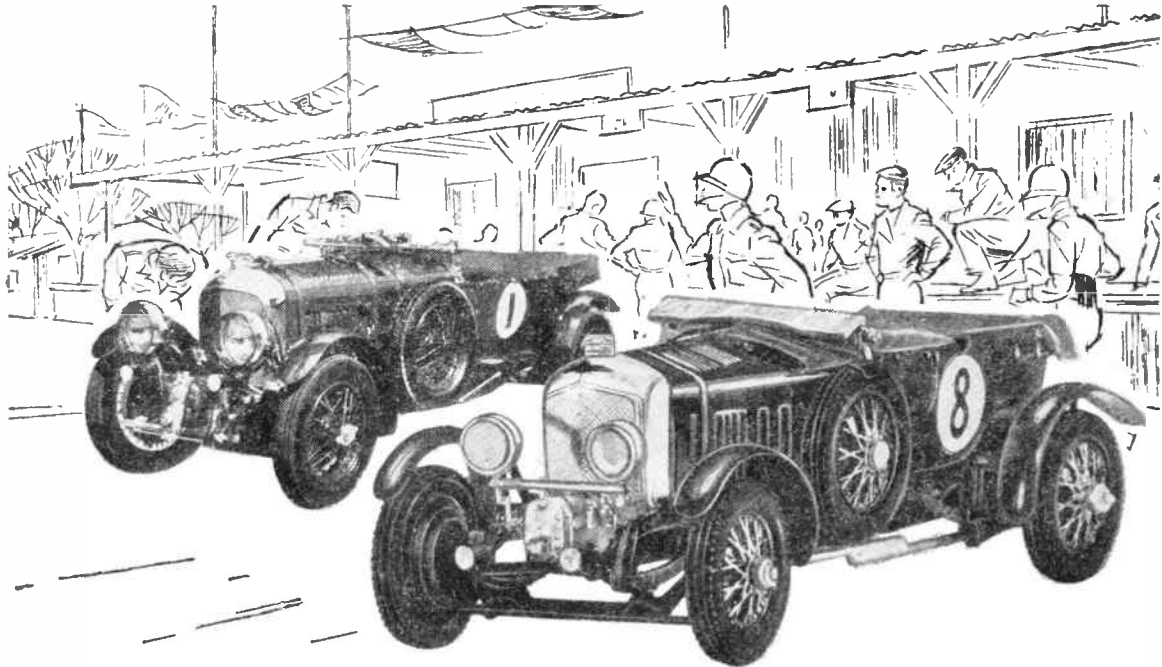

Just like the real thing!

Believe it or not, the nearer one is the Airfix model of the 1930 Bentley, 1/32nd scale (Kit 2/-). Behind it is a picture of the real thing.

That's how wonderfully realistic Airfix models are! Close attention to every detail gives them their faithful-to-the-original look—makes them true collector's pieces. And every Airfix series is to a constant scale. This means Airfix models look proportionally right, one against another, because they *are* right! You can't beat Airfix for realism—or value.

AIRFIX

Constant Scale Construction Kits

From Model & Hobby Shops, Toy Shops and F. W. Woolworth

There are over 100 Airfix models from 2/- to 10/6.

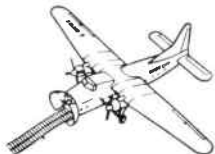

AIRCRAFT

Bristol Superfreighter 7/6

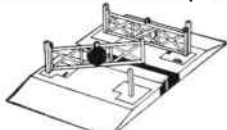

TRACKSIDE SERIES

Level Crossing 2/-



MODEL FIGURES

Lifeguard 2/-

BRITISH WARSHIPS

H.M.S. Cossack 2/-



STOP PRESS!

Latest Airfix Production

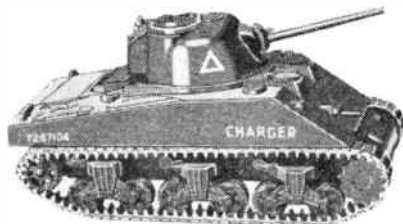

SHERMAN MK I TANK

Another model in the new Airfix OO/HO scale tank series. This American tank was used by the Allies in World War II. 75 mm. gun raises and lowers, fully revolving turret, detailed working track gear, 11 piece transfer set. **55 part kit**.....2/-
Also New Railway Turntable. OO/HO gauge replica of vacuum-operated turntable, carries any British OO/HO rolling stock and track. **54 part kit**.....4/6d.