

1st NOVEMBER 1961

VOL. 133

NUMBER 3438

THE ORIGINAL
'DO-IT-YOURSELF'
MAGAZINE

HOBBIES *weekly*

FOR ALL
HOME CRAFTSMEN

★ *FREE design inside*

Also in this issue :

MAKE A LONG
RANGE BOOMERANG

COLLECTORS' CLUB

MORE LAYOUTS
FOR RAILWAYS

GARDENING HINTS
AND CHEMISTRY

MAKE COLOURFUL
WINDOW PANELS

A MODEL
TOY TURBINE

ETC. ETC.

**MAKE THIS PULL-ALONG TOY
FOR A YOUNGSTER**

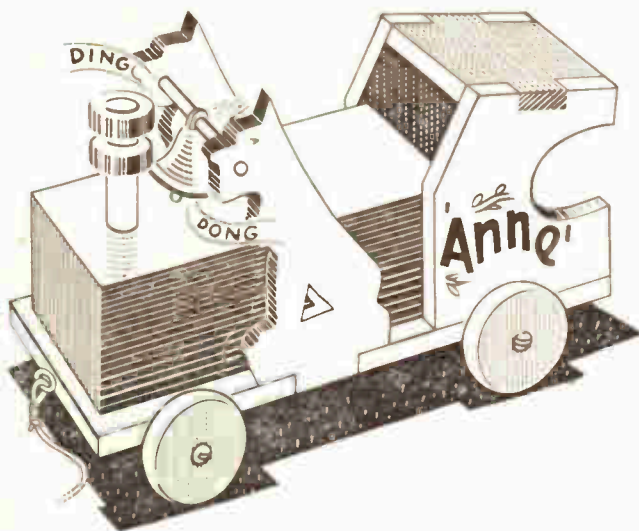

NURSERY EXPRESS



Up-to-the-minute ideas

Practical designs

Pleasant and profitable things to make

5^D



THE eight special British stamps now on sale are all printed in two or three colours. Three-colour stamps have not previously been printed by the British Post Office. The stamps commemorate the Centenary of the Post Office Savings Bank, the seventh Commonwealth Parliamentary Conference, and the first European Conference

NEW STAMPS FOR BRITAIN

of Posts and Telegraphs to be held in this country.

Savings Bank Centenary

Three stamps, 2½d., 3d., and 1/6d. mark the centenary of the establishment of the Post Office Savings Bank — the first savings scheme for the man in the street which was guaranteed by the Government.

The 2½d. value is a vertical design predominantly red with black relief. The stamp shows the Queen's portrait and a symbolic thrift plant linked by a figure of eight outline and surrounded by the words 'Post Office Savings Bank Centenary 1861-1961' in white. The value is shown twice in black in the middle of the design.

The 3d. and 1/6d. values are both horizontal. The 3d. is printed in purple with red, brown and white. In addition to the Queen's portrait the design shows a nut tree: a bird is sitting on its nest in the branches on the left of the design and from the right an owl is watching a squirrel gather nuts from the tree and place them in a pile below. The tree represents the growth and branching out of the savings movement and familiar aspects of savings are illustrated by the wise owl;



P. O. Savings Bank Centenary

the bird with its nest egg of savings, and the squirrel with its hoard of nuts caring for the future. The value is shown in the bottom left-hand corner.

The background of the 1/6d. stamp is steel blue. The design shows a thrift plant with red flowers on the left balanced on the right with the Queen's portrait in red. The lettering is in white with the value in the top centre.

CEPT issues

The 2d., 4d. and 10d. stamps marking the second anniversary — at Torquay — of the Conference of European Postal and Telecommunications Administrations (CEPT) came on sale on 18th September. Many other members of CEPT issued stamps on the same day.



European Conference (CEPT)

The 2d. British stamp shows, on the left, the CEPT symbol (four post horns enclosing the letters CEPT) and on the right the Queen's portrait framed by an adaptation of the four posthorns. The basic colour of the stamp is brown with the CEPT symbol in orange and white; the frame round the Queen's portrait and the value figure are in pink.

The 4d. stamp is in azure blue, violet, tan and white. The Queen's portrait is centrally placed and printed in tan over blue. It is flanked on the left by a motif of nineteen doves — representing the nineteen members of the Conference — arranged in flight to make one large dove printed in shades of violet and on the right by the posthorn symbol in violet and white. The value is printed in pale blue above the doves.

The 10d. value is in shades of blue, yellow and white. The nineteen-dove motif in yellow is on the left, the value figure in white surmounted by the posthorn symbol in pale blue is in the centre and the Queen's portrait in another tone of blue is on the right.

Commonwealth Conference

The 6d. and 1/3d. stamps marking the seventh Commonwealth Parliamentary Conference were on sale on 25th September, the day the Conference opened.



Commonwealth Conference

The 6d. value is designed horizontally in purple and gold with white lettering. The design consists of a representation of the hammer beam roof of Westminster Hall, around the portrait of the Queen. To the left is the crossed mace and the staff of office of the gentleman usher of the Black Rod taken from the Commonwealth Parliamentary Association's badge, balanced, on the right, by the value figure. The lettering is 'VIIth Commonwealth Parliamentary Conference 1961'.

The 1/3d. value is an upright design in green and blue with white lettering. It bears a stylized representation of the Palace of Westminster at the foot of the stamp surmounted by the crossed mace and Black Rod and the value with the Queen's portrait in blue in a rectangular panel at the top of the stamp. The words 'Seventh Commonwealth Parliamentary Conference 1961' form a border.

AUSTRIA

ASPECIAL stamp was issued on 2nd September, marking the 75th Anniversary of Sonnblick Mountain Meteorological Observatory. Situated on a 10,190 ft. peak of the Hohe Tauern mountain range, which forms part of the Central Alps, this Observatory — see illustration — towers above the region of perpetual ice and snow.



adding another one to them. I will show you how this is done in the next article. One should build strongly when it comes to the baseboard. After all, this is the foundation of all of your future work, and if this is weak or flimsy, then the whole of your efforts will be most unsatisfactory. Derailments, which cause half of the trouble with a model railway, can be avoided if the basic structure is sound in every way. One should try to emulate the engineers that design and build the actual railroads.

I have recently had the pleasure of seeing and making up some Airfix kits that might be of interest to my readers. One is of a Panzer Tank, and made to a scale of 4 mm. to 1 ft. That is to say it is suitable for use with OO gauge railways. It is a lovely little model, and could be used on a layout either as a load on a flat car, or else put in the town centre as an exhibit, or could be used on a field. Airfix are bringing out a whole range of these, and so one could build up quite a collection.

There are available many sets of figures in the Airfix range, all to the OO gauge scale. Two recent ones are Cow-

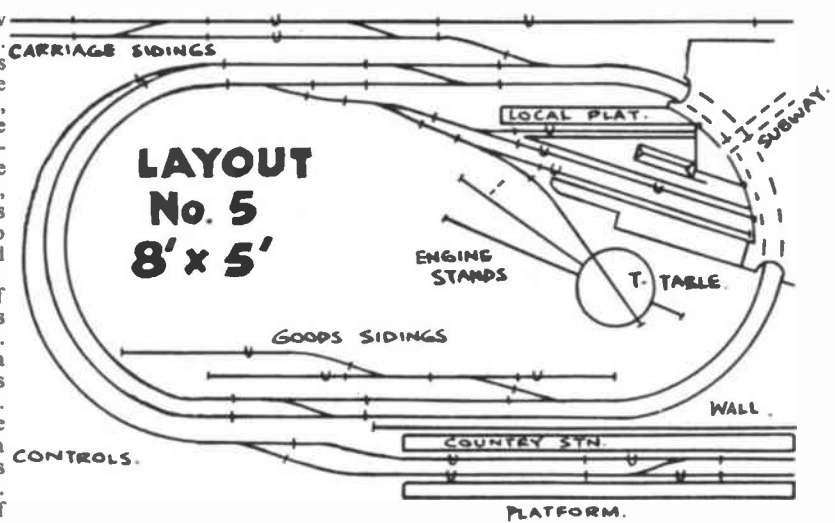

boys, and Indians. In each of these sets there are no less than forty-two figures, and all for 2s. 0d. per set.

Now you are, perhaps, wondering why

I mention Cowboys and Indians in connection with model railways. Well another firm, Kitmaster, make a very excellent old American Locomotive kit, and with this on your layout you could have a lot of fun with imaginary fights, especially on Layout No. 4. I know that my older readers may not be very keen on this, but, when us older people are busy making models, it is sometimes a good idea to give the junior members of the family something to keep them out of the way whilst we are trying to lay that little bit of difficult trackwork. Yes, it has happened to me, so I can speak with authority! To be more serious, the two sets I have mentioned have horses in them which could be adapted to ordinary use on the layout, and one could plan a point to point meeting, or a race, or the farmer doing the rounds of his farm on horseback. There are many ways in which these excellent figures can be used, and I am sure that many more ideas will come to you if you purchase one of these sets.

SOME NEW MODELS FOR YOUR LAYOUT



Modern Signal Box. 'OO/HO' gauge for Triang Railways. Rovex Scale Models Ltd, 7s. 6d.

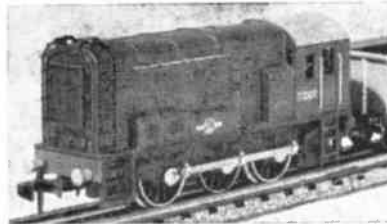

Hornby-Dublo Diesel Electric Shunting Loco. £2. 15s. 6d. (2-rail) and £2. 18s. 6d. (3-rail)

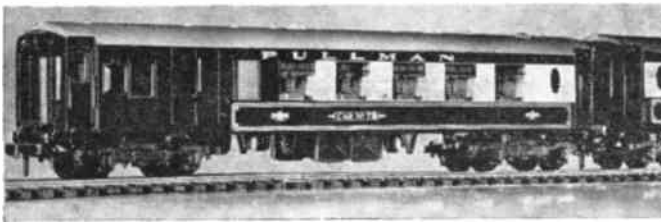

Hornby-Dublo Pullman Car Brake, 9½ in. long, 18s. 6d. Also Pullman Car 2nd class at same price



Curtiss-Wright Rear Dumper. 'OO' scale, 6 cm. long. Matchbox model 5s. 6d.



Freight Station. Revell accessory building in 'HO' gauge

 ★ Next Wednesday's 'Hobbies
 ★ Weekly' will contain instructions
 ★ for making modern barometer
 ★ cases. Also methods of casting
 ★ non-ferrous metals at home,
 ★ Christmas features and other
 ★ projects. Make sure of your copy.
 ★

Ornament in Brass

CUT out the fish from sheet brass, using a Hobbies Fretsaw with metal cutting blade. The base is $\frac{1}{2}$ in. wood, painted black. Clean and polish the brass, and lacquer it to preserve the high gloss. (M.p.)

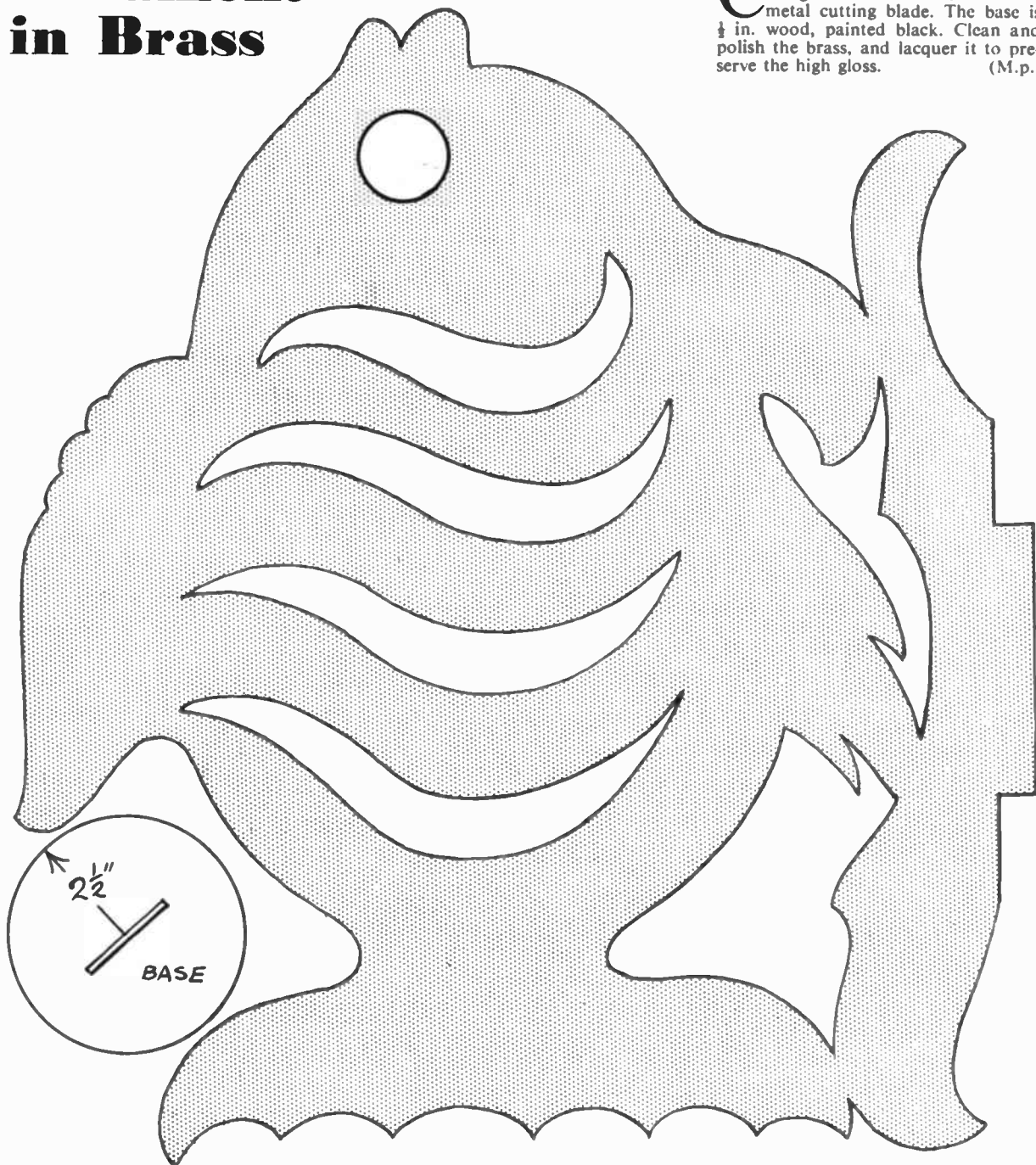

THE NURSERY EXPRESS

THIS dual purpose toy is ideal for making up as a Christmas gift for a child. When all the pieces have been cut and finished, it can be left as a constructional toy for the child to put together and take apart at will, thus giving a good insight into model making. For this purpose, the joints should naturally be carefully made to ensure a tight fit.

Alternatively, the model can be made up as a completed pull-along toy — 'The Nursery Express'. As the toy is pulled along, the bell held by the two dogs tinkles merrily. The completed size is 7 in. long by 3 in. wide.

If it is intended to be used as a toy to construct and pull apart, certain sections such as the rectangular 'boiler' will have to be made up and glued permanently. Similarly, the axles will be fixed to the base. Other pieces, such as those which make up the cab, the bell holder, funnel and wheels, will be put together by the child as shown separately in Fig. 1 on the design sheet.

All parts for the main construction are cut from $\frac{1}{4}$ in. wood. They are shown full size on the design sheet. Trace the pieces and transfer them to the wood, taking particular care with the joints when cutting out the parts as previously mentioned. Finish in all cases should be in brightly coloured enamels with the name of the child added on the side of the cabin.

For use as a permanently assembled toy, make a start with the 'boiler', pieces 3 being glued between the two end pieces 2. The top 4 is next added, the hole for the funnel being, of course, at the front. This 'boiler' section is now

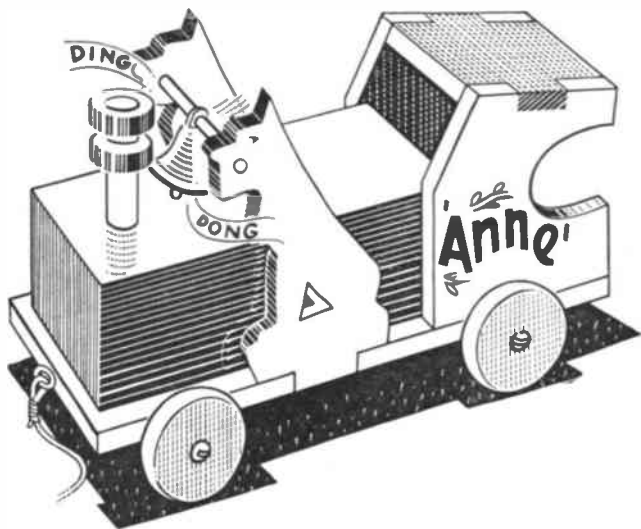

glued in tenons in the base 1. Next glue the axles 11 underneath the base in the positions shown by dotted lines on the design sheet.

The cab section is next assembled from pieces 5 and 6 as shown in Fig. 2, and glued to the base as shown in Fig. 1.

Fig. 3 shows the makeup of the bell holder. The two dogs (pieces 7) are tenoned and glued to the base. The bell is suspended on a piece of $\frac{1}{4}$ in. round rod 10, the ends of which are glued in holes provided in the dogs.

The funnel is made up from pieces 9 glued to the dowel in the positions shown (piece 8). The funnel fixes in

Hobbies Kit No. 3438 for making the Nursery Express contains panels of planed wood, round rod, bell, etc. Kits from branches or by post from Hobbies Ltd. Dereham, Norfolk, price 6/2 (post 2/-).

the hole on the boiler top 4. The four wheels, also cut from $\frac{1}{4}$ in. wood, are fixed to the axles by roundhead screws. Make sure that the wheels work freely on the screw shanks. Add a screw-eye at the front of the toy, to which is attached the string for pulling along.

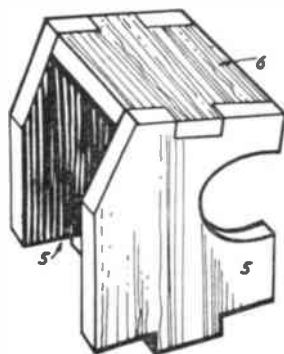

Fig. 2

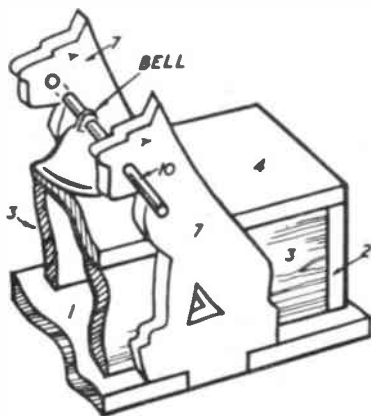

Fig. 3

A GADGET FOR CHALK

AN empty lipstick case may be converted into a neat and handy container for carrying a piece of chalk. A stick of chalk has innumerable uses in many occupations, but if simply placed inside your pocket (or handbag) it will soon make a mess of the lining and may spoil other articles.

Wedge the chalk into the tiny movable 'cup' inside the case. You may need to bind a strip of paper round the base of the chalk stick for a really tight fit. Use the case like a propelling pencil. You may solder a pocket clip to the side of the case so that the gadget may be worn like a fountain pen. (A.E.W.)

NEW Thoughts on

RAILWAY MODELLING

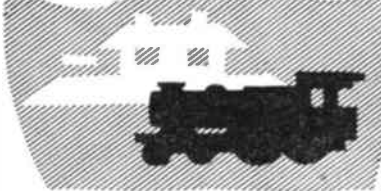

WE will continue our study of layout planning, and I give here three drawings from the handbook of Messrs. G. & R. Wrenn Ltd, suppliers of a very excellent trackwork that I can thoroughly recommend. It is available in OO gauge, and also TT 3 gauge in a variety of point layouts and, of course, straight track in 36 in. lengths.

Well, let us consider the layouts in more detail. Layout No. 3 is ideal for the corner of a room. It is designed for end-

to-end working, but as space becomes available it could be extended to go round an entire room if needed. One could have some very interesting running on this layout, but I personally should add one or two little refinements, such as an engine shed and a coaling plant, etc. The open space in the front could accommodate quite a nice village if desired.

Layout No. 4 gives us a very interesting scheme on two levels, with a nice climbing gradient, a bridge, and other interesting features. This layout could be made most attractive with plenty of scope for all types of scenery, trees, fields, and ample room for planning a village, and other forms of buildings.

The gradient would serve to cut off one station from the other, and, therefore, you could let your imagination run riot in the planning of scenic features.

MORE IDEAS FOR LAYOUTS

By F. A. Barrett

Layout No. 5 has been designed for the modeller who wants lots of tracks in a small space. The addition of a goods depot and an engine shed would make this layout more attractive, and there is also scope for scenic work. I should point out that in all these layouts you will see a U on some of the tracks. This is to mark the fact that an uncoupler can be incorporated in this section. These naturally make for much greater flexibility in working the trains, as shunting operations can then be indulged in to the full.

It is very difficult to give you precise details of these layouts at this stage. There are so many considerations to bear in mind; the actual layout that you are planning, the amount of room that you have available, and also the cost of the project. But we will go ahead with telling you how to build your layout, and then leave it to you to decide just what layout you are planning.

It is most essential to have some aim in view when planning a layout, though there is a very true saying that a model railway can always be complete, but never finished. The desire to expand will always be with you when you start on this most fascinating hobby, and it is as well, at the start, to make provision for this. When making up your baseboards make sure that there is provision for

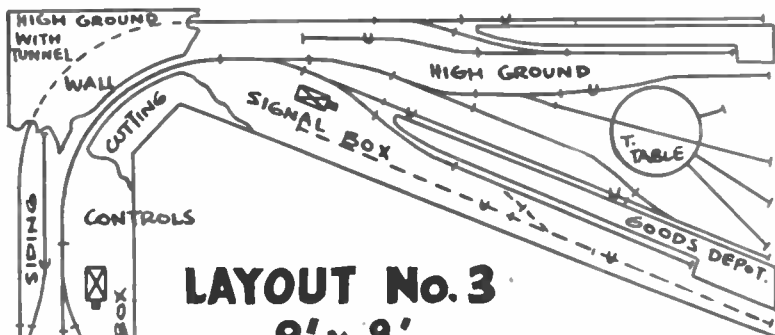

LAYOUT No. 3
8' x 8'

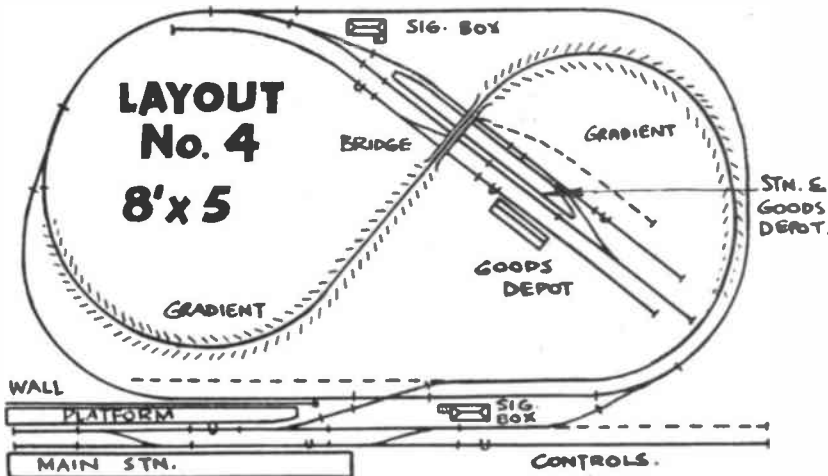

LAYOUT No. 4
8' x 5'

Layouts with acknowledgment to G & R Wrenn Ltd

CHEMISTRY

AT HOME

OUR raw material for these experiments is boracic powder, which is the everyday name given to boric acid, H_3BO_3 . Its value in ointments, lint, and as an antiseptic is known to all of us, and to some its fireproofing properties.

The first fact which strikes one about boric acid is its greasy feel. Partly on account of this, partly because of its antiseptic properties, it is used in talcum powders. Perhaps you would like to make a supply of your own. Intimately mix 95 grams of talc (French chalk), which is one of the magnesium silicates, and has the formula $Mg_3Si_4O_{10}(OH)_2$, 2 grams of boric acid, and 3 grams of basic magnesium carbonate (formula indefinite, since it is a mixture). If it is desired to have a scented product, spread out the powder on a sheet of paper, sprinkle with perfume, and allow the solvent to dry off. Put the whole into a bottle, and shake thoroughly to disperse the scented areas.

Fire-proofer

So many tragedies occur through the catching fire of light fabrics that it is well for the home chemist to know how to kindle-proof such textiles. Dissolve 5 ounces of borax (sodium tetraborate), $Na_2B_4O_7 \cdot 10H_2O$, and 4 ounces of boric acid in a half gallon of warm water, H_2O . If the article is coloured, first test a clipping from the seam so as to find if there is any effect on the colour. Dip the clipping in the solution, squeeze, and hang to dry. If there is no change, immerse the whole garment until thoroughly wetted, lift, squeeze well, and hang to dry. The article will now be kindle-proof. As the proofing washes out on laundering, it should then be redipped.

The boric acid you have in stock is probably in powder form. Its crystals are worth seeing. Put a little of the acid in a test tube, add a few c.c. of water, and shake. It appears to be insoluble. In the cold, 100 parts of water actually dissolve only 3.9 parts of the acid. Now boil the mixture. The acid dissolves. As it cools again beautiful white scales of crystalline boric acid separate.

Stain test

A test for boric acid may be tried with a drop or two of the solution. Turmeric paper is stained brown by it. Alkalis, such as sodium hydroxide, $NaOH$, also give this brown stain, but if you compare the two stains by touching each

with a drop of dilute sulphuric acid you will find the alkali stain is destroyed, whereas the boric acid stain is not. If you have no turmeric paper, by the way, it is easily made by putting some turmeric (from your pharmacist) in a bottle with methylated spirit, shaking occasionally until a bright yellow solution is obtained. Filter and dip in the filtrate slips of filter paper, and hang to dry. The turmeric solution may be kept for further use in a well-corked bottle.

Ethyl alcohol, C_2H_5OH , dissolves the acid rather more readily and the solution gives us a further test for boric acid. Put a little boric acid in a dry test tube, add a few c.c. of methylated spirit, and shake. If all does not dissolve, stand the test tube in warm water. Pour the solution into a tin lid on a sand bath, and light the spirit. Instead of the usual blue



Boron trioxide threads

flame appearing, the spirit now burns with a characteristic green-edged flame.

An easy preparation from boric acid is that of boron trioxide, B_2O_3 . Put some boric acid on a clean tin lid supported on a tripod (see diagram). Now heat it. It begins to swell up and evolve steam. Large glassy-looking bubbles then form,

collapse, and reform. Dip a nail into the mass and raise it slowly. Long silky threads are drawn up from the mass, which at once cool, and become brittle.

When no more bubbling takes place in the heated mass, let it cool. A glassy mass of boron trioxide remains. This has been formed by simple evolution of water:



Crack it off the lid, and store it in a screw-capped bottle, fitted with an extra

BORIC ACID EXPERIMENTS

disc of sheet rubber, since atmospheric moisture attacks the trioxide causing it to become opaque, and reform boric acid:



With boron trioxide another test for boron, B, may be tried out. Mix a small quantity of powdered boron trioxide with twice its weight of calcium fluoride (or fluor spar, which is essentially calcium fluoride), CaF_2 . Twist a loop of thin iron wire round a pencil point, and then heat the wire red hot in a sootless flame. Dip the hot wire in the mixture, and hold it in the flame again. Green flickers will be seen in the flame. This is due to the formation of the gas boron trifluoride, BF_3 . Calcium metaborate, $Ca(BO_2)_2$, remains in the residue on the wire:



Acidic properties

A typical preparation showing the acidic property of boric acid is that of sodium tetraborate (borax). Weigh out 2.64 grams of anhydrous sodium carbonate (soda ash), Na_2CO_3 . Boil 50 c.c. of water, and dissolve in it 6.18 grams of boric acid. In small portions add the sodium carbonate. Carbon dioxide, CO_2 , is evolved, and one should wait until this slackens before adding more sodium carbonate. When all has been added, continue boiling for a few moments and then let the solution cool down overnight. Prismatic crystals of sodium tetraborate separate. Drain off the mother liquor, and spread the crystals on a porous tile to dry. The equation for the reaction is:

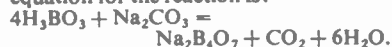

Boric acid does not only behave as an acid, however. It may behave as a base under certain conditions. An easy example for the home laboratory is the

● Continued on page 71



THESE NOTES REFER CHIEFLY TO MIDLAND GARDENS — DUE ALLOWANCE SHOULD BE MADE FOR CHANGE OF LATITUDE.

IF you have young children in the family who are looking forward to November 5th it might be a good idea to encourage a general clear up of all burnable rubbish. Dead leaves, broken seed boxes, cabbage stalks, prunings and any other refuse can be piled on the bonfire, but keep a few dry pieces handy for starting the blaze.

Build the fire on a plot which has not been dug and keep it well away from

hedges and shrubs. The ashes can later be spread on next year's potato plot to provide extra potash.

Tulips and daffodils that have remained in the ground are beginning to shoot and push their way to the surface. For this reason it is important to fork over the borders now, digging in as much old stable manure or compost as you can spare.

There is still time to prepare sites for

shrubs and roses, incorporating compost in the second spit for future use by the plant.

Heavy soils should be thrown up rough when digging, to allow the frost to produce a fine tilth for spring planting.

The sweet pea trench can be opened out now, making it about 20 in. deep, loosening the bottom and leaving open until Christmas.

SUGGESTIONS FOR WORK THIS MONTH

- Plant tulips
- Sow sweet peas in pots and keep under glass
- Protect celery with straw during frosts
- Set out pansies and Canterbury Bells
- Protect tender alpinas
- Cut down asparagus, mulch with well decayed manure
- Prune orchard trees
- Lift dahlias and gladioli if not already done
- Prune black currants by cutting away old wood
- Sow broad beans under cloches

- Sow early peas
- Cover rhubarb with straw
- Plant cauliflower seedlings into frames
- Pot up lily of the valley crowns for early flowering
- Put border carnation layers into frames when rooted
- Stake sprout plants if top heavy.

- In the warm and cool greenhouse**
- Scrub and clean wood work
- Ventilate when possible
- Bring in bulbs for early flowering
- Keep seedlings near glass

Increase heat to about 50°F during night

Sow sweet wivelsfield for spring blooming.

In the cold house

- Cut down and remove flowered chrysanthemums to frames
- Keep lettuces dry
- Ventilate whenever possible. (M.h.)

● Continued from page 70

BORIC ACID

preparation of boron phosphate, BPO₄. In an evaporating basin grind to a paste 3 grams of boric acid and strong phosphoric acid, H₃PO₄, of specific gravity 1.75. About 14 grams of phosphoric acid will be needed. To aid the incorporation a few c.c. of water may be added. Now evaporate the mixture over wire gauze. At first the solution is clear, but soon it becomes milky from formation of insoluble boron phosphate:



Evaporate the liquid almost to dryness, let it cool, and then stir it with water. At this point the boron phosphate usually forms a milky colloidal solution, and passes a filter paper.

It may be thrown down in a filterable form by the addition of an equal volume of a saturated solution of sodium chloride (salt), NaCl, and allowing to stand a few hours. Now filter off the boron phosphate, wash it with cold water, and let it dry for your specimen collection.

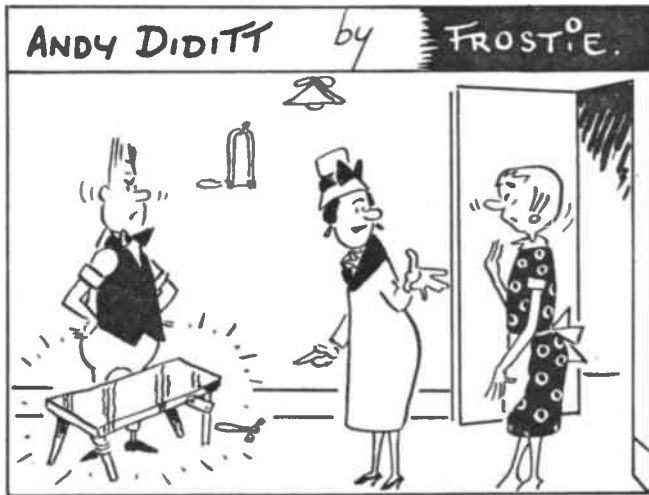

"I WON'T GO TOO NEAR THE COFFEE TABLE ANDY'S JUST FINISHED, I DON'T WANT TO GET ANY SPLINTERS IN MY FINGERS."

Make a Long Range Boomerang

THERE are only two simple basic parts to this boomerang, identical in shape, and so the flight properties will depend very much on how carefully these are made and finished. Choose hard, straight-grained material for the blades, so that they can be finished

off on one blade only, as shown in Fig. 3, along the length of the slot. This is to provide a flat surface to rest flush with the underside of the second blade when the two are bolted together. Do not reduce the thickness too much in this region or the blade will be unduly weakened. A flat amounting to half the full width of the blade will be sufficient. The tips of each blade can then be finished as shown in Fig. 4.

The next step consists of steam-bending each blade to a dihedral angle, as shown in Fig. 5. Completely saturate the centre portion of each blade with steam by holding in front of the spout of a boiling kettle, and gently bend to the required curve as increased flexibility is felt in the material. Bend both blades in the same way to approximately the same curve. Now pour boiling water on to the centre of each blade. Pin them both

appropriate nut, with large diameter washer bearing against the wood surfaces (Fig. 6). This permits a full range of adjustment, both of the angle of the two blades, and the symmetry of the assembly. Normally the blades should be locked at 90 degrees to one another, although slight variations of this angle may be attempted later on for improved control. Practise first with the blades at right angles.

Governing the flight

The radius of flight is governed by the respective position of the crossing point. With all four legs equal, i.e., the boomerang perfectly symmetrical, the largest flight radius is achieved, i.e., $A = B$ for large diameter circles. Increasing the ratio of B to A reduces the effective flight diameter in that the boomerang tends to curve more sharply, and return to its starting point more quickly. The second arrangement of Fig. 7 is probably the easiest to start practising with, making B about equal to twice A . As you gain proficiency you can decrease the ratio of B to A and make longer flights.

The art of launching is to hold the boomerang by one leg, grasped firmly in the palm of the hand, and tilted outwards at an angle of about 45 degrees. The dihedral curve (upwards) should be on the side of the boomerang nearest to you. Throw forwards, and very slightly upwards with a strong spinning motion, making the spin forwards, i.e., the blades advancing against the direction of flight.

Many faults, which can be cured by practice, are lack of launching spin, which makes the boomerang slow up

● Continued on page 73

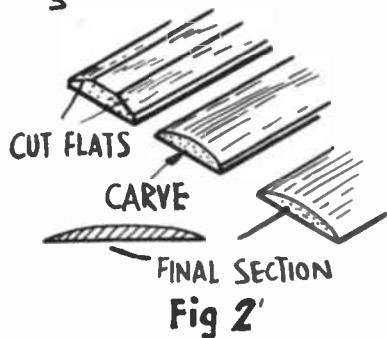
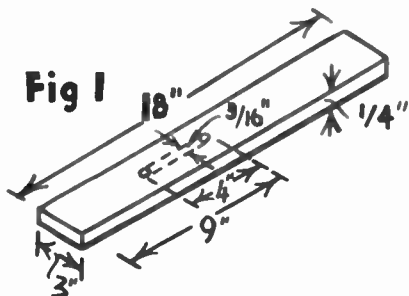

smooth and true, and will withstand the hard knocks inevitable during practice. Soft wood will tend to split around the slot on impact, which will render the boomerang useless. No two boomerangs will be absolutely identical, even made to exactly the same plan. Each will have a certain individual 'feel' to which the user must accustom himself by practice.

The pattern for the two blades is shown in Fig. 1. Cut to rectangular shape first, then drill holes representing the limit of the central slot, and complete this slot by fretcutting out and filing smooth. Each blade in turn is then carved down to the required aerofoil section.

Stages in reproducing the required section are shown in Fig. 2. First each blade is chamfered off slightly over one third of its width, on one surface only. Leave an edge thickness of roughly $\frac{3}{16}$ in., which is subsequently carved down and rounded off. Carving consists of transforming the three flats formed by planing into a smooth, symmetrical convex section. The section is finally finished to shape by glasspapering.

The finished section is then flattened

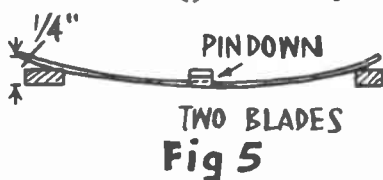
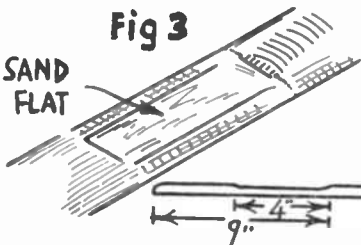

down in a jig, as shown in Fig. 5, and leave overnight. This should ensure that the dihedral angle steamed in remains permanent, and is the same for each blade.

Before final assembly, each blade should be given several coats of grain filler, sanded down perfectly smooth between each, and given two or three coats of waterproofing paint or varnish. It will also help if, after the final coats have hardened, the blades are polished with a wax polish.

The actual assembly is accomplished with a short machine screw and appro-

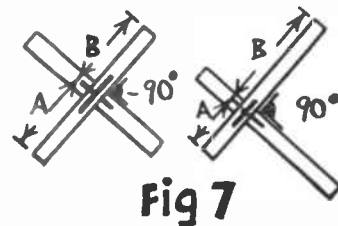
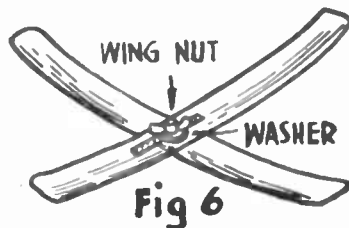

Inexpensive—and effective

How to Build a 'Dry' Wall

MOST of us have paused to admire a well-built dry wall and appraised the craftsmanship which must have gone into its construction.

Many of us must have wished for just such a wall in our own garden, for it has many merits. Forming a more substantial boundary than a wire fence, a dry wall harmonizes with the beauty of a garden, being informal in appearance and an ideal setting for many rock plants and trailing subjects.

There is a fascination in building oneself a dry wall, or in stone-facing a bank or dilapidated hedge. There is nothing in this job to be frightened of, and provided one has a good eye, the result can exceed all expectations. In a steeply sloping garden a terraced effect with low stone-faced banks can be very pleasing.

In building a wall the first essential is, of course, an adequate supply of stones, and if there is a quarry nearby it should be possible to obtain them fairly cheaply as the type required is usually unsuited to the better markets. Many stones are grained and can be split by applying a wedge and administering a sharp blow to it with a hammer. Mis-shapen stones can be improved by judicious hammering.

Various arrangements of the stones are used in dry wall building, and three of these are shown in the illustrations.

In Fig. 1, the stones stand vertically, in Fig. 2 they are laid horizontally, and in Fig. 3 a patterned design is used.

A dry stone wall is built against a

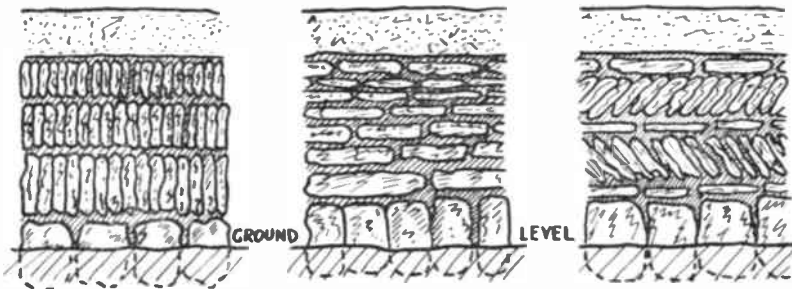

Fig. 1

Fig. 2

Fig. 3

bank of earth, and it must always slope backwards from bottom to top, otherwise it will quickly bulge and collapse. The largest stones should be used in the bottom row, and they should be partly buried in a shallow trench, the earth from which can be used for packing between the stones as the wall is built. As each row of stones is completed, earth from the bank is pulled down on to them and firmed, the resulting soil cap forming a cushion for the next row. A certain number of long stones should be driven well into the bank to anchor the whole. Where stones vary in height the level may be maintained by placing larger stones above the smaller. The flattest side of each stone should, of course, face outwards, and care must be taken that the bottom is not sloped in such a way that it will slide easily outwards.

Care should also be taken that all gaps behind the stones are filled with earth, which should be well firmed down. Plenty of earth and no hollows should be the rule.

Stones for the top row must be carefully chosen for size, so that the top of the wall is nicely level, and it may be finished off with large capping stones. A further cap of soil or turf may be added, and planted with flowers or shrubs.

With reasonable care, and using garden lines, the novice can build a wall of which he need not be ashamed, and may, in fact, be justly proud. It is safe to say he will enjoy every moment of its building.

Apart from the labour, the wall will cost little, and will certainly look better in a garden than the inevitable concrete blocks, of which one tires so quickly. (E.)

● **Continued from page 72**

LONG RANGE BOOMERANG

and climb steeply about half way round its circular flight, to fall to the ground without returning; and incorrect launching angle which sets the boomerang off on a substantially straight course, instead of inclined inwards in a natural banked attitude.

It should not take too much time to acquire the knack of making 'back to hand' flights. Properly thrown, all the spin and launching energy should have been expended by the time it returns to the thrower, so that it is just on the point of 'falling out of the air'. Remember to duck if it returns too fast! Those spinning blades can give you quite a nasty rap!

One problem you will have at first, unless the weather is calm, is wind upsetting the flight path. This, again, is something you can allow for with practice. Normally a boomerang will tend to climb sharply and slow up when heading into wind, and tend to dive, and, perhaps, fall straight to the ground when headed downwind. If there is a wind, launch so that the boomerang only heads into the wind on the last part of its circular flight.

And having built a successful model, use it sensibly, so as not to cause inconvenience or injury to other persons or property. (E.)

FUN WITH SCIENCE

by Mae and Ira Freeman

THE authors are specialists in bringing science to young people in simple, non-technical language, and in a way which explains its vital importance in everyday life. Text and pictures together illustrate how sound waves travel; why an aeroplane stays up, and a boomerang flies back to the sender; the way pressure melts ice; and many other important facts about heat, light, and sound.

All the experiments described have been fully tested to make sure that they work, and are straightforward, safe, and entertaining. Each experiment is accompanied by large photographs.

Published by Edmund Ward, 194-200 Bishopsgate, London, E.C.2. Price 11s. 6d.

Make Colourful Window Panels

By S. H. L.



FIG 1

NO doubt you will have often seen examples of stained glass windows in a church where a religious scene is portrayed in coloured glass, the varying shapes being bonded together by means of lead stripping.



FIG 3

careful planning we can make similar pictorial, coloured panels by the use of coloured cellophane. This is made in a variety of brilliant hues equal to those in glass. The panels can be placed against a window pane in your room or den and viewed by transmitted light just like a colour transparency, but much larger in size.

The dimensions will vary according to the picture of your choice and the glass available. For the initial attempt it may be wiser to prepare a panel about 7 in. by 5 in.

First of all we require some kind of picture to make the design. It should be reasonably simple and preferably a line drawing of perhaps a bird, animal or ship. Avoid too much detail work. It is suggested

that you peruse some of the simple sketches in children's painting or drawing books for these early experiments. Some of the overlay motifs which appear regularly in *Hobbies Weekly* would be ideal.

In Fig. 1 you will see that we have sketched a bird perched on a twig, with a few leaves at the top and base to help the design. This is prepared on a sheet of stout paper within a rectangle measuring 7 in. by 5 in. and the divisions of the outlines are then thickened to no less than $\frac{3}{8}$ in. in width. This width is essential if we are to add different pieces of cellophane later. You will now understand why it is necessary to select a simple design, for the line thickening absorbs space and we have also to subdivide this outline into a mosaic form.

The design should now be cut out, leaving nothing but the $\frac{3}{8}$ in. tracery. You will realise that if we cut out the shape shown in Fig. 1 it would not be fastened to the frame so we are obliged to make some modification to the pattern. If you will now refer to Fig. 2 you will see that we have added more links, particularly on the bird's wing and the leaves. This not only divides up the design itself into



FIG 2

a mosaic pattern but also the surrounding area. It therefore links up the design with the frame. Fig. 3 shows another example with a Dutch boy as the motif. The actual design is shown by the thicker lines while the additional mosaic divisions are shown by thinner lines. Note that each line is carried to the frame on all sides.

You may now cut out the pattern, removing the waste and leaving what appears to be a stencil. Lay the paper on a hard surface, using a sharp knife to achieve clean cuts. Colour the front of this cut-out with black water-colour or Indian ink and allow to dry.

We now require some small pieces of coloured cellophane to make the illuminated panel and it is great fun selecting the appropriate colours. You may be able to use odd pieces such as sweet wrappers or buy small packets of assorted colours. It is assumed that you have more or less decided on the basic colour scheme and it is now a matter of filling the mosaic blanks with the cellophane, which is attached to the back of the cut-out.

Start in the centre of the design and work towards the outside, cutting a

● Continued on page 76

**BUILD YOUR OWN SUPER
MODELS WITH REAL
BRICKS AND CEMENT!**

Real bricks, real cement and a wide range of models to build with them. Designed to O-Gauge Scale by architects to look exactly true to life. Roofs, windows, doors, plans, full instructions—everything's complete. You can make permanent models or dismantle them and re-use bricks and other components. Kit "A"—20/6 Kit "B"—27/11 Kit "C"—53/6

CONTEMPORARY

BRICKPLAYER

WIN A PRIZE! £21.0.0 £10.10.0 £5.5.0

also consolation prizes are offered in the BRICKPLAYER contest

At good toyshops, hobby shops, departmental stores. Leaflet on request, together with name and address of nearest stockist if required.

J. W. SPEAR & SONS LTD., (Dept.HW) Enfield, Middlesex



Model Launching Pad

A MODEL launching pad which fires wooden missiles, and which can be remotely controlled by a long thread, is really quite a simple toy to make,

The basis of each launching unit is an ordinary wooden mousetrap. Each unit is fitted with two launching tubes which can be used simultaneously or separately. The tubes are 4 in. long and are made of tinplate. Each tube is shaped round a length of $\frac{3}{8}$ in. diameter dowel rod so that this rod will slide freely inside the tube. Alternatively, plastic tubing of suitable diameter can be used if this is available.

By A. Liston

Before firing, the launching unit is jacked off its four 1 in. diam. wheels, if these are fitted, by four 2 in. nuts and bolts. These are fitted as follows. A hole, a little larger than the diameter of each bolt, is drilled through the base and axle beam at each corner. A recess is cut in the underside of the base to take the bolt and prevent it from turning. The base and axle beam are then screwed together with the bolt held firmly between them, and the screw inserted. (Fig. D). Turning the screws by hand will of course, jack the unit off its wheels.

A long thread is tied to the bait prong of the trap so that it can be fired from a distance. The trap is set, a missile

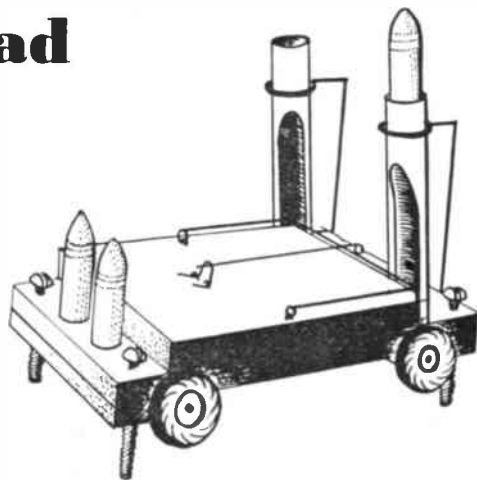

lowered carefully down its tube so that it rests on the sprung arm of the trap, and the launcher is ready to operate.

The unit can be painted grey or green, and the missiles white. These units can also be mounted on flat model railway trucks of gauge O scale, or on a model ship of 1 in. thick wood, about 12 in. long and 3 in. wide.

● Continued from page 74

COLOURFUL WINDOW PANELS

small piece of cellophane to fill a particular space. Allow an additional $\frac{1}{4}$ in. all the way round so that you may stick it on to the dividing lines. Dab a few spots of glue on to the strip around an aperture, fit the cellophane in position and hold down for a moment or so. You will find that an amyl acetate adhesive or Britfix 77 is suitable for this purpose. The same procedure is continued until the whole of the design has been treated.

Note that it is not always essential to cover every aperture. Whenever white is desired you may leave a blank. For instance, Fig. 2 shows that the bird itself has been given prime attention, the different colours being represented by lines in various directions. It is essential that the main motif of your design should dominate in this way if it is to be seen quite clearly. Consequently, the surrounding area should contain many blank spaces with the remainder in subdued tones.

It is possible to vary the hues considerably by using combinations of differently coloured pieces of cellophane or a double thickness of the same colour.

For binding the panel you may use either two pieces of glass, 7 in. by 5 in., or two pieces of celluloid. The panel is

sandwiched between and bound on all four sides with passe partout.

While we originally embarked on a project to make a panel to be seen by transmitted light like the window we can also use it as a picture by placing it on a cardboard or tinfoil backing.

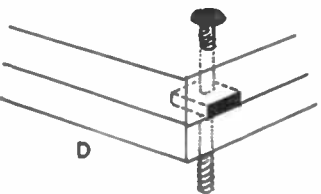
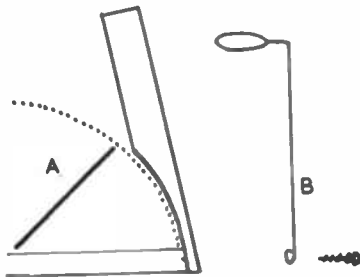

The lower two inches of each tube is cut away on one side so that when it is fitted at one corner of the mousetrap, the sprung arm just clears the tube when the trap is fired. (Fig. A).

Each tube should be at a slight angle to the vertical for maximum efficiency. When the best position has been found, the tubes are pinned to the corners of the trap. A 3 $\frac{1}{4}$ in. high supporting bracket of stiff wire (Fig. B) is fitted over the top of the tube and screwed in place by a loop at its lower end.

The missiles are 2 in. lengths of $\frac{3}{8}$ in. dowel rod, filed to a point at one end.

The mousetrap is pinned and glued to a block of $\frac{1}{2}$ in. thick wood which is 3 in. longer than the wooden base of the trap, and two axle beams of the same thickness of wood are screwed below this at each end. (Fig. C).

QUIK-TIP



COTTON REEL CUT IN HALF MAKES USEFUL PAIR OF DRAWER HANDLES

full industrial strength

CASCAMITE 'ONE-SHOT' RESIN GLUE

waterproof and heat resistant

Table-tops, worktops and kitchen cabinets . . . bathroom panels and fittings . . . wherever you need strong, waterproof and heat-resistant bonds, use CASCAMITE "One Shot"—the resin glue that has proved its worth in the furniture, joinery, boatbuilding and many other industries. With CASCAMITE "One Shot" you have ample time to position your work before the glue begins to set.

for permanently bonding WOOD
HARDBOARD·FORMICA·WARERITE
FABLONITE and other plastic lami-
nates. Also for model making and
general repairs.

3½-oz. tin 2/6d.
7-oz. tin 4'-d.
18-oz. tin 8/6d.



CASCO 'CONTACT' INSTANT ADHESIVE

For practically everything that needs to be stuck instantly, without pressure. Ideal for handicrafts. In a handy hang-up pack. Tubes 1/- and 1/9d.

MANUFACTURED BY LEICESTER, LOVELL & CO. LTD., NORTH BADDESLEY SOUTHAMPTON



141

LET 'Plasticine'



HELP YOU DO-IT-YOURSELF Regd. Trade Mark
Special Trial Offer. We will send 4 lb. 'Plasticine' (any
colour) with booklet 'Plasticine Modelling for Amateurs'
Post free: 10/- U.K. only.
Harbutt's Plasticine Ltd, Bathampton, Bath

HEAR ALL CONTINENTS With H.A.C. Short-Wave Receivers

Suppliers for over 18 years of radio S-W Receivers of quality.

One-Valve Kit, Price 25/- Two-Valve Kit, Price 50/-
Improved designs with Denco coils. All kits complete with all components,
accessories and full instructions. Before ordering, call and inspect a demon-
stration receiver, or send stamped addressed envelope for descriptive
catalogue.

'H.A.C.' Short-Wave Products (Dept. 22), 11 Old Bond Street, London, W.1.

REMUNERATIVE. RELAXING. Paint
designs on paper. Flowers, Abstracts. Any-
thing YOU wish. Exceptional opportunities,
beginners, others. Read exciting 'PROFIT-
ABLE ART' (free). Popular Art (HW), Clun,
Shropshire.

100 DIFFERENT stamps free Request 1d.
upwards discount approvals. — Bush,
53 Newlyn Way, Parkstone, Dorset.

ENJOY WRITING? Then write for Profit.
Send for 'Writers' Handbook' (free) detailing
countless opportunities for beginner or ex-
perienced. — Writers' Ring (HW), 5 Edmund
Street, Birmingham.

PERSONAL COLUMN LTD., Falcon
House, Burnley, Lancs. Pen Friend — all
hobbies. Correspondents in almost every Country.
All ages. S.A.E. for details.

LEARN

RADIO & T/V SERVICING

for your OWN BUSINESS/HOBBY

● by a new exciting no-maths system, using
practical equipment recently introduced to this country
FREE Brochure from:—

RADIOSTRUCTOR

DEPT. G81, READING, BERKS. 1/11/61

HOMEWORKERS required to make up and
machine simple household goods. Experience
unnecessary. Good pay. Regular work. S.A.E. for
details to Dept. 28. Arnold, 10, Shelley Road,
Worthing, Sussex.

STOP SMOKING

You can overcome the Smoking habit in 3 days
or money back. Safe, pleasant, permanent. The
only scientific way. No will power necessary.
'Conquered the habit in 2½ days'—F.C. 'Within 2
days I was free.'—W.G. Complete Course 7/6
Details 2d. Sent under plain cover.

NATURE REMEDIES, (H156), 28 Dean Road,
London, N.W.2. Established 1928

FINE ART COLOUR PRINTS — Old
Masters, Landscapes, etc. for Calendars,
Framing, Table-mats, Miniatures, etc. Full value
selection with Titles, Sizes, Prices 5/-, or send for
List. — 'The Studio', Dept. H., 31 Everest Drive,
Bispham, Blackpool.

WILL PAY worthwhile for one or more
compass lens combination, sandwich type;
stamped Made in England. New. used. — Alexei
Zardzke, 340 Bowery, New York 12, New York,
U.S.A.

MAKING YOUR HOBBY MAKE MONEY

HOW, WHY any handicraft can make money
for you — everything you should know.

40 pages of experience — 5/6 from

G. SEALE
Regent House, 26 Queen's Rd., Coventry

See how it works

A MODEL TOY TURBINE

FEW boys can resist the lure of toy steam engines, and a working model of even the simplest of steam driven machines can be guaranteed to captivate their interest. A model of Branca's steam turbine is easy to construct for the cost of no more than a few pence.

To build the turbine you will need a tall tin with a press-on lid to serve as a boiler, a cork, a 2 in. length of thin bore glass tubing, some stout wire, a piece of dowel rod, and a thin metal jam jar cover.

Bore a hole near the edge of the tin lid into which the cork will fit tightly. A drill and a rat-tail file will be useful tools when you tackle this. Use a red-hot nail or cork borer to make a hole through the middle of the cork, into which the glass tube may be tightly inserted. A convenient internal diameter for the tubing will be $\frac{1}{8}$ in. Hold one end of the glass tube in the top part of a hot Bunsen flame, and wait until the glass has melted, and closed in at the edge of the hole to form a reduced aperture of $\frac{1}{8}$ in. before taking the glass away from the flame. Let the glass cool.

Twist a 24 in. length of stout wire

twice around the top of the tin, and then bend it up 3 in., and then crossways for $2\frac{1}{2}$ in. to form a neat 'gallows' arrangement above the centre of the tin. Pliers should be used to do this, and the wire must be twisted a few times, after being wrapped round the tin, before you bend it upwards to make the gallows support. The diagram will further clarify these instructions.

The jam jar cover will be used to make the turbine wheel itself. Fit a sharp steel knitting needle into a pair of compasses, and use this instrument to scratch out a big circle on the plain side of the jar cover. Mark an inner circle upon the metal, with a radius of approximately $\frac{1}{4}$ in. Divide the circle into twelve equal segments. Now cut out the disc, using an old pair of scissors, and cut down each of the twelve inscribed radii as far as the inner marked circle. Carefully cut a little way along the concentric circle in an anti-clockwise direction, starting at the termination of each of the twelve radial cuts. (See diagram.)

Puncture a small hole, slightly greater in diameter than the wire, in the centre of the turbine disc, and then pro-

ceed to twist the twelve 'blades' of the wheel aside to form a tidy water wheel-shaped object. Cut two $\frac{1}{2}$ in. long slices off a $\frac{1}{2}$ in. diameter dowel rod, and bore holes through the slices, from end to end, using a red-hot needle. Mount the wheel upon the crosspiece of the gallows, between the two dowel slices, both of which should fit tightly upon the wire. If you have carried out your task exactly as described the turbine wheel should spin easily when you blow upon it. If the wheel wobbles you can move the dowel slices closer together.

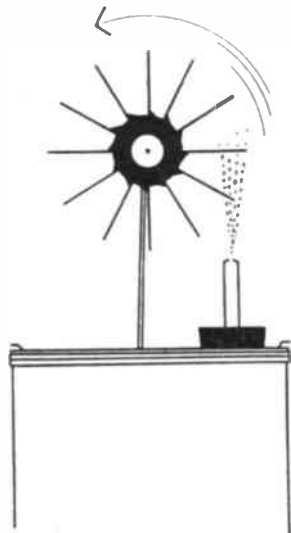
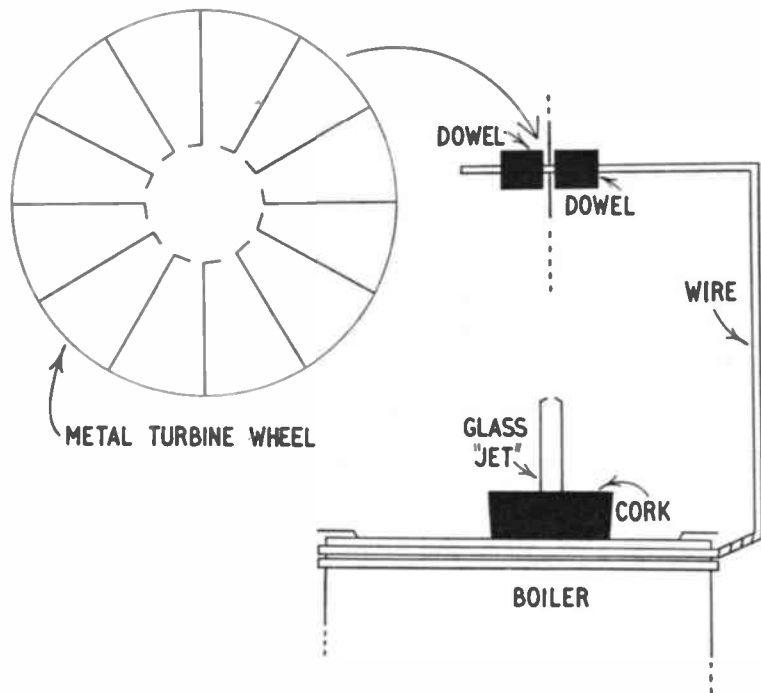

Mount the glass 'jet' tube vertically in the tin lid by pressing it through the cork and then securing the cork in the hole in the lid. One third fill your tin boiler with water, and place on the lid whilst arranging matters so that the jet aperture is immediately below one side of the turbine wheel. Heat the water over a gas ring, and watch the wheel turn at high speed when steam eventually issues from the jet tube.

Make sure that the glass tube is clear of any obstruction whenever you operate your model. The press-on lid will serve as a simple safety valve should you accidentally permit high pressures to mount inside the boiler, but try and avoid high steam pressures forming by refraining from heating the apparatus too fiercely. An additional safety measure would be to avoid ramming down the lid too tightly. (A.E.W.)

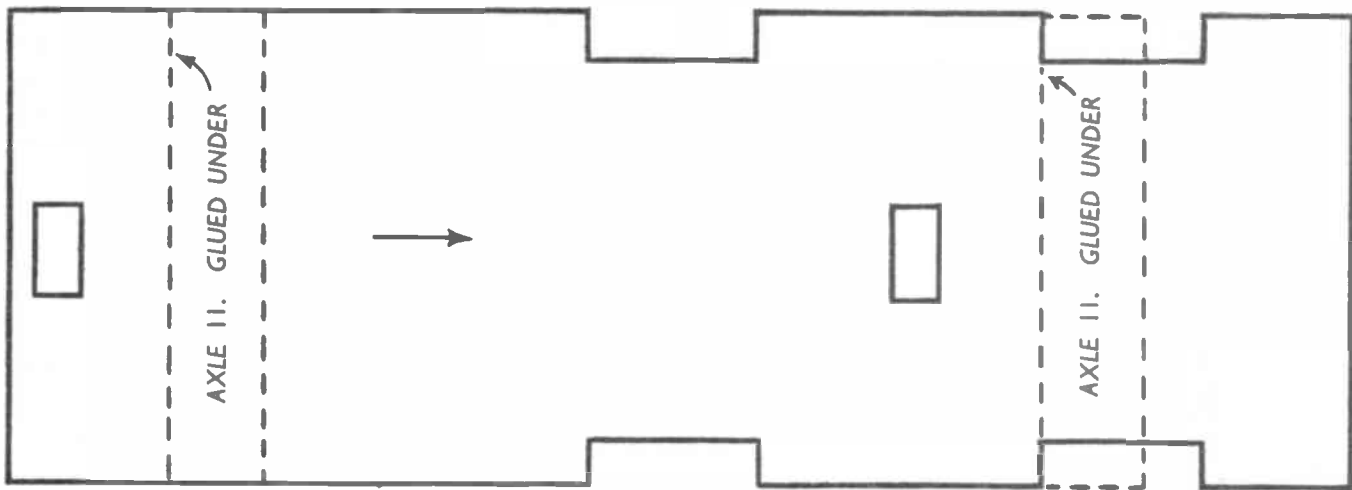

PIECE 1. CUT ONE 1/4 in.

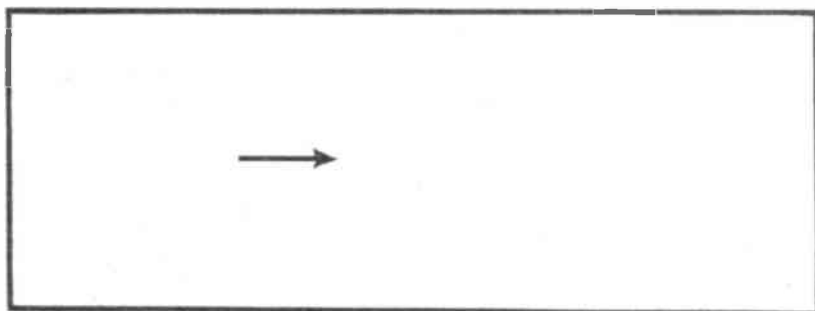

PIECES 3. CUT TWO 1/4 in.

THE ARROWS
INDICATE THE
DIRECTION
OF GRAIN
OF WOOD.

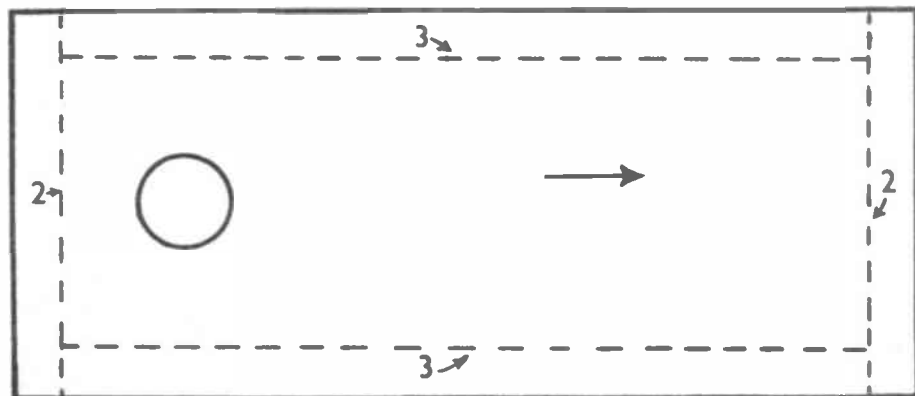

PIECE 4. CUT ONE 1/4 in.

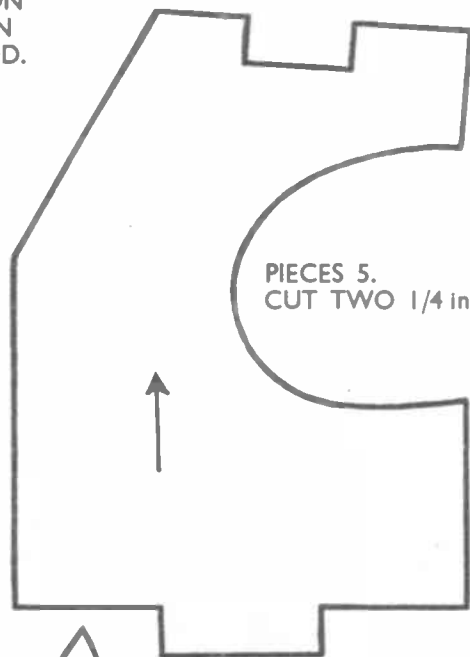

PIECES 5.
CUT TWO 1/4 in.

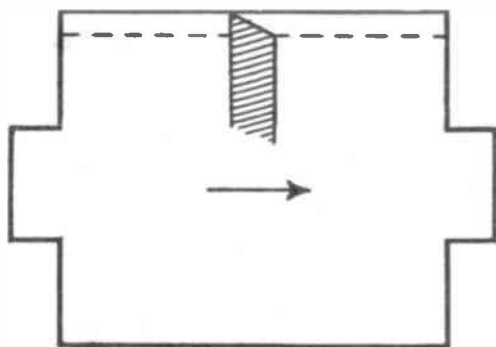

PIECE 6. CUT ONE 1/4 in.

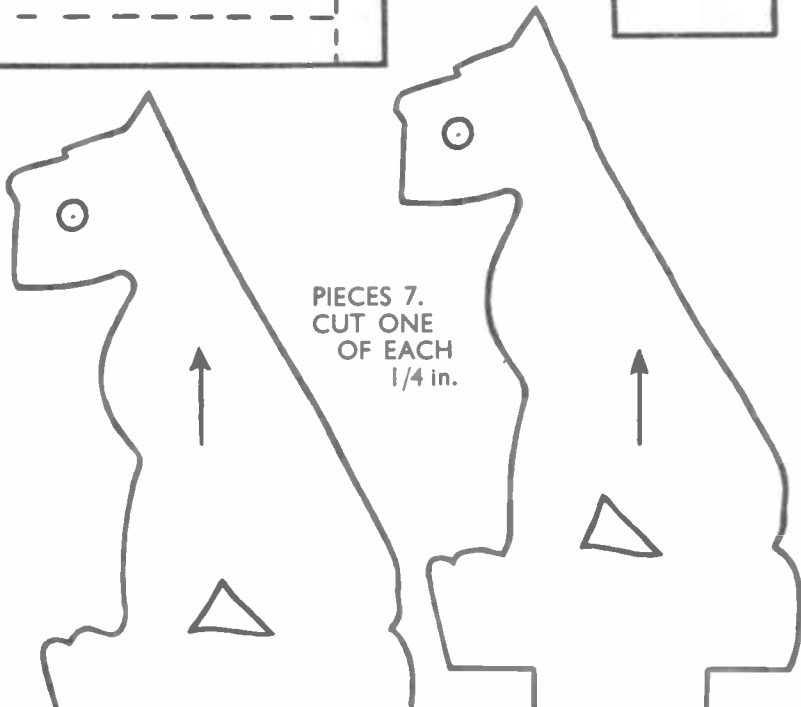

PIECES 7.
CUT ONE
OF EACH
1/4 in.

PIEC

PIEC

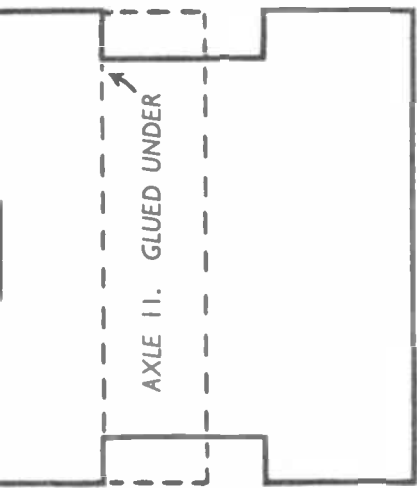

PIECES 2. CUT TWO 1/4 in.

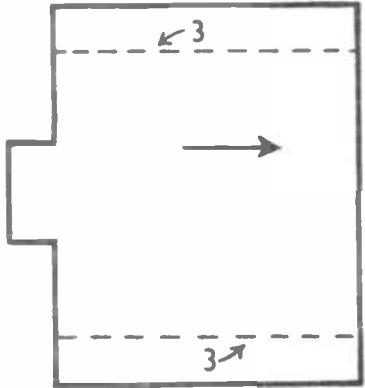

PULL APART — PULL ALONG
“NURSERY EXPRESS”

SIZE: 7 in. BY 3 in.

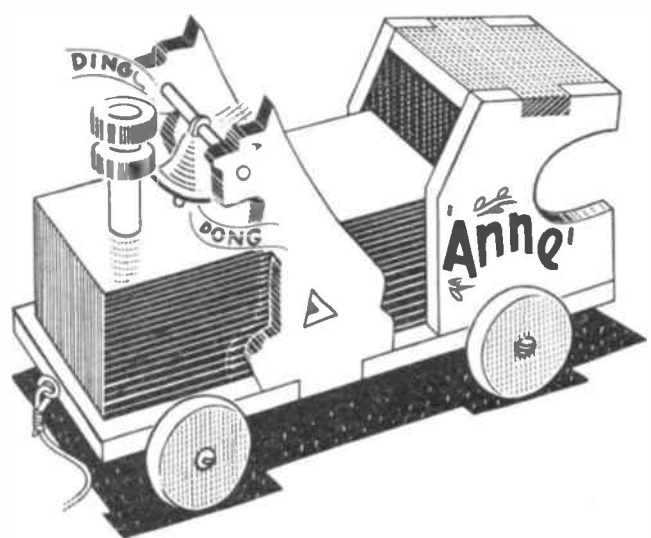

ARROWS
CATE THE
CTION
GRAIN
WOOD.

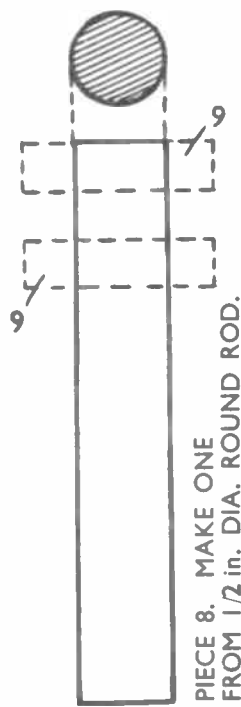
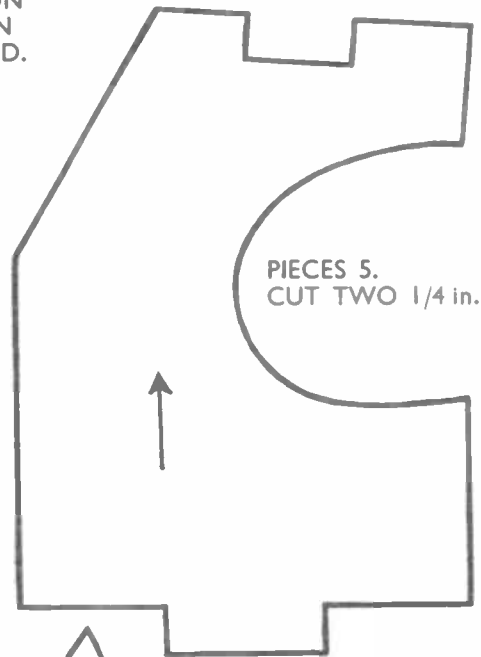

A KIT OF MATERIALS FOR MAKING THIS DESIGN IS SUPPLIED BY HOBBIES LIMITED, DEREHAM, NORFOLK. PRICE ON APPLICATION.

Use **CASCAMITE**
‘One Shot’
Resin Glue
for all Model Making



Obtainable in:
3 1/2-oz: 7-oz.
and 18-oz tins.
Stocked by: Ironmongers, Builders' Merchants, etc.
Manufactured by:
LEICESTER, LOVELL & CO. LTD. North Baddesley, Southampton

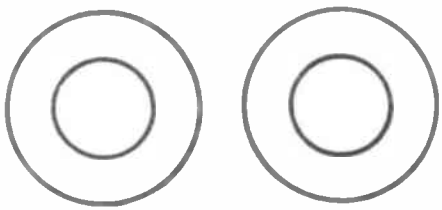
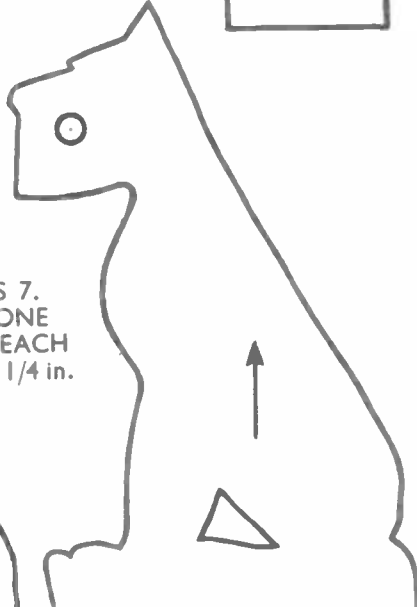

PIECE 10. MAKE ONE FROM 1/8 in. ROUND ROD.



AXLES II. CUT TWO FROM 1/2 in. BY 1/2 in. STRIPWOOD.

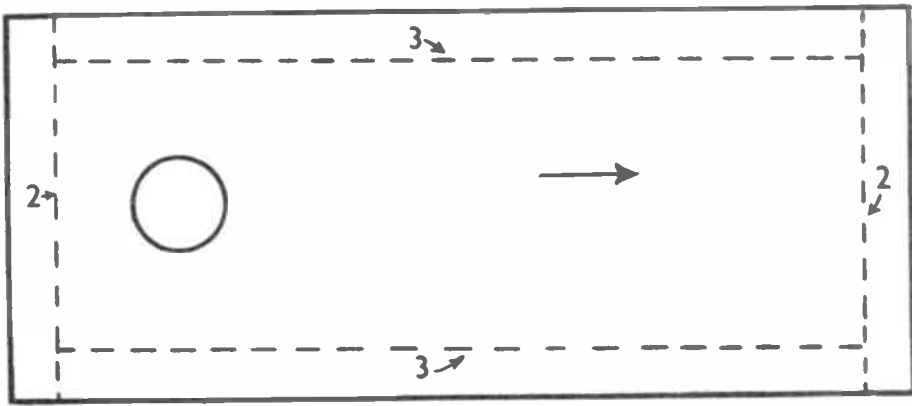

PIECE 4. CUT ONE 1/4 in.

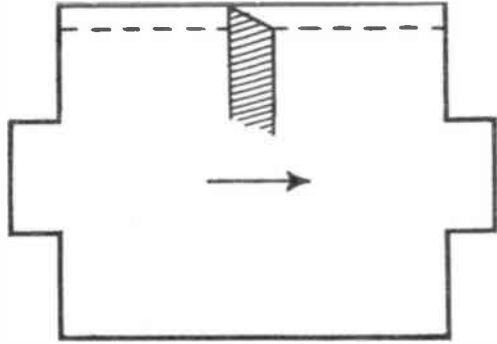
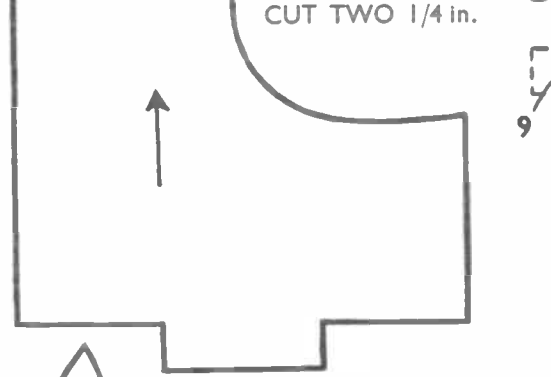

PIECE 6. CUT ONE 1/4 in.



PIECES 7. CUT ONE OF EACH 1/4 in.

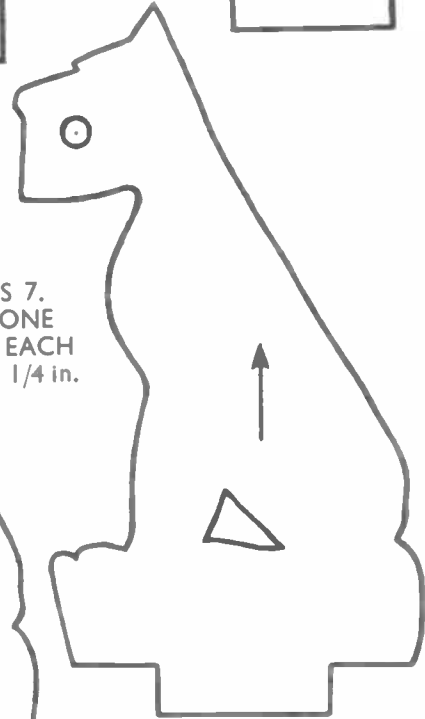

PIECES 9.

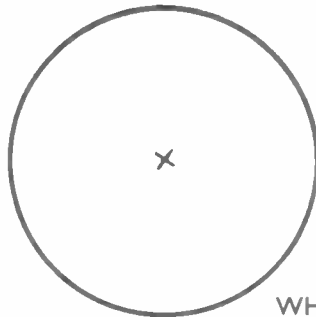
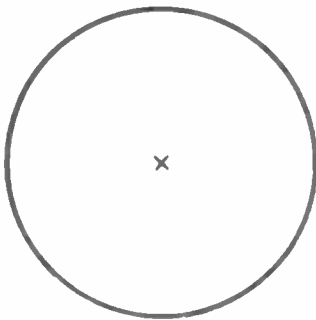

WHEELS 12. CUT ONE OF EACH 1/4 in.

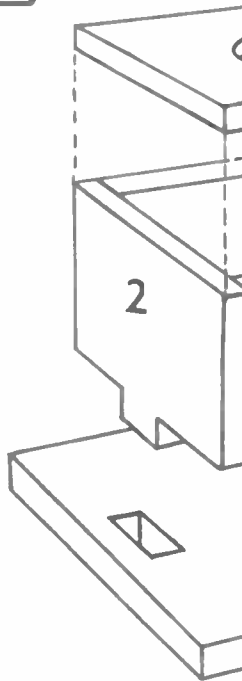
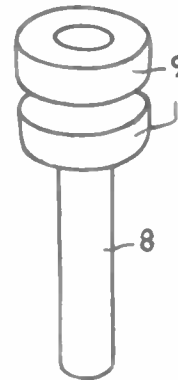
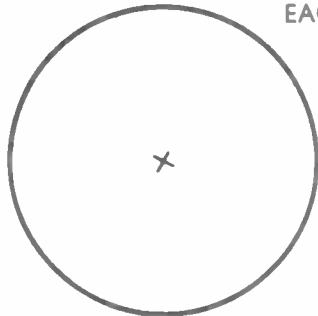
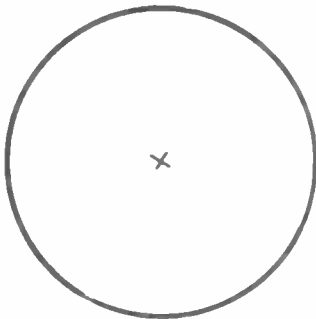

THE ARROWS INDICATE THE DIRECTION OF GRAIN OF WOOD.

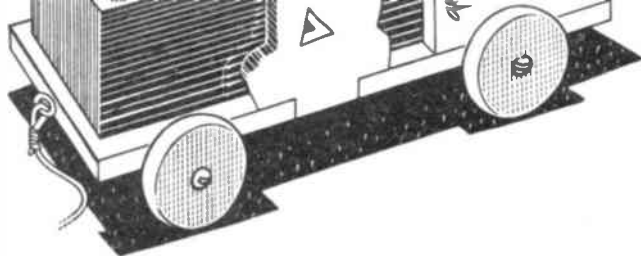

A KIT OF MATERIALS FOR MAKING THIS DESIGN IS SUPPLIED BY HOBBIES LIMITED, DEREHAM, NORFOLK. PRICE ON APPLICATION.

Use **CASCAMITE** 'One Shot' Resin Glue for all Model Making



- Mixed & use cold
- Waterproof type
- Gap-filling and non-staining

Obtainable in: 3½-oz.; 7-oz. and 18-oz. tins.

Stocked by: Ironmongers, Builders' Merchants, etc.

Manufactured by: **LEICESTER, LOVELL & CO. LTD.** North Baddesley, Southampton

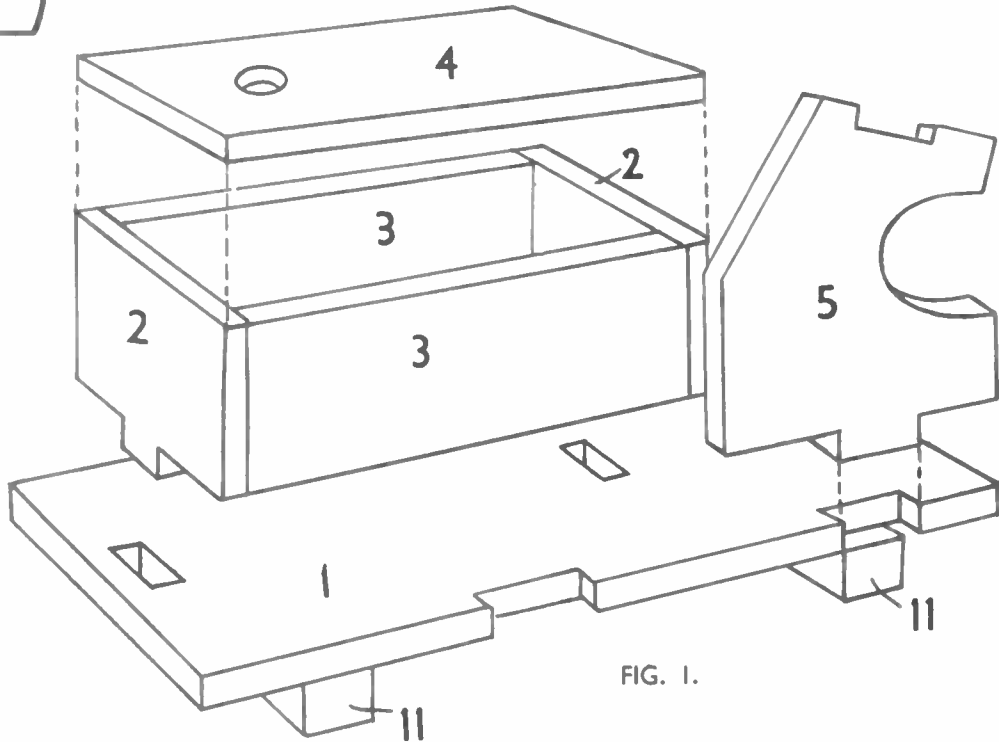
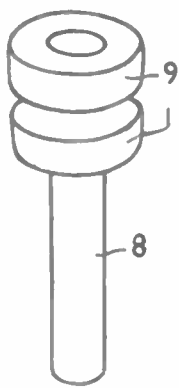
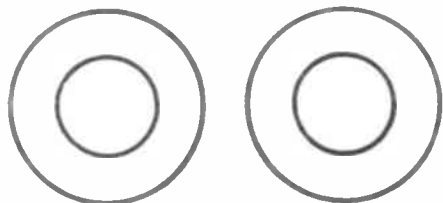
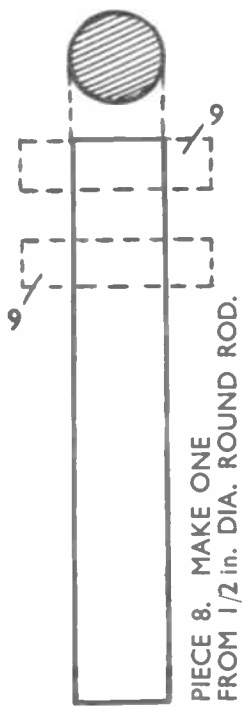
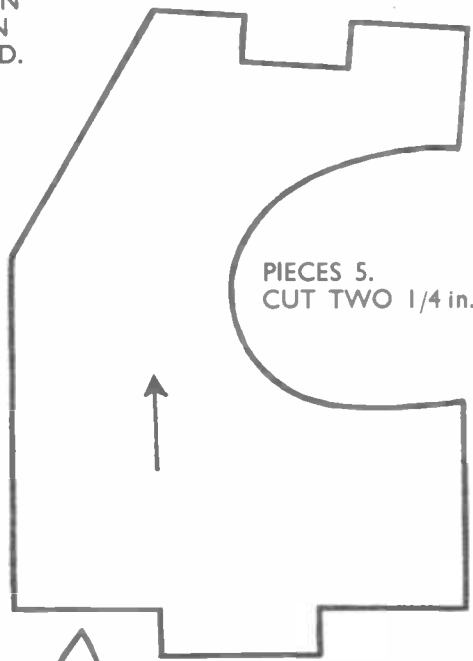

FIG. 1.