

23rd NOVEMBER 1960

VOL. 131

NUMBER 3389

THE ORIGINAL  
'DO-IT-YOURSELF'  
MAGAZINE

# HOBBIES *weekly*

FOR ALL  
HOME CRAFTSMEN

**Instructions  
for making . . .**

*Also in this issue:*

MAKE A PLATE  
CAMERA

COLLECTORS' CLUB

MATCHBOX MAP  
MEASURER

CHEMISTRY AND  
WEAVING

DOUBLE BUNK  
FOR DOLL'S HOUSE

PLANT TROUGH  
BUILT OF BRICK

STORAGE CASE  
FOR SLIDES

ETC. ETC

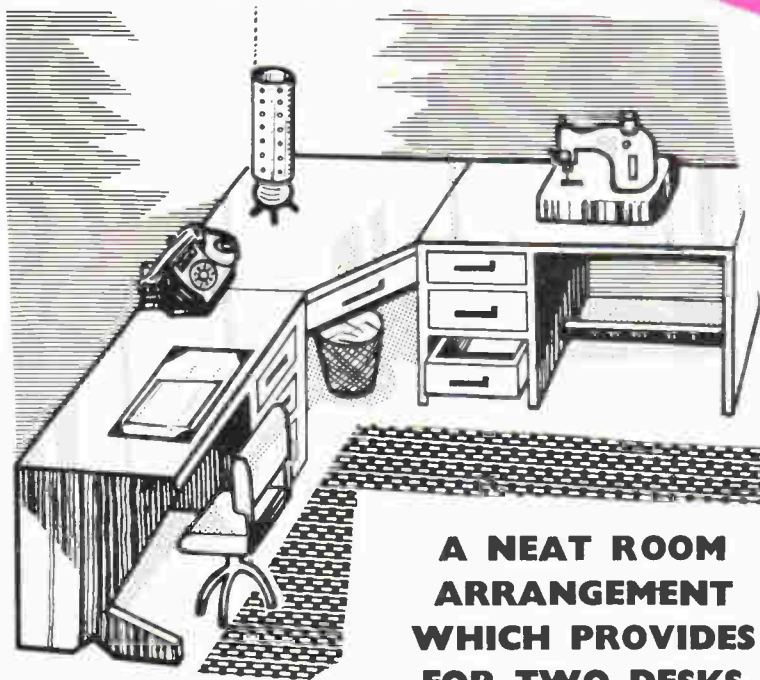

**A NEAT ROOM  
ARRANGEMENT  
WHICH PROVIDES  
FOR TWO DESKS**

## **A CORNER UNIT**

*Up-to-the-minute ideas*

*Practical designs*

*Pleasant and profitable things to make*



**5<sup>D</sup>**



# Four-way Roller Table Loom

**W**HEN the weaver can build and operate a four-way roller loom, he need no longer call himself a beginner. It can be used for most of the patterned weaving he will wish to do, and offers endless scope for experimentation.

The only adaption of the two-way roller loom called for, is to install four heddles and a means of controlling in which order they are used.

The wooden part of the mechanism consists of a framework set centrally across the loom, and a small toggle holder at the front of the loom. (See illustration.)

**MATERIALS NEEDED**  
**CENTRAL MECHANISM**  
 Two pieces 10½ in. by 3 in. by ½ in. wood for the uprights.  
 Two pieces 18 in. by 3 in. by ½ in. wood for the cross members.  
 Two 3 in. lengths of 1 in. by 1 in. wood for the heddle stops.  
 Eight 8 in. lengths of 6-cord white elastic, ¼ in. Ball of string.  
**TOGGLE HOLDER**  
 One piece 3 in. by 3 in. wood.  
 One piece 1½ in. by 3 in. by ½ in. wood.  
 A length of narrow dowel for the toggles.

One of the cross-members is for the base. At the centre of the length of the base drill four equally spaced holes across the width, where the first hole is ½ in. from the near side and the last ½ in. from the rear. The holes should allow the string to run easily through them.

10 in. from the front of the loom make a saw cut at the bottom of each side frame. 3 in. farther along make another ½ in. deep saw cut. Chisel out the spaces between these saw cuts and fit the cross-

member therein. Screw it to the frame.

Fit the uprights perpendicular to this base on either side and screw to the base and to the frame.

The remaining cross-member is to be used as the top of the central mechanism from which will hang the heddles. 5 in. from each end of the top member, drill two holes across the width at the following measurements from the nearest edge. The first at 1 in. and the second at 2 in. Now screw the top to the uprights.

Now for the toggle holder. Nail or screw the smaller piece to the edge of the larger as shown in illustration. Make four saw cuts on the smaller piece equally spaced apart. These will keep the toggles in place. Place it in its position at the middle of the bottom of the front of the loom and mark its position. Above this mark drill a line of holes to take the string, each hole corresponding to a saw cut. Screw the holder into position.

Now to hang the heddles. Tack one of the lengths of elastic at 4 in. on either side of the centre of the top of each heddle. Tack both of the elastics on the first heddle to the leading edge of the heddle holder so that the holes on the heddle are level with the top of the front roller. Each elastic should be in line with the holes in the top of the heddle holder.

The elastics on heddles 2 and 3 are threaded through these holes and knotted when the heddles hang level with No. 1. No. 4 heddle is hung at the rear edge of the top of the heddle holder parallel to the others. Next fix the heddle stops as shown in Fig. 1.

Lastly a string is greased and tied to the centre of the lower frame of the first

heddle and is threaded through the first hole in the base cross-member, taken through the first hole just above the toggle holder, placed in the first saw cut and pulled so that the heddle holes are level with the top of the roller. A toggle is fixed to the end of the string so that it is held in the saw cut keeping the heddle in this position.

If the toggle is released the elastic on the first heddle raises the loom to form the first shed, that is if the loom were set up with warp. The remaining heddles are held in position by these toggles in the same way. The loom is now finished.

The operating is a simple matter. A flick of the finger releases heddle No. 1. Replacing the toggle in the first saw cut brings it level with the others. No. 2 is released and then replaced, followed by No. 3 and then by No. 4.

Setting-up also presents no difficulty. The warp is made and rolled on to the rear roller in the same way as for the two way roller loom as described in a previous article. The warp is also cut and bunched in the same way, but the threading is different.

Each warp strand must pass through a hole on one or other of the heddles, and only passes through a space so that it can reach the hole in any particular heddle.

Working from the back, pass the first strand on the left through heddle No. 4 (this strand is doubled for selvedge); the second through the first hole in heddle No. 3; the third strand through the first hole in heddle No. 2; the fourth strand through the first hole in heddle No. 1. This pattern is continued until the last hole is threaded. This hole is also doubled for selvedge.

To begin weaving lift heddles 1 and 3 and insert a shed stick so that the subsequent weaving can be beaten against a firm edge. Plain or Tabby weave is obtained by lifting 1 and 3 together alternately with 2 and 4 together. Lifting 1 and 2 together alternately with 3 and 4 together produces a Tapestry weave if the weave is beaten so no warp is visible. Twill patterns will arise from the following formulae. R and L stand for the side from which the shuttle is passed.  
 1 and 2, R; 2 and 3, L; 3 and 4, R; 4 and 1, L; repeated.

The same diagonal reversed:  
 1 and 2, L; 4 and 1, R; 4 and 3, L; 3 and 2, R; repeated.

Zig-zags are obtained by alternating these two patterns.

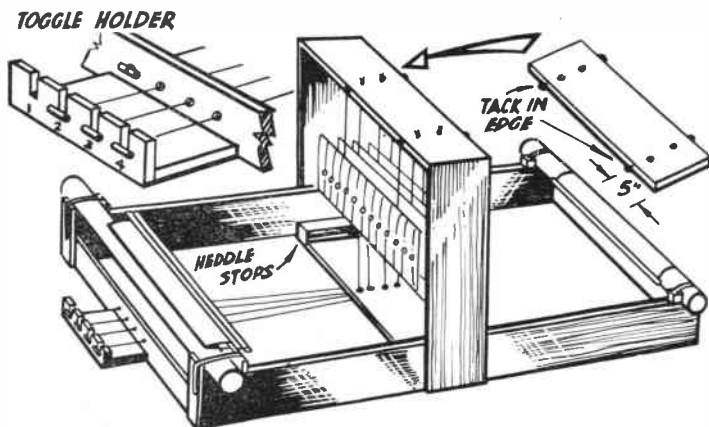

● Continued on page 129

For the enthusiast

# A PLATE CAMERA

By  
P. R.  
Chapman

The completed camera

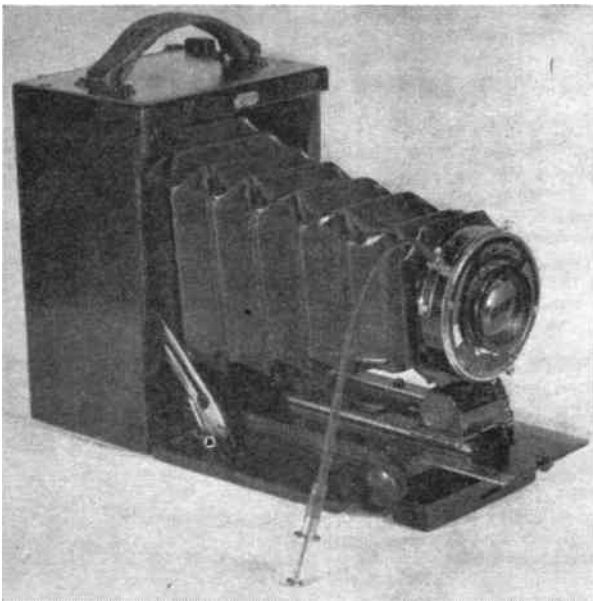

A PLATE camera, using cut film in a plate holder, with, perhaps, the alternative of a roll film adapter, is a most useful possession for the amateur photographer interested in table top photography, plant portraits, architecture, or any branch of photography where the ability to focus at leisure on a ground glass screen is an advantage. Most amateurs at some time wish to take just one shot and see the result quickly, and a sheet of cut film, or for the more fastidious, a plate, is the ideal way of doing this.

Desirable as such an instrument is, the amateur with only an occasional use for it may well consider it not worth the expense. Such cameras, except the highly priced professional models, exist only in the secondhand market, and may cost from £10 to £20.

After discovering an *f*4.5 Voigtar lens

in an eight-speed shutter for 17/6 in a secondhand shop it occurred to me that it should be possible to construct a serviceable camera of this type for a small outlay. Admittedly this was a lucky 'buy', but even if it should be necessary to spend a little more on a suitable lens, the camera would nevertheless be far cheaper to make than to buy, and there is the added pleasure of creation.

An old Kodak Junior II camera was available, and this was utilized for the lens mounting with its sliding runners, and also for the locking bars to hold the front panel rigid when open. The bellows, which would not have given sufficient length for double extension, were not used. These old cameras can often be obtained quite cheaply. Although not essential, the parts facilitated the construction of the plate camera, and in particular made it possible to make a folding instrument which is much more convenient, even for home use.

There is, of course, considerable scope for variation in construction, depending upon whether or not the parts of an old camera are to be utilized, and in individual requirements, so that only the general principles of my instrument will be described.

The 'body' of the camera consisted of a shallow box (A, Fig. 1), 5½ in. tall, 4 in. wide, and 3 in. deep, with a hinged front, B.

The back of this, holding the bellows on the inside, and the plate carrier on the outside, will be described later. A good piece of flat plywood about ¼ to ⅜ in. should be used for the body. To the hinged front were attached the slides for the camera extension. These can be seen in transverse section in Fig. 2. A, B, and C are three strips of sheet brass, about ⅛ in. thick, B being narrower than the others, so that when bolted together a groove is left in which a plate of the same material can slide, D. These strips will need to be about 4 in. long.

A ¼ in. wide rack and pinion were purchased, and 4 in. of the rack was fastened to the underside of the plate D by means of a small nut and bolt at each end. The rack and pinion are shown at E in the diagram. The pinion was

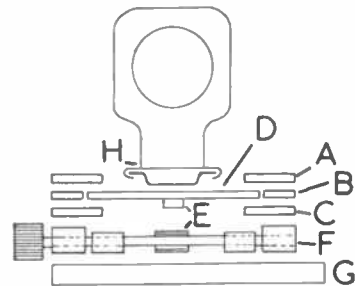
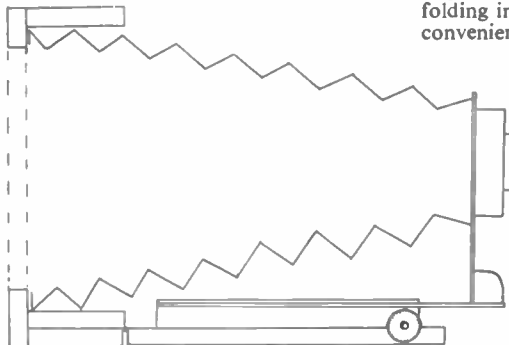

FIG. 2

brazed to the centre of a short length of rod passing through two brass blocks screwed to the hinged front or base-plate, G, Fig. 2. A milled knob was fastened to one end of this rod, and its position can be seen in the photograph.

Wooden strips, F, were needed to give the correct separation between the rack and pinion. The strips A, B, and C, together with the wooden strips F, were drilled and bolted to the base G. The bolt holes were large enough to allow slight adjustments to be made before finally tightening down. This, together with a rub with fine emery cloth on the edges of the slider plate D, was necessary in order to ensure a smooth sliding movement of the latter. It could thus be



A B FIG. 1

racked back and forth by means of the milled knob. To this plate, D, was bolted the slider attachment from the old camera. On to this could be slid the clip carrying the lens mount, H. Had these old sliders not been available, it would have been quite easy to arrange for the mount to clip on to the plate, D.

The old lens and shutter were removed, and the ones to be used fastened to the lens mount. A thin plywood washer bolted to the mount carried one end of the bellows. (10 in. extension bellows were easily obtained from a photographic dealer advertising in the photographic press.) The other end of the bellows was glued to the back of the body box. This latter had an aperture of  $2\frac{1}{2}$  by  $3\frac{1}{2}$  in. cut in it.

The click-lock struts from the old camera were fastened between the body and the hinged front. Normally the lens and mount on the collapsed bellows fitted into the body, and the hinged front was closed. When required for use, the latter was opened, being locked by the struts, and the lens mount slid on to the guides. It could then be racked forward as far as required, up to the maximum double extension.

Fig. 3 shows the rear of the body box. The wooden guides should be positioned so that a standard plate holder or roll film holder can be slid into them with a minimum of 'play'. The plate holder or roll film holder, which are interchangeable if of the same type, should be purchased first, since there are several different fittings. In the instrument described, the 'single knife edge'

type was used. A strip of  $\frac{1}{4}$  in wide velvet tape (bought at a draper's) glued along the top edge ensured a light-tight fitting between the holder and the camera.

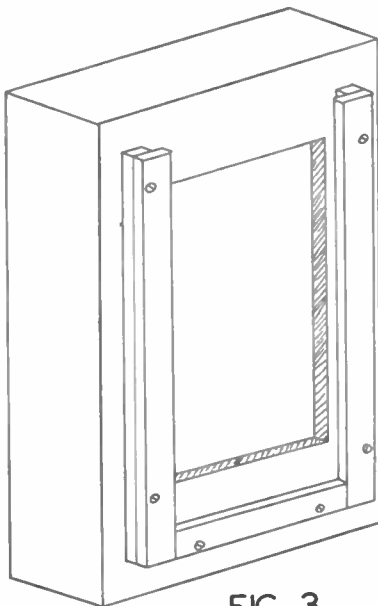

FIG. 3

For focusing, a ground glass screen is necessary. This consisted of a piece of finely ground glass recessed into a ply-

wood frame, shaped at its edges to slide into the plate holder guides. The exact position of the glass must be adjusted so that the ground side comes into the same plane as the plate or cut film in the holder when substituted for the focusing screen. This can be effected by measuring the distance from an old plate in the holder to the front of the holder, and from the ground glass in its frame to the front of the frame. These distances should be equal. If not, the glass may be either recessed slightly more by paring down the wood, or packed slightly with gummed paper.

Finally, of course, the camera was painted, black enamel on the outside, and matt black on the inside of the body. A tripod bush can be purchased and fastened to a convenient place on the body. The carrying handle from the old camera was also fitted.

This camera was found to be extremely efficient in use and, when using a roll film holder masked to give sixteen exposures on 120 film, very economical. In this case, of course, the ground glass screen must be marked to outline the picture area. The 10 cm. lens with this size gives a telephoto effect, ideal for portraits.

A few plate holders loaded with cut film are handy in reserve should it be necessary to take an odd single shot.

A colour film (120 size) in this camera was most successful when used for flower portraits. When mounted in 2 in. square mounts (as for 'super-slides') really imposing transparencies resulted.

## Peeps at Nature

# The Domestic Pig

LIKE many domestic animals, the history of the pig is obscured in the mists of time. It is said to have been domesticated in China about 3000 B.C.

Originally the pig was kept as a

scavenger, and in some Eastern religions the animal is still considered unclean. Since pigs in the Orient are still allowed to scavenge, it would probably be most unwise to eat their flesh in any case. Even the well-fed animal of the Western world harbours undesirable parasites that are harmful to man, and pork should always be eaten well cooked.

The present domesticated pig is thought to have been developed from a cross between the European and Indian wild animal. Various breeds have been produced to suit different geographical locations and economic needs.

The pig is omnivorous and produces a litter of

about ten piglets. The animal has a thick skin covered with coarse bristles. Each foot has two functional and two non-functional toes. Although many pigs look dirty, this is the fault of the owners; if kept in good surroundings they are as clean as any other animals.

● Continued from page 127

## WEAVING LOOM

Other patterns for the beginner are: Rosepath. 1 and 2 (twice); 4 and 1 (twice); 3 and 4 (twice); 2 and 3 (four rows); 3 and 4 (twice); 4 and 1 (twice); 1 and 2 (twice). There should be a Tabby row after each pattern row.

Monk's Belt. Four rows of 3 and 4; six rows of 1 and 2; four rows of 3 and 4. With a Tabby row after each row of pattern.





# A Corner Unit with Two Desks



I 'VE been wanting to build it for some time now, but it seemed rather a complicated job', said Paul Rogers. The famous stage star was talking to Ed. Capper in his dressing room at the Fortune Theatre, London, where R. C. Sherriff's play 'A Shred Of Evidence' continues its successful run.

Paul continued: 'My wife and I could, of course, work on separate desks, but we thought it would be much more fun if we could build a corner unit where we could work together. So tell me, Mr Capper, is such a unit feasible, and could a simple carpenter like myself tackle it?'

My drawing shows just how easily a corner unit can be built. Each desk is made up from a drawered, whitewood bedside cabinet that can be purchased locally. A top to the desk is made from 1/2 in. plyboard or chipboard, screwed to the top of the cabinet. The other end is a fitted side piece, again made up from 1/2 in. plyboard.

These side pieces can be shaped, as shown on the left-hand desk or left as a plain rectangle, as shown on the right-hand desk. If you prefer the shaped piece, use a pattern that allows the base

\*\*\*\*\*  
 ★ Paul Rogers who starred in ★  
 ★ R. C. Sherriff's play 'A Shred of ★  
 ★ Evidence' at the Fortune Theatre, ★  
 ★ London, likes this neat arrange- ★  
 ★ ment. ★  
 ★  
 ★  
 \*\*\*\*\*

to be of the same width as the top. Otherwise, it will be top-heavy.

As it is the side pieces cannot be very firm unless they are supported in some way. If the usual form of strengthener, viz., angle brackets, were fitted in the underside corner of the join to the desk top, it would look ugly.

The best support is to semi-anchor the bottom of the side pieces into the floor. Two, 1/2 in. holes should be drilled in each of the side pieces. These should locate over two beheaded nails, driven into the

floor boards (see floor fixing detail). This fixing will prevent any wobble or strain on the side pieces, but naturally, it will be one of the last jobs to be done on the unit.

An alternative method of holding firm the side piece is to fit a footrest, as shown in the right-hand desk. This should be a length of 3 by 1 in. planed timber, screwed between the inside edge of the side piece, and the outside of the bedside cabinet. The footrest can be enlarged to form a shelf on which to stow away the typewriter or sewing machine (see dotted lines). The extra width of this shelf will give the side piece the maximum support. Also, a stowaway position such as this leaves the desk top clear, when needed.

Of course, you can take the easy way out, and instead of having enclosed side pieces, fit screw-on, tapered beech legs. They can be obtained from Hobbies.

To cut out the odd-shaped corner shelf, first place your two completed desks in the positions they will occupy. Measure the distance from the corner wall angle to the edge of each desk. Cut a square piece of 1/2 in. plyboard to these measurements, plus 1 in.

You will be fortunate if the wall corner is an exact rightangle. Therefore, trim the sides of the cut square of plyboard to make it as near a perfect fit into the corner as possible. Having done this, again place the plyboard to rest on the two desk tops, mark underneath with a pencil along the line of the edge of each desk.

Remove the plyboard, mark a diagonal line between the ends of the other pencil lines you've made, which will give you the angled front of the shelf piece. Now cut around the pencil lines, and glasspaper smooth.

The corner shelf piece is fitted in

● Continued on page 131

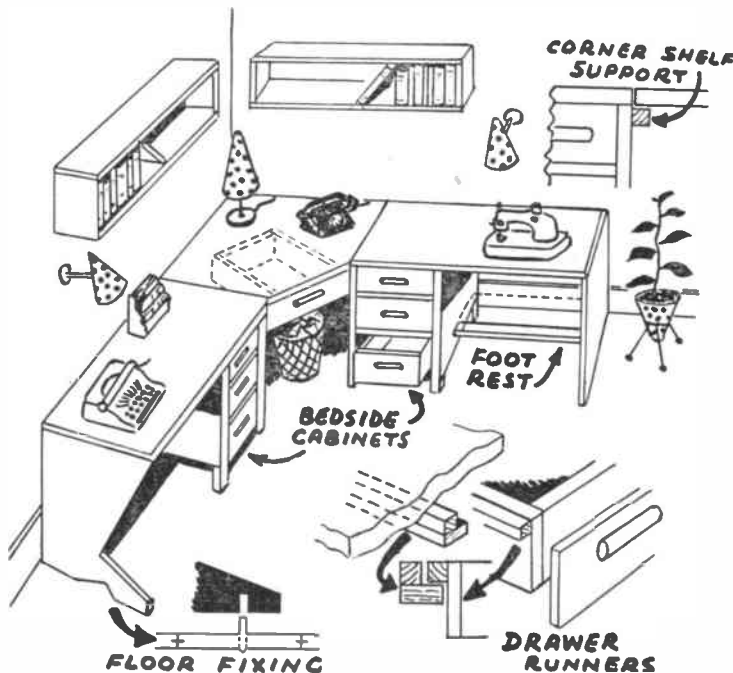

# MATCHBOX MAP MEASURER

**B**EFORE you go on a hike or an expedition, do you like to work out a route? Do you also like to work out how many miles you would like to do?

You probably find it a bit chancy with the latter. You take a road map, look at the scale, and find you just cannot get the exact mileage as the road twists and turns. Also, at some points you notice you could cut across a field or take some other short cut. How then, can you estimate the correct mileage?

*By E. Capper*

You can, of course, buy a map measurer for around 7/6, but it is more fun to make your own from odds and ends around the house. All you need are two wheels from an old alarm clock, and a matchbox. Any clock repairer can provide a pair of wheels.

The sketch shows the basic construction of the measurer. The wheels which comprise the mechanism should be a pair that normally work together. One should be large; the other small. A good basis is the balance wheel, recognized by its teeth, which are like little triangular feet. The larger matching wheel is the escape wheel, but any other suitable pair of large and small wheels will do.

The next step is to find out the ratio of the two wheels selected. You will probably know some scientific formula for this. It is quite sufficient, however, to find the number of turns the small wheel makes compared with the large wheel. In the model I made, I found the ratio was sixteen to one.

Next, fix with glue a temporary cardboard dial to the larger wheel. Now, hold the pair in gear and run the smaller wheel along a stick, marked off in inches. Mark a small point on the small wheel, and on the cardboard dial of the large wheel. Make a mark for each inch of travel of the small wheel. The mechanism of my measurer was accurate enough for the last inch to register exactly with the first mark on the dial.

Now, remove the dial and replace it with a better one, adding in figures for every five miles, as shown.

The case to hold the works can be made from a matchbox, or you can make up a stronger job from cardboard. What is important is that you do not want too much side-play of the wheels and, of course, the small wheel must revolve with around half of it outside of the box

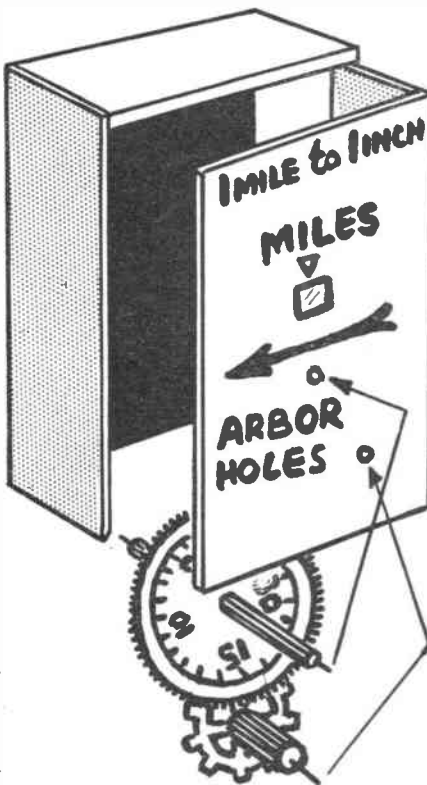

bottom. If you use a matchbox, cut it down as shown in the drawing to reduce any side play of the wheels, and fit into it a top piece of strong cardboard. It can be held together with adhesive tape.

A small window is cut in the box front and backed with a small piece of cellophane. Above is marked a pointer; and an arrow, showing which way the wheels should revolve, is useful.

It is important for the smooth working of the wheels that the arbors (the small axles) should be the exact distance apart that they were when in use originally in the clock. To ensure this, put a postcard under the original holes in the clock, and prick through with a pin. When the matchbox is being made to house the wheels, lay the card over the front and back, and mark the holes. It is a good idea to reinforce the arbor holes with a fillet of glue.

The exact position of the holes is immaterial, provided they are in exact relationship with each other on opposite sides of the box.

To work the measurer, run the small wheel along the road to be measured on the map. You can work the mileage direct if it is a 1 in. to the mile map. Multiply the reading by two if it is a 1/2 in. map, and so on. A conversion scale could be written out neatly, and stuck on the back of the matchbox for future reference.

● Continued from page 130

## THE PAUL ROGERS' CORNER UNIT

place to come level with the desk tops by dropping it on to a pair of 1 in. square battens, which are screwed across the side of the cabinets (see corner shelf support). The corner shelf is then screwed to the battens through clearance holes.

The corner of the shelf piece is supported by a length of 6 by 1 in. planed timber, cut to measure from floor level to the underside of the shelf. The timber is screwed into and diagonally across the skirting boards corner. It is held at the other end by two screws through the shelf top. If the room has no skirting board the base of the timber support should be held to the floor with an angle bracket.

A drawer can easily be fitted into this corner shelf, if needed, as shown by the dotted lines. First, make up a simple drawer to the depth you require. Its width will depend on allowance being

made for the side runners.

These runners are shown in the enlarged detail. To the top, outside edges of the drawer side should be fixed lengths of 1 in. square planed timber. These lengths slide into a channel formed of 1 in. square timber, screwed to lengths of 2 by 1 in. timber, set broadside, as shown. The completed channels are then screwed to the underside of the shelf piece.

To conceal the runner pieces, a false front of three-ply wood is cut and fitted, as shown. Do not, however, let this false front piece act as the stop in preventing the drawer from being pushed in too far. The continuing bumping on to the false front piece will loosen it. Instead, fit a stop piece of 1 in. battening to the underside of the shelf piece, to abut against the end of the drawer when it is in its closed position.

# CHEMISTRY AT HOME

**T**HOUGH it is now being replaced by the newer synthetic drugs, potassium bromide, KBr, has enjoyed long use by doctors as a sedative in nervous disorders. The photographic industry still uses large quantities and it is a source of bromide and hydrobromic acid for the chemist.

Many interesting experiments can be done with it. Like most other bromides it is easily soluble in water, yielding a colourless solution. Dissolve a crystal or two in a little water in a test tube. Add a few drops of a solution of chlorine, Cl, in water. The solution turns orange-red and acquires a very pungent odour. Warm the solution. An orange-red vapour appears above the surface and the liquid itself is decolorized.

Bromine is actually a deep red liquid which is corrosive to the skin. What you saw in the test tube was a weak solution in water. As bromine water is often needed in the laboratory it is useful to know how it may be produced without having to handle the unpleasant liquid bromine.

## POTASSIUM BROMIDE EXPERIMENTS

This method depends on the fact that when an acid such as sulphuric acid,  $H_2SO_4$ , is added to a mixed solution of potassium bromide and potassium bromate,  $KBrO_3$ , bromine is set free and dissolves. Water,  $H_2O$ , and potassium sulphate,  $K_2SO_4$ , are also formed:

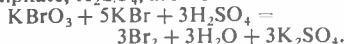

To make a supply dissolve 1.11 grams of potassium bromate in 40 c.c. of warm water and let the solution cool. Mix it with a solution of 3.96 grams of potassium bromide in 40 c.c. of water in a glass stoppered bottle, for bromine rots cork. Add 10 c.c. of dilute (10 per cent)

If kept in the dark, this solution will keep its strength for several months. In the light it decomposes with time into hydrobromic acid, HBr, and oxygen, O:



and is decolorized.

Bromine water may be used as a test for iodides, since it displaces iodine, I, from them. With potassium iodide, KI, for example, potassium bromide and iodine are formed:



To a little potassium iodide solution add a few drops of bromine water. A black precipitate of iodine is at once produced.

Bromine water is also an invaluable reagent in testing for phenols and organic bases. With ordinary phenol (carboic acid),  $C_6H_5.OH$ , there is formed tribromophenol,  $C_6H_2Br_3.OH$ , and hydrobromic acid:

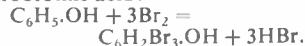

Dissolve a small crystal of phenol (caution: the solid causes blisters if touched) in a few c.c. of water. Drop by drop add bromine water until a permanent light yellow colour remains (showing a slight excess of bromine to be present). A white precipitate of tribromophenol appears.

Repeat the experiment with aniline hydrochloride (aniline salt),  $C_6H_5.NH_2.HCl$ , instead of phenol. Again the precipitate appears, this time consisting of tribromaniline,  $C_6H_2Br_3.NH_2$ . Hydro-

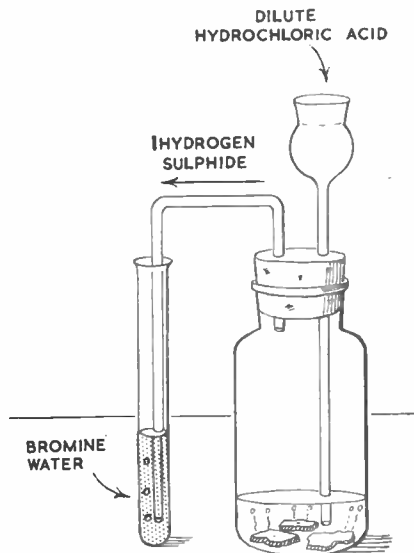

Fig. 1—Acting on bromine water with hydrogen sulphide

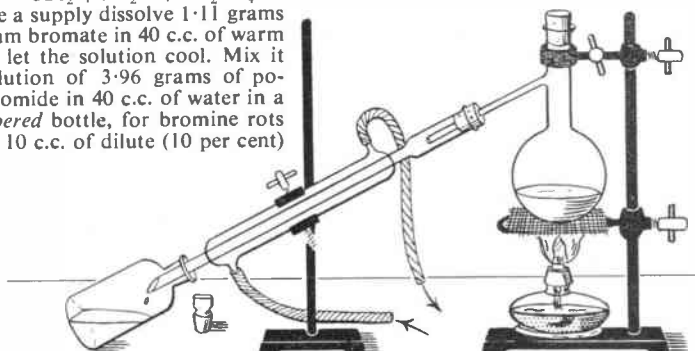

Fig. 2—Purifying hydrobromic acid by distillation

This orange-red colour is due to the displacement of bromine, Br, by chlorine, and formation also of potassium chloride, KCl:



Bromine derives its name from the Greek *bromos*, which means 'a stench'. Inhalation of more than very small quantities causes soreness in the nose and throat. Hence experiments in which bromine vapour is produced should be conducted in the open air.

sulphuric acid, swirl the bottle to mix the whole, and put in the stopper.

The solution turns yellow at once and in a few hours becomes deep orange-red. Bromine fumes above the liquid indicate that a saturated solution in water has been formed. This solution contains about 3 per cent of bromine. Also present is a little more than 1 per cent of potassium sulphate, but this is of no consequence for the great majority of uses to which bromine water is put.

chloric acid, HCl, is also formed:

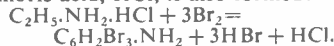

By purifying such bromo-compounds and taking their melting points, which are characteristic, the original phenol or base can be identified.

We are beginning to see that bromine is a very reactive element. It will also displace sulphur, S, from hydrogen sulphide,  $H_2S$ . Generate hydrogen sulphide from ferrous sulphide, FeS, and



dilute hydrochloric acid in the apparatus shown in Fig. 1. This should be done in the open air owing to the fetid smell of hydrogen sulphide. Ferrous chloride,  $\text{FeCl}_2$ , is also formed:

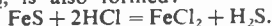

Put a little bromine water in the test tube. As the hydrogen sulphide bubbles through the bromine water the latter is gradually decolorized and sulphur is precipitated. Filter off the sulphur. Bring the filtrate to the boil to expel excess hydrogen sulphide and test the liquid with blue litmus paper. The paper is reddened, showing an acid substance to be present. This is hydrobromic acid, produced as follows:



This solution of the acid is weak, containing only about 3 per cent.

A stronger solution, containing about 10 per cent hydrobromic acid, may be made by acting on potassium bromide solution with tartaric acid,  $\text{C}_4\text{H}_6\text{O}_6$ , when hydrobromic acid is set free and potassium hydrogen tartrate (cream of tartar),  $\text{C}_4\text{H}_5\text{O}_6\text{K}$ , precipitated:

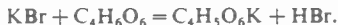

Dissolve 14.87 grams of potassium bromide in 50 c.c. of water, and 18.75 grams of tartaric acid in 50 c.c. of water. Mix the solutions in a glass stoppered bottle, shake well, and allow the mixture to stand overnight. Filter off the precipitate of potassium hydrogen tartrate. The filtrate of 10 per cent hydrobromic acid contains about 0.5 per cent of dissolved potassium hydrogen tartrate. This can be removed by distilling, when it remains in the distillation flask.

Use the apparatus shown in Fig. 2 and continue heating until only a few c.c. of liquid remain in the flask. With such a solution of hydrobromic acid you can make soluble metallic bromides by just neutralizing the acid with a carbonate, filtering if necessary, and evaporating.

Though most metals form water-soluble bromides, notable exceptions are lead, Pb, silver, Ag, and monovalent mercury, Hg. Consequently, their bromides can be made by precipitation. By mixing a solution of lead acetate,

$\text{CH}_3\text{COO})_2\text{Pb} \cdot 3\text{H}_2\text{O}$ , with one of potassium bromide, for instance, lead bromide,  $\text{PbBr}_2$ , is precipitated and potassium acetate,  $\text{CH}_3\text{COOK}$  is left in solution:

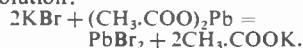

Stir a solution of 7.93 grams of potassium bromide in 100 c.c. of water into one of 12.64 grams of lead acetate in 150 c.c. of water. Let the white precipitate of lead bromide settle and pour off the upper liquid. Though lead bromide is only slightly soluble in cold water, it is considerably so in hot. Therefore it may be purified by recrystallization.

Pour on small quantities of boiling water until most has dissolved. Boil up the solution and add very small further quantities until the whole is in solution. Then let the solution cool down overnight. Beautiful white needle-like crystals will form. Remove these and let them dry for your stock.

## Make Cut Paper Bookmarkers

**A**n elegant habit of Victorian times was the frequent use of book-markers. Occasionally you will be lucky enough to find a rare example of one of these decorative and handy objects tucked away inside an old book owned by your grandparents or hidden within an ancient tome upon a dusty shelf in a second-hand bookshop.

fashioned fragments of variously coloured papers. You should be able to manage appealing bird and beast shapes, flowers, ornate faces and simple patterns. Gum the cut-out pieces precisely in the appropriate places.

To complete your book-markers you will need a collection of colourful 'tails'. Prepare a number of gummed paper

strips measuring 5 in. by 3 in. and fold each one in half, longways, down the middle. Gum the two halves of each strip together, but leave about a third of an inch unstuck at one end (see Fig. 1). This arrangement will enable you to fit the tail to the tab effectively later on. To make the tails, fold the strips in half, longways, a second time, and cut them into original shapes, as suggested in Fig. 2. Prettily-shaped holes may be cut in the folded papers to resemble hearts, leaves and flowers, or merely simple circles, wedges and oval shapes.

When the tails are complete, moisten the little 'flaps' which you left unstuck and gum the tabs securely between them, as shown in the impression of a finished book-marker illustrated in Fig. 3. Cut paper book-markers are cheaply and rapidly made and will fetch modest prices at charity bazaars. Also they may be enclosed as 'extra' surprise gifts with greetings cards.

*By A. E. Ward*

Nowadays book-markers are seldom seen and hasty methods employed to mark a page may result in valuable books suffering unsightly 'broken backs' and ugly dog-eared pages.

Gummed coloured paper and stout cardboard may be used to manufacture a small stock of attractive book-markers that will add charm to your books and protect your treasures from careless damage. Packets of brightly coloured gummed papers may be purchased at stationery shops and educational supply houses. Draw the shapes of the 'tabs' of your markers upon pieces of the gummed paper. Use a ruler and compass to draw squares, triangles and circles of convenient sizes.

Cut out the tabs and moisten them before gumming each shape to stiff cardboard. Next, cut out the stiffened tabs and proceed to decorate them, to your own taste, by means of deliberately

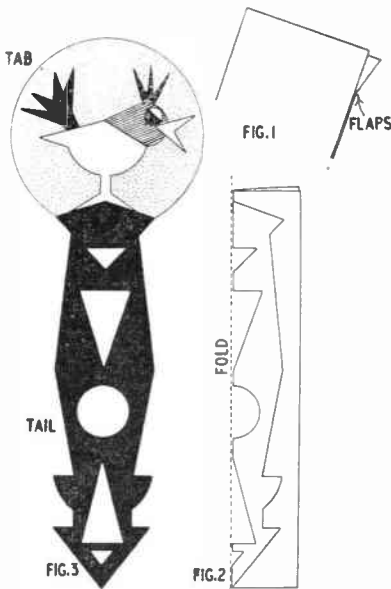

Next week's free design will be for making that popular seasonal subject, a perpetual calendar. Also other articles on a festive theme. Make sure of your copy.

# SOMETHING

# SPECIAL FOR YOU

## \* DOUBLE BUNK

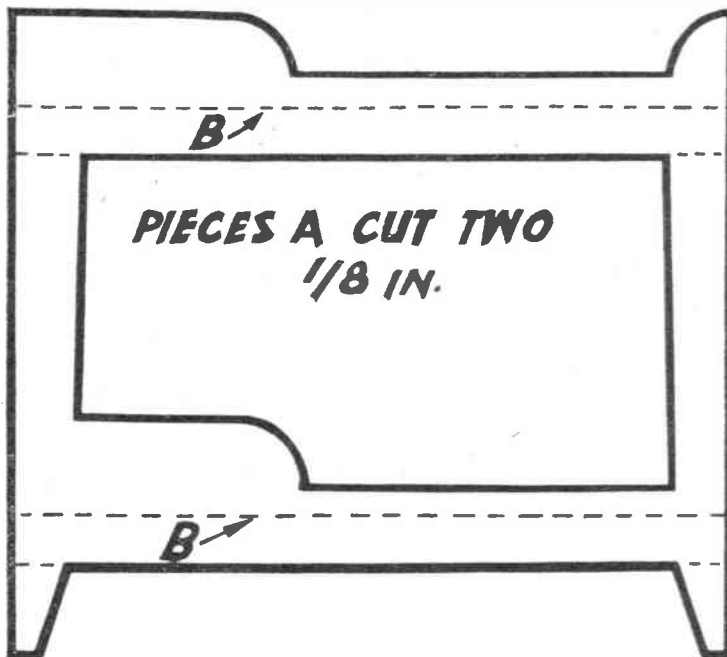

SCALE APPROX.  $3/4'' = 1\text{ FT.}$

# AL UR DOLL'S HOUSE

PIECES C. CUT  
ONE OF EACH  
 $\frac{1}{8}$  IN. →

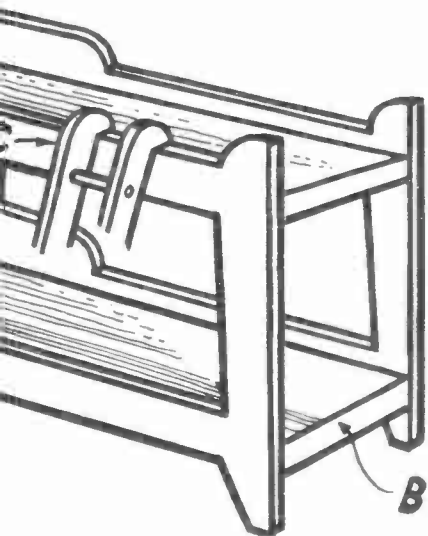
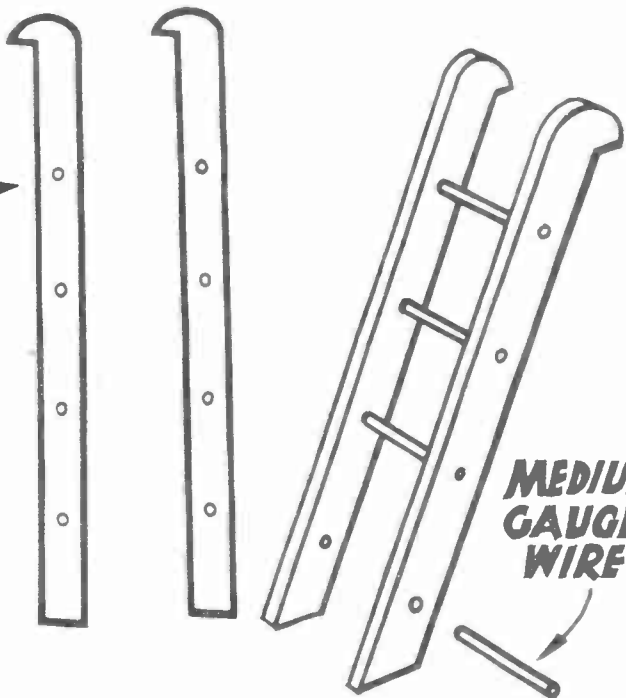
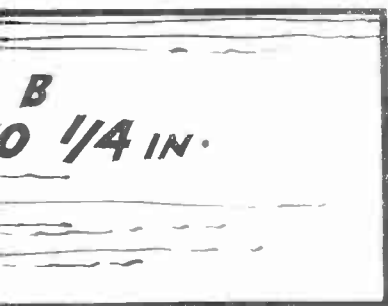

DESIGNED TO  
SUIT **Hobbies**  
DOLL'S HOUSES

# A PADDLE RIVERBOAT

**I**F you have seen the television series called 'Riverboat', you will have, no doubt, noticed that the vessel is propelled by means of a paddle at the rear instead of a propeller as fitted to our modern ships. A small boat of this type is quite easy to construct from a few simple materials, the motive power being nothing more than a rubber band.

*By H. Mann*

You will need a piece of  $\frac{1}{4}$  in. wood measuring 9 in. by 3 in. for the boat, which is shown in detail in Fig. 1. It is advisable to draw a centre line on the wood, preparing a piece of paper of the same size, and folding down the centre. If a curve is made for the prow, and the pattern cut out accordingly, you will have a perfectly balanced design when

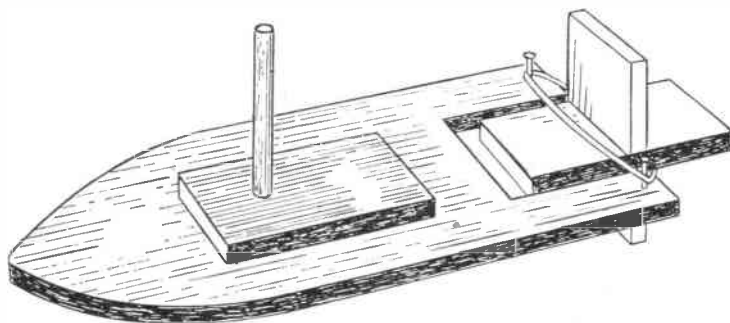

slot must be equal to the thickness of the wood, and it is essential that the slots be most carefully cut to ensure a tight fit. Smooth away any burrs with file and glasspaper, apply a little glue, knock the two pieces together, and the paddle is complete.

coats of paint in any desired colour, and both the boat and paddle should be treated similarly before launching.

The paddle is fitted between the two arms at the rear of the boat, and a rubber band placed over the nails, as shown in the diagram. Take this rubber

FIG 1

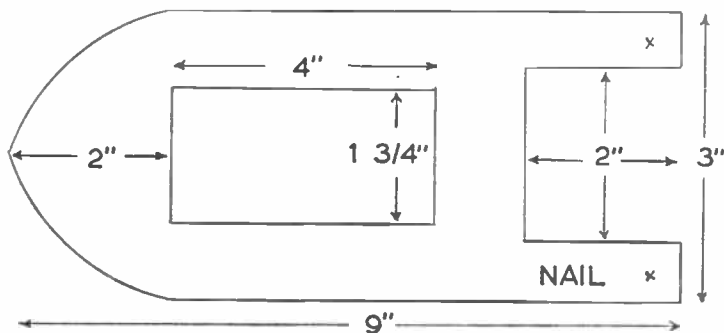
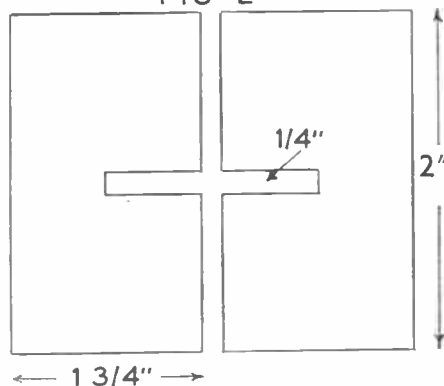

FIG 2



the paper is opened. This pattern is placed on the wood, and the outline traced, and the boat shaped. This part is then finished by cutting away a 2 in. square at the reverse end where the paddle is to fit.

The cabin is simply made from a piece of  $\frac{1}{4}$  in. material measuring  $1\frac{3}{4}$  in. by 4 in., glued in position, as indicated, and pinned from the underside with short panel pins. To finish this part we only need a funnel represented by a short length of  $\frac{3}{8}$  in. dowel rod fitted through the cabin and boat.

The paddle is made from two pieces of  $\frac{1}{4}$  in. material each  $1\frac{3}{4}$  in. by 2 in., as shown in Fig. 2. These are placed together in the vice, and a  $\frac{1}{4}$  in. slot cut in the centre to make a half joint. This

Two nails are hammered into the boat, one at each side, and each  $\frac{1}{2}$  in. from the end, as shown, and we are then almost ready for assembling. Since the novelty will be subject to immersion in water it is advisable to apply at least two

band underneath the rear vane of the paddle. Wind the paddle backwards to produce sufficient tension on the rubber band and, when the boat is launched, the paddle will revolve to produce a forward motion.

## Board and Table Games

*By R. C. Bell*

**T**HE ninety-one games covered in this book include board and table games over a period of 5,000 years, and from many civilizations. Using material from his own valuable collection and reports from museums and learned

societies, the author has managed to describe rules and methods of play in a manner that is not only instructive, but also takes one back into the distant past to give the history and origin of the games. The coverage ranges from simple noughts and crosses to complicated games of Oriental origin.

*Published by Oxford University Press, Amen House, Warwick Square, E.C.4. Price 21s.*

# A DECORATIVE PLANT TROUGH

A PLANT trough can be a decorative feature at a doorstep, especially when filled with alpines and dwarf conifers which look well against a background of stonework.

The following instructions are for an easily-made trough just over 2 ft. long, but this can be altered to suit individual requirements.

The trough is in two parts; the base, which is built of brick, and the container, which is made of natural stone.

For the base, facing brick should be used, if this is possible. First, two piers are built with a space of 18 in. between them (Fig. 1). For the sake of appearance, they should not be more than

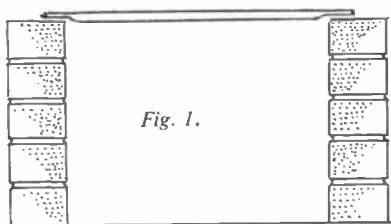

Fig. 1.

five or six bricks high, unless the trough is longer than 3 ft.

Next, two 2 ft. lengths of metal rod — old electrical conduit rod is ideal — are placed in position on top of the piers after the ends of the rods have been hammered flat.

The row of bricks forming the top of the base is then cemented into place. The end bricks are cemented into position first, making sure that their lower edges are in line with the top of the rods. With the end bricks in place, the rods will now be held steady while the rest of the bricks are cemented into position. Make sure that the cement is packed firmly between them. Next, a  $\frac{1}{2}$  in. thick covering of cement is spread over the top surface of the bricks, smoothed over, and left to dry.

The following method of making the trough from natural stone is surprisingly easy. Any kind of fairly flat stones will do. Choose those about 1 in. thick; even stones with rounded edges from a beach or stream are suitable. These are broken into pieces 3 or 4 in. long, and about 2 in. wide.

Using a strong cement mixture — two parts of sand to one of cement is suitable — the stones are put in place with their freshly-broken surfaces facing outwards (Fig. 2). Build up the end walls to the desired height first.

Use the cement between each stone to take up any variation of thickness, so that the corners are all the same height.

*By A. Liston*

The side walls are then built up in the same way, leaving drainage holes at each side. Instead of using a trowel, smooth the cement between the stones with a finger, and this will give a con-

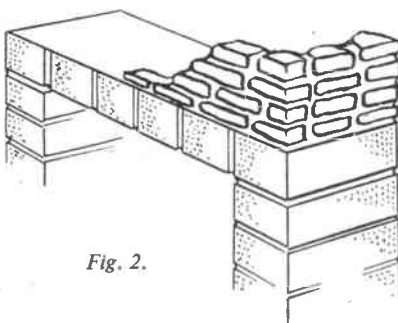
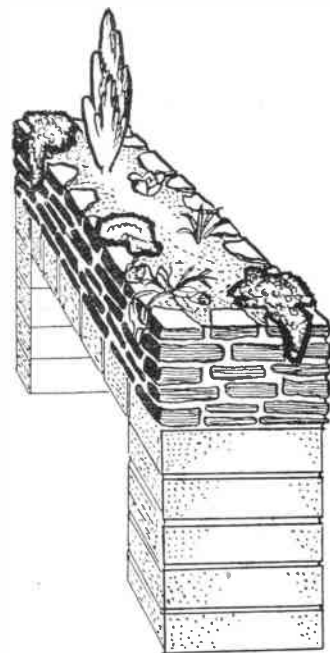

Fig. 2.

cave finish which emphasizes the outlines of the stones.



Care must be taken not to let cement mark the face of the stone. If this happens, rub it carefully with a wire brush when it is dry. The interior of the trough will be quite rough, but this will, of course, be hidden when it is filled with soil. This can be done after a few days when the cement has dried thoroughly.

## MINIATURE GARDEN TOOLS

THE owner of a few pot plants or a small window-box will find it useful to have some specially small tools. Although these miniature tools can be bought, their expense often does not justify it. They are, however, quite easy for the handyman to make, and a set of three, perhaps in a suitable box, would make an acceptable gift for a wife, mother, sister or girl friend who has an interest in plants.

The three tools suggested are a hoe (A), a miniature trowel for lifting plants (B), and a narrow tool for lifting seedlings and distributing fertilizer, etc. (C). All can be cut from sheet brass or iron by following the shapes shown in the diagrams. The hoe should have its blade bent at a slight angle, whilst the other two tools should be bent to a rounded shape by bending or hammering around a wooden rod.

Each tool may be gently tapped into the end of a piece of dowelling for a handle, or the more ambitious worker

may prefer to attach a metal handle. (P.R.C.)

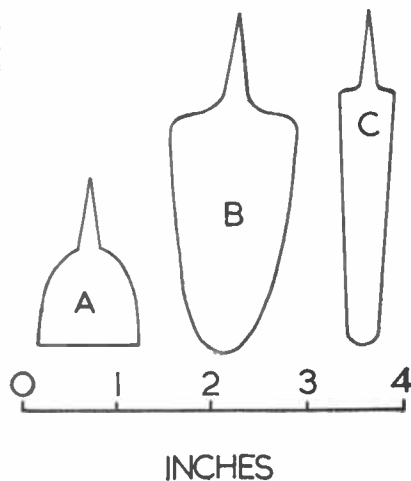

For 2in. x 2in. slides

# A HANDY STORAGE CASE

AS you obtain more and more valuable colour slides, you will realize that some efficient means of storing them is necessary.

First, two frames are made from the  $1\frac{1}{2}$  in. x  $\frac{3}{8}$  in. wood for the box and lid. Lengths are as shown in the diagram. The corners are glued and

small viewer to be stored in one corner of the case. Finally, to stop the slides vibrating in the box as it is being carried, a piece of baize can be glued to the inside of the lid. (D.J.R.)

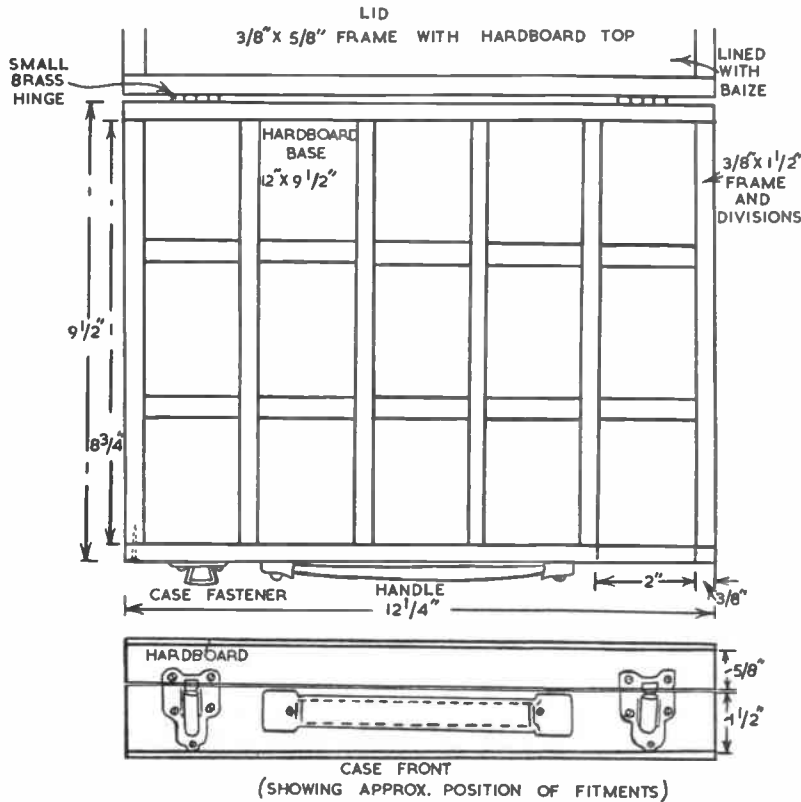

The slide case described here does not have the usual slots to hold the transparencies, as their construction would seem too difficult for the average handyman. However, the advantage of this system is that as many as 350 glass, or 700 cardboard slides may be stored. Also, slides may be kept in strict order after showing, for once a slide has been projected it is returned to the end of its compartment, and so on, until all in that block have been seen. Then they are back in order once more.

## MATERIALS REQUIRED

25 ft. lengths,  $1\frac{1}{2}$  in. by  $\frac{3}{8}$  in. hardwood.  
14 ft. length,  $\frac{3}{8}$  in. by  $\frac{3}{8}$  in. hardwood.  
2 pieces of hardboard,  $12\frac{1}{2}$  in. by  $9\frac{1}{2}$  in.

Various case fittings — Small brass hinges and screws. Spring loaded handle and case fasteners.

tacked for ease. The two hardboard sheets make the base and top of the case, and they are attached to the frames with panel pins.

In the box, strips of  $\frac{3}{8}$  in. x  $\frac{3}{8}$  in. wood are used for divisions. The more experienced worker may prefer to make elaborate halving joints for the cross pieces, but a simpler method is to have four strips of the wood glued in the appropriate places, with three 2 in. divisions between each column. All corners, joints, and rough edges should now be neatly finished and glass-papered. If required, leather cloth or even plastic material may be used to cover the case. This makes it look quite professional.

Case fittings are now added, the lid is hinged, and the fasteners and handle are attached to the front of the box, as shown. Provision could be made for a

## LAMP STANDARD

THE standard is a 6 ft. length of dural tube about  $\frac{1}{2}$  in. diameter. The bulb holder is screwed to the top of a plywood collar pressed on to the top of the standard. A larger collar, about  $\frac{3}{4}$  in. thick, is fitted to the centre of the standard, drilled to take four 6 in. long  $\frac{3}{8}$  in. diameter dowels radiating from it.

The legs are  $\frac{3}{8}$  in. diameter dural tubes passing through holes drilled in the bottom end of the standard, and angled downwards to give a uniform base. Lock these tubes in place with a machine screw locating in holes drilled and tapped in the centre of each leg pair.

Bracing wires hold the standard rigid, these being plastic-covered flex or bell wire, pulled quite tight and made off as shown. (R.H.W.)

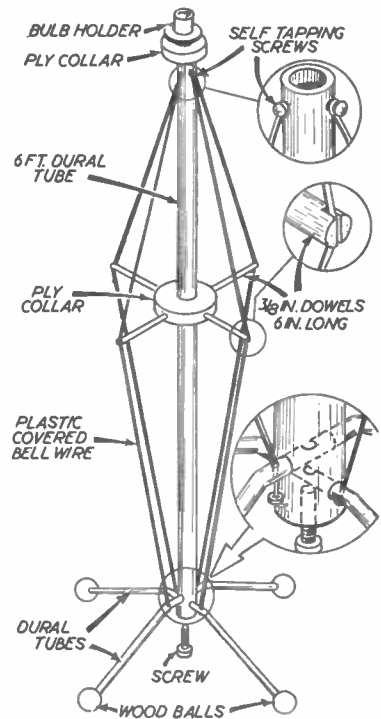

*Now you can let off steam!*

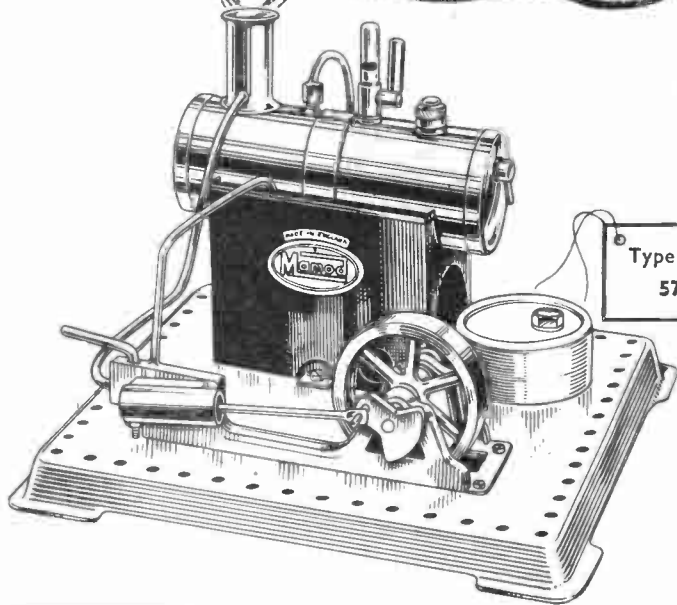

Type S.E.2  
57/6

What better way than with a **MAMOD** Steam Engine?

A delightful toy that operates alone or with working models to provide hours of constructive enjoyment for youngsters of all ages. Safe, practical and really well made, a Mamod steam engine makes an ideal gift for a deserving son.

**PRICES 26/9 TO 94/-**

**Mamod**

STEAM ENGINES

Manufactured by

**MALINS (Engineering) LTD.**

25-31 CAMDEN STREET · BIRMINGHAM 1

Tel. CEN. 6175/6 Grams MAMOD, B'HAM

**APPARATUS & CHEMICALS**

For your experiments. Let us help you equip a **HOME LABORATORY**

Beakers, Crucibles, Flasks, Funnels  
Gas Jars, Test Tubes, etc.

Booklets:

(including postage)

- 'Experiments' 1/3
- 'Formulae' 1/3
- 'Home Chemistry' 2/11

New edition

Send 4d. Stamp for latest **PRICE LIST**

**A. N. BECK & SONS (Dept. H.W.)**

60 Stoke Newington High Street, London, N.16



**'LOG CABIN' CLOCK**

Kit No. 3018

This Kit contains design with instructions, panels of selected wood and a reliable 30-hour movement, 27/-, plus 2/- postage.



**HOBBIES LTD (Dept. 992) DEREHAM, NORFOLK**



The **STRONGEST** handy glue

STILL ONLY

**1/2** a large tube

# WAGING WAR ON WOODWORM

SOMEONE once said that the unseen enemy is the greatest enemy. We can see flies, beetles, ants, etc, when they invade the home, and we do not hesitate to take action. Yet the tiny woodworm continues to spread, mostly because it is unseen unless you really look for it.

In furniture, it is generally the unseen and, therefore, the unpolished parts, like the backs of cupboards, the undersides of chairs and drawers, that the woodworm attacks. It will attack polished surfaces, but usually it takes the line of least resistance, and goes for the untreated wood.

If you see a series of tiny holes and small piles of sawdust immediately below them, then the worm is active. Holes without dust mean the worms were there at one time, but are no longer working that area. All the same, these holes should also be given treatment. Don't delay treatment or the scourge will spread.

Woodworm is the name given to the larva that comes out of the egg which is laid by the wood-boring beetle. The beetle merely spreads the attack by flying from one piece of wood to another, laying its eggs along the line. The eggs become worms, which eat their way through the wood, leaving a trail of riddled timber. Eventually the worm matures, and after a few weeks the adult beetle emerges, leaving the characteristic round holes.

There are four main kinds of woodworm trouble, caused by four different beetles — the longhorn, the death watch, the lyctus, and the common furniture beetle.

The longhorn is rare in Britain. It grows to 3 in. long, and attacks seasoned softwoods. The notorious death watch is not very common either. It is ½ in. long, with a chocolate-brown body, and prefers old hardwood like the beams of old churches.

The lyctus beetle is similar except that it likes to attack only new hardwood. The common furniture beetle, the one usually called woodworm, is much more prevalent here, and is responsible for 90 per cent of the damage found.

It is only ¼ in. long, with a hard, dark brown body. You can often see it flying

or crawling about in June, July, and August. If you can attack the beetle at this stage with a good aerosol spray, you can forget woodworm holes until the same time next year.

Failing this, treatment should begin as soon as an attack is discovered. However, the final extent of the damage must be determined before treatment can be considered complete, especially in rafters, where careful examination of the darker areas of the loft is necessary. Examine furniture too, in rooms seldom

used, paying particular care to antique pieces. Woodworm particularly likes plywood.

If only a small area is affected, then you can usually treat it successfully by liberal doses of an approved woodworm insecticide. Use a special injector, obtainable quite cheaply, and inject the liquid into every hole.

If you find that floorboards are affected, inspect the joists below before undertaking any treatment. If the attack is extensive, then treatment should be carried out professionally, after you've obtained advice. This treatment consists of pressure spraying and fumigation to make sure all timbers have been thoroughly treated. Pest experts will usually inspect your house, and give you an estimate for a complete cure.

If you are buying a house you should get professional advice by a qualified surveyor. He can tell you if woodworm is present, and to what extent, and the treatment needed to cure it. (E.C.)

## A 'Match-Stick' Violin

A MAN with an unusual hobby is Mr William Benstead, of 6 Stubbins Lane, Chinley, Derbyshire. He utilizes used matches, which he collects himself, or are saved for him by friends, from which he constructs useful objects. Not the models usually associated with match-stick constructors, but full size, such as the replica violin pictured here. Retired after thirty years in the mill, he sought around for something to occupy his time, and the match-stick violin is the result.

The work occupied about five weeks, consisting of a few hours per day. But Mr Benstead considers he could have done it in much less time, had it not been necessary to wait for the glue to dry on each small portion.

The body of the violin is of 2-ply thickness to give it strength. On the front of the instrument the first thickness of matches goes from side to side, while in the second (outer) ply they are fitted end to end. In the case of the back the foundation material also goes from side to side, while the finishing ply is formed into an effective herringbone pattern. The sides are made from lilly-sticks cut to the required depth, glued together, and curved to follow the outer edge of the violin. Between two and three thousand matches were used in the construction.

The only tools used were a fretsaw to cut the scroll, a knife, and glasspaper, and the only portion not made by Mr Benstead was the string assembly consisting of pegs, strings, and bridge.

Asked about its musical qualities, Mr Benstead expressed appreciation: 'Not quite so loud as my normal violin, but a beautiful tone just the same'. (R.R.)



Violin made from match-sticks by Mr Wm. Benstead, Stubbins Lane, Chinley, Derbyshire



# BOYS

*and fathers*

# here is the most realistic soccer game ever invented



From Sports and Games shops everywhere.  
For name and address of nearest stockist:

**RELUM LTD.**  
Ossulston Street, London, N.W.1. Tel: EUSton 9088

## PRICE

only **42/-**

## Webley

### AIR PISTOLS



High Accuracy  
and Hitting Power  
Perfect Balance  
Robust Construction

Send  
for  
Catalogue

### WEBLEY & SCOTT LTD

34 PARK LANE, HANDSWORTH, BIRMINGHAM 21

## Watch & Clock Repair Outfit



The complete Outfit for cleaning and repairing. Comprises: Illustrated explanatory booklet, eye-glass, tweezers, screwdrivers, oil, dusting powder, oilers, also catalogue, tools and materials.

P. & P. 1/- extra. C.O.D. if required. **15/-**

The above with additional luminous compounds, jeweller's rouge, dial brush, jewels.

P. & P. 1/- extra. C.O.D. if required. **25/-**

Also available on request:

Illustrated Catalogue of Swiss watches on Credit terms.

**BOLSTER INSTRUMENT CO.** (Dept. H), Govett Avenue, Shepperton, Middlesex

## COMPLETE TABLES SUPERBLY STYLED



Size 24½ in. by 15½ in.  
— 9 mm. thick.

Price:  
32/- including P. & P.

**SEND FOR  
FREE LEAFLET**

TABLE TOPS CAN BE SUPPLIED SEPARATELY

**IDEAL FOR COFFEE TABLES  
TV TABLES, Etc.**

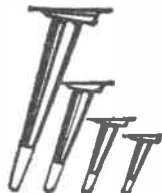

**CONTEMPORARY LEGS AT  
NEW LOW PRICES**

Made from Beech, polished black, fitted with brass ferrules and supplied WITH METAL PLATES READY FOR FITTING IN SETS OF 4

6 in. high	19/5 per set	15 in. high	21/6 per set
9 in. high	20/- per set	18 in. high	23/6 per set
12 in. high	20/9 per set	24 in. high	27/6 per set

Post and Packing FREE. Trade enquiries invited. P.O. or Money Order.

**RENOQUIPMENT LTD, (Dept. HW3), BERKELEY ROAD, LONDON, E.12**

Satisfaction Guaranteed

# BIRMINGHAM

## DO YOU KNOW?

**HOBBIES LTD.** have a branch at  
**100A DALE END**

where the manager and staff are always willing to give you the benefit of their experience with any of your handicraft problems. Why not pay a visit?

**PROFIT AND PLEASURE** is obtainable from **WRITING** (typewriter unnecessary) or **ARTISTRY**. Send for free fascinating bumper package '**PROFITABLE LEISURE**'. — Writers' & Artists' Ring (HW), 5 Edmund Street, Birmingham.

**LEARN RADIO & ELECTRONICS** the **NEW** Practical Way! Very latest system of experimenting with and building radio apparatus — 'as you learn'. **FREE** Brochure from: Dept. H.W.10, Radiostructor, 40 Russell Street, Reading, Berks.

**WORKERS** with sewing machines required for making cushion covers. Regular work guaranteed. Apply enclosing s.a.e., Dept. 28, Arnold Trading, 10 Shelley Road, Worthing, Sussex.

**JAPANESE PYGMY TREES/MINIATURE GARDENS.** Complete outfits of either, 20/- Instructs. **WREATH & BOUQUET MATERIALS.** Artificial Flowers, Everlastings, Grasses, Ferns, Foliage, Posy bowls; Stamp all lists. — Station Nurseries (H.W.), Oakengates, (Salop).

**NEW!**

LEARN  
**RADIO & T/V**  
SERVICING and  
ELECTRONICS

and how to make and build your own equipment — using an exciting new Practical apparatus course. Ideal for starting your own business or as a fascinating hobby.

**FREE** Brochure, without obligation, from  
**RADIOSTRUCTOR** Dept.  
READING . BERKS G.81  
Britain's leading radio training organization

**50 KENYA** Stamps 3/-. **25 Malta** 4/6. **25 Philippine** 5/-. Stamp Magazines 1/- monthly. Try our 7 day approvals.—E. C. F. Townsend (H), 92 Tenby Road, Edgware, Middx.

**TRANSISTORS,** Germanium Crystals. Headphones, etc. Lists and diagrams free. Germanium Diodes with three crystal set circuits 1/-. Postage 4½d. P.R.S. (H), 33 Bourne Gardens, London, E.4.

**SELL** what you make at a handsome profit! Cash in on the growing demand for hand-made articles of all types. Write to me giving fullest details of your work and experience, enclosing 10/6 for my *personal* advice on marketing. — John Storey, Marketing Expert, 60 New Oxford Street, London, W.C.1.

**"GLOBE-KING"**  
WORLD-FAMOUS KITS AND RECEIVERS  
for the Radio Amateur and S.W. Listener. Catalogue Free, enclose stamp for postage. Kits from 79/6 obtainable at your dealers or direct from sole manufacturers  
**JOHNSONS (Radio)**  
ST. MARTINS GATE — WORCESTER

Completely new 54 page Edition  
**WHERE'S THAT CAR FROM?**  
Price 1/- (Postage 4d.)  
Of all Booksellers  
or  
**RALEIGH PRESS, Exmouth, Devon**

**MAKE ART PAY.** Learn to Draw/Paint Flowers, Birds, etc. in Designs or Pictures for waiting manufacturers. Profitable. Remunerative. Even beginner's work can sell. Post-card brings free brochures. Clun Valley Features (H.W.), Clun, Salop.

**100 DIFFERENT** stamps free! Request ¼d. upwards discount approvals. — Bush, 53 Newlyn Way, Parkstone, Dorset.

**BARGAINS** in Complete Radio Kits. Easy Instructions. Radio knowledge unnecessary. Temporary post free prices: Fascinating Short Wave Radio 22/-; following kits soldering unnecessary — Pocket Transistor Radio 19/-; Quality Crystal Set 14/-; Beginners' Crystal Set 8/3; Transistorised Amplifier for above 12/-. Send P.O. NOW or stamp for details and Lists. — **RADIOMATIC (I)**, 26 Blackburne Drive, Hunts Cross, Liverpool.

## THE BENCH FOR YOU!

With a bench like this you can work to your heart's content. Perfectly rigid, but can be easily taken apart if space is required. Best selected timber, complete with hardwood vice with twin screws. Easy payments 30s. down and 6 monthly payments of 17s.6d. Ask for agreement form.

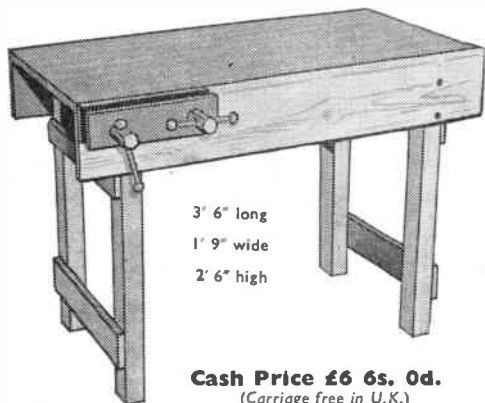

**Cash Price £6 6s. 0d.**  
(Carriage free in U.K.)

From Branches or direct from:  
**HOBBIES LTD (Dept. 992), DEREHAM, NORFOLK**

## All over the World ...

*Hobbies Weekly* is a regular source of ideas and inspiration for readers all over the world. Free design plans worth at least 1s., for making all kinds of projects such as toys, novelties, models, and furniture, are included in every alternate issue. Costing only 5d. each Wednesday, *Hobbies Weekly* is therefore a sound investment for the craftworker and hobbyist.

A missed copy means foregoing hours of pleasure — and perhaps not a little profit. For there's bound to be something to interest you — and the rest of the family — in every issue of *Hobbies Weekly*. So place a firm order with your newsagent.

In some places, readers of *Hobbies Weekly* may experience difficulty in obtaining regular copies, in which case it is advisable to become postal subscribers. Rates are: 12 months 30s., 6 months 15s., 3 months 7s. 6d. (all including postage to any part of the world). Complete the form now.

To the Publisher, *Hobbies Weekly*, Dereham, Norfolk

Please send me a copy of *Hobbies Weekly* every Wednesday for.....months, commencing date.....for which I enclose cost of.....

Name .....

Address .....

(block letters please)

# A CUT-OUT XMAS CARD

**A** CARD made by your own efforts will be much more appreciated. Cut the back B from  $\frac{1}{8}$  in. wood and the overlays A and C from thin plywood, veneers or pearl acetate. Several thick-

nesses of veneers or acetate can be cut at once with your fretsaw if they are sandwiched between two waste pieces of  $\frac{1}{8}$  in. wood. Choose woods of contrasting colours and leave in natural state (M.p.)

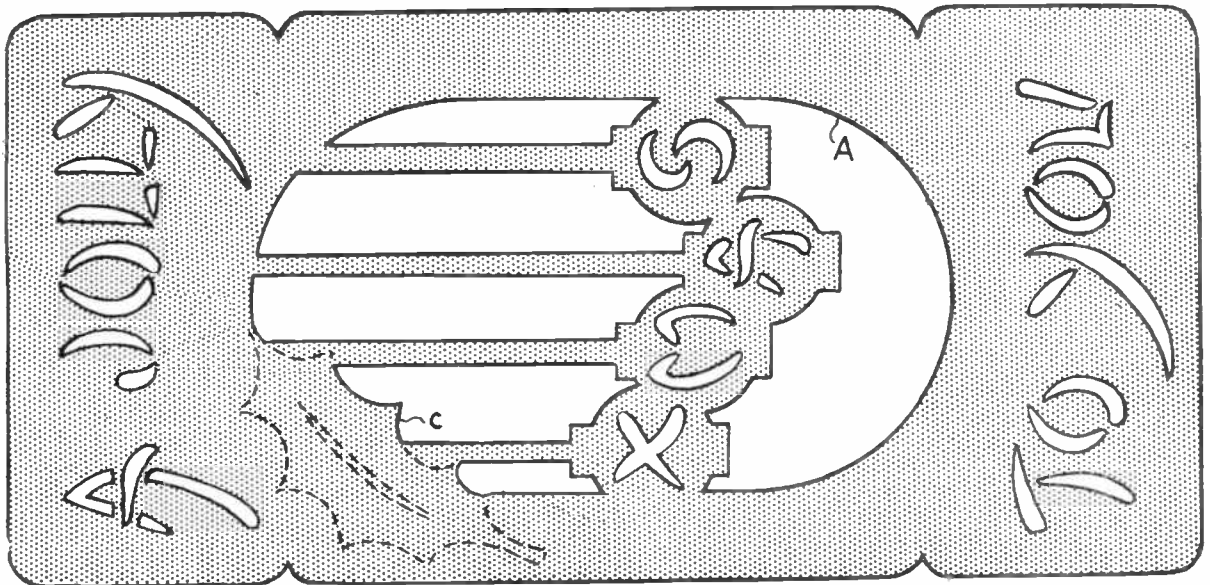
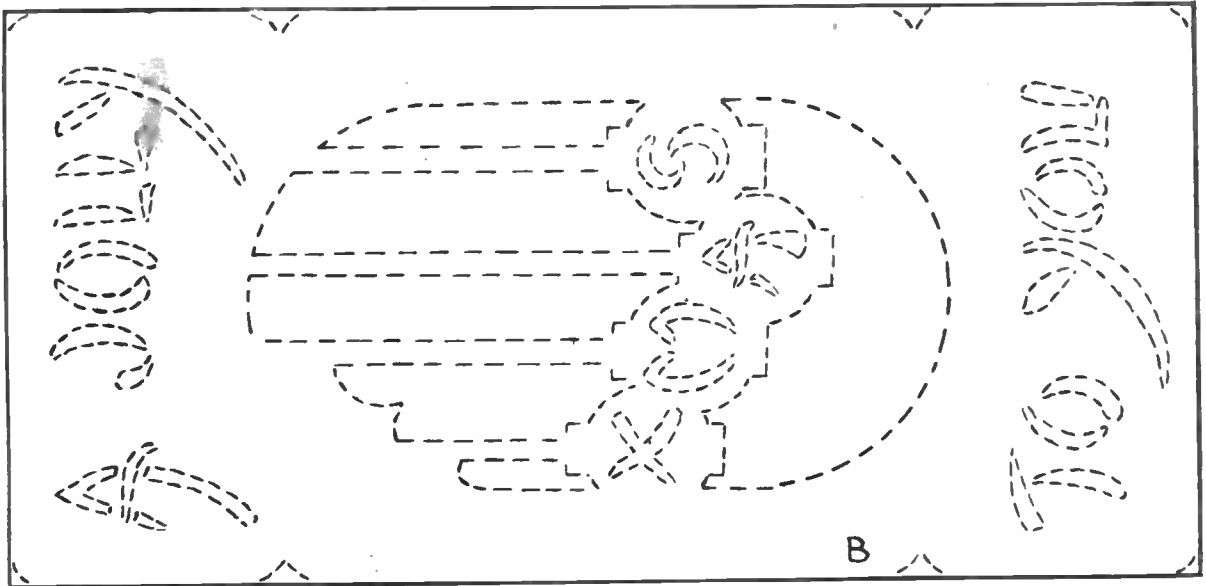
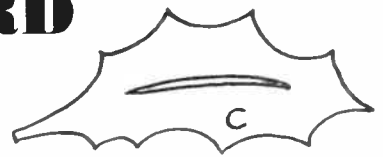

# GIFTS FOR BOYS & GIRLS

The making of these gifts is a job well within the capabilities of any handyman. With a fretsaw, a few simple tools and one of Hobbies kits, he can make a lasting model of which he can be really proud, and one which is certain to please its small owner.

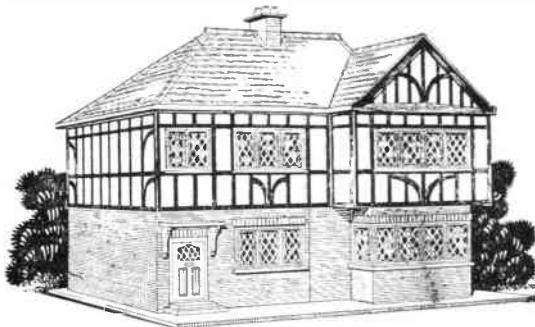

**TUDOR DOLL'S HOUSE No. 237 Special**  
A large and attractive model of a typical half-timbered Tudor house. Double-hinged front. Metal windows, doors and fireplaces, and all necessary wood and fittings. 2 ft. wide, 2 ft. high, 16 in. deep.  
Price **92/6**



**New low-priced DOLL'S HOUSE, No. 254 Special.** Sturdy hardboard ensures rigid construction. Back opens to facilitate furnishing. 20 in. high.

Price **45/11**

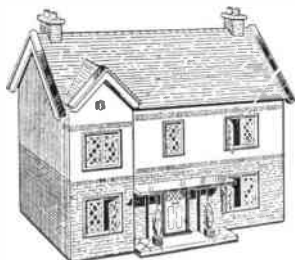

**DOLL'S HOUSE, No. 2910**  
Another low-priced house, 17 in. wide. The front is hinged to reveal four rooms, a hall and landing.

Price **59/11**



**SERVICE STATION Kit No. 258 Special.** Modern garage with base 20 x 15 in. Kit includes pumps and car ramp.

Price **25/11** (post 2/9)



**TOY FORT with moat and drawbridge No. 260 Special.** Round towers, courtyard, turrets, etc. Base: 20 x 15 in.

Price **26/3**  
(post 3/3)

**TOY FARM No. 3334.** Kit for making four buildings. Set of plastic farm animals.

Price **28/-**  
(post 2/9)



## To HOBBIES LTD (DEPT. 992), DEREHAM, NORFOLK

Please send kit marked (X) and a free copy of 'Profitable Leisure'

- |  |                          |                                      |                          |   |                          |
|--|--------------------------|--------------------------------------|--------------------------|---|--------------------------|
| TUDOR DOLL'S HOUSE<br>No. 237 Special 92s. 6d. | <input type="checkbox"/> | DOLL'S HOUSE<br>No. 2910 59s. 11d.   | <input type="checkbox"/> | DOLL'S HOUSE<br>No. 254 Special 45s. 11d.   | <input type="checkbox"/> |
| TOY FARM<br>No. 3334 30s. 9d.                  | <input type="checkbox"/> | TOY FORT<br>No. 260 Special 29s. 6d. | <input type="checkbox"/> | SERVICE STATION<br>No. 258 Special 28s. 8d. | <input type="checkbox"/> |
- (Prices include post and packing)

NAME .....

ADDRESS .....

Send for your free copy of 'Profitable Leisure' which contains dozens of interesting projects.

P.O./Cheque enclosed for.....