

5th OCTOBER 1960

VOL. 131

NUMBER 3382

THE ORIGINAL
'DO-IT-YOURSELF'
MAGAZINE

HOBBIES *weekly*

FOR ALL
HOME CRAFTSMEN

GRAND FRETWORK COMPETITION over £200 in prizes

Make up this free design

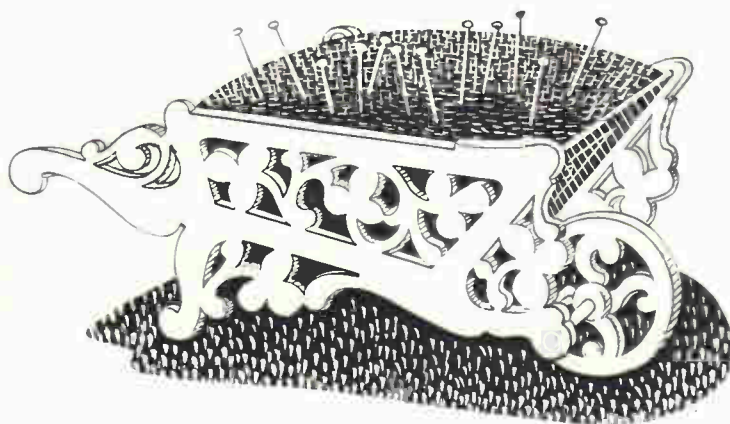

WHEELBARROW PINCUSHION

Also in this issue:
GAMES TO MAKE
WITH MATCHBOXES
COLLECTORS' CLUB
ANOTHER FEATURE
ON CACTI
MAKING GATES
FOR A DRIVE
PHOTOGRAPHY
AND CHEMISTRY
MODELLING TIPS
ON SCALE WORK
ETC. ETC.

Up-to-the-minute ideas

Practical designs

Pleasant and profitable things to make

World Radio History



5^p



LABELS often seem similar except for a slight difference in colouring. This may be due to the ink fading after many labels have been printed. But sometimes the colour is actually different. As in stamp collecting a good magnifying glass is needed for close study.

STUDY YOUR LABELS TOO

In making a comparison, first try to determine if the colour is an actual shade difference or if it may be due to a fading of ink. Second, compare the paper. Third, compare the gum on the reverse side. Fourth, compare small sections of the labels slowly and carefully. You may start finding differences which were not apparent at first glance.

You may find that one has a printer's name and the other does not. Then again, the printer's name may be on both labels but on close inspection the printing type may be different. Close inspection may show colour differences in little sections and in some cases the border of the label may have differences.

Once you start to find little differences then the whole label seems to be different. You wonder why you did not notice the differences right away.

As your collection grows you will receive in exchanges many labels which seem familiar and which you are sure you already have. Instead of putting these with your duplicates to pass on to friends treat them as possible new addi-

tions to your collection. Check them carefully with those already in your album in the ways suggested. You will thereby add many new specimens to your collection.

You'll find many colour variations in the Russian Sport Issues of 1956 (see examples below). Why not start with these?

Fresh as a daisy

WHEN we say 'daisy', we are really speaking of the 'eye of the day' — and that is the meaning of the word 'daisy.' It comes from the Old English 'Dayes Eaye.'

The closing of the flower to conceal the yellow disc in the evening, and its opening in the morning has given rise to this name.



The daisy is depicted on this new Russian match label.

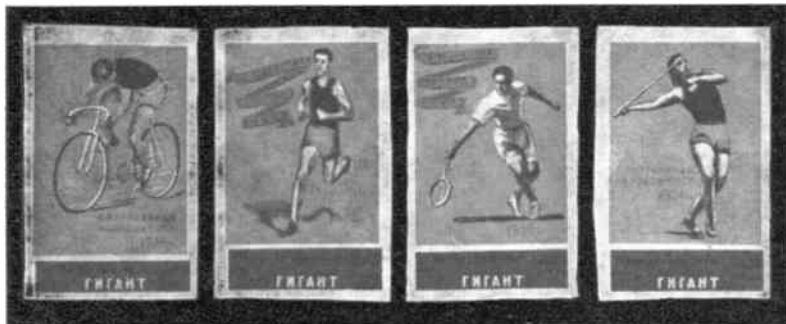

French King danced

THE Ballet is the latest subject depicted on Russian match labels some of which are seen below.

Ballets were first introduced in Italy in the 15th century. They became popular in France about 1580.

Cardinal Richelieu designed gorgeous ballets, in which Louis XIII took part.

The ballet was first seen in England at Covent Garden in 1734.



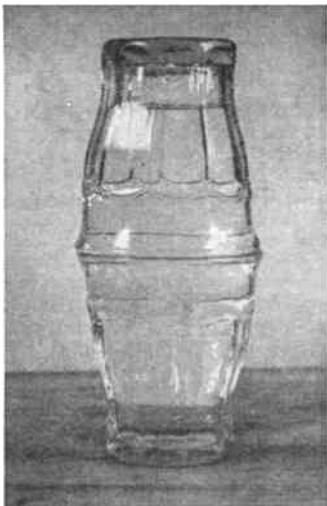

Fig. 1—These two tumblers stood one on top of the other are full of water

THIS trick of placing two tumblers one on top of the other enclosing a volume of water represents a novel little effect to mystify your friends.

No matter how hard you try to fill the two glasses and stand them in the position shown in Fig. 1, there is only one way to successful performance of the feat.

Obtain two tumblers of equal size, filling one with water to the brim, and placing it on a level surface. Take the second tumbler, filling as before, and

A TRICK WITH TWO TUMBLERS

then cover it with a piece of paper large enough to extend at least 1 in. beyond the rim of the glass. Use a good quality non-absorbent paper.

Take hold of the second tumbler in the right hand, place the left hand palm downwards on the paper and turn the whole upside down. You will discover that the paper will stay in position,

By 'Mystifier'

holding the water in the tumbler. This is due to external air pressure, and is quite a trick in itself.

Carefully place the second tumbler, still with the paper in position, on top of the filled one, so that the rims exactly coincide (Fig. 2). All that remains to be done is to draw away the paper, and there you are.

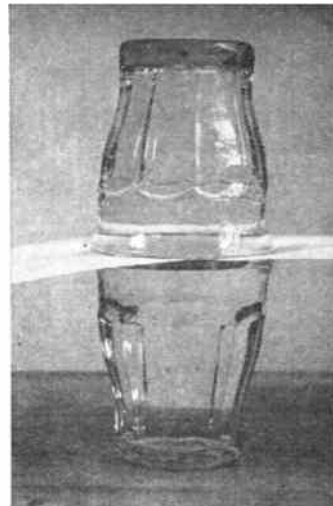
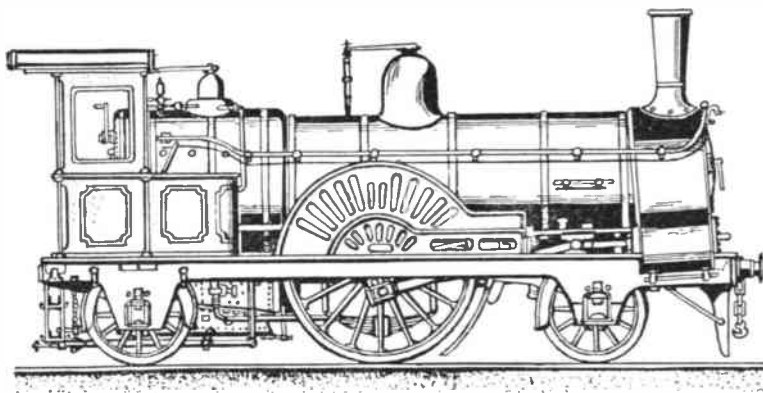

Fig. 2—Note the piece of paper between the glasses

There will be a slight loss of water from the upper tumbler, but this is negligible.

If you are to avoid trouble, first try this trick near the sink, and use fairly substantial tumblers, so that there will be no difficulty in balancing them one on top of the other. Note that any irregularity at the tops of the tumblers will make the water leak, but you may test by standing on a level surface. Finally, do be careful when moving or emptying, or you may get a wetting!

INTERESTING LOCOS—No. 27



OUR illustration shows an interesting G.E.R. 'single' express locomotive of 1862. This type was

designed by Robert Sinclair and a number of them were made by outside makers, including Fairbairn, Kitsons,

the Avonside Engine Co., and Schneider (Creusot) between 1862 and 1867.

The thirty-one engines in the class had 7 ft. 1 in. diameter driving wheels, cylinders 16 in. by 24 in., and working pressure of 120 lb. sq. in. Heating surface was: tubes 969 sq. ft., firebox 82.3 sq. ft. Total 1,051.3 sq. ft. Grate area 15.7 sq. ft. The weight on the driving wheels was 11 ton 7½ cwt., and the engines weighed in working order 29 ton 5½ cwt. Gooch valve gear was provided.

For more than twenty years these excellent engines were employed on the fastest main line express trains of the G.E.R. where their efficiency, economy, and performance were among the finest of the locomotive work of the period.

It will be observed that the notable high-class firm of Schneider et Cie of France were among the makers of these engines. They built six in 1866-67, the last engine of the batch being exhibited at the Paris Exhibition of 1867. At the same time, this firm had under construction a batch of ten 2-4-0 type engines for the G.E.R. (A.J.R.)

CHEMISTRY

AT HOME

THE usefulness of potassium dichromate, $K_2Cr_2O_7$, can hardly be over-estimated. In the laboratory we use it as an oxidizing agent, as a reagent in both quantitative and qualitative analysis and for many other purposes. Industry uses it in dyeing and as a source of brilliant pigments. Even an early method of photography needed it.

This photographic method is easy and cheap. You may find it useful for taking leaf prints, portrait silhouettes and similar sideline activities.

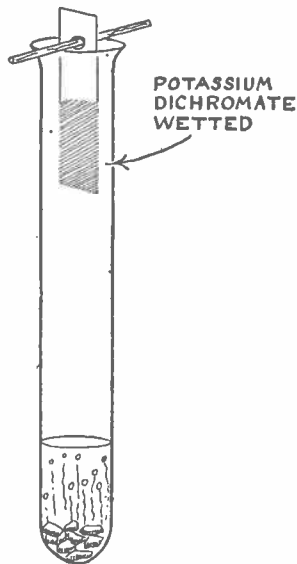

Detecting sulphur dioxide with potassium dichromate

The sensitized paper is soon made by soaking a piece of drawing paper in strong potassium dichromate solution for five minutes in a dim light and then hanging it up to dry in a dark cupboard.

To take a leaf print, place a leaf on the paper and bind the two between two sheets of glass. Now expose the impromptu printing frame in strong daylight—preferably sunlight, for this is naturally quicker. In a minute or two the uncovered part of the paper begins to darken. When this darkens no further, remove the paper in dim light. A print of the leaf will stand out in yellow on a brown background. Wash the print in several changes of warm water until the wash waters are no longer coloured

yellow. The print is now fixed and may be dried and handled in ordinary light.

Portrait silhouettes may be made in a similar way. Simply cut out head and shoulders from a snap and treat it as you did the leaf. If you prefer a brown silhouette on a pale background, trace the portrait on thin transparent paper, cut out carefully, paste it on black paper and

POTASSIUM DICHROMATE

very carefully cut out the black paper round the tracing. Put the black paper on a piece of sensitized paper and expose as before. The silhouette hole in the black paper now allows the reverse action to take place. Wash as before to fix the image. If framed, these silhouette portraits add interest to a room.

An illustration of potassium dichromate as an oxidizing agent and as an analytical reagent is its behaviour with sulphur dioxide, SO_2 . Put some sodium sulphite crystals, $Na_2SO_3 \cdot 7H_2O$, in a test tube and pour in some dilute sulphuric acid, H_2SO_4 . Sulphur dioxide is evolved with simultaneous formation of water, H_2O , and sodium sulphate, Na_2SO_4 :

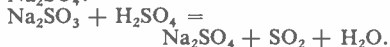

Cut a slip of filter paper, wet it with potassium dichromate solution, and hang it in the test tube by means of a thin sliver of wood, as shown in the diagram. The paper turns green. In oxidizing the sulphur dioxide the potassium dichromate has been reduced to green chromium sulphate, $Cr_2(SO_4)_3$, and potassium sulphite, K_2SO_3 :

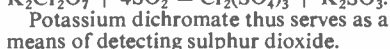

Potassium dichromate thus serves as a means of detecting sulphur dioxide.

It may also be used as a test for hydrogen peroxide, H_2O_2 . Pour a little potassium dichromate solution into a test tube, add some dilute sulphuric acid. This liberates chromic acid, H_2CrO_4 , and also forms potassium sulphate, K_2SO_4 :

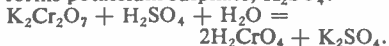

Now add hydrogen peroxide dropwise. A fine blue colour appears owing to the formation of perchromic acid, $HCrO_4$:

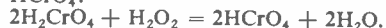

The test is made very delicate by adding about 1 c.c. of ether, $(C_2H_5)_2O$, and shaking. The perchromic acid dissolves in ether with a deeper blue colour than in the aqueous solution. It is very unstable and soon decomposes.

One of the uses of potassium dichromate in dyeing is as a mordant. A mordant is a substance which fixes a dyestuff on a fibre which would not otherwise hold the dyestuff.

Put a small piece of clean white wool into half a beaker of water and bring to the boil. Remove the wool and put in some logwood chips. When the water is well coloured by the extracted dye, filter, boil up again and enter the wool. Stir for about fifteen minutes. Remove the wool and rinse it in water. The dye washes out.

Now weigh a piece of woven white wool and snip off bits until it weighs 1 gram. Put it into a beaker and add enough water to cover it well. Boil up the water, remove the wool and add 1 c.c. of a solution of 0.45 gram of potassium dichromate in 10 c.c. of water. Replace the wool and boil for one hour, stirring constantly. Wash the wool in several changes of water until the final wash water is not coloured. The wool is now yellow and in the mordanted state.

In the mordanting bath the potassium dichromate acts as if it were potassium chromate and chromic acid:

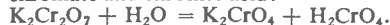

Textile chemists believe that the chromic acid then combines with some constituent of the wool to form an insoluble chromate.

Now enter the mordanted wool into the decoction of logwood chips. Boil one hour, stirring constantly. The wool now becomes deep blue or black, according to the amount of logwood chips extracted. Wash the wool in water. The colour remains firmly fixed to the fibre.

Logwood contains haematoxylin, $C_{16}H_{14}O_6 \cdot 3H_2O$, and haematein, $C_{16}H_{12}O_6$. Haematein is the dyeing principle. The mordanted wool acts as though it contained chromic acid, oxidizes the haematoxylin to haematein; and chromium hydroxide, $Cr(OH)_3$, remains in the fibre:

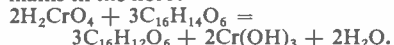

The haematein then combines with the chromic hydroxide to form insoluble chromium haematein, $(C_{16}H_{10}O_6)_3Cr_2$:



The chromium haematein is the fixed dye in the fibre.

● Continued on page 5

Make these Matchbox Games

MATCHBOX games are easy to make, and cost next to nothing, for all that is needed are the odds and ends that are found in most homes.

For Capping the Clown (Fig. 1), you need a matchbox tray, a small piece of cardboard, a conical plastic cap from a toothpaste or cosmetic tube, and a transparent jam-pot cover. First, a piece of cardboard is cut to fit in the tray as a background. A fairground scene can be painted on this before it is gummed into place. The clown is cut from a double thickness of card and has a pointed hat over which the plastic cap can slip. Bend the bottom edges of the figure outwards to form flanges and use these to gum the clown in place as shown.

The cover is made from transparent jam-pot cover or film from a cigarette packet. Cut a rectangle an inch larger than the matchbox tray, and after putting the plastic cap inside, gum the cover on, longer sides first, then the short ones, and trim off the corners. Moisten the cover, then warm it gently, to remove wrinkles and make it taut.

The idea, of course, is to lodge the hat on the clown's head.

Another game (Fig. 2), needs two small plastic caps from tubes and two beads. A piece of cardboard is glued to the tray as a background, then two small squares of card are bent into L shapes and glued to the card, one above the other, to form small shelves. A plastic cap is glued to each of the shelves. The inside of the tray looks better patterned with a bright design, such as stars. Two small beads are put in the tray and the transparent cover glued on, as before.

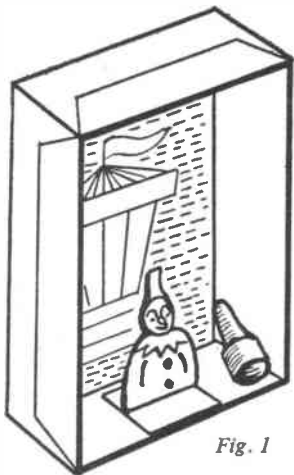

Fig. 1

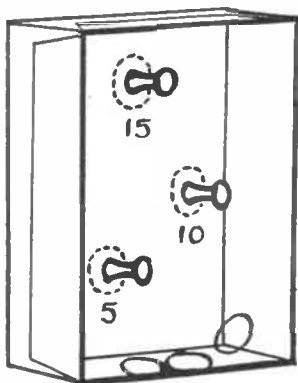

Fig. 3

This time, the object is to get a bead into each 'cup'.

A miniature hoop-la game (Fig. 3), needs three plastic or metal studs such as those sold with shirts, and a paper clip. Three small holes are made in a piece of card which fits into the tray, and the studs pushed through from behind. The card is then glued in place in the tray. Three rings are made by bending pieces of paper clip round a pencil. Number the studs 5, 10 and 15 for scoring, and after putting in the rings, gum the transparent cover in place. The idea of the game is to 'ring' the studs.

'Garaging the Cars' (Fig. 4), needs two strips of card, each the depth of the tray, and three small beads of different colours. Bend the strips as shown and cut three little 'doorways' in each. Glue in place, insert three beads and cover

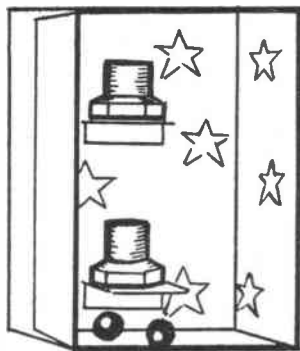

Fig. 2

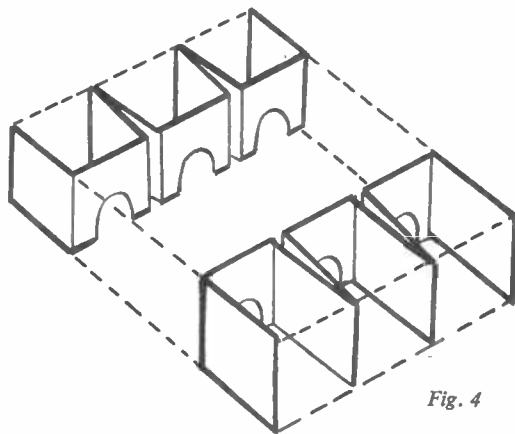

Fig. 4

with transparent paper. The aim is to get the three beads from their respective garages at one end to those at the other. Each set of garages will be painted the same colour as its bead.

(A.L.)

● Continued from page 4

POTASSIUM DICHROMATE

The brilliant pigment Chrome Orange consists of basic lead chromate, $PbCrO_4 \cdot Pb(OH)_2$, and is easily prepared by the action of a mixture of potassium dichromate and potassium hydroxide, KOH, on lead acetate, $(CH_3COO)_2Pb \cdot 3H_2O$:

$$2(CH_3COO)_2Pb + K_2Cr_2O_7 + 4KOH = PbCrO_4 \cdot Pb(OH)_2 + K_2CrO_4 + 4CH_3COOK + H_2O$$

CH_3COOK is the formula for potassium acetate.

Dissolve 7.58 grams of lead acetate in 80 c.c. of water. Dissolve 2.94 grams of potassium dichromate and 2.24 grams of potassium hydroxide each in 70 c.c. of water, mix the two and stir into the lead acetate solution. An orange, rather bulky precipitate forms. This is basic lead chromate. Now let it stand a few hours. It becomes dense, sinks to the bottom of the vessel and is now of a fiery red-orange colour. Filter it off and wash well with water until one wash water is colourless. Then let the precipitate dry. The difference in colour between the original and final product is one of particle size only.

(L.A.F.)

ACTI & SUCCULENTS

TWO very large genera of succulent plants are the Stapelia and Euphorbia. Although a few species are found outside Africa (*Euphorbia canariensis* for example) these are basically plants of the African continent.

The Stapelia are spreading plants with stems about 1 ft. in height, and they are leafless. These plants are characterized by their five petalled flowers which vary from over 1 ft. to less than 1 in. in diameter.

6—STAPELIA AND EUPHORBIA

Stapelia are pollinated by flies and some, although by no means all, have an unpleasant smell of decay which attracts these insects. As a result they are popularly known as 'carrion flowers.' The most common species is *S. variegata* which has yellow and purple spotted

flowers open. They lay their eggs on the flowers, but the young grubs soon die of starvation. *S. magna* and *S. grandiflora* are simply larger flowered types of the above plant. The flowers of *S. grandiflora* are about 7 to 8 in. across.

One of the most unusual and beautiful of the Stapelia is *S. leenderzii*. In this plant the petals have been fused together to form a huge bell about 4 in. deep and 7 in. across, the inside of which is rich, velvety red.

One of the smallest of the Stapelia is *S. arenosa*. This has dark purple flowers less than 1 in. across. At the other end of the scale is *S. gigantia* which has one of the largest flowers in the world, being well over 1 ft. in diameter. This is one of the larger growing Stapelia, and the stems tend to be rather coarse.

Most Euphorbia are not grown for their flowers but for their plant form. Some are natives of Madagascar, and these are the only ones that are grown for their 'flowers'. Actually the brilliant red 'flowers' of *E. splendens* are really coloured bracts, the actual flowers being quite insignificant. The plant itself con-

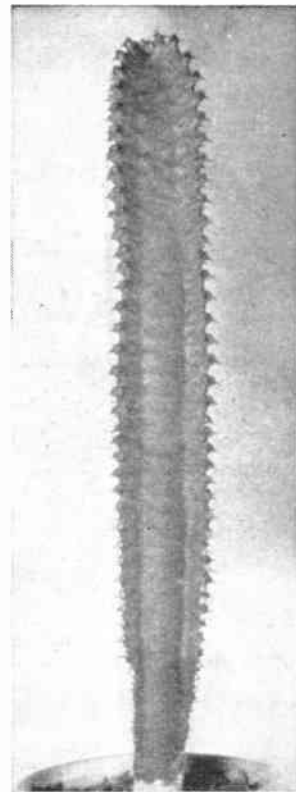

EUPHORBIA CANARIENSIS

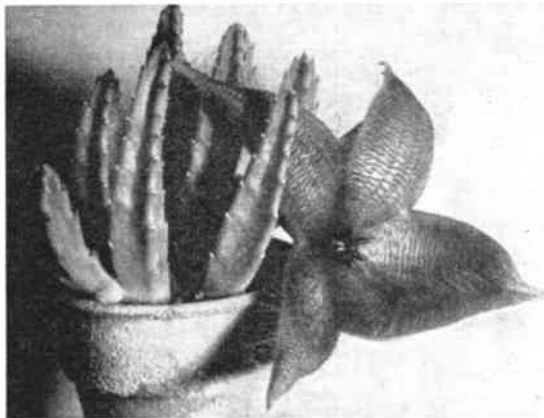

STAPELIA HIRSUTA

flowers about 2 in. across, looking rather like starfish. This is an easy plant to grow and flower.

Stapelia hirsuta has purple, hairy flowers about 4 in. across. These appear to be odourless, but even so they are apparently extremely attractive to flies which come as if by magic as soon as the

sists of very thorny stems with small bright green leaves. These are shed during the winter if the plant is kept cool. In tropical countries *E. splendens* is grown as a hedging.

Some Euphorbia resemble tiny palm trees. *E. clandestina* and *E. bubulina* have grass-like leaves on the top of thick



EUPHORBIA OBESA, male plant

stems. As new leaves are formed, the old ones are shed, leaving scars as on a palm.

One of the largest groups of Euphorbia is the so-called 'Cactiform types'. These are spiny, mainly leafless plants which bear a superficial resemblance to the columnar Cerei. Some of these plants

● Continued on page 7

MAKE DOUBLE GATES FOR THE GARDEN DRIVE

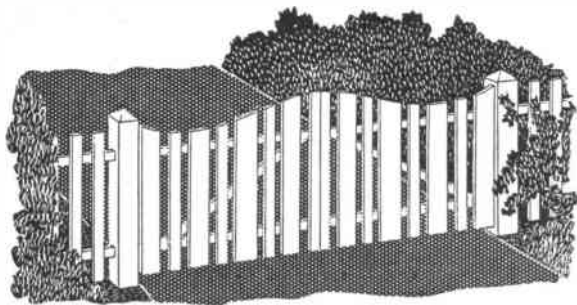

THE appearance of your driveway and your home can be greatly enhanced by an attractive pair of gates. They are not difficult to construct, and are certainly a great saving in expense.

The width will, of course, depend upon your own requirements, but 10 ft. should be ample for most homes. The height can be about 3 ft. 6 in. to 4 ft.

The gates must be hung on substantial posts, say, 6 in. by 6 in., and let

work which is tenoned and halved together. Dowels can be used to secure the joints, and a good waterproof glue will give added strength, and also prevent moisture getting into the joints.

Commence by cutting the various pieces of timber to the sizes shown. Pieces A, which will be hinged to the posts, are cut from 3 in. square wood. Pieces B, C, and D are 2 in. square. The general layout and measurements are shown in the front view in Fig. 1.

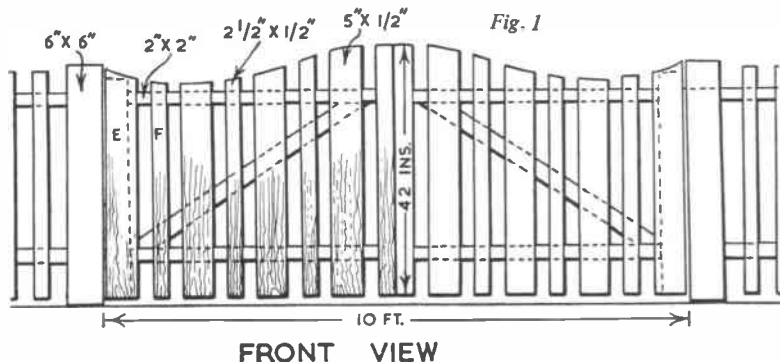

into the ground about 2½ ft. Extra strength can be achieved by cementing the posts into the ground.

Each gate consists of a braced frame-

work which is tenoned and halved together. Dowels can be used to secure the joints, and a good waterproof glue will give added strength, and also prevent moisture getting into the joints.

thick wood, E being 5 in. wide, and F 2½ in. They are spaced out equidistantly, and are nailed in place. The tops are shaped to a graceful curve, and are cut with a fretsaw.

Clean up and paint, giving one

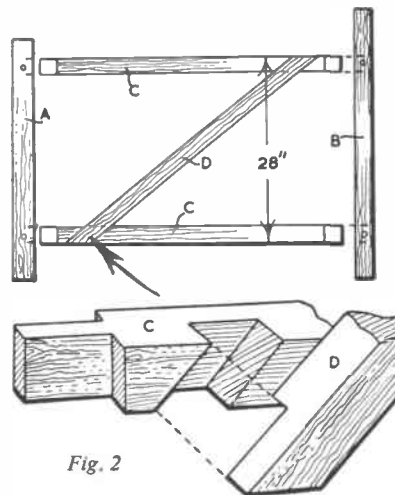

priming coat, one undercoat, and a finishing coat of high gloss paint. Hinges can be purchased from your local ironmonger who will advise you as to types available. (M.h.)

● Continued from page 6

CACTI AND SUCCULENTS

reach tree-like proportions. *E. canariensis* reaches a height of about 50 ft. in its native state. Most of these plants are very slow growing, so that final height is only of academic interest. Amongst these plants some of the best are *E. canariensis*, *E. resinifera*, *E. ceriiformis* and *E. pseudocactus*. *E. canariensis* is initially a columnar plant which will branch at about 15 in. The other three plants are bushy, and reach an ultimate height of about 2 to 3 ft.

The most difficult but the most interesting of the Euphorbia are the globular, extreme succulent forms. The best known is *E. obesa* which is a smooth globular plant, beautifully marked in brown and green. On the top of the plant the minute flowers are produced. These extreme succulents are interesting in that the male and female flowers are borne on separate plants.

E. valida and *E. meloformis* are rather similar in appearance. They have

quite definite ribs, and the flowers are borne on long stalks. These remain on the plant long after the flowers have withered, giving it a spiny appearance.

The cultivation of *Stapelia* and *Euphorbia* is very similar. They can be grown most successfully in a fifty-fifty mixture of leaf mould and sand to which some bone meal has been added. In the summer they should be given the full sun and kept moist. In the winter they should be kept mainly dry, and only watered a little on very bright sunny days.

Next: Some other succulents.

DETAILS OF 1961 COMPETITION

WE again have pleasure in announcing details of our Fretwork Competition in which prizes to the value of £200 will be awarded to successful competitors.

For this 1961 competition it has been decided to give cheques for the main prizes, details of which are listed below. In addition, vouchers to the value of £1 will be awarded for the next best entries, entitling the winners to obtain goods to that value from the items listed in *Hobbies Annual*. There will also be dozens of other valuable consolation awards and Certificates of Merit will be issued for work which qualifies according to the decision of the judges.

In addition to receiving the main prize of 15 guineas, the winner of the Open section will be acknowledged as the champion fretcutter for 1961 and he (or she) will hold the magnificent silver Challenge Cup for a year. With this award also goes a permanent cup replica as a reminder of the achievement.

To give readers of all ages a chance, the competition is judged in two sections — for seniors aged 16 and over, and for juniors aged 15 and under. There are separate prizes for each section and the



subject for the competition is the same for both classes.

In the Junior Section, incidentally, it must be thoroughly understood that competitors shall receive no help from an adult, and receipt of an entry in this section will be taken as an honourable guarantee that it is, in fact, their own work.

The subject of the test piece is the 'Wheelbarrow' Pincushion, which lends itself admirably for this purpose. As can be seen from the finished illustration, it is an excellent test of fretcutting, on which the judges will naturally concentrate, but an attractive finish will also be taken into consideration.

All competitors should read thoroughly the rules conditioning entry, and all entries should be well packed so as to ensure safe delivery through the post. They must reach the competition office not later than April 29th, 1961.

Photograph is of Mr D. H. GODDARD, Fretwork Competition Winner 1959-1960, holding the Silver Challenge Cup and replica.

PRIZES

OPEN SECTION

1st Prize	Cheque for	£15 15 0
2nd Prize	"	" £12 12 0
3rd Prize	"	" £10 10 0
4th Prize	"	" £7 7 0
5th Prize	"	" £5 5 0
6th Prize	"	" £4 4 0
7th Prize	"	" £3 3 0
8th, 9th and 10th Prizes	"	" £2 2 0
11th and 12th Prizes	"	" £1 10 6

JUNIOR SECTION

(Open to those 15 years of age and under)

1st Prize	Cheque for	£12 12 0
2nd Prize	"	" £7 7 0
3rd Prize	"	" £5 5 0
4th Prize	"	" £3 3 0
5th, 6th and 7th Prizes	"	" £2 2 0
8th, 9th and 10th Prizes	"	" £1 10 6

Vouchers for £1 will be awarded for the next best entries

In addition, dozens of other valuable prizes and Certificates of Merit will be awarded. Winners of the vouchers may choose any Hobbies goods to the value of the voucher.

RULES

1. All entries must be made from Hobbies Design No. 3382 presented free with this issue of *Hobbies Weekly*.
2. Points will be awarded for the quality of the fretcutting, plus the excellence of the finish.
3. An entry must be the unaided effort of the competitor. This rule must be strictly adhered to.
4. Entries must be sent to the Competition Dept., Hobbies Ltd, Dereham, Norfolk, to reach there not later than April 29th, 1961.
5. A label bearing the name and address of the competitor, age, and Section of the Competition for which the entry is to be judged, must be firmly affixed to the entry. Competitors who wish their entries returned must include a 1/- P.O. to cover cost of repacking and postage.
6. Because of Customs restrictions, etc, entries are confined to those from Gt. Britain and Northern Ireland.
7. Prizewinners will be notified by June 30th, 1961, and details will also be given in *Hobbies Weekly*.
8. Hobbies Ltd cannot accept responsibility for any loss or damage to entries, but all reasonable care will be taken with them.
9. The judge's decisions are final, and no correspondence can be entered into.

The Wheelbarrow Pincushion

DETAILS
FOR
MAKING
THIS
CHARMING
NOVELTY

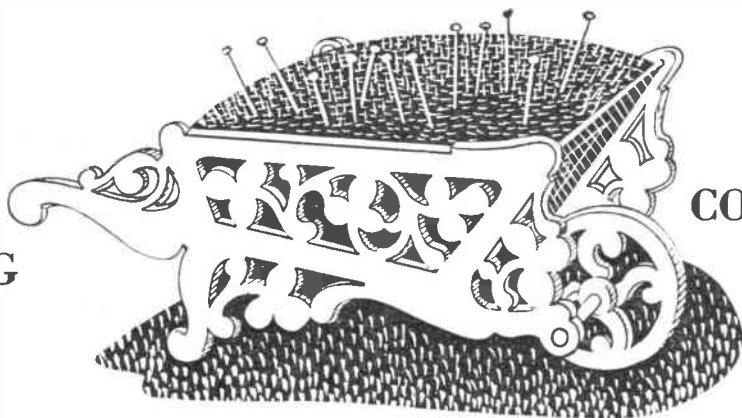

HOBBIES
1961
FRETWORK
COMPETITION
TEST
PIECE

THIS attractive design for a pincushion is also a good test of fretcutting, and should be popular with all readers. Makeup is quite simple, but it will be appreciated that the attractiveness of the finished article will depend to a large extent on the quality of the fretcutting and finish applied. In the form of a wheelbarrow, there is a pad let into the top which acts as a pincushion.

A study of the design sheet will show that with the exception of the axle, all parts are cut from $\frac{3}{8}$ in. wood. These are all shown full size on the design sheet, from which they should be traced and then transferred to the wood by

means of carbon paper. All the internal frets should, of course, be cut out first, before proceeding with the outlines.

The model consists of a right-hand side (1), left-hand side (2), a top (8), floor (3), front (4), back (5), and a wheel (10). The wheel turns on an axle formed from a $3\frac{1}{2}$ in. length of $\frac{1}{4}$ in. dowelling, one of the little washers being glued on either side. The spindle goes between the two sides of the barrow, and a washer is then glued on the inside. The spindle should work loosely in the sides of the barrow in order that the wheel may revolve. The wheel assembly is shown in detail in Fig. 1.

First of all fit the front (4) and back (5) to the sides, as clearly shown by dotted lines on the design sheet. Then glue and pin the floor (3) from underneath. The top (8) must lie flat and level inside the front and back. It is supported by two fillets (6 and 7). Piece 6 is glued to the front (4) and piece 7 is glued to the back (5) in the positions shown by dotted lines on the sides.

The top, of course, must not be fixed in position until it has been stuffed and covered suitably to act as a pincushion. The top should be made to fit nicely after the material on the cushion has been fixed.

Fig. 2 shows how the cushion is made and added to the top. Get a piece of soft material large enough to allow a reasonable amount of stuffing to be added between it and the top, and turn the sides underneath. Put the stuffing in quite tightly, using flock, small portions of cloth or cotton wool. Make the pad up to a nice curve, then pull the covering over tightly, gluing and pinning it down on the underside of the top. The com-

pleted piece should fit in comfortably without having to be forced.

To give a nice effect the sides of the wheelbarrow are backed up from behind with some suitable material or linen paper. This is glued carefully behind all the fretted sides, but not high enough so as to interfere with the top when this is in position.

Finish is left to the choice of the worker. Many will prefer to paint all the woodwork to colours of their own choice, but this should not be applied too thickly so as to obscure the cleanliness of the fretcutting. Other finishes can be by staining, and finally polishing or varnishing.

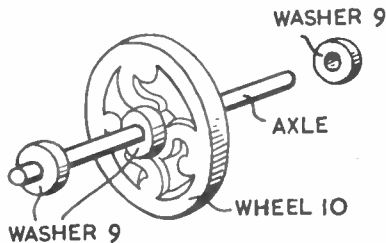

Fig. 1



Fig. 2

A KIT FOR ONLY 4/3

Hobbies Kit No. 3382 for making up the competition piece consisting of the Wheelbarrow Pincushion contains panels of wood, round rod, backing paper, etc, and costs only 4/3. Kits are obtainable from all Hobbies branches and stockists or by post from Hobbies Ltd, Dereham, Norfolk (post 1/- extra).

A ONE-SOLUTION DEVELOPER/FIXER

FOR many years attempts have been made to produce a single liquid which would both develop and fix a film, to avoid the need for carrying out these processes separately. The idea has been that the solution should contain both a developer and a fixer, so that it is only necessary to immerse the film in the liquid and wait a certain time until both processes are completed.

Home-mixed solutions of this kind

By 'Photographer'

have always seemed to have various disadvantages. Some developers and fixers, when mixed, give very poor results. For example, if the fixer begins to work very rapidly, it dissolves away the sensitive materials before these have been developed into an image. Alternatively, if the fixer is slow, development goes on too long before the fixer takes effect.

A combined developer/fixer could have other advantages, in addition to doing away with the need for separate developing and fixing. When developing, it is necessary to keep a close check on the developer activity, which is governed by temperature, amount of water added, and possible exhaustion of the developer. If the solution is too diluted, too cold, or the film left immersed for too short a period, negatives are weak and thin. On the other hand, high temperatures, strong solutions, or too long development, will all give dense negatives. It is thus necessary to keep a careful watch on temperature, and to measure solutions carefully, and allow extra time if the developer is used more than once.

Fixing, however, is a process which reaches a particular stage, then stops. This means that there is no need to control the temperature of the fixer, or to time the period of fixing carefully. Nor does some exhaustion of the fixer matter. It is only necessary to leave the film in long enough. The process then stops, and longer immersion has no harmful results.

With a combined developer/fixer, it would be expected that the same factors would apply as are present in fixing in the ordinary way. If the solution is at a

fairly high temperature, development would proceed rapidly, but the negatives would not become too dense, because fixing would also proceed rapidly. Again, if the solution is at a lower temperature, or has been used, both development and fixing would be slowed, but would still proceed together at the correct rate. Furthermore, when the film has reached the stage of being completely fixed, no further development can take place. There would thus be no need to time processing exactly, or use any particular temperature.

A one solution developer/fixer called 'Monophen' has now been produced by Ilford Ltd., who have been known for many years as suppliers of films, chemicals, etc. Tests with it have shown that it provides excellent negatives, with a full range of tonal values, which print or enlarge well.

When this developer/fixer is used, there is no need for any more chemicals to be kept for the complete processing of films. The work is also much simplified, as will become clear from the following directions, which are quoted with the maker's permission.

Processing

'Provided that the temperature of the solution lies between 65°F. and 80°F. the processing of all Ilford roll and 35 mm. miniature films will be completed in 6 minutes. Over development is impossible.'

This means that an exact check on temperature need not be made, and that after at least 6 minutes have elapsed, the development and fixing are complete. If the film stays in longer than 6 minutes this has no apparent effect.

'It is important that the film should be completely covered by the solution within the first few seconds and that agitation should be continuous for the first half minute and thereafter intermittent.'

This is easily arranged. The solution is poured rapidly into the developing tank, so that it can quickly reach all the film. If an agitating rod is provided, this is worked smartly for half a minute, to dislodge air bubbles, and keep the solution moving over the surface of the film. Tanks with airtight lids are inverted — it is only necessary to follow the maker's directions. The usual intermittent agitation can be for about 5



seconds every half minute or so. After 6 minutes the tank lid can be removed.

Washing is then carried out with water initially at the temperature of the solution. This can be done by filling the tank with water at the same temperature as that of the developer/fixer, and placing the film back in the tank. A slow stream of tap water is then directed into the centre of the spiral, so that the temperature only changes gradually. After half a minute or so the tap can be let run at the usual rate for washing — that is, a good flow, but not at violent pressure. Only 5 minutes washing is required, but longer is not harmful.

After washing, the film is removed from the spiral and hung up to dry in the usual way. The emulsion should not be touched after processing or washing, while wet, because it is swollen and soft.

A 500 c.c. bottle will process about twelve films. When the developer/fixer has been mixed with water, it should be returned from the tank to a bottle having a rubber bung, so that it can be used again. For the usual 10½ oz. tank, a 10 oz. bottle, with bung, obtained from a chemist, will do well. Or a polythene bottle can be squeezed to expel air, then an air-tight cap screwed on.

It should be noted that the solution is particularly intended for Ilford films, and these can be exposed in the usual way. Suitable roll films are FP3, 29° Scheiner, HP3, which is 34° Scheiner, and the extremely fast film HPS, which is of 37° Scheiner rating, and particularly useful for poor light. It is also suitable for 35 mm. Ilford films.

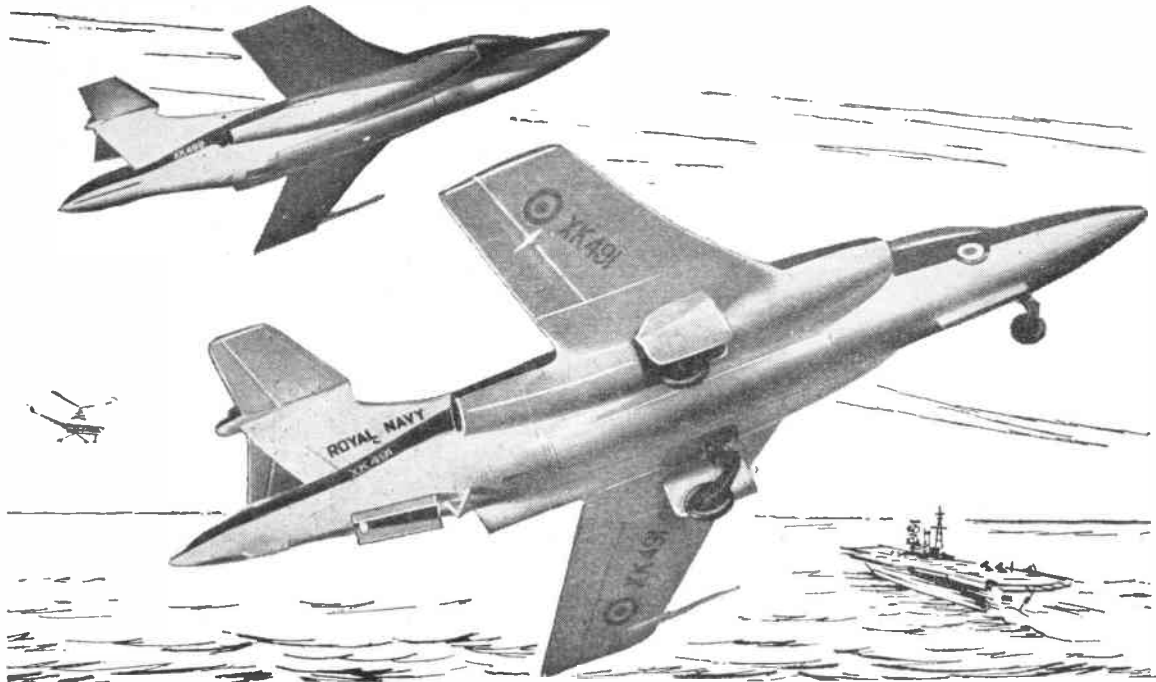

Just like the real thing!

Believe it or not, the nearer one is the Airfix model of the Blackburn N.A.39, 1/72nd scale (Kit 4/6). Behind it is a picture of the real thing.

That's how wonderfully realistic Airfix models are. Close attention to every detail gives them their faithful-to-the-original look—makes them true collector's pieces. And every Airfix series is to a constant scale. This means Airfix models look proportionally right, one against another, because *they are right!* You can't beat Airfix for realism—or value.

AIRFIX

Constant Scale Construction Kits

From Model & Hobby Shops, Toy Shops and F. W. Woolworth

There are over 100 Airfix models from 2/- to 10/6.

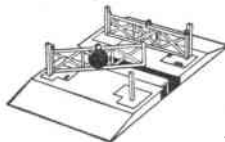

TRACKSIDE SERIES
Level Crossing 2/-



VINTAGE CARS
1930 Bentley 2/-



MODEL FIGURES
Lifeguard 2/-

BRITISH WARSHIPS
H.M.S. Cossack 2/-



A.160

STOP PRESS!

Latest Airfix Production

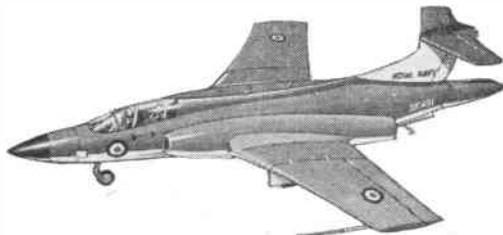

BLACKBURN N.A. 39

A perfect 1/72nd scale model of the latest naval strike aircraft, with Royal Navy markings. 10 $\frac{3}{4}$ " long, it has folding wings, hinged nose cone and other moving parts. 4/6.

Also new: 1/12th Scale model figure of BLACK PRINCE 3/-.

Mainly for Modellers

IN introducing this series I suggested that some of our readers might wish to build larger models of these fascinating little ships and to that end the making of drawings to different scales is our present consideration.

Apart from the usual squares method, many new model makers know of no other way of enlarging or reducing drawings or plans, and the methods outlined here will be useful for all model makers and in fact woodworkers and other handicraft enthusiasts.

A drawing or plan can be enlarged by using the draughtsman's method. If you are the lucky possessor of a pair of proportionate compasses it is a simple

(February 5th, 1958) with instructions for making your own set.

SCALES FOR SMALL CRAFT By 'Whipstaff'

The last set is one designed mainly for model yacht building, but still very

useful in all branches of ship-modelling. The shapes are shown in Fig. 2 and can be cut from fibre, celluloid, or any strong thin material. Both of my own sets were made from heavy celluloid cut from an army surplus map case, purchased for 1/-.

We will now consider the actual method of enlarging or reducing. As shown in Fig. 3, this can be used to convert a drawing to any required scale, large or small. It is much to be preferred to the squares method because it is accurate. Except for toys or furniture design, I do not favour the squares method because small discrepancies creep in, which, while not making a great deal of difference in a toy, would be inexcusable in a scale model.

As an example, we will describe how to reduce a drawing from 30 in. to 15 in.

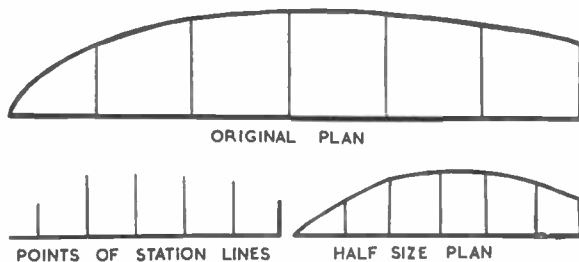

Fig. 1—Reducing to half-size

matter to enlarge or reduce by means of these. Most of us, however, do not possess such an expensive drawing instrument, but most of us have, or can purchase at a reasonable price, a pair of dividers, and these are quite handy for our purpose.

In using these to enlarge or reduce the procedure is to draw your base line as in Fig. 1. Such measurement is taken off with the dividers for accuracy. The dividers are then set to the measurement required for the new scale and stepped off on your base line. When all points are marked, they are then connected, using a ruler for straight lines and a French curve for the curved lines.

I use three different sets of curves, and between them they cover every shape I am likely to find in drawing for ship models.

The first is an ordinary set of draughtsman's French curves, the set of five costing 8s. 6d. The second is the set of French curves designed especially for ship modelling and which formed the subject of my article in *Hobbies Weekly*

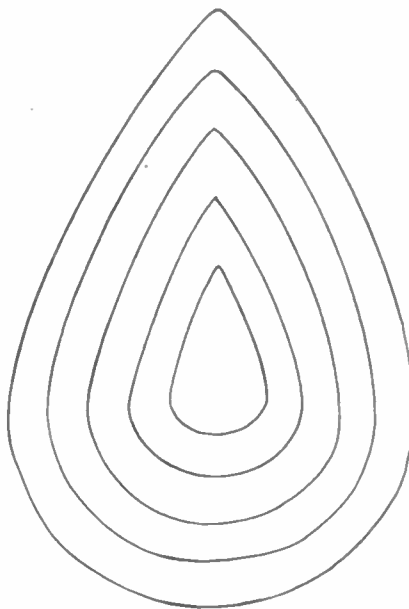

Fig. 2—Curves for model yacht drawing. (These are half scale of the original.)

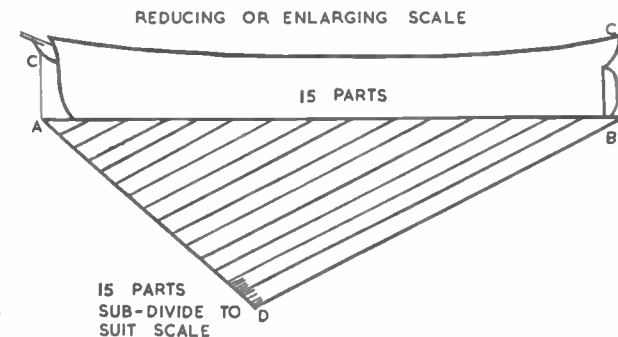

Fig. 3—Reducing or enlarging scale.

First draw a base line AB parallel to the waterline of your plan. At each end, at A and B, a vertical line C is drawn to define the length of line AB. From point A, draw a line AD equal to the length you wish AB to be in your new scale (in this example 15 in.). The angle formed by AB and AD can be of any value. Join point B to point D. Now divide line AD into fifteen equal parts, and do the same with line AB. Now join up these dividing points so that you have fifteen lines running parallel to line BD. Sub-divide these inch divisions on line AD into $\frac{1}{2}$ in. or $\frac{1}{16}$ in. to make your measuring easier.

To measure any part or unit, set your divider points to length, height, or width. Then place one of the divider points on point A and note where the other point comes on line AB. From this mark on line AB, follow down the parallel line where it falls on line AD. From this point on AD to point A is the new measurement required.

It will be seen that the length of line AD determines the new scale, whether reducing or enlarging.

Quick! pass the CERTOFIX

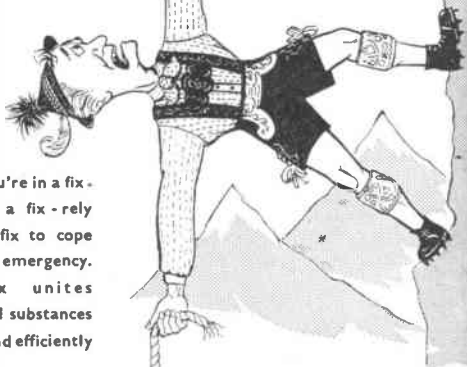

When you're in a fix - or need a fix - rely on Certofix to cope with any emergency. Certofix unites almost all substances cleanly and efficiently

CERTOFIX FOR ALL YOUR FIXES!
Obtainable at Woolworth Stores

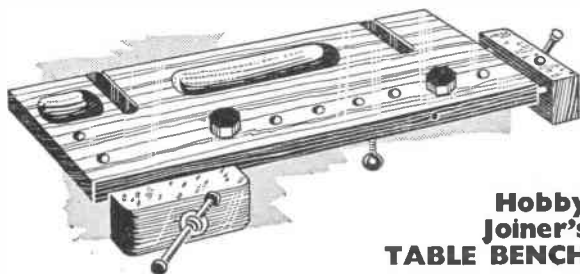

Hobby Joiner's TABLE BENCH

Cramps to kitchen table to provide an ideal working surface for cutting, shaping and assembling small parts. The spaced holes and pegs permit work to be held for planing. Two sturdy vices, two metal cramps. Size 37/6
20 in. long. Made of seasoned hardwood for years of service.

HOBBIES LTD., Dept. 99, Dereham, Norfolk

HEAR ALL CONTINENTS With H.A.C. Short-Wave Receivers

Suppliers for over 18 years of radio S-W Receivers of quality.
One-Valve Kit, Price 25/- Two-Valve Kit, Price 50/-
Improved designs with Denco coils. All kits complete with all components, accessories and full instructions. Before ordering, call and inspect a demonstration receiver, or send stamped addressed envelope for descriptive catalogue.
'H.A.C.' Short-Wave Products (Dept. 22), 11 Old Bond Street, London, W.1.

KITS for OLD TIME SHIPS

Hobbies range of Ship Models includes Elizabeth Jonas, Cutty Sark, Victory, Mayflower, etc. Complete kits of wood, sail material, guns, pulleys, cord, etc., with full-size patterns of parts and planed wood ready to cut out, shape and construct. A fascinating pastime.
Ask for free illustrated list at Hobbies Branches or from Hobbies Limited, Dept. 99, Dereham, Norfolk.

MANY MODELS from ONE TIN!



Pyruma, plastic and ready to use from its tin, can be fashioned into the widest variety of models imaginable. Buildings for your model railway set, houses, ship models, animals and figures, ashtrays and plaques — all of which when set or baked to stone-hardness can be finished in natural colours. Get the Pyruma Model Instruction book — see Coupon, and start making things like those shown below.

SANKEY'S PYRUMA PLASTIC CEMENT

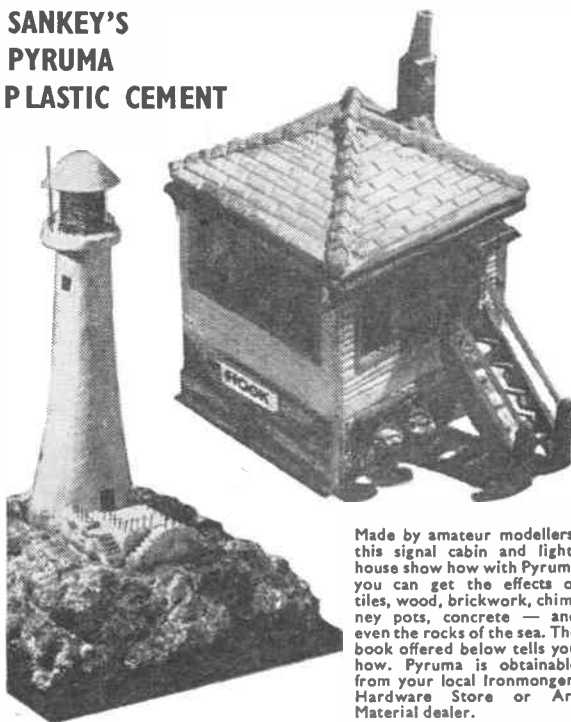

Made by amateur modellers, this signal cabin and lighthouse show how with Pyruma you can get the effects of tiles, wood, brickwork, chimney pots, concrete — and even the rocks of the sea. The book offered below tells you how. Pyruma is obtainable from your local Ironmonger, Hardware Store or Art Material dealer.

POST THIS BOOKLET COUPON TO-DAY

To J. H. SANKEY & SON, LTD (Dept. HW),
ILFORD, ESSEX

I enclose P.O. 6d. (not stamps) for a copy of Pyruma Modelling Instruction Booklet, post free to:

NAME

ADDRESS

(BLOCK LETTERS PLEASE)

125 STAMPS FREE to approval applicants. — Read, 19 Keistern Close, Cinderhill, Nottingham.

GRAND OFFER — Pkt. of Stamps Cat. Value 20/-; Stamp Album; Sheet of Flags; Pkt. Stamp Hinges. **THIS BARGAIN OFFER** for **ONLY 7/6**. Postage extra. — 'APPROVALS', 32 Cross Whitehouse Row, Leeds 10, Yorks.

FOR SALE — Hornby Dublo 2007 Train Set, and Marshall 2 power unit; Cost £6, never used. What offers? — Goldsmith, Holly Farm, Rocklands, Attleborough, Norfolk.

SUPERB Mint Colonial blocks free to approval applicants. — Dartnall, 16 Crossmead, Eltham, S.E.9.

HOME WOODWORKERS wanted. Good opportunity to earn spare cash. Fair and genuine offer; details — Southern Sports, Longstone Road, Eastbourne.

MAIL ORDER and home employment course in one 10,000 word manual. Copy 5/6 Mosaic (Dept. 8), 124 Newport Street, Bolton.

KUKLOS ANNUAL. Indispensable cyclists' handbook. Tours, resthouses, money-saving hints. 3/- post free. — Burrow, Publishers, 2 Imperial House, Cheltenham.

100 DIFFERENT stamps free! Request 1/4d. upwards discount approvals. — Bush, 53 Newlyn Way, Parkstone, Dorset.

NEW!

LEARN
**RADIO & T/V
SERVICING and
ELECTRONICS**

and how to make and build your own equipment — using an exciting new Practical apparatus course. Ideal for starting your own business or as a fascinating hobby.

FREE Brochure, without obligation, from
RADIOSTRUCTOR Dept. G.81
READING, BERKS
Britain's leading radio training organization

MODELS. You can make lasting stone-hard models with Sankey's Pyruma Plastic Cement. Supplied in tins by Ironmongers, Hardwaremen and Builders' Merchants. Ask for instruction leaflet.

WORKERS with sewing machines required for making cushion covers. Regular work guaranteed. Apply enclosing s.a.e., Dept. 28, Arnold Trading, 10 Shelley Road, Worthing, Sussex.

WHEELS (Hardwood and Rubber Tyred Metal). Cot, Pram, and Doll's House Fittings and Papers, Beads, Transfers, Prints and other accessories. Stamp for new lists. (Trade supplied.) New address — **JOYDEN CO.**, 91 Peplins Way, Brookmans Park, Herts.

PERSONS (either sex). Soft toy assembling. The ideal profitable pastime. Experience unnecessary. Everything supplied. Apply, enclosing s.a.e. Dept. H.W. Cuddycraft Supplies, East Road, London, N.1.

LEARN RADIO & ELECTRONICS the NEW Practical Way! Very latest system of experimenting with and building radio apparatus — 'as you learn'. **FREE Brochure** from: Dept. H.W.10, Radiostructor, 40 Russell Street, Reading, Berks.

IF YOU LIKE Writing, Drawing, Painting or Designing read 'WRITE FOR PROFIT' or 'PROFITABLE ART'. State which, both free. Absorbing data, beginner or otherwise. Exceptional opportunities. **WRITERS' RING** (HW), 5 Edmund Street, Birmingham, 3.

50 KENYA Stamps 3/-. 25 Malta 4/6, 25 Philippine 5/-. Stamp Magazines 1/- monthly. Try our 7 day approvals. E. C. F. Townsend (H), 92 Tenby Road, Edgware, Middx.

TRANSISTORS, Germanium Crystals, Headphones, etc. Lists and diagrams free. Germanium Diodes with three crystal set circuits 1/-. Postage 4d. P.R.S. (H), 33 Bourne Gardens, London, E.4.

MAKE ART PAY. Learn to Draw/Paint Flowers, Birds, etc. in Designs or Pictures for waiting manufacturers. Profitable. Remunerative. Even beginner's work can sell. Postcard brings free brochures. Clun Valley Features (H.W.), Clun, Salop.

NEW Angles on **OLD favourites**

from these Books bulging with BRIGHT IDEAS

Any volume in this most interesting range of books, each dealing with a different aspect of gummed papercraft, will show you a wealth of ideas, the way to carry them out, and give hours of intense enjoyment. Each is the key to an economical hobby that is rich in variety, ranging from the making of a charming picture to framing it delightfully — from three dimensional models to wall decorations, from paper sculpture to charming flower studies.



GUMMED STRIP AND PAPER MODELLING
FREDERICK T. DAY



Decorative Flower and Leaf Making
FREDERICK T. DAY

**Other books by
FREDERICK T. DAY**

Coloured Paper Decoration	7/6
Coloured Papercraft for Schools	7/6
Coloured Papercraft for Infants' Schools ..	6/-
Lampshade and Parchment Craft	8/6
Decorative Flower and Leafmaking	8/6
Gummed Strip and Paper Modelling	7/6
Paper Sculpture for Schools	7/6



PASSE-PARTOUT FOR SCHOOL and HOME
FREDERICK T. DAY



BUTTERFLY BRAND

8/6

SAMUEL JONES & CO. LTD.

STATIONERY MILL, CAMBERWELL, LONDON, S.E.5. RODNEY: 5064

All books obtainable from:
Newnes & Pearson Ltd.
Tower House, Southampton St., Strand, W.C.1.
Ask your stationer to show you the Butterfly range of
handicraft materials.

INDOOR LETTER-BOX COVER

CUT this shape from cardboard and try out on the letter box. Make necessary adjustments to fit, and then transfer the shape to heavy grade polished aluminium. Cut out with a Hobbies metal cutting fretsaw, lubricating the work with oil to facilitate cutting. The cover is secured to existing bolts at A or it may be screwed into place. (M.p.)

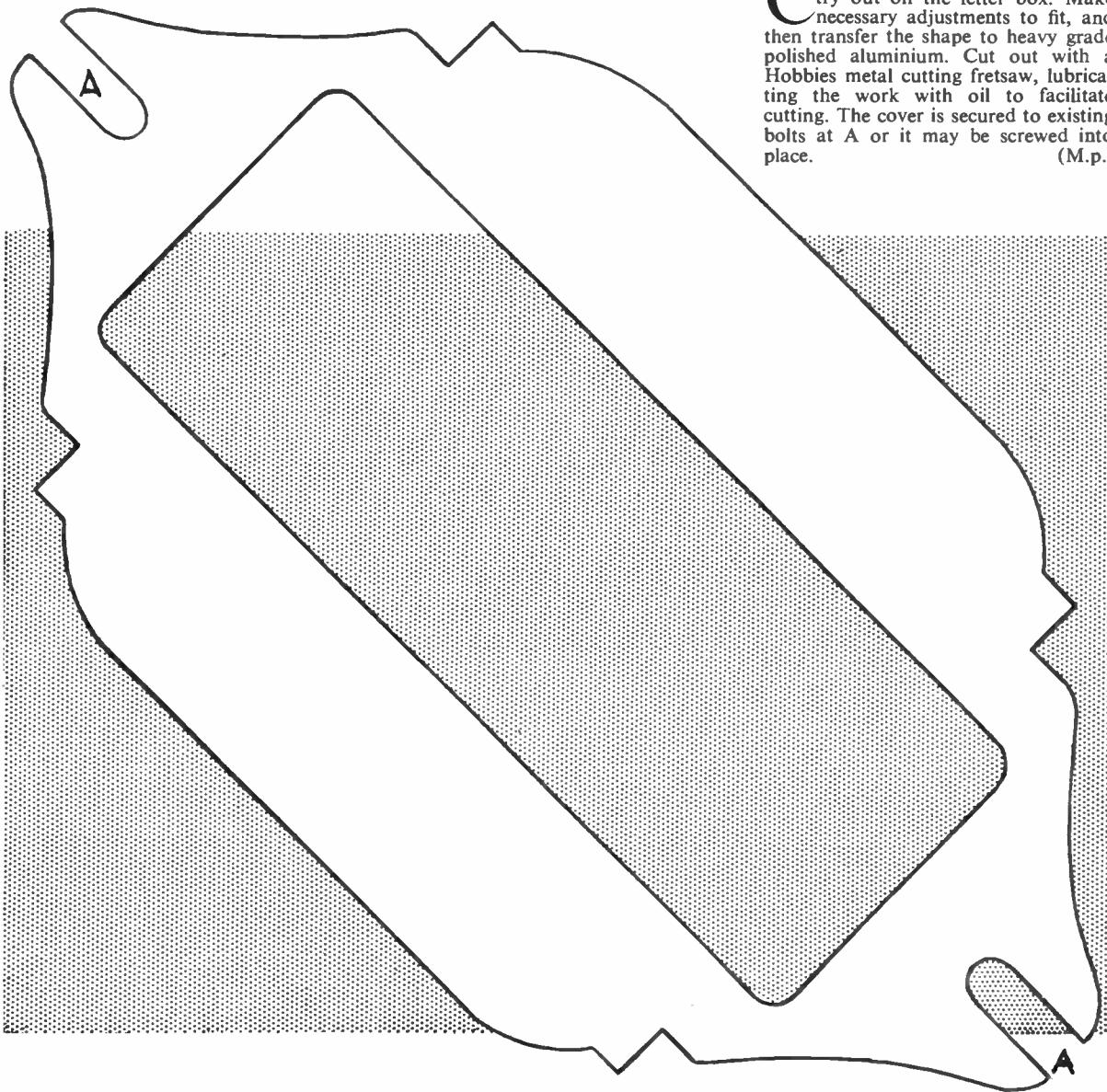

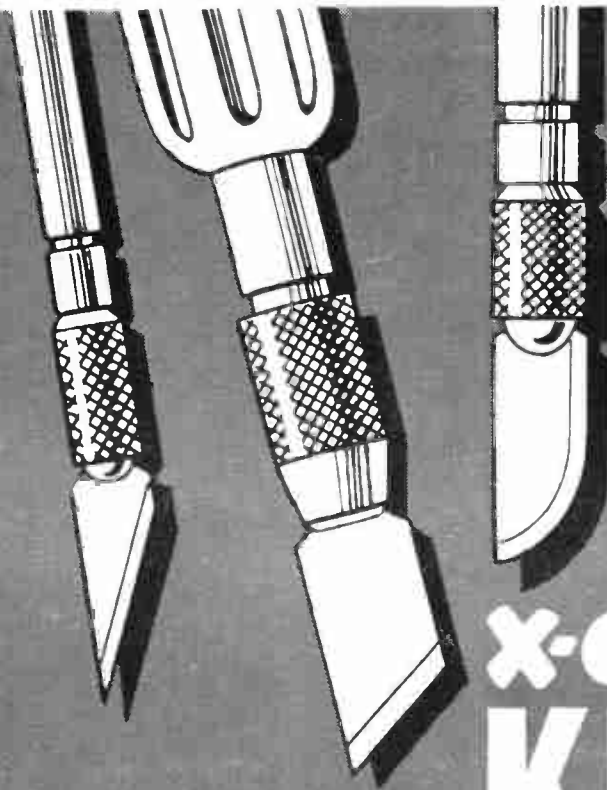

x-acto KNIVES

with the **BIG RANGE** of

INTERCHANGEABLE BLADES

X-acto Knives with their nine different blades and three different weights of handles are a delight to use. They enable you to tackle every modelling job with skill and precision. Made in razor sharp surgical steel you can get them from Hobby Shops and Ironmongers.



DUFAY (B'HAM) LTD.

(X-ACTO DIVISION)
308 SUMMER LANE BIRMINGHAM 19

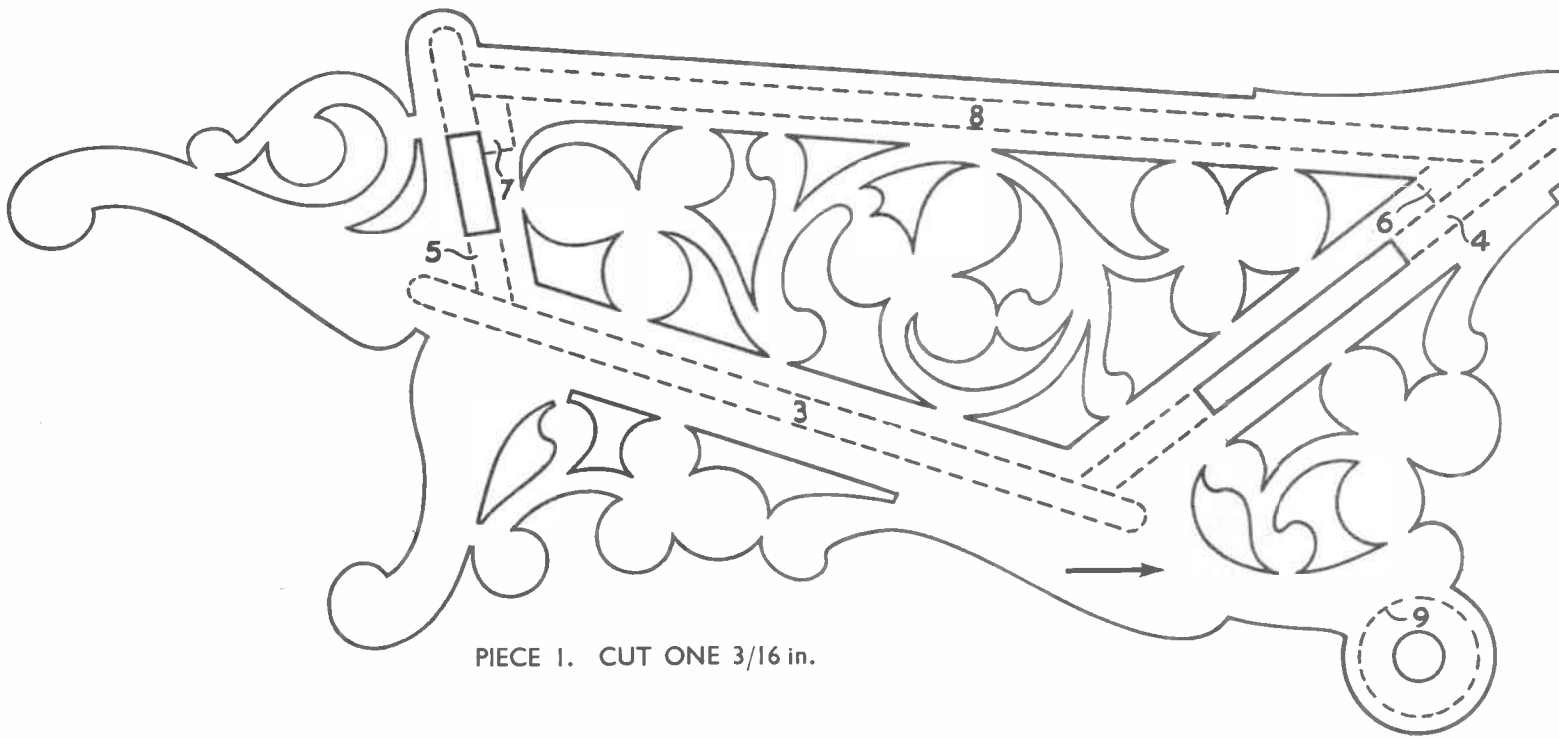

PIECE 1. CUT ONE 3/16 in.

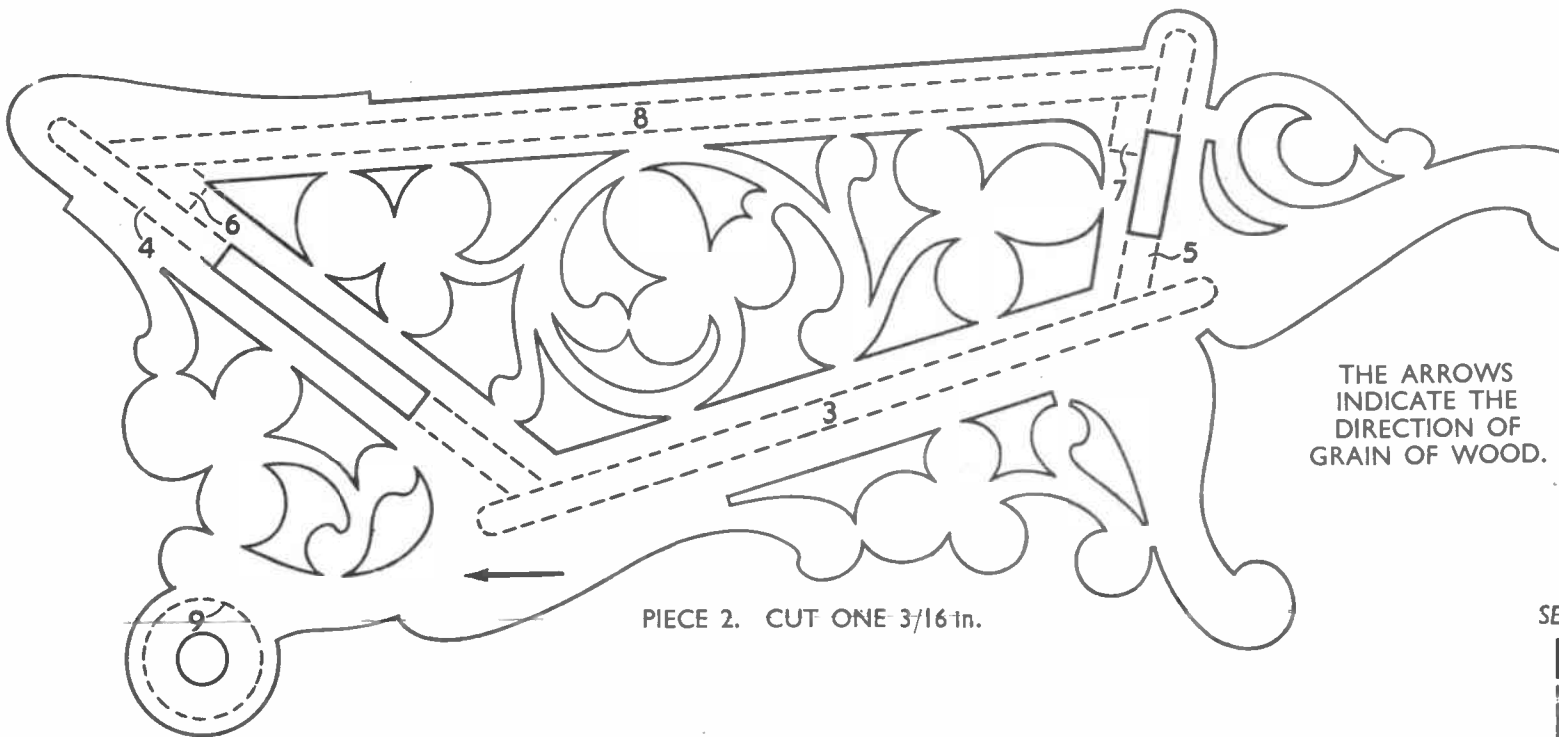

PIECE 2. CUT ONE 3/16 in.

THE ARROWS
INDICATE THE
DIRECTION OF
GRAIN OF WOOD.

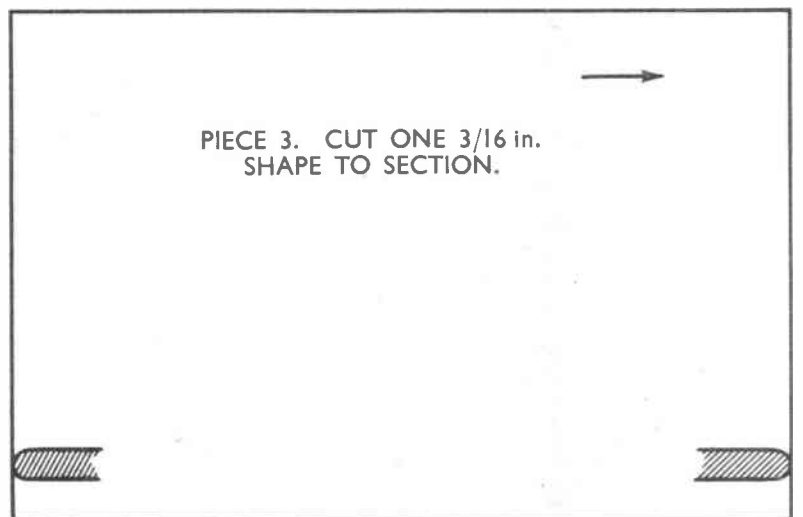
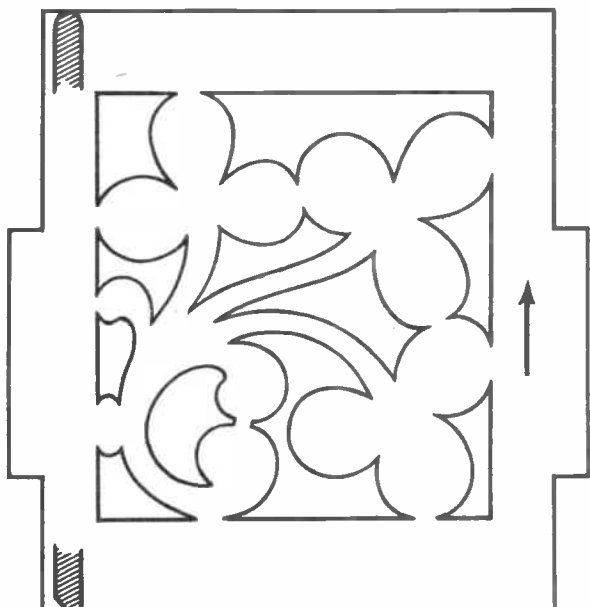

PIECE 3. CUT ONE 3/16 in.
SHAPE TO SECTION.

PIECE 1. CUT

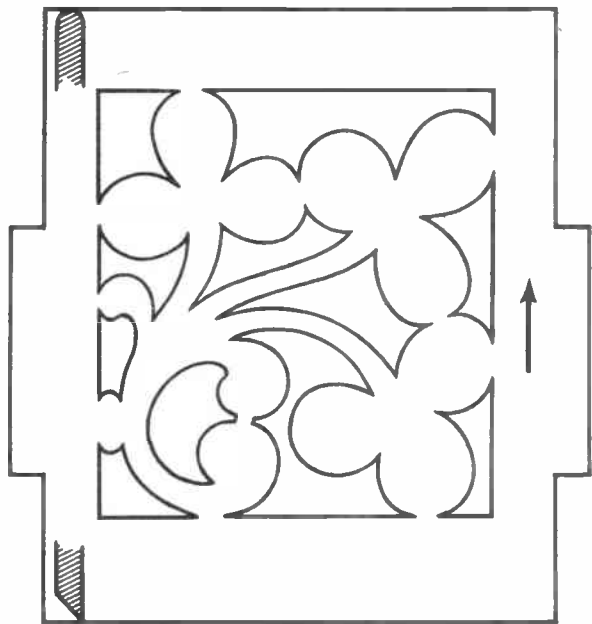
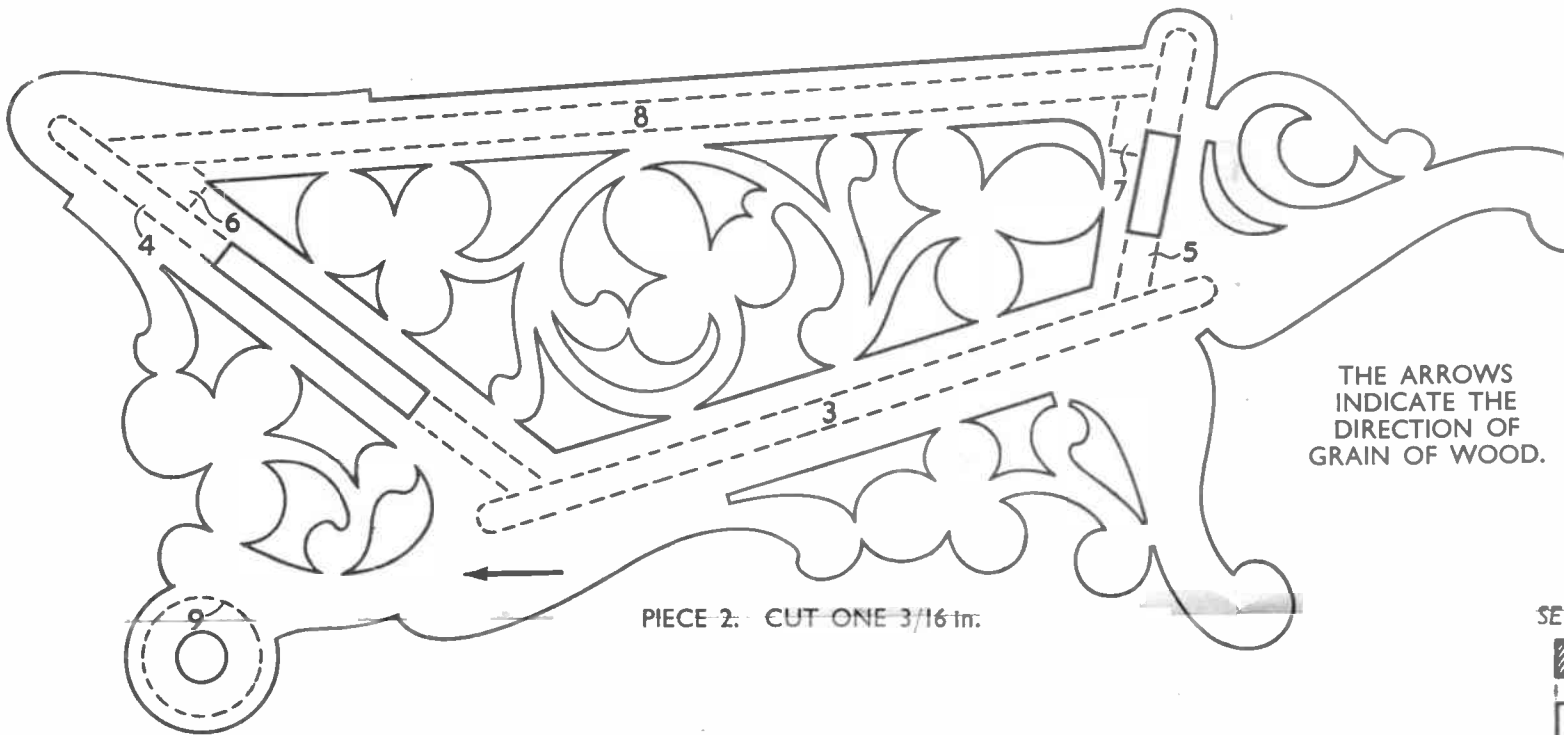

PIECE 4. CUT ONE 3/16 in. SHAPE TO SECTION.

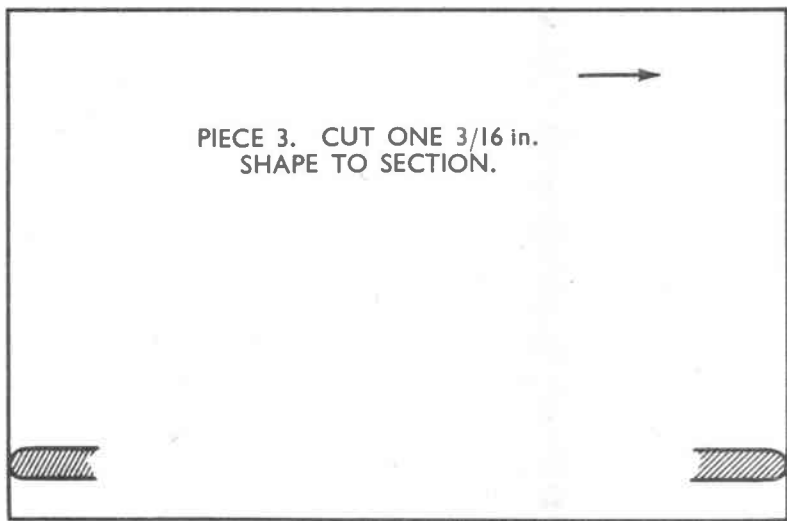

PIECE 3. CUT ONE 3/16 in. SHAPE TO SECTION.

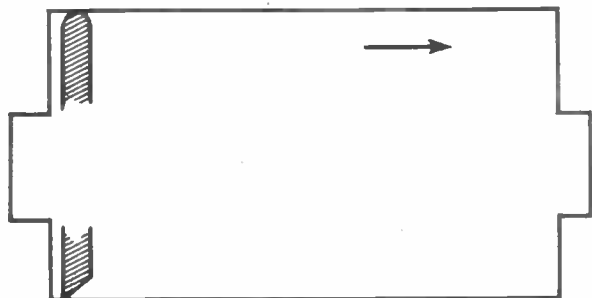

PIECE 5. CUT ONE 3/16 in. SHAPE TO SECTION.

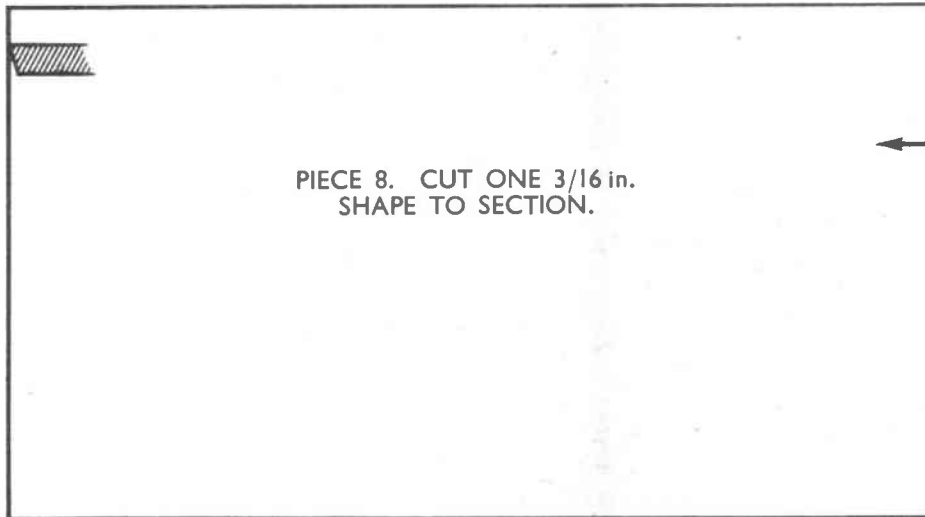

PIECE 8. CUT ONE 3/16 in. SHAPE TO SECTION.



THE ARROWS INDICATE THE DIRECTION OF GRAIN OF WOOD.

6 in.

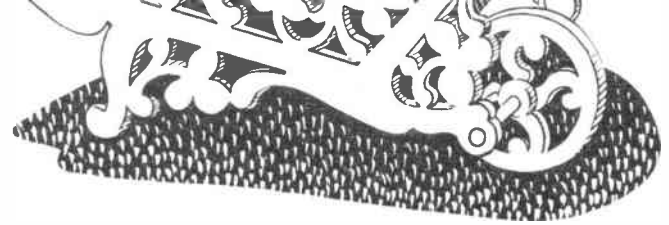

SIZE: 8½ ins. LONG.

A KIT OF MATERIALS FOR MAKING THIS DESIGN IS SUPPLIED BY HOBBIES LIMITED, DEREHAM, NORFOLK. PRICE ON APPLICATION.

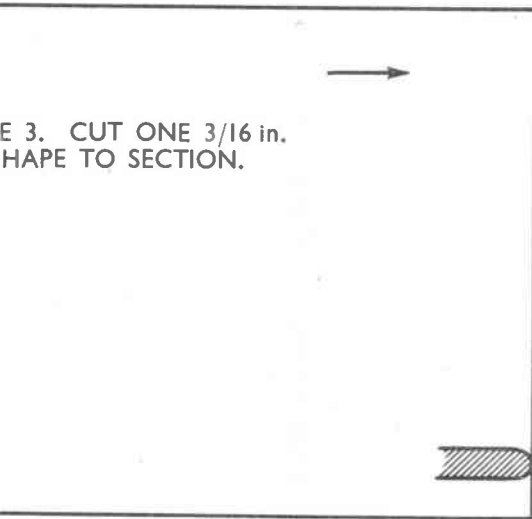

PIECE 3. CUT ONE 3/16 in. SHAPE TO SECTION.

SECTION



PIECE 6. CUT ONE 3/16 in. SHAPE TO SECTION.

SECTION



PIECE 7. CUT ONE 3/16 in. SHAPE TO SECTION.

THE WORLD'S STRONGEST GLUES

Stick it with-

Croid AERO

HOME OUTFIT COMPLETE WITH BRUSH AND AERO GLUE

This is a hot animal glue of tremendous strength. It's ready prepared in this handy Home Outfit, comprising 8 oz. tin of Croid Aero, a hot water container and a spreader—4/- complete.

BUY CROID FROM YOUR LOCAL HOBBIES BRANCH



PIECE 10. CUT ONE 3/16 in.

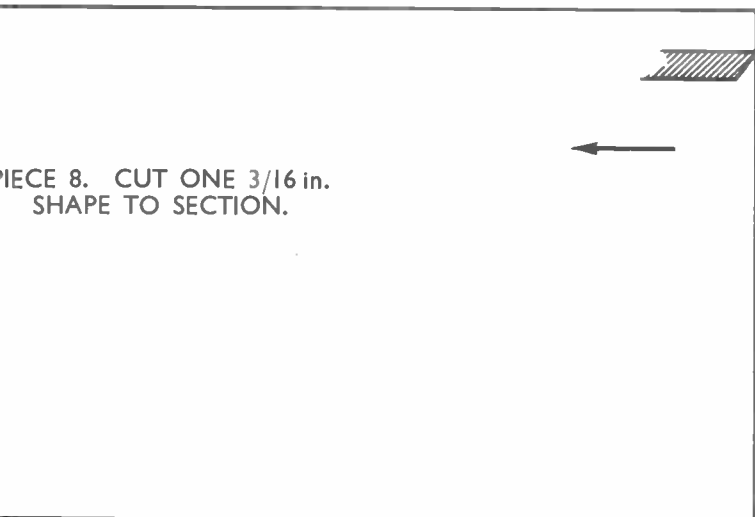

PIECE 8. CUT ONE 3/16 in. SHAPE TO SECTION.

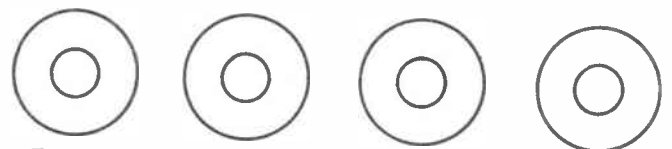

PIECES 9. CUT ONE OF EACH 3/16 in.

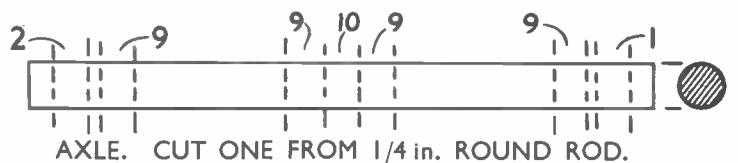

AXLE. CUT ONE FROM 1/4 in. ROUND ROD.

PRINTED IN ENGLAND.

NOVELTY WHEELBARROW PINCUSHION

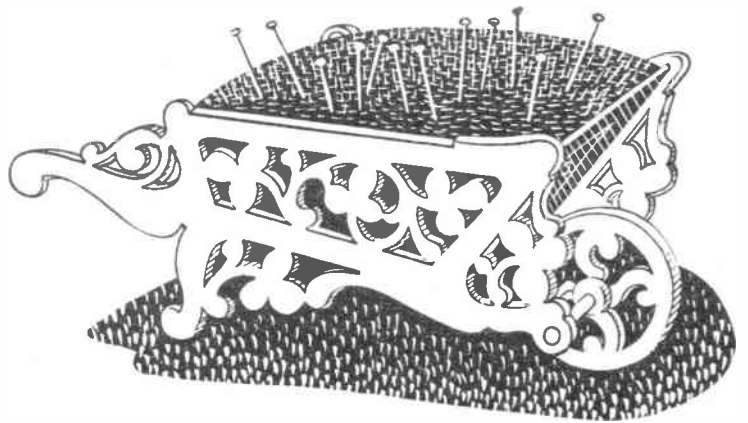
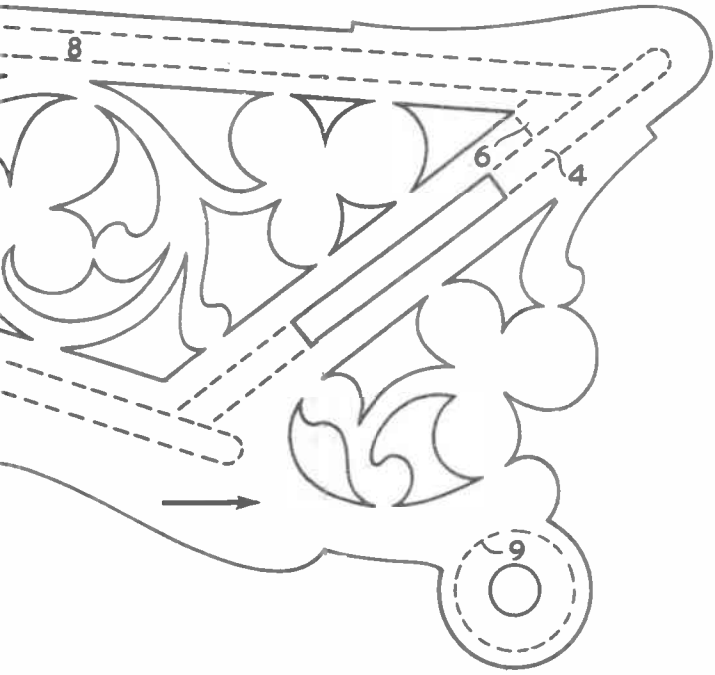

SIZE: 8½ ins. LONG.

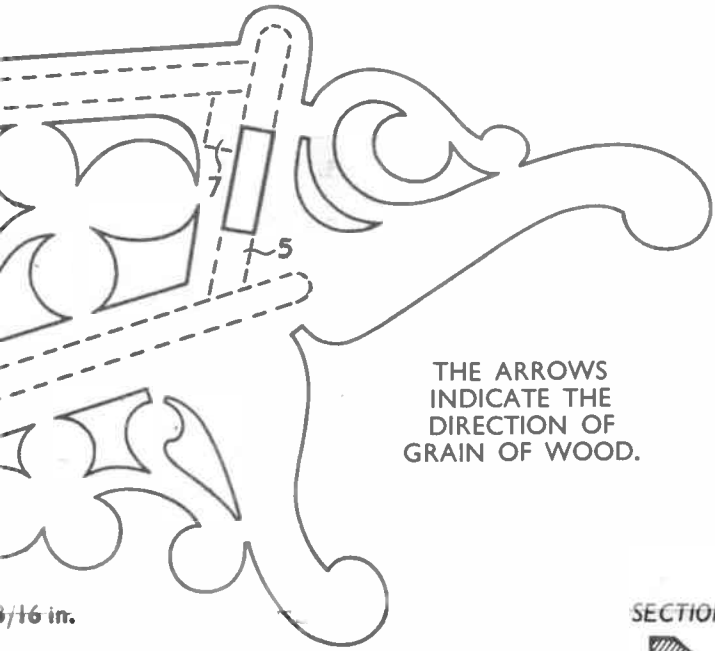

THE ARROWS INDICATE THE DIRECTION OF GRAIN OF WOOD.

A KIT OF MATERIALS FOR MAKING THIS DESIGN IS SUPPLIED BY HOBBIES LIMITED, DEREHAM, NORFOLK. PRICE ON APPLICATION.

3/16 in.

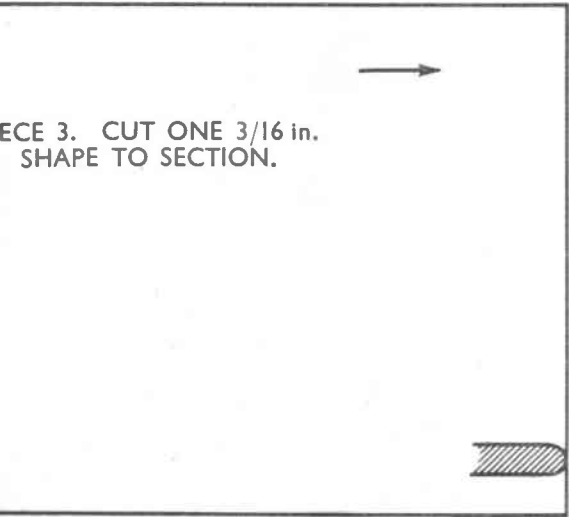

PIECE 3. CUT ONE 3/16 in. SHAPE TO SECTION.

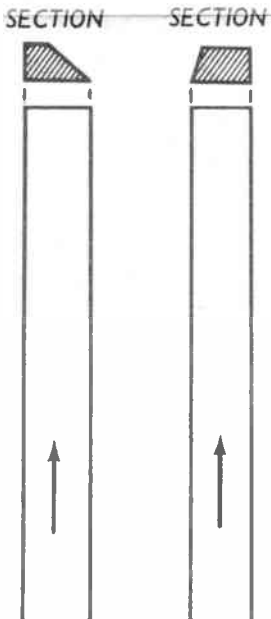

PIECE 6. CUT ONE 3/16 in. SHAPE TO SECTION.

PIECE 7. CUT ONE 3/16 in. SHAPE TO SECTION.

THE WORLD'S STRONGEST GLUES
Stick it with-
Croid AERO

HOME OUTFIT
 COMPLETE WITH SPREADER AND
 AERO GLUE

This is a hot animal glue of tremendous strength. It's ready prepared in this handy Home Outfit, comprising 8 oz. tin of Croid Aero, a hot water container and a spreader—4/- complete.

BUY CROID FROM YOUR LOCAL HOBBIES BRANCH

