

9th MARCH 1960

VOL. 129

NUMBER 3352

THE ORIGINAL
'DO-IT-YOURSELF'
MAGAZINE

HOBBIES *weekly*

FOR ALL
HOME CRAFTSMEN

FREE design supplement

**MAKE THIS DELIGHTFUL
TRAY IN MARQUETRY**

Also in this issue:

A SERVICEABLE
COAL HOD

COLLECTORS' CLUB

JIMMY LOGAN'S
PICNIC BOX

YOUR FRETWORK
PATTERN IS ON

page 415

USING PHONES
WITH A RADIO

RETOUCHING DESK
FOR NEGATIVES

MODELLING AND
NOVELTY PROJECTS

ETC. ETC.

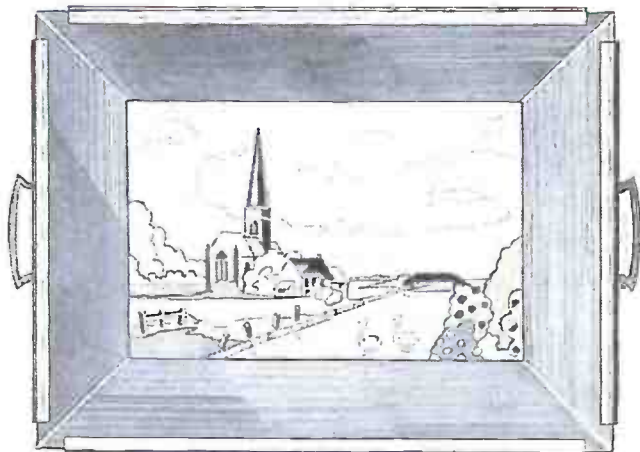

'THE LANDMARK'

A LASTING PICTURE IN NATURAL WOODS



Up-to-the-minute ideas

Practical designs

Pleasing and profitable things to make

5⁰

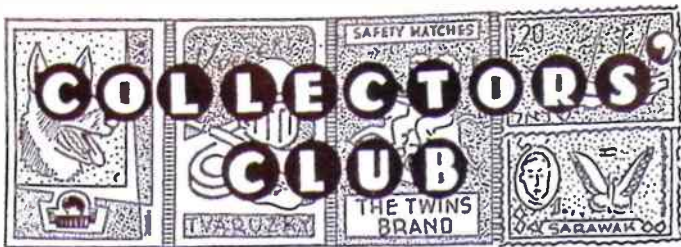

SARAH C. Cook of 1008, 45th Street, Oakland 8, California, U.S.A., has proved an interesting and reliable pen friend to many readers. In her last letter she said: 'I hope the photograph of my husband and self is not disappointing. I am 72 years of age but don't feel that old.'

works for a solicitor, collects stamps and film star pictures, and enjoys all outdoor sports.

Trevor Mann, 2 Lambs Plot, Chetnole, Sherborne, Dorset, works on a farm. He has a large collection of classic stamps and labels.

Mrs E. R. Tuttle, Eagle Street, R.I., Ware, Mass., U.S.A., collects dolls. She has many interesting items for exchange. H. Ginters, 2 Elsham Station Cot-



Trevor Mann

St. Catharines, Ont., Canada, writes: 'I receive your *Hobbies Weekly* from my employer, Mr A. R. Marshall. We are keen collectors of stamps and beer labels and would like letters from fellow readers.'

Mrs Mary Arnold, 29 Bendrick Road, Barry, Glam., South Wales, would like to exchange brewery labels with other readers. 'I am an invalid and have been confined to the house for the past four years,' she says. 'I take a great interest in my son's copy of *Hobbies Weekly*, which I have taken for him since his childhood.'

Keen sportsman

Roberto M. Acuna of Casilla Correos 1720, Buenos Aires, Argentina, has recently become a regular reader of the magazine. In a recent letter he said: 'I like sports very much, especially wrestling, weight-lifting, boxing, swimming,



Mr and Mrs Cook



St. Andrew's Church, Oakland, Calif.

Regular reader Bill Robinson of 35 Hartley Street, Cairns, Queensland, Australia, has sent a photograph of his 16-year old daughter, Betty, who would like friends throughout the world. She

tages, Barton Road, Wrawby, Brigg, Lincs., will answer all pen friend letters. Mr Ginters collects stamps and all types of brewery labels.

John M. Boyle, 44 Bloomfield Avenue,



Betty Robinson



Mrs E. R. Tuttle



Roberto M. Acuna

football and rugby. I also like music, dancing, reading books and travel.' Roberto collects stamps, hotel labels and postcards. (R.L.C.)

A SERVICEABLE COAL HOD

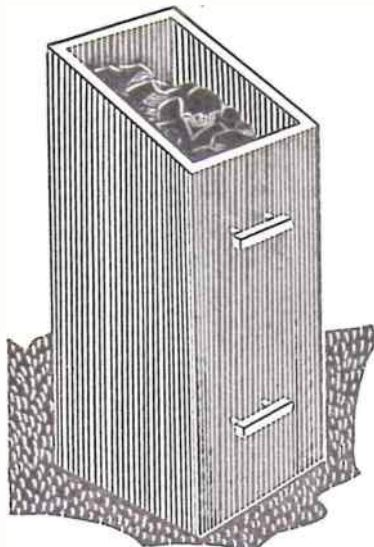

making sure that they are square and true. Note the slope on pieces C, also the chamfer on the back A, and the front B, as seen in Figs. 2 and 3. The chamfer will conform to the slope of the sides C, and may be planed off after assembly. The assembly is shown clearly in Fig. 2.

The sides C and pieces A and B should be drilled to take 1 1/4 in. No. 12 screws, which should be countersunk, and the holes filled with plastic wood. Assemble with glue to give extra strength.

Suitable handles may be purchased from Hobbies Ltd, Dereham, Norfolk, price 1/4 each, post 4 1/4d. Each consists of a brown plastic bar, 3 in. long, with black spacers (Fig. 3). The front B should be drilled to take the threaded portion of the handles.

Rub down the assembly, and fill with wood filler, paying particular attention to the end grain. Give one undercoat, and finish off with two top coats. The outside could be painted to match existing furnishings, but the inside should be painted black. (M.h.)

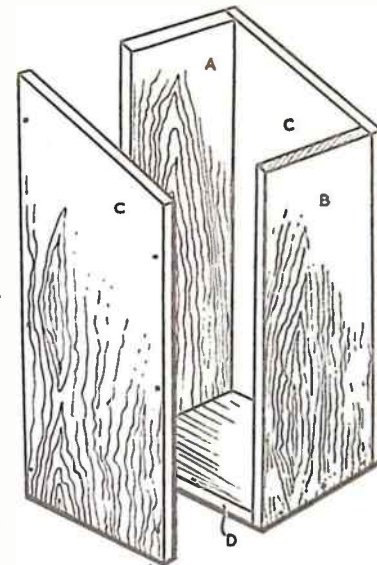

Fig. 2

A STRONG and serviceable coal hod can be made from 1/2 in. hardwood, as shown in the diagrams. Oak or Spanish chestnut is the ideal wood, but other kinds may be used if readily available. The sizes are not important, but for your convenience we have shown suggested measurements.

Fig. 1 shows the various pieces, and they should be marked out carefully.

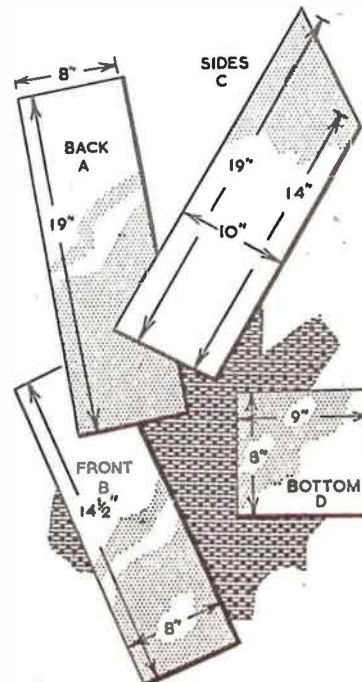
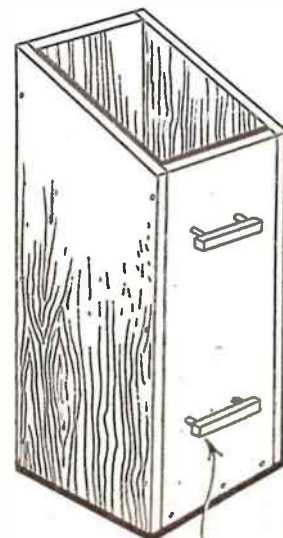

Fig. 1



HOBBIES No.700 HANDLE

Fig. 3

NEXT WEEK

Next week's issue will show how to make decorative trellis sections and arches for the garden. There will also be patterns for an Easter picture and the usual features on chemistry and photography.

Gordon Allen will describe the construction of a corner cabinet for the kitchen.

MAKE SURE OF YOUR COPY

Instructions for making

Delightful Marquetry Tray

BESIDES its practical uses for serving tea and drinks, etc. to friends, this charming tray will be particularly welcomed for its pictorial value.

The picture subject will appeal to all lovers of marquetry. The scene, with the church as its focal point, lends itself to a beautiful picture in wood containing wide expanses of cloud and sky for effect, to which is added animation by way of a stretch of water complete with swans. The scene is bordered by walnut veneers, and the tray is finished off with contemporary moulding which is left open at the corners to facilitate cleaning. The size of the tray is 20 in. by 15 in., and it has two metal handles for carrying.



'The Landmark'

Big range of colours

The Hobbies kit for making up the tray includes a piece of $\frac{1}{2}$ in. plywood 20 in. by 15 in., which is the exact size to be used. A pack of named veneers gives a big range of wood colourings, and also included are moulding for the edges, handles, screws, etc. There are also special walnut veneers for the borders.

The picture is completed in knife marquetry, and the veneers to be used for each part are indicated on the design sheet. Where arrows are shown, this indicates the direction of the grain of the veneer.

Transfer the complete details of the picture from the design sheet with carbon paper on to the plywood base. Do not mutilate or mark the design sheet too heavily, as it will be needed again when marking the individual veneers for cutting out. Make a start on veneering by transferring the sky shape from the

design sheet on to the sycamore veneer which is shown as the wood to be used. When tracing, be guided by the shape of the heavy outline shown in Fig. 1. From this it will be seen that the top and sides are cut exactly to shape, but the piece also includes the cloud effects, which will be removed, and a substitute veneer added at a later stage. Note also that there is an overlap of approximately $\frac{1}{2}$ in. all round the bottom outline of the piece of sycamore. This overlap will also later be cut away when adjoining veneers are added.

Fixing the veneers

Cut neatly round the sky shape. Use a metal rule and sharp knife for getting the top and sides straight. After cutting out the shape, fix the veneer in position on the baseboard. To do this, rub some balsa cement on to the back of the veneer, smooth it down, and allow to dry. Do the same to the backing board in the section where the veneer will be attached. When dry, apply some more cement, and then stick the veneer firmly in position, pressing down well with the fingers, and making sure that there is no lifting, particularly at the corners.

Now trace the shape of the centre cloud on to the indicated horse-chestnut veneer. This is shown shaded in Fig. 2. Again cut neatly to the outline, and hold it in position on the sky veneer (sycamore). This cloud piece is now used as a template. Hold it perfectly still, and cut round its outline in the sycamore veneer

with a sharp knife. Place the cloud veneer on one side, and prise up the unwanted sycamore shape from the baseboard, as shown in Fig. 3. It can now be seen that the cloud shape should be a perfect inset in the sky piece, and it can next be stuck down in place as previously described. It will be appreciated that by using this overlapping and template method, a perfect fit for each subsequent piece should be ensured.

GET A KIT

Hobbies Kit No. 3352 for making this very attractive tray contains plywood base, suitable veneers and borders, moulding, handles, etc. Kits from branches, price 21/9, or by post from Hobbies Ltd, Dereham, Norfolk (2/- extra)

All the cloud effects are worked into the sky in this same manner. Now continue working down the picture, adding new features as they adjoin previous pieces. For instance, the steeple, trees, etc., can be worked in next. In all cases allow an overlap, so as to ensure perfect fitting of the veneers.

When the central picture theme has been completed, the walnut borders can be added. These are mitred at the corners as shown in Fig. 4.

The attractiveness of the finished tray will depend a great deal on the result obtained when polishing the veneered surface. Begin by scraping and glasspapering. A very satisfactory method is to use the edge of a piece of glass for scraping until a fair level has been obtained. Then finish with a glasspaper block. Work down from medium to fine grade until the surface is perfectly smooth.

A word of caution is, perhaps, necessary here. Be careful not to apply too much pressure with the scraper or glasspaper so as to rub away the veneers completely, and thus reveal the base. When as flat a surface as possible has been attained, the picture is ready for polishing. Apply white wax polish with the finger tips, rubbing well into the veneers. Then go over lightly with a duster, and give a rub down with a fine grade glasspaper. It will be necessary to change the paper about frequently, because the wax will fill it up. Repeat this process of waxing, polishing, and glasspapering until such time as a high gloss finish has been obtained to the surface. Remember that the more work you put into this operation, the better will be the finish.

The addition of the tray moulding is

Fig. 3—
Removing
unwanted
veneer

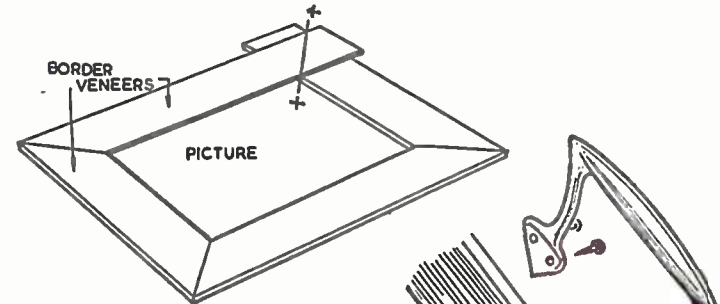
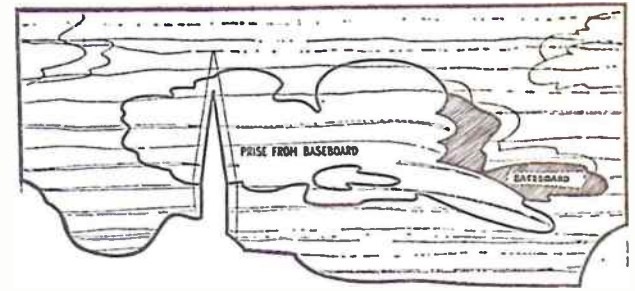

Fig. 4

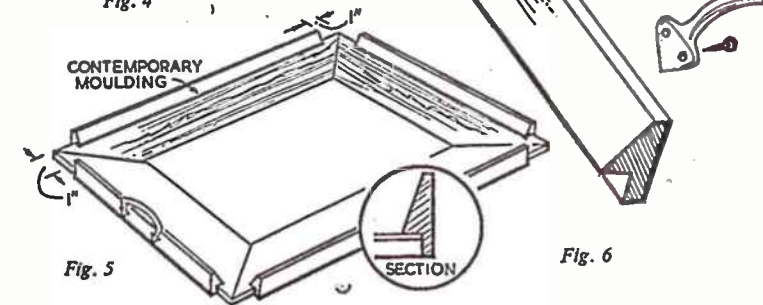

Fig. 5

Fig. 6

shown in Fig. 5. It is glued in position, and pinned if necessary. The moulding can be painted, stained, and polished or

varnished as desired. To finish your work, the handles are screwed to the end moulding, as shown in Fig. 6.

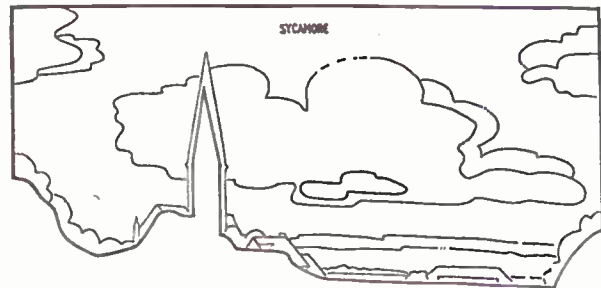
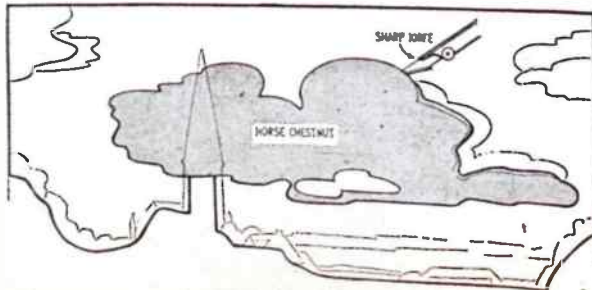

Fig. 1—
The first
veneer
shape

Fig. 2—
The
second
veneer
shape



Can we help these readers?

MR J. A. STEEL of 35 Patrick Avenue, Orrell, Bootle 20, Liverpool, Lancs., has been very well pleased with the 'wonderful response' to a previous request for an old design which was printed in this column. Other designs which he would appreciate are: Nos. 1418 (Card Box and Draughtsboard), 1879 (Coal Cabinet), 2081 (Folding Dressing Table). Readers who would like to help should write direct to Mr. Steel.

Another request for a design of Hobbies No. 202 Special for the Taj Mahal comes from G. E. Beardwell of 186 Whalebone Lane Sth., Dagenham, Essex.

He is also on the lookout for 'any other tricky design with plenty of fancy fretcutting', and No. 75 Special for the Corridor Coach. Will any reader who can oblige Mr Beardwell please contact him direct.

Incidentally, it is sincerely hoped that readers who benefit from this 'help one another' service will play the game, and return designs to the owner if such is requested. It has come to the notice of the Editor that a request for the loan of a design for the Lord's Prayer Tablet was generously met by another of our readers, who, despite repeated applications, cannot get his design back.

For personal listening

PHONES WITH YOUR RADIO

HEARPHONES can be used with any ordinary radio set, either for personal listening without disturbing other people, or to help those who are somewhat deaf. With a partly deaf person, the loudspeaker either has to be worked at such volume that it is too loud for other people, or a deaf aid is needed. If headphones are run directly from the receiver, a deaf aid is not necessary, and the loudspeaker may be operated at normal volume, or switched off.

Receiver changes

Fig. 1 shows the connections which will be necessary in the receiver. The output transformer will be fixed to the loudspeaker in the receiver, or will be connected to it. One lead from the transformer secondary to the speaker speech

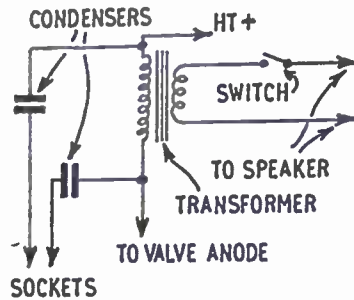

Fig. 1—Connections to receiver sockets

Phones circuit

Ordinary medium or high impedance phones are used, and wired to a volume control as shown in Fig. 2. This control is best enclosed in a small wooden box which can be placed on a table near the person using the phones. A twin-flex lead of suitable length goes from the volume control to two plugs, which are inserted in the sockets fitted to the receiver.

The value of the volume control is not critical, but about 5,000 ohms to 15,000 ohms or so will suit most receivers and phones. When the volume control is turned to minimum, no signals will be heard in the phones, though the receiver speaker can be worked normally,

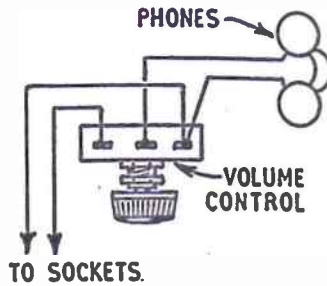

Fig. 2—Phones with volume control

with the switch closed.

When a person wishes to use the phones, the volume control knob should be slowly turned until sufficient volume is obtained. The receiver speaker can be on or off, according to the position of the switch. With the speaker working at normal volume, volume in the phones will seem to be very great indeed, if the phone volume control is turned very far. A deaf person can thus listen with the phones. When listening with the phones has ceased, the phone volume control should be turned back to minimum. This will avoid any uncomfortable burst of volume if the phones are put on before the receiver is switched on, on another occasion.

By 'Radio Mech'

coil is cut, and the leads lengthened by joining on a piece of twin flex. The joints should be covered with insulating tape. The flex leads are taken to an on/off switch, fixed at a convenient point at the back of the receiver. When this switch is opened, the receiver speaker is silenced. The phones may thus be used with the speaker either on or off, as necessary.

The other winding of the transformer, or primary, will be wired to the high tension positive circuit and valve anode or anodes. A fixed condenser is joined to each end of the primary, as in Fig. 1. These condensers isolate the headphone circuit from high tension voltages. Good quality condensers of 500V. or 750V. rating should thus be used. The capacity is not very critical, but about 0.05 mfd. will be satisfactory.

Insulated leads from the condensers are taken to a twin socket strip of the kind which can be purchased for loud-speaker connections and similar purposes. This socket strip is fixed at a handy point at the back of the receiver cabinet. The sockets or fixing screws should not be in contact with the chassis or metal parts.

The receiver can be mains or battery operated. With a mains set it is particularly important to use good quality condensers. The mains plug feeding the set should be pulled out of its socket before making the alterations, because of the danger of mains shocks.

(A.F.T.)

Easy-Window-opening Gadgets

EVER have trouble in opening or closing the top sash of a window? Some can be very obstinate, especially a tall window or one that does not get opened often.

Here is a little device to make this task simple. We show two methods, and both will be found equally efficient. The easiest to fix consists of a strong round-head screw let into the top bar so that the head projects about 1/2 in. This is sufficient for a substantial screw-eye, fixed into the end of a dowel rod, to be passed over it, thus making opening and closing a simple matter.

The second method shown is a more attractive fitment and consists of a neat strip of wood screwed to the top bar. This is operated by a right-angled screw hook. Painted to match the window, these fitments will be barely seen.

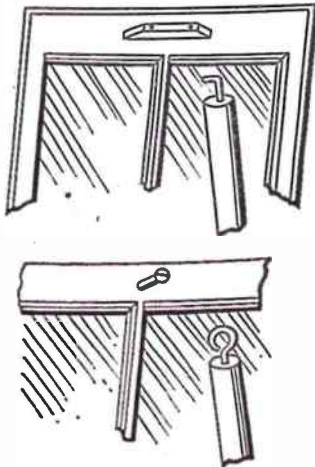

406

SIMPLE DESK FOR RETOUCHING YOUR OWN NEGATIVES

HOWEVER much care we take with processing our photographs, 'pinholes' do still appear in our negatives from time to time, usually in the sky or other light areas, resulting in an objectionable black spot on the finished print.

'Knifing' out, or 'bleaching away' with a chemical reducer are of course the accepted methods of getting rid of these, but when a large number of prints are to be made from one negative this can be tedious work — work that can be avoided by 'filling in' the pinhole in the negative itself.

For this, and any further negative retouching the more advanced photographer may feel like attempting, an essential piece of equipment is a 'retouching desk'. This can easily be constructed by the handyman. The size, and pattern, can be left to individual choice so long as it serves the required purpose, but, as my illustration shows, by utilizing an old half-plate printing frame half the work has been already done.

The brass strips which were to hold the back in position when used for printing, and the back itself, have been discarded. Two sides have been cut from plywood to the size and shape necessary to set the working surface at a suitable angle, and screwed into position. Next, a piece of black paper is cut to the size of the glass. An aperture is cut in the centre of this paper, which is then pasted on to the glass itself. The desk is then ready for use.

To use, place the desk on a sheet of white paper on a table close to a window, if used in daylight, or close to the light source if used in artificial light. The negative to be 'worked upon' should then be laid on the glass and moved around until the area requiring the 'spotting' is over the aperture in the black paper. It will be found that sufficient light will be reflected up from the white paper through the negative, making the matching of colour of your spotting medium and negative density a simple task.

Spotting itself, while being quite easy when once mastered may present some difficulty to the beginner. Perhaps by rounding off this article with a few general hints worth remembering I may be able to help anyone who may be experiencing difficulties with this work.

By
Clifford
Robinson

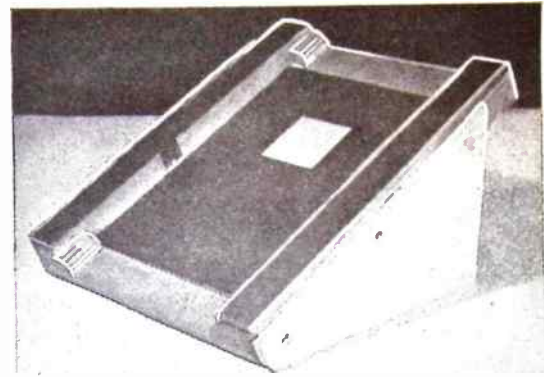

1. Use one of the specially prepared dyes, mediums, or water colours.
2. Take great care in keeping your brush clean. It should be specially purchased for the job and the point protected.
3. Work on the matt (emulsion) side of the negative.
4. Hold the brush almost vertical in use. Small spots as usually found in negatives can often be 'filled' by one application of the point of the brush. Larger areas should be tackled by a 'stippling' action, and never strokes.
5. A ring which may appear around your spot is a sign of one thing only —

your brush is too wet. It must be almost dry, with just a faint touch of your medium on the point.

6. Some of the dyes, once applied, cannot be removed; others can be washed out in water and mistakes can then be rectified. You must of course wait until the negative is perfectly dry before attempting any further work on it.

By following these few tips and keeping a steady hand this should not be a too difficult task and one that when mastered will save hours of tedious work.

Ben Boa, a lively Snake

BEN BOA, the paper snake that shakes and gyrates above a candle-flame, has been a popular toy for many generations. You can begin to make him by drawing a spiral 3 1/2 in. in diameter on stiff paper or thin cardboard, using a ruler and compasses.

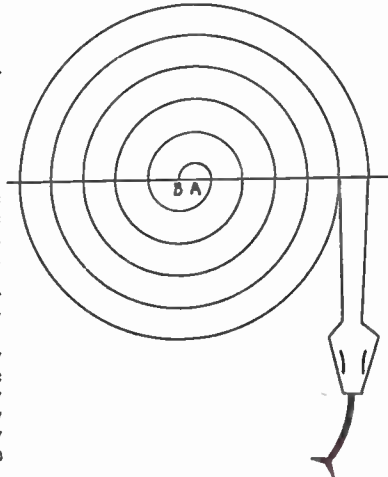

Prepare to draw the spiral by ruling a line across the paper. With the compass-point on the centre (A) of the straight line, draw a semi-circle on one side. Let one end of the semi-circle be point (B).

With point (B) as centre make a semi-circle on the other side of the line, after widening the radius of the compasses so that the first semi-circle can be continued to commence the spiral. Complete the spiral by drawing semi-circles on opposite sides of the ruled line with points (A) and (B) as alternate centres, while remembering to widen the radius of the compasses each time. The finished spiral will be the body of Ben Boa.

When you have drawn the serpent's head, marked on the eyes and decorated the coiled body with attractive markings, you are ready to cut out the toy, using sharp scissors. As a final detail you might glue on a forked tongue cut from bright red paper.

To make Ben Boa come alive suspend him over a candle flame, or lighted electric lamp bulb, by a pin pushed underneath through point (A) and held in the hand. The rising current of warm air will cause the toy snake to gyrate realistically. (A.E.W.)

407



JIMMY LOGAN'S BOX FOR A PICNIC

JIMMY has hit upon a good idea, says Ed. Capper; a picnic box, tailor-made to fit an individual car boot. Whilst the following dimensions are to suit Jimmy's car boot, you can easily amend the measurements to fit your own boot.

First, make up a square box with sides of 2 ft. in length, and from 6 in. by 1 in. planed deal. For the bottom piece use hardboard or 3-plywood, cut 2 ft. square. Screw together the four side pieces. Similarly, use screws to fit the hardboard bottom piece.

Divide the box into four compartments with two cross-intersecting pieces of 6 in. by 1 in. Use a halving joint where the two lengths cross at the centre. Make sure these divisions are accurately cut and fitted, so that each compartment is exactly identical. Hold the dividing pieces by screwing through

 ★ Dear Mr Capper,
 ★ Could you design for me a picnic
 ★ box to fit into my car boot? It would
 ★ need to be approx. 2 ft. square by
 ★ 6 in. deep. Also, could trays be
 ★ incorporated?
 ★ Yours sincerely,
 ★ Jimmy Logan.
 ★

As shown at A, the flap lids are held level and firm by being supported underneath with triangular brackets. These are hinged with one butt hinge for each bracket, so that they can fold back flat to



Jimmy Logan, popular TV and Radio Star

the side piece when the unit is being stowed away.

Four legs are fitted in the position shown. They can be of any length, although not so long as to make the unit wobbly. They are made from 3 in. by 1 in. deal, shaped as shown for a better appearance. They are held with a screw and washer, the screw tightened sufficiently to hold the leg firmly against the side, and only movable if pushed.

For rigidity the legs must splay outwards. They are held in such a position as shown in detail B. A 3/8 in. slot is cut on the off-side edge, which locates over a peg made from 3/8 in. dowelling or a screw with countersunk head. If using dowelling, it should be glued firmly in place.

The slot is cut at a slight upward angle,

Continued on page 409

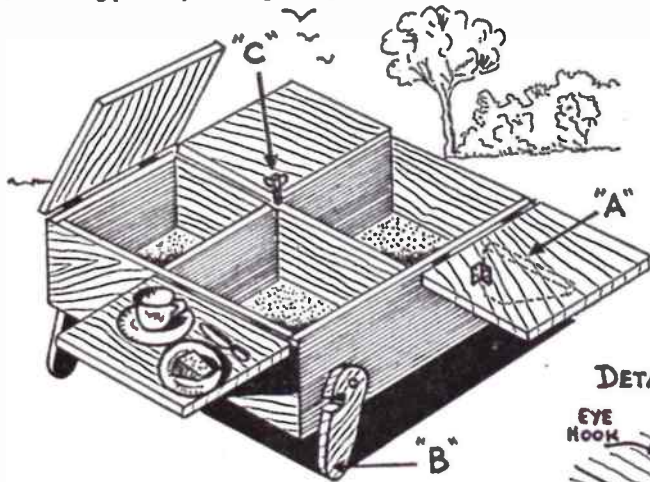

from the side pieces of the box, and the hardboard bottom piece.

As shown in the drawing, the lid of the box is cut into four identical squares, which, when folded back, act as individual food trays. Use 3/8 in. thick plywood or chipboard, 2 ft. square. Cut it into four 1 ft. square pieces, and hinge each section to the side pieces with butt hinges as shown. When closed, the lid pieces should rest along the centre line of the compartment division pieces — hence the importance of fitting accurately the division pieces.

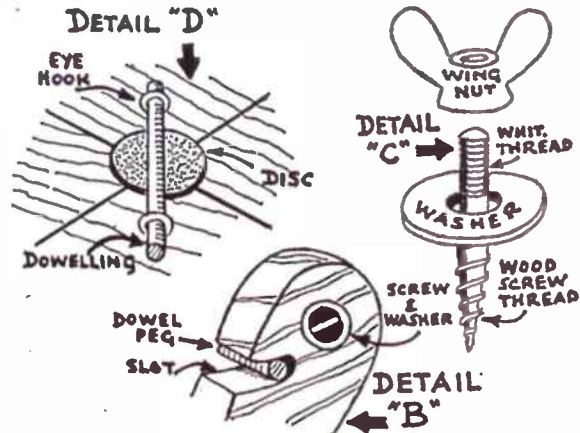

Wall Tiling with Hardboard

ONE of the most attractive wall finishes for kitchens and bathrooms is tiling, which is also so hygienic and easy to keep clean. Wall tiling with glazed tiles, however, is rather expensive, and this, no doubt, limits its use. Nevertheless, there are several substitute materials on the market which are much cheaper to buy, and also produce finishes comparable with tiling.

Such a material is tiled hardboard. This is manufactured in a similar manner to ordinary hardboard, but its face surface is made with a smooth plastic finish divided up into squares to resemble tiling. Tiled hardboard is made in standard sheet sizes, and is obtainable in a variety of colours. It makes an ideal surfacing material.

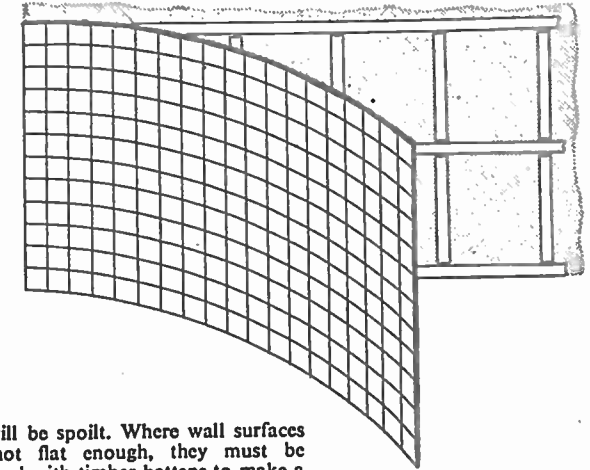

By K. Finlay

If you wish to tile the whole of the walls from floor to ceiling, then the sheets should be fixed vertically, preferably in single sheets without any horizontal joints. The popular trend, however, is to tile to a height of about 4 ft. from the floor (known as the dado height).

There are many excellent adhesives on the market to enable the tiled hardboard to be stuck straight on to almost any surface, provided it is perfectly flat, otherwise the appearance of the finished

job will be spoilt. Where wall surfaces are not flat enough, they must be strapped with timber battens to make a flat foundation for the tiled hardboard as shown.

The dimensions of the timber battens used for this purpose are unimportant provided they are strong enough, but generally speaking they are made from 1 1/2 in. by 3/4 in. sawn timber. The top horizontal batten should be fixed to correspond with the top edge of the sheet when it is in position. The bottom batten should be kept 1 in. or so above the level of the floor. The third horizontal batten should be positioned midway between the top and bottom battens.

After this, vertical battens should be fixed in between the horizontal battens at approximately 18 in. intervals. When the battens are being fixed to the walls, it is advisable periodically to check them with a straight-edge. If this preliminary work is done properly, then a flat surface can be guaranteed for the final job.

The tiled hardboard should be fixed to the framework with a strong adhesive. One or two small panel pins can be inserted occasionally to keep the sheets in place. These should be driven in at the limitation joints, their heads punched below the surface, and the holes filled up afterwards with a suitable filler.

For neatness, the exposed edges of the hardboard should be covered with a quarter-round moulding or a flat projecting moulding. At external corners, chromium-plated angle irons may be screwed on to give a decorative and strong finish. Alternatively, use wooden corner beads.

Generally speaking, if the tiled hardboard is neatly fitted to the floor, then skirting boards or cover mouldings are usually unnecessary. If, however, one is required, then this can be done by nailing into the bottom batten. Similarly, at internal corners, if care is taken to scribe the sheets to produce a neat fit with continuity of the tiled pattern, then no cover is necessary. If not, a quarter-round bead may be fixed in the corner.

Finally, as with all types of hardboard, it is advisable to soak the back of the sheets with water prior to fixing in position. This precaution prevents swelling and buckling afterwards.

Continued from page 408.

Jimmy Logan's Picnic Box

so that it easily locates over the peg and can swing in the opposite direction to fold back flat against the side piece when being stowed away.

There remains only the lid locking arrangement to keep the four lid sections in place when the box is closed and carried. The best arrangement is to use a screw and bolt stud as shown in detail C. The bottom portion of the stud bears an ordinary wood screw form, whilst the top half carries a Whitworth thread. The bottom portion is screwed in with grips at the intersection of the compartment division pieces. An ordinary wingnut and washer locates over the Whitworth threaded portion at the top.

If your local hardware dealer does not stock these studs, try a coachbuilder. He is most likely to use them. Alterna-

tively, you can 'behead' an ordinary wood screw, file a level diameter on the tapered, plain shank remaining, and cut your own Whitworth thread with a die. If you do use this arrangement, cut away a small portion at the corners of the four lids where they meet at the centre, so that the corners fit snugly around the locking bolt.

A simpler locking arrangement is shown at detail D. It consists of a metal disc resting over the corner meeting point of the lids. It is held in place with a short length of dowelling, locating into two hook eyes, screwed into corners of the lids.

It is not advisable to paint the finished box, as the paint is liable to chip with constant use. A wood stain can be used, protected with general purpose varnish.

UNUSUAL OPTICAL ILLUSIONS

THAT 'seeing is believing' is an often quoted maxim, yet frequently the mind can play curious tricks when interpreting what the eye perceives, and we are easily deluded into thinking that we see things which are not really there. Optical illusions can be very amusing for their own sake, and here is a collection of diagrams and simple apparatus which will provide much entertainment and not a little astonishment.

Figs. 1 and 2 illustrate the effects which bundles of parallel lines have upon obliquely drawn lines and simple geometrical figures. These are phenomena known as 'irradiation'. In Fig. 1 you must guess which, of XY and XZ, is the straight line. Surprising as it may seem, XZ is the straight one, not XY, as casual observation may lead you to expect. Fig. 2 depicts a pattern made up of curved lines, which you can draw, using a pen and compasses, upon a large

whether lines are approaching or receding from us; however this is not such an easy matter when we examine simple drawings. Draw the outline of a cube as if it were made of glass, with all its twelve edges showing. Do not shade your picture. Now try and decide whether your drawing depicts a glass cube seen from slightly above or slightly below.

By A. E. Ward

Examine Fig. 5, and state quickly which of points AB or BC is the farthest apart. Since BC suggests 'contraction' to your brain, you will most likely say that AB is the greater distance, but when you check more accurately, with a ruler, you will realize that both distances are the same.

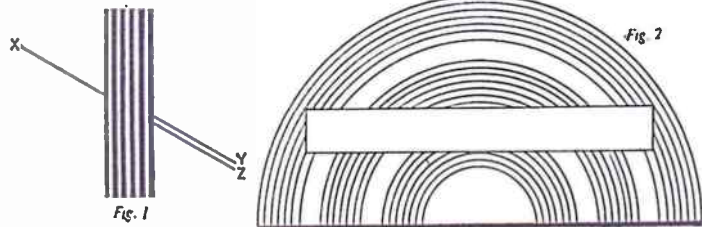

sheet of white paper. When you place a straight ruler upon the diagram it will be difficult for you not to believe that it has not become curved.

'Fake machinery' would be an appropriate title for Fig. 3. If you hold this page firmly between both hands, and then give the paper a gentle circular movement, the wheels will appear to turn around, the spoked wheel rotating in the opposite direction to the others. For the best effect, do not gaze too intently at any of the wheels. Now reverse your movements, and observe the wheels. Try inventing other types of 'fake machinery', but keep your drawings simple.

When you look at Fig. 4, you will be unable to say for sure whether you are looking down upon the table or seeing it from underneath. Also, the cylinder will confuse you. Is it standing upright or lying upon its side? In real life we can use our powers of judgment to decide

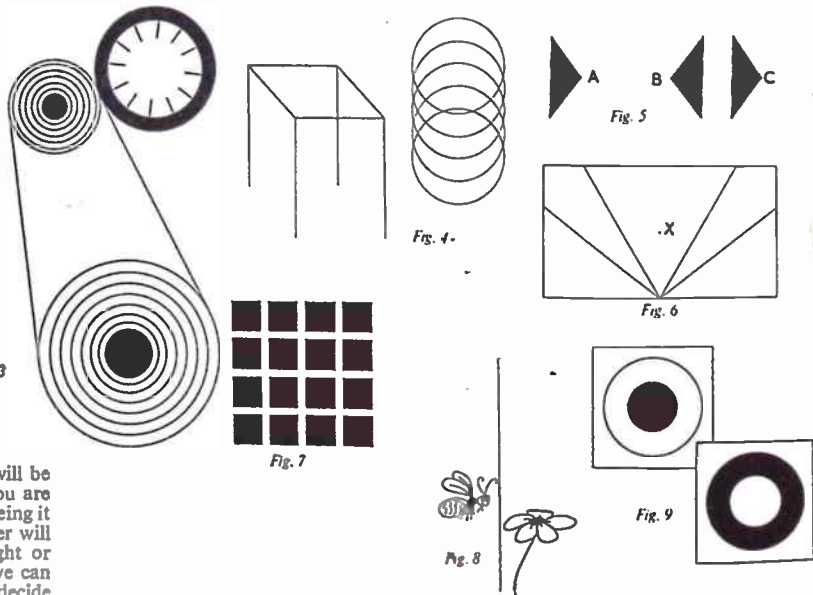

You will need to draw the diagram shown in Fig. 6 upon a piece of white cardboard measuring 2 in. by 3 in. Pierce point X with a pin, and spin the card upon it. You will see two concentric 'magic' circles. This illusion is an example of the principle of the persistence of vision.

In Fig. 7, you will be conscious of mysterious grey shadows which occur where the white lines cross, but these do not appear when you look directly at the intersections.

The little bee in Fig. 8 will appear to fly over and settle upon the flower when you slowly bring the diagram to within a few inches of your eyes. You may devise other versions of this illusion, such as a fly that settles upon a man's nose or a parrot that goes into a cage.

Make the two diagrams shown in Fig. 9 upon two separate white cards. Place them widely apart, and then ask a friend if he thinks that it would be possible to place the small white circle exactly upon the black circle. He will probably be surprised when you inform him that both circles are in fact the same size. White shapes make a much stronger impression upon the retina than black ones; therefore, they seem larger than they really are.

Send for this book

Worry and upsets between husbands and wives are so frequently caused because they lack knowledge of modern family planning. This useful book deals frankly with many of the questions which too often have to go unanswered. Written in an understanding and straightforward way, "Planned Families are Happy Families" can help to resolve one of the commonest problems in married life. Every married couple should have a copy. You can get yours now, absolutely free.

All applications are strictly confidential.



FREE! POST THIS COUPON NOW

To: Planned Families Publications,
12 Oval Road, London, N.W.1

Please send me, under **PLAIN COVER**, a free copy of "Planned Families are Happy Families". I am an adult.

NAME

ADDRESS

2/HW

BLOCK CAPITALS PLEASE

★
£50
in
CASH
PRIZES



In the grand Pyruma Model-Making Competition which starts in February and ends on 30th April, 1960. Here are your three steps towards £20 or a lesser prize in cash. (1) Send for the above booklet by using the coupon below. If you already have the booklet, all you need is the Entry Form. (2) Make a model by following the instructions in the booklet. (3) Send a photograph or snapshot of your model as directed in the Entry Form. Tins of Pyruma are obtainable from Ironmongers, Hardwaremen, Builders' Merchants and many Art Material Dealers.



With a 2/6 tin of ready-to-use Pyruma you could make a winning model. Pyruma produces animals, figures, houses, buildings, ash-trays, bookends, plaques, etc. The Instruction Booklet tells you how to model and how to make and use simple tools.

CUT OUT AND POST THIS COUPON TODAY

TO **J.H. SANKEY & SON, LTD.** Dept. H.W., ILFORD, ESSEX

Established over a century

Please send illustrated instruction booklet and Entry Form for Pyruma Modelling Competition.

Postal Order Value 6d. (not stamps) enclosed. If Entry Form only is required do not send P.O.

NAME (Block Letters)

ADDRESS

Mainly for Modellers

THE beauty of old ships lies not only in the delicate tracery of rigging, and the billowing sails, but also in the hull lines. To the expert or student, the hull shape can tell many things; the period to which the vessel belongs, the purpose for which she was built, and her nationality, etc.

In making models we strive to depict the actual vessel in miniature. The model, being three-dimensional, shows the beauty of the lines far more clearly than can any photographs or painting; and to obtain accuracy we use templates.

The expert worker making a model on the 'built up' system, that is frames (ribs) and planks, can be certain that this model will have the correct curves and contours if his parts have been made accurately. However, we have not all got the same skill or patience, and most of us build our model either from a solid block, or better still, by the 'bread and butter' method. In either case templates can assure us that our model hull is correctly carved to shape.

Templates can also be used for many other purposes in modelling, as we have many items that have to be duplicated. Among their uses are the making of guns. These can either be turned separately, using a template as in Fig. 1 to ensure each gun is exactly the same, or they can be turned with a turning tool made as a template in shape.

A further purpose is to check the deck camber when we are shaping our deck surfaces. Many other uses will arise according to each modeller's requirements. Templates are very useful for duplicating parts where jigs may be unsuitable. Also, as in industry, they can be used for marking out when a number of similar parts are to be cut.

As an example, suppose one is making

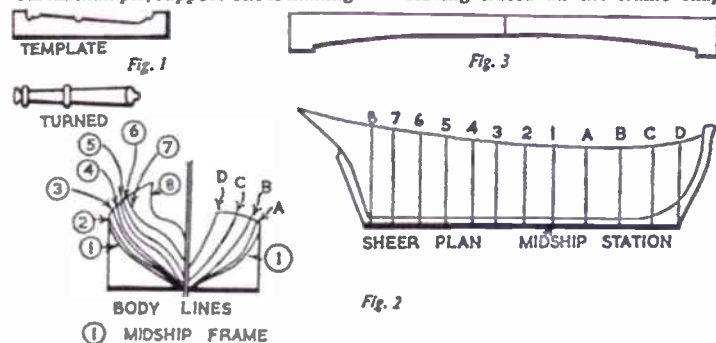

several models of a galleon. A template for each part speeds up the marking out, and avoids waste of time in pasting on patterns or tracing them on to wood.

And now to the most important use of these aids, as far as our hobby goes — the shaping of the hull. In Fig. 2 we have the body lines of a sailing ship, and from these we make our template. The body plan shows on the right-hand side the shape of the hull at each station, proceeding forward from the midship

USING TEMPLATES By 'Whipstaff'

frame. The left hand side shows the shape at each station aft of the midship frame.

From this plan we trace the shape of each frame (or rib) on to a square of cardboard or thin ply. For my models I use 3 ply $\frac{1}{8}$ in. or $\frac{1}{4}$ in. thick, the purpose of which I shall later show.

It is important to remember when drawing out the template shapes that the shape of each frame on the body plan is given to the *inside* of the planking. The size of each frame has, therefore, to be increased, as shown in Fig. 2, by the thickness of the planking. If you have no record of the thickness of planking in your prototype, it is necessary to use the thickness that was in actual use at that period for that particular type of ship. In this matter I shall be very pleased to help any reader in difficulty. For a model made to $\frac{1}{2}$ in. scale (that is $\frac{1}{4}$ in. to 1 ft.) a 4 in. layer of planking would mean increasing the contour of the frame by $\frac{1}{12}$ in.

Having traced all the frame shapes

out, and numbered them to correspond with the station lines on the sheer plan, we are ready to use them in shaping the hull. First we must mark exactly the position of each station line on the keel, and on each side of our rough hull block.

The hull is now first carved roughly to shape and then, commencing at the amidships station line, the templates are offered up in turn at their corresponding station lines as carving proceeds. If, as I have stated, plywood is used, the shaped edge of the template can be rubbed with a soft lead pencil, and by moving the template backwards and forwards along the hull a fraction of an inch or so, the lead will mark the high spots. As these are carefully shaved off with your chisel, the hull will gradually fit the template shape perfectly. The templates are transferred to the opposite side of the hull, and the procedure repeated, thus resulting in a perfectly shaped hull, with both halves, starboard and port, exactly matching.

In Fig. 3 is shown a template used in securing the correct deck camber. This again varies with different vessels, and the shape can be obtained from your blueprint.

A Series of Books on 'BASIC ELECTRONICS'

by Van Valkenburgh, Nooger & Neville, Inc., New York, U.S.A.

THESE six books on 'BASIC ELECTRONICS' are essentially training manuals. Like their fellow series 'Basic Electricity' (reviewed in our issue of 13th May 1959), a great deal of planning has gone into this course, so that only the essential facts about each piece of equipment are presented in the simplest possible language, and the approach is strictly non-mathematical.

The coverage is extensive, dealing with Power Supplies, Rectifiers, Amplifiers and Oscillators, Transmitters and Receivers, Frequency Modulations, and ending with a clear and concise section on Transistors.

This course was originally developed for use in the United States Navy, and has since been adapted to British standards for training purposes by the Royal Electrical and Mechanical Engineers with War Office approval.

These books can be obtained separately at 12/6 nett, or the set of six cost 66/-.

These six manuals, together with the five manuals on 'Basic Electricity', comprise the core of a Standard Course of Technician Training for the United States Navy.

Published in Great Britain by The Technical Press Ltd, 1 Justice Walk, Chelsea, London, S.W.3.

THE Sculptorcraft people present!

'MODOLO' Here's a fabulous new modelling hobby for children of every age. Even adults will find this fascinating. Many delightful figures of animals, flowers, etc. can be made.

'Rubbacraft' These delightful figures are designed as squeaky toys for younger children. But they have sufficient merit to be hung as mascots.

1. Dulcie Doll.
2. Christopher Choirboy.
3. Clarence Clown.
4. Money Monkey (Illustrated).
5. Pete the Pied Piper.
6. Terry Teddy Bear.
7. Gordon Golliwog.

MODOLO: Handpack 2/11 plus post and packing 1/6. Drums (illustrated) 6/11 plus post and packing 2/6.

RUBBACRAFT: 24/- plus post and packing 2/11

SEAMER PRODUCTS (SCULPTORCRAFT) LTD
23-27 Eastbourne Street, Hull

MUSICAL CIGARETTE BOXES with **Hobbies kits & outfits**

Hobbies kits for novel musical boxes are extremely popular for making up as gifts and for sale. Kits include materials and full instructions for making with a few simple tools. Musical movements are extra. Make your choice of tune from list below.

GET A KIT NOW!

Kit No. 3312
15/- (post 1/6)

Kit No. 3152
7/11 (post 1/3)

Kit No. 3250
12/6 (post 1/6)

TREASURE CHEST. Kit includes wood, anchor, chain, metal fittings, etc.
Fit your box with one of these tunes
No. 1 movement 14/11 (post 6d.)

GRAND PIANO. Kit includes printed keyboard.

Other models detailed in free Booklet
To Hobbies Ltd, Dept. 993, Dereham, Norfolk.
Please send free copy of 'Profitable Leisure' and items detailed.

Kit No.
Musical Movement.
Name
Address
P.O. for enclosed.

Estab. **Hobbies** 1897



HOBBIES No. 2 CORNER CRAMP
Made of cast iron. Will take mouldings up to 4 in. (post 1/9) **27/6**
GUARANTEED BRITISH MADE



ALL-STEEL CORNER CRAMP
The all-steel corner cramp will take work up to 2½ in. wide. (post 1/3) **11/9**

**HOBBIES LTD (Dept. 99),
DEREHAM, NORFOLK**

STAMPS FREE — Empire Packet including Pictorials and Victorians with approvals. — Robert J. Peck, 7A Kemp Road, Bournemouth.

MODELS. You can make lasting stone-hard models with Sankey's Pyrama Plastic Cement. Supplied in tins by Ironmongers, Hardwaremen, and Builders' Merchants. Ask for instruction leaflet.

EARN PROFIT. If you like writing send for 'Writers' Guide' (free). Thousands of words to interest beginner or experienced. Typewriter unnecessary under our system. — Writer's Ring (H.W.), 5 Edmund Street, Birmingham 3.

INTERESTED in drawing or painting for pleasure and profit? Then send for 'Make Art Pay' (Free) and see how you can develop your talent and sell your work to us. — Clun Valley Features (HW), Clun, Salop.

CRYSTAL DIODE, instructions, etc. to build matchbox diode receiver, reception guaranteed. Send 4/- P.O. only to — BCM/ALEXTONE, London, W.C.1.

FREE — 50 Large colourful Pictorials including Triangulars, Giants, Animals, Comemms., PLUS 75 Foreign and Colonial. Send 4½d. requesting approvals. — Salter, 42 North Road, Rotherham.

YOU MUST HAVE THIS SET — Hungary 1959 Water Sports. Sent Free to approval applicants enclosing postage. — E. D. Standen (Dept. H.), 97 Granville Avenue, Long Eaton, Notts.

★ LEARN ★ RADIO & T/V SERVICING for your OWN BUSINESS/HOBBY

● by a new exciting no-maths. system, using practical equipment, recently introduced to this country.
**FREE Brochure from:—
RADIOSTRUCTOR**
DEPT. G81, 46, MARKET PLACE,
READING, BERKS. 9/3

KUKLOS ANNUAL. Indispensable cyclist's handbook. Tours, resthouses, money-saving hints, 3/- post free. — Burrow, Publishers, 2 Imperial House, Cheltenham.

100 DIFFERENT stamps free! Request ½d. upwards discount approvals. — Bush, 53 Newlyn Way, Parkstone, Dorset.

WHEELS (Hardwood and Rubber Tyred Metal). Cot, Pram and Doll's House Fittings and Papers. Beads, Transfers, Prints and other accessories. Stamp for new lists. (Trade supplied.) New address — JOYDEN CO., 91 Peplins Way, Brookmans Park, Herts.

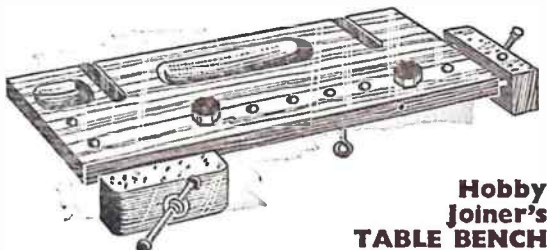

**Hobby Joiner's
TABLE BENCH**

Cramps to kitchen table to provide an ideal working surface for cutting, shaping and assembling small parts. The spaced holes and pegs permit work to be held for planing. Two sturdy vices, two metal cramps. Size 20in. long. Made of seasoned hardwood for years of service. **37/6**

HOBBIES LTD., Dept. 99, Dereham, Norfolk

HEAR ALL CONTINENTS With H.A.C. Short-Wave Receivers

Suppliers for over 18 years of radio S-W Receivers of quality.
One-Valve Kit, Price 25/- **Two-Valve Kit, Price 50/-**
Improved designs with Denco coils. All kits complete with all components, accessories and full instructions. Before ordering, call and inspect a demonstration receiver, or send stamped addressed envelope for descriptive catalogue.
'H.A.C.' Short-Wave Products (Dept. 22), 11 Old Bond Street, London, W.1.

A HANDY GLASSPAPER BLOCK

A wooden block with special handle which holds glass-paper taut and always in place. In two sizes 3in., price 1/9 (post 6d.); 5in., price 3/- (post 9d.)
**HOBBIES LTD., DEREHAM
Norfolk, and all Branches**



APPARATUS & CHEMICALS

For your experiments. Let us help you equip a **HOME LABORATORY**

Beakers, Crucibles, Flasks, Funnels
Gas Jars, Test Tubes, etc.

Booklets:
(including postage)
'Experiments' 1/2
'Formulas' 1/2
'Home Chemistry' 2/10
New edition

Send 3d. Stamp for latest **PRICE LIST**

A. N. BECK & SONS (Dept. H.W.)
60 Stoke Newington High Street, London, N.16





COT FITTINGS (full size)

The fellow handy with tools can make quite easily a drop-side Cot using these fittings. The set comprises two bright steel rods 36in. long, six heavy-duty screws (four plain and two threaded for rods) and two catches. Price 7/9 (Post 1/6)

From branches or:
HOBBIES LTD., Dept. 99, Dereham, Norfolk

Full-size patterns

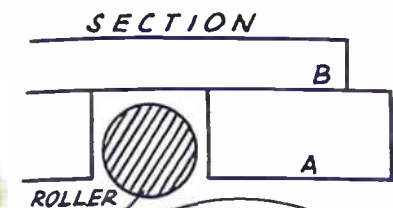
MAKE A TOY HOVERCAR



THIS toy glides along the floor, like the car of the future. The rollers underneath give the appearance of hovering.

Cut one of A (½ in. thick), one of B (¼ in. thick), and one of C (½ in. thick). The rollers are ½ in. diameter round rod, and are pinned in the sections cut out of piece A. Glue the pieces together, round off, and paint. (M.p.)

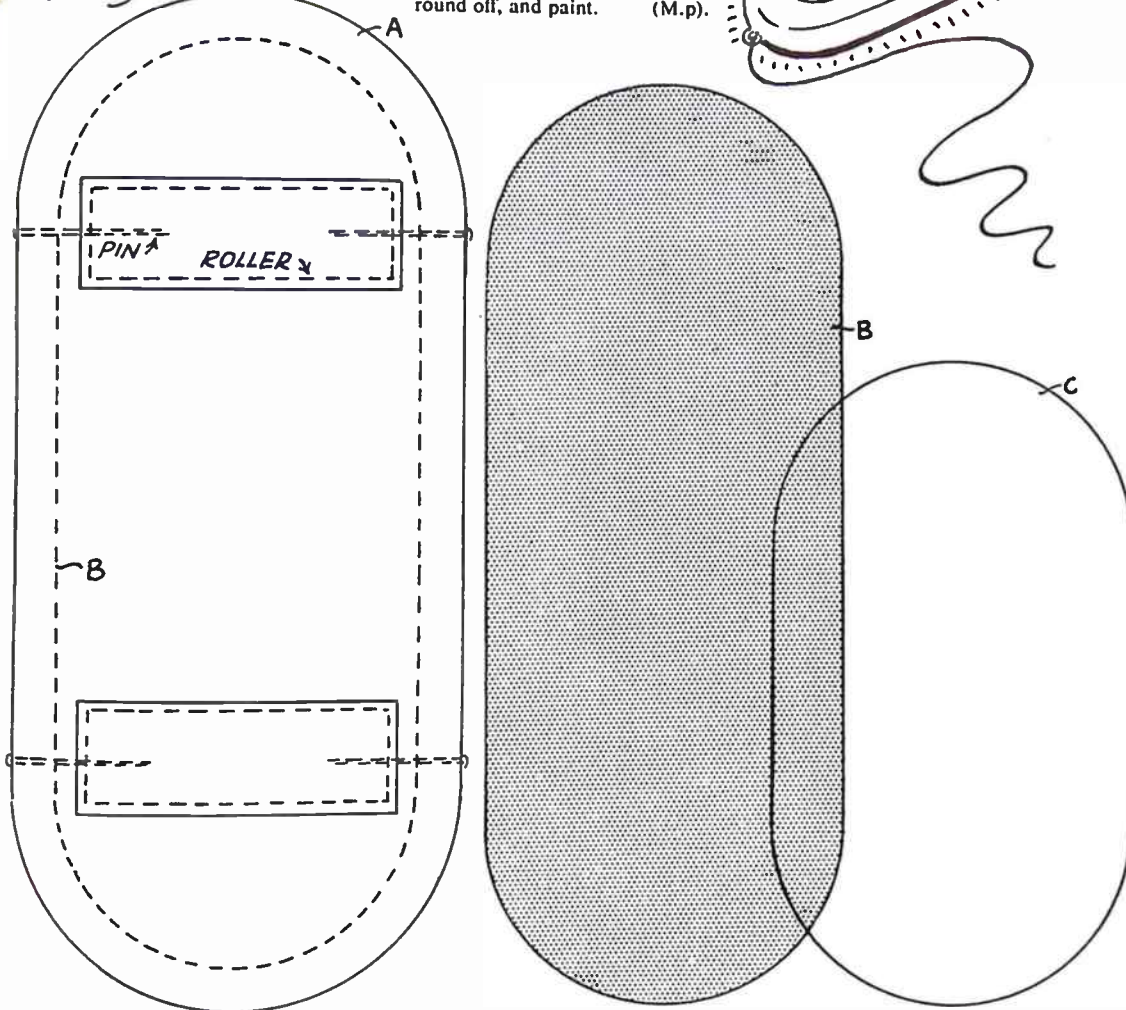
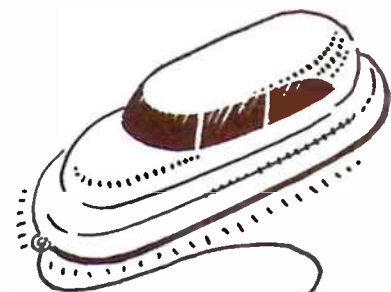

415

Printed by **BALDING & MANSELL, LTD.**, London and Wisbech, and Published for the Proprietors, **HOBBIES LTD.**, by **HORACE MARSHALL & SON, LTD.**, Temple House, Tallis Street, E.C.4. Sole Agents for Australia and New Zealand: Gordon & Gotch (A'sia) Ltd. For South Africa: Central News Agency Ltd. Registered for transmission by Canadian Magazine Post.

READER'S REPLY
MAR
1960

NOW—BRING IT TO LIFE

WITH THE HUMBROL TOUCH!

There's magic in the Humbrol touch! Humbrol is the supreme model builder's enamel, the 'professional' finish which makes so much difference. Equally effective on plastic, wood or metal it dries smoothly and without brushmarks. It gives a hard coating which will last for years and years.

There are 34 highly accurate and consistent colours, glossy, matt and metallic. All are intermixable, enabling you to achieve the finest variations in tone. Humbrol is dry in an hour, a great advantage in speeding up model building. Ask any expert—he'll have the Humbrol touch!

At all good hobby, handicraft and model shops, from $\frac{1}{2}$ oz. to $\frac{1}{2}$ pint tins.



Illustration by courtesy of Hobbies Ltd.

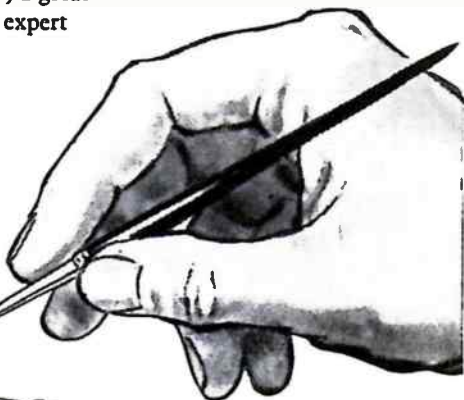

Use Britfix 99 too!
A powerful general purpose adhesive that sticks wood, metal, rubber, glass and many other materials. Extremely durable and proof against water and weather conditions. Large tube 1/9.

HUMBROL

the art enamel that turns models into masterpieces!

THE HUMBER OIL COMPANY LTD., PAINTS DIVISION, MARFLEET, HULL.



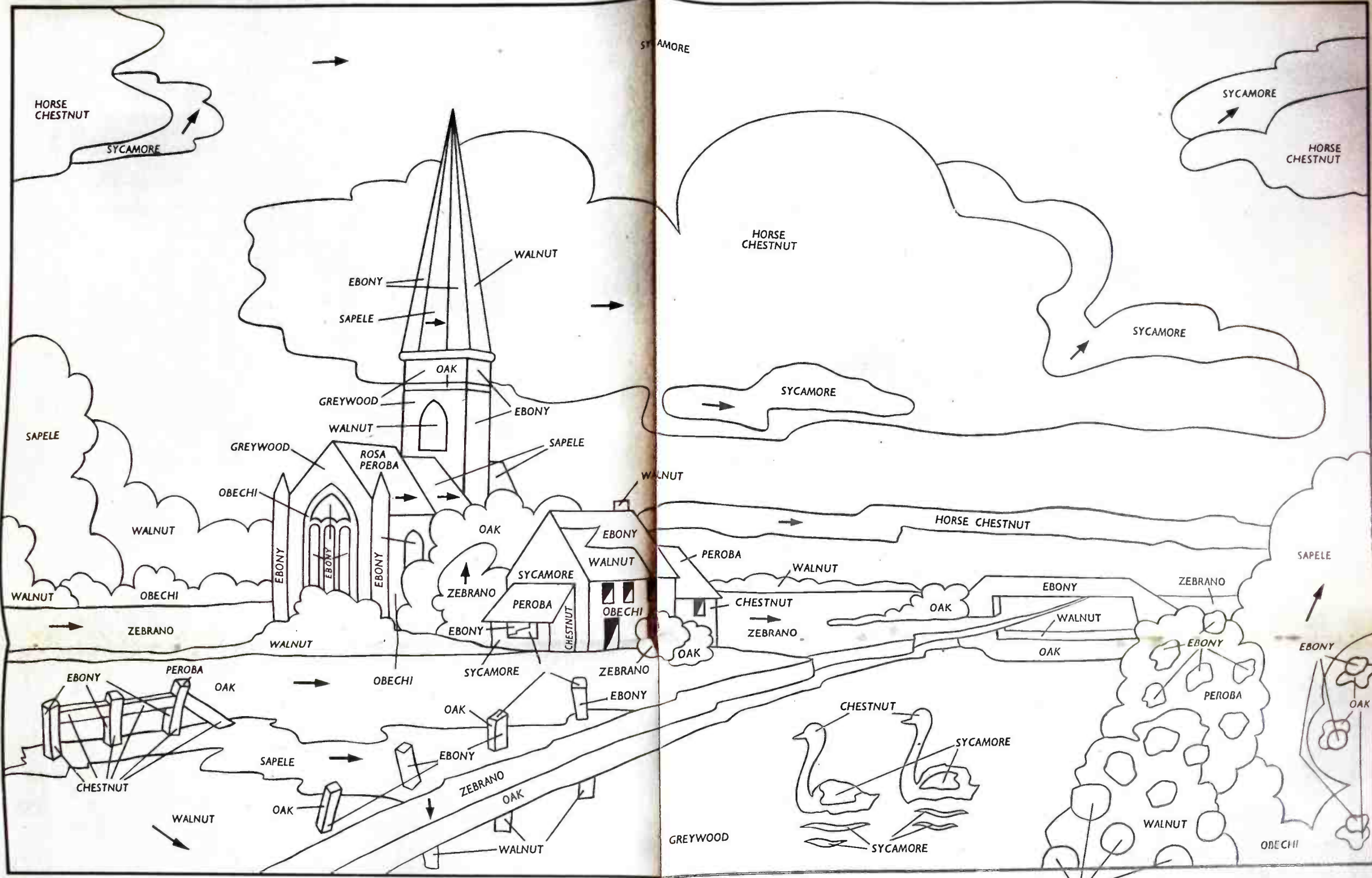

*HOUSE WINDOWS GREYWOOD AND EBONY

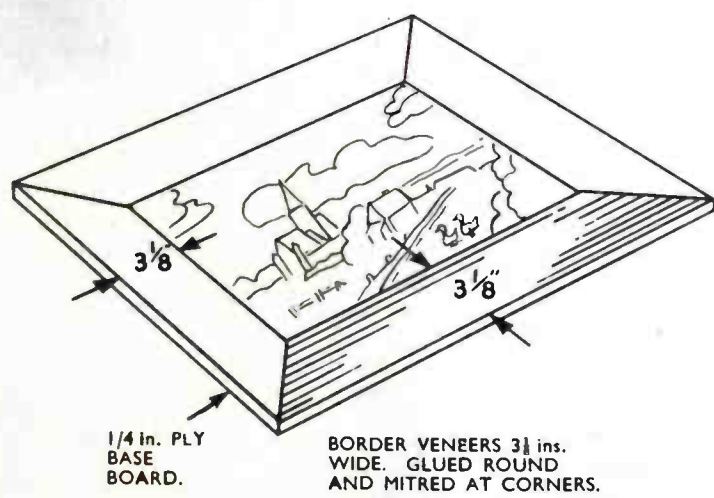

A KIT OF MATERIALS FOR MAKING THIS DESIGN IS SUPPLIED BY HOBBIES LIMITED, DEREHAM, NORFOLK. PRICE ON APPLICATION.

Use **Croid UNIVERSAL**

ITS DESIGNED FOR THE JOB

The popular general purpose liquid glue, used cold for all making and mending with wood, leather, card, etc. The best glue for sticking laminated plastics. Large tube 1/2, 8 oz. tin 2/10, 16 oz. tin 4/6.

AVAILABLE FROM ALL BRANCHES OF HOBBIES LTD

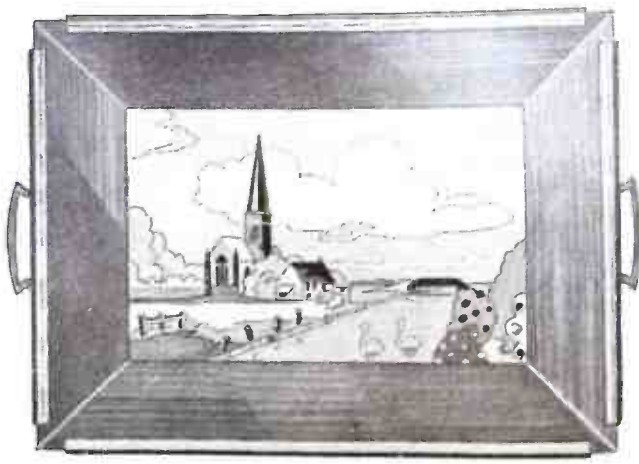

A MARQUETRY TEA TRAY

'THE LANDMARK'

SIZE 20 ins. x 15 ins.

Hobbies DESIGN

No. 3352