

18th NOVEMBER 1959

VOL. 129

NUMBER 3336

THE ORIGINAL
'DO-IT-YOURSELF'
MAGAZINE

HOBBIES *weekly*

FOR ALL
HOME CRAFTSMEN

★ *FREE Design Supplement*

Also in this issue:

MODELS FOR A
'SAND' MOTOR

COLLECTORS' CLUB

LAMPS FOR INDOOR
PHOTOGRAPHY

A TIDDLEWINKS
GOLF COURSE

MAKE NOVELTIES
IN LEATHERWORK

ETC. ETC.

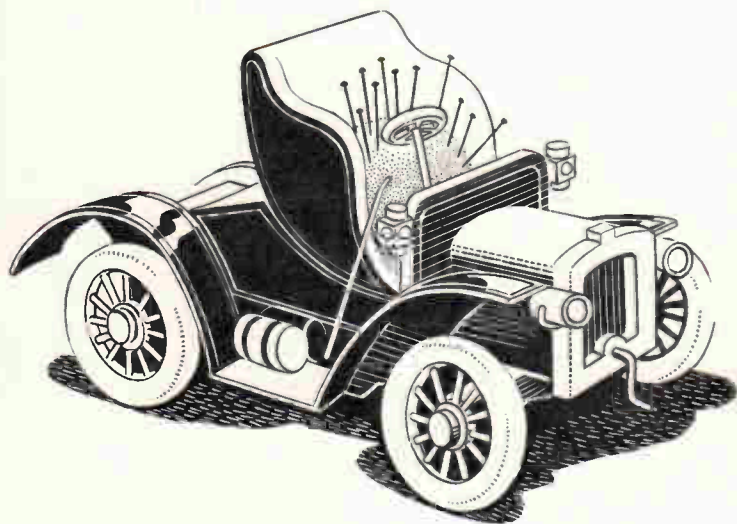

VETERAN CAR PINCUSHION



Up-to-the-minute ideas

Practical designs

Pleasing and profitable things to make

WorldRadioHistory

5^D



NOVEMBER was formerly the ninth month of the year, and has retained its name ever since. Its Saxon names were Wint-Monath, or wind-month, from the high gales of wind which caused the Scandinavians to lay up their keels in November till more propitious weather; and Blot-Monath, or blood-month, so called from its being the month when cattle were killed for the winter store.

NOVEMBER

On All Saints' Day (Nov. 1st) it used to be the custom, as on Hallowe'en, to have a feast of apples and nuts. Nuts were thrown into the fire, and those that burned brightly betokened prosperity,

Memorial — 1/8 mint. Canada 1937, 10 cent red — Memorial Chamber — 2d. used.

14th, 1948, Prince Charles born. New Zealand Health stamp of 1950 depicting H.M. the Queen and Prince Charles — 4d. used.

19th, 1600, King Charles I born. The King appears on a Barbados stamp of 1939 — ½d. green, 1/6 mint.

20th, 1947, The Royal Wedding Day. The Queen as Princess and the Duke of Edinburgh appear on a Canadian stamp of 1951 — 4d. used.

27th, 1949, 'Brumas' (Polar Bear), born. A Polar Bear is depicted on the 30 öre Greenland stamp of 1938 — 9d. mint.

On the first Monday in November the fox hunting season starts. Stamps: Hungary 1953, 70 filler brown and

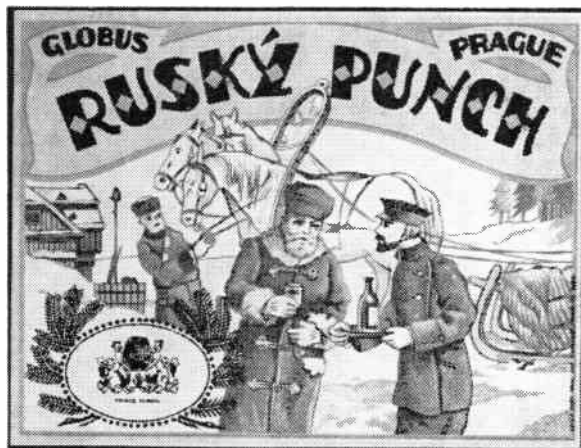

and those that grew black, adversity.

In Shropshire the children go from house to house, on All Saints' Day, collecting money and 'soul-cakes', and singing:

'God have your saul
Beans and all.'

In Lancashire and Herefordshire it is known as 'a-souling'. The 'soul-cakes' are a kind of oat-cake. It is considered lucky to keep them — the longer the better.

November anniversaries, etc.

11th, Armistice Day. Stamps: New Zealand 1946, 1/- grey-black — National

olive — Fox — 5d. used. Match Labels: Czechoslovakia 1956 — Fox and Hounds — 3d. mint.

'If there's ice in November that will bear a duck,
There'll be nothing after but sludge and muck.'

Depict these facts with the Globus 'Rusky Punch' label (see illustration). For free copy write to Globus Brewery Ltd., Prague, Czechoslovakia, enclosing 6d. for return postage.

England's wettest November was recorded in 1940; driest in 1945; warmest in 1938 and 1851.

VERY little information is to be had on the Lore of the Bookmark, but there is plenty to be said on the Lure of the Bookmark.

Collectors of these little treasures play a continuous game of 'hide and seek', for previous owners have placed them lovingly in favourite books, and as the years rolled on, the books and their owners have parted company, the books finally going to an old bookshop, the little bookmarks consigned by fate to oblivion.

Enter the collector: bubbling over with enthusiasm he inquires of the proprietor as to available bookmarks, only to receive a negative reply. He then decides to buy a few books. Turning the pages of several he comes upon a precious bookmark. After making forages into many other books, he leaves the shop the richer by several types.

The first books were done by hand.

BOOKMARKS - I

Many were done by monks. In those days books were so precious that they were often attached to the table or stand by a heavy chain. This prevented accident by dropping and often prevented theft.

In the 1400's, when movable type came into use, books were made with tabs, or strips of leather, parchment or silk, suspended between their pages.

As time passed, and books became the proud possession of more and more people, of necessity the separate bookmark was born. Pieces of paper, string, even flowers and their leaves have been found in old books, marking favourite passages, or simply proclaiming to the reader, that 'Here is where I fell asleep', a sentiment found on many bookmarks.

Once the need for these little page reminders was recognized, various types began to appear. Publishers took heed of this trend and many beautifully-designed commercial bookmarks were produced.

The hand painted or embroidered bookmarks were popular, and in today's vocabulary are considered exquisite flower miniatures. Painted on delicate or deep glowing satin ribbon, many bear bouquets that would do justice to professional artists, which, of course, many of the early teachers were. These were generally stamped with a design for hand painting or embroidering, and were left to the skill of the worker to enlarge on. They continued to hold the public fancy until the early 'nineties, then the vogue for beautifully hand-written signatures swept the scene, and memory-tickling names come to light, such as Chenault, Thomas, Brinker.

● Continued on page 118

Instructions for making

VETERAN CAR PINCUSHION

THIS representative model, based on a veteran 1908 Cadillac car, should suit all modellers, and the design also serves a practical purpose as a pincushion, making it a useful novelty as a welcome gift. The pincushion is provided by a well-upholstered seat and the whole model is 7 in. long and 3½ in. in height.

SEE FINISHED ILLUSTRATION ON FRONT PAGE

All the parts are shown full size on the design sheet, from which they should be traced and transferred to their appropriate thicknesses of wood by means of carbon paper. Make sure before cutting them out with a fretsaw that all the parts which go to the make-up of the car are allowed for, and after cutting, clean them up well with glasspaper.

The first step in assembly is to glue together the two pieces 1 (as shown in Fig. 1) to give the main shape of the body. Then add pieces 2 as shown in Fig. 2. Continue building by adding pieces 3, 4 and 5 (Fig. 3).

The next parts to be added in sequence are shown in Fig. 4 and consist of the

dashboard (piece 6), radiator (piece 7), mudguard supports (pieces 8 and 9) and axles (piece 10).

Next glue piece 11 across the underside of the body of the car so as to project at each side, and thus form the running boards. The rear and front mudguards (pieces 12 and 13) can next be glued around pieces 8 and 9 respectively.

Shape piece 14 from a length of wire to form the brake lever, which is sharpened at one end and pushed into piece 3. At this stage piece 15 can be added to the running board.

The detail on the design sheet shows the method of assembling the two side lamps. When completed, these are glued one on each side of piece 6 in positions as shown in the finished illustration. The headlamps (17) consist of pieces of ⅜ in. round rod which are held in position on the radiator (7) by pieces of shaped wire (18). Sharpen the lengths of wire at both ends, push one end into piece 17, bend to the shape shown on the design sheet and finally push the other end into the radiator (piece 7).

The wheels are pivoted to the axles (10) by means of countersunk screws, the heads of which are covered by four

hub caps made of ⅓ in. wood glued in position.

Other details to add are the steering column, steering wheel and starting handle.

To make the padded portion for the pincushion, fill the well of the seat (Fig. 4) with cotton wool or other absorbent material, which is covered with a piece of coloured velvet or suitable cloth fixed in position by adhesive.

The final colouring of the model is left to individual choice and as thought desirable to give the best effect. Incidentally the lamps on this model were of highly polished brass.

KIT FOR 4/9

Hobbies Kit No. 3336 for making the Veteran Car Pincushion contains panels of wood, round rod, wire, etc. Kits cost 4/9 from branches etc., or by post from Hobbies Ltd., Dereham, Norfolk (post 1/3 extra).

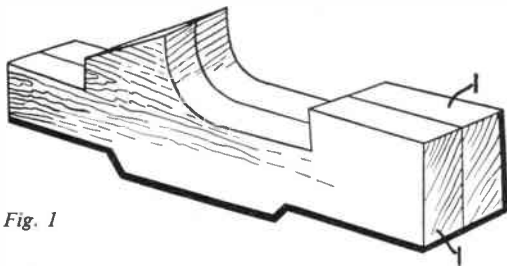

Fig. 1

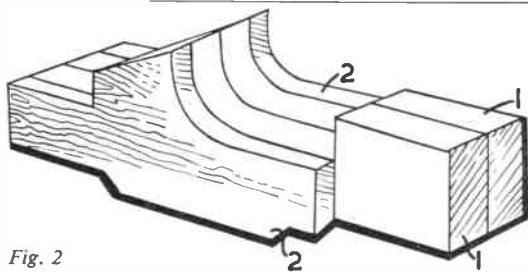

Fig. 2

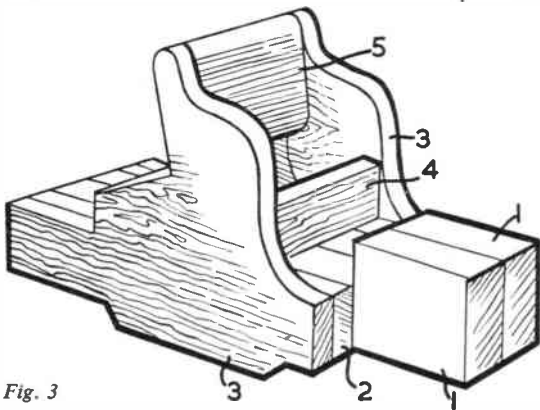

Fig. 3

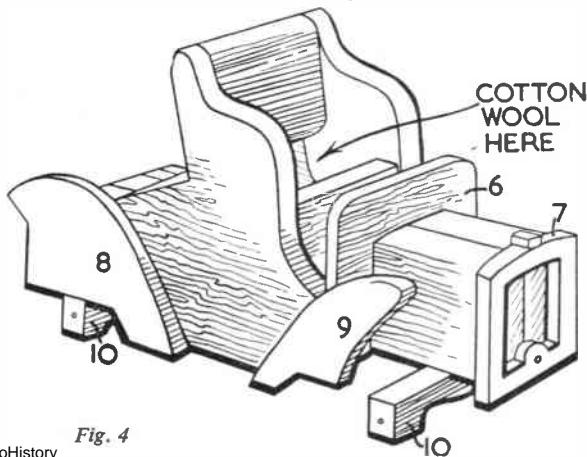

Fig. 4

MODELS FOR A 'SAND' MOTOR

WHEN you have constructed the sand motor described in the November 11th issue of Hobbies you will want to demonstrate its use as a 'power station' by letting it drive various toys and models, which can be made up in any form you desire. Here are three such items that can be assembled without any difficulty.

Mount the wheel and pedal spindle upon the wheel supports.

You must now erect a bent steel knitting needle between the wheel-supports, in order to provide a means of suspension for the body of the cyclist. Use a large cork for the figure's body and make the head from a sizeable wooden bead. Glue the arms in place. Take care, when assembling the articulated legs, to ensure that all movements will be as free as possible. Drawing pins make ideal pivots and can be supplied with washers, in the form of tiny cardboard discs.

in the diagram, and assemble them by folding and gluing. Bore pin holes in the sides of the cars to take the mounting spindles. Also bore pin holes, $\frac{1}{8}$ in. from

By A. E. Ward

the ends of the Ferris Wheel arms, through which the car mounting spindles can be inserted.

Put the Ferris Wheel together as follows: Fix the large spindle in its mounting and place the drive wheel in

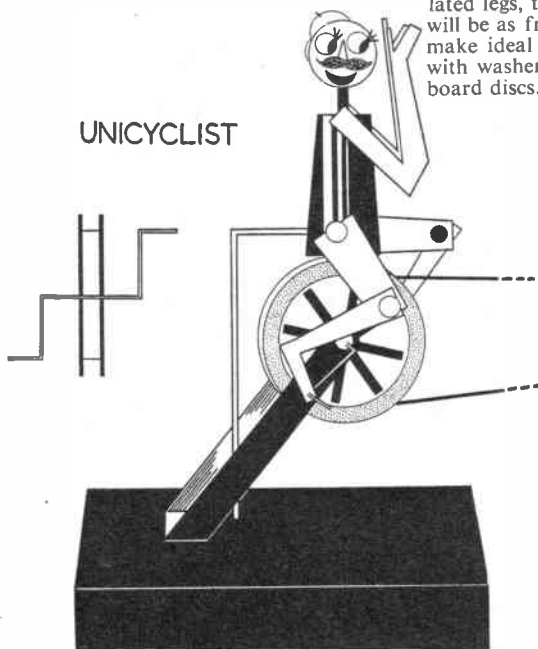

UNICYCLIST

The UNICYCLIST will present a cheerful appearance and provide entertainment for young and old as he pedals his single-wheeled vehicle, yet seems to get nowhere. Use a block of $\frac{3}{4}$ in. thick wood, measuring 6 in. by 3 in., as a base and make the wheel supports from 5 in. lengths of $\frac{1}{2}$ in. wide strips of sheet metal. Bend the strips at one end, so that they can be mounted obliquely, in parallel, upon the baseboard. Bore holes in the other ends of the strips to receive the pedal spindle. Nail the wheel supports in positions $\frac{1}{2}$ in. apart.

Make the wheel by gluing 2 $\frac{1}{2}$ in. diameter cardboard circles on either side of a $\frac{1}{2}$ in. thick wooden disc, 2 in. in diameter. Bore a fine hole through the centre of the completed wheel to take the pedal spindle, which is fashioned from stout wire. Mark out the part of the jointed legs and arms upon strong cardboard and cut them out, using sharp scissors. Bore little holes in the toes, into which the 'pedals' can be inserted.

Paint your toy in bright colours and connect him, by means of a wool band, to the drive wheel of the sand motor. Watch his intriguing movement as he pedals his unicycle.

Build up the FERRIS WHEEL upon a 1 in. thick base block, measuring 6 in. by 2 $\frac{1}{2}$ in. Make two 6 in. tall spindle supports from $\frac{1}{2}$ in. wide strips of metal. Bore holes in the supports to receive the spindle and bend their bases through right angles about $\frac{1}{8}$ in. from the ends. Nail the spindle supports upon the base block as far apart as possible. Use a steel knitting needle for the spindle and construct a drive wheel in the manner described for the wheel of the unicycle.

The arms of the Ferris Wheel are made from pairs of $\frac{1}{2}$ in. wide strips of cardboard, 6 in. long. Glue the pairs of strips to form equal-armed crosses on either end of a 1 $\frac{1}{2}$ in. long cork. Fix the cork, together with the arms, upon the spindle. Make four little 'cars' from thin cardboard, according to the pattern

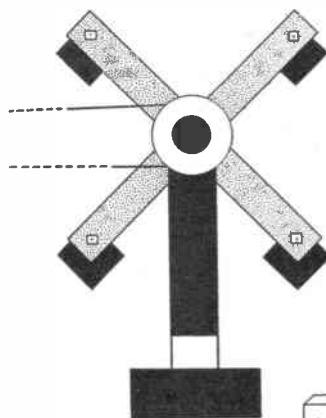

FERRIS WHEEL

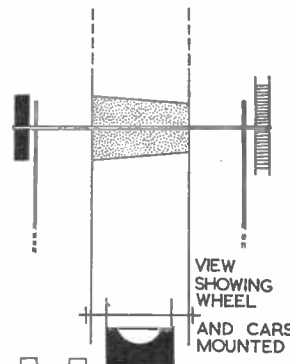

VIEW SHOWING WHEEL AND CARS MOUNTED

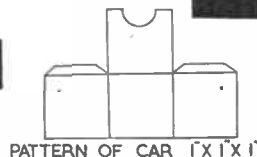

PATTERN OF CAR 1 x 1 x 1"

position on one end of the knitting needle. Attach a small wooden disc to the free end of the spindle. Use long sewing needles as spindles upon which to hang the four 'cars' and place little cardboard washers upon the outside ends of the needles. Arrange your cars in such a manner that they remain freely suspended when the wheel is turned. Finally, decorate your model and connect it to the sand wheel to set it in motion. If you wish, you may place tiny cut-out passengers in the cars.

Perhaps the gayest sort of toy which can be driven with your sand motor is the ROUNDABOUT. Provide a 6 in. sq. of $\frac{1}{2}$ in. thick wood to serve as the base block and bore a fairly deep hole, slightly less than $\frac{1}{2}$ in. in diameter, in the centre. Obtain a 6 in. length of $\frac{1}{2}$ in. thick glass tubing and heat-seal one end in a hot flame, to provide a spindle mount. Fix a large cork upon one end of a steel knitting needle, to use as a spindle and mounting for the top of the roundabout.

Glue a 2in. diameter circle of cardboard on the 'lower' end of the cork (see diagram). Make the top of the roundabout from a large tin lid, in the centre of which a small hole is bored. You will also need to provide a drive wheel, as described, and three model horses made from corks and matches.

Large rotund corks will be suitable for the horses' bodies and matchsticks will make admirable legs, as the burnt tops will resemble hooves. The horses, heads are smaller corks mounted upon matchstick necks and the tails are knotted 'brushes' composed of strands of wool.

Begin to erect your roundabout by firmly fixing the blunt end of the glass tube into the hole in the base block. Place the spindle into its mounting and glue the tin lid over the cork, upon the spindle. Mount the drive wheel upon the top of the spindle. Suspend the three

horses, by means of bright wool strands, from the roundabout top, by securing the strands to the top with strips of Sellotape, or tying them through holes previously bored in the rim of the tin lid. Finish off your toy by painting the different parts with poster colours and do not forget to give your horses amusing facial expressions. Join up the drive wheel to your sand motor and observe how the horses are swung outwards as the roundabout gathers speed.

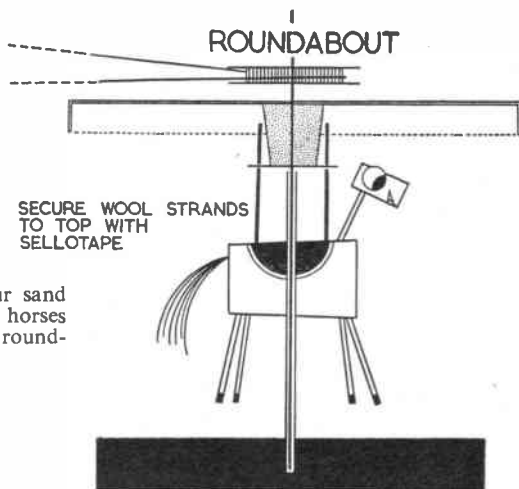

Make a Toy Flying-Singing Bird

A PRETTY toy, with an oriental flavour, is the gaily-coloured bird with a spinning tail, which can be made to fly around on a thread, whilst emitting a pleasant twittering sound. Such toys may be seen for sale at fairs, etc., but you will be able to make one yourself from a few odds and ends and will keep a child happy for hours.

be only slightly longer than the cork. Heat one end of the glass tube until the glass is soft, then press it against a flat piece of metal, to form a smooth and regular rim. Press the tube into the cork, in such a manner that the rim just projects a little at the cork's broad end.

The tail is made from two 3 in. strips of very thin balsa wood, $\frac{1}{2}$ in. wide.

the glue is set, carefully bend apart the two prongs of the tail, as shown in the diagram. You may need to score the wood, using a ruler and a blunt pencil, before the strips can be neatly bent outwards.

Mount the tail on the body, using a straight length of thin strong wire as a spindle. Fix the spindle to the apex of the tail by pushing one end of the wire into the wood, then pass the spindle through the glass tube in the body and bend it over, to form a tidy loop which will hold the spindle in place.

Cut out the head and wings from stout cardboard and glue these into slots cut in the body with a penknife. Press a thumb tack into one side of the body and tie on three or four feet of strong thread. Tie the other end of the thread to the top of a penny bamboo cane. Finish off the toy attractively by painting in bright poster colours.

The bird will glide and twitter when the stick is held in one hand and the toy is swung round in a circle. The singing sound is produced as the wire loop of the spindle rubs against the glass rim.

(A.E.W.)

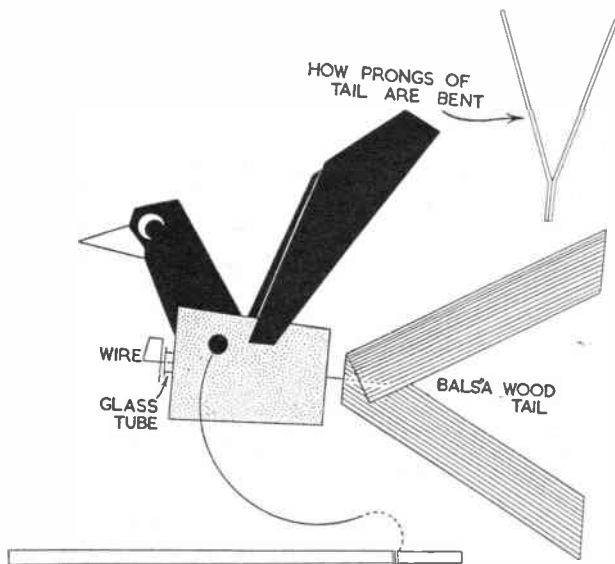

Make the bird's body from a fairly large cork, through the middle of which you must bore a hole to take a length of thin glass tubing. The glass tube should

Alternatively you may use the wood from the sides of a matchbox cover. Glue the strips securely together to form a V-shape, opening at about 40°. When

Details for building a 'Hobby Clipper' Model Aircraft will be given in next week's issue. Also other exciting projects for the modeller and handyman.

MAKE SURE OF YOUR COPY

BATTERIES AND SWITCHING

A MODEL sometimes fails to work properly because the battery used is not suitable. Or when two batteries are wired together they may be wrongly connected. Luckily troubles from this kind of mistake can easily be cured.

The usual dry battery has several cells. Each cell is about $1\frac{1}{2}$ volts, so that a 2-cell battery is 3 volts, a 3-cell battery $4\frac{1}{2}$ volts, and a 4-cell battery 6 volts. With small batteries, the cells may lie end to end, as in a 3 volt or 2-cell torch battery. When the cells are larger, they are side by side, as in a 3 volt (2-cell) cycle lamp battery, or $4\frac{1}{2}$ volt (3-cell) flashlamp battery.

By 'Modeller'

The larger the cells, the heavier is the current which the battery can provide. For example, a 6 volt battery with large cells could drive a model electric motor well, whereas a small 6 volt battery might not be able to supply enough current.

In some compact models small batteries have to be used, but when there is ample space it is false economy to buy a battery with small cells, because a larger battery will have a much longer life. Good permanent magnet model motors are quite economical to run, with dry batteries of reasonable size.

Larger, more powerful model motors may consume a rather heavy current, and the manufacturers may indicate that they cannot be run satisfactorily from dry batteries. In this case, an accumulator is often used. With such accumulators, each cell is 2 volts, so a 3-cell accumulator would provide 6 volts.

Permanent magnet motors need direct current, from a dry battery, accumulator, or rectifier. But motors with wound fields instead of a permanent magnet will run from either direct current or alternating current, and can thus be worked directly from a mains transformer, if desired. Parts 6 and 7 of this 'Guide' will give full details about running motors in this way.

Wiring batteries together

Some batteries have positive and negative markings. If not, then the zinc case of dry batteries will be negative. The polarity does not need to be known when using a single battery in a simple lighting or motor circuit, but must be observed if two or more batteries are used together.

When using a single battery with a permanent magnet motor, it is only necessary to remember that the direction in which the motor runs can be changed by reversing connections to the battery.

In Fig. 9, a single $4\frac{1}{2}$ volt (3-cell) dry battery is shown at 'A' and this will work bulbs, or a small motor, bell or buzzer, etc. If more voltage is wanted, it would be possible to connect two batteries in series, as at 'B'. Note that positive on one battery is joined to negative on the other. The total voltage can then be found by adding together the voltages of the batteries. Two 3 volt batteries would give 6 volt, two $4\frac{1}{2}$ volt batteries would give 9 volt, and two 6 volt batteries would give 12 volts.

If more current is wanted, perhaps to light more bulbs all wired in parallel, then two batteries of the same voltage can be joined in parallel, as shown at 'C'. Here, positive must be joined to positive, and negative to negative. The total voltage is only the same as a single

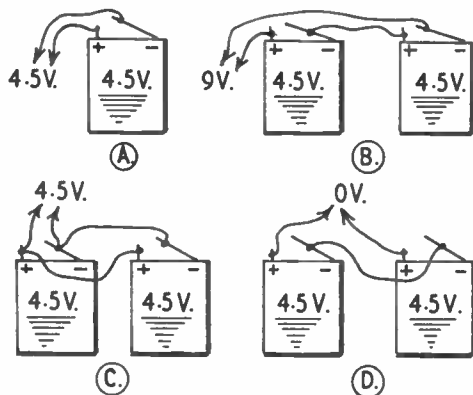

Fig. 9—Ways of connecting batteries

battery, but more current can be drawn, exactly as if a battery with larger cells were used.

If two batteries were connected in series like those at 'D' no operating voltage at all would be obtained, and the model could not work. The correct way, for series connections, is shown at 'B'.

When batteries are connected in series, as at 'B', they need not be of the same voltage. For example, a $4\frac{1}{2}$ volt battery and 3 volt battery in series would give $7\frac{1}{2}$ volts.

With model motors the best or maximum operating voltage is usually given. There is a reason why a lower

voltage should not be used, if the model runs briskly enough. But very low voltages will not be satisfactory, because the motor will not develop enough power, or will stop.

Bulbs and switches

The way in which series and parallel connections affect bulb and switch circuits will become clear from Fig. 10. In the series circuit, the lamps and switch are all wired in series: that is, current flows through each in turn. If the circuit is broken at any point, no current can flow. This means that a single switch will put out all the bulbs. In the same way, if one bulb were defective, the others could not light.

When bulbs or other items are wired in parallel, each is independent of the others. In Fig. 10, two lamps are shown wired in parallel. Each draws current separately from the circuit, and each will continue to burn if the other is defective, or removed or switched off.

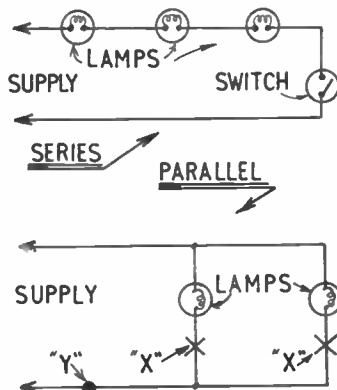

Fig. 10—Series and parallel connections

If two switches were added at the points marked 'X' either or both lamps could be extinguished at will. But if a single switch were wired in at 'Y' this would put both lamps out together.

In a model, it is often convenient to have separate switches such as those at 'X' to control bulbs, motors, etc. as needed, with a single or master switch at 'Y'. Switching off at 'Y' then automatically puts the whole model out of action.

Insulation and connections

Any conductor will carry electricity, and metals are most often used. Silver and copper are good conductors, and

copper is popular because of its low cost and the ease with which it can be handled. Iron and various alloys are poor conductors, and may thus be used for speed control or dimming resistors.

Good metal to metal contact should exist right through the circuits which are wired up. Terminals should be clean and tight, and bulbs screwed well into their holders. If flex is used for wiring, all the thin strands of wire should be twisted tightly together, after removing insulation. A loop can then be formed to go round the terminal or connecting screw.

To avoid short circuits, an insulator is used where necessary, and may be of rubber, Bakelite, Paxolin, wood, or other non-conductor. For the low voltages used in models, wood is a suitable insulator, and terminals and other parts can be mounted directly on it. Sheets or strips of Paxolin, ebonite and similar material may also be used, and give a better finish.

When wiring up, short circuits must be avoided. These arise when stray ends of wire, or bare leads, touch each other or other parts of a circuit. With any kind

of short circuit, the battery or accumulator may be rapidly discharged, and current may be prevented from reaching the model, which will then fail to work. It is particularly wise to avoid short circuits when using an accumulator, or taking current from a transformer, because the accumulator or transformer may be permanently damaged by the heavy current.

NEXT :
Speed controllers as applied to models

SIMPLE PHOTOGRAPHIC LAMPS

WHEN contemplating indoor photography, whether portraiture or 'still life', some form of special illumination is almost essential for best results. The expense of a commercial lamp is unjustified for occasional use, but it is quite easy to make cheap and effective ones.

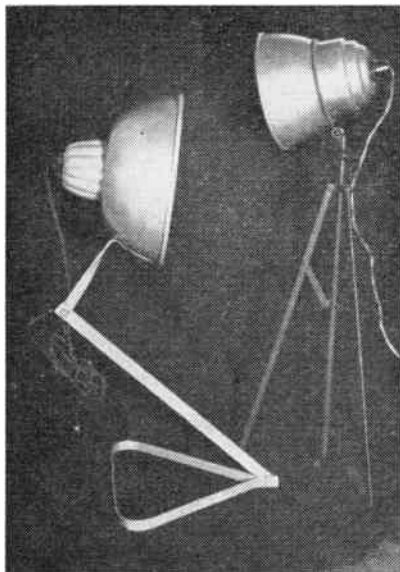

Fig. 1

The basis of the lamps illustrated is an aluminium bowl, the diameter depending upon the size of reflector required; the larger sizes are more often used for portraiture. In order to extend the depth of the bowl, a hole is cut in the bottom and a smaller one riveted to it. This is quite easy with small aluminium rivets. A visit to your local Woolworth's should provide a selection of suitable bowls for a few shillings.

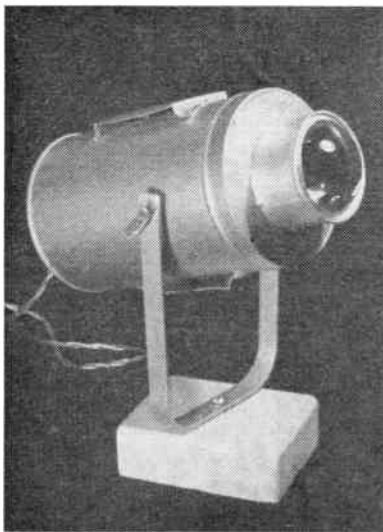

Fig. 2

For photographing small objects, and particularly where side lighting is required to emphasize texture or surfaces, a smaller, more concentrated source of light is useful. The one shown

By P. R. Chapman

in Figs. 2 and 3 was constructed from a dried milk tin with a smaller tin soldered to the lid in which a hole had been cut to take it. This takes a cheap moulded condenser lens about 2½ in. diameter, obtainable from most photographic stores for about three shillings. The lamp is mounted on a simple stand made from strip iron on a wooden base and fitted to the lamp by bolts through the tin together with spring washers and wing nuts. Light trapped holes at top and bottom serve to ventilate.

Although any lamp may be utilized, a very suitable one is a 150 watt enlarging

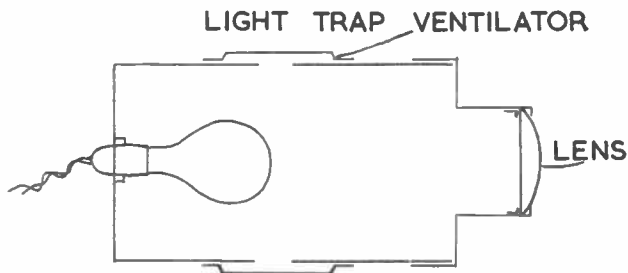

Fig. 3

A hole is cut in the bottom of the smaller bowl to take a standard lamp holder. A stand for the lamp (Fig. 1) can either be constructed from strip iron, or an old music stand may be pressed into service.

lamp which is smaller than a domestic one of the same wattage and gives more light. The spotlight is painted with heat-proof aluminium paint inside and out. Without the lid and lens, it acts as an ordinary lamp, giving a wider beam.

Make this exciting game

Tiddleywinks Carpet Golf

Described
by
L. A.
Gribble

Players take turns arranging the trees and bunkers and fences on the course for as many holes as required. Bunkers may be placed on the 'fairways' as well as around the 'green' (near to the hole). Each player places his tiddleywink-ball on the 'tee' (a position on the carpet from which all can start off), then 'drives off' by shooting towards the hole. After all players have had this first turn, the player who is then furthest from the hole must play the next shot. Continue thus, with the player furthest from the hole always playing up towards the hole, until every player has managed to 'hole' his tiddleywink-ball. The winner of one hole starts off first at the next one. Play over an agreed number of holes, perhaps six, and call that the end of the 'round'. A hole in one is possible, as in the real game — if you can persuade a long-shot tiddleywink to remain in the eggcup or hole!

How to score

Playing over an agreed number of holes, each player counts every stroke that he takes during a round. The winning player is the one who has taken the least number of shots altogether.

Alternatively, play the first hole, and the winner counts his score as 'one up', the loser as 'one down'. A draw at any hole means no alteration of the score: such holes are 'halved'. Play on in this way, making each hole a separate competition, as it were. Leading by two holes, a player can be caught up by losing the next two, and so on. If there are fewer holes left to play than the winning margin one player is holding, then there is no purpose in playing out the remainder of the holes. Thus a player can win a round by 'three holes up with only two holes left to play', in which case he cannot be beaten.

If a tiddleywink-ball comes to rest on the base of any tree or fence, move it on to the carpet without penalty. But when a 'ball' comes to rest on a bunker, it must be played from where it is lying.

Going 'out of bounds' over any boundary fence is always penalized and means shooting again from the old position of the 'ball', but counting the bad shot as one stroke on to your score.

Such a game as this will make an ideal present, but be sure to provide tiddleywinks as well as the special fittings you have made.

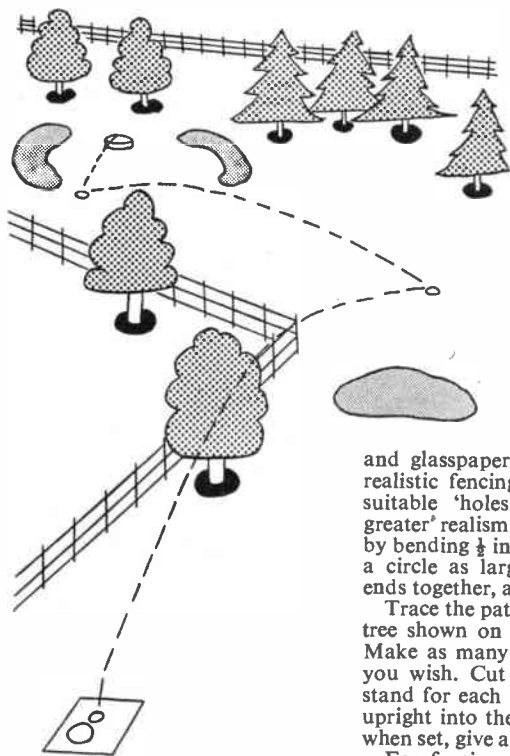

and glasspaper. Pins and cotton make realistic fencing. Small egg cups make suitable 'holes' to aim for: but for greater realism make lower-sided holes by bending $\frac{1}{2}$ in. strips of cardboard into a circle as large as a penny, glue the ends together, and paint green.

Trace the patterns for the two types of tree shown on to your three-ply wood. Make as many trees of each variety as you wish. Cut these out, as well as a stand for each tree. Then glue the trees upright into the slots in the stands, and when set, give a coat of green paint.

For fencing, cut strips of ply about 1 in. wide, just as long as possible from the wood you are using. Paint these green on the top side, and when dry, tack pins at intervals along the painted surface, and bind cotton twice or thrice along the line of pins to make realistic fences.

FULL-SIZE PATTERNS FOR THE 'HAZARDS' ON OPPOSITE PAGE

For bunkers or sand-traps, cut various shapes of wood, perhaps twelve in all. Take each shape one at a time, and trace its outline on to a piece of coarse glasspaper. Then cut out the shape from the glasspaper and glue, rough side uppermost, on to the ply of the same shape. These make ideal bunkers, and suitably penalize any player whose 'ball' lands upon them.

Mark a strip of the carpet with chalk to represent a stream or a lake over which players must make their strokes at some holes. Shots landing in these water-hazards must be taken again, with the first shot counting in your score. The chalk marks can easily be brushed off after the game.

FEW of us are strangers to the time-honoured game of tiddleywinks. Now here is a game which turns your skill at tiddleywinks in the direction of indoor golf. By means of stand-up trees and fences and other fittings it is possible to transform your living-room into a miniature golf-course!

The ball will be... well, a tiddleywink! And the club is a large 'flicker' tiddleywink. You will be surprised what realism is obtainable, particularly from eye-level, as you are getting ready to make an approach shot to the green! The advantage of this type of indoor game over many others, and, indeed, over the full-size game of golf itself, is that the fixtures on the course, such as the fences and bunkers and trees, are easily transferred from place to place, so that no two games of tiddleywink-golf need ever be quite the same.

Challenge your dad!

You can also represent the real lay-out of the full-size holes at the course where Dad plays at weekends, with the certainty that he will want to play over your miniature course with just the same enthusiasm as he plays over his full-size one.

The only materials you will need to build your miniature golf-course are a little three-ply wood, glue, green paint,

PATTERNS FOR TIDDLEYWINKS GOLF

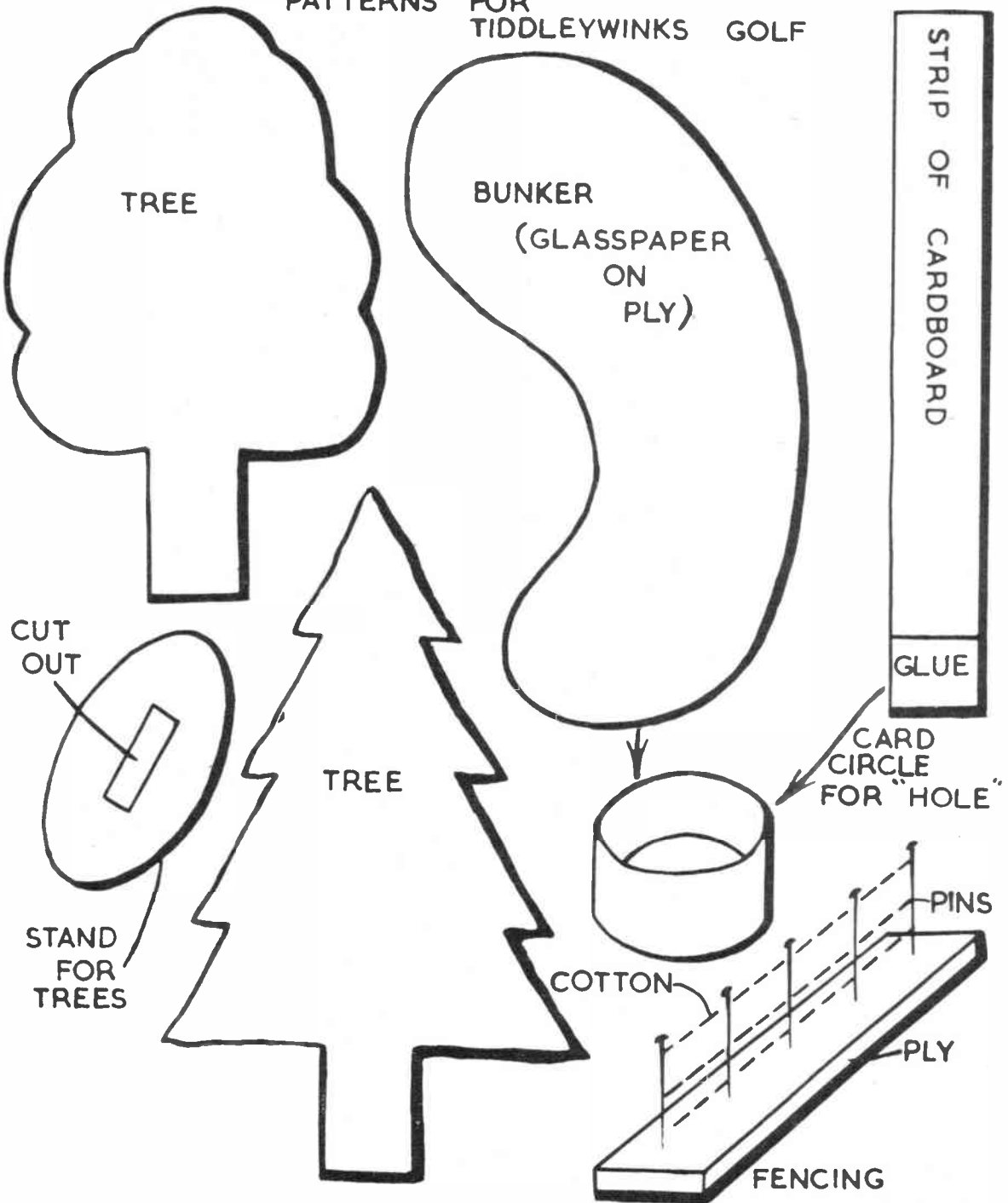

NOVELTIES IN LEATHERWORK

TWO easy-to-make leather novelties are a stamp book case and a bookmark. Only a small amount of material is required for either of these articles, and it is possible to make them from oddments, or from scraps bought at a handicrafts shop. In the case of the bookmark you may use two colours for a smarter appearance.

It is best to make a template of cardboard for the stamp book case, pre-

By *H. Mann*

pared surface of the latter. When the leather is so highly finished it will be found advisable to rub away the surface gloss with glasspaper, so that the two surfaces to be joined will absorb the glue and ensure perfect adhesion. Bulldog clips and weights will

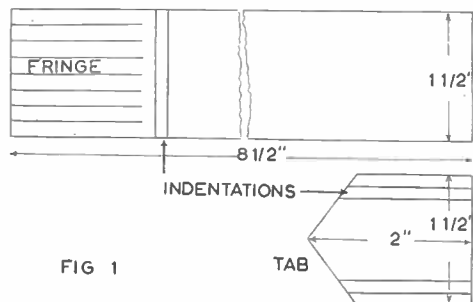

FIG 1

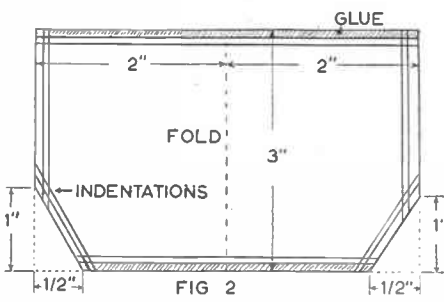

FIG 2

pared according to the dimensions given in Fig. 2. This will enable you to cut out several to the same pattern if you wish to make them for gifts. Moreover, it is much easier than trying to mark out the leather.

The only tools required are a sharp knife for trimming, a straight edge for cutting, and an indenting tool for making the ornamental lines. The latter is easily made by drilling a small hole through the legs of a clothes peg to take a small nut and bolt. A washer is inserted between the legs, and held in place by the bolt.

The prepared template is laid on the leather and a piece of material cut out. All that remains to be done is the folding, as represented by the dotted line, and gluing, as shown by the shaded portions of the diagram. Take a spare piece of cardboard, placing on one edge so as to leave a margin of $\frac{1}{8}$ in., then apply the glue. Take care not to allow too much margin or the case may become too small to accept the stamp book. Similar treatment should now be given to the other edge, when the leather may be folded and left under a weight until the glue has set.

A P.V.A. glue is suitable for this work. The adhesion is improved when the surfaces to be joined have been made rough, or the leather is in the unfinished state. In the instance of the bookmark it will be seen that the tab is fixed to the longer strip and on the grained,

supply sufficient pressure for these small articles.

If you allow about half a hour to elapse it will be possible to proceed with the ornamentation. Lay the stamp book case on a firm base, drawing the lines with the aid of the indenting tool as shown in Fig. 2.

The bookmark is made from two pieces of leather, a thin strip $1\frac{1}{2}$ in. wide by $8\frac{1}{2}$ in. long, and a smaller strip of the same width but only 2 in. long (Fig. 1). The latter is trimmed to a point. The end of the longer strip is fringed by cutting

with a sharp knife to a depth of 2 in., the cuts being made about $\frac{1}{8}$ in. apart. Assembly is quite easy, and all that is required is the tab attaching to the uncut end of the long strip, again by adhesive. When dry, the lines may be ruled on the tab and above the fringed end as shown.

Turn a screw into one end of a piece of dowel rod, cutting another notch in the head at right angles. Smooth off with a file if necessary, and you will have a little tool which will indent crosses in the leather when hammered.

● Continued from page 110

Collecting Bookmarks

Another beautiful type is the woven silk bookmark called Stevengraphs. Many of these were produced in England by Stevens of Coventry, who did much of this early work, including sporting pictures, racing, fire-engines, locomotives, portraits, etc. A collection of woven bookmarks would be a real challenge.

In America most of this type of work was done in Paterson, N.J., by B. B. Tilt and Sons. A large bookmark by this firm bears the portrait of Geo. Washington, and commemorates the Centennial of American Independence, 1776 to 1876. 'The Star-Spangled Banner' is another beauty, bearing the words and music,

and the American Flag unfurled in the breeze. 'Home Sweet Home' is a splendid example, showing the old cottage woven in thin black silk, much like a fine engraving, and the words of the song set to music.

In the sentimental series are six by Stevens of Coventry — Happy New Year, Remember Me, A Wish, Friendship, Unchanging Love and Compliments of the Season. 'The Lord's Prayer' is done on purple ribbon, the letters in shimmering white silk. There are many with cardboard mounts on satin ribbons, carrying printed quotes by famous people.

(R.L.C.)

BRITAIN'S NEW NAVY

**offers boys
of 15-17½
one of the finest
Engineering
Apprenticeship
Schemes
in the world**



As an Artificer in Britain's New Navy you will receive a fine training in engineering and will enjoy all the travel and variety that a seafaring life has to offer—plus special high rates of pay.

Altogether there are five highly specialised Artificer Branches:—Electrical, Engine Room, Ordnance, Aircraft, and Shipwright and at least forty per cent of all Technical Officers

in the Navy will be promoted from the Lower Deck.

The age for entry is between 15 and 17½ and if you do not possess the G.C.E. (or S.L.C. or equivalent) with passes in Mathematics and Science or technical subjects you will be asked to take an entry examination.

The closing date for applications for the next entry is 15th January, 1960.

Apprentices now have the opportunity to qualify for the Ordinary National Certificate during their training. Basic pay, marriage allowances and living-out allowances have been increased—in fact, the Royal Navy has a great deal to offer you.

**You're better off
in the Navy**

**To: The Admiralty, Director of Naval Recruiting
(Dept. HS/3) Queen Anne's Mansions, London, S.W.1**

*Please send me a copy of the illustrated booklet
'ARTIFICER APPRENTICES IN THE ROYAL NAVY'*

NAME

ADDRESS

.....AGE



...ab evenly on the paper m... to know if you could... wish to make some plan... mitter? (R.P.—Wolverhampton.)
 ...ght and hang to dry under... to go over the wallpa... on the same... EXTRACTOR, Channel 10, would

Replies to Readers

...recip... the severity is a brush point... —... B... to charge a 12V. battery, as... was made by fixing... board over a sto...

D.D.T. Solution

COULD you name a solvent for D.D.T. which is non-poisonous to people who come in contact with it? The preparation is to be sprayed around windows, etc. (E.E.—Rugeley.)

D.D.T. is commonly dissolved in a specially prepared petroleum distillate. Excessive inhalation of this can cause toxic symptoms. We suggest the substitution of n-propanol, which though dearer is stated by the Medical Research Council to carry little risk for human beings. The product will be inflammable, as are the proprietaries, and so should not be operated near flames.

* * *

Hardboard Canoe

WHEN visiting some lakes I went in a two-seater canoe and found that it was made of hardboard. It was about 24 in. wide, 10 or 11 ft. long and about 1 ft. deep. It had a flat bottom. Is it feasible to build it, and if so can I proof the hardboard as I can only get 8 ft. long already proofed nearby. I have the plans for PBK 14 and thought of using that as a guide. (T.T.—Tadworth.)

HARDBOARD and plywood are materials which cannot be bent in more than one direction at a time. Consequently they cannot be used in sheets to cover a round-bottomed canoe such as PBK 14. There is a flat-bottomed design available (PBK 16) which is very easy to build and suitable for a hardboard skin. Most hardboard manufacturers produce an oil-tempered version of their boards. This is water-resistant and providing it is kept painted it is quite satisfactory as a canoe skin. Trade names usually indicate the grade, such as 'Oil-tempered Royal Board' or 'Tempered Masonite'. Standard sheets are 8 ft. long in all makes. Joints are made with synthetic resin glue and cover pieces inside.

Cleaning Platinum Ring

MY engagement ring is 18c. gold with three diamonds set in platinum. The platinum has got dulled and dirty-looking. Is there any way I can clean this myself or will it have to be done by a jeweller? (R. McCormack—Cummock.)

THE dullness of the platinum may be due to both minute scratches and grime. If the setting is plain, that is, smooth and not engraved, brush with soapy water and jeweller's rouge made into a thin slurry with the addition of enough ammonia to give a slight odour. Rinse with warm water. If no improvement is made by brushing for some time, a jeweller's aid is needed, for though grime will be removed and also more minute scratches, the coarser scratches will need more expert treatment. If the setting is fancy, one should treat for grime, using the above mixture, but with precipitated chalk in place of jeweller's rouge. If no improvement results, hand the ring to a jeweller.

* * *

★ LEARN ★ RADIO & T/V SERVICING for your OWN BUSINESS/HOBBY

● by a new exciting no-maths. system, using practical equipment, recently introduced to this country.

FREE Brochure from :—

RAIDOSTRUCTOR

DEPT. 681, 46, MARKET PLACE,
READING, BERKS, RG1 1J

2-Transistor Check

REFERRING to the 2-transistor beginners' receiver you described in Hobbies Weekly, dated June 24th, I have been unable to obtain satisfactory reception, though my circuit has been checked. (D.R.—Poplar.)

BAD results may be caused by trying to use the set in a metal-framed building or other screened locality, or by using a deaf-aid earpiece of the kind which can only work with a transformer. The text covers these points. If the set itself is definitely not working properly, and all wiring is correct, it can be tested stage by stage with the earpiece. Wire the earpiece from diode negative to earth line. If normal crystal set volume is not obtained, the diode must be faulty, if coil and condenser are in order. The coil can be tested for continuity with a dry battery and earpiece. If normal crystal set volume is obtained, wire the earpiece across the 6·7K resistor. Amplification from the first transistor should then give louder signals. If not, check battery, switch, and transistor wiring, and try the second transistor in this position. If volume is satisfactory, connect the earpiece to the output terminals. If volume is not again increased, by the second transistor, check connections, and test the transistor by comparing it with the first one (phones across 6·7K). Some suppliers sell manufacturer's 'reject' transistors, and these are thus best obtained from a reliable supplier who will replace them if they are faulty.

Model Railway Hill

I WISH to construct a model railway that runs round a large hill. Could you please send me instructions how to make the hill cheaply. (T.D.—Chessington.)

AN old piece of wire-netting (chicken wire) is crumpled up to about the size and shape required. Cover with strips of newspaper well pasted both sides. Put on four or five layers. Leave to dry for a few days. You then have a shell which can be covered with plaster. Use builders pink plaster and cover to a depth of about ¼ in. to ½ in. Plaster is quite cheap — about 3s. 6d. per stone. You might even omit the plaster and paint the paper shell.

HEAR ALL CONTINENTS With H.A.C. Short-Wave Receivers

Suppliers for over 18 years of radio S-W Receivers of quality.

One-Valve Kit, Price 25/- Two-Valve Kit, Price 50/-
 Improved designs with Denco coils. All kits complete with all components, accessories and full instructions. Before ordering, call and inspect a demonstration receiver, or send stamped addressed envelope for descriptive catalogue.

'H.A.C.' Short-Wave Products (Dept. 22), 11 Old Bond Street, London, W.1

WOOD BENCH VICE



Price 7/6 (Post. 1/6)

A strong hardwood vice which can be screwed to the work bench. A real serviceable tool, well made, and fitted with hardwood screws. 12ins. long.

From branches or:
HOBBIES LTD.,
 Dereham, Norfolk

NOW build modern Style!
with REAL BRICKS AND MORTAR

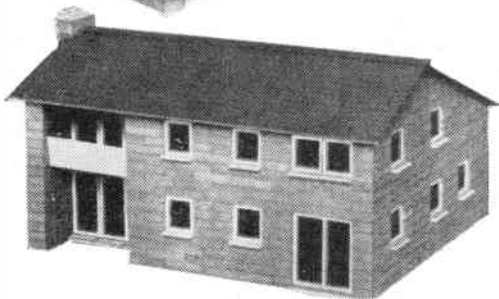
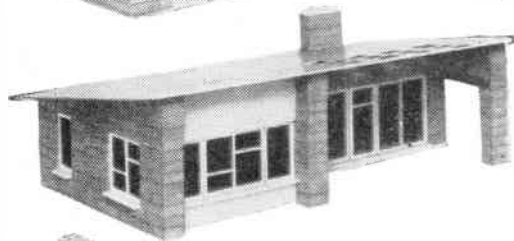
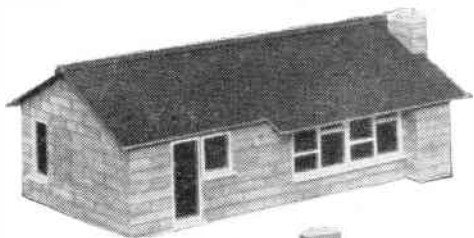
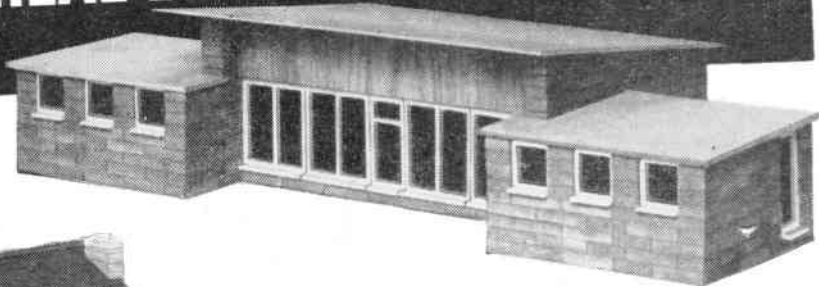

Exciting Contemporary Brickplayer enables you to *build modern!* It's the famous Brick and Mortar Building Kit brought bang up to date. New models are architect-designed to 'O' gauge scale. Kits include bricks in all required shapes, mortar, roofing, windows, doors; plans and instruction booklet. Models can be permanent or dismantled by merely soaking in water and bricks used again and again.

CONTEMPORARY BRICKPLAYER KITS :

"A" — 19/6; "B" — 26/9; "C" — 48/-

Extra bricks, roofing, cement, in low-priced packs: windows and doors obtainable singly.

TRADITIONAL BRICKPLAYER KITS also still available - Kit 3—26/9; Kit 4—50/-; Farm Kit—61/6

At good toy shops, hobby shops and departmental stores. If your dealer cannot supply, please write for leaflet and address of nearest stockist.

CONTEMPORARY
BRICKPLAYER

J. W. SPEAR & SONS LTD., Dept. H.W., Enfield, Middlesex

BUYING OR SELLING?

Classified advertisements on this page are accepted at a cost of 6d. per word prepaid. Use of a Box No. is 1/- extra. Send P.O. with advertisement to *Hobbies Weekly*, Advert. Dept., Dereham, Norfolk. Rates for display advertising on application.

EXTRA cheques from writing. Send for 'Ideas for Writers' (free). Scores of suggestions for beginners and others. Typewriter unnecessary. — *Writer's Ring* (H.W.), 5 Edmund Street, Birmingham 3.

TRANSISTORS, Germanium Crystals, Headphones, etc. Lists and diagrams free. Germanium Diodes with three crystal set circuits 1/- Postage 3d. — P.R.S. (H), 33 Bourne Gardens, London, E.4.

WHEELS (Hardwood and Rubber Tyred Metal). Cot, Pram and Doll's House Fittings and Papers. Beads, Transfers, Prints and other accessories. Stamp for new lists. (Trade supplied.) New address — **JOYDEN CO.**, 91 Peplins Way, Brookmans Park, Herts.

KUKLOS ANNUAL. Indispensable cyclist's handbook. Tours, resthouses, money-saving hints, 3/-. post free. — Burrow, Publishers, 2 Imperial House, Cheltenham.

MODELS. You can make lasting stone-hard models with Sankey's Pyrama Plastic Cement Supplied in tins by Ironmongers, Hardwaremen and Builders, Merchants. Ask for instruction leaflet.

LEARN RADIO and ELECTRONICS the LNEW practical way! Very latest system of experimenting with and building radio apparatus — 'as you learn'. FREE brochure from — Dept. HW 10, Radiostructor, 46 Market Place, Reading, Berks.

Refund if not worth double!

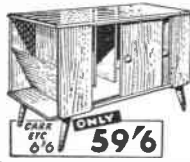

TV TABLE & EXTRA LARGE RECORD CABINET

Not only sand polished but also sprayed light or medium WAL-

NUT tone. NOTE—ROOMY BOOK CASES AT BOTH ENDS — one converts to Magazine Rack by insertion of sloping panel provided, as illustrated. Amazing offer — 59/6, carr. 6/6 or sent for £1. Balance 6 monthly payments 8/-. plus carr. A well-built contemporary piece of furniture to solve your record problem and also ideal as stand for TV, Radio or Record Player. 30" x 15" x 24" high. Modern sliding doors. Roomy interior, partitioned for classifications, holds up to 200 records (upright for perfect condition). Entirely of seasoned timber. Detachable legs. SEND quickly. **LISTS, FURNITURE.**

SEND FOR OUR FREE ILLUSTRATED CATALOGUES OF RADIOS, JEWELLERY, RINGS, BINOCULARS, FURNITURE, GUITARS, CLOTHING, ETC. ALL AVAILABLE ON THE EASIEST OF TERMS.

HEADQUARTER & GENERAL SUPPLIES LTD.

(HOBW/89) 196-200 Coldharbour Lane, Loughboro Junc., London, S.E.5. Open Sat.

MAKE A MUSICAL BOX for as little as M21/-. New kits and tunes available. Movements 13/-. post free. Please send 3d. stamp for free illustrated catalogue. — *The Swisscross Co.*, Dept. B, 202 Tulse Hill, London, S.W.2.

BRASS, COPPER, DURAL, ALUMINIUM, BRONZE

ROD, BAR, SHEET, TUBE, STRIP, WIRE
3,000 STANDARD STOCK SIZES
No Quantity too small List on Application
H. ROLLET & Co. Ltd.
6 CHESHAM PLACE, LONDON, S.W.1
Also at
Liverpool, Manchester, Leeds, Birmingham

100 DIFFERENT stamps free! Request 1d. upwards discount approvals. — Bush, 53 Newlyn Way, Parkstone, Dorset.

BUILD YOUR OWN HI-FI at home! At last, for reasonable cost — the chance to make your own quality HI-FI audio equipment and to gain the knowledge to service and maintain it. FREE brochure from — Dept. HW 20, Radiostructor, 46 Market Place, Reading, Berks.

STAMPS FREE — Empire Packet including SPictorials and Victorians with approvals. — Robert J. Peck, 7A Kemp Road, Bournemouth.

BUILD AN EFFICIENT Crystal Receiver with our quality complete kit. Easy instructions. Soldering unnecessary. Good reception anywhere. Reduced price for short period 14/6 post free. Send P.O. NOW. — Radio Components, Accessories, wonderful new Transistor Receiver Kits supplied. Send 3d. stamp for Bargain List. — **RADIOMATIC**, 26 Blackburne Drive, Hunts Cross, Liverpool.

FREE packet of Match Labels to all genuine Approval Applicants. We can cater for all your Label needs. Please enclose 6d. post and packing. — Holmes, The Haven, Whichchurch, Reading, Berks.

GIFT for philatelists requesting Approvals. GState interests. Postage please. — Jones, 46 Penallt Terrace, Llanelly.

GLYNE RADIO LTD.



Everything for the Radio Hobbyist!

Send stamp for complete list of equipment for Home Construction.

COSSOR KITS!

A unique opportunity to obtain a first class amplifier and/or the latest type VHF/FM receiver at the most reasonable price ever.

COSSOR AUDIO AMPLIFIER KIT 562K. This excellent amplifier supplied in kit form in manufacturers' original presentation carton comprising: Pre-assembled printed-circuit board, valves: 6V4, 6BQ5, EF86, output transformer, two loudspeakers, 4in. circular and 10x6in. elliptical, wiring wire, nuts, bolts, attractive escutcheon and control knobs, mounting brackets and fully illustrated assembly instructions. With negative feedback incorporated, and the high performance loudspeakers provided, a really high quality output is assured. Suitable for use with radio tuners, microphone, or gramophone units. For AC 200/250v. operation. **BRAND NEW AND COMPLETE AT ONLY £5. 19. 6 plus 3/6 p. & p.** (List price £9.15.0).

COSSOR VHF/FM RECEIVER KIT 701K ONLY £8. 19. 6 plus 3/6 p. & p. (List price £15.15.0). Full details on request.

OUR NEW SUPER TRANSISTOR CRYSTAL RECEIVER



Employing special NEW SUPER SENSITIVE circuit and incorporating built-in Ferrite Aerial. For use with deaf-aid type earpiece. Attractive ivory and black plastic case only 4in. x 2 1/2in. x 1 1/2in. Very simple to construct. Runs for months on pen torch battery. Completely safe. No external Aerial or Earth required. Excellent quality reception on Medium Waveband. Easy to follow instructions provided. **Special Price for all required components (incl. battery) only 27/6 plus 2/- p. & p.** Deaf-aid earpiece with lead extra at 12/6. Full details and assembly instructions separately if required 1/- post free.

ALL POST ORDERS AND CORRESPONDENCE TO

162 HOLLOWAY ROAD, LONDON, N.7. NOR. 6295/6/7
18 TOTTENHAM COURT RD., LONDON, W.1. MUS. 5929/0095

Callers welcome at both branches

Christmas is coming!



Ask your folks for a

LOTT'S CHEMISTRY SET

Conduct experiments with proper apparatus and chemicals. Supplies of spare apparatus and chemicals are always available.

Also for younger brothers and sisters

LOTT'S TOY STONE BUILDING BRICKS are the perfect gift.

Enquire at your Toy Dealer or write for price list enclosing 2d. stamped, addressed envelope to—

LOTT'S BRICKS LTD., DEPT. 9, WATFORD, HERTS

APPARATUS & CHEMICALS

For your experiments. Let us help you equip a HOME LABORATORY

Beakers, Crucibles, Flasks, Funnels
Gas Jars, Test Tubes, etc.

Booklets:

- (including postage)
- 'Experiments' 1/2
- 'Formulas' 1/2
- 'Home Chemistry' 2/10
- New edition

Send 3d. Stamp for latest PRICE LIST

A. N. BECK & SONS (Dept. H.W.)

60 Stoke Newington High Street, London, N.16



Ideal children's novelty

SAMMY THE SNAKE

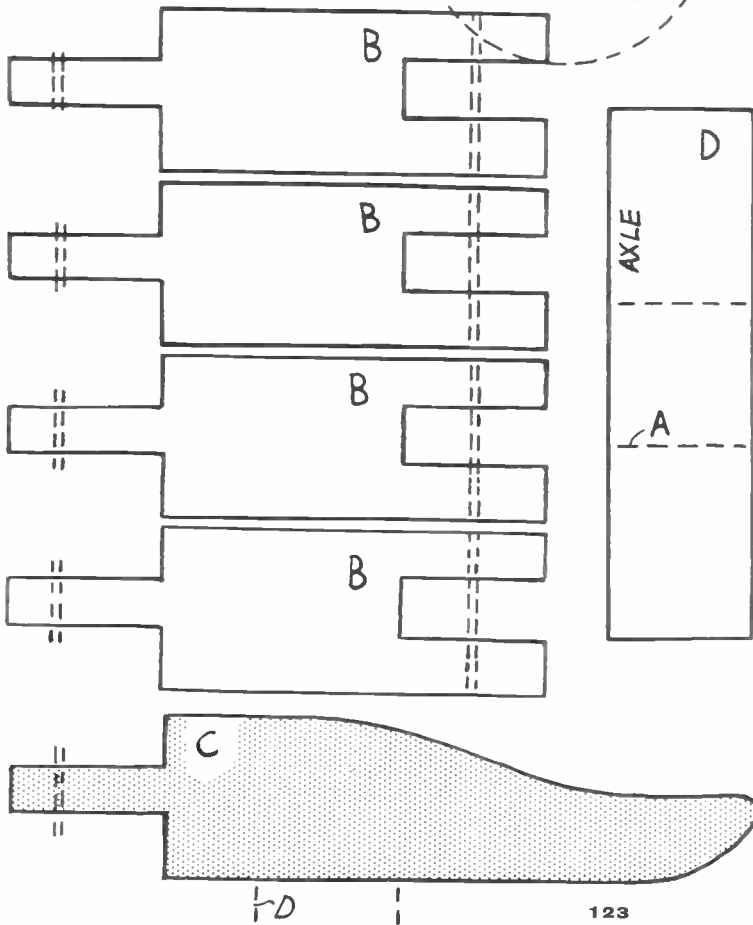
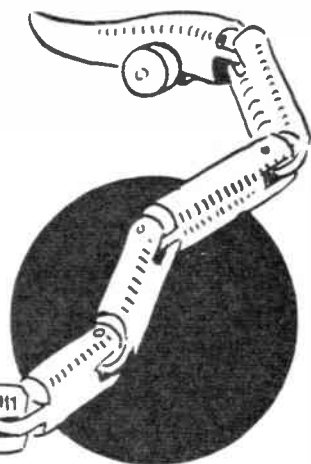
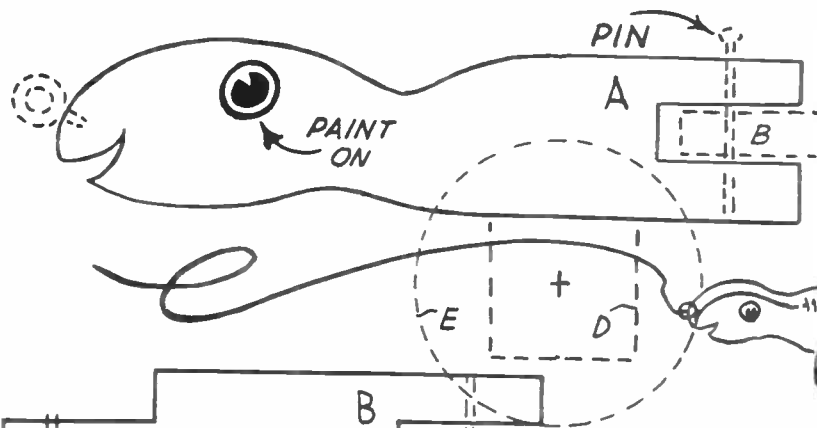

USE THESE FULL-SIZE PATTERNS

IT is easy to make this novel toy if you use a fretsaw. Trace the pieces A, B, C, D and E, and transfer them to $\frac{3}{8}$ in. wood by means of carbon paper. Cut out the pieces and round them off with a rasp or knife. The head A, the tail C and the middle pieces B should fit nicely into each other and should work freely. They are held together by means of pins as indicated.

The axles D are fixed to pieces A and C. The wheels E are secured to these by means of roundhead screws. Finish off by painting in suitable colours. Attach a cord to a screw-eye in piece A. (M.p.)

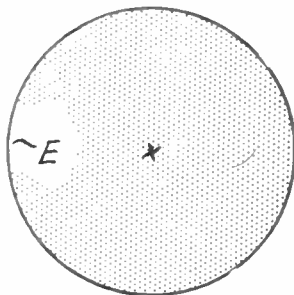

10

1

123



Just like the real thing!

Airfix kits are not just models — they're exact replicas, each series to a constant scale.

Airfix 1907 Lanchester
Lcndaulette 2/-

There are models galore in the Airfix range! Aircraft from fighters to bombers (all to the same 1/72nd scale), 00 gauge railway accessories, vintage cars, historical ships. Airfix value is unbeatable — ask your dealer for the latest list.

Nearly 100 kits from 2/- to 7/6d.

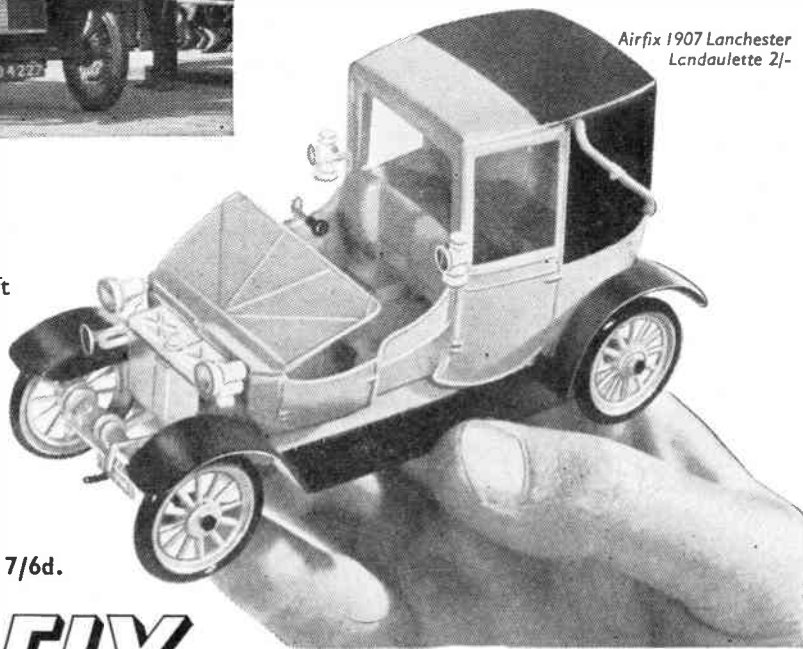

AIRFIX

THE WORLD'S GREATEST VALUE
IN CONSTRUCTION KITS

From Model and Hobby Shops, Toy Shops and F. W. Woolworth

STOP PRESS!

Latest Airfix Production

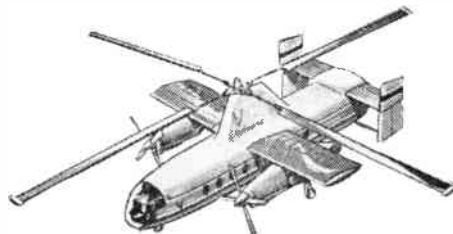

FAIREY ROTODYNE

A superbly accurate 1/72nd scale model of this famous vertical take-off airliner. Length 10 inches, moving propellers and rotor blades, opening loading doors, retractable undercarriage. Complete with marking transfers, 6/-.
Also new: 1/72nd scale ZERO fighter, best known of all Japanese wartime aircraft, 2/-.

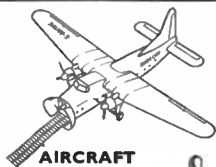

AIRCRAFT

Bristol Superfreighter 7/6d.

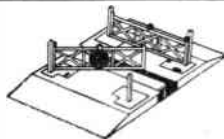

TRACKSIDE SERIES

Level Crossing 2/-

MODEL FIGURES

Lifeguard 2/-



HISTORICAL SHIPS

H.M.S. Victory 2/-

VETERAN CAR PINCUSHION

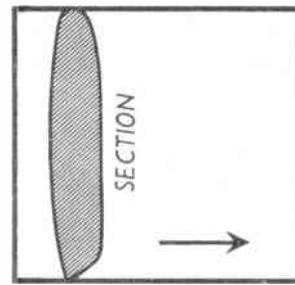
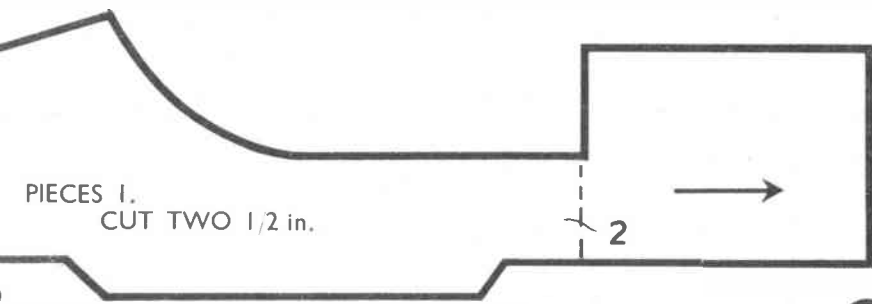
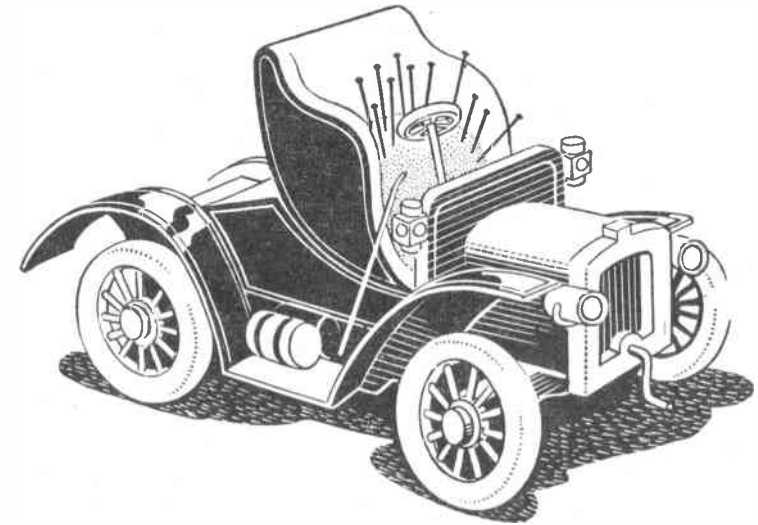

PIECE 5. CUT ONE 1/4 in.



SIZE— 7 ins. LONG. 3 1/2 ins. HIGH.

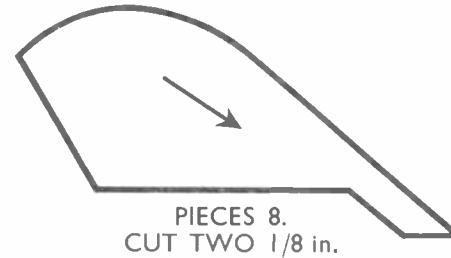
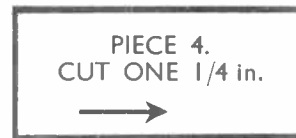
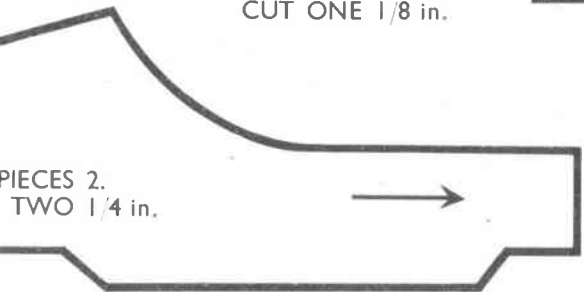
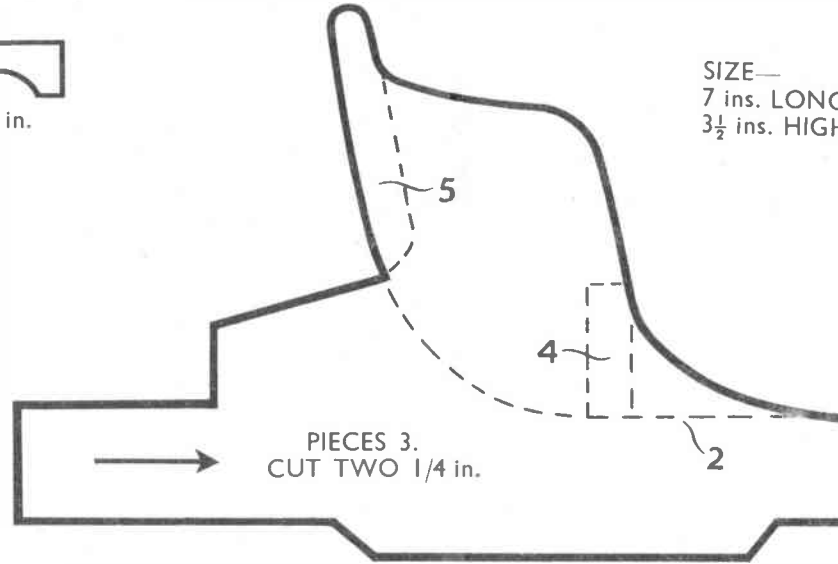
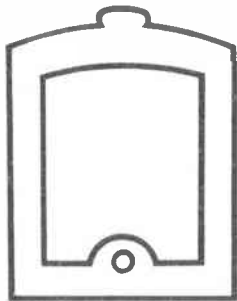

PIECES 18. SHAPE TWO FROM MEDIUM GAUGE WIRE

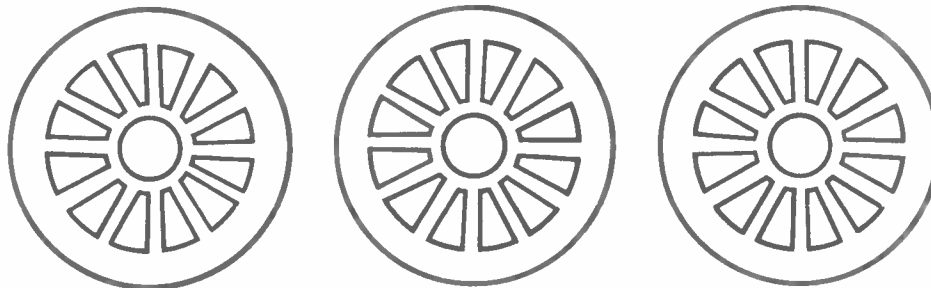
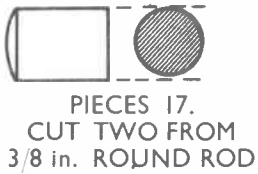

WHEELS. CUT ONE OF EACH 1/4 in.

WorldRadioHistory

PIECE 14. CUT ONE FROM MEDIUM GAUGE WIRE

A KIT OF MATERIALS FOR MAKING THIS DESIGN IS SUPPLIED BY HOBBIES LIMITED, DEREHAM, NORFOLK. PRICE ON APPLICATION.

Use **Croid** UNIVERSAL

IT'S DESIGNED FOR THE JOB

The popular general purpose liquid glue, used cold for all making and mending with wood, leather, card, etc. The best glue for sticking laminated

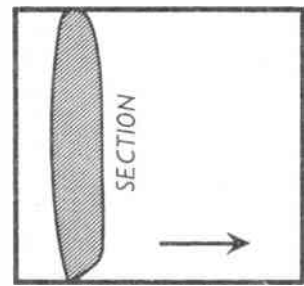
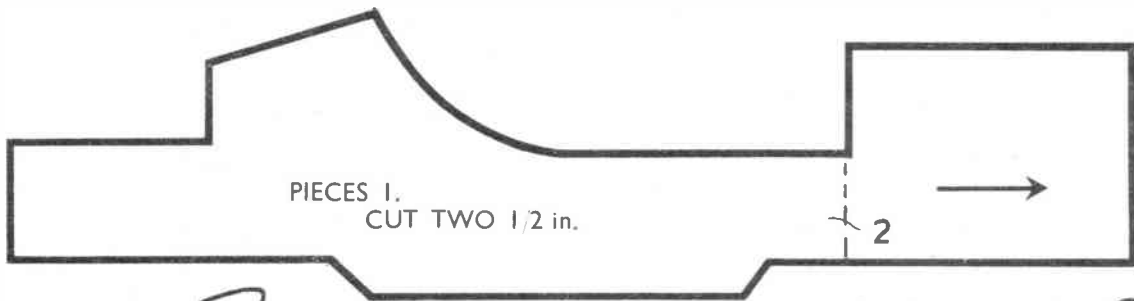

PIE
CU

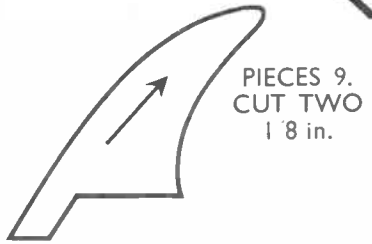

SIZE—
7 ins. L
3 1/2 ins. H

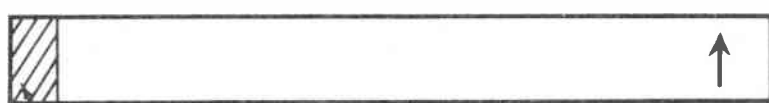
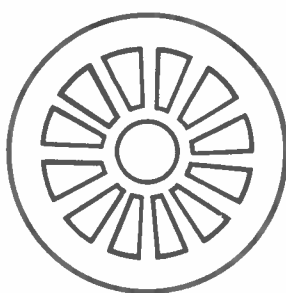
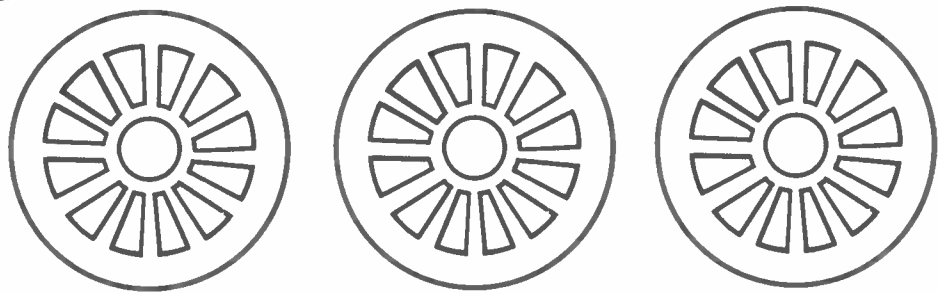
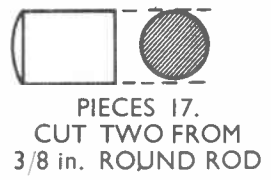
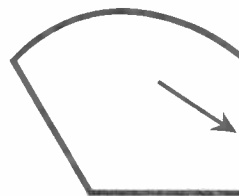
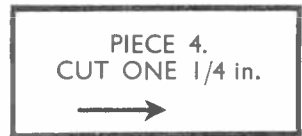
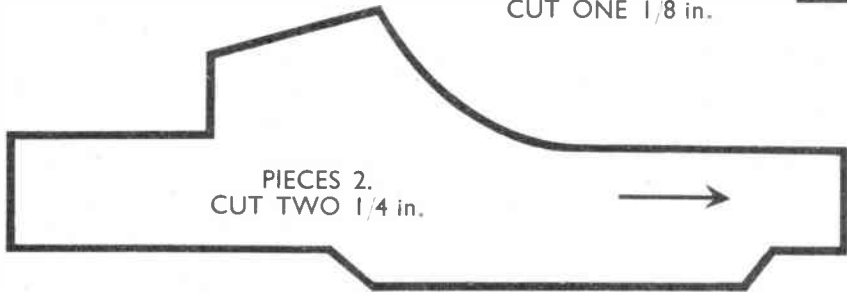
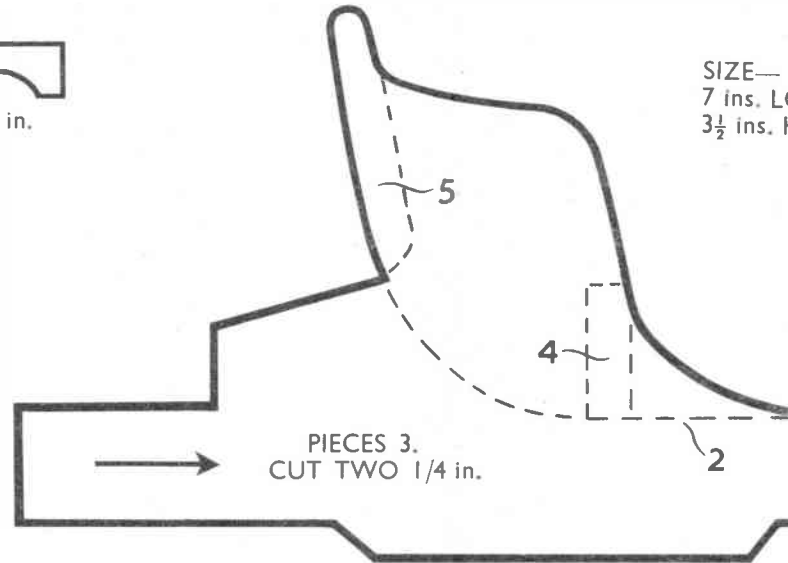
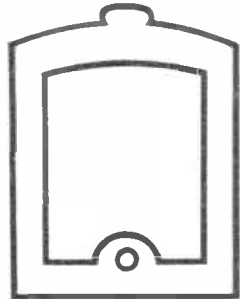
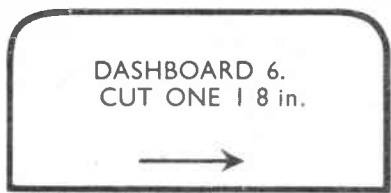

THE ARROWS INDICATE
DIRECTION OF
GRAIN OF WOOD

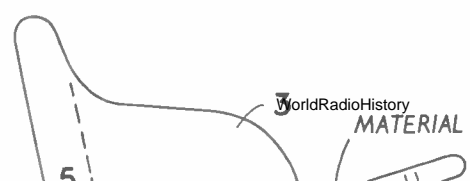
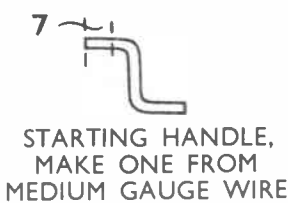

PIECE 11.
CUT ONE
FROM THIN
PLYWOOD

PIECES 17.
CUT TWO FROM
3/8 in. ROUND ROD

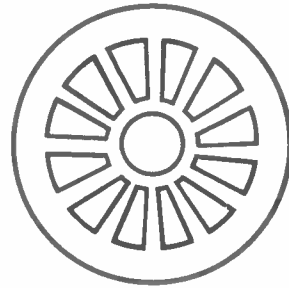
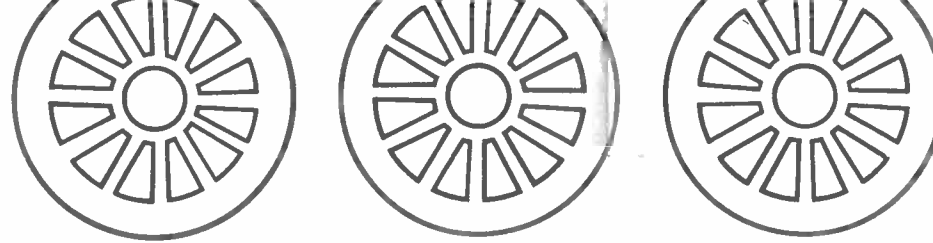

WHEELS. CUT ONE OF EACH 1/4 in.



FRONT MUDGUARDS 13,
CUT TWO FROM THIN
PLYWOOD

PIECE 14.
CUT ONE
FROM
MEDIUM
GAUGE
WIRE



STEERING
WHEEL
CUT ONE 1/8 in.

Use
Croid UNI
IT'S DESIGNED FOR THE J
The popular general purpose liquid g
used cold for all making and mend
with wood, leather, card, etc. The
best glue for sticking laminated
plastics. Large tube 1/2, 8 oz.
tin 2/10, 16 oz. tin 4/6
AVAILABLE FROM ALL BRANCH

PAINT ON



HUB CAPS
CUT FOUR
1/8 in.

PIECE 15.
CUT ONE FROM
3/8 in. ROUND ROD



CUT

WA

10

V

P

16

P

STE

MA

ME

PRIN

PRIN

PRIN

PRIN

PRIN

PRIN

PRIN

PRIN

PRIN

PRIN

PRIN

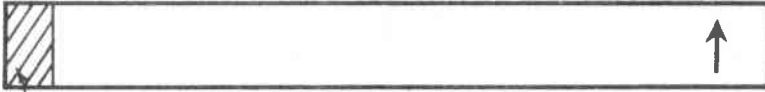

REAR MUDGUARDS 12.
CUT TWO FROM THIN PLYWOOD

WASTE FOR
TRIM

THE ARROWS INDICATE
DIRECTION OF
GRAIN OF WOOD



STARTING HANDLE,
MAKE ONE FROM
MEDIUM GAUGE
WIRE

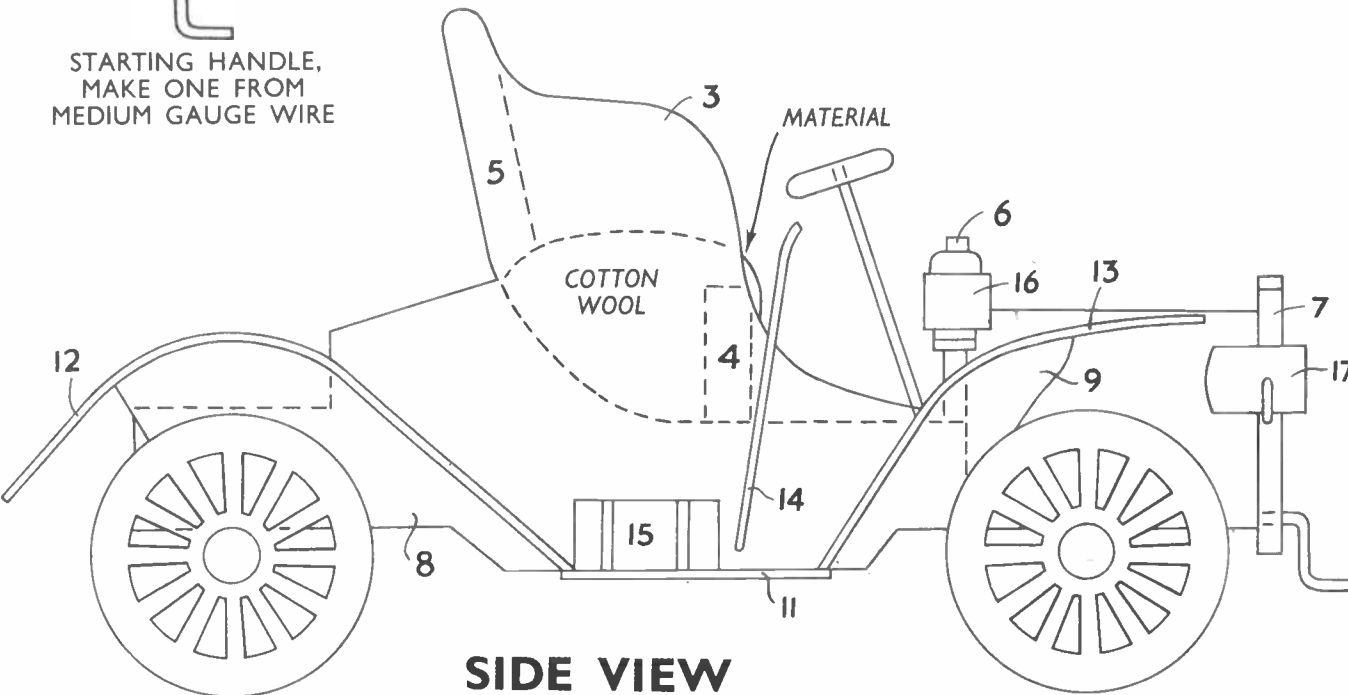

SIDE VIEW

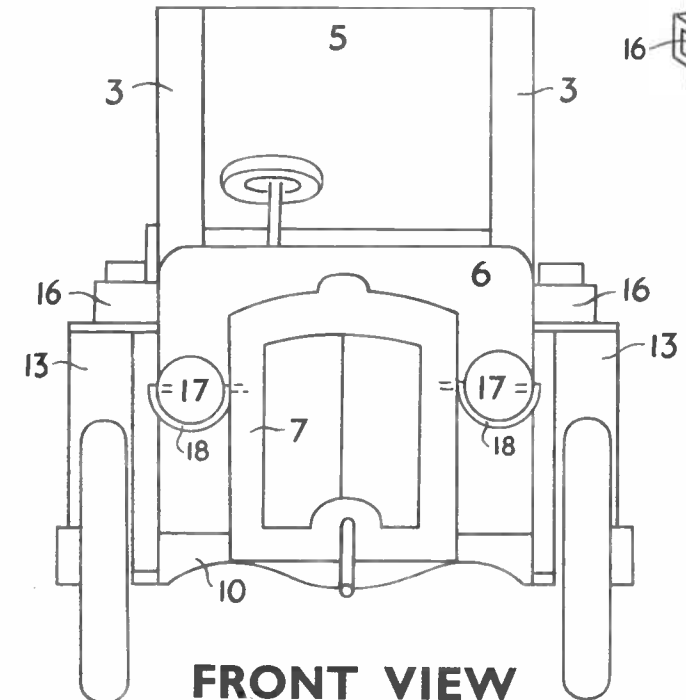

FRONT VIEW

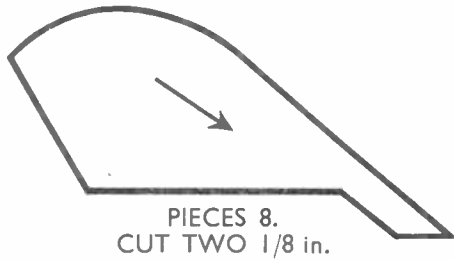
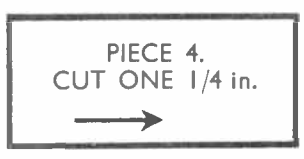
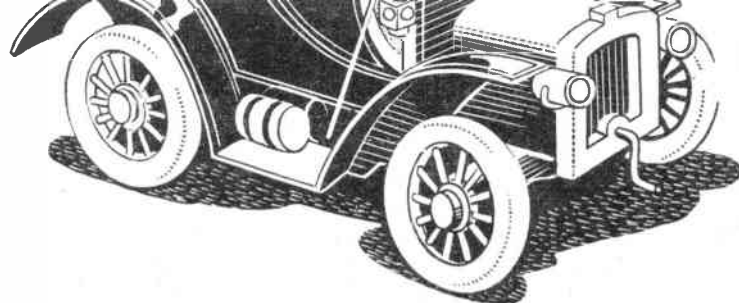
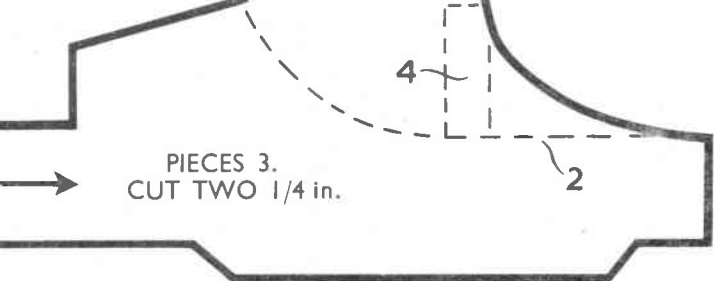

A KIT OF MATERIALS FOR MAKING THIS DESIGN IS SUPPLIED BY HOBBIES LIMITED, DEREHAM, NORFOLK. PRICE ON APPLICATION.

TAPE TWO FROM MEDIUM GAUGE WIRE

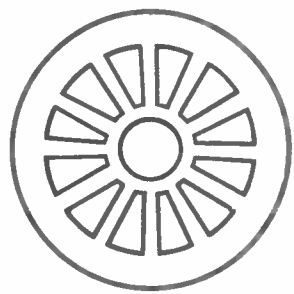
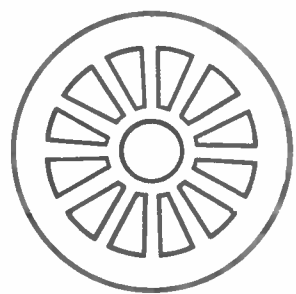

PIECE 14.
CUT ONE FROM MEDIUM GAUGE WIRE



ONE OF EACH 1/4 in.



STEERING WHEEL
CUT ONE 1/8 in.

Use **Croid UNIVERSAL**

IT'S DESIGNED FOR THE JOB

The popular general purpose liquid glue, used cold for all making and mending with wood, leather, card, etc. The best glue for sticking laminated plastics. Large tube 1/2, 8 oz. tin 2/10, 16 oz. tin 4/6

AVAILABLE FROM ALL BRANCHES OF HOBBIES LTD

T MUDGUARDS 13,
TWO FROM THIN PLYWOOD

WASTE FOR TRIM

HUB CAPS
CUT FOUR
1/8 in.

PIECE 15.
CUT ONE FROM
3/8 in. ROUND ROD

PIECE 16.
CUT TWO 1/4 in.

WASTE 1/8 in. WOOD

16

WASTE

THE ARROWS INDICATE DIRECTION OF GRAIN OF WOOD

16

PAINT ON

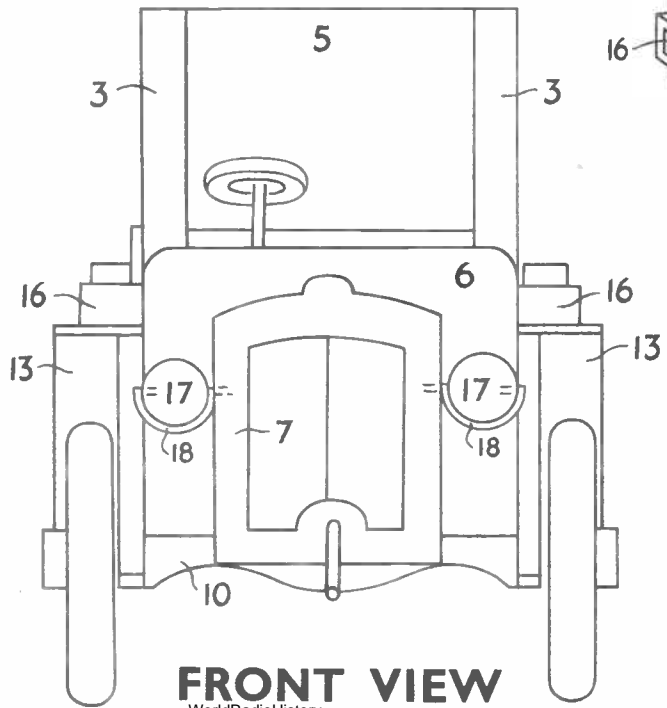
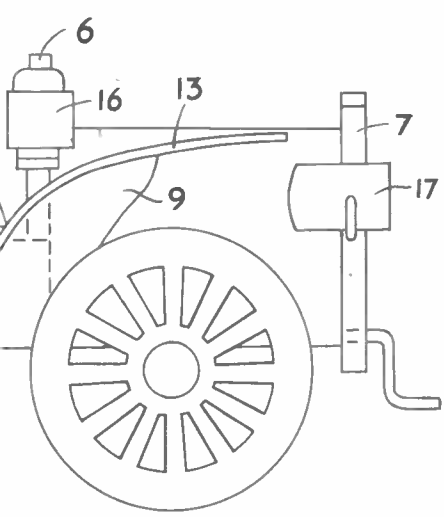

STEERING WHEEL

STEERING COLUMN
MAKE ONE FROM MEDIUM GAUGE WIRE