

HOBBIES *weekly*

FOR ALL
HOME CRAFTSMEN

FREE £200

CONTEST

MAKE UP THIS
NOVEL DESIGN AND
WIN A HANDSOME
PRIZE AS DETAILED
IN THIS ISSUE

Also in this Issue:

PLANS FOR A
WORKSHOP

KEEPING A
HAMSTER

GIFT HOLDER
FOR MATCHBOXES

RADIO PHONES
AND SPEAKERS

COLLECTORS' CLUB

WOODWORK AND
NOVELTY PROJECTS

ETC. ETC.



Up-to-the-minute ideas
Practical designs
Pleasant and profitable things to make

5^D



A WELL-KNOWN firm in the gun trade is W. W. Greener Ltd, of St. Mary's Row, Birmingham.

In a recent interview Mr Leyton Greener explained, 'Although most of our guns go overseas, we do cater for our home market.'

The real romance of the gun trade lies in the making of sporting guns. The raw material consists of four basic parts — a piece of French walnut for the stock;

On one occasion during a shooting display, father was asked to express his opinion of the Russian team — "Not bad," he said. When the Czar invited him to do better, his display was so good that large orders were placed for our guns.'

'Sportsmen are welcome to our advice at any time,' said Mr Greener.

Mr Len Onions, the foreman-maker, is very well informed about firearms — 'the word expert is seldom used in the Greener factory because all the

men are expert in their own particular job.'

Greener labels and stationery are among the best, the gunpowder cover being very rare.

The firm was founded in 1829 by the late W. Greener, who became famous for his technical contributions to the science of gunnery, and for his numerous and diverse inventions. His harpoon guns were considered the best of their day by the Scottish 'whalers'. At a public contest held at the London Docks in 1848 he was successful in obtaining a record flight of 120 yards from one of his swivel harpoon guns.

THE 'GREENER' STORY

In 1851, at the first great Exhibition of all Nations, he was awarded a prize medal and diploma — the highest honour — 'for guns and barrels perfectly bored and finished'.

As head of the firm, W. W. Greener quickly emulated his father's example in the writing of books. His first effort was *The Modern Breechloader* published in 1871. This was followed by *Choke Bore Guns* in 1876. *The Gun and its Development* (1881) was soon recognized as the standard work on firearms and today is accepted as the encyclopaedia on gunnery.

In the firm's showroom there are rows and rows of firearms dating from the 17th century, probably one of the finest collections of its kind. (R.L.C.)

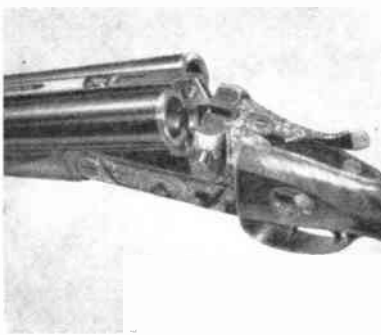

solid forgings of special steel, with good elastic limit and tensile strength, for the barrels; forgings for the breech action body; and the fore-end. Compare these rough beginnings with the sleek beauty of a finished gun and you will realise the wealth of skill and patience which is lavished on steel and wood to rejoice the sportsman's heart.

During the last war Greener's made guns for battle. To day they are producing smooth-bore single and double-barrelled sporting guns.

I asked Mr Leyton Greener why Greener guns are so popular in Russia. 'My father opened a shop in Russia during the Czar's reign,' he explained. 'Shooting matches were a regular sport.

'God Bless the Prince . . .'

OUR second National Anthem originated in a happy thought which occurred to a Welsh gentleman, Mr Ceiriog Hughes, some ninety years ago.

During the progress of one of the famous Eisteddfodau Mr Hughes confided to his friend, the composer Brinley Richards, the fact that he had written a song in honour of the Prince of their country. It was in the Welsh tongue, and was called 'The Prince of Our Brave Land.'

'Would Mr Richards set it to music?' he asked.

After a little pressure, the latter consented. He altered the title to 'God bless the Prince of Wales', and endowed the words of the hymn with the inspiring melody which has been declared to be of more real value to the Throne than the whole of the Crown Jewels, or the Koh-i-Noor itself.

The song was promptly translated into English, and at St. James's Hall, on February 14th, 1863, was sung for the

first time in public by Mr Sims Reeves.

'God bless the Prince of Wales' made a profound sensation. The impressive air, rendered with vigour and expression by the great singer, aroused the audience to enthusiasm. They demanded encore after encore, and sang the refrain as they trooped out into the street.

In next week's issue we will commence instructions for building a multimeter — a desirable piece of apparatus for the radio constructor. Also, designs for a model of a hansom cab, and other projects for the handyman.

MAKE SURE OF YOUR COPY

KEEPING A HAMSTER

THIRTY years ago there was not a single Golden Hamster in this country. Today there are thousands; all descended from a single family found in 1930 near Aleppo, Syria. The hamster is so popular because it is odourless, easy to feed and has an attractive appearance. Their antics can also be a source of great amusement and they may be easily tamed.

In the wild state, hamsters are burrowing animals, making their tunnels near cultivated fields, and hoard quantities of grain which they carry to their underground storage rooms by means of their cheek pouches. Although the tame hamster has a continuous supply of food, this hoarding habit still persists. It is important to remove any stale food your pet has secreted in his sleeping quarters and also small sharp objects which would damage his cheek pouches must be kept out of his way. He may try

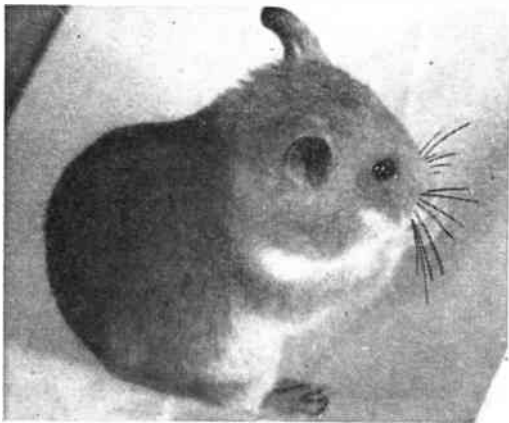

to pouch and hoard small nails and similar dangerous objects!

Different colours

Although the colour most frequently seen is the original 'golden', various mutations have occurred and hamsters may be obtained in two shades of the original golden, golden fawn and golden agouti. The first is a light fawny gold and the latter is a dark mahogany red. In addition to the golden shades, there are cream, albino and piebald hamsters. They may also be obtained in the 'ruby-eyed' mutation. In this mutation, the natural colouring is diluted and the blood vessels show through the eye pigment. These types are not readily obtained through pet shops, and if you wish for one of these rarer animals, you should contact the Hamster Society who

will be able to put you in touch with a breeder. Also the various pet magazines often have advertisements for hamsters.

Housing

Having purchased a hamster, the most pressing problem is to give him a home, and, of course, this should have been considered beforehand. Adult hamsters

By P. R. Chapman

must be housed separately, since they are aggressive little beasts, and if several are kept together, they will fight and, undoubtedly, damage one another. The female hamster is particularly aggressive and if not in 'season' will damage the more docile male badly.



A handful of hamster!

hinged top covered with $\frac{1}{2}$ in. mesh wire netting, and a sliding glass front. A supply of clean hay or wood shavings should be given to the hamster to construct a

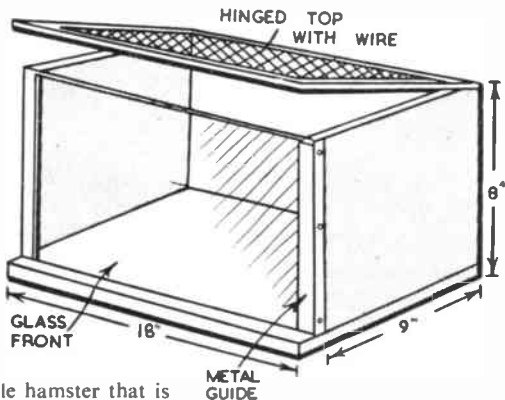

The cage for a single hamster that is going to be allowed to play and run around the living-room in the evening should be about 18 in. by 9 in. by 8 in. deep. Although metal cages are tooth-proof (hamsters are great gnawers!) they are cold in winter. Wood is far better, and provided the cage is well-made with nicely fitting corners it should be safe against your pet's teeth. It should be well painted with lead-free enamel. The exact design is not important; probably the most suitable type is one with a

nest. The bottom of the cage should be covered with sawdust.

Feeding

Hamsters are omnivorous. They will eat grain, nuts, raw meat and fish, raw or cooked vegetables, bread (brown), acorns, grubs and worms. In the summer, plenty of greenstuff should be given, dandelions being greatly appreciated, so there should be no difficulty in giving your pet a

● **Continued on page 12**

DETAILS OF 1960 COMPETITION

WE again have pleasure in awarding prizes to the value of £200 for our 1960 Fretwork Competition, full details of which are given in this issue.

All you are asked to do is to cut out the design for the novelty Pencil Box and Sharpener as neatly as possible and submit it to the organisers by April 30th 1960. The competition piece is quite simple to cut and entry is free. To give readers of all ages a chance, the competition is judged in two sections — for seniors aged 16 and over and for juniors aged 15 and under. The subject for the competition is the same for both classes.

The valuable prizes to be won are detailed below and the various vouchers offered will enable the winners to obtain any of Hobbies goods listed in their Annual to the amount of the voucher won. Tools, kits, machines, materials, etc., all come within this category, thus giving a grand opportunity for competitors to add to their workshop equipment and hobby requirements.

In addition to the main awards listed there will also be many £1 vouchers for those who just fail to enter the main

prize list. There will be dozens of other valuable consolation awards, and certificates of merit will be issued for work which qualifies according to the decision of the judges.

In addition to being presented with a voucher for £15 15s. 0d., the chief

The open and junior sections will be judged independently and young workers aged 15 and under who compete with others in this limited age group will therefore stand an excellent chance of winning a prize. In the junior section, incidentally, it must be thoroughly understood that competitors shall receive no help from an adult, and receipt of an entry in this section will be taken as an honourable guarantee that it is in fact their own work.

The judges will naturally concentrate on the quality of the fretcutting, while an attractive finish will also be taken into consideration.

All competitors should read thoroughly the rules detailed below. The entry should be well packed so as to ensure its safe delivery through the post and must reach the Competition Office not later than April 30th 1960.

The subject of the Pencil Box and Sharpener, which is the competition piece, makes up into a very attractive novelty and though it has obviously been designed as a test for fretcutting it is nevertheless a subject which lends itself ideally for completion by all workers.

FULL INSTRUCTIONS FOR MAKING UP THE COMPETITION DESIGN ARE ON PAGE 5

winner in the open section will be acknowledged as the Champion Fretcutter for 1960 and will hold the magnificent silver challenge cup for a year. With this award goes a permanent cup replica as a reminder of the achievement.

1960 COMPETITION RULES—PRIZES TO THE VALUE OF £200

OPEN SECTION

Winner receives cup and replica

	Voucher for	£	15	0
1st Prize	£15	15	0	
2nd Prize	£12	12	0	
3rd Prize	£10	10	0	
4th Prize	£7	7	0	
5th Prize	£5	5	0	
6th Prize	£4	4	0	
7th Prize	£3	3	0	
8th, 9th and 10th Prizes	£2	2	0	
11th and 12th Prizes	£1	10	6	

JUNIOR SECTION

(15 years of age and under)

	Voucher for	£	12	0
1st Prize	£12	12	0	
2nd Prize	£7	7	0	
3rd Prize	£5	5	0	
4th Prize	£3	3	0	
5th, 6th and 7th Prizes	£2	2	0	
8th, 9th and 10th Prizes	£1	10	6	

Vouchers for £1 will be awarded for the next best entries

In addition, dozens of other valuable prizes and Certificates of Merit will be awarded. Winners of the vouchers may choose any Hobbies goods to the value of the prizes won.

RULES

- All entries must be made from Hobbies Design No. 3330, presented free with this issue of *Hobbies Weekly*.
- Points will be awarded for the quality of the fretcutting, plus the excellence of the finish.
- An entry must be the unaided effort of the competitor. This rule must be strictly adhered to.
- Entries must be sent to the Competition Dept., Hobbies Ltd., Dereham, Norfolk, to reach there not later than April 30th, 1960.
- A label bearing the name and address of the competitor, age, and Section of the Competition for which the entry is to be judged, must be firmly affixed to the entry. Competitors who wish their entries returned must include a 1/- P.O. to cover cost of repacking and postage.
- Because of Customs restrictions, etc., entries are confined to those from Great Britain and Northern Ireland.
- Prizewinners will be notified by June 30th, 1960, and details will also be given in *Hobbies Weekly*.
- Hobbies Ltd. cannot accept responsibility for any loss or damage to entries, but all reasonable care will be taken with them.
- The judges' decisions are final, and no correspondence can be entered into.

A GIFT HOLDER FOR MATCHBOXES

NOVELTY gifts in the form of matchboxes as shown in our illustration can be quickly made with the aid of two pieces of cardboard and two of your own snapshots. You may use views taken on your holiday, or portraits, and the popular 2½ in. by 3½ in. will be found large enough for this purpose. Besides being a novelty, the illustrated boxes look very attractive, while the case can be refilled with new drawers when the matches have been used.

Take two ordinary sized matchboxes, gluing together at the sides so that both abrasive edges remain on the outside. We now need two pieces of thin cardboard measuring 2½ in. by 2½ in. for

gluing on to the back and front. These reinforce the boxes, make a 'case' and form a mount for the pictures. You should verify the above-mentioned size since some boxes vary slightly.

Before gluing the two small pieces of card on to the boxes it is as well to select and prepare the pictures to the same size. Trim carefully with a sharp knife. The two cards can be fixed with any reliable adhesive and left under a weight until firmly attached. The novelty is then completed by pasting a picture on each side.

If you like to extend the idea a little further, using four matchboxes, see Fig. 1. This shows how to arrange four boxes

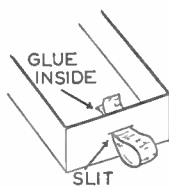
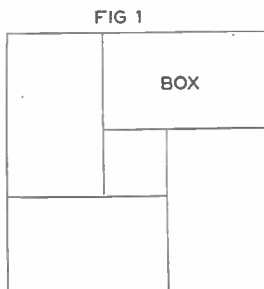
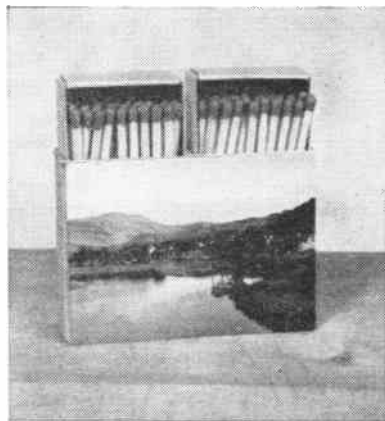

FIG 2



pletely covered. It should be noted that when arranging the four boxes in this order the abrasive edges should be on the outside.

We must also make some provision for opening the drawers. Make a small slit in one end of each of the drawers as shown in Fig. 2. A small loop of narrow ribbon is passed through the slit and the two ends glued fast inside the drawer.

As a further precaution it is advisable to apply a small strip of passe partout or paper binding on top of these ends of ribbon and this will allow the drawers to be opened quite easily by a gentle pull on the loop. (S.H.L.)

COMPETITION TEST PIECE

Making up the Pencil Box

THE novelty container for pencils, illustrated on the front page, also has provision for sharpening them and is an excellent subject to make up as gifts or for sale, particularly at bazaars and work stalls, etc.

Standing 4 in. high, the model is 5½ in. wide and there is provision in the container at the back for a dozen or so pencils. It can conveniently stand on a desk, bureau or sideboard, etc.

The humorous picture and lettering are added in the form of overlays, and the subject should be nicely finished to add to its attractiveness. Workers should endeavour to get nice clean lines when cutting, but otherwise the make-up is quite simple and can be attempted by all.

The parts which go to its make-up are all shown full-size on the design sheet. These should be traced and transferred to their appropriate thicknesses of wood by means of carbon paper, cut out with a fretsaw and cleaned up thoroughly with glasspaper. When cutting out the

KIT FOR ONLY 3/-
Hobbies Kit No. 3330 for making the Pencil Box costs only 3/- and contains panels of wood in the correct thickness. A pencil sharpener is also included and kits are obtainable from Branches, etc., or by post from Hobbies Ltd., Dereham, Norfolk (post 1/3 extra).

individual letters of the slogan, make sure to take out the interior frets first. For instance, start by cutting out the interior pieces of the letters 'P', 'A', 'R', 'O', etc. Then cut round the outlines of the individual letters.

In assembling, piece 1 (which forms the background for the overlays) is glued to the base (piece 2). The position is shown by the dotted lines on the design

sheet. Pieces 3, 4, 5 and 6 are next added behind piece 1. Pieces 3 and 4 form a collecting trap for the shavings from the sharpened pencils, and pieces 5 and 6 form the container to hold the pencils.

The positions of the various overlays are clearly shown by dotted lines on piece 1 on the design sheet. It will be noted that pieces 15, 16 and 17 are in turn added to the car overlay (piece 8).

Pieces 18 are glued behind piece 1 in the position also indicated by dotted lines. These pieces should be made to fit nicely round the sharpener, as shown in the detail on the design sheet. A locking screw can be inserted through the top piece 18. An ordinary round head brass screw will suffice. Piece 19 is glued in front of the lower piece 18 to give added strength to the fitment.

Finish is left to the discretion of the worker. The wood can be left plain or stained and polished. Alternatively, this subject would look very attractive if painted in gay colours.

PHONES AND SPEAKERS

THE headphones or loudspeaker used with a receiver can make a great deal of difference to results. Unsuitable phones or speaker can easily reduce volume, or may cause distorted reproduction. Because of this, it is worth while to make sure that reception is not spoiled through this reason.

Headphones are usually employed with crystal sets, or small valve or transistor sets. With crystal sets, in particular, there will be no volume to spare. Unsatisfactory phones can then make reception seem so weak that the set is useless.

Fig. 1 shows the important parts of the most popular type of phone. A complete headset consists of two such units with a headband and long lead. The diaphragm is very thin, and near the poles of the magnets, which have bobbins each containing some thousands of turns of wire. Signals flowing through these windings make the strength of the magnetic field fluctuate, so that the diaphragm vibrates, producing the sound, which is heard through an opening, or holes, in the cover.

Sensitive phones of this kind have a resistance of between 500 and 4,000 ohms. This high resistance shows that there is a large number of turns on the windings, and this results in a good sound output even with very weak signals. But with various ex-service and other surplus phones the windings may only be a 100 ohms, or less, in resistance, because there are fewer turns on the magnets. If these phones are used with a small receiver, such as a crystal set, results will be very poor. Even local stations may be too weak for satisfactory listening.

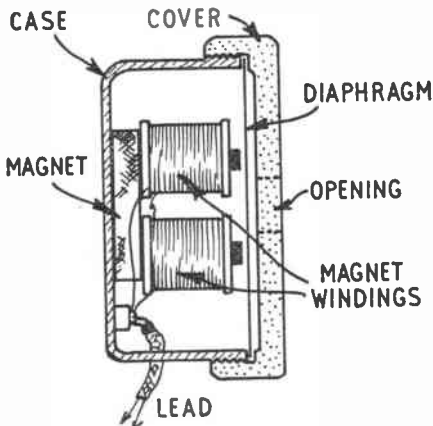

Fig. 1—An earphone

The high resistance type of phones cost more than surplus, low-resistance headsets, but can be regarded as almost essential for proper listening with a crystal set.

Impedance matching

Results with low-resistance phones can be improved by using a matching transformer between the receiver and phones. These transformers are sometimes available with the phones, at extra cost. The primary is connected to the receiver, and the secondary to the phones.

For best results the transformer and phones must be intended for use together, exactly as when using an output transformer with a moving coil speaker, as explained later. Usually, however, a speaker transformer will not be satisfactory for matching low-resistance phones, because phones and speakers have a different resistance, or impedance.

With a crystal set or similar receiver, it is thus best to buy medium or high resistance phones to begin with. If not mis-used, they can have an extremely long life indeed.

In valve and transistor sets, a steady direct current flows from the battery through the phones. The phones are usually marked so that they can be connected in the correct polarity. That is, positive to H.T. positive, with a 1-valver; or negative to battery negative, with a transistor set. The current in the magnet windings then tends to increase the magnetism. If connected the wrong way, this

current tends to demagnetise the phones, and after a long period of use they can then become less sensitive.

Balanced armature phones are also made, and are of rather lower resistance than the kind shown in Fig. 1. With these, an armature vibrates between two magnet poles, and operates the diaphragm through a slender rod. Such units give a good sound output when they are of fairly high resistance, but low-resistance units will need the matching transformer already mentioned.

By 'Radio Mech'

Transistor sets work quite well with phones of only moderate resistance, because a transistor has a lower 'optimum load' than a valve or crystal detector. But very low resistance balanced armature phones will need a matching transformer, even with a transistor set.

A third kind of headphone is made, and often sold as surplus. This is the moving coil type, resembling an extremely small moving coil loudspeaker. With these, a matching transformer must always be used.

Moving coil speakers

Present day loudspeakers are usually of moving coil type, and the important parts are shown in Fig. 2. The speech coil is wound upon a tube fixed to the cone, and moves in the space between inner and outer poles of a magnet. Flexible leads from the cone to a small tag board, fixed to the speaker frame, allow the signal from the receiver to be fed into the speech coil. This makes the cone move, producing the sounds heard.

In mains sets, energized speakers are sometimes used. These do not have a permanent magnet, but draw current from the mains (after rectification) to produce the necessary magnetism. Mains energized speakers of this kind are sometimes sold very cheaply, but are best avoided. They cannot be used at all with battery sets. With mains sets, it may be awkward to arrange a suitable supply of rectified current to magnetize them.

The usual moving coil speaker, for transistor, battery, or mains sets, has a permanent magnet. The stronger this is, the better will results be. For this reason, a moderately large speaker, of good make, will give louder, better reproduction than will a very small cheap speaker.

Speakers are often listed by the diameter of the cone. For average use, a 5 in. or 6 in. speaker will do well.

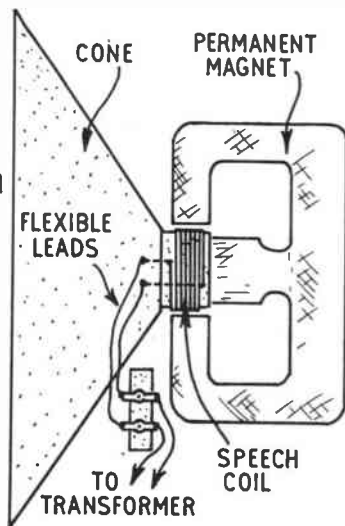

Fig. 2—Moving coil speaker

The speech coil has only a few turns of wire, and is thus of very low resistance, or impedance. Most popular speakers are of 2 ohm to 3 ohm impedance. Some units are of 15 ohms, however, and other resistances are also made. As the resistance, or impedance, influences the ratio of the output transformer, it is helpful to know this figure.

In lists, the speech coil impedance is usually given, and is often 2/3 ohms, as mentioned. When the speaker is listed in this way, no difficulty arises. If, however, the impedance of a speaker is not known, it is usually safe to measure the direct current resistance of the speech coil with a meter, and multiply this by 1.4, to obtain the impedance. Resistance and impedance are closely related, but not the same thing, because the resistance also depends on the gauge of wire used to wind the coil.

Output valves have an 'optimum load'. That is, a load with which they give best

results. For most small battery output valves such as the 3S4, this is about 8,000 ohms. For mains valves it is rather less, being about 5,000 ohms for a typical valve such as the 6V6.

Because the speaker is only 2 or 3 ohms or so, results would be very poor if it were connected directly to the valve. To overcome this, a matching transformer is used, as mentioned for low-resistance phones.

Finding correct ratio

If desired, the correct ratio, for any valve and speaker, can be worked out. To do this, divide the optimum load of the valve by the speech coil impedance of the speaker, and extract the square root of the result. This is the correct ratio. For a 8,000 ohm load, a ratio of about 60:1 would do, with a 2/3 ohm speaker. The ratio for a 5,000 ohm load

would be about 45:1, also with a speaker of 2 ohms to 3 ohms impedance. For a 15 ohm speaker, 23:1 would do for a 8,000 ohm load, and 18:1 for a 5,000 ohm load.

The ratio is not critical, but should be reasonably near, for best results. Some transformers have tapings, so that the best ratio can easily be found by trial.

With transistors, a rather lower ratio is usually needed. For example, if the transistor has an optimum load of 1,000 ohms, a 20:1 transformer could be used with a 2 ohm or 3 ohm speaker, or an 8:1 transformer with a 15 ohm speaker.

When making up an experimental or similar receiver, it should be remembered that the loudspeaker can only give proper results when it is enclosed in a cabinet, or attached to a baffle board. A baffle board can be of any convenient size, say 12 in. by 12 in. It has a circular hole, of the same diameter as the speaker cone, and the speaker is screwed to it.

Simple Tank and Rocket Launcher

THE little toy tank, which can be made up in a few moments from a cardboard cigarette packet, was probably invented by a bored soldier. A pair of nimble hands are the only tools needed to construct the model, and a child will be delighted with the result.

Remove the tray from an undamaged small size cigarette packet and form the body of the tank as follows. Bend both ends of the two sides to resemble slanting tracks and fold back the two flaps along the top of the body. (See illustrations.) Now you must make the gun turret

Carefully cut the cover into three similar bands of roughly equal width and interlock the three parts together to form a hexagonal shape that will serve as a mounting for the gun. Fix the turret upon the body by slipping the two flaps under one of the cardboard bands. Adjust the shape of your model until you are quite satisfied with its resemblance to a tank. Mount the 'gun' by inserting a matchstick into the front of the turret.

Now you may care to demonstrate one of the most up-to-date anti-tank weapons by attacking your armoured

vehicle with miniature rockets. Make the rockets from live matches. Encase the heads of the matches in tight 1/2 in. long 'caps', which are formed from silver paper, such as cigarettes are packed in. Stand a matchbox upon end to serve as a rocket launcher. Lay one of the 'rockets', with its *stick end* pointing towards the target, across the top of the upturned box.

Fire the rocket by striking a match and holding the flame beneath the silver paper cap. Suddenly the encased match head will burst into flame and the rapidly expanding hot gases it produces will drive the matchstick rocket towards its objective. The effective range of the rockets is between 12 and 20 in. It is best to do this out of doors, and ensure that the smouldering matches can do no harm. (A.E.W.)

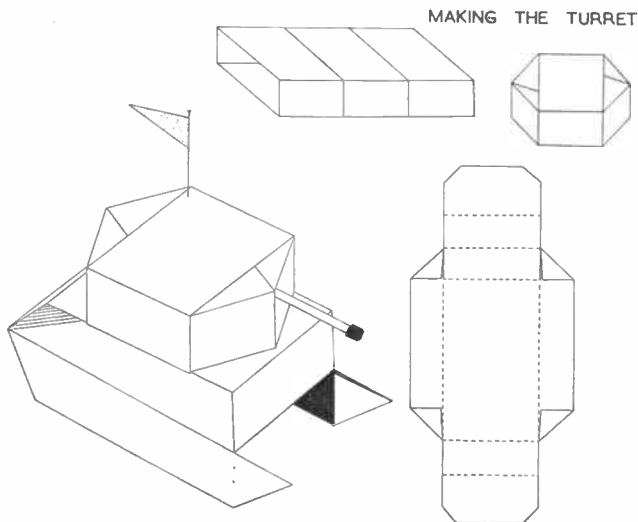

PHOTOGRAPHIC WEIGHT RECORD

AT Rotterdam, Holland, the goods station has been fitted with an automatic weigh-bridge. This records the weight of the wagons as they are drawn across it, so that all the operator has to do is press a button. This operation produces a photograph on which is recorded the time and the date, the number of the weighbill and the weight of the truck. The photograph is developed, fixed and dried in six minutes.

HANDY WORK- SHOP

(EASY TO TAKE APART
AND RE-ASSEMBLE)

THIS workshop, which can be taken apart at any time and removed to another site, is quite as easy to build as the permanent type, and stands just as firm. Anyone who is handy with woodworking tools can build it with confidence. A point to notice is the introduction of double doors. This may be of convenience when making or repairing a rather bulky article, to facilitate its removal.

Figs. 1 and 2, end and side elevations of the framework, should be studied carefully. The timber used is of 1½ in. by 2 in. section, good quality deal. When making up the ends, position with the narrow sides of the wood (the 1½ in. sides) facing each other; when putting the sides framework together, the 2 in. or wider sides of the timber face each other.

The corner joints are half-lapped, as at A, and the other joints notched and

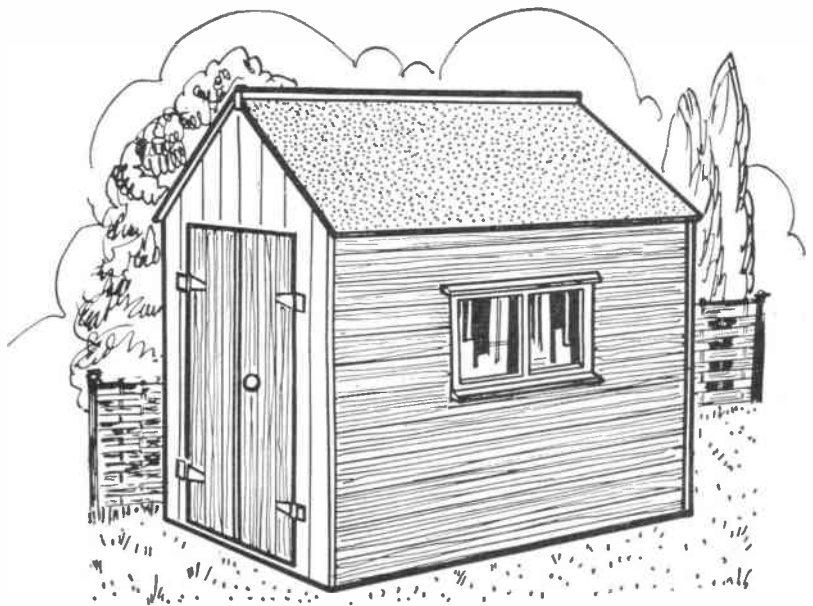

Described by *W. J. Ellson*

nailed in between, as at B. Nail all together. Fig. 1 shows the end frame in which the doors will be fitted. The opposite end simply has two intermediate posts (as shown by dotted lines) and cross-bars. For the roof rafters, for each end cut two to length given in Fig. 4.

These are sawn across at each end of their length to angles given. Join together at 1 in. down from the ridge with a 1 in. square length of wood, and above this saw out a

notch to admit a 1 in. thick ridge board. These details are made clear at C. Nail the roof rafters in place.

The side frames can now be made. The one illustrated is that with a window opening. The opposite side will not need this opening, therefore crossbar D can be omitted. The position of the three intermediate rafters, with ridge board in place, is shown above the framework. For these cut six more rafters and join

● **Continued on next page**

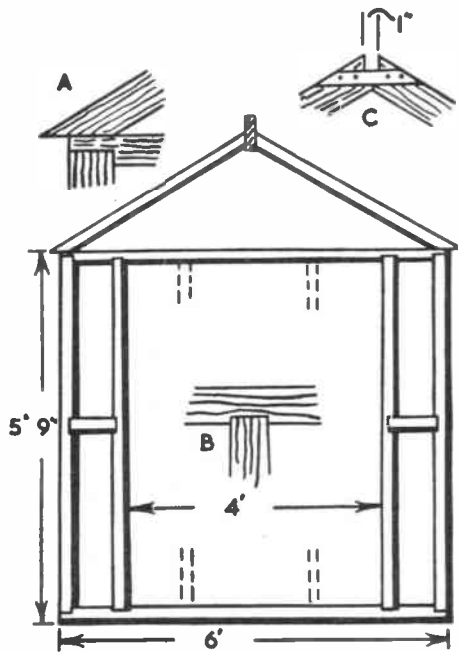

Fig. 1

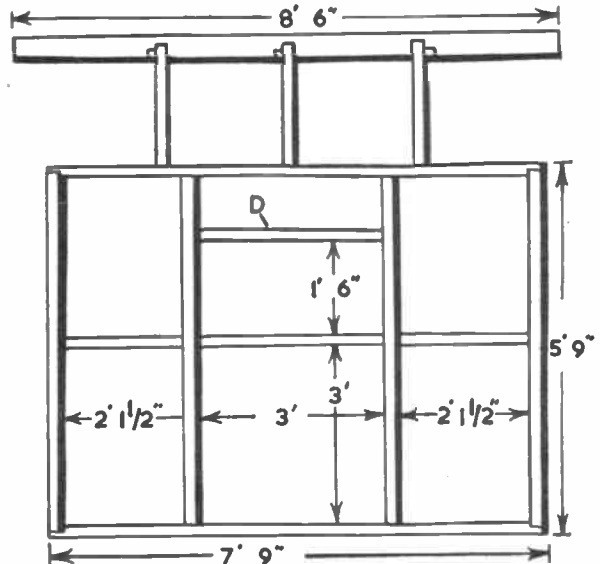

Fig. 2

together at top. Make the ridge slots as before. About half-way down each nail a tiebar of 1 in. by 2 in. wood across, as in Fig. 3 and then fix the rafters across with metal tiebars.

The ends and side frames are now fitted together with bolts, three to each corner. Position these at a few inches from top and bottom, and one bolt central. Cover the sides with tongued and grooved boards, trimming clear of the window opening. Start fixing the boards from the bottom, and nail with tongued edges uppermost. These boards are laid horizontally. The last board at the top

merchants. Given a right angled twist these are useful for joining together when the parts to be so joined have their face sides at different angles.

The roof can be made of T. and G. boards, or plain boards as preferred, as they will be subsequently covered with roofing felt. Nail them to the strips E, not to the rafters themselves, then, as will be obvious, by withdrawing the bolts holding strips E, the whole side of each half roof can be lifted away.

Now cover the roof with the felt. A strip of wood, 1 in. by 3 in. and as long as the ridge should be nailed over it as a

CUTTING LIST	
Framing.	1 1/2 in. by 2 in. by 250 ft. run.
Side and end boarding.	1 in. tongued and grooved 1 1/2 squares.
Roof boards.	3/4 in. thick. 3/4 of a square.
Door battens and braces.	1 in. by 1/2 in. wood. 30 ft. run.
Tie bars, etc.	1 in. by 2 in. wood. 30 ft. run.
Ridge.	1 in. by 4 in. by 8 ft. 6 in.
Capping for same	1 in. by 3 in. 8 ft. 6 in.
FITTINGS	
1 doz.	3/8 in. by 5 in. bolts and nuts. 1 doz. 1/2 in. by 4 in. bolts. Door lock and handles. 2 door bolts. 1 pair 9 in. T hinges. 1 window stay. Roofing felt.

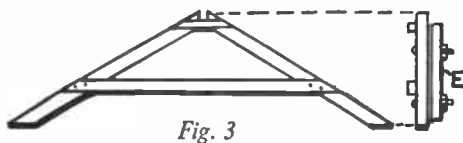

Fig. 3

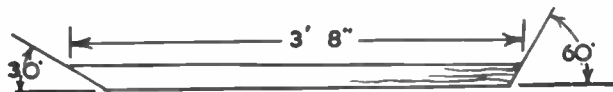

Fig. 4

must come level with the top edge of the rafters. Cover the ends similarly, but this time the boards are nailed vertically. Trim level with the door opening. It will be necessary temporarily to remove the bolts as boarding up proceeds and replace when holes in the boarding are bored for their re-entry as at Fig. 5.

To lay the roof, first cut six strips of 1 in. by 2 in. wood to nearly the length of each rafter, and bolt these to the fixed rafter at the ends and to the middle one. Detail E, Fig. 3 shows these. The parts E are bolted on the inside faces of the ends, and cross-strips at the ridge. Fix the ridge board at the top with a screw to each driven through the cross-strips below. The rafters are fixed to the side frames with metal ties as at Fig. 6. These ties can usually be bought at ironmongers and builders'

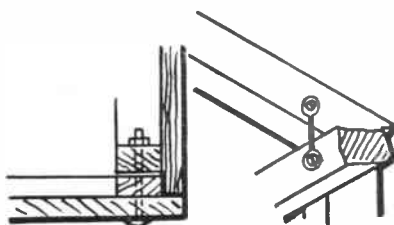

Fig. 5

Fig. 6

capping. This has its upper edges bevelled off. A window can be made, or bought as preferred. The doors, 2 ft. wide each, are made up with tongued and grooved boards and battened behind in the usual manner. Let them be long enough nearly to cover the gap

below left between the cover boards and the ground member of the framework. Hinge with 9 in. T hinges and fit one door with a bolt, top and bottom, on the inside, and the other with an ordinary latch and handles.

If a wood floor is to be added, make it up with 1 in. thick tongued and grooved floor boarding, but do not nail it to the framework of the workshop, but to separate battens beneath. It can then be taken out without trouble. Finish the whole with a coloured preservative, or just paint in the normal manner. The window, which should be hinged to open, should be fitted with the usual casement stays. Fit it to open upwards. The list of materials shows approximately the amount required, but careful planning when cutting to lengths will save waste.

A Useful Tie Rack

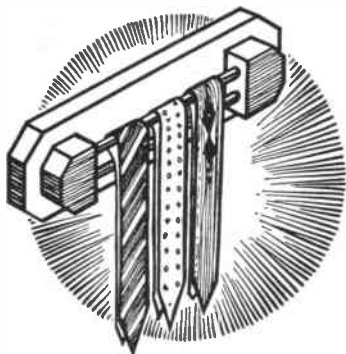

THIS handy tie rack is simple to make and will be found to be very useful. It can be screwed to the back of a wardrobe door or fixed on a

wall of your bedroom. Use either hardwood or softwood as desired.

The back piece is made from 1/2 in. thick planed timber. Cut out the required shape shown in Fig. 1 and smooth off the sawn edges with a rub of glasspaper.

Next, the two side pieces should be cut to the required shape (Fig. 2). These pieces should be cut from 3/8 in. thick planed timber and two holes are afterwards bored in each member in the

positions shown in Fig. 3. A depth of 1/2 in. is quite suitable for these holes. The two rails consist of two 10 in. lengths of 1/4 in. diameter dowel rod.

Use a little glue to secure the dowel rails to the side pieces and afterwards screw on the back piece by inserting four short screws from the back.

Complete the rack by applying a coat of enamel, staining and varnishing or French polishing. (F.K.)

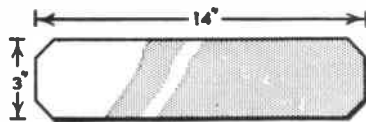

Fig. 1

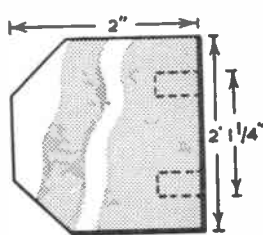

Fig. 2

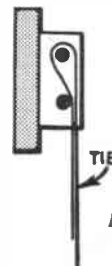

Fig. 3

THE DROPPING BALL GAME

HERE is an extremely entertaining game for you to make. It requires only a shallow box of suitable size and one can be easily constructed from $\frac{1}{2}$ in. material 2 in. wide. The object of the game is to score the maximum number of points by dropping a set of three table tennis balls through the hole in the top which ultimately thread their way through the maze of nails to lodge finally in one of the scored pockets.

You will require two strips of 2 in. material 15 in. long and two strips $12\frac{1}{2}$ in. long to make the box frame, but before assembling, the two shorter ones require additional attention. In one a hole of $1\frac{1}{8}$ in. diameter is made to accept a table tennis ball, and this hole is drilled so that it is 2 in. from the right side of the frame. We also require six partitions in

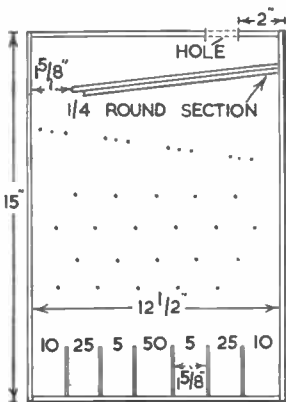

Fig. 1

the other strip made from $\frac{1}{8}$ in. plywood and measuring $1\frac{1}{2}$ in. long by $1\frac{1}{2}$ in. deep. Grooves are made in the $12\frac{1}{2}$ in. strip each $1\frac{1}{8}$ in. apart for these partitions, which are then glued into position. These make the scoring boxes for the balls.

The back of the box is made from hardboard and has a flap door at the

Described by

S.H.L.

base to permit quick release of the balls for the next player. Cut the hardboard to fit the back of the frame, then cut off $2\frac{1}{2}$ in. from the full length for the flap, fastening the two pieces together again by means of hinges as shown in Fig. 2 and nailing the upper half of the frame. On the inside of the back an inclined piece of plywood 11 in. by $1\frac{1}{2}$ in. is fixed to provide a runway for the balls. This is merely a strip of plywood as indicated, glued to the back and reinforced with a strip of quarter-round section underneath. The latter may be pinned and glued. It must be noted that the slope of this runway must not be too steep and should be fixed so that it lies $1\frac{1}{8}$ in. from the top right-hand side, giving sufficient clearance when the ball is dropped through the hole.

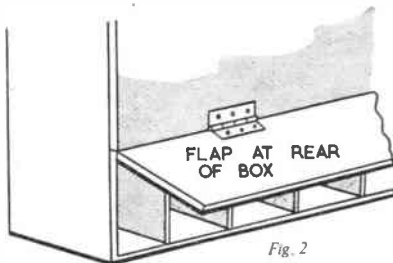
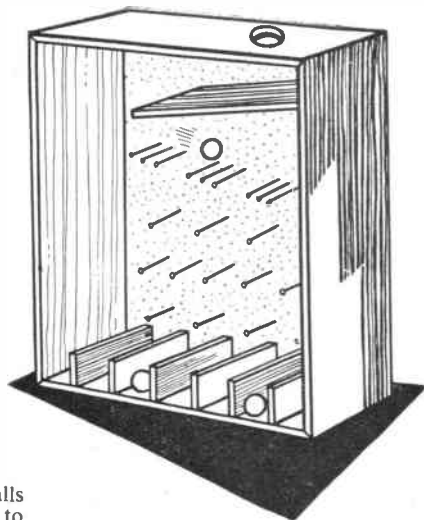

Fig. 2



This is shown clearly in Fig. 1, which also gives an indication of how a series of panel pins should be arranged. The top line is composed of groups of three nails, inclined in an opposite direction to the runway so as to give additional speed to the ball. The remainder of the nails are arranged parallel to the base but as you will see they alternate. It is best to measure out first these positions carefully, using $1\frac{1}{2}$ in. or $1\frac{3}{4}$ in. panel pins. Finally, there is the question of applying the scores themselves and it is suggested that these are cut out from an old calendar bearing large figures.

When the back has been prepared and the two ends finished the box may be assembled, a sheet of celluloid or clear plastic material being fastened over the front. It will also be advisable to finish off by applying strips of $\frac{1}{2}$ in. half-round section over the celluloid to give a neat finish.

It is suggested that you use at least three table tennis balls for the game, the winner being the highest scorer. The box is quite light, and can be held in the hands, and you may try to manipulate the balls to the required score.

HEAR ALL CONTINENTS With H.A.C. Short-Wave Receivers

Suppliers for over 18 years of Radio S-W Receivers of quality.

One-Valve Kit, Price 25/- Two-Valve Kit, Price 50/-

Improved designs with Denco coils. All kits complete with all components, accessories and full instructions. Before ordering, call and inspect a demonstration receiver, or send stamped addressed envelope for descriptive catalogue.

'H.A.C.' Short-Wave Products (Dept. 22), 11 Old Bond Street, London, W.1.

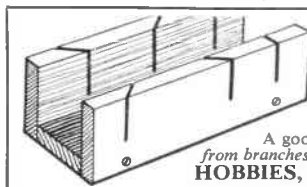

WOOD MITRE BOX

Made with selected hardwood with slots for 45° and right-angle cutting. Size 9ins. long.

A good tool at a modest price **5/6**

from branches or :- (post 1/6)
HOBBIES, DEREHAM, NORFOLK

**DON'T LET SOLDERING
LEAD YOU A DANCE**



**use
FLUXITE**

Soldering ceases to be a knotty problem the moment you use FLUXITE. Solder flows on easily and smoothly—and stays on. For over half a century FLUXITE has been the choice of craftsman and engineer alike and, in this age, its reliability and speed has made FLUXITE even more in demand than ever.

**IT
SIMPLIFIES
ALL
SOLDERING**



FLUXITE LTD., Bermondsey St., London, S.E.1
GM.83

*When you ask
for a knife
-say X-acto*

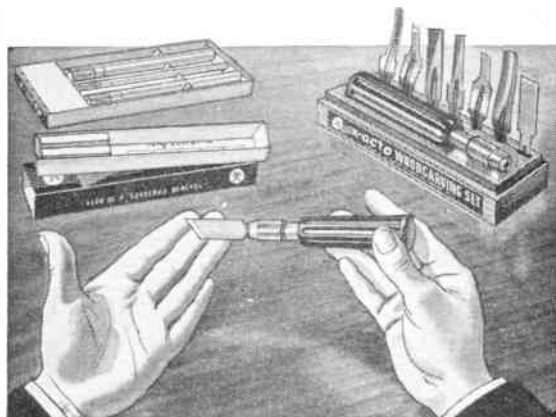

**...they're made to
develop your skill!**

A man knows that X-acto is *right* the moment he picks up one of these superb knives. X-acto have three different weights of perfectly balanced handle. 25 interchangeable blades, gouges, routers and punches—all in razor-sharp surgical steel.

X-acto's a precise tool. And an all-round tool—right for delicate modelling, right for handyman work around the house. When you ask for a knife—say X-acto.

From Hobby Shops and Ironmongers

*And ask to see all the other tools
in the X-acto range*



DUFAY (B'ham) LIMITED

(X-acto Products Division)

308 SUMMER LANE, BIRMINGHAM, 19

A WALLET FOR PENSION BOOKS

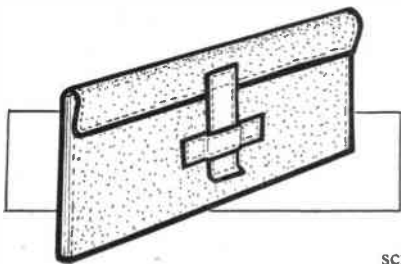

By *W. J. Ellson*

THE type of wallet, illustrated, is designed for the safe custody of Old Age Pension books, keeping them clean and unfolded.

For making it there is a choice of quite a number of materials: thin leather, American cloth, plastic imitation leather, to name but a few. No difficult work is involved in the making and most of the tools required can be found in any home. A fine sharp awl is essential, and one can be bought at any hardware store for a few pence. A made-up clamp, such as the one described in this article, is desirable to assist in the work of sewing, but even this can be dispensed with if you are prepared to accept a little unevenness in the lines of stitching.

The wallet is made up of three parts, shown in Figs. 1 and 2. The body, or main part, and the loop and tab, for keeping the wallet closed. The main part is seen in Fig. 1, with dimensions. Mark these out on the back surface of the chosen material, using a soft lead pencil. An all-round hem of $\frac{3}{8}$ in. is added, shown by the thicker lines.

Use strong thread

Snip these hems with scissors where indicated in the diagram, and cut the whole piece out. Treat the parts in Fig. 2 similarly, (A) being the loop, and (B) the tab. Both these latter parts have their hems folded over, and then stitched down. For sewing, use either a strong thread or tough silken sewing thread, coloured if possible, to match the material to be employed. A simple in and out stitch would serve using about eight stitches to the inch.

Take the main part of the wallet, and in the middle of the lower portion, where shown by the dotted outline, sew on part (A), sewing a $\frac{3}{4}$ in. length of it each end, leaving a loop in the middle, 1 in. long under which the tab can subsequently be tucked. For ease in accurate sewing of the main part, a simple form of clamp, as shown in Fig. 3, will be found helpful.

Two lengths of $\frac{3}{8}$ in. by 1 in. hardwood, about 10 ins. long are, cut and the top edges sharply bevelled off. These are held together with a stout round headed

screw at each end. The work is then clamped between to hold the parts together firmly while being stitched.

First fold over the bottom hem, a-b, and sew down. Then double over for a-b to come level with line e-f. Sew through both from c to e, and then from d- to f. Fold over and stitch the hems of the flap to complete that part. Now

for sewing the sides. For clarity the stitching line is drawn higher above the edges of the clamp than is usual in practice. In actual fact the line should be almost level with the edges of the clamp, using these as a straight edge to ensure an even line of stitches.

For the benefit of readers who may wish to make this wallet for holding notes, the length could be shortened to 7 ins. for better convenience in carrying in ones pocket. If a division is desired in the wallet, for pound and ten shilling notes, cut a piece of the material the full

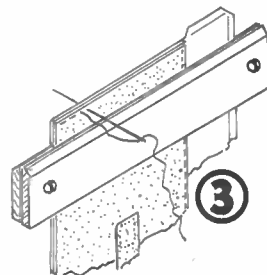
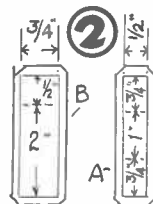
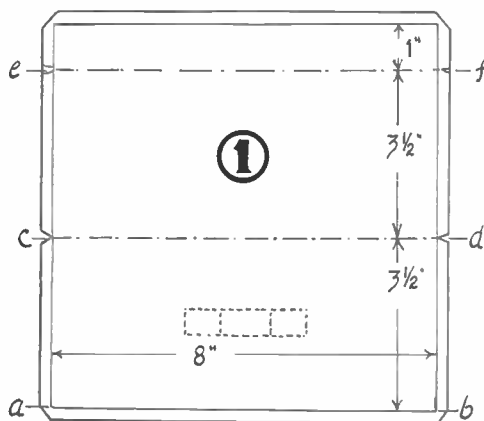

stitch part (B), to centre of flap. About $\frac{1}{2}$ in. length of this should be stitched leaving a tab of 2 ins. for tucking under the loop.

The lines of stitches should be as close to the edges as secure sewing will allow, say $\frac{1}{8}$ in. or a shade less. Fig. 3 show how the parts are held together in the clamp

length, (i.e. 8 ins.) and $3\frac{1}{2}$ ins. wide, with $\frac{3}{8}$ in. extra at the top for a hem. Fold over and sew down the hem, then insert between the top and bottom halves of the wallet before sewing together, thus sandwiching the division between.

● Continued from page 3

Keeping a Pet Hamster

varied diet. During winter months, a desertspoonful of warm mash may be given.

The amount of food given depends on the individual hamster, some having larger appetites than others. Sufficient food should be supplied, so that the hamster can put a little in his larder. Remember that stale food is bad for animals, therefore, remove it regularly.

Taming

When first purchased the hamster should be left alone in his cage for a day,

so that he may get used to his new surroundings. After that you should start to handle him. Do not be upset if he is not very enthusiastic at first. If handled gently but regularly, you will have a tame and delightful little pet.

Just a word about hibernation. If subjected to considerable changes of temperature late in the year, hamsters may hibernate. This is better avoided by keeping your pet in a fairly constant temperature; it need not be very warm if plenty of bedding is given.



LOOK! the latest Kitmaster model

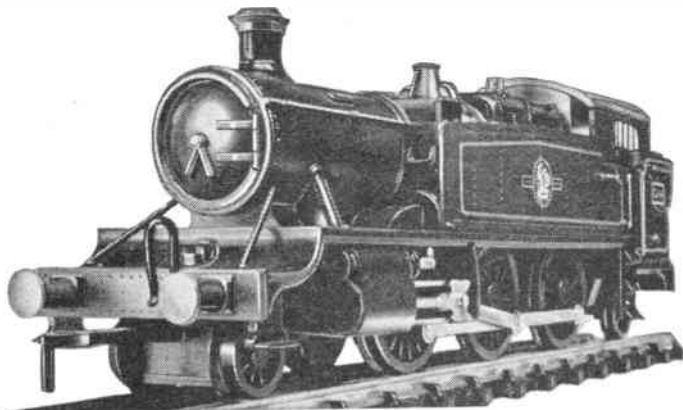

ROSEBUD KITMASTER LIMITED

No. 7 Prairie Tank 6/6

Start to build it right away! No. 7 in the fascinating series of 'KITMASTER' plastic model railway kits is an authentic scale model of the London Suburban area's 'PRAIRIE TANK' engine — for use on your OO and HO gauge tracks and with moving parts. Good model and toy shops have it now. Check up and see you've collected all the 'KITMASTER' models to date!

KMC4

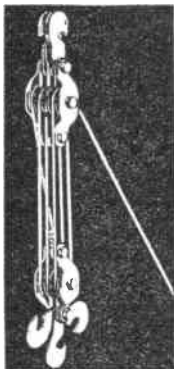

The HALTRAC MIDGET HOIST

Weighs 1 lb. Tested to lift 1,000 lbs.

PRICE 57/6

will pull or lift anything. Self-lubricating solid nylon pulleys — 72 ft. nylon rope — rustless aluminium construction throughout. Standard equipment for the Motorist, Caravaner, Gardener, Workshop, etc. etc.

Available from all good Stores, Ironmongers, Halford Branches, Yacht Chandlers, etc., or from:

HALTRAC LTD. (Dept. HW. 8)
BOURNE WORKS, WEIMAR STREET,
LONDON, S.W.15

Trade enquiries also invited

YIPEE·E·E·E·E·E·E



CERTOFIX

Really

FIXES

CERTOFIX liquid glue can cope with all general repairs. It unites wood, glass, metal and almost all substances. It is clean in use; its joints are stronger than the materials it unites.

Sold at all Woolworth Stores

CERTOFIX

STICK TO SECCOTINE

Regd.

it sticks everything



1/3
PER TUBE

Sole Manufacturers—

McGAW, STEVENSON & ORR LTD., BELFAST 13



BUTTERFLY BRAND

Introducing YOU to an ABSORBING HOBBY with beautiful really worthwhile RESULTS

Some of the beautiful, interesting and useful items include fish tank models, sea shells and s:arfsh; butterflies and moths; seasonal display flowers; model gardens and floating water lilies, etc.

All the models can be made from coloured paper and easily obtained materials of exceptionally low cost. The book is illustrated throughout with colour and monochrome photographs as well as many 'step-by-step' line diagrams.

An essentially practical book which will be tremendously useful for educational and therapy work.

Other works
by **FREDERICK T. DAY**

- COLOURED PAPER DECORATION . . . 7/6d.
- COLOURED PAPER-CRAFT FOR SCHOOLS . . . 7/6d.
- COLOURED PAPER-CRAFT FOR INFANT SCHOOLS . . . 6/0d.
- LAMP SHADE AND PARCHMENT CRAFT . . . 8/6d.
- PASSE PARTOUT FOR SCHOOL AND HOME . . . 8/6d.
- GUMMED STRIP AND PAPER MODELLING . . . 7/6d.
- PAPER SCULPTURE FOR SCHOOLS . . . 7/6d.



8/6

All books obtainable from:
Newnes & Pearson Ltd.
Tower House, Southampton
Street, Strand, W.C.1
Ask your stationer to show you the
Butterfly range of handicraft
materials

SAMUEL JONES & CO. LTD.

STATIONERY MILL, CAMBERWELL, LONDON, S.E.5. RODNEY 5064

TRANSISTORS, Germanium Crystals, Head-phones, etc. Lists and diagrams free. Germanium Diodes with three crystal set circuits 1/-. Postage 3d. P.R.S.(H).—33 Bourne Gardens, London, E.4.

MAKE A MUSICAL BOX for as little as 21/- . New kits and tunes available. Movements 13/- post free. Please send 3d. stamp for free illustrated catalogue. — The Swisscross Co., Dept. B, 202 Tulse Hill, London, S.W.2.

STAMPS FREE — Empire Packet including Pictorials and Victorians with approvals. — Robert J. Peck, 7A Kemp Road, Bournemouth.

EXTRA CHEQUES from writing. Send for 'Ideas for Writers' (free). Scores of suggestions for beginners and others. Typewriter unnecessary. — Writers' Ring (H.W.), 5 Edmund Street, Birmingham 3.

FREE stamp album and 20 stamps. Request approvals, enclosing 6d. Additional gifts given. — Beeze, 8 Langland Villas, Mumbles, Swansea.

INTRODUCTIONS to new friends; home and Overseas. — V.C.C., 34 Honeywell Road, S.W.11.

KUKLOS ANNUAL. Indispensable cyclists' handbook. Tours, resthouses, money-saving, hints, 3/- post free. — Burrow, Publishers, 2 Imperial House, Cheltenham.

100 DIFFERENT stamps free! Request 1d. upwards discount approvals. — Bush, 53 Newlyn Way, Parkstone, Dorset.

Refund if not worth double !



TV TABLE & EXTRA LARGE

RECORD CABINET

Not only sand polished but also sprayed light or medium WAL-

NUT tone. NOTE—ROOMY BOOK CASES AT BOTH ENDS — one converts to Magazine Rack by insertion of sloping panel provided, as illustrated. Amazing offer — 59/6, carr. 6/6 or sent for £1. Balance 6 monthly payments 8/- plus carr. A well built contemporary piece of furniture to solve your record problem and also ideal as stand for TV, Radio or Record Player. 30" x 15" x 24" high. Modern sliding doors. Roomy interior, partitioned for classifications, holds up to 200 records (upright for perfect condition). Entirely of seasoned timber. Detachable legs. SEND quickly. LISTS, FURNITURE.

SEND FOR OUR FREE ILLUSTRATED CATALOGUE OF BINOCULARS (EVERY KNOWN MAGNIFICATION), RINGS, WATCHES, FURNITURE, ETC. ALL AVAILABLE ON THE EASIEST OF TERMS

HEAQUARTER & **G**ENERAL SUPPLIES LTD.

(HOBW/83) 196-200 Coldharbour Lane, Loughboro Junc., London, S.E.5. Open Sat.

MODELS. You can make lasting stone-hard models with Sankey's Pyrama Plastic Cement. Supplied in tins by Ironmongers, Hardwaremen and Builders' Merchants. Ask for instruction leaflet.

WHEELS (Hardwood and Rubber Tyred Metal). Cot, Pram and Doll's house Fittings and Papers, Beads, Transfers, Prints and other accessories. Stamp for new lists. (Trade supplied.) New address — JOYDEN CO., 91 Peplins Way, Brookmans Park, Herts.

LEARN RADIO and ELECTRONICS the NEW practical way! Very latest system of experimenting with and building radio apparatus — 'as you learn'. FREE brochure from — Dept. HW.10, Radiostructor, 46 Market Place, Reading, Berks.

BUILD YOUR OWN HI-FI at home! At last, for reasonable cost — the chance to make your own quality HI-FI audio equipment and to gain the knowledge to service and maintain it. FREE brochure from — Dept. HW 20, Radiostructor, 46 Market Place, Reading, Berks.

GIANTS, Triangles, Pictorials, etc. — 100 Free Request Approvals. Postage. — Salter, 42 North Road, Rotherham.

BUILD AN EFFICIENT Crystal Receiver with Bour quality complete kit. Easy instructions. Soldering unnecessary. Good reception anywhere. Reduced price for short period 14/6 post free. Send P.O. NOW. — Radio Components, Accessories, wonderful new Transistor Receiver Kits supplied. Send 3d. stamp for Bargain List — RADIOMATIC 26 Blackburne Drive, Hunts Cross, Liverpool.

TRUMP INDICATOR

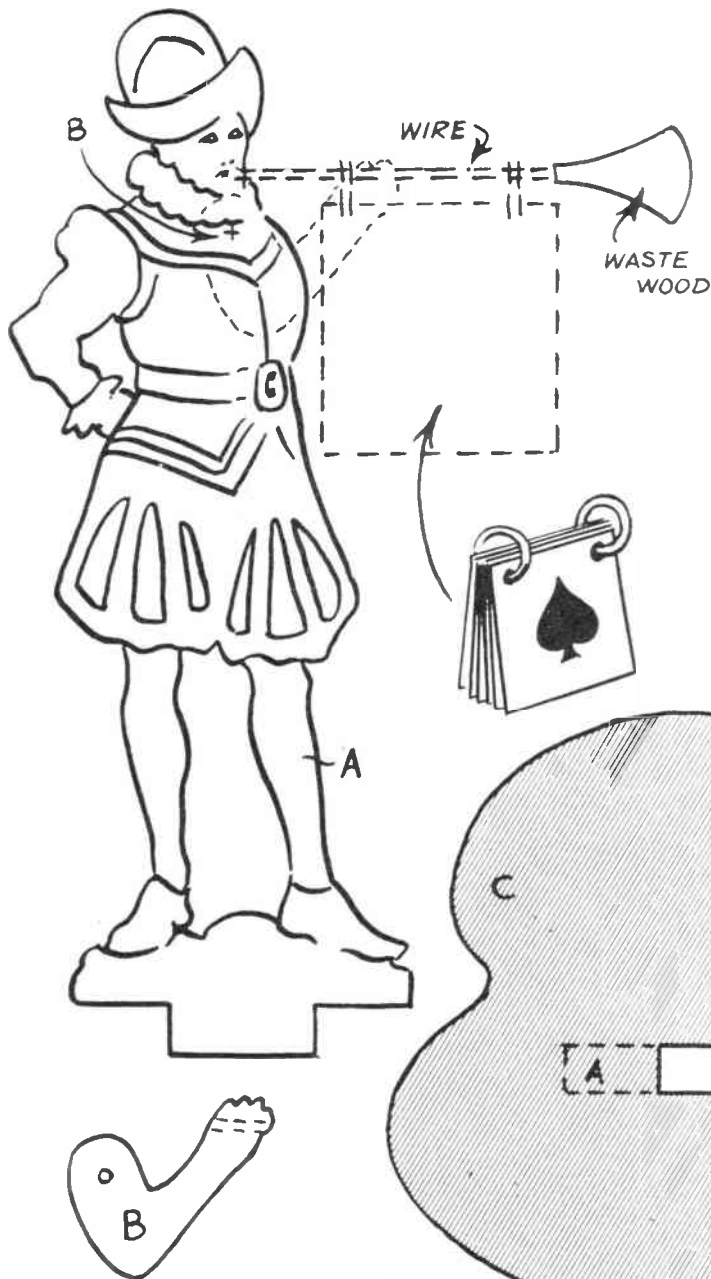

THE indicator consists of a figure made up to look like an old time trumpeter. Cut pieces A, B and C, from $\frac{1}{4}$ in. wood. Glue piece A into piece C and pivot piece B behind the figure in the position shown by the dotted lines. Use a round-head screw as a pivot, and tighten so that the arm will not fall down. When trumps are changed, the arm B is depressed to allow the indicator to be moved.

Make the trumpet from wire and waste wood, inserting it in the mouth and bending it so that the arm B just touches it.

Finish off by painting in bright colours, using red and yellow freely.

The trump indicator leaves and rings may be obtained from Hobbies Ltd. Dereham, Norfolk, price 1/6, postage 3d. (M.p.)

**AN IDEAL JOB
FOR YOUR
FRETSAW**



Copyright photograph by permission of Imperial War Museum.

Just like the real thing!

Airfix kits are not just models — they're exact replicas, each series to a constant scale.

There are models galore in the Airfix range! Aircraft from fighters to bombers (all to the same 1/72nd scale), OO gauge railway accessories, vintage cars, historical ships. Airfix value is unbeatable — ask your dealer for the latest list.

Nearly 100 kits from 2/- to 7/6d.



Airfix 1/72nd scale Lancaster bomber. 17" wing span. 7/6d.

AIRFIX

THE WORLD'S GREATEST VALUE
IN CONSTRUCTION KITS

From Model and Hobby Shops, Toy Shops and F. W. Woolworth

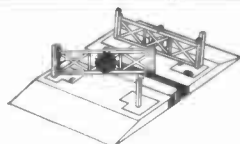

TRACKSIDE SERIES

Level Crossing 2/-

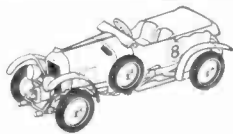

VINTAGE CARS

1930 Bentley 2/-

MODEL FIGURES

Lifeguard 2/-



HISTORICAL SHIPS

H.M.S. Victory 2/-

STOP PRESS!

Latest Airfix Production

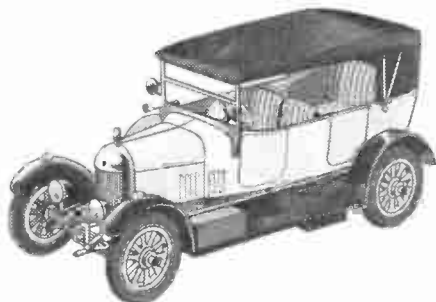

MORRIS COWLEY An authentic 1/32nd scale model of the famous 1923 'Bull Nose' Morris. 2/-.

Also new 1/72nd scale Fiat G91 NATO strike fighter 2/-, and OO gauge Platform Canopy 2/-.

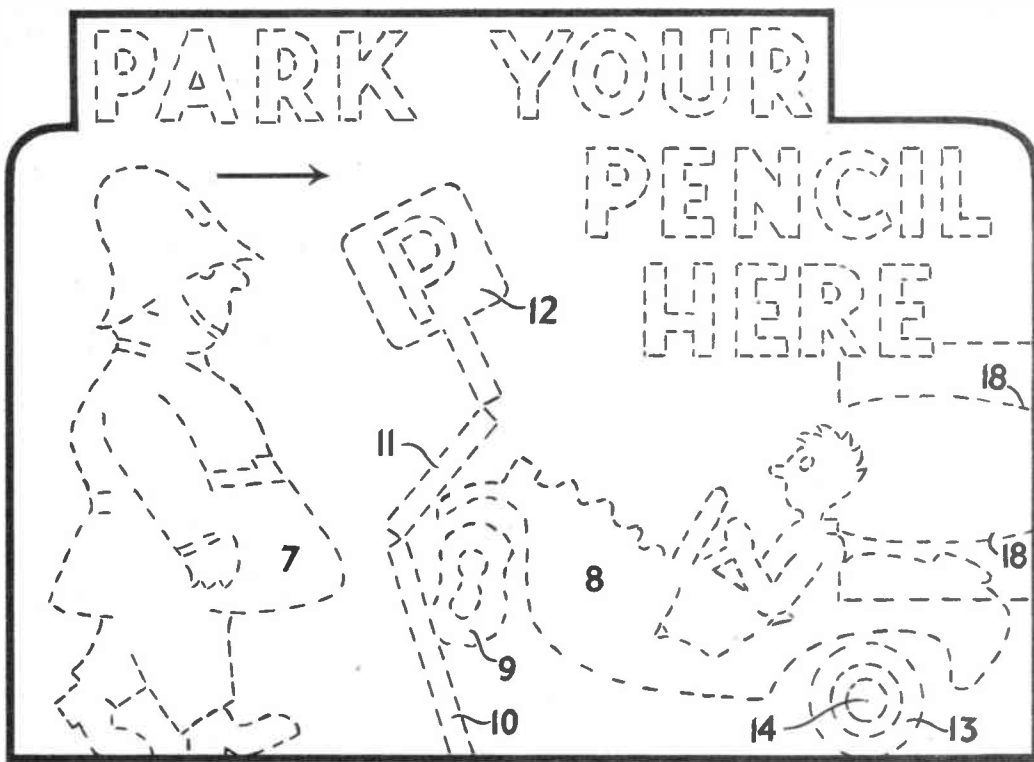

PIECE 1. CUT ONE 1/4 in.

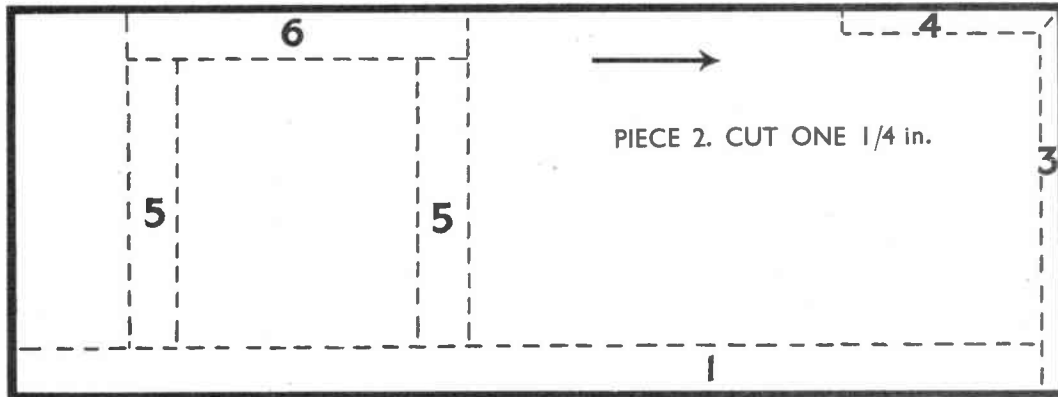

PIECE 2. CUT ONE 1/4 in.

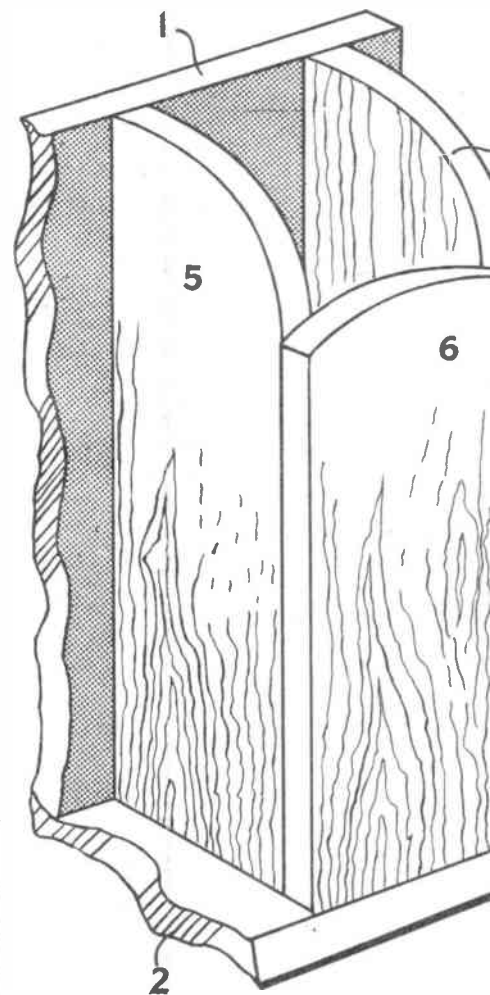

PIECE 3. CUT ONE 1/8 in.



PIECE 4. CUT ONE 1/8 in.

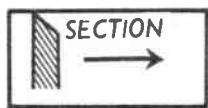

PIECE 19. CUT ONE 1/8 in.

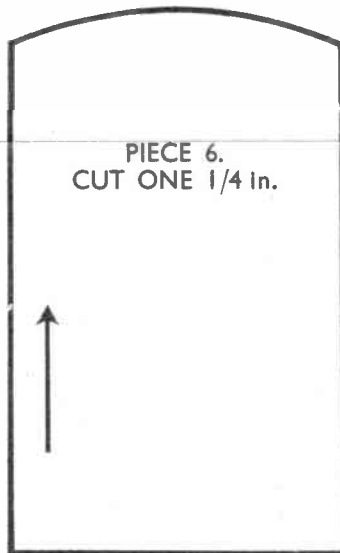

PIECE 6. CUT ONE 1/4 in.



PIECES 18. CUT TWO FROM 1/2 in. by 3/8 in. STRIPWOOD



PIECE 15. CUT ONE 1/8 in.

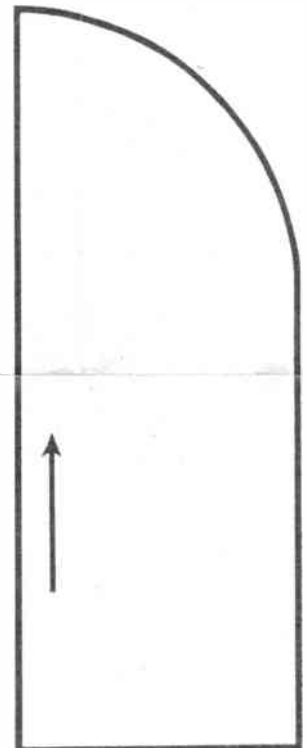

PIECES 5. CUT ONE 1/4 in.



PARK YOUR PENCIL HERE

LETTERS CUT ONE OF EACH 1/8 in.

PENCIL BOX & SHARPENER

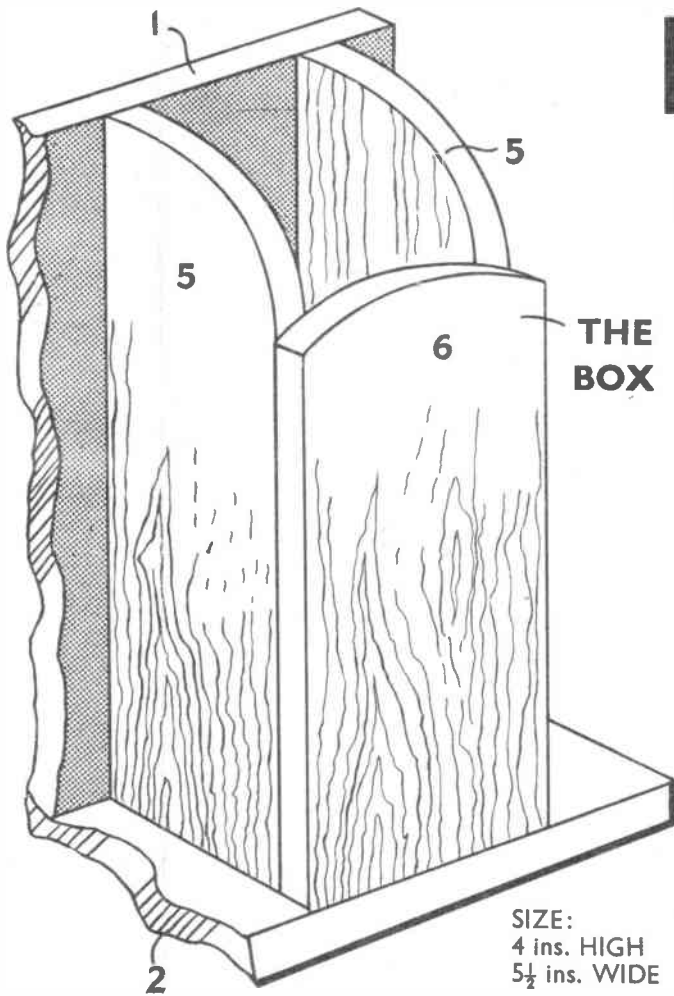
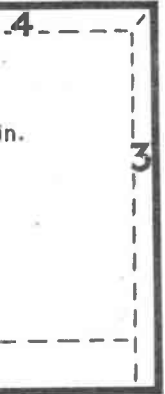
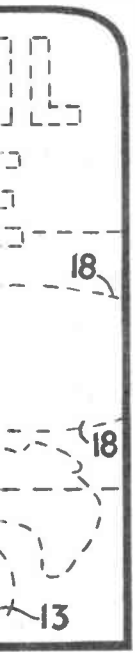

SIZE:
4 ins. HIGH
5½ ins. WIDE

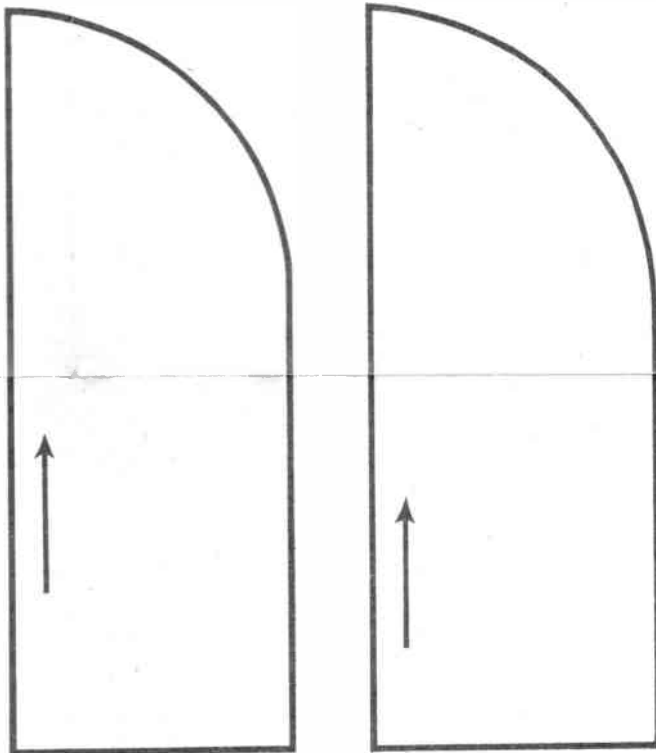

PIECES 5. CUT ONE OF EACH
1/4 in.

PIECES 18.
CUT TWO FROM
1/2 in. by 3/8 in.
STRIPWOOD

PIECE 15.
CUT ONE
1/8 in.

PIECE 16.
CUT ONE
1/8 in.

PIECE 17.
CUT ONE



A KIT OF MATERIALS FOR MAKING THIS DESIGN IS SUPPLIED BY HOBBIES LIMITED, DEREHAM, NORFOLK. PRICE ON APPLICATION.



Use **Croid** POLYSTIK

IT'S DESIGNED FOR THE JOB

A cold liquid PVA adhesive combining instant grip with immense and lasting strength. Clean to use, non-staining. In polythene bottle with spreader 2/6.

AVAILABLE FROM ALL BRANCHES OF HOBBIES LTD.

CUT TO THE OUTSIDE OF THICK LINES

YOUR PENCIL HERE

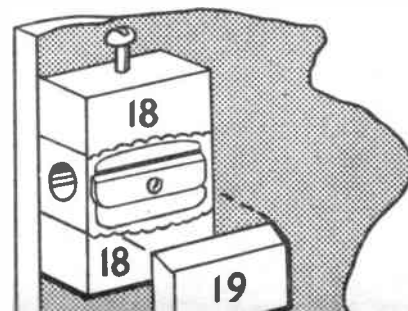

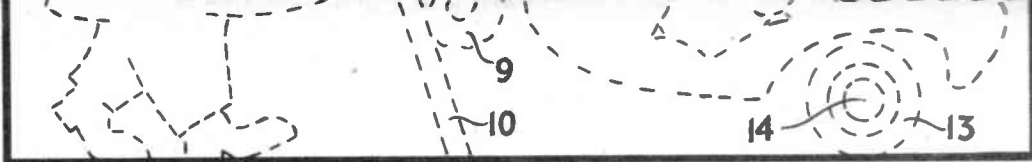

PIECE 1. CUT ONE 1/4 in.

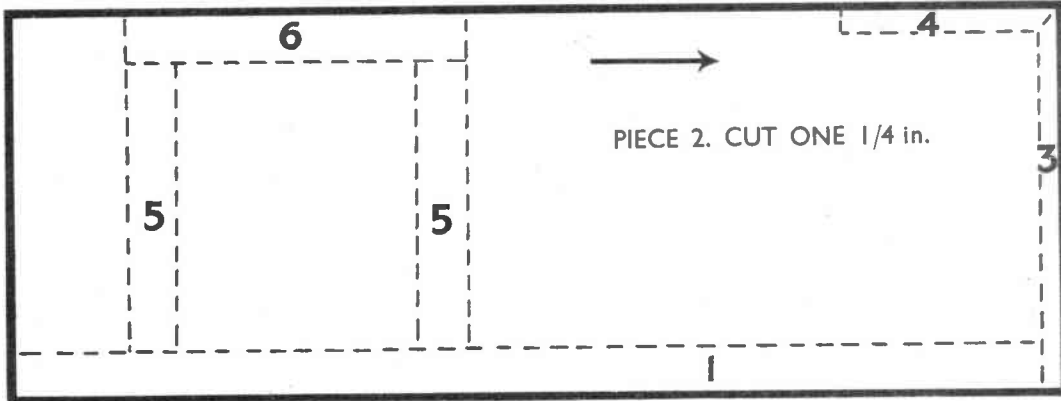

PIECE 2. CUT ONE 1/4 in.

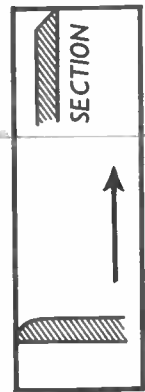
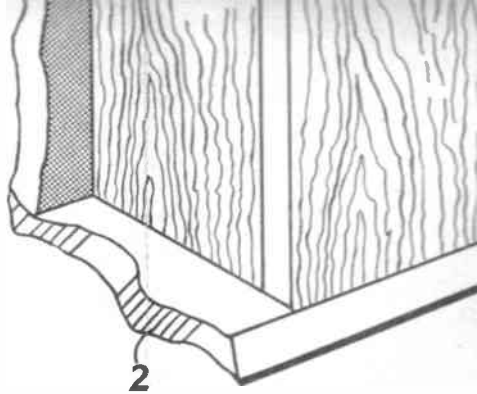

PIECE 3. CUT ONE 1/8 in.



PIECE 4. CUT ONE 1/8 in.

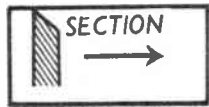

PIECE 19. CUT ONE 1/8 in.

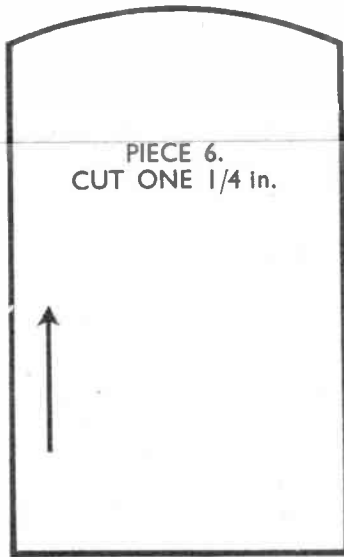

PIECE 6. CUT ONE 1/4 in.



PIECES 18. CUT TWO FROM 1/2 in. by 3/8 in. STRIPWOOD



PIECE 15. CUT ONE 1/8 in.

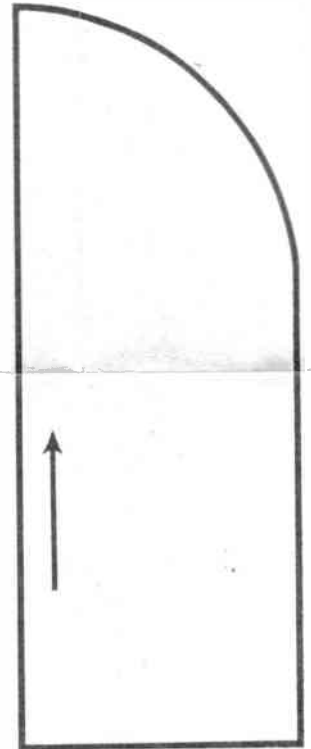

PIECES 5. CUT ONE 1/4 in.



POLICEMAN 7. CUT ONE 1/8 in.

PARK YOUR PENCIL HERE

LETTERS CUT ONE OF EACH 1/8 in.

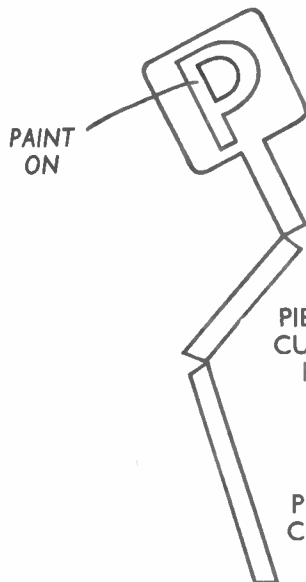

PIECE 12. CUT ONE 1/8 in.

PIECE 11. CUT ONE 1/8 in.

PIECE 10. CUT ONE 1/8 in.

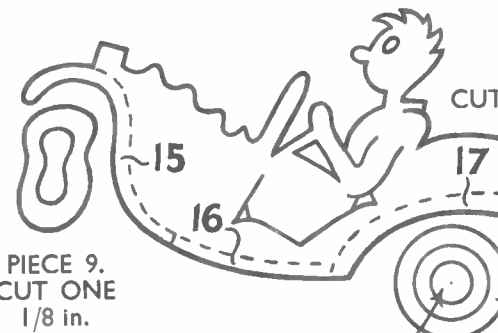

PIECE 9. CUT ONE 1/8 in.

PIECE 14. CUT ONE 1/8 in.

THE ARROWS INDICATE DIRECTION OF GRAIN OF WOOD

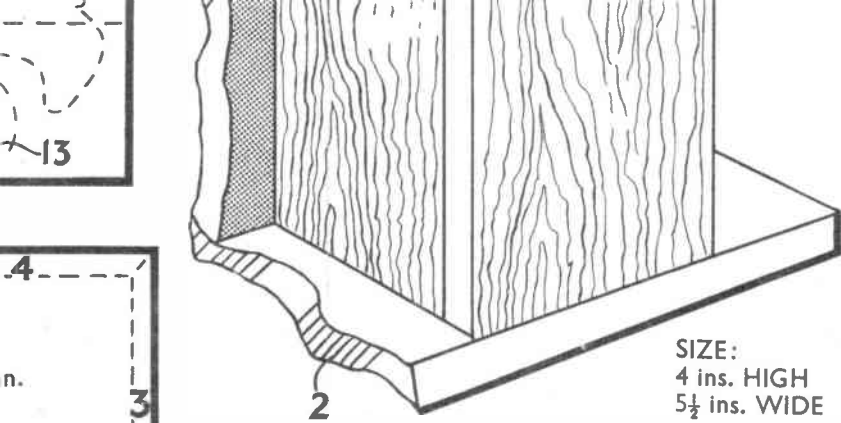

SIZE:
4 ins. HIGH
5½ ins. WIDE

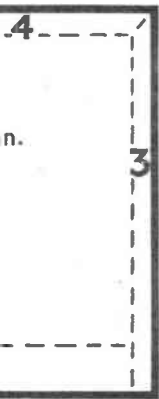

PIECES 18.
CUT TWO FROM
2 in. by 3/8 in.
STRIPWOOD

PIECE 15.
CUT ONE
1/8 in.

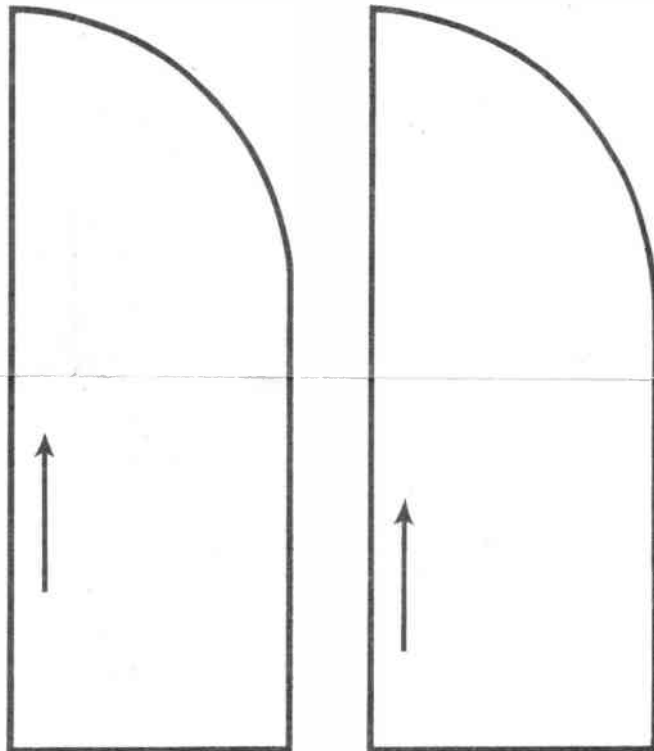

PIECES 5. CUT ONE OF EACH
1/4 in.

YOUR
PENCIL
HERE

PIECE 16. CUT ONE
1/8 in.

PIECE 17. CUT ONE
1/8 in.

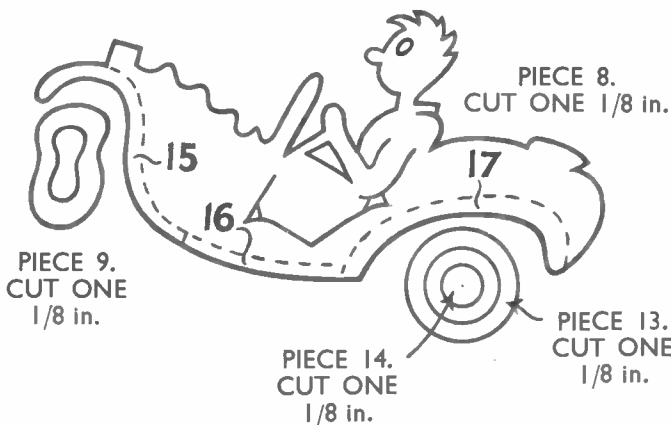

PIECE 9. CUT ONE
1/8 in.

PIECE 14. CUT ONE
1/8 in.

PIECE 8. CUT ONE 1/8 in.

PIECE 13. CUT ONE
1/8 in.



A KIT OF MATERIALS FOR MAKING
THIS DESIGN IS SUPPLIED BY
HOBBIES LIMITED,
DEREHAM, NORFOLK.
PRICE ON APPLICATION.

**Use
Croid POLYSTIK**

IT'S DESIGNED FOR THE JOB

A cold liquid PVA adhesive combining instant grip with immense and lasting strength. Clean to use, non-staining. In polythene bottle with spreader 2/6.

AVAILABLE FROM ALL BRANCHES OF HOBBIES LTD.

CUT TO THE OUTSIDE OF
THICK LINES

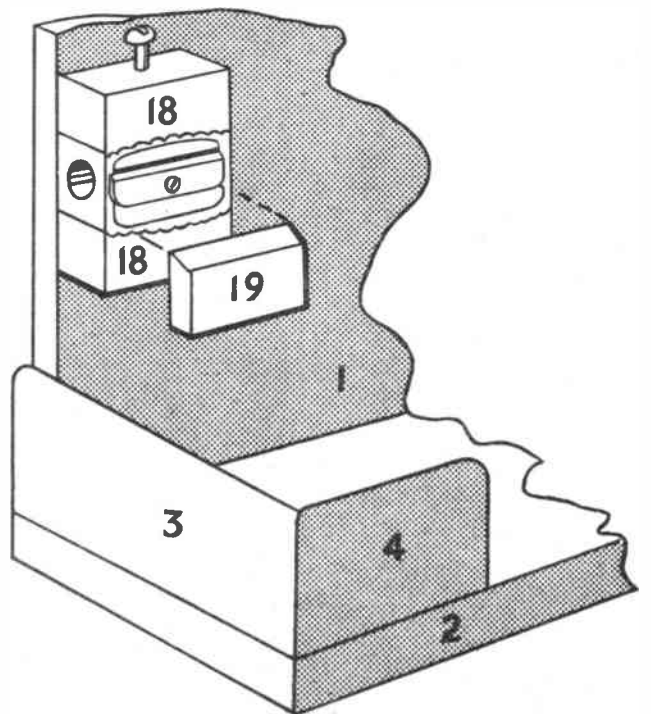

SHARPENER AND TRAP

PRINTED IN ENGLAND