

17th JUNE 1959

VOL. 128

NUMBER 3320

THE ORIGINAL
'DO-IT-YOURSELF'
MAGAZINE

HOBBIES *weekly*

FOR ALL
HOME CRAFTSMEN

Also in this issue :

A REVOLVING
CLOTHES LINE

COLLECTORS' CLUB

PROBLEM BY
'MYSTIFIER'

HOW TO MAKE
MOBILES

NOVEL 'FLIP THE
CONE' GAME

TRANSISTOR FOR
RADIO CONTROL

TOY PATTERNS

ETC ETC.

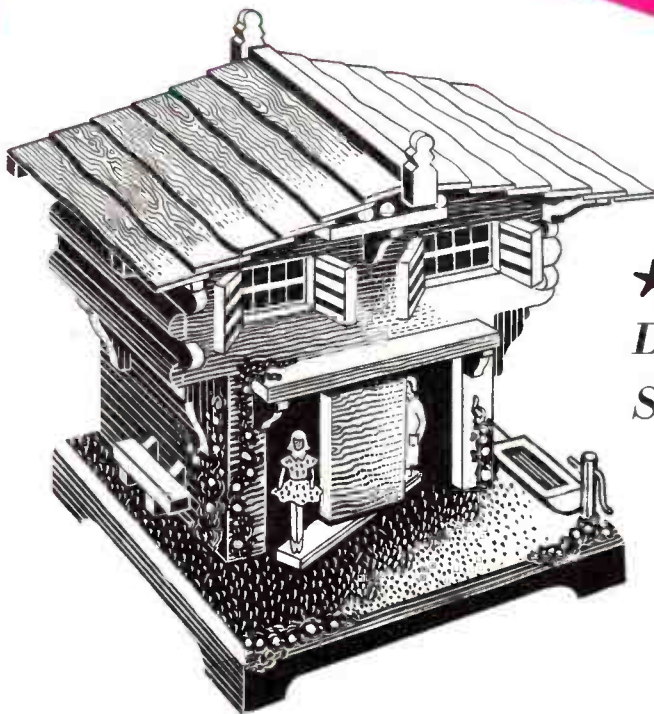

★ **FREE**
*Design
Supplement*

WEATHERHOUSE (IN SWISS CHALET STYLE)

Up-to-the-minute ideas

Practical designs

Pleasing and profitable things to make



5^D

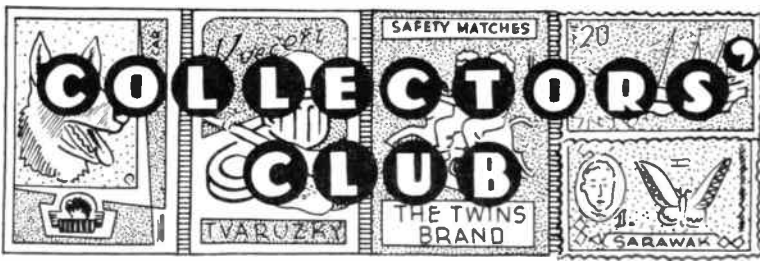

MANY useful grasses have been depicted on postage stamps. There is no plant more common than grass and none more useful. It feeds our sheep and cattle whose flesh forms part of our diet. Therefore we get our food indirectly from grass.



Sheep are depicted on the 1952 ½d. stamp of the Falkland Islands (1d.).

Bread is made of flour, flour is made from wheat, wheat is the seed of a plant that grows in the fields, and that plant is really a species of grass — a further proof that man is a grass-eating animal. 'Australia 1953, 3d. green — Wheat field (3d. used).'

The sugar-cane from whose sweet juice we get most of our sugar appears on a 1946, 40 cent stamp of Argentina

THEMATIC GRASSES

— *By R.L.C.*

(2d. used). Rice is a grain-plant which grows in warm countries such as India and China. Many of the people in India and China live on rice. The fields where it is grown must be covered with water at certain times of the year. This makes work in the 'paddy fields' very unhealthy. Natives are pictured planting rice on the 1949, 3 anna stamp of Burma (3d. used).

This short review of philatelic grasses is by no means exhaustive and it would be interesting to follow this instructive thematic sideline.



Royal Dates on Stamps

IMPORTANT events and dates in the life of the Royal Family may be recorded in the stamp album. For example: H.M. Queen Elizabeth II was born on April 21st, 1926. She was married on November 20th, 1947, to Prince Philip, and acceded to the Throne on February 6th, 1952. You will find all this pictured on the following New Zealand stamps.

1953, Royal Visit, 3d. purple — H.M. the Queen (6d. mint); 4d. blue — The Queen and Duke of Edinburgh (8d. mint). 1953 Coronation, 2d. blue — Buckingham Palace (6d. mint). H.R.H. Prince Charles was born on November 14th, 1948, and Princess Anne, August

15th, 1950. See 1952, Health — two values showing the Royal Children (1/8 mint).

Princess Margaret was born August 21st, 1930. She appears on the 6d. Victory stamp of Southern Rhodesia 1947 (8d. mint).

The Union Jack is flown on Government and public buildings from 8 a.m. to sunset on Royal occasions, including Royal Birthdays, the Royal Wedding Day, Empire Day, Coronation Day, Remembrance Sunday and in Greater London at the opening and closing of Parliament by the Queen. This custom also lends itself admirably to philatelic illustration.

For confined spaces

A REVOLVING CLOTHES LINE

(ALSO USEFUL AS A SUNSHADE)

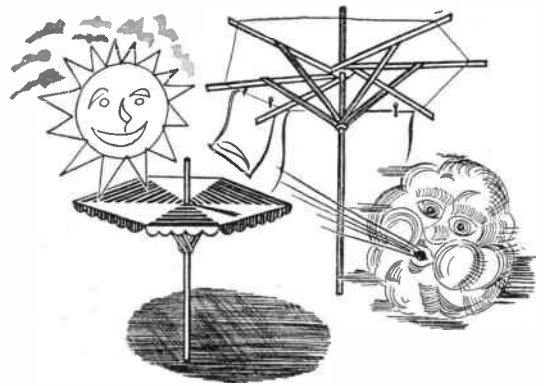

By Karl
Albers

IT is often a problem to dry washing in a confined space, but even where there is a lot of room in the garden, or yard, a revolving clothes line may be welcomed.

In the first instance it saves a lot of room, and secondly it is no longer necessary to carry the laundry basket up and down a far reaching clothes line.

The revolving clothes line described in this article has three lines 12ins. apart and an outer diameter of about eleven feet. At this dimension an approximate length of 80ft. of line is accommodated.

Drill $\frac{1}{2}$ in. diameter holes into the pipe at the positions indicated in the elevation sketch. The holes are 9ins. apart in order that the height of the line can be adjusted to convenience.

Dig a hole for the pipe at a desired position in your garden or yard, the required size of the hole to be 18ins. by 18ins. by 2ft. 3ins. deep. Grease or oil the bottom of the galvanized pipe. Place the pipe into the hole, set upright and secure in this position. Fill in concrete around the pipe. Turn the pipe just

MATERIALS REQUIRED

- No. 1. $1\frac{1}{2}$ ins. diameter galvanized pipe, 11ft. 2ins. long.
- No. 6. 3ins. by $\frac{3}{4}$ in. wooden strips, each 6ft. long.
- No. 6. 2ins. by $\frac{3}{4}$ in. wooden strips, each 4ft. long.
- No. 2. 2ins. thick wooden blocks of hexagon shape, 7ins. diameter.
- No. 36. $1\frac{1}{2}$ in. long wood screws, and about two buckets full of concrete. Straight grained pine or western cedar is most suitable.

before the concrete sets hard, and withdraw the pipe when the concrete has set.

Drill holes into the centre of each of the hexagon shaped blocks, making the holes a bit larger than the outside dia-

meter of the pipe — about $\frac{1}{2}$ in. all round.

Taper off the 3in. by $\frac{3}{4}$ in. strips down to $1\frac{1}{2}$ in. by $\frac{3}{4}$ in. at the ends. These strips will form the arms. Screw one arm to the hexagonal top block. Put the pipe through the top block and also place the other block into position on the pipe. Mark out one of the 2in. by $\frac{3}{4}$ in. strips to serve as a strut. See the elevation sketch for the position of the struts. Now you can cut all other struts and arms to exactly the same length and shape. Drill and countersink for two screws at each joint.

Screw all arms to the top block, after the pipe has been removed from the blocks. Take the top portion and place upside-down on to the ground. Begin

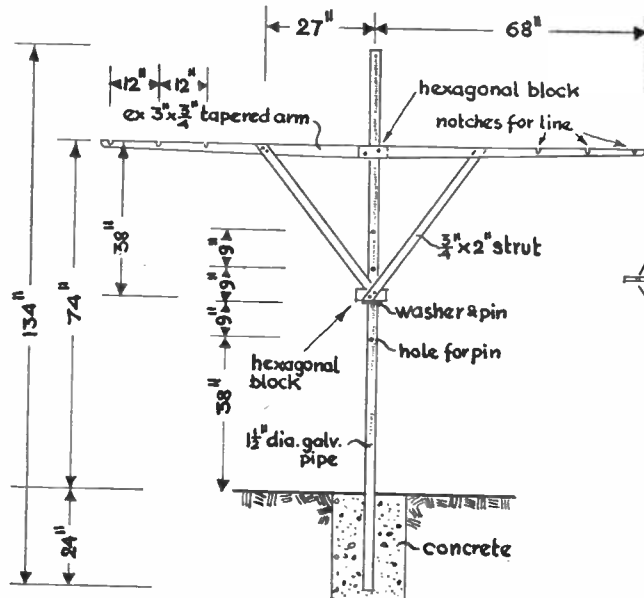

ELEVATION

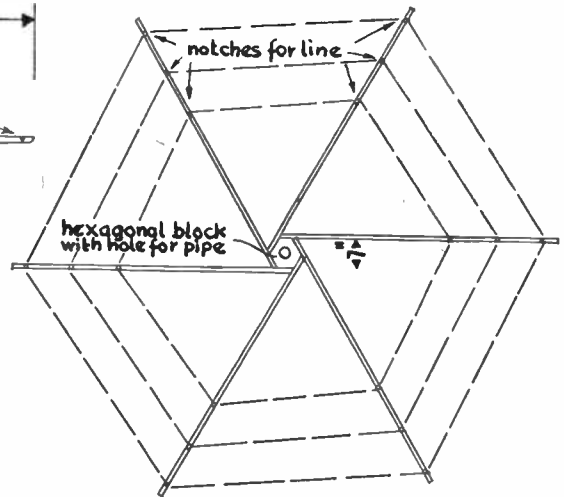

VIEW OF UNDERSIDE

the screwing-on of the struts by first fixing two struts opposite to each other,

● Continued on page 186

Instructions for making

SWISS CHALET WEATHERHOUSE

A NOVEL weather indicator which tells when it is going to rain by the action of two charming little figures, makes an excellent idea for a gift and is always acceptable.

Set in a charming Swiss chalet, the appearance of the appropriate figure outside gives an indication of what kind of weather to expect. It is arranged so that when the girl is outside, fine weather is indicated, and if rain is in the offing, the young boy emerges and the girl goes inside. As the humidity in the air alters, so the figures change position. This is brought about by the natural property of a piece of gut which stretches when dampened and so turns, and when dry it contracts and reverses. The kit supplied by Hobbies Ltd, includes a suitable piece of gut for this purpose.

It is, of course, a matter of which direction the gut turns that brings out the appropriate figure, and to ensure accuracy a trial should be made with the indicator assembled outside the chalet and before the actual figures have been fixed on their platform.

All the cutting and assembly is straightforward, and there should be no difficulty in making up this novel design. All parts are shown full size on the design sheet, and they should be traced and transferred to their appropriate thicknesses of wood and cut out cleanly with a fretsaw.

Commence assembly with the base as shown in Fig. 1, gluing pieces 6 and 7 underneath piece 5 after mitring at the corners.

Continue by erecting the front, back and sides. Pieces 4 are glued to the front (1) and back (2), and the upper sides (3) are similarly glued in position as shown in Fig. 2. The pieces of No. 35 half-round beading (22) can also be added at

KIT FOR ONLY 5/-

Kit No. 3320 for making the Swiss Chalet Weatherhouse contains panels of wood, round rod, beading, wire and catgut, etc. Costing only 5/-, kits are obtainable from all Hobbies branches or from Hobbies Ltd, Dereham, Norfolk (post 1/6 extra).

of a small screw-eye. The length of gut is adjusted so that when the ridge piece is in position, the platform for the figures swings just clear of the floor. At this

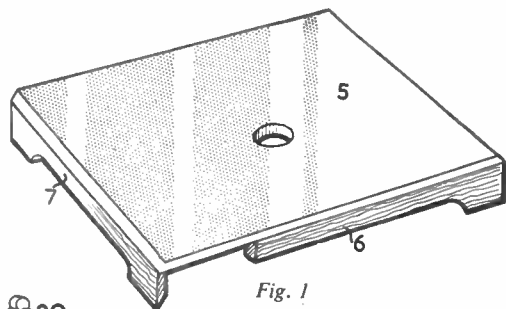

Fig. 1

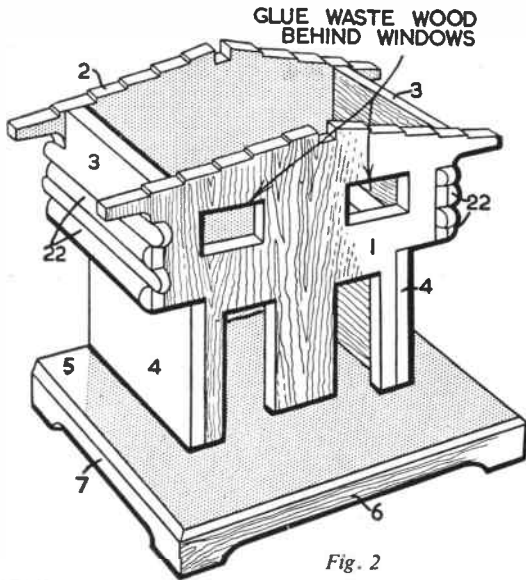

Fig. 2

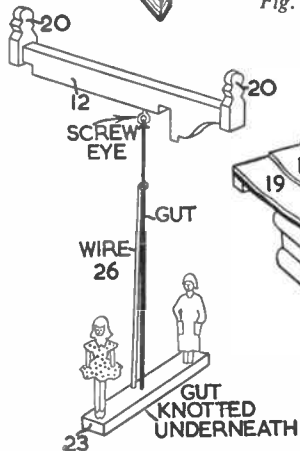

Fig. 3

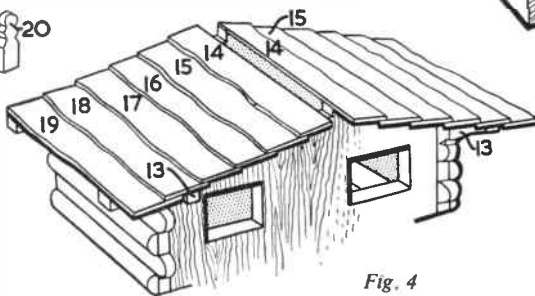

Fig. 4

this stage, and pieces of waste $\frac{1}{8}$ in. wood should be glued behind the window openings.

Fig. 3 shows how the catgut is attached to the ridge piece (12) by means

stage test the twisting action of the gut as already mentioned, before gluing the ridge piece in place. The addition of the finials (20) and wire stabiliser is also shown in Fig. 3.

Continue with the roof as shown in Fig. 4, by gluing pieces 14 to 19 in place, overlapping each other up to the ridge. The projecting pieces 13 are glued underneath pieces 18 in the front.

The chalet can now be glued in position on the base before adding other adornments such as the shelf and bracket

● Continued on page 185

A SAFETY KEY BOARD

KEYS have a knack of getting lost just when wanted, and it is most annoying to have to hunt for the garage key in order to put the car away or get the cycle out.

By keeping all the important keys carefully labelled and all together in a convenient place there will be no fear of this happening and much time will also be saved.

By A. F. Taylor

Make this very useful key board and have them all available in a handy position for all the members of the family. Each key is attached to a special label which indicates where it belongs only when it is in position on the board. Therefore if a stranger got hold of a key he would not know where it fitted, and this is an added safeguard.

By making the label of transparent perspex, the name, which is written only on the board, can be read through it when it is in its proper slot. On the end of the label, however, will be found some dots which correspond with the numbers 1 to 5 on the board to ensure that it is placed in the proper slot.

Our board has been designed to hold

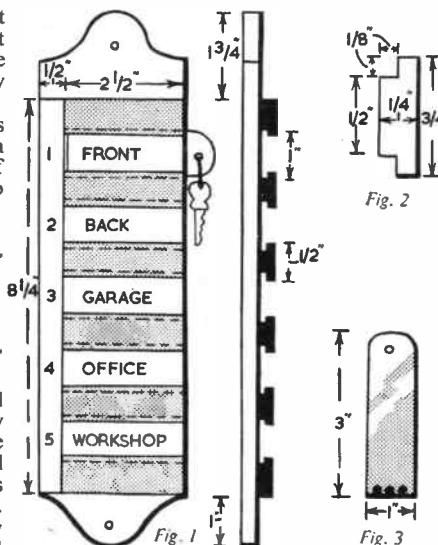

Fig. 1. shows the lay-out together with all measurements. Down the left side is a strip of $\frac{1}{4}$ in. ply or hardboard which carries the figures 1 to 5, and also acts as a stop for the key labels. It is $8\frac{1}{4}$ ins long and $\frac{1}{2}$ in. wide, and is glued to the board as shown.

The runners for the key labels, six in number, are $2\frac{1}{2}$ ins. long $\frac{3}{8}$ in. wide and $\frac{1}{8}$ in. thick. Make the rebate $\frac{1}{2}$ in. wide and $\frac{1}{8}$ in. deep and this is done on both sides of four runners and on one side of the remaining two which are placed at the top and bottom respectively.

Glue the runners in position and secure with panel pins from the back, leaving a space of $\frac{1}{16}$ in. between each for the labels to slide in easily.

For the labels use transparent perspex having a thickness of about $\frac{1}{16}$ in. and cut these to the shape shown in Fig. 3. In the rounded end drill a hole large enough to take the cord which is attached to the key.

The dots on the other end are made by drilling half way through the material. A dab of paint placed in each sink will then make each stand out very clearly. Different colours can be used in order to aid in the identification of the keys.

Now paint in the numbers 1 to 5 down the left side and also the names which will show through the key labels. Drill a hole in the top of the board for fixing it to the wall in a convenient position and finish off with a coat of varnish.

five keys, but it can easily be altered to take more or less if needed. The base-board is $\frac{1}{4}$ in. plywood or it could be a similar thickness of hardboard, and the size for a five-key board is 11 ins. long and 3 ins. wide.

● Continued from page 184

Swiss Chalet Weatherhouse

(9 and 10), wood logs (21), pump and trough, seat, window shutters, etc., shown in Fig. 5.

In applying the finish the aim should be to give a 'weathered' look to the chalet. Stain can be diluted to give a variety of shades, particularly to the roof and sides. An intelligent use of various colours of paint will also do much to enhance the picturesqueness of the model. Floral decorations can be fashioned from plastic wood or painted on, and the windows are painted as shown on the design sheet.

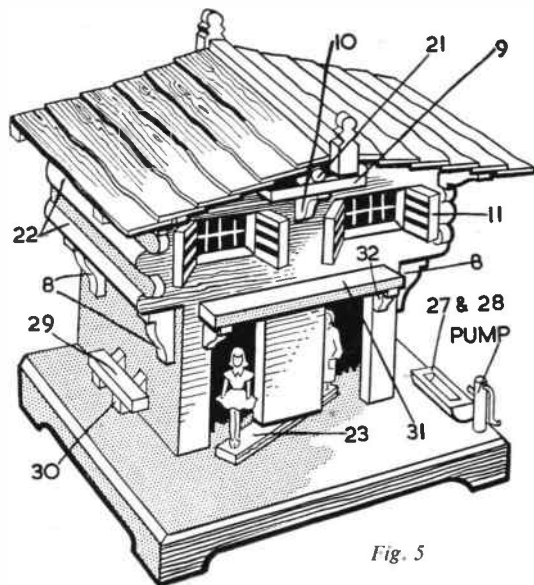
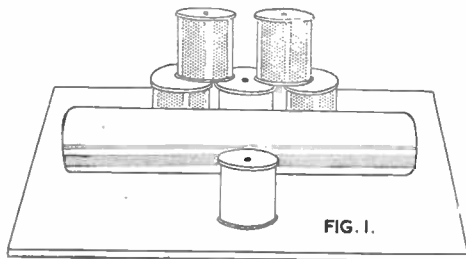

Fig. 5

THE CHANGING REELS

HERE is a neat little trick for you to perform using cotton reels and a paper tube. First of all we will give the method of presentation, indicating the secret and mechanics of the effect later.

The performer brings forward five



cotton reels on a little tray, ultimately stacking them one on top of the other with a solitary white reel at the top. He then takes a tube of paper, which is just wide enough in diameter to slip over the reels and long enough to cover them entirely from view of the audience. The tube is passed over the stacked reels but after removal of this tube the white reel is found to have been transferred to the bottom of the stack!

Six reels needed

Actually there are six reels used for this trick, and you will need two white ones and four of any other colour, but preferably dark to show the contrast. Before presenting the trick the reels should be stacked on the little tray in the form of a pyramid as shown in Fig. 1, with the sixth white reel at the rear so that it is unseen by your audience. As a further precaution against observation of this reel you may lay the prepared tube of paper flat on the tray between the pyramid and the odd white reel. As stated, this paper tube must be wide enough to slip over the reels, yet not too slack — you will see why later — and long enough to hide six reels when stacked one on top of the other. So much for the few properties required, but you are advised to read the following routine carefully and to practise before presenting.

You commence the trick by displaying the tube of paper, passing a wand through the opening, or even allowing an inspection, displaying your empty hands in the accustomed manner.

Having displayed the paper tube you next stand it vertically on the tray so that

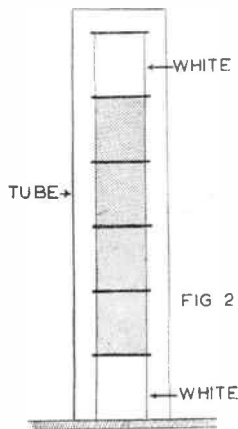

it covers the odd white reel which has been placed behind the pyramid of five reels. Now take up the five reels, which may also be offered for inspection, stacking into a pile so that the white one is on top. You must draw the attention of your audience to this fact and then drop the entire stack into the vertical tube. If you wish to drop the reels in separately you may do so, showing that the white reel is the last one.

You may now explain that the trick is to transfer the white reel from the top to the bottom of the stack, a difficult task even with the help of your wand and a few magic words.

After saying the magic words take hold

of the tube at the top, where the six reels stand as shown in Fig. 2, so that the finger and thumb of the right hand grip the top white reel concealed within. Slide the tube off vertically still gripping the reel thus revealing the piled stack with a white reel at the bottom. Tilt the tube quickly into the air — still retaining your hold — and the white reel will drop into the palm of your right hand as you release your grip. Almost at the same time the left hand must take the tube which can be shown as empty!

It sometimes creates a distraction to toss the tube to some member of the audience while you take the opportunity of turning the right side of the body away from the audience, allowing you to dispose of the cotton reel by dropping it into the jacket pocket. When the right side is turned away from the audience the quick action of disposing of the reel will be unseen if all movements are coordinated, but in some circumstances it may be necessary to proceed more calmly, placing the hand into the pocket for a handkerchief (while disposing of the reel) to mop the brow after such an exhausting feat!

The mechanics of this little trick are really quite simple but for successful performance it is essential that you understand the method and carefully practise many times so that the tilting of the tube upwards, taking by the left hand and disposal of the white reel appear automatic and natural movements. The surprise of the audience will amply repay your efforts.

● Continued from page 183

Revolving Clothes Line

then screw on all the remaining struts.

It may be found difficult to get all the arms into one true level plane, and the remedy for this is to work on block and arms upside down on a level concrete or wooden base. You may also find it difficult to screw the last arm into position. This can be overcome by drilling the holes through this last arm at a slant, in order that you may be able to get at the last two screws from above or from below the arm next to it.

Treat the wood with a preservative, such as Presotim or Cuprinol (not creosote). The timber can have sawn edges only, but the better job is to plane them and to chamfer all edges.

There are several ways to secure the line in position. In this example the arms

have been notched out. A wire pin, or a small bolt is placed through one of the holes in the pipe to hold the wooden framework for the revolving clothes line in the desired position (i.e. height).

In most households the washing-line is only required once a week, so our revolving clothes line may play a dual purpose. Turn it into a sunshade, under which you can sit in a deck-chair.

The wooden top structure (see Fig. 2) will serve as a template to cut out suitable sections of canvas for the top cover. Cut six triangles, making a seam over each arm. An edging strip can be made of differently coloured material.

The completed canvas top simply rests on the top supported by the wooden arms and by the clothes line itself.

HOW TO MAKE EXCITING MOBILES

MOBILES are darkly silhouetted or brightly coloured objects suspended upon wires or threads, which perform a perpetual aerial ballet in response to the slight air currents in the rooms where they are hung.

A mobile is like a kaleidoscope in space, its variously shaped parts never repeating the same pattern exactly. A well constructed mobile is intriguing and as soothing to the nerves as a tank of goldfish. In fact, the commonest subject for a mobile is swimming fishes. If you are artistic you can copy the gay colours and fantastic shapes of exotic fishes and make them float about in the air with all the mystery and enchantment of an underwater fairyland.

Described

By A. E. Ward

There is nothing difficult about making a mobile. Why not prove it for yourself by constructing a simple mobile of the swimming fishes type. You will need some thin, good quality black or coloured cardboard, a few strips of $\frac{3}{16}$ in.

thick balsa wood and some black cotton. Draw out the two fairly large fish shapes (A) and (B) shown in Fig. 1, on the cardboard and cut them out, using sharp scissors. Suspend these at different heights, on lengths of cotton, from each end of a one foot length of balsa strip. The cotton can be glued into place, or threaded through the cardboard and balsa, using a needle and the cotton lengths knotted where required (Fig. 2).

Cut out the smaller fishes (C) and (D) and suspend them, upon short threads, from each end of a 9 in. long strip of

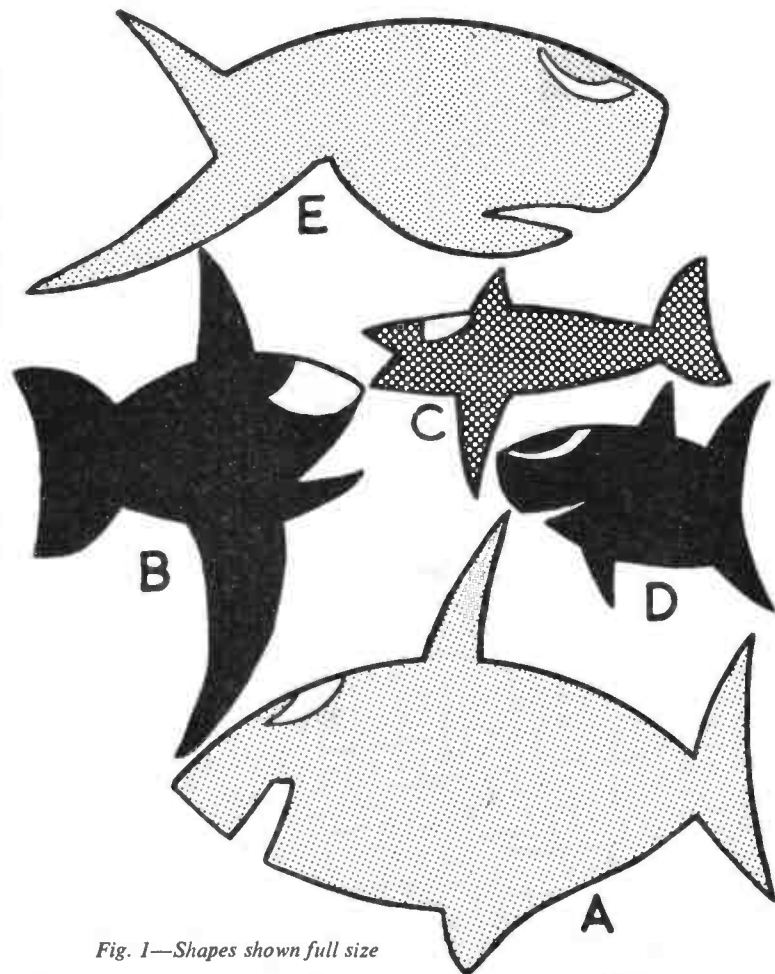
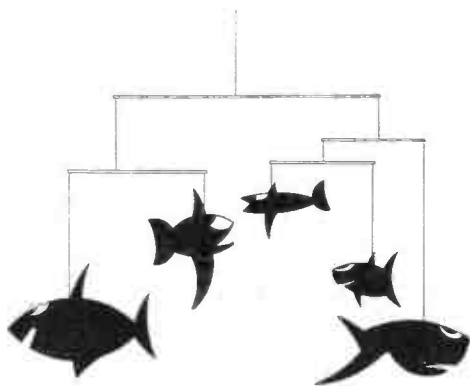

Fig. 1—Shapes shown full size



KNOT **BALSA**

COTTON



Fig. 2

balsa. Make fish (E) roughly as heavy as both fishes (C) and (D) together with their supporting strip. Suspend the supporting strip of fishes (C) and (D) from a short thread, so that the strip hangs horizontally. You may need to trim away little pieces of (C) or (D) to achieve the correct balance. Join the short thread to one end of a 10 in. long balsa strip. To the other end of the 10 in.

strip fix fish (E) on a longer thread. Suspend the 10in. strip from a short length of cotton, so that fishes (C) and (D) balance fish (E) and the 10in. strip is also horizontal. Again you may need to trim away pieces of the various fishes to achieve even balance.

Moved by air currents

Suspend the supporting strip of fishes (A) and (B) from a fairly short length of cotton, adjust the balance so that the strip is horizontal, and fix the thread to one end of a two foot strip of balsa. Suspend fishes (C), (D) and (E) from the other end of the long strip. Now suspend the long strip upon a long piece of cotton and let the whole mobile hang from a lampshade while you adjust the balance of every part. All the supporting strips should be horizontal. Stand back and watch your completed mobile come to life as the cardboard fishes are moved about by the air currents in the room.

You will realise that the secret of success in making mobiles is, largely, in the achievement of perfect balance between the various parts.

If the mobile described has interested you, no doubt you will wish to make



Fig. 3

other mobiles of your own design. Shapes fashioned from metal, chicken wire, balsa or plywood can be suspended from supporting pieces made of stout wire, bamboo, twigs or even drinking straws. Pieces of coloured wool, cloth strips and Christmas decorations can

all be utilized. Little frames, within which small shapes are suspended, may be hung upon the supporting pieces and you might arrange matters so that suspended fragments of coloured glass or metal ring together in stronger air currents.

Challenge to imagination

Of course, colour is an important element to consider in an attractive mobile, though do not make the mistake of using too many colours at once. Parts may be painted different colours on both sides to produce effects of changing hues. Black shapes, enlivened with a single form coloured bright yellow make mysterious, abstract compositions.

Subjects for your mobiles may include falling leaves, dancers, birds and weird flying machines and compositions of abstract shapes (Fig. 3) will offer a challenge to your imagination. Mobiles are often used as decorations in large shops and many advertisers have used them to draw attention to their products.

Cut-out characters from story books will make suitable mobiles to hang in a child's bedroom or nursery, where they will give great pleasure.

Entertaining 'Flip the Cone' Game

A PROVED favourite presented in a new and novel form, this 'Flipper Hand' is easily made in wood, while the 'target' is improvised from an egg tray fitted into the score box.

Competitors, striking the arm of the flipper hand, direct cardboard cones into numbered compartments of the score target.

First make up the 'Flipper Hand' cone launcher, consisting of parts (H) and (S) (shown full size on pattern page), and 2½in. square pivot block (P), mounted to base piece (B). This base piece, cut from ½in. soft wood, measures 10ins. by 2½ins. Transfer patterns of shapes (H) and (S) on to ¾in. 3-ply wood. Extend length of arm of flipper hand (H) at (X) by 2½ins. to make complete length of 9½ins.

Cut out hand and arm piece and two of bearers (S) with fretsaw. Cut the slot to accommodate the pivot rod with a tenon saw. Cut the 3½in. long pivot from ½in. metal rod, and with the rod fitted neatly in the slot, glue and nail the block (P) to underside of flipper hand arm. This should be fixed 2½ins. from end of arm. Holes in supports (S) are drilled a loose fit for pivoting ends of the rod. With parts (H), (P) and (S) assembled, glue and nail supports in alignment, 2ins. from one end of base (B).

Described by
T. S. Richmond

Missiles used in the game, consist of cardboard discs of 5ins. diameter cut out and formed into cones. A full-size

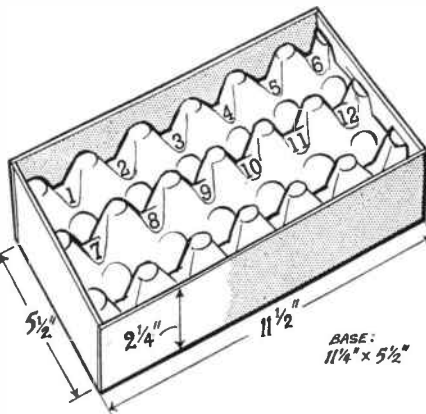

The target box housing the 'egg tray' score compartments

pattern of (C) is included on facing page and a number of these, transferred on to thin, flexible card are cut out with scissors. Form discs into 2½in. cones, as shown, securing with glue and staples, or Sellotape.

PATTERNS ON PAGE 189

Glasspaper smooth the flipper hand unit before painting in plastic enamel. Paint hand pink, adding finger and thumb markings when dry with darker colour. Paint arm blue or other colour to represent the sleeve of garment. Paint base and uprights in darker or same shade of colour used on arm. The cones can also be decoratively coloured.

Make up the target unit consisting of sides and ends cut from ¾in. material and glued around base piece of same or slightly thicker wood. Compartments for housing correctly-aimed cones are provided by an egg tray section. Cut a 12-compartment section to fit neatly inside the prepared box and add score numbers against each hole.

'FLIP THE CONE' GAME PATTERNS

(See page 188)

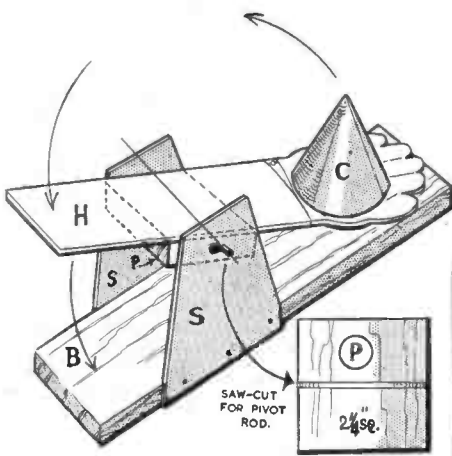

LAUNCHER ASSEMBLY

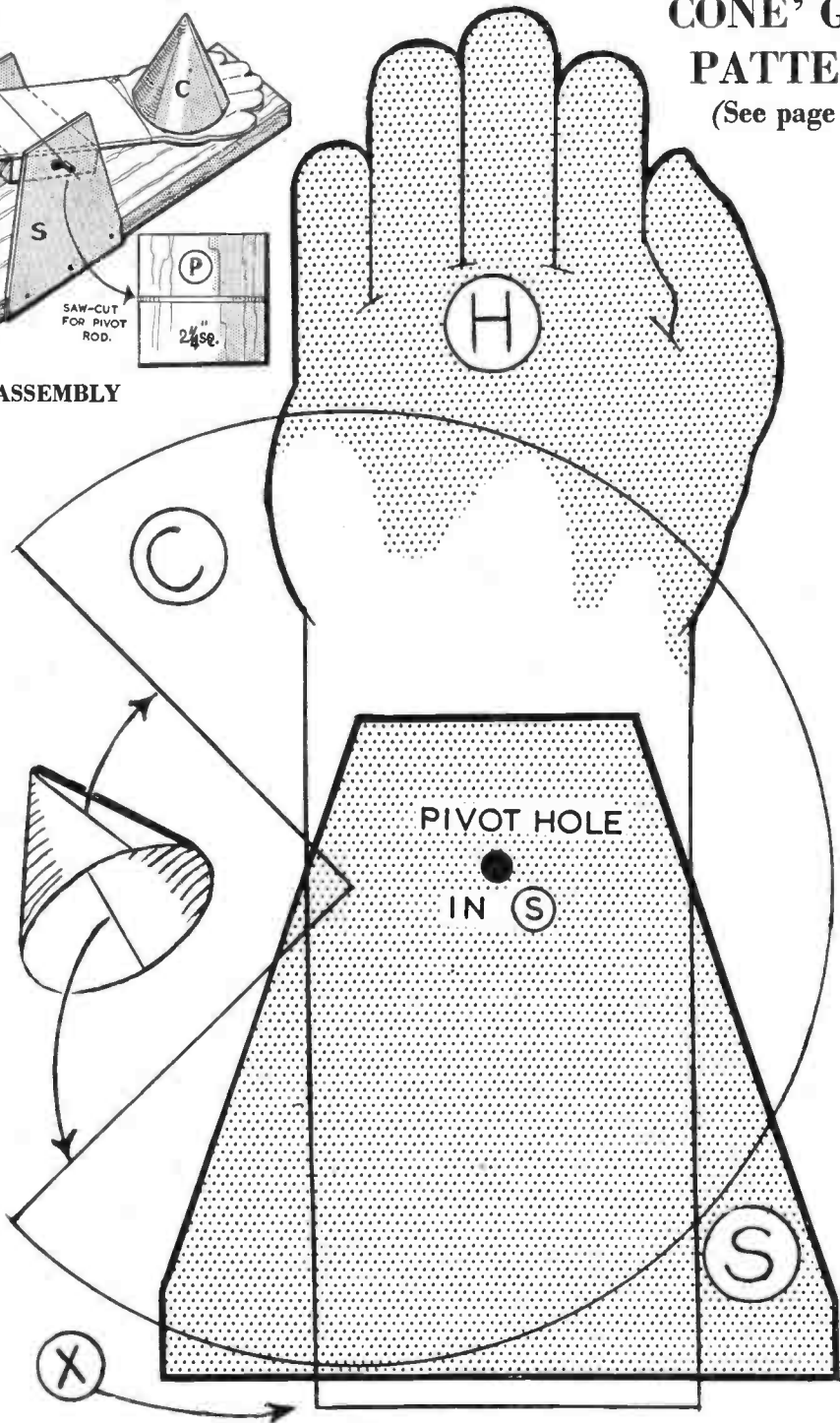

Transistor and Other Circuits

SOME further notes on adjusting the model control equipment which has been described should be helpful. A transistor receiver may also be more convenient than the valve set, in a very small model, and for short range working.

With the transmitters described, no adjustment is necessary, except tuning into the 27 mc/s model control band, as explained. The transmitter should be tuned fairly accurately *before* connecting up an aerial, to avoid causing interference by radiating a signal of wrong wavelength. Final, exact tuning should be done after connecting the aerial, because using the latter slightly changes the transmitter frequency.

By 'Radio Mech'

When testing the equipment indoors, with a valve receiver, no aerial need be fitted to the transmitter. For greater range, or for adjusting a transistor receiver, a short aerial will be needed. This can be a metal rod, standing vertically, or single strand or flexible wire may be used. When the wire is too thin, or too long, to stand alone, it may be supported by a string loop attached to any convenient object. Out of doors, a thin bamboo cane may be used to hold up the top of the wire.

The actual length of the transmitting aerial can be from a few inches up to approximately 8ft. 6ins. As the aerial is increased in length, the power radiated also increases. It can thus be adjusted to suit circumstances. For example, a long aerial would be unnecessary when testing at short range, or for a small pond, unless an insensitive transistor receiver were used. Rod aerials, in 1ft. sections, or of telescopic type, are very handy because they will stand alone, and can be collapsed or taken apart for transport.

Signal strength meter

If experiments are made with transmitters and aerials, it is helpful to make up a meter which will show the strength of the signal actually radiated. This unit consists of a coil, tuned to 27 mc/s, a crystal diode as used in crystal sets, and a 0-50 or 0-100 microamp meter, wired as in Fig. 1, with a condenser of 100pF to 0.05μF or so across the meter.

The coil can be made as described for transmitter or receiver, that is, 9 turns of 18 S.W.G. or similar wire, self-supporting, 5/8in. outside diameter, and turns

spaced so that the winding is about 1in. long. For tuning, a beehive pre-set may be used, or a small 20pF or similar variable condenser, with control knob, can be fitted instead. If a calibration mark is made, as explained for the bulb meter, the unit will also show when the transmitter is on the correct frequency.

The signal strength meter aerial can be a single rod, or wire 9ins. to 18ins. or so long. Remember that changing this aerial will slightly alter tuning.

In use, the unit is taken a short distance from the transmitter, and tuned for maximum reading on the meter. If the pointer tends to move backwards, reverse connections to the diode or meter. With a 1-valve transmitter, the unit can be up to 5 yards or so from the transmitter, this being increased to about 20 yards with a 2-valve transmitter.

Changes to the transmitter aerial which increase the power radiated will at once be shown, because the distant meter will give a higher reading. A friend to call out meter readings is helpful. The transmitter aerial may have one sliding section, allowing length to be adjusted from about 8ft. to 8ft. 9ins. As the aerial length is adjusted to a fraction of a wavelength of the transmitted signal, a rise in power will be indicated by the distant meter, this again falling off as the aerial is made too long.

Using a resonant aerial length in this way is useful for maximum range. For average working, however, there is no need to use any particular length of aerial.

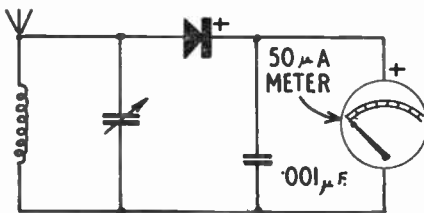

Fig. 1—Signal strength meter.

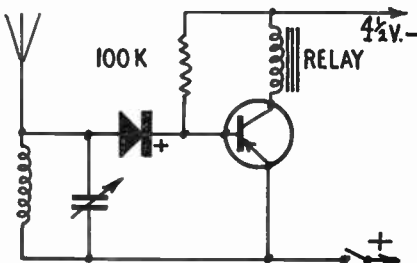

Fig. 2—Single Transistor circuit

Do not take the signal strength meter very near a powerful transmitter, without first de-tuning it, or disconnecting the meter, or it may be damaged.

1-valve set adjustments

When making receiver adjustments, it is very helpful if a friend will open and close the transmitter key at one or two second intervals. Receiver adjustments can then be made with and without a signal. A clockwork device can be made which will open and close a pair of contacts wired in the H.T. circuit, thereby automatically keying the transmitter. The surplus 'master contactor' will do this, giving 1/2-second pulses each second.

Initially, the receiver potentiometer may be set at full value. The transmitter signal should then be found on slowly turning the trimmer. A vertical aerial about 12ins. long will do well for these adjustments. Tuning is quite critical, as the signal will be almost lost if the trimmer is set even a little off the correct point. Correct tuning is that which gives the lowest current reading on the receiver H.T. meter, with the transmitter radiating.

An insulated tool at least 4ins. long must be used for tuning, as the proximity of the hand, or a metal blade, will alter tuning.

The receiver meter should now rise and fall each time the transmitter is keyed. This current change will be from almost zero, up to 1 1/2 mA or so, near the transmitter. As the receiver is carried away from the transmitter, the minimum current will be higher. At a distance, the meter may show 1.4 mA, and 1.5 mA, representing a current change of only 0.1 mA, which is near the minimum which can be relied upon to operate the relay.

Final adjustments to tuning and potentiometer should be at a distance, to secure the greatest *current change*. A friend to key the transmitter, or a clockwork keying device, is almost essential. Working adjustments should be made with the receiver in the model, with its aerial in position.

The 1-valve receiver described gives very easy, reliable working at short range, with a current change of 1 mA or more, which will work the relay strongly, but adjustments become more and more exact as the distance is increased.

A little experiment with the relay, with the meter, potentiometer and dry battery wired in series, will be worth while. It should be so adjusted that the maximum receiver current *just* holds the armature against the magnets. When this current falls, the armature will then be released.

SO far I have kept to items which mainly concern the freshwater fisherman but this week I think we should give a little space to those anglers who live on or near the coast and are chiefly interested in sea fishing. There are numerous tackle items for sea fishing which one can make on the kitchen table, as it were, and at very little cost.

Floats, for instance, of a size used in the sea can be costly, so I propose to show how to make two floats, the larger of which will carry quite a lot of weight and costs only a few pence to make. The smaller one, of course, carries less weight but also costs even less.

For the two floats your 'building kit' will consist of three table-tennis balls, two lengths of $\frac{3}{8}$ in. wood dowelling, a couple of small rod rings (the stand-off

FLOATS FOR SEA ANGLERS

By 'Kingfisher'

type are the best), and two valve caps. We will start with the smaller float.

The first job is to bore a hole through the ball and you must continue this so that it comes out *exactly* opposite. This hole should be slightly smaller than the diameter of your dowelling so that the latter is a tight fit.

The length of the dowel should be seven or eight inches and the size, not being critical, can be to your own ideas provided that you do not make it too short. This is pushed through the ball and out at the opposite side and then rounded liberally with waterproof cement to prevent the entry of water.

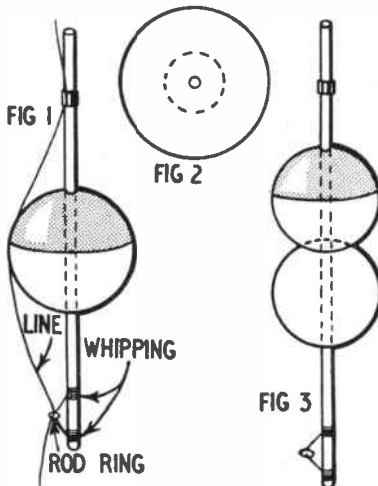
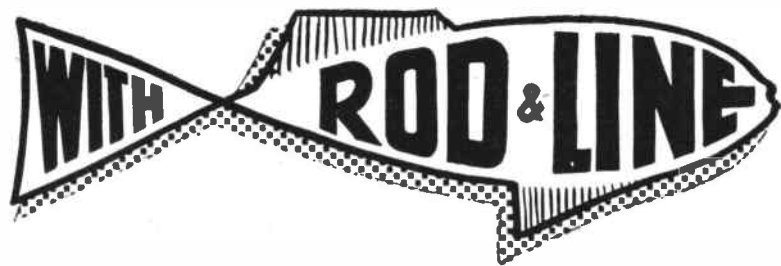

Next operation is to whip on the rod ring at the bottom end of the dowel. This is to take the line and I use a rod ring in preference to a loop so that the line is not pulled into the side of the ball too much. The bottom half of the ball can be left white and the top can be painted in a colour of your own fancy. Here I recommend the use of fluorescent enamel which shows up the float very well when

in the water. The finished float should appear as in Fig. 1.

To make the larger float, bore a hole through a table tennis ball and mark a ring on a second ball with a compass. This ring should be just over 1 in. in diameter. Bore a hole from the centre of this circle through the ball (Fig. 2).

Now carefully cut out the marked circle with a razor blade and you will have a ball with a small hole at one side and a hole just over 1 in. diameter at the other.

The dowelling for this float should be a couple of inches longer. The complete ball is pushed on to the dowel and is cemented at a point two-thirds of the way down. The second ball is now pushed on the dowel so that the larger hole sits on the first ball, to which it is cemented. This must be done carefully in order to leave no gap for entry of water. The dowel is also cemented in and the float is ready for the addition of the rod ring whipping and painting. The float should appear as in Fig. 3.

It is obvious that this float will carry a lot more weight than the first one. Incidentally, although these are two good floats for sea fishing I should add that they are useful when live-baiting for pike and they are buoyant enough to carry quite a large bait.

Musical Drinking Straws



DRINKING straws provide the main material for the construction of a variety of instructive sound toys.

Begin by making a straw trumpet as follows. Squeeze flat about $\frac{1}{4}$ in. of one end of a drinking straw and use scissors to trim away a fraction from each corner of the flattened part. Place the straw between your lips with the twin 'reeds' just inside your mouth, and blow. As the air inside the straw is caused to vibrate the instrument will give out a curious low pitched sound. Keep your lips as dry as possible.

You can make trumpets capable of producing higher pitched notes by using

shorter lengths of straw. The rule to remember is that the shorter the column of air which is set in vibration, the higher will be the pitch of the note obtained. If you wish to sound a really low pitched note make a long pipe by carefully telescoping two or more straws together. You may care to make a flute by piercing some holes along a single straw pipe. Place your fingers over the holes and uncover them one at a time as you play your instrument to produce notes of different pitch. If you are very patient you will be able to play a simple tune.

To imitate the principle of the trombone in which different notes are obtained by varying the tube length of

the instrument, you will need a straw trumpet as already described and an 8 in. length of glass tubing to fit over the straw. Play different notes upon your toy trombone by sliding the glass tube to and fro as you blow steadily into the mouthpiece. If you use a small glass funnel as a 'slider' your sounds will be remarkably amplified. Indeed, all drinking straw instruments can be improved by adding a funnel as an amplifier.

Why not form an orchestra with your friends by giving each of them a straw trumpet tuned to a different note of a musical scale. You, as the conductor, can point with your baton to the instrumentalist whose note is required next and together your band can play a tune. The result should be highly entertaining and will provide a very amusing interlude at a party.

(A.E.W.)

**DON'T LET SOLDERING
GET YOU DOWN**



**use
FLUXITE**

Soldering ceases to be a knotty problem the moment you use FLUXITE. Solder flows on easily and smoothly—and stays on. For over half a century FLUXITE has been the choice of craftsman and engineer alike and, in this age, its reliability and speed has made FLUXITE even more in demand than ever.

**IT
SIMPLIFIES
ALL
SOLDERING**



FLUXITE LTD., Bermondsey St., London, S.E.1

GM.81

**LADY'S SEWING
'COMPANION'**

**ALSO FOR
USE AS
A SMALL
TABLE**

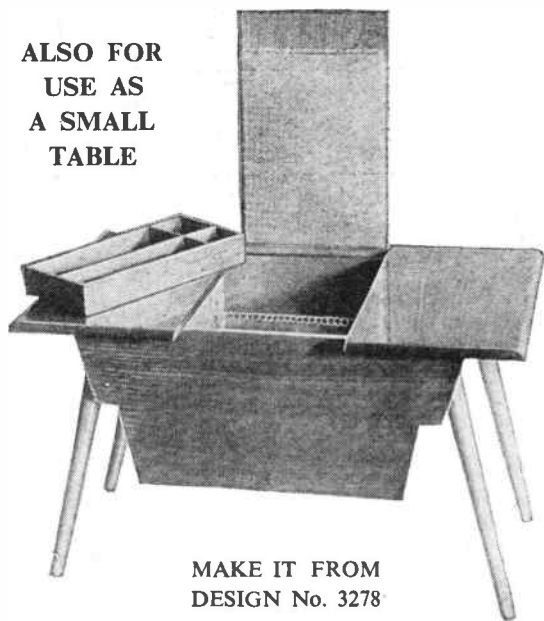

**MAKE IT FROM
DESIGN No. 3278**

A well-designed piece of furniture in contemporary style to hold all sewing and mending materials, etc. When closed it serves as a handy occasional table.

Today's value is in the region of £9 but a big saving can be made by working with Hobbies Kit No. 3278, price 65/-. This contains all planed wood panels, contemporary legs which are simple to fit, hinges, etc. Kits from all Hobbies branches, etc., or post free (see coupon).

Send for details of other furniture kits which will save you pounds.

To HOBBIES LTD., Dept. 99, DEREHAM, Norfolk

Please send details of furniture kits and Kit No. 3278 for Lady's Sewing Companion, price 65/-.

Name

Address

MAKE A MUSICAL BOX for as little as 21/- . New kits and tunes available. Measurements 13/- post free. Please send 3d. stamp for free illustrated catalogue. — The Swisscross Co., Dept. B, 202 Tulse Hill, London, S.W.2.

100 DIFFERENT stamps free! Request 1d. upwards discount approvals. — Bush, 53 Newlyn Way, Parkstone, Dorset.

WHEELS. (Hardwood and Rubber Tyred Metal), Cot, Pram and Doll's House Fittings and Papers, Beads, Transfers, Prints and other accessories. Stamp for new lists. (Trade supplied.) New address — JOYDEN CO., 91 Peplins Way, Brookmans Park, Herts.

LEARN RADIO and ELECTRONICS the NEW practical way! Very latest system of experimenting with and building radio apparatus — 'as you learn'. FREE brochure from — Dept. HW10, Radiostructor, Reading, Berks.

BUILD YOUR OWN HI-FI at home! At last, for reasonable cost — the chance to make your own quality HI-FI audio equipment and to gain the knowledge to service and maintain it. FREE brochure from — Dept. HW20, Radiostructor, Reading, Berks.

BRASS, COPPER, DURAL, ALUMINIUM, BRONZE

ROD, BAR, SHEET, TUBE, STRIP, WIRE
3,000 STANDARD STOCK SIZES

No quantity too small List on Application

H. ROLLET & Co. Ltd.
6 CHESHAM PLACE, LONDON, S.W.1

Also at
Liverpool, Manchester, Leeds, Birmingham

Sent for 10/-. bal. 18 fortnightly payments 7/6. Plus carr. **1/2 PRICE OFFER!** The FLIGHT LIEUTENANT **GENUINE NEW WATERPROOF 8oz. DUCK TENT** **SENT FOR 10/-** **CASH PRICE £5 17/6** **CHEEK 6/-**

Waterproof 1959 Tents of real 8oz. WHITE Duck. Galeproof Brand new, surplus to export order. DON'T CONFUSE with Tents made from drab material never meant for tentage. This is real thing, withstands anything even in our climate. Approx. 7ft. 6in. x 6ft. x 6ft., 3ft. walls. Cash £5 17/6, carr. 6/- complete ready to erect, incl. valise. 'Willessden' Green 42/- extra. Ridge pole if req. 7/6. Flysheet available 37/6. Rubberised Groundsheet 19/6. LISTS, TENTS, ETC. TERMS.

These **1500 TELESCOPE SIGHTING-GUN SIGHTS** fitted with genuine scientific hand-ground lenses are precision built and graticuled for dead-on sharp shooting accuracy. Made for precise sniper's action they represent an absolute bargain. Actual cost of production, without any profit, £8.10.0. OUR PRICE only 17/6., post, etc., 2/6. If you want to get a precise bead on anything, this is the instrument to do the trick. Limited offer only. Lists, Binoculars, Telescopes. **Headquarter & General Supplies Ltd.** (HOBW/67) 196-200 Coldharbour Lane, Loughboro Junc., London, S.E.5. Open Sat.



INTRODUCTIONS to new friends; home and overseas. — V.C.C., 34 Honeywell Road, S.W.11.

STAMPS FREE, including Q.E.II. Send for **Sour famous Discount Approvals**. Enclose 3d. stamp. The Lodge Stamp Services, The Lodge, Clonmel, Co. Tipperary.

STOP SMOKING! Quick guaranteed remedy. Testing sample free! — Triumph Remedies, A(16), Exeter.

MODELS. You can make lasting stone-hard models with Sankey's Pyruma Plastic Cement. Supplied in tins by Ironmongers, Hardwaremen and Builders' Merchants. Ask for instruction leaflet.

KUKLOS ANNUAL. Indispensable cyclists handbook. Tours, resthouses, money-saving hints, 3/- post free. — Burrow, Publishers, 2 Imperial Houses, Cheltenham.

FREE — Homeworkers' opportunity. S.A.E. — Esprey, 29 Newmans Grove, Rugeley, Staffs.

STAMPS FREE — Empire Packet including **SPictorials** and Victorians with approvals. — Robert J. Peck, 7A Kemp Road, Bournemouth.

EXTRA CHEQUES from writing. Send for 'Ideas for Writers' (free). Scores of suggestions for beginners and others. Typewriter unnecessary. — Writers' Ring (H.W.), 5 Edmund Street, Birmingham 3.

PERSONS required, to make new type fancy cushion covers. Apply, enclosing S.A.E. — Dept. 28, Arnold Trading, 10 Shelley Road, Worthing, Sussex.

APPARATUS & CHEMICALS
For your experiments. Let us help you equip a **HOME LABORATORY**

Beakers, Crucibles, Flasks, Funnels
Gas Jars, Test Tubes, etc.

Booklets:
(including postage)

- 'Experiments' 1/2
 - 'Formulas' 1/2
 - 'Home Chemistry' 2/10
- New edition

Send 3d. Stamp for latest **PRICE LIST**

A. N. BECK & SONS (Dept. H.W.)
60 Stoke Newington High Street, London, N.16



The **'WENSUM'** Sailing Dinghy

by P. W. Blandford, A.I.N.A.

and The **'VENTURER'** Outboard Motorboat now being manufactured by

PORTACON (PANGBOURNE) LTD.

The Wharf, Pangbourne, Berks. Telephone 567

Personal and Trade enquiries invited

STICK TO SECCOTINE

it sticks everything



1/3
PER TUBE

Sole Manufacturers —

McGAW, STEVENSON & ORR LTD., BELFAST

'WENSUM' DINGHY KITS

Canoes and Dinghies, kits and finished craft. Marine Ply. Oars, Paddles and Materials.

Stamp for details

H. W. PALSER

1 Dean Road, Erdington, BIRMINGHAM 23

ERD 0870

HEAR ALL CONTINENTS
With **H.A.C. Short-Wave Receivers**

Suppliers for over 18 years of Radio S-W Receivers of quality.

One-Valve Kit, Price 25/- Two-Valve Kit, Price 50/-

Improved designs with Denco coils. All kits complete with all components, accessories and full instructions. Before ordering, call and inspect a demonstration receiver, or send stamped addressed envelope for descriptive catalogue.

'H.A.C.' Short-Wave Products (Dept. 22), 11 Old Bond Street, London, W.1

COTTON REEL ENGINE

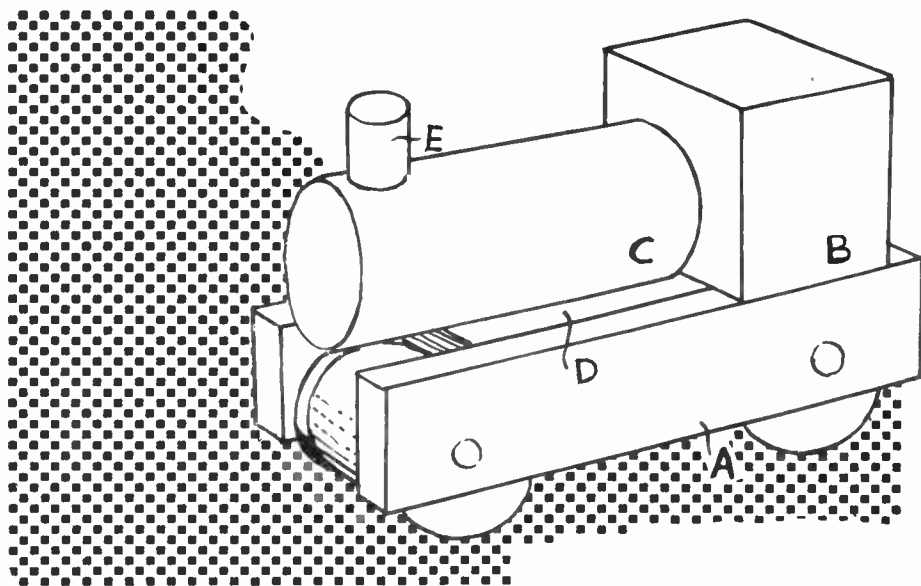
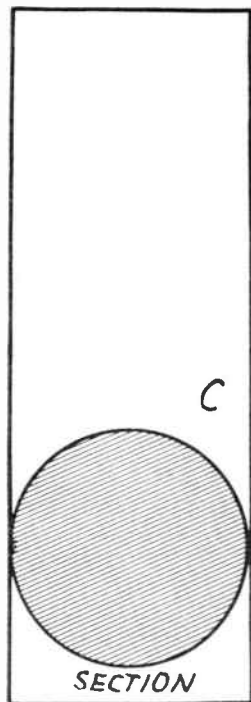

USE THESE PATTERNS

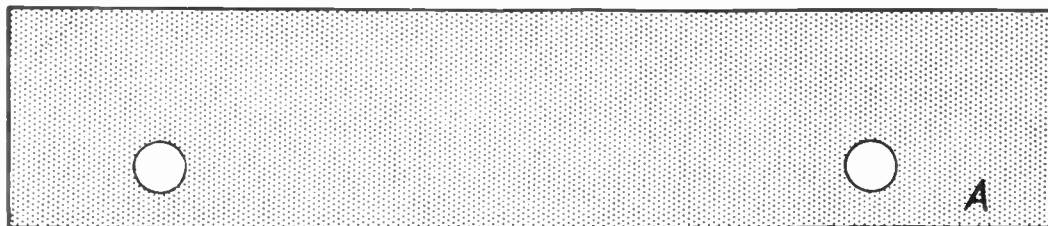
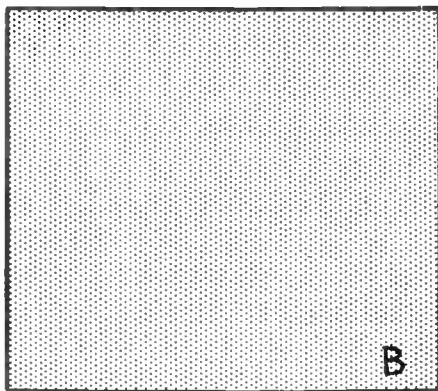
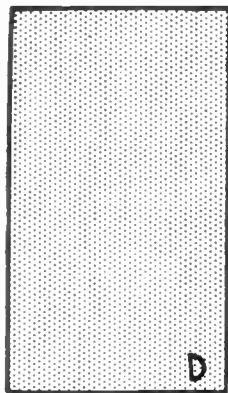

CUT two sides (A) from $\frac{1}{2}$ in. wood, using a fretsaw, and glue the block (D) between them. The block (D) is cut $1\frac{3}{4}$ ins. thick, so that the pieces (A) will be $1\frac{1}{2}$ ins. apart.

The block (B) is $1\frac{1}{2}$ ins. thick and the piece (C) is cut from round rod about $1\frac{1}{4}$ ins. diameter. Both pieces are glued in position shown by the sketch. Make the funnel from $\frac{1}{2}$ in. round rod. Axles of round rod go through the two cotton reels and are glued into pieces (A). The diameter of the axles will depend upon the size of the hole in the cotton reels.

Any type of cotton reel may be used if adjustment is made to the overall size of the engine. (M.p.)

Be snap-happy ... buy **ILFORD**

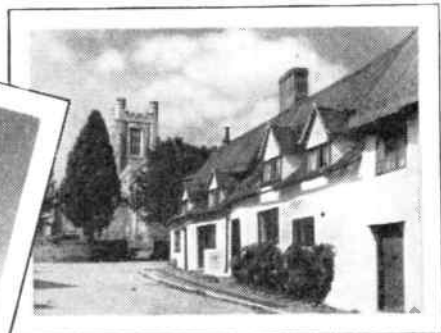

ILFORD SELOCHROME PAN is the all-purpose film that millions of happy snappers choose. For the very pick of the pictures on holiday—and all summer through—this panchromatic film is the one to ask for.
The famous film for Faces and Places

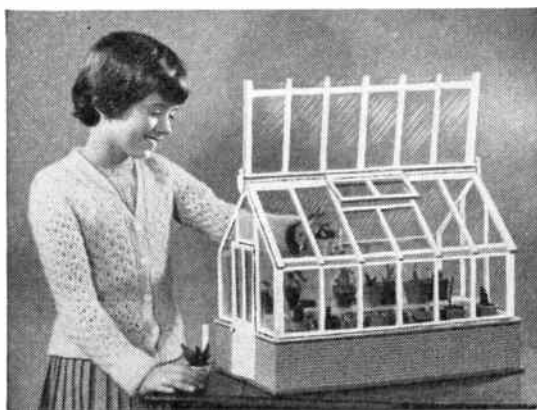

MINIATURE GREENHOUSE

*A really practical
model for the home*

For growing cacti, succulents, miniature trees, seedlings, etc., and can be used as a propagating frame.

JUST LIKE DAD'S!

You can make this ideal showpiece from Hobbies Kit No. 3300, which contains all wood, materials, etc., and 12 sets of pots and saucers. Hinged roof, window, door. 18 ins. x 12 ins. x 13 ins. high. Only a few simple tools needed in construction.

Kits from Hobbies branches, stockists or post free (see coupon). **39/6**

ALL-THE-YEAR-ROUND INTEREST

To **HOBBIES LTD.**, Dept. 99, Dereham, Norfolk

Please send Kit No. 3300 for making Miniature Greenhouse.

1 enclose P.O. for 39/6.

Name

Address

.....
.....

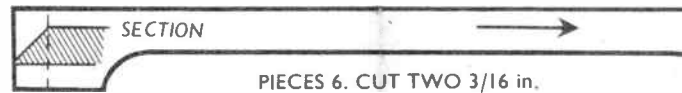
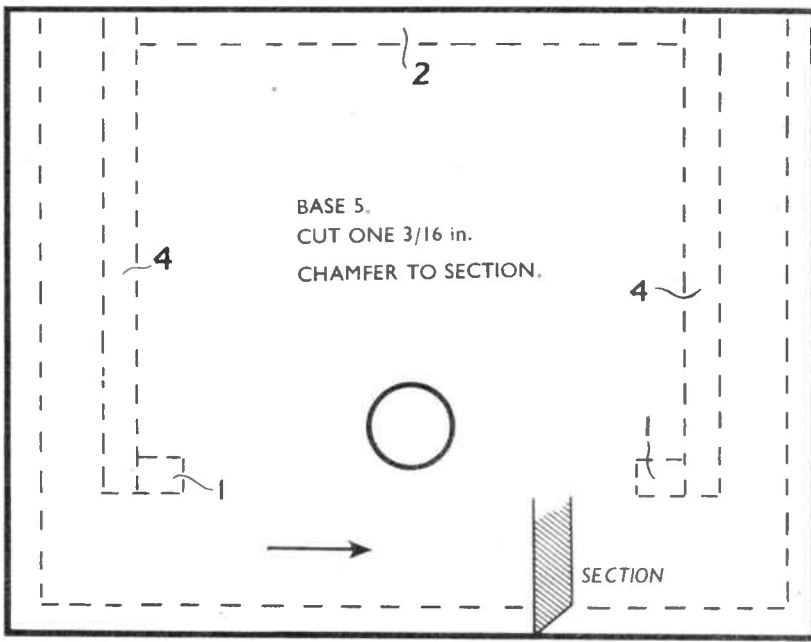

PIECES 6. CUT TWO $\frac{3}{16}$ in.
CHAMFER TO SECTION.

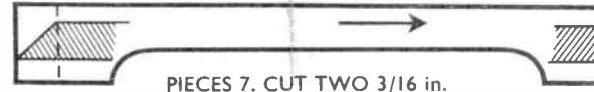

THE ARROWS INDICATE
THE DIRECTION OF THE
GRAIN OF THE WOOD.

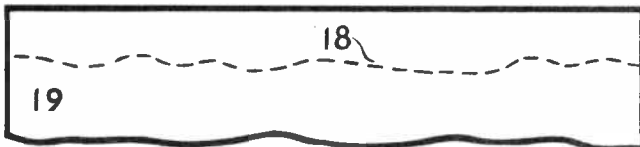
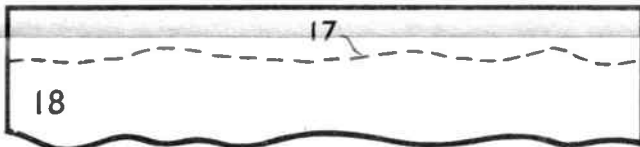
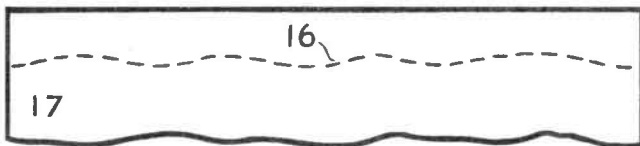
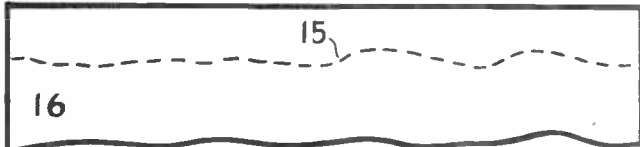
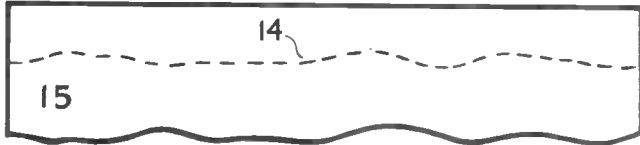

ROOF PIECES 14 TO 19.
CUT TWO OF EACH $\frac{1}{16}$ in.

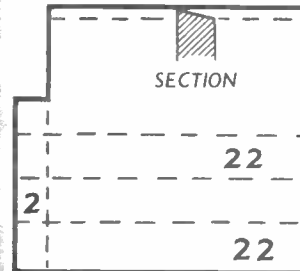
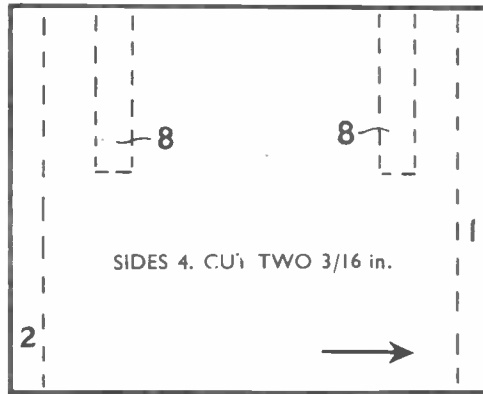

SIDES 3. CUT TWO
CHAMFER TO SECTION



PIECES 22. CUT FOUR FROM
HOBBIES No. 35 $\frac{1}{4}$ in. $\frac{1}{2}$ ROUND BEADING.



WINDOWS. PAINT ON THIN
CARD OR PAPER. PASTE IN
POSITION.

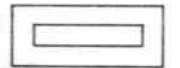

PIECE 27.
CUT ONE $\frac{3}{16}$ in.



PIECE 28.
CUT ONE $\frac{3}{16}$ in.



GLUE PIECES 27 & 28
TOGETHER AND
SHAPE TO THIS
SECTION.

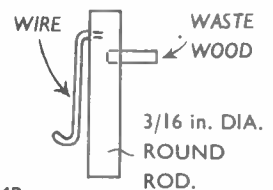

PUMP.
MAKE ONE.

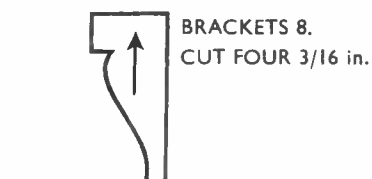

PIECE 31. CUT ONE $\frac{3}{16}$ in.

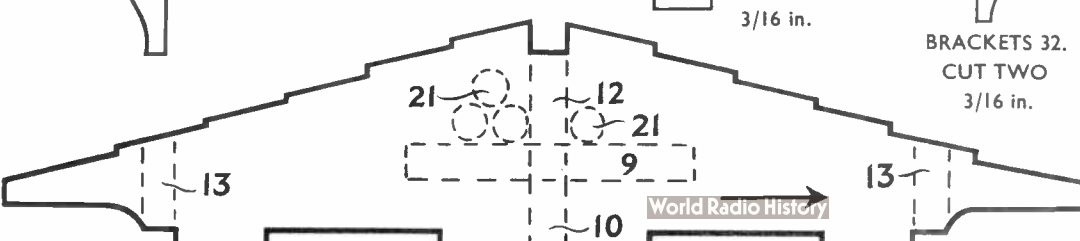

SWISS CHALET WEATHERHOUSE

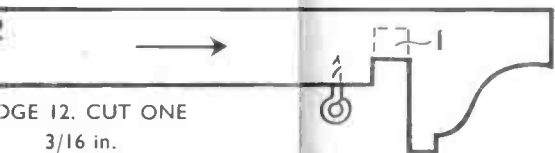
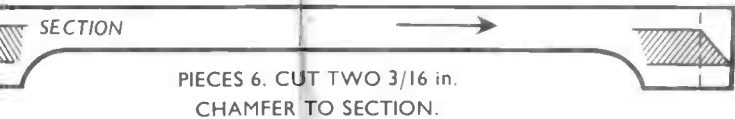
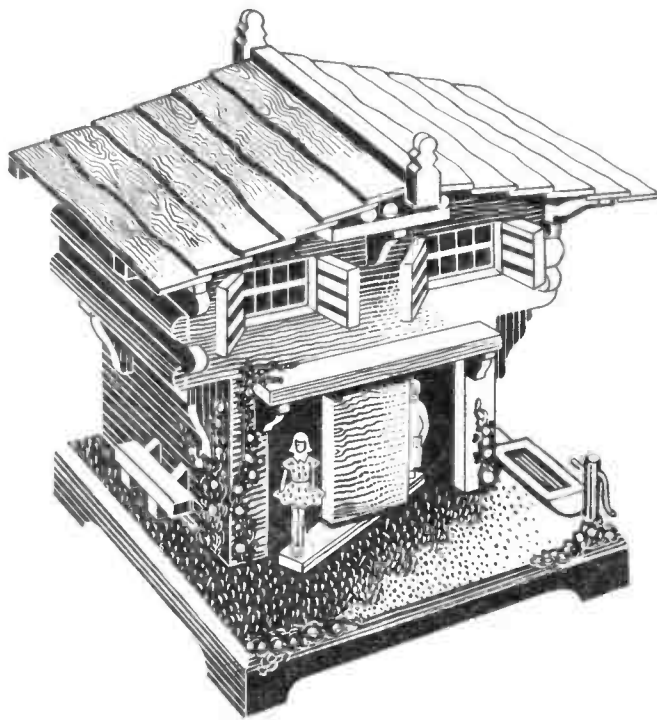

SIZE: 5 1/2 in. WIDE
5 in. HIGH
APPROX.

THE ARROWS INDICATE
THE DIRECTION OF THE
GRAIN OF THE WOOD.

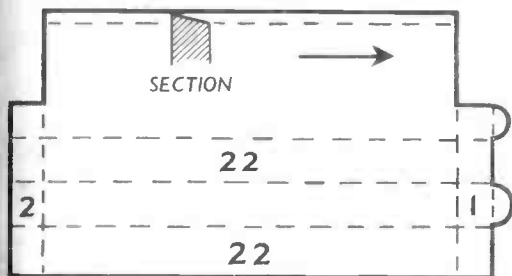
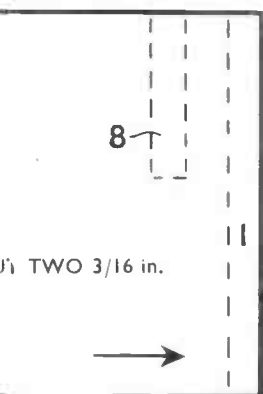

PIECES 22. CUT TWO 3/16 in.
CHAMFER TO SECTION.

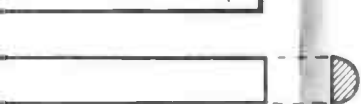

PIECE 9. CUT ONE 3/16 in.

PIECE 27. CUT ONE 3/16 in.

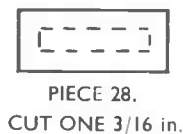
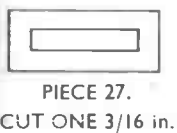

PIECE 29. CUT ONE 3/16 in.

PIECE 29. CUT ONE 3/16 in.



PIECES 32. CUT TWO 3/16 in.



PIECES 32. CUT TWO 3/16 in.

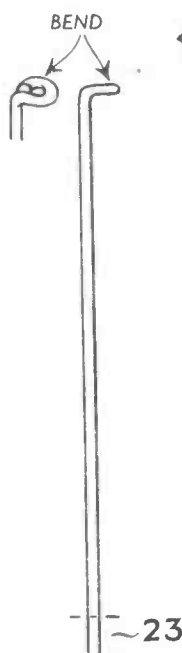
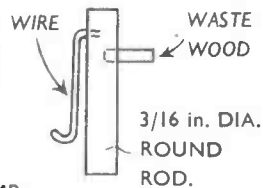
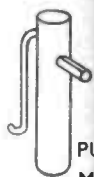

PIECE 24. CUT ONE 3/16 in.



PIECE 25. CUT ONE 3/16 in.

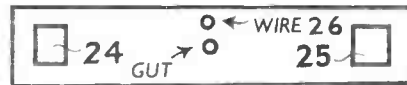

PIECE 23. CUT ONE 3/16 in.

A KIT OF MATERIALS FOR MAKING THIS DESIGN IS SUPPLIED BY HOBBIES LIMITED, DEREHAM, NORFOLK. PRICE ON APPLICATION.

Use



Croid AERO

IT'S DESIGNED FOR THE JOB

This pure hot animal glue of great strength needs no mixing or preparation. The Home Outfit consists of 8 oz. tin Croid Aero Glue — Hot Water Container — Handy Brush — 4/- complete.

AVAILABLE FROM ALL BRANCHES OF HOBBIES LTD

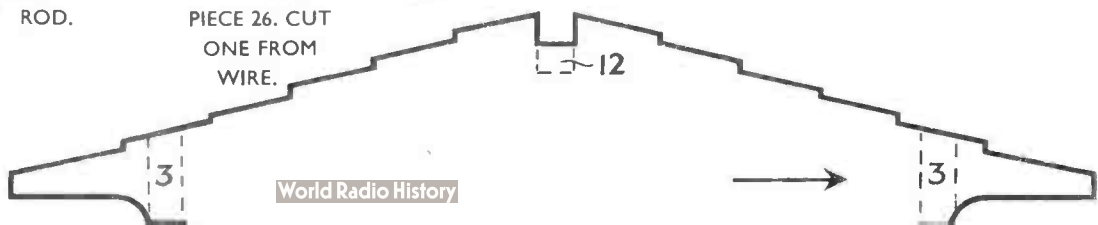
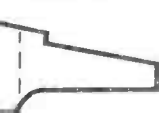

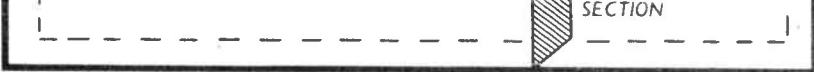

THE DIRECTION OF THE GRAIN OF THE WOOD.

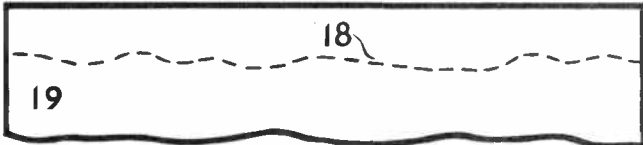
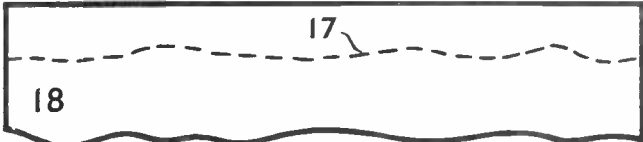
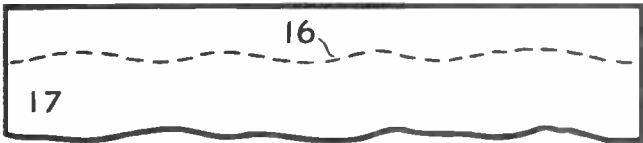
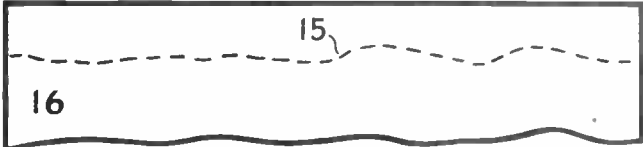
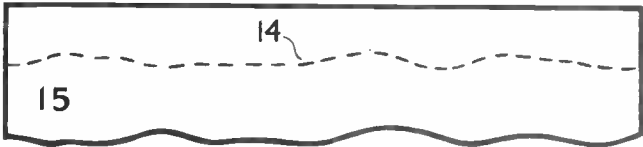

ROOF PIECES 14 TO 19.
CUT TWO OF EACH 1/16 in.

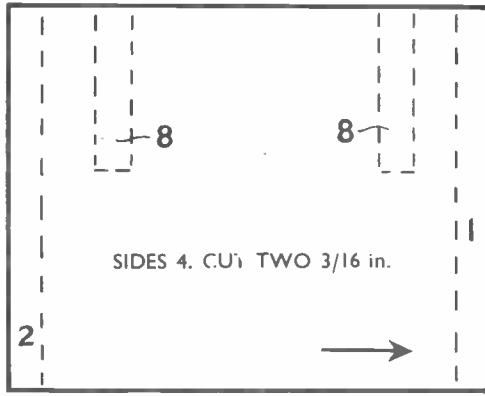

PIECES 22. CUT FOUR FROM
HOBBIES No. 35 1/4 in. 1/2 ROUND BEADING.



WINDOWS. PAINT ON THIN
CARD OR PAPER. PASTE IN
POSITION.



PIECE 29.
CUT ONE 3/16 in.

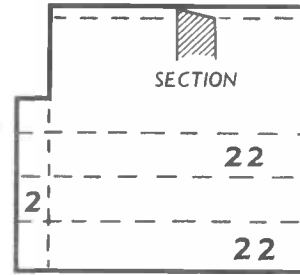

SIDES 3. CUT TWO
CHAMFER TO SIDE

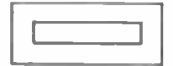

PIECE 27.
CUT ONE 3/16 in.



PIECE 28.
CUT ONE 3/16 in.



GLUE PIECES 27 & 28
TOGETHER AND
SHAPE TO THIS
SECTION.

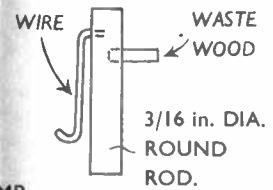

PUMP.
MAKE ONE.



PIECE 31. CUT ONE 3/16 in.



BRACKETS 8.
CUT FOUR 3/16 in.



PIECES 30.
CUT TWO
3/16 in.



BRACKETS 32.
CUT TWO
3/16 in.

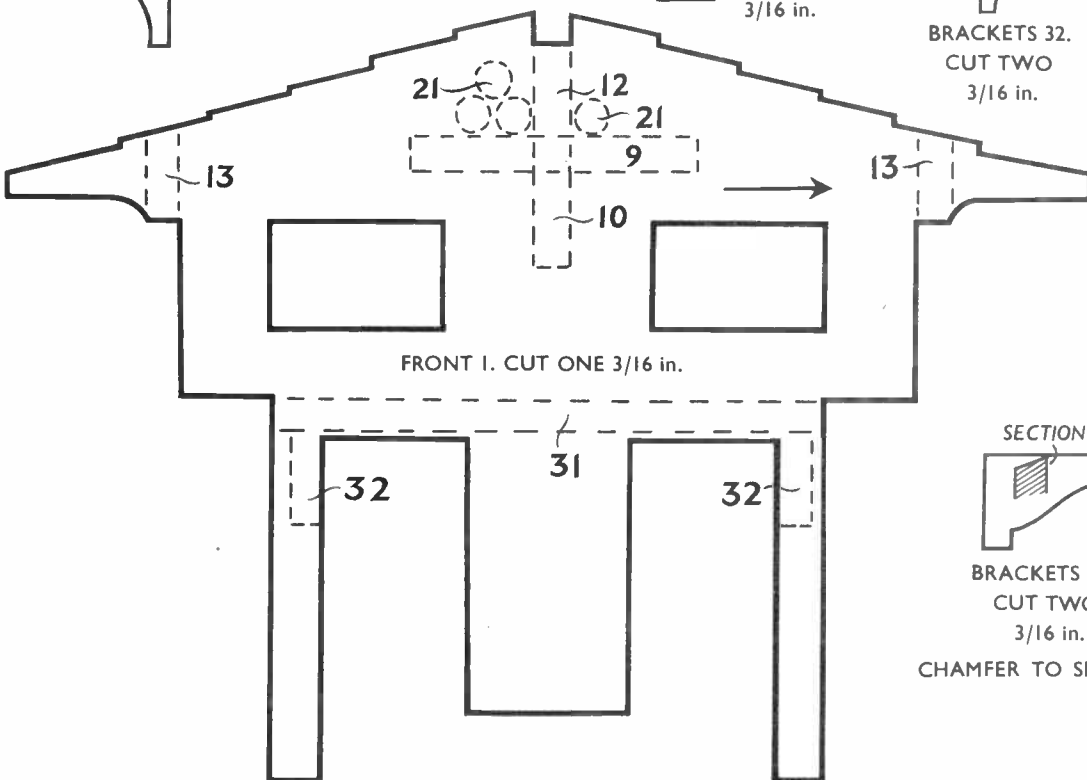

FRONT 1. CUT ONE 3/16 in.



PIECES 21.
CUT FOUR
FROM 3/16 in.
ROUND ROD.

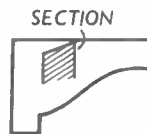

BRACKETS 13.
CUT TWO
3/16 in.
CHAMFER TO SECTION



BRACKET 10.
CUT ONE 3/16 in.

PRINTED IN ENGLAND.

THE DIRECTION OF THE GRAIN OF THE WOOD.

5 in. HIGH APPROX.

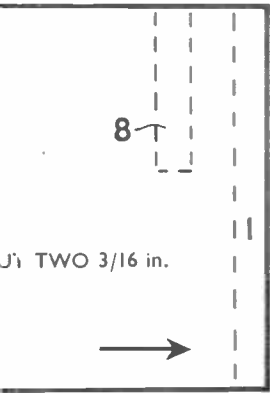
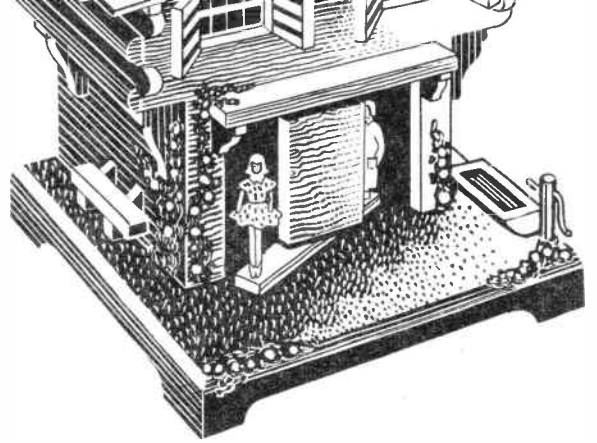

CUT TWO 3/16 in.

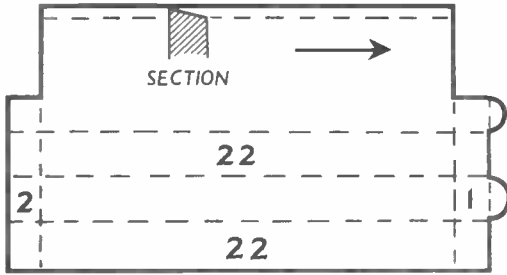

SIDES 3. CUT TWO 3/16 in. CHAMFER TO SECTION.

CUT FROM 1/2 in. 1/2 ROUND BEADING.



SHELF 9. CUT ONE 3/16 in.

A KIT OF MATERIALS FOR MAKING THIS DESIGN IS SUPPLIED BY HOBBIES LIMITED, DEREHAM, NORFOLK. PRICE ON APPLICATION.

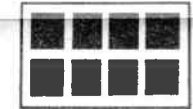

PRINT ON THIN PAPER. PASTE IN POSITION.

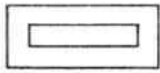

PIECE 27. CUT ONE 3/16 in.

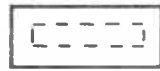

PIECE 28. CUT ONE 3/16 in.

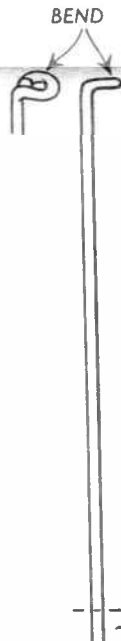

PIECE 24. CUT ONE 3/16 in.



PIECE 25. CUT ONE 3/16 in.

Use

Croid AERO

IT'S DESIGNED FOR THE JOB

This pure hot animal glue of great strength needs no mixing or preparation. The Home Outfit consists of 8 oz. tin Croid Aero Glue — Hot Water Container — Handy Brush — 4/- complete.

AVAILABLE FROM ALL BRANCHES OF HOBBIES LTD

PIECE 29. CUT ONE 3/16 in.



GLUE PIECES 27 & 28 TOGETHER AND SHAPE TO THIS SECTION.

SECTION SHUTTERS 11. CUT FOUR 3/16 in. CHAMFER TO SECTION.



BRACKETS 32. CUT TWO 3/16 in.

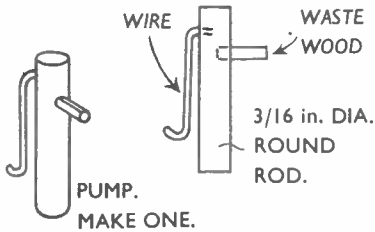

PUMP. MAKE ONE.

PIECE 26. CUT ONE FROM WIRE.



PIECE 23. CUT ONE 3/16 in.

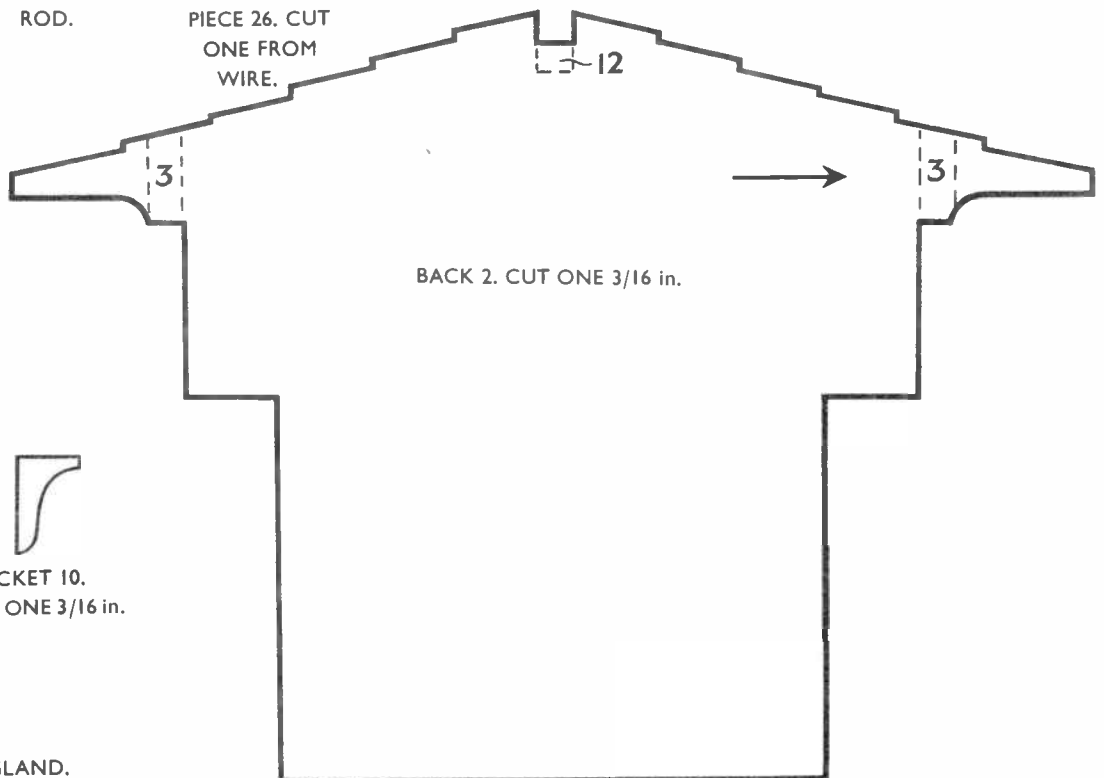

PIECES 21. CUT FOUR FROM 3/16 in. ROUND ROD.

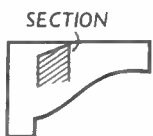

BRACKETS 13. CUT TWO 3/16 in.

CHAMFER TO SECTION

BRACKET 10. CUT ONE 3/16 in.

PRINTED IN ENGLAND.