

HOBBIES WEEKLY

FEBRUARY 4th 1959

VOL. 127

NUMBER 3301

IN THIS ISSUE

	Page
'Junior' Bench	289
Two-minute Quiz	290
Home-made Coil Packs	291
Keeping a Cat	292
Strength of the Wind	293
Reflection of Plane Mirrors	294
Fit a Threshold Bar	294
A Set of Screwdrivers	295
Games you can carry in your pocket	295
Patterns for a Weatherhouse	296
With Rod and Line	298
Collectors' Club	300
Is this Your problem?	302
Patterns for Working Model Tanker	303



All correspondence should be addressed to the Editor, Hobbies Weekly, Dereham, Norfolk

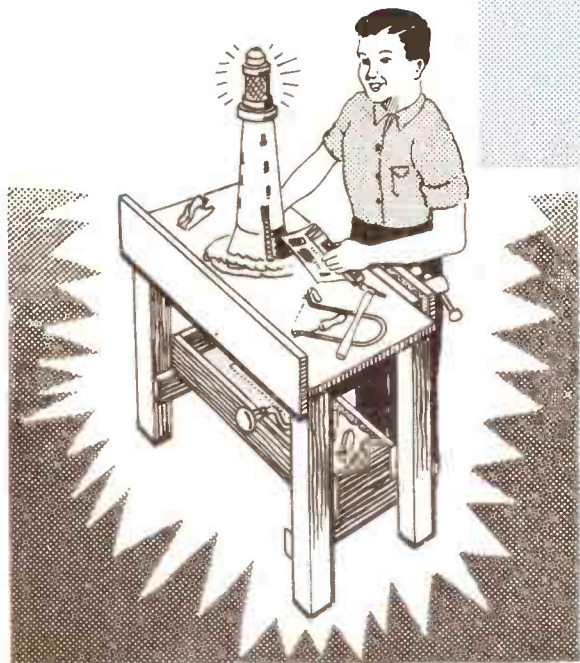

Complete with a tray for tools, this bench is ideal for the young carpenter or modeller

THIS bench is intended primarily for the young craftsman but it is quite sturdy enough for general use as a modelling table or for light carpentry.

'JUNIOR' BENCH

**MAKE IT FROM
INSTRUCTIONS
INSIDE**

289

FOR ALL HOME CRAFTSMEN
Over 60 years of 'Do-it-Yourself'

World Radio History

4^{1D}/₂

DETAILS FOR MAKING THE 'JUNIOR' BENCH

ALTHOUGH of small dimensions the 'Junior' Bench can be used for heavier work if the thickness of the top is increased to 1½ ins. or 2 ins. If the overall size of the bench is increased it would be advisable to make the thickness of pieces (B) and (I) 1½ ins. and the depth 6 ins.

The diagrams in Fig. 1 show the front view and side view, with the various parts lettered for easy reference to the instructions, which should be read through carefully before commencing work.

The legs (A) are 2 ins. square and 27 ins. high, the front (B) is 1 in. thick by 3 ins.

The top, pieces (C), should now be fixed with countersunk screws. Each piece measures 1 in. by 9 ins. by 31 ins. Fig. 3 shows pieces (C) in position.

The tool tray should be 27 ins. long by 13 ins. wide, and is made from ½ in. wood. Pieces (G) and (H) are 3 ins. deep and the bottom (F) ½ in. thick giving an overall depth of 3½ ins. It is suggested that the bottom should be cut from plywood or alternatively from two pieces of hardwood 6½ ins. wide.

The tool tray may be painted, but the bench itself should be left in the natural wood. It can, however, be given a coat of clear wood preservative. (M.h.)

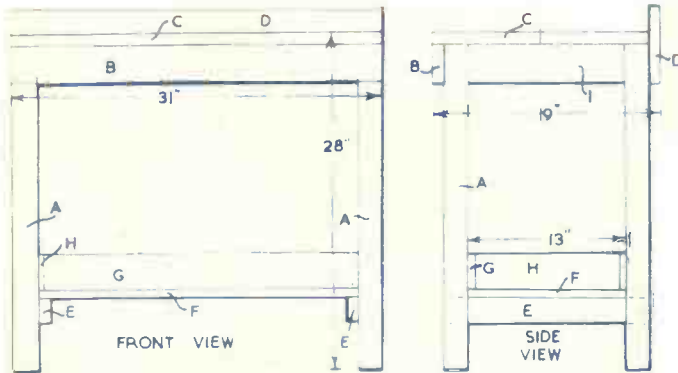

Fig. 1

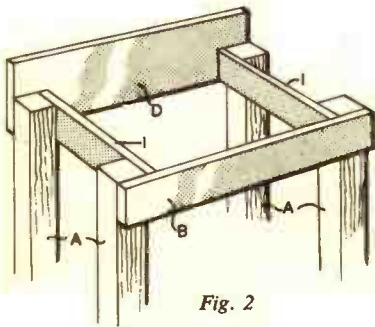

Fig. 2

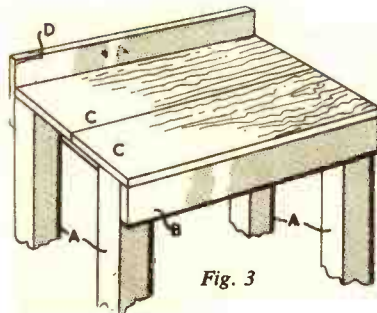

Fig. 3

deep by 31 ins. long, the rails (I) are 1 in. by 3 ins. by 17 ins. and the back (D) is 1 in. by 6 ins. by 31 ins.

Commence assembly as shown in Fig. 2, using countersunk screws or nails for fixing. Note that the rails (I) go inside the legs, and piece (B) on the front. Next fix the rails (E) in position as shown in Fig. 1. They measure 2 ins. by 1 in. by 17 ins., and should be 4 ins. up from the floor.

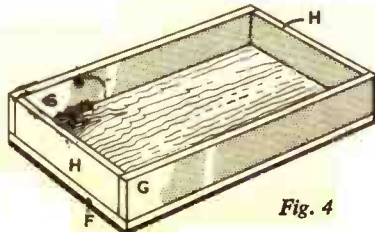

Fig. 4

TWO MINUTE QUIZ

by Ed Capper

1

NAME THE JOINT

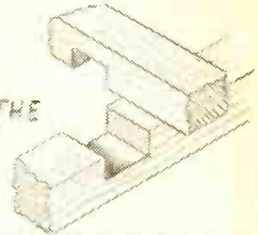

2

NAME THE BRICK HOLLOW

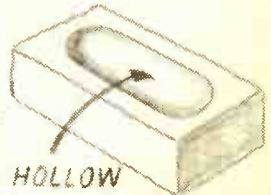

3

THE DIMENSIONS OF A ROLL OF WALLPAPER ARE WHAT?

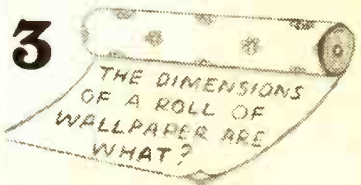

4

IS THIS TOOL UNSINKABLE?



5

NAME THE STONE SLAB OVER WINDOW



ANSWERS ON PAGE 298

Concluded from last week

HOME-MADE COIL PACKS

THE home-made coils are made from Alladin coil formers (with dust core) of $\frac{3}{8}$ in. diam. First, cheeks or washers must be made to fit tightly round the former stem. These can be of plastic, cardboard, etc, held in position by cement or insulating tape.

For medium waves, separate the washers $\cdot 2$ (two-tenths) of an inch apart. Wind in 100 turns of 28 gauge enamelled wire, leaving about 2 ins. free ends. Secure with a layer of insulating tape, and on top wind 30 turns of 34 gauge wire, and secure this again with tape, leaving 2 ins. free ends. Identify the beginning and end of each winding.

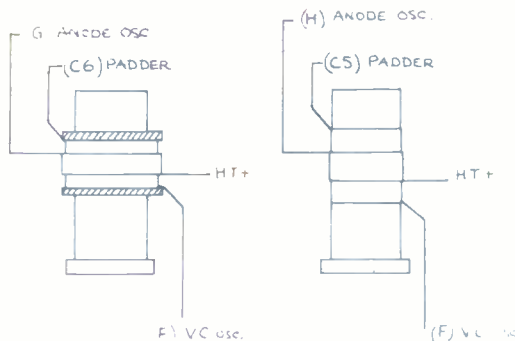

Fig. 5—Medium and short wave oscillators

The medium wave oscillator coil consists of 75 turns of 28 gauge with 25 turns of 34 gauge on top.

Those wishing long wave coils, should leave a space between washers of $\cdot 3$ (three-tenths) of an inch, with primary winding of 360 turns of 34 gauge with 100 turns on top. The oscillator coil has 180 turns with 60 turns on top.

Short wave coils need no washers. Just wrap a layer of $\frac{1}{8}$ in. insulating tape round the coil former stem and on this wind nine turns of 24 gauge enamelled wire, evenly spaced to cover the width of the tape. Secure with another layer of tape and wind on five turns of 30 gauge (or any similar gauge). Secure again with tape. Identify the start and finish of each winding.

The oscillator is the same except that the second winding should be less, about 3 or 4 turns.

In all the above cases, the second winding (on top) must be wound in the same direction as the underlying winding.

Fig. 5 shows the connections of home made coils, for superhet performance, as far as the oscillator is concerned, because correct connections for this are

extremely important. Medium and short oscillators are shown.

Wire in the home-made coils as follows:

SA (short aerial coil):

Join start of small winding to tag (B) on switch.

By A. Fraser

Join end of small winding to end of large winding and take to chassis tag. Join start of large winding to tag (D)

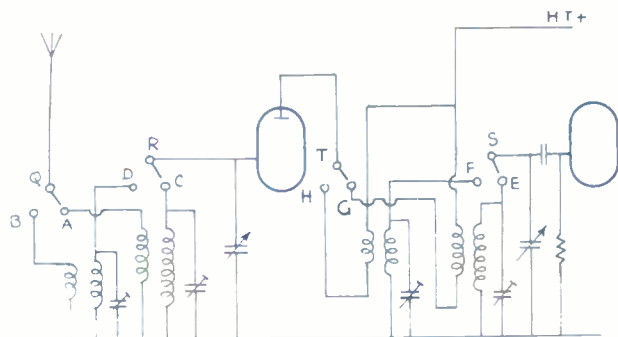

T.R.F. circuit

on switch and also to C1.

MA (medium aerial coil):

Join start of small winding to tag (A).

Join end of small winding to end of large winding and take to chassis.

Join start of large winding to tag (C), and also to C2.

SO (short oscillator):

Join start of small winding to start of small winding on lower medium oscillator.

Join end of small winding to H.

Join start of large winding to F and C3.

Join end of large winding to padder C5.

MO (medium oscillator):

Join end of small winding to G.

Join start of large winding to E and also to C4 (trimmer).

Join end of large winding to padder C6.

The coil pack should be mounted in the front runner on the radio's chassis, into which holes can be bored opposite the coil cores, if these are to be adjusted from in front. But this is not usually necessary. When fixing the pack, see that the coil's tags do not contact the chassis.

The yellow (S) lead is taken to the tag of the oscillator section of the tuning condenser. The green (R) lead is taken to aerial section of the tuning condenser. The brown (T) lead goes to the oscillator anode tag of the valve. The red lead goes to the H.T. + line.

For T.R.F. sets, the oscillator coils are not needed. Instead, exact replicas of the aerial coils are used. With Osborn coils, QHF7 for short (SO) is used, with QHF8 for medium in MO position. The padders (C5, C6) are discarded. Tag (3) on both coils is taken to chassis.

With home-made coils, the ends of the large windings of both short and medium

coils (SO and MO) are taken to chassis instead of to padders (C5, C6).

For T.R.F. circuits, the yellow lead (S) goes to the H.F. section of the tuning condenser, while the green lead (R) joins to the aerial section. The brown lead (T) goes to the anode of the H.F. valve. The red lead goes to H.T. +.

In both T.R.F. and superhet, the aerial is joined to tie-post (U) on the edge of the chassis.

When in position and connected up, the pack must be aligned. With the dial pointer at the Third Programme position, adjust the slugs of the medium coils (MA and MO) for maximum performance. Then tune to the Light on 249 (or Luxembourg on 208) and adjust the trimmers C2 and C4.

On short waves, a signal generator is preferable, but one can use Luxembourg on the 49 metre band as a guide. Turn the pointer to this and tune in the station by adjusting slugs of SO and SA. Adjust the trimmers C3 and C1 with the pointer on the 20 metre amateur band.

Once the coil pack is aligned, it needs no further adjustment and can be used in any set having a normal circuit.

KEEPING A CAT

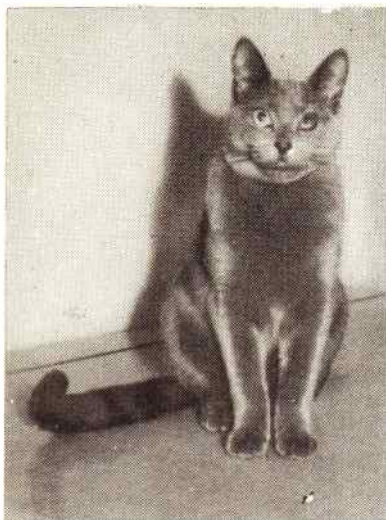

A Russian Blue with a plaintive appeal

NOTHING certain is known of the origin of the domestic cat, except that it is not a tamed version of the European Wild Cat; no-one has succeeded in taming that to this day.

A popular theory is that Puss is a descendant of the household pets of the Ancient Egyptians. It is thought that the Egyptians tamed one or more breeds of the small wild cats found in Africa. However domestic cats were known in India and China long before the birth of Christ and presumably were tamed varieties of their local wild cats. Since there are two distinct varieties of domestic cats, those with round shaped heads and others with wedge shaped heads, it would thus appear that the modern cat comes from several sources.

Everyone knows that there are Long-Haired cats and Short-Haired cats, but what is not so widely known is that there are two varieties of the Short-Haired cat; the British type and the Foreign type.

Popular Blue Persians

Long-Haired cats are often known as Persians, although there is no evidence to show that they came from that country. Probably the most popular variety is the Blue Persian. This is a magnificent grey animal with orange eyes. If the fur is parted the cat will be found to have a blue skin.

In addition to the above colour, Long-Hairs come in all the colours that are found in the British Short-Haired cats. There are also several colourings specific to the Long-Haired types; smoke, chinchilla and colour point. This last is particularly beautiful, the body being a creamy fawn colour and the head, legs and tail a dark brown.

The Long-Haired cat has a broad, round head and a heavily built body with short legs. It should have a long silky coat and a short thick tail.

These animals are on the whole quieter and more placid than the Short-Haired cats, but perhaps less hardy. Long-Haired cats are extremely beautiful creatures, but they require a great deal of grooming to keep them that way. No-one should buy a Long-Haired cat unless he is prepared to spend considerable time each day brushing and combing his pet, otherwise the fur will mat and pull on the skin, causing sores.

The British Short-Haired cat may be seen on any door-step, sunning itself. It

The Burmese is a handsome creature with a dark nigger-brown coat; this is a new breed of cat that has been largely developed in America.

The Russian Cat is noted for its beautiful dense grey coat with its velvety sheen. It should not be confused with the heavier British Blue which is a completely differently shaped animal.

The best known of the Foreign Cats is the Siamese and the Seal-Pointed is the most popular variety. The great attraction of the Siamese is the beautiful deep blue eyes. There are several varieties; the Seal-Point with nigger-brown points (or hair tips), the Blue Point has grey points and a white body,

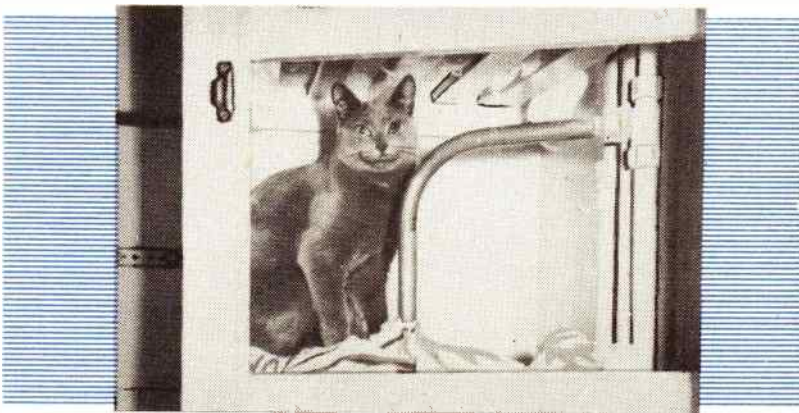

A cosy spot in the airing cupboard

is a sturdy, short-legged animal, with a broad round head. The main difference between the household pet and the show cat is that the former often has white patches. The only pedigree cat that is permitted white markings is the tortoiseshell and white. In addition to the commonly seen colours, Short-Haired cats may be had with blue and blue-cream fur coats. These colourings are recessive characteristics and are only maintained by careful breeding.

The Foreign Short-Hair is completely different from his British 'cousin'. He is a slender animal with long legs, a long 'whip-like' tail, and a wedge-shaped head. The varieties accepted by the Cat Fancier are the Abyssinian, Burmese, Russian and Siamese.

The Abyssinian Cat has colouring bearing a strong resemblance to the wild rabbit. Officially it is described as a brown, tipped with black or brown, and is a very pretty animal.

and the Chocolate Point with milk chocolate markings and an ivory body colour. In addition, red, frost and lilac pointed cats have been bred, but these are great rarities.

Buying a kitten

Before buying a kitten, it is a good idea to attend one of the big cat shows that are held throughout the winter months. Here you can see cats as near perfect as cats can be. This should help you to decide which breed of cat you really want, and if you decide upon a particular variety you will be able to contact a breeder. Even if you do not wish to own a pedigree cat, it will be useful to note how a cat in the peak of condition should look.

Pedigree animals

When buying a kitten it is advisable to buy from the breeder; if spending considerable money on a pedigree animal it

is essential. By visiting the breeder you can see that the kitten has been kept under good conditions, also you will be able to see whether the rest of the litter are healthy.

A kitten should not be chosen too young; three months old is a good age. A kitten of that age will not present any feeding problems. Before purchase it should be thoroughly inspected; it ought to have clear eyes, soft shiny coat, and should not have a distended stomach. If any kitten in the litter has a running nose or messy ears, go to another cattery. Also to be avoided are timid, nervous kittens. It is useful to pull a piece of string along the floor and see if the kitten gives chase. While you cannot expect a strange kitten to be friendly, you want to be sure that you are getting an active, alert little animal.

When you have brought your new kitten home, it will probably want to explore the house. Once it has satisfied its curiosity, it will have a little more confidence and will no doubt show an interest in food.

It is important to find out from the breeder just what food the kitten is used to, and the timing of its meals. It is better to stick to its original diet until the kitten has thoroughly settled down. Kittens, like babies, must be fed at regular times each day, and to begin with several small meals will be required. As the kitten gets older the number of meals may be decreased and each meal made larger. It is important to give a kitten finely chopped raw lean meat as its staple diet. This may be alternated with a saucer of milk. Since no-one wants a faddy cat, occasionally a little steamed, boned fish should replace the meat, and also it may be introduced to one of the proprietary cat foods. To ensure that it is getting its vitamins, cod liver oil and yeast tablets should be added to its diet, and it should always have a bowl of clean drinking water available.

Provide a bed

The kitten needs a warm draught-proof bed. A box or a small dog basket will be perfectly adequate. This should be lined with newspaper and the animal given an old piece of blanket to sleep on. It is important that the kitten should be kept clean, as even the best cat gets an occasional flea. Brushing and combing should become part of the daily routine. By doing this regularly the cat won't get fur balls and you will not have hairs on your clothing. Also, if the cat starts keeping its own 'pets', the insects may be dealt with before getting out of hand.

Most people automatically have a male kitten neutered but what is not so widely known is that female kittens may also be neutered. This is known as

'spaying' and as it is a more serious operation it is important to get a competent veterinary surgeon. The cat is usually away for a day and the fee is approximately twenty-five shillings. It is well worth it not having to worry about finding homes for kittens.

Vary the diet

There is one important item not yet mentioned, namely house training. When the cat is young, it should be provided with a tray of peat or sand; a large baking tin will make a perfectly good sanitary tray. If the kitten is three months or more old, it will probably have been trained by its mother to use a tray. In any case, place the animal in the tray and very gently make digging movements with its front feet. It will very soon catch on!

We have been talking about the care of the kitten; most of this applies also to

the adult cat. The adult needs one or two meals a day; you will soon find out if your cat is not happy on one meal a day. Two points on the feeding of adult cats should be emphasised. One, cats drink water. Milk is a food and should only be given sparingly and a saucer of milk, if not drunk, must not be left down. The second point is that cats should not be fed exclusively on fish. Many unfortunate animals have had skin troubles due to too much fish. The ideal cat food is chopped, raw, lean meat. This should always be served slightly warm. Fish may be given once or twice a week to provide variety. The well-known proprietary cat foods may also be alternated with meat. But do not expect your cat to live out of a tin; you would not want to!

One final point, it is well worth having a kitten immunised against enteritis, or cat 'flu.

Strength of the Wind

HAVE you ever thought what a strange thing wind is? Of course, we know that it is air in motion, and although we say we can *feel* it blowing, we can't really feel it the way we feel a solid thing like a lump of coal. We have all seen the effects of wind, but,

of course, no one has ever seen the wind itself. Now here is a table that tells you a lot of interesting facts about wind. It can be very useful when you are flying model aeroplanes or when you are describing the weather.

(M.H.G.)

Miles per hour	Feet per second	Force in lbs. per sq. ft.	Description
1	1.47	.005	Hardly perceptible.
2	2.93	.020	
3	4.4	.044	Just perceptible.
4	5.87	.079	
5	7.33	.123	Gentle breeze.
10	14.67	.492	
15	22.0	1.107	Pleasant breeze.
20	29.3	1.968	
25	36.6	3.075	Brisk gale.
30	44.0	4.428	
35	51.3	6.027	High wind.
40	58.6	7.872	
50	73.3	12.300	Very high wind.
60	88.0	17.712	
70	102.7	24.108	Storm.
80	117.3	31.488	
100	146.6	49.200	Great storm.
			Hurricane.
			Hurricane that carries away trees, buildings, etc.

Reflection of Plane Mirrors

A SIMPLE experiment can be made to determine the position of an image in a plane mirror.

Apparatus required— Piece of glass about 8ins. by 6ins., two short pieces of candle of equal lengths, retort stand and clamp, glass of water.

Light the two pieces of candle and mount the piece of glass vertically on a table by holding it in a retort stand clamp. Place one piece of candle about 6ins. in front of the glass. On looking through the glass you will see an image of this lighted candle behind the glass. Place the other piece of candle behind the glass so as to coincide with the position of the image whatever position the image is viewed from.

If you measure the shortest distances

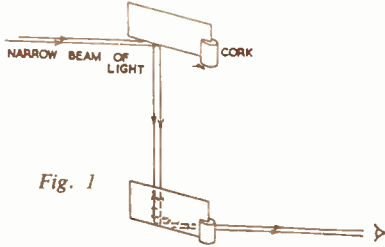

Fig. 1

of the two pieces of candle from the front and back of the glass you will see that they are always equal.

A glass of water may be placed in the position of the image, and a candle will then appear to be burning inside a glass filled with water, when viewed from the front of the glass.

Lateral inversion in plane mirrors

Required — Paper, blotting paper, mirror.

Has it ever occurred to you that when you look at the image of your face in a mirror the right side of your face becomes the left side of the image? This is called lateral inversion, or inversion from side to side. It does not affect the appearance of the images of objects which are balanced on either side of a vertical line down the middle, or bilaterally symmetrical as we say.

Write your name with a thick pen on a piece of paper. While the ink is still wet, place the paper ink downwards on a clean piece of blotting paper commencing at the right, and every letter is turned from left to right. Now hold the piece of blotting paper commencing at the right, and every letter is turned from left to right. Now hold the piece of blotting paper near a mirror and look at the mirror.

Hold a piece of paper near to a mirror and try to write your name on the paper looking at the image of the paper in the mirror.

Have you read 'The Talisman' by Sir Walter Scott? If not, find and read the passage which tells how one of King Richard's men disguised as a Nubian slave, saved his master's life by watching the movements of a would-be assassin in the surface of a shield which he was polishing.

The periscope

Apparatus required— Two pieces of mirror about 2ins. by 1½ins.; apparatus for producing a narrow parallel beam of light described in my article in the August 13th 1958 issue of *Hobbies*.

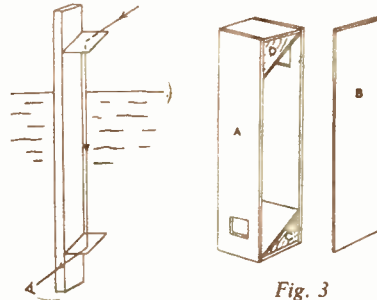

Fig. 2

Fig. 3

Sheet of white paper; piece of wood 18ins. by 2ins. by 1in., wooden box 15ins. by 3ins. by 3ins.

You have probably seen periscopes in

use at important processions. They were much used in the trenches during the first world war and they are an important part of the equipment of a submarine, for looking across the surface of the sea while the vessel itself is below water. The submarine periscope is not so simple in construction as the apparatus described here, but the principle is the same.

Place two pieces of mirror parallel to each other and about 15ins. apart on a sheet of white paper on a table as shown in Fig. 1.

Using the cylindrical cigarette tin, the cylindrical convex lens and the narrow vertical slit, as described in my article in the August 13th issue of *Hobbies Weekly* to produce a narrow beam, note how the beam is reflected from the first mirror on to the second, and then from the second mirror parallel to its original direction. If the eye is placed as shown, an image of the slit can be clearly seen.

A simple form of periscope can be made by fitting two pieces of mirror into parallel slits made in a walking stick or in a long piece of wood.

A more elaborate periscope can be made as shown in Figs. 2 and 3. The mirrors must be parallel to one another, and the inside of the box should be painted dead black with a solution of lamp black in shellac.

The wooden box with plywood sides (A) and (B) should be about 15ins. long, 3ins. wide and 3ins. deep. The triangular pieces of wood (C) and (D) are glued into position, and the mirrors can be fixed to the surfaces of these pieces of wood with glue. (T.A.T.)

FIT A THRESHOLD BAR

WHEN laying carpets near to doorways, the home handyman is often presented with the difficulty of making the doors open over

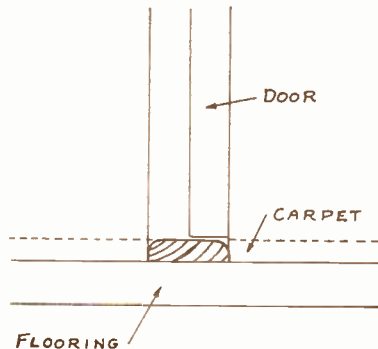

the carpets. This is sometimes achieved by fitting on rising butt hinges to the doors but if the carpet is very close to the door you will find that this method is not the answer because the doors won't rise quickly enough to clear the carpet. Usually, a door has to be opened at least half-way before it can clear an average carpet.

The best method of dealing with this problem is shown in the accompanying sketch. Obtain a piece of hardwood such as oak or beech to fit between the jambs of the doorway. The width should be equal to the width of the door jambs and the thickness equal to the thickness of the carpet plus the underfelt. Fix the hardwood strip in position and then remove and cut the door to suit leaving only the minimum amount of clearance at the bottom.

A SET OF SCREWDRIVERS

MANY of the old craftsmen took a great pride in their tools, the great majority of which they had probably spent countless hours in making and, therefore, knew how to look after them. Tools in those days were practically unobtainable, and were so expensive, that the average workman could not afford to buy them, so he made them himself.

Today almost any tool can be bought in a great variety of patterns, but there is a certain satisfaction in having made them yourself. If you have not made any before, here is your chance to start off with a simple set of precision screwdrivers.

They are very suitable for assembling or dismantling various types of scientific instruments, small electrical equipment and especially for watch work. The shank of the tool is made from dowel rod, while for the swivel top a knurled terminal nut is used.

Various sizes of steel needles or knitting pins are ideal for the points. These, however, are too hard to use as they are, and the temper must be drawn slightly. Heat them in a spirit lamp or

gas flame until the colour changes to deep straw. You may take it a shade further till it reaches blue without being too soft.

The tapered end of the dowel shank can be turned in a lathe if you possess one, otherwise it can be filed to shape. It could of course, be left the same size all along, but this looks rather clumsy, and has not that professional touch about it.

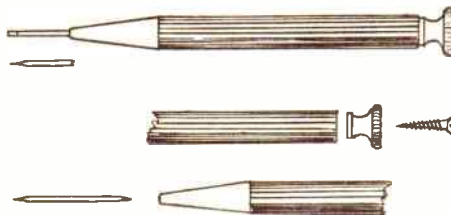

The top end must be cut perfectly square, so that the nut has a firm level seating, and is able to rotate freely. Before fixing this into the centre of the dowel end, countersink the nut, so that the holding screw is well down, and will not foul the finger when pressure is

applied. Screw down so that the nut will rotate easily, but will not be too loose.

Greater pressure can be applied to the handle if a series of ribs are cut round this, and a triangular file will do the job quite well.

You will have to drill the hole for the screwdriver blade rather carefully to ensure its being perfectly true, as the success of the tool largely depends on this. The blade must be a very tight fit in the hole, otherwise it will turn when used. To make doubly sure that this does not happen, grind both ends to screwdriver shape. When tapped into the hole this enables it to bite into the wood, and so hold it firm.

The sizes given in the illustration are for the largest size, in which the dowel handle is 4ins. long and $\frac{3}{8}$ in. diameter, and will take a knitting needle blade slightly over $\frac{1}{8}$ in. diameter. The smallest size can be 3ins. long and $\frac{1}{8}$ in. diameter rod, with a blade of $\frac{1}{16}$ in., while to complete the set, an intermediate one 3 $\frac{1}{2}$ ins. long of $\frac{1}{4}$ in. rod and a blade $\frac{3}{16}$ in. diameter would be about right. (A.F.T.)

Games you can carry in your pocket

OBTAIN a polish tin, 3 $\frac{1}{2}$ ins. in diameter, the bottom portion being not less than $\frac{1}{2}$ in. in depth. Cut a circle of wood, $\frac{1}{8}$ in. thick, to cover the bottom of the tin. Mark off on this a 2 $\frac{1}{2}$ in. square, as shown in Fig. 1B. Drill small holes for scoring, on the outside of the square, the pegs being made from matchsticks.

Cut a 2 $\frac{1}{2}$ in. square of thin felt, and glue it down on the pencilled square. Divide the felt into nine squares by means of a pen and indian ink. Cut ten pieces of wood, $\frac{1}{8}$ in. thick, of the same size as the felt squares. Glue thin felt to the underside of these pieces. Five noughts and five crosses are painted on with black enamel.

Glue the wooden disc to the bottom of the tin. Apply a coat of enamel, and the game is completed.

Pocket crosses puzzle

This is similar in construction to the noughts and crosses, but the felt, which provides a non-slip surface, is divided into sixteen smaller squares, as shown in Fig. 2. Sixteen wooden pieces are cut from $\frac{1}{8}$ in. wood. Paint a cross on

ten of these and shade another one, leaving five blank.

The problem is how to divide the large square into five equal portions, each the same shape, and each shape having two of the ten crosses. The answer is shown by the heavy black lines in the illustration. (H.R.)

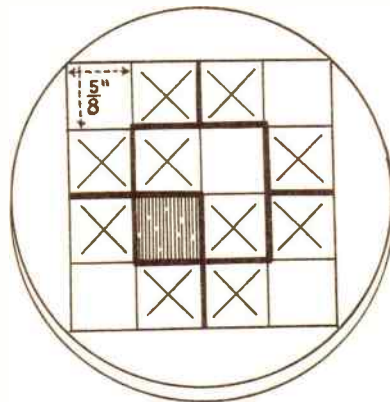
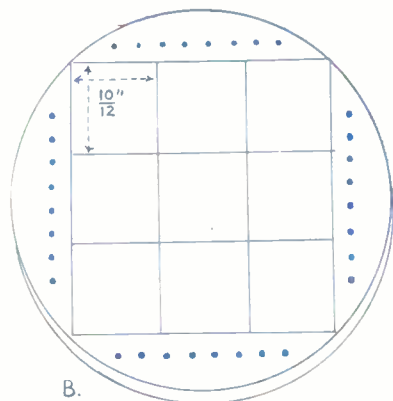
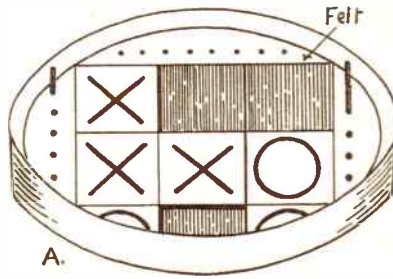

Fig. 2



B.



A.

Fig. 1

MAKE THIS Simple

CUT ONE

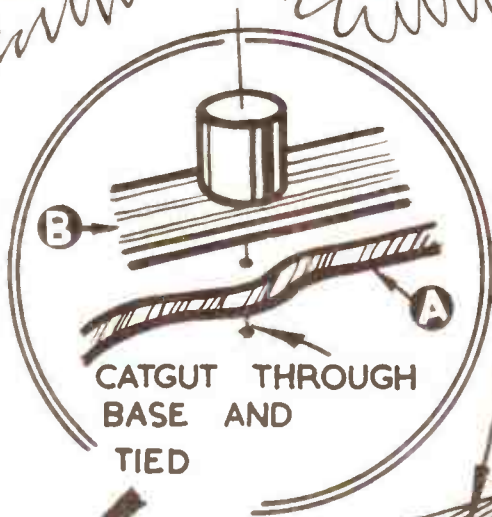

$6\frac{3}{4} \times 2 \times \frac{1}{8}$

$\frac{1}{4}$ " DOWEL

CATGUT

$2 \times 1\frac{1}{4} \times \frac{1}{4}$

FLOWERS FASHIONED FROM PLASTIC WOOD

$3 \times 1\frac{1}{2} \times \frac{1}{8}$

FIGURES SHAPED FROM $\frac{3}{8}$ " DOWEL

PEBBLES

6"

EATHERHOUSE

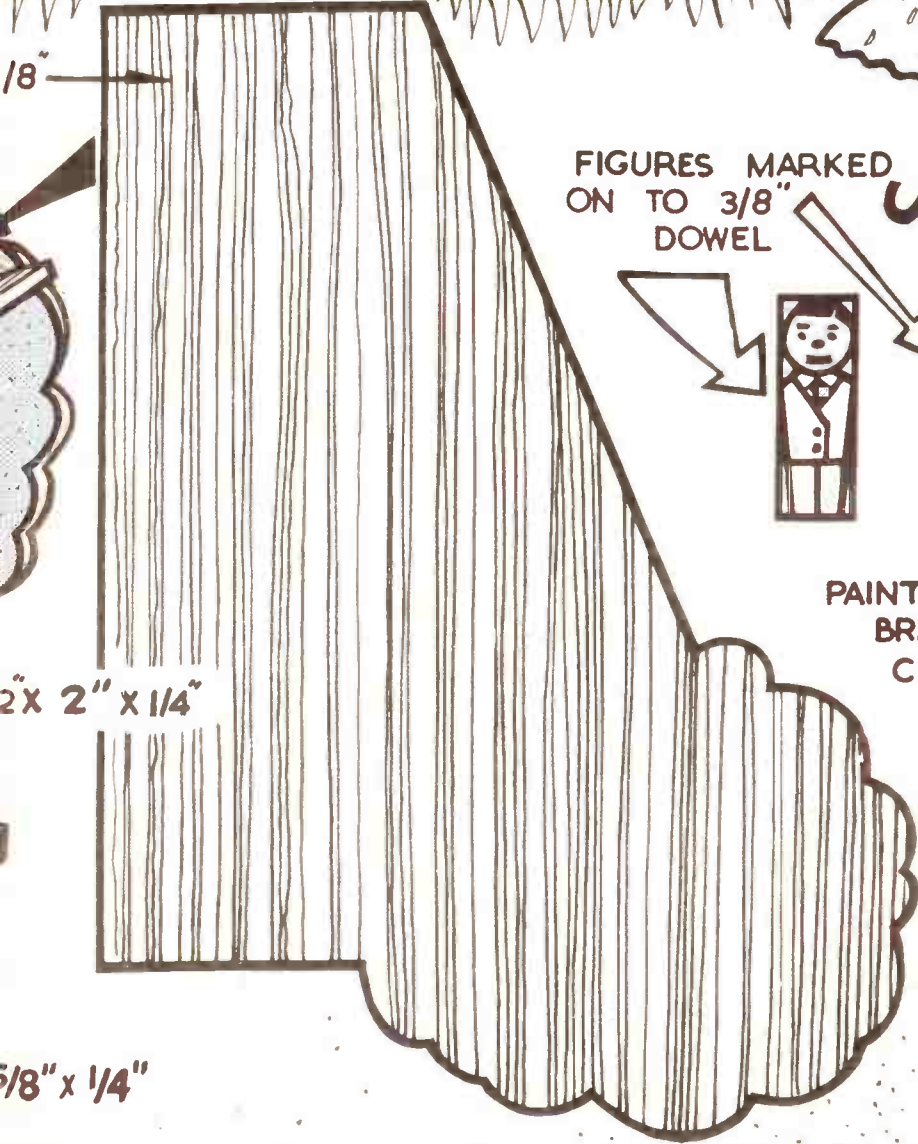

FIGURES MARKED
ON TO 3/8"
DOWEL

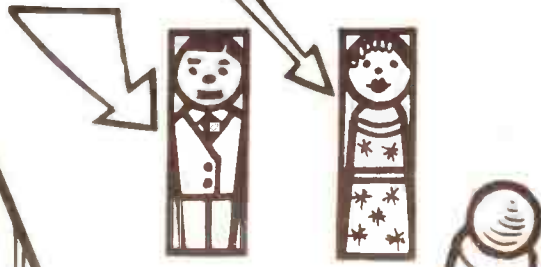

PAINT WITH
BRIGHT
COLOURS

Simple
to
Make



MAKING A ROD — Part 3 By 'Kingfisher'

WE now come to the final part of building our rod. You have got your set of rod rings by you. The ring for the top of the rod will be lined with either Agatine or a material known by the name of Saphrite. The reason for this is that rings so lined offer very little friction to the line and are, therefore, a help in casting. The ring for the bottom joint will also be lined in a similar manner. The rest of the rod rings are not lined, as the line passes through them in a straight line with practically no resistance.

The fitting of the top ring should be left until the last. Now, as you are probably aware, the position of the rings on any rod has a vital effect on its curvature when you have a fish on the line, so the rings must be spaced out correctly. Assuming that you are building a rod which is 10ft. 6ins. in length, then the following list of figures gives the measurements which I myself have used for a long number of years. You will note that the space between the rings gets greater as one proceeds along the rod, the reason for this being that as the rod gets thicker, it is, naturally, much stronger and bends less under strain. Here, then, are the figures:—starting at the tip of the rod, the first ring is positioned at 6½ins. from the rod tip to the centre of the ring, NOT the foot of the ring. (See Fig. 1.) Having grasped that point, here are the figures as they go down the rod. 6½ins.; 7½ins.; 8½ins.; 9½ins. That completes the top piece. Now we come to the middle joint, and here you measure off 5ins. from the top of the ferrule for the position of the first ring on that joint. The next ring is 12ins. distant, and the third one is 13ins. away. You now have the butt ring left, and for this measure 8ins. from the top of the ferrule for the final ring. (Fig. 2.)

You will be wondering how to hold the ferrules and bind them at the same time. This can be difficult, but with the use of any good cement, the job becomes very easy. Apply a little to the foot of each ring, and put them on the rod in the correct position. Half-an-hour will see them set sufficiently to start whipping. You can't do each joint at once this way, so put one ring on the

top joint and one on the middle joint. When you have whipped the one on the top joint, cement another one in position, where it will be setting whilst you whip the one on the middle joint. Continue in this way until all the rings are fixed. (Fig. 3.)



FIG. 1.



FIG. 2.



FIG. 3.



FIG. 4.



FIG. 5.



SHOWING WHERE EXTRA WHIPPING SHOULD BE DONE

FIG. 6.

The whipping is easy to do, and you start at the point shown at Fig. 4, and bind outwards with silk towards the foot of the ring, which you should always cover, and take about four turns beyond. To finish off, you lay a separate loop of silk with the loop outwards, and bind it down to the rod with about six turns. Break or cut the silk, and holding the whole thing tight, push the end of the whipping through the loop, pull on the ends, and you will draw the end of the whipping under the last few turns, where you can carefully cut off close to the binding to make a neat job. (Fig. 5.)

All the rings are done in this manner and your rod, in effect, is finished. Remember always to put the rings on a flat side of the cane if you have a split-cane rod. If you are using round cane, you cannot do this, but you will have to ensure that each ring is cemented in correct line with the others

that you get a nice smooth job when you have put on the final coat of varnish.

This, in fact, is the final job of all. You should leave the rod for twenty-four hours to enable the cement to set, then varnish as before with the finger, and apply a thin coat only. Allow a week for this to really harden, and then apply a final thin coat, and the rod is complete.

If you have carefully carried out my instructions, you will have a rod which will last you a lifetime, and which you will be proud to own, having built it yourself.

ANSWERS TO
'TWO-MINUTE QUIZ' (see page 290).

1. Half-cut through joint.
2. Frog.
3. English — 21ins. wide by 11½yds. long; French — 18ins. wide by 9yds. long.
4. It should be. It is a plasterer's wood float.
5. Lintel or lintol.

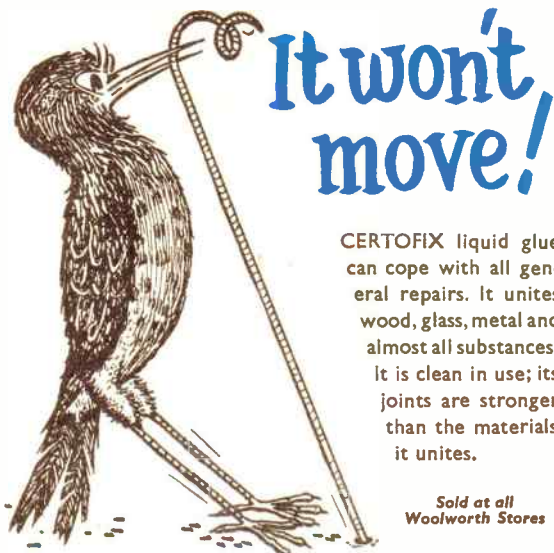

It won't move!

CERTOFIX liquid glue can cope with all general repairs. It unites wood, glass, metal and almost all substances. It is clean in use; its joints are stronger than the materials it unites.

Sold at all Woolworth Stores

CERTOFIX

WILL *Really* FIX IT!

Photographers!

Here's everything you need to 'PRINT-IT-YOURSELF'



ONLY £1 - 17 - 6
Complete
From Photographic
Dealers Everywhere

This outfit will set you up to print your own pictures. It contains everything you require to embark on an absorbing hobby: printing frame (3½ x 2½), masks, dishes, developer, fixer, thermometer measure for chemicals and darkroom lamp.

JOHNSONS
OF HENDON LTD

FOR CONFIDENCE IN PHOTOGRAPHY

This model farm cost less than 2/6

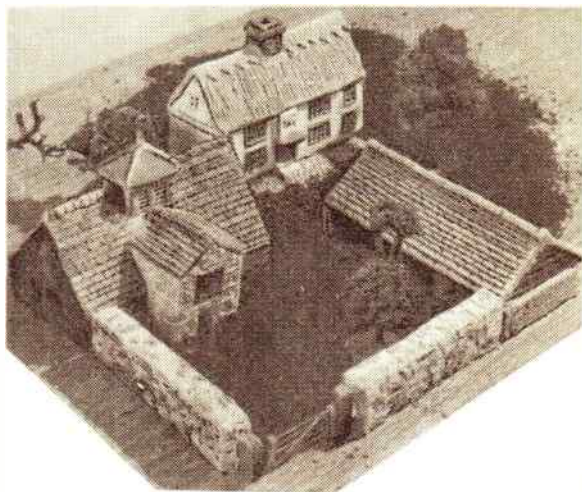

It was made from a half-crown tin of Sankey's PYRUMA — farmhouse, barn, implement shed, walls and gate — and there was still plenty of this grand modelling material left to build many more farm features, by simple methods described in the Instruction Book (see Coupon below). PYRUMA, plastic and ready-for-use, becomes stone hard after drying or baking, and can be painted in natural colours. For permanent modelling —

MAKE IT AND BAKE IT IN



Obtainable from your local Ironmonger or Hardwareman and many Art Material dealers. Ideal for making —

Model Railway Buildings and Accessories. Harbours. Ship Models. Airport Buildings and Features. Houses. Bookends. Ashtrays. Animals and Figures. Plaques, etc.

Post this Coupon today for your Instruction Book.

J.H. SANKEY & SON, LTD

Established over a century
Dept. H, ILFORD, ESSEX

Please send ILLUSTRATED INSTRUCTION BOOK with full colour pages on Pyruma Modelling.

Enclosed Postal Order value 6d. (not stamps)

NAME (Block letters).....

ADDRESS



HORSES are featured on stamps, match, cheese and hotel labels, air transport covers, poster stamps, charity seals and cigar bands.

The Assyrians and Egyptians drove and rode horses at an early date. The Scythians were among the earliest horsemen. When the Greeks first saw mounted Scythians they were afraid, for they thought that the horse and his rider were one animal.

THE HORSE

—By R.L.C.

The horse is intelligent. Its senses of hearing and of smell are strong. Its sight is excellent — it can see by night better than a man. It has a good memory and easily finds again a road over which it has once travelled, or a place it has once

visited. It knows its master well and if kindly treated will work willingly and cheerfully.

The horse sometimes lives to be 30 years old. The male horse is called a stallion, the female a mare; the young

when first born is called a foal, and afterwards a colt; and the female colt is usually called a filly.

All have read the story of Black Bess, Dick Turpin's famous horse, which carried him from London to York. Some say that Turpin's ride is a myth, based on the amazing feat of 'Swift Nick' Nevison, a notorious highwayman who, in 1676, is said to have robbed a sailor near Rochester, in Kent, at 4 a.m. and to have established an alibi by riding to York, reaching the city at 7.45 p.m. on the same day.

Alexander the Great had a favourite horse called Bucephalus. After the animal's death, Alexander built a city to its memory called Bucephala.

Celer, the horse of the Roman Emperor Verus, was fed on almonds and raisins. It slept in the imperial palace.

Copenhagen, Wellington's charger at Waterloo, died in 1832, aged 27.



Kent Man's Fine Collection

PPETER DALLY, a 27-year old postman of Northfleet, Kent, owns one of the finest collections of beer, wine and spirit labels.

Recently, while showing me his treasures, Peter explained — 'I got the idea about a year ago while looking at a friend's collection of match labels. I have 1,632 different covers to date, including issues from 63 foreign and commonwealth firms and 24 nations. I have labels from 120 British firms.'

He pointed to a Japanese set. 'Those are pre-war labels not easily come by', he said. 'They were sent to me by the Ashi Brewing Company of Tokyo in exchange for 400 British labels'.

He showed me some beautiful Australian sets, including special brews for such occasions as the visit of H.M. Queen Elizabeth II to the brewery, the visit of the King of Siam, and Sir Winston Churchill's State visit to

Denmark.

The most unusual item is a label from Geo. Young and Co., which states that the beer is non-intoxicating.

Over a cup of tea Peter remarked: 'I could write a book about all this. My albums contain so many covers of equal merit, depicting heraldry, races of mankind, landscapes, famous buildings, maps, animals, and many other subjects too numerous to mention.'

Peter spends most of his leisure hours writing to breweries for labels, mounting up his collection and answering correspondence from fellow enthusiasts.

On the way home I found time for a glass of beer at the station. The barmaid was very amused when I asked for the label on the bottle. From beneath the counter she drew a rubbish basket. 'There's heaps of them things in here if you want them', she said. I took the lot and found many interesting items. (R.C.)

Incitatus, the horse of the Roman Emperor Caligula, had an ivory maner and drank wine from a golden pail.

People once thought that a horseshoe nailed to the house door was a protection against witches. This idea has led to the present belief that it is lucky to pick up a horseshoe.

Horses have played an important part in man's affairs. They are often mentioned in the Bible — 'And I saw heaven opened, and behold a white horse; and he that sat upon him was called Faithful and True, and in righteousness he doth judge and make war' — Rev., 19.11. They have been used in war and peace, in sport and forms of entertainment. Even in this 'Space Age' horses are a popular feature of tale, talk and song everywhere.

These animals deserve a place in any thematic album — there are hundreds of designs to choose from. But don't forget the many 'Hobbies' kits which feature horses and horseshoes — why not use one as a basis for a decorative album cover?

HOBBIES BRANCHES

LONDON

78a New Oxford Street, W.C.1

(Phone MUSEUM 2975)

87 Old Broad Street, E.C.2

(LONDON Wall 4375)

81 Streatham Hill, S.W.2

(TULSe Hill 8796)

151 High St., Walthamstow, E.17

GLASGOW—326 Argyle Street

(Phone CENTral 5042)

MANCHESTER—10 Piccadilly

(Phone CENTral 1787)

BIRMINGHAM—100a Dale End

SHEFFIELD—4 St. Paul's Parade

(Phone 26071)

LEEDS—10 Queen Victoria Street

(Phone 28639)

HULL—179 Ferensway

SOUTHAMPTON—134 High St.

(Below Bar)

BRISTOL—65 Fairfax Street

NEWCASTLE—42 Dean Street

Newcastle-on-Tyne 1

GRIMSBY—88 Victoria Street

STOP SMOKING in 3 days or money back. Safe, pleasant, permanent. The only scientific way. No Will Power necessary. 'Conquered the habit in 2½ days'—F.C. 'Within 2 days I was free from the tobacco habit'—W.G. 'Was a smoker for 2 years and broke the habit in 2 days'—F.N. 'I used to smoke 20 a day . . . now I have no desire to smoke'—J.M. Recommended by 'Health and Efficiency Magazine'. Complete course 7/6 (or \$1.00 bill). Details 3d. stamp. Sent under plain cover. **NATURE REMEDIES**, 28 (H/188) Dean Road, London, N.W.2. Established 1928

Completely new 54 page Edition

WHERE'S THAT CAR FROM?

Price 1/- (Postage 4d.)

Of all Booksellers

or

RALEIGH PRESS, Exmouth, Devon

MAKE A MUSICAL BOX for as little as 21/- New kits and tunes available. Movements 13/- post free. Please send 3d. stamp for free illustrated catalogue. — The Swisscross Co., Dept. B, 202 Tulse Hill, London, S.W.2.

BUYING OR SELLING?

Classified advertisements on this page are accepted at a cost of 6d. per word prepaid. Use of a Box No. is 1/- extra. Send P.O. with advertisement to *Hobbies Weekly*, Advert. Dept., Dereham, Norfolk. Rates for display advertising on application.

* GREAT CAMPING OFFER *



RIDGE TENT SENT FOR 4/-

BRAND NEW de luxe 'Safety' Tent. All colours. Complete. Ideal cyclists, campers. Length 7' 3" sleeping base x 4' 6" wide x 3' 6" high x 12" walls, all approx. Weight 3½ lb. Cash 55/-, or 4/- deposit and 9 monthly payments 6/-, 1 of 2/6. WITH FLYSHEET 83/6, or 9/3 deposit and 8 monthly payments of 9/9, 1 of 4/9. Both carriage 2/6. **LISTS, TENTS, TERMS.**

GREAT HALF PRICE OFFER!



Matakari FOLDING CAMP BEDS

CASH PRICE 27/6

Makes Camping Holidays a Joy!

BRAND NEW, famous lightweight, tremendously strong beds fold to practically nothing in size for easy transport. Full 6 ft. length, normal width. This represents the finest camping bargain. Half price of other types. Lightweight rustless sprung steel. Lasts years. Ideal as occasional bed for visitors. Makes up like divan. 27/6, post 3/6. Three for 89/6, including post. **Headquarter & General Supplies Ltd. (HOBW/48) 196-200 Coldharbour Lane Loughboro Junc., London, S.E.6 Open Sat.**

HOME-MADE WINE. Complete equipment. Books, etc. List free.—Leigh-Williams (Dept. C), 5 Weston Drive, Liverpool 19.

MEN/WOMEN with spare time required for new simple weaving work. For details send S.A.E. — Dept. 4, Weava Products, 10 Shelley Road, Worthing.

15/6 CRYSTAL RADIO kit. Easy-to-build with only a screwdriver and pliers. Post free, send 15/6 P.O. — Also 1 and 2 valve kits, headphones, etc. Send stamped addressed envelope for complete list to Blanchard's Radio, Dept. HC8, 13 Gainford Gardens, Manchester 10.

STAMPS FREE — Empire Packet including Pictorials and Victorians with approvals. — Robert J. Peck, 7A Kemp Road, Bournemouth.

100 DIFFERENT stamps free! Request 4d. upwards discount approvals. — Bush, 53 Newlyn Way, Parkstone, Dorset.

100 FREE including Giants, Triangles. Request approvals. Postage. — Salter, 42 North Road, Rotherham.

The Pride of any Boy

'JAPONICA'

A magnificent Sailing Cruiser with Auxiliary Motor

This fine model of a characteristic craft used on the Norfolk Broads is 20 ins. long. Extra mechanical power is provided by a Mighty Midget electric motor and propeller unit.

Make this magnificent craft with Hobbies Kit No. 3254 containing all wood, materials, motor, propeller, metal keel, etc., and easy-to-follow instructions. From branches, stockists, etc., or by post.



GET A KIT TODAY

To **HOBBIES LTD,**

Dept. 99, Dereham, Norfolk

Please send free copy of 'Profitable Leisure' and 'Japonica' Kit No. 3254. P.O. for 65/- enclosed.

Name

Address



'JAPONICA' Kit No. 3254 65/-

FREE 20-page booklet 'Profitable Leisure' showing kits available for dozens of other exciting models (ships, aircraft, etc.)

Replies to Readers

Is this YOUR Problem?

cover the roof in one piece. Several colours are available, and you should be able to get it at a good hardware shop. Stretch it over the roof, press down to free it from creases and tack to the roof at its edges. Where possible cover the lines of tacks with a half-round moulding.

Amplifying Musical Boxes

HAVING made several musical boxes most successfully, I wonder whether it would be possible to amplify the sound similar to the ice cream vans which use these musical instruments. Naturally, the components would have to be small and I am wondering if such equipment could be run on a battery instead of mains. If this is possible, could you please give me some idea of how to construct the equipment required for such a project? (J.M. — Leyton.)

THERE is no simple method of providing the amplification necessary. You would require a microphone, fitted on or near the note plate, an amplifier and loudspeaker. At least two valves would be required in the amplifier, and three would be preferable for good volume. The amplifier could be battery or mains operated, the latter requiring more space, but being more powerful and costing less to run. All this equipment would occupy a fairly large space, so that a much larger containing case would be needed.

Hair Lacquer Formula

I UNDERSTAND that hair lacquer consists of shellac and methylated spirit, plus a little perfume. Is this so, and could you please give me the proportions? (R.G. — Shoreham.)

HAIR lacquer consists of a dilute alcoholic solution of benzoin. Dilute 1 volume of tincture of benzoin with 4 volumes of alcohol (or industrial methylated spirit), perfume to suit by adding perfume oils for preference, though ordinary handkerchief perfumes may be used by incorporation with the alcohol used for the dilution of the benzoin.

White Deposit on Aluminium

I HAVE a cast aluminium pan, the underneath of which gets a white deposit after only a few minutes use. This deposit invariably drops all over the cooker. Could you please tell me if this can be treated? (W.R. — Sale.)

THE trouble mentioned probably arises from the pan not being pure aluminium, but an alloy of aluminium with small quantities of other metals. Under certain conditions aluminium is very sensitive to the influence of other metals, producing white aluminium oxide or hydroxide. There is the possibility that this pan may have been made

from recovered aluminium containing other activating metals. This oxide can act as a protector if formed on the metal in the right way, and may offer a solution to the difficulty. If the pan has been cleaned normally with an abrasive cleaner, change to simple washing, so as to allow the film to form in an adherent layer. If the pan still drops the white matter, anodising may cure it. Make a 3 per cent solution of sulphuric acid in cold water and sink most of the pan in

 * Readers are reminded that all *
 * requests for information should be *
 * accompanied by a stamp for return *
 * postage. Otherwise they may have *
 * to wait weeks for a printed reply *
 * in this column. *
 * *****

this, so that the outside only is in contact with the solution. Pass a current of 10 to 20 volts through for 20 to 30 minutes, using a lead sheet for the negative pole and the aluminium pan as the positive pole. Rinse. This finish should still be bright enough not to offend a housewife. Abrasive cleaners should not be used on this film.

Papering a Doll's House

WOULD you please advise me if one can satisfactorily coat Hobbies doll's house papers with, say, Valspar clear gloss varnish or pearl matt finish without deterioration of the paper. Also what adhesive would you recommend for paper to plywood. (R.M. — Devizes.)

THERE is a special paper varnish obtainable from wallpaper shops, etc. For applying the paper you should use a paste adhesive or the new Polystik. A gum adhesive would perhaps, tend to show through the paper.

Replacing a Caravan Roof

CAN you please advise me the best thing with which to treat the roof of a caravan? It is made of some kind of fabric and has been painted. (M.D. — Barnstaple.)

YOU can now obtain a special material for covering the roof of caravan or car. It is sold as waterproof hood material and made in widths up to 6 ft., wide enough in most cases to

Removing French Polish

WE have some french polished furniture which we wish to clean down to the wood. Could you please advise a process or product to do this? (M.L. — Wallington.)

A QUICK method of stripping off the old polish is to employ a cabinet-maker's scraper. Parts where a scraper cannot operate should be rubbed vigorously with pumice powder on a felt pad. Alternatively, for such parts you could employ a proprietary brand of paint and varnish remover, but then the wood should be washed over with household vinegar to kill the alkali. Go over the surfaces with a medium grade glasspaper to remove any stray streaks of polish still remaining, then dust off and glasspaper with a fine grade before repolishing.

Cleaning a Wine Cask

WE want to use a vinegar cask for wine-making. Can you let me know the right way to clean it? (A.Q. — Chelmsford.)

A STRONG solution of washing soda in boiling water put into the cask and allowed to remain for about 24 hours, swilling it round occasionally, should remove the acid. If very bad, repeat the dose. Then clean out thoroughly with plenty of water (hot first and then cold). After this, the cask will need to be sterilised with a few Campden tablets (obtainable from most chemists) dissolved in water and left in the cask for a few hours. Thoroughly swill out with plenty of clean cold water.

The free design in next week's issue will be for a delightful marquetry wall plaque featuring a galleon. It is made on the fretsaw inlay principle which provides for 3 or 4 pictures to be cut simultaneously from the coloured wood panels.

MAKE SURE OF YOUR COPY

Lots of fun with this

WORKING MODEL TANKER

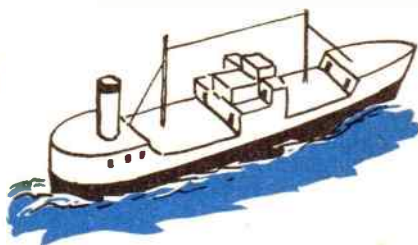

MAKE IT FROM THESE FULL-SIZE PATTERNS

YOU can have plenty of fun with this working toy ship. The full size patterns are easy to follow and to cut. Piece (A) is $\frac{1}{4}$ in. thick, pieces (B), (C), (D) and (E) are $\frac{1}{4}$ in. and piece (F) $\frac{1}{8}$ in. Trace the shapes, transfer them to the wood and cut out with a fretsaw. Glue together with waterproof glue. Glue the funnel, which is a piece of $\frac{1}{4}$ in. diameter round rod, to piece (B).

The tanker is driven by a propeller cut from tin or brass. An old pair of scissors will cut tin quite easily. Make the bracket from a strip of brass and screw it to piece (A). The hook at the front is a small screw-eye opened out. It is screwed into a small wood block glued in the position shown.

Clean up with glasspaper and give two or three coats of plastic enamel paint. The masts and rigging are inserted after painting is completed. (M.p.)

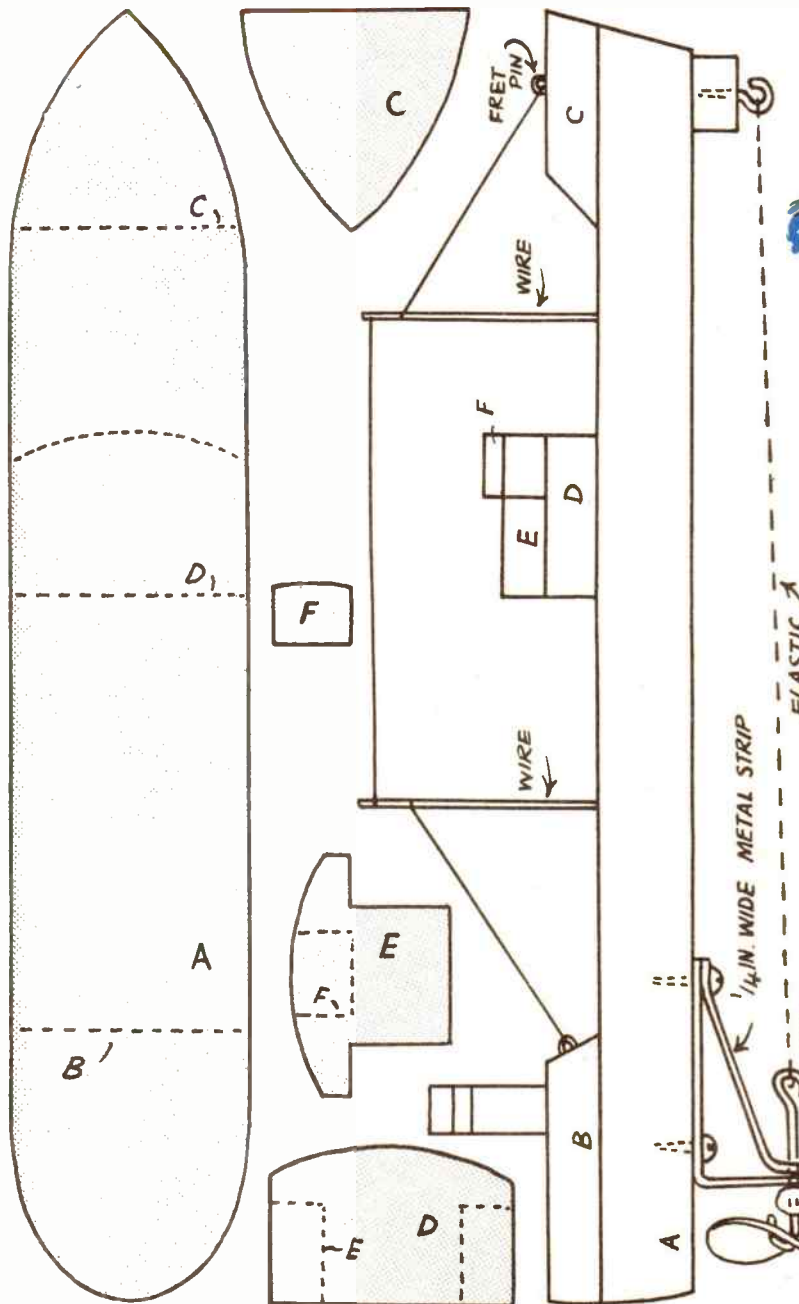

ELASTIC

$\frac{1}{4}$ IN. WIDE METAL STRIP

SHAPE FROM TIN OR BRASS

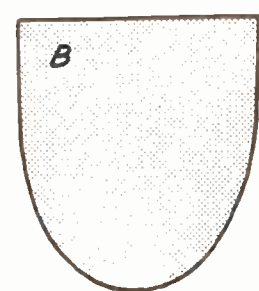

THINKING OF YOUR HOME?

Any handyman can make a success of these projects for the home and save himself pounds. Hobbies kits contain all materials and full instructions for making.

GET YOUR KIT NOW!

Kit No. 3268



CONTEMPORARY TABLE
Designed to hold a pot plant.

24/9 (post 2/9)

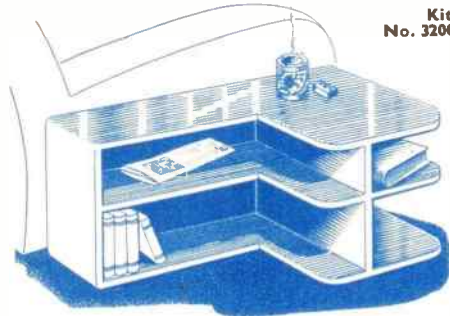

Kit No. 3200

FIRESIDE TABLE/BOOKCASE.
Kit of selected wood panels, etc.

68/9

Please everybody with these charming pieces of furniture

★ ★ ★ ★ ★ ★ ★ ★ ★ ★ ★ ★ ★ ★ ★ ★
★ Dozens of similar money-saving kits in Hobbies 1959 Annual. Only 2/- from branches, news-agents, etc., or by post 2/6.
★ ★ ★ ★ ★ ★ ★ ★ ★ ★ ★ ★ ★ ★ ★ ★

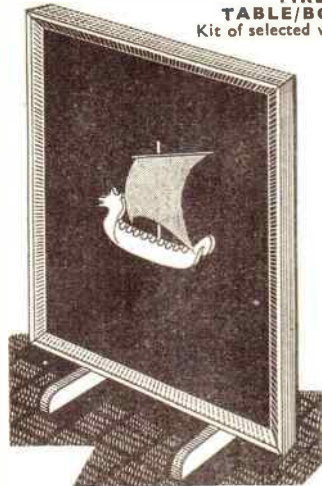

Kit No. 3208
VIKING FIRESCREEN. With ship model in semi-relief.

13/6 (post 2/-)



Kit No. 3212. **CONTEMPORARY TABLE.**
With shelf for books, etc. Made in an evening.

29/6 (post 3/3)



Kit No. 3266

RECORD CABINET AND BOOKCASE. Holds over 200 records, plus books.

65/-



Kit No. 3174
BED TRAY/BOOK REST. A practical two-purpose job.

13/6 (post 2/6)

SEND FOR FREE BOOKLET TODAY!

To Hobbies Ltd., Dept. 99, Dereham, Norfolk. Please send free 20-page booklet 'Profitable Leisure', name of nearest Hobbies stockist and items marked x.

Hobbies 1959 Annual (2/6 post free)

Kit No.

Name

Address

Orders totalling 30/- and over, post free