

HOBBIES WEEKLY

MAY 1st 1957

VOL. 124

NUMBER 3209

IN THIS ISSUE

	Page
Rock Around the Clock with A Hobbies Guitar - - - - -	49
Is This Your Problem? - - - - -	50
Word in Your Ear - - - - -	51
Many-Purpose Table - - - - -	52
Mainly for Modellers - - - - -	53
Stamp Collector's Corner, - - - - -	54
Table Lamp - - - - -	55
A Spanish Guitar - - - - -	56
Chemistry in the Home - - - - -	58
The Uses for Timbers - - - - -	60
Cut-out Alphabet and Figures - - - - -	63



All correspondence should be addressed to the Editor, Hobbies Weekly, Dereham, Norfolk

ROCK AROUND THE CLOCK

*Instructions
to make
on p. 56*

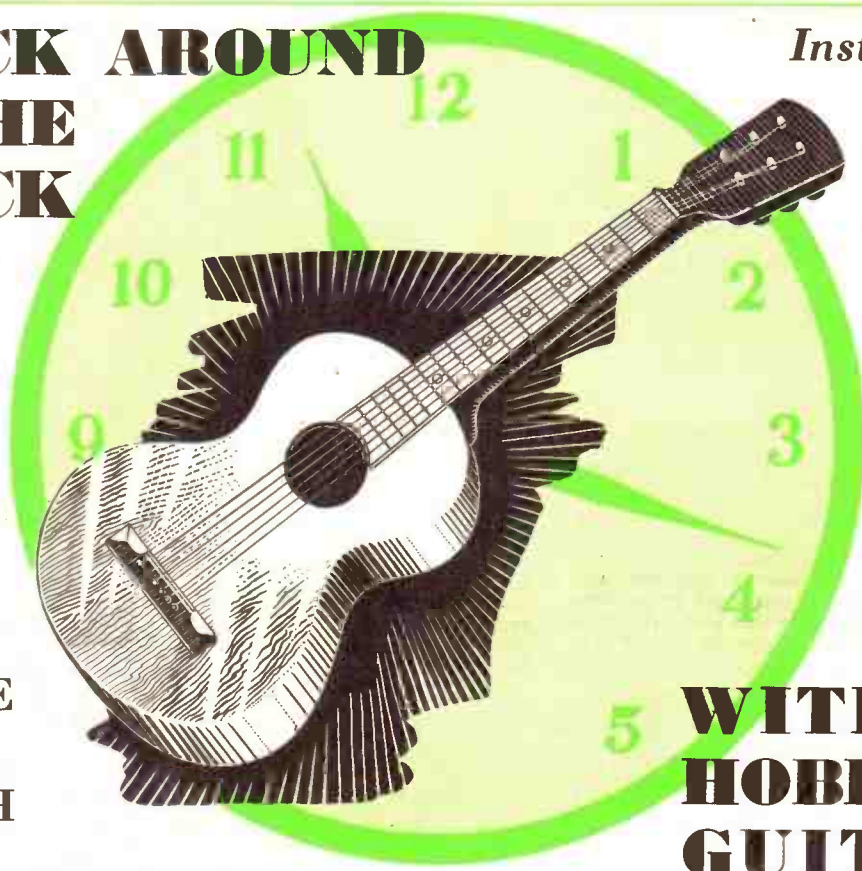

**SKIFFLE
OR
SPANISH
STYLE**

**WITH A
HOBBIES
GUITAR**

49

**FOR ALL HOME CRAFTSMEN
Over 60 years of 'Do-it-Yourself'**

World Radio History

4 1/2^D

Replies to Readers Is this YOUR Problem?

Removing Stain from Furniture

PLEASE give me a formula for removing a medium oak stain from a dining-room suite so that the natural wood can be clear polished to effect a more contemporary style. (G.B.—Wisbeck).

HOW far you will be able to eradicate the stain must naturally depend on the depth it has penetrated. First remove entirely the polish with a proprietary brand of paint and varnish remover such as Stripit, or if a cellulose varnish has been employed, Tix would be better. Well glasspaper the wood then if desired of a lighter shade, mop over with dilute oxalic acid, applying it on a small rag mop-head tied to a wood stick. Take care to avoid any splashes of acid on hands or clothes. A safer substitute but not always so effective, is a paste of bleaching powder and water, left on for as long as necessary. If acid is used, wash off with plenty of water; if bleaching powder, wipe over with common vinegar after.

Lamp for Chemistry

MY son wishes to carry out some simple experiments in chemistry. Unfortunately we are not connected to a gas supply so he cannot use a bunsen burner. Do you know of any simple alternative? I had in mind that perhaps some type of methylated spirit lamp would do. (T.C.—Aylesbury).

AS you surmise, a methylated spirit lamp will answer well. A glass spirit lamp is specially made for laboratory use and serves for all ordinary heating, such as boiling test tubes, flasks, beakers and also for simple glass working and crucible heating where very high temperatures are not needed. The intensity of the heat can be regulated by pulling up or pushing down the wick. A spirit lamp may be had from any laboratory furnisher for 3/- to 3/6.

Fireproof Paint

PLEASE let me know whether I can purchase some kind of material to paint over some roofing felt to make it fireproof, as my shed is of wooden construction and I have covered it completely with bitumastic felt for weatherproofing purposes and extra warmth. Also would it be alright to paint the inside woodwork with pink red lead paint to combat condensation? (T.S.—Knowsley).

A FIREPROOF paint can be made by mixing equal parts of powdered asbestos and slaked lime with a small

quantity of boiled oil, and thinning down with a silicate of soda solution. This can be coloured with any pigment desired. Should you experience difficulty in making this adhere to the roofing felt, paint the felt with shellac knotting first. You can reduce condensation in the shed by painting with one of the rubberised brands of paint now on the market — Siscomatte, for example.



A HOBBIES
HINT

PPIPE cleaners can be utilised quite successfully when spreading glue. Drill a hole in a piece of dowel rod and insert one or two cleaners, or perhaps, one folded several times if the hole in the dowel is not too long. Twist the ends of the pipe cleaners around.

Shortening a Spring Mattress

IS it possible for a novice to shorten a 6ft. by 2ft. spring interior mattress, and if so, please advise me how it can be done. (R.M.—Mountain Ash).

THERE are several forms of internally-sprung mattress, but if yours consists of a number of separately-cased springs, shortening may well be a feasible proposition. The unwanted portion could have the hems unpicked and then springs taken away, the empty casing being neatly folded up. The padded covering could then be shortened to suit, and the hems neatly resewn. The type of mattress with springs harnessed to each other, and then to a metal outer frame, would not, we fear, be easily dealt with by a novice, and would be best left alone.

Waterproofing a Tent

WILL you give me a method of waterproofing a tent? (R.V.S.—Ludlow).

THE best and most modern method for tent waterproofing is to use a solution of aluminium naphthenate.

Dissolve the aluminium naphthenate at the rate of 1 ounce in 8 fluid ounces of white spirit. Erect the tent and brush or spray both sides and allow to dry.

Steam Problem

OWING to steam penetrating up the stairs to the bedroom, I find some clothing in my wardrobe, is contaminated with mildew and the wardrobe itself smells rather strongly of the mildew. Can you suggest a remedy and something to clear the mildew from clothing and wardrobe? (H.E.—Liverpool).

IF the dampness in the bedroom is really due to steam rising up the stairs, it would be best to tackle the job from the source. This is really a problem for a builder who can have access to the premises. All we can suggest is to keep closed the door of the room downstairs from whence the steam escapes, and the windows open to allow steam an outlet to the open air. Unless this is done, much damage throughout the house may eventually result. There is a steam-resisting paint now obtainable from oil shops, etc., and this might be given a trial.

Print mounting guide

AVERY useful guide for use when mounting prints can be made quite easily from a 1in. wide strip of cardboard, plastic, hardboard or thin wood about 12½ins. long. Just mark the centre with an (O) and mark equal spaces on each side as shown in sketch. The device is just like a ruler except that the (O) is in the centre instead of being at one end. With this ruler it is easy to mount a picture centrally on its mount.

Position the print so that the size to each edge of both the print and the mount is the same at both sides, and the print is correctly positioned. (T.H.M.)

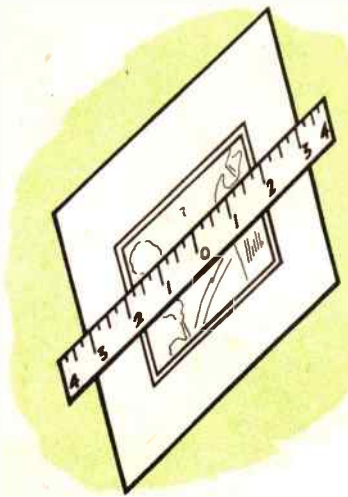

A Word in your Ear

From the Editor

INVARIABLY, after we have published a radio circuit, our experts receive queries from readers. Perhaps the made-up set does not give the performance claimed, or in some cases there is no result at all. This is almost invariably because the carefully worded instructions have not been closely followed by the constructor. Some readers have even substituted valves and other components different from those suggested, and usually, after having been put right, they are able to make a success of the job.

On the other hand, there are also letters from readers reporting an even better performance from their sets than was claimed by the writer of the article. In this category is one from Mr. A. J. Goodley of Horncastle, Lincs., who says his 'Beginner's One Valve Radio Set' built from instructions contained in our issue of September 19th, 1956 "proved to be more selective than a 4-valve commercial superhet". High praise, indeed, from Mr. Goodley, who receives up to 30 different stations, including B.B.C. Home and Third and A.F.N. He recommends any beginner at radio construction to 'have a go' at this circuit, which uses earphones.

AN ADAPTATION

MR. ROY GAMBIN, who lives on the George Cross island of Malta, very kindly sent me photographs, taken by his brother Guido, of an excellent model of the 'Pretoria Castle'. It was

based on Hobbies Design No. 242 Special, which was designed as a water-line model. Mr. Gambin, however, scaled this up to twice the size and completed his model with a true-shaped hull. Readers will also notice from the photograph printed on this page, some of the extra details added, such as the cotton wool 'smoke' issuing from the funnel.

Many hours of work were involved, but the result gave intense satisfaction, and Mr. Gambin is to be commended on his craftsmanship.

HAPPY HOBBYISTS

THE benefit to be gained from working with a treadle fretmachine is emphasised by Mr. A. Northam of Middlesbrough, Yorks. A disabled pensioner of the 1914-18 war, Mr. Northam is an inveterate toy maker and says he is 'really astonished at the amount of work turned out by Hobbies Gem fretmachine'. Apart from having a 'really happy time' with his hobby, it is, says Mr. Northam, 'far superior to all the doctor's care and attention, and also a little something extra on my table — from the extra shillings gained by my hobby'.

Incidentally, a letter addressed to the Sales Department of Hobbies Ltd. recently, made quite interesting reading. After asking for a quotation for a component for Hobbies treadle fretmachine and lathe, the reader remarked: 'This machine has given almost 30 years of hard service and is still going strong — a

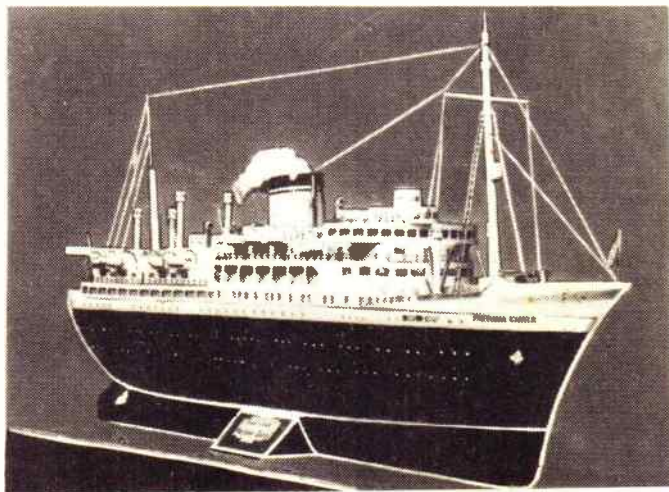

Mr. Gambin's 'Pretoria Castle'

BUILD A CANOE

Thousands of PBK canoes are built by amateurs every year for their own enjoyment. Few tools are needed, there are no awkward joints, and we have heard from lots of people, including boys and girls who have found no difficulty in building the canvas-covered rigid type. Building costs range from about £7 (for the PBK 10, which is a single seater).

On the back page of this issue will be found a list of the PBK canoe plans which can be obtained from Hobbies Ltd., Dereham, Norfolk. These include the PBK 14, Mark 2, the building instructions for which were given recently in this magazine.

The main construction parts are drawn full size on these plans and this is an ideal job of work for boys' clubs or youth centres where many willing hands can make light work.

sterling tribute to the excellence of your products'.

MIDDLESBROUGH'S 'SANTA'

IHAVE also been happy to see a newspaper cutting detailing the efforts of Mr. W. G. Brown, another Middlesbrough reader, who since he retired from working on the railways twenty years ago has spent much of his time all the year round making children happy. Mr. Brown makes toys for boys and girls who are sick or have no homes of their own, and at 82 he is 'as nimble as ever'. Dolls' houses, motor-cars, railway engines, forts — all designs come alike to Middlesbrough's 'Santa Claus', who is now busily engaged on making toys to be distributed next Christmas.

CHEESE LABELS

IHAVE been advised by Mr. L. G. Schumann, secretary of The Cheese Label Collectors' Club, who lives at 16 Kingsmead, Cuffley, Herts., that his club has taken upon itself the mammoth task of compiling a complete record and collection of all cheese labels ever used, for historical purposes. He appeals for all labels collectors can spare, covering the period dating back to the earliest days of their use.

Mr. Schumann says that all correspondence concerning this fascinating hobby will be answered, and he guarantees every assistance with their own collections which individual collectors may desire from the club, which is interested in all types of labels from every country in the world.

MANY-PURPOSE TABLE

By H. C. King

HOUSEWIVES will welcome this easily-made piece of furniture for its many uses as well as for its neat appearance. Although designed as a coffee table with bookshelves, it can be used to hold the interval sandwiches and cakes during a television session. In the summer it can serve at 'tea in the garden'.

Two Hobbies Furniture Panels No. S8 are required, but there will be a little left over for other work. The 20in. piece is cut from one panel, and the 17½in. base from the other. The rest of the parts are then set out. Reference to side and end views at Fig. 1 will help with this part of the work.

The corners of both top pieces, the base, and the shelf can be cut at this stage. When the ends have been squared off and the edges trimmed, the cut-away corners are marked out. These

upright piece to take the shelf, and a further one for the lower top. In both cases the grooves must be $\frac{3}{8}$ in. deep right across. The half lap joint (type A) where the top meets the centre board is made next. Here it is a good idea to leave about $\frac{1}{8}$ in. overhang, so that it can be planed flush later.

The Rails

Preparing the upright rails is the next part of the job. Selected 1½in. by ½in. hardwood is obtainable from Hobbies and Agents. Although the lengths between shoulders are 19ins. and 14½ins., it is best to check them by reference to the centre piece. Details of the stub tenon joints are given at (C) in Fig. 2. The tenons, which go the full width of the rails, are ½in. wide and ½in. long. Both mortices and tenons must be marked out and cut very carefully, or

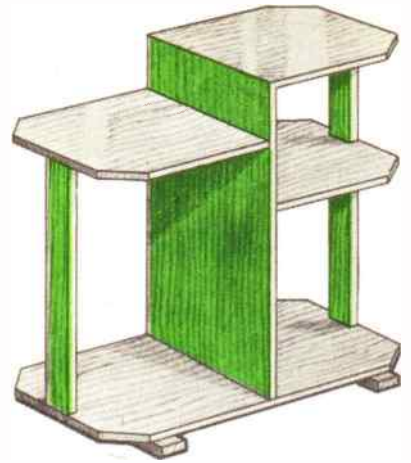

ordinary joiner's hot glue. A supply of 1in. panel pins should also be available.

Start construction

A start can be made by gluing and panel pinning the centre upright to the base. This is followed by the shorter rail and the lower top. The structure should be quite firm now. Fitting the shelf with glue and panel pins comes next, and immediately after, the longer

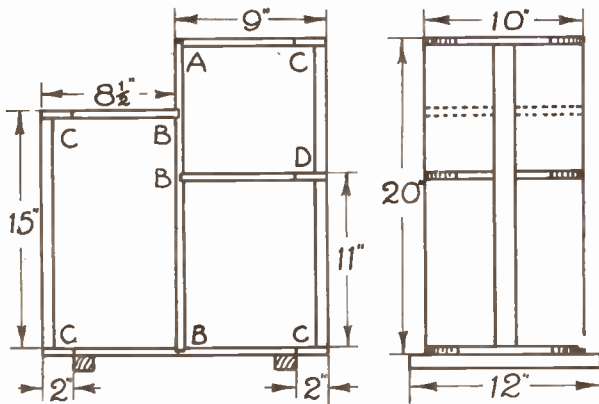

Fig. 1—Side and end views.

extend 2ins. each way from the corners. The main waste is sawn off and the edges finished to the line with a small plane.

The Joints

At Fig. 2, details are given of the four types of joints used. The diagrams are lettered so that they can be referred to the front and end views at Fig. 1. A start can be made by marking a groove across the baseboard to take the upright centre member. This is $\frac{3}{8}$ in. deep and must be the same depth throughout its length. Before cutting the groove, its width should be checked by standing the upright piece over it. This will ensure a good neat joint.

Another (type B) joint is made in the

the table will not be neat and strong.

The only joint remaining to be made is the one where the shelf meets the rail. This is shown at (D) in Fig. 2. As will be seen from the illustration, ½in. is cut away from the rail and ½in. from the shelf. The outer edge of the shelf, therefore, lies flush with the outside of the rail.

The two pieces of 1½in. by ½in. rail for the feet are 12ins. long, and merely need to have their ends squared off.

Although the Hobbies Furniture Panels and rails are planed to a silky finish, the work should be rubbed, with the grain, with a fine grade of glass-paper to remove pencil marks, etc. Cold glue, such as Croid Universal or Casco Casein, should be used in preference to

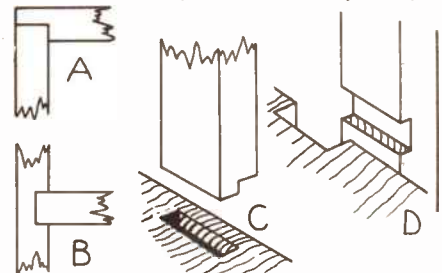

Fig. 2—Details of the joints.

rail is added. When these are in position, the upper top can be fixed. To add to the firmness of the table, a screw can be driven through the base into each vertical rail.

When the glue is really set, any excess outside the joints can be removed, and panel pins punched below the surface. The slight overhang of the upper top at the half lap joint needs to be planed off flush, working from each end alternately. The feet, which stand out 1in. at each end, are screwed from the underside to the base. They should be set in from the ends of the base by 2ins.

Before staining, the grain of the wood must be filled, preferably with Celestor wood filler. This is well rubbed into the grain, the excess being taken off across the grain with a coarse rag, and the work left over-night.

● Continued on page 53

MAINLY for MODELLERS

DURING more than twenty years of the study of maritime history and early naval architecture it has been my custom to make a note of every piece of information, modelling hint, etc., later typing out and binding these notebooks for easy reference. It is my intention to take extracts from these occasionally for this feature, as I believe they will prove a source of interest and help to our readers, encouraging them to try their hands at research themselves.

The following sources of information are open to those wishing to do their own research, added to which it is often possible to obtain first hand information from families who have long connections with the sea. This often discloses valuable information unobtainable elsewhere.

The chief sources are: The British Museum, The Science Museum, The Maritime Museum, Historical and Antiquarian Societies in all parts of the world. The Institute of Naval Architects, Lloyd's Register, Lloyd's List, ship owners and shipbuilders, records of old historical towns both here and abroad (such as any of the Hansa Towns), old books on naval architecture, early issues of newspapers, such as The Illustrated London News, The Army and Navy, etc.

In addition, readers can collect about them a reference library of their own. My own library consists of some 250 books, to which I am always adding. Where an old book is out of reach by reason of rarity and cost, it can usually be consulted at a good reference library or the maritime museums and notes made of the information likely to be useful.

The following items are taken at random from my notebooks and will serve to illustrate the variety of information that can go into your notebook. Where the information will be made clearer by sketches, they will be included.

Sail Canvas for Royal Navy

Canvas or sail cloth is 24ins. wide. A bolt consists of 38yds. To distinguish quality each bolt is numbered and should weigh, No. 1, 44 lbs. No. 2, 41 lbs. No. 3, 38 lbs. No. 4, 35 lbs. No. 5, 32 lbs. No. 6, 29 lbs. No. 7, 24 lbs. and No. 8, 21 lbs. Nos. 1 to 6 are termed double and numbers above No. 6 single canvas.

(Steel 1805)

This is useful both for the scale modeller and the average model maker.

From it we can determine the spacing of the lining of our sails, whether we are drawing them in on parchment or sewing them in on fabric sails.

Range of Sizes of Deadeyes and Blocks

110 guns to 74	Sins. to 26ins.
64 guns	Sins. to 24ins.
50 guns to 36	Sins. to 20ins.
32 to 28 guns	Sins. to 20ins.
24 guns	Sins. to 18ins.
22 guns	Sins. to 16ins.
18 to 14 guns	Sins. to 14ins.

(The old wooden walls were classified as to size by the number of guns carried).

(Steel)

In making blocks and rigging for this 18th- and early 19th-century period we know from the above the sizes to make our deadeyes and blocks in order that they will not be out of scale size. Nothing is more out of place than deadeyes and blocks that are obviously too large in size.

Types of Blocks in Use around 1600 A.D.

Single blocks, double blocks, snatch blocks (these bring the ropes to the capstan), winding blocks (to accommodate large weights), double long blocks, ram heads (blocks fastened to ties for the halyards to go in), deadeyes.

(Leconfield M.S.S. 1625 A.D.)

The Painting of Warships, late 19th century

ENGLISH.—Black sides, white upper works, yellow funnels, masts and ventilating cowls.

FRENCH.—Usually all black, or black hulls with grey masts and funnels, sometimes painted all over in grey drab.

GERMAN.—Grey all over with bands on funnels. For active service painted all over yellowish brown.

ITALIAN.—Black sides, yellow upper works, black funnels.

AUSTRIAN.—Black sides, white upper works and funnels.

RUSSIAN.—Yellow washed funnels with black boot tops, black sides, white masts.

TURKISH.—Distinguished by their red funnels.

Note on Santa Maria from Chatterton

At this period there were no ratlines forming the 'ladders' on the shrouds. A rope ladder up the aft side of the mast gave access to the mast top. The mainstay was undivided and there was no bobstay. The mizzen yard was in two parts, the stern was round. Outriggers for lateen sails are doubtful at this period. Note: Ratlines came some forty years later.

FROM MY NOTEBOOK By 'Whipstaff'

Rigging Tip

Figure eight loops twisted around steel rod of same diameter as mast form excellent fastening for shrouds on models whose scale is too small to allow of following actual practice.

Small rigging cords can be spliced by using a needle to pass the cords through the strands.

A simple method of making mast bands is to wrap a dowel that has been covered with greaseproof paper with wood shavings, gluing sufficient shavings to make the required thickness. Belaying pin bands can be made in the same way of paper with fine wire eyes to hold the belaying pins.

For large scale models, excellent bollards can be made from used rifle cartridges of low calibre, such as .22, mounted on a base of thin wood or metal and painted; they give an authentic appearance that is hard to beat.

● Continued from page 52

Many-purpose Table

The colour of the finished table will depend on that of the furniture with which it is to be used. However, our table will look equally well if polished a natural colour. If stain is to be used, then Reward is an excellent choice. One of the six shades available from Hobbies

is sure to suit requirements. The filled work should be rubbed down with glass-paper before staining.

Reward New Process Polish will enable a first-class finish to be obtained, even if the reader has little skill as a polisher.



Stamp Collector's Corner

THERE seems to be a very great craze to collect stamps on a thematic basis; certainly by so doing one gets a little more out of the hobby than by collecting a number of stamps and just mounting them in an album and leaving them to mount up in numbers. This thematic collecting does, however, cramp one's style a little. For

stamp, this need not necessarily be the case. Neither do we know where the piece of land is situated on the globe. It might be in the Pacific or it might be in the Antarctic and, finally, it is incorrect, since it does not indicate that Northern Ireland is not part of Eire. Now can you think of another stamp that has very nearly as many faults as this? How

THE THEME OF MAPS

By L. P. V. Veale

jection, this showing direction correctly but not scale. Unfortunately, only land very close to the Equator is true for scale, land towards the poles being greatly exaggerated in area. Compare this stamp with the stamp from Australia in connection with the Y.M.C.A. centenary celebrations. The areas are mostly correct, but the direction varies from one side of the map to the other.

A few lines back we made the statement that the Eire map does not show



Spanish issues depicting the Amazon basin (above) and the route of the Madrid-Manila flight.

instance, one might be given a stamp from a certain country, but have no use for it, because it has no bearing with one's theme.

One of the most interesting subjects that one can mention is that of maps. Luckily also, there are a very large number of countries which have used these as subjects for the design of their stamps. Just as one notes with other stamp designs, there are good and bad maps and it is as well to consider what one can find. Eire for her present 1d., 1½d. and 2d. values shows a map of Eire and Northern Ireland, but what a useless map it is! The only merit that it has is that it shows the shape of the whole island. There is no scale shown, so that we do not know by looking at the stamp if we are looking at an area as large as Australia or an island as large or rather as small as Caldy Island off the South Wales coast. There is no north point shown, so that although we think the north is at the top of the



Dominica. Leaves Haiti a small piece on the East.

Liberia in Africa.

Fiji. Showing latitude 180°

about the New Zealand stamp issued in 1923 — 'Restoration of the Penny Post'?

One country nearly had a war with a neighbouring state because of the wrong drawing of the map design — the guilty country was Dominica. She printed a map of the island and showed her share of the whole island as far too big, and this upset the other country occupying the other share, and that was Haiti. Luckily they patched up the quarrel without any bloodshed. This gives an instance of the importance of drawing the map correctly. As to the north being at the top, that is not always the case. For example the 20c. of the Humphrey Gilbert set of Newfoundland shows the island drawn with the north of the island at the bottom of the stamp, but a small compass is also shown, and this, of course, gives the direction of N., S., E. and W. Furthermore, there is a scale shown, so that we may know the size of the land.

Another very well-known map stamp is the Canadian issue of 1898 commemorating the introduction of the Imperial Penny Postage. You will notice that British Possessions are shown in red. Now this stamp gives us a false idea of the size of these possessions. The map is drawn on Mercator's pro-

jection, this showing direction correctly but not scale. Unfortunately, only land very close to the Equator is true for scale, land towards the poles being greatly exaggerated in area. Compare this stamp with the stamp from Australia in connection with the Y.M.C.A. centenary celebrations. The areas are mostly correct, but the direction varies from one side of the map to the other. A few lines back we made the statement that the Eire map does not show where the island is on the globe. There are some very interesting points about this position question. The Fiji stamps 2d. and 6d. values of the 1938-1955 set were at first printed showing lines of latitude and longitude, the parallel of latitude was shown as 18 degrees south and one meridian of longitude was labelled 178 degrees east, but the second meridian was not marked. It was not long before the omission was noted, and the missing figure 180 degrees inserted. Now these two stamps differ very much in price, the case of the 6d. stamp is rather remarkable, the value of the unused 6d. of the second die is 10d., but the first die (without the figure 180) is catalogued at £2, and a used specimen is a few shillings more than that!

The point is, of course, that without having the lines properly marked, there is no scale to the map, so that the Fiji islands might be any size one liked to attribute to them, but immediately you label two meridians you indicate the scale.

Liberia in 1928 issued a map stamp and one which very clearly marks the position of this Republic in Africa.

The stamp shows a map of Africa — nothing very remarkable in that you

● Continued on page 55

Of novel construction

TABLE LAMP

THE top of the lamp is made by cutting a 3ins. diameter wooden ball in half. The upper part of the hemisphere so formed is further flattened until the 'plateau' thus obtained exactly matches the diameter of a standard light bulb holder. The most satisfactory way of forming this 'plateau' is by sanding, as it is difficult to grip the half ball

the curtains). A suitable section can readily be made by gluing up four lengths of 1½in. square stock if larger section material is not readily available.

Ideally the bottom is a subject for turning on a wood lathe. However, if fairly soft straight grained wood is chosen, it can just as readily be carved with a knife, finishing smooth with glasspaper. Make a template to check

whole length of the bottom is available use a ¼in. twist drill at each end, drilling as deep as the length of the drill will allow. If the two drillings do not meet they can be joined by burning through the rest of the wood with a red hot piece of stout wire, or a heated thin poker. Work from the top if you do this, as any scorch marks on the top face will be hidden in the final assembly.

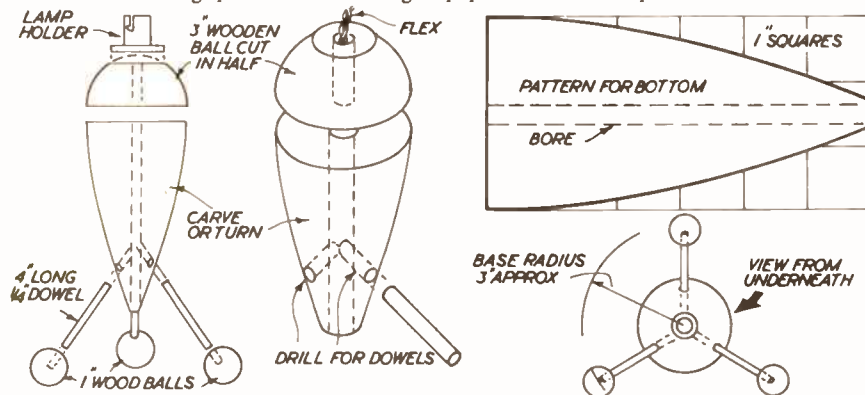

satisfactorily for planing or sawing. A ¼in. diameter hole is then drilled through the centre to take the flex.

The body part is 6ins. long and 3ins. in diameter, shaped to a tapered form. The original was actually made from a scrap length of Victorian-era curtain runner (massive 'cylinders' of wood carrying large wooden rings for taking

the shape and ensure a symmetrical section.

Once shaped the bottom is bored through with a ¼in. diameter hole. In the case of a hand carved piece it is best to bore this hole first whilst the ends of the block are square. When turning, boring is best done after shaping.

If no suitable bit for traversing the

The method of assembly is quite simple. The hemispherical top is glued to the carved bottom. Three ¼in. diameter holes are then drilled into the lower part of the bottom, upwards at an angle. It is not necessary to make a jig for this. You can judge the angle required fairly readily and provided the effective base diameter is about 6ins., the lamp will be quite stable when standing.

The supporting legs are 4in. lengths of ¼in. diameter dowel, glued into the holes drilled in the bottom. Trim off the ends of the legs until the assembly stands perfectly upright. Then blind drill (about half way through) three 1in. diameter wooden balls and mount on the ends of the legs to complete. The flex is fed down through the hole in the centre of the lamp, and the lampholder is mounted with small screws.

(R.H.W.)

● Continued from page 54

Map Stamp Themes

may consider, 'but the Republic has made it very plain as to where it is situated, because there is a blank map except for the small mark labelled 'Liberia'. Such a map creates some interest in the land by indicating so clearly where it is.

Another very plain map stamp was the one issued by the United States of America in 1904, just a plain map of the U.S.A., with the date 1803 written over a shaded portion. The shaded portion is Louisiana Territory which was purchased by the United States from the French Republic — obviously in 1803, and the stamp commemorates the purchase as well as the International Exposition held in St. Louis that year. The price paid, by the way, was about £3,000,000.

In addition to the old map of New-

foundland or the Sir Humphrey Gilbert chart, there are two more ancient maps appearing on stamps that we shall describe. One is the 1944 issue from Sweden, and it commemorates the tercentenary of the first Swedish Marine Chart. When one examines these old charts the marvel is not so much that the mariners took such a long time to go anywhere, but that they went anywhere at all. The other old one that may interest us comes from Spain. It was issued in 1935 in connection with the Iglesias Expedition. A close look at the stamp shows that the upper reaches of the river Amazon are hidden by a pattern of leaves, and that just about sums up the matter.

One of the most interesting of the map stamps comes again from Spain. This time it was issued in 1926 — a Red

Cross Air stamp to commemorate the Trans-Atlantic and the Madrid to Manila flights. The map illustrates the latter route with a black line, the places of importance being marked with white dots. Remember, this was 1926. Flights across the Atlantic are nothing now, but then it was a different matter.

Of all the air stamps that have been issued the \$1 1931 air stamp from Newfoundland is the most interesting. On this stamp the two sides of the Atlantic Ocean are shown and seven routes that had been flown up to that date are marked. 1919 was the date of the first crossing and overprinted stamps had to do duty. Five of the crossings were from America to Europe only two being in the reverse direction.

Many of the British Colonies are now sending map stamps and very instructive they are.

Try to collect these unused if possible; if not, then do try for lightly postmarked specimens.

Instructions for making

A SPANISH GUITAR

THE guitar is one of the oldest musical instruments known to the world, and latterly it has been brought much in the public eye by such performers as Bill Haley, Elvis Presley, Tommy Steele, Lonnie Donegan and other instrumentalists in rock'n'roll, skiffle and calypso rhythm.

To buy such an instrument in the shops is very expensive, and we have had many requests from budding guitarists for instructions how to make one. While we do not claim that the guitar described here will have the same refinements as one costing, perhaps, 20 guineas or so — such as is used for professional work — nevertheless, it is a practical job, and will suit the needs of most enthusiastic amateurs. Care taken in the work and close following of the directions will result in an instrument which will give much pleasure — at a reasonable cost.

It is based on the Spanish style, using gut strings and wooden pegs for tuning. With steel strings this is a typical instrument as used in skiffle groups.

Making and shaping the body of the instrument entails patience and careful

the same tonal results, will be found quite satisfactory.

Four fillets

The fillet pieces, on which will be glued the sides, are $\frac{3}{8}$ in. wide and $\frac{1}{2}$ in. thick. They are cut to the same shape as the outline of the face and back pieces, but $\frac{1}{8}$ in. less to allow for the addition of the thin plywood sides. A glance at Figs. 1 and 2 will show what is meant. You will need four separate fillets, two for the face piece and two for the back. To save wood, each fillet can be made in two or more pieces. If fillets are cut from $\frac{1}{2}$ in. plywood, $\frac{1}{4}$ in. fretpins can be added as strengtheners when gluing to the face and back pieces.

Two end blocks of deal measuring $2\frac{1}{2}$ ins. by $2\frac{1}{2}$ ins. by $\frac{1}{2}$ in. are first squared and then glued to the inside surface of the back shape, being inset $\frac{1}{8}$ in. as shown in Fig. 1. The fillets are glued

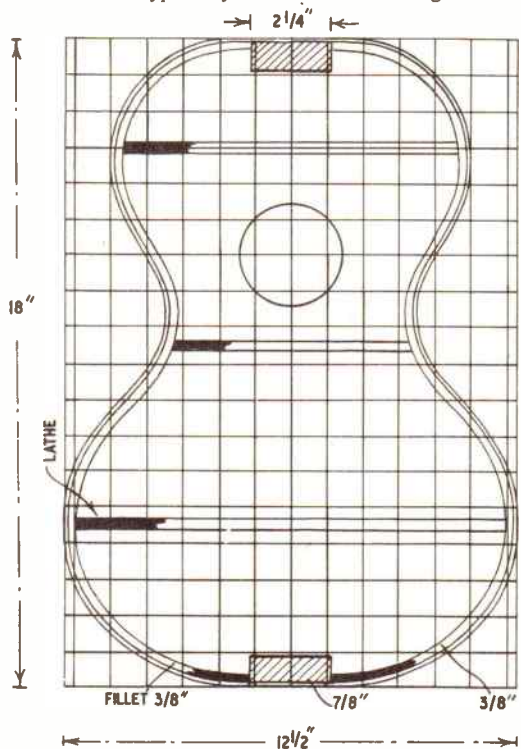

Fig. 1

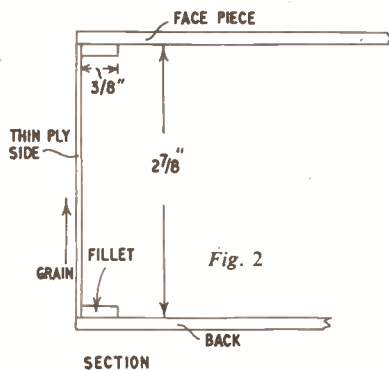

Fig. 2

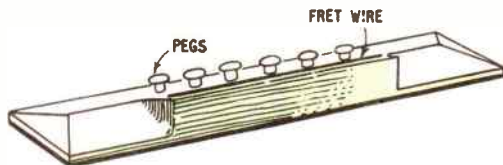
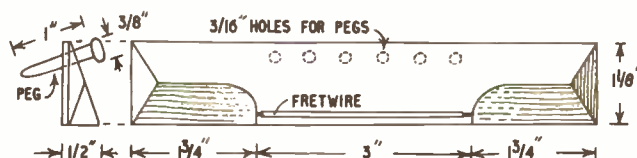

Fig. 4



work if a good job is to be made of it. The shape shown in Fig. 1 should be drawn by means of the squared method on to a piece of cartridge paper. The squares shown in Fig. 1 are enlarged to 1 in., and the shape drawn out square by square. Draw one half of the shape, trace it and turn it over to transfer the other side and thus complete the whole. It will be noted that the face piece and the back are the same outline, and that the 3 in. diameter circle is cut in the face piece only.

Satisfactory results

When completed, the shapes are transferred by means of carbon paper to $\frac{1}{2}$ in. wood. If you can obtain them, use white chestnut for the face piece and mahogany for the back. On the other hand plywood, whilst not giving quite

round up to the blocks, being inset $\frac{1}{8}$ in. to allow for the thin plywood sides as already mentioned.

Mark the positions of the blocks on the interior side of the face piece and fix the fillets round this as before. Now make six tension laths. These are pieces of deal measuring $\frac{3}{4}$ in. wide by $\frac{1}{2}$ in. thick. Cut them to length when positioned, as shown in Fig. 1, and glue across the top and bottom.

Before gluing the face piece in position the bridge is shaped as in Fig. 4, and a length of fret wire embedded in the place indicated. Make a cut across with a fine tenon saw and tap the fret wire in position. The bridge is glued in place $4\frac{1}{2}$ ins. from the bottom of the body. Screws for strengthening are inserted from underneath at each end.

Six $\frac{3}{16}$ in. holes are drilled through the bridge and the body at the angle indicated. File six stopping pegs from $\frac{3}{16}$ in. diameter round rod, tapering them slightly. The tops can be inlaid if desired.

Now glue the face piece on to the blocks and ensure that the assembly is in true alignment.

The strips of $\frac{1}{8}$ in. plywood to be bent round to form the sides are $2\frac{1}{2}$ ins. wide and cut to length (approximately 27 ins.). Find the centre of the end blocks, mark a line up with a set-square, and then glue and pin the squared ends of the strips to the lower end block to make a neat join.

Apply plenty of glue to the fillets and plywood edges. Working both side pieces together, gently force them under the face and back pieces and flush up against the fillets. As the work progresses bind round and round the instrument with plenty of string to hold the sides tight while the glue is drying.

Now trim the sides to the block centre line. Glue and nail the strips to the block as in starting, again ensuring a neat join. If nails do not hold the ends securely, wind cord round the whole casing until the glue is dry.

the fret positions with a set-square before shaping the board. Insert $\frac{1}{4}$ in. discs of mother of pearl or whitewood inlaid in the positions shown.

Adding the fret wires

Cut across the fret lines with a fine tenon saw and tap the fret wire in place before gluing the board to the neck. The nut is a piece of bone or hardwood which is glued in place and slotted just enough to position the strings.

The shoulder is cut from a piece of mahogany 2 ins. square and shaped as indicated in Figs. 3 and 5. Bore a $\frac{3}{16}$ in. dowel hole in the end of the neck and a screw hole in the shoulder. Matching holes will be made in the block of the body. The dowel is inserted and the whole is glued up, securing with the screw. Finally drill holes for the six tuning pegs as shown in Fig. 3, ensuring that the pegs are a tight fit in order to obtain accurate tuning. Drill the two lines of peg holes in straight lines 1 in. apart.

To finish, the bridge, pegs, head and underside of the neck are polished ebony black, with the rest clear french polished.

ALL THE MATERIALS FROM HOBBIES

All the materials necessary for completing the Spanish Guitar can be obtained from branches or from Hobbies Ltd., Dereham, Norfolk (post free).

Realising that some workers will be using their own wood, we have separated the various components which can be obtained as detailed.

Parcel of wood including plywood, with a semi-shaped neck in hardwood	25/-
Full-size plan of the Guitar, together with instructions to build	3/6
Six pegs (1/2 each)	7/-
One set (6) strings, nylon 'King'	10/6
One set (6) strings, wire 'Skiffle'	9/9
40 in. fret wire	2/6
Tutor	2/-

The complete kit therefore costs with nylon strings, £2.10.6 and with wire strings, £2.9.9.

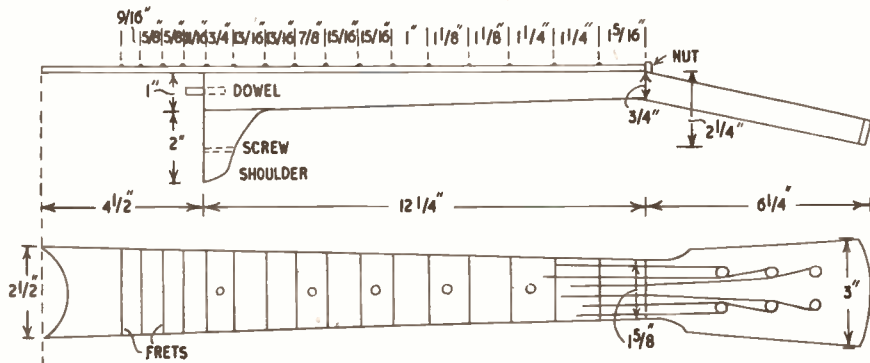

Fig. 3

The neck is made from a solid block of mahogany 18 $\frac{1}{2}$ ins. by 3 ins. by 2 $\frac{1}{4}$ ins. First mark the side view (Fig. 3) on the thickness of the wood, then saw to shape, working from each end. Keep the saw perfectly upright while cutting and secure the neck in a vice if possible.

Shaping the neck

Now mark out the plan of the neck and cut as before. Final shaping can be done with a Surf-form file or a wood rasp, shaping to the section shown in Fig. 5. Plane and glasspaper the head and neck smooth.

Mark out the finger board as shown in Fig. 3 on a piece of $\frac{1}{8}$ in. walnut or beech, measuring 16 $\frac{1}{2}$ ins. by 2 $\frac{1}{2}$ ins. Mark

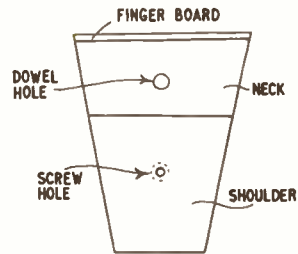

Fig. 5

Use gut strings, fixing by tying a large knot at one end of each, inserting in the bridge holes and then plugging with the pegs. A piece of cord or leather thonging can be attached to the top and bottom

of the guitar for looping over the head. It is suggested that a good tutor should be bought, this will deal with many questions such as tuning and playing the instrument.



NEXT WEEK'S FREE DESIGN—A MUSICAL MYSTERY

What is the use of a jewel box which cannot be opened? That question will be solved next week when we shall give a free design for such a mystery box—but the secret will be revealed to the worker. A musical movement is also incorporated, making this a delightful idea to make as a gift for a very special person to place on her dressing table.



CHEMISTRY IN THE HOME

A PART from the everyday metals, a few home chemists have seen the metals whose salts they constantly use. It is extremely interesting to prepare specimens of them. Again, it is invaluable to know how all, common and not so common, may be prepared in a finely divided form, for some experiments require them in this state.

Given full facilities, any metal may be prepared in the laboratory. Most home chemists do not possess these facilities, and some metals — such as potassium and sodium — can be dangerous to prepare. Therefore, a selection is given of metals which are easy and safe to make.

Antimony is prepared from a solution of antimony trichloride, to which a little hydrochloric acid has been added. As antimony trichloride is poisonous if swallowed, care should be taken to wash your hands before eating anything. Place the solution in a beaker and clamp a rod of zinc in it (Fig. 1). The zinc immediately blackens, and metallic antimony quickly begins to deposit on the zinc in the form of a loose black powder. The bulk of the antimony will be deposited in twenty-four hours, and may then be detached from the zinc rod and washed by decantation until one wash water is no longer acid in reaction, that is, it does not turn a blue litmus paper red. Dry the antimony in a warm place. It will now have the appearance of a grey-black powder.

Polished steel appearance

In this form antimony is sold as 'antimony black' and 'iron black'. It is used for imparting to papier mâché and plaster the appearance of polished steel.

Bismuth can be prepared in the dry and in the wet way. If you happen to need a small quantity of the metal quickly, it is best made in the dry way. Here is how to do it. Scoop a small hollow in a charcoal block and fill it with bismuth carbonate. With your mouth blowpipe, direct a reducing flame upon it (Fig. 2). Note that the tip of the blowpipe is kept just *outside* the spirit lamp flame. Globules of molten bismuth soon form. By adding further quantities of bismuth carbonate and proceeding in the same way, you will soon have a few grams of the metal.

If speed is not essential, it may be made with less expenditure of breath! In this case, simply clamp a stout iron

nail in a solution of bismuth chloride. A grey-black sausage-like furry deposit forms on the iron in the next few hours. When it increases no more, remove it from the iron and wash it in a filter with water.

Bismuth so made usually contains a little iron as impurity. To remove this, put it into a beaker and cover it with dilute hydrochloric acid. After five minutes, filter off the metal and wash it well with water until one wash water is no

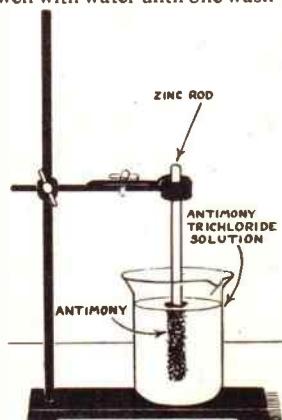

Fig. 1—Making antimony powder.

longer acid to litmus. Dry it in the oven.

Bismuth is much used for making alloys of low melting point, such as are used for laboratory metal baths and for the safety plugs of boilers.

Cadmium, too, is easily prepared in the wet way, a zinc rod being clamped in a solution of cadmium sulphate. The deposition takes a good many days to complete. At first, the metal appears as a powdery deposit, but later, grey-white plate-like crystals of the metal appear.

After ten or twelve days test a drop or two of the solution with ammonium sulphide. If a yellow precipitate (cadmium sulphide) appears, the reaction is not over and should be allowed to continue until ammonium sulphide gives only a trace of yellow precipitate. The metal may then be detached from the zinc and washed well by decantation with several lots of water. Finally let it dry in a warm place. If you place a little of this on a crucible lid and heat gently, the metal suddenly takes fire — well below a red heat — and burns to

MAKING METALS PART 1

cadmium oxide. This experiment is quite spectacular and should certainly be tried out.

Cadmium is now much used for rust proofing car parts. This is achieved by depositing the metal on them by the electro-plating method.

Cobalt is a metal generally regarded as too difficult to prepare without rather specialised equipment. There is, however, a little-known method which gives excellent results, even when the only source of heat is a spirit lamp.

You will need some cobalt oxalate for the experiment. This can be prepared by dissolving 5.29 grams of ammonium oxalate in 100 c.c. of hot water, allowing the solution to cool and adding it to a solution of 7.46 grams of cobalt chloride in 100 c.c. of water. In a few moments a deep flesh-coloured precipitate of cobalt oxalate appears. Filter it off and wash it

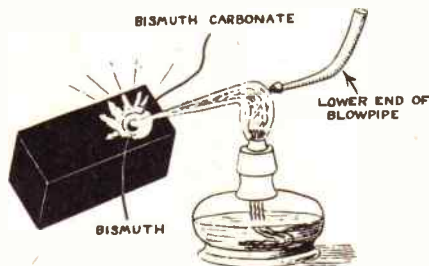

Fig. 2—A quick way of making bismuth.

with water until one wash water gives no precipitate with silver nitrate solution. Then dry it in the oven.

Place about half of the cobalt oxalate in a crucible, close it with the lid and heat for twenty to thirty minutes. Let the crucible cool *with the lid on*. Removal of the lid will cause the cobalt to burn and so spoil the result. When cold, empty out the crucible contents on to a sheet of paper. You will now have a black powder.

Bring a magnet close to it. It will be strongly attracted. Cobalt is one of the few magnetic metals. This property can be used for separating it from any carbon formed in the reaction. By taking it up with a magnet and tapping the latter, adhering carbon will fall away.

Cobalt is much used for making hard alloys, and is especially important these days as the bonding agent in tungsten carbide cutting tools.

Nickel, too, is generally regarded as not easy to prepare in the home laboratory, but here again by heating nickel

● Continued on page 60

Follow the **FLUXITE** way to Easy Soldering.



No. 4 Tinning the Bit

Cut off small piece of solder and lay it, together with a little **FLUXITE**, in a shallow tin lid. Quickly rub faces of heated bit in **FLUXITE** then on solder. Surplus solder wiped off with cloth.

FLUXITE is the household word for flux that is famous throughout the world for its absolute reliability. In factory, workshop and in the home **FLUXITE** has become indispensable. It has no equal. It has been the choice of Government works, leading manufacturers; engineers and mechanics for over 40 years.



FLUXITE Limited, Bermondsey St., London, S.E.1
GM.54

THE LATEST SENSATION
in the
International Handicrafts Exhibition
Olympia
were our Plastic Moulds
for Wall Plaques for Plaster Casting

Prices from 1/3 to 5/- each
Rubber Moulds from 1/- each
Illustrated catalogue 9d.
S.A.E. for list

TRADE ENQUIRIES INVITED

F. W. NUTHALL
69 St. Mark's Road
HANWELL, LONDON, W.7

Make model buildings —



as simply
as this!

A new method—described in a new book on Pyruma Modelling. This shows how to turn empty match boxes into model buildings, by Pyruma 'Plasticraft'. It is one of the many methods of modelling in plastic Pyruma, shown in black and white and full colour pages, which enable you to build and finish in natural colours:—

MODEL FARMS, RAILWAY STATIONS, SIGNAL CABINS, AIRPORT BUILDINGS, DOCKS, SHIPS, FIGURES, ANIMALS, ASHTRAYS, BOOKENDS, DOLL'S FURNITURE, PLAQUES, RELIEF MAPS, ETC.



is a ready-to-use material, cheap to buy locally, and easy to work by following the Instruction Book offered below. Pyruma dries or can be baked to stone-hard permanence, then painted in natural colours. Sold by local Ironmongers and Hardwaremen, Hobbies shops and Art material Dealers, in airtight tins from 1/6 upwards.

Send Coupon and 6d. P.O. (not stamps) for this NEW Book of Instructions to:—

J. R. SANKEY & SON, LTD.

1857-1957

Dept. H. ILFORD, ESSEX

Enclosed 6d. P.O. (not stamps) for PYRUMA MODELLING INSTRUCTION BOOK addressed to:—

NAME (Block letters)

ADDRESS

THE USES FOR TIMBERS

THE individual properties of the more popular woods make them particularly useful for various definite purposes, and it is proposed to set these out here. It is quite impossible to deal with all the woods employed by builders and others, as they are so numerous, but some of the kinds most often encountered have been listed, in alphabetical order for easy reference.

African Whitewood

Also known as Obeche, this is a soft wood easy to work, and is used for much of the less exacting type of joinery, such as cheap furniture, or the inner parts of drawers. It is also employed by plywood manufacturers, and may be used for panelling. If used alone it is liable to warp, but a good surface is obtainable upon it, and it has some use in veneers.

Ash

A close-grained, strong whitewood, very tough and elastic. Not usually available in large sizes, it is particularly suitable where elasticity and durability are required, as in tool handles. It also finds use in oars, and quartering for joinery. Being very strong, yet not brittle, it is excellent for axe hafts, etc.

Beech

A very large British tree, fairly hard in texture, and can be found in large planks. A strong wood, it is suitable for truck bottoms, and in furniture, etc., where large, strong planks are wanted.

Cedar

There are several species of cedar. One acclimatised to England is the Cedar of Lebanon, with a yellow wood and strong, pungent smell. This is a large tree with wide branches. When well seasoned, the smell fades, and the wood is used for drawer-bottoms, etc. The seasoned wood is of a straw colour. It also finds use in floors.

Chestnut

This wood does not have a great deal of general use, its most frequent outdoor application being in chestnut fencing. This is made by splitting the chestnut, of small diameter, and spacing a few inches apart on twisted wires. It has quite a long life in such circumstances, though does not equal hardwoods.

Elm

A hard, tough, close-grained timber, with many applications. As weather-board, a good overlap is necessary, unless the wood is well seasoned, as it is very liable to shrinkage. It has good

durability when permanently under water, and this accounts for its use as boat bottoms, and in other submerged work. Well seasoned, it has applications in furniture, such as chair seats, and it has uses in strong, rough shelving, etc., especially when no great change of temperature is encountered. Fairly thick planks are not so liable to warp, but thin ones will, if poorly seasoned.

Fir

Numerous trees can be classified as firs or spruces, and the planks obtained from these often go under the common name of 'Deal'. The Douglas Fir is a light, reddish brown, and does not last well out of doors unless treated with preservatives. It is useful for doors, shelves, and the cheaper kind of furniture. The Canadian Spruce is light and easy to work, and is quite strong, but liable to warp.

Maple

A reddish brown wood with a fine, even texture, it does not last well outside unless preserved. It is used for panels, furniture, flooring, plywood and veneers. When well seasoned, it is a hard wood.

Oak

A well known, very hard, durable wood with many uses. Among these may be listed oak-block flooring, furniture, veneers, and all kinds of superior work of high finish and good quality. It has a long life outside, and this makes it very suitable for posts and other exposed purposes: gates, durable fencing, etc.

Sycamore

The sycamore tree is large, and has been naturalised in Britain for very many years. It yields a close-grained, firm wood, used in furniture, and suitable for toys, or turning on a lathe. Wooden sink draining-boards may be made from it.

Walnut

This tree has grown in Britain for over four hundred years, and the seasoned wood is relatively expensive, but is used in furniture and cabinet-making. It can take an excellent finish, and has seen much use in items where appearance is important, as in gun stocks, and good-class furniture.

Willow

This is very pliable when green, and is then used for all types of basket-weaving, wicker hurdles and fencing, etc. It is sometimes called Withy. As lopped trees rapidly grow many straight

branches of convenient diameter, it is much used in fencing, for stakes, etc., in country areas, but does not last well, and is not a strong wood.

Most of the other timbers encountered in ordinary work have characteristics similar to one of the above. When the work will be spoiled by warping, it is most necessary that the wood be thoroughly seasoned. If planks are bought from a reputable source, this will have been attended to, but seasoning is a lengthy process and timber obtained from a sawmill will probably be unseasoned. If the wood is damp, or seems very fresh, or has sap in it, then it is unwise to use it, as it stands, for any job requiring seasoned wood.

When medium and soft woods are used out-of-doors, it is essential to prevent rot. A preservative such as creosote will help to do this, or the wood may be painted. Toolsheds, etc., are liable to rot around nails and joints, if not attended to in this way.

Exposed, unpainted soft woods have a life of only a few years. The hard woods such as oak are much more durable under such conditions, and will become almost everlasting if painted.

Indoors, the soft woods are also much more likely to be attacked by furniture beetle, when left in a natural state, as in concealed positions. A preservative will prevent this, and hidden panels of plywood should certainly be treated, though the hard woods are not so likely to be attacked. For weather-vanes or out-door models, a hard wood will be best, painted or varnished to repel rain.

● Continued from page 58

MAKING METALS

oxalate in the same way as cobalt oxalate, black nickel powder is obtained. Bringing a magnet near it will show that it shares with cobalt and iron the property of being attracted by the magnet and can in this way be separated from any admixed carbon.

The nickel oxalate needed may be prepared by dissolving 8.96 grams of nickel sulphate in 65 c.c. of hot water and mixing the solution with one of 4.54 grams of ammonium oxalate in 65 c.c. of hot water. In a few moments a light green precipitate of nickel oxalate forms. After letting it stand half an hour, filter it off, wash it on the filter until one wash water gives no white precipitate with lead acetate solution, and then dry it in the oven. (L.A.F.)

Make no mistake about it . . .

When it's a wood gluing job, there's only one way to get really first class results — use a glue manufactured specifically for use with wood. And for this type of gluing, CASCAMITE "One Shot" Resin Glue is unsurpassed both in performance and in its simplicity of use. Supplied in powder form, this resin glue is easily mixed in cold water, is used cold, and is unique in that it requires *no hardener additions* — the hardening agent is incorporated in the powder during manufacture. The glue is gap-filling (to the British Standard Specification requirement), is non-staining and makes joints which, in addition to having tremendous strength, are water-proof and heat and mould-resistant.

Available from ironmongers, hobbies shops, builders' merchants, etc., in 3½-oz., 7-oz. and 18-oz. tins (prices 2/6d., 4/- and 8/6d. respectively).

. . . for wood gluing, choose CASCAMITE "One Shot"

One of the range of



SYNTHETIC RESIN AND CASEIN GLUES

73a

Manufactured by: LEICESTER, LOVELL & CO. LTD. NORTH BADDESLEY, SOUTHAMPTON



Remember, too . . .

When you want a good general-purpose glue, be sure to choose CASCO Grade "A" Powdered Casein Glue. It is mixed and used cold, heat and moisture resistant, very economical in use (1-oz. of powder makes 3-oz. of liquid glue) and will glue a wide variety of materials. Packed in 2½, 7½ & 16-oz. tins (2/-, 4/6 & 7/6 respectively). Ask your local stockist for free descriptive leaflet.

CASCO GLUES
are recommended for
"Build-it-Yourself"
with **Easi-Bild** Patterns

NEW!
THE TRANSPARENT LACQUER THAT SPRAYS ITSELF ON

Just press the tab to spray a hard, glossy finish on to untreated hardwood, whitewood, metal or paper. This transparent lacquer dries in 10 minutes—protects and improves toys, models, furniture, paper

lampshades, maps, prints, table tops, chromium plating, brass, copper, silver . . . and hundreds of other articles. Obtainable from Halfords Ltd. **12/6 per tin.**

PARSONS TRANSPARENT LACQUER in SELF SPRAY Aerosol CONTAINER



THOS. PARSONS & SONS LTD.

ESTABLISHED 1802

70 GROSVENOR STREET, LONDON, W.1.
TELEPHONE: MAYFAIR 7951 (10 LINES)

For wood, card, plastic, leather, metal, etc.

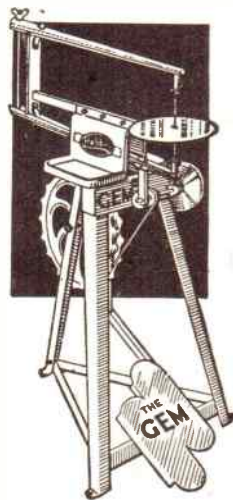

£5 - 17 - 6

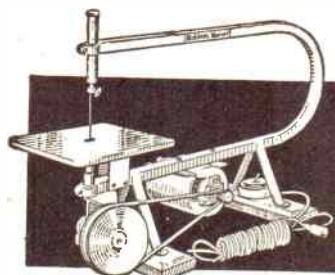

£12 - 5 - 0

TREADLE OR MOTOR FRETSAWS

Whatever the handyman or craftsman is cutting or making, one of Hobbies Fretmachines will help with the job. For toy making, fretwork, model making, it provides easy and speedy cutting in all kinds of material. A pleasure to use, a factory for output, a lifetime of service.

Obtainable at any Hobbies Branch or good class ironmonger or hardware stores. Or carriage paid U.K. from:

HOBBIES LTD., (Dept. 99), DEREHAM, NORFOLK

GOVERNMENT SURPLUS BARGAINS. Inter-room Telephones, comprising 2 self-energised microphone/receivers and approx. 6yds. flex (may be extended if desired). No Batteries needed. Nothing to wear out. Complete 9/6, post. 6d. Motors, Transformers, Switches, etc. 3d. stamps for illustrated list. Milligan's, 24 Harford Street, Liverpool, 3. Money Back Guarantee.

EVERY CAR THAT PASSES—YOU WILL FIND THE INDEX MARK ALPHABETICALLY ARRANGED IN

WHERE'S THAT CAR FROM?

Price 9d.

from all Booksellers or from the Publishers

(2d. postage)

RALEIGH PRESS, EXMOUTH

STOP SMOKING!! Quick guaranteed remedy. Free testing sample!! — Triumph Remedies (H), Exeter.

LEARN it as you do it—we provide practical equipment combined with instruction in Radio, Television, Electricity, Mechanics, Chemistry, Photography, etc. — Write for full details to E.M.I. Institutes, Dept. HW47, London, W.4

100 DIFFERENT stamps free! Request 1d. upwards discount approvals. — Bush, 53 Newlyn Way, Parkstone, Dorset.

STAMPS FREE — Empire Packet including Spectatorials and Victorians with approvals. — Robert J. Peck, 7A Kemp Road, Bournemouth.

GENUINE Swiss Musical Movements. The best and largest selection of tunes in the country, lowest prices 16/3 each. Genuine Thorens Movements, 22/9 each. All guaranteed. P. & P. 9d. extra on all orders. — Richardson & Forder, HW, 5 Chapel Place, White Hart Lane, London, N.17.

*** GREAT CAMPING OFFER *
RIDGE TENT** SENT FOR 4/-



BRAND NEW de luxe 'Safety' Tent. All colours. Complete. Ideal cyclists, campers. Length 7' 3" sleeping base x 4' 6" wide x 3' 6" high x 12" walls, all approx. Weight 3½ lb. Cash 55/-, or 4/- deposit and 6/- monthly. WITH FLYSHEET 83/6, or 9/3 deposit and 9/9 monthly. Both carriage 2/6. LISTS OTHER EQUIPMENT, TENTS, CLOTHING, WATCHES, ETC., TERMS.



Full size 72" x 24" factory tested, on 1 y 17/6 post etc. 1/6. If you require THE HEAVIEST

GAUGE MADE in Air Beds, namely 12,000, in satin floral design finish 72" x 24", price 21/-, post, etc., 1/9. **WRITTEN MANUFACTURERS GUARANTEE.** Strongly made, three length reeds, one additional for head rest pillow. Will bed, float you and rest you. Supplied in all colours. Double size 39/11, post, etc., 2/7. Childrens 48" x 21" 16/11, post 1/9. 3 or more post free. Limited stocks, send quickly.

Paints, Oils & Chemicals Department
(HOBW/57), 196-200 Coldharbour Lane Loughboro Junction, London, S.E.5 Open all day Saturday. 1 p.m. Wednesday.

'PAINTSPRAYING' HANDBOOK. Covers Car, Industrial & Flock Spraying. 3/6, post 4d. Catalogue of our Cellulose and Paints and all Allied Sundries 2/6. — Leonard Brooks Ltd., 81 Oak Road, Harold Wood, Essex.

STOP SMOKING in 3 days or money back. Safe, pleasant, permanent. The only scientific way. **No Will Power necessary.** 'Conquered the habit in 2½ days'.—F.C. 'Within 2 days I was free from the tobacco habit'.—W.G. 'Was a smoker for 2 years and broke the habit in 2 days'.—F.N. 'I used to smoke 20 a day . . . now I have no desire to smoke'.—J.M. Recommended by 'Health and Efficiency Magazine'. Complete course 6/6 (or \$1.00 bill). Details 2d. stamp. Send under plain cover. **NATURE REMEDIES, 28 (H/167) Dean Road, London, N.W.2.** Established 1928

MUSICAL BOX MOVEMENTS

14/9d. ONLY

Complete kits 21/6d.

SAE for details:—
SWISSCROSS CO., Dept. B, 116 Winifred Rd, COULSDON, SURREY

SWISS MUSICAL MOVEMENTS. Before you buy send 2d. stamp for our illustrated brochure. — Metwood Accessories (Dept. HW), Church St., Wolverton, Bucks. (Trade enquiries invited.)

SHIPS in bottles or electric light bulbs. Fascinating, profitable novelties. Complete instructions, diagrams, 2/- — Fraser, 157a Sheen Road, Richmond, Surrey.

STAMP CATALOGUE FREE — to all sending 3d. postage and asking for my approvals. — C. S. Berry (Dept. H.2), 32 Cross Whitehouse Row, Leeds, 10, Yorks.

Musical Novelties in Kits



No.3152 KIT 6/11

THE SWISS CHALET CIGARETTE BOX
Lift the roof to offer a cigarette — and it plays a tune of your choice. Kit No. 3152 includes wood, wire, hinges and full instructions to make the chalet and costs only 6/11.

MOVEMENTS 18/10

Fit them with these Musical Movements, 18/10.

Choose from this list:—

- A. Auld Lang Syne. B. Limelight.
- C. Swedish Rhapsody. D. Silent Night.
- E. Brahms' Lullaby. F. Harry Lime Theme. G. Blue Danube.
- H. Parade of the Wooden Soldiers. J. Bells of St. Mary's. K. Moulin Rouge. L. Vienna, City of my Dreams. M. Jingle Bells.
- N. Home Sweet Home. O. Some Enchanted Evening. P. Greensleeves. Q. O My Papa.

by



From branches, stockists or direct.

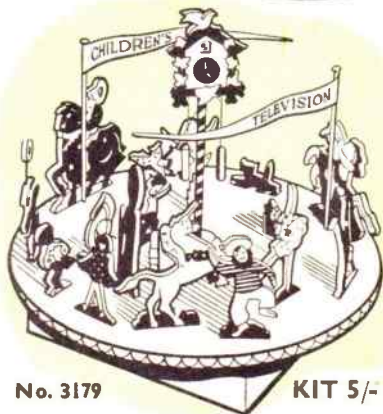

No. 3179

KIT 5/-

CHILDREN'S HOUR T.V. ROUNDABOUT
Delightfully authentic reproduction of the B.B.C. Roundabout which thrills millions of children each evening. Goes round to the music. Kit 3179 contains all wood and full instructions for making and the Roundabout costs only 5/-.

To Hobbies Ltd., Dept. 993, Dereham, Norfolk.
Please send name of nearest stockist and items marked thus X (all post free).

- Kit 3152, Swiss Chalet 6/11
- Kit 3179, T.V. Roundabout 5/-
- Musical Movement 18/10 (A. B. C., etc.)

Name

Address

Cut-out Alphabet and Figures

ABCDEF

GHIJKLM

NOPQRS

TUVWXYZ &

1234567890

THERE are many uses for these letters and figures. They are specially suitable for cutting from wood, plastic or metal, and can quickly be traced and transferred by means of carbon paper.

They are useful for window displays, house names, sign boards, etc. Word building blocks for children can be cut and the letters painted on, or the letters themselves can be used if cut from metal. Do not forget to use a Hobbies metal cutting sawblade in the latter case.

If you have a fretmachine it is simple to cut four alphabets at once. Pin four pieces of $\frac{1}{4}$ in. plywood together round the edges, and cut four at a time. (M.p.)

Paddle Your Own Canoe

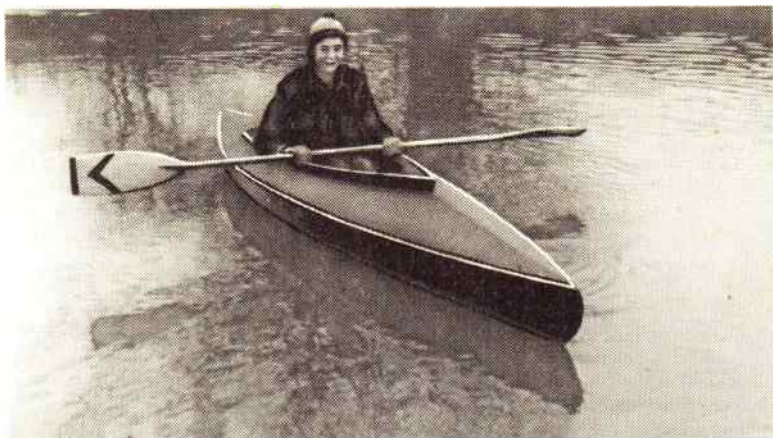

... and make
it with the
aid of
full-size
plans from

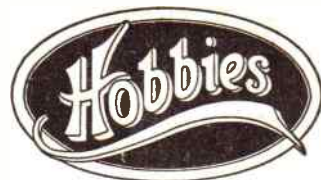

BUILDING COSTS FROM ABOUT £7

These plans contain all the information needed to build the canoe and its accessories. The main frames and other shaped parts are drawn full size for tracing direct on to the wood. There are plenty of constructional diagrams, with step-by-step instructions, and a detailed material list. Accessory instructions include the making of paddle, spray cover, trolley, rudder, sailing gear, etc.

All of these canoes are of the decked kayak type and are primarily paddling craft, but sail is useful as an auxiliary and can add to the fun of canoeing. If sailing capabilities are particularly required, PBK 20 is the best selection.

A canvas canoe can be built by the novice with limited equipment, and the average handyman can complete the job in about 40 hours. The structure consists of widely-spaced laths on cross frames, covered with a fabric skin. There are no difficult joints or awkward work. Plywood skinned canoes need more skill and a larger tool kit.

Building costs range from about £7 (for the PBK 10). We do not supply materials for building, but addresses of firms who do so are included with the plans.

DETAILS OF PLANS AVAILABLE

RIGID CANVAS-COVERED

PBK 10. Single seat, 11 ft. long, 28 in. beam, normal max. load 300 lb. The shortest satisfactory canoe. Economical in size and building costs. Room for lightweight kit. Price 11/-

PBK 14. A roomy single for the big man, or a two-seater for an adult and child, or two young people. 14 ft. long, 29 in. beam, normal max. load 500 lb. Popular tourer. Price 12/6

PBK 15. Single seat, 14 ft. 6 in. long, 26 in. beam, normal max. load 400 lb. The enthusiast's fast touring craft. Safe and stable. Suitable for any waters. Price 12/6

PBK 20. Two-seat, 15 ft. long, 32 in. beam, normal max. load 600 lb. Stable and seaworthy. Easily paddled and a good performer under sail. Popular with scouts and youth clubs. Price 12/6

RIGID PLYWOOD-SKINNED

PBK 16. Two-seater. 16 ft. long, 32 in. beam, normal max. load 700 lb. Flat-bottomed. Safe and robust. Popular for local hire on sea and river. May be left afloat. Price 12/6

FOLDING

PBK 24. Single seat, 11 ft. long, 28 in. beam, normal max. load 300 lb. Similar lines to PBK 10 but longer cockpit. Only canoe which packs into one bag small enough to go on bus. Price 12/6

From branches or direct (post free)

HOBBIES LTD (Dept 99) Dereham, Norfolk