

HOBBIES WEEKLY

IN THIS ISSUE

	Page
Record Storage Cabinet	81
Novelty Cube Puzzle	82
Beginner's Crystal Set	83
A Fine Model Farm	84
Novel Holder for a Broom	85
Make Ball Catches for Cabinets	85
Making the Best of Towers	86
Take Care of Brushes	87
Duck and Truck to Pull Along	88
After the Camping Season	89
The Right Adhesive for the Job	90
Handy Table for the Hall	91
Pattern for Novel Broom Holder	95



OCTOBER 31st 1956

VOL. 123

NUMBER 3183

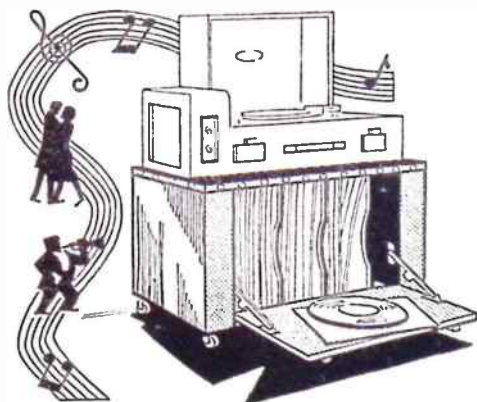

It's easy to make this **RECORD STORAGE CABINET**

DESIGNED for the modern record reproducer, this handsome cabinet serves a two-fold purpose. It holds about 200 records and is designed to increase the bass-response of the relatively small loudspeaker of the average record-player.

The records are readily accessible; they are stored in a way least conducive to warping and the whole equipment, being mounted on castors can be easily moved from room to room. It will be found particularly useful for operation at 'armchair level'.

The materials used are quite cheap, but most effective. The 'Weyroc', a modern man-made timber, gives good strength, and the hardboard cladding provides the baffle required to increase the bass notes without resonance.

Measurements given are based on the larger type of 'portable' record-player, but they can, of course, be adapted to suit any size of instrument. The finish, too, can be made to match the player by using rexine or any other covering over the hardboard similar to that on the machine.

The principal materials required are:

½in 'Weyroc' (oak-faced if desired)	4ft by 2ft.
½in hardboard	4ft by 4ft
1½ins by 1½ins deal	5ft
½in. rose beading	7ft.
4 castors, 2 cabinet stays, 1 pair of hinges, 2 ball catches and stays, 2 suitable handles (for hinged flap) and a square of green baize approx. 14ins. by 18ins.	

Starting with the framework, cut the

deal into four equal lengths of 13ins. Cut the 'Weyroc' into three pieces, two of 21ins. by 15ins. and one of 13ins. by 16½ins. The two larger pieces can then be fixed, at the corners, on to the four lengths of deal, forming the main framework as in Fig. 1. The method recommended for fixing the top corners is to drill through the 'Weyroc', screw down into the legs, and fill in the countersink in the 'Weyroc'.

The lower piece should be fixed in the same way, but here allow room for the castors to be fixed into the legs (Fig. 2). Two smaller screws are better than one large one in this case.

Now the hardboard can be fitted on to the framework with panel pins. Start by covering inside each end of the framework, then cover the outside, back and

All correspondence should be addressed to The Editor, Hobbies Weekly, Dereham, Norfolk

For Modellers, Fretworkers
and Home Craftsmen
World Radio History

4½^D

sides up to the lower edge of the top (which is finished off with beading). Cover the front of the two front legs with hardboard. The finish of the cabinet can be improved by chamfering the edges of the hardboard so that the corners are clean and sharp.

Fixing the partitions

The partitions in the cabinet are fixed in the following manner: Thin strips of wood 12ins. long are fitted in pairs at intervals along the inside top and bottom of the cabinet, leaving just enough width between them to allow the partitions to slide in. These partitions are of hardboard 13ins. by 12ins., with a cut-out piece for easy access to the records (Fig. 3).

The flap is made from the third piece of 'Weyroc,' 13ins. by 16½ins. It can be faced with hardboard outside to match the rest of the cabinet. Glue a piece of green baize on to the inside. This protects record surfaces when they are lying on the open flap. Now fix the flap into position on the front of the cabinet, securing the hinges on the under edge of the flap and on the floor of the cabinet (Fig. 4). When fitting the cabinet stays, ensure that the elbows do not fold back as far as the records. Fix the ball-catches on to the top of each side of the flap, the stays correspondingly in the cabinet.

Suitable handles can be screwed to the front. (The writer carved two handles 3ins. by ½in. by 1in. deep, sinking them into the flap and finishing off the outer edge in some of the 'rose' beading).

The castor spindle holders can now be

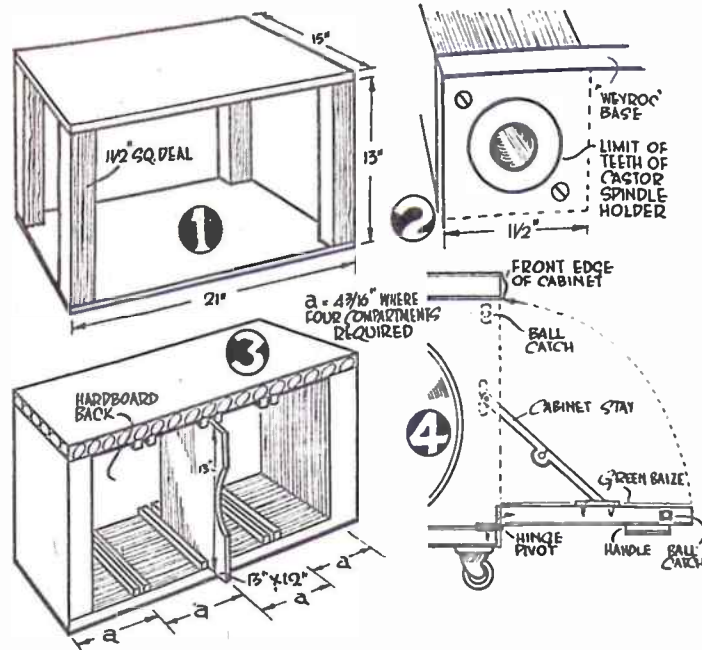

fitted tightly into the holes in the legs (see Fig. 2) and the castors pushed home.

To give more effect to the baffle arrangement, countersink the rubber feet of the record player into the cabinet top until the bottom board of the instrument touches the cabinet top.

The 'Weyroc' can be stained with wood dye, and the whole cabinet can then be given two coats of good clear varnish. The hardboard will tone down with clear varnish only and needs no staining.

(A.J.R.)

Novelty Cube Puzzle

THIS puzzle can be made from a scrap piece of wood in about twenty minutes. It can be solved in many different ways, but few people are able to solve it first time.

No definite sizes need be adhered to, but care must be taken to mark out and cut with great accuracy. The thickness of

wood chosen must be noted carefully. When planed up and ready for marking out as in Fig. 2, the width of the wood must be three times the thickness and the length ten times the thickness. For example, if ½in. wood is to be used, the width must be 1½ins., and the length 5ins. by 10=6½ins. It is

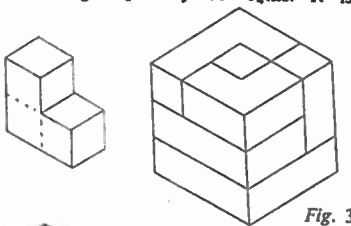

Fig. 3

Fig. 2

recommended that the thickness be not less than ½in.

Fig. 1 shows the shapes to which the piece of wood must be cut. Three pieces of shape (X) must be cut, making eight pieces in all. Providing a thin saw is used with great care no allowance is necessary for the saw-cut waste.

Mark out the piece of wood in squares, the side of each square being equal to the thickness of the wood (Fig. 2). The continuous lines represent saw-cuts and should, therefore, be pencilled in heavily. The arrowed lines indicate the first saw cuts, and the shaded squares are waste.

Cut out the various pieces and remove any sharp edges with a piece of fine glasspaper.

The object of the puzzle is to assemble the pieces to form a cube. Many solutions are possible, one of which is given in Fig. 3. (K.J.)

For medium and long waves

BEGINNER'S CRYSTAL SET

By F. G. Rayer

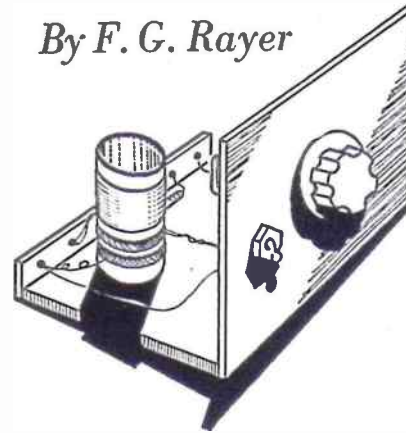

Medium and Long wavebands can be tuned. The full .0005μF condenser will usually have twenty to thirty plates, half fixed and half moving, the exact number depending upon the area of the plates, and distance between them.

An on/off switch is used for wave-changing, and can be of any type. Any kind of crystal, germanium diode, or crystal diode is satisfactory. Some crystal diodes have wire ends, and these can be taken directly to the terminals. Others require clips for the ends, or need to have connecting wires twisted on. Leads must on no account be soldered in place, or the detector is likely to be ruined.

Five bolts with nuts or terminals, and a strip of paxolin or ebonite 1in. by 6ins. will be required, and a wooden baseboard 6ins. by 4ins. by ½in. thick. The panel can be of 3-ply, 4½ins. by 6ins.

Making the Coil

This is shown in Fig. 2, and requires an insulated tube about 1½ins. in diameter. A Paxolin tube may be purchased, or it can be made by winding glued card or brown paper round a suitable object, removing, and allowing to dry. When dry, such home-made tubes should be varnished to exclude moisture, and to stiffen them. The tube needs to be at least 3ins. long.

For the M.W. section, eighty turns of

28 SWG enamelled wire are used, wound closely side by side. When about forty turns have been wound on, a loop long enough to reach the one aerial terminal is twisted in the wire. This is point (2) in Fig. 2, (1) being the beginning of the winding, and (3) the end.

A space of about ½in. is then left, and some 32 SWG cotton-covered wire is joined to the end of the M.W. winding. One hundred turns are then wound on, in a compact pile about ½in. wide. A ½in. space is left, a further hundred turns wound on, and the wire finished off at (4). All turns throughout the whole coil must be in the same direction, and the ends can be anchored by passing them through pairs of small holes in the

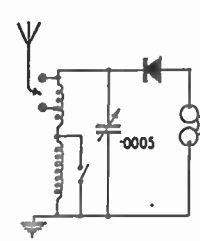

Fig. 1—Circuit

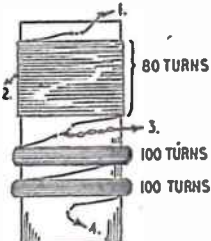

Fig. 2—Tuning Coil

tube. End (3) will be two wires, as in Fig. 2.

The coil is mounted by cutting a strip of wood upon which it can be pushed, and screwing this to the receiver baseboard, as in Fig. 3. The finished coil

MANY constructors begin with a crystal set, and that described here is ideal for a beginner, as there are no snags or difficulties, and good results can be anticipated. The set tunes both Long and Medium Waves (like the average domestic radio).

Readers who have never built a crystal set may appreciate a few details of the results to expect. To begin with, such a receiver requires no mains or battery supplies whatever, which helps to account for the popularity of sets of this kind. Its chief limitations are lack of sensitivity, and rather flat tuning — which means that a crystal set is really intended for listening to local stations only. The actual maximum range from a major B.B.C. station is around 100 to 150 miles or so, though it is occasionally possible to hear some overseas stations, at low volume, after dark. (Wave propagation is reduced by daylight).

It is also very desirable to provide a good aerial and earth or volume will be reduced. There is no amplification, as in valve sets, so that a very short aerial, and using the set with no earth, will not be very satisfactory.

Crystal detector and other parts are almost 'everlasting' and no further licence is required if the householder has a licence for an existing receiver. Running costs are thus absent.

Circuit and Parts

The circuit (Fig. 1) is of the usual type which proves best for general results. The .0005μF tuning condenser should be air-spaced, though a solid-dielectric one can be used, if to hand. A knob will be required for it. Condensers of less than .0005μF will reduce the wavelength coverage, so that only part of the

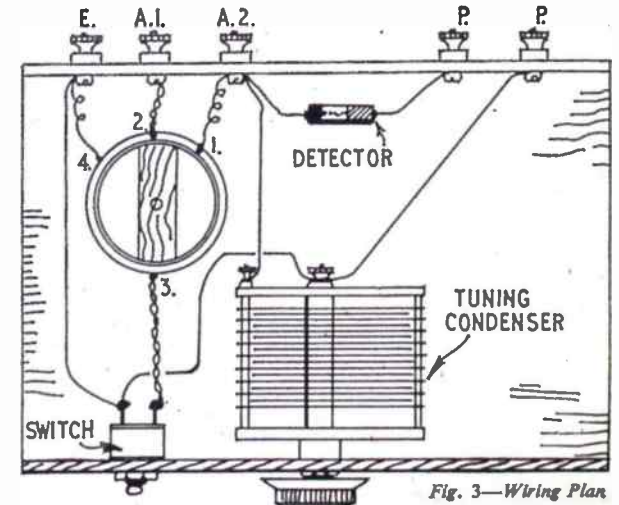

Fig. 3—Wiring Plan

must not be painted with varnish, wax, or any other substance, though a touch of varnish or wax will help to hold the ends secure. The turns will not move, if tight. It is in order to fit large cardboard 'washers' to the tube, if desired, and to wind the two 100-turn piles between these, to keep them compact. Slight modifications in the coil diameter, wire gauge, or number of turns will not significantly influence results, but very thin wires and small tubes are not satisfactory.

Wiring Up

Some of the 28 SWG wire will be satisfactory for connections in the set, all of which will be seen in Fig. 3. Insulation must be scraped from the ends of the connections, and a tight clean joint obtained. Leads from the coil are numbered to agree with Fig. 2.

Some tuning condensers will be different from that shown, and may have tags or terminals situated in different places. However, one will go to fixed plates, and this tag or terminal is wired to A2 in Fig. 3. Similarly, the moving plates terminal, tag or contact strip (or frame, with a metal-framed condenser) is connected to the terminal marked (P).

Failure to obtain proper tuning may arise from a broken coil winding or shorted condenser. This can be tested for with phones and a dry cell. Continuity through the coil windings will be shown by a loud click in the phones. There should be no contact between fixed and moving plates of the condenser. Examination or testing with a battery and bulb will check for this.

Volume obtained can be greatly influenced by the type of headphones, and those suitable for crystal sets are necessary. These will be of medium or high impedance. Low impedance and moving-coil phones are sold by some ex-service stores. These are designed for other equipment, and are not satisfactory with crystal sets.

In the event of no signals being heard, the phones or their leads must be suspected if they are old. The phones should click loudly if the leads are momentarily touched on a dry cell. If not, they cannot function. Testing up at each ear-piece will show if the fault is in the flex leads or phones themselves.

Using the Set

The phones are wired to terminals marked (P) in Fig. 3. The Earth lead is taken to the terminal (E). The best earth consists of a metal spike or other metal object buried in damp soil out-of-doors. Sometimes a lead may be clamped to a descending water pipe. Gas pipes are not suitable, nor are rising water pipes, or any connection which only goes to earth by a round-about path. Fair results with no Earth will only be obtained up to twenty-five miles or so from a station.

For maximum volume, a long high out-door aerial well away from walls, trees and any earthed object is best. It can be of 7/22 wire, which will also do well for the Earth connection. One or two small egg insulators should be fitted at suspension points. About 60ft. of wire will provide an efficient aerial, carried in one length to form both aerial and down-lead. The latter should

be kept a few feet from walls, etc., for maximum signal strength.

Sufficient volume will often be obtained with less effective aerials, or even with an indoor aerial. The latter should be near the ceiling, and can be carried round two walls of the room. With such an arrangement, an Earth becomes very necessary. Indoor aerials are not suitable in metal buildings. Short rod aerials are not satisfactory.

An average aerial can be taken to terminal A1. Using terminal A2 will slightly increase volume, but flatten tuning. It is thus most suitable for a relatively inefficient aerial. Medium Waves are tuned with the switch closed, and Long Waves with it open.

It is possible to sharpen tuning to almost any desired extent by providing a tapping nearer to point 3 on the coil, or by using a pre-set condenser in series with the aerial lead-in. Such modifications will result in a loss of signal strength, and this limits their practical use, except when a local station is very near.

 * Next week's free de- *
 * sign will be for a novel *
 * Weather House and *
 * Thermometer. Make *
 * sure of your copy. *

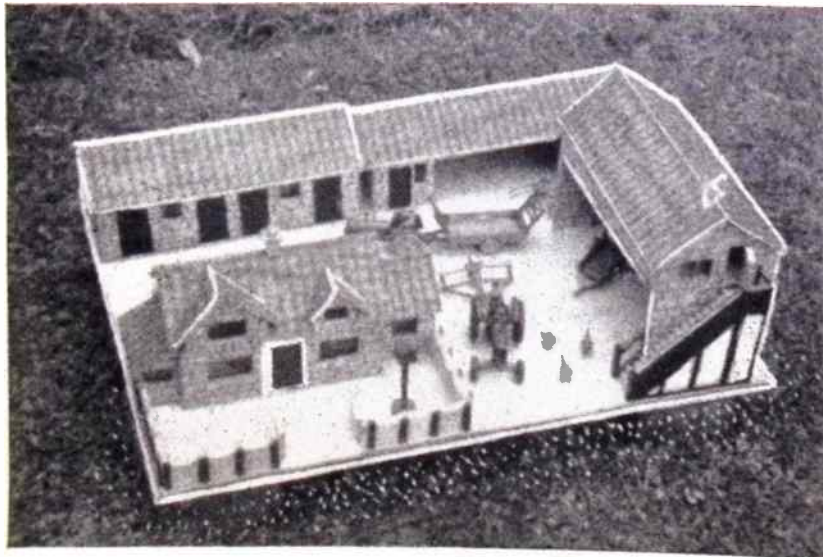

A FINE MODEL FARM

It looks like the real thing photographed from an aircraft—but in reality this is a Model Farm made from Hobbies Kit No. 249 Special by a young reader. There is a farmhouse, a barn with loft, stables and cowshed, and the kit with full instructions for making, costs 47/6, from branches etc., or post free from Hobbies Ltd, Dereham, Norfolk

There is plenty of time to make up one of these model farms for Christmas. Get a kit now and give some youngster a thrilling present in his or her stocking.

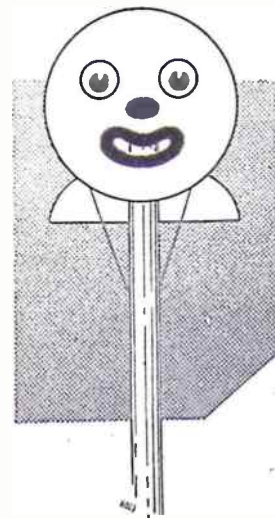

THIS is just the thing for a boy to make up as a present for his mother. It should be fixed to the kitchen wall or broom cupboard in a convenient position. The broom handle is simply pushed up from underneath and is supported by the two eyes which move realistically as the handle is inserted.

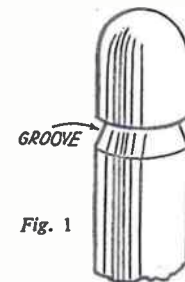

Fig. 1

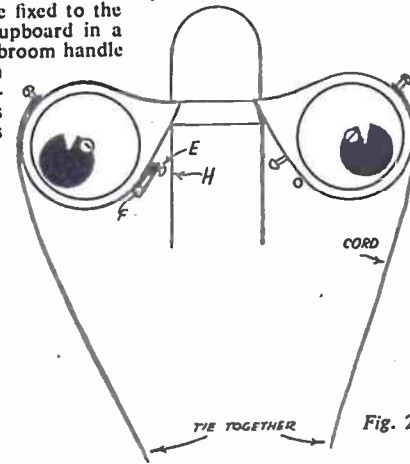

Fig. 2

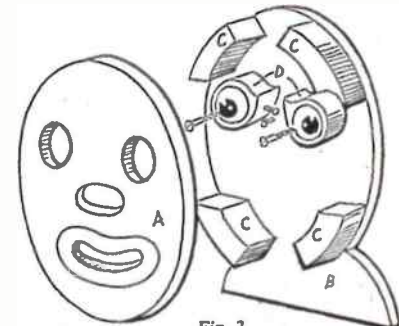

Fig. 3

A Gift for Mum

NOVEL HOLDER FOR A BROOM

The handle is grooved as shown in Fig. 1 and it is held in position as shown in Fig. 2. A general view is shown in Fig. 3.

The head is made in two pieces and both are cut from 1/4 in. wood. They are shown full size on the pattern page. The front (A) is a circular piece with the eyes

Patterns on Page 95

and mouth cut out and the back (B) is plain with an extra piece at the bottom to form the shoulders. Cut two pieces to the shape (D) and paint the eyes on as shown. Remember that one faces left, the other right.

The spacing pieces (C) should be 1/4 ins. thick. They can be made up from one 1/4 in. and one 1/8 in. piece glued together. The shape is shown by the dotted lines on piece (A).

To assemble the holder glue the spacing pieces to the back (B). Next secure the eyes in place, making sure that they will swivel easily. Keep the eyes in position by means of a small elastic band over the pin (E) in the eye and the pin (F) in the back. This is shown clearly in Fig. 2. The broom is removed by pulling on the cord attached to the eyes.

The final job is to paint the face in bright colours, giving three or four coats if necessary. Secure the holder to the wall by means of screws in the positions (G). If the elastic needs renewing, the face can easily be removed by means of the four roundhead screws. (M.p.)

MAKE BALL CATCHES FOR CABINETS

WHEN making small wooden cabinets, etc., why not make your own ball catches for the doors? This simple means of keeping the doors closed requires only a ball bearing, spring, and a strip of ordinary tin.

Three-eighth in. wood is a most suitable thickness on which to apply the catch, but where your door is only 1/4 in. wood, make the complete unit with a small panel of 1/4 in. and screw on to door and frame.

Ascertain the position on the door where you require the catch to operate. Drill hole 1/4 in. deep for the spring and ball to drop into. The hole needs to be only a fraction larger than the ball itself.

The tin cover (ordinary tin 1 1/2 ins. by 1 in.) requires a hole in the centre drilled with special care until the ball almost passes through. While still flat place this over the hole in the door and neatly bend to shape, rounding off ends with file and emery paper.

Test the spring

With the ball and spring in position test the action with your finger, shorten the spring as necessary until the ball works satisfactorily, then finally fix the tin cover to the door with appropriate pins or small screws.

A similar component is made from the same kind of tin, shaped as before,

for fitment in a corresponding position, to the door frame to engage the ball. The hole may be slightly larger this time, but make a recess in the frame before fixing.

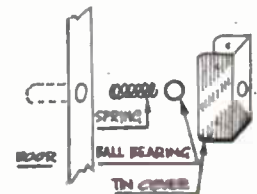

Photographing Churches

MAKING THE BEST OF TOWERS

OLD Cathedrals, Abbeys and village Churches which have withstood centuries of weathering offer unlimited scope for picture making — architectural, record, interior details, tombstones, fountains and ancient entrances. Yet, often it is the tower which dominates the whole structure on one's 'first glimpse', giving each its individual, characteristic 'memory tug'.

In many old cathedral or market towns or villages, it is again the tower, solid and foursquare, or turreted, or spired, which seems to dominate the first view above the roof-tops or the trees. Frequently, however, a snap seems to have lost this dominant characteristic; — the tower rising high above all

some loss of definition and distortion of proportions. To correct really satisfactorily calls for a tilting easel and the negative tilted the OPPOSITE way, not possible with all enlargers.

By E. G. Gaze

Sometimes a deliberate angle shot with the camera tilted sharply upwards is effective in securing an unusual shot of the tower against an effective sky background: but an album of such tower prints tends to become monotonous.

Moving further away means that the

tower is smaller on the negative space, but it is often better shown in its proper high-up seclusion among its surroundings. Its dominant, soaring characteristic is retained. The owner of a telephoto or long-focus lens has the advantage here inasmuch as a large image of the tower may still be obtained on the negative, but the ordinary camera user is not necessarily at a disadvantage.

Looking for a view point which allows the tower to dominate often takes the ordinary camera to little suspected view points. Most old towns and villages have narrow by-ways and alleys which give one unexpected vistas leading to the tower. It is always worth while to scout around for these, even if it means returning in conditions of different lighting — for, except for silhouette purposes, side or near back lighting on the tower gives a better chance of good texture-rendering of stonework and decoration. A Church amid clusters of trees often shows an unexpectedly attractive vista of the tower framed by the foliage, and a tower rising above old gabled roofs may be more attractive and characteristic than a simple plain view of the tower alone.

Too close a snapping position results in cropping the tower, all effect of its soaring dominant quality being lost.



else. In most cases a little care and forethought will help to avoid this.

In many instances the fault lies in getting too close to the whole structure. As one nears the lower portions of the building and those around grow nearer and larger in proportion — the tower still rises high and dominates, but we raise our gaze TO IT. A snap from this position means raising the camera by tilting to include the tower — this causes converging verticals. Converging verticals can be partially or wholly corrected in enlarging by tilting the enlarger easel and stopping down the enlarger lens, but the result entails often

Away from the town, a meadow view has tower in attractive setting, allows camera to be far enough away to avoid cropping tower. Contrasting and detailed foreground helps to counteract small air-space above tower.



The church tower snapped rising above a line of old gabled roofs, from a quiet back lane — proportionately large air-space above tower lends air of spaciousness to scene.

In searching for these not-obvious vistas you may decide that the best taking position is from someone's garden or yard, and generally most folks are willing to allow you to enter to snap. A print sent to them is a kindly gesture, often much appreciated.

Another bugbear of photographing too close is the cropped tower, or one jammed right to the print top. The soaring quality of a tower calls for clear

air space above its highest point, with nothing man-made fouling the background above it. If you search for the view which best shows the dominant nature of the tower you will move further from it — and so avoid this fault.

The amount of air-space above the tower may be very small in proportion to the size of the whole print. A large air-space lends a sense of spaciousness,

but often a well-filled and detailed foreground will balance a very small amount — but some air-space there must be, the tower must not be cropped off.

Final Tips

To sum up; too-close a snapping position often entails losing the characteristic dominating quality of the tower, may mean tilting the camera and causing converging verticals, may not isolate the tower well enough from its immediate surroundings, may very likely mean cropping the tower and leaving no air-space above. Moving further away, searching by-ways, alleys and meadows, often enables you to isolate the tower while still presenting it in a pleasant vista, giving it the quality of soaring height as it was conceived and built, to dominate the church itself and its immediate surroundings.

A final tip. Filters are often used to bring out the clouds, but they can be used for a different purpose — to improve texture rendering. A yellow filter on a light stone or sandstone tower will deepen the shadows of the pattern-work and texture, enhance contrasts and so improve detail rendering. Similarly an orange filter can be used to effect on a red brick or marl coloured tower — a red filter may well darken the blue sky unnaturally. Remember to take into account the increased exposure factor when using filters — for any purpose.

Take care of Brushes

WATER has always been regarded as the natural enemy of paint and varnish, and so it should be regarded in its relation to the brush. Never, under any circumstances, allow a brush to come into contact with water.

A new brush can be dealt with quite sensibly by working it gently over the palm of the hand, removing as much loose dust as possible. After this the bristles should be completely immersed in benzine with one hand and worked with the fingers of the other hand at the same time, until the brush is as clean as possible.

A common mistake is to put the clean brush on the bench to dry after cleaning. Instead, it should be hung up by a piece of string, otherwise there is always the danger of it getting knocked on to the floor, and will then be dirtier than before washing.

If it is intended that a brush should be used for varnish, then keep it solely for that purpose, and do not permit its use for paints. The reason is quite simple. If used for paint, then small particles of paint will work their way into the hollow

ends of the bristles and under the metal clamp of the holder. These will dry, and if the brush is next used for varnishing, some of these are bound to come out on the job, and completely spoil your careful work.

It is advisable not to use your new brush for finishing coats immediately after the initial cleaning. When dry, the brush should be dipped into the varnish and the bristles worked on the side of the container several times. Having thus 'worked in' the brush, use it for a few days for undercoating only, which will enable the bristles to settle down well for the harder painting of finishing coats.

Unfortunately, it is the usual practice for anyone painting to leave their brushes on top of the paint container whilst they have a break — perhaps, for a meal. These sticky bristles act as a well-made fly catcher and all passing pieces of stuff are invariably caught.

It is far more sensible, although taking longer, to park the brush free from the unwelcome attentions of this dust, which is undoubtedly the greatest enemy of varnish.

The brush must be suspended in the varnish, thereby completely submerging the bristles but not, however, so that they are bearing the weight of the stock and are bent on the bottom of the paint container.

Probably the easiest method is to make a lid out of cardboard, or better still, out of plywood or hardboard, to fit the top of the container. Cut a slit across the lid from the centre to the side about 1/2 in. in width. Next, drill a small hole through the handle of your brush, sufficiently large to accommodate a small nail or matchstick.

Thus, when the work has to be left for a short while, it is a simple matter to push the nail or stick through this hole, placing the brush through the lid into the paint or varnish, and the nail will stop the brush from falling into the paint.

Unfortunately, if through accident or neglect, a varnish brush has been allowed to dry with varnish in its bristles, then its life as a varnish brush may be said to be over. There are, of course, several patent cleaners on the market which are quite satisfactory to soften up such brushes, but it will be found that such treatment makes the bristles lose their spring. The brushes can only then be used on rough painting work, such as cement or bricks. (A.T.)

DUCK AND TRUCK TO PULL ALONG

CHILDREN love an animal or bird pull-along toy, especially if it has some mechanical motion about it. The prototype model of the pull-along toy illustrated belongs to this order, and proved to be eminently popular when given to a child for its trial run-around.

By T. S. Richmond, Jr.

The duck has plenty of movement. The little fellow's beak 'chatters' as his legs revolve along in a true walking manner, pulling behind him the four-wheel truck loaded with wood bricks or other material.

Fig. 1 gives reduced-size patterns of the shapes that make up the duck when cut out with a fretsaw, and assembled in four stages, as in the sketches at Fig. 2. Copy carefully the pattern on thin paper which has been ruled off in 1 in. squares. Draw in the inside shapes, using a compass for marking out the four-legged 'wheel' and the semi-circle within which it revolves. Divide the wheel off and draw in the four legs and feet. Transfer

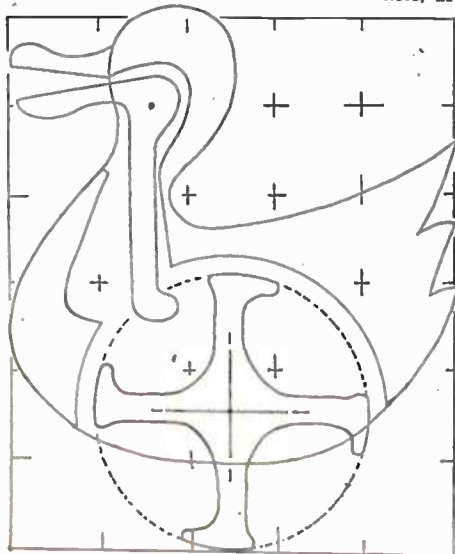
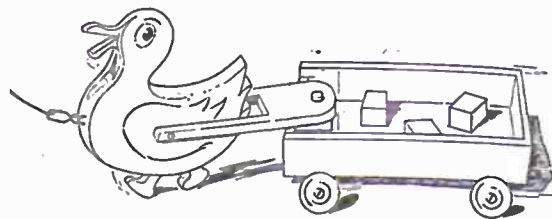

Fig. 1

the outline of the figure on to wood of $\frac{1}{4}$ in. thickness. Repeat this on another piece of wood of same thickness and cut the two shapes out, or, better still, if you can pin the two boards together temporarily, cut them out together. Next transfer the centre sections onto wood of $\frac{1}{4}$ in. or $\frac{1}{2}$ in. thickness. All the centre parts, including the legs and the lower beak parts can be cut out from one panel of wood, or alternatively cut from oddments of wood which are large enough to take the individual shapes. Unless plywood is to be utilised for the centre parts, it would be as well to arrange the shape of the beak on to the wood in such a way that the grain of the wood runs along the length of the beak. It will then not be so likely to get broken off as may happen if the grain of wood runs through the width of the bill. Smooth the cut-out shapes with fine glasspaper, and glue the two centre shapes to one of the sides. Drill a hole through the lower beak piece, and one also in the centre of the four-legged wheel, so that a wire nail may be slotted through each.

A shaving or two will have to be taken off these two pieces to reduce the thickness, as they must pivot freely within the body of the duck when the second side piece is fixed on. Hold these parts in their respective positions as outlined on the pattern, and shown in sketch (3), Fig. 2. Drive a nail through the hole in the beak into the side, so that it can pivot freely. It should drop to the 'open' position on its own weight. Pivot also the legs on a nail, after positioning centrally. When the legs are turned, they close and release the beak movement intermittently.

Nick the pivot nails down with pliers to a length a little longer than the thickness of the beak and legs. Press on the second side piece so that two indentations are made by the nails. Take the side off again and bore holes deep enough to accept the nails, before finally fixing on with fret nails. Unless the reader intends to paint the



FOR A CHILD

bird's legs and feet before assembling, the side should be only temporarily pinned on, without using glue, so that it may be removed when the time comes for painting the finished toy. Give a little shape to the head and breast by smoothing round with a file and glasspaper. Paint the body white, and feet and beak yellow. Paint in the eyes with a fine brush.

The Truck

Fig. 2 shows the simple construction of the pull-along truck. The measurements of the few pieces of wood that go to make it up are as follows, and may be varied to suit the wood that the reader may have available. Base: 8 ins. by $4\frac{1}{2}$ ins., $\frac{1}{4}$ in. plywood. Sides: 8 ins. by $1\frac{1}{2}$ ins. Length of end pieces cut to fit between sides, according to thickness of wood used for sides. The front end piece, which should be about $\frac{1}{4}$ in. thick, is only 1 in. in width. Behind it is glued a block of hard wood of the same width, and is approx. $1\frac{1}{2}$ ins. square. A hole is drilled centrally through the block and base to accept the pivot rod.

Cut the shaft piece to the shape given in Fig. 2, from wood of about $\frac{1}{4}$ in. thickness, and drill the hole at one end. The rod is about $2\frac{1}{2}$ ins. long and $\frac{1}{4}$ in. diameter. Glue it into the shaft and leave to set. Cut two wheel bearers from $\frac{1}{4}$ in. stripwood, 5 ins. long by $\frac{1}{4}$ in. wide. Glue and nail one bearer to the rear of the truck. Drill a hole centrally in the front bearer. Slot the rod through the block after dropping on a washer or two, and turn the truck over; holding the shaft in position. Slip another washer on to the rod before gluing on the front bearer.

The truck would be best painted in a

gay colour before fixing on the four wheels. $1\frac{1}{2}$ ins. diameter is a suitable size wheel for this size of truck, and can be of wood or metal. Drill holes into each bearer before screwing on the wheels. Washers can be added.

The two units complete, they can be hitched together to complete the toy. Slot the truck into the shaft. It should fit neatly in place if the measurements given have been followed. The slot in the shaft should, of course, be the same width as that of the duck. Pivot in place with two short screws. When the duck has been adjusted so that its feet 'walk' the floor, the two screws are tightened up. The screws should, however, not go right through the sides and prevent movement of the 'works' within. Oddments of wood can be put in the truck, and a staple or screw-eye added to the duck on which to tie a length of cord.

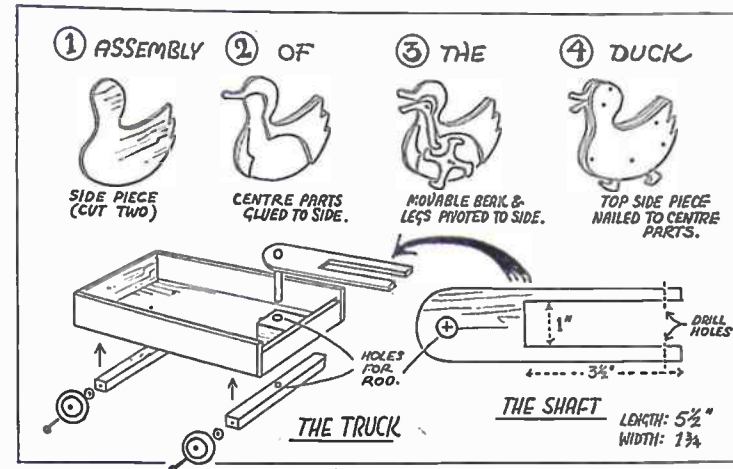

After the Camping Season

BEFORE storing away your tent for the winter, it should be carefully inspected, and any repairs done where necessary, and all frayed or torn places cut out and new canvas sewn in on the underside of tent. Give it a good brush over. Hang the tent on the clothes line and dry it thoroughly.

Badly-frayed guy ropes and broken toggles or eyelets should be replaced with new material. All ropes and guys may be affected adversely if stored away while damp. It is a sensible thing to examine and test all guys before winter storage to ascertain if they have developed weak places during the season when in use. If any are suspected, replacements must be made before you go camping again. Stretch well all new rope to take the twist out of it. Ropes will be no worse for a brush over with boiled linseed oil. Check over all runners, tent pegs or skewers. Wood tent pegs can be given a coat of green outdoor paint.

Special attention must be given to the tent pole 'housing'. See that the pole sockets are in good order, and that the poles have not sustained any damage or defects. Replace with new poles if necessary before going camping again. Tapes for door fastenings should be renewed if necessary. Sew round all corners and rings with waxed thread.

Waterproofing

When you have made sure that the tent, including fly-sheet, is quite ready for housing, hang it up in store — always in a dry airy place — with any metal parts well greased with Vaseline.

If you find it necessary to waterproof the tent, apply a proofing solution with

a soft brush, painting the solution all over the canvas and working it well into the seams. Start work at top or ridge of tent with your 'painting' and carry on methodically down to the walls and bottom. Most camping outfitters supply waterproofing solutions. Read the directions on the tin and follow them. It is a wise thing to get this done before storing away the tent. Make sure the canvas is in good order before doing this task, and do any necessary repairs before commencing. See that the tent is perfectly dry before housing it. You will, of course, choose what the housewife calls 'a good drying day' on which to do this waterproofing job.

Cooking gear should be well cleaned, inside and out, and then smeared with grease to prevent rust. Give your cooking stove a good clean-up and empty it of any paraffin or petrol, then pack in a wooden box placed in a dry corner of your store-shed, or attic. Canvas buckets and basins should be washed and thoroughly dried out, and then hung up.

Look over ground-sheets and see that the rubber is not perished. Rubberised ground-sheets should be given a wash, and dusted with french chalk before hanging them up along with the tent. Mend any torn places or holes with patches cut out of an old cycle inner tube. Ordinary rubber solution will serve for such patching and also for repairing cycling capes.

Parked camping gear will probably need a 'once-over' occasionally during winter. Check up on it at intervals, to make sure that the old enemy DAMP is not getting a foothold anywhere. It is an insidious thing, attacking stealthily

canvas materials and resulting in mildew and mould.

If you spot such traces brush off the greeny 'moss' at once.

Remember, camping outfits should be stored always in a thoroughly dry place that is airy and well ventilated. It is better to hang up the tent if you have the accommodation than to fold it up.

If you perform these tasks you have the satisfaction of knowing that you have done your best in taking care of your kit, and this is much better than just dumping it in some spare corner. Taking due care of equipment will pay you handsome dividends in the long run. (A.S.)

REGILDING A FRAME

WASH the frame with turps, and repair all chipped edges as follows. Make a paste with powdered whiting and liquid glue. Spread a little glue on the broken parts, then apply the paste so that it stands a little above the moulding. Allow one day for this to set hard, then shape to the moulding with a sharp pen knife and glasspaper.

To regild, paint the surface with gold size, leave a minute or two till it is tacky, then 'paint' or dust very lightly over it (with a brush) a gold-bronze powder of suitable shade. If the frame is a large one, regild it in sections. When quite dry, dust off the superfluous bronze powder. (R.L.C.)

Facts you should know

The Right Adhesive for the Job

EVERY handicraft calls for some kind of adhesive. Thanks to modern research, we now have a variety of adhesives for every type of material, with the old fashioned glue pot superseded by handy tubes, jars and tins. These modern dehydrated powders are not only more convenient and economical, but more effective. Bonding is so strong that the material is more likely to give way than the joint.

Glues may be roughly divided into two principal classes, animal and vegetable. The animal glues, made from bones, require heat for mixing, and their power diminishes with successive heating. This is quite apart from their unpleasant odour. Vegetable glues are not so strong, yet form the basis of our mucilages, gums and starch pastes. We use them for smaller gluing jobs like bookbinding and in the manufacture of medicines or foodstuffs. And, of course, neither of these two classes is waterproof. Research has given us the synthetic resin glues, which should not be confused with the natural resin of trees. The following glues are now available to the handyman and their different uses and values will be shown.

Casein Glues

Little Miss Muffett little thought that one day curds and whey would lose popularity as a delightful comestible to be the basis of a very useful adhesive. Cow's milk contains a white tasteless substance named casein, the name of the glue. Skimmed milk is allowed to sour, when it separates into curds and whey. The latter is filtered off, leaving the curd, which is ultimately pressed, dried and ground to a powder. Much of this powder is imported to this country from various parts of the world since home production is insufficient. An alkali is added to make the glue.

Cold water only is needed to make this glue ready for use, but note that being an animal glue, some heat is required. Fortunately, the normal room temperature of 65° is sufficient, but icy cold water or cold work will impair the strength.

These glues have tremendous strength. They resist moisture to a large extent, although it is not claimed that they will withstand all external weather conditions. They can be used in practically all joinery work or for gluing wood to a variety of other materials, including plastics. It should be noted that the alkali in some casein glues is liable to

stain oak, but a stainless variety is also available.

Synthetic Resins

These have no connection with the natural resins found in vegetation, but are the result of controlled chemical processes. Urea and Formaldehyde, popularly known as U/F glues, produce a viscous liquid, spray dried for conversion into powder form. Mixed with cold water only for use, they are widely used in the manufacture of plywood. The handyman will find them extremely useful for joinery work where dampness is suspected. They are quite stainless, suitable for joinery, fine cabinet work and bonding plastic materials to wood.

Amyl Acetate Glues

This type of glue could almost be called the glamour girl's friend, for it will stop ladders and polish her nails. True, it is closely related to nail varnish and film cements, being sold under a variety of different proprietary names. It is extremely useful for many household repairs, particularly for broken glass or china. If care is taken in making the repair, joints will bond perfectly, resisting water. This adhesive is first applied to both surfaces of the break and allowed to dry. A second coating is then applied with the parts kept under pressure until set. It is also useful for insulating and fixing together the loose threads of electric flex.

Polyvinyl Acetate Glues

You may have used this unknown to yourself, for it is a constituent of the popular emulsion paint. Many of the tins bear the letters P.V.A., although few know the actual meaning. This type of glue is a comparatively new introduction to this country, although widely used in the U.S.A. It is available in small jars ready for use and is very useful for a multitude of household jobs such as repairing smaller wooden articles like toys, mounting photographs and such like. It will keep almost indefinitely if the lid is firmly replaced.

Latex Glues

Here we have an entirely different type of adhesive from all the foregoing. In effect, it is a virgin rubber solution. While it is suitable for an abundance of small handicrafts, it is not intended for woodwork. Its value is in dealing with fabric repairs of all kinds. Carpets may

be bound, rugs may be made and torn clothes repaired quite easily. It is extremely good for mounting photographs. This adhesive dries rather rapidly and is best applied with a celluloid spreader on large areas like photographic prints. If a brush is used, you will need to steep it in carbon-tetrachloride to remove the waste.

Thermo Plastics

This is one of the latest types of adhesive to be introduced, and one suitable for many types of handicrafts. It will be found particularly useful for leather and plastic repairs, although wood, paper and many small articles may be satisfactorily bonded. An application of heat will improve the bond and with smaller articles the domestic iron — provided protection be given to the article itself — will supply the necessary temperature.

There you have quite a wide variety of modern adhesives, but to get the best results, all are dependent on one thing, that is, adequate pressure while undergoing setting. Pressure can be applied by weights or cramps, while wedges may be used as an emergency measure. Nails or screws will apply pressure, or rubber bands for china and glass. With larger pieces of joinery, and if you have no cramps, a good way is to bind with strong cord. A short batten is inserted in the centre of the cord to allow twisting in the fashion of a tourniquet. Make sure that the batten is firmly held, or the cord will untwist and the pressure will be lost. Rubber bands made from the inner tubes of motor tyres also form a useful means of applying pressure.

There is just one other thing. Remember that all glues work the best when applied thinly. (S.H.L.)

A 'BOY' at 35

'Hobbies 1957 Annual was just the book I was looking for, and may I say how pleased I am with it. It has solved my problems of a winter's evening hobby. Although I'm 35 I shall be a boy again, thanks to Hobbies'.

So writes a Plymouth reader of Hobbies 1957 Handbook, which is now on sale (only 2/-) at all branches, newsagents, etc. You can obtain a copy of this grand 152-page issue, which contains absorbing articles on how to make toys, furniture, novelties, etc., by sending a 2/3 P.O. to Hobbies Ltd., Dept. 991, Dereham, Norfolk.

CHRISTMAS CRACKER MATERIALS

We can supply Everything for this interesting and very Profitable Occupation. (No experience needed.) SNAPS . . . HATS . . . FILLINGS . . . CREPE and LINING papers ready cut to size . . . AND the BOXES for the finished crackers . . .

Send stamp NOW for FREE LISTS and INSTRUCTIONS. Special Beginners Outfit making two dozen crackers 5/-, post free.

GAITY NOVELTIES (Dept 3)
AMEN CORNER :: TOOTING :: S.W.17

12/6! CRYSTAL RADIO

Make the 'WINNER' crystal set—only a screwdriver and pliers required, only 6 screws to fit, no soldering. Kit of parts with building instructions only 12/6 post free. Building instructions alone, 1/.

Send P.O. 1/- or 12/6 to:—

BLANCHARD'S RADIO

(Dept. H2), 13 GAINFORD GARDENS, MANCHESTER, 10

A HANDY GLASSPAPER BLOCK

A wooden block with special handle which holds glass-paper taut and always in place. In two sizes, 3in., price 1/6; 5in., price 2/9, post free.

HOBBIES LTD., DEREHAM
Norfolk, and all Branches

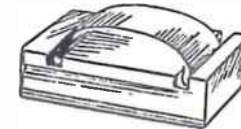

Make Leisure a Pleasure with



and be a 'favourite' with the children

MODERN GARAGE and SERVICE STATION

Base 24 x 18 in. Every boy's ideal. Easily made from Hobbies kit which includes petrol pumps.



From branches, stockists, etc., or by post.

39/11

To Hobbies Ltd., Dept. 991, Dereham, Norfolk. Please send FREE 20-page booklet and items marked with X.

- Garage Kit, No. 3129, 39/11.
- Tudor Doll's House Kit, No. 237 Spl., 89/6.
- Hobbies 1957 Handbook, 2/3 (all post free).

NAME

ADDRESS

"A few minutes to spare" NOW'S THE TIME TO DO THAT SEALING

JOB WITH PLAX

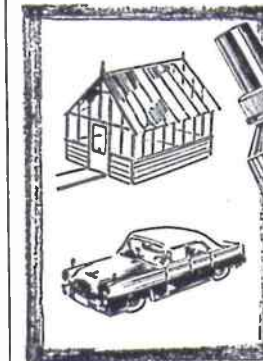

Use 'PLAX' the all-purpose flexible sealing compound . . . Ideal for repairs to garages, greenhouses, cars, caravans or boats. Quick and easy to apply. Cracks and leaks sealed in a few minutes.

No handyman should be without a tube in his kit Available in Ivory, white or black from Ironmongers, Stores, etc.



Complete with application tool

PLAX

An Expandite Product, distributed exclusively by CHARLES CLEEVE & CO. LTD
45 Great Peter Street, S.W.1

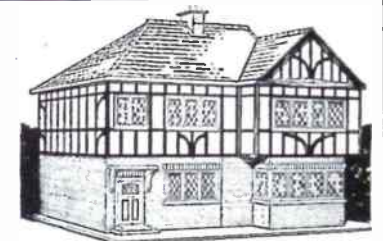

LARGE TUDOR DOLL'S HOUSE

2ft. wide, 2ft. high. Strong and lasting. Kit includes metal doors, windows, etc. 89/6

HUNDREDS of Ideas in

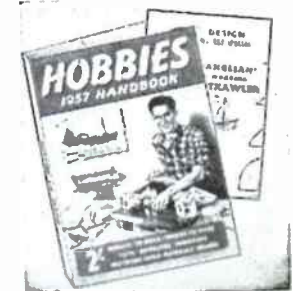

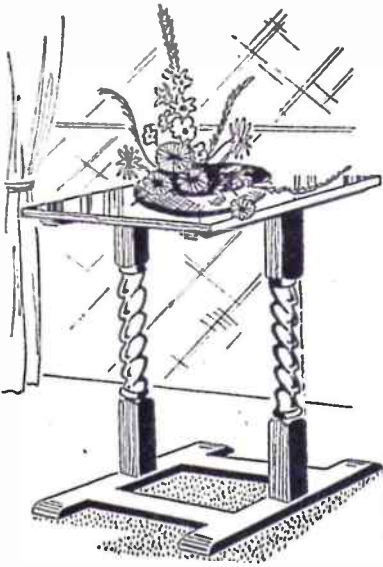

In Jacobean style
**HANDY TABLE
 FOR THE HALL**

The legs are prepared by cutting off a portion at each end as shown in Fig. 2. Make sure that they are cut dead square. The ends are then sawn to form stub tenons as detailed in the small diagram. The tenons should be marked out carefully before cutting and checked against the mortices in the rails.

Make the rails from 1 1/2 ins. by 1/2 in. wood to the dimensions shown in Fig. 2. Pieces (D) are dowelled into pieces (C) and are also glued and cramped. Here again pieces must be cut perfectly square to ensure a good fit. The construction is the same for top and bottom frames, but the pieces (C) are 2 ins. shorter than pieces (A).

Keep under pressure

The top consists of a single piece of wood 12 ins. by 14 ins. by 1/2 in. It is glued to the top framework and countersunk screws are inserted underneath. After gluing and screwing, the top should be kept under pressure for a day or two to prevent warping. Place it on a flat surface and pile books on top.

The complete assembly is shown in Fig. 3. The top and bottom frames, the legs and top are shown in their correct position for gluing together.

The finish will consist of staining and polishing. Clean up with glasspaper and fill the grain with woodfiller. Apply the stain lightly at first, gradually working up to the required colour.

If you are not proficient at polishing, a good finish can be obtained by using clear lacquer. Allow the first coat to dry and lightly glasspaper before applying the next.

Hard gloss finish

After two or three applications sufficient body will have been built up to use Silicon Carbide paper with water. Rub down well and give a final coat of clear lacquer. The result will be a good hard gloss almost equal to french polishing. (M.h.)

THIS light and useful table is intended for the hall or lounge and will support a large bowl of flowers or a pot plant. It could also usefully be employed as a stand for a telephone. It is rather short for this, however, and would be better if longer legs were used to give a total height of about 2ft. 4ins.

Ready-turned legs

The legs shown in the illustration are Hobbies No. 535, price 8/- pair, post free. They can be obtained from Hobbies Ltd., Dereham, Norfolk. Plain pieces of 1 1/2 ins. square wood may be used, however, in place of the turned legs to give a contemporary appearance.

The diagrams in Fig. 1 show a front view and side view with parts lettered for easy recognition. Other diagrams are lettered correspondingly.

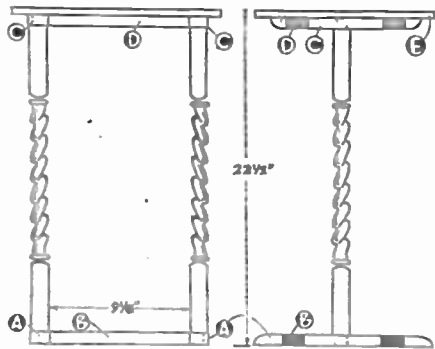

Fig. 1

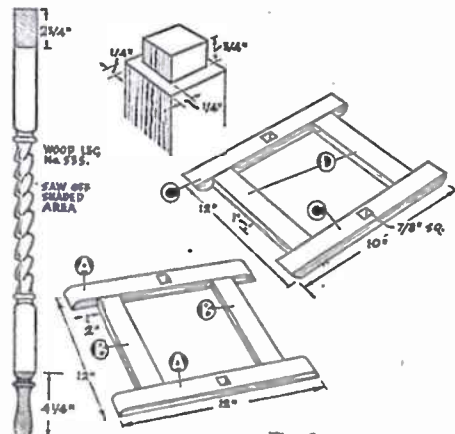

Fig. 2

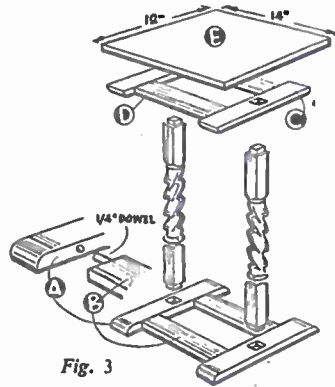

Fig. 3

LOOK! Take your popular **4\"/>**

Selecta (PAT. APP. FOR)
HOME WORKSHOP
 and you have a **COMPLETE**
"ALL-IN-ONE" UNIT MADE IN ENGLAND

**DO ALL THE ABOVE
 JOBS AND
 MANY MORE
 WITHOUT
 ADDING
 ANY
 OTHER
 KIT!**

CASH PRICE £13-10-0
 (EXCLUDING DRILL)

YOURS FOR £2-10-0 DEPOSIT
 and 8 monthly payments of £1-12-6 (plus 6/- carriage)
MONEY REFUNDED IF MACHINE RETURNED WITHIN 7 DAYS
 Visit our Stand No. 57 at the Manchester Home and Handicrafts
 Exhibition Nov. 13-24

POST COUPON NOW

Please send me your **FREE** 32 page illustrated Booklet

NAME.....
 ADDRESS.....
 B. Elliott & Co. Ltd. (H.W. 1.)
 Victoria Works, Willson
 London, N.W.13.

Make model buildings—

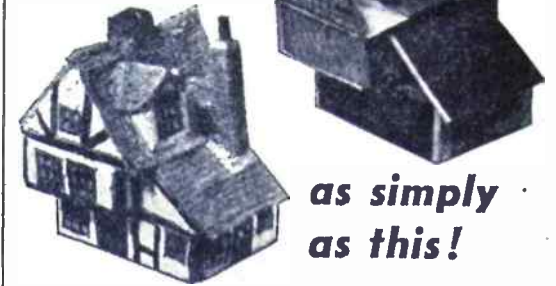

**as simply
 as this!**

A new method—described in a new book on Pyruma Modelling. This shows how to turn empty match boxes into model buildings, by Pyruma 'Plasticraft'. It is one of the many methods of modelling in plastic Pyruma, shown in black and white and full colour pages, which enable you to build and finish in natural colours:—

**MODEL FARMS, RAILWAY STATIONS, SIGNAL CABINS,
 AIRPORT BUILDINGS, DOCKS, SHIPS, FIGURES, ANIMALS,
 ASHTRAYS, BOOKENDS, DOLL'S FURNITURE, PLAQUES,
 RELIEF MAPS, ETC.**



is a ready-to-use material, cheap to buy locally, and easy to work by following the Instruction Book offered below. Pyruma dries or can be baked to stone-hard permanence, then painted in natural colours. Sold by local Ironmongers and Hardwaremen, Hobbies shops and Art material Dealers, in airtight tins from 1/6 upwards.

Send Coupon and 6d. P.O. (not stamps) for this **NEW** Book of instructions to:—

J.H. SANKEY & SON, LTD.

Estd. 1857
 Dept. H, ILFORD, ESSEX

Enclosed 6d. P.O. (not stamps) for **PYRUMA MODELLING** INSTRUCTION BOOK address as:—

NAME.....
 ADDRESS.....

'PAINTSPRAYING' HANDBOOK. Covers Car, Industrial & Flock Spraying. 3/6, post 4d. Catalogue of our Cellulose and Paints and all Allied Sundries 21d. — Leonard Brooks Ltd., 81 Oak Road, Harold Wood, Essex.

LEARN it as you do it — we provide practical equipment combined with instruction in Radio, Television, Electricity, Mechanics, Chemistry, Photography, etc. — Write for full details to E.M.I. Institutes, Dept. HW47, London, W.4.

100 DIFFERENT stamps free! Request 1d. upwards discount approvals. — Bush, 53 Newlyn Way, Parkstone, Dorset.

STAMPS FREE — Empire Packet including Pictorials and Victorians with approvals. — Robert J. Peck, 7A Kemp Road, Bournemouth

Sent **2/6** For CASH 21/- POST 2/6



THE Tom-Tom WIGWAM TENT

CONSTRUCTED OF SUPERB "TOM-TOM" COTTON PROOFED FABRIC AND NOT MADE OF NYLON. 4' 3" x 4' 3", height 5' 6". Built with collapsible poles, dismantle swiftly and transport elsewhere. No centre pole. Erect anywhere. A real waterproofed Tent. Holds 4/5 children. ALL AGES. Send 2/6 dep., then 4 mthly. payts. 5/9. Cash 21/-. Post 2/6. Waterproof Groundsheet 10/6 if req.

CASH **59/6** WRIST WATCHES REAL GOLD PLATED FRONT AND BACK NO DEPOSIT LADIES OR GENTS MODELS



'AIRCRAFT' shock resisting wrist watch. Fitted accurately tested pin-lever movement. Written guar. Cases are REAL GOLD PLATED all over, dials are silvered with gilt raised figs. and hands. Send only 2/6 for packing & registration. bal. 18 fortnightly payts. 3/8. CASH, on strap, 59/6 or LADIES' MODEL 10/- extra. Matching bracelet 12/6 extra. Luminous 6/6 extra. Lists, Terms. Headquarter & General Suppliers Ltd. (HOBW/31), 196-200 Coldharbour Lane Loughboro Junc., London, S.E.5 Open Sat.

Stick to **SECCOTINE** — it sticks Regd. everything!



KEEP A TUBE IN THE HOME Sole Manufacturers: McCaw, Stevenson & Orr Ltd., Belfast

I MUST GET ...the EXTRAORDINARY Home-made GADGETS MAGAZINE ... EVERY MONTH it fully describes OVER FIFTY ingenious gadgets, devices and novelties I CAN MAKE. I'll get it at W. H. Smith's etc., or send 1/3 direct to:— Home-Made GADGETS MAGAZINE (26) Kingsbury, London, N.W.9 ● 10/- buys the HUGE 1957 Gadgets Annual ●

Classified advertisements are accepted at a cost of 6d. per word prepaid. Send P.O. with advertisement to Advertisement Dept., Hobbies Weekly, Dereham, Norfolk

GENUINE Swiss Musical Movements. The best and largest selection of tunes in the country, lowest prices 16/3 each. Genuine Thorens Movements, 22/9 each. All guaranteed. P & P. 9d. extra on all orders. — Richardson & Forder, HW, 5 Chapel Place, White Hart Lane, London, N.17

SWISS MUSICAL MOVEMENTS. Before you buy send 2d. stamp for our illustrated brochure. — Metwood Accessories (Dept. HW), Church St., Wolverton, Bucks. (Trade enquiries invited).

CONJURING catalogue and Trick Changing Card. 1/- — DeHempsey, 363 Sandycombe, Kew, Surrey.

MUSICAL box movements only 14/9 post free. Complete kit including movement 21/9 post free. S.A.E. for details. — The Swisscross Co., Dept. B., 116 Winifred Road, Coulsdon.

EXCITING and worthwhile stamps free. Send 21d. requesting discount approvals. — Raemor Trading Co., 185 Willesden Lane, London, N.W.6.

HUNGARY 1955 Winter Sports — this most attractive set sent free to approval applicants enclosing postage. — Yulwontmor Stamps (Dept. H5), 29 Layton Avenue, Mansfield.

CASTING moulds for lead soldiers, animals, etc. Illustrated catalogue 4d. Sample mould 6/6. — G. F. Rhead, Bacton, Stowmarket, Suffolk.



Build the *real thing* —

with **BRICKPLAYER**

- Brickplayer Kit 3 26s. 0d.
- Brickplayer Kit 4 48s. 9d.
- Kit 3A converting Kit 3 into Kit 4 26s. 0d.
- Brickplayer Farm Kit 58s. 3d.
- 2000 Bricks Box 55s. 0d.
- Extra Bricks, Roofing and Cement in low-priced packs.
- Windows and Doors obtainable singly.

BRICK AND MORTAR BUILDING KIT AND ACCESSORIES

The Brickplayer Kit contains miniature bricks in all required shapes, mortar, roofing, plastic windows and doors, plans and instruction booklet. All models are architect designed to 'O' gauge scale. Buildings, can be permanent or dismantled by merely soaking in water and the bricks used again and again. Obtainable from good toy shops and departmental stores. If your dealer cannot supply, write for leaflet and address of nearest stockist to:



J. W. SPEAR & SONS LIMITED
Dept. 'HW', Enfield, Middlesex

See page 85

Novel Broom Holder

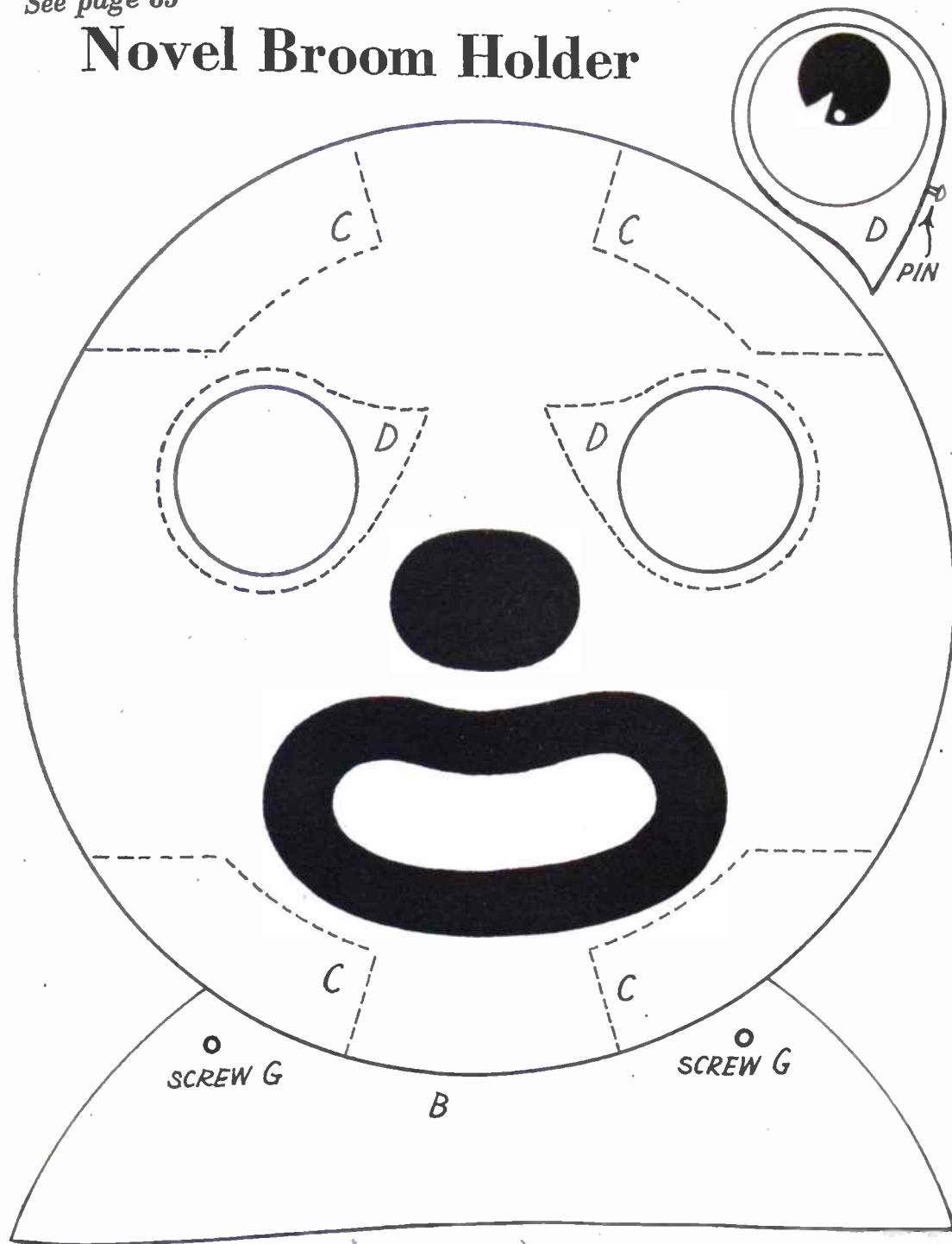

A Touch of Distinction..

in YOUR home

MAKING colourful models of famous ships of history is a hobby which has existed ever since men first sailed the seas, and the finished models make a distinctive display in any home. Hobbies market an extensive range of kits for models from 7in. to 22in. long. Each contains a design sheet and complete instructions, planed wood ready to cut to shape, sail parchment, cord, etc. With a fretsaw and a few odd tools even the amateur can begin right away. The model illustrated is the 7½in. "Regent" for which a complete kit (No. 3064) costs only 8/6. Another popular miniature is the 'Warwick' (No. 3164) the kit for which is 8/1.

Other kits are shown in Hobbies free booklet, and details of all Hobbies kits and tools are contained in the 1957 Handbook—152 pages packed with interest for the handyman. Use form below and receive your kit by post. Also obtainable from ironmongers or stores, and Hobbies branches.

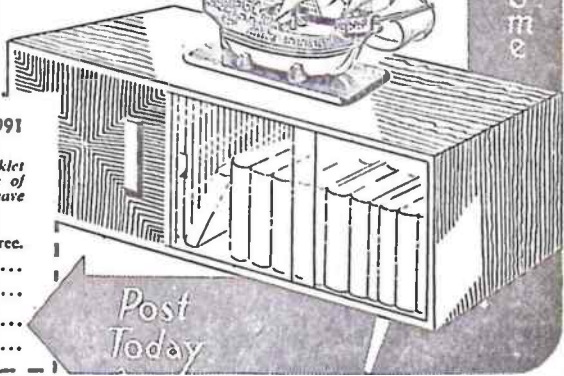
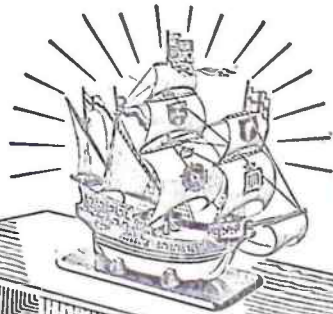

To: **HOBBIES LTD., DEPT. 991
DEREHAM, NORFOLK**

Please send me your Free 20-page booklet "Profitable Leisure", and name and address of my nearest stockist. Also send me items I have marked thus X.

- 1957 Handbook 2/3, post free. Regent Kit (3064) 8/6, post free. 'Warwick' Kit (3164) 8/1, post free.

NAME

ADDRESS

I enclose P.O. for

.....

NEW!

**THE PRACTICAL WAY
of learning RADIO
TELEVISION · ELECTRONICS**

- Beginners Radio Course
- Advanced Radio
- Short Wave Technique
- Lesson Manuals

Experimental work includes construction of Basic Oscillators, Amplifiers, Deflectors, Power Units, 1, 2 and Multivalve TRF and Super-het receivers.

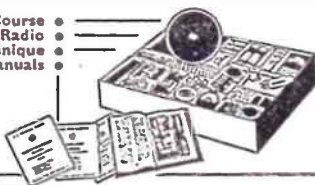

COMPLETE EXPERIMENTAL COURSES IN RADIO ENGINEERING and SERVICING

An entirely new series of courses designed to teach Radio, Television and Electronics more quickly and thoroughly than any other method. Specially prepared sets of radio parts are supplied and with these we teach you, in your own home, the working of fundamental electronic circuits and bring you easily to the point when you can construct and service radio receivers, etc. Whether you are a student for an examination; starting a new hobby; intent upon a career in industry; or running your own business—these Practical Courses are ideal and may be yours at very moderate cost. With these outfits, which you receive upon enrolment and which remain your property, you are instructed how to build basic Electronic Circuits (Amplifiers, Oscillators, Power Units, etc.) leading to designing, testing and servicing of complete Radio and Television Receivers.

COURSES FROM 15/- PER MONTH

POST THIS COUPON TODAY

To E.M.I. Institutes,
Dept. 31, Grove Park Road, London, W.4.
Please send me your FREE book on Practical Courses

NAME

ADDRESS

31 OctIC74

**EMI
INSTITUTES**

associated with
"His Master's Voice,"
Marconiphone,
Columbia, etc.

Don't just stick it



FIX it

CERTOFIX liquid glue can cope with all general repairs. It unites wood, glass, metal and almost all substances. It is clean in use; its joints are stronger than the materials it unites.

Make it immovable with

CERTOFIX

Sold at all Woolworth Stores