

# HOBBIES WEEKLY

IN THIS ISSUE

	Page
A Cabinet for a Toolmaker	241
Useful Advice on Metal Cleaning	242
Baits for Winter Pike	243
Experiments with Chrome Alum	244
Short-Wave Receiver	245
Make a Dutch Cradle	246
Puzzle in Wood	247
Making a Leather Purse	247
A Postcard Masking Frame	248
Stringholder and Knife	248
New Ways with Old Vases	249
Modern Bureau-Bookcase	250
Replies to Readers	252
Patterns for Stringholder and Knife	255



JANUARY 25th 1956

VOL. 121

NUMBER 3143

*Many uses will be  
found for this*

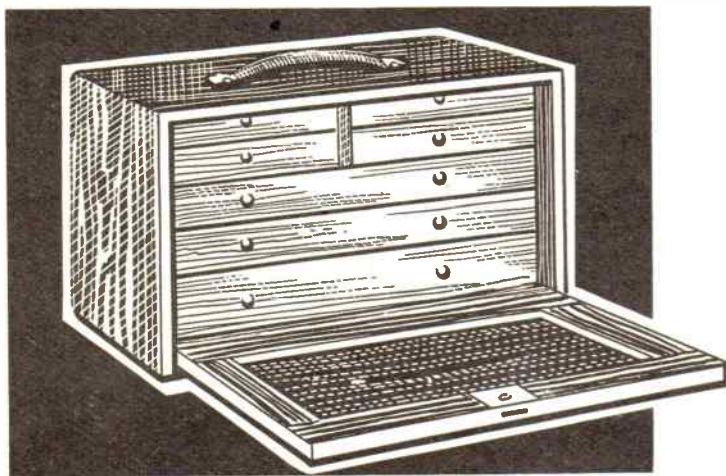

**A**LTHOUGH designed specifically for storing tools, this cabinet can be utilised in many other ways. The gardener might find it handy for storing seeds, bulbs, catalogues, etc. The housewife could keep paper bags, cake and greaseproof paper in such a container.

To meet the needs of the engineering apprentice, construction has been kept as simple and as cheap as possible, and it will be seen from the diagrams that the make up is quite straightforward.

The side and front views in Fig. 1 show the main dimensions. If a smaller cabinet is needed make the necessary calculations as to size before commencing to cut out the various parts.

The sides, top and bottom are cut from  $\frac{1}{2}$ in. wood and are simply glued and screwed together as shown in Fig. 2. The back consists of a piece of  $\frac{1}{2}$ in. or  $\frac{3}{8}$ in. plywood glued and screwed in position. The edges of the plywood may be slightly rounded. Use countersunk screws and fill with plastic wood or putty before staining.

#### Partition Piece

The partition piece is next prepared. It is  $7\frac{3}{8}$ ins. long by  $4\frac{1}{2}$ ins. deep and is cut from  $\frac{1}{2}$ in. wood. Glue pieces of  $\frac{3}{8}$ in. by  $\frac{1}{2}$ in. stripwood along each side as shown in Fig. 3. These pieces form the runners for the two top drawers. Note that a notch is cut  $\frac{3}{8}$ in. by  $\frac{1}{2}$ in. into which the front of the first long drawer fits.

Continue by cutting lengths of  $\frac{3}{8}$ in. by  $\frac{1}{2}$ in. stripwood  $7\frac{1}{2}$ ins. long to act as runners for the drawers. The positions are shown in the sketches in Figs. 4 and 8, and they depend upon the depth of the drawers. The drawers are flat at the bottom and the fronts project at the top as seen in Fig. 5.

## CABINET FOR A TOOLMAKER

Make the drawers from  $\frac{3}{8}$ in. wood and the bottoms from  $\frac{1}{2}$ in. plywood. The overall depth of each drawer is  $7\frac{3}{8}$ ins. and the depth of the sides is 1in. The back is the same depth as the sides, but

All correspondence should be addressed to The Editor, Hobbies Weekly, Dereham, Norfolk

For Modellers, Fretworkers  
and Home Craftsmen

World Radio History



PAGE 241

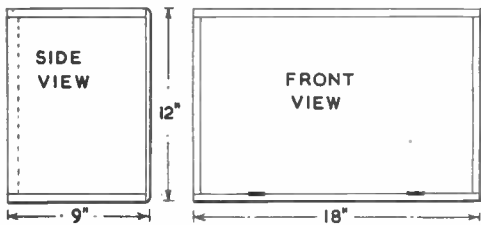

Fig. 1

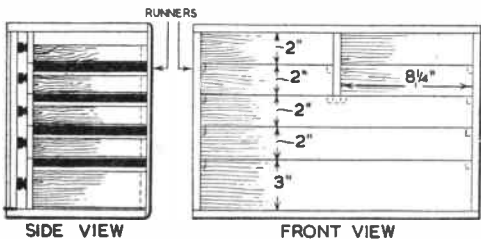

Fig. 4

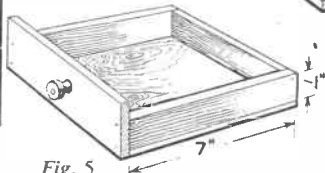

Fig. 5

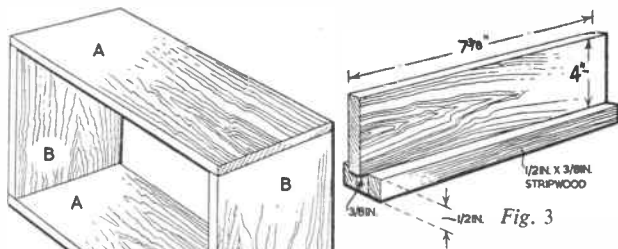

Fig. 2

Fig. 3

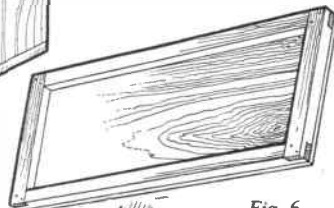

Fig. 6

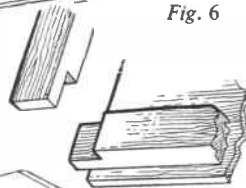

Fig. 7

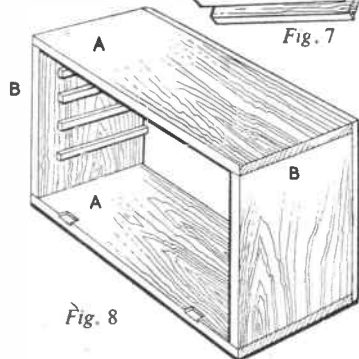

Fig. 8

the length of this and the front varies according to which drawer is being made.

The lower drawer is deeper than the others and 1 in. should be added to the depth of sides and back. This drawer has sufficient depth to allow for partitioning if required. Make sure that there is sufficient clearance to allow the drawers to slide easily. No. 707 knobs can be screwed to the front as shown in the picture of the finished cabinet. The knobs cost 4½d. each, post free, from Hobbies Ltd., Dereham, Norfolk.

#### Plywood Door

The door is cut from ½ in. plywood which is framed with 1 in. by ½ in. stripwood. Fig. 6 shows the door and framing, while Fig. 7 shows a detail of the halving joint employed. Use glue and

screws throughout when framing the door. It would be wise before commencing to cut the parts for the door to decide the type of lock to be used. You may have to increase the dimensions to the top rail to allow for the depth of the lock.

Having fitted the lock, the door is hinged in place using 1½ in. heavy brass hinges which can be obtained from Hobbies Ltd., price 11d. per pair.

Finish off by staining and polishing, or by giving a few coats of clear lacquer. The drawers should be lined with green baize. Finally add a suitable handle such as an attache case handle, No. 6189, obtainable from Hobbies Ltd., price 7d. Metal corners can be made and fitted if desired, but these are not essential.

(M.h.)

## Useful Advice on Metal Cleaning

**W**HATEVER the type of metal, whether it be silver, chromium or pewter, brass or copper, care should be taken in cleaning, particularly to use the right cleaning agents.

For **SILVER**, a good grade silver cream should be applied with a sponge or a soft cloth. Warm soapy water should afterwards be used to wash the silver and a soft cloth for drying it. Silver should not be piled or knocked together.

There is another way of cleaning silver, known as the aluminium-pan method, but this method should not be adopted for cleaning ornamental silver, as it removes the oxidation of the silver in the design as well as on the surface.

The procedure is to put a small

quantity of silver in an aluminium pan of boiling water. Then add 1 tablespoonful of salt and 1 tablespoonful of baking soda to each quart of water used. Let the silver stand in the hot

~~~~~  
*By E. M. Blackman*  
 ~~~~~

water until the tarnishing has disappeared. Next, taking care to avoid scratching or denting, remove the silver from the pan and wash it in hot soapy water, after which, rinse and dry it thoroughly.

**CHROMIUM** and **PEWTER** requires no elaborate method. All that is necessary is for it to be washed—with hot soapy water—then rinsed thoroughly with clear hot water and polished with a clean dry cloth.

**BRASS** and **COPPER** can be washed with ammonia water.

The tobacco stains which soil brass and copper ash-trays can be removed with denatured alcohol. Any good metal polish can then be used to polish, or a combination of vinegar and salt will serve the purpose. In either case, the process of washing with warm soapy water; then rinsing and drying thoroughly, needs to be adopted.

As a final word of advice, in all polishing avoid the use of 'fluffy' or 'bitty' cloths.

*With rod and line*

## Baits for Winter Pike

**P**IKE are now in their winter quarters, where an attractive bait should prove irresistible. There are many the angler may choose from to try. Big pike prefer a live-bait to anything else. You may try your luck with a small 'jack' fished on a snap-tackle, and probably catch fish of any weight from 3lbs. to 20lbs.; for if there's one thing a pike likes better than another for his dinner it is a nice plump young one of his own kind.

However, he does not turn up his snout at other fish, and is never 'finicky' in his tastes when hungry—a dead sparrow, a piece of offal, the rind of a piece of pork, a white herring or a rat—he just dotes on rats!

However, the angler will much prefer to use more orthodox baits and lures. Try the tail-end of an eel—if you can catch one of the slippery customers!

It is a very taking bait. First, catch your eel—that's the rub! Failing eel-tail, try a small dace 4ins. to 6ins. or so, or a gudgeon; or any fish, such as roach, etc.

Dace are brighter and livelier than many other species, and so catch the eye of a cruising pike bent on dining, more than the sober-hued gudgeon or similar fish. Next in order, select a roach, or a bleak, or small chub. Your live baits must be freshly caught. Carry them to the waterside in a suitable container, with an inner kettle which can be withdrawn and lowered into the water, until you need the baits.

Live-baiting where permissible, as it is on most waters, is a popular method and accounts for more pike than other methods.

Another likely method is to use a paternoster tackle baited with a live or

a dead fish, which can be a minnow or other smallish fish. A pickled or salted sprat can also be tried. With a paternoster you can test the deeper holes and corners, under boughs, weir-pools, by camp sheathing, and similar spots.

### *Spinning is fun Says A. Sharp*

If you would enjoy some good fun, try a day's spinning with a lightweight outfit—a 7ft. split cane rod, a spool-reel and fine thread line. With such an outfit you can cast a lure all day without fatigue, and cast to a long distance. When you do hook a fair-sized fish, say, 10lbs. upwards, you'll have plenty of thrills ere you land it.

There are many artificial spinning lures. The spoon-bait is popular and is usually a 'killer' when pike are on the prowl. Devon minnows, wagtails, phantoms, artificials representing fish of various kinds, spoons with tassels, kidney spoons, etc.—there is a wide choice. Wagtails in blue and silver, and red and gold, are well worth trying. For shallower waters the American-type plug lure is excellent.

Spinning is also carried out with dead natural baits mounted on special spinning flights. Salted and pickled baits can be used in this method, but dead natural roach, dace, rudd, gudgeon, etc., are the best. Spinning flights vary, some are intended to 'wobble', others to spin straight. They are more killing on some days than others.

Though pike are sometimes suicidal in their eagerness to snatch up a bait, on other occasions they are just as different, and refuse to be tempted. Pike can be caught in all sorts of winter weather, but a day when there is a ripple on the surface of the water is better than a still day.

There is something fascinating about fishing for winter pike. We are inclined to think that it is because the pike is so attractive an opponent—a fish worthy of one's steel. There is, too, the thrill of anticipation—you never know what may be lurking down there in the greeny-brown winter waters—maybe a 20-pounder or even something bigger. That is, no doubt, the subtle attraction of pike-fishing. You never know what you may get, particularly if fishing a worth-while water noted for its outsize fish with the primrose-marbled greeny flanks.

## *Profiting from his Hobby*



Mr. E. O'Rourke, 8 Dunlop St., Newton, Cambuslang, is seen here at work with his Hobbies A1 fretmachine, which has proved a profitable source of income. He has made up numerous articles from the designs appearing in Hobbies, and by selling these, has procured for himself quite an array of tools

for his workshop. Readers will recognise some of the models displayed. Those on the walls are made as plaques and look very attractive with the use of tinfoil and Velvet Spray.

Mr. O'Rourke so rightly points out that with his fretmachine he can speed up work by cutting out two or more at a time.

# Experiments with Chrome Alum

**T**HE deep purple crystals of chrome alum are familiar to most amateur photographers. Besides its photographic application, the chemical is used in dyeing and leather tanning. In tanning it has the advantage of yielding a much faster process than does bark tanning. Chrome-tanned leather can be recognised by its grey-blue colour.

Chrome alum is actually a double salt containing one molecule of chromium sulphate, one of potassium sulphate and twenty-four of water of crystallisation, its chemical name being chromium potassium sulphate. If you

hold a thin crystal of it to the light, you will see that it appears red, instead of the deep purple when viewed in reflected light.

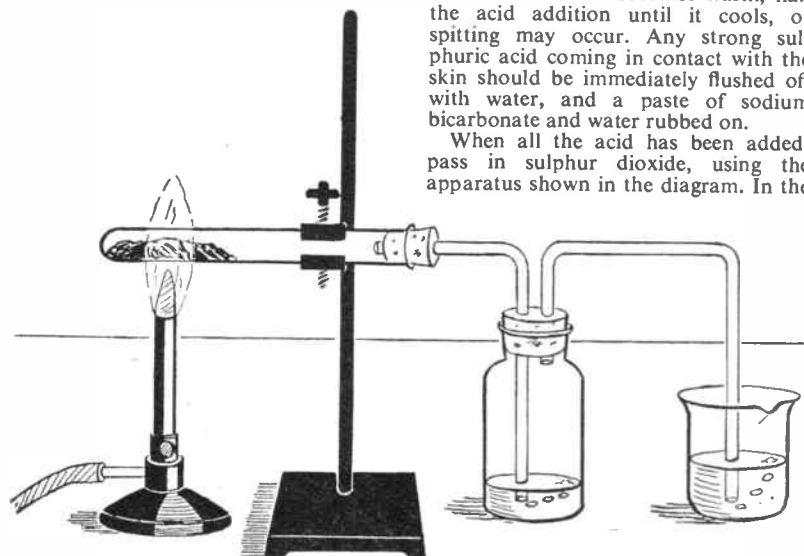

Double colour effects are also seen in its solution. Grind a gram of it with 10 c.c. of cold water, pour the solution into a test tube and view it from different angles. It appears a dingy blue tinged sometimes with red. Boil the solution. It becomes a pure deep green, and this colour does not change on cooling. Indeed, many month's standing would have to pass by before it changed back to the bluish shade. This colour change is caused by a complex intramolecular rearrangement which would take up too much space to explain here. Suffice it to say that we must work with cold solutions in the following experiments.

Chrome alum is manufactured by the reduction of potassium dichromate, which is itself directly obtained from

## Acid Precaution

chromium iron ore. Though chrome alum is very cheap, and a bought stock is most convenient, it is interesting to make a small specimen to demonstrate its formation, for this shows that though the metal chromium plays the part of an acid in potassium dichromate, it can be made to act as a base under suitable conditions.

Dissolve 6 grams potassium dichromate in 60 c.c. of water, partially immerse the vessel in cold water and very gradually stir in 10 c.c. of strong sulphuric acid. If the potassium dichromate solution becomes warm, halt the acid addition until it cools, or spitting may occur. Any strong sulphuric acid coming in contact with the skin should be immediately flushed off with water, and a paste of sodium bicarbonate and water rubbed on.

When all the acid has been added, pass in sulphur dioxide, using the apparatus shown in the diagram. In the

test tube is placed a mixture of 3 parts flowers of sulphur and 4 parts manganese dioxide by weight. On heating the tube sulphur dioxide is given off, and may be freed from any sulphur carried over by passing it through a small quantity of water in the wash bottle before it passes on to the beaker containing the acidified potassium dichromate solution. The latter darkens in colour and at length becomes green. Stop passing in sulphur dioxide and allow the solution to stand. A violet solid will deposit. This is chrome alum. When no more seems to be forming, filter it off, wash it lightly and allow it to dry on a tile at room temperature.

In this experiment the reducing action of the sulphur dioxide converted the acid-acting dichromate radical in a basic-acting chromium radical. This can again be reversed by oxidising a chromium salt. Dissolve a little chrome alum in a

few c.c. of water, add sodium hydroxide solution until the precipitate which first forms redissolves. Then add some lead dioxide, shake and allow to stand a few minutes. On filtering the solution you will find it has changed from dingy blue to bright yellow, indicating the change to a chromate.

Everyone has heard of the pigment chrome green. Here is a way to make it from chrome alum. You will first need a solution of chrome alum. Though the strength of the solution does not matter, it is better to work to some definite quantities, so that you will be sure of obtaining a suitable yield. Use about 10 grams chrome alum to 150 c.c. water. The quickest way to dissolve it in cold water is first to powder it in a mortar and then to grind it with some of the water. Pour off the solution from the undissolved residue and repeat the process until all is in solution.

Now stir in ammonia until a drop of the mixture gives a blue colour with red litmus paper. A grey-green bulky precipitate of chromium hydroxide will have formed. Filter this off and wash it on the filter with about a litre of water. Then dry the product in the oven. To convert the chromium hydroxide so obtained into chrome green, heat it to redness in a crucible for a quarter of an hour. The chromium hydroxide loses water and forms chromium sesquioxide, which is chrome green. The tone of chrome green varies according to the method of manufacture. The brightest greens are made by other methods.

Every home chemist likes to aim at a wide stock of chemicals, so as to bring him a larger field of experiment. Though many thousands of chemicals can be had 'over the counter', one learns little about them by mere buying. It is sound practice and more interesting to make your own from cheap raw materials. There are several chromium compounds which are easy to make from chrome alum.

## Chromic Chloride

To make chromic chloride, for instance, you need only dissolve chromium hydroxide in hydrochloric acid. First prepare chromium hydroxide as directed in the making of chrome green, but do not dry it after filtering it off and washing it. Instead, open out the filter paper on a flat surface, scrape off the moist precipitate with a spatula and transfer it to a beaker. Stir in strong hydrochloric acid a few drops at a time until about two-thirds of the chromium hydroxide has dissolved to a green solution. Then let it stand overnight,

● Continued on page 245

# SHORT-WAVE RECEIVER

THE coils can be made next. These are wound on Bakelite formers which have six ribs and are also slotted. The pins which plug into the sockets on the chassis are easily made from thick wire (copper or tinned copper). A loop is formed at the end of a piece of this wire, and through this passes the bolt which fixes the pin to the wall of the coil former. This is shown in Fig. 5 inset. The pins should project about  $\frac{1}{4}$  in., and should be placed so as to fit the sockets.

The wire for the coil should be anything from 24 to 18 gauge, preferably enamelled. Thick wire is best. For the other two coils thinner wire is used as specified. Each coil has two windings and these must both be in the same direction. The ends are passed down through holes in the former to their appropriate pins. The connections are made clear in Fig. 5.

For coils 3 and 4 the teeth of the slots are filed down smooth.

Coil 1 consists of 3 turns (using the slots) for the primary. Miss a slot and wind 4 turns for the secondary.

Coil 2 has 4 turns for primary and 12 turns for the secondary.

Coil 3 consists of 10 turns primary, and 30 turns secondary. The wire is 28 gauge enamel and is spaced the diameter of the wire.

Coil 4 has 25 turns primary and 82 turns secondary. The wire is 32 gauge enamel and is close-wound (i.e., no spacing).

The distance between primary and secondary in both coils 3 and 4 is  $\frac{1}{8}$  in.

If only the two-valve version of the set is being made, then only one coil for each range is needed. Otherwise, two coils of each kind are necessary.

The ranges are approximately as follows:—Coil 1—12 to 28 metres. Coil 2—28 to 60 metres. Coil 3—60 to 130 metres. Coil 4—130 to 350 metres.

Although this is a short wave set, coil 4 was included so that, if need be, the Home and Light programmes of the B.B.C. can be heard. The set, therefore, has a dual wave capacity, which is bound to be appreciated by readers, especially as reception is excellent on this last band.

In the three-valve version, the matching of the two coils is important. If necessary, small variable trimmers of up to 30 pfd. can be mounted over the

secondary coil and the coils matched by adjustment. Alternatively, the coils can be tapped, which is no expense at all.

A really good job of the control panel can be done by adopting the scheme shown in Fig. 6. The panel can

version where economy demands this. Obviously, valve one and holder will not be wanted. Neither will coil one and holder, nor the choke, nor R1, C1 and C2. The lead from section one of the tuning condenser will not be needed.

After omitting all these, all that is necessary is to join the aerial, through a 30 pfd. trimmer condenser, to the top of coil L2. This is tag S on the coil socket base (see Fig. 1).

The 30 pfd. trimmer should be set by means of the screw for best results. Screwed down half-way, it will probably be satisfactory.

In operating the set, plug in the correct coils, choose a section of the band by operating the main tuner, while bringing up the reaction. The bandspread control is then used to explore the chosen section.

The set will function excellently without an earth, but a proper one can be tried as an additional improvement.

The ganged tuner and bandspread condensers can be obtained from the following firm: W. A. Benson, 308 Rathbone Road, Liverpool, 13. Valves, holders, resistors and condensers, etc., are also available from this firm. The valve bases used as coil holders, the coil formers, the chokes, switch, are procurable from J. E. Annakin, 25 Ashfield Place, Otley, Yorkshire.

This concludes A. Fraser's instructions for making a short-wave receiver. Readers who missed last week's issue containing preliminary steps and diagrams can obtain a copy from the Editor, price 6d.

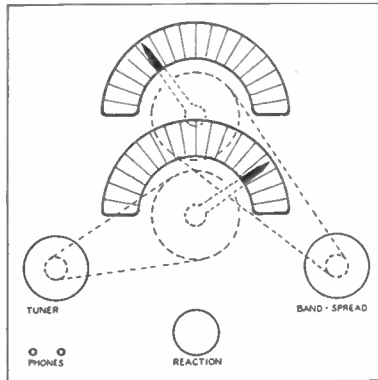

Fig. 6—Front Panel

be of  $\frac{1}{8}$  in. or  $\frac{1}{4}$  in. plyboard and the dial cut-outs can be executed with a fretsaw. Excellent dials can be made from old protractors backed with white card. Slow-motion control is established by drive drums fitted to the condenser spindles, and driven from drive spindles to which knobs are attached. The pointers can be home-made.

When a station is tuned in, the numbers on the dials should be noted for future use.

Now, to deal with the two-valve

●Continued from page 244

## Experiments with Chrome Alum

for the action is rather slow, and to add enough hydrochloric acid to dissolve it immediately would leave an excess of acid in the solution.

Filter off the undissolved chromium hydroxide. The green filtrate is a fairly strong solution of chromic chloride. This is another double colour effect chromium salt. In a dark room switch on an electric torch behind the bottle. The solution will appear red. Chromic chloride so prepared is best kept as solution, for spontaneous evaporation yields not crystals, but a viscous green syrup.

Chromic sulphate can be made in a similar manner, but using a diluted sulphuric acid of only 10 to 20 per cent strength. The solution of this, too, is green by reflected light, but the torch beam will show it to be red by transmitted light. To obtain solid chromic

sulphate, let the solution evaporate spontaneously in a warm room, when it will dry up to a green crystalline mass.

Chromic orthophosphate is insoluble in water, and so is easy to prepare by double decomposition. It is a salt often prepared, and so should be doubly interesting.

Dissolve 12 grams disodium hydrogen phosphate (the common 'sodium phosphate' of the laboratory) in 200 c.c. of water and stir this solution into one of 8 grams chrome alum in 100 c.c. water. A violet crystalline precipitate slowly separates. When the liquid has stood about an hour, filter off the precipitate and wash it on the filter until one wash water gives no cloudiness with ammonia. The moist violet powder in the filter is chromium orthophosphate and may be dried on a porous tile. (L.A.F.)

# Make a Dutch Cradle

**C**ONSTRUCTION has been simplified for the 'do-it-yourself' handyman, but shapes and proportions follow the lines of a traditional Dutch cradle, with overhanging head curtain. Select good quality knot-free wood throughout, gluing and pinning or screwing all joints, except the main frame-end joints, which are dowelled. A synthetic resin-type glue is recommended.

End facings are cut from 24ins. by 24ins. by  $\frac{1}{4}$ in. ply. Mark out according to the squared pattern given, or use the

Side frames are simple rectangles, from 2ins. by 1in. stock. Uprights are half-jointed, glued and screwed. Note the  $\frac{3}{4}$ in. protrusion of top and bottom members each end. Hardboard panels are glued and pinned to one side of each side frame, after which the slats may be added, also pinned and glued.

*By R. H. Warring*

Completed sides should now be assembled on the two end frames, check-

of sides. Capping strips and runners are glued and woodscrewed in place.

Clean up assembly thoroughly at this stage, removing all traces of surplus glue, etc., and paying particular attention to rounding and smoothing the ends. Then apply either a paint finish or stain and polish.

Curtain struts are assembled separately and finished before screwing to the back. The curtain holder is a 16in. length of  $\frac{3}{8}$ in. diameter dowel, mounted cantilever fashion on a triangular-shaped gusset. Hollow gusset to accommodate

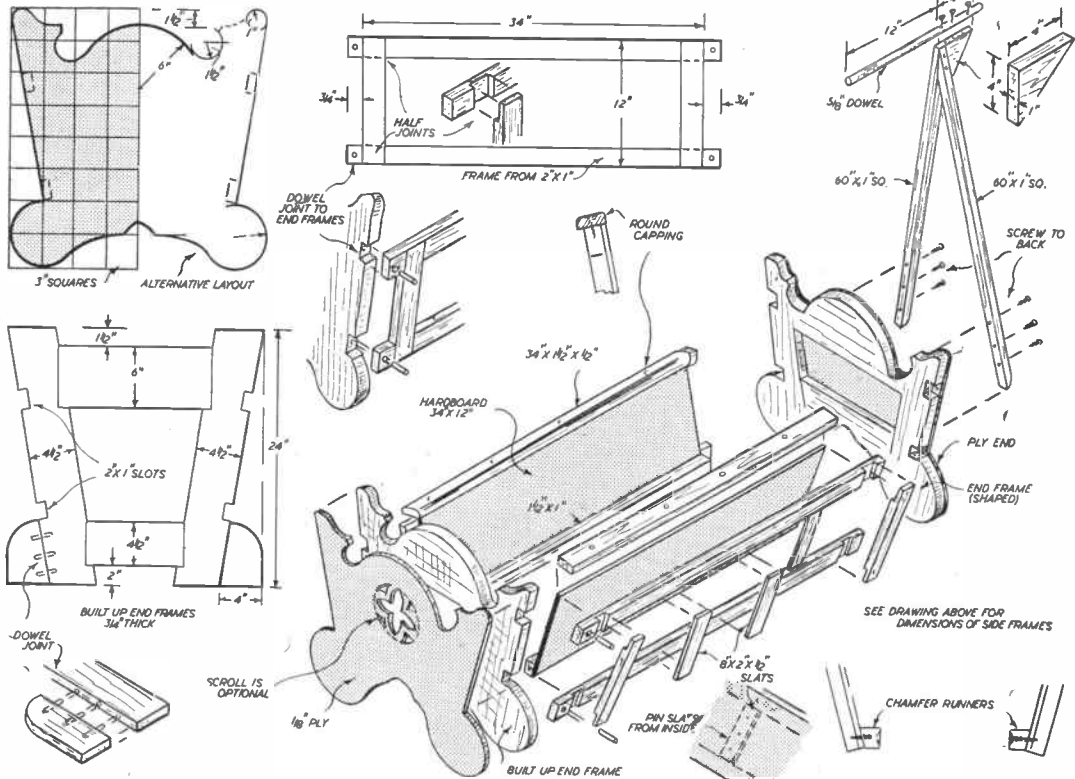

layout dimensions. Only one panel need be drawn out. Cut to shape it can be used as a pattern for marking the second panel.

### The End Frames

End frames are assembled from  $\frac{3}{4}$ in. stock, gluing all joints well. Outer leg pieces are dowelled for additional strength. When these frames are set, lay a ply end over and mark to matching outline. Frames are then cut to this outline with a coping saw.

ing for a good accurate fit and true alignment. Protruding ends fit into slots cut in the end frames, these joints being well glued, drilled and dowelled. Finish off ends flush and then fit ply end facings. Glue only is sufficient, if the ply panels can be clamped uniformly, otherwise reinforce with pins with the heads driven down just below the surface of the ply.

Capping strips are then fitted to the top of each side. Chamfer bottom runners to lie horizontal and fit to bottom

dowel, fastening the latter with woodscrews. The curtain fitting may be omitted, if preferred.

### Modification

The cradle may be lengthened to take a standard 36in. spring and mattress, if required, simply by amending the frame length measurement to 36ins. Also, to simplify construction, the end frames can be omitted and the two end panels cut direct from  $\frac{3}{4}$ in. thick ply, slotted to take the side frames.

Readers helped with this

# PUZZLE IN WOOD

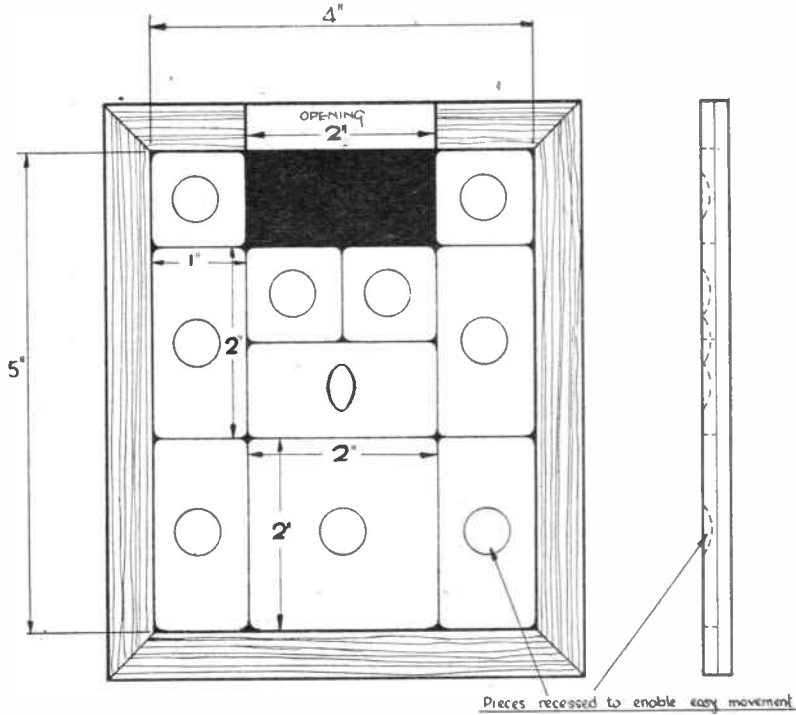

**C**APT. T. J. WILLIS, 146 Green Lane, Chislehurst, Kent, was one of the many readers who forwarded dimensions of a wood puzzle which we requested in the November 2nd, 1955 issue of Hobbies Weekly. Here are the details.

After making the frame, the moving pieces of wood required are four pieces 1in. by 1in., five pieces 2ins. by 1in., and one piece 2ins. by 2ins.

**See page 252 for moves to solve puzzle**

The corners are rounded slightly and the starting position is as shown in the illustration. The object is to slide the pieces to and fro and up and down *without twisting* until the large piece 2ins. by 2ins. passes out of the opening. Instead of leaving an opening, a piece of different coloured wood can be inserted in the frame. Another refinement is to fit a lid. The quickest way known to do the puzzle takes about 100 moves.

Incidentally, Mr. H. R. Beggs, who raised the original query, made his pieces from  $\frac{3}{4}$ in. thick teak and applied a wax finish. His plywood base has sides  $\frac{3}{4}$ in. high. The object of the puzzle is, of course, to get the 2ins. by 2ins. piece through the 2ins. aperture.

## Making a Leather Purse

**T**HIS neat little purse can be made from odd scraps of leather, and is, therefore, cheap as well as simple to complete.

Pieces of leather are cut out to the size shown in the diagram. A penny is of assistance for marking the corners. The leather is glued to the skiver, and the

edges trimmed. These edges should be dyed to the appropriate colour.

The two large pieces are marked, and the holes punched out. The gusset is then marked with the same number of holes as the corresponding side of the front and back, and the holes are punched out.

Tie in an edging piece of thonging along the top of the flap and commence thonging at the centre, working round until the first hole in the gusset is reached. The thonging goes twice through this hole and the one in the back to make a firm joint. Thonging continues until the ends meet at the base. Here the thongs are cut off and the ends tucked under a few of the loops.

Tie in an edging piece along the base of the front

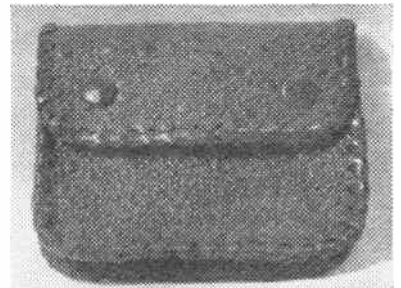

and commence thonging at the centre of the base working towards the ends of the gusset. When this point is reached, cut off the thonging and tuck the end under the loops. 9ft. of thonging is required to complete the purse.

The two press-studs are inserted last,  $\frac{3}{4}$ in. in from the top and  $\frac{3}{4}$ in. from the side.

The purse is now ready for use, and will repay the short time spent on its construction by long and useful service. (D.L.)

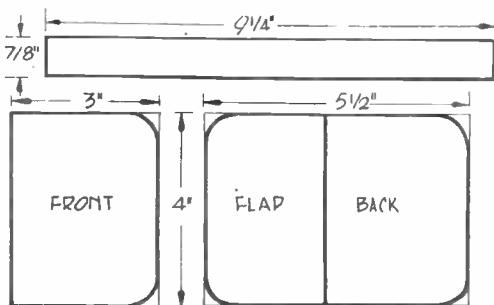

All the measurements

For amateur photographers

# A Postcard Masking Frame

By S. H. Longbottom

TO produce a neat white border to your postcard enlargements, a masking device of some description is necessary, and here is an easily constructed frame, of new design, with no mechanical parts to go wrong, or metal parts which rust.

The basis is a block of wood exactly 3½ ins. by 5½ ins. of ¼ in. or 1 in. shelving,

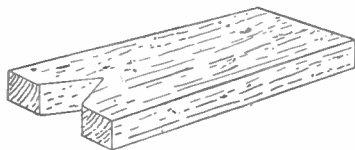

Fig. 1

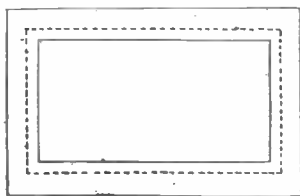

Fig. 2

or the size of the usual photographic postcard. This should be planed and glasspapered until quite smooth, and then shaped as Fig. 1. A notch is cut out 1½ ins. wide and 1½ ins. deep, the purpose being to facilitate easy removal of the cards following an exposure, and the corners of this notch should be neatly smoothed and rounded.

## Preparing the mask

The preparation of the mask follows, and a piece of good quality cardboard 7 ins. by 5 ins. is required. First of all, mark out the opening, exactly 3-1/10 ins. by 5-1/10 ins., cutting out with a sharp knife and good straight edge. Check the corners with a set square and see that they are properly cut. If it should be found that the inside is not perfectly straight, or a little jagged, strips of gummed brown paper may be attached, but care should be exercised to maintain a matching width of the border. When the opening has been made, the waste card may be trimmed away as shown by the dotted lines in Fig. 2. The outside measurements are 3½ ins. by 5½ ins. to match the size of the block, leaving a frame of this size, but only 1/5 in. wide, and ultimately, the width of the border on your postcards.

Before fastening the mask to the block it is as well to prepare a sample postcard with a border ruled off exactly 1/5 in. all the way round, attaching this, temporarily, to the block by tacks after

ensuring it is perfectly square.

The mask is then laid in position and held in place with rubber bands the long way of the block, allowing the sides to be attached. Moreover, it should be remembered that for easy usage, the mask should not be fastened too tightly or the postcards may bind when inserting or withdrawing. To overcome this, place another card underneath the temporary one mentioned above before proceeding to attach the mask.

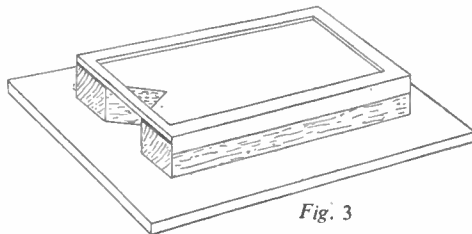

Fig. 3

Held by rubber bands, the mask is bound to each side of the block and one end by means of gummed strip paper, passe partout, or if you have any, strips of linen as used for bookbinding, using a good glue. When dry, the nails may be withdrawn in readiness for the next stage.

## Make this novel Gift

# Stringholder and Knife

THIS is just the kind of novelty to make as a small gift. It is both useful and amusing. When string is pulled from the ball the head revolves as the ball turns. A razor blade cutter is provided at the side.

All the pieces are shown full size on the pattern page and it is only necessary

## See Patterns on Page 255

to trace them and transfer to the correct thicknesses of wood. Cut them out with a fine grade fretsaw and clean up with glasspaper ready for assembly.

Glue pieces 2 and 3 to the base as shown by the dotted lines and then assemble the head on the shaft. The end of the shaft goes into piece 5 of the head and then piece 6 is glued in place.

From Fig. 3 it will be noticed that a baseboard has been added, primarily to give stability, but also for ease of manipulation. The base is cut from hardboard 6½ ins. by 8½ ins., allowing 1½ ins. on all sides. Drill two holes in the centre and screw to the block of wood. Note that sometimes it may be necessary to make a run of prints, in which case the frame should remain in one position on the enlarger baseboard. To achieve this, drill a small hole on each side of the hardboard to accommodate a push-pin for fastening to the enlarger baseboard.

In use, the postcards are slotted into the frame and withdrawn by placing a finger in the notch, in contact with the back of the cards. Modification of the measurements will enable the same principle to be adapted for ¼ plate cards.

### MAKE SURE!

To be sure of obtaining the grand free designs to be given in future issues of *Hobbies Weekly* place a firm order with your news-agent. Better to be sure than sorry!

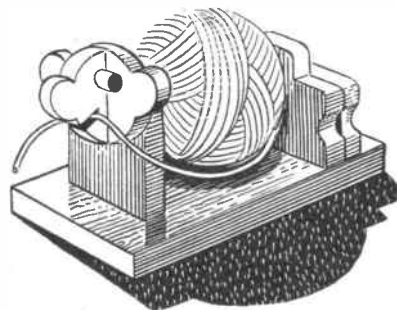

A short length of ¼ in. round rod is glued in to form the eyes.

Paint the parts with plastic enamel and when dry, screw the piece 4 to piece 3 with a razor blade in position. The ball of string is pushed on to the shaft and the novelty is ready for use.

(M.p.)



## Gaiety in the home

# New Ways with Old Vases

VASES are not unlike human beings. Sometimes a change of face, or place, can act like a tonic. Surfaces may be retextured and given a new ground colour, finishing with stippled colours. Charming effects may be achieved by using rustic earthenware bowls bought for a few pence, and even old Virol jars can be transformed into dainty flower vases.

Most horticultural shops sell earthenware jugs, vases, cacti pots and bulb bowls, while any interested craft worker may like to work on candlestick holders, wall vases, troughs or lamp bases. All these are inclined to be porous, necessitating a coat of flat paint inside and outside. Two coats are recommended and then a final coat of gloss paint. Very little paint is required and often some left over from a household job will be sufficient. Incidentally, the inside may be treated in a contrasting colour to the outside, e.g., pale blue inside, cream outside.

### Choose pastel shades

Choose light pastel shades toning with any personal colour scheme. Pale cream, pale pink, turquoise or silver

strong or they will not blend nicely. Take a piece of cotton wool, dip in the turpentine, rub the colour round on the saucer mixing the colour. See that the wool is not overloaded and with a very

*By S. H. Longbottom*

light pressure, dab the colour on to the vases at various points. Note that this pressure must be light and is comparable with the difference between shaking pepper and applying salt. A little practice on a spare piece of card will reveal the technique.

Proceed in a similar manner with all the colours selected. It is unnecessary to use all the colours advised. Autumn tints for example, are best represented by red, yellow and green. The two former colours blending together make a delicate orange. Finally, a little gold dust is spread on a piece of paper, taken up with a clean dry swab and applied at a few places on the vase. When the paint is quite dry, a protective coating of Cellulose lacquer is necessary. Buy about 4 ounces of this from any good paint shop. But do be warned that it



*Here, an old Virol jar has been treated with plastic paint for texture; an old vase repainted, while the posy basket and jug were painted and stippled*

it is desired to give a new surface, the best way is to use a plastic paint like Marb-I-cote; or similar preparation sold by the crafts shops. The powder is mixed to a thick paste with lukewarm water and painted on the vase. While still wet, the texture is formed by dabbing with a piece of flat wood to give a lace effect. A comb will produce a rustic effect. Allow the material to dry a little, then smooth down with a flat piece of celluloid. When finally dry any sharp points may be removed with glasspaper. Dust off any powder before painting and the textured surface may then be painted to any desired colour.

Very little outlay or labour is involved in this method, and all your old vases may be given a new lease in life.

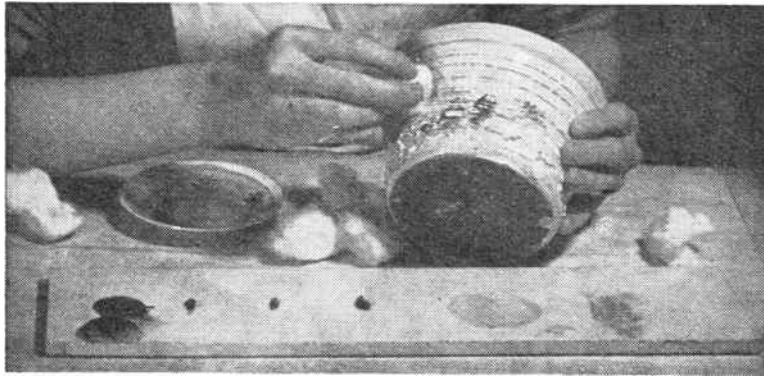

*Applying colour to a bowl*

grey are charming ground colours for the process. To avoid the application of more paint to yourself than to the vases it is easier to treat the insides and outsides on alternate days.

The next stage involves the application of the colours. You will need small tubes of students' oil paints in chrome yellow, crimson lake, sap green, rose madder, china blue and violet. In addition, obtain a small tube of Florescan gold powder.

An old saucer makes a good palette. A touch of oil colour is placed on the rim. In the centre of the saucer pour a little turpentine. Tints must not be too

must be applied all over the outside with a small *soft* brush. A hard brush loaded too liberally may cause the paint to crinkle or peel.

Another refinement is a touch of gold to the rim. First, paint the rim with a coat of japanners' gold size followed by an application of the dust with a dry swab. Any irregularity may be removed with a rag dipped in turpentine.

To prevent scratching furniture, a small piece of felt may be fixed to the bottom of the ornament by means of one of the new rubber adhesives.

Any old vase may be repainted and coloured in the manner described. When

### FIXING PELMETS

This useful idea for the easy hanging of pelmets has been sent to the editor by Mr. T. Green, of 16 Colville Avenue, Anlaby Common, Hull.

Having experienced trouble in fixing up the supports, he plugged the wall and screwed hooks into each plug. In the top of the back corners of the pelmet, eyelets were screwed in and the pelmet was hung on the hooks as illustrated. The assembly makes for easy detachment, which of course facilitates painting and wall papering.

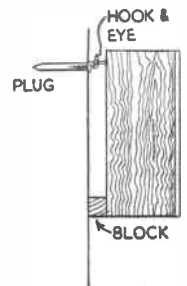

# MODERN BUREAU-BOOKCASE

**T**HIS typically modern fitment is simple in outline and not at all difficult to make. Any good hard wood would be suitable, but either oak, or mahogany is the best choice. Two useful diagrams are given in Figs. 1 and 2, the former supplying all the necessary measurements for assembly, while the latter clearly shows the construction.

Commence by preparing the sides (A). These will be dovetailed at the top to the cross rails (C) (see detail Fig. 3), and either rebated or dovetailed to the floor (B). The two shelves (E) can be grooved into the sides, or better still, dovetailed.

One of two methods may be followed for fixing the back (H). It may be simply screwed direct to the edges of the sides (A), the shelves (E) and the floor (B), or the inside edges of the sides may be rebated so that the back fits in flush.

hand door at the top to fit into a wood block, which is glued to hold the doors flush when they are closed. A ball catch is fitted to the right-hand door and also to the falling front of the bureau. To the latter a pair of quadrants must be fixed to support the front when lowered.

CUTTING LIST	
(A).	(2). 4ft. 1in. by 14½ins. by ¾in.
(B).	(1). 1ft. 11½ins. by 14ins. by ¾in.
(C).	(2). 1ft. 11½ins. by 2½ins. by ¾in.
(D).	(1). 1ft. 11½ins. by 14ins. by ¾in.
(E).	(2). 1ft. 10½ins. by 14ins. by ¾in.
(F).	(2). 1ft. 1½ins. by 3ins. by ¾in.
(G).	(2). 2ft. by 3ins. by ¾in.
(H).	(1). 4ft. 1in. by 23½ins. by ½in. ply.
(I).	(2). 2ft. 1in. by 1½ins. by ¾in.
(J).	(1). 1ft. 10½ins. by 11ins. by ¾in. overall size.
(K).	(2). 2ft. 1in. by 12ins. by ¾in. overall size.

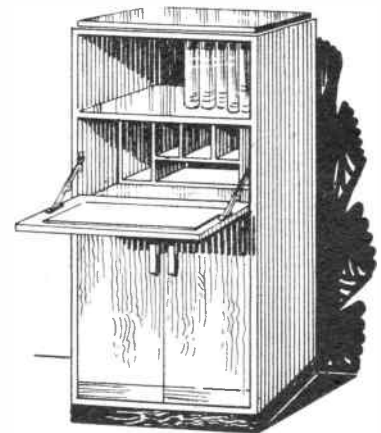

for the shelves, but a neater job should be to have grooved bearers as shown on Fig. 5.

The finish will differ according to the wood and personal taste; oak would be best left its natural colour, or, perhaps, lightly stained, with the base of the bureau ebonised and polished. Mahogany would

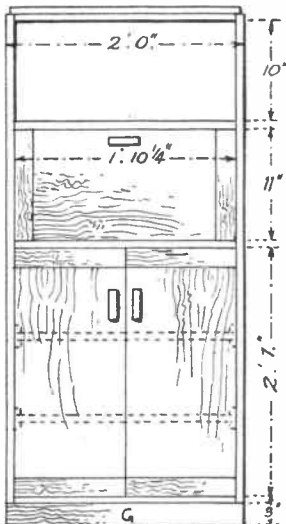

Fig. 1

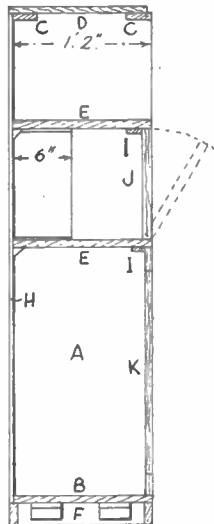

Fig. 2

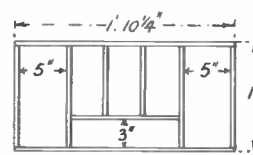

Fig. 6

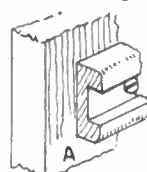

Fig. 5

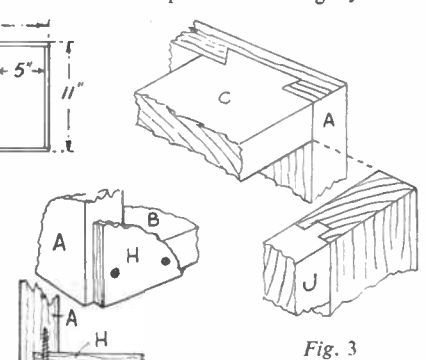

Fig. 3

Fig. 4

Both methods are given in Fig. 4. The shelves (E) and the floor (B) will be ¾in. less wide if the second method is adopted. In assembling the various parts connect the top of the sides by the cross rails, and add the floor (B).

The base of the fitment consists of the rails (G) and two rails (F). They are rebated and screwed to the floor, as shown, with blocks glued behind them. The hinged front of the bureau is solid, and is partly framed by the two upright rails as seen in the detail Fig. 3. The two doors are made in similar manner as seen in the front view, Fig. 1. The doors and the bureau front are fitted with 2½ins. brass or chromium plated hinges, and a small bolt is put behind the left-

A small block of wood should be glued underneath the top shelf (E), against which the flap will rest. A lock can be fitted if necessary.

The main top of the bureau is fixed to the rails (C) by screws from beneath. In Fig. 6 the plan is shown for making the pigeon hole fitment. This is constructed from ¾in. wood and then slipped into place and screwed. A separate back is not required for this fitment, as it fits snugly against the main back of the bureau. A triangular fillet may be added to enable it to be screwed firmly into place. Two shelves can be fitted in the cupboard as suggested by the dotted lines in Fig. 1. Plain strip wood bearers screwed to the sides would act as supports

look most pleasing if stained and waxed-polished. Plain wood block handles would suit the piece, but black bakelite handles would look effective with oak. The cutting list will be found to be a useful aid to construction. (S.W.C.)

**Stick to**  
**SECCOTINE**  
*- it sticks <sup>Regd.</sup> everything!*  
FOR TUBE  
**KEEP A TUBE IN THE HOME**  
 Sole Manufacturers:  
 McCaw, Stevenson & Orr Ltd., Belfast



SAVE POUNDS AND POUNDS on Furnishing with

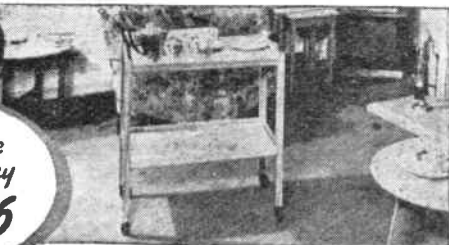

*Wren Craft*

HOME-ASSEMBLED  
FURNITURE

**FREE!**

The Wren Craft Book of  
Furnishing. Post Coupon

**NOW!**



... a lavish,  
beautifully illustrated book  
... yours NOW, without  
obligation.

A bedstead for 72/- ... a coffee table for 46/- ... a wardrobe for 210/-. You can assemble them yourself from perfectly fitting Wren Craft parts. There's no skill needed — and the instructions are so clear. It's top-quality furniture too — made of the finest matured OAK, WALNUT, MAHOGANY or BEECH. All items on easy terms. Post the coupon now for the FREE Wren Craft book of furniture — and see the many lovely things you can make!

Just fit the ready-made parts together!

MAKERS GUARANTEE 100% SATISFACTION — OR MONEY BACK IN FULL!

Please send me — free — a copy of the WREN CRAFT BOOK OF FURNITURE

NAME .....

ADDRESS .....

.....

WREN CRAFT FURNITURE LTD., KINGSTON ROAD, NEW MALDEN, SURREY

H.6

**PRINT YOUR OWN SNAPSHOTS**

with this super

**3/6 PHOTOGRAPHY  
KIT**

Think of it! Now you can make your own prints of holiday snapshots with this Johnson Print-A-Snap Pack. It's wonderful fun and so easy too. Each pack has everything you need for making perfect pictures from your negatives.

There are two sizes. One has 16 sheets of 3½ x 2½ in. contact paper — that's for the camera that takes 8 pictures on each roll of 120 film. But if your camera takes 12 pictures to a roll, ask for the pack with 24 sheets, 2½ x 2½ in. Get the Johnson Print-A-Snap Pack today and show the family what you can do.

Only 3/6 a pack



- 1 pkt. developer.
- 1 pkt. fixing powder.
- 1 pkt. of the new Johnson contact paper, a cardboard printing frame and a sturdy wallet for keeping your prints in after you've made them, together with full instructions.

Ask any Photo-Dealer for the  
**JOHNSON PRINT-A-SNAP PACK**

**A Professional Finish  
at your Finger-tips!**

With easy to use Robbialac Lacquer you can give your own handiwork a flawless finish. You will enjoy using this quick-drying versatile Lacquer which covers perfectly in one coat, leaves no brush marks and dries dust-free in 2-4 hours. Overnight it sets to a hard glass-like gloss that resists steam and hard wear.

Sold in a range of 24 brilliant colours plus black, white and silver, Robbialac Lacquer is available from all good paint shops, cycle shops, ironmongers and hardware dealers in handy ½, ¼, ⅛ and 1-pt. tins.

**ROBBIALAC  
LACQUER**

FREE: Pu. a 'factory finish' on your handiwork. For free Instructional Leaflet send 1½d. stamp to: Dept 6LK, Jenson & Nicholson Ltd., Carpenters Road, London, E15.



# Replies to Readers

## Is this YOUR Problem?

### Brass Engraving

**C**AN you tell me how to set about engraving on brass? I have made a lady's workbox and used some strips of brass upon it. I now wish to put some scrolls, etc., on the brass and have tried scratching them with a sharp instrument, but cannot get a deep incision. (D.L.—Limerick.)

**C**HEMICAL engraving is done by means of strong sulphuric acid. Remove the strips from the box and clean them. Then paint over completely, both sides, with varnish or hot wax. When dry or cold, scratch away this covering with a needle or other tool, where lettering, etc., is to appear. The whole is then placed in the acid bath, which will attack the exposed metal, but

☆☆☆ **WORTH KNOWING** ☆☆☆  
 ☆ Sawdust Firelighters ☆  
 ☆ **SAWDUST** firelighters can be ☆  
 ☆ made by melting 10 parts of ☆  
 ☆ either rosin or pitch and mixing ☆  
 ☆ with 10 parts of sawdust (the ☆  
 ☆ sawdust to be added to the melted ☆  
 ☆ rosin or pitch). Then cast in forms. ☆  
 ☆ Small cardboard boxes do well for ☆  
 ☆ moulds. ☆  
 ☆☆☆☆☆☆☆☆☆☆☆☆☆☆☆☆☆

not the varnish or wax. The depth of engraving may be modified by the time the metal is left in the acid. It is suggested you make a few trials on waste metal of the same kind. After the work is done, clean thoroughly. Do not get the acid on fingers, clothing, etc. Electrical engraving is done by means of a vibratory tool, often powered from A.C. mains, which gives a rapid succession of blows to a steel point. Some skill is required for pleasing results with either method.

### Staining Floors

**P**LEASE give me some advice on staining a floor—the finish to be glossy, so that it can be polished. (J.S.—W.C.2.)

**U**SE powder stain, soluble in water, and apply as many coats as necessary. A cheaper stain is 2ozs. permanganate of potash, in about a quart of water. Be careful to wash the floor previously with warm soap and

soda water, and if a filling is necessary, to close up cracks between the boards, colour it to match the floor with a little of the powder stain or brown umber. When dry, it can be polished with Johnson's floor wax, or oak varnish. The latter, if the floor is to be kept in good condition with Ronuk polishing oils.

### Sealing a Gap

**I** WISH to carry out the job of filling in a  $\frac{1}{2}$ in. gap between a strip of wood and a rough-cast wall and shall be glad of your advice. (H.B.—Barry.)

**T**HE usual method employed is to fit a zinc flashing; that is a strip of zinc with one edge mortared in the wall, and the remainder lying over the joint. If this is not convenient, we suggest you fill the gap to  $\frac{1}{2}$ in. with cement mortar, and when that is set, apply a layer of Seelastic to fill up.

### Colouring Aluminium

**I**S it possible to colour anodised aluminium at home? I have a small laboratory. (P.C.—Birmingham.)

**A**NODISED aluminium can be coloured at home, provided the anodising has been done recently. Such

aluminium is coloured with solutions of dyes, but its affinity for these decreases with time and finally disappears. Ordinary packet dyes as obtained from the grocer are suitable. First degrease the metal—even if no grease is apparent—by swabbing freely with benzine. Allow to dry and immerse in a one per cent solution of the dye, keeping the solution at about 80 degrees Centigrade. When the metal has acquired the desired depth, remove from the solution, rinse in water and allow to dry. Specialists in anodising—natural and coloured—are Anodising and Platings Ltd., Anotec Works, Holland Street, Radcliffe, Lancs.

### 'Patchy' Table

**H**OW can I treat a discoloured patch on a polished table which has been in storage and has got a bit damp? (B.P.—Diss.)

**S**UCH patches can often be removed by rubbing the surface with a mixture of equal parts of linseed oil, turpentine and vinegar. If greasiness is left behind, remove it with a clean rag moistened with methylated spirits. Apply this lightly at first, then as it becomes drier, press a little harder and finish in the direction of the grain.

## Solve the Wood Puzzle

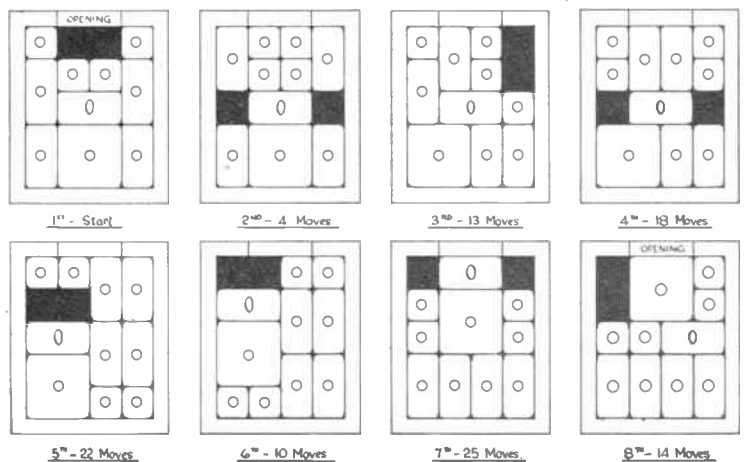

When you have made the wood puzzle described on page 247, here are shown moves to enable you to solve it

# FREE! 16 Page Book tells you how to save pounds with *the New "Self-Build" Furniture!*

All the hard work done for you — you do the interesting part . . .

Whether you're a beginner or an 'old hand' at Woodworking, here is a free book you certainly ought to read. It tells you all about Furni-Kit—the new and better way of getting the finest quality furniture. We've done all the hard, routine work for you — you put it together and do the individual finishing which can add so much value to a fine piece of furniture.

We use only the finest timber—mainly solid oak, walnut, or mahogany—the kind of prime timber you'd always buy if you could get it in small quantities at reasonable prices. We use laminates only where they definitely improve the job.

**FURNI-KIT  
GIVES YOU  
QUALITY  
FURNITURE  
AT LESS THAN  
HALF THE  
NORMAL  
SHOP PRICES**

Craftsman-designed Furniture Kits in traditional and contemporary styles—mainly in Solid Oak, Walnut, or Mahogany—at sensational prices.

## This book will tell you

Find out about this exciting new idea by sending for illustrated book, 'I Made it Myself!' Details of 30 Kits, including ideal gifts like Occasional Tables, Bookcases, Cots, Kitchen Cabinets, Child's Desk and Chair, Tea Trolleys, Nest of Tables, Bathroom Furniture, T/V Tables, Needlework Cabinets, (every woman wants one!), etc., real photos, dimensions and 100% Satisfaction or No Charge Guarantee. Send for this intriguing book now — FREE and without obligation.



## YOU MUST READ THIS BOOK

YES . . . please send me Free Book and details of Easy Terms  
(Write if you prefer not to cut page)  
NAME .....  
ADDRESS .....  
..... (HS/4)

## AMAZING VALUE! HERE IS JUST ONE EXAMPLE . . .

This sturdy Occasional or T/V Table, 22in. high by 20in. by 20in., is made throughout of SOLID OAK, SOLID WALNUT, or SOLID MAHOGANY, except for lower shelf which is faced laminate. Legs will easily take castors if required. Solid top is moulded and outer edges of legs rounded. You couldn't possibly buy such a quality table anywhere for less than five guineas. Made with Furni-Kit, it costs only 63/-.



**YOURS FOR ONLY 8/2 DOWN**

**EVERY KIT  
READY TO ASSEMBLE**  
All the precision-machined parts come to you tongued, grooved, mortised, etc., and satin smooth. We supply everything—hinges, ball-catches, rule-joints, plate glass . . . even screws and special cold-water glue. Furni-Kit is ready to assemble at once, complete with instructions and, if you want it, a wonderful new friction polish specially developed for our Kits.

## FURNI-KIT

Dept. HS/4, 29-31 Wright's Lane  
London, W.8

**A New idea that is sweeping the country—simple, fascinating and anyone can do it!**

# NEW!

# EXPERIMENTAL KITS

## LEARN THE PRACTICAL WAY

Here is home study of the most effective kind under expert tutors. There is no better way of studying for an examination for a career in industry or starting a new hobby. Our Practical courses comprise the most modern methods of postal tuition, combined with a practical kit of parts (which is supplied upon enrolment and remains your property).

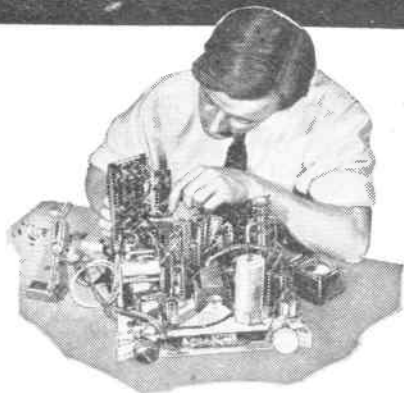

## COURSES FROM 15/- A MONTH

COURSES WITH KITS INCLUDE : Radio, Television, Mechanics, Electricity, Chemistry, Photography, Carpentry; also Draughtsmanship, Commercial Art, Amateur S.W. Radio, Languages, etc.

# EMI INSTITUTES

The only Postal College which is part of a world-wide Industrial Organisation.

## POST THIS COUPON TODAY

E.M.I. INSTITUTES, Dept. 31X, Grove Park Road, London, W.4. Please send me your free book.

Subject(s) of Interest .....  
NAME .....  
ADDRESS .....

25/1/56

C

## YOU CAN BECOME A HANDICRAFTS INSTRUCTOR

### EXPERIENCE NOT ESSENTIAL

Men who enjoy making things in wood or metal can turn their hobby into a permanent and interesting Career. Short hours, long holidays and security in a job you would really enjoy, can be yours if you become a Handicrafts instructor. Let us send details of the easiest and quickest way to get the necessary qualification.

**We guarantee "NO PASS—NO FEE"**

If you would like to know about our unique method of preparing you for one of these appointments, write today, and we will send you our informative 144 page Handbook—free and without obligation. Mark your letters "Handicrafts Instructor".

**BRITISH INSTITUTE OF ENGINEERING TECHNOLOGY**

# BIET

595 College House, Wright's Lane  
Kensington, London, W.8

**HARD HITTING ACCURATE**



**Webley AIR PISTOLS**

**AIR RIFLES · ACCESSORIES**

Write for Catalogue  
WEBLEY & SCOTT Ltd., 166 WEAMAN ST., BIRMINGHAM, ENGLAND

### ACCESSORIES

Telephone Handset Mouldings—P.O. Type—12/6 per set  
Single Pin—2-way plugs—4/6 each.  
Set of Transmitter Parts—10/6 each.  
Set of Receiver Parts—10/6 each.  
Twin Tinsel Flex—tagged each end, approx. 6ft. lengths—1/- each.  
Oak Switches—10/6 each. Kelog Keys—S.H.—10/6 each.  
Other accessories—PRICE on application with stamped addressed envelope.

'ONILY' COMPONENTS LTD  
Llanerch-y-Mor, Holywell, Flintshire

## Wolf Cub ELECTRIC DRILL AT ONLY £5.9.6



or 6/- deposit and 6 monthly payments of 19/6d.  
This wonderful Electric Drill is also the power unit for ALL Cub equipment. Drilling capacity: Mild Steel, 1/4"; Hard Wood, 3/8"; with 210 watts input on full load. Complete with 1/4" three-jaw chuck and Allen key and 5ft. of cable. TV Suppressed. State Voltage. ALSO Sanding & Polishing Kit (drill, discs, etc.). Cash Price: £6. 10. 6 or 19/- deposit and 6 monthly payments of 21/-  
Send for Illustrated Brochure

### ELECTRIC PAINT SPRAYER

4/- deposit and 6 monthly payments of 13/6  
Cash Price 75/-



Paint easily, evenly, twice as fast with the Burgess Electric Sprayer. Sprays paint, varnish, etc. Complete with sturdy glass container, flex, nozzles for ceiling spraying and extra nozzle discs for different liquids. A.C. mains—state your actual voltage. Fully guaranteed. Also Horvell Electric Paint Stripper 30/- cash, or 4/- deposit and 3 monthly payments of 10/-.  
Leaflets free.

### THE MOST VERSATILE TOOL EVER!

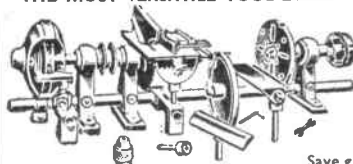

## PICADOR PUP

ONLY £6.15.0  
OR 25/- deposit and 6 monthly payments of £1

Save ground space with this modern multi-purpose tool. PICADOR PUP comprises a wood turning lathe, a rise and fall, fully tilting circular saw, a hooded grindstone with drill sharpening attachment, together with sanding and drilling attachments also. IT GRINDS, including Twist Drill Grinding. TURNS, SAWS wood, plastics or soft metals. SANDS and DRILLS. PICADOR PUP is small, compact, hardy and motor driven. Only £6.15.0 cash or 25/- deposit and six monthly payments of £1. Extra cradle providing for drive by 1/2" drill, Price 23/-. 3" four-jaw Chuck suitable for the above £3 cash or 16/- deposit and three monthly payments of 16/6. ALSO Picador Rotosaw, Price 33/-, Spare blades available, 8/6 each.  
Send 3d. for Illustrated Brochure.

**BARGAIN DISTRIBUTORS** (Dept. 124), 5 Silver Street, Luton

9.5 MM. Hire Service. List 3d.—Wayland, 219 Longley Rd., Tooting, London.

100 DIFFERENT stamps free! Request 1/4d. upwards discount approvals.—Bush, 53 Newlyn Way, Parkstone, Dorset.

MODELLERS—make your own musical box. Movements supplied, only 14/- each. Send S.A.E. for details.—Swisscross, Dept. B., 116 Winifred Rd., Coulsdon, Surrey

50 STAMPS free to all approval applicants enclosing 2 1/4d. stamp.—Cliffe West, 61 Wynyard Rd., Sheffield, 6.

QUEEN ELIZABETH Coronation packet. Valuable free gift for approval applicants enclosing postage.—Yulwontmor Stamps (Dept. H5), 29 Layton Avenue, Mansfield.

MATCHBOX size crystal sets. All parts, Merystals, instructions; complete 3/6.—Bailey's, 44 Stanley St., Oldham.

**£3 A WEEK** easily made at home—without tedious, monotonous work—by becoming sole local agent for the Enfield 'Rent-a-Rack' Scheme.

Roof racks for luggage are a virtual necessity for motorists' holidays. Yet they are only wanted for one or two weeks each year, so most motorists would rather rent than buy.

You at your own address can become the sole stockist and renting agent in your locality for the Enfield Roof-rack (fits all Saloon cars).

Write for full description of how to launch your own spare-time 'Rent-a-Rack' business at your own address, with your own organisation and with no interference from anyone.

Sole agents are now being appointed.  
Write without delay for full details to

**ENFIELD TYRE COMPANY**  
Dept. H.W.  
123-5 Baker Street, Enfield, Middx. (Enfield 2982)

### \* GREAT CAMPING OFFER \*



## RIDGE TENT SENT FOR 4/-

BRAND NEW de luxe 'Safety' Tent. All colours. Complete. Ideal Cyclists, Campers. Length 7 ft. 3 in. sleeping base x 4 ft. 6 in. wide x 3 ft. 6 in. high x 12 in. walls, all approx. Weight 3 1/2 lb. £21 5s. or 4/- deposit and 6/- monthly. With fly-sheet £4 2s. 6d. or 10/- deposit and 9/9 monthly. Both carr. 1/6. Don't delay, send now.

### GERMAN PRISMEX BINOCULARS

6 LENSES x 40 mm COATED LENSES. Popular Squat Model  
**No Deposit CASH PRICE 69/6**



For wide field viewing, finest value for German Prismex Binoculars. 5 1/2" x 4 1/2". Bending Bar for eye adjustment, centre focus. Splendid magnification, 3D viewing. Clear Bloomed lenses, wide angle. Sports and holiday use, day and night lenses. Lightweight model. With case lanyard and leather straps. Send 2/6 for pack. & reg., etc. 7 days approx. if satis. send 4/6 then 8 pays. 9/- in 8 months. CASH 69/6. LISTS, TERMS

**H** HEADQUARTER & **G** GENERAL SUPPLIES LTD.

(HOBW/90), 196-200 Coldharbour Lane, Loughborough Junc., London, S.E.5.

LEARN it as you do it—we provide practical equipment combined with instruction in Radio, Television, Electricity, Mechanics, Chemistry, Photography, etc.—Write for full details to E.M.I. Institutes, Dept. HW. 47, London, W.4.

7 MAGNIFICENT Giant Triangles free! Request approvals, postage 2 1/4d.—Dicker (HW1), 14 Clement Hill, Hastings.

WANTED for small business, high quality craft goods (soft toys, basketwork, leather, novelties). No samples in first instance.—Write Box No. 24, Hobbies Weekly, Dereham, Norfolk.

ACID-SHARPENED FILES. One dozen assorted specially sharpened files, all types and cuts; ideal for modelmakers, etc. 12/6 post free.—Phoenix File Co., 22 East Union St., Manchester.

GENUINE Swiss Musical Movements. The best and largest selection of tunes in the country, lowest prices 16/3 each. Genuine Thorens Movements 21/- each. All guaranteed. P. & P. 9d. extra on all orders.—Richardson & Forder, 5 Chapel Place, White Hart Lane, London, N.17.

STAMPS FREE—Empire Packet including Pictorials and Victorians with approvals.—Robert J. Peck, 7A Kemp Road, Bournemouth.

'PAINTSPRAYING' HANDBOOK (1954 Ed.). Covers Car, Industrial & Flock Spraying. 3/6, post free, including catalogue of our Cellulose and Synthetic Paints and all Allied Sundries and Plant Hire.—Leonard Brooks Ltd., 81 Oak Road, Harold Wood, Essex.

MODELS. You can make lasting stone-hard models with Sankey's Pyrama Plastic Cement. Supplied in tins by Ironmongers, Hardwaremen and Builders' Merchants. Ask for instruction leaflet.

SWISS MUSICAL Mechanisms for cigarette boxes, etc., 16/6 post free. S.A.E. for illustration and list of tunes available.—Dept. HW., Metwood Accessories, Church St., Wolverton, Bucks. (Trade supplied.)

See page 248

# Stringholder and Knife

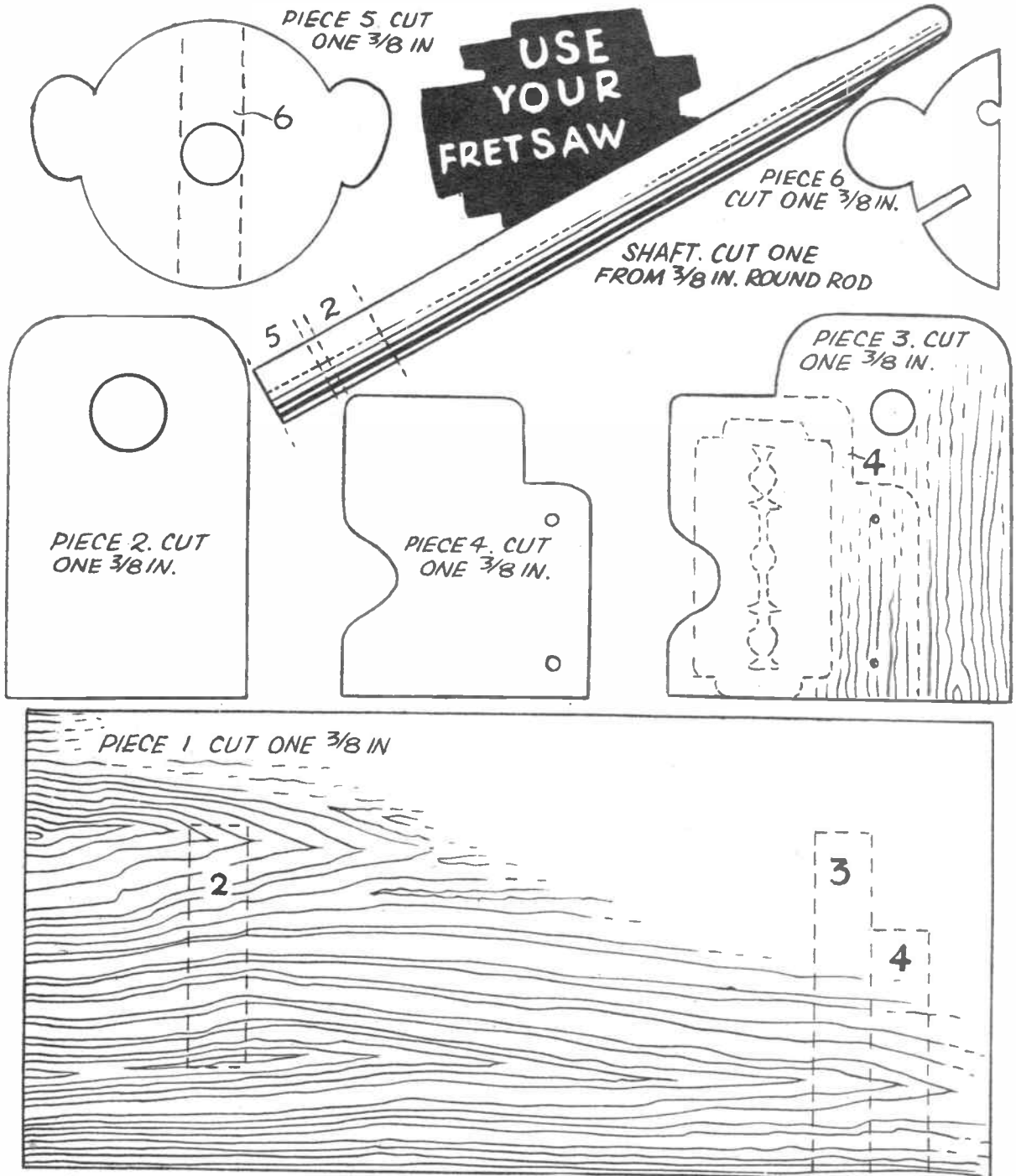

# You can do EVERY home job with Black & Decker Tools!



Tackle your own home maintenance and repairs. Make furniture and kitchen fittings. Keep a showroom shine on your lounge furniture, silverware, pots and pans, and on your car. Every job is looked after with a B & D Home Workshop Outfit powered by the peppy  $\frac{1}{4}$ " Utility Drill (T.V. suppressed). You don't have to be an expert and you don't need lots of money.

You can select your own complete workshop—and if it's valued at £15 or over, then it's yours for only 30/- down, and 12 monthly payments of as little as 25/6.

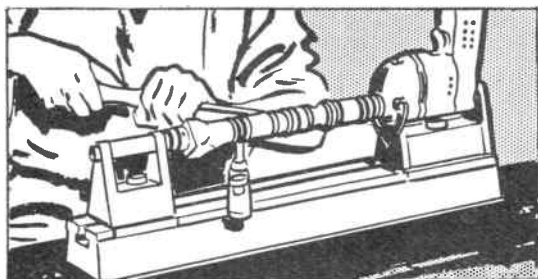

Professional wood turning and decorative furniture making is easy—even for the beginner—with the B & D lathe attachment. With the drill chuck and bit attached, you can put up shelves, fittings, in no time. The drill bores easily through wood, tile, brick—even steel. B & D equipment more than pays for itself in modernising your home.

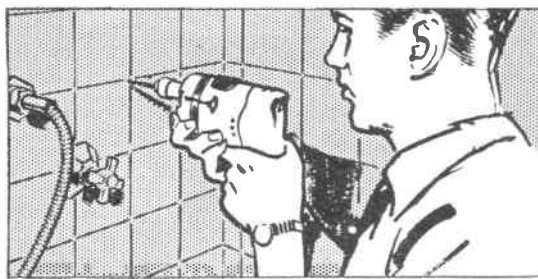

Two more examples of the tool at work. Effortless furniture polishing quicker than you could imagine—but what beautiful results. Pots, pans, silverware—even the old car shines like new now! With the easy-to-fit saw table you can rip through timber accurately—no fatigue! You could make a shelf in the time it takes to read this page!

*Send p.c. for full details and free copy of the second in a series of hints for the handyman—"Sanding and Polishing jobs around the Home".*

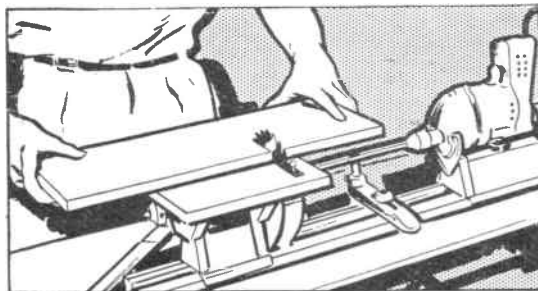

**PUT THE 'DO IN 'DO'-IT-YOURSELF'**

# Black & Decker

HANDY  TOOLS

**BLACK & DECKER LIMITED · DEPT. 52A · HARMONDSWORTH · MIDDX:**

Printed by BALDING & MANSELL, LTD., London and Wisbech, and Published for the Proprietors, HOBBIES LTD., by HORACE MARSHALL & SON, LTD., Temple House, Tallis Street, E.C.4. Sole Agents for Australia and New Zealand: Gordon & Gotch (A'sia) Ltd. For South Africa: Central News Agency Ltd. Registered for transmission by Canadian Magazine Post.