

# HOBBIES WEEKLY

IN THIS ISSUE

	Page
A Small Press - . . . . .	49
Know the Colour Code - . . . . .	50
Give the Ruler a Rest - . . . . .	51
Fitting a Letter Box - . . . . .	51
Contact Printer are Easy - . . . . .	52
New Finish for a Table - . . . . .	53
Wallet and Key Container - . . . . .	54
A Novelty Powered by Elastic - . . . . .	55
Feeding Table for Birds - . . . . .	56
A Rustic Flower Basket - . . . . .	56
An Arm-Chair Tray and Book-Rest - . . . . .	57
Modern Newspaper Rack - . . . . .	57
Keeping Tropical Fish - . . . . .	58
Replies to Readers - . . . . .	60
Patterns for the Newspaper Rack - . . . . .	63



NOVEMBER 2nd 1955

VOL. 121

NUMBER 3131

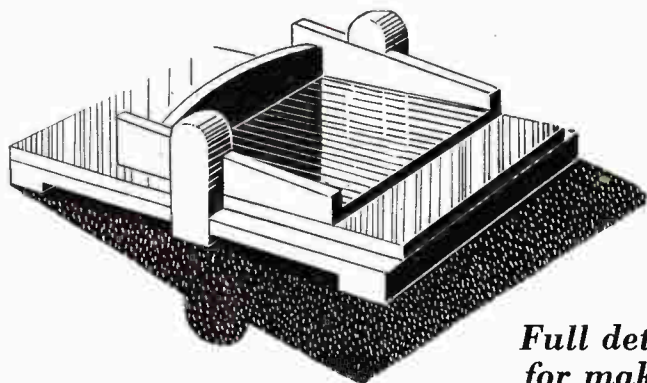

*Amateur Photographers  
will find this useful*

course, give the better finish, but plywood is less likely to warp.

It will be seen from the diagrams that there are three distinct parts—the base, the cover and the pressure board. The base is shown in Fig. 1 and base com-

● Continued on page 50

*Full details  
for making*

## A SMALL PRESS

A PRESS of some sort is often needed when mounting small drawings or for storing them flat. The one shown in the illustration is easily made and answers the same purpose as an expensive bought article. The amateur photographer will find it particularly useful for storing prints.

### Wedge Principle

The press works on the wedge principle and is easy to make if the diagrams and dimensions are followed. Any number of prints or papers up to a total thickness of about  $\frac{1}{2}$  in. can be comfortably put in the press.

The dimensions shown should be adequate for most purposes, but they can, of course, be modified to suit

individual needs. The present measurements are large enough to take a quarto sheet which is 10ins. by 8ins. All parts are cut from  $\frac{3}{8}$  in. wood.

Use a hard wood such as beech, or plywood throughout. Beech would, of

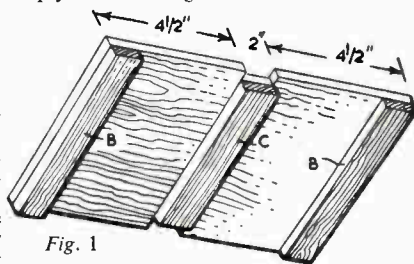

Fig. 1

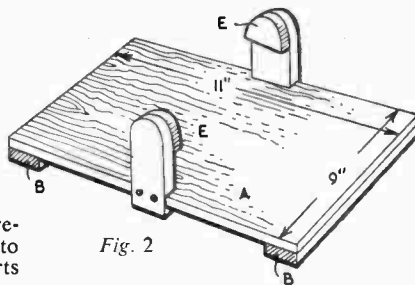

Fig. 2

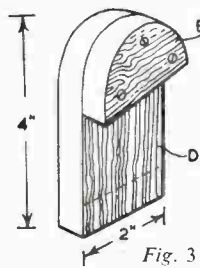

Fig. 3

All correspondence should be addressed to The Editor, Hobbies Weekly, Dereham, Norfolk

For Modellers, Fretworkers  
and Home Craftsmen

4<sup>D</sup>

# Know the Colour Code

Says *F. G. Rayer*

**M**OST radio resistors now have the value shown by colour coding, and some readers seem confused about this. When replacing a resistor in a receiver, or building a set, it is necessary to know the value of the component. An understanding of the colour code is then of great advantage, and the method is really a simple one.

Instead of figures, ten colours are used, representing numbers from 0 to 9. (Colours are easier to apply during manufacture than are numbers, as there is usually no level surface on which the latter can be printed.) The same colours represent 'numbers of noughts' from 0 to 9.

### Correct Sequence

In order that a resistor may be read correctly, the colours must be taken in the proper sequence. With resistors such as shown at (A) this is Body, Tip, and Dot. The colour of the body thus gives the first number, the colour of the resistor tip gives the second number, and the colour of the dot gives the number showing how many (0's) must be added. Some small resistors have bands instead. If so, these are read one by one from the end, as shown at (C).

Some resistors have three colours

only—three bands, or body, tip, and dot colours, as at (A) and (C). When this is so, the actual value of the resistor is within about 20% of that marked. Resistors with this amount of accuracy are suitable for most positions in a receiver. When the resistor is correct to within 10% of its marked value, this is shown by a 4th band, of Silver, as at (B) and (D). If the resistor is accurate to 5%, this band will be Gold. The colours used to show 10% and 5% accuracy (Silver and Gold) are not used for numbers, so no confusion in reading the value arises.

The ten colours, and their numbers, are as follows:—Black 0; Brown 1; Red 2; Orange 3; Yellow 4; Green 5; Blue 6; Purple 7; Grey 8; White 9.

### Examples

Bearing the foregoing in mind, a number of examples will now make the method clear. A resistor as at (A) with Red body, Green tip, and Orange dot would be 25,000 ohms. One as at (B) with Blue body, Black tip, Brown dot, and Gold tip, would be 600 ohms, to 5%.

A resistor such as at (C), with Brown,

Black, Orange bands in the order shown, would be 10,000 ohms. One such as at (D), with 3 Orange bands and Silver tip, would be 33,000 ohms, correct within 10%.

### Popular Values

To simplify colouring, manufacturers often use values such as 33,000 ohms. Such a resistor would be dipped wholly in Orange, thus giving Orange Body, Tip and Dot colours. If a Tip or Dot is not visible as a different colour, then it is the same colour as the body.

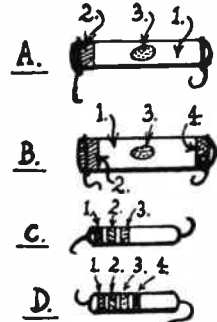

How resistors are coded

(1) in the diagram always gives the 1st number; (2) always gives the 2nd number; and (3) always gives the number of noughts. With the last colour (Dot or 3rd band) Black does not indicate (0) but *no noughts*, as a moment's thought will show. One (0) is shown by Brown.

Some popular values are:—2 megohms: Red, Black, Green. 1 megohm: Brown, Black, Green.  $\frac{1}{2}$  megohm (500,000 ohms): Green, Black, Yellow.  $\frac{1}{4}$  megohm (250,000 ohms): Red, Green, Yellow. 100,000 ohms: Brown, Black, Yellow. And, in low values:—100 ohms: Brown, Black, Brown; 500 ohms: Green, Black, Brown.

●Continued from page 49

## Making a Small Press

plete with uprights in Fig. 2. Most of the measurements are shown in the two sketches.

The battens under the base (A) are cut from 2ins. by  $\frac{3}{8}$ in. wood. Note that

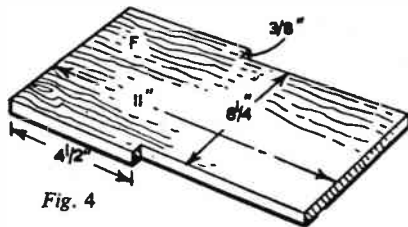

Fig. 4

the centre batten (C) is shorter than pieces (B). (C) measures  $8\frac{1}{2}$ ins. and pieces (B) are 9ins. long. Glue and screw them under the base as shown in Fig. 1.

The notches in the base are for the uprights (D) which are 2ins. wide and 4ins. long. The upright (D) and sloping pieces (E) are shown in Fig. 3. The pieces (E) slope at the same angle as the

pieces (H) of the pressure board. Pieces (E) must be securely screwed to the uprights, which must themselves be firmly screwed to the base.

Piece (F) is merely a flat board which forms a cover to go over the points. The dimensions are shown in Fig. 4.

The pressure board is made up as shown in Fig. 5. The sloping sides (H) are screwed and glued to piece (G). The curved piece is  $7\frac{1}{2}$ ins. long and is fixed between the sides as shown.

Clean up the press with glasspaper and give two or three coats of varnish or high-gloss paint. (M.h.)

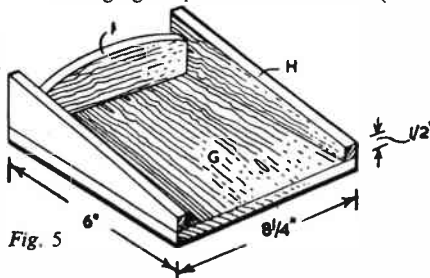

Fig. 5

## Remember



## Poppy Day

*It's indispensable, but—*

# GIVE THE RULER A REST

**T**HE ruler, though an indispensable item of equipment in the home workshop, is often overworked. The result is that the standard of work suffers and much time is wasted.

For an illustration, suppose that the worker requires to make a door frame to fit a cupboard. One way would be to measure the size of the opening and transfer these measurements to the rails and stiles (the upright parts of the frame). But here two operations are involved—finding the correct measurement, and transferring it to the wood. There are, therefore, two opportunities for error.

The correct method is to place the door rails and stiles in the position which they will occupy in the finished assembly, and mark off the distances directly on to the wood (see Fig. 1). These marks are then squared round

with a try-square. By dispensing with the ruler in this way, the possibility of error is greatly reduced, if not entirely eliminated. And, after all, there is no real reason why the distance should be resolved into feet, inches and fractions of an inch.

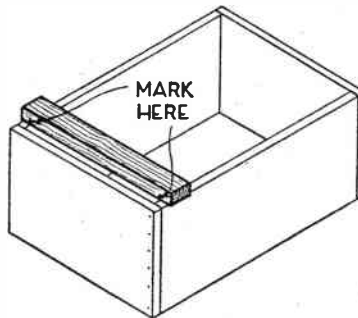

There is another instance in which the ruler can be partly dispensed with, so that greater accuracy is achieved. Suppose that four legs have been prepared ready for marking out. Each leg must be marked to length and the positions of the mortises indicated. To

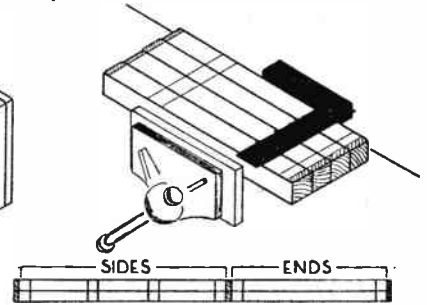

do this individually would need great care to ensure that each leg was marked precisely the same as its neighbour. But if the four legs are placed in the vice together as shown in Fig. 2, and the lines squared across, the operation is much simplified. Any error which may be made in the measurements will be repeated on all the legs, and the mistake will probably not affect the appearance of the finished article. It should be noted that, once the lines have been squared across in this way, the pieces should be removed from the vice, and each line should then be squared round individually.

## Mark Pairs Together

The same method should be used when marking out the rails of a stool or similar construction. Pairs can be marked out together, and in some cases (when there are lower rails) four pieces can be marked out together.

The construction of a box divided by partitions is a good example in which both of the principles described are put into practice. To make the box, two pieces of wood are cut—each of sufficient length to make one side and one end. After planing, they are placed together in the vice for marking out (see Fig. 3). Note that, in addition to the overall length, the positions of the grooves and the shoulder lines of the dovetail joints are marked. The lines are then squared round separately. When the box has been assembled and glued, the divisions are placed in position and the lengths marked off from the bottoms of the grooves.

If these principles are adopted, you can be sure that the standard of your work will show a great improvement.

(K.B.)

## Fitting a Letter Box

*By F. G. Rayer*

**F**ront doors without a letter box prove to be a nuisance to both postman and householder. If a box or flap is fitted, there is no need for the postman to wait for the door to be opened, or for anyone to be present to answer his knock.

located by measurement from the edges of the door.

To remove the section necessary, a hole about  $\frac{3}{16}$  in. to  $\frac{1}{4}$  in. in diameter should be drilled at each corner, for the insertion of a keyhole- or pad-saw. The four sides are then sawn, and the wood removed. Any rough edges of wood should be taken off with a rasp. Now the letter box fitting can be secured in place. Some fittings have projecting threaded rods, which are passed through suitable holes, with nuts being screwed on behind. Others may be screwed directly to the door by woodscrews of a suitable size and type. If a box to catch letters is required, this can be about 4 ins. deep, 8 ins. wide, and 2  $\frac{1}{2}$  ins. from back to front. It is screwed inside directly under the flap.



*Central position, chest high*

Suitable fittings can be purchased cheaply, in a range of styles and finishes to match the door. They usually consist of a metal frame to which a flap is hinged. The latter opens inwards, and may have a spring to keep it closed.

The size and position of the required aperture should be carefully marked on the door. A central position, at about chest height, is generally best. The opening should be large enough for the flap to turn back freely, and accurately

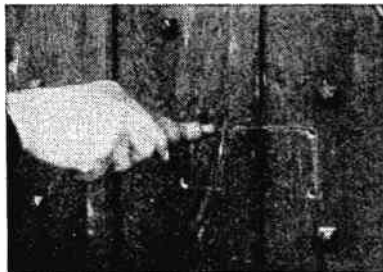

*Use saw, and finish off rough edges with rasp*

# Contact Prints are Easy

Says F. G. Rayer

**M**ANY people introduce themselves to the 'chemical' side of home photography by making contact prints, and this is both easy and interesting. No special darkroom is required. The necessary materials are low in cost, and prints in every way equal to those done by professional establishments can be produced. Anyone may readily produce extra prints for friends, or the album, without delay and with very little expense indeed.

All processing may be carried out in an ordinary room with subdued artificial light. No black-out arrangements are necessary, after dark. In the summer daylight remains until late evening, and thick curtains are then helpful in darkening a room, if no dark boxroom or other suitable spot is available. All work (except the actual exposure) is done in subdued artificial light. Yellow bulbs and globes can be purchased, or an ordinary table lamp, placed in the corner of the room and shielded so that

suit any negative. The most popular roll-film cameras give negatives 2½ ins. by 3½ ins. and 2½ ins. square, and paper 2½ ins. by 3½ ins., or 2½ ins. square, will be used for these. The printing frame resembles a small picture-frame, with removable back, and holds negative and paper together during exposure.

## Chemicals Required

These are only two—developer and fixer. Any chemist can supply, and any well-known make is satisfactory. The developer may be liquid, powder, or in tabloid form. Liquids are diluted as explained on the bottle; e.g., usually 7 parts of water to 1 part developer. Powders and tablets are mixed with water, as instructed. In practice, there is a great deal of latitude here. If the developer is too diluted, it will merely take longer for the print to develop.

into the developer, or to touch the surface of the printing paper with fingers wet with chemical. Print 'paddles' and forceps are obtainable so that the hands can be kept dry, but these are by no means essential.

The quality of the finished print depends on the correct printing time. When beginning work, this is found by making a test-strip print, as a rule. Later, there will be no need to make experiments of this kind, unless the lamp distance is changed, a bulb of different power substituted, or a different type of printing paper used. To avoid unnecessary complication, it is recommended only one normal grade printing paper be used, at first. This is available in packets of 25 sheets upwards, in many makes.

The negative is placed in the printing frame, emulsion side to the back. With lighting subdued, a sheet of printing paper is placed with its glossy side against the emulsion side of the negative.



Find the perfect exposure —



— and then print

direct light does not fall on the printing paper or dishes, will do. An ordinary candle is excellent, since its light does not influence contact printing paper.

For printing, any ordinary electric bulb of 25 to 100 watts is used. It should be kept at the same distance from the printing frame, and about 1ft. to 3ft. is satisfactory. If the distance is changed, the printing time will have to be altered also. A table lamp with switch is suitable, or the ordinary room light. With the latter, printing can be done on a table directly under the light, so that the distance will always be the same.

For the prints, glossy contact paper is best, and easily obtainable in sizes to

For fixing, hypo, or acid-hypo, is used. This is a powder, mixed with water. After use it can be stored indefinitely in a bottle for further prints. The diluted or mixed developer will only keep a day or two, however, so this is usually mixed each time prints are to be made.

Developer and fixer may be placed in photographic dishes, or any suitable vessels. It is helpful to have the developer in a dish or shallow receptacle, so that the print may be watched. Jugs, basins, or any other container will do well for the fixer. A jug or vessel of clear water is also required.

Care should be taken not to get fixer

The frame back is then clipped in place. The remainder of the printing paper should be returned to its envelope, or covered over.

The printing frame is placed in its usual position for printing, and covered with a sheet of card. The printing light is then switched on, and the card drawn a little aside to expose a strip of the negative. After ten seconds the card is drawn further away, and this continues for each ten-second interval, until the whole negative is exposed.

The paper is then removed from the frame and developed for about two minutes. This will give a result similar to

● Continued on page 53

# NEW FINISH FOR A TABLE

**M**OST homes have some piece of furniture which would look so much more attractive if given a new finish, and how often it is a table which needs refinishing most.

It is possible to remove the old finish from solid wood, and whether or not the surface is veneered, the same processes can be applied. With a thinly veneered surface, the varnish must be removed speedily to avoid loosening the veneer and ruining the finish.

As a precautionary measure for the protection of the floor, and your hands, spread newspapers underneath the table to be refinished, and wear a pair of old gloves.

Now dust the table, and use a cheap 2ins. brush to flow on the paint and varnish remover freely with the grain.

Care should be taken to ensure that none splashes on your skin or clothing. Cover about 1 to 2 square feet at a time, but do not attempt to work it in or brush it backwards and forwards, or try to cover all the surface in one operation.

Having done this, wait for the varnish to bubble, blister, and crumble, and then, using a 3in. scraper, remove the crumbled varnish. The scraper should be held away from the body, and pushed firmly with the grain. Too much pressure, however, should not be

applied or the wood may gouge. As it is inflammable, the loosened varnish should be disposed of immediately.

These operations should be repeated at least twice, until all the old varnish or paint is cleared from the surface.

The scraper should only be used on a flat surface. Where curved or carved surfaces are involved, such as the legs of a table, the first layer of crumbled varnish should be removed with small pieces of burlap instead of a scraper, after the paint remover has caused the finish to blister. Where traces of the old finish can still be seen, a stiff wire brush will prove helpful to clear the remains. In the case of intricate carving, an old toothbrush will be useful.

As soon as the removal of the old finish has been completed, thoroughly wipe the surface with a soft cloth saturated in denatured alcohol, to prevent the paint remover from clogging the pores of the wood and causing rot.

When the alcohol has evaporated leaving the natural wood exposed, get some fine glasspaper, wrap it round a block of wood, and rub lightly backwards and forwards with the grain. The table will be scratched if you go against the grain.

The wood should be glasspapered until smooth as satin. No marring marks should show when the work is

completed—a job which often takes considerable time if it is well done.

If the wood is open-grained, any tiny holes which are still apparent can be filled up with a wood-filler. First, tint the wood-filler with a penetrating oil stain to blend with the colour of the wood, and rub it into the wood with a cloth, against the grain. When this has dried, the surface should be re-glasspapered to ensure complete smoothness and all traces of lint or dust removed.

Now for the new finish. It is advisable to use a good quality varnish brush with long soft bristles, and, of course, a good quality varnish.

The varnish should be applied direct from the tin to the wood surface, and be well brushed out in long smooth strokes. Care must be taken to make certain that the whole of the surface is covered. The varnished table must then be left for at least twenty-four hours to allow the varnish to dry, for there must be no stickiness when the polishing is commenced. If possible, it should be left where no dust will settle on it.

When it is all thoroughly dry, saturate a cloth with linseed oil, dip it into powdered pumice, and use it to rub down the varnish. Rub with the grain but without applying too heavy a pressure which would burn the varnish.

●Continued on page 54

●Continued from page 52

## Contact Prints are Easy

that in the illustration. Here, the card was moved from left to right at ten-second intervals, giving strips with exposures ranging from 70 to 10 seconds. Examining the print shows that the long exposures give dark results, while the short exposures are insufficient. Between these extremes will be found a correctly exposed strip (40 seconds, in the example). A new piece of paper is thus placed in the frame, and the light switched on for the appropriate time. The print is then developed as before, giving a result such as that illustrated.

The same exposure will do for all negatives of similar density. If they are held up to the light their general density, or blackness, can be seen. Very thin negatives will need a shorter exposure. These can be put to one side and a test-strip print made from one of them. Very dense negatives can go into a third group, and will require longer exposures. If all future negatives are similarly graded into 'Thin', 'Average'

and 'Dense'(or dark), prints can be made without further test exposures.

If the printing light is very powerful or near, the strips may be exposed for 5 seconds each. With extremely dense negatives, and a low-powered bulb, even 70 seconds will be insufficient, and the test strips can be exposed for  $\frac{1}{2}$  minute each instead of 10 seconds.

### Finishing

A properly exposed print will cease to grow darker, however long it is developed. If the print appears to be growing too dark, another one should be made, with shorter exposure. Pulling a print from the developer quickly, to prevent it becoming black, results in degraded tonal values. It is best to expose correctly, so that the print can be developed for at least 2 minutes.

After development, the print is washed for a few seconds in the vessel of water to remove most of the developer. It is then placed in the fixing solution, where it should be kept on the move for

a few seconds. It can then be left, face downwards, while other prints are made.

The time the print is left in the fixer is of no importance, within reason. Fixing will usually be complete in about 5 minutes, but the print may be left for 30 to 45 minutes or more, while other prints are made and dealt with. If many prints are made, it is best to transfer the fixed prints to a vessel of water, after about 15 minutes, to give more room for the new prints being fixed.

To obtain permanent prints, ample washing is required, to rid the paper of chemicals. About 30 to 45 minutes in running water is satisfactory. If no running water is available, 10 to 12 changes in clean water, at 5-minute intervals, will be suitable. The washed prints are allowed to dry, then pressed flat.

For high-quality prints, the following should be remembered: Exposure should be correct, as explained, developer should be freshly mixed, and the print should be fully developed. To avoid possible stains, keep the print on the move when first put in the fixer. And to prevent eventual discoloration, wash thoroughly. Quite a large number of prints, of high quality, can then be made in a short time.

## Two Projects in Leather

# Wallet and Key Container

**N**OTE wallets are simple and inexpensive to make and there are many designs available from which the leather-worker may choose. The layout of the wallet illustrated can be altered to suit individual tastes by, perhaps, adding larger-sized panels or extra pockets. However, the measurements are suitable for most requirements, and the wallet is a familiar example of a masculine item which rarely changes in design.

The wallet has two compartments for £1 and 10/- notes, an inner pocket, a large back pocket which runs the full

length and a stamp pocket. A flap fitted beneath a loop has also been added to keep the back pocket closed. The wallet is devoid of fittings or fastenings and has no lining, for if suitable leather is chosen this is unnecessary.

The layout gives the measurements, which should be drawn on to stout paper, a pattern constructed and cut to shape. Carefully cut out the leather parts, stain the raw edges a suitable shade and glue the flap strengthener to the inside of the cover. Allow a period for the article to dry well before commencing to stitch the edges.

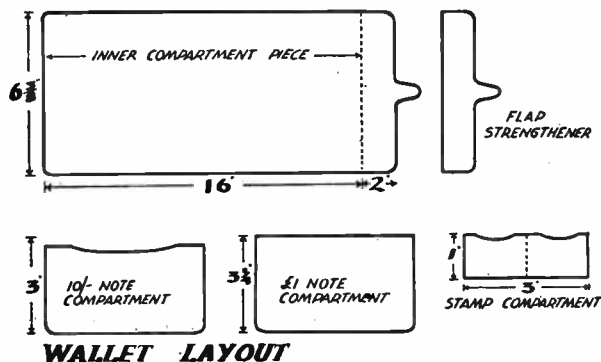

The tab-retaining strip must now be fitted. Cut slits in the inner compartment front, insert strip and glue ends inside. On front of the 10/- note compartment the stamp section may now be stuck down and stitched. Press the wallet under a weight and allow to dry before stitching along the edges and down the middle to separate the pockets. The remainder of the wallet can now be glued and assembled completely stitched when the glue has dried.

The wallet should be well polished to provide a good finish. It is not difficult to tool initials in one corner and the note compartments can also be marked with their different values.

*Article  
No. 5  
in our  
series  
by  
James  
MacIntyre*

● Continued from page 53

## New Finish for Your Table

When the glossy appearance has disappeared, the varnishing and polishing processes should be repeated twice more. Then for the fourth time apply the varnish. When this has dried, gently rub with a cloth dipped in linseed oil and then in powdered rottenstone. Keep on rubbing until the surface is quite smooth.

If you already possess a certain amount of aptitude for this work, so much to your advantage. It will get the job done more quickly. But if you are quite new to it, do not let that deter you. Patience is a grand substitute for experience. If you use it when waiting to proceed with the processes, such as waiting for the drying out before applying the next coat of varnish and so on, you will be amply rewarded.

The cost of giving your table a new finish will be only a fraction of what it would cost to buy a replacement.

But apart from the economy, you will experience a justifiable pride in the satisfaction of having turned something shabby into an attractive asset. (E.M.B.)

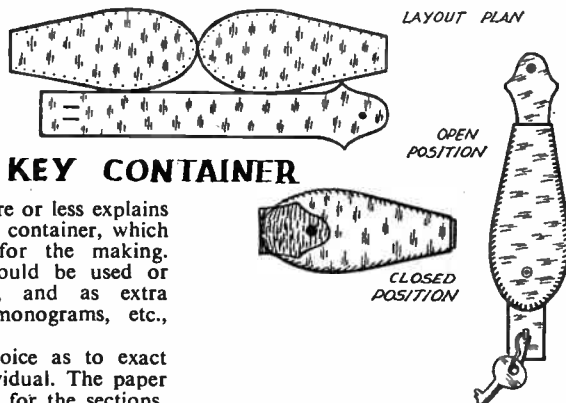

The illustration more or less explains the structure of a key container, which needs little leather for the making. Fancy reptile skin could be used or even tooled leather, and as extra decoration initials, monograms, etc., may be added.

Once again the choice as to exact measurements is individual. The paper pattern should be cut for the sections, which consist of a long inner strip and a back and front of the same dimensions. Sections should be cleanly cut in leather from paper patterns. The fastener, a snap one, should first be attached to the end of the inner strip. At the opposite end of this strip two tiny slots will need to be cut and the key ring clipped through. Attach a key so that you can measure just how it will hang when in the case. Next, fit the strip between the

front and back sections, pull up until the key is well out of sight. It is now brought down the back of the container, folded over the bottom and then up the front. This now gives you the correct spot for the insertion of the opposite end of the fastener.

With this accomplished the whole container will have to be punched and laced. Directions for lacing were given in a previous article.

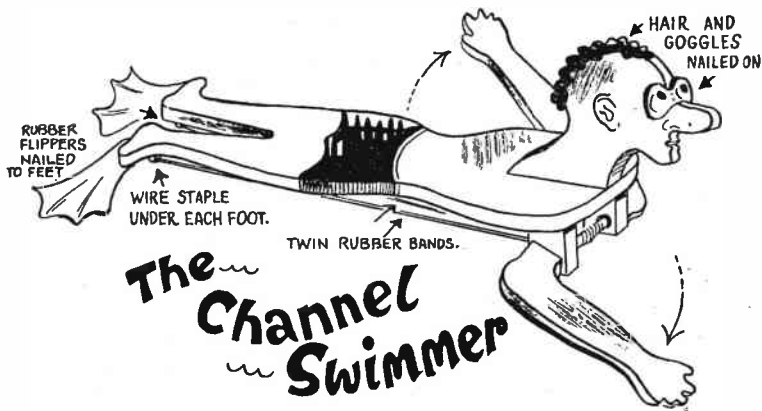

# The Channel Swimmer

# A NOVELTY POWERED BY ELASTIC

Described by  
T. S. Richmond, Jr.

HERE is something different from the usual elastic-driven toy boat—a paddle-arm swimmer that sets out to beat all records with his fast stroke, and rolls from side to side as he goes along in a most realistic manner. He will 'swim' wherever there is water—even in the bath.

Although of simple construction a certain amount of care is needed, in order that the paddle arms will turn smoothly. All parts may be cut from  $\frac{3}{8}$  in. thick hardwood, though the body piece may vary slightly from this thickness.

Mark out a length of wood 11 ins. by 3 ins. wide, and divide it into 1 in. squares. Draw in the shape of the body, including the slots for the paddle supports and head. Cut out with your fretsaw, and also the parts (B), (C) and (D).

The two supports (B) have a hole drilled large enough for a length of dowel to turn freely, and allowance is made for the wood swelling at this point when wet. The supports, and the head (D) are fitted into the body, and should be a tight fit, as no glue is used. One or two fret-nails are knocked in for extra support.

of each foot, or thread a length of wire through the legs. Cut a strip of rubber-band about  $\frac{1}{8}$  in. wide from an old cycle inner-tube. Thread this through the two staples, or tie the centre to the wire between the legs. Fasten the ends of the band securely to the paddle rod.

Hold the figure by the legs and wind up the paddle arms, so that, when released, they turn in a forward motion.

Instead of two lengths of band, one only could be used, the spare staple being used for tying a length of string, to prevent the toy from swimming out of reach.

Give the toy two coats of flesh-colour enamel paint. Put in details to the face, and give him a pair of trunks. Nail on the pair of goggles and hair. Web-shaped flippers may be cut from inner-tube rubber, and a pair nailed to the feet. These flippers increase the effect of movement.

Having made a satisfactory working toy, you may wish to make more, as the kiddies will enjoy racing them on the river or swimming-pool. The dowel rod should be greased with Vaseline occasionally at each end, to prevent sticking.

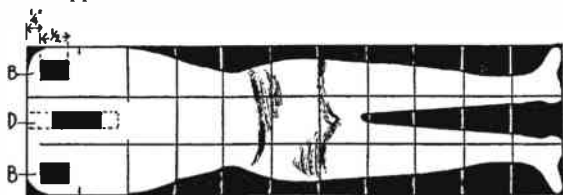

THE BODY. 11" X 3". MARK OUT IN 1" SQUARES.

Place the paddle-arms in a vice, and carefully drill a hole in each at one end. Note that this hole goes half-way, and should be a very tight fit for the dowel-rod. Tap on the paddle arms as in the front view drawing on the patterns. Note that they are fastened to the rod in opposite directions. One or two pins are driven in through the arm and into the rod.

Fasten a wire staple to the underside

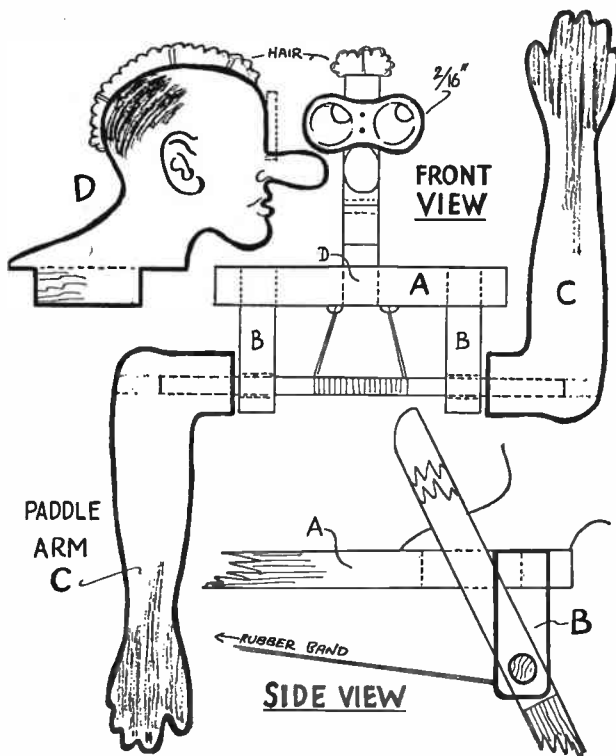

Note: Diagrams on right are half-scale

## A 'Popular' Theme

# Feeding Table for Birds

By F. G. Rayer

WITH winter approaching a bird table will prove to be popular with small birds both in country and town, if kept supplied with crumbs and other scraps. That described here is primarily intended for wood-working classes of boys over 10 years, and can readily be made by anyone. Junior schools may well have one or two such tables at suitable spots out-of-doors.

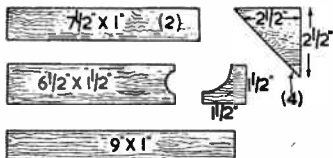

All the pieces required

Except for the stick and perch,  $\frac{1}{2}$  in. thick wood may be used throughout, secured with lin. nails. The base is 7 ins. by 9 ins. The other small parts required are shown in the diagram. The longest strip is nailed to the back of the

baseboard, and two  $7\frac{1}{2}$  in. strips are used at the sides. The  $6\frac{1}{2}$  in. piece is nailed vertically, and supported by the small wooden bracket. A round perch a few inches long is nailed to the top of this upright.

The completed table is mounted on a pole or stick at least 3 ft. long. A broom-handle is suitable, or piece having a square section about  $\frac{3}{4}$  in. by  $\frac{3}{4}$  in. or so. Four of the triangular brackets, at 90-degree intervals, support the table rigidly on top of the pole.

### Saw Accurately

The parts will fit together even if poorly sawn, but a class or pupil should be made to mark each out correctly, and saw accurately, so as to develop the habit of proper workmanship from the very beginning.

The completed table may be painted with any outdoor paint, a green or brown colour probably being most

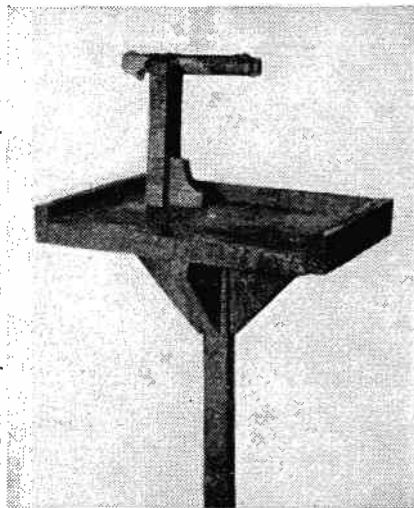

natural. If circumstances make it impossible to fit the pole upright in soil, then a square base can be made to hold it vertical. During very cold weather water is almost as important as food, especially in towns, and should be provided in a shallow vessel.

## A Rustic Flower Basket



AN easily-constructed article which every housewife would appreciate, because it makes a suitable decoration for the display of miniature garden plants when placed on a table or a window-ledge, is this rustic flower basket. It could also, with the addition of chains, be suspended from a porch or doorway.

Woods such as pine, oak or ash are excellent for the making. From one limb of timber other shapes than the one illustrated could very easily suggest themselves.

When a piece has been decided on, glasspaper the ends well to get rid of any roughness. To remove the centre core, drill a series of small holes with a hand drill, then use a chisel to finish and smooth the sides of the hole.

If a chain is added, fasten screweyes in such a position that the basket will hang straight. As the basket will swing very readily in the wind it is advisable to make certain that all hooks and fittings are well secured.

Many classes of small flowering plants are available for growing in moss and a little soil will nurture the vine type of

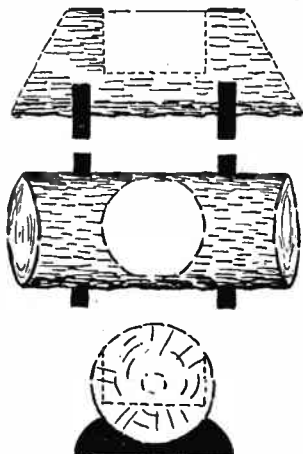

plant if the basket is to hang in a porch. One advantage of the basket is that it retains a lot of moisture and thus dispenses with frequent watering. (J.M.)

## NATIONAL BIRD LEAGUE FORMED

A NATION-WIDE Junior Bird League has been formed, open to all young people up to the age of 18.

Its objects are:—(i) to foster the love of birds; (ii) to encourage observation of wild bird life; (iii) to promote the study of birds in cages and aviaries; (iv) to cultivate interest in bird breeding.

Membership costs 2/6—which is not an annual fee, but lasts until the member has reached her or his eighteenth birthday. Every member will receive a coloured enamelled badge, and a certificate of membership on which the aims and objects of the league are set out.

Members of the J.B.L. will also enjoy certain privileges such as admittance to specified zoos at reduced prices; free advice service, and so on. Promoter of the scheme is 'Cage Birds'. Applications for membership should be addressed to: The Secretary, Junior Bird League, Dorset House, Stamford Street, London, S.E.1.



# AN ARM-CHAIR TRAY AND BOOK-REST

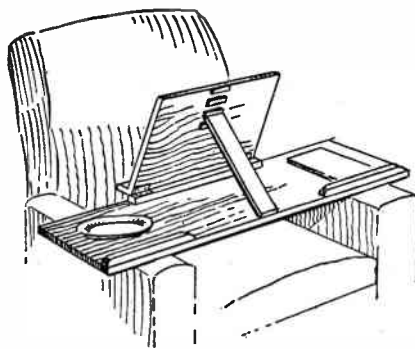

Fig. 1

**W**HY not enjoy extra comfort in your arm-chair by including the tray and book-rest illustrated in Fig. 1. The folding sloping support for book or newspaper will be found most useful and restful for reading, while tea can be taken in comfort at the same time.

The article consists of a plain board 30ins. long or as suits the width of the arms of the chair. To the ledge of wood fixed at the front of the board is hinged a rack as can be seen in the illustrations.

## Varied Slope

At the back of the rack there are four small fillets of wood into which the hinged back strut will fit, the slope being varied to suit the comfort of the reader. When the rack is not in use it may be folded down flat, the strut being first

in the diagram Fig. 2. In Fig. 3 the rack is shown erected, while Fig. 4 gives a detail of the rack, its hinges and support fillets. Both these diagrams show the ledge (B) which is to hold the book or paper in proper place. Glue and screws will make a good joint here, and, indeed, to all the fillets and ledges.

All sharp corners and edges should be glasspapered off and made smooth. The book-rest itself may be  $\frac{3}{4}$ in. thick with rounded corners at top and the two hinges fitted and screwed on as shown in Figs. 3 and 4. The small fillets at the

rear of the rest should be spaced about  $\frac{1}{2}$ in. apart.

Note how the top of the strut is shaped as in Fig. 2 to go in between the fillets. Note, also, that when the strut is folded down it lies level with the top of the front hinging fillet.

The completed article may be stained and varnished or just painted according to the taste of the reader. (S.W.C.)

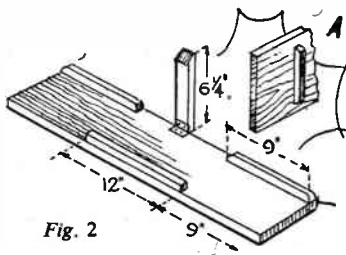

Fig. 2

## ANY IDEAS ?

H. R. Beggs of 203 Rose Lane, Liverpool 18, writes

'Some years ago I had a puzzle made in wood, but cannot remember all the sizes of the pieces. The base was 4ins. x 4ins. with a raised side leaving a 2in. aperture. The object was to move the pieces about until a block 2ins. x 2ins. could be drawn out through the aperture. I know the other pieces were 2ins. x 1in. and 1 in. x 1in. but how many were there? Can anyone help?'

## For Your Home

# Modern Newspaper Rack

**U**SE your fretsaw to make this modern newspaper rack, which would make an attractive addition to the home. It is easily made if the measurements and diagrams on the pattern page are followed.

The two sides are cut from  $\frac{1}{2}$ in. plywood to the size shown. Use a piece of plywood 20ins. by 18ins. long. Draw a centre line down the middle. Draw a full circle of 9ins. radius and part of a circle to form the feet.



## Easy-to-follow patterns on page 63

The rims inside are each cut in three parts from  $\frac{1}{2}$ in. wood. Screw the rims to the inside of the sides, and join the sides together by means of a rail of 2ins. by 1in. wood about 10ins. long. Insert screws through each side into the rail.

Finally bend some thin plywood round, pinning it to the rims. Plywood about  $\frac{1}{4}$ in. or less will be suitable.

To finish off, clean up with glass-

paper and give two coats of Chinese lacquer. Flat down with glasspaper or silicon carbide paper used wet and give two more coats. The result will be a high gloss almost equal to a spray finish. The sides can be left plain or decorated with large transfers. (M.p.)

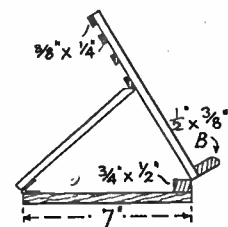

Fig. 3

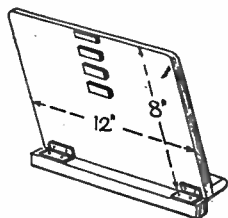

Fig. 4

laid down on the board with the rack on top of it. At the rear of the tray two ledges are fixed which will prevent articles on the tray from sliding on to the floor.

To hold the tray in position between the arms of the chair two cross-fillets of wood are fixed, one being shown as (A)

## An inexpensive hobby

# Keeping Tropical Fish

**T**ROPICAL fish keeping can be within the reach of everyone. Contrary to popular belief it is an inexpensive hobby, in recent years the increase of aquatic enthusiasts has reduced the price of most fish to a few shillings. If you have already constructed the bookshelves that were described in a previous issue, the size of your tank has already been decided, but for tropical fish it is advisable to buy one with a plate glass or slate bottom, as a galvanised base is not really suitable.

### Heating

The most efficient and cheapest form of heating is by electricity; an immersion heater used in conjunction with a thermostat will keep your running costs down to a few pence a week. A 60 watt heater will be sufficient for the 24ins. tank. The thermostat should be set to control the water temperature at 75°. In this way the headache of keeping watch on a changing temperature is solved, but it is advisable to have a submerged thermometer fixed to the front glass of the tank.

### Lighting

A well-balanced tank needs healthy plants which will, therefore, require the use of artificial lighting in addition to daylight. The amount of light needed depends on the size of the tank and its position in relation to natural light. In a dark corner it must be illuminated most of the day. In a room with an average amount of daylight a small tank would need a 75 watt lamp for about 6 hours. It is easy to check if the amount of light is correct; too much light will make the plants grow tall and spindly. There will be a tendency for the water to go green due to algae (microscopic life). Insufficient light will cause the plants to look sickly, lose their bright green colouring, and turn brown.

### Aquarium Layout

If the back of the tank is clear glass it is a good plan to paint the outside with pale blue enamel. This will limit the amount of side light which is alien to the fish in their natural state, give an appearance of greater depth, and make a pleasing background. The bottom of the tank should be covered with clean builder's sand. To wash this place it in a bowl and run clean water over it, turning the sand until the water runs clear. Repeat this with aquarium compost which can be purchased from your fish supplier. First lay the sand over the floor of the aquarium, banking

it high at the back with a slope down to a shallow layer in the front. This will ensure that decayed matter rolls forward for easy cleaning. Lay the aquarium compost on top of the sand in the same manner. There are many theories as to the best material for the floor, but from experience sand and compost will be most trouble free for the beginner.

☆☆☆☆☆☆☆☆☆☆☆☆☆☆☆☆☆☆☆☆  
☆☆ Some helpful hints to the beginner ☆☆  
☆☆ on the stocking of an aquarium ☆☆  
☆☆ are given here by ☆☆  
☆☆ *R. J. Burt* ☆☆  
☆☆☆☆☆☆☆☆☆☆☆☆☆☆☆☆☆☆☆☆

Rocks are added to the aquatic scene next. It is best to buy them by the pound from your supplier. They are quite cheap and will have no harmful effect on the water, but do not overdo it and keep the appearance natural. The layer of compost can be quite thick at the back if the rocks are used to hold it at different levels; but avoid crevices where food can decay and foul the tank.

The heater should be placed on the bottom of the tank. The best place is at the back, so that the flex can be taken up the corner angle, and the thermostat which is wired to the heater should be placed in the corresponding corner. Now place a saucer on the floor of the aquarium and fill the tank with water by pouring it on to the saucer. This will prevent the sand and the rocks being disturbed.

### Plants

Oxygenating plants are a necessity for a healthy aquarium; buy them from your dealer. Vallisneria is a good plant for supplying oxygen to the water; when it is planted care should be taken not to push the crown of the plant under the compost. Ludwigia is another plant that will be useful and will grow well with vallisneria. If the plants are not weighted it is a good plan to wind strip lead to the roots to prevent them floating to the surface. For the best effect the plants should be placed in groups along the back; the heater and the thermostat can be disguised in this way. It is not advisable for the beginner to use floating plants. They are useful as shelter for newly born fish, but most of them will multiply rapidly shutting out all light from the top.

If possible it is an advantage to let the tank settle for a couple of days before placing the fish in it. With so many

species available, the beginner may be tempted to fill the tank with several different kinds. This is a mistake. Concentrate, at first, on two or three of the hardier types. It is safest to start with 'live-bearers' as they will fill the bill both for colour and interest. The platy can be obtained in many colours. They are hardy little fish, natives of Mexico, and will be quite happy in a temperature of 70°-75°. The guppy is another multi-coloured fish in the male of the species, but the female is a more sombre hue. This fish, which comes from Trinidad, is most prolific in 70°-75°. In a well-planted tank that affords plenty of shelter the guppy community will soon increase, and they will live happily with the platy. Small egg-laying fish will be safe in the same tank as live-bearers, but the chances of any baby fish surviving are small.

### Maintenance

When new fish are introduced to the tank, float the jar in the aquarium until the temperatures of the water are the same, then tip the jar carefully so that the fish can swim out.

More trouble will result from over-feeding than from any other cause. Fish do not die from over-eating, but they will die from the pollution caused by decayed food. Fish can live without food for a couple of weeks, but feed them with a small pinch of dried food every day. Food uneaten after five minutes should be skimmed from the surface of the water with a piece of paper. As an alternative diet shrimps can be given. The dried shrimp eggs are purchased in a tube and will keep for several years. Put a teaspoonful of sea salt in a jar of water, and sprinkle some shrimp eggs on the surface. After two or three days hundreds of tiny live shrimps will be seen. Strain them through a piece of silk, and feed them to the fish. In this way you can safely vary the diet with live food.

### Removing Sediment

Never completely change the water of the aquarium unless troubled with disease. A dip tube can be used once a week to remove sediment from the bottom, but when performing this operation, be careful of small fish.

Once a balanced aquarium has been attained it needs little attention. Success will be more certain if the aquarium is not often disturbed. With increased knowledge more ambitious schemes are possible, and there are many helpful books on the subject; but the elementary points given here will assure a smooth beginning.

**Abrasive papers  
and cloths  
by  
CARBORUNDUM**



**Garnet-coated products**

For wood-workers, CARBORUNDUM make papers and cloths coated with grains of specially prepared garnet. Careful factory preparation and size-grading of the tough, hard-wearing garnet grains makes abrasives that do better work than glasspaper can, and go on doing it for longer. Garnet-coated papers by CARBORUNDUM are excellent for wood-working. They are available in a wide range of grit sizes from coarse (for really fast, easy removal of material) to very fine, for producing super smooth finishes.

**Aluminium oxide and**

**silicon-carbide grains**

Papers and cloths coated with ALOXITE\* abrasive (aluminium oxide) or silicon carbide grains are made in grades and grit-sizes suitable for wood-work, for all classes of metal-finishing, and for rubbing down paintwork on metal or wood.

\* Regd. trade mark.

**Waterproof papers for  
use on clogging materials**

For sanding or rubbing down materials of a clogging nature, CARBORUNDUM make special waterproof papers with silicon carbide grains. These papers can be rinsed in water during use, whenever the abrasive becomes clogged with material removed from the work. They are specially suitable for rubbing down paintwork whether in house decorating or on car bodies or other metal or wooden surfaces.

**Electro-coating process**

Compared with grains of crushed or natural emery, grains of silicon carbide

or ALOXITE abrasive (aluminium oxide) are more regular in shape, with tougher, more enduring cutting edges. In the manufacture of all their finer-grained waterproof papers CARBORUNDUM use an electro-static coating process for depositing the grains. An electro-static field arranges the grains so that they stand on end in the adhesive that binds them to the paper. These electro-coated papers make work easier and quicker because their cutting edges are more effectively presented to the work. This is a typical example of the care that CARBORUNDUM take to make their coated papers and cloths the best that you can buy.

**Coated abrasive products by**

**CARBORUNDUM**

*from your local tool shop or hardware store*



# Replies to Readers

## Is this YOUR Problem?

### Repairing Camera Bellows

*IS there any preparation which will enable an amateur to make the bellows of a camera light-proof? There are pin-pricks at every fold. What is the usual method employed for this job? (U.A.M.—Ilford.)*

IF the bellows of your folding camera are badly gone, it is best to have new ones fitted. Should you, however, wish to try repairs yourself, the faulty edge of a fold can be cured by running a strip of thin but opaque adhesive tape along the inside, creasing first and then rubbing well home until a perfect fit is secured. For individual holes, an excellent sealing preparation is the black rubberised solution sold for attaching rubber soles to leather shoes. To check for the position of holes, take the camera into a dark room and insert a torch end inside with any top glasses taken off.

### Turning Model Wheels

*PLEASE describe to me how (with the help of a lathe) to make model 2in. wheels like those on the modern 4-wheeled lorry. (C.B.—Chelsea.)*

YOU should screw a block of wood to the faceplate of your lathe. Cut the wood for the wheels into conveniently sized squares and fasten to the block with a screw to two opposite corners. Run the tailstock to the block to impress a centre point, and strike the

circle for the wheel. Partly cut through the circle, then cut the recess between central boss and tyre. Finish the outer edge to a quarter circle and cut right through with a parting tool. The wheel will then drop off and can have its axle hole bored. If the inner face is also to be turned you will need a suitable chuck for that part.

### Iron Marks on Table

*A TABLE used for ironing has had both stain and polish removed in several places, and the panelling on top of the table has blistered. Will you tell me how to remove the remaining polish and stain as well as the blisters—and repolish it mid-oak? (A.C.—Cheltenham.)*

TREATMENT will depend on whether the table top is solid wood or veneered. If solid, remove old polish with a cabinet scraper, which should also reduce any swellings, etc., caused

The Editor welcomes letters from readers concerning their particular hobbies. Correspondents should, however, confine queries to one subject and to those dealt with in this magazine.

by ill usage. Glasspaper, then stain, grain fill if necessary, and french polish or coat with white hard spirit varnish. If the wood is veneered remove old polish with a varnish remover first, then reduce the blisters by making a cross-cut across them, lifting the tips of the

### ☆☆☆ WORTH NOTING ☆☆☆

Slits in Metal  
 WHEN cutting slits in metal, such as tubes and rods, the cut is not always wide enough. To avoid filing, and presuming a double width of the cut is required, a good plan is to fit two hacksaw blades on the frame and thereby double the width of the cut. Should the additional blade be a trifle slack a binding of tape will secure it.—(E.M.B.)

cut veneer and forcing a little tube glue beneath. Press flat, cover with newspaper and weight or cramp down. Finish with glasspaper, restain, and polish as described.

### Tinting Perspex

*I DESIRE to colour some Perspex I with an amber tint—please tell me how to do this. (P.J.R.—Deal.)*

THE Perspex may be surface-coated to an amber tint by painting with a clear amber dope. Such dope may be made by diluting Durofix with an equal volume of amyl acetate and dissolving an amber synthetic dye therein. For the dye you should write to George T. Gurr Ltd., 136/138 New King's Rd., London, S.W.6, specifying that the colours required should be amyl acetate soluble. Coloured Perspex may also be obtained cut to buyer's sizes, from Henry Moat & Son Ltd., Atom Works, Newcastle, I.

## Miscellaneous Advertisements

100 DIFFERENT stamps free! Request 4d. upwards discount approvals.—Bush, 53 Newlyn Way, Parkstone, Dorset.

POLAND 1948 Firework Display. Grand complete set, free to approval applicants enclosing postage.—Yulwontmor Stamps (Dept. H5), 29 Layton Avenue, Mansfield.

50 STAMPS free to all approval applicants enclosing 2½d. stamp.—Cliffe West (H1), 61 Wynyard Road, Sheffield, 6.

WANTED for small business, high quality craft goods (wood, felt, basketwork, leather). No samples in first instance.—Write Box No. 21, *Hobbies Weekly*, Dereham, Norfolk.

250 STAMPS FREE! Request approvals, postage 3d.—Dicker (H.W.), 14 Clement Hill, Hastings.

FREE—50 different stamps plus 10 San Marino mint, on requesting approvals.—P. E. Bentham, 40 Little Glen Road, Nr. Leicester.

KUKLOS ANNUAL. Indispensable cyclist's handbook. Tours, resthouses, money-saving hints, 2/10, post free.—Burrow, Publishers, 2 Imperial House, Cheltenham.

PLYWOOD — HARDBOARD — at amazing low prices. Send S.A.E. for samples and prices to—N. Gerver, 10 Mare Street, Hackney, London, E.8.

### DO YOUR OWN CHROMIUM PLATING

COMPLETE OUTFITS 10/- and 25/- EACH  
 Guaranteed! this product has the British Good Housekeeping Certificate Sand P.O. now for complete outfit, or 4d. in loose stamps for details and plated sample to—  
 O. DUTCH & CO., 51 Monkham Lane  
 WUDFORD GREEN ESSEX

'PAINTSPRAYING' HANDBOOK (1954 Ed.). Covers Car, Industrial & Flock Spraying. 3/6, post free, including catalogue of our Cellulose and Synthetic Paints and all Allied Sundries and Plant Hire.—Leonard Brooks Ltd., 81 Oak Road, Harold Wood, Essex.

BUILD your own T/V and learn about its operation, maintenance and servicing. Qualified engineer-tutor available whilst you are learning and building. Free Brochure from—E.M.I. Institutes, Dept. HW58, London, W.4. (Associated with H.M.V.)

GENUINE Swiss Musical Movements. Owing to large purchase now reduced to 14/6 each. Genuine Thorens Movements, all guaranteed, 19/3 each. P. & P. 9d. extra on all orders.—Richardson & Forster, 5 Chapel Place, White Hart Lane, London, N.17.

400 STAMPS free. Genuine. S.A.E. for approvals. Details—W. H. Self, 36 Fairfield, Boro Green, Kent.

PLYWOOD; large sizes, 14 lbs. 10/- delivered (Express) C.W.O. — H. Leader (1920), Gosford St., Middlesbrough.

SWISS MUSICAL Mechanisms for cigarette Sboxes, etc., 16/6 post free. S.A.E. for illustration and list of tunes available.—Dept. HW, Metwood Accessories, Church St., Wolverton, Bucks. (Trade supplied.)

STAMPS FREE — Empire Packet including Spectatorials and Victorians with approvals.—Robert J. Peck, 7A Kemp Road, Bournemouth.

# LOOK!

**AMAZING**  
this lovely table  
for ONLY 49/-  
Average shop price  
£4.15.0.

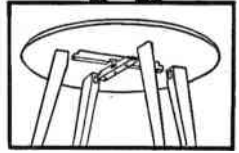
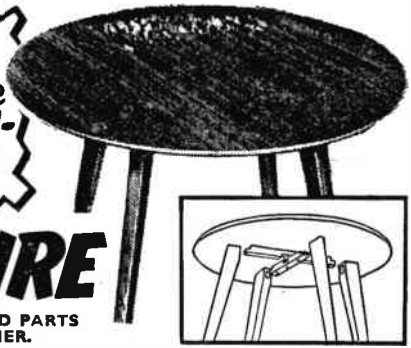

## assemble this wonderful WREN CRAFT FURNITURE yourself—and save pounds

BEAUTIFULLY-FINISHED PARTS  
YOU JUST FIT TOGETHER.

Make your own furniture with WREN CRAFT home assembly outfits. Each contains precision-cut parts, screws, pins, special glue and easy-to-follow step-by-step instructions. Make lovely, modern furniture all your friends will envy—make tables, beds, cabinets, wardrobes, stools, dressing-tables, bookcases, out of top quality timber. And choose from oak, walnut, mahogany, beech . . . just as you please. Make them at a fraction of shop prices and on easy terms if you wish. Satisfaction guaranteed or full cash refund!

Here's just a few of the wonderful WREN CRAFT things you can make

- Stool · Candelabra
- Occasional table
- Book case · Cot
- Cocktail cabinet
- Tea Trolley · Bedstead
- Kidney Dressing Table
- Wardrobe

. . . and lots more useful, attractive articles you'll be proud to own. You may get a copy of the FREE WREN CRAFT book—see left.

**FREE!**  
The WREN CRAFT  
book of  
Furnishing  
Post  
Coupon  
NOW!

**YOURS**  
—this lavishly—  
illustrated book  
**FREE**

**ACT NOW!** Get this exciting **FREE WREN CRAFT** book and see all the lovely, luxury furniture you can make. You'll be amazed at the low prices! Don't wait—post coupon **NOW** for free copy.

Please send me **FREE** copy of THE WREN CRAFT BOOK OF FURNITURE

NAME \_\_\_\_\_

ADDRESS \_\_\_\_\_

WREN CRAFT FURNITURE : KINGSTON ROAD : NEW MALDEN : SURREY



## NEW! EXPERIMENTAL KITS

### LEARN THE PRACTICAL WAY

Here is home study of the most effective kind under expert tutors. There is no better way of studying for an examination, starting a new hobby or for a career in industry. These special courses comprise the most modern methods of postal tuition, combined with a Practical Kit of parts (which remains your property).



COURSES FROM 15/- A MONTH

COURSES WITH PRACTICAL EQUIPMENT INCLUDE: Radio, Television, Mechanics, Electricity, Chemistry, Photography, Carpentry; also Draughtsmanship, Commercial Art, Amateur S.W. Radio, Languages, etc.

**POST THIS COUPON TODAY**

For FREE brochure write: E.M.I. INSTITUTES,  
Dept. 31X, Grove Park Road, London, W.4.  
SUBJECT(S) OF INTEREST \_\_\_\_\_  
NAME \_\_\_\_\_  
ADDRESS \_\_\_\_\_  
2/11/55 \_\_\_\_\_ IC51A

**E.M.I. INSTITUTES**  
The only Postal College which is part of a world-wide Industrial Organisation

**YOURS** for only  
**15/-**  
down!



Save time and work on sewing jobs with this excellent 'Essex' Miniature Sewing Machine. Beautifully finished with chromium plate. Supplied with clamp for fixing firmly to table. 6 months' guarantee. Cash price £4.14.9 or 15/- deposit and 6 monthly payments of 16/-. Electric model available A.C./D.C. with foot control £9.17.6, or 31/- down and 6 monthly payments of 31/-. Protective carrying case 17/6 extra. Send for leaflet today.

**PHILISHAVE**  
14 DAYS' FREE TRIAL



Try the wonderful Philishave Electric Dry Shaver. FREE for 14 days. Send only 5/- deposit (returnable if not satisfied). Two shaving heads with two 6-bladed cutters have unique rotary action which gently shaves—doesn't just snip at the hairs. Result—better, quicker shave. Operates 110/250 volts. A.C. D.C. £7.9.3 cash less your deposit. Or 5/- deposit can be first payment, followed by 8 monthly payments of £1. 12 months' guarantee. Brochure of this & other shavers free.

**ELECTRIC PAINT SPRAYER**



for 4/- deposit

Cash 75/-. Or 4/- deposit and 6 monthly payments of 13/6  
Paint easily, evenly, twice as fast with the Burgess Electric Sprayer. Sprays paint, varnish, etc. Complete with sturdy glass container, flex, nozzles for ceiling spraying and extra nozzle discs for different liquids. A.C. mains—state your actual voltage. Fully guaranteed. Also Horwall Electric Paint Stripper 30/- cash, or 4/- deposit and 3 monthly payments of 10/-. Leaflets free

**Wolf Cub**  
ELECTRIC DRILL AT

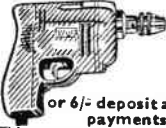

REDUCED PRICE  
**£5.9.6.**

or 6/- deposit and 6 monthly payments of 19/6d.  
This wonderful Electric Drill is also the power unit for ALL Cub equipment. Drilling capacity: Mild Steel, 1/2"; Hard Wood, 3/4"; with 210 watts input on full load. Complete with 1/2" three-jaw chuck and Allen key and 5ft. of cable. TV Suppressed. State Voltage. ALSO Sanding & Polishing Kit (drill, discs, etc.). Cash Price: £6. 10. 6 or 19/- deposit and 6 monthly payments of 12/1- Send for Illustrated Brochure of Wolf Cub equipment.

**BARGAIN DISTRIBUTORS**  
(Dept. 124), 5 Silver Street, Luton

*A really superior finish!*  
... FOR 101 JOBS

Easy to apply and quick to dry, these inexpensive lacquers have many uses. They will impart a rich and lustrous finish to models, picture frames, lamp standards, wicker chairs, work baskets, those unsightly water or gas pipes, etc. Fine for dance shoes too! Be sure to ask by name for

**CROWN SILVER LACQUER AND GUINEA GOLD LACQUER**



Obtainable only from  
**WOOLWORTHS**

**Build your Daughter this**



**TUDOR DOLL'S HOUSE 75/3**

(Carriage paid U.K.)  
When completed, this beautiful doll's house is 2 ft. wide, 2 ft. high and 1 ft. 4 ins. deep. The complete kit (No. 237 Special) contains all necessary wood, metal "open and close" windows and door, fireplaces, materials for stairs, and brick, tile, floor and wall papers. A smaller modern-type house, 1 ft. 5 ins. wide, can be built from Kit No. 2910, price 48/3, carriage paid. The Doll's House Electric Lighting Set has provision for six lights and costs only 7/11. Other kits are shown in Hobbies free booklet, and the complete range of all Hobbies goods is given in the 1956 Handbook.



To **HOBBIES LTD.**, Dept. 992, Dereham, Norfolk.  
Please send me your Free 20-page 2-colour Booklet and name and address of nearest stockist. Also send me items I have marked thus X

- Tudor Doll's House Kit (237Sp.) 75/3, carr. paid U.K.  Doll's House Lighting Set 7/11  
 1956 Handbook 2/3, post free  Modern Doll's House Kit (2910), 48/3, carr. paid U.K.

NAME .....  
ADDRESS .....

**YOU MUST HAVE THE**

**Micromodels BOOK**

**MAKING Authentic Models of Historic Buildings, Locomotives, Ships, Aeroplanes, Trams, Cars, etc. is the Hobby for a Lifetime.** Using card, model making is a tidy fireside hobby. This new book

**'MAKING MODELS IN CARD'** with full-colour cover and 32 pages and 40 illustrations of valuable Hints & Tips and Stimulating Ideas, is being sold at the actual cost of production to tell you how to make Micromodel Museum Pieces at small cost. A Hobby that challenges and rewards your skill.  
The Publisher: **MICROMODELS LTD.**  
3 (H) Racquet Ct., Fleet St., London, E.C.4



**2/9**

**MAKE A RADIO SET**

**NO SOLDERING**—only a screwdriver and pliers needed. **FULL-SIZE** plans and building instructions for 8 sets, 2/6 post free.  
**CRYSTAL RADIO KITS**, "Varicoil", coil tuned, 10/6; "Popular", condenser tuned, 17/6; "Twin", very selective, 21/-; "Major", works well anywhere, 21/-.  
**EXPERIMENTAL KIT No. 1**, builds all 4 crystal sets above, 27/6.  
**"BASIC"**, a very simple 1 valve set, 35/- with valve and batteries.  
**"NEW ECONOMY 1"**, receives scores of stations, 52/6 with valve and batteries.  
**"NEW ECONOMY 2"**, works with loud-speaker, 82/6 with valves and batteries.  
**"PERFECT" 1-VALVE LOUDSPEAKER** set, £3 with mains type valve and batteries.  
Prices include postage and packing  
Send S.A.E. for list—or send 2/6 P.O. for easy to follow building instructions for all sets.

**BLANCHARD'S, DEPT. RH,**  
13 Gainford Gardens, Manchester, 10

**A GRAND BOOK FOR ALL THE FAMILY.** The "Kaylee Year Book of Bright Ideas". A really helpful guide to home planning, decoration, Hobbies, toys, etc. Showing famous Kaylee Transfers in brilliant colours, and most effective uses. From "Hobbies" stockists **1/-** or direct. Postage 3d.  
**KAYLEE TRANSFERS LTD., (HW) Long Eaton, Nottingham**

**EVERY CAR THAT PASSES—YOU WILL FIND THE INDEX MARK ALPHABETICALLY ARRANGED IN WHERE'S THAT CAR FROM?**

Price 9d.  
from all Booksellers or from the Publishers (11d. postage)  
**RALEIGH PRESS, EXMOUTH**

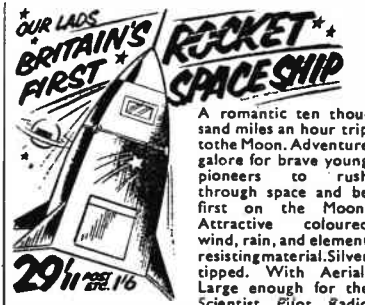

A romantic ten thousand miles an hour trip to the Moon. Adventure galore for brave young pioneers to rush through space and be first on the Moon. Attractive coloured wind, rain, and element resisting material. Silver tipped. With Aerial. Large enough for the Scientist, Pilot, Radio operator and 1 crew. Stands indoors or outdoors. A bargain complete 29/11, post etc. 1/6.

**THE NEW INTERPLANETARY SPACE SUIT**  
SENT FOR 2/6 CASH 29/11 POST 1/3 ETC.

Be an Interplanetary Commando. Wear this metallic blue Space Suit and pressure helmet. Be the first Earth Man to Jupiter. Can also be worn over outdoor clothing, guaranteed waterproof. For boys aged 4 to 10. Waisted and adjustable, visor on helmet. Lightning flashes on breast panel. Attractively boxed. Sent for 2/6 deposit and 5/- monthly. **LISTS, Clothing, Watches, TERMS.**

**HEADQUARTER & GENERAL SUPPLIES LTD.**  
Dept. NOBW/76, 196/200, Coldharbour Lane, Loughborough Junction, London, S.E.5.  
Open all Saturday 1 p.m. Wednesday.

**YOU CAN MAKE XMAS CRACKERS**  
We can supply all materials and fillings for this interesting and profitable occupation. Beginners—our special Learner Pack contains enough materials to make two dozen crackers complete with easy step-by-step instructions, only 5/-. Full sample range of fillings 2/- refundable. Lists free.  
**GAILEY CARNIVAL NOVELTIES**  
Aman Corner, TOOTING, S.W.17

£5 to £20 weekly earned at home running your own Mail Order business. Complete Course 5/6.—Courses, 28(HB) Dean Road, London, N.W.2.

See page 57

# Patterns for Newspaper Rack

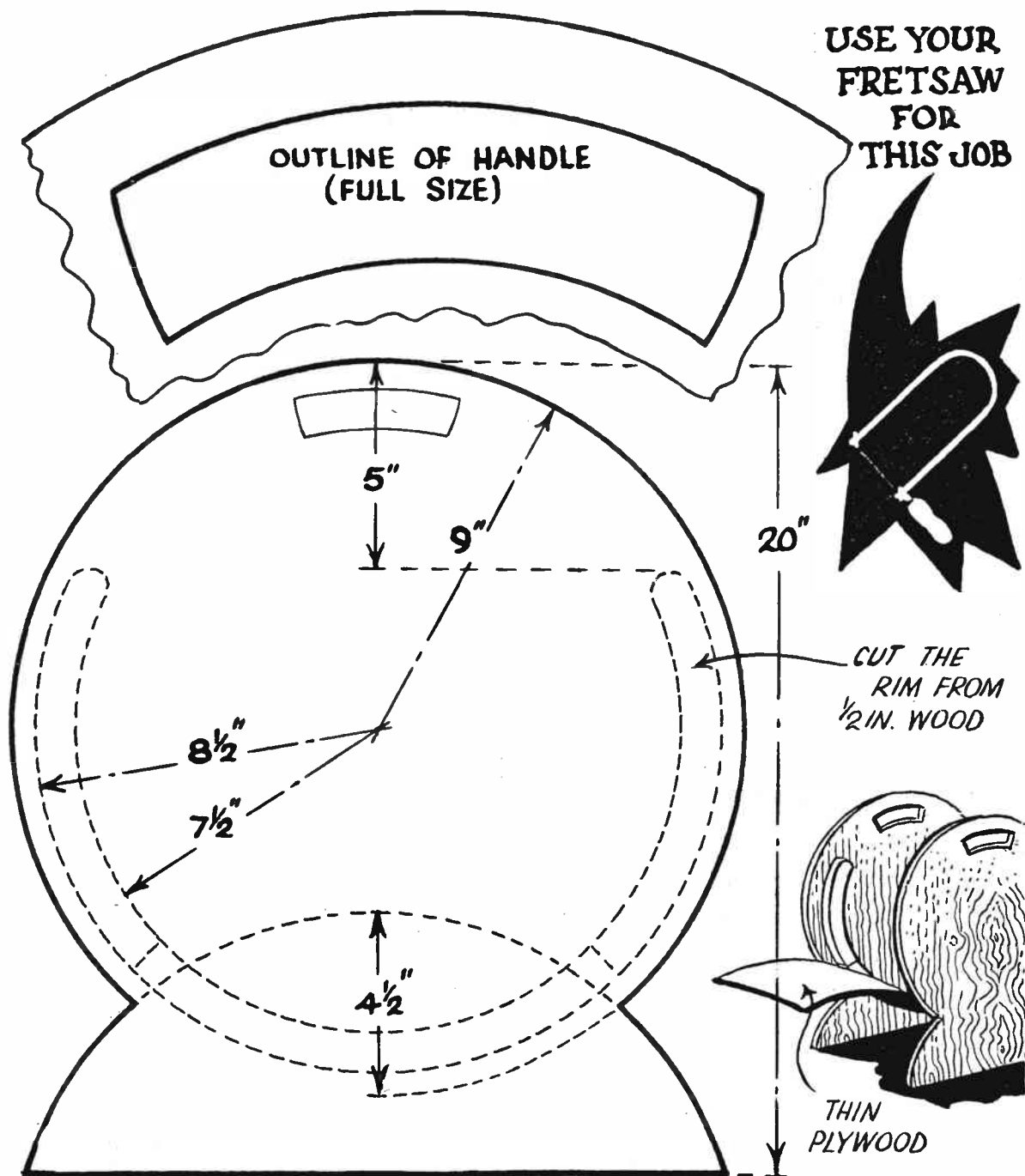



*Proof  
against  
Boiling  
Water*

**VALSPAR**

REGD. TRADE MARK

**2-4 Hour LACQUER • VARNISH • WOOD STAIN**

- ★ NO KNOTTING PRIMING OR UNERCOATING REQUIRED
- ★ DRIES IN 2-4 HOURS
- ★ SUITABLE FOR ALL SURFACES—EVEN TILES
- ★ EASILY APPLIED, EASY TO KEEP CLEAN



Write for booklet and name of stockist to the Sale Manufacturers U.K.

**GOODLASS, WALL & CO., LTD.**

179/185, (ACIO) Gt. Portland St. W.I. Est. 1840

**NEW-  
for  
you!**

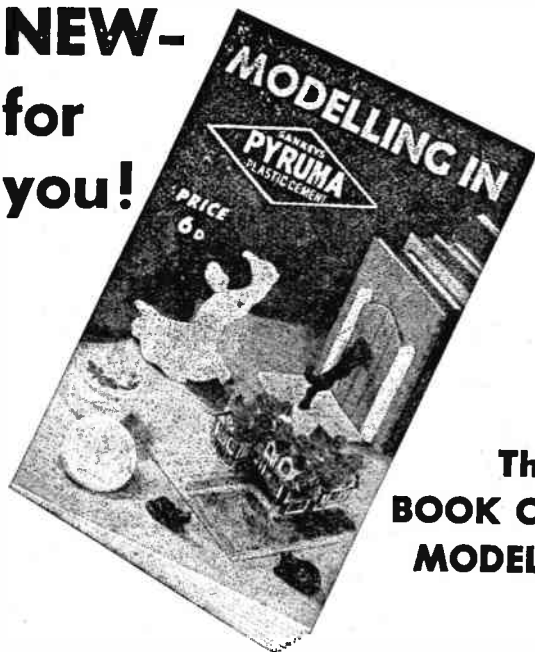

**This  
BOOK OF  
MODELS**

**M**ODELS of every kind from one plastic ready-to-use material—PYRUMA! This book with new methods—new ideas—shows you how to acquire simple skill in making many types of permanent models listed below. And pages in full colour show how your models of animals, buildings, figures, etc., can be painted in natural tints.



Pyruma is supplied, plastic and ready for immediate use, in air-tight tins, obtainable from your local Iron-monger, Hobbies shop or Art material dealer, from 1/6d. upwards. Finished Pyruma Models can be baked or air dried to stone hardness ready for colouring after simple treatment. Send 6d. P.O. (not in stamps) with the coupon below for the book which shows how to make **MODEL RAILWAYS, STATIONS, SIGNAL CABINS, FARM COTTAGES, SHIPS, FIGURES, ANIMALS, ASH-TRAYS, BOOK-ENDS, MODEL FURNITURE, PLAQUES, RELIEF MAPS, ETC.**

**COUPON**

To: **J.H. SANKEY & SON, L<sup>TD</sup>**

Estd. 1857

Dept. HW, ILFORD, ESSEX

Enclosed 6d. P.O. (not stamps) for PYRUMA MODELLING INSTRUCTION BOOK addressed to:

NAME (Block letters) .....  
ADDRESS .....

**2 SENSATIONAL BARGAINS FOR THE CRAFT WORKERS**



The complete Kit yours for only

**10/6**  
deposit

and 8 monthly payments 18/6  
Cash Price £7.2.0

**ALTERNATIVE OFFERS!**

Black & Decker No. 050B, the more powerful, higher speed, multi-purpose Sander polisher drill (3000 r.p.m.) includes—5" moulded rubber pad, lambswool bonnet and 3 assorted sanding discs. Cash price £8. 10. 0 or £1. 0. 9 deposit and 8 monthly payments of £1. 0. 9 or together with the L1No.2 kit comprised of:-

Wire brush, calico mop, grinding wheel and arbor. Making complete drilling, polishing, sanding, buffing and grinding outfit. Cash price £8. 19. 6, deposit £1 and 9 monthly payments of £1.  
Either power unit is suitable for all other B & D attachments.

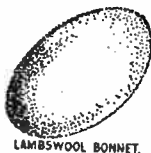

FREE:

Write for illustrated list of attachments for Turning, Buffing, Sanding, Drilling, etc., on the **EASIEST OF EASY TERMS.**

ALL POST FREE

**LES JOHNSON** (Dept. H), Supa Buildings, Greenhill Street, Stratford-upon-Avon.

Printed by BALDING & MANSELL, LTD., London and Wisbech, and Published for the Proprietors, HOBBIES LTD., by HORACE MARSHALL & SON, LTD., Temple House, Tallis Street, E.C.4. Sole Agents for Australia and New Zealand: Gordon & Gotch (A'sia) Ltd. For South Africa: Central News Agency Ltd. Registered for transmission by Canadian Magazine Post.



# HOBBIES WEEKLY

## IN THIS ISSUE

	Page
Working Toy Land Yacht . . . . .	65
Make a Shooting Board . . . . .	66
Third-Dimensional Hanging Pictures . . . . .	67
Stop that Draught . . . . .	67
Easily-Made Country Station . . . . .	68
Make a Plaster Cast . . . . .	69
Improve 'Snaps' by Trimming . . . . .	71
Stencil Craft . . . . .	72
Garden Litter Truck . . . . .	74
Stamp Collector's Corner . . . . .	76
A Novel Calendar . . . . .	79



NOVEMBER 9th 1955

VOL. 121

NUMBER 3132

### Christmas Present Suggestion

THE question of toys for the kiddies' Christmas stockings will be ever present in the minds of parents from now until December 25th. A colourful land yacht which can be pulled along, or 'sailed' in the wind on a smooth surface, is presented with this week's design, and would provide an excellent choice as a gift for either a young boy or girl.

Running on three wheels, two in the front and one at the back, there is

★ *Make it  
from FREE  
Design  
Inside*

*IT 'SAILS'  
WITH THE  
WIND ON  
LAND*

## WORKING TOY LAND YACHT

sufficient beam in this toy to give excellent stability. All the materials, including sailcloth and wheels, are provided in the kit.

The construction is quite simple, the hull merely consisting of three pieces of wood glued together one on top of the other, and completed by the addition of sails and wheels.

Trace the three pieces of the hull from the design sheet on to the appropriate thicknesses of wood, and cut them out with the fretsaw. Next screw on the three wheels to the positions indicated on piece 3. Incidentally there is not much room to 'work' the screwdriver when adding the back wheel, but this can be done satisfactorily by holding the wheel tight up against the wood whilst

**ALL YOU NEED  
FOR 9/-**

Kit No. 3132 contains all materials needed to build the Land Yacht, including wood, round rod, plastic wheels, brass rings, cord and cloth for sails. Price 9/- from branches, etc, or post free from Hobbies Ltd, Dereham, Norfolk.

screwing in. This will ensure that the screw goes in horizontally. When fixing the wheels to the bows, the ends of the screws will protrude through the sides, and these can be filed or cut off.



Now glue the three sections together as shown in the sketch on the design sheet, making sure that the holes for the mast, provided in pieces 1 and 2, correspond. When the glue is dry, shape the hull at the bows to give the toy

● **Continued on page 66**

All correspondence should be addressed to The Editor, Hobbies Weekly, Dereham, Norfolk

*For Modellers, Fretworkers  
and Home Craftsmen*



Save Time and Temper

# Make a Shooting Board

**T**O the amateur woodworker, a shooting board is a great time-saver. Accurately made it will produce squarely planed ends to the wood in a fraction of the time ordinarily taken. The shooting board illustrated is made from a hard-wearing wood such as beech or elm. Made from carefully selected timber, it will last a con-

Says *A. E. Hollingsworth*

siderable time before it requires 'trueing-up'—which, in any case, is quickly and easily done.

CUTTING LIST	
Framework	.. 2ins. by 1in. by 8ins.
Wedge	.. 2½ins. by 2ins. by 6½ins.
Top	.. 6½ins. by 24ins. by 1in.
Stop	.. 2ins. by ½in. by 6½ins.

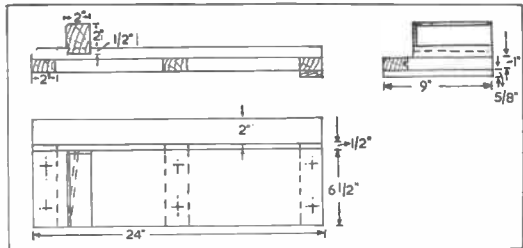
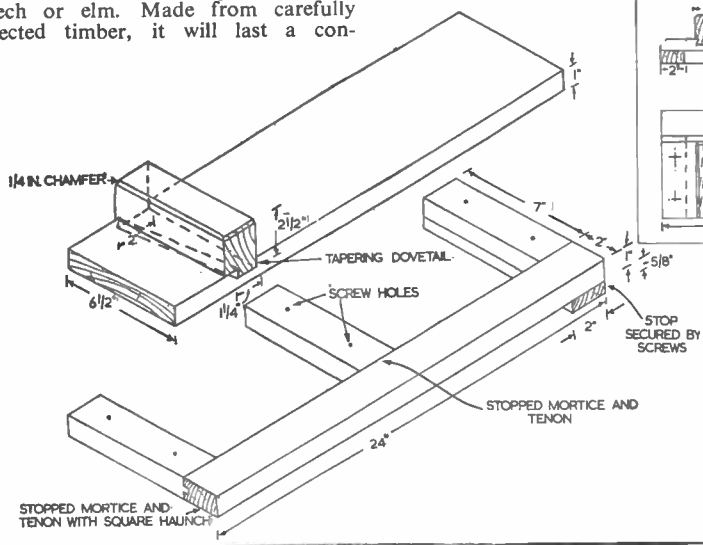

The framework is constructed from 2ins. by 1in. timber and is joined together as follows—(a) at the ends: a topped mortice and tenon joint with square haunch. (b) in the centre; a stopped mortice and tenon.

Care must be taken to see that the joints are a tight fit. The framework is glued together and afterwards carefully cleaned up with a smoothing plane and chisel.

The piece of wood for the top of the shooting board is planed to 24ins. by 6½ins. by 1in., taking care that the edges are perfectly square, and is secured to the framework by means of 1½ins. screws.

The wedge is accurately and squarely planed to the size stated and marked out with a tapering dovetail, so that, when fitted, a slight tap will always ensure a tight fit. Any movement in the wedge during use would result in an uneven cut on the end of the wood being planed. After fitting the dovetail and ensuring that the joint goes home squarely, the top edge of the wedge is chamfered. This chamfer helps to guard against the back edge of the wedge splitting when the shooting board is in use.

Finally, a stop 2ins. by ½in. by 6½ins., is screwed to the back end of the framework so that, when in use, the shooting board may be pushed up against the edge of the bench. A screw hook may be fitted to this stop, so that the shooting board may be hung up when not in use.

A final word of warning. It always pays to mark out the ends of the wood carefully with a sharp knife before using the shooting board. This will prevent the back edge 'turning over' and guard against any small splits.

Besides being a great time-saver, this piece of equipment saves many a frayed temper.

Continued from page 65

## Working Toy Land Yacht

pleasing lines, and at this stage the construction can be painted. Remember that bright red or blue are always attractive colours for children.

We next come to the making up of the sails. The size of these is shown on the design sheet, and both can be cut from the material provided in the kit. When cutting out, extend approximately ¼in. wide all round to allow for a hem. Sew four rings to the mainsail in the positions indicated in order to attach it to the mast and sew a length of cord to the three corners of both sails.

Shape the mast, boom and bowsprit from ¼in. round rod. The bowsprit should be flattened for about two-thirds of its length, where it will be fixed to the deck. The mast is tapered slightly and the boom merely rounded at the end furthest from the mast.

The bowsprit is fixed to the deck with glue, and two fret pins. Put the mast in the hole in the deck, and fix the boom to the foot of the mast by means of two screweyes. This is done by inserting one into the mast and opening the other before screwing into the boom. Connect

the two and close the boom screweye, thus giving a swivel joint.

Drill two holes through the mast in the positions shown on the diagram on the design sheet. Through these the cords attached to the tops of the sails will later be threaded and tied. Insert five small screweyes into the deck.

To attach the mainsail, slide the rings over the mast. Thread the cord on the top of the mainsail through the upper hole before tying off. Secure the lower corner to the forward end of the boom, and the outside corner to the other end of the boom, leaving 12ins. to 15ins. of cord spare to allow for alteration in the setting of the sail.

The top of the jib sail is fixed to the mast through the lower hole provided, and the forward edge to the front of the bowsprit.

The four screweyes just forward of the mast, provide adjustments to the positioning of the jib sail by means of the other cord.

The toy is now ready for pulling along, or 'sailing' into the wind on a stretch of smooth concrete.

# THIRD-DIMENSIONAL HANGING PICTURES

**M**AKING third-dimensional pictures can be a very pleasant and profitable pastime, and it is easily accomplished with the minimum of tools.

To start this fascinating work you will need one picture or photograph from which to copy, and several sheets of thin glass, cut to the size of the picture. The number of pieces of glass depends upon the amount of detail and depth of the picture. One piece of good quality paper mounted on a piece of plywood is required for the back of the picture, and finally you will need sufficient wood to make the picture frame.

When you have decided upon the picture you wish to transform, study carefully the amount of detail and depth of the picture, making a note of all the foreground detail.

Assuming that you have cut five pieces of glass, stretch a sheet of tracing paper over the picture, and sketch on it a

Having split the picture into the required amount of 'foreground' to 'background' pictures, each piece of tracing paper should be placed under one sheet of glass, and the appropriate amount of picture painted carefully on to each. Chintex paints would do admirably for this work.

While the paintings are left to dry thoroughly, carry on with making the wooden frame which is accomplished quite easily by following the instructions which are shown on the sketch.

The finished picture frame should be glasspapered down to a fine finish, and then polished or painted to the desired colour. To complete, fasten the back on to the frame with small pattern pins, and then lay the set of glass pictures inside in their correct order. Place a piece of clear glass over the top of them all, and fasten them in with four pieces of quarter-round beading.

The picture is now nearly complete

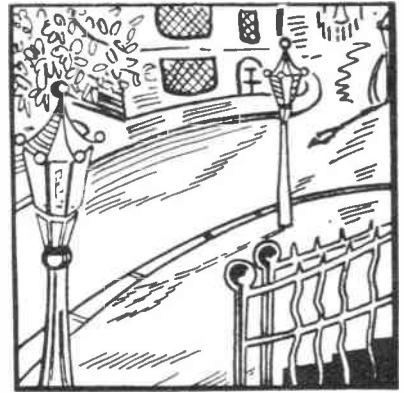

and all that remains is to fix two small clips to the sides of the frame, for hanging purposes, and then touch up the frame and beading. (W.F.W.)

## STOP THAT DRAUGHT

**F**EW things are more annoying than cold draughts in a room, especially in winter. Readers suffering from this annoyance should try the draught excluding strips drawn in the diagram.

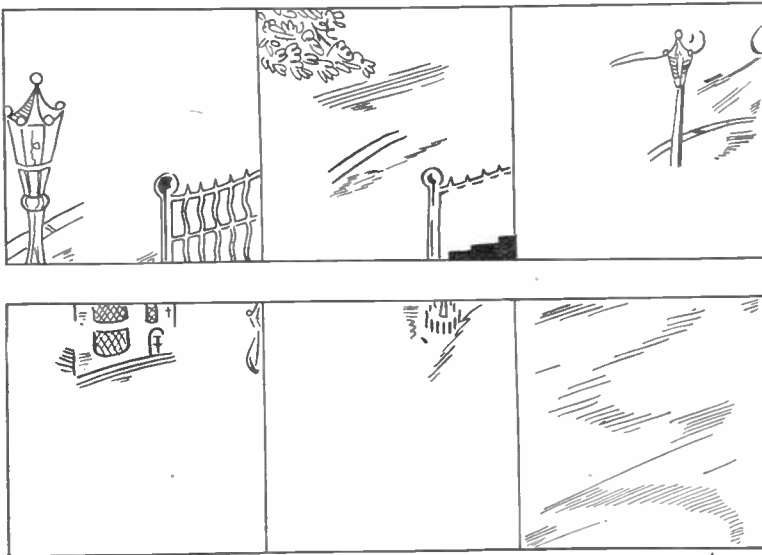

PICTURE SPLIT INTO 5 PARTS

fifth of the detail which encompasses all the foreground matter.

Proceed in a similar manner on the other four pieces of tracing paper, working progressively towards the background on each piece, and ensuring that none of the detail of the picture has been overlooked. Finally, the background sheet of white paper should be painted with the necessary merging colours, and all the white portions of the picture left untouched.

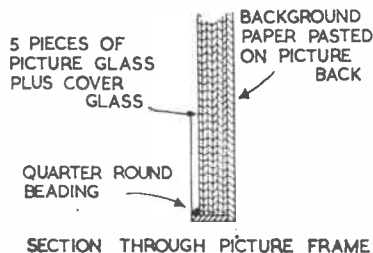

SECTION THROUGH PICTURE FRAME

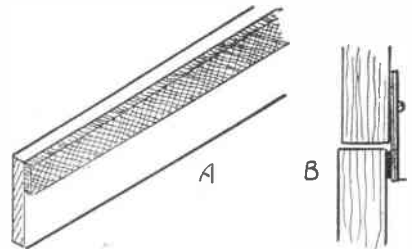

These strips should be of thin wood —  $\frac{3}{16}$  in. serves well — about  $1\frac{1}{2}$  ins. wide. The width, however, will need modification to suit the door. It should be wide enough to provide  $\frac{1}{4}$  in. to be screwed to the door and an overlap of  $\frac{1}{2}$  in. on the door frame. To these strips glue  $\frac{1}{2}$  in. strips of thick, soft material, as at (A). For this, baize or velvet is the best, while any glue will do the sticking.

Screw the completed strips to the edges of the door, ensuring that the material presses against the door frame, as at (B). If desired, the strips can now be painted to match the door. Except for the bad cases presented by ill-fitting doors, these strips will stop the incoming stream of air most satisfactorily; but if not, fasten a second strip of material to the frame of the door in such a position that the strip on the door presses against it, forming a double thickness. This should effect a cure.

# Easily-Made Country Station

**W**OOD and cardboard make an excellent combination for model railway accessories. The use of wood makes a firm and solid structure; cardboard is easily and quickly worked for the various parts to be added to the wood sections. Cardboard, when painted with oil colour, hardens and becomes firm enough for all normal handling.

## The Baseboard

A baseboard is first prepared of thin wood or even cardboard, on which the complete station is built (Fig. 1). The height of the platform should be 13 mm. above the top level of the rails, and so the complete height of the station platform will vary with the type of track material used. The measurements given fit with track material, giving rail

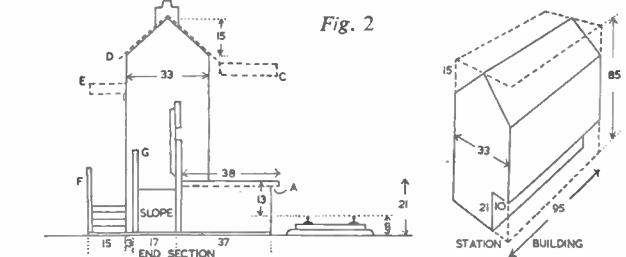
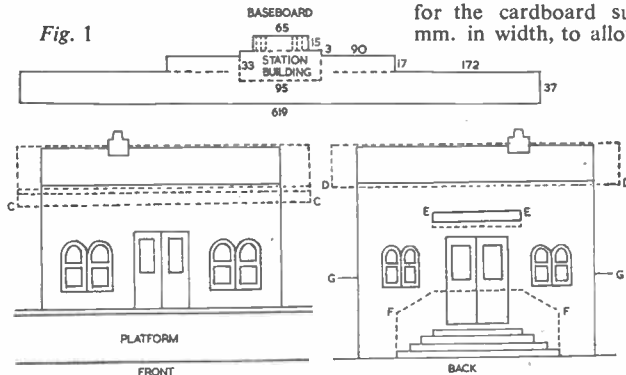

height of 8 mm. With other track measurements the height of the platform can be adjusted accordingly (Fig. 2). The relative measurements of the thicknesses of cards and wood composing the platform are shown as a guide. The main point is in getting the correct height of platform in relation to the track. The length of the platform can be varied to suit individual requirements. It will be noticed some measurements of the base are slightly larger than the actual sections. This is to allow for

## KEY TO ILLUSTRATIONS

- Fig. 1—The baseboard on which the station is built
- Fig. 2—Shows platform and street sides of station building; section showing station building, platform, walls, station name, slopes and steps to street. The main station building cut from a block of wood. Various letters show corresponding points in the sketches
- Fig. 3—Wooden section of platform and main station building
- Fig. 3a—End of wooden platform mounted on base and showing cardboard surface tapered to fit.
- Fig. 3b—Walls to be attached to back of platform, slopes and walls behind slopes
- Fig. 4—Sketches showing assembly of parts back and front of station building
- Fig. 5—Roof and covers over platform and steps on street side. Chimney cut out of strip

the card surfaces projecting beyond the wooden slopes (Fig. 3a). The wooden section of the platform is cut out to shape, 35 mm. wide, 16 mm. in depth, and 450 mm. long at its top level, sloping down each end to 600 mm. at the base level (Fig. 3). A strip for the cardboard surface is cut, 38 mm. in width, to allow for the overlap

this block the roof shape is cut to a depth of 15 mm. A section is removed from the base to fit over the platform. This runs the entire length of the block, cutting in 10 mm. and 21 mm. up from the base. The roof of the station building and the cover extending over the platform is made separately but in one piece out of thin card. The shape

**Make it in wood and cardboard for your 00 gauge—says D. Y. Gooderson**

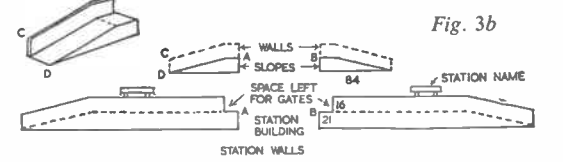
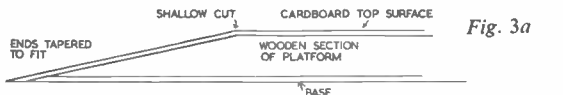
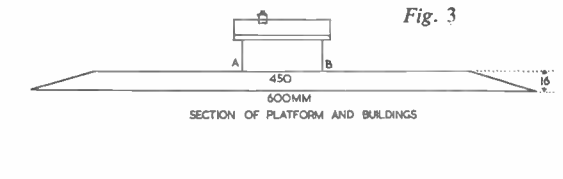

over the track (see (a) Fig. 2) and 650 mm. in length. This latter measurement will allow for the extra length required when bending to form the slope. Any excess is cut away when glued to the wooden section of the platform. To bend the card in a clean, sharp angle, make a shallow cut on the upper surface. The various ends must be tapered to fit (Fig. 3a).

The main station building is cut out of a small block of wood, 95 mm. by 33 mm. by 85 mm. high (Fig. 2). From

and measurements are given in Fig. 5. The card is bent along the dotted lines as indicated. Two wooden angle pieces can be added if extra strengthening is needed for the cover over the platform. The chimney and stack is made from a small rectangular strip of wood, filing one end round to form the chimney. Cut out the inverted V-shape at base to fit over roof. For the back of the building a cardboard cover is cut, bent

● Continued on page 70

# MAKE A PLASTER CAST

IN an earlier series of articles I demonstrated how a head may be modelled in clay. You may now wish to make the results of your labour more durable. This can be achieved by making a plaster cast. This has the advantage that it is washable and may even be coloured, whereas the clay head is allergic to any sort of moisture.

The method described below is known as the waste mould system, which means that the clay head is destroyed to make the cast. Consequently a thorough grasp of the instructions should be acquired before

to the bottom. Continue until the sediment rises to the surface of the water. Leave it until it stops bubbling. Now place your hand palm downwards under the surface. Keep it horizontal and extend the fingers. Note that on no account should the mixture be stirred. A quivering motion of the hand and fingers is required to disturb all the particles at once. Keep the hand under water, and do not splash as air bubbles are liable to form. When all the sediment is absorbed the plaster is ready for use.

Casting can be divided into four

would do. Let the plaster thicken to a creamy consistency, then splash it on thinly, making sure that you have entirely covered the front half of your model. Leave to set hard. This is just a preliminary coat which acts as a warning when chipping out. Clean out your basin and tools with plenty of water, otherwise the plaster will harden on them. Do not put plaster down a drain.

## Add Plaster

When the first coat has set (in about an hour's time) add white plaster to bring the thickness to about 1in. Where it touches the clay wall make it  $1\frac{1}{4}$ ins. for greater strength. Allow the mould to set. Then take away the clay wall, and cut two or three V-shaped notches in the rim of the mould. These will answer to corresponding projections in the second mould. Their purpose is to lock the two halves tightly together. Do not make the sides of the notches too deep, as you will find that you have a lock that cannot be opened. Brush over the rim

By  
*Thomas McCreanor*

of the plaster including the notches with a clay solution to make it non-absorbent. Remove the newspaper from the back of the model. Roll out some clay bands and place them along the outside edge of the rim, thus forming a guard. Now make five wedges of clay and space them along the rim, placing them with the thin end pointing inwards but not quite touching the model.

The second mould can be made in the same way as the first and left to set.

## Stage 2

Set the model now encased in its two moulds under a running tap. First remove the clay bands and pick out the wedges to allow the water access to the head inside. It may take some time for the water to penetrate thoroughly between the rims. When you think you have given it sufficient soaking you may gently insert wooden wedges into the wedge openings and very carefully ease off one mould. Take great care not to damage the rims. If you have difficulty in moving the moulds keep using plenty of water to soften the clay. Scoop out enough clay to make possible the removal of the armature.

Having cleared out the clay and ensuring that none is left in any crevices, give the moulds a further cleaning by squirting water into them from a tap.



1



2



3



4



5



6

you begin to avoid complete loss of your model. Indeed, a few preliminary experiments on some less important object might be advisable to give practice.

## Materials Required

The best dental plaster is the material to be used—a 7lb. bag will be enough to start with. It should not be bought in large amounts as it rapidly deteriorates unless stored in a very dry place. Buy it as you require it. Other necessities are an enamel basin, half a rubber ball, which is used for lifting the wet plaster, a blunt chisel, a small mallet, a knife, clay, newspapers, a small brush, and some soft soap. Plenty of running water will also be required, as well as a few drops of olive oil.

Now the necessary ingredients are ready for the mixing, but before commencing to work, it is advisable to cover the carpet with newspapers in case of stray splashes.

To prepare the plaster, partially fill the basin with cold water. Sprinkle the plaster gradually and evenly over the surface of the water, allowing the particles of powder to fall undisturbed

distinct operations. As considerable time is involved and plaster sets quickly it is necessary to complete each stage before going on to the next. I will here briefly state the stages to give the overall picture before going into detail.

Stage 1. Making the moulds.

Stage 2. Clearing the moulds.

Stage 3. Filling the cast.

Stage 4. Removing the cast from the moulds.

## Stage 1

In casting a head at least two moulds are necessary, and it is safer to make three. I will, however, proceed on the assumption that the model is simple, and, therefore, two will suffice.

Roll out some clay and knead it to make it pliable. Flatten it in a band  $1\frac{1}{4}$ ins. broad and  $\frac{1}{4}$ in. thick. With this build a wall over the top of the head, going in front of the ear on one side and behind it on the other. Cover the back of the model with a damp newspaper to prevent it being spoiled by splashes of plaster.

For the first coat, make up a small amount of plaster and add some colouring matter—a little yellow ochre

They can now be left till you are ready to go on to the next stage. If they are tied tightly with thick cord with the aid of tourniquets they may be left indefinitely without warping.

### Stage 3

Prepare a saturated solution of soft soap by using boiling water and a few drops of olive oil. Pour this solution

should be given careful attention. If they are inadequately washed the moulds will be left greasy and will not give a true impression. There is also the danger of bubbles forming. If they are insufficiently soaped it will be almost impossible to separate them from the cast.

Now mix some white plaster for filling the front mould. First fill the ear, nose and any other deep or elaborate

Treat the back mould in the same manner.

Now tie the two moulds very tightly together. Stand the moulding on its head, and pour in enough plaster to give a thickness of about 1 in., with rather more than that at the base. Roll the moulds around to ensure an even distribution of the weight. Scrape the base level with a ruler. Leave to set.

### Stage 4

To chip off the moulds, set the casting on a heap of cloth to act as a shock-absorber. The moulds should be cracked away from the cast, keeping the chisel at a shallow angle to the head. Start with the rims of the moulds at the base so that you will be able to keep the cast itself always in view. Take care, of course, not to go below the warning layer of coloured plaster. Actually, the outer casing should come away easily because of the soap film inserted earlier. But do not try to lever it off, as this would probably result in breaking off pieces of the cast. Work around the back of the head first of all. Be particularly careful of the projections—ears, nose and lips—and leave the plaster under the chin until the last, as it acts as a support.

When the head has been completely extracted it may be mounted on a wooden block that has been countersunk to accommodate the base.

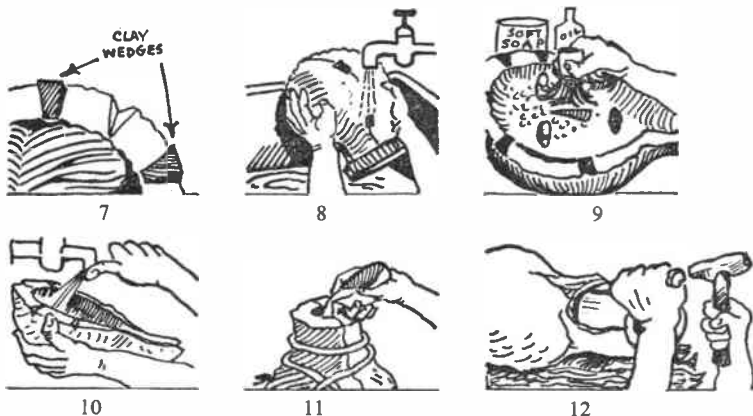

into each of the moulds, working it into a lather with a brush and making sure it penetrates all the crevices. Immerse in cold water for ten minutes and wash away excess soap. These operations which render the moulds non-absorbent

details. Leave the surface rough so that it will bind with the main filling. Then coat the entire interior and roughen the surface. Soak some rags in plaster and press them into the first filling. Carefully wash the rim.

### Continued from page 68

## Making a Country Railway Station

and fixed over the doors leading out of the station building (Fig. 5).

The wall at the back of the platform is cut from card in two sections, the space between allowing for the position of the station building. These sections are 37 mm. high. When fixed to the back

Below the doors at the back of the station building, steps are fixed. These consist of varied strips of wood, gluing each smaller strip one above the other. To these steps another wall is glued, following the shape of the steps.

paint the details on paper, cut round the edge and stick the parts on to the building. Station names can be bought or painted on to thin wood, and attached to the platform wall by thin but strong wood strips.

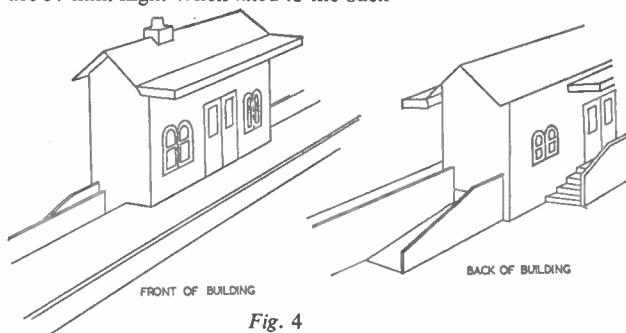

Fig. 4

of the platform this gives a height of 16 mm. above the platform (Fig. 3b).

There are two slopes leading from the platform gates at either side of the station building. These are of wood cut to shape, at the back of which two cardboard walls are glued (Fig. 3b and Fig. 4.)

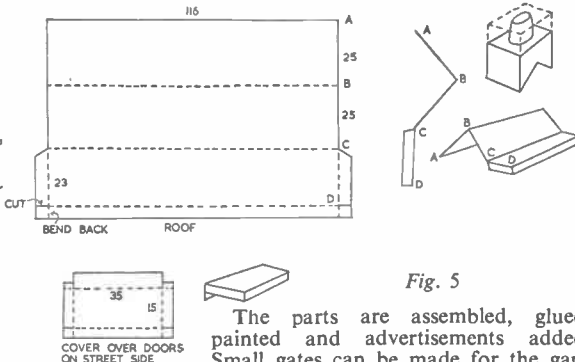

Fig. 5

(See dotted line at back of station—Fig. 2.)

The station building could be painted before assembling and windows and doors marked out direct on to the building, or an alternative method is to

The parts are assembled, glued, painted and advertisements added. Small gates can be made for the gaps leading from the platform to the slopes at the back. The gates are attached by thin pieces of material, or for simplicity the gaps can be left open. Station seats and staff can be added to complete the touch of realism.

Get the Best Picture

# Improve 'Snaps' by Trimming

Says D. Y. Gooderson

THE success of the composition of a picture relies to a great extent on the viewpoint. With most subjects, the component parts cannot be moved around, although in some cases use can be made of animate objects, by placing them in the best position in relation to the rest of the picture.

The best viewpoint often entails taking more than is necessary. The sky may be cloudless, the fact cannot be

foreground required, the top and side sections can be moved in relation to balance the rest of the composition. After a rough impression of the positions has been obtained, finer movements can be made to decide on the final positions. These are then marked, and the print trimmed accordingly.

The illustrations Figs. 1 to 4, show the effect of trimming. Fig. 1 is a print from the complete negative. It is typical of a snapshot taken on holiday, an odd corner in an old town. The ancient buildings reflected in the still water attracted the attention, and were beautiful to see. But what of the print? It is interesting up to a point, but there



Fig. 1

altered, but the sky may not be really essential. There may be too much foreground, but to move nearer may alter the whole aspect of the view; or it may entail going downhill, in which case the proposed view may be lost altogether. So to obtain the best view, often more has to be included than is required. In all cases, it is better to include too much than too little, for the print can always be trimmed to obtain the best picture.

On looking through a collection of prints, it is surprising to find how much of each print can be removed. Nearly all of them can be improved by judicious trimming. If enlargements are made, there are many beautiful pictures to be found by using only a small portion of the negative.

As an aid to see the effect of trimming, cut out two L-shaped pieces from thin card. By placing these over the print, with the ends of the L's meeting, a rectangle is formed through which the print can be seen. By altering the positions of the L-shaped cards, the rectangle can be altered in size and shape. In this way the effect of cutting off parts of the print, the sides, the top and the bottom, can be seen without actually cutting the picture. By fixing the bottom strip to give the amount of



Fig. 2

is so much in it; the attention is divided. The eye wanders round from the old house on the water's edge to the reflections, then to the street at the side. There is no unity in it.

Fig. 2 is an improvement. The print has been trimmed on two sides. The attention is confined to a smaller area. The eye has a chance to grasp the main points better, but there is still a division of interest. The reflections are so persistent and solid, that the picture is almost divided into two. The division into parts is emphasized by the line of the water's edge. The buildings and their reflections pull against each other. Let us try further trimming.

In Fig. 3 the street is hardly shown at all; the triangular piece at the bottom



Fig. 4

right-hand corner is reduced to a minimum; the water's edge no longer divides the picture into two equal parts.

Fig. 4 shows still further trimming. Only about a quarter of the actual



Fig. 3

negative is used. The result is different again. The reflections have been largely forsaken, but the best of the old buildings have been retained. The reflections that are left are sufficient to indicate that the buildings stand on the edge of a canal. It is a pleasing composition, a picture the eye can take in at a glance.

## Charming and attractive

# STENCIL CRAFT

**S**TENCILLING is a very old craft—one of the oldest means of applying decorative forms to various surfaces in order to beautify them. Its great appeal lies in its simplicity and directness of method.

It consists of applying colour through a perforated plate. A sheet of paper or thin metal has shapes cut out of it, through which a colour-laden brush is applied to the surface to be decorated, thus painting, as it were, the particular shape of the cut-out on to the material one is decorating.

The directness and clarity of this technique are evident and bears resemblance to actual painting. It has a charm and attraction peculiarly its own, against which block-printing finds it

### Modern applications for an old craft described by

*A. Fraser*

difficult to compete. In one particular it is superior to block-printing. It can produce gradation of colour or tone with the greatest ease, thus creating a variety which can give a very beautiful effect.

As a decorative craft it can be used in various directions. The ornamentation of dress fabrics, curtain materials, cushion covers is possible with it, as is the decoration of table centres, lampshades, models, book-covers, and even walls and wooden chests. The possibilities are, in fact, almost endless.

### Silk Decoration

The most beautiful work, however, probably lies in the decoration of silks, satins, cottons and linens. The decoration of these can be an occupation of deep pleasure and result in objects of considerable worth. It is, perhaps, the cheapest craft of all.

The stencil plates can be made from ordinary cartridge paper, or can be bought prepared. To make one's own, the paper should be treated first with a mixture of 2 parts boiled linseed oil to 1 part turpentine. This will strengthen it and prevent it being absorbent. Transparent or semi-transparent plastic sheeting of various kinds can be tried. So also can thin aluminium sheeting. These materials are, of course, more expensive.

The decorative design may involve a single colour and, therefore, need only one plate cut out. In more complex patterns several plates may be needed.

One plate may carry cut-outs for two or more colours only if they are well separated.

### Make Tracing

When one has drawn out a design and decided on the colours, then it should be worked out what plates will be needed. A tracing should be made of the pattern, and a key mark drawn in. This can be a horizontal and vertical line drawn at the left-hand top corner of the tracing. The tracing should then be transferred to the various plates. Each plate takes only its own particular shapes, but all plates must have the key lines drawn in. If this is not done, to ensure that the plates are in the correct position will be impossible with any degree of accuracy.

To cut the stencils, lay the paper on a sheet of glass, or smooth sheet metal. This will give a clean cut. The knife can be a special stencil knife, or a linocutting tool. A sharp penknife can also be used, or a razor blade.

of ties to hold the central portion to the rest of the plate. However, many patterns are possible without ties, and in any case, they present no difficulty.

Before starting on the decoration of some special piece of material, it is always best to try out the stencils on a sheet of paper first, to see if they have been cut properly and register truly. Corrections can then be carried out if need be. Moreover, different colour schemes can be tried, and the best one selected.

### Special Brushes

Special stencil brushes of various sizes are available and these should be used. Hold the brush vertically and work with a dabbing turning movement. On large areas don't scrub sideways with the brush, as this might ruffle up the material being treated, especially if it is delicate.

Fine intricate passages will need special care to ensure that the brush penetrates into the cuttings.



Fig. 1

Fig. 1—Three simple shapes from an interesting pattern

Fig. 2—'Tractor and driver' stencil cut by a boy of 8

Fig. 3—Four-tone design which would make an interesting curtain pattern

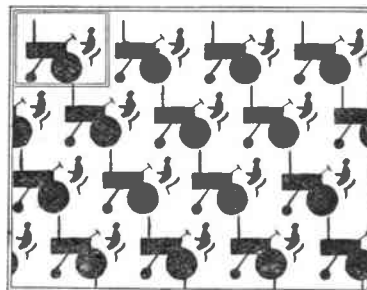

Fig. 2

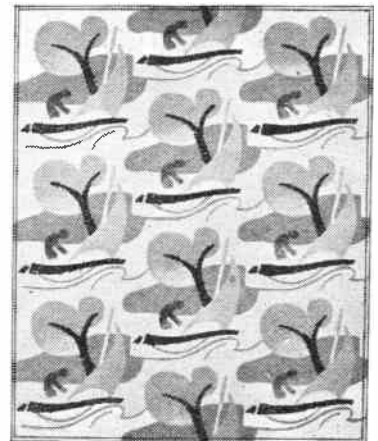

Fig. 3

Take time and use patience when cutting the stencil, especially so when dealing with the fine intricate parts. Incidentally, these should be cut first, leaving the big crude parts until later.

The use of 'ties' is often seen in stencilling, as the design cannot be effected without them in some cases. For instance, it would be impossible to produce the letter 'O' without a couple

Water-colour can be used in stencil. So also can dyes. The ideal medium is specially prepared stencil paint sold in tubes or pots. This is wash-proof. One can also use ordinary oil-colours, but these will not resist washing for very long. Either proper stencil paint or oil paint is recommended.

### Dab on Paper

Squeeze some of the paint out on to a palette or plate and mix to the desired colour. A little medium can be used to thin out if necessary. Use an ordinary hog-hair brush to mix the pigment.

Then take the stencil brush and dip



into the pigment and dab away at a piece of paper until the paint settles into the bristles and the brush is leaving a smooth, even imprint on the paper. The brush must not be too wet nor too dry. Experience will soon teach the proper condition for good work.

When the brush reaches this condition, the stencilling proper can be started, the brush being charged again when too dry to work well.

### Tone Gradations

To make gradations of tone, do the lightest tone over the whole part first, then gradually deepening the darker areas by harder working of the brush.

The running of two colours into each other must be done by working one colour at a time, each colour having its own brush and drying before the next colour is applied.

Brushes must be kept clean and washed with turpentine after use.

While stencilling, the plates must also be kept scrupulously clean. Each time the stencil plate is taken off the material it must be wiped with cotton wool or a soft rag. This applies especially so to the back of the plate, as colour often creeps underneath and will mark the material if not removed before being used again.

A word must now be said about preparation of the material which one is to decorate. This should be pinned on

a drawing board firmly and flatly with drawing pins, care being taken to see the weave is as straight as possible. It should be fairly tight to preclude any ruffling.

With very thin fine fabrics such as silk, etc., the stencil colour is liable to bleed through, so it is advisable to place some absorbent material underneath to take the surplus colour. Old cotton sheeting will do, but in an extremity newspapers are better than nothing.

When the material has been pinned down, there must be some method of guidance to ensure the correct position of the plates. This is best done by stretching black thread across the width of the board where the line of pattern is to come. Drawing pins will hold this taut.

Another line at right angles to the first, is then pinned down, in the position where the left-hand side of the pattern is to start.

The plates are placed so that the keys cut in them coincide with the appropriate guide lines. Secure with drawing pins.

With some stencils, once the first horizontal and vertical rows have been completed, it is possible to dispense with the guide threads and use the already printed designs as working guides.

But it is usually more efficient to shift the threads to the next line of pattern required. Accuracy is thus guaranteed.

It is as well to experiment to some extent in making out a pattern design.

While some ideas will come to nothing, it is, nevertheless, surprising what good patterns can be created from the simplest of forms. Haphazard forms of no special merit cut out of three or four plates will often, when printed in conjunction, provide an interesting design which is enhanced by repetition.

The pattern in Fig. 1 is composed of three very simple shapes, each having its own tone or colour. The minimum of work is involved here, yet it will make quite an interesting pattern for curtain or dress material. The design is so simple that a large plate holding half a dozen cut-outs could be made for each shape, to make printing easier.

Fig. 2 shows a print made from a small stencil cut by a boy of eight years old. The actual unit, representing a tractor with driver seated, is shown outlined. Despite its simplicity, it could make a good curtain pattern. The alternate rows could be of a different colour to give variety.

Fig. 3 shows a more interesting design. It will be seen that four tones or colours are used, while gradational touches are introduced to make the design more effective. This, again, would make an interesting curtain pattern.

The reader will understand that the designs illustrated are unavoidably in monochrome. These designs, carried out in tastefully chosen colours, would be decidedly more exciting and attractive.

**Make it or Mend it — you can't go wrong!**



### MAKE MODELS

Rawlplug Plastic Wood is of enormous help in modelling. Intricate shapes and curves become easy. You apply it like putty; when dry it's wood—can be sawn, planed, or polished.

**RAWLPLUG PLASTIC WOOD**  
Tubes 1/- Tins from 2/3



### MEND MODELS

Durofix is a strong, colourless adhesive that sticks almost anything to anything with a practically invisible join. Being heat-proof and waterproof, Durofix is ideal for repairing crockery, china and glass.

**RAWLPLUG DUROFIX**  
Tubes from 9d Tins from 2/9

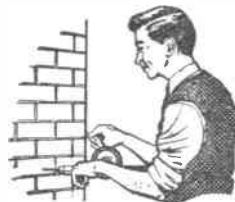

### DRILL BRICK

You'll drill brick, tile, cement, etc., with astonishing ease and speed by using a Rawlplug Durium-tipped Drill. Can be used in hand or suitable electric drills.

**RAWLPLUG DURIUM-TIPPED DRILLS**

821 FROM YOUR IRONMONGER OR HARDWARE STORE  
**THE RAWLPLUG COMPANY LIMITED • LONDON • S.W.7**

Keep tidy with a

# Garden Litter Truck

Says *W. J. Ellson*

AT this time of the year the tidiness of one's garden becomes spoilt with broken twigs, and fallen leaves. The truck illustrated is designed to deal easily with such litter, as it is light to handle, and lying almost flat to the ground enables the rubbish to be swept on it, and avoids a deal of unnecessary stooping. The container of the truck is pivoted, and so can be tilted forward to let its contents fall out.

Construction need present no difficulty, and for material  $\frac{3}{4}$ in. thick wood of good quality should prove satisfactory. If a cheap hardwood such as elm or beech is available, all the better, as the truck will last the longer. A side view is given in Fig. 1, and a front view in Fig. 2, giving useful dimensions. From these drawings it will be seen that the truck embodies a frame with wheels and handle, with a 'lift-up' container for the litter to be swept in.

to the rear of the frame just 6ins. apart. It would be wise to groove these in position. Quite shallow grooves will suffice, say,  $\frac{1}{4}$ in. deep in the back piece of the frame.

The lower outer corners of the standards are rasped to a curve. The actual handle can well be a piece of 1in. round rod (broomstick wood) screwed between the standards. Alternatively, a plain bar of 1in. by 2ins. could be substituted, well screwed across, and rounded off at the middle part to provide a comfortable grip for the fingers.

### Positioning Wheels

The wheels are 4ins. discs. These are fitted to the sides of the frame with stout round-headed screws, with metal washers sandwiched between their heads and the wheels, and also between wheels and frame sides. Position these approximately where shown, so that the points of the screws, if long enough to penetrate the sides enter at the middle of the crossbar between. The whole frame should now be firm enough, but if some additional stiffening should be necessary, screw a steel angle bracket to each outside corner of the rear.



the frame with about  $\frac{1}{4}$ in. each side to spare.

Though not actually essential, it would help to prolong the wear of the truck if the front edge of the plywood bottom of the container were covered with a strip of metal, tin or zinc, for example. This could be nailed across and bent over the edge to save the latter from being worn away by litter being swept over it.

### Fitting Container

To fit the container in its frame, place the latter on a flat surface (table or bench) and then insert the container, with its front ends level with that of the frame, and its rear part resting on the crossbar. At about 1in. from the ends bore a hole through each side of the frame, large enough to admit of a stout 2ins. screw being pushed through with the fingers. Continue this hole, this time with a gimlet, through the sides of the container. Now drive the screws through. It should then be an easy matter to tip the container up for disposal of the load.

At the rear of the container, where shown in Fig. 1, insert in each side a screw-eye. To these tie the ends of a length of strong cord. Fold at the centre, and tie round the handle. The length of cord should be sufficient to prevent the container, when tilted forward, from going over too far.

As a finish, the truck could well be creosoted as a preservative against the weather, or painted as preferred.

Fig. 3

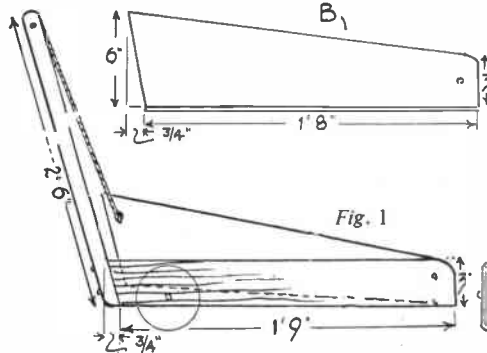
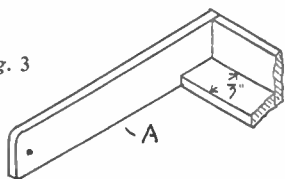

Fig. 1

Make the frame first. Cut two side pieces 3ins. wide and to length given. Note that the back end is cut to slope backwards a little. The sides are joined by a back piece strongly nailed or glued to them, and the whole stiffened with a crossbar inside, as in detail (A) in Fig. 3. The ends of the crossbar should be sawn across at a true rightangle to better ensure the sides of the frame being parallel. This is important. The standards of the handle part of the frame are of  $\frac{3}{4}$ in. by 1in. square section wood. Cut to the given length, and screw

to the rear of the frame just 6ins. apart. It would be wise to groove these in position. Quite shallow grooves will suffice, say,  $\frac{1}{4}$ in. deep in the back piece of the frame. The lower outer corners of the standards are rasped to a curve. The actual handle can well be a piece of 1in. round rod (broomstick wood) screwed between the standards. Alternatively, a plain bar of 1in. by 2ins. could be substituted, well screwed across, and rounded off at the middle part to provide a comfortable grip for the fingers.

Positioning Wheels

The wheels are 4ins. discs. These are fitted to the sides of the frame with stout round-headed screws, with metal washers sandwiched between their heads and the wheels, and also between wheels and frame sides. Position these approximately where shown, so that the points of the screws, if long enough to penetrate the sides enter at the middle of the crossbar between. The whole frame should now be firm enough, but if some additional stiffening should be necessary, screw a steel angle bracket to each outside corner of the rear.

Fitting Container

To fit the container in its frame, place the latter on a flat surface (table or bench) and then insert the container, with its front ends level with that of the frame, and its rear part resting on the crossbar. At about 1in. from the ends bore a hole through each side of the frame, large enough to admit of a stout 2ins. screw being pushed through with the fingers. Continue this hole, this time with a gimlet, through the sides of the container. Now drive the screws through. It should then be an easy matter to tip the container up for disposal of the load.

At the rear of the container, where shown in Fig. 1, insert in each side a screw-eye. To these tie the ends of a length of strong cord. Fold at the centre, and tie round the handle. The length of cord should be sufficient to prevent the container, when tilted forward, from going over too far.

As a finish, the truck could well be creosoted as a preservative against the weather, or painted as preferred.

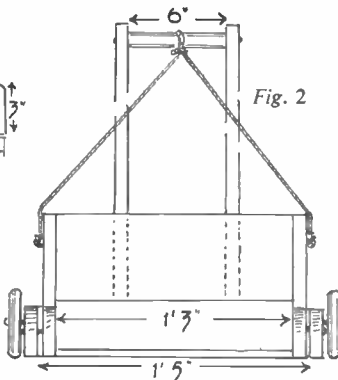
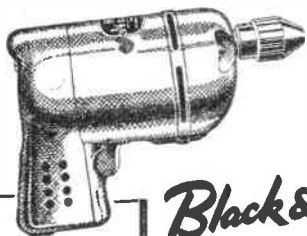

Fig. 2

### YOU CAN MAKE XMAS CRACKERS

We can supply all materials and fillings for this interesting and profitable occupation. Beginners — our special Learner Pack contains enough materials to make two dozen crackers complete with easy step-by-step instructions, only 5/- . Full sample range of fillings 2/- refundable. Lists free.

**GAIETY CARNIVAL NOVELTIES**  
Amen Corner, TOOTING, S.W.17



Start a  
Home  
Workshop  
with a

**Black & Decker**

**NOW ONLY**

**5/-** deposit

and 6 monthly payments of 21/-, plus 2/- post and packing.

Cash Price

**£5. 19. 6**

Complete

**Basic Power Unit**

**B & D  
1/4" ELECTRIC DRILL**

You can base any B & D Home Workshop Outfit on this superb basic power unit. All B & D Accessories fit the tool. You can add to your equipment piece by piece until you have everything you need for all the jobs you want to do yourself, drilling, sawing, polishing, sanding, turning and paint and rust removing.

B & D power tools and accessories are the finest obtainable anywhere. A deposit now, and then monthly pay-as-you-earn repayments of the balance and they can all soon be yours!

Send for the full exciting details TODAY of all the magnificent B & D Home Handyman Outfits available on our low easiest-ever terms!

**LAFCO COMPOUNDS Ltd** (Dept. HW2)

3 Corbetts Passage, Rotherhithe New Road, London, S.E.16

## LOOK FOR THESE BOXES

your guide to popular pastimes



### ★ PLAYCRAFT HOBBY KITS

These kits are available in three attractive boxes each complete to enable modellers to produce a three-dimensional wood picture with the charm, colour and perspective of an old master. Price 22/6

- PICTURE CARVING for the modeller .. .. 22/6 ea.
- COLOUR CRAFT for the adult enthusiast .. .. 14/11 ea.
- T. V. FAVOURITES for the younger children .. .. 8/11 ea.
- DISNEYLAND a popular favourite .. .. 12/11 ea.
- JUNIOR ARTIST for the teenager .. .. 7/11 ea.

### ★ PLAYTOWN BY PLAYCRAFT

Architect-designed scale model construction kits which enable you to build your own village or town and provide garages and background buildings for your cars and railways. Price from 4/6

FROM ALL HIGH-CLASS HOBBY, ART AND TOY SHOPS

**PLAYCRAFT TOYS LTD**

120 MOORGATE, LONDON, E.C.2

## NEW! EXPERIMENTAL KITS

### LEARN THE PRACTICAL WAY

Here is home study of the most effective kind under expert tutors. There is no better way of studying for an examination, starting a new hobby or for a career in industry. These special courses comprise the most modern methods of postal tuition, combined with a Practical Kit of parts (which remains your property).

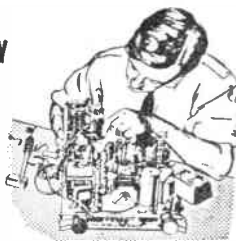

**COURSES FROM 15/- A MONTH**

**COURSES WITH PRACTICAL EQUIPMENT INCLUDE:** Radio, Television, Mechanics, Electricity, Chemistry, Photography, Carpentry; also Draughtsmanship, Commercial Art, Amateur S.W. Radio, Languages, etc.

**POST THIS COUPON TODAY**

For FREE brochure write: E.M.I. INSTITUTES, Dept. 31X, Grove Park Road, London, W.4.  
SUBJECT(S) OF INTEREST \_\_\_\_\_  
NAME \_\_\_\_\_  
ADDRESS \_\_\_\_\_  
9 11/55

**E.M.I.  
INSTITUTES**

The only Postal College which is part of a world-wide Industrial Organisation

ICS1A



## L. P. Veale on FIRST-DAY COVERS

**A** FEW collectors have raised the question of the value of first-day covers, and mentioned the difficulty of storing them; but this need not deter them. I will deal with this difficulty first.

Albums to take complete envelopes are certainly rather expensive, and consequently some people remove the stamp from the first-day cover and keep it in their album, throwing the envelope away. There must be a better solution than this, and there is, in fact there are many possible solutions.

One is to use a loose-leaf stamp album with only a few sheets, and on each sheet mount a cover or covers with photographic corner mounts.

Another solution is to make a storage album from cardboard. An excellent one can be made by using the sheets of cardboard that many laundries place in

Another great value of the first-day cover is clearly seen in the first illustration. By looking at the stamp alone little information can be discovered except by an expert. If you look carefully you will be able to see the name 'Mackenzie' and if you use a magnifying glass you may be able to see the date 1952 just below the end of the name. That is all that you can learn from the stamp. Who is or who was this Mackenzie? When, exactly, was the stamp issued? By looking at the rest of the envelope you see the amount of information that can be given on a first day cover.

Mackenzie was the 'Stainless Statesman' whose Government founded the Supreme Court of Canada, The Right Honourable Alexander Mackenzie—Prime Minister 1873-1878. Note also the careful way in which the postmark is applied; only the bottom of the stamp is marked, and the date Nov. 3rd 1952 is perfectly clear.

original structure that was the first post office in Western Canada. William Ross was appointed on 28th February 1855 by the council of Assiniboia, which is now Winnipeg, Manitoba. Now the house is run as a museum and sub-post office by the Manitoba Historical Society. It is normally open only in the summer, but it was especially opened on 28th February this year, exactly 100 years after its first opening as a post office.

### Dated Stamps

In connection with the stamp bearing the portrait of Mackenzie it was mentioned that if you had a magnifying glass, then you would see the date of the stamp, 1952. The same remark applies to quite a large number of Canadian stamps. If you use a magnifying glass you will be able to see the date of issue tucked away in some inconspicuous place. Stamps which mark an occasion such as a centenary have that date quite clearly defined as part of the design. For example, the stamp commemorating the death of Alexander Graham Bell has the dates 1847-1947 clearly below the portrait. Those stamps which have a frame around the design, such as the Peace Re-Conversion set, have the date in the centre of the lower part of the frame. The figures are very small, but can be seen quite clearly with a glass. There are other designs, however, where the date is quite difficult to find. As an exercise, time yourself to see how long it takes you to find the date in the following cases:—The one-dollar fisherman stamp, the 10c. stamp, showing the drying of furs, the 50c., showing the oilwells of Alberta, and the 50c. green, showing the entrance to Vancouver Harbour.

The search and discovery of these dates should enable you to mount all Canadian stamps correctly in chronological order; although, if one is using a loose-leaf album with paper ruled with fine quadrille lines, it would not lead to a very pleasing arrangement to hold slavishly to a strict chronological order. The arrangement of the stamps in a pleasing manner is a very important matter.

Acknowledgment is made to Mr. Reg Gills of Hanover, Ontario, for co-operation in obtaining the illustrations in this article.

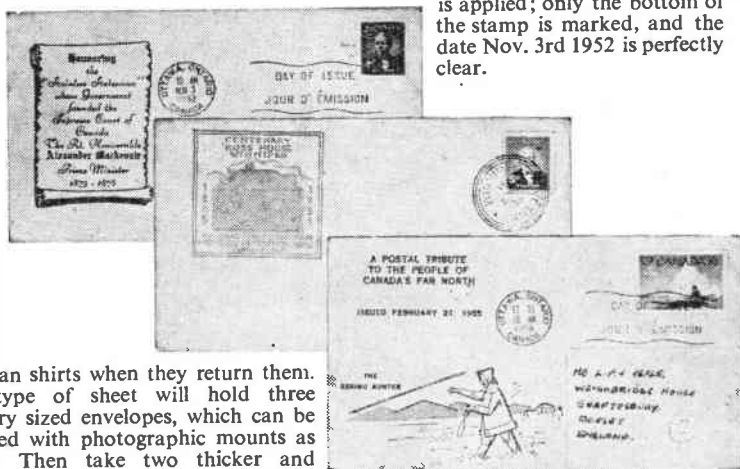

the clean shirts when they return them. This type of sheet will hold three ordinary sized envelopes, which can be mounted with photographic mounts as before. Then take two thicker and slightly larger sheets of cardboard for the cover of the album. An ordinary paper punch will make holes in the cardboard which should be threaded with a piece of cord to tie the sheets together. If holes are punched at the sides, then the covers can be kept in an ordinary file such as used for foolscap, dispensing with the need for making a new cover.

Now a little about the value of first-day covers. The careful collector usually looks at the postmark in order to place his stamps in the correct order of their date of issue. When you have a complete cover it is fairly easy to see the date on the postmark, but this is seldom possible on a solitary stamp.

If you look at the illustration showing the 10c. stamp picturing an Eskimo in his kayak backed by an iceberg with an aeroplane above, you will see that again the date is perfectly clear on the date stamp, and also the day of issue is printed on the envelope, 'Issued February 21st 1955'.

Just one week later another cover was issued. In this case it could not be called a first-day cover because it was not the day of issue of a stamp at all, in fact the stamp has nothing to do with the cover. A stamp might well have been issued to mark the event but, instead, a cover was selected. The illustration on the cover shows the

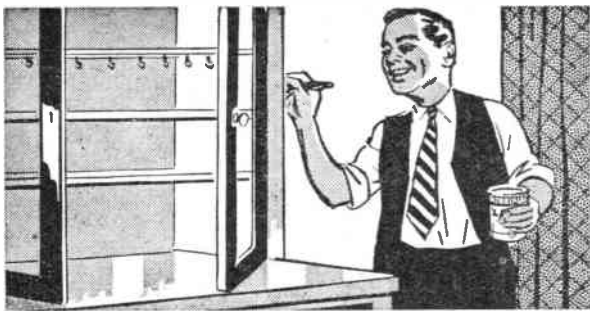

## Leaves no Brushmarks!

Here is a paint that provides a smooth professional finish at the touch of a brush, an easy to use quick-drying finish that covers perfectly in one coat and leaves no brushmarks. Just ask for Robbialac Lacquer, the gloss finish that is available in 24 brilliant colours plus black, white and silver and which provides a hard wearing surface that resists weather, water, steam and chemical atmosphere. Robbialac Lacquer comes in handy  $\frac{1}{8}$ ,  $\frac{1}{4}$ ,  $\frac{1}{2}$  and 1 pint tins and is sold by all good paint shops, cycle shops, ironmongers and hardware dealers.

## ROBBIALAC LACQUER

**FREE:** Put a 'factory finish' on your handiwork. For free Instructional Leaflet send 1 $\frac{1}{2}$ d. stamp to: Dept. 6LII.

JENSON & NICHOLSON LTD., CARPENTERS RD., E.15

### ELECTRIC PAINT SPRAYER



for 4/- deposit

Cash 75/-. Or 4/- deposit and 6 monthly payments of 13/6

Paint easily, evenly, twice as fast with the Burgess Electric Sprayer. Sprays paint, varnish, etc. Complete with sturdy glass container, flex, nozzles for ceiling spraying and extra nozzle discs for different liquids. A.C. mains - state your actual voltage. Fully guaranteed. Also Horvell Electric Paint Stripper 30/- cash, or 4/- deposit and 3 monthly payments of 10/-. Leaflets-free



**BATHROOM SCALE BARGAIN**

★FOR ONLY 5/-

★ and 6 monthly payments of 13/- (or Cash Price 69/6)  
**WATCH YOUR WEIGHT** every day with this streamlined Bathroom Scale. Magnified dial easy to read. Weighs accurately from 1lb. to 20st. Lovely white enamel finish. Non-slip plastic mat. All mechanism enclosed. 2 years' guarantee. Cash 69/6, or 5/- dep. and 6 monthly payments of 13/-.

**BARGAIN DISTRIBUTORS**  
(Dept. 124), 5 Silver Street, Luton

### PHILISHAVE 14 DAYS' FREE TRIAL

Try the wonderful Philishave Electric Dry Shaver **FREE** for 14 days. Send only 5/- deposit (returnable if not satisfied). Two shaving heads with two 6-bladed cutters have unique rotary action which genuinely shaves - doesn't just snip at the hairs. Result - better, quicker shave. Operates 110/250 volts. A.C./D.C.  $\mathcal{E}$ . 9/- cash less your deposit. Or 5/- deposit can be first payment, followed by 8 monthly payments of  $\mathcal{E}$ 1. 12 months' guarantee. Brochure of this & other shavers free.



### Wolf Cub ELECTRIC DRILL AT

**REDUCED PRICE £5.9.6.**

or 6/- deposit and 6 monthly payments of 19/6d.

This wonderful Electric Drill is also the power unit for ALL Cub equipment. Drilling capacity: Mild Steel,  $\frac{1}{2}$ "; Hard Wood,  $\frac{3}{4}$ "; with 210 watts input on full load. Complete with  $\frac{1}{2}$ " three-jaw chuck and Allen key and 5ft. of cable. TV Suppressed. State Voltage. ALSO Sanding & Polishing Kit (drill, discs, etc.). Cash Price: £6. 10. 6 or 19/- deposit and 6 monthly payments of 21/-.



Send for Illustrated Brochure of Wolf Cub equipment.

Make extra prints of your summer snapshots

It's so amazingly easy!



Even if you've never before printed snapshots, you can do so now with the Print-A-Snap Pack. A printing frame for exposing the paper and negative by ordinary electric light, powders to make up the developing and fixing solutions are all provided. Wash and dry your prints and there you are. You would never have thought that making prints could be so easy. No darkroom, no equipment is needed.

### PRICE 3/- COMPLETE

For films taking 8 exposures, 16 sheets of Contact Paper ( $2\frac{1}{2} \times 3\frac{1}{2}$ ) are supplied, and for films taking 12 exposures there are packs containing 24 sheets of Contact Paper ( $2\frac{1}{2} \times 2\frac{1}{2}$ ). Further supplies of chemicals and Contact Paper are available from your local photographic dealer.

### Ask your chemist or photographic dealer for THE JOHNSON PRINT-A-SNAP PACK

Made by Johnsons of Hendon world famous manufacturers of Photographic Chemicals, Apparatus and Accessories

## HEAR ALL CONTINENTS With H.A.C. Short-Wave Receivers

Suppliers for over 18 years of Radio S-W Receivers of quality. One-Valve Kit, Price 25/- Two-Valve Kit, Price 50/- Improved designs with Denco coils. All kits complete with all components, accessories and full instructions. Before ordering, call and inspect a demonstration receiver, or send stamped addressed envelope for descriptive catalogue. 'H.A.C.' Short-Wave Products (Dept. 22), 11 Old Bond Street, London, W.1

**PLYWOOD**; large sizes, 14 lbs. 10/- delivered (Express) C.W.O.—H. Leader (1920), Gosford St., Middlesbrough.

**DO-IT-YOURSELF BOOKS.** List free.—D.S.P. Ltd., 28(H) Dean Road, London, N.W.2

**CHRISTMAS DECORATIONS, ETC.** Everlasting Flowers/Grasses/Ferns/Foliage/Artificial 3/- per bunch. Post 6d. Ass'd. Colours and types. The five kinds 14/6 c.p. Tinsel ribbon, Glitter Gilt, Silver foils, etc. **WREATH OR BOUQUET-MAKING OUTFITS**, Instructions and design 20/- each. Combined 30/- c.p. Instructions and designs 2/6. Book 'Making Floristry Your Business', 6/6. Stamp, list all materials—Station Nurseries, (H) Oakengates, Salop.

**PYGMY TREE-GROWING OUTFIT** 17/6 c.p. 6 Trees, 6 Cuttings, 6 Pkts. Seeds, 18 Growing Pots, Compost, Cuttings powder, Instructions. **MINIATURE-GARDENS OUTFIT**, 20/- c.p. 5 Growing Trees, Container (10" x 8") and Tray, Sunk Flower Centre, Pool, Fish, House, Rocks, Compost, Instructions. **BOOK 'Jap Mini Gardens and Pygmy Trees'** 2/10 c.p. Instructions Leaflets 9d. Stamp, list all materials—Station Nurseries, (H) Oakengates, Salop.

**MODELS.** You can make lasting stone-hard models with Sankey's Pyrama Plastic Cement. Supplied in tins by Ironmongers, Hardwaremen and Builders' Merchants. Ask for instruction leaflet.

**SHORTHAND** in 1 week. Test lesson, 24d. Stamp.—Duttons (HB/SV), 93 Gt. Russell St., London, W.C.1.

**AMERICAN MAGAZINE** Subscriptions. One year Popular Mechanics 30/-, Popular Science 43/-. Homecraftsman 16/6. Homecraft 18/-. Deltagram 10/6. Free booklet quoting others.—Willen Ltd. (Dept. 57), 101 Fleet St., London, E.C.4.

**TOY CASTING MOULDS.** Soldiers, sailors, airmen, etc. 1,000 varieties from 3/- each. Rubber moulding compound for flexible moulds, granulated ready for use, 8/6 per lb. Aluminium moulds for plaster work. S.A.E. for list. Catalogue 9d.—F. W. Nuthall, 69 St. Mark's Road, Hanwell, London, W.7.

**PLYWOOD — HARDBOARD —** at amazing low prices. Send S.A.E. for samples and prices to — N. Gerver, 10 Mare Street, Hackney, London, E.8.

**'PAINTSPRAYING' HANDBOOK** (1954 Ed.). Covers Car, Industrial & Flock Spraying. 3/6, post free, including catalogue of our Cellulose and Synthetic Paints and all Allied Sundries and Plant Hire.—Leonard Brooks Ltd., 81 Oak Road, Harold Wood, Essex.

## TROPICAL SHELLS

for making these and hundreds of other attractive novelties.

Illustrated leaflet and richly assorted exotically shaped and coloured shells.

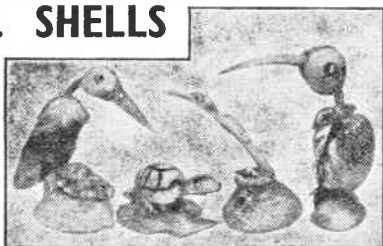

# Eaton

Parcels 1lb. 6/6 or 5lbs. 26/6  
Post free.

MANETTE STREET, Soho, London, W.1. Phone: GERrard 9391



Radio operator and 1 crew. Stands indoors or out-doors. 29/11, post etc. 1/6.



## THE NEW INTERPLANETARY SPACE SUIT

Only 12/11 POST 1/6 ETC.

Be an Interplanetary Commando Officer. Wear this metallic blue Space Suit and pressure helmet. Be the first Earth Man to Jupiter. Can also be worn over outdoor clothing, guaranteed waterproof. For boys aged 4 to 12. Wristed and adjustable, visor on helmet. Lightning flashes on breast panel. State age for size. 12/11 post etc. 1/6. LISTS, TERMS.

**HEADQUARTER & GENERAL SUPPLIES LTD.**

Dept. HOBW/77, 196/200, Coldharbour Lane, Loughborough Junction, London, S.E.5. Open all Saturday 1 p.m. Wednesday.

**SWISS MUSICAL** Mechanism for cigarette boxes, etc., 16/6 post free. S.A.E. for illustration and list of tunes available.—Dept. HW., Metwood Accessories, Church St., Wolverton, Bucks. (Trade supplied.)

**STAMPS FREE**—Empire Packet including Pictorials and Victorians with approvals.—Robert J. Peck, 7A Kemp Road, Bournemouth.

## A GRAND BOOK FOR ALL THE FAMILY.

The "Kaylee Year Book of Bright Ideas". A really helpful guide to home planning, decoration, Hobbies, toys, etc. Showing famous Kaylee Transfers in brilliant colours, and most effective uses. From "Hobbies" stockists 1/- or direct.

**KAYLEE TRANSFERS** Postage 3d. LTD., (HW) Long Eaton, Nottingham

**WOODEN WHEELS**, stock clearance bar. gains, 2½"–32", 1" recessed 5/-, Recessed round tread, 1½"–10/-, 2"–15/-, 4"–70/- gross. Doll's house fittings and papers. Brochure S.A.E.—Jasons, 135 Nags Head Road, Enfield, Middlesex.

**BUILD** your own T/V and learn about its operation, maintenance and servicing. Qualified engineer-tutor available whilst you are learning and building. Free Brochure from—E.M.I. Institutes, Dept. HW.58, London, W.4. (Associated with H.M.V.)

**GENUINE** Swiss Musical Movements. Owing to large purchase now reduced to 14/6 each. Genuine Thorens Movements, all guaranteed, 19/3 each. P. & P. 9d. extra on all orders.—Richardson & Forder, 5 Chapel Place, White Hart Lane, London, N.17.

**200 STAMPS** free. Genuine offer. S.A.E. for approvals.—W. Self, 36 Fairfield, Boro Green, Kent.

**100 DIFFERENT** stamps free! Request 4d. upwards discount approvals.—Bush, 53 Newlyn Way, Parkstone, Dorset.

**S.W. AFRICA** 1948 Voortrekker set. Smashing free gift for approval applicants enclosing postage.—Yulwontmor Stamps (Dept. H5), 29 Layton Avenue, Mansfield.

**50 STAMPS** free to all approval applicants enclosing 24d. stamp.—Cliffe West (M2), 61 Wynyard Road, Sheffield, 6.

**'PROFITABLE HOBBIES'**, America's leading monthly. Year's subscription 28/6, specimen 3/6. Full list American magazines free.—Hobson, 79 Southbrook Road, Exeter.

**COINS** for sale—cheap. S.A.E. list.—Box No. 15, Hobbies Weekly, Dereham, Norfolk.

**MARQUETRY** pictures from your own photographs. Let me design an exclusive picture. Send photo and 10/6 for 10in. x 8in. guide print. Larger sizes pro rata.—Box No. 22, Hobbies Weekly, Dereham, Norfolk.

**STAMPS**—25 different packets; Australia 8d.; SBelgium 4d.; Belgian Colonies 2/10; Bolivia 3/-; Canada 6d.; France 4d.; India 5d.; Manchuria 1/2; Portugal 8d.; Spanish Colonies 2/10; Yugoslavia 7d.; Vatican 3/-. Guaranteed. Postage extra. List of over 60 mint (unused) Queen Elizabeth Colonials available at one penny each free with all orders.—J. T. Hilton, 2 Junction Road, Deane, Bolton, Lancs.



## DECRA-LED LEADED WINDOWS are worth looking into...

so much better than net curtains and so distinctive in appearance. Improve your home with charming Leaded Lights—you can transform all your plain windows with DECRA-LED and you really can Do-It-Yourself as demonstrated on T.V. A 10"- DECRA-LED kit will do 3 panes 30" by 18" in attractive diamond design.

Obtainable from your local dealer—ask to see our range of New Full Scale Motif Designs.

If unobtainable, direct from Trade enquiries invited  
**T. BROWN & CO. LTD., Dept. 1,**  
50 WOOD STREET, ASHTON-UNDER-LYNE  
LANCASHIRE



For your friends—

# A NOVEL CALENDAR

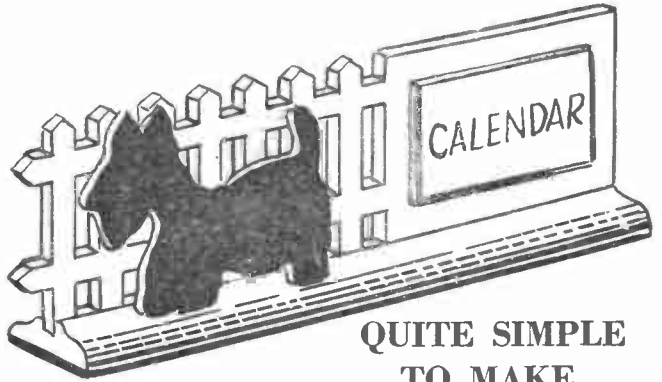
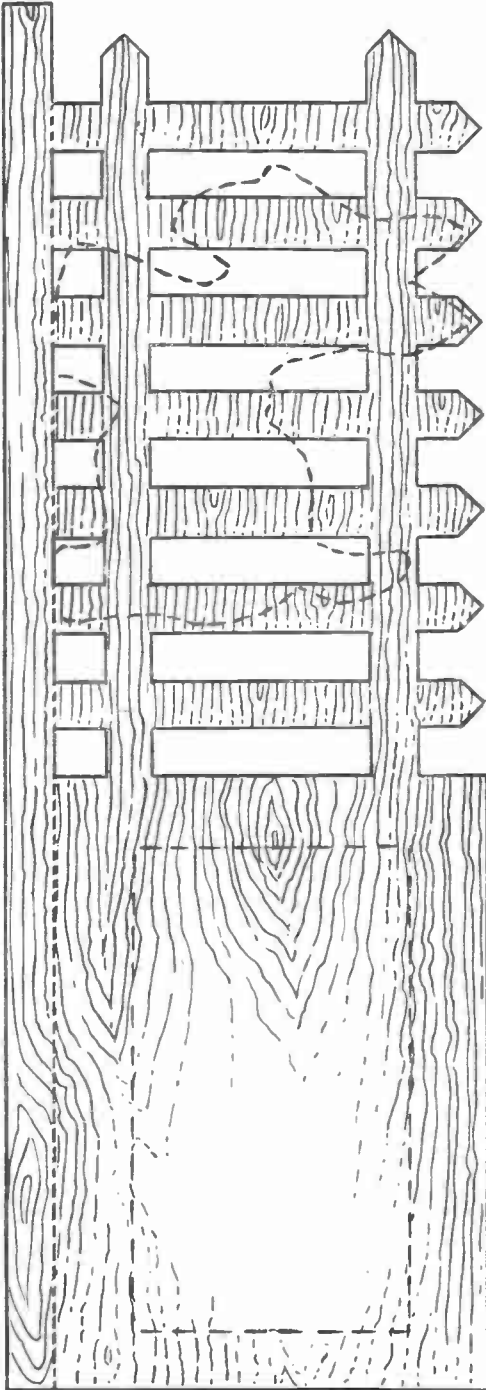

**QUITE SIMPLE  
TO MAKE**

**N**OW is the time to make a few calendars to give to your friends at Christmas. With a coat of glossy enamel and a stick-on calendar they make attractive presents.

By cutting two or three at a time on a fretmachine they can be made quickly and cheaply. There are no joints at all to worry about—the background is simply stood in grooved moulding which can be bought specially for the purpose.

Trace the patterns, which are full size, and transfer them to  $\frac{1}{8}$  in. wood by means of carbon paper. Cut them out and glue together as shown. The dog should be painted jet black, so as to stand out in relief against the railings. Two or three coats of paint will give a good glossy finish.

The moulding, No. 48b, costs 1/- per 3ft. length and the calendar pads are 2½d. each from Hobbies Ltd., Dereham, Norfolk. (M.p.)

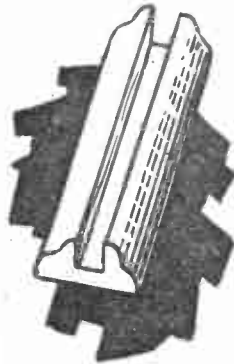



# IF SAMSON could have tried his strength on a CASCO-glued joint...

... he would have torn out his hair in desperation. However hard the wrench, the glued joint stands firm, whereas the wood gives way. The photograph shows the result. No matter which CASCO glue is used, a properly made joint is given the same amazing strength. CASCO glues (available in a range of sizes) cover all individual requirements—from ordinary household gluing jobs to the speciality work of the expert handyman

and model maker. Ask your local Ironmonger or Builder's Merchant for the free leaflets which describe in full detail the products listed below.



For **QUICK** Gluing Jobs  
use **CASCO P.V.A. Glue**

- The new "family" glue
- All ready for use
- Clean and strong

For **HEAVY-DUTY** Gluing

use **CASCO Cold Water Casein Glue**

- Easy to mix and use
- Very economical
- Glues almost everything



For **SPECIALITY** Wood Gluing  
use **CASCAMITE "ONE SHOT" Resin Glue**

- Mixed and used cold
- Gap-filling and non-staining
- Water-proof type

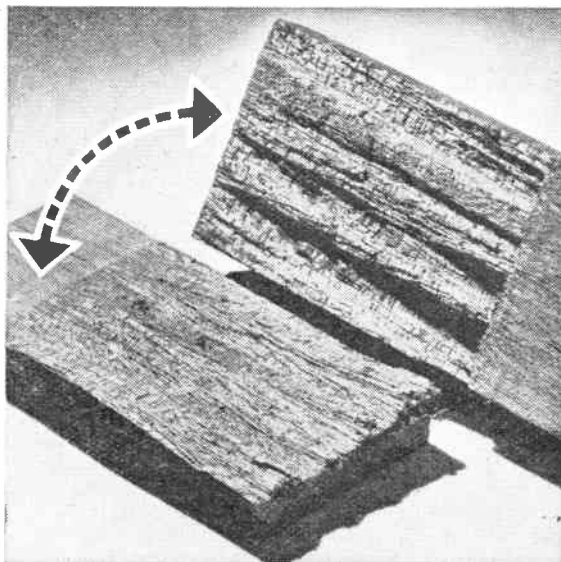

*A hardwood lap joint, forcibly separated, showing how the glue has proved stronger than the wood. The joint was glued with CASCAMITE "One Shot" Resin Glue, but the same results are obtained with both CASCO P.V.A. and CASCO Cold Water Casein Glue.*



CASCO GLUES are recommended for  
"Build-it-Yourself" with **Easi-Bild** Patterns

## SYNTHETIC RESIN AND CASEIN GLUES

Manufactured by LEICESTER, LOVELL & CO. LTD · NORTH BADDESLEY · SOUTHAMPTON  
Main Distributors: CHARLES CLEEVE & CO. LTD · 45 Great Peter Street · LONDON · S.W.1

Printed by BALDING & MANSELL, LTD., London and Wisbech, and Published for the Proprietors, HOBBIES LTD., by HORACE MARSHALL & SON, LTD., Temple House, Tallis Street, E.C.4. Sole Agents for Australia and New Zealand: Gordon & Gotch (A'sia) Ltd. For South Africa: Central News Agency Ltd. Registered for transmission by Canadian Magazine Post.



SIZE:-  
 14 1/2 ins. LONG  
 18 ins. HIGH

THE ARROWS INDICATE  
 DIRECTION OF  
 GRAIN OF WOOD.

PIECE 2. CUT ONE 1 2 in.  
 PIECE 1. CUT ONE 1 4 in. TO OUTLINE ONLY.

MAST. SHAPE ONE FROM 1 4 in.  
 DIA. ROUND ROD 16 ins. LONG.

BOOM. SHAPE ONE FROM 1 4 in.  
 DIA. ROUND ROD 9 ins. LONG.



BOWSPRIT 4. CUT ONE  
 FROM 1 4 in. ROUND ROD.

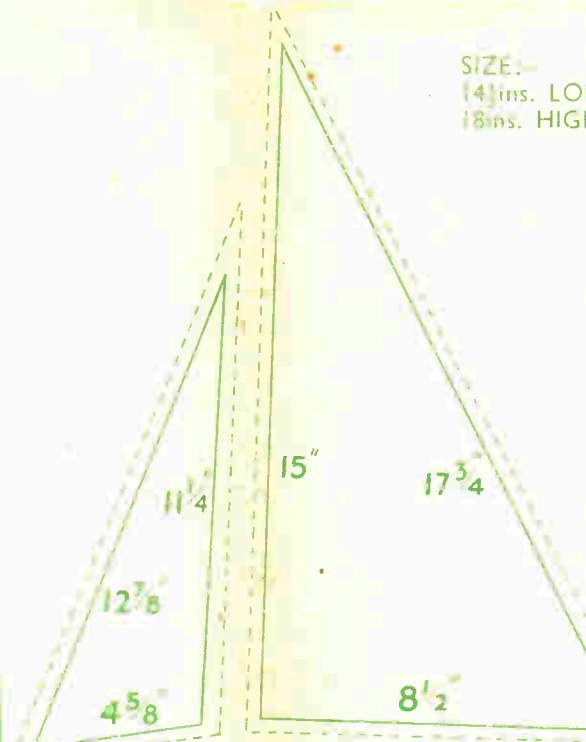
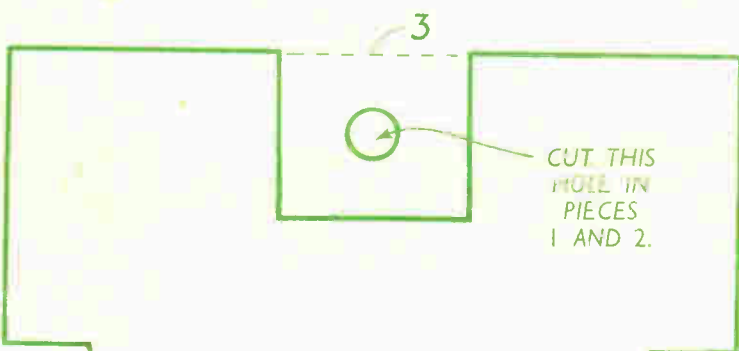

SAILS. CUT ONE OF EACH.

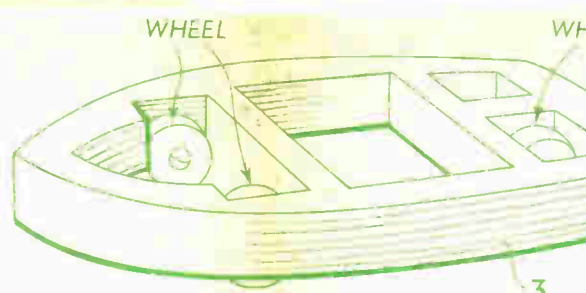
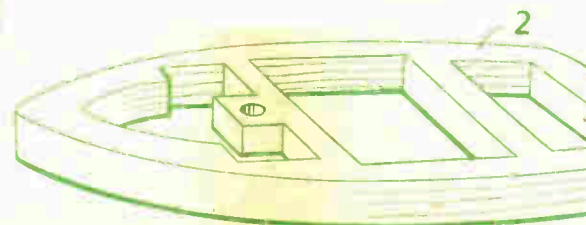

SKETCH SHOWING  
 GENERAL ASSEMBLY.

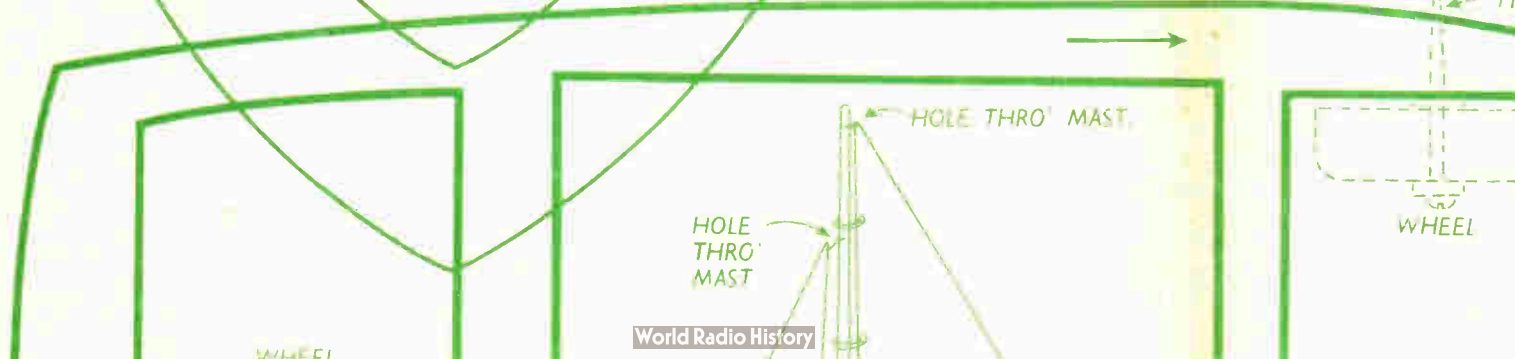

SIZE:—  
14½ ins. LONG  
18 ins. HIGH.

A WORKING TOY  
**LAND YACHT**

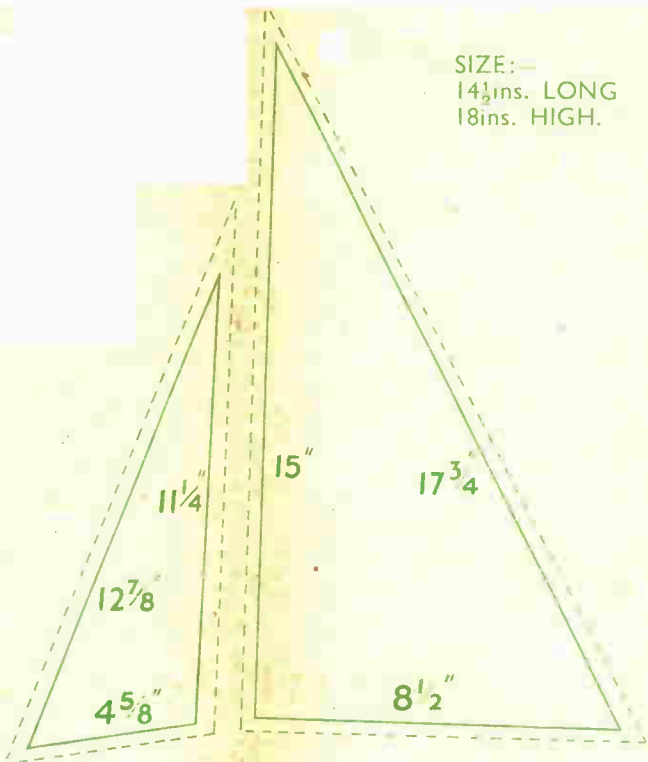

SAILS. CUT ONE OF EACH.

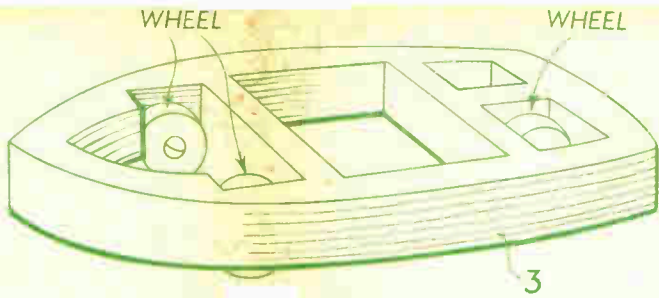
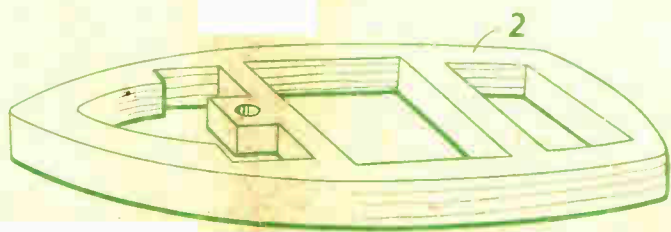
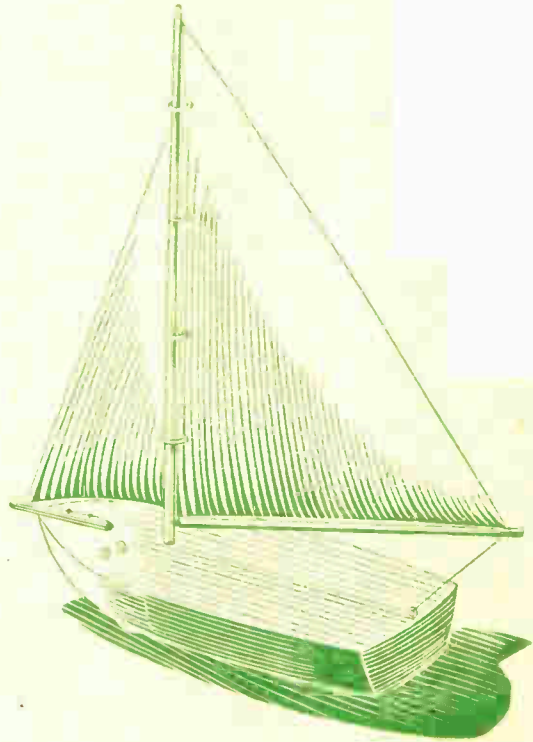

SKETCH SHOWING  
GENERAL ASSEMBLY.

PANELS OF WOOD REQUIRED  
FOR THIS DESIGN

ONE ND 12      ONE ND 8  
ONE Q4

A complete kit of the above materials can be obtained from  
**HOBBIES LTD., DEREHAM, NORFOLK**

The Sparkling Enamel

**PAINT IN TUBES**

Ready for use

Handy and economical. Suitable for all right for class and small painting jobs.

**Starlon**

PLASTIC ENAMEL PAINT

Available in 14 different shades everywhere

STARLINE, SOUTHEND-ON-SEA, ESSEX

1/- PER TUBE

QUICK DRYING PLASTIC ENAMEL PAINT

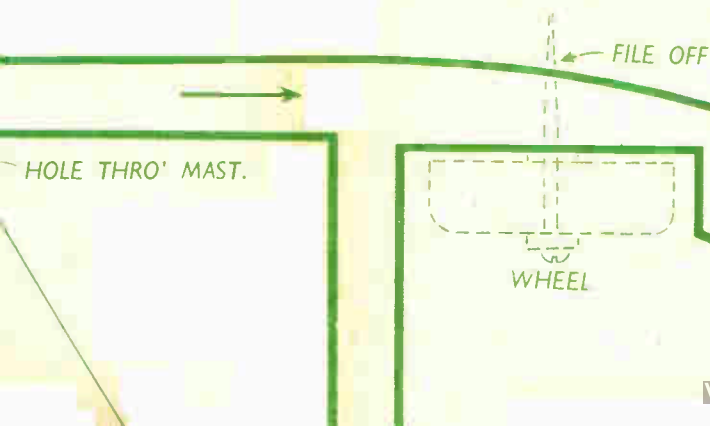

SKETCH SHOWING  
HOW BOOM IS  
SWIVELLED TO  
MAST.

MAST. SHAPE ONE FROM 1/4in. DIA. ROUND ROD 16 3/4ins. LONG.

BOOM. SHAPE ONE FROM 1/4in. DIA. ROUND ROD 9ins. LONG.

BOWSPRIT 4. CUT ONE FROM 1/4in. ROUND ROD.

4 5/8"

8 1/2"

SAILS. CUT ONE OF EACH.

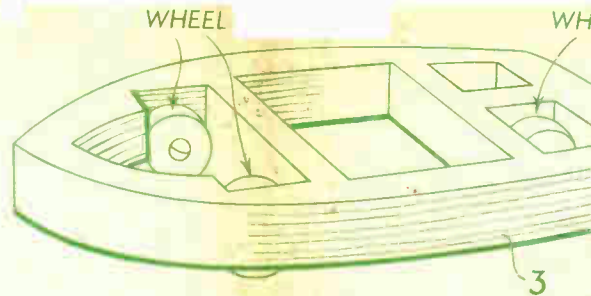
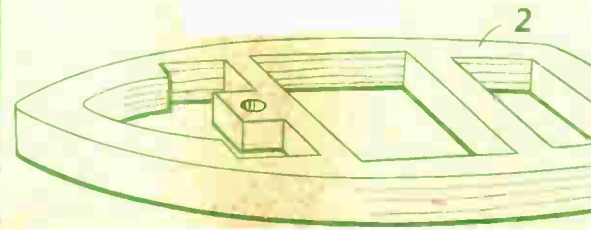
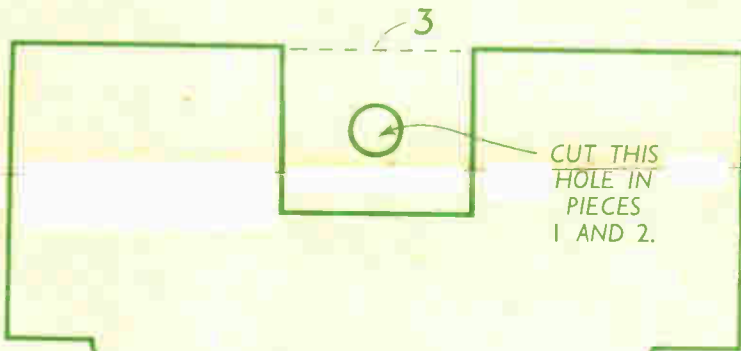

SKETCH SHOWING GENERAL ASSEMBLY.

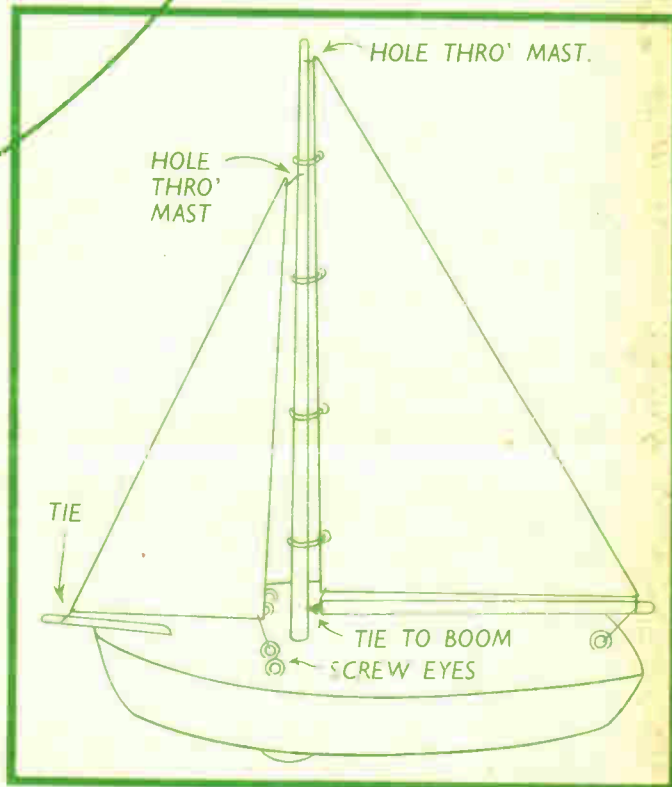
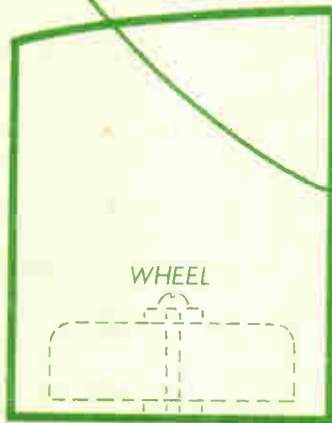

PIECE 3. CUT ONE 3 4in.



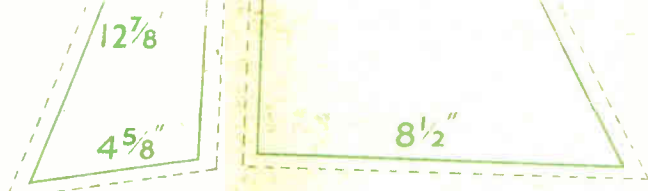

SAILS. CUT ONE OF EACH.

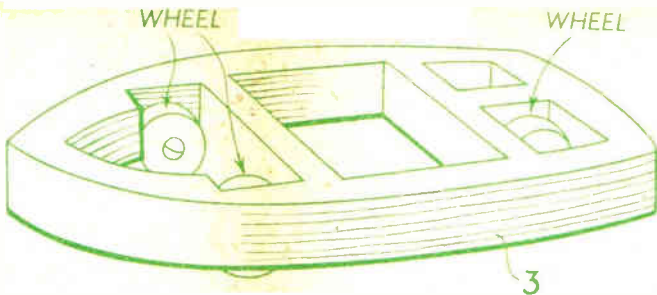
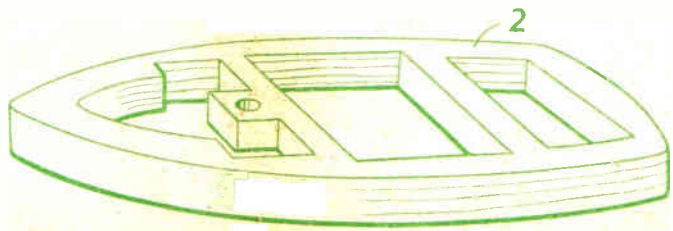
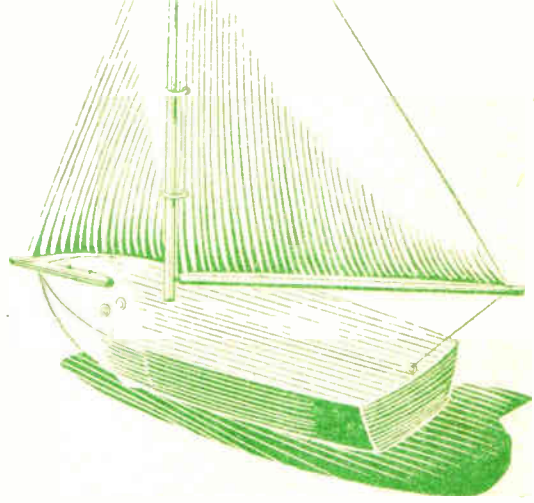

SKETCH SHOWING GENERAL ASSEMBLY.

PANELS OF WOOD REQUIRED FOR THIS DESIGN

ONE ND 12      ONE ND 8  
ONE Q4

A complete kit of the above materials can be obtained from  
**HOBBIES LTD., DEREHAM, NORFOLK**

The Sparkling Enamel  
**PAINT IN TUBES**

Ready for use  
Handy and economical Starlon is just right for these small painting jobs.

**Starlon**  
PLASTIC ENAMEL PAINT

Obtainable at all Hardware Shops everywhere  
**STARLINE, SOUTHEND-ON-SEA, ESSEX**

PER TUBE  
in 14 lovely colours and Clear

QUICK DRYING  
PLASTIC ENAMEL PAINT

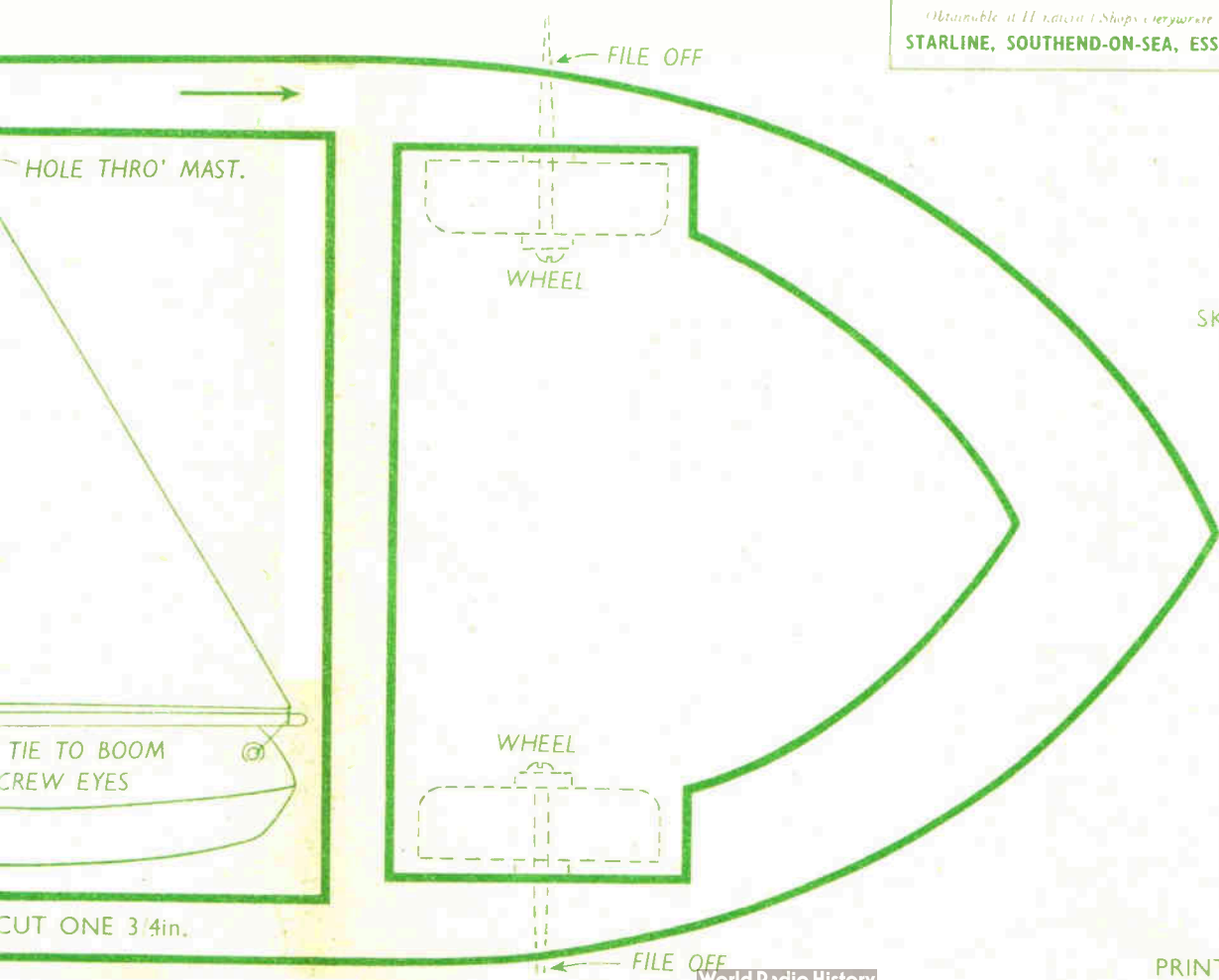

SKETCH SHOWING HOW BOOM IS SWIVELLED TO MAST.

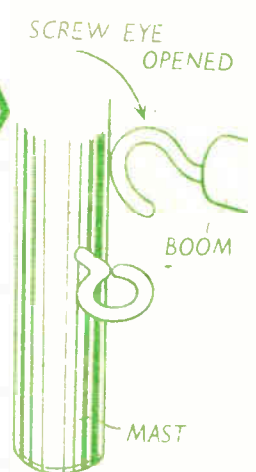

# HOBBIES WEEKLY

IN THIS ISSUE

	Page
A See-Saw . . . . .	81
Chiselling with the Grain . . . . .	82
Decorative Plaques . . . . .	83
Make Handkerchief Sachets . . . . .	83
Nieuport 17 Scout . . . . .	84
A Seat for Two . . . . .	86
Renovating a Clock Dial . . . . .	87
The Egg and Card Enigma . . . . .	88
Planking for Galleons . . . . .	88
Make this Cutlery Box . . . . .	88
Try Unusual Viewpoints . . . . .	89
Models Give Atmosphere . . . . .	90
Replies to Readers . . . . .	92
Cutlery Box Patterns . . . . .	95



NOVEMBER 16th 1955

VOL. 121

NUMBER 3133

## Keep them warm in winter - make . . .

**C**HILDREN always love a see-saw and it is particularly welcome in the winter time when the exertion needed keeps them warm and happy. Place it in a corner of the garden where it catches the sun and sheltered from the chilling winds.

The post is buried in the ground to depth of 2ft. 3ins., which makes it

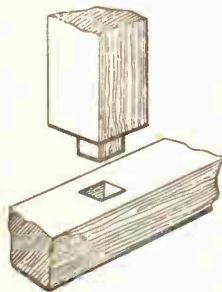
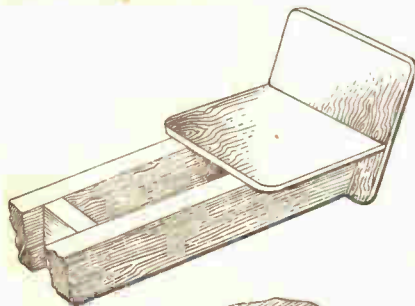
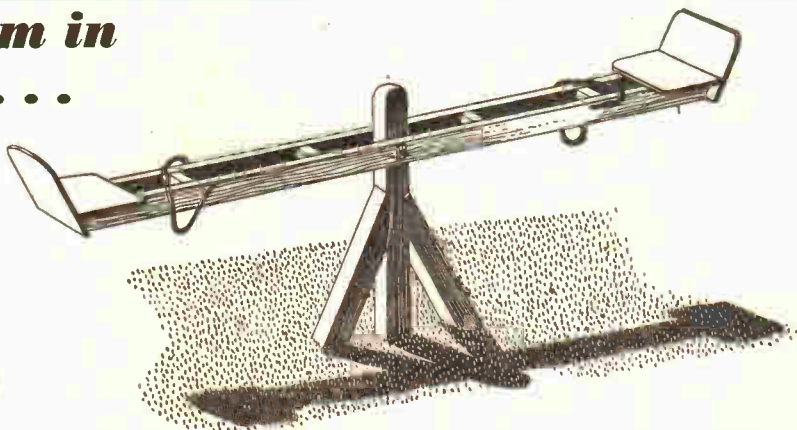

Fig. 3

## A SEE-SAW

certain that it will not move however severely it is tested. Plenty of rubble must be packed in when filling the hole. Stones and bricks can all be utilised for this purpose.

The general construction is shown in diagrams 1 and 2 where the main measurements are indicated. Details of the joints are shown in the other sketches.

The centre post is cut from timber 4ins. square and is 5ft. long. The struts and foot are cut from 4ins. by 2ins. wood or could be even heavier, up to 4ins. by 4ins. The post is stub tenoned into the foot as shown in Fig. 3, and the struts are let in as in Fig. 4. Shape the struts and cut away the post as shown. The struts are cut first, laid on the post for position, marked round and the



Fig. 2

All correspondence should be addressed to The Editor, Hobbies Weekly, Dereham, Norfolk

For Modellers, Fretworkers  
and Home Craftsmen

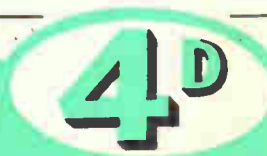

post then cut to fit. The same applies to fitting the struts to the foot. Cut the struts first, then shape the foot.

The four pieces must now be joined together, using stout screws, with, possibly, a bolt through the post and struts where they join. Do not rely entirely on nails for strength.

The see-saw is made up from two pieces of wood from 9ft. to 12ft. long and about 4ins. by 1½ins. in section. They are held apart by four spacing pieces cut from the same material, and to the length shown in Fig. 5. The seats and backs are cut from ½in. or ¾in. wood and screwed on as indicated in Fig. 6.

#### Add Metal Plates

Pivot the see-saw to the post by means of a bolt going right through. It will add considerably to its life if metal plates are screwed to the bearing surfaces before assembly. These plates can be seen in Fig. 7. It will be appreciated, of course, that the post goes between the two pieces of the see-saw.

Before inserting the post in the ground it should be well creosoted or tarred to give some protection against rotting. The rest can be painted after knotting, priming and a suitable undercoating. Add a rope 'handle' to each end as shown in the illustration of the completed see-saw. It should be rubbed down and given a fresh coat of paint every year if possible. (M.h.)

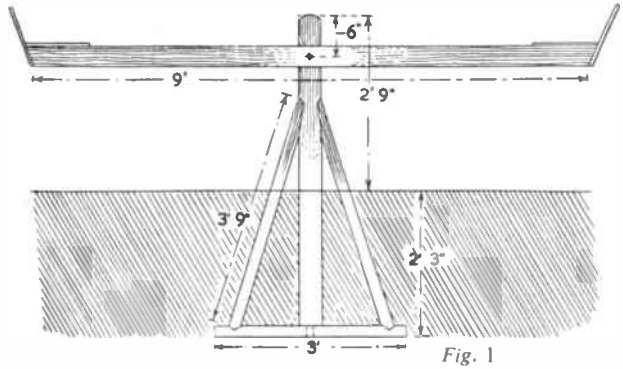

Fig. 1

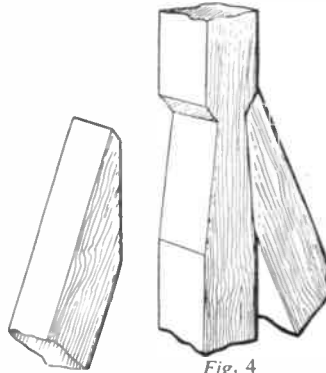

Fig. 4

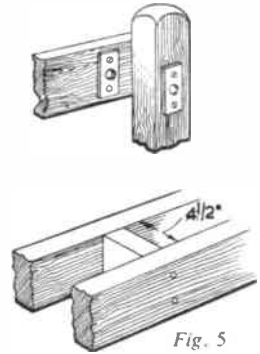
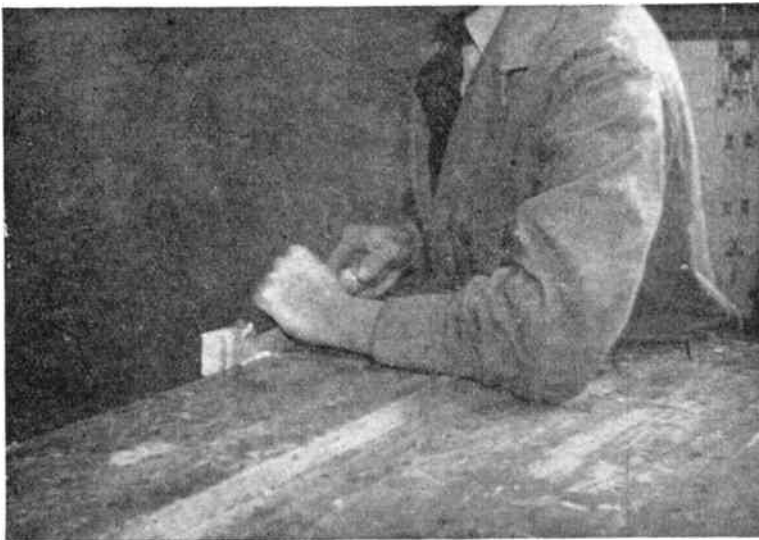

Fig. 5

## Handling Woodwork Tools

# Chiselling with the Grain

By Kenneth Blackburn



Positioning of the body and correct handling of the chisel is all-important

**C**HISELLING along the grain is an operation which can be hazardous unless it is tackled in the correct way.

The photograph shows a slope being cut on a piece of wood. Stand at the end of the bench, and, with the feet well out, support the top part of the body on the bench. The right hand grips the handle of the chisel and the whole of the left hand rests on top of the blade, giving downward pressure and controlling the direction of the chisel. The thumb cannot be put under the blade, as this would mean raising the chisel to a higher angle.

Do not be tempted to stand by the side of the bench while chiselling in this way. If the chisel slips, you may lose your balance, and the consequences could prove disastrous.

This method cannot be used if you are left-handed (unless your vice is at the right-hand end of the bench). The only practical solution then is to secure the wood to the bench by means of a G clamp.

Cast in plaster

# DECORATIVE PLAQUES

**W**ALL decorations, in the form of plaques, small pictures and miniatures are in wide use. Plaques have an advantage in that you can choose both the subject and colour. The choice of subject is almost without limit, and if something difficult is chosen it is usually possible to find a picture somewhere which can be used as a basis for the design.

Four pieces of  $\frac{1}{4}$ in. stripwood 10ins. long by 2ins. wide will serve for the construction of plaques within the normal range of sizes. They should be smoothly finished so that the wet plaster of paris which is used for the plaques does not adhere to them. To obviate this a little castor oil can also be smeared on to them with the finger before pouring in the plaster.

Choose the subject, and arrange the four strips as shown in Fig. 1 according to the size of the plaque. Now put the mould, of clay or plasticine, into the square, stopping the strips from slipping apart by a few balls of clay wedged at the outside corners. Work your subject into the mould, using fingers, pencil, knife, and other suitable instruments. Care must be taken to avoid undercutting—that is, making an indentation in the mould which becomes locked with the plaster when it is poured in to set (see Fig. 2).

When the mould is ready, half fill a basin with water and add the plaster of paris powder slowly and stir. Do not stir too much, as this causes small air bubbles to form throughout the mixture. Also, of course, the liquid must be of a consistency that will pour readily. Pour the mixture on to the mould to a depth

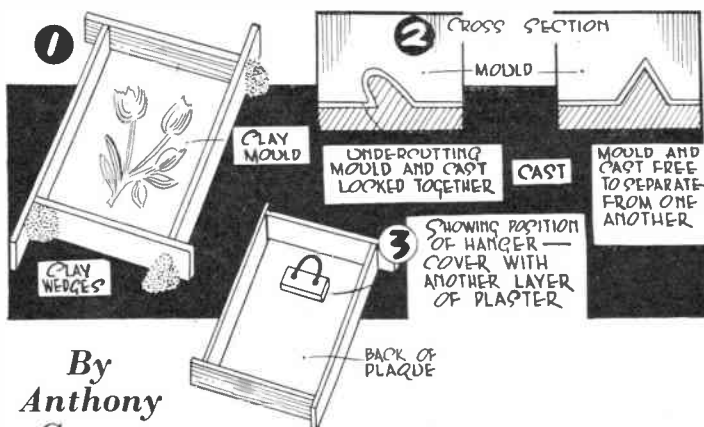

By  
**Anthony  
Gower**

of about  $\frac{1}{4}$ in. This level can be marked on one of the strips when the mould is complete.

Leave the plaque for about half an hour to set. Remove the clay wedges and strips of wood and turn the plaque face down. A small hanger can now be made from a piece of cardboard or tin 3ins. long and 1in. deep. Make two holes in it and tie through these a loop of curtain cord of suitable length. Note that in the case of a plain plaque it is not usual to have the cord showing when it is hanging. However, if a calendar is to be attached to the plaque, the cord will be longer. Place the strips in position round the plaque, having removed the mould, and pour another, thinner layer of plaster on the back and leave to set. Do not touch the plaque for twelve hours,

so that it dries out completely—then remove the four walls again.

When it is completely dry, the plaque can be coloured either with poster or water colours. Some subjects are better left in plain white.

If a calendar is to be fastened, this is best done with two short strips of matching ribbon glued to the back of the calendar and the back of the plaque. Cover the ends glued to the plaque with a further glued strip of paper for strength.

While the liquid plaster is being used keep a sharp watch to see that no air bubbles form. Blow on the mixture to burst the bubbles when they form, and any that are seen when the plaster has dried can be filled in before it sets completely.

## Make Handkerchief Sachets

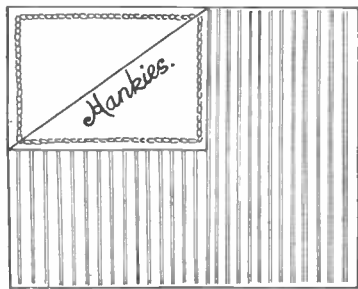

**D**O not be too discouraged when mummy and your big sisters begin to make their Christmas presents. You can save pocket-money by making lovely handkerchief sachets.

You will need oblong pieces of material; cretonne, rayon, candy stripe, satin or sateen are best; but any left-over material mummy can spare from her workbox will do. You will also need one skein of brightly coloured embroidery silk. That will cost you 4d.

The material for uncle's sachet should measure about 18ins. long and 10ins. wide. Auntie's sachet is smaller. A piece of material 10ins. and 8ins. wide will do nicely.

Make auntie's sachet first. It is always easier to handle small sizes and by the time you start to make uncle's sachet you will have gained a little experience. Neatly hem both ends of the material. Fold the work in half and join up one side only. Be sure you fold

the sachet wrong side out before you start to sew. Join  $1\frac{1}{2}$ ins. only on the other side of the sachet, starting to sew at the bottom. Hem the remainder of this side neatly, first the front hem then the back.

Turn down the front corner to make a flap. Make the flap secure by fastening it down with three or four small stitches. Thread a needle with embroidery silk and chain stitch along all the hems which show.

Now take a soft lead pencil and print or write the word 'Hankies' on the turned-down flap. Embroider with stem stitches.

Uncle's sachet is made in exactly the same way, but join 4ins. of the open side instead of only  $1\frac{1}{2}$ ins. (F.L.B.)

## Famous fighter aircraft—No. 3

# NIEUPOINT 17 SCOUT (Single Seater)

IN the latter part of 1915 and early part of 1916 the German Fokker monoplane, the first aircraft to be armed with a machine gun firing through the propeller, had obtained a great measure of superiority in the air over the Western Front in France and was taking a terrible toll of the slower Royal Flying Corps aircraft.

At first we had no machine which could compete on level terms with this single-seater German scout. Single-seaters were designed in England to meet the 'Fokker Menace' but the R.F.C. squadrons were short of

make a name for himself as a great fighter pilot.

The Nieuport had a length of 19ft. and a wing span of 27ft. The bottom wing was very narrow and served more as a support for the interplane struts than as a wing. The armament was usually a Lewis gun mounted on the top wing, but later it mounted a Vickers gun on top of the cowling, firing through the airscrew.

Though highly manœuvrable and used with considerable success by both British and French pilots, the Nieuport was never altogether popular. It had the

2ins. by  $\frac{1}{8}$ in.; for the struts (interplane and centre-section and undercarriage) thin sheet metal from coffee, biscuit or other food tins will be found extremely useful, and should be cut with thin-nosed metal cutters or a pair of old scissors. Some of these tins are painted on the outside and if the various parts are marked out on the painted side, they will show up clearly. The wheels are  $\frac{7}{8}$ in. in diameter. Linen buttons to this size can be used and the rim painted grey to give the effect of a tyre, or the wheels on the tiny 'Dinky' toy cars may be purchased from most toy shops. These are rubber and are  $\frac{7}{8}$ in. diameter. Refer to No. 2 of this series for details of how to make a Lewis and Vickers gun. The propeller may be made from thin

By D. G. Norton

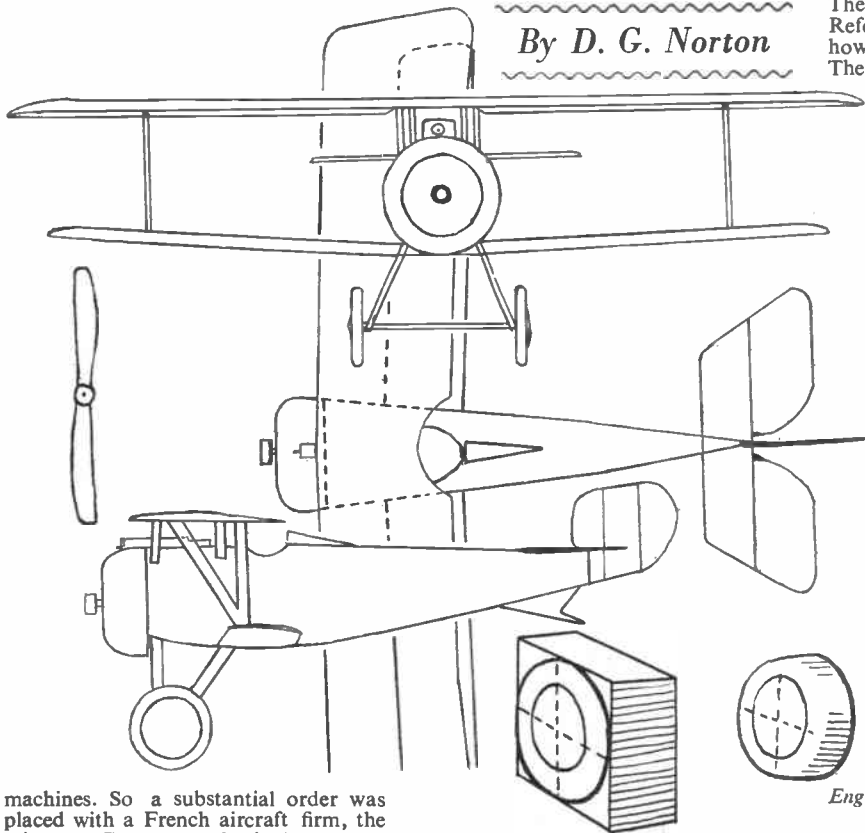

Engine cowling

machines. So a substantial order was placed with a French aircraft firm, the Nieuport Company, who had produced a single-seater scout, the Nieuport 17. When, in 1916, this aircraft was brought into action against the Fokker monoplane, it was powered with a .110-120 h.p. Le Rhone rotary engine and its speed of 95-105 m.p.h. represented the fastest that was reached by a war aeroplane up to that time. It did much to wrest the supremacy of the air from the Germans, and it was in this machine that Captain Albert Ball, V.C., began to

most unpleasant habit of shedding its top wing in a power dive, for the wing construction was weak.

All the plans in this series are drawn to a scale of 1/72nd, or 6ft. to the inch.

### Materials

A block of balsa 2 $\frac{1}{2}$ ins. by  $\frac{3}{8}$ in. by  $\frac{3}{8}$ in. for the fuselage; a sheet of balsa 4 $\frac{3}{8}$ ins. by 1 $\frac{1}{2}$ ins. by  $\frac{3}{8}$ in. for the wings; for the tail units a sheet of balsa 3ins. by

card or sheet metal. The engine cowling can be turned on a wood lathe or made from balsa by hand.

The tools have already been described in No. 1 of this series and will serve for all the models.

Reference should be made to the first article for the general methods of preparing the fuselage, wings and tail units. Both the Sopwith Camel and the Nieuport had rotary engines. Therefore, the fuselage of the Nieuport is



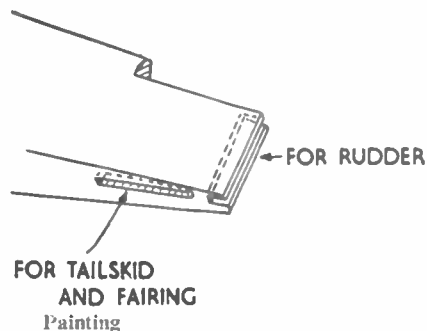
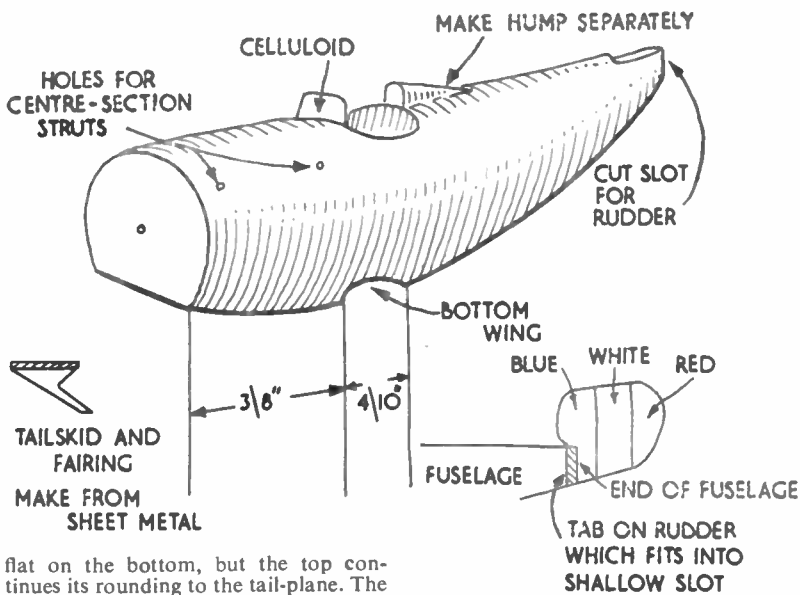

In the Royal Flying Corps squadrons the Nieuport was painted silver. There were the usual red, white and blue markings on the rudder. Interplane and centre-section struts were varnished. For this yellow ochre poster colour, with a touch of glue, can be used or orange-coloured dope is suitable. The undercarriage was also silver, as were the wheel discs. The propeller can be grey or the same colour as the struts. The red, white and blue rings or cockades were used.

One at either end on the top wing, but due to the very narrow lower wing the cockades were also used on the underside of the upper wing (in the space between the end of the wing and the interplane strut) and there were none on the lower wing. Two smaller rings were on the sides of the fuselage. Transfers may be purchased at model shops.

flat on the bottom, but the top continues its rounding to the tail-plane. The rounding on the sides gradually disappears and, at the cockpit, is flat (see above). Do not forget that the cowling, glued in place, will act as a guide for obtaining the roundness of the fuselage. The wings have a slight sweep back, and there is a dihedral on the bottom wing.

The tail-plane is straightforward, as is the rudder. The tailskid is combined with a fairing and the fuselage should

have a slot made in it in which the fairing should be glued.

#### Assembly

Reference should be made to No. 1 of this series. The bottom wing is so narrow that it can fit into the cut-out in the fuselage. The top wing should rest  $\frac{1}{8}$  in. above the fuselage. The track of the undercarriage should be  $\frac{7}{16}$  in.

## Proud as Peacocks (and rightly so)

Looking as proud as peacocks are these members of the Port Erin Boys' Fretwork Club, who meet three nights a week in the home of the organisers, Mr. and Mrs. A. R. Buttell (in background).

This club has 54 enthusiastic members aged from 6 to 17, who are particularly proud of one of their number, Alaric Laurence, aged 9, whose entry in the 1955 Hobbies Fretwork Competition was favourably commented on by the Editor.

Mr. Buttell, whose address is Martins Bank House, Station Road, Port Erin, Isle of Man, would like to exchange views etc. with leaders of similar organisations. He says his boys, apart from their fretwork and model making activities undertake all sorts of furniture repairs etc. for friends and neighbours.

Looking around we can distinguish many articles made from Hobbies Designs and no doubt the boys find their A1 and Gem fretmachines in the foreground a great help in speeding up their efforts.

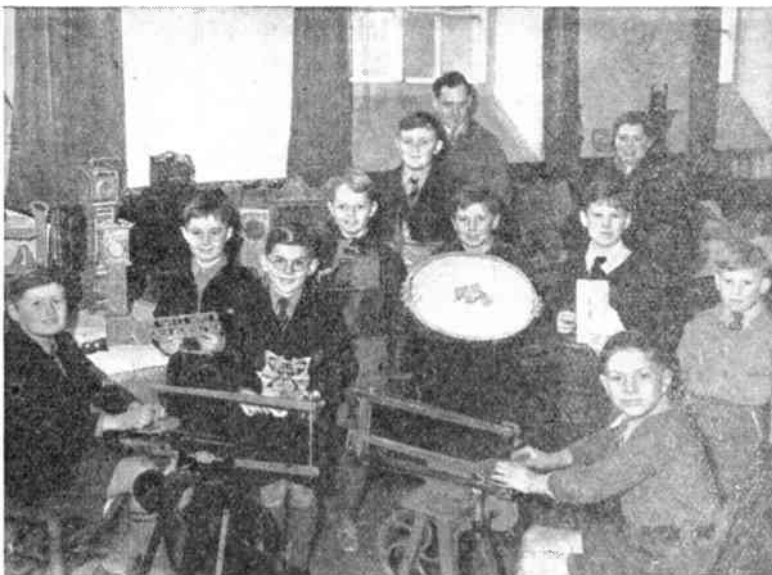

Some of the boys proudly display their work. Alaric Laurence is second from right in the centre row

# A SEAT FOR TWO

*Incorporating  
a box for toys  
and books  
described by  
W. J. Ellson*

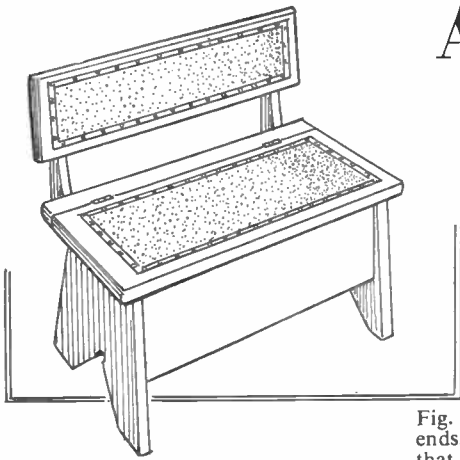

**T**HIS handy attractive little seat is designed especially for young children, and is large enough for two. The seat is also the lid to a box beneath, for toys and books. This should aid in teaching tidiness, and be a safe place for keeping the toys.

A section through the side of the seat is given in Fig. 1, and a front elevation in Fig. 2. The work of construction is quite easy, and for material, a good

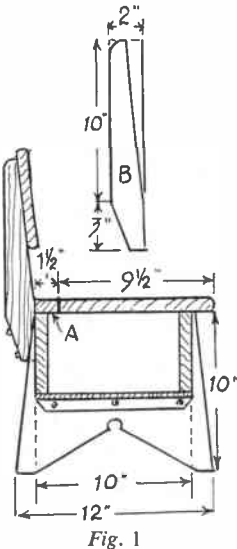

Fig. 1

quality deal of  $\frac{3}{4}$  in. thickness is suggested. The article must be strong enough to stand up to the treatment usually expected from a couple of lively youngsters. The shape of the ends can be obtained from Fig. 1. Owing to the width here, it may be necessary to glue two boards together, and if so, a dowelled joint is advised for strength. Cut both ends and pencil on them the exact position of the two box sides which join the ends together.

Cut the sides to the dimensions given in

Fig. 2, and either nail or screw to the ends. Position them correctly, to ensure that the seat stands firm and level. A bottom of stout plywood is nailed to the sides underneath, and at each end, a fillet of wood,  $\frac{3}{4}$  in. square is nailed for support. These fillets can be seen in Fig. 1. At this stage thoroughly glasspaper the work.

The seat itself is in two parts, a wide board which is the lid of the box, and a narrow strip to which the lid is hinged. The latter, shown at (A) Fig. 1, is firmly screwed or nailed to the rear side

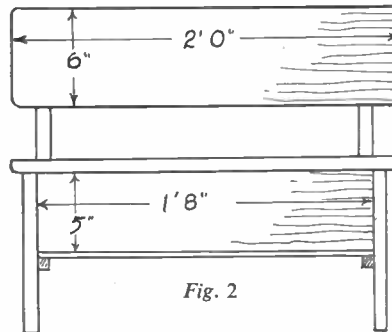

Fig. 2

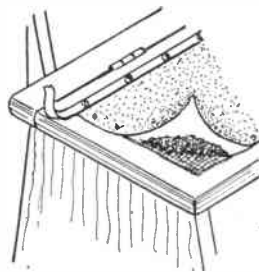

Fig. 3

of the box, its back edge being level with the box side. The lid, cut to the same length is fitted to strip (A) with a pair of 3 in. iron butt hinges. It will be seen from Fig. 2 that both are cut to a length of 2ft., and will project over the ends and front of the box. These projecting edges should be rounded with a plane and glasspaper.

## CUTTING LIST

Ends (2)	10ins. by 12ins. by $\frac{3}{4}$ in.
Box sides (2)	1ft. 8ins. by 5ins. by $\frac{3}{4}$ in.
Box bottom.	1ft. 8ins. by 10ins. by $\frac{3}{4}$ in. plywood.
Seat.	2ft. by 9 $\frac{1}{2}$ ins. by $\frac{3}{4}$ in.
Hinge strip.	2ft. by 1 $\frac{1}{2}$ ins. by $\frac{3}{4}$ in.
Back rest.	2ft. by 6ins. by $\frac{3}{4}$ in.

—  
Remainder from scrap wood.

## FITTINGS

1 pair	3in. iron butt hinges.
For upholstery	American cloth or Rexine, 1/3rd of a yard.
	Banding to match, 3yds.
	Studs, 3 doz. (approx.).

Some extra support for the lid is advisable at the middle. A division across the centre of the box to separate it into two compartments serves this purpose well. The lid should be cut from a single board for greatest strength, or it could be constructed from a frame of 3in. wide wood and covered with  $\frac{3}{4}$  in. plywood. If this method is used, a middle bar must be included in the frame.

The back rest is a length of wood, nailed to supports as in the drawings. Cut the two supports to the shape shown at (B) in Fig. 1, from pieces of wood 2ins. wide and 13ins. long. As the drawing shows, they are quite easy to cut. Fix these with stout round-headed screws to the rear side of the box with the sloping front edges level with the seat. Screw the back rest across these at a suitable height above the seat. Now carefully glasspaper until the wood is smooth everywhere. It is important that all possibility of splinters or roughness should be avoided.

A little simple upholstery to the seat and back rest is desirable, but before adding this, paint or varnish the seat, etc., as desired. A stain and varnish finish is pleasant, but as young children generally prefer bright colours, a coating of hard gloss paint over an undercoat may be preferable.

Upholstering should not be an elaborate job. For covering, a good quality of Rexine or American cloth is suggested, as marks can be easily removed by washing. For padding, a good thickness of cotton wool would serve, or a double thickness of old blanket, covered with a layer of wadding. Cut to the dimensions of the area to be upholstered and press down well to the wood. The final covering should be gently laid over, to avoid disturbing the padding. Cover the lines of tacks with a banding and brass nails, or studs to match. The detail sketch (Fig. 3) will make this clear.

# Renovating a Clock Dial

**T**HE resilvering of a clock dial is best done as in the old days of the horological craftsman.

First detach the hands and put them in a safe place, and then the dial, laying it on a clean flat surface where you can work easily.

Great care must be exercised to prevent the depth of the dial engraving being affected when cleaning, and any trace of former silver-plating or grease on the brass must be freed. Having thus cleaned the dial, polish it reasonably

By *E. M. Blackman*

well and then wash it in clean water, applying salt liberally on the surface.

To silver, mix a paste of chloride of silver, salt, and cream of tartar, and rub this over the whole surface with a piece of cotton waste, as evenly and as quickly as possible for the action is rapid.

Then give a final gentle rubbing with cream of tartar in water alone.

Now flood the silvered part again with clean water, dry it, and then apply a thin film of oil to the surface. Or else, the part can be warmed and given a coating of colourless lacquer.

Olden day craftsmen used to use shellac dissolved in alcohol—not methylated spirits. Silvered in this way, a brass part will remain bright and white for half a century.

Tarnish on an original gilding can be freed by washing gently with weak ammonia solution. If this does not entirely remove the tarnish, flush the dial with benzine to clear any grease and then immerse for a few minutes in a solution of one ounce of cyanide of potassium and one ounce of lump ammonia to half-a-pint of water. Whilst cleaning the plate by this method, take care not to inhale, as cyanide solution gives out fumes.

Finally, wash the plate in water or alcohol, and dry the surface very carefully to avoid scratching.

Where the clock hands are coated with rust, soak for several hours in light oil. Unless the corrosion is very severe, however, do not use an abrasive, as it will destroy the sharp edges of the original filing.

To polish clock hands, place them in a tray of sand and hold over heat. A light straw colour will first appear and this will quickly darken, change to brown, then purple, and finally, blue.

Immediately the blue starts to bloom on the surface, remove the hands from the sand and rub lightly with oil. Do not risk leaving any longer, as the blue will fade to a steel grey and necessitate the polishing being done all over again.

Where any soft-solder repair has been done to the hands, this method cannot be used, as the parts would loosen.

Apart from usefulness, a clock should also be regarded as a piece of furnishing, so it is well to consider its general appearance and to ensure that the colour and decoration is imposing, and, as far as possible, in harmony with its environment.

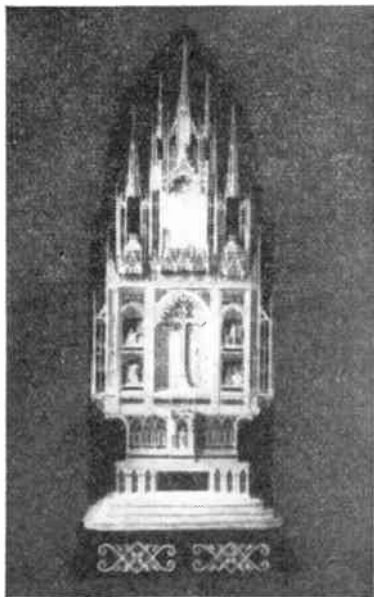
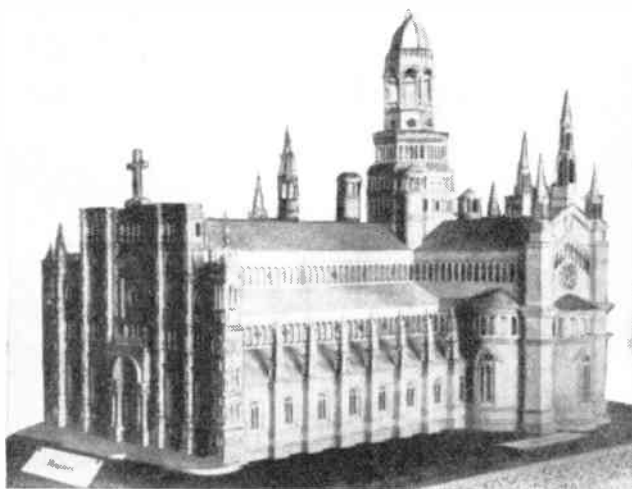

## FINE EXAMPLES OF MODELS MADE ON A FRET MACHINE

**W**ORKING almost entirely with a treadle fretsaw, Mr. Richard Old, of Middlesbrough, in 33 years turned out a series of architectural models of amazing detail and finish.

One of his most superb miniatures is that of Chartreuse Monastery (above) which contains 8,000 pieces, 2,000 of which were used for the beautiful frontage. It is made entirely of sycamore, except for the window bows of cotton wood. The scale is 1 in 50.

In his High Altar of St. Peter's, Rome (on the left) five woods, including maple, cotton wood and white chestnut were used. The time of making was 2½ years and the miniature stands 7ft. high.

(H.A.R.)

## TELEPHONE PARTS

- Telephone Handset Mouldings—P.O. Type—12/6 per set.
- Single Pin—2-way plugs—4/6 each.
- Set of Transmitter Parts—10/6 each.
- Set of Receiver Parts—10/6 each.
- Tinsel Flexible Cords—tagged each end, 4ft. 6ins. long—8d. each.
- Oak Switches—10/6 each. Kelog Keys—S.H.—10/6 each.
- Other accessories—Price on application with stamped addressed envelope.

'ONLY' COMPONENTS LTD  
Llanerch-y-Mor, Holywell, Flintshire

## HERE'S MAGIC FOR YOU

# THE EGG AND CARD ENIGMA

**A** HARD-BOILED egg is passed among the audience for thorough examination. It is seen to be undamaged and quite free from preparation. It is left in charge of a volunteer assistant while the experiment proceeds.

A pack of cards is now shown and a card is chosen entirely by chance. This is handed to the assistant who is requested to rub the egg with the face of the card. Of course, everyone is allowed to see the chosen card.

The performer now asks the assistant to remove the shell from the egg. This is done, and to everyone's surprise the name of the chosen card is written clearly on the white of the egg!

The explanation of this seeming miracle lies in the preparation of the egg and the method by which the card is chosen—apparently by pure chance.

To prepare the egg, take half-an-ounce of alum (obtainable from any chemist) and half-a-pint of vinegar. Dissolve the alum in the vinegar, dip a brush into the mixture and paint on the shell of the egg the name of any card. When the painted words are thoroughly dry, boil the egg for fully fifteen minutes. The egg will appear unprepared, but the words will now have passed through the shell on to the white where they will appear as though written in ink.

The proper card must now be chosen as if by chance. There are many ways of having a card thus selected, such methods being known to magicians as 'forcing'. Here is an easy method that cannot fail. Have the proper card secretly set ninth from the top of the pack as it rests face down on the table. Take up the cards and ask for a number

between 10 and 20 to be called out. Anyone may call the number quite freely.

Deal this number of cards on to the table. Then add together the digits of the number, telling the audience exactly what you are doing. Pick up the dealt cards and deal off from these the new number (the total of the digits). The next card will be the wanted card whose name has already been boiled into the egg.

For example, say that the number 17 is called after the egg has been examined.



## PLANKING FOR GALLEONS

**A**N interesting and useful gadget which can be used to simulate the planking on decks of model galleons has been made by one of our Belfast readers and the idea will be welcomed by all galleon modellers.

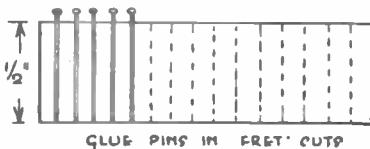

Cut two lengths of stripwood  $\frac{1}{2}$  in. by  $\frac{1}{2}$  in. to suit the width of the galleon. You will probably find it easiest to make two markers, one fairly small to fit the narrower parts of the galleon. On one of these pieces of wood, cuts should be made across the  $\frac{1}{2}$  in. width with a fretsaw. These cuts, which should be about  $\frac{1}{4}$  in. apart, form grooves in which pins are glued. Cover the whole board with a generous coating of glue and place the pins in the grooves with their heads extending about  $\frac{1}{8}$  in. beyond the edge of the wood. Place the second piece of wood on top and clamp firmly to set.

When the glue has dried hard the surplus which has oozed out can be trimmed off except from the top edge where it will help to keep the heads of the pins firm.

The marker is now ready for use. Pull it at a slight angle along the decks before the bulwarks or any other fittings are added. By this method the scoring of the pin heads will give an even planking effect. When the grooves have been made on the deck, crush the lead

of a pencil, and rub the powdered graphite over the whole deck. If the decks are then lightly glasspapered, the grooves between the planks will be clearly and realistically marked.

To finish the deck a coat of varnish should be applied. This method, says our reader, gives a pleasing and a natural effect as well as meeting the demands of scale detail.

## Wedding in the offing?

# Make this Cutlery Box



**T**HE page of patterns this week gives details of how to make a box to hold a small quantity of cutlery. The idea is to buy, say, half a dozen knives, and then make a presentation box to fit them. You will then be able to give an expensive looking

Seventeen cards are dealt out and then picked up from the table. The digits 1 and 7 are added together, giving the new number 8. Eight cards are dealt out, and the next is the card to be handed to the assistant.

It adds greatly to the effect when the magician invites the person who has given the number to change it if he so wishes.

'I want a card to be chosen purely by chance', he adds innocently.

wedding or Christmas present at a reasonable cost to yourself.

We have given no actual measurements, because these will depend on the cutlery purchased. The illustrations, however, show enough of the construction to allow you to make up any size without difficulty.

## FULL-SIZE PATTERNS ON PAGE 95

The box should be made up in two portions, the lid and base. Both are constructed on the same lines, but the lid is not so deep as the base. Both top and bottom are covered with plywood.

Make partitions from  $\frac{1}{2}$  in. wood and cut them as shown in the diagram at the bottom of the page.

Cover the whole of the inside with green baize or finish with coloured velvet spray. The outside of the box can be stained and varnished and a suitable catch fitted. (M.p.)

Get 'Out of the Rut'

# TRY UNUSUAL VIEWPOINTS

Suggests E. G. Gaze

*Using window screen and camera tilt to produce interesting pattern*

a flatness of tonal values when taken from a high viewpoint unless there is a

strong composition of light and shade. But simple subject matters in good lighting conditions often gain in interest from being snapped from the bird's-eye-view. Try a shot from the bedroom window into your own or the next-door garden with a figure as the main object of interest. The angle of view with the camera pointed down is relatively small and often produces unexpected pattern lines of garden paths and flower beds not readily seen from ground level. The figure, too, is generally unaware of the camera, and can be caught in characteristic, unposed moments of relaxation.

(3) *The Arch-or-Window-view.* Here you return to normal eye-level viewpoint but utilise a window or screen pattern, or the framework of an archway, to add atmosphere or pattern-play to the main subject. Exposing from within an archway, or from inside a room, calls for sharp focusing on the arch-shape or window pattern—a small enough lens aperture to secure depth of field through the opening to the main subject outside—and a shutter speed based on the brightly lit outside scene. This means complete under-exposure for the arch-frame or window pattern with normal tonal values for the scene beyond, giving an effective frame or pattern-play super-imposed on the normal scene. But you must adjust focusing so that the arch or pattern is sharp in the foreground—front, or strong side-lighting will sometimes produce slight 'flare' to the form of the arch; strong back or nearly 'back' lighting produces the best effect as in illustration No. 4.

By these simple changes of normal viewpoint you can add occasional prints to your album that have something 'different' about them. Try them.

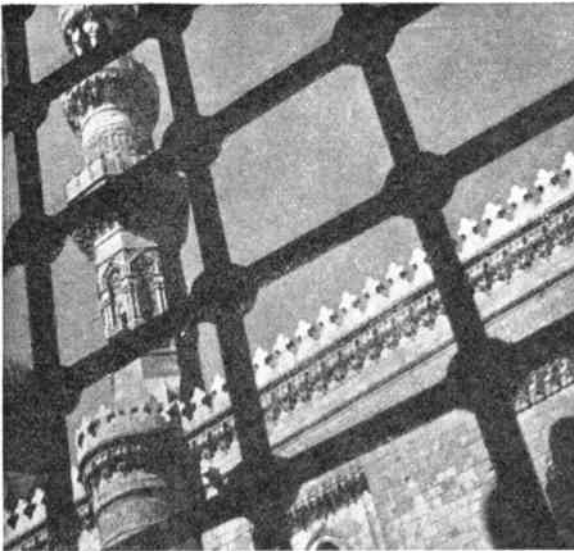

It is often interesting, photographically, to get 'out of the rut' and so add to the attractions of your albums with occasional prints that are 'different'. And there are three simple ways of presenting normal subjects so that they are different.

(1) *The Worm's-eye-view.* Normally, converging verticals—caused by having to tilt the camera to secure inclusion of a tall building—are unnatural in the final print. Yet an effective, eye-catching print, can often be obtained by concentrating on the tower or building alone and unashamedly tilting the camera so that the tower is snapped



soaring upwards against a good sky background. Effective silhouettes can be made in this way, either against the light, or by exposing for the sky tones alone and having the tower itself under-exposed, and so printing 'dark' to 'black'.

(2) *The Bird's-eye-view.* Wide, open scenes—such as landscapes—often have

*From the bedroom window and (right) an arch as a frame*

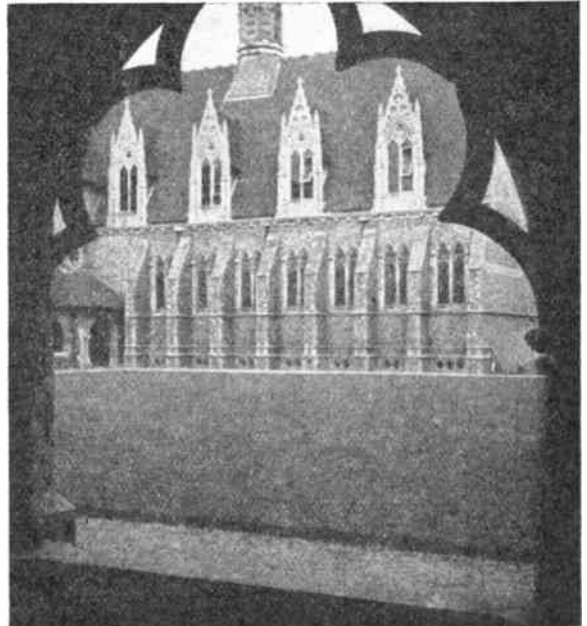

# Models Give Atmosphere

**N**O matter how perfect the engineering aspect of a model railway, a layout always looks strangely empty if there are not plenty of small accessories of the non-technical kind about. This is particularly noticeable with the absence of passengers (and people in general) and loads in the trucks.

If you are very keen on the engineering angle of the system there is, perhaps, a feeling that 'playing about' with little toy people is not quite worthy of your steel, yet I have seen many really excellent layouts quite spoilt by deserted platforms, empty cabs, and level crossings with no one about.

By *H. A. Robinson*

One does not see these things in nature. Why, then, allow them in a model? One would not allow a locomotive to run, say, without a cab, because this would not be following true practice. Why, then, allow deserted platforms and the like?

Having thus argued the case for model people, and plenty of them, let us see how the want can be supplied. Model personnel can be purchased, but they can become rather expensive if introduced in any number. Quite good people, however, can be made for platforms at the further side of the line from the operating space on the cut-out principle.

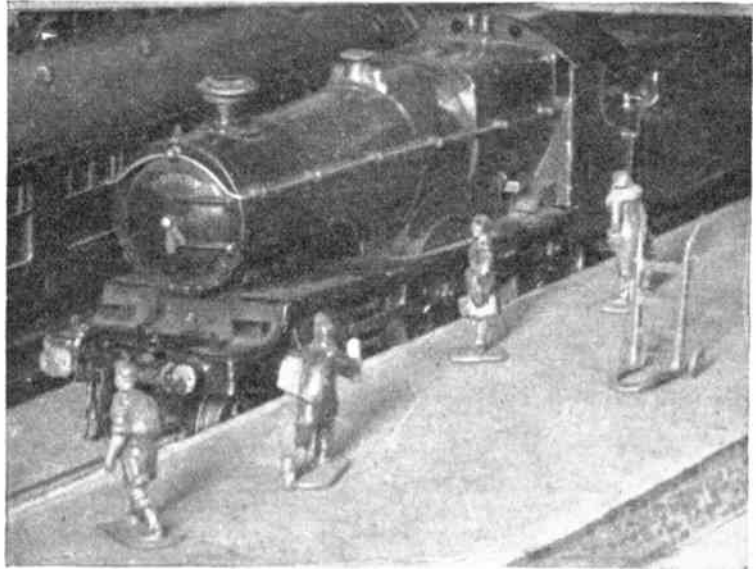

*With models around the station looks 'alive'*

The figures (of appropriate size) are snipped from coloured book plates and mounted on not too thin card, which in its turn is cut to agree with the outline, using a very sharp blade for the purpose. Clean up with fine glasspaper and then with a touch of paint carry the colours of the various parts of the figure round

the cut edge at that point. Thus, if the figure has a red hat, colour the edge red.

Standing can be effected by leaving a trifle of card below the feet which is split and the halves turned out in opposite directions. These tabs can then be glued in position, glasspapered a shade to make them thin and then painted the same colour as the surface in question.

## Solid Figures

Figures nearer to the observer can also be cut out if they are to be located close back against a building. People well out towards the edge of near platforms must be solid, as also at level crossing, etc., where card figures might be seen edge on with disastrous results to realism.

Model people look well in other places than on platforms, in fact, the odd man (or woman) here and there is quite as helpful to the final effect as obvious train travellers. A level crossing is, undoubtedly, improved by a few men, women and children standing near the gate. While a man or two about a goods yard improves the effect immensely. Any hut, like a plate-layer's or fog-man's, is really unfinished without a miniature member of the staff standing near by. If some distance away and flat on to the angle from which the line is always viewed, many of these odd people can also be cut-outs.

● **Continued on page 92**

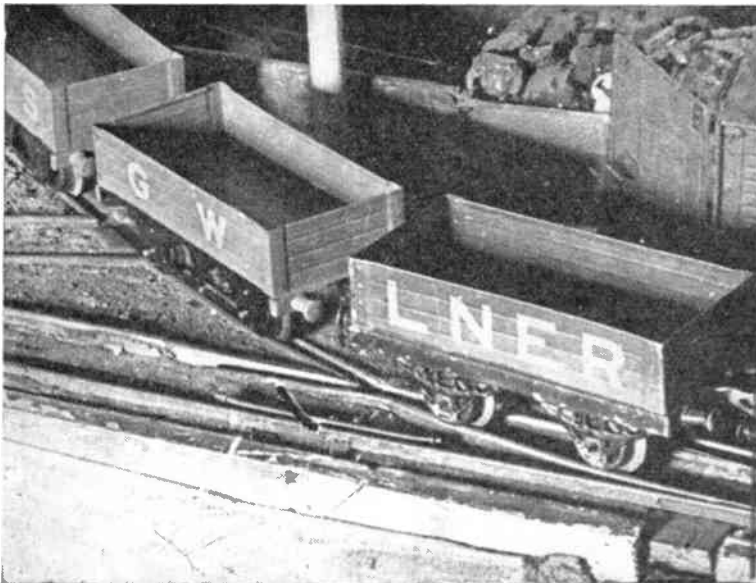

*Empty model trucks look so very empty!*



# EXPERIMENT DATA SHEETS

We have pleasure in presenting our latest range of 'EXPERIMENT DATA SHEETS'. Each Sheet gives complete instructions for a series of experiments, suitable for students and beginners

- E.D.S./1 The Home Laboratory (3 Sheets) Price 6d.
- E.D.S./2 Home Made Apparatus (2 Sheets) Price 5d.
- E.D.S./3 Carbon Dioxide (1 Sheet) Price 4d.
- E.D.S./4 Oxygen & Oxides (2 Sheets) Price 5d.
- E.D.S./5 Elements etc. (2 Sheets) Price 5d.
- E.D.S./6 Ammonia etc. (2 Sheets) Price 5d.
- Complete Set of all Six Sheets Price 2/3d.



All post free

Also, our latest illustrated catalogue of scientific apparatus and chemicals suitable for all experimenters. Send 2½d. stamp to:

**A.D.P. CHEMICALS & APPARATUS**  
50 (DH) SUFFOLK ROAD, BARKING, ESSEX

## PLYWOOD Bargains

9 Ply Offcuts (12m/m)  
at less than cost Price  
(BIRCH FACED)

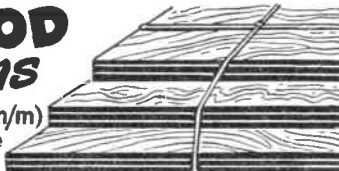

IDEAL FOR MODELLERS, HANDYMAN, HANDICRAFT WORKERS

NO BOARD LESS THAN 17" x 12".  
Make fine pastry or drawing boards.

- 2 boards for 8/6
- 4 boards for 16/-
- 6 boards for 23/6
- 8 boards for 30/-
- 10 boards for 37/6

CARRIAGE AND PACKING FREE  
Send P.O., Cheque, Money Order today.  
2½d. stamp for sample.  
Quotations for larger quantities on request.  
Quick delivery.

**JOHN RYSDALE (Dept. H2), Heathayne, Colyton, Devon**



**FAMOUS  
KITS FOR  
GALLEONS**

Every ship modelling enthusiast will want to make Hobbies latest 7 in. miniature galleon, the 'King's Ship' (illustrated). The kit and building instructions for this cost only 7/6. The 12 in. Bounty (12/-), and 8 in. Bonaventure (6/6) are other popular choices  
Get one of these kits NOW from branches & stockists or post free from:



**HOBBIES LTD, (Dept. 992), DEREHAM, NORFOLK**

# NEW! EXPERIMENTAL KITS

## LEARN THE PRACTICAL WAY

Here is home study of the most effective kind under expert tutors. There is no better way of studying for an examination, starting a new hobby or for a career in industry. These special courses comprise the most modern methods of postal tuition, combined with a Practical Kit of parts (which remains your property).

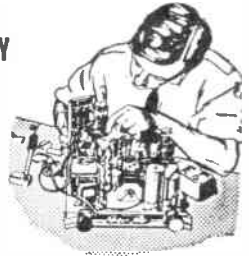

### COURSES FROM 15/- A MONTH

**COURSES WITH PRACTICAL EQUIPMENT INCLUDE: Radio, Television, Mechanics, Electricity, Chemistry, Photography, Carpentry; also Draughtsmanship, Commercial Art, Amateur S.W. Radio, Languages, etc.**

**POST THIS COUPON TODAY**

For FREE brochure write: E.M.I. INSTITUTES,  
Dept. 31X, Grove Park Road, London, W.4.

SUBJECT(S) OF INTEREST \_\_\_\_\_

NAME \_\_\_\_\_

ADDRESS \_\_\_\_\_

16/11/55 \_\_\_\_\_ ICS1A

**E.M.I.  
INSTITUTES**

The only Postal  
College which is  
part of a world-wide  
Industrial Organisation

## SEE US AT THE MODEL RAILWAY HOBBY SHOW

The Railway Modeller, the magazine for the Average Enthusiast, will be exhibiting at the Model Railway Hobby Show at the Central Hall, Westminster. This fine exhibition is fully described in the enlarged October issue, now on sale. Get your copy now!

### THE RAILWAY MODELLER Monthly 1/6

1/8 post paid from

**Dept. H.W., PECOWAY, STATION ROAD, SEATON, DEVON**

## THE 'ROYAL CHARLES'

is the latest design in Hobbies wide range of models of famous old-time galleons. Obtain your design FREE with

### HOBBIES 1956 HANDBOOK

Now on sale (2/-) at newsagents, etc., or 2/3 post free from Hobbies Ltd., Dept. 992, Dereham, Norfolk

# BE TALLER

in 12 days or money back. New gland and spinal discovery increases height 2 to 5 inches. 'I have gained 4½ inches in height. My weight increased from 9-stone 4-lb. to 10-stone 3½-lb.'—P.D. 'Increased 3 inches'—H.G. Guaranteed harmless. Full course 10/- (or \$1.50), Air Mail 16/3. Details 1½d. Sent under plain cover. J. H. MORLEY, 28 (H/148) Dean Rd., London, N.W.2. Practical Courses, all subjects. List free.

# Replies to Readers

## Is this YOUR Problem?

### Portable Blackboard

**CAN** you tell me how to make a portable blackboard; the kind made of calico or something, and treated with blackboard paint so that the whole thing can be easily carried rolled up for use at a party or lecture? (S.M.—Millwall).

**STRETCH** a piece of strong calico on a made-up wood frame and apply a coat of boiled linseed oil. When dry, give a coat or two of Winsor & Newton's black fabric painting colour and try out. If the chalk will not 'bite' on the surface, apply a coat of drop black or lampblack, worked to a paste with the boiled linseed oil, and thinned down with turpentine. Test with this on a spare piece of the treated calico, and add a little patent driers if found necessary. The above is a suggested treatment, which may be effective, and a little experiment may be necessary to get the best results.

### To Darken Light Wood

**PLEASE** tell me how I can darken a light oak wardrobe to mid or golden oak, without 'lifting' the existing high polish. (F.G.H.—Grimsbly).

**YOU** will have to remove the present polish from your wardrobe to enable you to darken the wood. You could remove the polish with a solution of  $\frac{1}{2}$  lb. potash to a gallon of hot water, which would have a darkening effect on the wood, or a proprietary brand of paint remover would do the job. If the former is resorted to, wash over afterwards with brown vinegar to arrest further action. An aniline oak stain would then be applied to darken the wood, or a spirit stain mixed with the polish, when re-polishing the article would serve the same purpose.

### Creaking Boards

**CAN** you tell me how to stop a floor-board creaking when trodden on, and is there any way of stopping a new wooden bedstead creaking? (S.T.C.—Coventry).

**THE** most likely reason for a floor-board creaking is a broken tongue or groove on the edge of the board. A careful examination should reveal this, and if so, the board should be lifted and the broken tongue or groove replaced. Creaking of a wooden bedstead may be caused by the screws holding the mattress frame becoming loose, but the more common cause is poor construction, the ends of the bedstead tending to distortion under the strain of

a person getting in or out of bed. The addition of steel furniture brackets in the lower angles of the bed may cure the trouble.

### A New Handle

**I** HAVE an old bill-hook blade which I wish to sink into another handle. I have the same problem with a knife. In each case I cannot make it so that it stays in firm.

**T**O fix a bill-hook or other blade to a wooden handle, the first thing is to see that the tang is straight and true, also that it tapers nicely and is free from

**The Editor welcomes letters from readers concerning their particular hobbies. Correspondents should, however, confine queries to one subject and to those dealt with in this magazine.**

rust. Next, if the handle already has a hole in it that is larger than the tang, open it out and glue in an accurately fitting plug of tough wood that completely fills the hole. Leave for a day to allow the glue to set properly. Next drill out or form a tapered hole that conforms accurately to the shape of the tang. This is the really important part and some users advocate making the tang red hot at the tip to drive it into

● Continued from page 90

## Models Give Atmosphere

The writer once saw a very realistic model plate-laying scene with ballast scraped away for a short distance and men standing round. It was very effective and gave quite a 'punch' to that part of the line.

Other places where model figures give additional realism is in the cab of a locomotive and on the platform of a guard's van. Even broken solid figures will do, for in both cases only the tops show. The figures should be jammed in position so as not to fall about when the train is in motion.

Sources of figure supply apart from the official sets are discarded toy farmyards and the like. Also moulds can be got for cast figures (often soldiers) and with one of these and some lead piping you can soon turn out goodly crowds. Such casts need colouring, but variety can be introduced by painting on as far as possible different kinds of clothes.

Loads for trucks are much more cheaply obtained, but here an eye must

## WORTH NOTING

### Enamelling Sink

**R**EADERS who wish to enamel an old stone sink should apply a priming coat of white lead paint, with a little red lead mixed in. On this, put three coats of white lead paint, rubbing each coat down when dry. A final coat of bath enamel should make a good finish.

the wood. Whichever way it is done, make sure the tang really fits the slot on all four sides, but leaves lin. or so to drive down, which can be done by sharp heavy blows with a hammer.

### Scratches on Furniture

**O**UR bedroom suite is scratched through being in store. If I bought a bottle of french polish and filled the scratches, would the new polish show? (J.A.C.—York).

**I**F you filled the scratches with french polish and did the job carefully, it might be quite successful, unless the scratches have penetrated through the polish to the wood, leaving white marks. We suggest instead of french polish you use brown hard spirit varnish and put this on either with a small paint brush, or the pointed end of a matchstick. Two or more applications may be necessary to fill up the scratches, then when quite dry, a rub over with furniture polish should make a good finish



**YOU MUST HAVE  
THE**

**Micromodels**

**BOOK**

**MAKING** Authentic Models of Historic Buildings, Locomotives, Ships, Aeroplanes, Trams, Cars, etc. is the Hobby for a Lifetime. Using card, model making is a tidy fireside hobby. This new book

**'MAKING MODELS IN CARD'**

with full-colour cover and 32 pages and 40 illustrations of valuable Hints & Tips and Stimulating Ideas, is being sold at the actual cost of production to tell you how to make Micromodel Museum Pieces at small cost. A Hobby that challenges and rewards your skill.

The Publisher: **MICROMODELS LTD.**  
3 (H) Racquet Ct., Fleet St., London, E.C.4



**2/9**

**HOBBIES BRANCHES**

**LONDON**

- 78a New Oxford Street, W.C.1 (Phone MUSEUM 2975)
- 87 Old Broad Street, E.C.2 (LONDON WALL 4375)
- 81 Streatham Hill, S.W.2 (TULSE HILL 8796)

**GLASGOW**—326 Argyle Street (Phone CENTRAL 5042)

**MANCHESTER**—10 Piccadilly (Phone CENTRAL 1787)

**BIRMINGHAM**—100a Dale End

**SHEFFIELD**—4 St. Paul's Parade (Phone 26071)

**LEEDS**—10 Queen Victoria Street (Phone 28639)

**HULL**—10 Paragon Square (Phone 32959)

**SOUTHAMPTON**—134 High St. (Below Bar)

**BRISTOL**—30 Narrow Wine Street (Phone 23744)

**IT'S A 'DO-IT-YOURSELF'  
ESSENTIAL**

**"SURFORM"**



**MARVELLOUS  
NEW TOOL  
FOR THE  
HANDYMAN!**

**"SURFORM"**

Files, Forms, Spokeshaves and Planes on Wood, Rubber, Leather, Fibre, Plastics and Non-Ferrous metals. Faster than filing—as smooth as planing. The Carbon Steel Blade is a Firth-Brown patent.

**PLANE** 17/6 | Philip Cox & Co.  
Illustrated

Post & Packing 9d. FROM 97-99 PRAED ST.  
**FILE** 12/6 | LONDON, W.2  
P. & P. 9d.

**VIBRO-ARC**

**ELECTRIC METAL  
ENGRAVING TOOL**

Engraves, etches,  
marks, writes . . . on

Brass, Copper,  
Silver, Nickel,  
Aluminium,  
Chromium,  
Hardened  
Steel



**ONLY  
10/-**

**POST FREE**

Complete with instructions for use. Additional 12 engraving points 2/6, post free. Operates from 4 or 6-volt Accumulator or Mains Transformer. Suitable for Name Plates, Dog Collars, Cutlery, Tools, etc.

**TEEBEE MANUFACTURING CO. LTD.**  
Dept. V46, 205 Hook Road,  
Chessington, Surrey.

**A GRAND BOOK FOR ALL THE FAMILY.** The "Kaylee Year Book of Bright Ideas". A really helpful guide to home planning, decoration, Hobbies, toys, etc. Showing famous Kaylee Transfers in brilliant colours, and most effective uses. From "Hobbies" stockists 1/- or direct.

**KAYLEE TRANSFERS** Postage 3d.  
**LTD. (HW), Long Eaton, Nottingham.**

**GOVERNMENT SURPLUS BARGAINS.** Inter-room Telephones, comprising 2 self-energised microphone/receivers and approx. 6yds. flex (may be extended if desired). No Batteries needed. Nothing to wear out. Complete 9 6, post 6d. Motors, Transformers, Switches, etc. 3d. stamps for illustrated list. Milligan's, 24 Harford Street, Liverpool, 3. Money Back Guarantee.

**YOU CAN MAKE XMAS CRACKERS**

We can supply all materials and fillings for this interesting and profitable occupation. Beginners—our special Learner Pack contains enough materials to make two dozen crackers complete with easy step-by-step instructions, only 5/-. Full sample range of fillings 2/- refundable. Lists free.

**GAIETY CARNIVAL NOVELTIES**  
Amen Corner, TOOTING, S.W.17

**ENOUGH  
SAID!**

**WHEN THE B.B.C. AND  
OVER 100 LEADING NEWS-  
PAPERS AND JOURNALS  
GENEROUSLY PRAISE A  
DE-LUXE "OPEN-FLAT"  
ANNUAL—  
IT**

**MUST  
BE GOOD!**

Price 10/- ONLY FROM:

**THE GADGET MAGAZINE,  
SPECIAL BOOK DEPT.,  
26 SWAN HOUSE,  
KINGSBURY,  
LONDON, N.W.9.**

**• A GIFT AT THE PRICE—AND THE RIGHT PRICE FOR A GIFT •**

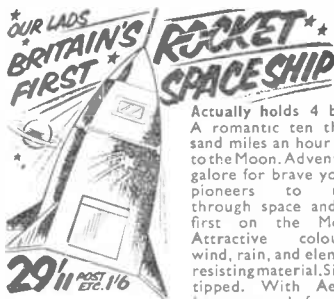

Actually holds 4 boys  
A romantic ten thousand miles an hour trip to the Moon. Adventure galore for brave young pioneers to rush through space and be first on the Moon. Attractive coloured wind, rain, and element resisting material. Silver tipped. With Aerial. Large enough for four boys, the Scientist, Pilot, Radio operator and 1 crew. Stands indoors or out-doors. 29 11, post etc. 1 6.

Radio operator and 1 crew. Stands indoors or out-doors. 29 11, post etc. 1 6.

**THE NEW INTERPLANETARY  
SPACE SUIT**

**Only 12/11 POST 1/6  
ETC.**



Be an Interplanetary Commando Officer. Wear this metallic blue Space Suit and pressure helmet. Be the first Earth Man to Jupiter. Can also be worn over outdoor clothing, guaranteed waterproof. For boys aged 4 to 12. Waisted and adjustable, visor on helmet. Lightning flashes on breast panel. Sate age for size. 12 11 post etc. 1 6. **LISTS, TERMS.**

**HEADQUARTER & GENERAL SUPPLIES LTD.**

Dept. HOBW/78, 196/200, Coldharbour Lane,  
Loughborough Junction, London, S.E.5.  
Open all Saturday 1 p.m. Wednesday.

**STOP SMOKING** in 3 days or money back. Safe, pleasant, permanent. The only scientific way. **No Will Power necessary.** 'Conquered the habit in 2 1/2 days'.—F.C. 'Within 2 days I was free from the tobacco habit'.—W.G. 'Was a smoker for 2 years and broke the habit in 2 days'.—F.N. 'I used to smoke 20 a day . . . now I have no desire to smoke'.—J.M. Recommended by 'Health and Efficiency Magazine'. Complete course 6/6 (or \$1.00 bill). Details 1/4d. stamp. Sent under plain cover. **NATURE REMEDIES**, 28 (H/149) Dean Road, London, N.W.2. Established 1923

**THE BRAND NEW  
DE-LUXE**

**GADGETS** 10/- ONLY  
**• 1956 EDITION NOW READY ANNUAL**

**All New**

**THIS HANDSOME MASSIVE BOOK  
DESCRIBES HOW TO MAKE OVER  
350 OF THE VERY LATEST GADGETS,  
GIFTS, GIMMICKS AND DEVICES FOR  
EVERY PURPOSE. MANY ARE SALE-  
ABLE INVENTIONS OF EXTRAORDIN-  
ARY INGENUITY AND NOVELTY.  
OVER 200 ILLUSTRATIONS.**

**KUKLOS ANNUAL.** Indispensable cyclist's handbook. Tours, resthouses, money-saving hints, 2/10, post free. — Burrow, Publishers, 2 Imperial House, Cheltenham.

**PLYWOOD — HARDBOARD —** at amazing low prices. Send S.A.E. for samples and prices to — N. Gerver, 10 Mare Street, Hackney, London, E.8.

**'PAINTSPRAYING' HANDBOOK** (1954 Ed.). Covers Car, Industrial & Flock Spraying. 3/6, post free, including catalogue of our Cellulose and Synthetic Paints and all Allied Sundries and Plant Hire. — Leonard Brooks Ltd., 81 Oak Road, Harold Wood, Essex.

**STAMPS FREE** — Empire Packet including Pictorials and Victorians with approvals. — Robert J. Peck, 7A Kemp Road, Bournemouth.

**SWISS MUSICAL** Mechanism for cigarette Sboxes, etc., 16/6 post free. S.A.E. for illustration and list of tunes available. — Dept. HW., Metwood Accessories, Church St., Wolverton, Bucks. (Trade supplied.)

**BUILD** your own T/V and learn about its operation, maintenance and servicing. Qualified engineer-tutor available whilst you are learning and building. Free Brochure from — E.M.I. Institutes, Dept. HW.58, London, W.4. (Associated with H.M.V.)

**GENUINE** Swiss Musical Movements. Owing to large purchase now reduced to 14/6 each. Genuine Thorens Movements; all guaranteed. 19/3 each. P. & P. 9d. extra on all orders. — Richardson & Forder, 5 Chapel Place, White Hart Lane, London, N.17.

**PLYWOOD;** large sizes, 14 lbs. 10/- delivered (Express) C.W.O. — H. Leader (1920), Gosford St., Middlesbrough.

**CHRISTMAS DECORATIONS, ETC.** Everlasting Flowers/Grasses/Ferns/Foliage/Artificial 3/- per bunch. Post 6d. Assd. Colours and types. The five kinds 14/6 c.p. Tinsel ribbon, Glitter Gilt, Silver Foils, etc. **WREATH OR BOUQUET-MAKING OUTFITS**, Instructions and designs 20/- each. Combined 30/- c.p. Instructions and designs 2/6. Book 'Making Floristry Your Business' 6/6. Stamp, list all materials. — Station Nurseries (H), Oakengates, Salop.

**PYGMY TREE-GROWING OUTFIT** 17/6, c.p. 6 Trees, 6 Cuttings, 6 Pkts. Seeds, 18 Growing Pots, Compost, Cuttings powder. Instructions. **MINIATURE-GARDEN OUTFIT**, 20/- c.p. 5 Growing Trees, Container 10" x 8" and Tray, Sunk Flower Centre, Pool, Fish, House, Rocks, Compost, Instructions. **BOOK 'Jap Minigardens and Pygmy Trees'**. 2/10 c.p. Instruction Leaflets 9d. Stamp. List all materials. — Station Nurseries (H), Oakengates, Salop.

**BEAUTIFUL** free gift. Sp. Colonies 1954 Fishes set for approval applicants enclosing postage. — Yulwontmor Stamps (Dept. H5), 29 Layton Avenue, Mansfield.

**50 STAMPS** free to all approval applicants enclosing 2½d. stamp. — Cliff West (M3), 61 Wynyard Road, Sheffield, 6.

**FREE**—50 different stamps plus 10 San Marino mint, on requesting approvals. — P. E. Bentham, 40 Little Glen Road, Nr. Leicester.

**PHILATELISTS** tie pin gratis approvals. S.A.E. — Neave, 5 Surrendale Place, Paddington, W.9.

**FREE** stamp on application of discount approvals. — P. Mills, 59 Cudworth Road, S. Willesborough, Ashford, Kent.

**TREMENDOUS** offer! Mystery free gift with approvals. — G. J. Pollard, 5 Lawrence Gardens, London, N.W.7.

**MATCHBOX** size crystal sets. All parts crystals, instructions, complete, 3/6 post free. — Baileys, 44 Stanley St., Oldham.

**STAMPS FREE!!** Twenty unused (2½d.). — G. H. Barnett, Limington, Somerset.

**CHINA** repairing. This fascinating and profitable hobby can be learnt successfully and inexpensively at home. Particulars from — The Chelsea Studio, 10 Blacklands Terrace, S.W.3.

**100 DIFFERENT** stamps free! Request ¼d. upwards discount approvals. — Bush, 53 Newlyn Way, Parkstone, Dorset.

**9.5 M.M.** hire service. List 3d. — Wayland, 219 Longley Rd., Tooting, London.



## with **BRICKPLAYER**

- |   |          |
|---|----------|
| Brickplayer Kit 3                                     | 25s. 6d. |
| Brickplayer Kit 4                                     | 47s. 6d. |
| Kit 3A converting Kit 3 into Kit 4                    | 25s. 6d. |
| Brickplayer Farm Kit                                  | 56s. 6d. |
| 2000 Bricks Box                                       | 53s. 6d. |
| Extra Bricks, Roofing and Cement in low-priced packs. |          |
| Windows and Doors obtainable singly.                  |          |

### **BRICK AND MORTAR BUILDING KIT AND ACCESSORIES**

The Brickplayer Kit contains miniature bricks in all required shapes, mortar, roofing, plastic windows and doors, plans and instruction booklet. All models are architect designed to 'O' gauge scale.

Buildings can be permanent or dismantled by merely soaking in water and the bricks used again and again. If your dealer cannot supply, write for leaflet and address of nearest stockist to :

**J. W. SPEAR & SONS LIMITED**

Dept. 'HW', Enfield, Middlesex



## **YOUR IDEAL XMAS GIFT**

See page 88

# CUTLERY BOX PATTERNS



A  
FRETSAW  
WILL  
CUT THE  
PARTITIONS

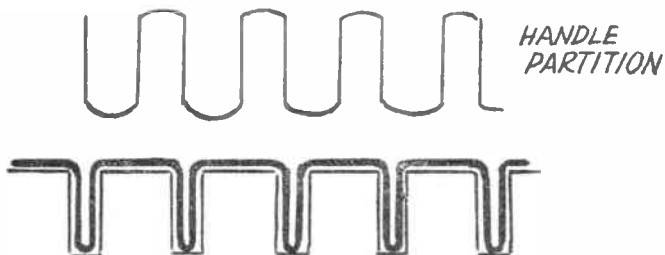
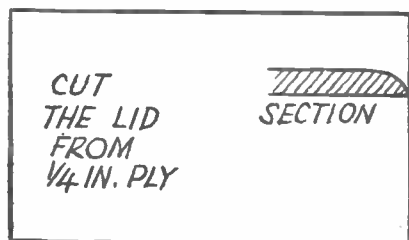
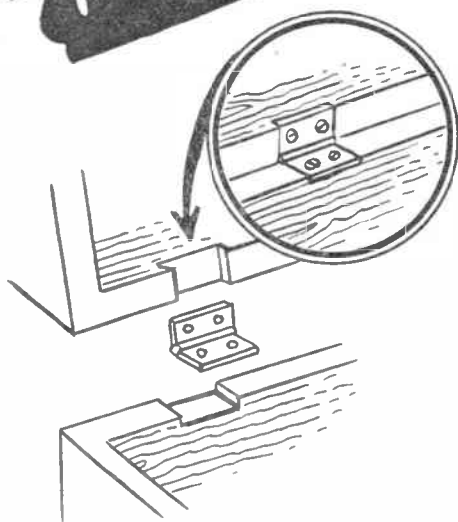
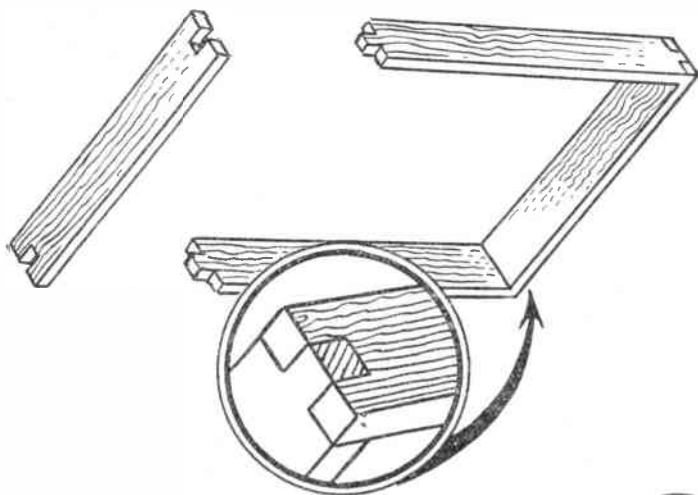



Why should  
boys have  
all the  
fun?

Girls, too, can spend many happy hours building real-life models with LOTT'S BRICKS. They'll love helping their brothers make houses, shops, farms and even whole villages! LOTT'S BRICKS are a perfect companion to a model railway, too. There are sets to suit all ages from 6/11 to 57/6 per box. Don't forget, it's LOTT'S this Christmas, for boys and girls.

also LOTT'S  
**CHEMISTRY SETS**

for youngsters of scientific bent, complete with real chemicals, apparatus and instruction book. Prices from 12/3 per box.

Stocked by all branches of **HOBBIES LTD.** and Toy Shops everywhere. Ask for illustrated list.

The sparkling enamel  
**PAINT IN TUBES!**

Handy, Economical

STARLON in handy, economical tubes is just right for all small or multi-coloured painting jobs, cycles, prams, etc.

- No wasteful 'left-overs'
- Easy to apply
- Quick drying
- No brush marks
- Brilliant lasting finish



1/-  
IN 14  
LOVELY  
COLOURS

Trade Enquiries  
welcomed by  
the makers

See STARLINE paints  
on INDEPENDENT  
TELEVISION  
'DO-IT-YOURSELF'  
programmes  
London, Sats. 5.15 pm.  
presented by  
W. P. Matthew

**Starlon**

PLASTIC ENAMEL PAINT

Obtainable at Handicraft shops everywhere

STARLINE, SOUTHEND-ON-SEA, ESSEX

**YOURS** for only  
**15/-**  
down!



Save time and work on sewing jobs with this excellent 'Essex' Miniature Sewing Machine. Beautifully finished with chromium plate. Supplied with clamp for fixing firmly to table. 6 months' guarantee. Cash price £4.14.9 or 15/- deposit and 6 monthly payments of 16/-. Electric model available A.C./D.C. with foot control £9.17.6, or 31/- down and 6 monthly payments of 31/-. Protective carrying case 17/6 extra. Send for leaflet today.

**ELECTRIC PAINT  
SPRAYER**



For **4/-**  
deposit

Cash 75/-. Or 4/- deposit and 6 monthly payments of 13/6

Paint easily, evenly, twice as fast: with the Burgess Electric Sprayer. Sprays paint, varnish, etc. Complete with sturdy glass container, flex, nozzles for ceiling spraying and extra nozzle discs for different liquids. A.C. mains - state your actual voltage. Fully guaranteed. Also Horvell Electric Paint Scrubber 30/- cash, or 4/- deposit and 3 monthly payments of 10/-. Leaflets free

**BARGAIN DISTRIBUTORS**  
(Dept. 124), 5 Silver Street, Luton

**PHILISHAVE**  
14 DAYS'  
FREE TRIAL



Try the wonderful Philishave Electric Dry Shaver. FREE for 14 days. Send only 5/- deposit (returnable if not satisfied). Two shaving heads with two 6-bladed cutters have unique rotary action which genuinely shaves - doesn't just snip at the hairs. Result - better, quicker shave. Operates 110-250 volts. A.C. D.C. £7.9.3 cash less your deposit. Or 5/- deposit can be first payment, followed by 8 monthly payments of £1. 12 months' guarantee. Brochure of this & other shavers free.

**Wolf Cub**

ELECTRIC DRILL AT

**REDUCED  
PRICE  
£5.9.6.**

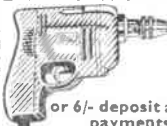

or 6/- deposit and 6 monthly payments of 19/6d.

This wonderful Electric Drill is also the power unit for ALL Cub equipment. Drilling capacity: Mild Steel, 1/4"; Hard Wood, 3/8"; with 210 watts input on full load. Complete with 1/2" three-jaw chuck and Allen key and Sft. of cable. TV Suppressed. State Voltage. ALSO Sanding & Polishing Kit (drill, discs, etc.). Cash Price: £6. 10. 6 or 19/- deposit and 3 monthly payments of 21/-

Send for Illustrated Brochure of Wolf Cub equipment.

**Croid**

The finest glues for every  
handicraft

Whatever your handicraft or hobby, use the Croid Glue recommended for it, and you will obtain completely satisfactory results. Croid—the strongest glue in the world—is obtainable everywhere.

**UNIVERSAL GLUE**

a general purpose cold liquid glue. Handy size tube 1/-, 8oz. tin 2/6. Specially recommended for sticking laminated plastics.

**FABREX**

a new latex based adhesive for quick sticking on fabric, carpets and porous materials. In 4 oz. and 8 oz. Polythene bottles 3/6d. and 6/-.

Obtainable at all Hobbies Branches.

**Croid** GLUES OF QUALITY  
THE BEST NAME IN ADHESIVES

CROID LIMITED, Imperial House, KINGSWAY LONDON, W.C.2

# HOBBIES WEEKLY

IN THIS ISSUE

	Page
A Clock for Mantelpiece or Bedroom	97
The Care of Boots and Shoes	98
A Tea Towel Rack	99
Burglar Precautions	99
Four-Valve Superhet	100
An Ornamental Duck	101
Try Colour Films	102
Cigarettes of Enchantment	103
A Marquetry Picture	104
Some Special Reagents	106
Replies of Interest	108
A Carpenter's Stool	111



NOVEMBER 23rd 1955

VOL. 121

NUMBER 3134

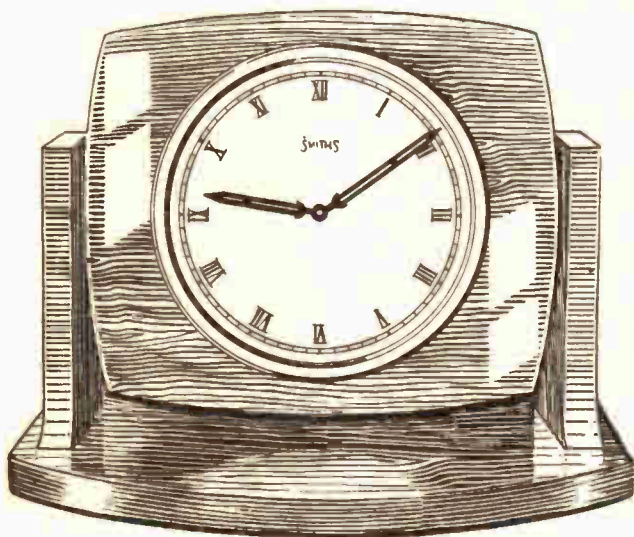

## A CLOCK FOR MANTELPIECE OR BEDROOM

Complete  
with  
alarm

*Make it for your  
home from the  
FREE Design  
inside*

**T**HE mantel or bedroom clock described here can easily be made up by the average handyman. It would suit admirably either for use in the bedroom or in a living room where a modern stove can only accommodate the smaller type of timepiece.

All the parts for the clockcase are cut from the same thickness of wood ( $\frac{1}{4}$  in.). The movement to fit into the case is made by a famous English manufacturer and is a reliable 30-hour movement, complete with alarm. A 12-month guarantee covers all defects in material and manufacture. It has a

polished brass bezel with convex glass, and the figuring is very clear and distinctive.

Trace all the parts of the clock from the design sheet on to the wood and cut out with a fretsaw. Note that for economy in the use of wood piece (A) and the two pieces (B) are cut together, the curve of piece (A) coinciding with the curves of pieces (B).

Piece (C) forms the front of the clock. Pieces (D) which form the barrel to contain the movement are glued together, and it will be found that this double thickness is slightly larger than required. The extra can be taken off with a file or glasspaper. Incidentally, the groove in pieces (D) is to allow for the movement of the alarm pin. Pieces (D) are now glued to the back of piece (C).

The two uprights (B) are glued to the base and screwed from underneath, using countersunk screws. Their positions are shown on the design sheet. A chromium plated screw through each side (B) into the front (C) holds the

● Continued on page 98

All correspondence should be addressed to The Editor, Hobbies Weekly, Dereham, Norfolk

*For Modellers, Fretworkers  
and Home Craftsmen*

World Radio History



PAGE 97

## Winter precautions

# The Care of Boots and Shoes

**B**OOTs and shoes could often have a prolonged life if their owner treated them well and took care of them. Old shoes can even be resurrected and new ones can be made smarter, pleasanter to wear, and better able to keep ones feet dry.

Castor oil is an excellent dressing for leather, besides rendering it vermin proof. It should be mixed in the proportion of half and half, with tallow and other oil. No rats, cockroaches or other vermin will attack leather which is treated with this preparation.

An old upper properly treated can be made to shine, however rusty looking it may appear. For ladies' shoes of black morocco or kid, which may have become stiff, dry and dull, use a little oil. This will make them more soft and flexible. Providing only a *little* oil is used, the lustre will not be materially injured. A delicate coating of prepared varnish designed for the purpose should be placed over the oil, and when this has dried the shoes will be improved.

Sometimes a calf kid will begin to appear rusty and reddish, in which case a slight application of oil may probably restore the colour. If not, put on blacking and brush it off when dry, going over it again very lightly with the oil. In this way a new appearance will be achieved.

To oil patent leather will not only improve the lustre but will also make the leather softer.

The same treatment can be used for any kind of grain leather that has become brown, and also for pebbled calf. When it is only slightly red, an application of oil, or even tallow, will often restore the colour. When it is very brown, black it thoroughly; then oil it afterwards and finally give it a dressing of dissolved gum tragacanth.

This is a splendid method for improving the uppers, involving little labour and giving a most satisfactory result.

### Removing Mould

When mould appears on boots or shoes which have, perhaps, been stored away for a time, a little rubbing with benzine will be necessary at first to clean them. An application of cod oil and tallow would prove useful to make the leather soft and pliable. If the colour has deteriorated, however, this should be preceded by the application of a prepared black leather stain.

To preserve from penetration by damp, rub footwear over with linseed oil which has been allowed to thicken in a leaden vessel for a few months. To

secure against snow water, melt equal quantities of beeswax and mutton suet in a pipkin over a slow fire, and, whilst hot, lay the mixture on the boots or shoes. Rub them dry with a woollen cloth.

### Recipe for Blacking

For the average householder the tin of blacking obtained from the local shop is more quickly obtained with less labour than the home-made blacking, but for those who wish to attempt making their own, here is a recipe which is said to have proved the source of a fortune to its discoverer.

☆☆☆☆☆☆☆☆☆☆☆☆☆☆☆☆☆☆☆☆☆☆☆☆☆☆☆☆☆☆  
☆☆☆☆☆☆☆☆☆☆☆☆☆☆☆☆☆☆☆☆☆☆☆☆☆☆☆☆☆☆  
☆☆ Footwear is an expensive item of the family budget and readers will welcome these tips on the preservation of the leather given by  
☆☆ *E. M. Blackman* ☆☆☆☆☆☆☆☆☆☆☆☆☆☆☆☆☆☆☆☆☆☆☆☆☆☆☆☆☆

Take one part of the juice which comes from the shrub called 'goats' thorn', during June, July or August; four parts of river water; two parts of neat's foot, or some other lubricating or softening oil; two parts of a deep blue dye prepared from iron and copper; and four parts of brown sugar candy. Evaporate the water until the composition becomes a proper consistence, form into cakes of such a size as to produce, when dissolved, a pint of liquid blacking.

● Continued from page 97

## Mantel or Bedroom Clock

clock in position, and enables it to be swivelled to the desired angle.

A natural finish completed by wax polishing would set off the timepiece admirably if required for the living room. Use plain white furniture polish, rubbed well in with the fingers. Polish with a duster and then glasspaper lightly. Repeat this process until the grain is filled, and then finally finish off with a brisk polish with the duster.

An alternative finish would be staining and polishing, especially if required to match existing furniture in the room. If required for bedroom use, the clock would look well finished in a pastel shade of paint. Fill the grain with a proprietary brand of woodfiller, give an undercoat and then finally finish

Another recipe, containing more easily obtainable ingredients is as follows:—3ozs. burnt ivory; 1oz. candied sugar; 1oz. oil of vitriol; 1oz. spirits of salt; 1 lemon; 1 tablespoonful of sweet oil; 12ozs. vinegar.

Mix the ivory first with the sweet oil; then the lemon, sugar, a little vinegar, and the spirit (which should be previously mixed with the vitriol); then add the remainder of the vinegar.

### Softening Boot Uppers

To soften the uppers of boots, wash them quite clean from the old blacking and any dirt with lukewarm water. Immediately the water has soaked in, apply a good coating of currier's dubbin, and hang them up to dry. The dubbin will amalgamate with the leather, thus keeping them soft and resistant to moisture. They should not be held to the fire, and this especially applies when oil or grease has been applied to them. In fact, all artificial heat is injurious to boots and shoes, for it forces the fatty substance through and produces hardness.

### Waterproofing

To make boots or shoes waterproof great care should be used, particularly in making the preparation, as all the ingredients are inflammable. Half a pound of shoemaker's dubbin, half a pint of linseed oil, and half a pint of solution of india-rubber. This should be dissolved with a gentle heat and the mixture applied evenly.

Take care of your boots and shoes and they will take care of your feet!

**OBTAIN A KIT**  
Kit No. 3134, obtainable from Hobbies branches and post free from Hobbies Ltd., Dereham, Norfolk, contains wood necessary for making the clock case and the movement and screws. The complete kit cost 37/5.

with enamel.

If thought necessary, the underside of the base can be sprayed with velvet spray, or a piece of baize can be glued on.

Two hours — two shillings . . .

# A TEA TOWEL RACK

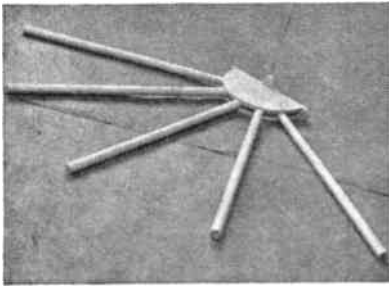

**T**EA towels get wet all too quickly, and it isn't always easy to dry them thoroughly before re-use. Here is a simple rack design you can make in a couple of hours at a cost of about two shillings. Several towels can be hung or draped over it, and, if you fasten it to the wall above the cooker, the heat from this will help speedy drying.

Start by cutting two semi-circles of  $\frac{1}{2}$  in. ply each with a radius of  $2\frac{1}{2}$  ins. You may find it easier to cut a circle 5 ins. diameter with a fretsaw, and then

halve it. Trim the edges smooth, and glue the pieces to a backplate, leaving a  $\frac{1}{4}$  in. gap between them. The shape and dimensions of this backpiece are obtained from Fig. 1. When it has been cut out and glasspapered, drill the three  $\frac{1}{8}$  in. diameter holes as indicated. These are to take the fixing screws.

*By G. Allen*

When gluing the semi-circles in place make sure they are at right angles to the backpiece. A piece of  $\frac{1}{4}$  in. ply temporarily sandwiched between them will ensure the correct gap. Drive a row of panel pins through the backplate into each semi-circle.

Next cut five lengths of  $\frac{1}{4}$  in. diameter wooden dowelling, each  $13\frac{1}{2}$  ins. long. Using a coping saw cut down one end of each to give a 'flat' surface  $\frac{1}{4}$  in. thick and  $1\frac{1}{2}$  ins. long (Fig. 2). These flat ends are sandwiched between the semi-circular plates at 30 degree intervals, to dispose them fanwise (Fig. 3).

Mark these positions on the top face of one of the semi-circles with fine pencil lines running from the edge to the centre. Note that the rim will have to be divided into six equal divisions. These lines act as guides when the rods are glued in place. By viewing each rod

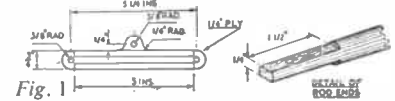

Fig. 1

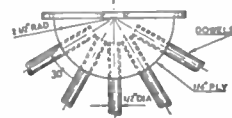

Fig. 2

Fig. 3

from its extreme end, when in position, it is an easy matter to align it with the appropriate pencil line.

Finish the rack with colourful enamels. All the materials you require are: one piece  $\frac{1}{2}$  in. ply 8 ins. by 8 ins., a 6 ft. length of  $\frac{1}{4}$  in. dowelling, panel pins, glue, screws and enamel.

## Burglar Precautions

**T**HE 'small-time' thief who works on the terrace and avenue type of residence can quite well be put off by a sash window that stubbornly refuses to come up, or a lock that suddenly seems to have turned into a solid mass, and the home handyman can do much in this direction.

First take the back door. It is best when possible to leave the key in the lock on the inside and give it a half-turn. Then run a piece of stiff wire through the loop at the end and take this to some fastening. A staple screwed in the door with the wire bent as in Fig. 1 will do. Or if there is a knob handy, the wire can be looped round this as at Fig. 2. With this set-up the key cannot be turned by pliers, nor can it be pushed out, as the projections at the end are lying (by the half-turn) inside the body of the lock. This arrangement is very effective and takes only a few minutes to rig up.

Door bolts should be shot well home top and bottom, the turned-up end in each case then being held by a short big-headed screw, with the head just catching over the short turned-up arm. The bolt cannot then be worked back.

In the sash variety of window an excellent burglar precaution is to drill a fine hole through the two frames where they overlap at the middle. Into this insert a long thin screw, the head being

countersunk. This hidden lock does not take long to make and the screw is easily taken out again when you return home. A thin nail would do, but there is always the chance of it being shaken out, either by design or through the window

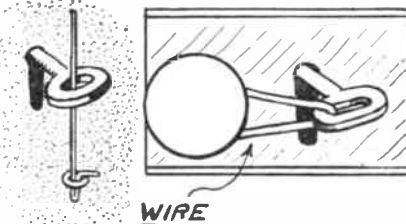

vibrating in the wind. This method of locking a sash window is really good for the odds are against an intending intruder finding out what is causing the stoppage, even after he has eased back the catch, or broken a pane.

Windows that swing outwards on hinges are not so easy to fix, but a screw through one of the holes of the adjuster bar prevents any attempt to open it with a knife or wire from the outside, or from any vent window that is set just above.

Some houses have pantry windows on the ground level. These are very inviting to the burglar who does not intend to

take much trouble. The most effective solution is to screw an iron bar across on the inside. Some ground-level windows have bars as a constructional fitting. If the bar or bars are bent at the ends, and then set with cement in between brick courses a much stronger precaution is the result.

While checking the locks examine the hinges and latches. Hinges often become loose without being noticed, and it is no good making locks doubly firm if the hinges give way to slight pressure.

(H.A.R.)

### The New Surform

With 500 razor-sharp cutting teeth, the Surform files, forms, spokeshaves and planes on wood, plastics, rubber, leather, hardboard and even soft metals. It is available in 'plane' and file types.



# FOUR-VALVE SUPERHET

IF you have built a straight T.R.F. radio set, or even if you have not, there is no reason why you should not build a superhet. On the grounds of selectivity alone, it is well worth the small extra trouble.

The main practical difficulty is that of aligning the receiver, especially the I.F. transformers. But if you cannot make, buy or borrow a signal generator for this process, one can still overcome the impasse. The local wireless shop or service man will align your set for you for a very small fee, perhaps, even for nothing. On the other hand I.F. transformers can be bought ready aligned for only a shilling extra. This solves the difficulty from the start, and if you can

For battery operation, and using Button-Base Valves.

★  
Described by  
A. Fraser

COMPONENTS LIST

- L1. 'Wearite' coil PA2.
- L2. 'Wearite' coil PA3.
- L3. 'Wearite' coil PO2.
- L4. 'Wearite' coil PO3.
- C1, C2, C3, C4. 75 pfd. trimmers.
- C5. 550 pfd. paddler.
- C6. .005 mfd. mica.
- C7, C8. .0005 mfd. two-gang condenser.
- C9, C10, C11. .1 mfd. (non-inductive).
- C12, C13, C14. .0001 mica.
- C15, C16. .01 (non-inductive).
- C17. 4 mids. (200 volts working).
- C18. .25 mfd. (non-inductive).
- R1. 27K ohms.  $\frac{1}{2}$  watt, or  $\frac{1}{4}$  watt.
- R2. 100K ohms.  $\frac{1}{2}$  watt, or  $\frac{1}{4}$  watt.
- R3. 68K ohms.  $\frac{1}{2}$  watt, or  $\frac{1}{4}$  watt.
- R4. 47K ohms.  $\frac{1}{2}$  watt, or  $\frac{1}{4}$  watt.
- R5. 1 meg. volume control, with D.P.S.T.
- R6. 1 meg.  $\frac{1}{2}$  watt, or  $\frac{1}{4}$  watt.
- R7. 3.3 meg.  $\frac{1}{2}$  watt, or  $\frac{1}{4}$  watt.
- R8. 10 meg.  $\frac{1}{2}$  watt, or  $\frac{1}{4}$  watt.
- R9. 2.2 meg.  $\frac{1}{2}$  watt, or  $\frac{1}{4}$  watt.
- R10. 560 ohms.  $\frac{1}{2}$  watt, or  $\frac{1}{4}$  watt.
- R11. 18K ohms.  $\frac{1}{2}$  watt, or  $\frac{1}{4}$  watt.
- I.F.T. 1, 2. 465 kcs. transformers.
- S. 4 pole, 3-way switch.
- V1. IR5, with valveholder.
- V2. IT4, with valveholder.
- V3. IS5, with valveholder.
- V4. 3S4, with valveholder.
- 90 volts H.T. battery. 1.5 v. cell.
- Loudspeaker (3 $\frac{1}{2}$  ins.), with transformer to match 3S4.

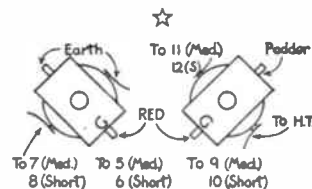

Fig. 4—Wearite coil connections, aerial and oscillator

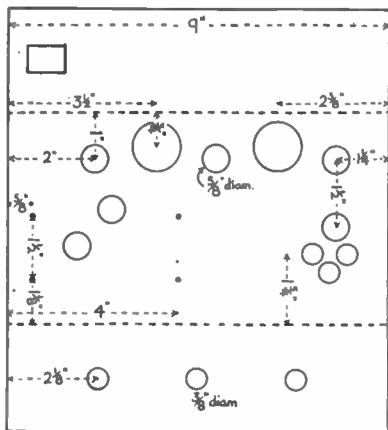

Fig. 1—Chassis cut-out

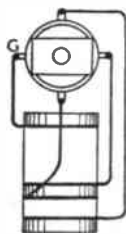

Fig. 5—Connections of home made coil

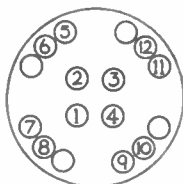

Fig. 6—Switch connections

afford a pair of such transformers, it is advisable to do so.

The transformers used in the present design, however, were unused surplus types. These were chosen merely for economy and cost only seven shillings a pair. The valves used are the popular button-base type, which are also fairly cheap.

To reduce complexity, only two wavebands have been covered (medium

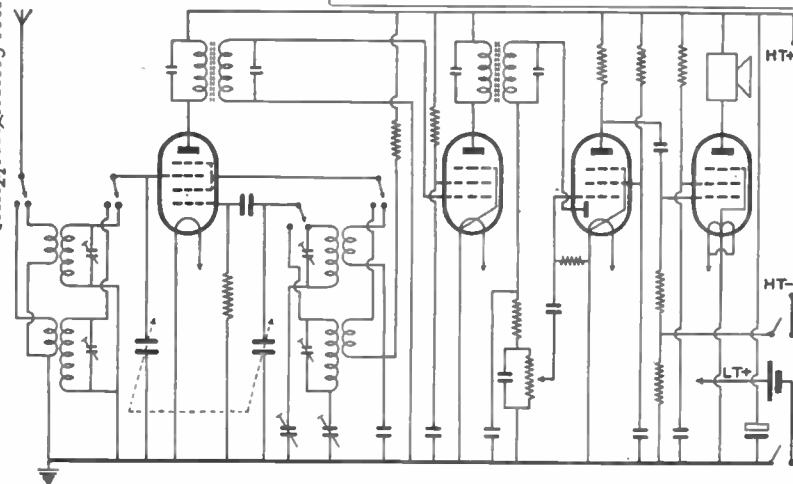

Fig. 3—Theoretical diagram

and short). These can be reduced to one band, or increased to three, as the constructor wishes. 'Wearite' coils are specified, but even this expense can be avoided by making one's own coils. Details are given later.

A special effort has been made to simplify the process of construction, both by drawings and by step by step instruction. If these are followed, there should be no difficulty in building the set, even for the youngest reader.

Although a twin-gang condenser is used (thus simplifying the tuning

process), two separate single ones can be used. In this case, the trimming and padding condensers are unnecessary. This effects further economy, and obviates 'tracking' or alignment difficulties. The newcomer to radio is advised to adopt this separate oscillator tuning method.

A metal chassis for the set could be bought, but it is much cheaper to make one's own, only about one and sixpence. Sheet aluminium, 18 to 22 gauge, is suitable. The various positions should

● Continued on page 101



# AN ORNAMENTAL DUCK



**A** CARVING like the one shown here will greatly enhance the appearance of the mantelpiece as well as the reputation of its owner. Most handymen will find that they have the tools which are necessary for the preliminary roughing out. These are—a vice, bow-saw, chisel, and scribing gouge. A penknife and glasspaper are used for finishing off.

Any close-grained hardwood is suitable for the carving. Makore or Rauli are pleasant to work with, and have an attractive reddish-brown colour. Sycamore is white, and has a similar texture to the first two woods, and Beech, though a little tougher to work, finishes very well.

The piece of wood should be 4ins. long, 2½ins. wide, and 1½ins. thick. The grain should run in the direction shown by the arrow in the drawing (Fig. 1). Plane one side smooth, and one edge flat and square with the first side. Transfer the side view of the duck (Fig. 1) on to a piece of paper divided into ¼in. squares, and glue the drawing to the wood. The bottom of the drawing should be level with the lower edge of the wood.

## Care in Sawing

When the glue is dry, cut round the outline with the bow-saw, keeping on the waste side of the line. It is most important that the saw should be kept absolutely square with the wood when sawing. If this is found to be difficult, a second person can help by standing at the end of the bench and indicating when the saw deviates from the horizontal, while you concentrate on keeping the blade at right-angles to the front of the bench. With a little practice, however, the sawing gives no difficulty. The angle behind the neck is too acute for the saw to be turned, so it should be sawn into from both directions.

Trim down to the line by using the

chisel vertically while the wood rests on a piece of wastewood. The gouge is used to reach the concave parts. The chisel and gouge must be kept perfectly vertical during this operation.

Next, the outline (i.e., the thick lines in the drawing Fig. 2) of the top view must be drawn carefully on to the top of the wood. The head will be shaped later. Saw round this outline in the same way, as before and finish off by chiselling vertically downwards.

*Described  
by  
Kenneth  
Blackburn*



Fig. 3

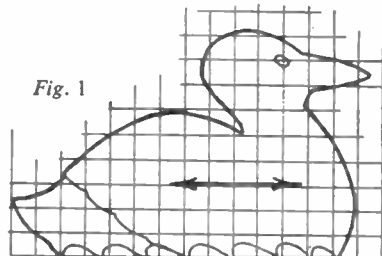

Fig. 1

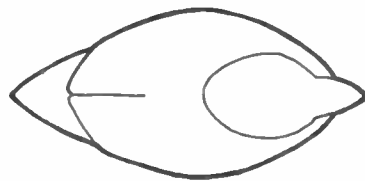

Fig. 2

The rest of the shaping is done with a penknife. It takes a good deal of practice to find, by examining the grain, which way to cut, but if a trial cut is made at each point, you will be able to decide which cut gives the smoothest result.

The head, neck, and beak are whittled down to the correct proportions first. Then round off all sharp corners, and cut away the body a little behind the wings so that they stand out in relief. A few cuts can be made on the rear edge of the wings to indicate the feathers. The point at which the wings join down the middle of the back is shown by cutting a

A pleasant and durable finish can be obtained by applying several coats of French polish, rubbing down lightly with fine glasspaper between each coat.

● Continued from page 100

## Four-Valve Superhet

be marked out, and cut with a drill and fretsaw. Then the sheet is bent at right-angles along the dotted lines. Clamp it between wooden boards for bending.

The valvholders are first fixed to the chassis. Be careful to place these correctly, with particular reference to the position of the marking spot between the heater tags. Bore the fixing holes for the holders after trying in the cut-outs.

Next, attach the switch and volume control, then the I.F. transformers. (The variable condenser can be left until later.) Finally, fix the coils to the chassis. Note that the aerial coils occupy the left-hand side of the chassis, as viewed in the wiring drawing (Fig. 2), while the oscillator coils are placed towards the centre of the chassis.

Notice, also, the placing of the coils as

shown by the position of the top of the grid winding (indicated here by a letter G). With 'Wearite' coils this tag is marked red.

If a twin-gang condenser is used, trimmers will be needed on all coils—60 pfd. for all, except the medium wave oscillator, which needs 75 pfd. These should be mounted on the grid tag and its opposite, by bending the tags and soldering. (That is, in the case of Wearite coils.) These trimmers will be unnecessary if separate tuning condensers are used.

The key to the coil tag connections is shown in the drawings. They are numbered to facilitate the wiring instructions.

'STEP-BY-STEP' WIRING INSTRUCTIONS FOR THE FOUR-VALVE SUPERHET WILL BE GIVEN NEXT WEEK. MAKE SURE OF YOUR COPY.

# TRY COLOUR FILMS

Says F. G. Rayer

COLOUR photography has gained universal attention during the last few years, encouraged by considerable progress in the manufacture of films. A few colour shots will increase the interest of a collection considerably, and many subjects are transformed by being shown in their natural hues, instead of black and white.

A variety of materials exists, some of which may be processed at home. It is proposed to set out details of these, and the best way of obtaining good results, so that the amateur photographer can judge for himself. Colour photography is more exacting than black and white, and also more expensive, though cheaper films are beginning to appear.

## Transparency or Print?

Colour films are broadly divided into two groups. One gives coloured transparencies which may be viewed direct, by holding them to the light, by showing them in an illuminated viewer, or by projection on to a screen by means of a slide or film projector. This type of film is the cheaper, but some form of viewer or projector is necessary to show the pictures. Cheapest of all is the 35 mm. film of this kind. Used with a 35 mm. projector, excellent pictures, of large size, can be shown on a screen.

The second type of film provides negatives, which are made into colour prints by contact-printing or enlargement, as with black and white negatives. The film itself is not suitable for projection, because the colours are reversed and very weak in appearance. In these negatives, green fields appear as a bilious red, blue skies appear sickly yellow, and the whole thing seems so poor in colour that the photographer may be tempted to throw the film away. However, splendid prints can be obtained.

The prints or enlargements will be more expensive, but they can be inserted in an album with other pictures, and no expensive projector is necessary. A number of copies of one picture can also be obtained for friends.

## Exposure

When the type of film to be used has been chosen, some means of securing correct exposure must be decided upon. With black and white films there is considerable latitude of exposure, but this is not so with colour films. Some means of calculating the correct exposure is essential.

An exposure meter, properly used in accordance with instructions, is the most reliable method to employ. An

alternative is to follow the exposure tables which the film makers issue, and which will list exposures for various subjects and lighting conditions. Exposures will be long, compared with those for fast black and white film, so still subjects give the best results.

Very simple box and folding cameras, with small lenses of *f*11 or *f*16 are not suitable for colour film. With such lenses it is difficult to obtain sufficient exposure, while the outlines of objects may be broken up into rainbows from lack of any colour-correction in the lenses. All the better class cameras with *f*6.3, *f*4.5, or larger lenses, will be suitable, however.

## Choice of Subject

As the colour shots will be relatively expensive, every effort should be made to assure each is completely successful. All 'special' lighting effects, such as back-lighting or strong side-lighting, should be avoided, as the result is likely to be extremely disappointing. So, too, should strong, direct sunshine. With it, parts of the subjects may be clear, while those parts which were in shadow (such as chin, eyes, forehead, etc.) are rendered only as patches of dark blue-black, devoid of detail.

The best lighting, therefore, is really strong daylight, or sunlight of a diffused or indirect nature. If the sun is slightly obscured by thin cloud, etc., this will do excellently. Direct sunshine of the kind which casts needle-sharp shadows should only be used if there are large white clouds, white buildings, or other reflective surfaces which throw some light into the shadows.

Most colour films are intended for artificial light only, or for daylight only. If one type is to be used in lighting conditions proper to the other, a suitably tinted filter, as recommended by the maker, should be placed over the camera lens.

Almost all ordinary subjects will yield sufficient colour, but drab scenes are best avoided, as are distant views which contain many tiny patches of different colour. Instead, close-up and middle-distant subjects, such as groups, are most successful, and it is often possible to choose colourful surroundings or dress for the purpose. Children with flowers, coloured toys, animals, or anything with fairly large expanses of colour will do well.

The same care should be taken with correct focus and composition of the

picture in the viewfinder as with any ordinary black and white shot. If the shots are to be projected or contact printed, then crookedness, unwanted objects round the edges of the picture, and similar defects must be avoided. But any photographer who has had a little experience with ordinary black and white films should anticipate good colour results at once, with reasonable care.

## Films to Use

Agfacolor Reversal and Dufaycolor are, perhaps, the best-known transparency films, at present. The Reversal is not intended for colour prints on paper, but the purchase price of the film includes the processing charge, the work being done by the makers themselves. The Dufaycolor film does *not* include processing, which may be done at home, or for an additional charge.

Ektachrome and Ferraniacolor Reversal may be processed at home, processing kits being readily available for the latter. The makers do not process Ektachrome. Other makes are Gevacolor Reversal, Ilford Colour Film, and Kodachrome, all of which are now well established. If necessary, colour prints may be made from such positive transparencies, but the method is a rather difficult one. Where prints are in view, a negative film, intended for this purpose, is the wisest choice.

For prints, Agfacolor Negative, Gevacolor Negative and Pakolor are suggested. Enlargements can also be made from these negatives, but they are not suitable for projection viewing. It is not feasible to quote prices, as these fluctuate, but any photographic supplier will give these.

The user of the 120 or 620 type of camera should note that Pakolor have introduced a half-length film, with free development when 'En-Prints' are ordered. This allows a trial to be made without the difficulty of home processing, and at low cost. As with black and white, en-prints are moderately enlarged prints from the whole negative—usually 3½ins. by 4½ins. from 35 mm., or 8-on-120 or 16-on-120 size, and 3½ins. by 3½ins. from 2½ins. square negatives.

## Home Developing

This is more exacting than with ordinary black and white films, owing to the various processes required. It is not proposed to give exact details, since these are given by the makers when home development is possible. As a

● Continued on page 103

Here's magic for you!

# Cigarettes of Enchantment

THIS showy trick is easy to construct and easy to perform. It is an ideal number for the amateur magician.

A paper parcel is shown, then unwrapped on the magician's table, the paper being fully spread out. The audience now see a wooden box 8ins. long, 5ins. deep and 3½ins. wide. The magician picks up the box, explaining that he received it just this morning as a present. On opening it he shows it to be a box of cigarettes. He throws one or two out among the audience, inviting them to have a smoke at his expense.

'Now', he continues, 'I have thought of an interesting trick with this box.' He closes the lid, takes up the paper from his table and rewraps the box, holding it for a moment on one hand while he mutters the magic words 'Bazooka, bazooka!'

## Construction Secret

On unwrapping the box and opening it again he shows that the cigarettes have vanished, their place being taken by a small dove or a pair of budgerigars!

The main secret lies in the construction of the box, and this is shown in the sketch. There is a top lid and a bottom lid, either being top or bottom according to which is uppermost. About ¼in. down from one lid a piece of thin wood is fixed which measures exactly the length and width of the box. A touch of glue and panel pins through

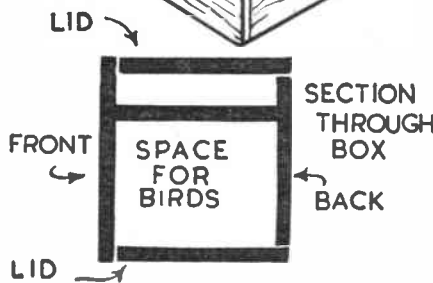
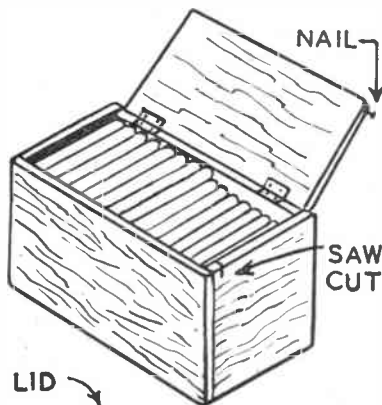

each end will secure this. Punch the pins well in and cover with plastic wood.

The lids of the box, when closed, must be flush with the edges of the sides, and to ensure this the side to which they are hinged is slightly narrower than the

opposite side. This narrow side plus the thickness of both lids makes up the depth of the box as seen from the front. For the hinges are, of course, at the back. This arrangement is shown in the sketch where small butt hinges are suggested. The lids should fit tightly within the sides. If this cannot easily be managed, two small pieces of tapered wood may be glued just within the openings of the box, so that the edges of each lid will be flush against them.

By R. W. Wood

For easy opening of the lids, drive a thin nail into the end of each, allowing just a little over the thickness of the sides to protrude. A slight sawcut in each end will accommodate each nail when the box is closed, but sufficient will protrude to be pressed upward by thumb or finger when opening. This is also shown in the sketch.

Now a row of dummy cigarettes, made of lengths of dowel covered with cigarette paper, is glued inside the box at the shallow opening. Over these a few genuine cigarettes are arranged. At the opposite side, the deep opening, the dove or budgies are hidden. The livestock is placed in the box just a moment before the trick is presented.

It will now be seen that when the box is unwrapped it may be shown as a box of cigarettes, but on rewrapping it is hidden a moment behind the wrapping paper. While hidden it is quickly turned over so that the other opening is uppermost when finally unwrapped. The box should be made from ½in. plywood.

Obviously it must look exactly the same when turned upside down. Therefore if any fancy pattern is painted around the sides, it must be such that appears the same when the box is reversed.

Of course, anything may be produced from the box apart from small birds or animals. But livestock magically produced adds a nice professional touch to an amateur show.

● Continued from page 102

## Try Colour Photography

guide to the processing required, however, Ferrantiacolour Reversal may be mentioned, as kits of chemicals for this are readily available.

The actual developing processes are quite critical, the time must be kept accurately, and the solution kept within ½ a degree F. of that specified. Twelve processes are required, compared with the three or four of black and white films, and are as follows:—

1. Initial development of the image, in darkness (e.g., tank), for 20 minutes.
2. Wash for 20 minutes to remove chemicals from the emulsion.
3. Exposure to white light for a stated time. Electric light is usual, so that the strength is known. This may be done by taking the film from the spiral, or by using a transparent spiral of the new type. If the film is

removed, the whole will have to be held under water, to get the film back in its groove, with some tanks.

4. Colour development for 10 minutes.
5. 20 minutes' washing to remove chemicals.
6. Hardening of the emulsion for 5 to 8 minutes.
7. Washing for 5 minutes.
8. Bleaching to complete image.
9. Washing to remove chemicals for about 5 minutes.
10. Fixing.
11. Final wash to remove chemicals.
12. Drying in dust-free atmosphere.

The work required for black and white development would be represented by stages 1, 10, 11 and 12 only. Nevertheless, many home photographers are doing such processing with great success, and the pleasure of seeing the results at once.

**A GRAND BOOK FOR ALL THE FAMILY.** The "Kaylee Year Book of Bright Ideas"; A really helpful guide to home planning, decoration, Hobbies, toys, etc. Showing famous Kaylee Transfers in brilliant colours, and most effective use. From "Hobbies" stockists or direct.

**KAYLEE TRANSFERS** Postage 3d.  
LTD. (HW), Long Eaton, Nottingham.

HOBBIES PICTORIAL GUIDE  
TO MAKING

# A MARQUETRY PICTURE

ALL YOU NEED

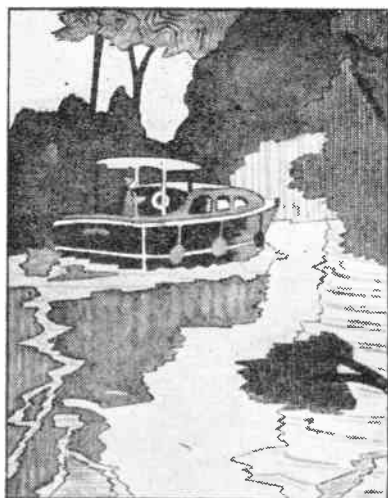

## KEY TO WOODS

TB	THUYA BURR
H	HOLLY
ME	MACASSAR EBONY
A	AVODIRE
C	CEDAR
VB	VAVONA BURR
BW	BLACKWOOD
G	GREYWOOD
FR	FIGURED ROSEWOOD
L	LAUREL
FA	FIGURED AVODIRE
Z	ZEBRANO
S	SAPELE

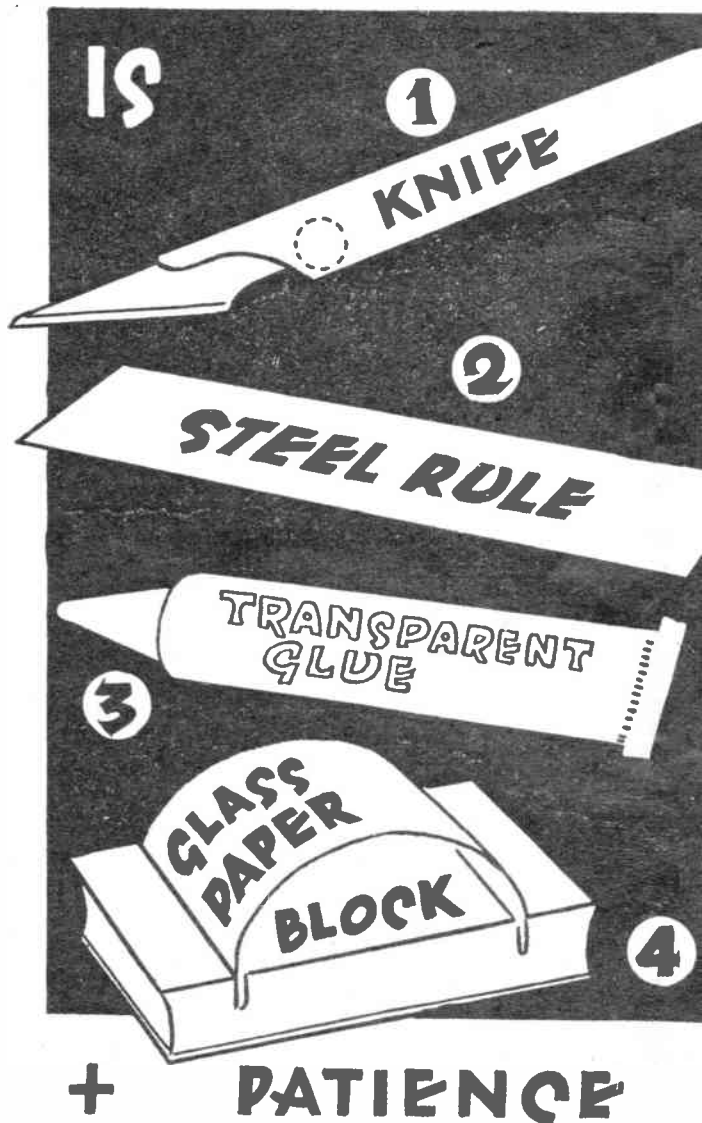

ORE

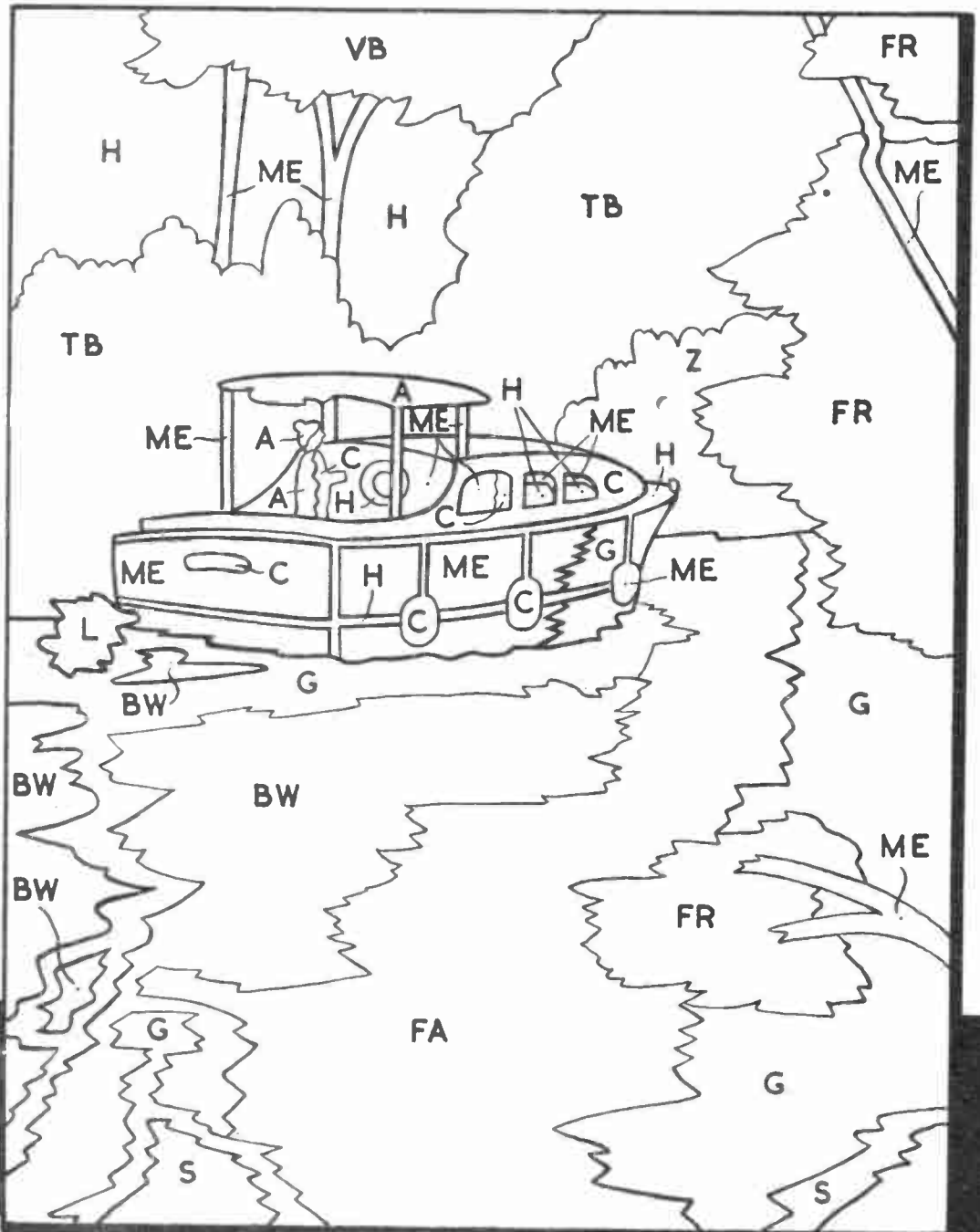

# Some Special Reagents

**I**T is a big advantage to have access in the laboratory to reagents which are specific for certain substances or groups of substances. While general reagents point the way, special reagents can give strong confirmatory evidence of the presence of the substances being tested for. This is especially true of organic chemistry.

Many special reagents have been evolved by various chemists expert in their own fields. Only a selection from these is necessary for the substances likely to be met by the home chemist. Consequently, a small carefully chosen list of the most useful of them is presented in this article.

**MILLON'S REAGENT.** This is used for testing for albumen. Dissolve a little mercury in a small quantity of strong nitric acid. Add more mercury until some remains undissolved. Note the rough volume of the solution and add twice the volume of water and let the solution stand and settle. Pour off the clear upper liquid into a bottle. Like all soluble mercury products, it is poisonous.

## Red Solution

Add about 1 c.c. of this reagent to about 3 c.c. of the solution suspected to contain albumen. A white precipitate forms. Boil the solution. If albumen is present, the precipitate will become brick-red; occasionally it dissolves, forming a red solution.

**BLEACHING POWDER.** This is also known as 'chloride of lime' and its solution is a delicate test for aniline or aniline salts. Shake some bleaching powder with about four times its volume of water and filter.

A few drops of the filtrate added to the test solution produces a purple colouration if aniline or its salts are present. This test can be made extremely delicate by adding dilute ammonium sulphide solution. Even when the test solution is too dilute to produce a purple colouration with bleaching powder solution, the addition of a few drops of diluted ammonium sulphide solution will give a red colour. You can gain practice in this by adding bleaching powder solution to the test solution and then diluting until the purple colour becomes extremely faint. Ammonium sulphide will then give the red colour.

**NESSLER'S REAGENT.** This is poisonous since it contains mercury, but it is the most delicate and valuable reagent for ammonia and ammonium salts, it being possible to detect merest traces by means of it. To prepare it, dissolve 0.5 gram of mercuric chloride in 3 c.c. of distilled

water. Add to this a solution of 1.25 grams of potassium iodide in 3 c.c. of distilled water. Next stir in a solution of 6 grams of potassium hydroxide in 12 c.c. of distilled water. Keep the solution in a rubber-stoppered bottle.

## Red-brown precipitate

To show its sensitivity, add one drop of 10 per cent ammonium chloride solution or a drop of ammonia to a test tube almost full of distilled water. The addition of one drop of Nessler's reagent produces a red-brown precipitate. In more dilute solutions red-brown or yellow colorations appear. Even when no colour is apparent on viewing a highly dilute solution horizontally, the colour will be distinctly seen when viewed vertically.

**BORAX.** Glycerine may be detected with this. Dissolve 1 gram of borax in 100 c.c. of water and add phenolphthalein solution drop by drop until a full pink colour develops. To some of this reagent in a test tube add glycerine. The pink colour disappears. Warm the liquid. The colour reappears, but on cooling again vanishes.

**BARFOED'S REAGENT.** Glucose or glucose syrup can be differentiated from sugar or syrup by means of this reagent. Add 0.5 c.c. of glacial acetic acid to 100 c.c. of water and then dissolve in this 7.5 grams of copper acetate. To carry out the test, dissolve the solid or some of the syrup in water and mix a c.c. or two with an equal volume of Barfoed's reagent. Immerse the end of the test tube in boiling water. In two minutes exactly remove the tube. If a red precipitate has formed, glucose is indicated. Sugar will give no precipitate.

**IODINE.** Starch is detected by iodine solution. Dissolve 4 grams of potassium iodide in 100 c.c. of water, add 2 grams of solid iodine, and shake until it has dissolved. A little of the substance suspected to be starch is ground with water to a cream, boiling water added, the mixture boiled for a few moments and allowed to cool. A drop or two of the iodine reagent added to this produces a deep blue colour. Boil the solution. The colour vanishes, but reappears on cooling. This test is extremely delicate, as you can ascertain by adding only a drop of the liquid containing starch to a beaker full of water and stirring in a drop of the iodine reagent, a full blue will appear.

**STARCH.** By using the last test in reverse, the presence of iodine in a liquid can be confirmed. The starch paste is best freshly prepared, for it will then detect more minute traces of iodine than

if it has been prepared some time previously. If you wish to have a temporary stock, grind about 0.5 gram of starch to a cream with water, add 100 c.c. of boiling water and boil up again for about a minute. Allow to cool and add two or three drops of chloroform to stop it going bad. Such a starch solution gives good reactions for iodine for about a month.

**SCHIFF'S REAGENT.** Aldehydes and some ketones are tested for with this reagent. Formaldehyde in the shape of formalin is the most likely one to be met by the home chemist. Dissolve a few specks of basic fuchsine (magenta) in 100 c.c. of water—enough to produce a full pink colour. Pass in sulphur dioxide until the colour just disappears. Keep it in a well closed bottle, preferably rubber stoppered.

To some of the reagent add a little formaldehyde. The colourless liquid becomes pink again.

**OXALIC ACID.** If other tests point to urea, oxalic acid will confirm its presence. Shake powdered oxalic acid with water until no more will dissolve. Let the surplus solid settle and pour off the clear upper liquid. To test for urea, make a strong solution of the suspected substance and add an equal volume of the reagent. A white crystalline precipitate of urea oxalate will appear if urea is present.

## Freshly Prepared

**GELATINE.** Tannic acid (tannin) gives a buff coloured precipitate with gelatine solution. The gelatine solution must be freshly prepared. Warm a few small crumbs of gelatine with a few c.c. of water and when nearly cold add it to an aqueous solution of the suspected tannic acid.

**DRAGENDORFF'S REAGENT.** Aqueous solutions of most alkaloids give an orange-red precipitate with this reagent. Quinine is the most likely alkaloid to be met by the home chemist. Dissolve 2 grams bismuth metal in just enough dilute nitric acid made by diluting each 3.7 c.c. strong nitric acid to 10 c.c. with water. Add this solution to one of 6.75 gram potassium iodide in 10 c.c. water. Thensdilute the whole to 25 c.c. and store it in a bottle covered with black paper, since it is affected by prolonged exposure to light.

**SODIUM NITROPRUSSIDE.** This is a delicate reagent for soluble sulphides. As its solution decomposes when kept, it should be prepared fresh by dissolving a little in water. The sulphide solution should be made alkaline by adding

● Continued on page 108

**YOURS for only  
15/-  
down!**



Save time and work on sewing jobs with this excellent 'Essex' Miniature Sewing Machine. Beautifully finished with chromium plate. Supplied with clamp for fixing firmly to table. 6 months' guarantee. Cash price £4.17.6 or 16/- deposit and 6 monthly payments of 16/6. Electric model available A.C./D.C. with foot control £10.3.4, or 31/- down and 6 monthly payments of 32/-. Protective carrying case 18/4 extra. Send for leaflet today.

**ELECTRIC PAINT  
SPRAYER**



**for 4/-  
deposit**

Cash 75/-. Or 4/- deposit and 6 monthly payments of 13/6

Paint easily, evenly, twice as fast with the Burgess Electric Sprayer. Sprays paint, varnish, etc. Complete with sturdy glass container, flex, nozzles for ceiling spraying and extra nozzle discs for different liquids. A.C. mains - state your actual voltage. Fully guaranteed. Also Horvell Electric Paint Strippor 30/- cash, or 4/- deposit and 3 monthly payments of 10/-. Leaflets free.

**PHILISHAVE  
14 DAYS'  
FREE TRIAL**



Try the wonderful Philishave Electric Dry Shaver FREE for 14 days. Send only 5/- deposit (returnable if not satisfied). Two shaving heads with two 6-bladed cutters have unique rotary action which genuinely shaves - doesn't just snip at the hairs. Result - better, quicker shave. Operates 110/250 volts. A.C. D.C. £7. 14. 2 cash less your deposit. Or 5/- deposit can be first payment, followed by 8 monthly payments of £1.0.6. 12 mths' guarantee. Brochure of this & other shavers free.



**BATHROOM  
SCALE  
BARGAIN  
★FOR  
ONLY 5/-**

★ and 6 monthly payments of 13/4 (or Cash Price £3.11.6)

WATCH your WEIGHT every day with this streamlined Bathroom Scale. Magnified dial easy to read. Weighs accurately from 1lb. to 20st. Lovely white enamel finish. Non-slip plastic mat. All mechanism enclosed. 2 years' guarantee.

Cash £3.11.6, or 5/- dep. and 6 monthly payments of 13/4.

**LOOK! THE BASIS OF  
A MAGNIFICENT  
HOME WORKSHOP  
for only  
6/- deposit  
Wolf Cub  
1/4" DRILL**

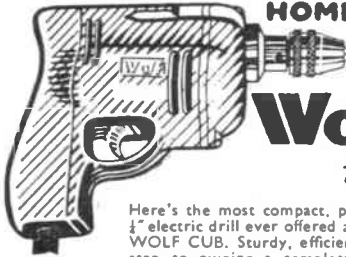

Here's the most compact, powerful and fully guaranteed 1/4" electric drill ever offered at such a popular price - the WOLF CUB. Sturdy, efficient and reliable, it's the first step to owning a complete home workshop, and the power unit for all Wolf Cub Sets. Drilling capacity: Mild Steel 1/2 in.; Hard Wood 3/4 in.; with 210 watts input on full load. Complete with 1/2 in. three-jaw chuck and Allen key and 5ft. of cable. T.V. suppressed. State voltage.

Cash price for Drill is £5.9.6 or only 6/- deposit and 6 monthly payments of 19/6.

**ALSO**

Sanding and Polishing Kit (drill, discs, etc.): £6.10.6 or 19/- deposit and 6 monthly payments of 21/-.

Saw Kit (including drill): £9.17.0 or 20/- deposit and 8 monthly payments of 25/-.

Fretwork Kit (including drill): £10.10.6 or 21/- deposit and 8 monthly payments of 26/6.

Lathe Kit (Drill and Tools): £10.10.6 or 21/- deposit and 8 monthly payments of 26/6.

Home Workshop Outfit (drill, saw, lathe, sanding and polishing kits): £16.17.6 or 40/- deposit and 8 monthly payments of 41/6.

No. 5 Saw Set: £3.1.6 or 4/- deposit and 6 monthly payments of 10/6.

No. 10 Bench Planer Set: £3.13.6 or 6/- deposit and 6 monthly payments of 12/6.

No. 8 Fretsaw Set: £3.15.0 or 10/- deposit and 6 monthly payments of 12/6.

Send at once for full details, including a profusely illustrated and informative leaflet.

**BARGAIN DISTRIBUTORS** (Dept. 124), 5 Silver Street, Luton

**THE SHAPE OF THINGS  
TO COME?**

Would a visitor from another planet look like this? You can give your imagination free rein with 'Plasticine', and model all kinds of figures; serious, humorous and grotesque. 'Plasticine' is clean to handle, long-lasting, and made in seventeen wonderful colours. Get some today and try your hand.



**HARBUTT'S  
Plasticine**

REGD.

HARBUTT'S PLASTICINE LTD, Bathampton, Bath, Somerset.

**HEAR ALL CONTINENTS  
With H.A.C. Short-Wave Receivers.**

Suppliers for over 18 years of Radio S-W. Receivers of quality One-Valve Kit, Price 25/- Two-Valve Kit, Price 50/- Improved designs with Denco coils. All kits complete with all components, accessories and full instructions. Before ordering, call and inspect a demonstration receiver, or send stamped addressed envelope for descriptive catalogue.

'H.A.C.' Short-Wave Products (Dept. 22), 11 Old Bond Street, London, W.1

**THE 'ROYAL CHARLES'**

is the latest design in Hobbies wide range of models of famous old-time galleons. Obtain your design FREE with

**HOBBIES 1956 HANDBOOK**

Now on sale (2/-) at newsagents, etc., or 2/3 post free from Hobbies Ltd., Dept. 992, Dereham, Norfolk

**YOU CAN BECOME A  
HANDICRAFTS INSTRUCTOR**

**EXPERIENCE NOT ESSENTIAL**

Men who enjoy making things in wood or metal can turn their hobby into a permanent and interesting Career. Short hours, long holidays and security in a job you would really enjoy, can be yours if you become a Handicrafts instructor. Let us send details of the easiest and quickest way to get the necessary qualification.

**We guarantee "NO PASS-NO FEE"**

If you would like to know about our unique method of preparing you for one of these appointments, write today, and we will send you our informative 144 page Handbook—free and without obligation. Mark your letters "Handicrafts Instructor".

**BRITISH INSTITUTE OF  
ENGINEERING TECHNOLOGY**

**BIET**

595 College House, Wright's Lane  
Kensington, London, W.8

**STOP SMOKING**

**Any Man or Woman in the World May Now Stop Smoking  
Quick and Sure**

**To Prove It. A Free Trial Package Sent Sealed To All Who Write**

If you want to stop smoking, this should be just the thing you need. Simply send your name and address to Mr Brian Hussey, Dept. HD/6, The Triumph Remedies, Exeter, and he will send, absolutely free of charge, a trial package of our remedy to show how it is used and how it will quickly conquer the habit of smoking, also full directions how to use it, free advice, and everything needed to aid you in overcoming the habit quickly and certainly. No matter what else you have tried or how many times you have failed, this time you will succeed. Please send name and address now—as this free offer may never appear again.





**NEW!**

# EXPERIMENTAL KITS

## LEARN THE PRACTICAL WAY

Here is home study of the most effective kind under expert tutors. There is no better way of studying for an examination, starting a new hobby or for a career in industry. These special courses comprise the most modern methods of postal tuition, combined with a Practical Kit of parts (which remains your property).

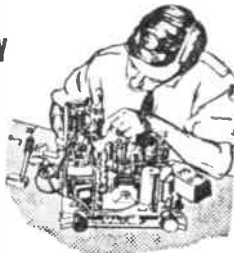

### COURSES FROM 15/- A MONTH

**COURSES WITH PRACTICAL EQUIPMENT INCLUDE:** Radio, Television, Mechanics, Electricity, Chemistry, Photography, Carpentry; also Draughtsmanship, Commercial Art, Amateur S.W. Radio, Languages, etc.

#### POST THIS COUPON TODAY

For FREE brochure write: E.M.I. INSTITUTES, Dept. 31X, Grove Park Road, London, W.4.  
SUBJECT(S) OF INTEREST \_\_\_\_\_  
NAME \_\_\_\_\_  
ADDRESS \_\_\_\_\_  
23/11/55

IC51A

**E.M.I.**

**INSTITUTES**

The only Postal College which is part of a world-wide Industrial Organisation

Use this fine equipment in Your home workshop!

Post Coupon with 10/- Today!

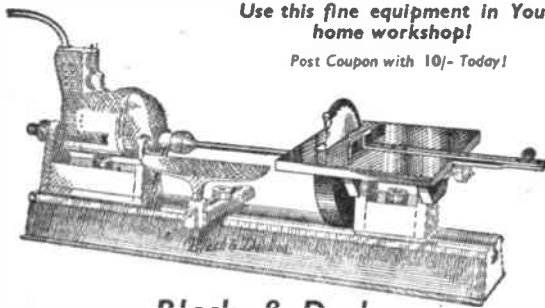

**Black & Decker**

# DRILL, LATHE & SAW

Start a home workshop with this famous Black & Decker DRILL, LATHE & SAW outfit. Enjoy the thrill of using this fine equipment. Outfit consists of 4in. Electric Drill complete with drills and polishing equipment in fitted tool-box, B & D wood turning Lathe and Sawbench attachment with 5in. circular saw.

### How to Get This Outfit

All you have to do to get immediate delivery is to send coupon with first instalment of 10/-. 48 further weekly payments of 10/- complete purchase. Post Coupon NOW!

**10/-**

49 weekly payments of 10/- or £21/5/6 cash

### To NEW TRADING HOUSE

Dept. O.E. 15, Primrose Hill Mill, Preston, Lancs.

Send - one BLACK & DECKER DRILL, LATHE & SAW Outfit. I enclose 10/- and will send 48 further weekly payments of 10/- under your H.P. scheme.

Signed.....

Please PRINT name and address in margin

# Make-and-give-

wonderful

# WREN CRAFT FURNITURE

this Christmas Save pounds

on presents

with these easy to-assemble outfits

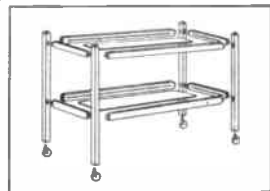

Here's the best money-saving idea in years — beautiful WRENCRAFT furniture you can assemble and give to your friends this Christmas. It's so quick, so easy, with simple WRENCRAFT home assembly outfits. Satin-smooth parts, step-by-step instructions, pins, glue — everything supplied. Fit parts together — finish — and you have lovely modern furniture . . . perfect Christmas gifts at a fraction of shop prices. Choose from oak, walnut, mahogany, beech — all really top quality timber. Satisfaction guaranteed or full cash refund. Another Gift brainwave! Give your friends an inexpensive WRENCRAFT furniture outfit — they'll love to assemble and finish the parts themselves.

Here's just a few of the wonderful WRENCRAFT things you can make

- Cot · Stool
- Candelabra
- Occasional Table
- Book Case
- Cocktail Cabinet
- Bathroom Cabinet
- Tea Trolley · Bedstead
- Kidney Dressing Table
- Wardrobe

. . . and lots more useful, attractive articles you'll be proud to own. You must get a copy of the FREE WRENCRAFT book — see below

## ACT NOW!



Get this exciting FREE WRENCRAFT book with full details and pictures of all the lovely modern furniture you can make for yourself or your friends. Hurry! Post this coupon NOW for your FREE copy!

Please send me FREE copy of THE WRENCRAFT BOOK OF FURNITURE

NAME .....

ADDRESS .....

WRENCRAFT FURNITURE LTD.  
KINGSTON ROAD  
NEW MALDEN SURREY H.5

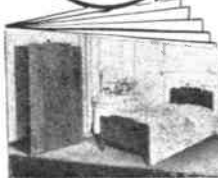



Actually holds 4 boys A romantic ten thousand miles an hour trip to the Moon. Adventure galore for brave young pioneers to rush through space and be first on the Moon. Attractive coloured wind, rain, and element resisting material. Silver tipped. With Aerial. Large enough for four boys, the Scientist, Pilot,

Radio operator and 1 crew. Stands indoors or out-doors. 29/11, post etc. 1/6.



### THE NEW INTERPLANETARY SPACE SUIT

Only 12/11 POST 1/6 ETC.

Be an Interplanetary Commando Officer. Wear this metallic blue Space Suit and pressure helmet. Be the first Earth Man to Jupiter. Can also be worn over outdoor clothing, guaranteed waterproof. For boys aged 4 to 12. Waisted and adjustable, visor on helmet. Lightning flashes on breast panel. State age for size. 12/11, post etc. 1/6. LISTS, TERMS.

**HEADQUARTER & GENERAL SUPPLIES LTD.**  
Dept. HOBW/79, 196/200, Goldharbour Lane, Loughborough Junction, London, S.E.5. Open all Saturday 1 p.m. Wednesday.

**SUPER** free gift of 25 different South African for approval applicants enclosing postage.—Yulwontmore Stamps (Dept. H5), 29 Layton Avenue, Mansfield, Notts.

**50 STAMPS** free to all approval applicants enclosing 2d. stamp.—Cliffe West (V), 61 Wynyard Road, Sheffield, 6.

**TRY** the approval service which offers free gift and bonus scheme. Details and sample selection by return.—Paragon Stamp Co., 138 Oakley Rd., Shirley, Southampton.

**MODELS.** You can make lasting stone-hard models with Sankey's Pyruma Plastic Cement. Supplied in tins by Ironmongers, Hardwaremen and Builders' Merchants. Ask for instruction leaflet.

**AMERICAN MAGAZINE** Subscriptions. One Year Popular Mechanics 30/-. Popular Science 43/-. Homecraftsman 16/6. Homecraft 18/-. Deltagram 10/6. Free booklet quoting others.—Willen Ltd. (Dept. 57), 101 Fleet St., London, E.C.4.

**TOY CASTING MOULDS.** Soldiers, sailors, T-aimen, etc. 1,000 varieties from 3/- each. Rubber moulding compound for flexible moulds, granulated ready for use, 8/6 per lb. Aluminium moulds for plaster work. S.A.E. for list. Catalogue 9d.—F. W. Nuttall, 69 St. Mark's Road, Hanwell, London, W.7.

**PROFITABLE HOBBIES.** America's leading monthly. Year's subscription 28/6, specimen 3/6. Full list American magazines free.—Hobson, 79 Southbrook Road, Exeter.

**200 DIFFERENT** stamps 2/- Excellent value.—Lee, 27 Nursery Avenue, Bexleyheath, Kent.

**STAMPS**—send for approvals to—Roy, S37 Lyndon Rd., Olton, Birmingham. Send 3d. stamp free gift.

**COIN COLLECTORS!** S.A.E. for list of inexpensive coins. Box No. 15, *Hobbies Weekly*, Dereham, Norfolk.

**PLYWOOD—HARDBOARD**—at amazing low prices. Send S.A.E. for samples and prices to—N. Gerver, 10 Mare Street, Hackney, London, E.8.

**GENUINE** Swiss Musical Movements. Owing to large purchase now reduced to 14/6 each. Genuine Thorens Movements, all guaranteed, 19/3 each. P. & P. 9d. extra on all orders.—Richardson & Forder, 5 Chapel Place, White Hart Lane, London, N.17.

**PAINTSPRAYING HANDBOOK** (1954 Ed.). Covers Car, Industrial & Flock Spraying. 3/6. post free, including catalogue of our Cellulose and Synthetic Paints and all Allied Sundries and Plant Hire.—Leonard Brooks Ltd., 81 Oak Road, Harold Wood, Essex.

**STAMPS FREE**—Empire Packet including Pictorials and Victorians with approvals.—Robert J. Peck, 7A Kemp Road, Bournemouth.

### MAKE A RADIO SET

**NO SOLDERING**—only a screwdriver and pliers needed. **FULL-SIZE** plans and building instructions for 8 sets, 2/6 post free. **CRYSTAL RADIO KITS.** "Varicoil", coil tuned, 10/6; "Popular", condenser tuned, 17/6; "Twin", very selective, 21/-; "Major", works well anywhere, 21/-.

**EXPERIMENTAL KIT No. 1**, builds all 4 crystal sets above, 27/6. **"BASIC"**, a very simple 1 valve set, 35/- with valve and batteries.

**"NEW ECONOMY 1"**, receives scores of stations, 52/6 with valve and batteries.

**"NEW ECONOMY 2"**, works with loud-speaker, 82/6 with valves and batteries.

**"PREFECT" 1-VALVE LOUDSPEAKER** set, £3 with mains type valve and batteries.

Prices include postage and packing. Send S.A.E. for list—or send 2/6 P.O. for easy to follow building instructions for all sets.

**BLANCHARD'S, DEPT. RH, 13 Gainford Gardens, Manchester, 10**

**SWISS MUSICAL** Mechanism for cigarette boxes, etc., 16/6 post free. S.A.E. for illustration and list of tunes available.—Dept. H.W., Metwood Accessories, Church St., Wolverton, Bucks. (Trade supplied.)

**BUILD** your own T/V and learn about its operation, maintenance and servicing. Qualified engineer-tutor available whilst you are learning and building. Free Brochure from—E.M.I. Institutes, Dept. HW.58, London, W.4. (Associated with H.M.V.)

### HOBBIES BRANCHES

LONDON

78a New Oxford Street, W.C.1 (Phone MUSEUM 2975)  
87 Old Broad Street, E.C.2 (LONDON Wall 4375)  
81 Streatham Hill, S.W.2 (TULSE Hill 8796)

GLASGOW—326 Argyle Street (Phone CENTRAL 5042)

MANCHESTER—10 Piccadilly (Phone CENTRAL 1787)

BIRMINGHAM—100a Dale End  
SHEFFIELD—4 St. Paul's Parade (Phone 26071)

LEEDS—10 Queen Victoria Street (Phone 28639)

HULL—10 Paragon Square (Phone 32959)

SOUTHAMPTON—134 High St. (Below Bar)

BRISTOL—30 Narrow Wine Street (Phone 23447)

**PLYWOOD:** large sizes, 14 lbs. 10/- delivered (Express) C.W.O.—H. Leader (1920). Gosford St., Middlesbrough.

**CASTING** moulds for lead soldiers, animals, cowboys, Indians, etc. Illustrated catalogue 4d. Sample mould 6/6.—G. Rhead, Bacton, Stowmarket, Suffolk.

**DO-IT-YOURSELF BOOKS.** List free.—S.P. Ltd., 28(H) Dean Road, London, N.W.2.

**CHINA** repairing. This fascinating and profitable hobby can be learnt successfully and inexpensively at home. Particulars from—The Chelsea Studio, 10 Blacklands Terrace, S.W.3.

**100 DIFFERENT** stamps free! Request 4d. upwards discount approvals.—Bush, 53 Newlyn Way, Parkstone, Dorset.

**COINS** for sale: English/Foreign. Very cheap. S.A.E. long list.—Box No. 15, *Hobbies Weekly*, Dereham, Norfolk.

**MATCHBOX** size crystal sets. All parts, crystals, instructions, complete 3/6.—Bailey's, 44 Stanley St., Oldham.

**DAD WAS RIGHT—UHU STICKS EVERYTHING TO ANYTHING!**

**AND QUICKLY TOO!**

**UHU INSTANT GLUE**

**Sticks in seconds**

- Wood
- Glass
- Paper
- Metal
- Fabrics
- Marble
- Leather
- Stone
- Celluloid
- Plastics
- Porcelain
- Plaster
- Pottery
- Cement, etc.

**DON'T SAY GLUE—SAY YOO HOO**  
A necessity in every home, office, factory.

**TUBES 1/6**  
Also other sizes

**LIBERTA-IMEX 281 Regent St., W.1**

Made in a few hours

# A CARPENTER'S STOOL

SHAPING IS  
SIMPLE WITH A  
FRET MACHINE

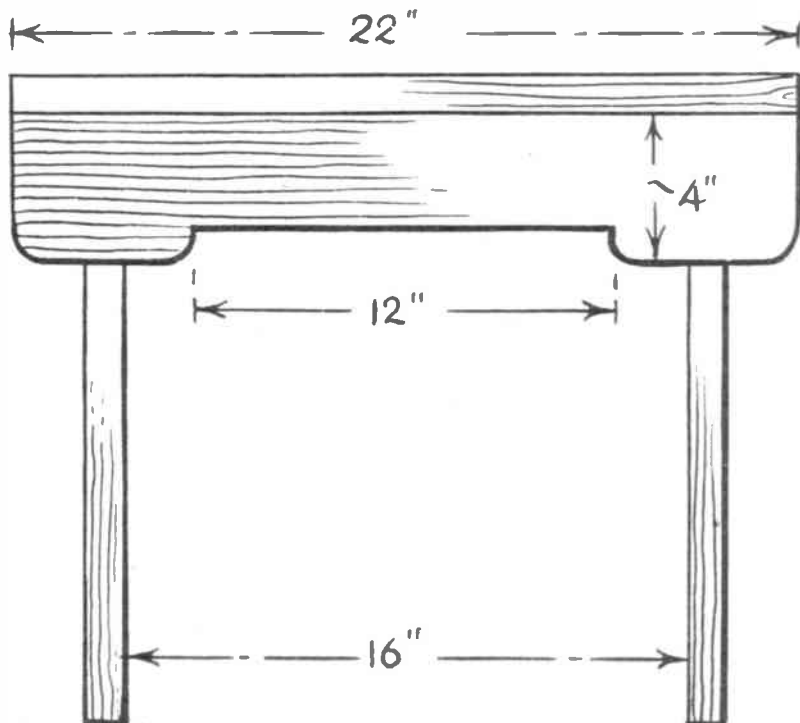
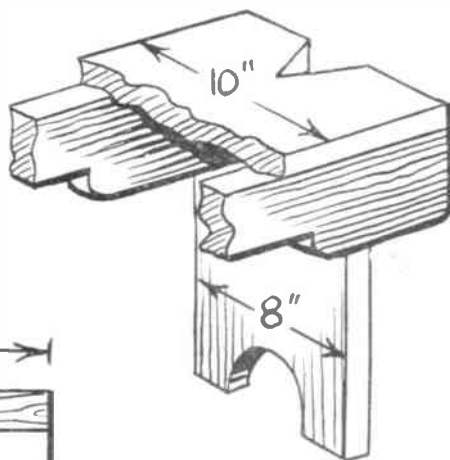
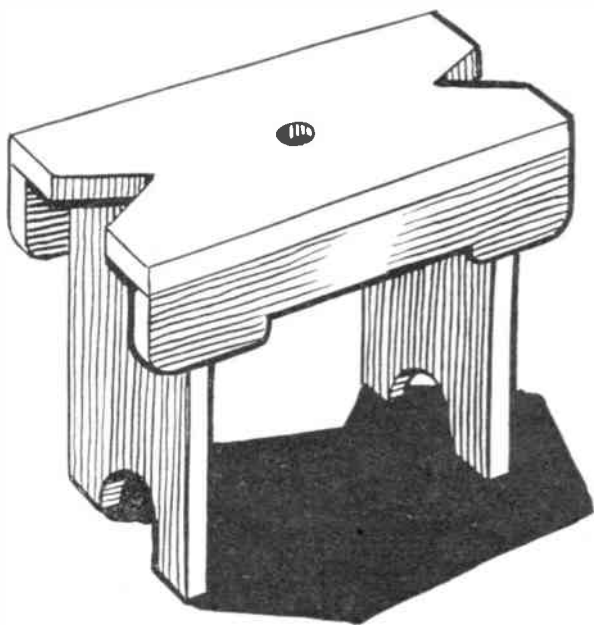

## USE SCREWS WHEN ASSEMBLING

**I**F you have a fret machine it is an easy job to cut shapes in thick wood. This stool is cut from 1in. thick wood throughout and can be completed in a few hours.

Of course, it can be cut with a hand-frame, but you need a heavy saw and the work will take longer than with a machine.

Most measurements are shown in the diagrams, but they may be modified if necessary. Make the legs 18 ins. long. Clean up all the pieces after cutting and then put together using countersunk screws. Fill the heads with plastic wood.

Complete the stool by giving two or three coats of brush polish. (M.p.)

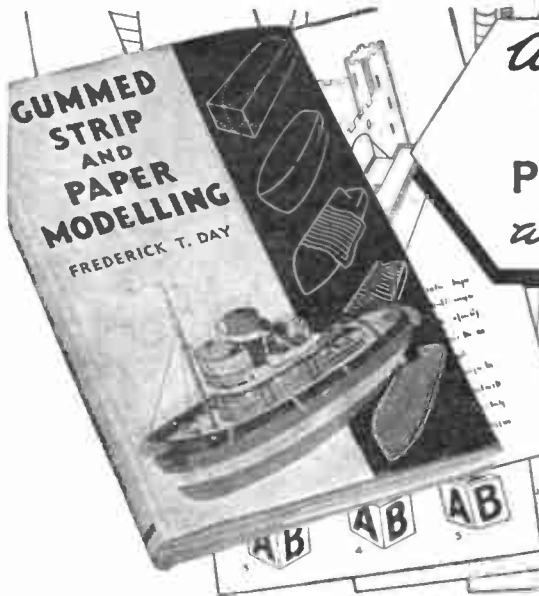

*An inspiration to*  
**EVERY MODELLER**  
**PRACTICAL · INGENUOUS**  
*and CRAMMED WITH IDEAS*

Make your own ships, aeroplanes, puppets and models of many kinds with Gum-strip Sealing Tape. Ideal for mending, making and many other things too.

**76**

**SAMUEL JONES & CO. LTD**

STATIONERY MILL, CAMBERWELL, LONDON, S.E.5

GRAMS: NONCURLING, PECK, LONDON

TELEPHONE: RODNEY. 2346

Published by C. Arthur Pearson Ltd., Tower House, Southampton Street, Strand, London, or obtainable from Samuel Jones & Co. Ltd.

**the**  
 • **perfect**  
**adhesive**  
*for the Handyman*

BRITFIX CEMENT—a fine all-purpose adhesive. Transparent, water and heat proof. Combines rapid drying with utmost tenacity . . . No wonder it's the handyman's favourite throughout the world! Available in ½ oz. tube, 6d., 1 oz., 10d. and 2½ ozs., 1s. 6d.

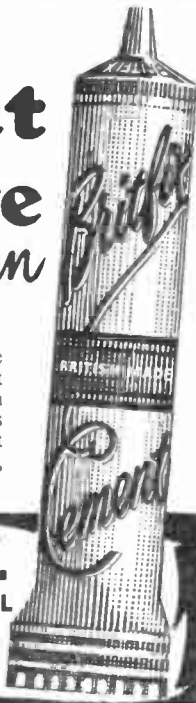

*You simply pour out these*

**NOVELTIES**

with **NEW LIQUID PLASTIC**

Here's the hobby to make your spare time pay dividends. You simply choose your mould and pour out beautiful castings. We supply everything, including instructions. Wonderful results achieved—wonderfully quickly! Start right away—no training needed. Send 2½d. stamp for exciting book and market details. No obligation.

**QUALITY PLASTICS LTD.**

DEPT. H.19, BRENTWOOD, ESSEX

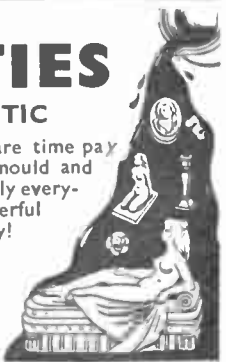

**HUMBROL**  
**ART OIL ENAMEL**

Ideal for handicrafts of all kinds—extremely durable—4 hr. drying

Products of

**HUMBER OIL CO. LTD., MARFLEET, HULL**



Printed by BALDING & MANSELL, LTD., London and Wisbech, and Published for the Proprietors, HOBBIES LTD., by HORACE MARSHALL & SON, LTD., Temple House, Tallis Street, E.C.4. Sole Agents for Australia and New Zealand: Gordon & Gotch (A'sia) Ltd. For South Africa: Central News Agency Ltd. Registered for transmission by Canadian Magazine Post.

SIZE APPR

PIECE D.  
CUT ONE 1 2in.

PIECE D. CUT  
1 2in.

SH  
FR

CLOCK RIM



DESIGN

No. 3134

# A MANTEL OR BEDROOM CLOCK

(WITH ALARM)

APPROX. 7½ ins. WIDE.  
6 ins. HIGH.

CUT ONE  
2 in.

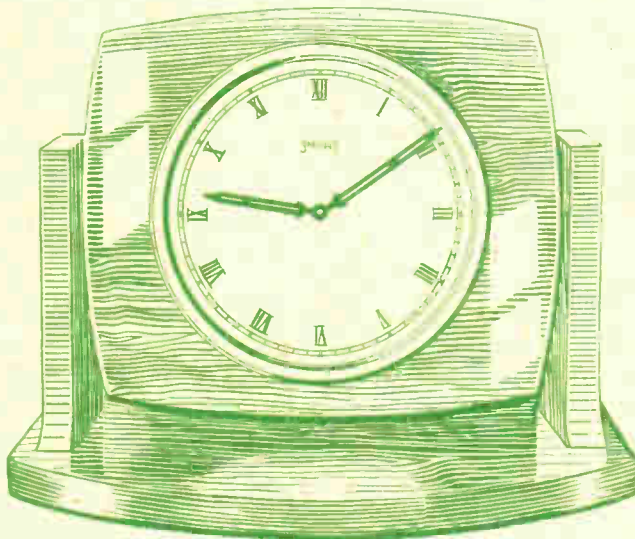

SHOWING HOW PIECE A AND B ARE CUT FROM THE SAME PIECE OF WOOD.

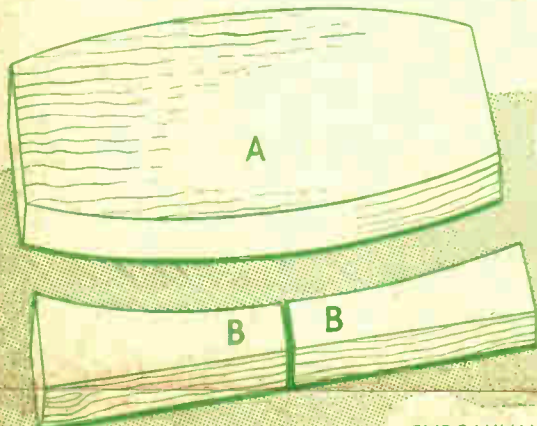

CHROMIUM  
PLATED  
SCREW



*Materials required for this design*

WOOD

ONE PIECE

14 ins. X 10 ins. X ½ in.

A complete kit of the above materials can be obtained from  
**HOBBIES LTD., DEREHAM, NORFOLK**

## Did You Know . . . .

. . . That details of hundreds of designs and kits, chosen from among the best of those produced during the past few years, are given in . . .

# HOBBIES Annual HANDBOOK

In addition, there is an extensive editorial section full of "how-to" articles, a large FREE Design, and a comprehensive catalogue of tools and materials.

CLOCK RIM

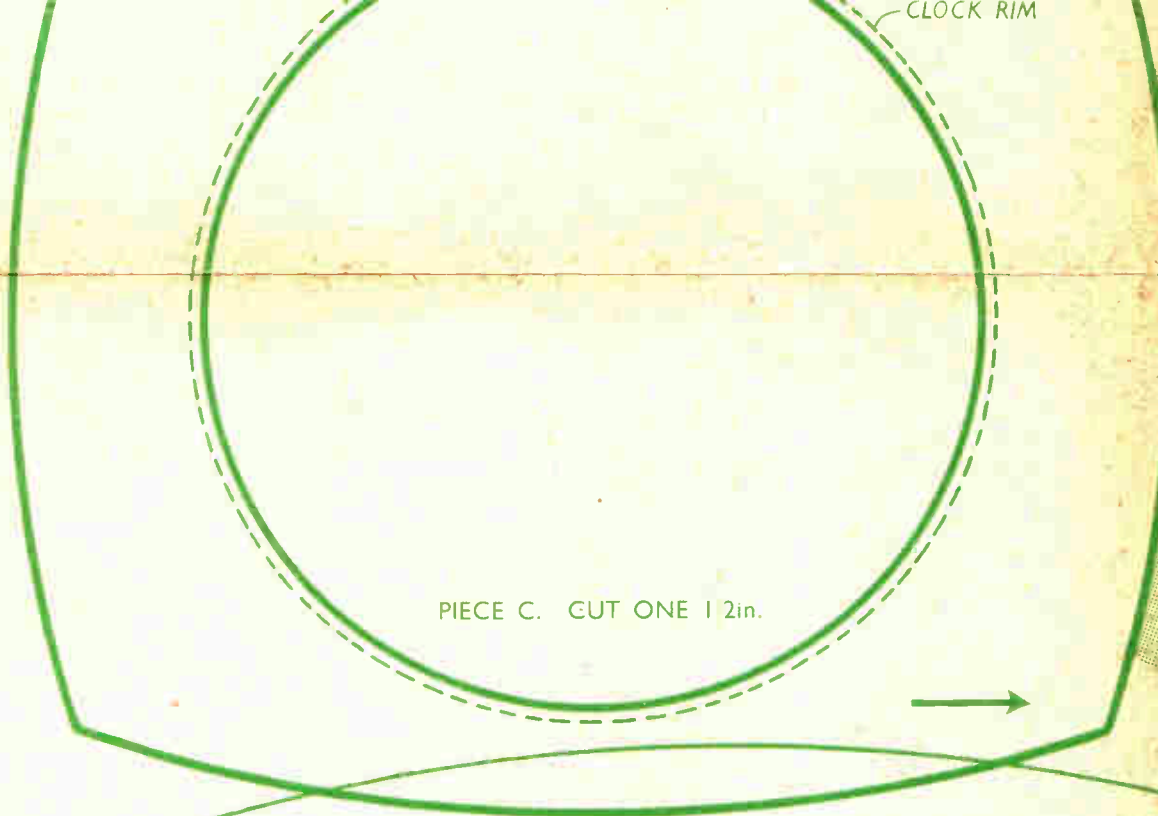

PIECE C. CUT ONE 1 2in.

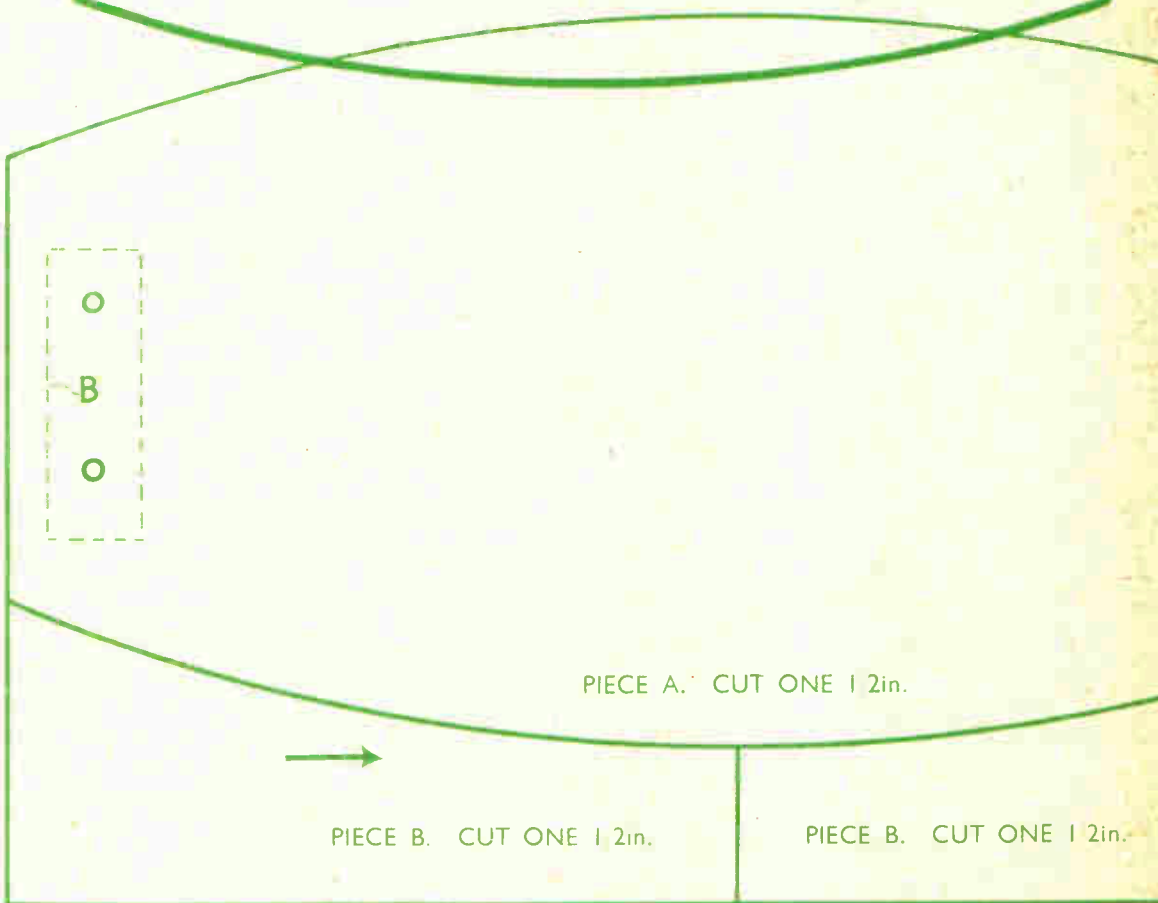

PIECE A. CUT ONE 1 2in.

PIECE B. CUT ONE 1 2in.

PIECE B. CUT ONE 1 2in.

14 ins. x 10 ins. x 2 in.

A complete kit of the above materials can be obtained from  
**HOBBIES LTD., DEREHAM, NORFOLK**

### Did You Know . . . .

. . . That details of hundred- of designs and kits, chosen from among the best of those produced during the past few years, are given in . . . .

## HOBBIES Annual HANDBOOK

*In addition, there is an extensive editorial section full of "how-to-make" articles, a large I.F.I.E. Design, and a comprehensive catalogue of tools and materials.*

The Handbook is published each year, and is obtainable from newsagents or Hobbies stockists and Branches, or by post from Hobbies Ltd., Dereham, Norfolk.

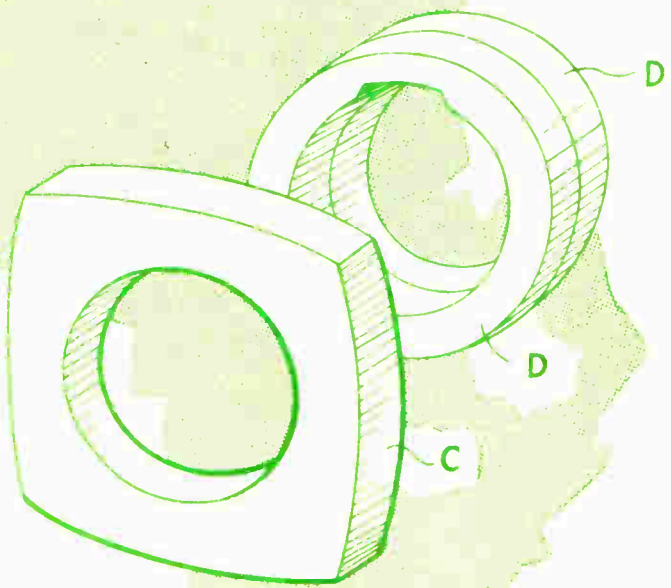
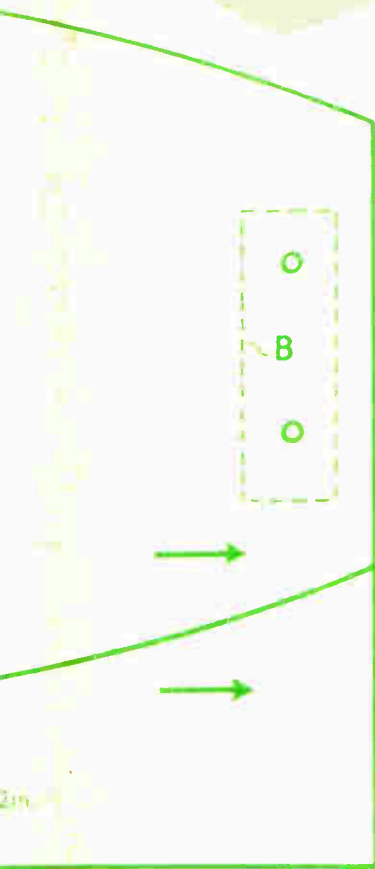
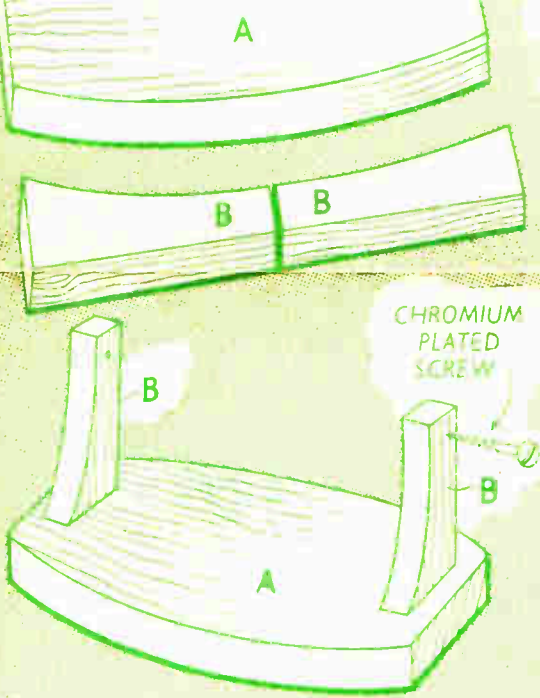

THE ARROWS INDICATE DIRECTION OF GRAIN OF WOOD.

PRINTED IN ENGLAND.



# HOBBIES WEEKLY

IN THIS ISSUE

	Page
How to Utilise Pictures in Wood	113
Stamp Friends Abroad	114
The Bramah Puzzle	115
A Gem—With a 'Gem'	115
Four-Valve Superhet	116
An Archway—a Picture	118
A Handy Tool for Extracting Staples	119
A Picture in Wood Relief	120
Make This Showcase	122
A Sleeve Ironing Board	122
The Shipmodeller's Corner	124
Patterns for Sleeve Ironing Board	127



NOVEMBER 30th 1955

VOL. 121

NUMBER 3135

## Applications for Marquetry

WHAT could be more attractive than this picture in beautiful coloured woods? It is a medium in art which always commands attention and admiration.

The picture has a history, too. It is an authentic reproduction of a Norfolk

## HOW TO UTILISE PICTURES IN WOOD

Broads scene, taken during a holiday cruise. Details of the actual picture were given in Hobbies Weekly No. 3134, published last week. The object of this article is to show how this picture can be utilised for any number of useful gifts and ornaments.

First and foremost it can be used

purely and simply as a picture. It should be polished and framed, using a fairly heavy picture moulding. Use two picture rings for hanging and stretch a cord tightly across, so that it is not seen when the picture is hung.

A blotter is useful in the home and

the picture will work up into an attractive pad. The illustrations in Fig. 1 show how it can be made up from two pieces of plywood. The top piece (A) will, of course, be the completed picture. The two pieces forming the top (A) and bottom (B) are laced together with cord through the holes shown.



THREE SUGGESTIONS ON THE USE OF SUCH A PICTURE ARE GIVEN IN THIS ARTICLE

On the piece (B) are glued four corners of leather, leather cloth or card as shown in the inset detail. These four corners hold the sheets of blotting paper in position. To finish off, the bottom piece (B) should be stained to match the border of the picture and then wax polished.

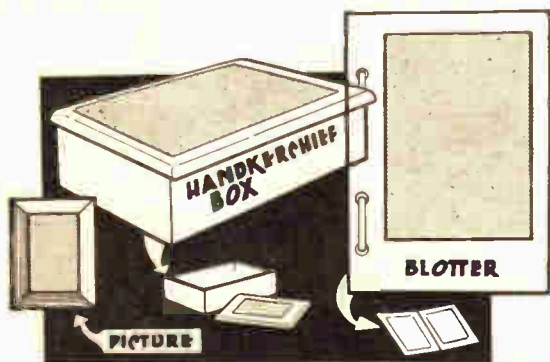

MARQUETRY PICTURE IS INDICATED BY DOTTED TINT

Continued on page 114

All correspondence should be addressed to The Editor, Hobbies Weekly, Dereham, Norfolk

For Modellers, Fretworkers  
and Home Craftsmen

World Radio History



# Stamp Friends Abroad

ON my ninth birthday a relative gave me a stamp collector's outfit. The following year when I had collected hundreds of stamps, she presented me with Gibbons' catalogue. Discovering my wonderful collection was almost worthless—every item listed at 1d.—I disgustingly threw it aside.

Years later my mother came across it while spring cleaning. On her suggestion the stamps were revalued. Many had risen in price; some worth shillings, others pounds. Among a mixture of Great Britain many minor perforations, shades and errors were found.

## Pen-friends

I decided to specialise in English stamps. A stamp club introduced pen-friends with whom I exchanged the other items from my boyhood collection. To facilitate writing-up, I used good class exercise books for housing stamps. One contained Victorian,

Says R. Cantwell

another Edwardian issues and so on. Eventually these were transferred to a Stanley Gibbons album.

The following hints should prove useful to beginners. If using loose-leaf album or exercise book write name of country on title page. Briefly describe each stamp or set, i.e., date of issue; current or obsolete; catalogue value. Write in pencil to allow for alterations.

Never trim stamps no matter how irregular their edges. This applies particularly to imperforate specimens. Removal of the smallest fraction may render them worthless.

Use tweezers for sorting even the commonest stamps, so that later, when rarer varieties come your way, they won't suffer damage through mis-handling.



The Gay Venture Album, a Stanley Gibbons product, which can be recommended to the beginner

Continued from page 113

## Applications for Marquetry

The diagrams in Fig. 2 show how to make a box suitable for handkerchiefs or collars. The sides and ends can be butted as shown or mitred together. The bottom should go between the sides and ends and be glued in position. Small fretpins may be added for extra strength.

The lid will be the marquetry picture. The edges can be rounded as shown in the detail and it can be hinged to the box as shown. Use small butt hinges and let them into both the lid and the side. Countersunk screws should be used for

fixing. To keep the lid in position fix a small brass catch No. 6219, price 3d., from Hobbies Ltd., Dereham, Norfolk.

Complete the box by staining to match the border of the picture. Polish with white wax to give a semi-gloss effect. Add four small rubber feet underneath to prevent it from marking the furniture. They can be obtained from Hobbies Ltd., price 5d. for 4.

(M.h.)

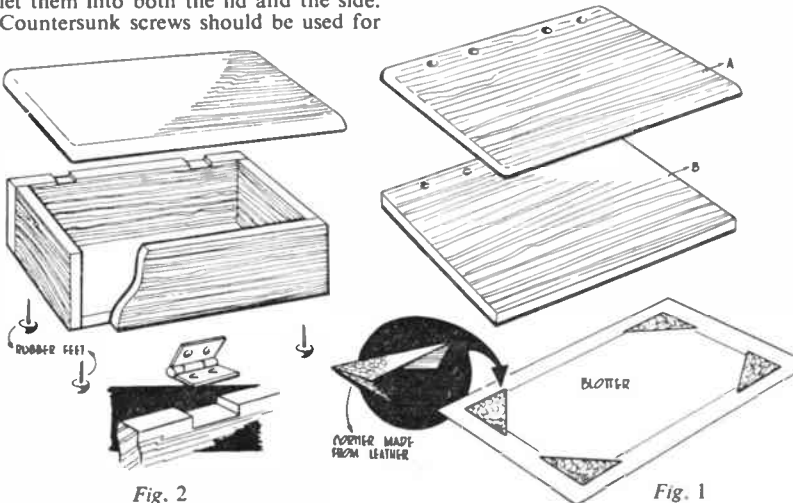

Fig. 2

Fig. 1

There is only one way to mount stamps—with hinges. Any other method of fixing causes irreparable damage. When buying stamps refuse any but perfect copies, free from cuts, tears, stains or finger-marks.

Unused stamps should bear original gum, unsmudged. Those used should be lightly post-marked with perforations intact. Margins of imperforate copies should be sufficiently wide to prove they are not perforated specimens cut down.

Despite their drabness English stamps are of absorbing interest. Innumerable water-mark varieties, minor perforations and shades and printing errors have made many of them valuable.

Philatelists abroad are ever willing to exchange them for stamps of their own country. Therefore, overseas pen friends are worth seeking. There's always a chance of sharing other hobbies and gaining interesting knowledge of the country concerned.

Stanley Gibbons stamp albums can be obtained from all branches of Hobbies Ltd., or direct from Hobbies Ltd., Dereham, post free. They are: 'Gay Venture' 2/6, 'Improved' 5/- and 7/6, 'Fanfare' 10/6 and 'Swiftsure' 15/-. Also obtainable are stamp hinges (8d. packet), gauges 9d., magnifiers 1/- and tweezers 1/3.

The 'Swiftsure' is ideal for use by those whose collections are ever-growing. Loose leaves can be supplied to add to the album, costing 2/6 a packet of 25

Make it — then solve it!

# THE BRAMAH PUZZLE

By A. F. Taylor

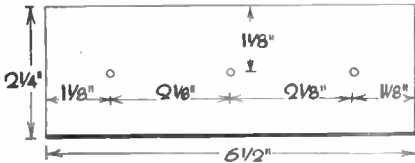
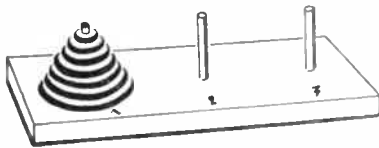

**T**HIS extremely old puzzle is just the thing with which to entertain your friends. Its successful accomplishment demands a certain amount of patience and it is an excellent test of ingenuity.

For a lonely person it can give many hours of amusement, while with several people an interesting game can be played, the winner being the one to solve it in the least number of moves.

## Eastern origin

The puzzle is, undoubtedly, of Eastern origin, but there appears to be two claimants for that honour. The title suggests that it had its birth in India, but it is also known by another name—'The Tower of Hanoi', which gives it a certain Chinese flavour.

The puzzle consists of seven circular discs of increasing diameter from the smallest at the top down to the largest at the bottom. These are slipped over a peg on a baseboard which has two more empty pegs as shown in the sketch.

The puzzle is to transfer all the discs from peg No. 1 on the left to peg No. 3 on the right and in the same descending order. There are, however, two very important rules which must not be broken on any account—the discs must only be moved one at a time and a larger disc must never be placed on top of a smaller one. They may be moved backwards or forwards as much as you like, using the centre peg to facilitate the process, provided the two rules are strictly observed.

## Dowel 'Posts'

Cut the baseboard from a piece of hardwood 6 1/2 ins. long, 2 1/4 ins. wide and 1/2 in. thick, and drill three holes along the centre to take 1/2 in. dowel rods. Holes 1 and 3 are 1 1/8 ins. from the ends with No. 2 in the centre. Into these securely fix dowel rods 2 1/2 ins. long, so as to project above the board 1 1/8 ins. Round

off the tops so that the discs will slip over easily.

The discs may all be cut from the same kind of wood, or, to make a more attractive puzzle, two different colours can be used, placing them alternately. They are all cut from 1/2 in. wood and have a 1/2 in. hole in the centre. The top disc is 1 in. in diameter and each succeeding one is 1/6 in. larger, therefore, the seven discs will be 1 in., 1 1/6 ins., 1 1/3 ins., 1 1/2 ins., 1 2/3 ins., 1 5/6 ins., and 2 ins.

Glasspaper all quite smooth and see that the discs slip over the dowels easily. The wood may be left in its natural state or finished off with french polish or varnish.

It would be impossible in this short article to give all the moves necessary to transfer the discs from one side to the other, but we give a few opening ones in order to explain the method. To facilitate this we will number the pegs 1, 2, and 3, while the discs from smallest to largest will be A to G.

## The Moves

Move A to 2, B-3, A-3, C-2, A-1, B-2, A-2. Continue with D-3, A-3, B-1, A-1, C-3, A-2, B-3, A-3. At this stage we have now transferred the four top discs from peg 1 to peg 3, and having grasped this, it is quite easy to continue with the remaining three. The puzzle can be done with less or more discs as desired, but with more than 10 it becomes much more complicated and takes a considerable time to do.

## A Gem — With a 'Gem'



Geoffrey Walker of The Flags, Cartmel, Grange-over-Sands, aged 11 1/2 years, with the model farm he made with his Hobbies Gem fretmachine. For the third year in succession he has won First Prize at Cartmel Show for handicrafts for boys under 15. This year he was also awarded the Third Prize by The Young Farmers' Club. This covers all entries in the Show up to 25 years—a grand effort considering

there were very large entries in some classes.

Geoffrey's fretmachine is a constant source of pleasure to him, and he spends hours with it in winter time.

A 'Gem' makes an ideal present and at £5 5s. is real value for money. The Editor will be pleased to send details of this and other machines which can make your work so much easier.

## Step-by-step wiring for the

# FOUR-VALVE SUPERHET

**W**iring may now be started. 22 gauge plastic-covered connecting wire, single or stranded, can be used, or, alternatively, tinned copper wire with sleeving slipped over it. For connections to the coils from the switch, different colours are very helpful, to avoid confusion. These will be dealt with in due course. Proceed by the step by step instructions and clarify these by reference to the wiring diagram.

Deal first with the negative ends of the valve filaments:—

1. Join tag 1 of V1, V2 and V3 to the chassis by means of an adjacent nut and bolt.
2. Join tag 5 of V4 to chassis, similarly.

Now turn to the positive ends of the filaments:—

3. Join tag 7 of V1 to tag 7 of V2.
4. Join tag 7 of V2 to tag 7 of V3.
5. Join tag 7 of V3 to tag 1 and tag 7 of V4.

Before wiring the coils, attend to the variable condenser:—

7. Join 2½ in. leads to the bottom tags of the condenser which is mounted with nuts and bolts, passing the leads through the chassis holes. (Soldering tags should be fixed under the bolts on the under-side of the chassis.)
8. Join switch outer tag 5 to medium coil (5).
9. Join switch outer tag 6 to short coil (6).
10. Join switch outer tag 7 to medium coil (7).
11. Join switch outer tag 8 to short coil (8).

To complete wiring of aerial coils:—

12. Join tags G, G on medium coil to chassis bolt.
13. Join tags G, G on short coil to chassis bolt.

Now, deal with oscillator coils:—

CONCLUDED FROM  
LAST WEEK

14. Join free end of 27K (R1) to tag A on I.F. transformer number one.
15. Join free end of 27K to tag A on I.F. transformer number one.
16. Bolt medium-wave padder to chassis and join one tag to tag P on medium coil, and other tag to chassis by bolt.
17. Join one end of short-wave padder (C6) to tag P on short-wave coil, and other end to chassis.

We can proceed to complete the wiring of the oscillators:—

18. Bolt medium-wave padder to chassis and join one tag to tag P on medium coil, and other tag to chassis by bolt.
19. Join one end of short-wave padder (C6) to tag P on short-wave coil, and other end to chassis.

### The Transformers

The I.F. transformers may now be wired up as follows:—

First I.F. transformer:—

20. Join end B to tag 2 on valve one.
21. Join end D to chassis.
22. Join end C to tag 6 on valve V2.
23. Join end A to one end of 68K (R3) and tag A on I.F. transformer number two.
24. Join free end of R3, and one end of .1 condenser (C10), to tag 3 on V2.
25. Join free end of C10 to chassis.

The second I.F. transformer:—

26. Join end B to tag 2 on valve V2.
27. Join end C to tag 3 on valve V3.
28. Join end D to ends of .0001 (C13) and 47K (R4).
29. Join free end of C13 to chassis side.
30. Join free end of R4 to outer tag on volume control.
31. To the same tag, join .0001 (C14), and join the other end of the condenser to the other outer tag on the volume control.
32. Join this last outer tag to chassis.
33. Join centre tag on volume control to one end of .01 (C15), and join the other end of this condenser, together with an end of 10M (R8), to tag 6 on valve V3.
34. Join free end of R8 to tag 1 of V3. Note that the lead from centre tag

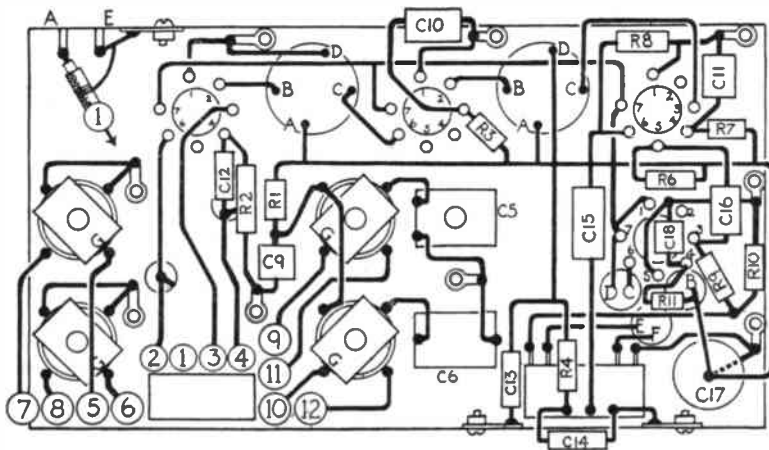

Fig. 2—Wiring diagram

6. Join 5 ins. of yellow-covered wire to tag 7 of V4, and pass through hole in chassis. (This is lead D (yellow).)

Remember, all wires should be insulated, and ultimately soldered to their connections. All holes in the chassis, through which wires pass, should have rubber grommets set in.

The connections between switch and coils are clarified by the diagrams, the numbered coil leads being joined to their appropriate numbered tags on the switch. Starting first with the aerial coils, it is helpful to have these leads differently coloured to those of the oscillator coils. (If possible, all the leads should be differently coloured to avoid confusion.)

14. Join switch outer tag 12 to short coil (12).
15. Join switch outer tag 11 to medium coil (11).
16. Join switch outer tag 10 to short coil (10).
17. Join switch outer tag 9 to medium coil (9).

Before completing the oscillator coils, return to the switch:—

18. Join switch centre tag 2 to condenser lead projecting through chassis, and then join to tag 6 on valve one.
19. Join switch centre tag 3 to tag 3 on V1.
20. Join switch centre tag 4 to other condenser lead through chassis, and thence, through mica con-

volume control can be of screened wire, as can the lead from D on transformer.

The switch can now be completed:—

43. Join a lead to the bottom left-hand tag on the volume control, and join the other end of this lead to ends of 2.2M (R9) and 560Ω (R10). Let the other ends of the resistors hang free for the time being.
44. Join a black-covered lead to the bottom right-hand tag on volume control, and pass this through the chassis. (F lead.)
45. Join a blue lead to top left-hand tag on volume control, and pass it through chassis. (E.)
46. Join a lead to top right-hand tag of control, and join this, together with negative end of 4 mfd. condenser (C17) to bolt on chassis.
47. Join tag 5 on valve four to chassis bolt, and to same bolt, join free end of resistor 560Ω (R10).
48. Join free end of other resistor 2.2M (R9), and one end of C16 (-01), to tag 3 on V4.
49. Join a white lead to tag 6 on V4 and pass through chassis. (Lead C.)
50. Join one end of R11 (18K) and one end of C18 (-25) to tag 4 on V4, and the other end of C18 to chassis bolt.
51. Join free end of C16, and one end of R6 (1M), to tag 5 on V3.
52. Join ends of C11 (-1) and R7 (3.3M) to tag 4 on V3.
53. Join free end of C11 to chassis, and free end of R7 to free end of R6 (1M).
54. Join the junction of these two resistors to the positive end of C17 (4 mfd.).
55. To same end of condenser C17, join free end of R11, and pass a red lead from this joint through the chassis hole. (Lead B.)
56. Make a further connection at the junction of R6 and R7 again, and join to tag A on I.F. transformer number two.

To complete the under-chassis wiring:—

57. Attach aerial and earth sockets strip, and join earth socket to bolted tag on chassis.
58. Join aerial socket to tag 1 on wavechange switch. Use screened wire, the metal covering of this being joined to chassis (i.e., earthed).

The chassis may now be turned over. Mount the output transformer in a convenient position, and also the H.T. and L.T. batteries.

A metal clip can be fashioned to hold the H.T. battery, while a broad elastic band, or a strip of insulating tape, will hold both batteries together. The connections to the L.T. cell can be held

New Readers who missed last week's issue containing the first part of this article on making a four-valve superhet by A. Fraser can obtain a copy (6d. post free) from the Editor

fast by a similar band passed round the length of the cell.

Connect leads as follows:—

59. Join white lead (C) to one end of the input winding of the loud-speaker transformer.
60. Join other end of input winding to H.T. positive.
61. Join red lead (B) to H.T. positive.
62. Join black lead (F) to H.T. negative.
63. Join yellow lead (D) to L.T. positive.
64. Join blue lead (E) to L.T. negative.
65. Join output leads of transformer to the loudspeaker.

The provision of tuning control, dial and cabinet is left to the reader. They can be bought or made. Slow-motion tuning, either epicyclic, or drive spindle and drum is advisable. A metal dial is cheap and a good investment.

When everything is set up, the alignment should be undertaken. If you have decided to do this yourself, put the receiver oscillator out of action by connecting a .1 mfd. condenser between oscillator grid (tag 4) of valve one, and the chassis. Then join the generator output to tag 6 on valve one, and the earth lead to the earth socket of the set. Tune to 465 kcs. on the generator, and trim the I.F. transformers, starting from the second one. Repeat until satisfied.

Then remove the generator lead from tag 6 and insert in the aerial socket of the set. Remove also the .1 condenser over the oscillator.

Set both generator and receiver to 250 metres and adjust the trimmer condenser on the medium oscillator coil for maximum response. Then trim the condenser on the aerial coil.

Next, set both generator and receiver to 500 metres, and adjust the padder condenser situated on the chassis. Revert, then, to 250 metres again, and

retune. Then retune at 500 metres again. Go on doing this until satisfied. Finally, adjust the aerial trimmer.

The short wave is treated similarly, using various dial settings. In this case, only the trimmer is adjusted, as the padder is fixed. However, padders of slightly different values may be tried out.

Where pre-aligned transformers are used, and no generator is available, one must align the circuits by setting the dial at chosen stations and tuning in the signal by trimmer adjustment as before. Suitable stations are the Light and the Third. The short wave is not so easy, as the stations are not so quickly identified; but once they are, it is straightforward.

As stated before, all this trimming and padding is avoided by the use of separate tuning condensers.

One further note. If no response occurs, it is probable that the feed-back winding on the oscillator has been connected wrongly. Reversing the leads to the smaller winding will put matters right.

The oscillators must not be allowed to interact with the aerial coils, so if these is any trouble, erect a metal screen between them. This is easily fixed with a bolt.

If home-made coils are used, paxolin formers of lin. diameter can be employed, about 2½ ins. long.

For the medium wave, wind on the turns side by side, using 34 gauge enamelled wire. The main winding should be lin. in length. Leave a space of ½ in. or so, and wind on ½ in. for the coupler. The distribution of the ends is seen in the drawings.

For the oscillator coil, wind on .6 in. for the main winding, with ½ in. for the feedback. These windings should be close to each other. Use 24 gauge wire for the short waves, and space the wire one diameter of the wire apart. For the aerial coil, wind 6 turns, and 3 turns for the coupler, spacing them ½ in. or so apart. (These will cover the 16 to 50 metre band.) For the oscillator, wind 5½ turns for the main winding, with 2½ turns for feedback. These should be close together.

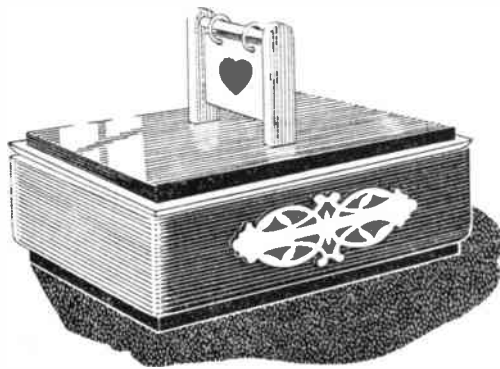

## MADE IT YET?

This is the design piece for Hobbies 1956 Competition. Entry is FREE and prizes are valued at £200. Full rules and instructions for making this novel trump indicator in which can be incorporated a musical movement appeared in Hobbies Weekly, 14th Sept. Send 6d. to the Editor for a copy.

For photographers

# An Archway — a Picture

By E. G. Gaze

**A**RCHWAYS—from roofed gateways to miniature tunnels formed by an upper storey over a courtyard entrance—are visually attractive. It may be that they attract because they frame a view, and natural curiosity prompts most of us to look through to discover what more we shall see. More often, they attract us by their combination of uprights and curves, weathered stone-work and worn cobbles. All provide photographic picture-making qualities.

beyond the opening—probably brightly lit as is the outside form of the arch—will occupy a central, eye-holding, place of interest in the print. Such an area of bright high-light on the print will detract interest from the more subdued play of light and shadow within the archway or passage.

Furthermore, it is often preferable to set your focus so that the arch and its

brightness is lessened. Toning-down is achieved by shading the remainder of the image in enlargement while giving longer exposure to the light area.

Exposure with archways is generally a compromise. In dull or cloud-diffused lighting it is fairly safe to base your exposure speed on that required for the main shadow area; but, a low contrast range of lighting produces a result which lacks sparkle.

In strong lighting conditions, however, the contrast range may be too great, the outside of the arch and the scene beyond may be brightly lit, whereas within the archway little direct sun-light may penetrate. To expose for the shadows will give you over-exposed high-lights, which are dense and difficult to print with detail; to expose for the high-lights will give thin, detail lacking shadows, difficult to prevent from printing a deep, uninteresting black.

A general adage is to expose for the shadows and let the high-lights look after themselves, and to balance the contrast by shading during enlargement. But with the strong contrast within and without an archway you need a compromise to get the best printable negative.

## Compare exposures

In general, provided you are not using the arch-shape merely as a frame to a distant view, you will need good, printable detail within the shadows themselves. To achieve, the type of developer you use, the sort of negative you like best for enlarging, the grade of paper you normally use for printing—all play their part in the final result. There is no firm substitute for experience based on your own experiments to obtain the effect you like. But as a starting point for your experiments, an exposure based on slightly less than half that indicated for the main shadow area, with slightly increased development time, will, in general, give good, printable negatives. But, on your first well-lit archway, make one or more exposures slightly above and below this starting point to compare the negatives. From this you have a basis for assessing future exposures for similarly well-lit archways, to produce the negative which suits you best.

Figures have three uses in photographing archways: they give proportion to the size of the arch, they add human interest to a static scene, and they can be used to counterbalance areas which you wish to subdue.

The first two uses need no comment, except to keep the figure impersonal to



*Use of impersonal figure to counter-balance the eye attraction of background through the far opening of passage way*

Here are some tips to get the best from them.

Avoid the central view. A viewpoint off-centre will reveal unequal proportions of detail and light and shadow, which give 'roundness' and 'depth'. A central position will tend to concentrate the interest of the final print, right through the opening to what lies beyond. This effect is only desired when you use the arch-shape as a mere frame for the distant view. Unequal proportions of detail and of light and shade keep the interest within the archway—as in illustration No. 1.

Snapping your archway from the centre will mean, too, that the scene

interior are sharply defined, whereas the distant scene beyond is slightly off-focus. This adds to the impression of depth and lessens the interest of the background. It helps to ensure that interest is concentrated on the main subject, the archway itself.

Snapped off-centre, use is made of unequal proportions of detail and tone within the passage-way. The area of comparatively brightly lit background through the far opening is reduced in size, and also thrown slightly off-focus to avoid clear distracting detail competing with that of the arch. This area of background is toned down in enlarging so that its eye-catching

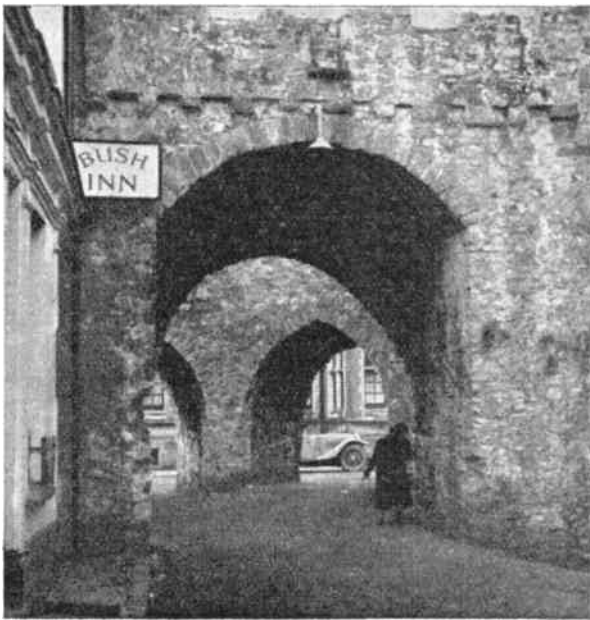

*Unequal proportions of light and shade within the archway*

avoid making it the centre of eye-catching interest and detracting from the arch itself. Thus, darkly clothed figures walking away from the camera are usually preferable. They should not be in a conspicuous position.

Figures used as a counterbalance are equally straightforward. Sometimes the depth of field required in focusing to give

sharp detail from your viewpoint to the far opening, means that intentional blurring of the distant background is not practical.

It follows that if that background is brightly lit, and sharp in detail, it will catch the eye, leading it through the arch straight to the background, ignoring your main subject, the arch and passage-way completely.

A figure, impersonally back to camera, caught just before or just inside the entrance will cause the eye to pause, and dwell on the arch-interior before passing through to the far opening and background. This may sound complicated, but our first illustration will clarify it. Sunlight and shade and the quaint form of the courtyard passage originally caught the eye of the photographer. Cover up the figure just entering the arch and the eye speeds its glance straight to the brightly lit, detailed background through the far opening. The figure here acts as a balance, causes the eye to pause, and then dwell longer on the main subject, the passage-way.

It's quite simple in practice, particularly if you have a friend who will oblige, if not, a little patience will often be rewarded with a complete stranger who, having passed you, is completely unaware of being snapped and thus not camera conscious.

To sum up:

(1) a taking position off-centre is preferable unless you use the arch-shape as a mere frame to a distant view.

(2) Concentrate on rendering the arch detail sharp in shadow and high-light areas and counteract an obtrusive background by

- (a) adjustment of focus to blur it slightly, and/or
- (b) subdue its tonal value in printing, and/or
- (c) make use of an impersonal and inconspicuous figure placed to give proportion to the archway.

# A Handy Tool for Extracting Staples

*By A. F. Taylor*

THE task of removing old staples without damaging the surrounding wood or plaster can be quite a problem and often calls for a certain amount of skill and ingenuity. When using pliers it is generally necessary to lever them out and this often means denting or scratching the near-by surface however carefully you try to do it.

With the aid of a simple little tool, however, the job is made very easy and the tightest staple can generally be removed without doing any damage whatever. It can be made quickly from material to be found in the junk box of most handymen. Doubtless, many other uses will soon be found for it.

The tool consists of a metal rod with a hook on one end, while most of the remainder is threaded so that a nut can be screwed on to it. This is put into a 'bridge' and placed over the staple with the hook under the staple loop as shown in Fig. 1. When the nut is tightened the staple will be drawn out quite easily.

The screw and hook should be made of mild steel or iron, and if any difficulty

is experienced in turning over and making a neat hook, a cheese-headed screw can be used for the job. The top of the head is filed down to remove the slot and then the sides cut to the shape shown by the dotted lines in Fig. 2.

Two different shaped hooks are given in Fig. 3—(A) being a straightforward pattern, while the barb in (B) will hold the staple very securely during the drawing operation.

The size of the screw will depend on the size of the staple, but for most general purposes  $\frac{1}{4}$ in. Whitworth or the equivalent size in B.A. (about 4 B.A.) will be found about right. An ordinary nut may be used, but as this will require a spanner to tighten it up, it is quicker and more satisfactory to fit a wing nut.

The 'bridge' consists of a substantial metal plate about  $1\frac{1}{2}$ ins. long and  $\frac{1}{2}$ in. wide with a block of wood screwed to each end to raise it sufficiently for the staple to be drawn easily. For small work  $\frac{1}{4}$ in. to  $\frac{1}{2}$ in. should be enough for this. Drill a hole in the plate just large enough for the screw to slide in easily.

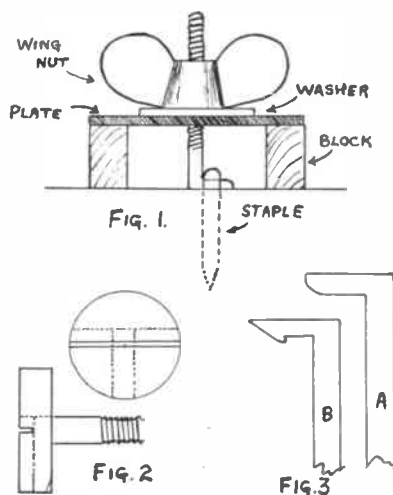

# A PICTURE IN WOOD RELIEF

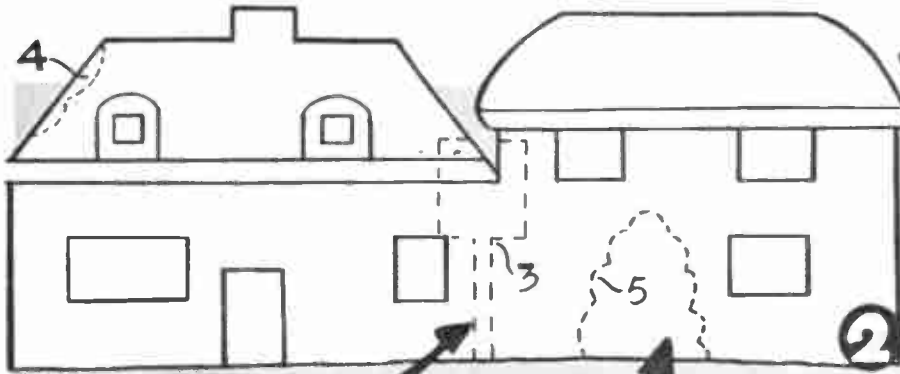

	DARK
	MEDIUM DARK
	LIGHT
	MEDIUM LIGHT

MAKE UP PIECE 2 FROM THE FOUR COLOURED WOODS BEFORE GLUING TO THE BACKGROUND

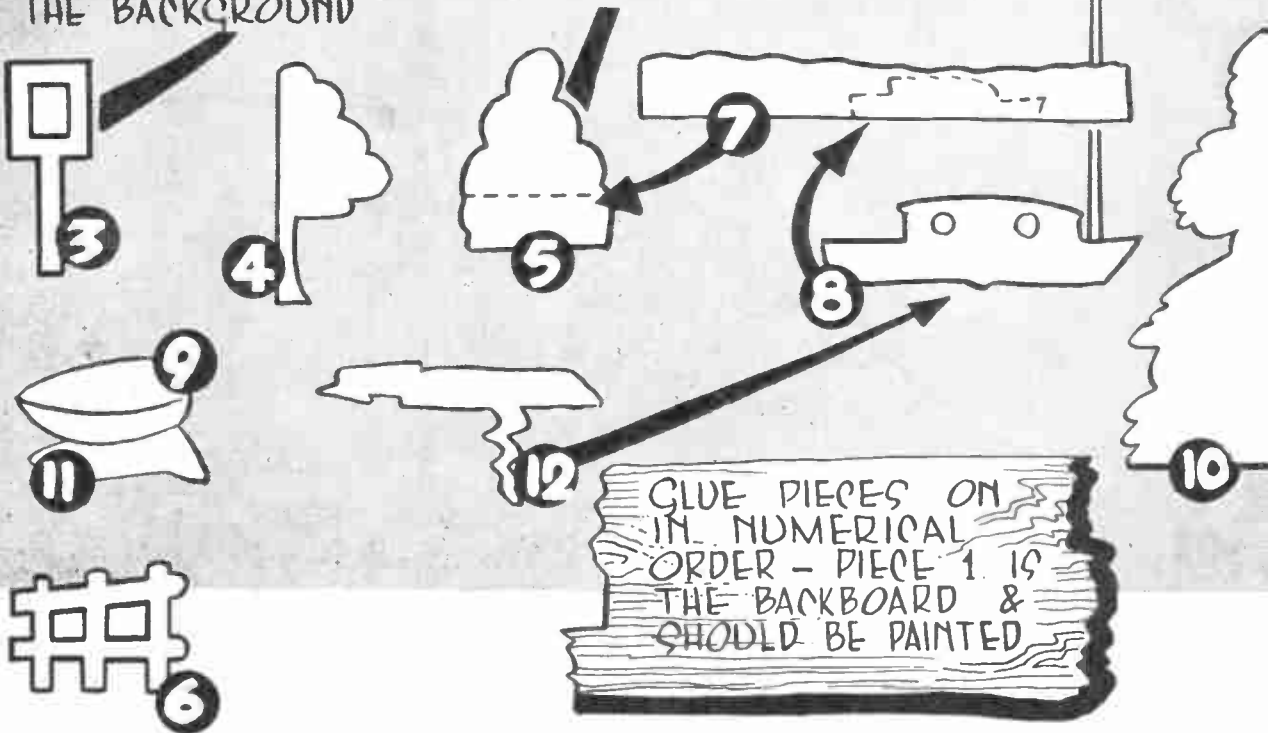

GLUE PIECES ON IN NUMERICAL ORDER - PIECE 1 IS THE BACKBOARD & SHOULD BE PAINTED



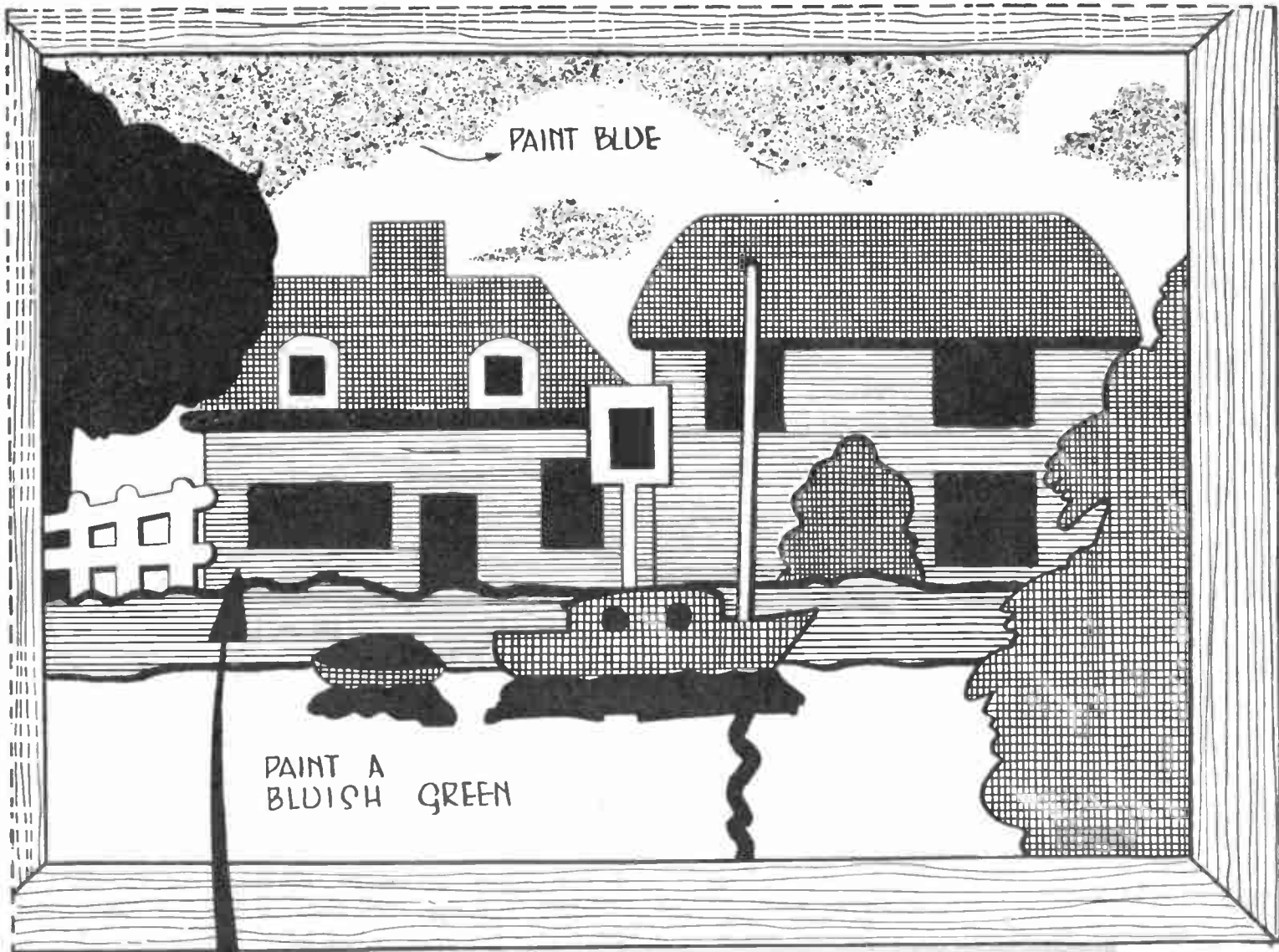

PAINT BLUE

PAINT A  
BLUISH GREEN

Display your specimens—

# MAKE THIS SHOWCASE

**M**ANY of our readers, no doubt, go in for preserving eggs, butterflies, moths, etc., and yet have not a suitable showcase in which to display them. This can be remedied by making the case shown. It measures 20ins. by 15ins., but, of course, it may be larger or even smaller than this if desired. The construction, however, can be the same.

lid frame is made up of four rails simply halved together at the ends and glued and strengthened by

An interesting project  
for the collector

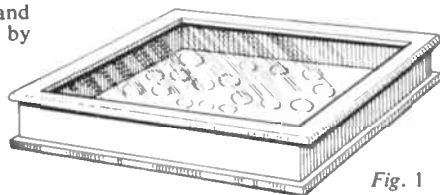

Fig. 1

adding flat brass angle plates screwed on underneath at each corner.

Fig. 5 shows a sectional view, with also a detailed cross section (I, J) being the lid frame and (K) strips mitred and glued on underneath to form the rebate for the glass. The glass is shown as (M) and to hold it in place four small beads (L) are mitred at their ends and glued or pinned to the frame. Take care that the rebate strips (K) fit tightly into the frame sides. Hinges could be fitted to the lid and frame if desired.

The lid frame should be made to the same outside measurements as the base but to a smaller section of wood, of course. The inside of the case should be painted with eggshell black or ordinary matt-black paint, and the outside finished in dark stain and varnish or painted to any desired colour. (S.W.C.)

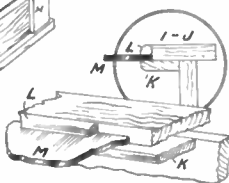
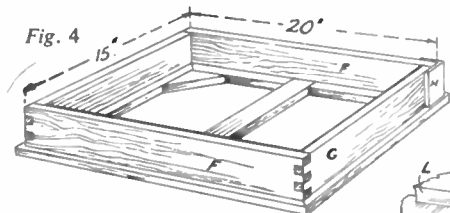

Fig. 5

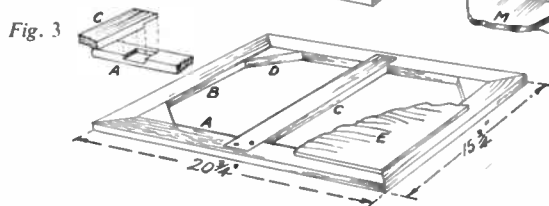

Fig. 2

The kind of wood does not matter much, but a good hardwood such as oak would be best. If this is not available ordinary straight-grained deal or pine would answer the purpose.

## Cut Mitres Carefully

First make a flat base as Fig. 2. Cut the four mitres of the rails carefully to 45 degrees, and cut in the recess in the long rails (A) for the cross-rail (C). The method of cutting these are given in Fig. 3. Glue all the parts together and add screws at the ends of the rail (C). Add the four blocks (D) which will help to strengthen the frame.

Now the case or frame may be made to almost any reasonable depth, but we think a clear depth of about 3ins. to 3½ins. inside, from floor to glass, would be sufficient. The four sides of the frame, being about ¾in. to 1in. thick, should be pin-jointed and glued together as shown in Fig. 4 and then glued and screwed to the base. If it is desired to hide the joints of the corners of the case, narrow pieces of thinner wood may be shaped and mitred and glued on as shown in Fig. 4.

The floor of the case fits down inside the frame, and may consist of ½in. plywood. Take careful measurements and cut round with the fretsaw and then glue and screw it to the base-rails. The

## A Sleeve Ironing Board

Make it for  
mother as a  
big surprise

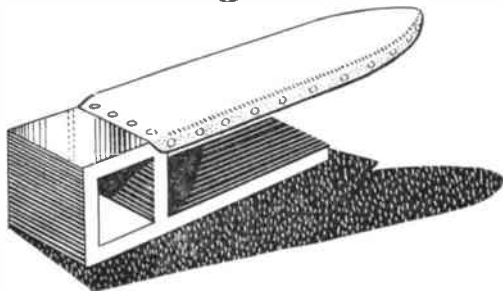

**T**HIS addition to the ordinary ironing table is a straightforward job for the young fretworker. It is sure to make a pleasing gift for mother.

There are only four parts to cut and these are ripped to the required width of 5ins. with a handsaw. Piece (A) is 24ins. long, (B) 18ins. long, (C) and (D) 6½ins. long. All the pieces are cut from ¾in. thick wood.

Note that pieces (C) and (D) are let into both (A) and (B). Make sure that these joints are a good fit in order to keep the whole sleeve board rigid.

When you have cleaned up the parts, glue them together and add screws or nails where necessary. Shape the front

edge as indicated by the section and give two or three coats of brush polish.

The final step is to cover part of the board with material. Two or three thicknesses of an old blanket will give

Patterns shown  
on page 127

sufficient padding. The covering material should be white, and is held in place all round by small brass drawing pins which can be easily removed when the material needs washing or renewing.

(M.p.)

## YOURS for only 15/- down!



Save time and work on sewing jobs with this excellent 'Essex' Miniature Sewing Machine. Beautifully finished with chromium plate. Supplied with clamp for fixing firmly to table. 6 months' guarantee. Cash price £4.17.6 or 16/- deposit and 6 monthly payments of 16/6. Electric model available A.C./D.C. with foot control £10.3.4, or 31/- down and 6 monthly payments of 32/-. Protective carrying case 18/4 extra. Send for leaflet today.

## ELECTRIC PAINT SPRAYER



for 4/-  
deposit

Cash 75/-. Or 4/- deposit and 6 monthly payments of 13/6

Paint easily, evenly, twice as fast with the Burgess Electric Sprayer. Sprays paint, varnish, etc. Complete with sturdy glass container, flex, nozzles for ceiling spraying and extra nozzle discs for different liquids. A.C. mains - state your actual voltage. Fully guaranteed. Also Horvill Electric Paint Stripper 30/- cash, or 4/- deposit and 3 monthly payments of 10/-. Leaflets free

## PHILISHAVE 14 DAYS' FREE TRIAL



Try the wonderful Philishave Electric Dry Shaver FREE for 14 days. Send only 5/- deposit (returnable if not satisfied). Two shaving heads with two 6-bladed cutters have unique rotary action which genuinely shaves - doesn't just snip at the hairs. Result - better, quicker shave. Operates 110/250 volts. A.C. D.C. £7.14.2 cash less your deposit. Or 5/- deposit can be first payment, followed by 8 monthly payments of £1.0.6. 12 mths' guarantee. Brochure of this & other shavers free.



**BATHROOM  
SCALE  
BARGAIN**  
★FOR 5/-  
ONLY

★ and 6 monthly payments of 13/4 (or Cash Price £3.11.6)

WATCH your WEIGHT every day with this streamlined Bathroom Scale. Magnified dial easy to read. Weighs accurately from 1lb. to 20st. Lovely white enamel finish. Non-slip plastic mat. All mechanism enclosed. 2 years' guarantee. Cash £3.11.6, or 5/- dep. and 6 monthly payments of 13/4.

# LOOK! THE BASIS OF A MAGNIFICENT HOME WORKSHOP for only 6/- deposit **Wolf Cub** 1/4" DRILL

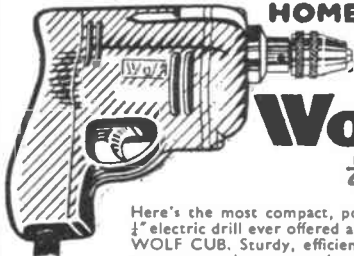

Here's the most compact, powerful and fully guaranteed 1/4" electric drill ever offered at such a popular price - the WOLF CUB. Sturdy, efficient and reliable, it's the first step to owning a complete home workshop, and the power unit for all Wolf Cub Sets. Drilling capacity: Mild Steel 3/16"; Hard Wood 1/8"; with 210 watts input on full load. Complete with 3/16" three-jaw chuck and Allen key and 5ft. of cable. T.V. suppressed. State voltage.

Cash price for Drill is £5.9.6 or only 6/- deposit and 6 monthly payments of 19/6. ALSO

Sanding and Polishing Kit (drill, discs, etc.): £6.10.6 or 19/- deposit and 6 monthly payments of 21/-.

Saw Kit (including drill): £9.17.0 or 20/- deposit and 8 monthly payments of 25/-.

Fretwork Kit (including drill): £10.10.6 or 21/- deposit and 8 monthly payments of 26/6.

Lathe Kit (Drill and Tools): £10.10.6 or 21/- deposit and 8 monthly payments of 26/6.

Home Workshop Outfit (drill, saw, lathe, sanding and polishing kits): £16.17.6 or 40/- deposit and 8 monthly payments of 41/6.

No. 5 Saw Set: £3.1.6 or 4/- deposit and 6 monthly payments of 10/6.

No. 10 Bench Planer Set: £3.13.6 or 6/- deposit and 6 monthly payments of 12/6.

No. 8 Fretsaw Set: £3.15.0 or 10/- deposit and 6 monthly payments of 12/6.

Send at once for full details, including a profusely illustrated and informative leaflet.

## BARGAIN DISTRIBUTORS (Dept. 124), 5 Silver Street, Luton

## NEW! EXPERIMENTAL KITS

### LEARN THE PRACTICAL WAY

Here is home study of the most effective kind under expert tutors. There is no better way of studying for an examination, starting a new hobby or for a career in industry. These special courses comprise the most modern methods of postal tuition, combined with a Practical Kit of parts (which remains your property).

#### COURSES FROM 15/- A MONTH

COURSES WITH PRACTICAL EQUIPMENT INCLUDE: Radio, Television, Mechanics, Electricity, Chemistry, Photography, Carpentry; also Draughtsmanship, Commercial Art, Amateur S.W. Radio, Languages, etc.

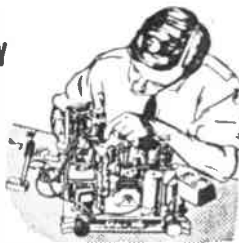

## TROPICAL SHELLS

for making these and hundreds of other attractive novelties. Illustrated leaflet and richly assorted exotically shaped and coloured shells.

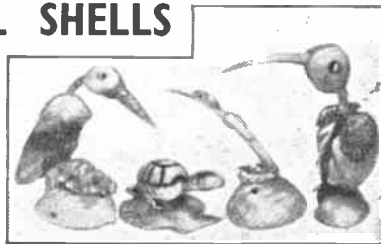

## Eaton

Parcels 1lb. 6/6 or 5lbs. 26/6  
Post free.

MANETTE STREET, Soho, London, W.1. Phone: GERrard 9391



### BRANCHES: LONDON

78a New Oxford St., W.C.1  
(Phone MUSEum 2975)  
87 Old Broad Street, E.C.2  
(LONDON Wall, 4375)  
81 Stratham Hill, S.W.2  
(TULse Hill 8796)

### GLASGOW

326 Argyle Street  
(Phone CENTral 5042)

Head Office & Factories—HOBBIES LTD., DEREHAM, NORFOLK

### MANCHESTER

10 Piccadilly  
(Phone CENTral 1787)  
**BIRMINGHAM**  
100a Dale End, Birmingham 4

### SHEFFIELD

4 St. Paul's Parade  
(Phone 26071)

### LEEDS

10 Queen Victoria Street  
(Phone 28639)

### HULL

10 Paragon Square  
(Phone 32959)

### SOUTHAMPTON

134 High St., (Below Bar)  
**BRISTOL**  
30 Narrow Wine Street  
(Phone 23744)

### POST THIS COUPON TODAY

For FREE brochure write: E.M.I. INSTITUTES,  
Dept. 31X, Grove Park Road, London, W.4.

SUBJECT(S) OF INTEREST \_\_\_\_\_

NAME \_\_\_\_\_

ADDRESS \_\_\_\_\_

30/11/55 \_\_\_\_\_

IC51A

## E.M.I. INSTITUTES

The only Postal  
College which is  
part of a world-wide  
Industrial Organisation

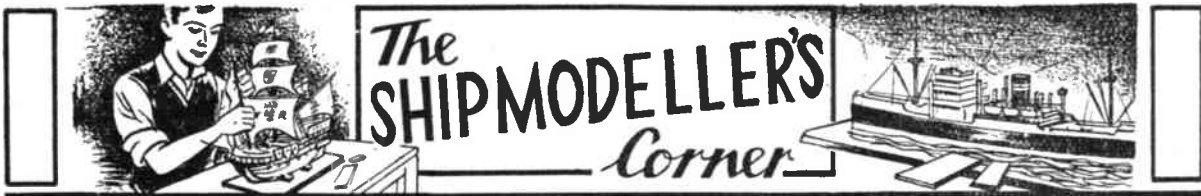

**I**N this article we will consider the methods used by experienced model makers as applied to deck houses. The finish and detail of these has a very great effect on the appearance of the finished model and will well repay the extra time spent in making them real miniatures of the prototypes.

In its simplest form the deck houses on a model are merely a block of wood cut to the exact dimensions and painted, if we use this simple method our biggest headache is to glasspaper all sides perfectly smooth without 'dubbing' the corners and spoiling the sharp, clean effect. To avoid this place a piece of fine glasspaper on a smooth surface and rub the block on the paper, gently doing all sides. Those with a lathe can use the small sanding disc and table as suggested in an earlier article on lathe tools.

## THE MAKING OF DECK HOUSES By 'Whipstaff'

windows and mark doors for painting, and after cutting the strip out, score along the dotted lines, bend round and glue to shape. Before cutting and adding the roof, glue thin Cellophane behind the windows to obtain the glazed effect.

Method two is for larger models. Using thin wood we cut the four walls and glue them together with butt joints, having cut out the window spaces first with a fretsaw. In this case we can improve the appearance by adding window bars. On the sides where the windows appear drill down with a fine drill through the edge above the window and into the window sill, afterwards driving small pins or wire according to scale to form the window bars; behind these bars glue in pieces of clear celluloid to form the glass of the windows as in Fig. 2.

### Super Finish

For those who like a super finish the joints in these walls can be joined as in Fig. 3, giving a very clean finish. This is a joint favoured by makers of fine jewellery boxes and leaves practically no end grain in view. It can be used with plain thin fretwood using X-acto or similar knives to cut the rebate, or it can be made in thin plywood by cutting away the two of the three sections.

For those making small block models with portholes in the sides here is a useful tip. Make a punch of the exact size of the portholes, from either a nail or a piece of steel rod. Gum on a strip of Cellophane, temporarily, and punch the portholes in. This will embed a circle of Cellophane in the porthole, giving a glazed effect.

In early ships, deck-house windows were fitted with leaded lights and to make these we need some old photographic negatives. First remove all the emulsion by washing it off in hot water and rubbing to loosen the coating. When clean, hang up to dry. Take the dry negative and rule in the lines with a pin, thus scoring them in slightly to prevent the ink running. Now draw the lines in with Indian ink. It only remains to cut

them to size and glue in the window spaces.

Fig. 4 shows a finished deck-house built from thin fretwood with Cellophane windows. Where decks are cambered we must curve the bottom of the deck-houses to fit the deck. This is easily accomplished by placing a piece of fine glasspaper on the deck where the fitting is to be placed, and rub the deck-house gently forwards and back-wards until the bottom is curved to fit the deck.

In making larger deck-houses we can be even more realistic. In one model I recently panelled the deck-houses by building up the body in the usual way and then adding the framework in very thin veneer strips, thus leaving the walls and doors with sunken panels as in Fig. 5. This type of work can be carried out in certain woods and polished where this finish is the one used in the prototype.

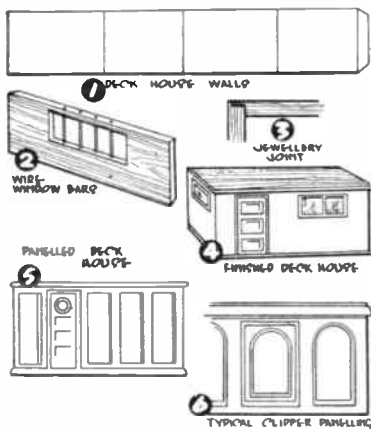

Another method, and one I prefer myself, is to use a flat file, placing the block on a flat surface and filing each face of the block in turn.

These block models can be improved by adding a roof that projects slightly over the sides. The roof can be cut from thin Bristol board and glued in place.

### Use Bristol Board

Bristol board can be used throughout for the building of a deck-house on small models and is really more suitable for this purpose than wood. Thin wood can be used for larger scale work.

To make a deck-house from Bristol board, draw out the four walls in a continuous strip as in Fig. 1. Cut out



*The Famous Bounty*

Fig. 6 shows the typical panelling of a clipper ship deck-house. In this case we cut two of each wall in either thin fretwood or Bristol board. One piece is left plain and the openings are cut in the second piece. The two are glued together to make the complete wall.

In the 'Cutty Sark' model from our kit I made the deck-houses as shown on the design sheet, glasspapered them down to slightly undersize and then cut walls in thin drawing paper with the openings cut out with a stencil knife. The paper walls were finally glued in position on the blocks. This was quite effective when painted. It has to be neatly done at this small scale but is well worth the effort.

In another article we will deal with the other deck erections—companionways, skylights, etc.

# ORDER BY MAIL AND PAY AS YOU USE—

SATISFACTION GUARANTEED OR MONEY REFUNDED

## ENDO NEON

### MAINS TESTER

Fountain Pen Size. Conveniently carried by the pocket clip. SIMPLE AND READY FOR USE. Protected by British and Foreign Patents' Tested to 250 volts. Demonstrates the live mains current with a glow through the top lens.

**CASH 12/6**

Post & Packing 1/6



## BURGESS VIBRO

### PAINT SPRAYER

FOR ONLY

**3/- DEPOSIT**

plus 2/- post & packing and 6 monthly pay'ts 13/4  
**CASH £3.15.0**



All-electric. Sprays paint, varnish, lacquer, light oils and insecticides. No tedious hand brushing. Just plug in and spray. State voltage when ordering.

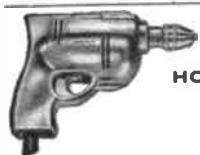

## Wolf Cub HOME CONSTRUCTOR ELECTRIC DRILL

Fitted with G.P.O. Approved T.V. Suppressor.

A beautifully efficient power unit for all home constructors, model makers and handymen. Takes all drudgery out of household repairs and construction jobs. With this as a basis you can soon build up a complete WOLF CUB Home Workshop. The Wolf Cub Drill drives all Wolf Cub Kits for Buffing, Vertical Bench Drilling, Fretsawing, Woodturning, Polishing.

YOURS FOR ONLY

**5/- DEPOSIT**

plus 2/- p. & p. 6 m'thly payments of 19/6

**CASH £5.9.6**

Drilling, Sawing, Wire-brushing, Sanding, Bench Planing, Grinding and Bench Sanding.

## THE No. 11 FLEXIBLE SHAFT SET

If you already own a Wolf Cub the No. 11 Set provides the means for intricate grinding, sanding, engraving, brushing, sawing and polishing. The No. 11 Set is comprised of a flexible shaft 3/32" collet, 1/8" collet, shaped grinding wheels, round burrs, cylindrical burr and pear shaped burr, rubber backing pad, felt bob, slitting saw, two arbors for felt bob and slitting saw-blade, packet and cup nylon brushes, plain of 12 assorted self-adhesive sanding discs.

**6/- DEPOSIT**  
plus 2/6 p. & p. and 6 monthly payments of 23/-  
**CASH £6. 10. 0**

Suspension bracket Part 10727 is available as an accessory to suspend the Cub for unrestricted movement of the shaft

## BRIDGES

### BENCH GRINDER, WIRE BRUSHING, DRILLING AND POLISHING KIT

COMPLETE WITH DRILL

FOR ONLY

**10/6**

DEPOSIT

plus 3/- p. & p. & 6 m'thly payments of 42/6

**CASH £12.1.3**

An engineer's standard general purpose kit. Enables user to carry out variety of wire brushing, grinding, polishing and drilling jobs on extensive range of materials. Toolpower 1/2" Drill ensures maximum efficiency eliminating laborious hand working.

COMPONENTS, Bridges 1/2" Drill Bench Stand — 4" Grinding Wheel — 4" Wire Brush — 4" Calico Buff — 4 High Speed Drills — Arbor Assembly — Paint Mixer and Stirrer — Polishing Compound.

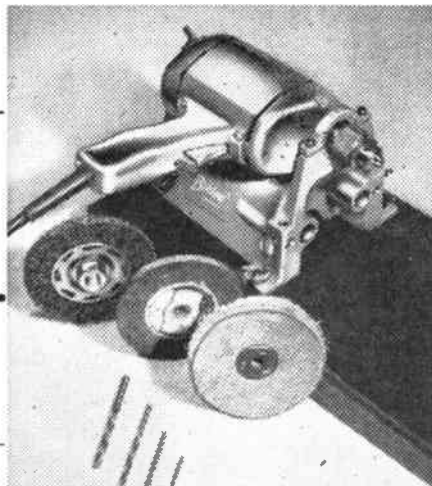

## THE

*Black & Decker*

## LATHE SAW TABLE

(For attachment to the Lathe Accessory.)

The B. & D. Lathe Saw Table is a robust and accurate saw table for cutting wood and a variety of other materials. The 5" blade cuts to a depth of 1 1/2", with rip fence adjustment up to 9" width. Automatic blade guard ensures safety. Supplied complete with Combination Blade.

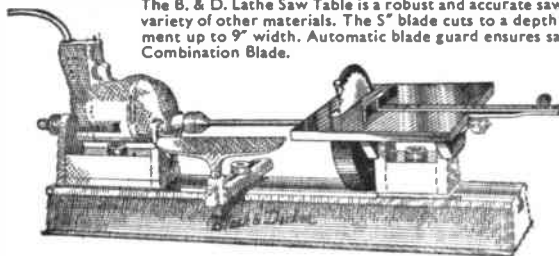

ONLY

**6/6**

DEPOSIT

plus 2/- p. & p. & 6 m'thly payments of 10/-

**CASH £3.0.6**

## CORONET LATHE

12 IN ONE UNIVERSAL WOODWORKER

ONLY **40/-**

DEPOSIT plus 10/- carriage & insurance & 6 m'thly payments of £5.0.0  
**CASH £29.0.0**

Accessories and Attachments can be obtained for the following operations: Turning to over 2ft. in diameter. Circular Sawing, Band Sawing, Belt Sanding, Disc Sanding, Buffing, Planing and Rebating, Tool Sharpening, Side and End Mortising, Spindle Moulding, Flexible Drive, etc. Height of Centres 4 1/2 ins. Distance between Centres 2ft. 9 ins. Weight (approx.) 1 1/2 cwts. Basic Equipment is Major CM500 Lathe complete Back and Prong Centres, large face plate, Long and Short Rests, complete and ready for bolting to bench. Also the popular "Home Cabinet" maker Lathe HCI £8.17.0 or on terms. Send for leaflets.

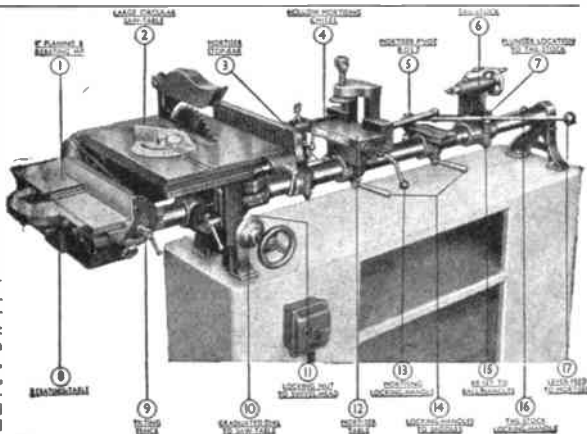

## LAFCO COMPOUNDS LTD (Dept. HW3)

3 Corbetts Passage, Rotherhithe New Road, London, S.E.16



Actually holds 4 boys A romantic ten thousand miles an hour trip to the Moon. Adventure galore for brave young pioneers to rush through space and be first on the Moon. Attractive coloured wind, rain, and element resisting material. Silver tipped. With Aerial. Large enough for four boys, the Scientist, Pilot.

Radio operator and 1 crew. Stands indoors or out-doors. 29/11, post etc. 1/6.

### THE NEW INTERPLANETARY SPACE SUIT

Only 12/11 POST 1/6 ETC. Be an Interplanetary Commando Officer. Wear this metallic blue Space Suit and pressure helmet. Be the first Earth Man to Jupiter. Can also be worn over outdoor clothing, guaranteed waterproof. For boys aged 4 to 12. Waisted and adjustable, visor on helmet. Lightning flashes on breast panel. State age for size. 12/11, post etc. 1/6. LISTS, TERMS.



### HEADQUARTER & GENERAL SUPPLIES LTD.

Dept. HOBW/80, 196/200, Coldharbour Lane, Loughborough Junction, London, S.E.5. Open all Saturday 1 p.m. Wednesday.

FREE—50 different stamps plus 10 San Marino mint, on requesting approvals.—P. E. Bentham, 40 Little Glen Road, Nr. Leicester.

9.5 M.M. Hire Service. List 3d.—Wayland, 219 Longley Rd., Tooting, London.

CHINA repairing. This fascinating and profitable hobby can be learnt successfully and inexpensively at home. Particulars from—The Chelsea Studio, 10 Blacklands Terrace, S.W.3.

100 DIFFERENT stamps free! Request 3d. upwards discount approvals.—Bush, 53 Newlyn Way, Parkstone, Dorset.

STAMPS — send for approvals to — Roy, 37 Lyndon Rd., Olton, Birmingham. Send 3d. stamp free gift.

A GRAND BOOK FOR ALL THE FAMILY. The "Kaylee Year Book of Bright Ideas". A really helpful guide to home planning, decoration, Hobbies, toys, etc. Showing famous Kaylee Transfers in brilliant colours, and most effective uses. From "Hobbies" stockists 1/- or direct.

KAYLEE TRANSFERS Postage 3d. LTD. (HW), Long Eaton, Nottingham.

CASTING moulds for lead soldiers, animals, cowboys, Indians, etc. Illustrated catalogue 4d. Sample mould 6/6.—G. Rhead, Bacton, Stowmarket, Suffolk.

RUSSIA 1955 Winter Sports. This magnificent set offered free to approval applicants enclosing postage.—Yulwontmor Stamps (Dept. H5), 29 Layton Avenue, Mansfield, Notts.

50 STAMPS free to all approval applicants enclosing 2½d. stamp.—Cliffe West (M1), 61 Wynyard Rd., Sheffield, 6.

TRY the approval service which offers free gift and bonus scheme. Details and sample selection by return.—Paragon Stamp Co., 138 Oakley Rd., Shirley, Southampton.

ALL components with instructions for slide-coil crystal set; tunes 200-550 metres; 4/-—Bailey's, 44 Stanley St., Oldham.

FREE—U.S.A. Commemorative packet to all collectors enclosing postage.—G. F. Bryan, 226 Cateswell Road, Birmingham, 11.

KUKLOS ANNUAL. Indispensable cyclist's handbook. Tours, resthouses, money-saving hints, 2/10, post free.—Burrow, Publishers, 2 Imperial House, Cheltenham.

PLYWOOD — HARDBOARD — at amazing low prices. Send S.A.E. for samples and prices to — N. Gerver, 10 Mare Street, Hackney, London, E.8.

PAINTSPRAYS' HANDBOOK (1954 Ed.). Covers Car, Industrial & Flock Spraying. 3/6, post free, including catalogue of our Cellulose and Synthetic Paints and all Allied Sundries and Plant Hire.—Leonard Brooks Ltd., 81 Oak Road, Harold Wood, Essex.

STAMPS FREE — Empire Packet including SPictorials and Victorians with approvals.—Robert J. Peck, 7A Kemp Road, Bournemouth.

SWISS MUSICAL Mechanism for cigarette boxes, etc., 16/6 post free. S.A.E. for illustration and list of tunes available.—Dept. HW., Metwood Accessories, Church St., Wolverton, Bucks. (Trade supplied.)

BUILD your own T/V and learn about its operation, maintenance and servicing. Qualified engineer-tutor available whilst you are learning and building. Free Brochure from—E.M.I. Institutes, Dept. HW.58, London, W.4. (Associated with H.M.V.)

GENUINE Swiss Musical Movements. Owing to large purchase now reduced to 14/6 each. Genuine Thorens Movements, all guaranteed, 19/3 each. P. & P. 9d. extra on all orders.—Richardson & Forder, 5 Chapel Place, White Hart Lane, London, N.17.

PLYWOOD; large sizes, 14 lbs. 10/- delivered (Express) C.W.O. — H. Leader (1920), Gosford St., Middlesbrough.



## with BRICKPLAYER

Brickplayer Kit 3 26s. 0d.  
Brickplayer Kit 4 48s. 9d.  
Kit 3A converting Kit 3 into Kit 4 .. 26s. 0d.

Brickplayer Farm Kit 58s. 3d.  
2000 Bricks Box 55s. 0d.

Extra Bricks, Roofing and Cement in low-priced packs.

Windows and Doors obtainable singly.

### BRICK AND MORTAR BUILDING KIT AND ACCESSORIES

The Brickplayer Kit contains miniature bricks in all required shapes, mortar, roofing, plastic windows and doors, plans and instruction booklet. All models are architect designed to 'O' gauge scale.

Buildings can be permanent or dismantled by merely soaking in water and the bricks used again and again. Obtainable from good toy shops and departmental stores.

If your dealer cannot supply, write for leaflet and address of nearest stockist to:

J. W. SPEAR & SONS LIMITED

Dept. 'HW', Enfield, Middlesex

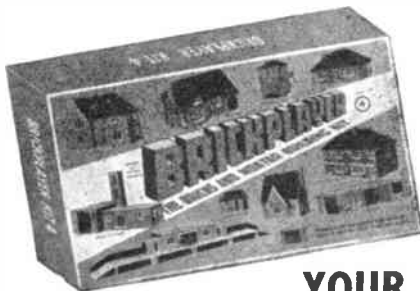

## YOUR IDEAL XMAS GIFT

# SLEEVE IRONING BOARD

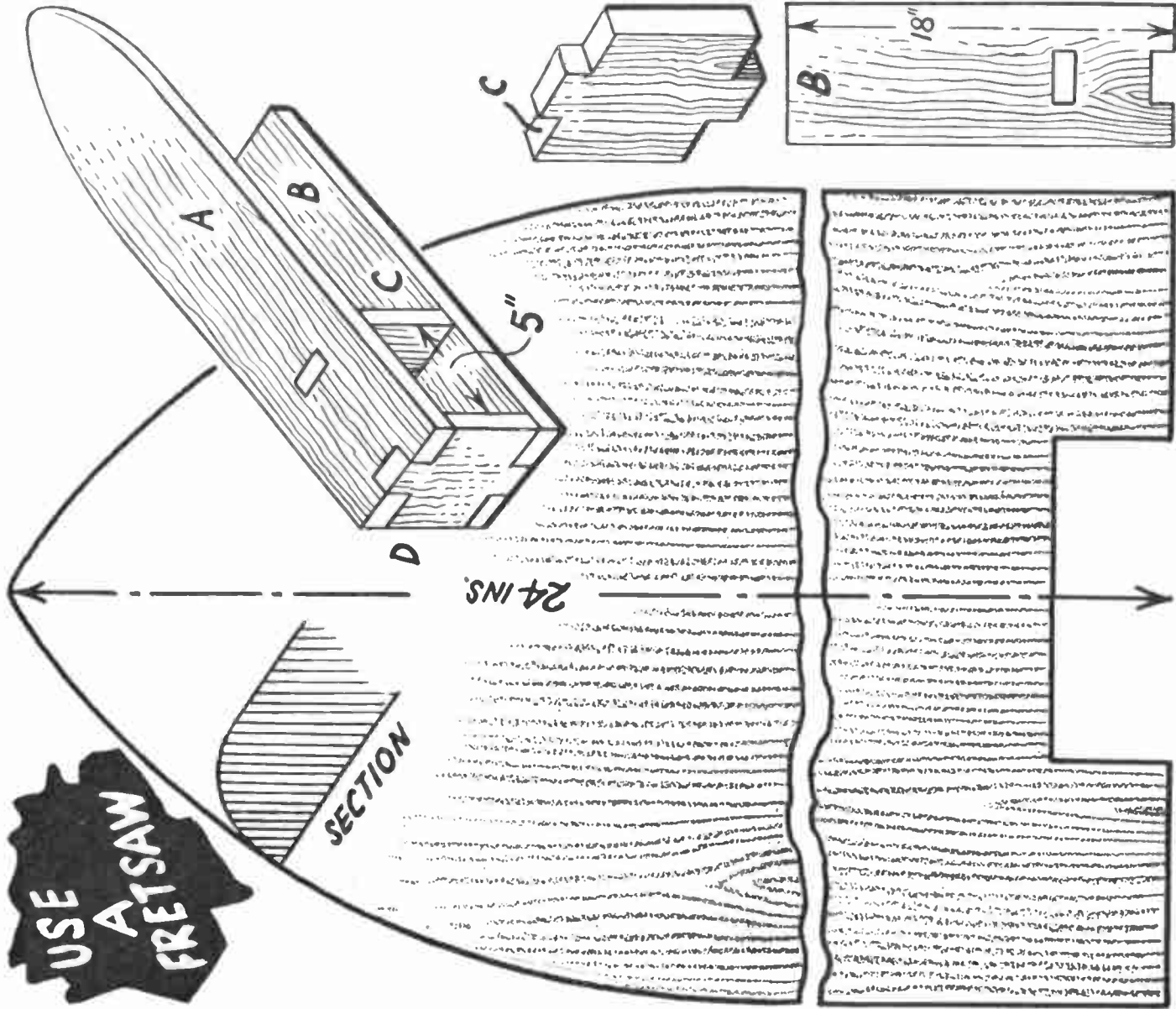

# Conduct real experiments

WITH A

# LOTT'S CHEMISTRY SET



Not just a toy but the real thing in miniature, a LOTT'S Chemistry Set provides an absorbing and instructive hobby for youngsters with a scientific bent. It contains real chemicals and apparatus with full detailed instructions for carrying out many fascinating experiments. Spare apparatus for converting your set into a student's laboratory also available. Sets from 12/3 per box.

**Model Railway  
Enthusiasts!**

Ask to see

**LOTT'S  
TOY STONE BUILDING  
BRICKS**

for true-to-scale trackside  
buildings.  
Price from 6/11 to 5/6

Stocked by all branches of  
**HOBBIES LTD**  
and Toy shops everywhere  
Enquire for list

# SAWS FOR THE PRACTICAL CRAFTSMAN SERVICED

LET US DO THIS BY **POST**

Circular Saws Set and Sharpened

5d. per inch

Hammered, Set and Sharpened

8d. per inch

Recut 1/- per inch

(Prices include return postage)  
Minimum charge per saw—2/6

**48 HOURS' POSTAL SERVICE**

**J. A. FOWLE**

(Saw Makers & Edge Tool Grinders)

**18-22 BELL ST., EDGWARE RD.,**

**TEL: PAD 1491 LONDON, N.W.1 EST. 1840**



## ★ PLAYCRAFT HOBBY KITS

- COLOUR CRAFT for the adult enthusiast ... .. 14/11 ea.
- T. V. FAVOURITES for the younger children ... .. 8/11 ea.
- DISNEYLAND a popular favourite ... .. 12/11 ea.
- JUNIOR ARTIST for the teenager ... .. 7/11 ea.
- PICTURE CARVING for the modeller ... .. 22/6 ea.

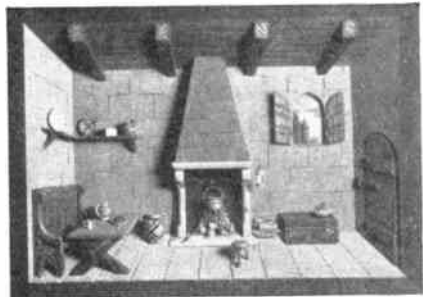

These kits are available in three attractive boxes each complete to enable modellers to produce a three-dimensional wood picture with the charm, colour and perspective of an old master.

These and other Playcraft products obtainable from all high class Hobby, Art and Toy Shops

**PLAYCRAFT TOYS LTD**

**120 MOORGATE, LONDON, E.C.2**