

Complete with
FREE DESIGN
for Cricketer
Photo Frame

VOL. 114

NUMBER 2956

Build this novelty

WHIP CONTROL- LINE PLANE

THIS is a rugged, almost indestructible control line model which can be flown on line lengths of up to 30ft. or more, with practice, and yet needs no power other than a strong right arm! It can be made to perform normal control line manoeuvres—loops, inverted flight, and so on—and it will be a very unfortunate 'pilot', indeed, who wrecks his model, however badly he flies it.

Getting the 'Feel'

Modellers who have flown 'whip control' recommend it as an ideal method of getting the 'feel' of control line flying and stunting, without risking an expensive engine-powered model. Others recognise 'whip control' models as a type of their own for inexpensive, pleasurable flying in almost any space. Simply adjust the line length to the limits of your own back garden—and off you go!

The model itself is made of plywood throughout, with screwed and glued assembly. The control system is metal. Actually the control system can be eliminated and the model flown on a single line, as explained later. The description of the model will, however, assume that normal controls are to be fitted.

The plans are reproduced exactly one-half full size and full size patterns

You can make it for a few coppers—and it costs nothing to operate!

of wings and tail and fuselage must be prepared. These are traced on to good quality plywood and fretted out. In cutting out the fuselage, cut the notch to fit the wing first, then cut the actual profile. The fuselage needs no further working other than a rounding off of all the edges with glasspaper hut the wings should be glasspapered down to a rough aerofoil shape. This is not strictly necessary hut will improve the performance of the model. Plane or carve and then finish with glasspaper.

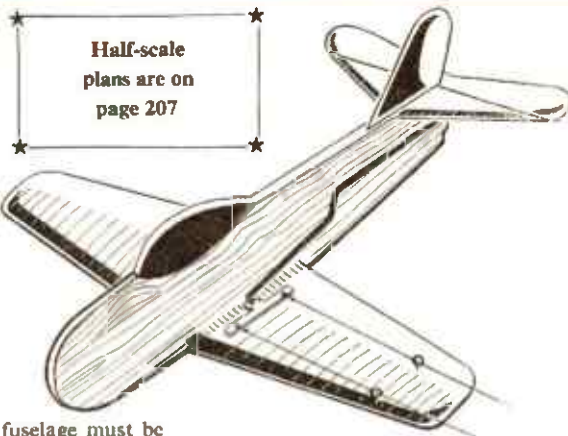

leaving the centre portion which fits in the fuselage slot square.

Tailplane

The tailplane is cut from slightly thinner ply, glasspapered down to rough section like the wings and then parted along the elevator line. The elevators are then rejoined to the tailplane with tape hinges. Ordinary tape about 1/8in. wide will do, well cemented in place. A control horn bent from stiff brass or similar metal is then screwed to the centre of the elevators, as shown in the detail sketches.

Next the control plate or bellcrank must be cut from 1/8in. duralumin. Dimensions are obtained from the plan. Actually the distance between the two lines is 2ins. and the crank has a 'throw' of 1/2in.

To assemble the model, glue and screw the wing in the fuselage slot, checking that the resulting assembly is

IN THIS ISSUE

	Page
Whip Control-Line Plane	193
Making a Milk Delivery Van	195
A Cricketer Photo Frame	196
Workshop Notes and Hints	196
Brains v. Bottleneck	197
Choosing the Glue for the Job	198
A Rustic Bird Table	199
Important Features in Picture	
Making	200
Replicas of Interest	202
Stamp Collecting	203
Whip Control Plane	207

All correspondence should be addressed to The Editor, Hobbies Weekly, Dereham, Norfolk.

THE MAGAZINE FOR MODELLERS,
HANDYMEN AND HOME CRAFTSMEN



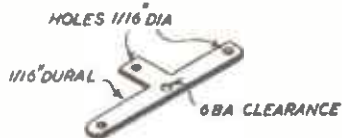
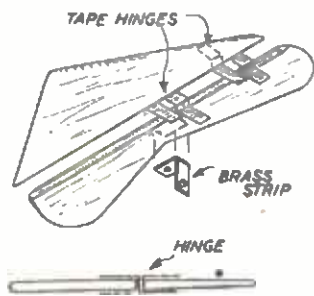
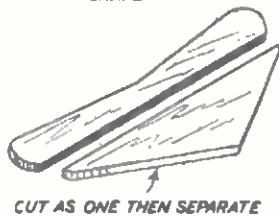
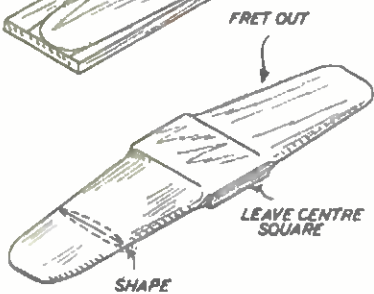
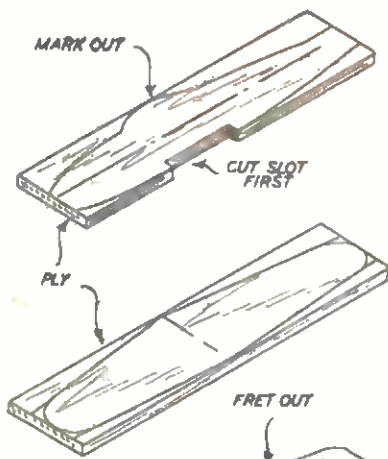

square. Reinforce this joint with a triangular gusset of hardwood on the starboard side only, as shown.

The tailplane is glued and screwed to the rear of the fuselage, again checking

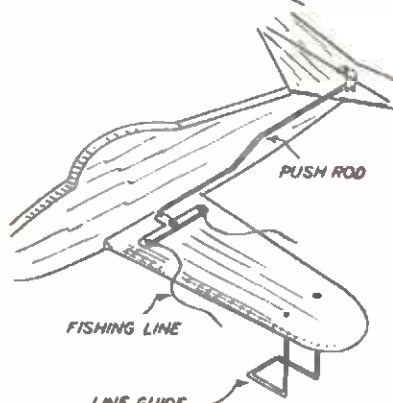
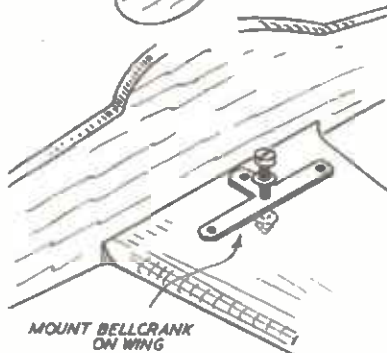
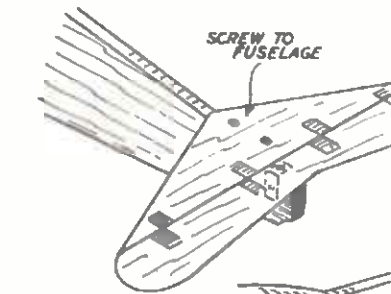
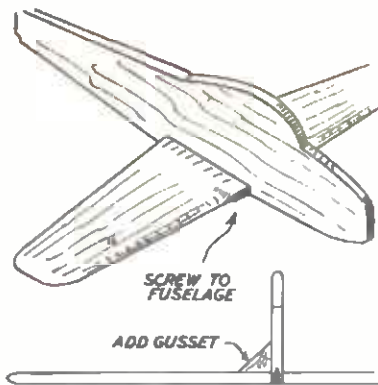

for squareness. Provided the fuselage profile has been cut accurately, the wings and tail should be parallel. Any deviation from parallel will make the model more difficult to control.

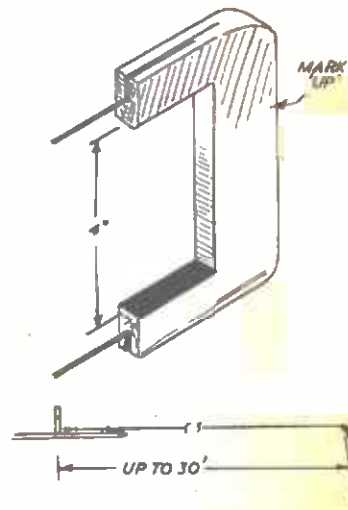
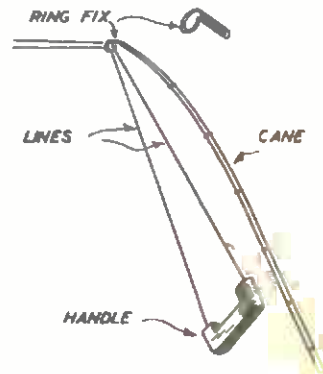
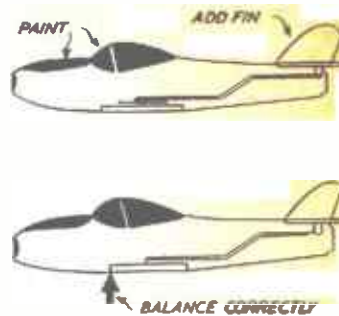

Now we can hook up the control system. The bellcrank is pivoted to the top of the port wing, near the fuselage, by means of a 6 B.A. bolt. Pass a bolt and washer up through a hole drilled in

(Continued on page 204)

Making a Milk Delivery Van



DIAGRAM BELOW SHOWING POSITION OF TOP & BACK

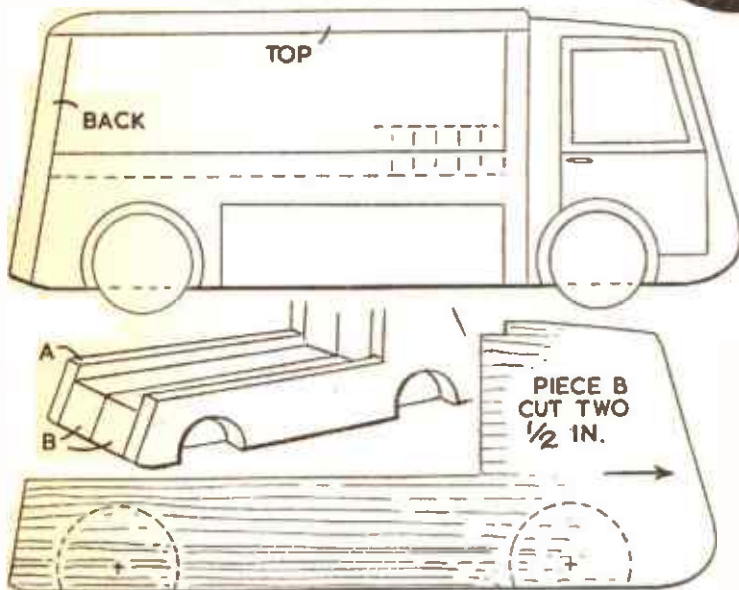

THE subject of our article this week is modelled on an electrically driven delivery van. This particular one has open sides and is used for delivering milk. It is made to the same scale as the two cars in previous issues of *Hobbies Weekly*.

Transferring the Patterns

All the parts are full size and very little shaping is necessary after the parts have been cut out with the fretsaw. Trace the patterns on to suitable pieces of wood, so that the grain runs in the direction shown by the arrows.

The first step is to glue together the two pieces (B) and the sides (A) as shown in the diagram. One or two 1/4 in. fretpins may be driven in for extra strength. The back, which is 1/4 in. thick, is cut out

and shaped to the section shown. Glue and pin this piece to the back of pieces (A) and (B).

The top also is cut from 1/4 in. wood and is extended to 2 1/2 ins. long. The position is shown in the side view, and it should be pinned as well as glued.

The only shaping that need be done is to round off the roof, back, and cab front. An indication of this is given in the picture of the finished thing.

Dummy milk bottles are cut from 1/4 in. diameter dowelling and glued inside the van. They could be shaped a little if you have time to spare. Round rod, too, is used for the four wheels. They consist of 1/4 in. lengths of 1/4 in. diameter dowelling, cut off with a small tenon saw. Drill a hole in the centre of each wheel to take the 1/4 in. round-head

screw that is used for fixing. Do not actually fix the wheels until after they have been painted.

Painting

The inside of the van should be cream and the milk bottles white. The tops of the dummy bottles could be painted red or green to represent the coloured tinfoil caps. Paint the whole of the van light brown or green and put the markings on in pencil. The windows and windscreen should be black. The name could be in cream.

The wheels are treated as for the previous toys, that is, shaped and painted to represent the real thing as near as possible. When the paint has dried thoroughly the wheels are screwed in place.

(444)

Made from Design No. 2956

A CRICKETER PHOTO FRAME



THIS novel photograph frame was designed to appeal especially to cricket fans. If you follow the game closely you will, no doubt, have a favourite among the famous cricketers, so what could be better than to mount his picture in a special 'cricketer' frame?

The various parts are all shown full-size and it is only necessary to trace them off on to the wood and cut them out with a fretsaw in the usual way. After cutting, clean up the parts with glasspaper, paying particular attention to the corners of the interior frets.

The design from which this photograph frame is made is given free in this issue. Materials for making the frame, including wood, glass and hinges, can be obtained from any Hobbies Branch or direct from Hobbies Ltd., Dereham, Norfolk, price 5/5 including tax and post free.

The Overlays

When the parts are ready, glue the overlays in position as shown by the dotted lines on the frame.

Smear the backs of the overlays with glue and place them on the frame. Lay the frame on a flat surface and put several books on top to prevent the wood from warping while the glue is drying.

When the glass is inserted it is prevented from falling out by the overlay on the front. The photo is trimmed to fit the glass and placed face downwards. Lay the rectangular piece, cut from the frame, on the photo and paste or glue a piece of stiff brown paper over the back. This will not only hold the backing piece in position but will

also exclude dust.

The frame is made to stand by means of a back rail and strut which are shown in detail on the design sheet. Hinge the back strut to the rail as shown and then screw the rail to the back of the frame.

Finishing

Paint the overlays with a dark stain so that they contrast with the background. You will find this quite easy if you use an artist's brush. Alternatively you may like to make the overlays very dark indeed, in which case they must be soaked in stain before gluing to the frame.

When the stain has dried, apply two coats of Reward polish with a brush. This will seal the grain effectively and will enable you to put in the markings without the ink running into the grain. Ordinary indian ink can be used for the markings. Finally, apply a coat of varnish or another coat of Reward polish.

Glossy Colours

Another effective finish can be obtained by using high gloss enamel. In this case, the trees, bat and cricketer could be picked out in their appropriate colours. The background could be buff or, alternatively, jet black. In either case, the overlays would stand out well.

WORKSHOP NOTES AND HINTS (9)

When Cramping Up

THERE never was a handyman who did not wish, on occasion, that he had another pair of hands, and this very often happens when one is cramping up work. As is well known, blocks of scrap wood have to be placed between the work and the jaws of the clamp to prevent bruising. Yet the woodworker is in for a hectic time if, whilst manipulating the cramps, he has also to juggle about with loose wooden packing pieces, which constantly fall out of place. That is—unless some means are found to attach the wooden blocks to the jaws of the cramps.

Here is a simple way. Prepare the blocks in the usual way and then cover them with a strip of rubber cut from a car tyre inner tube. The fixing, by tacks, is done at one end only, as in

sketch *b* and when the rubber is in place, a slit is made with a sharp knife, as in *b*. This slit enables the head of a G clamp to pass through as at *c* where the block is now held securely though with plenty of 'give' should adjustments be needed. In other words, it will not fall off.

A slightly larger slit may be needed when fixing the blocks to the heads of a sash clamp as at *a*. Apart from its main use in providing an elastic grip, the rubber also provides a soft face

on the other side of the glue block.

Such glue blocks will be of various sizes to suit different cramps, and it is a good idea to make up a set in advance, since when a job is actually due for gluing and cramping up one is apt to be impatient of holding up work to make such gadgets, essential though they are. (317)

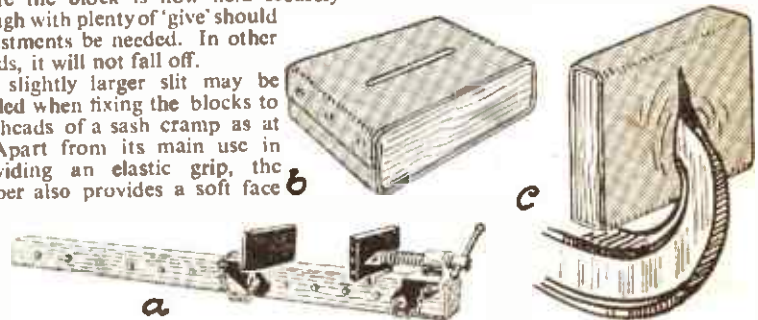

a

196

BRAINS v. BOTTLENECK

THERE is at least one wizard alive today. A man who can pass a coach and horses through the neck of a whisky bottle, and construct a row of houses inside the three glass walls of a Haig's 'Dimple'.

The name of this wizard? Mr. R. F. C. Bartley, of Bristol. How remarkable is his achievement can be judged at the Model Engineering Exhibition at the Horticultural Hall, Westminster, where some of his bottled models will be on view.

It is many years now since Mr. Bartley called that hoary Old Salts' bluff, the ship in the bottle. But it gave him the idea he had been waiting for. He would do this sort of thing himself, only better than it had ever been done before.

If models are worth making at all their proportions must be correct. But how was a galleon, say, with its high poop and relatively broad hull, to be passed through a bottle neck with an internal diameter of only $\frac{1}{4}$ in?

The Method

Briefly, Mr. Bartley's method is first of all to measure with the greatest possible accuracy the *inside* of every bottle he is proposing to use. He has found that Haig 'Dimples', otherwise known as 'pinched decanters', are the most suitable for his purpose, as they are comparatively roomy, artistic in shape, and will rest on their sides firmly without need of a stand.

The next step is to make a scale drawing, which is always as large as



Nat content with modelling a ship in a bottle. Mr. Bartley made a man making the ship—and bottled the lot

possible, so that the bottle is almost entirely filled. The actual model is then carved out of balsa or pine wood, coloured, and completed to the smallest detail. Water colours, poster paint, cellulose mixtures and shellac are used as required.

Now, to the artist, comes the hardest part of all. The perfect little model has to be ruthlessly dismembered. By means of a super-sharp razor blade it is sliced into longitudinal or horizontal sections, none of which must exceed $\frac{1}{4}$ in. in square section or (as a strip the thick-

ness of a card) be more than $\frac{1}{4}$ in. wide. These sections are then reassembled, still outside the bottle, and fastened together by pins which fit into slots prepared for them.

Once more the model is taken apart. Then, beginning at the bottom, it is passed section by section through the bottle neck and built up on the 'floor' of the bottle. Using a stout bent wire, each pin is driven home and, where necessary, secured by a touch of shellac. So deft is the sectioning, so closely do the parts fit together, that when the model is finally in position, it is virtually impossible to see how it has been built up.

Moderate Cost

The cost of the materials used, compared with the effect achieved, is moderate. The tools required are simple in the extreme. Just razor blades, darning needles, pins, bent wire, and paint brushes cranked at various angles.

By following the sectional system invented by Mr. Bartley almost any model of appropriate size can be 'bottled'. After mastering the galleon, which had beaten so many previous bottlers, Mr. Bartley successfully tackled the 'Sirius', one of the earliest paddle steamers.

Whilst creating a 'sea' for this model with putty, paint and shellac, Mr. Bartley's thoughts turned towards landscapes as an alternative to seasapes.



A clever model of old buildings after the Christmas Steps, Bristol

(Continued on page 198)

Choosing the Glue for the Job

THE manufacture of animal glues progressed very little from the time of the Pharaohs until the turn of the present century. In fact a cake of glue found in an Egyptian tomb, and known to date from about 1500 B.C., is indistinguishable from some types of cake glue still available today. A great deal of progress has been made, however, during the last fifty years.

The following remarks are intended to help the amateur to choose the right glue for the job in hand and to get the best results from his choice.

There are many adhesives now available to the handyman, but he need not go beyond the normal hot or cold animal glues for use with the materials most readily available, such as all types of wood, leather, hardboard, decorative plastic sheeting, canvas and so on.

Hot Glues

A hot glue sticks because, having been applied to, and penetrated, the surfaces to be joined in a hot liquid state, it solidifies or 'gels' as its temperature is allowed to fall. This process of gelling brings about the initial adhesion, and the bond is completed when the glue dries out into its final solid state. It will be seen that temperature is the vital factor to be considered in the use of a hot glue. The right temperature for the glue in the glue pot is 120 degrees Fahrenheit (as hot as you could just bear on your finger), and the 'gelling' temperature is about 70 degrees Fahrenheit (a little above normal room temperature). Thus it will be seen that the time between the application of the glue and the closing of the joint must always be less than the

time taken for the glue temperature to fall from 120 degrees Fahrenheit to 70 degrees Fahrenheit, or about five minutes at room temperature (about 60 degrees Fahrenheit).

It is important to remember 120 degrees Fahrenheit, as the right temperature for your glue pot. If the glue is too hot it will not only lose strength, but will become too thin, be absorbed by the surfaces of the wood and result in a 'starved' joint; if too cold the glue will be too thick and 'gel' before the joint can be closed. It cannot then penetrate the wood, and the result will be a 'chilled' joint. Either of these joints will fail when subjected to any strain.

These hot glues are obtainable in many types including cake, pearl, powder, cube, etc., but the most convenient are those supplied in jelly form (e.g. Croid Aero Glue) since not only do they need just heating to render them ready for use but there is no risk of variations in quality through errors in following soaking and mixing instructions.

Liquid Glues

Next come liquid animal glues. The best of these are made from the same raw materials and by the same basic processes as the hot glues. In the course of manufacture they are treated chemically to bring the 'gelling' temperature below room temperature, and they therefore remain liquid. They do not 'gel' in the joint and so must be allowed sufficient time to dry out before a bond can be formed. This type can be used direct from the container, and is therefore ideal for light jobs and repairs where only a small quantity is used at a time, or where no heating is available. It is also best to use a cold

liquid glue where the surfaces to be joined are large, for with a hot glue the film on one part may easily 'gel' before it can be applied to the whole.

The setting action of liquid glues can be considerably speeded up by exposing the glued surfaces to the air and allowing them to become tacky before closing the joint.

Some brands of liquid glue, such as Croid Universal, can be used for the adhesion of plastic sheeting like Formica and Wareite, etc., to wood.

Liquid animal glues should not be confused with fish glues which are similar in appearance but have different characteristics. Fish glues, for instance, are not suitable for ordinary joining since they lack the strength of animal glues; their added tackiness and flexibility, however, makes them quite suitable for leather work and light crafts.

Some Hints

In conclusion, the following hints will help to ensure that the joint is at least as good as the materials joined.

- (1) Never over-heat the glue.
- (2) If a hot glue is used, close the joint as soon as possible.
- (3) Make sure the surfaces to be joined are as true and as clean as possible.
- (4) Keep the glue container and brush clean and free from old glue.
- (5) Apply the glue in a *thin* even film over the entire surface.
- (6) Wherever possible, apply pressure as soon as you can, to the finished joint to aid penetration.
- (7) Use a well-known brand of glue. The name of the manufacturer will guarantee its consistent quality.

BRAINS v. BOTTLENECK

(Continued from page 197)

His next model was a windmill complete with sails.

The next achievement was the result of a bet laid by a friend who declared that to put a coach and four horses inside a 'Dimple' was beyond the skill even of Mr. Bartley. He admits that the problem took him six months to solve. The model which finally resulted is an exact replica in miniature of the first mail coach which ran between Bristol and Bath in 1784, even to the passengers and the coat of arms painted on the door.

Up to this point Mr. Bartley's main

pre-occupation had been with bottling models of inanimate objects. But why should he not make a man the central figure? And so the Man Making a Ship was bottled, together with his spectacles, his hammer, his saw and his pot of glue. In this model and in the little figures which have followed it, Mr. Bartley has reached the highest peak of his unique art, finding at last full scope for his imagination, his humour, and his gift for characterisation.

For his next subject, Mr. Bartley painted over the whole of the inside and outside of the bottle except for an oval

opening through which the Pied Piper is seen against an appropriate background. This figure, and also the White Rabbit, have been built up inside a bottle standing erect. Problems of perspective suggested by the two converging sides were first attacked in a build-up of a street scene in Old Bristol. More elaborate studies, showing both sides of a receding street, have followed. There seems no end to the possibilities of this most original and absorbing hobby. (440)

Those who would like to know more about this hobby should read Mr. Bartley's book, 'Models in Bottles', published by Percival Marshall Ltd., price 7/6.

How you can make

A RUSTIC BIRD TABLE

THIS rustic pattern of bird table would make a pleasing effect in the garden, especially in suburban or country districts. It is unconventional in design, and quite simple to make, the roof thatching being but rudimentary, but keeping the table dry, and providing shade in hot and sunny weather for the birds.

A general view of the article, ready for thatching, is given in Fig. 1. The pole should present no problem, as one could be bought at most timber yards as rustic wood, or in country parts cut down in some woodland, by permission, of course. It should be about 2½ ins. to 3 ins. diameter at base, and be at least 8 ft. long. As it is desirable for stability sake that some 2 ft. of the pole be buried in the ground, the bark of the pole at the bottom end to about that distance should be removed. Leave for a day or two for the wood to dry, then saturate the bared part with creosote, as a preservative measure.

For the table, a couple of 9 ins. wide boards, 18 ins. long, can be glued edge

post, as at (A), screwing them firmly in place. To these the table itself is also firmly screwed. Above the table, a framework is arranged, on which the thatched roof can be built. In the diagram, this arrangement is shown as two pairs of wood strips, 16 ins. long and about 1 in. square section halved where they cross, and notched in the post, in a similar manner to the table battens.

Only One Pair

One pair only need to be notched in, and the other pair jointed across them, as in detail sketch (B). The strips should be at a distance down from the top of about 9 ins. Get a length of stout galvanised iron wire, of the kind used as clothes lines in the garden, bend this to a ring, large enough to encircle the framework, and fix it to the ends of the framework with staples. Over this arrange a piece of wire netting, umbrella fashion, as a support for the thatch. Stretch it fairly taut, tack to the top of the pole and twist under and



A firm fixing should then result. Then creosote the whole.

A few good armfuls of straw will be needed for thatching. Fork it up to lie loosely on the ground, then draw out several at a time and lay together. When a double handful is ready lay it on the wire netting and tie it at top and bottom through the netting, and round the wire ring as well. When the whole surface is covered, as in Fig. 2, trim off at the eaves about 1 in. away from the ring, and at the top, leaving a pointed tip as it were.

Second Layer

A second and outer finishing layer is now to be fitted over it, to fill up the hollows and hide the rough tying. This layer is thinner than the foundation one, but put on in handfuls in a similar manner. A few staples made of wire to the shape at (C), in Fig. 3, are provided, and each handful of straw is kept in place by skewering it with a staple at the top. The lengths of wire, by the way, are 9 ins. long, and then doubled.

When the whole surface is covered, draw a stiff piece of wire between the straws, to comb them, so they lie flat and even all round. Trim at the eaves, and then tie above the ring in the following manner. With strong twine, preferably tarred as a protection against the wet, tie through the straw to the netting, just above the ring. Now pass the string round the thatch, and at every distance of about 3 ins. press over the twine a wire staple (withdrawn from

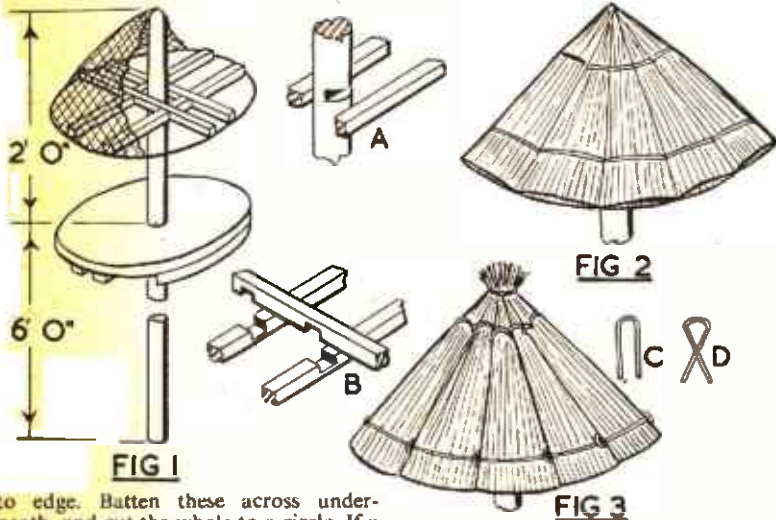

to edge. Batten these across underneath, and cut the whole to a circle. If a suitable pair of compasses are not to hand, a length of string, tied to a nail at the centre of the table, and with a pencil secured to its free end will answer the purpose near enough for a job of this simple type. Cut or bore a hole in the middle of the table large enough to allow it to pass over the top of the pole and fit it where it should go, at about 2 ft. down.

To fix the table securely in position, cut two battens, some 9 ins. long each, and notch these in each side of the

round the wire ring.

Stray ends of wire should be bent back out of the way, so no danger will exist of injuring the birds should they investigate the inside of the roof. At this stage the pole could very conveniently be set up in its position, as the thatching operation could be more easily accomplished with it firmly fixed. Dig a hole for it 2 ft. deep, push the pole in and ram the earth back hard. Mix a few small stones with the earth, and ram down every shovelful.

(Continued on page 202)

Important Features in Picture Making

THOSE readers who were interested in the recent article giving some hints on that most intriguing branch of our hobby, composition, will recollect that special mention was made of five outstanding features to be found either as a collection or in groups of two or three in almost every landscape study, whether in oil or water-colour or just a camera study in black and white.

In this issue we intend to deal rather more fully with at least two of these features, but perhaps it will not be out of place to first detail again the complete five, so as to give you the opportunity to link them up with what we have to say. The list consisted of clouds; cottage or church; lane or footpath; trees and water.

The Attraction of Water

What a tremendous pull water seems to have over all of us. Most amateur photographers will go out of their way to make an exposure by the side of a lake or stream, and a rough sea will attract everyone, photographer or not, and keep them thrilled as each great wave smashes itself on the beach, or against the breakwater, rocks or seawall.

Compare the two illustrations, 'Turmoil' and 'The Banks of River Derwent'. Here you have a complete contrast, the one displaying might, power, anger, and almost every one of the passions that go to make the bad side of nature; the other gives one the impression of peacefulness, quietness, gentleness, absence of worry and, in fact, the very opposite of turmoil. Surely it is this variety of emotional phases revealed at varying times by large and small volumes of water that make this element so popular and so

fascinating, and it is, undoubtedly, the reason why artists everywhere accept it as a most valuable factor in their work.

We amateurs must, however, strive to give a reason for introducing it into our pictures, and to use it at all times either as an aid to making the picture where other items are included, or as the main feature where, perhaps, a title is required to explain why the exposure was made.

'Turmoil' is not a picture in the true sense. It is really what I prefer to call a 'record' shot. About three hours before it was taken my wife and I were sitting for some time on the farthest point of rock. It was, therefore, a great surprise on our return from a walk to find that such fury had arisen in such a short time, hence the reason for using a film on such an occasion.

Now let us consider 'The Banks of River Derwent'. This stretch of water, as it meanders through the lovely valleys and dales of glorious Derbyshire, offers to every owner of a camera hundreds of similar scenes. Sometimes they are not quite so peaceful as the illustration, although this is typical of the river in summer time. After heavy rain, it displays quite a different type of passion.

On this occasion the author was with a rambling party of about 30 young people and, owing to the beauty of the spot, it was decided to rest and lunch there. Actually the spot selected was not ideal for a photograph, and as soon as my share of the lunch was finished I wandered a few yards farther along the bank and very soon found a bunch of wild flowers which helped to break up the line of the bank.



This picture, taken at Harlyn Bay, was aptly captioned 'Turmoil'

This, together with the reflections of the trees and the sky in the water, and also the delightful ripples on the surface, made such a combination that it was impossible to resist making an exposure. If time had permitted, I should have waited until some clouds made their appearance in the top left hand corner. The result then would have been a charming combination of some pictorial quality.

'The Old Bridge at Baslow' is another type of scene embodying water as one of its features, but not the most important. Yet without it as a foreground item, the result would be simply a photograph of a bridge and some buildings as viewed from the bank. By sliding down the bank on to some shingle I was able to get to the water's level and managed to introduce the tree foliage on the right, thus getting four items into my view-finder, all of them playing their part in the final result.

Take Your Time

You will realise from the foregoing that it is not always advisable to make your exposures on the spur of the moment or just when a favourable spot comes into view. If a scene presents itself and you feel that there is something about it which suggests the making of a picture, do not spoil a chance by being too hasty. If the features are there, then they are not likely to run away even if you move a few paces to the left or right or go forward or backward a step or two so as to examine the view from these other angles. Should this scrutiny



A peaceful scene taken on the banks of the River Derwent

not give you any better result you can always come back to the original spot and make a further comparison.

A good hint is to view the scene by framing it between the hands held at arms length at eye level and sideways, i.e. with the thumbs facing you. Artists often use this device when concentrating on what they desire to include, and it certainly helps us photographers to examine more intimately that portion of the scene which is likely to appear on the film without the interference of any of the surrounding details.

These suggestions, if taken seriously and put into practice before making your exposure, will prove invaluable to you. You will find that this little extra thought and care is making you rather more studious in your selection, and this definitely means more satisfying results.

Exposure Times

Doubtless many readers, having got so far and taken note of the tips, will be wanting a little advice on the exposure times required for these water studies and the films one should use. Naturally, where there is continual movement, short exposures are necessary, and there are usually two or three factors to be considered in arriving at the correct time. For instance, water reflects light, and if there is a fairly open sky it must be assumed that the light is strong. On the other hand, if there are some trees with heavy foliage in the foreground or middle distance and these are casting reflections in the water, then the light value is considerably reduced. It is, therefore, advisable to make use of an exposure meter to give you some sort of guide. It does not matter what type of meter you use provided you have had a little experience of it and know how to calculate its factors to ensure a correct finding.

If you do not possess a meter, then remember that during June, July and August light is at its strongest, especially at and around midday, and, as movement has to be allowed for, the shutter must be set to a speedy time, possibly 1/100th of a second with *f*11 stop if the film in use is of the super fast panchromatic group such as Ilford H.P.3.

Where the camera is fitted with a long range of stops the time mentioned can, of course, be reduced to even 1/250th by adjusting the stop to *f*7 or even *f*6.5. In any case, I advocate that when in doubt you should make a couple of exposures if the subject is worth while and is one that you are not likely to be able to take on another day. Vary the time for the second shot so that you have the possibility of at least one good negative. Incidentally, take the second from a different angle of view if this is possible, for the results may prove to be

two good pictures instead of one poor effort.

The Camera on Holiday

Many of our readers will be spending their holidays during the next few weeks, and, by hiking, cycling or motoring, will be visiting some of our interesting seaside and country places. To all these readers I want to emphasize how valuable a camera can be on these visits. When arriving at a village or town of historic interest, don't be in a hurry to rush out of it. Get off your bike or out of the car and do a spot of exploring. Wander through some of those very old and quaint streets, visit the Church and the local market place. You will find all this well worth while, even if it means spending an hour or two of your time. And it will be surprising if you do not find something interesting and of photographic value on which to expose a film or two.

Every town or village has something different to offer you. It only remains for you to find it, and, in seeking it, you will, undoubtedly, be well repaid by spotting much that is 'local' to that particular part of our country.

If you are contemplating some such tour I would strongly urge you to borrow from your local library beforehand any books devoted to the history of the towns on your route. Then when you arrive there, you can find any particular spot or building quickly. Further, you will have gained a certain amount of information which will make any photographs you take of considerably greater value, and of particularly good use should you decide to

make up a talk or lecture concerning the tour for your Scout Troop or other young people's organization.

The suggestion of a lecture compels me to end this article with a friendly note of warning against giving wrong information. It is so easily done and it is surprising how you will find yourself being corrected by someone who knows the place or incident better than you. So be on your guard and be certain of your facts by making copious notes while



A charming study of the old bridge at Baslow

actually on the spot, or within a very short while of visiting it. Further, and this is quite as important, make a note of every exposure you make, and let that entry in your diary be a complete record with the name of the place or subject, the date and time of day, the brand of film and the exposure time and stop. And be *certain* to enter all these details on the envelope in which the negative is to be kept and indexed.

You must realise that many changes are taking place in our countryside, as well as in the larger towns, and some of your negatives taken this year may, in a few years' time, be quite valuable as a record of what was at one time and has since disappeared. (429)

How you can Blow a Flame Towards You

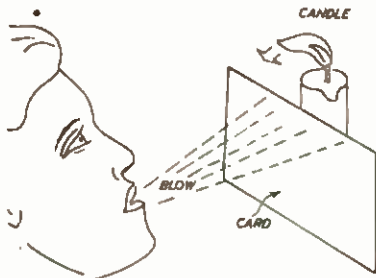

DO you know how to blow the flame of a candle towards you? Blow directly at the candle from a distance of about 6ins., but hold a card directly between your mouth and the flame. You will find that the candle flame is now sucked towards the card. You have blown the flame towards you! The illustration shows the set-up for the trick. (351)



REPLIES OF INTEREST



Spray-painting a Motor Cycle

I AM contemplating spraying my motor cycle, but I had previous trouble stripping numerous coats of paint. I hope it will be possible to fix up a stripping tank for the smaller and most awkward parts, such as the engine, etc. Can you offer me some suggestions for (a) building or obtaining such a tank, (b) the best chemicals to use and (c) the best materials and approach for spraying? (R.H.—Enfield).

It would be most unwise to immerse a motor cycle engine or any of the mechanical parts in a 'pickle' bath of adequate strength to remove paint, owing to the deleterious effect on the polished metal or working parts. Probably a proprietary brand of grease remover such as 'Grumph' would be most applicable. If, however, you wish to make a stripping or 'pickle' tank, use any earthenware or glass vessel of adequate size. Stripping agents can be hot caustic soda solution, or a cold solution composed of one part nitric acid and two parts sulphuric acid in about 20 times that amount of distilled water. Both these solutions are poisonous, emit noxious fumes and are dangerous in use, and our advice is leave them alone, unless you have special knowledge and experience of them. Spray painting can be achieved with any of the good quality proprietary spraying paints, either of the cellulose or synthetic kinds; the latter are probably the easiest to use.

Cutting out winding

I WISH to change my portable gramophone into an electric one. If this is possible, please send me full particulars. (B.W.—Southend-on-Sea).

ELECTRIC motors with turntable are readily obtained at various prices from shops and electrical stores. You should obtain one with a motor suitable for your mains voltage. It is then necessary to remove the present

clockwork motor and turntable, and to secure the electric motor in position, following any particular instructions as regards the fitting of a speed-regulator, etc., which the supplier of the motor has provided. The turntable is then placed in position, and normally secured with a spring clip. Such a motor and turntable would cost from about £3/16/- upwards, according to type. Northern Radio Services, 16 King's College Road, London, N.W.3 is an address from which such motors may be obtained.

Soldering Aluminium

I SHALL be obliged if you will inform me whether there is any flux for soldering aluminium. (C.S.—Morecambe).

DURING 1951 when we had a similar query, we told the enquirer that there was no known way of practical value to the amateur for uniting aluminium. When this letter was published, however, a press officer of the Ministry of Supply very kindly brought to our notice a preparation known as 'Uniflux No. 1', a paste made up with water, which, when applied to two pieces of aluminium (or its alloys) and heated, deposits metal and makes a really good 'brazed' joint. The temperature required is much higher than for soft soldering, but is easily attained with a plumber's blowlamp or a Bunsen burner, and no skill whatever is required in manipulation. This product is marketed by Unifluxes Ltd., 65 Balham Park Road, London, S.W.12. The standard container holds 8ozs., but the firm also packs a sample size which sells at something like 3/6. At the same time as we had the Ministry's reply, another was received from a Mr. Boardman of Newport, Mon., who told us that aluminium can be soldered using a mixture 90 per cent tin, 10 per cent zinc and solder which is the patent of the British Aluminium Co. The part to be

tinned is de-greased thoroughly with trichlorethylene, the surface then being filed to remove the oxide film. The filed surface must then be heated with a blowlamp and the solder mentioned applied without flux, adhering quite readily. This coating, however, is still not perfect, because the aluminium partially re-oxidises during the heating up. This layer of oxide can be overcome by brushing the solder coating vigorously with a wire brush while the solder is still molten. This gives a smooth and uniform layer and two surfaces thus prepared can be soldered quite strongly together. We are assured that this method is authentic and that the first layer of tinning will take ordinary solder afterwards.

Making Masks

I HAVE been trying to make masks of newspaper, but understand I must have a mould to make them. I would be pleased to know how to make the masks and moulds for same. (B.A.—Woodhall Spa).

YOU should make a mould with Pyruma cement and dry to hardness, then cover with soft soap. Tear the paper into small pieces and press over the mould to completely cover it. Coat this with Casein glue and add another layer of the paper, and continue until the mask is thick enough. Lift from the mould and leave to dry. Afterwards cut out eye and mouth spaces, rub over with fine glasspaper to remove inequalities, apply a coat of paint, then when dry, give the finishing coat of paint.

Bleach and Polish

PLEASE advise me the correct formula for household bleach, also for metal polish. (G.N.—Edinburgh).

A GENERAL purpose bleach consists of five parts hydrochloric acid to 100 parts of distilled water. This bleach is poisonous and must always be used with care. There are many kinds of metal polish, but one that can be generally applied consists of finely powdered chalk, about 90 parts, ammonia about two parts, linseed oil three parts and sufficient distilled water to form a moderately thick creamy mixture. Whitening may be used instead of chalk, and in some cases about half part of nitric acid can be used instead of the ammonia.

A Rustic Bird Table

(Continued from page 199)

those already at the top) bent as at (D). Let it penetrate through the foundation layer, as well as the top one, and force the ends apart and flatten underneath,

so that no dangerous sharp ends protrude anywhere.

This part done, tie the straw together at the top of the pole, and trim to a flat

top. A few wire staples, without the twine, can be inserted at the top to keep all in place. Now finally trim at the eaves, to leave a flat edge all round, which should, strictly speaking, be a horizontal flat, not slanting, and with a supply of crumbs and bits of fat, the table is ready for the birds. (434)



FAMOUS NOVELISTS ON STAMPS

IN these days of greater educational standards throughout the world, more books are read than ever before. The most popular form of book is the novel. There have been many famous novelists of many nationalities and a number of them have appeared on stamps.

In Britain we do not issue stamps bearing portraits other than those of kings and queens. This policy deprives our famous authors of a place on their country's stamps.

Despite this, one of our most well-beloved novelists, Robert Louis Stevenson, is portrayed philatelically. Stevenson settled in Samoa in 1889 and that country devoted the 7d. value of the 1939 20th anniversary of New Zealand Control set to his portrait. His Samoan home, 'Vailima', and his tomb can be seen on the 6d. and 1s. values of the 1935 set. Stevenson's chief novels are *Kidnapped*, *Treasure Island*—both beloved by children—and the contrasting and mystic *Dr. Jekyll and Mr. Hyde*.

France has produced many great novelists. Victor Hugo (1802-85), known in this country chiefly for his *Notre Dame de Paris* and *Les Miserables*, is portrayed on the 1935 1f. 25c. issued to commemorate the 50th anniversary of his death. Hugo also appears on the 65c. value of the 1938 Unemployed Intellectuals Relief Fund set, and on the 1936 50c. of the same series. Hungary honoured Hugo on the 6fi. of the 1948 Air Writers' set. Anatole France (1844-1924), the author of *La Revolte des Anges*, *L'Île des Pingouins* and *Le Crime de Sylvestre Bonnard*, was chosen by France for the 30c. values of both the 1937 and 1938 Unemployed Intellectual Relief Fund stamps.

Balzac

Another novelist honoured in this series is Honore de Balzac (1799-1850), whose portrait can be found on the 1939 90c. and the 1940 1f. His three novels, *The Chouans*, *The Wild Ass's Skin* and

The Human Comedy, are familiar to readers of French literature. Marie Henri Beyle (1783-1842) is better known by his assumed name of Stendhal. His best novels were *Le Rouge et le Noir*, *Armance* and *La Chartreuse de Parme*. On the 100th anniversary of Stendhal's death, France issued a 4f. commemorative bearing his portrait.

Alexandre Dumas (1802-70) is generally regarded as a Frenchman, but

classics. To complete the set, the 10c. bears a portrait of Samuel L. Clemens (1830-1910). Under his nom-de-plume of Mark Twain he wrote *Tom Sawyer*, *Huckleberry Finn* and *The Prince and the Pauper*, all universally read by the younger generation.

Although better known as a poet, dramatist and philosopher, the German Johann Wolfgang von Goethe (1749-1832) also wrote novels. Perhaps his best-known are *Wilhelm Meisters Lehrjahre*, *Wilhelm Meisters Wanderjahre*, *Werther* and *Hermann and Dorothea*. Goethe's portrait appears on the 1926 25pf., the 1945 French Zone 1m., and the Hungary 1948 Air Writers' 4fi. In 1949 the Anglo-American Zones commemorated the bicentenary of Goethe's birth with a set of three stamps, two bearing portraits and the third Goethe in Italy. Another German novelist, Gotthold Ephraim Lessing (1729-81), author of *Nathan the Wise*, *Miss Sara Sampson* and *Minna von Barnhelm*, can be found on the Germany 1926 30pf.

The father of the modern novel, Giovanni Boccaccio (1313-75), was honoured by his native Italy on the 10c. value of the 1932 Dante Alighicri Society stamps. Boccaccio's *Decameron*, containing one hundred tales, is a classic. The statesman and author, Gabriele D'Annunzio (1863-1938), is portrayed on the 50c. value of the Italian 1934 Annexation of Fiume set, and also on the Fiume 1920 set of 14 values. *The Child of Pleasure*, *The Virgin of the Rocks* and *The Dead City* are his best-known novels.

Don Quixote's Creator

Spanish literature is represented philatelically by Miguel de Cervantes (1547-1616), author of *Don Quixote*. Cervantes has been honoured by many of the Latin American countries as well. Spain issued a Don Quixote Commemorative set in 1905, which depicts scenes from the book including Don Quixote setting out, attacking the windmill, meeting with the country girls, Sancho Panza tossed up in a blanket, Don Quixote knighted by the innkeeper, tilting at the flock of sheep, Don Quixote on the wooden horse, the adventure with the lions, Don Quixote in the bullock cart, and the Enchanted Lady.

(Continued on page 204)



Some of the stamps mentioned in the text. Top left: Boccaccio. Right: 'The Ugly Duckling'. Bottom left: Rydberg pictured on a Swedish stamp. Right: 'The Little Mermaid'.

his grandmother was a negress. In 1935 Hayti commemorated the visit of the French Delegation to the West Indies with two postage and one air stamp showing Dumas with his father and son. Dumas' best known novels are *The Count of Monte Christo*, *The Three Musketeers* and *The Black Tulip*.

The U.S.A. allotted a section of the 1940 Famous Americans set to her novelists. Washington Irving (1783-1859), creator of Rip Van Winkle and Sleepy Hollow, and author of the novel *Bracebridge Hall*, appears on the 1c. James Fenimore Cooper (1789-1851) wrote many novels about the American Indians. The three most well-known are *The Last of the Mohicans*, *The Pathfinder* and *The Deerslayer*. A portrait of Cooper can be seen on the 2c. The 3c. was devoted to Ralph Waldo Emerson (1803-1882), the lecturer, essayist and poet. Louisa May Alcott (1832-88) appears on the 5c. Her books, *Little Women*, *Little Men* and *Good Wives*, are now acknowledged

WHIP CONTROL-LINE PLANE

(Continued from page 194)

the wing and lock with a bolt and washer on top. Another washer and then the control plate, followed by a further washer and another nut completes the assembly. Make sure that the bellcrank can pivot freely, but does not have too much rock. Lock the top nut in place by soldering, or use a locknut here.

The push rod which joins the bellcrank to the elevator control horn is bent from 16 S.W.G. steel wire. It is bent as shown and its length must be such that when the bellcrank is parallel to the fuselage the elevators are held truly horizontal with the push rod connected up. Any slight deviations can be taken out by adjusting the cranked bend in the push rod, once installed.

A line guide must now be attached to the port wing near the tip. This is bent, as shown on the plan, and pushed up through the wing. Hold in place with tape binding strips cemented to the undersurface of the wing and make off the protruding ends of the wire into loops. Then paint and balance the model after adding the fin and before attaching the lines. The fin is not strictly necessary for flying and is the one vulnerable part. Cut from 1/8 in. ply, it can be slotted into the top of the fuselage, as well as cementing, for additional strength, or omitted entirely.

To get the necessary 'whip' effect on long lines the model must balance no

farther back than the leading edge of the wing. The more forward the point of balance the easier it is to whip the model round and keep the lines taut, but the faster it tends to fly and the less manoeuvrable it becomes. Start with a forward position and remove weight, as practice is gained, to make the model more manoeuvrable.

The weights are lead washers, or equivalent, bolted through the fuselage, as shown. Attach these securely once the correct amount of ballast has been determined. If it is necessary to remove weight for fine trimming later, this can be pared off with a sharp knife or a file.

A full-size plan for this model, measuring 16ins. x 12 1/2 ins., can be obtained from The Editor, Hobbies Weekly, Dereham, Norfolk, price 1/8, post free.

To complete the model, attach the lines to the bellcrank and feed out through the line guides. To get sufficient 'whip' power a long flexible stick is used, made of bamboo or similar material, preferably at least 6ft. from top to bottom. A ring fitting is bound to the top and the lines passed through this down to a normal control line handle.

The control line handle is held in the left hand and the 'whip' or rod in the right. The model is 'powered' by a whipping action of the stick, which first leads the model until it has built up

speed, after which the model will continue to fly with less 'whipping' effort. At the same time the left hand controls the elevators of the model as in normal control line practice.

It will need a little practice to get the knack of whipping and controlling at the same time. A particular difficulty will be getting the model started. The best advice is to start with a short line length only—about 10ft.—and practice with this, getting an assistant to hand launch the model. Whip it up to flying speed as soon as it is released, holding the controls neutral. Soon you will be able to make a solo start, whipping the model right off the ground, and then progress to longer line lengths.

To launch with a longer line, double up the lines and hold about one-half of the total length in the left hand, making sure that the elevators are also held neutral. Whip start, and when the model is flying fast and level, release the spare line and quickly take up the slack with the whip, and take over control with the control handle.

Simpler, and almost as much fun, is to dispense with the control system entirely and use just a single line tied to the top of the whipping stick. Attach the other end of the line to a point near the wing tip, as shown on the plan. The model is 'powered' as before, but control is given by the attitude of the whip. Raising the whip makes the model climb, lowering the tip causes it to dive. Loops and inverted flight can be achieved, but there is not the same scope as with a normal control system.

FAMOUS NOVELISTS ON STAMPS

(Continued from page 203)

The tercentenary of Cervantes' death was the occasion for a special issue of Official Stamps, including one bearing a portrait of the writer and another his statue. The fourth centenary of Cervantes' birth brought forth the commemoratives from the American continent. Panama issued two postage and two air stamps in 1948, the postage stamps bearing a portrait, the 5c. air a monument to Cervantes, and the 10c. air Don Quixote and Sancho Panza. A 5c. was issued by Argentina in 1947 showing Cervantes and Don Quixote, and in the same year Chile issued a 40c. portrait. In 1947 also, Costa Rica issued two values, 30c. and 50c., bearing a portrait of Cervantes.

The Hungarian, Maurus Jokai (1825-1904), appears on a set of three values issued by his native land in 1925 to mark the centenary of his birth. His novels, *Black Diamonds*, *The New Landlord* and *Eyes Like the Sea* have appeared in English.

Hans Andersen (1805-75) is known

chiefly for his fairy tales. Denmark commemorated the centenary of these stories with an issue of six stamps. Four of these bear a bust of the author, one a drawing of the Ugly Duckling, and another the Little Mermaid.

The Norwegian novelist, Bjornstjerne Bjornson (1832-1910) wrote a number of books which have become universally known. They include *A Happy Boy*, *Flags are Flying in Town and Port* and *In God's Way*. Norway marked the centenary of his birth with an issue of four values in 1932 bearing a portrait.

The Lost of the Athenians has become a classic. The author of the book was a Swede, Abraham Viktor Rydberg (1828-95). Sweden issued two commemoratives in 1945 to mark the 50th anniversary of his death. These stamps contain a portrait.

To complete the novelists depicted on stamps, three Russians cannot be omitted. Maxim Gorky (1868-1936) was the author of *At the Lowest Depths*, *Kononov* and *Chelkash*. Two values

containing a portrait were issued by Russia in 1932 to commemorate the issue of Gorky's *Makar Chudra*. Two further portrait stamps were issued in 1943 to mark the 75th anniversary of Gorky's birth, and yet a further two in 1946 on the 10th anniversary of his death.

Hungary devoted the 40fi. value of her 1948 Air set bearing portraits of writers to Gorky, and the 30fi. to Leo Tolstoy (1828-1910). Tolstoy's novels *War and Peace*, *Anna Karenina* and *The Resurrection* are among the greatest the world has ever known. In 1935 Russia marked the 25th anniversary of Tolstoy's death with an issue of three values. These depict Tolstoy in 1860, Tolstoy in 1910, and the monument to Tolstoy in Moscow.

A Hero of Our Time was the magnificent work of Mikhail Lermontov (1814-41), who was killed in a duel. An issue of three values bearing different portraits was made by Russia in 1939 to mark the 125th anniversary of Lermontov's birth, and an issue of two totally different portraits followed in 1941 on the 100th anniversary of his death. (439)

Look WHAT YOU CAN MAKE AND DO WITH THE **Wolf Cub** HOME CONSTRUCTOR KIT

The Wolf Cub Outfit is the only equipment of its kind where every part is interchangeable. You can begin with as little as the Wolf Cub electric drill and build up with specially planned low priced sets of components or you can buy the complete outfit at once.

★ Take the first step today by writing for fully illustrated brochure!

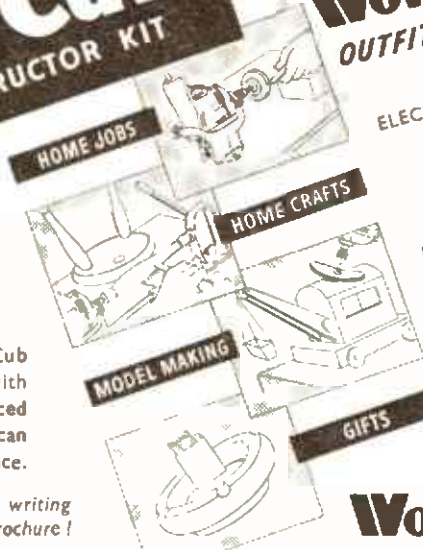

THE COMPLETE **Wolf Cub** OUTFIT INCLUDES...

ELECTRIC SAW KIT

ELECTRIC LATHE KIT

DRILLING GRINDING & POLISHING KIT

.. and all powered by

Wolf Cub ELECTRIC DRILL



WOLF ELECTRIC TOOLS LTD · PIONEER WORKS · HANGER LANE · LONDON · W.5
 TELEPHONE: PERIVALE 5631-4 · BRISTOL · BIRMINGHAM · MANCHESTER · LEEDS BRANCHES: GLASGOW

YOU CAN BECOME A HANDICRAFTS INSTRUCTOR

EXPERIENCE NOT ESSENTIAL

Men who enjoy making things in wood or metal can turn their hobby into a permanent and interesting Career. Short hours, long holidays, and security in a job you would really enjoy, can be yours if you become a Handicrafts instructor. Let us send details of the easiest and quickest way to get the necessary qualification.

We guarantee "NO PASS—NO FEE"

If you would like to know about our unique method of preparing you for one of these appointments, write today, and we will send you our informative 144 page Handbook—free and without obligation. Mark your letters "Handicrafts Instructor".

BRITISH INSTITUTE OF ENGINEERING TECHNOLOGY

BIET

595 Shakespeare House
 Stratford Place, London, W.1

Look at this sensational offer!

HOME DECORATORS



- One 5" pure bristle-hair distemper brush (varnished handle)
 - One 6" white fibre washdown/whitewash brush
 - One 9½" paperhanger's smoothing brush
 - One 1" and one 2" pure bristle paint brushes
- 25!** (inc. post & pack.)

A complete kit for re-decorating, all first quality guaranteed.

FARADAY MAIL ORDER CO.
 (DEPT. 25), 8 CHARING CROSS ROAD, LONDON, W.C.2



BRANCHES

- LONDON**
 78a New Oxford St., W.C.1
 (Phone MUSEum 2975)
- 87 Old Broad Street, E.C.2
 (LONDON Wall 4375)
- 117 Walworth Road, S.E.17
 (RODney 5509)
- GLASGOW**
 326 Argyle Street
 (Phone CENTral 5042)

Head Office & Factories—HOBBIES LTD., DEREHAM, NORFOLK

- MANCHESTER**
 10 Piccadilly
 (Phone CENTral 1787)
- BIRMINGHAM**
 14 Bull Ring
- SHEFFIELD**
 4 St. Paul's Parade
 (Phone 26071)
- LEEDS**
 10 Queen Victoria Street
 (Phone 28639)
- HULL**
 10 Paragon Square
- SOUTHAMPTON**
 25 Bernard Street
- BRISTOL**
 30 Narrow Wine Street
 (Phone 23744)

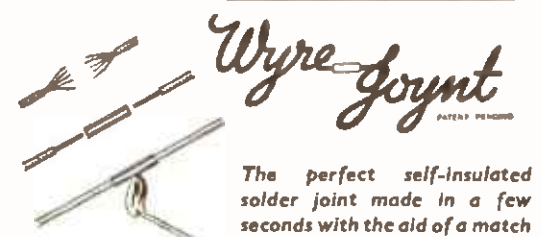

Wyre-Goynt

The perfect self-insulated solder joint made in a few seconds with the aid of a match

A Safe and Permanent Insulated Joint for all forms of electric wiring. Contains solder and flux, no tools or technical skill required, a necessity for Model Engineers, Electricians, Motorists, Radio and Television Builders, etc.

'PRICES 1.3 PER PKT OF 6, 2.3 PER PKT OF 12'
 FROM ANY HOBBIES BRANCH OR FROM ELECTRICAL DEALERS

Making Toys, Models or Novelties is a paying pastime—

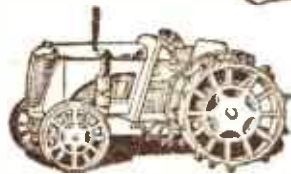
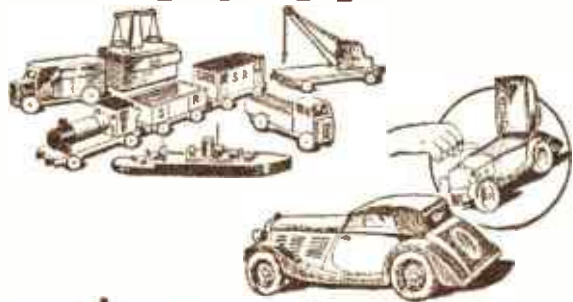

with a HOBBIES A1 FRET MACHINE

A Treadle Fretmachine provides a factory in the home. The treadle movement is easy, the machines running smoothly and fast. It is astounding the amount of work they will do in wood up to $\frac{1}{2}$ in. thick. Both hands are free to handle the work which can be manipulated up to 1ft. 7in. behind the sawblade. Machines are comfortably operated from a chair, rigid and easy running. The A1. has cast legs with wooden arms and special tension arrangement. Spare sawblades, a design and Instruction Manual supplied with each. Price ready **£7-19-6** to use

Carriage paid U.K.

Full range of Machines can be seen at any Hobbies Branch. Or ask particulars from large stores or Ironmongers. Illustrated leaflets free on request to Hobbies Ltd., Dereham, Dept. 99, Norfolk.

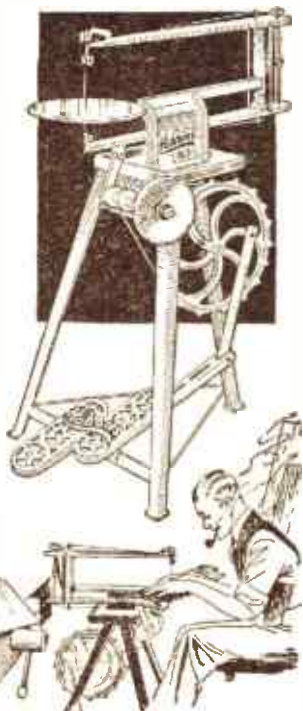

TOOLS FOR THE HANDYMAN



TOOL CLIP

For holding any handled tool. Spring steel. Holed for hanging.

7½d. each

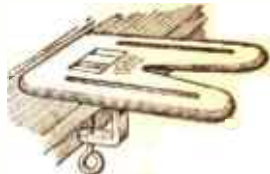

STEEL CUTTING TABLE

With clamp for easy fixing to bench. 6ins. by 4ins., strong and light. 3/6



BENCH STOP
3½ins. by 2ins. — Spring loaded top. 6/6

SINGLE HANDED SCREWDRIVER
5ins. long. Ideal for small work. 1/9

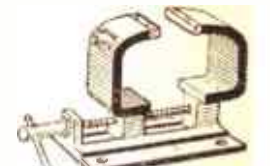

MODEL MAKER'S BENCH VICE No. 1
Strong, light and rigid. 3in. opening. 6/9



FRETWORK HAMMER

8ins. long. Strong and light for small work. 1/8

Is This Saw in Your Kit?

You can cut almost anything in wood with this Coping Saw. The blade is 6½ins. long and can be turned to cut at any angle. No tool-kit is complete without one. Get yours NOW.

6/-
Post Free

Buy from any Hobbies Branch or post free from Hobbies Ltd., Dept 99, Dereham, Norfolk

STOP SMOKING

You can overcome the smoking habit in 3 days or money back. Safe, pleasant, permanent. The only scientific way. No Will Power necessary. "Conquered the habit in 23 days. Am delighted". F.C. "Within 2 days I was free from the tobacco habit".—W.G. "Was a smoker for 2 years and broke the habit in 2 days".—F.N. "I haven't smoked a cigarette for 5 weeks".—J.E. "I used to smoke 20 a day . . . now I have no desire to smoke".—M. Recommended by "Health and Efficiency Magazine". Complete course 6/6. Details 1½d. stamp. Sent under plain cover. STEBBINGS, 28 (H/109), Dean Road, London, N.W.2. Established 1928.

J. WOTTON (Dept. H.)
140 HOLLINGS ROAD, BRADFORD, YORKS.
ALL TYPES OF MOULDS
3/- each
TOYS, ORNAMENTS, PLAQUES, ETC.
New 1952 Illustrated Catalogue. Send 6d. stamps, refunded on first order over 10/-

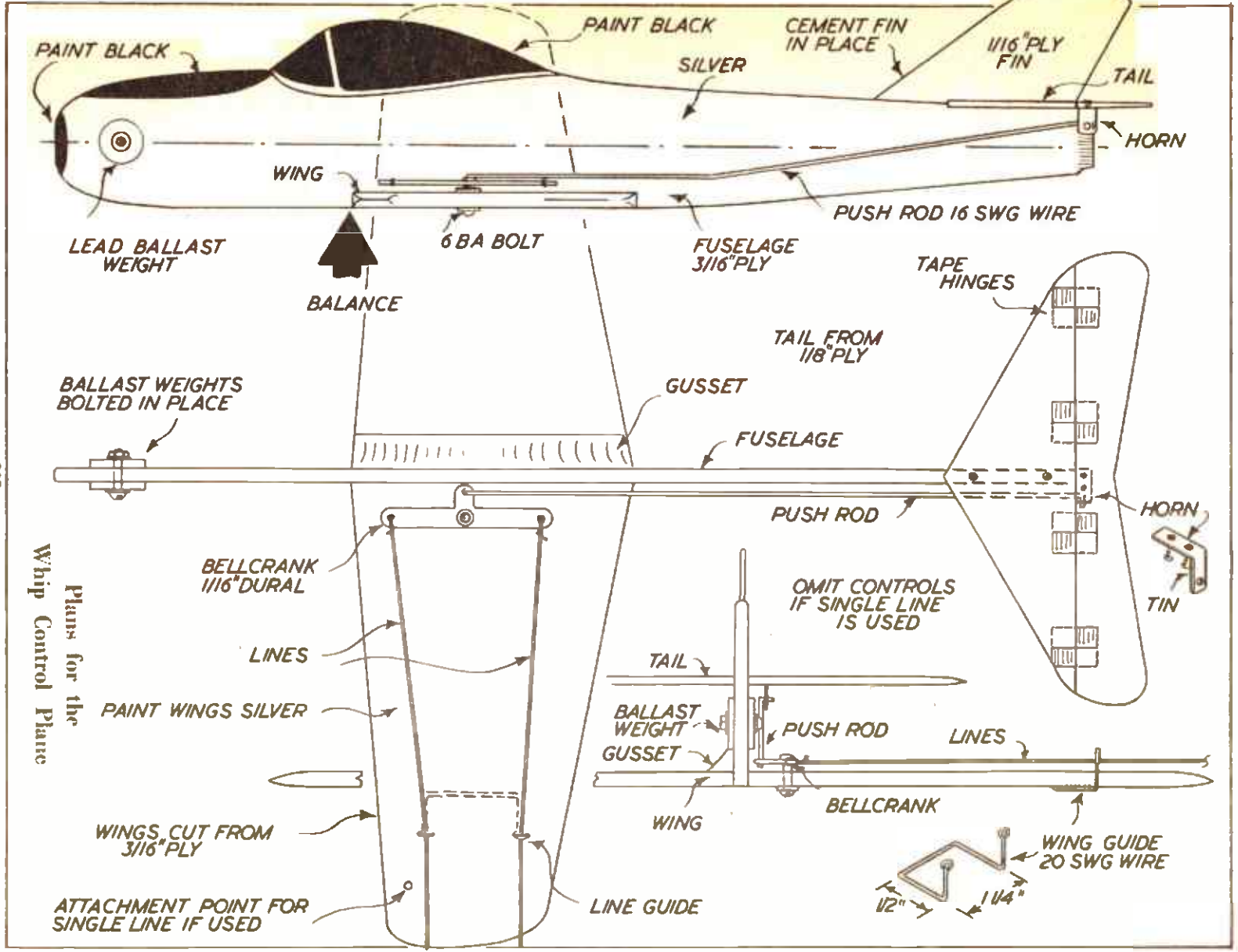

207

Plans for the
Whip Control Plane

ATTACHMENT POINT FOR
SINGLE LINE IF USED

WINGS CUT FROM
3/16" PLY

PAINT WINGS SILVER

LINES

BELLCRANK
1/16" DURAL

BALLAST WEIGHTS
BOLTED IN PLACE

BALANCE

LEAD BALLAST
WEIGHT

WING

PAINT BLACK

PAINT BLACK

SILVER

CEMENT FIN
IN PLACE

1/16" PLY
FIN

TAIL

HORN

PUSH ROD 16 SWG WIRE

6 BA BOLT

FUSELAGE
3/16" PLY

TAPE
HINGES

TAIL FROM
1/8" PLY

GUSSET

FUSELAGE

PUSH ROD

HORN

TIN

OMIT CONTROLS
IF SINGLE LINE
IS USED

TAIL

BALLAST
WEIGHT
GUSSET

PUSH ROD

LINES

WING

BELLCRANK

LINE GUIDE

WING GUIDE
20 SWG WIRE



What's My Job? - I Manufacture Weaklings into MEN!

GIVE ME a skinny, peplless, second-rate body—and I'll cram it so full of handsome, bulging new muscle that your friends will grow bug-eyed! . . . I'll wake up that sleeping energy of yours and make it hum like a high-powered motor! Man, you'll feel and look different! You'll begin to LIVE!

Charles Atlas
Actual photograph of the man who won the title "The World's Most Perfectly Developed Man."

Let me make YOU a New Man - in just 15 MINUTES A DAY!

You wouldn't believe it, but I myself used to be a 7-stone weakling. Fellows called me 'Skinny'. Girls sniggered and made fun of me behind my back. I was a flop. THEN I discovered my marvellous new muscle building system—'Dynamic-Tension'. And it turned me into such a complete specimen of MANHOOD that today I have twice won the title 'THE WORLD'S MOST PERFECTLY DEVELOPED MAN'. I felt so much better, on top of the world in my big, new, husky body, that I decided to devote my whole life to helping other fellows change themselves into 'perfectly developed men'.

What is 'Dynamic-Tension'? How Does it Work?

When you look in the mirror and see a healthy, luscious strapping fellow smiling back at you—then you'll be astounded at how short a time it takes 'Dynamic-Tension' to GET RESULTS! 'Dynamic-Tension' is the easy, NATURAL method you can practise in the privacy of your own room—JUST 15 MINUTES

My Illustrated Book is Yours FREE

Send NOW for my famous book, 'Everlasting Health and Strength'.

It has 48 pages, and is packed from cover to cover with actual photographs and valuable advice. It shows what 'Dynamic-Tension' can do, answers many questions that may be puzzling you. Page by page it shows what I can do for YOU. Don't put it off another minute. Send the coupon to me personally:

Charles Atlas (Dept. 102-F), 2 Dean Street, London, W.1.



FREE Post the coupon right now for my **FREE** book, 'Everlasting Health and Strength'. Tells all about 'DYNAMIC-TENSION' methods. Crammed with pictures, facts!



CHARLES ATLAS (Dept. 102-F), 2 Dean St., London, W.1

I want the proof that your system of 'Dynamic-Tension' will make a New Man of me. Send me your book, 'Everlasting Health and Strength', FREE and full details of your amazing 7-DAY TRIAL OFFER.

Name

(Please print or write plainly)

Address

BROOK 'GRYPHON' FRACTIONAL H.P. ELECTRIC MOTORS



If you're particular about your hobby . . . meticulously careful in your work . . . you'll appreciate the craftsmanship in the BROOK 'GRYPHON'.

Well designed—sturdily built—as reliable as the larger electric motors BROOK have been building for a half a century. In single phase types to suit your homeworkshop voltage; or, if you're running a full time business, the three phase types will cover all your requirements.

0-166 to 1-0 horse power.



1.LJ.234.

If you have a camera send 5/- for this TRIAL SET



Doing your own developing and printing doubles the fun of photography. You save money and have no end of a thrill making the negatives and getting prints from them. It is quicker, too, and you see the results within a few hours of making the snaps.

- The set comprises:—
- 1-oz. bottle of the famous one-solution developer AZOL.
 - 4-oz. of Acid Fixing Salts.
 - 2 M-Q Picturms for the prints.
 - 1-oz. bottle of 142 Solution.
 - 25 sheets of Contact Paper, size 2½ x 3½ inches, and an easy-to-follow booklet of instructions telling you how it is all done.

PRICE 5/-

which includes purchase tax and postage. Write your name and address in capitals, send P.O. and mark the envelope HOBBIES WEEKLY.

JOHNSONS OF HENDON LTD
335 HENDON WAY, LONDON, N.W.4.

THE ARROWS INDICATE THE DIRECTION OF GRAIN OF WOOD.



LOWER OVERLAY. CUT ONE 1/8".



OVERLAY AT TOP OF FRAME. CUT ONE 1/8". AND GLUE ON TO THE DOTTED LINES.



BACK RAIL TO TAKE STRUT. CUT ONE 2 1/2". AND GLUE BEHIND BACKING PIECE TO GLASS.



BACK STRUT. CUT ONE 1/8".

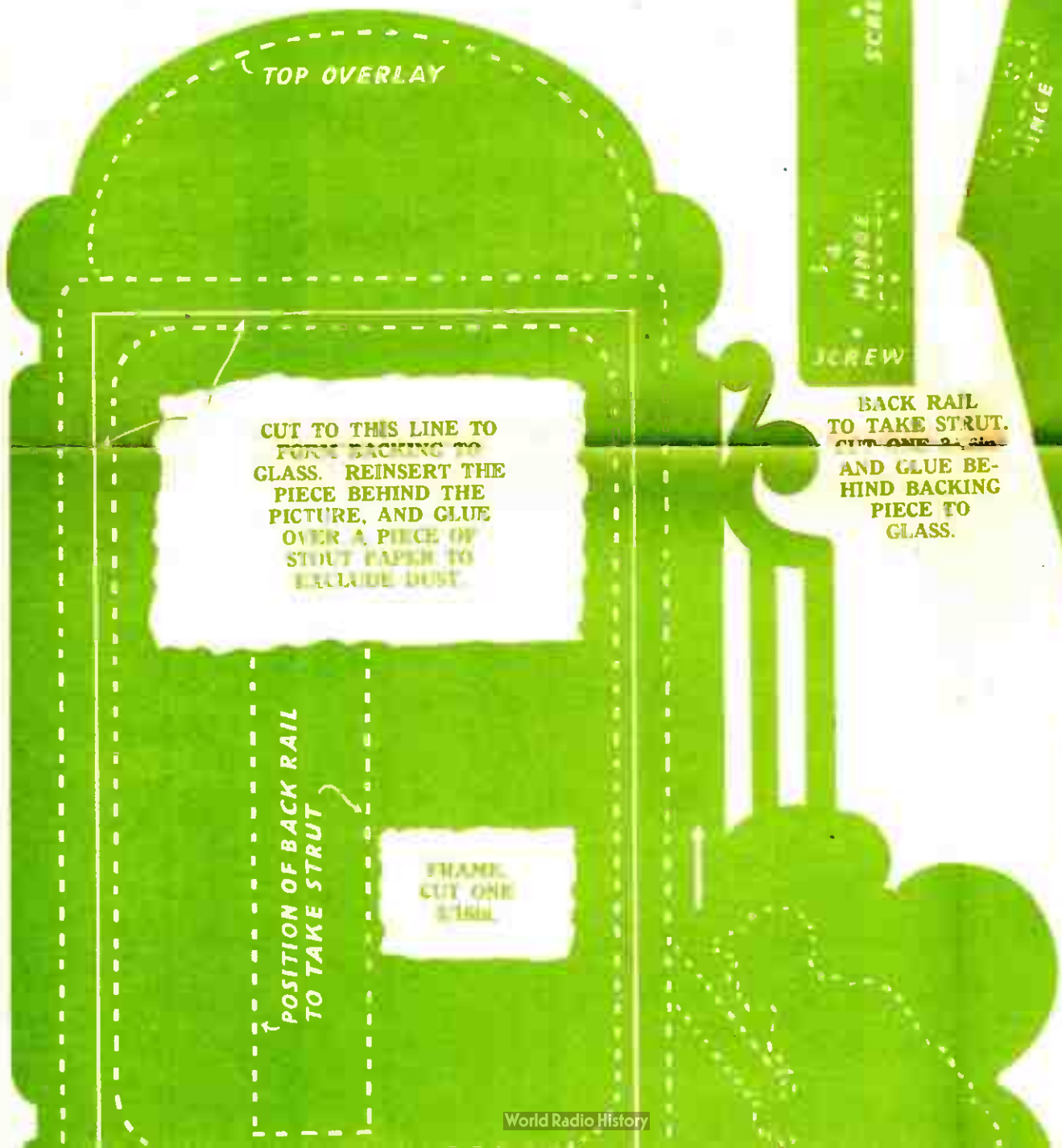

CUT TO THIS LINE TO FORM BACKING TO GLASS. REINSERT THE PIECE BEHIND THE PICTURE, AND GLUE OVER A PIECE OF STOUT PAPER TO EXCLUDE DUST.

POSITION OF BACK RAIL TO TAKE STRUT

FRAME. CUT ONE 1/8\"/>

NOTE: This set is only given with the current Hobbes and back numbers. copies may be

SUPPLEMENT TO HOBBIES
No. 2506

'THE CRICKETER' PHOTO FRAME

— SIZE —
HEIGHT 10 in.
WIDTH 6 in.



PANELS OF WOOD REQUIRED FOR THIS DESIGN
ONE H3 TWO G2
Materials for making this design are supplied by
HOBBIES LIMITED, Dereham, Norfolk.
Price on application.



SHOWING HOW THE TWO PIECES FORMING THE STRUT ARE ARRANGED TO HOLD DOWN FLAT.

THE ARROWS INDICATE THE DIRECTION OF GRAIN OF WOOD

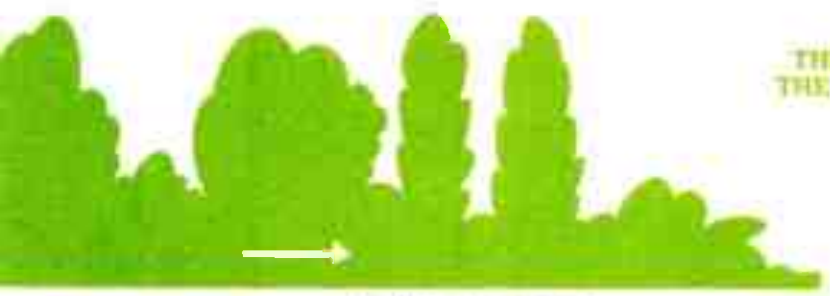

LOWER OVERLAY. CUT ONE 1 1/8 in.



TOP OF FRAME. CUT ONE 1 1/8 in. AND GLUE TO THE DOTTED LINES.

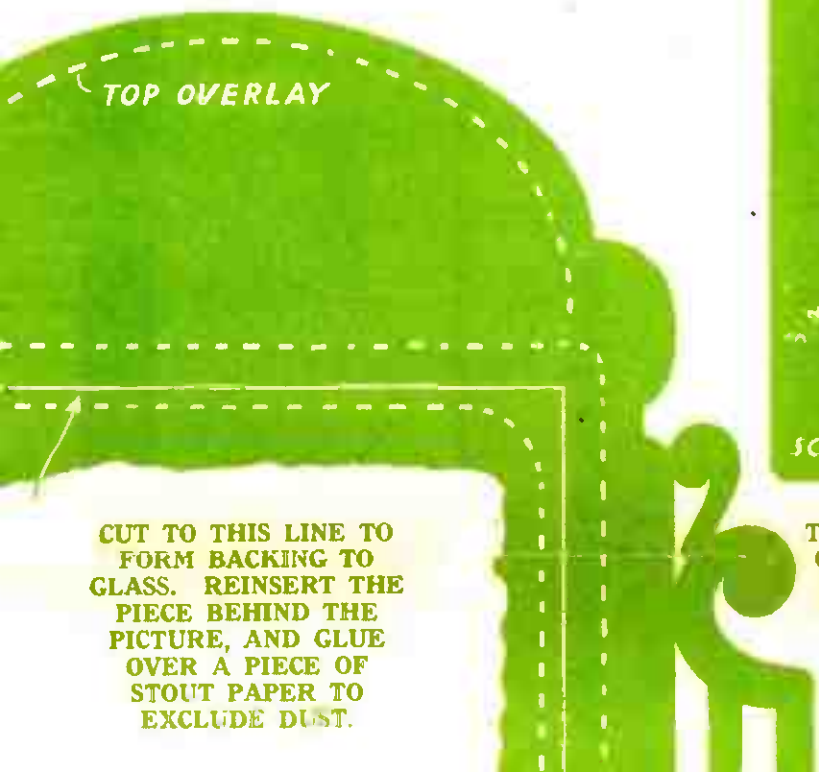

TOP OVERLAY

CUT TO THIS LINE TO FORM BACKING TO GLASS. REINSERT THE PIECE BEHIND THE PICTURE, AND GLUE OVER A PIECE OF STOUT PAPER TO EXCLUDE DUST.



BACK RAIL TO TAKE STRUT. CUT ONE 3/8 in. AND GLUE BEHIND BACKING PIECE TO GLASS.



SCREW

BACK RAIL
TO TAKE STRUT.
CUT ONE 3 1/2 in.
AND GLUE BE-
HIND BACKING
PIECE TO
GLASS.

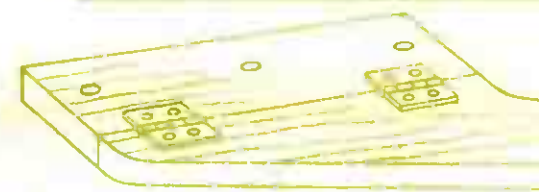

SHOWING HOW THE TWO PIECES
FORMING THE STRUT
ARE ARRANGED TO FOLD DOWN FLAT.

BACK STRUT.
CUT ONE 3 1/2 in.

NOTE - This design sheet
is only presented free
with the current issue of
Hobbies and not with
back numbers. Further
copies may be obtained.



PICTURE
CUT ON
USE THE
WOOD FOR

THE MARKINGS
MAY BE DRAWN
IN INK.

OVERLAY FOR GLASS
CUT ONE 1 1/2 in.

CUT TO THIS LINE TO
FORM BACKING TO
GLASS. REINSERT THE
PIECE BEHIND THE
PICTURE, AND GLUE
OVER A PIECE OF
STOUT PAPER TO
EXCLUDE DUST.

POSITION OF BACK RAIL
TO TAKE STRUT

FRAME
CUT ONE
3 1/2 in.

NOTE: THE OVER-
LAYS, BEING OF
1/8 in. WOOD, SHOULD
BE CUT WITH A
VERY FINE SAW
BLADE.

WIDTH 5 1/16"



PANELS OF WOOD REQUIRED FOR THIS DESIGN
ONE H3 TWO G2
Materials for making this design are supplied by HOBBIES LIMITED, Dereham, Norfolk.
Price on application.



SHOWING HOW THE TWO PIECES FORMING THE STRUT ARE ARRANGED TO FOLD DOWN FLAT.



BACK RAIL TO TAKE STRUT. CUT ONE 3 3/4 in. AND GLUE BEHIND BACKING PIECE TO GLASS.



BACK STRUT. CUT ONE 3 1/16 in.

NOTE: This design sheet is only presented free with the current issue of Hobbies and not with back numbers. Further copies may be obtained.

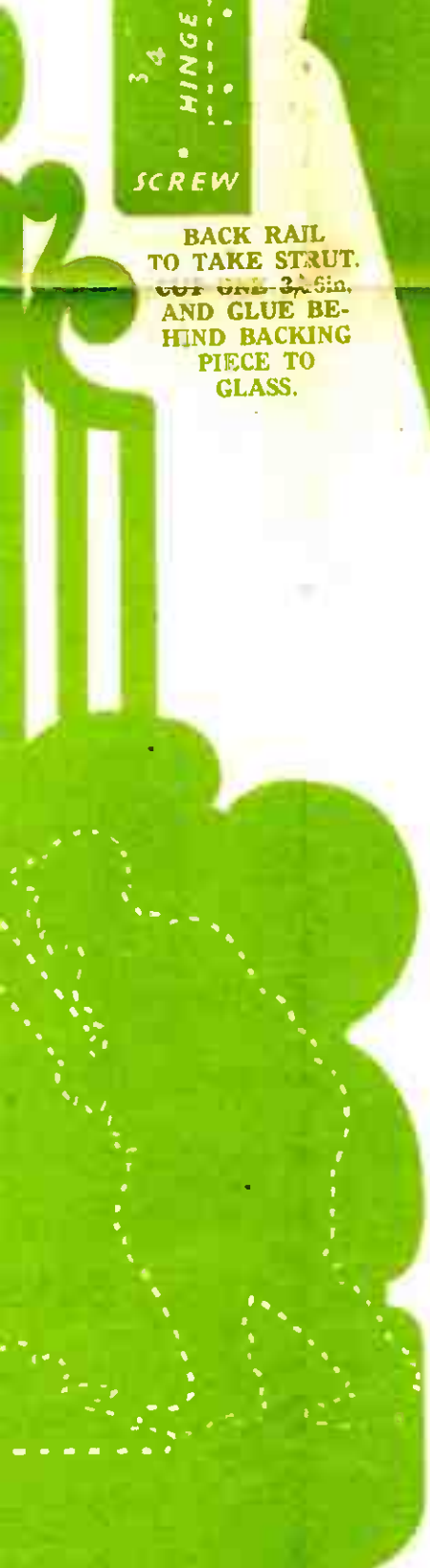

NOTE: THE OVERLAYS, BEING OF 1/8 in. WOOD, SHOULD BE CUT WITH A VERY FINE SAW BLADE.

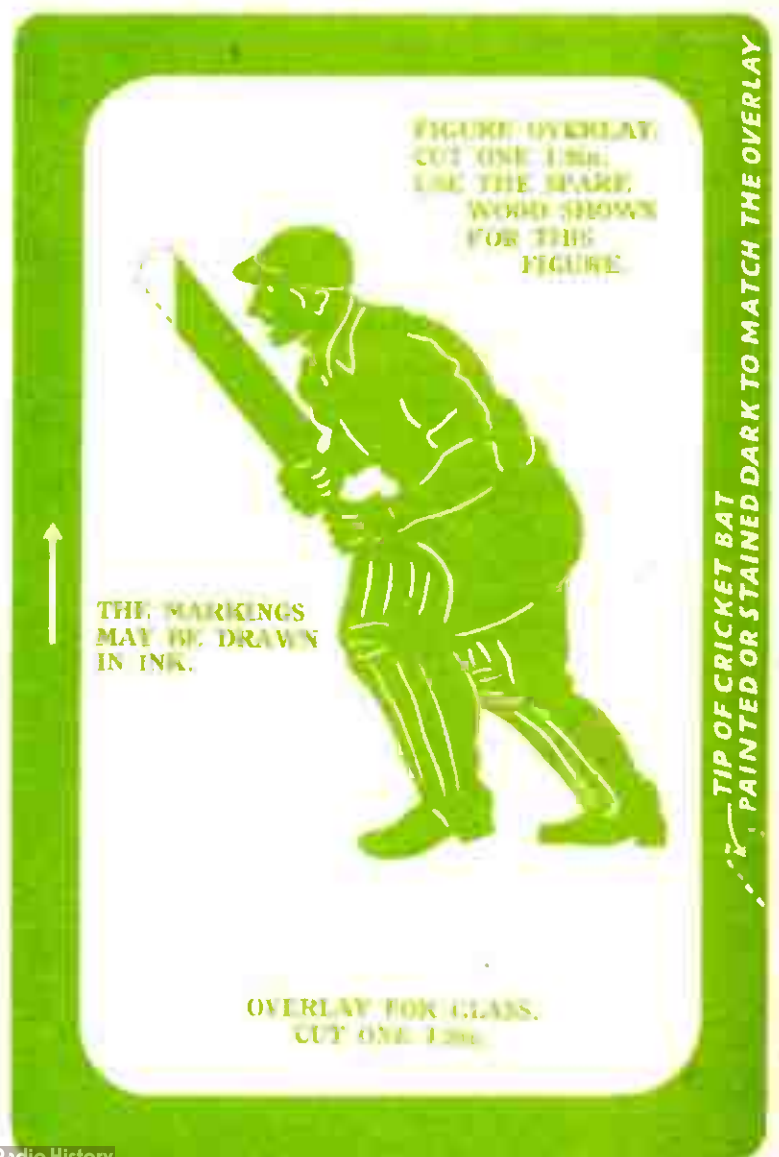

FIGURE OVERLAY. CUT ONE 1 1/8 in. USE THE SPARE WOOD SHOWN FOR THIS FIGURE.

THE MARKINGS MAY BE DRAWN IN INK.

OVERLAY FOR GLASS. CUT ONE 1 1/8 in.

TIP OF CRICKET BAT PAINTED OR STAINED DARK TO MATCH THE OVERLAY.

PRINTED IN ENGLAND.