

Hobbies

WEEKLY

CONTENTS

	Page
Pull-along Toy	
Windmill	241
Try Mirror-Viewing	243
Model Ranch	244
Oscillator & Amplifier	245
A Chemical Garden	246
House Telephone	247
Picturesque Receiver	
Case	248
A Fan Type Firescreen	249
Model Electric	
Refrigerator	250
Replies of Interest	251
Home Chemistry	252
Serviceable Vase Stand	253
Toy Windmill Patterns	255

August 1st, 1951

Price Fourpence

Vol. 112 No. 2909

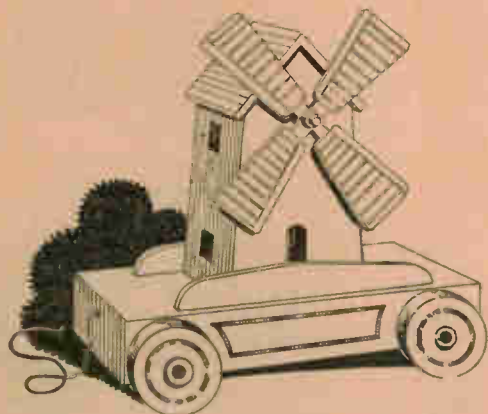

Fig. 1—The finished toy

THERE is always something fascinating about a windmill, and it is a pity that they are falling so much into disuse, in this country at least. Even a toy windmill can be fascinating, especially if the 'sails go round' without any apparent mechanical power.

Such a toy windmill is described here and full-size diagrams are also given. A general idea of the toy can be gathered from the sketch Fig. 1, and in the diagrams Figs. 2 and 3 we see the mechanism by means of an inside view of the body of the mill.

Then, on the inside back cover of this issue, we have been able to include certain parts of the toy which are shaped, and this, to many, will be extremely useful as all redrawing and enlarging from small illustrations is thus eliminated. The patterns can be either pasted down direct to the wood or traced in the usual way, and then sawn out.

The Mechanism

The base of the mill is mounted on four $1\frac{1}{2}$ ins. diameter wheels, one pair of these being fixed to a through axle on which, at its centre, is fixed a grooved pulley wheel. Further along the base are

Children will love this PULL-ALONG TOY WINDMILL

two more cross axles each bearing similar pulley wheels which revolve loosely about their axles. These are shown as (L) in Fig. 2.

In the body of the mill is another cross axle with the larger pulley wheel (K) fixed to it. To this axle, also, are fixed the sails of the mill, together with the two washers (I) which hold the axle in its proper place, and the small end washer (J) which binds the sails rigidly to the axle.

With these parts so arranged, it is easy to see how, by a continuous belt

are of $\frac{3}{8}$ in. wood. In marking out the top of the base, see that the angles are square. The sides (B) and ends (C) are glued under the top with a few fret pins driven through to give additional strength.

Note from the diagram the positions and spacings of the holes to take the four axles. These axles may be of either $\frac{3}{16}$ in. or $\frac{1}{4}$ in. diameter rod, and holes to suit the rod must be carefully marked and cut out. Cut off two lengths of the rod 6 ins. long for the axles of the large wheels, and two lengths $4\frac{1}{2}$ ins. for the inside pulley wheels. From the page of

Patterns for this Toy on page 255

running round all four pulleys, the action of the sails is obtained

Construction of Base

The base should be made up complete with its four wheels and two pulleys. Then the mill and sails are made up complete and glued to the base. In Fig. 4 is shown a diagram of the base with all necessary measurements. Wood $\frac{1}{2}$ in. thick is used for all parts of the base, and for all the mill except the sails, which

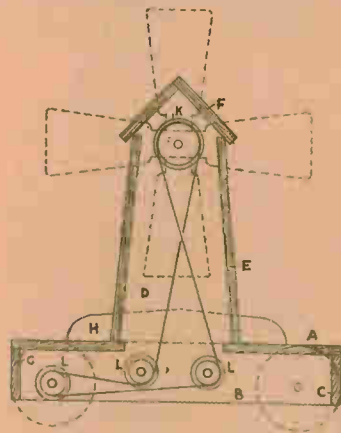

Fig. 2 Sectional view, showing how the toy works

All correspondence should be addressed to The Editor, Hobbies Weekly, Dereham, Norfolk.

patterns cut three of the pulleys (L), $\frac{1}{2}$ in. thick and form grooves in each by means of either a triangular file or a rat-tailed file.

Be sure to get the grooves all to the same even depth as shown by the dotted lines on the diagram. The centre hole in one of the pulleys, that to be fixed to the axle of the wheels, must be cut scant $\frac{1}{2}$ in. diameter so that it fixes stiffly on the axle. The other two pulleys must be loose on the interior axles. They should be threaded on the axles, and the axles then glued into the holes in the base made for them.

The wheel axles may be run through the sides of the base loosely, and on one of them the pulley (L) must be fixed tightly with glue. The four wheels should not be glued to the axles outside until the painting of the whole base is finished. Four wheels $2\frac{1}{2}$ ins. diameter can be bought from Hobbies Ltd. all ready for fixing, except that the centre holes must be enlarged to fit the axles.

The Mill

We now turn our attention to the mill, which is made up complete, and afterwards fixed to the base exactly over the hole in the top.

Turning again to the page of patterns, see at (D) the outline of the front and back of the mill. First cut out one with the fretsaw, not forgetting the hole near the top for the cross spindle to carry the sails. When the one piece has been cut, clean off the edges and use this cut-out as a template to get the second upright.

The two sides (E) of the mill are plain oblong pieces measuring $6\frac{1}{2}$ ins. long by $2\frac{1}{2}$ ins. wide and $\frac{1}{2}$ in. thick. Glue these pieces between the front and back and put in one or two fret pins to strengthen. The roof is an independent unit, and is not glued in place but simply slips in between the front and back and thus fits stiffly. The reason for its not being fixed is to facilitate its removal for effecting repairs to the pulley belt inside.

The roof is made up of the two pieces (F) and the two pieces (G), the latter being given full size on the pattern sheet. The length of the roof slopes (F) is $3\frac{1}{2}$ ins. and their widths $2\frac{1}{2}$ ins. and $2\frac{1}{2}$ ins., one being thus $\frac{1}{2}$ in. wider than the other to butt on as given in the diagram on the

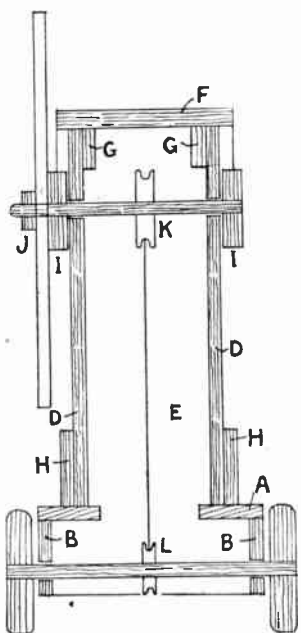

Fig. 3—Another sectional drawing to help the constructor

pattern sheet. It will be observed that the two pieces (G) hold the roof slopes together and slide down on the inside of the front and back of the mill. The ultimate position of the two parts (G) is shown in Fig. 3.

The axle or spindle carrying the sails should be $4\frac{1}{2}$ ins. long and $\frac{1}{2}$ in. diameter and $1\frac{1}{2}$ ins. from its back end there is glued on the large pulley wheel (K). This is given full size on the pattern sheet, and it is made in a similar manner to pulleys (L) of the base. Pass the spindle through the front and back of the mill, allowing it to project $\frac{1}{2}$ in. beyond the latter where a washer (I) is glued on to hold it in place. Washer (I) is of the same diameter as pulley (K). The pulley is glued to the spindle as mentioned, and then a second washer (I) is glued to the spindle a little way away from the face of the mill to allow of free action.

The Sails

These are easy to make, and by the

use of the full size patterns on the sheet, the shaping and cutting is simplified. Stick the outline of the sail to a piece of $\frac{1}{2}$ in. wood and cut round with the fretsaw. After cleaning the cut edges with fine glasspaper, lay it on a second piece of $\frac{1}{2}$ in. wood and draw round it with a sharp pointed pencil. Cut this out and clean it up in the same way as the first sail, and then put them together, edge to edge, while a hole is drilled through the centre of both to take the spindle. Now glue the two sails together, centre to centre, in their proper place and at right angles to each other. See that the holes properly coincide so that they may fit on to the spindle.

When the glue has hardened, push the sails on to the spindle and put on a little glue to hold them securely, then glue on the front washer (J) which should ensure the sails gripping the spindle properly.

Painting

The mill should be painted in bright colours. The sails may be painted before they are fixed to the spindle, if desired, the lines shown on the pattern sheet being first transferred to the wood before the pattern is destroyed.

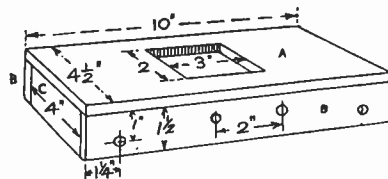

Fig. 4—Details of the base

It only remains now to put the finishing touches to the paint work and add a coat of varnish if the paint needs it. Now remove the roof section of the mill, which as mentioned, is fitted, and slides between the front and back. A piece of fine cord is next required and is passed round all four pulleys just as seen in Fig. 2. The cord should be of sufficient tension to grip the grooves of the pulleys, and must in no case be strained to distort the axles or the spindle. A stout cord should be attached to the base of the toy for pulling it along. (393)

Try Mirror-Viewing—(Continued from page 243)

will nicely take the standard $3\frac{1}{2}$ ins. by $2\frac{1}{2}$ ins. commercial print.

With the mirror-frame placed on the main spar, the apparatus is now complete. To use, a print is placed in the surround and the monoscope turned so that the light falls directly on to its surface. Now look over the top of the print as shown, and, by moving the arm in and out, bring the picture appearing in the mirror into sharp focus. The eye need not necessarily be exactly on the top lip of the print, and good focus is secured by the correct juxtaposition of mirror, print and eye.

For the best viewing, the apparatus should really not be held in the hand once the general positions have been obtained. No matter how steady the

hand may appear to be, there is always a certain amount of vibration in anything hand-held, and this, in the case of a photograph, will destroy very fine detail, the seeing of which is half the

SADDLE BAG

Many cyclists find that their saddle bags sag when empty, and often perish quickly. To stop this, a cardboard box, cut to the required shape, should be inserted. This gives the bag a nice square appearance, prevents it cracking, and so gives it a longer life.

beauty of an enlargement.

One final point. If you are making your own prints for mirror viewing, it is always best to have them rather on the soft side and full of details in both the high-lights and shadows. To this end P.O.P. (that is daylight paper) is the most satisfactory to use as this gives detail everywhere in a way that gaslight materials never do. This kind of paper is just coming back on the market after its long wartime absence.

The worst kind of prints for mirror enlarging are the hard 'soot and white-wash' type, for while these may look bright held in the hand, the apparent brightness is obtained by a complete absence of detail in both high lights and shadows. (281)

Get a better look at your snaps— TRY MIRROR-VIEWING

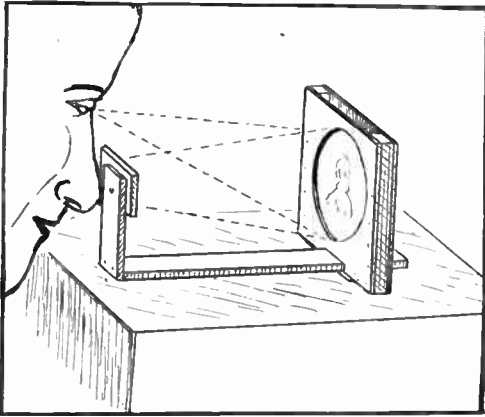

Some time ago a viewing instrument was sold on this principle, called a 'monoscope'. There was the curved mirror at one end of a base and a frame to hold the print at the other. This base was adjustable so that the print could be taken nearer to, or further from, the glass and for storing, both mirror and frame folded downwards.

The making of a monoscope comes well within the range of the handyman, so details are given here of how to construct a simple one.

Required is a 4in. or 5in. diameter concave shaving mirror. These can be obtained quite cheaply complete with a wire 'leg' at the back for standing purposes. This will not be needed but it can be readily removed as the ends of the wire are usually only sprung into the surround of the glass. Required, too, are two squares of card, about 5ins. by 5ins. (depending on the size of the mirror) and a few strips of wood.

glue and a series of short pins to form a shallow container into which the mirror will just slip. To this end the length of the horizontal strip is exactly equal to the diameter of the glass and surround, so that the uprights when in position will just touch the sides of the latter.

On the under edge of the horizontal piece, cut out the channel (e), which must just take the arm (g). The depth of the channel, therefore, is equal to the thickness of the arm and its width to the width of the arm. Thus when (e) is covered with the rectangle of wood (f) a tunnel is made which forms a comfortable sliding connection for (g). The arm must move nicely and easily in the tunnel, but it must not be too loose fitting or the mirror will fall out of the perpendicular. The arm (g) is 10ins. long.

At the further end of the arm fit the upright (h), to the top of which (and central to the mirror) is the piece (k). This is 3½ins. by 2½ins. and is attached by a single screw so that it can be turned at will into either a vertical or horizontal position. It is for holding the prints which are gripped by the two side lips (A) and a single piece of card along the

DESPITE their popularity, 3½ins. by 2½ins. snapshots are not seen at their best in prints of that size—and the better the camera the more this is the case. The reason is that there is generally a wealth of fine detail and subtle gradation in the pictures that the eye seems to lose when viewing at contact size.

Commercial enlarging helps, especially if the job is done by a careful worker who will slightly cut the unwanted foreground or trim the sky to just the right amount required.

But enlargements cost money—even to postcard size—and as films themselves, to say nothing of developing charges, are fairly expensive, the final cost of a picture can be really rather excessive. Enlargements, too, take up more room in albums or when otherwise stored.

There are other ways, however, of seeing your snaps 'big', and discovering their hidden detail and beauty apart from making bigger prints.

Simple But Effective

A simple and most effective way is by viewing with a concave mirror, such as is used in shaving. The print is turned towards the light and away from the observer and the mirror is held facing the print. Thus the observer is looking over the top edge of the print at its reflection in the concave glass.

Some adjustment of eye, print and mirror will be necessary, but this is not hard, and within a moment a position will be arrived at in which a clear and sharp reflection of the snapshot is seen in the mirror. This it will be found is greatly enlarged and by a little further adjustment of head, snap and mirror the size of the enlargement can be increased or reduced.

As well as being enlarged, the reflected picture will at one position be found to have a seemingly 'stereoscopic' or 'three-dimensional' effect. That is, everything will appear to stand out with all the solidness and roundness of nature.

quite cheaply complete with a wire 'leg' at the back for standing purposes. This will not be needed but it can be readily removed as the ends of the wire are usually only sprung into the surround of the glass. Required, too, are two squares of card, about 5ins. by 5ins. (depending on the size of the mirror) and a few strips of wood.

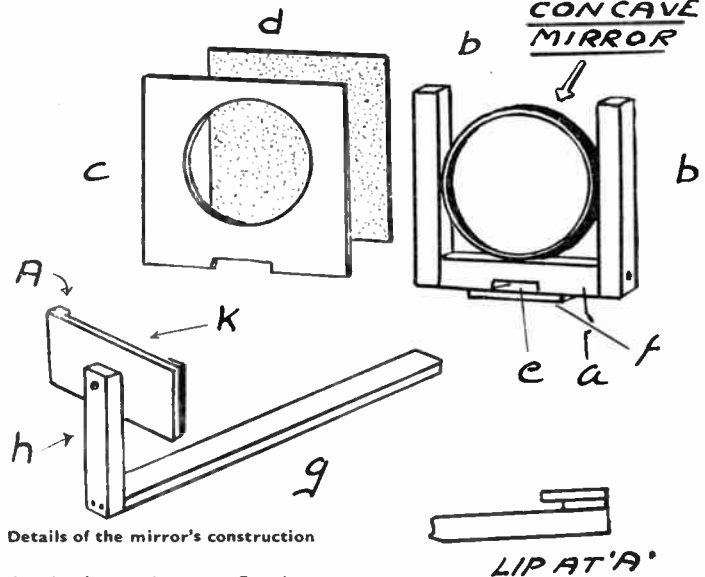

Details of the mirror's construction

First make the frame shown in Fig. 1. This is made up of the horizontal strip (a), two side verticals (b) and two pieces of card as (c) and (d). The squares of card sit one in front and the other behind the mirror and the one that goes in front has a circle taken out of it rather less than the diameter of the mirror. The other card (d), which is placed at the back, has no opening taken out.

The Uprights

The uprights (b) must be just as wide as the frame of the mirror. These five parts (the three strips of wood and two squares of card) are fitted together with

bottom. The lips are made by gluing a thin strip of card to either side and covering these with two other strips, slightly wider. The right-hand bottom sketch makes the idea quite clear. A single strip is merely used at the other edge to prevent the snap falling out when the holder is being used for horizontal pictures.

The distance between the inner edges of the smaller strips of the lips is a shade over 3½ins. Thus the lips and the bottom strip together form a surround which

(Continued foot of page 242)

Yippee! You can make this toy MODEL RANCH

EVEN the most martial of small boys will eventually get tired of a model fort. When something new in the way of indoor games is required, a model ranch will probably be found very acceptable. The popular stores are well stocked with suitable cowboys and Indians and similar models, and an 'Injun attack' on the frontier log cabin will give a new interest to table-top games.

The X-20 ranch as designed is capable of many improvements. In the form illustrated it is simply a log cabin surrounded by a stockade. According to the size of the base, cattle pens, stables, and so on, could be put inside the

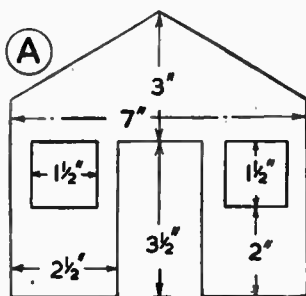

Dimensions of the gable ends

stockade walls, while a few shrubs and trees (made from sponges dyed green, and twigs) will add to the interest of the layout.

Square Cabin

The actual cabin is made up of three-ply and is square in plan. All sides are 7 ins. long, the gable ends being 6 1/2 ins. and the remaining sides 4 1/2 ins. high. Window and door openings are cut in the gable ends and windows in the sides to the dimensions shown on drawings (A) and (B). The door can be omitted from one gable end if desired. When completed, all four sides are glued and pinned to the sides of a 1/2 in. thick base.

All outside surfaces of this cabin are covered with half-round shapings to represent logs. The easiest method of providing these is to saw lengths of dowelling in half, and for this the gadget illustrated at (C) will be found very useful. It consists of two pieces of wood bevelled on the inside edge so that when laid together they form a V-shaped cradle. At one end of this cradle a vertical strip of wood is fitted, this having a guide cut in which a saw can work. The length of dowel being sawn is simply laid in the cradle and can easily be held there while the saw works through the cut.

This part of the cabin is mounted on the main verandah. Four strips of 3/4 in. wide by 1/2 in. thick wood are nailed at the edges to make a framework 10 ins. square, some additional cross-pieces are

put in to make the framework stronger, and the top is covered with a sheet of ply. The cabin is fastened down in the centre of this, then the roof (made in a similar manner to the walls) is fastened in place. Drawing (D) shows a side section of this.

Verandah fencing has then to be made and fitted, this being of 1/2 in. thick wood, 3/4 in. high. This is marked out with top and bottom rails 1/2 in. wide with similar uprights about 2 ins. apart, each small rectangle having two 1/2 in. wide diagonal braces. The four triangles inside each rectangle are then fretted out to give the fence shaping as shown on (D). This fencing passes right round the verandah, but an opening is left in it directly opposite the cabin doorway.

A long wooden step is fitted to the base immediately opposite the cabin door. This simply consists of two tri-

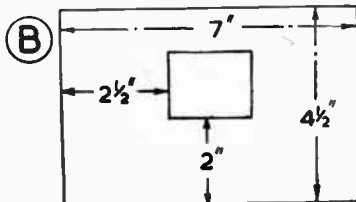

The sides

angular uprights that have their back edges fastened to the verandah sides, these being 5 1/2 ins. apart and connected by a step. This is also shown at drawing (D).

Although not shown on the sketch, the cabin has a door and window shutters. In all cases a piece of plywood is cut to fit the opening, is covered with dowel logs, and is hinged into

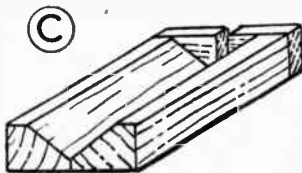

A simple gadget to assist in cutting dowellings in half

place. The window shutters are hinged on the top edge, and are kept propped open by a thin piece of wood. For a further realistic touch 'rifle slits' can be left in the shutters.

The next step is the making of the main base, which is of plywood on a framing of 3/4 in. by 1/2 in. wood laid on the flat. To a certain extent, the size of this base will be governed by the size of plywood available, but to keep the toy to table-top size a panel 2 ft. or 2 ft. 6 ins. square should be ample. If a much

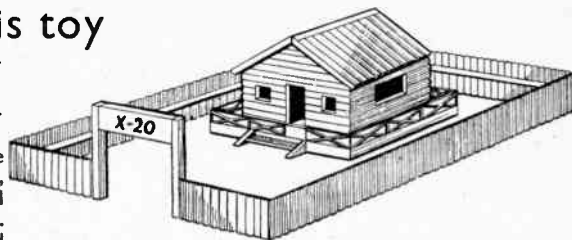

larger affair than this is needed, the cabin and stockade should be erected on a panel of the size suggested, and other panels built up to represent grass-land, etc., can be laid round the original model.

The outside framing of the base should be level with the edges of the ply, and several cross-pieces should be put in to keep the base firm and prevent its warping. Ordinary butt joints can be used for the assembly, and all nails should be punched well down. A rather thick coat of green paint should be given to the plywood, and while this is still wet some sawdust (previously dyed green) should be sprinkled on the upper surface. When the paint has dried, the surplus sawdust can be brushed off with the palm of the hand.

The log cabin is set towards the centre back edge of the base, being held by glue and fine nails running into its framing.

The Stockade Walls

Stockade walls running round the outside of the base are of sawn dowelling similar to the walls. As logs can hardly be expected to be of regular size it is advisable to use dowelling of various diameters on these fences to get the same effect. All pieces of dowel are about 2 ins. in length, and are glued side

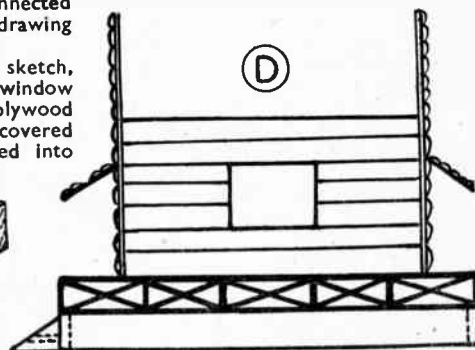

Side section of the cabin

by side on an upper rail of 3/4 in. by 1/2 in. or similar wood. They should be kept under pressure until the glue has set, when a fine brad may be driven through each dowel into the rail. A small rebate is worked along the bottom inside edge of each wall so that it can be nailed into place along the edge of the baseboard.

An opening can be left in the walls, and here two large gate-posts and a name-plate are fitted. A log door to close this opening can also be made and hinged into place. (352)

It's simple to build this combined OSCILLATOR & AMPLIFIER

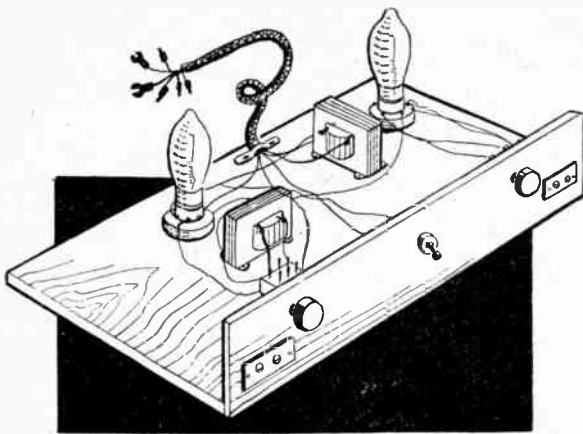

THOUGH the ordinary buzzer is suitable for Morse Code practice, it has the disadvantage that the tone produced is rather different from that obtained in radio Morse reception, and that it may need frequent adjustment. Youth organisations and others who are practising Morse should, therefore, find this unit of service, as it is a valve oscillator which produces an audible note.

So that the apparatus may be of maximum use, a change-over switch has been provided. When this is turned to the second position the unit functions as an ordinary 2-valve amplifier, and may be used for playing records with a pick-up, for amplifying the output of a microphone, and similar purposes.

Components to Use

The simplest form of construction is to employ a wooden base, with a small front panel to support the controls. A base about 4½ ins. by 6½ ins. is suitable, with a panel about 3 ins. high.

One 4-pin valveholder is used, and one 5-pin holder; the latter for an output pentode. But if a triode is used, as will be explained, two 4-pin holders can be used. A triode will provide slightly less volume.

The volume control is a .5 megohm one. This value is most generally suitable, but a control of .25 to 1 megohm may be used, if already to hand.

For on/off switching any small switch can be used. The other switch is a double-pole double-throw one, and may be of rotary, or

other type, such as employed for wave-change switching in many receivers.

Two socket-strips are used for Pick-Up and Speaker, or small terminals can be used. The .01 mfd. condenser can be of mica or paper insulation, the former being best, if to hand.

Two coupling transformers are used, and these may be of any ordinary type, with a step-up ratio of about 1:3 or 1:5. If the tags or terminals are marked

P, HT, G, GB, then P and HT indicate the primary, and G and GB the secondary. In the diagrams, primary and secondary are indicated by P and S respectively. Ex-service and some other transformers are marked OP, IP, OS, IS. Here, IP and OP are the primary, and IS and OS the secondary.

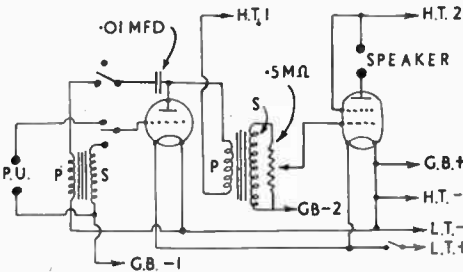

Fig. 1—The theoretical circuit

Pitch Adjustment

The note produced by the unit depends upon the characteristics of the transformers, and will normally be of medium pitch. The note may be modified, if desired, in a number of ways.

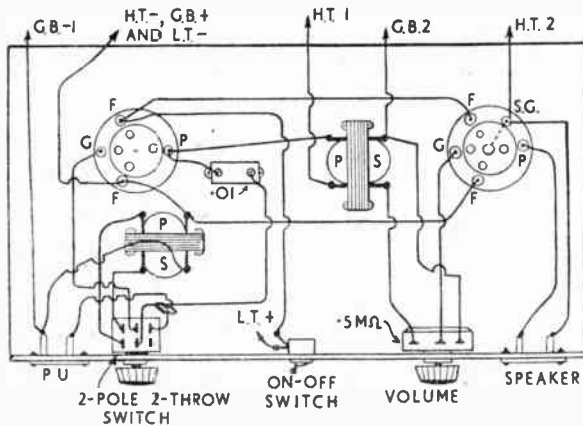

Fig. 2—Details of the wiring

Connecting a condenser across the primary of either transformer, or across the secondary of the first transformer, will lower the pitch. The larger the condenser, the more will pitch be lowered, and any value between .0002 mfd. and .01 mfd. or so can be tried. Pitch may be increased by connecting a resistor between the secondary of the first transformer and the one switch contact, instead of taking a direct connection. Wiring a resistor in parallel with primary or secondary of the first transformer will also have this result.

Different transformers will also produce different notes. With any transformer, the way in which the secondary of the first transformer is connected must be correct. So if no oscillations are produced, reverse leads to the secondary.

Finally, the high tension voltage at HT1, and the grid bias voltage at GB1, will considerably influence the note produced. However, if the pick-up sockets are in use, grid bias will have to be kept to a reasonable figure, or quality of reproduction will suffer.

Constructional Details

Fig. 2 shows all the wiring. For

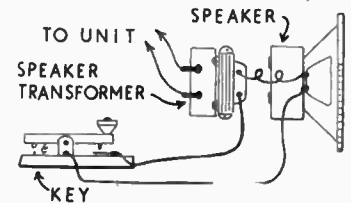

Fig. 3—How the morse key is connected

battery connections, use lengths of flex. These may be twisted together and secured by a clip at the rear of the baseboard. Take care not to apply more than two volts to the valve filaments (L.T. positive). It is also best to assure that the unit is never switched on without grid bias, as this causes some loss of emission in the valves.

Any insulated wire of 20 S.W.G. or stouter gauge can be used for wiring up, and no errors should arise if Fig. 2 is followed carefully.

Valves and Batteries

Almost any ordinary 2-volt filament valves can be used, but maximum volume will, of course, be obtained with good valves. A triode such as the HL2 can be used in the left-hand holder, and a pentode such as the 220HPT in the right-hand holder. A triode such as the LP2 can also be put in the right-hand holder, if desired.

There is, of course, no reason why other types of amplifier and output

(Continued foot of page 246)

You can easily make A CHEMICAL GARDEN

A CHEMICAL garden of this type is very easy to make, and the chemicals may be obtained very cheaply from any chemist. The accompanying photograph gives some idea of the type of growth which arises, but unfortunately cannot show the colours, which are very varied, ranging from dark brown to the lightest blues, pale greens, and white. In the early stages, growth is 1 in. or so in twenty-four hours, but this slows, and at last a stage is reached where growing ceases, unless more chemicals are added. The formations resemble coral.

The Containing Vessel

This should be deep, because the crystals will only grow from the bottom up to the surface of the water. A 2lb. jam-jar can be used, or any kind of glass bowl or tank. It should be set in a position where it need not be moved, and filled with a solution made by mixing sodium silicate and water. The sodium silicate is popularly known as water-glass egg preserver, and, ob-

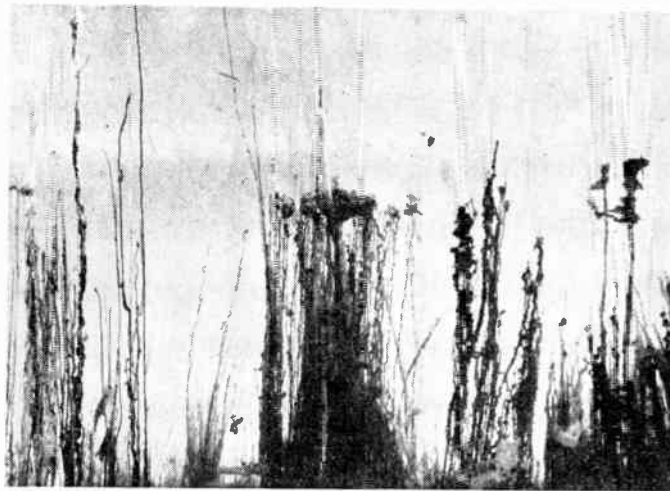

A picture of an actual 'garden'

tained for this purpose, normally costs about 6d. per 1lb. tin. Use one or two tablespoonfuls of water-glass to each half pint of water. Warm water will make mixing easier.

The more water-glass used, the more rapidly will the crystals later placed in grow. However, as the water-glass slightly clouds the water, very strong solutions should be avoided.

The Chemical 'Seeds'

These are the sulphates of various metals. Copper sulphate grows rather slowly into tall, blue formations, the size of which will depend upon the size of the crystals used. Iron sulphate grows quickly, sending up thin green and brown stems, while aluminium sulphate and magnesium sulphate produce white growths. Iron and copper sulphate are best, but the others will

add more variety.

The crystals are merely dropped into the vessel already filled with liquid. Shoots will appear from iron sulphate in a few minutes. Copper sulphate is very hard, and rather slow starting. The garden will keep indefinitely, and makes an ornament sure to attract attention. It is possible to syphon off the solution, adding clear water slowly, so as to make the liquid crystal-clear, after growing has ceased. However, this was not done in the case of the example photographed.

Clean pebbles or stones may be placed in the bottom of the vessel before adding the crystals. The deposits which form round the terminals of old accumulators and dry-cells may be used, as these are largely zinc sulphate, but the growth will not be so effective as with the proper chemicals mentioned. (353)

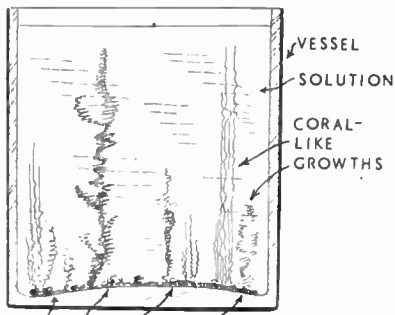

How a chemical garden is arranged

Combined Oscillator-Amplifier—(Continued from page 245)

valves should not be used, if to hand. Those quoted are only mentioned as a guide.

The high tension may be from about 60 volts up to 120 volts. If a 120 volt battery is used, insert HT1 in a socket at about 36 to 72 volts. GB1 will need to be about 1½ volts, and GB2 will be 3 to 6 volts or so according to valve type. The more grid bias applied, the lower will H.T. current consumption be.

For L.T. supply, a 2-volt accumulator is best. A dry battery can be used, but will not have such a long period of life. With a 3-volt dry battery, a resistor must be added in the L.T. positive lead to drop the excessive one volt, so that only 2 volts are applied to the filaments.

Morse Key Connections

In order that the unit may not be interfered with for P.U. purposes, the key is wired directly in one speaker lead. This is shown in Fig. 3. The lead going

from the speaker transformer to speaker speech-coil is cut, and two flex leads joined on. These are taken to the key.

When the key is depressed the circuit is completed, and the oscillation reproduced in the speaker. As with gram or mike reproduction, the output can be controlled by the volume-control knob on the right of the panel.

For Pick-Up and Mike

For playing records, turn the two-way switch to its second position. A pick-up, which may be of magnetic or crystal type, is connected to plugs which are inserted in the PU sockets at the left.

If a microphone is used, connections will to some extent depend upon its type. With a carbon mike, a microphone transformer is necessary, and a small dry battery. Wire the secondary of this transformer to the PU sockets. Take one primary connection to the microphone. The second primary con-

nection is taken to the battery, the remaining terminal of which is taken to the remaining microphone terminal. Usually about 3 to 6 volts are used with this type of microphone; best voltage can be found by trial.

The magnetic or moving-coil type of microphone needs no battery. A small moving-coil speaker, with transformer, can be used. It is wired directly to the PU sockets. A spare earpiece can also be used as a microphone, but is only moderately effective.

Sounds from the speaker should not be allowed to reach the microphone, or continuous howling will be set up. For best quality of reproduction, the speaker should be mounted in a cabinet.

The whole arrangement may be left permanently wired up, with the exception that, with a carbon microphone, the small dry battery used for energising it should be disconnected, when the mike is not in use. (356)

Save running about—install a home-made HOUSE TELEPHONE

A TELEPHONE for use between rooms on separate floors or between the house and garage is an obvious boon. The model described works quite efficiently and is made up almost entirely of oddments from the junk box.

In lieu of the calling bell used on an ordinary telephone, this model makes use of a buzzer, which is the first item to be made.

The Magnet

To make the electro-magnet, take a soft iron nail about 5ins. long, saw off the head and point with a hacksaw, and bend it to a U-shape. The height of the U should be about $1\frac{1}{2}$ ins., and the ends

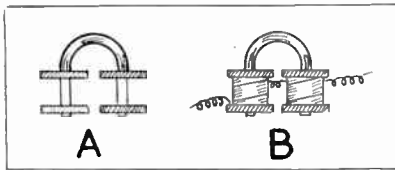

Details of the electro-magnet

of the arms must be filed perfectly flat. Four circles of $\frac{1}{4}$ in. thick wood (or preferably ebonite) $\frac{3}{8}$ in. in diameter are drilled in the centre so that they fit tightly over the arms of the U, and on each arm one disc is pushed along to a point just below the commencement of the curve, while the other is left at the end of the arm, as shown at drawing (A).

Double cotton-covered wire of 28 S.W.G. (standard wire gauge) is used for winding the magnet.

Some 9ins. of wire is left for connecting up, then one arm of the U is wound between the two discs, winding from the outside inwards. All turns of wire must be in close contact but not overlapping. When the first row is wound, lay a second row above it, but without breaking the wire. When the arm is fully wound carry the wire across to the other arm and repeat the process there, still coiling inwards as before.

It is important that the wire be in one continuous length and that 9ins. or so of wire be left over at each end to make a connection. When winding is complete some strips of gummed brown paper can be wrapped round the coil on each arm. The finished electro-magnet will then appear as at drawing (B).

The magnet must be mounted on a baseboard about 3ins. square, this baseboard also carrying the armature.

The armature is simply a $1\frac{1}{2}$ ins. long, $\frac{1}{4}$ in. wide strip of clock spring. A hole is drilled through one end of this and a small screw is driven through this hole and into a wooden block of about $\frac{1}{2}$ in. square end-section, this screw being at such a height that the piece of spring is held parallel to the ends of the arms of the magnet. Towards the other end of

the strip, a second wood block is fixed to the baseboard, and a thin brass screw is driven through this so that the end of the screw comes about $\frac{1}{4}$ in. away from the end of the spring. With both screws it is advisable to put a small washer under the head.

If a rather better armature is wanted, a very narrow strip of springy brass can be cut, and, after being given a slight bend down its length, it is soldered to the side of the clock-spring on the face

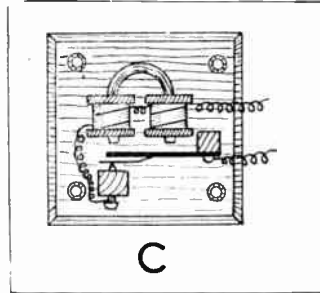

The complete buzzer

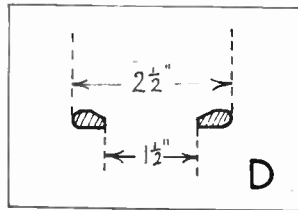

Section showing shaping of the rim of the mouthpiece

nearest to the contact screw, which should actually touch this springy strip when the buzzer is operating.

When the armature and magnet have been mounted on the baseboard, the spare wire from the start of the magnet winding is fastened under the head of the contact screw on the second block, while a spare length of wire is fastened to the screw holding the end of the armature. The top edges of the baseboard can be bevelled off and countersunk screw-holes can be drilled in each corner for the screws to fix it to the wall (drawing C).

The finished buzzer can be tested by connecting the free wires to a two-volt battery, and screwing the contact screw

in until a good high-pitched buzz can be heard.

Microphone

The microphone for each telephone consists of a wooden container holding a diaphragm, carbon and carbon granules.

Three pieces of wood are needed for the container, all being circular in shape. One piece is $2\frac{1}{2}$ ins. in diameter, $\frac{1}{4}$ in. thick, and has a $1\frac{1}{2}$ ins. diameter hole cut in the centre. This is the actual mouth-piece and should be shaped on the face in the manner shown on the sectional drawing at (D) so that the sound is directed into the instrument.

The two remaining pieces of wood are 2ins. in diameter, one being $\frac{1}{4}$ in. thick and the other $\frac{3}{8}$ in. thick. The thicker block has a hole $\frac{1}{4}$ in. in diameter drilled through its centre, while the thinner has a $\frac{1}{4}$ in. diameter hole in the centre. These two pieces of wood are glued and cramped tightly together.

Carbon Rod Needed

Some carbon rod will be needed and this could well come from an old dry battery. The carbon rod must be filed to $\frac{1}{4}$ in. diameter so that it will fit into the hole in the $\frac{1}{4}$ in. block. One end of the rod should be filed to a sharp point, and is then cut off to a length of $\frac{3}{8}$ in. from the tip. The end of another piece of carbon rod is filed out in such a way that the tipped rod will fit into it, and it is sawn off to an overall length of $\frac{3}{8}$ in.

A hole of $\frac{1}{8}$ in. diameter is bored through each small carbon rod, and some carbon granules are then prepared. A coarse file is used to make these, and again a piece of waste carbon taken from an old battery will be suitable. Fine carbon dust is not required, the granules needing to be about $\frac{1}{16}$ in. in diameter.

The actual diaphragm is a 2ins. diameter circle of very thin sheet brass or tinplate. In addition to this, two cardboard washers will be required, these also being 2ins. in diameter but having a $1\frac{1}{2}$ ins. diameter hole in the centre.

With these items, plus two small bolts of $\frac{1}{8}$ in. diameter and two screws, the microphone is ready for assembling. Instructions for this, however, will be deferred until the final article in this series. (343)

(To be concluded)

Novel Aquarium Aerator

From time to time we have published ideas for aquarium aerators, but most have required running water. Here, however, is one which does not.

It is made from a large airtight tin, a cycle inner tube valve, a gas tap and a few feet of tubing. The diagram shows the method of assembly.

To use, all you have to do is pump up the pressure in the tin with a cycle pump, and open the gas jet until bubbles

are rising to the surface of the water in the aquarium. With a large tin it is possible to keep the flow of air constant for about six hours.

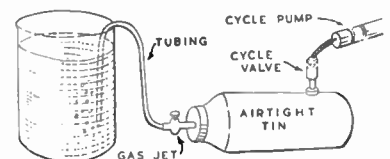

You can make this PICTURESQUE RECEIVER CASE

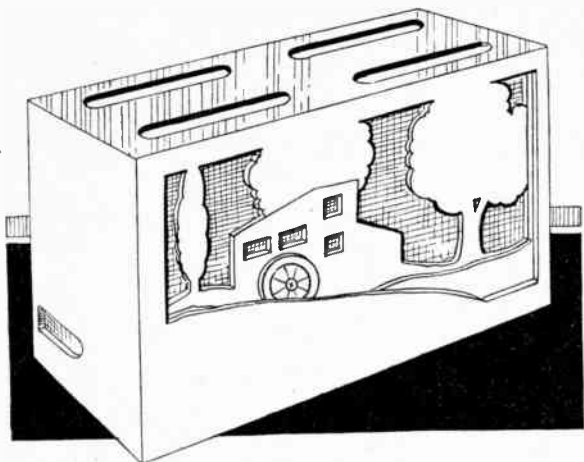

THE novel receiver case described was designed for people who live in flats or confined spaces where the floor or table receiver would take up too much room.

The construction is quite straightforward (see table for equipment). Take three pieces of plywood, two of $\frac{3}{8}$ in.

show the direction of grain. The cross on Fig. 1 is for those who want to make the waterwheel turn, and marks the position of the shaft.

Glue the three sheets together, Fig. 1 to the bottom. Leave until the glue has completely dried, then paint the scene in bright enamels, not forgetting to paint the cloud white.

and one of $\frac{1}{4}$ in. and cut to fit inside picture frame. Then cut out one $\frac{3}{8}$ in. sheet to Fig. 1, one $\frac{3}{8}$ in. to Fig. 3, the $\frac{1}{4}$ in. to Fig. 2. A margin of 1 in. is left round the top and sides and the squares are 1 in. The arrows

PARTS REQUIRED

Picture Frame to take 10ins. by 14ins. picture
Picture (1) — $\frac{3}{8}$ in. by 10ins. by 14ins.
Picture (1) — $\frac{1}{4}$ in. by 10ins. by 14ins.
Picture (1) — $\frac{3}{8}$ in. by 10ins. by 14ins.
Case (top and bottom) — $\frac{1}{4}$ in. by 5ins. by 14ins.
Sides (2) — $\frac{1}{4}$ in. by 5ins. by 9 $\frac{1}{2}$ ins.
Back — $\frac{1}{4}$ in. by 10ins. by 14ins.
Wheels (from waste) — $\frac{1}{2}$ in. by 2ins. dia.
Speaker Fret (waste) — $\frac{1}{4}$ in. by 6ins. sq.
Pivot Block — $\frac{1}{4}$ in. by 1in. by 1in.
Dowel — $\frac{1}{8}$ in. dia. by 1in.

Sky blue silk — 10ins. by 14ins.

Pair of 1in. hinges, clasp, picture chain, glue, nails and screws.

While the enamel is drying, make up the sides (Fig. 6), bottom and top (Fig. 7), not forgetting to cut the slots which are to allow air to circulate through the set. Butt joints are used with corner L pieces.

Take up the picture front again and glue the piece of silk in place, stretching it very tightly. Then glue the complete front into the picture frame and allow to set. Next cut out the speaker fret out Fig. 4, from $\frac{3}{8}$ in. wood, and glue and screw as indicated behind the

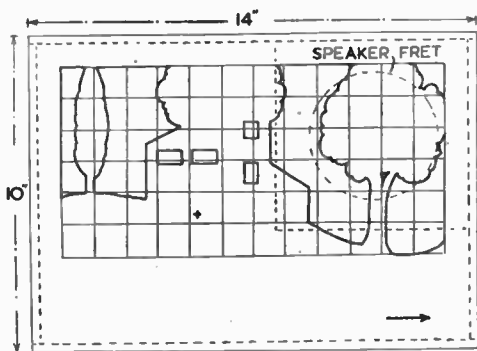

Fig. 1—Backboard of picture

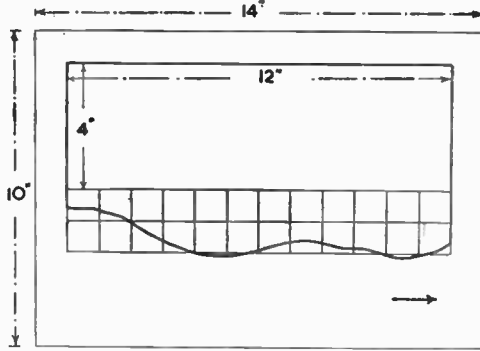

Fig. 2—First overlay

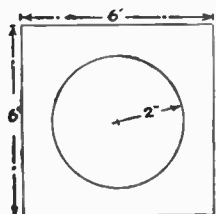

Fig. 4—The speaker fret

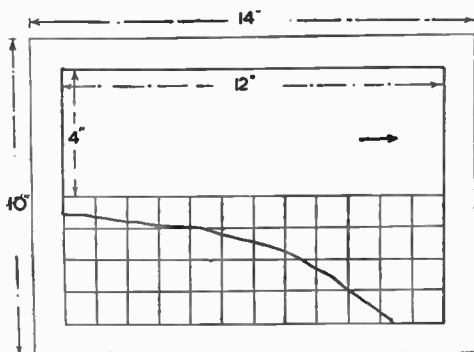
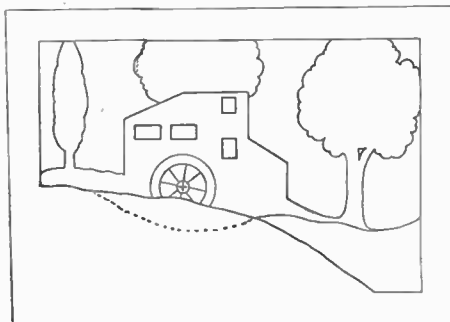

Fig. 3—Second overlay



Drawing showing picture after assembly of overlays and waterwheel



Fig. 5—Details of the waterwheel

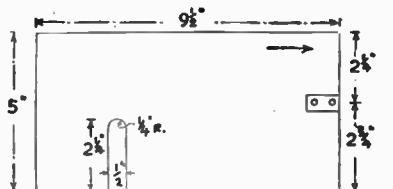

Fig. 6—Dimensions of the sides

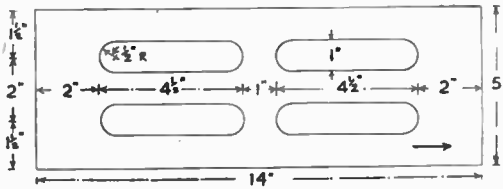

Fig. 7—The top and bottom

For the modern home— A FAN TYPE FIRESCREEN

THE method of making this fire-screen is a little different from usual woodworking practice, but should present no special difficulties.

A rounded outline with parallel sides is tacked to a base strip of 1in. square material. Into this is fitted a 'fan' made from a spray of sixteen 1in. by $\frac{1}{8}$ in. strips. The sides are then covered in with two panels of thin ply. These

panels can be left plain, fretted out to a suitable motif, or decorated with transfers or by painting.

Details of the frame are given in Fig. 1. A 15 $\frac{1}{2}$ ins. length of 1in. square material forms the base. The outline is bent from a 5ft. length of 1in. by $\frac{1}{2}$ in. birch or spruce. To facilitate bending to the required curve it may be necessary to soak the wood in hot water. Make a full size drawing of the outline, soak the

panels between the two side panels at the bottom (Fig. 6).

The feet are made from two pieces 6ins. by 2ins. by 1in., slotted and shaped as shown in Fig. 5. The screen itself is simply glued into these slotted feet or legs (Fig. 7). Make sure that it rests true and square—and vertical. (376)

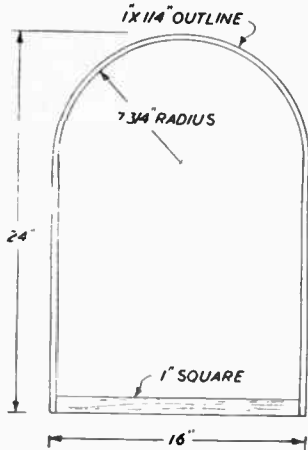

Fig. 1—The frame

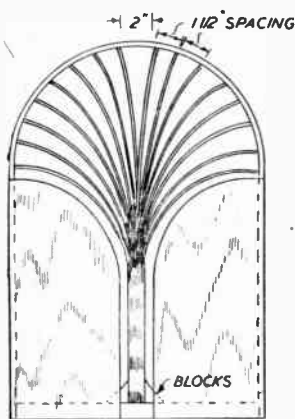

Fig. 2—Position of the fan and two side panels

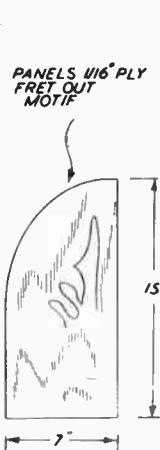

Fig. 3—Dimensions of the side panels

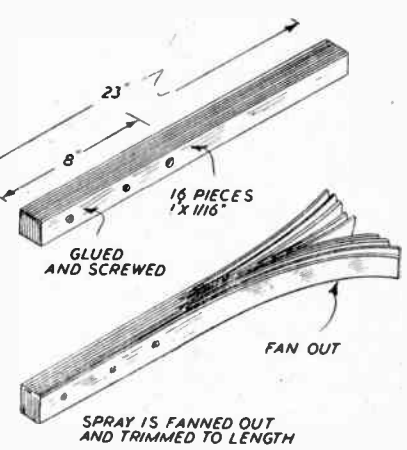

Fig. 4—How the fan is made

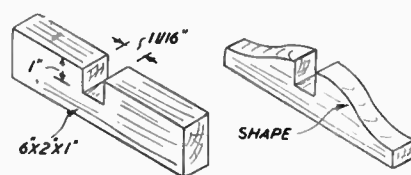

Fig. 5—Dimensions and shape of the feet

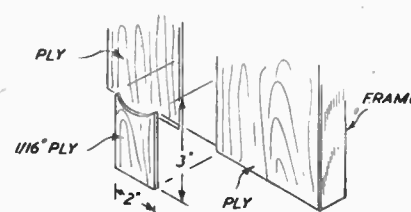

Fig. 6—The position of the filler piece

wood and pin out to shape and leave to dry. Then glue and screw to the base.

The position of the fan and the two side panels is shown in Fig. 2. The fan butts against the base member and is supported by two small triangular blocks, glued in place. Dimensions for the ply panels are given in Fig. 3.

To make the fan, take sixteen pieces of 23ins. by 1in. by $\frac{1}{8}$ in. material and glue and screw together for a length of 8ins. as shown in Fig. 4. Lay out and pin in place temporarily on top of the frame, fan out each individual piece to its correct end position and trim off to the required length. When all pieces have been trimmed to length the fan can be glued in place permanently. Then glue and pin on the two ply panels and add a small filler piece of ply to bridge the gap

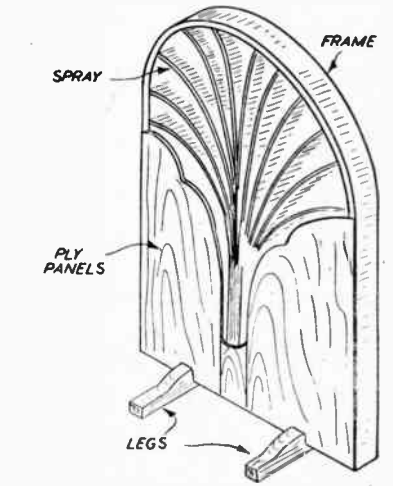

Fig. 7—The completed screen

Picturesque Receiver Case—(Continued from page 248)

picture. The box is now glued to picture using corner angle pieces.

For making the waterwheel turn—drill at the point marked with a cross (Fig. 1) with an $\frac{1}{8}$ in. bit. Cut out the waterwheel from $\frac{1}{8}$ in. thick wood and 2ins. diameter and assemble to picture as per Fig. 5, remembering that the wheel turns anti-clockwise. Any battery operated motor can be used. The details of drive can be left to the reader's own discretion.

The back is now cut out and fitted to the case. The clasp and hinges must be good fits, as the receiver is fastened to the back. This now completes the picture and case, which will look most effective stained to the same colour as the furniture.

The receiver itself can be any of the circuits already shown in previous issues of *Hobbies Weekly*. Tuning and volume shafts extend through the slots in the side members. The volume control

switch also operates the electric motor which turns the waterwheel. With internal aerial and a battery receiver this set will create an air of mystery when switched on.

Hanging

For hanging the set, screw on the chain to the side members as shown. Most important of all, use a Rawlplug in the wall to take the weight. Do not trust a nail. (371)

Just right for 'little ladies'—a MODEL ELECTRIC REFRIGERATOR

ONE of the advantages enjoyed by the handyman is that his home becomes replete with all sorts of modern comforts and conveniences; but in addition to this he has, too, the means, with his tools and the offcuts from his more serious work, of providing the youngsters with toys and amusements equally modern, and doubly acceptable to a small child by reason of their novelty and sturdiness.

This little model of a domestic refrigerator, for instance, is easily made from those bits and pieces which every fretworker collects. An actual cooling system is not, of course, within the scope of a simple toy of this type, but with its streamlined exterior and white

two fixed partitions come right up to the front. Remember to cut the main door from the thicker wood, and taper off the inside edges a little, as shown. The bottom door, which is cut from the $\frac{1}{2}$ in. stuff, is hinged from the bottom, as in many types of real refrigerators.

In Fig. 1 the two fixed partitions are shown in position, but before fixing them in cut a small piece out of the top one near the back, for the flex to come through. A little panel is cut out as shown at Fig. 3 and glued along the front at the bottom. The movable shelf measures 4 ins. by 4 ins. and is carried on two $\frac{1}{2}$ in. runners glued to the inside of the case.

The cooling unit is simply two pieces 3 ins. by 2 ins. glued to the top and back

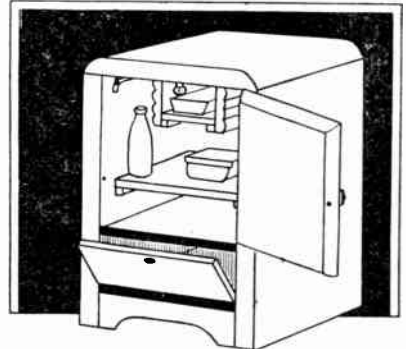

the lamp holder down in position, about 1 in. from the front edge to be clear of the door.

Door Fasteners

Suitable door fasteners can be bought quite cheaply, but the handyman can easily make up something that, in this case, serves equally well. Cut two small pieces of three-ply $\frac{3}{4}$ in. by $\frac{1}{2}$ in. and shape them to a diamond or whatever design is fancied. Fix them to the doors with a round-headed screw, with a washer of cardboard between, as shown. Then put another round-headed screw

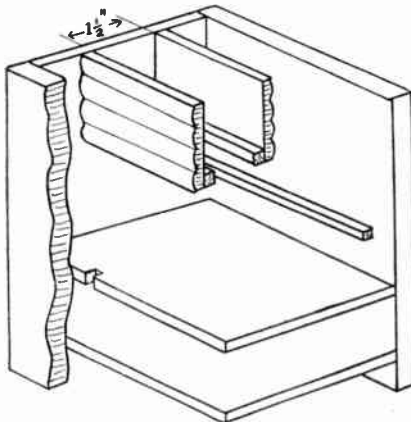

Fig. 1—Drawing showing the various compartments

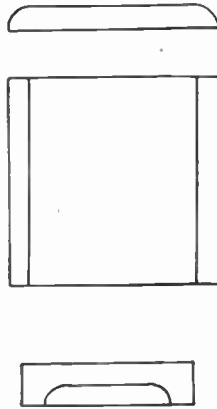

Fig. 2—Front view of main shell

Fig. 3—Bottom front

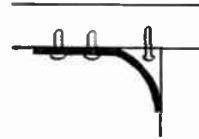

Fig. 4—The automatic light switch

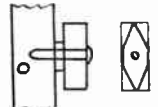

Fig. 5—Details of the handle and fastening

enamel finish it closely resembles the real thing, this effect being increased by its having an automatic light which is switched on each time the door is opened. This light is provided by a torch bulb and battery housed inside the model.

The measurements given make up a model which is 8 ins. high, 5 ins. wide and 5 ins. deep, but this can be easily modified to suit the material available, or scaled down all round if it is to form part of the internal fittings of a doll's house. The Cutting List allows for wood of $\frac{1}{2}$ in. thickness for the two sides, main door, and top, the remainder being all out of $\frac{1}{4}$ in. stuff.

In addition to the small pieces of wood shown, the only other requirements are the torch bulb, battery and lampholder, a piece of strong springy metal for the light arrangement, and a little white and black enamel or high gloss paint.

Construction

As will be seen from Fig. 1, the model has two compartments, the cold chamber and the small compartment underneath where the battery goes. Note that the back fits inside the two sides, and that the

as seen in Fig. 1. Before they are glued in place glue $\frac{1}{4}$ in. strips along the bottom inside edges to make a support for the little loose shelf, which measures 3 ins. by $1\frac{1}{2}$ ins. The suggestion of freezing coils is enhanced if the outside surface of these two pieces can be grooved neatly, either with gouge or saw cuts, as shown. For the top, cut a piece of the $\frac{1}{2}$ in. wood 5 ins. square, mark off $\frac{1}{2}$ in. down two opposite sides, then bevel these edges off nicely, finishing off well with glass-paper. Before the top is glued on, fix

in the edge of the door opposite the knob and towards the back edge of the door, and another in the side of the case exactly opposite, so that the two screw heads collide when the door is closed. Screw both of them in until they are almost flush, leaving them projecting only sufficient to give a slight catch to the door when it is pushed to.

The Automatic Light

To make the light automatic when the door is opened, a piece of stiff springy metal is required about 2 ins. long. A piece of old clock spring was used in the writer's case, and this has served quite well. Bend it in the vice into the shape of an arc, then drill it and fix it with two screws to the inside left hand top of the model, as shown at Fig. 4, in such a position that the free end of it is within $\frac{1}{2}$ in. of the front edge. Now hold it back a little with the hand and put a screw in the top immediately in front of it. Screw this down until, when the spring is released it just touches it, but when held in slightly (as it will be by the door

CUTTING LIST		
No. of pieces	Description	Size
2	Sides	$7\frac{1}{2}$ " x 5"
1	Back	$7\frac{1}{2}$ " x 4"
1	Top	5" x 5"
1	Main door	4" x $4\frac{1}{2}$ "
1	Bottom door	4" x $1\frac{1}{2}$ "
1	Base	4" x $4\frac{1}{2}$ "
1	Front bottom panel	4" x 1" x $\frac{1}{4}$ "
2	Fixed partitions	4" x $4\frac{1}{2}$ " x $\frac{1}{4}$ "
1	Movable shelf	4" x 4"
2	Movable shelf bearers	4" x $\frac{1}{2}$ " x $\frac{1}{4}$ "
2	Cooling unit sides	3" x 2" x $\frac{1}{4}$ "
1	Drip tray shelf	3" x $1\frac{1}{2}$ " x $\frac{1}{4}$ "
2	Drip tray shelf bearers	3" x $\frac{1}{2}$ " x $\frac{1}{4}$ "

(Continued foot of page 251)



Uniting Aluminium

COULD you tell me if there is any way I can solder aluminium? (H.T.—Homerton).

THERE is no known method of satisfactorily soldering aluminium. The only practicable ways of uniting aluminium, are by welding, riveting or screwing.

Mains Eliminator

IHAVE a 2-valve battery set and would like to know if it is possible to work it from the mains, which is 200 volts. A.C. 50 cycles. My set takes 120 volts. Also, is it possible to work a 3-valve from same? Is it possible to get a 70 volt tapping for the 3-valve set? (J.D.—Worcester).

DETAILS for a mains eliminator were given in our issue, February 21st, 1951. This also explains in detail how intermediate tappings can be obtained. Your circuit is workable, but a condenser of about 2 mfd. must be wired between H.T.—and the positive H.T. line (unless such a condenser is already present in the set), to provide a path for audio-frequency signals, alternatively include the resistor directly in series with the choke. Note that you have one mains lead in direct contact with H.T.—. This means all leads in the set (including metal parts, accumulator connections, etc.) are in contact with the mains, and care is, therefore, necessary to avoid shocks. With this circuit, do not take a direct earth to the set, or the mains will be earthed. Your 30 A rectifier would provide sufficient current for any ordinary battery set of up to 5 or 6 valves.

Strengthening a Loft

IWANT to make use of the loft at the top of my house. The rafters are 1in. by 4ins. thick and are laid on a brick wall which divides both bedrooms. I intend to lay boards 2ft. on either side of the wall, and to put tables all the way round for a model railway. Will the rafters stand my weight? The bedroom rafters are 2ins. by

bins. and they carry a big weight. (A.S.—Hull).

IF the width of the loft does not exceed 6 to 8 ft., with a floor of 1in. tongued and grooved boards, it should bear the weight of a man with safety. Beyond that distance, it may prove too risky. The floor could be stiffened by the addition of a beam, 7ins. by 3ins. underneath, if you could go to such trouble. The beam would be inserted in the wall, at right angles to the rafters, to a depth of 3ins., the brick walls having the necessary hole chiselled out, one of which would have to be 6ins. deep to admit the beam. The beam could have its edges chamfered, and if painted, need not look unsightly in the least. In any case, it would be as well to get a local builder to examine the rafters to see if their condition is satisfactory, and no dry rot present.

A Hearth Cement

OUR firegrate is a modern one made of wire-cut bricks which have a rough surface; while the surround looks very nice, the hearth is dirty and impossible to get clean. Could you tell me of a patent cement or stone with which I could cover the hearth? (S.P.—Cheslyn Hay).

ACEMENT composed of one part Portland cement, and two parts of finely crushed marble or hard red brick, or crushed tile of appropriate colour—if spread in a layer about 1in. thick, should produce a pleasing and durable finish for your fireplace hearth.

Removing Paint From Walls

CAN you tell me how to remove very hard dried oil paint from lime plastered walls? The walls of my bungalow have three coats of oil paints (two white over a green). I have tried blow torch and caustic soda, but find these very messy. I wish to remove the paint without destroying the lime plaster—scraping does this. (F.L.—Karachi).

PROBABLY the only way to remove the paint from the walls of your

bungalow, would be to have it 'sand blasted'—that is, assuming that a portable apparatus could be hired for the purpose. An alternative, is to remove the old paint by using very coarse sandpaper; it is, however, a laborious and tedious job. Either of these suggestions would avoid damage to the plaster wall surface. There are numerous paint removers available, but the cost of sufficient of it to thoroughly clean the walls, would be considerable.

Harmonica Amplification

ONE of my hobbies is playing the harmonica, and what I would like to do is connect it up to my radio and thereby amplify it. I do not know quite what kind of a microphone to obtain to fit to the harmonica. Would it be better to use a carbon mike or a crystal mike? The lead is to be plugged in the pick-up socket. Also is it possible to connect the harmonica lead to my gramophone pick-up, and have both running through radio at the same time, so I could accompany a record? Would it harm the radio at all? (P.C.—London, S.W.).

NO harm will arise to the receiver with proper connections. To use gram and microphone together, wire them in parallel. If it is desired to control the volume of either, separately (and this may prove necessary to get a correct balance of volume) a separate volume-control could be wired to each. A crystal mike will give better quality of reproduction than the normal carbon type, but the latter gives more output. With a carbon microphone, a proper coupling transformer is essential, with a dry battery on the primary side, to pass a current through the microphone. As you have already used a pick-up with your radio, you should not experience any difficulty in wiring up your microphone.

Crackle Finish

IHAVE been able to make a very successful job of an enlarger, and should like to paint it in the professional-looking crackle finish. Can you advise me on this point? (J.H.—Rosyth).

THE finish you mention, can be obtained by the use of a special crackle varnish. You may be able to buy or order this at a local paint or hardware shop; if not, it can be obtained from Nobel Chemical Finishes Ltd., Slough, Bucks.

Model Electric Refrigerator—(Continued from page 250)

when closed) the spring and screw are a little distance apart.

Wiring Up

Having made sure that the contact is broken when the door is closed, the wiring-up can be done. This is quite simple. One flex runs direct from the battery terminal to one screw on the lamp holder. Another piece goes from the other battery terminal to one of the

screws that holds the spring, and a third piece joins the separate screw to the other terminal on the lamp holder.

Finishing Off

Glasspaper the model until all surfaces are smooth and the doors and shelves work nicely, then finish off with white enamel, picking out one or two pieces, such as the front edges of the

two fixed partitions, in black. If desired, several little pieces can be made up from wood to go inside the model. A milk bottle, for instance, is easily carved out of a piece of 3/4in. dowel about 2 1/4ins. long; or a pie dish can be made by bevelling the edges of a small piece of 1/2in. wood. These can then be finished off in the appropriate colours, and give added pleasure for the child. (331)

Experiments with Potassium Bromide in HOME CHEMISTRY

POTASSIUM bromide is well known to most of us as a sedative, and is much used in nervous disorders.

It is, like most metallic bromides, soluble in water. The only insoluble bromides among the commoner metals are those of lead, monovalent mercury and of silver.

Lead bromide you can easily prepare by adding lead acetate solution to a solution of potassium bromide. A white crystalline precipitate of lead bromide will form and quickly sink to the bottom of the vessel.

Easy to Purify

This compound is easier to purify than most precipitates, which normally need thorough washing. Lead bromide, however, is fairly soluble in hot water and you can, therefore, purify it by recrystallisation.

To do this, first filter off the compound and then, with a jet of water from your wash bottle, transfer it to a beaker. Let the precipitate settle and decant off the water. Now add boiling water, with rapid stirring, until only a little precipitate remains undissolved. Boil up the solution on your tripod, and if the remainder of the precipitate does not then dissolve, add small quantities of boiling water until it goes into solution.

Remove the burner and let the solution cool down overnight. The lead bromide will crystallise out as shining white needles, and the impurities will remain in the solution above—or the mother liquor, as chemists call it. Drain the crystals on a clean porous tile or brick and allow them to dry at room temperature.

Mercurous bromide, too, is easily prepared. Add mercurous nitrate solution to potassium bromide solution until no more white mercurous bromide is precipitated. This precipitate, though not soluble in hot water like lead bromide, is easily purified by washing a few times by decantation, for it is heavy and sinks easily. After the washing, filter it off and dry it in the oven.

Since mercurous bromide darkens on exposure to light, the specimen tube in which you intend to keep it should be covered with black paper.

Silver bromide, too, is sensitive to light, and so it is widely used for sensitising photographic paper, plates and films.

It should, therefore, be prepared and dried in a dim light and kept in a tube covered with black paper. To prepare it add silver nitrate solution to potassium bromide solution. Pale yellow silver bromide will be precipitated and is best washed on the filter with hot water. Open out the filter paper and allow the whole to dry on a porous tile in the dark.

By employing this reaction you can

make a simple photographic printing paper. Take a small piece of filter paper and soak it for five minutes in potassium bromide solution. Remove it and pin it up to dry.

When it is quite dry, soak it for another five minutes in silver nitrate solution in a dim light. Remove it and hang it to dry in a dark cupboard.

Choose a bold negative and put it over the paper in a printing frame, or between two sheets of glass, and expose to full daylight in the usual way. To fix it, it merely needs treating with a solution of 'hypo', followed by thorough washing.

The bromine of potassium bromide can easily be liberated by passing chlorine into a solution of potassium bromide. Indeed, bromine is manufactured by this method or modifications of it. Soluble bromides exist in all sea

solution to absorb any bromine fumes which escape.

As you heat up the solution in the flask you will see red-brown vapours of bromine arise and fill the flask, pass over into the U-tube and condense to a brown liquid.

Allow the contents of the flask to boil until the solution has become pale yellow (indicating that only a trace of bromine remains therein). Remove the sodium hydroxide test tube, then turn out the bunsen, and disconnect the U-tube.

Above the bromine you will find a yellow liquid. This is water containing bromine and is the familiar reagent, bromine water. To separate the two liquids pour them into a separate funnel and run off the lower layer of bromine into a glass stoppered bottle (for bromine rots cork). The bromine water remaining in the funnel can now be poured into a bottle for your reagent shelf.

Bromine is the only element besides mercury which is liquid at the ordinary temperature. It is much used for

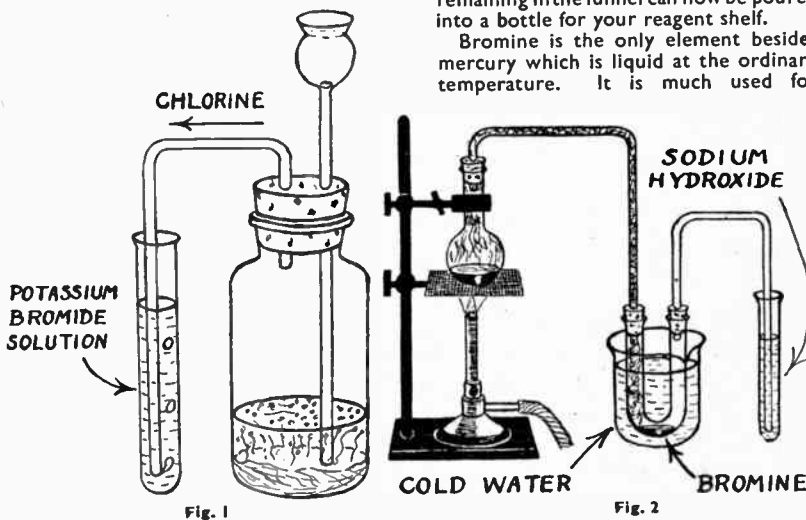

water and in the great salt beds of Stassfurt, and these are used as sources of bromine.

Generate chlorine from bleaching powder and dilute hydrochloric acid and pass it into potassium bromide solution, using the apparatus shown in Fig. 1. The solution immediately becomes yellow with the liberation of bromine.

As the passage of chlorine continues the solution deepens in colour as more and more bromine is set free. When the solution is dark red-orange and puffs of red vapour escape with each chlorine bubble, stop passing in chlorine. You will find the solution has acquired a pungent odour, rather like that of solid iodine, but more irritating.

As the bromine is present in solution we must now isolate it. This is done by distilling the solution from a small flask into a U-tube cooled in water, as shown in Fig. 2. Beyond the U-tube is a test tube containing sodium hydroxide

making ethylene dibromide, one of the ingredients of anti-knock petrol.

It is very volatile, too, as will become apparent, for the bottle containing the bromine will soon be more or less full of orange-coloured vapours.

By passing sulphuretted hydrogen into water containing bromine we can prepare a specimen of hydrobromic acid.

Pour a few drops of bromine into a test tube and add about 5 ccs. of water. Generate sulphur dioxide (by heating a mixture of sulphur and anhydrous ferrous sulphate), and pass the gas into the water-bromine mixture. Slowly the bromine disappears and sulphur will be precipitated.

When all the bromine has gone, filter the solution from suspended sulphur, boil the solution to free it from excess sulphur dioxide and you will have a colourless solution of hydrobromic acid. (354)

Avoid breakages — make this SERVICEABLE VASE STAND

QUITE a decorative fitment, carefully made and stained and polished, the purpose of this vase stand is to accommodate the taller types of vases which are so often upset and spilt or broken. The vase simply fits in a circular hole in the top of the stand and rests on the base. The stand provides a support against tipping.

The top is cut from $\frac{1}{4}$ in. ply. A square

piece with 8 ins. sides will be quite large enough for the average vase. The circular hole, which must be fretted out, can be measured against the actual diameter of the vase. Four diagonal grooves are cut at each corner of this square of ply, $\frac{1}{4}$ in. wide and $\frac{1}{8}$ in. (half the thickness of the ply) deep. These grooves come on what will be the underside of the top.

The Base

The base is a 6 ins. square of $\frac{1}{4}$ ply with diagonal slots cut at each corner. Each slot is 1 in. long and $\frac{1}{4}$ in. wide.

Four legs are then fretted out of $\frac{1}{4}$ in. ply, to the shape shown in Fig. 2. Using the grid, mark out the shape of the leg on to a piece of ply and cut out. This leg can then be used as a template to cut three more legs.

Assembly

Assembly is simple. The legs simply glue into the grooves in the underside of the top, and in the slots at each corner of the base (see Fig. 3 and Fig. 4). Careful workmanship will ensure a good joint at each junction and the glued assembly will be extremely rigid. (368)

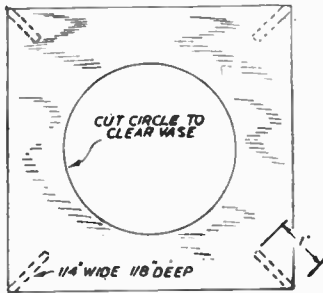

8" SQUARE $\frac{1}{4}$ " THICK

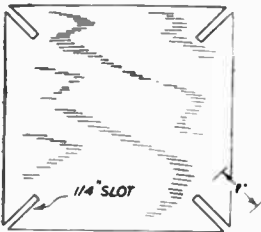

6" SQUARE $\frac{1}{4}$ " THICK

Fig. 1—Dimensions of the top and base

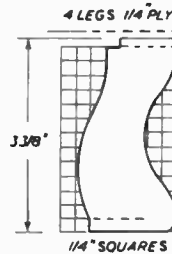

Fig. 2—Pattern of the legs

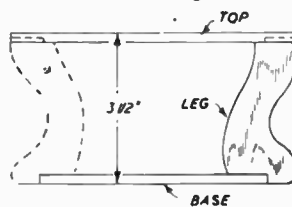
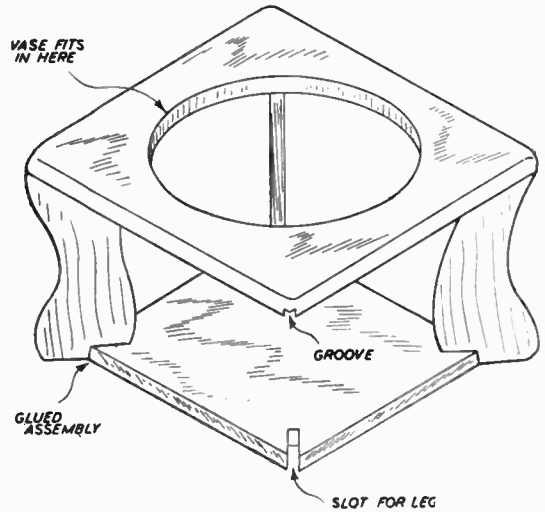

Fig. 3 and 4—Details of assembly



A Handy Glasspaper Block

A wooden block with special handle which holds glass-paper taut and always in place. In two sizes, 3 in., price 1/4; 5 in., price 2/6, post free.

HOBBIES Ltd. DEREHAM
Norfolk, and all Branches



EVERY CAR THAT PASSES YOU WILL FIND THE INDEX MARK ALPHABETICALLY ARRANGED IN WHERE'S THAT CAR FROM?

Price 6d.

from all Booksellers or from the Publishers (1½d. postage)

RALEIGH PRESS, EXMOUTH

PUPPETS

Kits of parts to make two Fully Jointed 12 inch puppets with controls.

15/6 post free

Send stamped addressed envelope for illustrated list of complete puppets and books

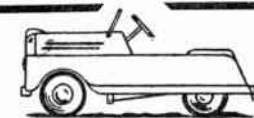

PEDAL MOTOR CAR

Any amateur can make this strong smart modern pedal car for children 2 to 5. Plan and instructions with list of available metal parts

2/6 post free

ZIMPLAN

**88 WARE ROAD
HODDESDON, HERTS**



BRANCHES

LONDON

78a New Oxford St., W.C.1
(Phone MUSEum 2975)

87 Old Broad Street, E.C.2
(LONDON Wall 4375)

117 Walworth Road, S.E.17
(RODney 5509)

GLASGOW

326 Argyle Street
(Phone CENTral 5042)

Head Office & Factories—**HOBBIES LTD., DEREHAM, NORFOLK**

MANCHESTER

10 Piccadilly
(Phone CENTral 1787)

BIRMINGHAM

14 Bull Ring

SHEFFIELD

4 St. Paul's Parade

LEEDS

10 Queen Victoria Street
(Phone 28639)

HULL

10 Paragon Square

SOUTHAMPTON

25 Bernard Street

BRISTOL

30 Narrow Wine Street
(Phone 23744)

MISCELLANEOUS ADVERTISEMENTS

The advertisements are inserted at the rate of 4d. per word prepaid. Name and address are counted, but initials or groups, such as E.P.S. or £1/11/6 are accepted as one word. Postal Order and Stamps must accompany the order and advertisements will be inserted in the earliest issue. Announcements of fretwork goods or those shown in Hobbies Handbook are not accepted. The charge for use of a Box No. is 1/- extra. Orders can be sent either to Hobbies Weekly, Advert. Dept., Dereham, Norfolk, or Temple House, Tallis St., London, E.C.4

100 STAMPS free, including Diamonds and Triangulars. Send postage for approvals. —Box No. 100, Hobbies Weekly, Dereham, Norfolk.

REGULAR spare-time income. Little capital needed. For full details send stamp.—Hyperion Services, 318 Walton Hall Avenue, Liverpool, 11.

STAMPS, 50—6d., 120 1/—Barson, 35 Station St., West Coventry, Warwick.

SHIRTS, underwear, socks, repaired by post. Ring CH1 0765. Write—OSEV, Chiswick.

STAMPS FREE!! Twenty unused (2½d.). S.G. H. Barnett, Limington, Somerset.

WOODWORKERS can produce £15 easily with B.I.F. Olympia alteration plan. Ideal full time occupation. Send P.O. 2/6 instructions, plan, free offer included.—P.B. 50964 Pastimer, 183 Bowes Road, London, N.11.

FINE Air Mail stamps free. Request approvals (2½d.). Cousar (Am), 17 Burns St., Dalmuir, Glasgow.

100 DIFFERENT stamps free (including Triangular and Pictorials) to all genuine collectors who apply for my approval selections. Please enclose 2½d. postage. N. Johnson (Dept. H), 19 Hillside, Slough, Bucks.

GENUINELY interested persons required to undertake light, clean assembly work in their own homes. Good rates of payment.—Dept. 918, Universal Products, 5 Cornhill, Lincoln.

STAMPS Free! 25 Turkey value 2/6. Send 3d. Requesting approvals.—H. Johnson, 7 Old Mill Lane, Forest Town, Mansfield.

PERMANENT employment available, full/part-time. S.A.E. for particulars.—Box No. 99, Hobbies Weekly, Dereham, Norfolk.

40 DIFFERENT stamps free, including Silver Wedding, U.P.U., Victory, Silver Jubilee, Coronation, Pakistan, etc. Send 3d. postage and request approvals. J. F. Smith, 39 Manor Park, London, S.E.13.

PLYWOOD offcuts. Nothing under 12ins. x 12ins. x ½ in. 15 sq. ft. parcel, 7/6, post paid. Quick delivery.—B. & M. Sales, 16 Hamm Moor Lane, Weybridge, Surrey. Weybridge 3311.

INTRODUCTIONS. Pen friends, companionship or marriage.—V.C.C., 34 Honeywell Road, London, S.W.11.

STAMPS. Special summer bargains. 100 large Pictorials, 6/-. 50—3/-. 10 U.S.A. Commemoratives, 1/-. Free gift to approval applicants. Postage appreciated. W. E. Tucker, 6 Higher Church St., Barnstaple, Devon.

MODELS. You can make lasting stone-hard models with Sankey's Pyruma Plastic Cement. Supplied in tins by Ironmongers, Hardwaremen and Builders' Merchants. Ask for instruction leaflet.

DOLL'S House fittings and papers; send S.A.E. for list. Doll's house plan special; send 2/6. Trade supplied.—Zimplan, 88 Ware Road, Hoddesdon.

LORRY Kits, 4 mm. and 7 mm. scale. Also large range of spare parts from which to build to your own design. Send for fully illustrated catalogue, price 1/-. Wilson's Lories Ltd., 6 Great Winchester Street, London, E.C.2.

PLYWOOD offcuts. Birch and Gaboon in various thicknesses. Handy sized parcels for the cabinet, toy, model maker, and all handicrafts. Parcels made up in £1 and 10/- lots. Carriage paid. Send P.O. to Reeves, Plywood and Timber Merchant, 33 Front Street, Monkseaton, Whitley Bay, Tel. W.B. 4677. Parcels are now despatched on day of receiving order.

BLUSHING, shyness, nerves, self-consciousness, Blears, ended. Details under plain cover, 1d.—Stebbing Treatment, 28 (HB) Dean Road, London, N.W.2.

DUPLEX self-adhesive Transfers for decorating fancy goods, trays, plastics, etc. List and samples, 3d.—H. Axon Harrison, Jersey.

BE Taller in 14 days or money back. Details, 1d.—Stebbing System, 28 (HB) Dean Road, London, N.W.2.

£5 to £20 weekly earned at home, running your own Mail Order business. Details, 1d.—Stebbing Publications Ltd. (HB), Naphill, High Wycombe.

EARN £5 to £20 weekly running your own Mail Order business. Details, 1d.—Stebbing Publications Ltd., Naphill, High Wycombe.

USE spare-time on profitable homework making fancy goods. Write for free booklet.—(Area 544), 54 Southgate Street, Leicester.

HOME Watch and Clock repair outfit. Includes watchmaker's magnifying eyeglass, tweezers, screwdrivers, oilers, oil, brush, dusting powder, plus illustrated explanatory book. Watch and clock repairing simplified. In container, 12/9 inclusive. D. Bolster (Dept. H), 5a Station Parade, Ashford, Middlesex.

LONELY? Then write Secretary, U.C.C.—55B.B. Hay Street, Braughing, Herts. Genuine. Est. 1905.

HAVE you got your Junero Riveting Jig yet? From all Hobby shops or post free from—Junero Ltd., Stirling Corner, Boreham Wood, Herts.

STAMPS Free. Empire packet including Pictorials and Victorians free to approval applicants.—Robert J. Peck, 7A Kemp Road, Bournemouth, Hants.

INTERESTING work available for all in spare-time. Experience unnecessary. Send S.A.E. for details to—Leathaweave Co. (Dist. 37), 2 Tudor Road, Leicester.

WHEELS for toys, etc., in Hardwood, Plastic and Rubber Tyred Metal. Doll's House fittings and papers. Doll's Cot and Pram fittings. Decorative Transfers. Beads for Counting Frames and other toy accessories. Fine Art Pictures for jig-saws, etc. Stamp for lists. Trade supplied.—Joyden Toy Co., 193 Chase Side, London, N.14.

HOMEWORKERS required, either sex, light Assembly, part or full time. S.A.E.—Esprey, Box 18, 41 Wade Street, Lichfield.

NOVEL Calendar Designs painted on plywood for cutting out, with date cards. Inexpensive gifts. Profitable to sell. Sample, 2/-. Half dozen, 11/-. including postage.—Cleaver (HW), 50 Windsor Road, London, N.W.2.

9.5 POPULAR Film Hire Library, 3d. stamp lists.—Wayland, 223 Longley Road, Tooting, London.

BUILD your own saw bench, shafts from 28/6. Pulleys, Belts, Motors, saws supplied. S.A.E. list.—Sullivan, 19 Allen Road, Wednesbury.

TRICKS for everyone. Vanishing candle, 1/3; tightrope ball, 2/6; cut and restored rope, 1/3; window mystery, 1/3; Eastern mystery, 1/3; rising card, 1/6; it's off, 2/3; phantom cigs., 1/6. Free trick to all spending 5/-.—Magician's Den, Wimborne Road, Winton, Bournemouth.

100,000 Bargains for the Model Maker and Handyman. ¼th H.P. 200/250v. A.C. mains electric motors, intermittent duty, wonderful value, 39/6, post 1/6. 24v. A.C./D.C. motors with powerful reduction gear (ratio 43 to 7), 12/6, post 1/6. Aluminium rivets, approx. 1lb. assorted, 2/6, post 6d. Strong elastic cord, ¾" dia. multi-core, ideal upholstery, hammocks, etc., 10yds., 3/6, post 10d. Spirit levels in 8" varnished hardwood body, 2/11, post 6d. Sample parcels guaranteed to contain at least 15/- worth of assorted electrical and other useful items, in useful wooden box, 5/-, post 1/6. Send 3d. stamp for full Mail Order catalogue. Money back guarantee.—Milligan's, 24 Harford Street, Liverpool, 3.

AMERICA'S famous hobby magazines. One Year's supply Popular Mechanics, 32/-; Popular Science, 28/6; Homecraftsman, 16/6; Popular Homecraft, 18/-. Free Booklet listing all others sent on request.—Willen Ltd. (Dept. 57), 101 Fleet Street, London, E.C.4.

CONJURING and Magic. New tricks and C Pocket novelties every month. List, 4d.—Roboati, Magician, 363 Sandycroft, Kew Gardens.

PROFITABLE spare-time employment for everybody, clerical, assembly, toymaking, etc., 100 firms! 'Sparetimer', 1/-—43 Douglas Avenue, Heanor, Derbyshire.

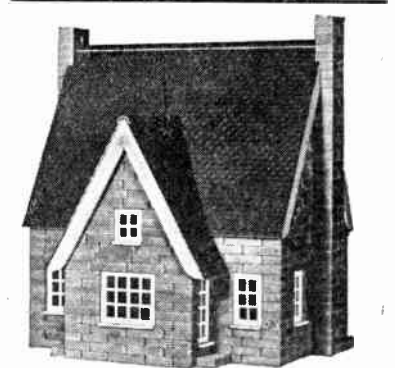

YOU can build this INN WITH

BRICKPLAYER

BRICK & MORTAR BUILDING KIT

It enables you to build Garages, Houses, Railway Stations, Signal Boxes, or from your own imagination. All railway models will fit 'O' gauge scale. Buildings can be permanent, or dismantled by merely soaking in water and the bricks used again and again.

BRICKPLAYER KITS AT 28/6 AND 52/6 ARE AVAILABLE FROM GOOD TOYSHOPS, HOBBY SHOPS AND DEPARTMENTAL STORES.

ACCESSORY PACKS		
No.	Contents	Price
100	100 Full size Bricks	3/-
101	52 ¾-Bricks and 72 ¼-Bricks	3/-
102	Gable and Peak Bricks	3/-
111	Capping and Roof Tiling	2/6
112	Concrete Roofing	2/6
114	Bag of Brickplayer Cement	1/3
115	Roofing Cement	9d.
8107	2 Bay Windows with 31 Splay Bricks	3/9

METAL WINDOW AND DOOR FRAMES
F1 F2 F3 F4 F6 F8 F10
8½d. 6½d. 7½d. 5d. 4d. 6d. 7½d.

8108 Sheets of Glazing, 1¾" x 6" (Plastic) 1½d.
If your dealer cannot supply, write for address of nearest stockist to:

J. W. SPEAR & SONS LTD.
DEPT. H . ENFIELD . MIDDLESEX

Patterns for Windmill Toy

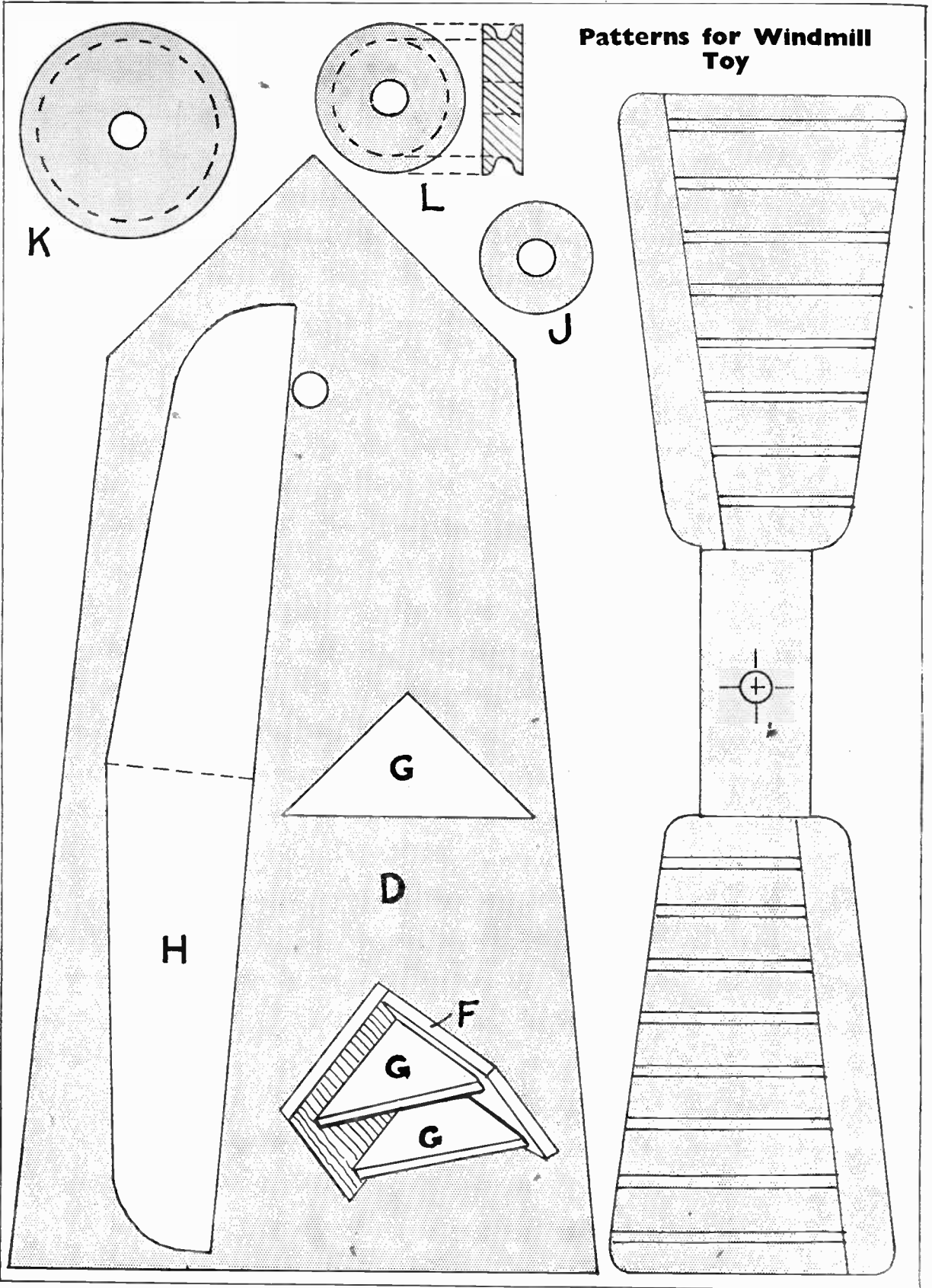

STUDY
AT
HOME

IN YOUR
SPARE
TIME

THE BENNETT COLLEGE

*will set you on the right
course for success*

You make sure of planned progress in the career of your choice when you let the most progressive, most successful Correspondence College in the world coach you through the post. By friendly, individual training we equip you with the specialized knowledge you must have for a well-paid key position. Make the first move TODAY—post the coupon below!

**ALL TEXT BOOKS ARE
FREE!**

to Students of The Bennett College Ltd., we send as many volumes as the subject demands and they become your personal property.



IS YOUR CAREER HERE? IF NOT, WRITE FOR FREE ADVICE

- | | | |
|----------------------|----------------------|----------------------|
| Accountancy Exams. | Engineering. | Radio Service En- |
| Agriculture | All branches. Sub- | gineering |
| Applied Mechanics | jects and Exams. | Radio (Short Wave) |
| Aviation (Engineer- | General Certificate | Road Making and |
| ing and Wireless) | of Education | Maintenance |
| Blue Prints | Examinations | Salesmanship |
| Boilers | General Education | Sanitation |
| Book-keeping, Ac- | G.P.O. Eng. Dept. | School Attendance |
| countancy, and | Heating and Venti- | Officer |
| Modern Business | lating | Secretarial Exams. |
| Methods | Institute of Munici- | Sheet Metal Work |
| Builders' Quantities | pal Engineers | Shipbuilding |
| Building, Architec- | Journalism | Shorthand (Pitman's) |
| ture, and Clerk of | Languages | Short Story Writing |
| Works (A.R.I.B.A. | Mathematics | Speaking in Public |
| Exams.) | Metallurgy | Structural Engineer- |
| Carpentry and | Mining. All Subjects | ing |
| Joinery | Mining. Electrical | Surveying (R.I.C.S. |
| Chemistry | Engineering | Exams.) |
| Civil Engineering | Motor Engineering | Teachers of Handi- |
| Civil Service | Naval Architecture | crafts |
| All Commercial | Plastics | Telecommuni- |
| Subjects | Play Writing | cations (City and |
| Commercial Art | Plumbing | Guilds) |
| Common Prelim. | Police, Special | Television |
| E.J.E.B. | Course | Transport Inst. |
| Concrete and Struc- | Preceptors, | Examinations |
| tural Engineering | College of | Viewers, Gaugers |
| Diesel Engines | Press Tool Work | Inspectors |
| Draughtsmanship, | Pumps and Pumping | Weights and Mea- |
| Electrical or | Machinery | wires Inspectors |
| Mechanical | Quantity Surveying | Wireless Telegraphy |
| Estate Agency | —Inst. of Quantity | and Telephony |
| | Surveyors Exams. | Works Managers |

COUPON. CUT THIS OUT

IF YOU ATTEND TO THIS NOW
IT MAY MAKE A WONDERFUL
DIFFERENCE TO YOUR FUTURE



To DEPT. 62
THE BENNETT COLLEGE LTD.
SHEFFIELD

Please send me (free of charge)

Particulars of

Your private advice

about

PLEASE WRITE IN BLOCK LETTERS

Name

Address

Age if under 21

(Cross out line
which does not
apply.)



all made with-



Croid

THE MODERN GLUE



Aero Glue. The strongest glue in the world.

Universal Glue. Cold glue ready for use from tube or tin.
Waterproof Cement. Spectacularly prepared for balsa wood.
Whyte Paste. For paper work and photo-mounting, etc.

CROID LTD., IMPERIAL HOUSE, KINGSWAY, LONDON, W.C.2

EXTRA CASH IN SPARE TIME

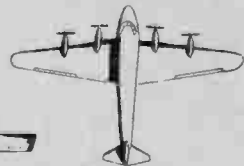
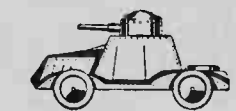

A fascinating way of earning extra cash in spare time from odd pieces of lead. Small Outlay—Large Profits. Sample mould 3/6d. Casting moulds, deep-cut and ordinary type Aeroplanes. Soldiers, Farm and Wild Animals, Cars, etc. Stamped envelope for full list Illustrated Catalogue 9d.

MASTERCRAFT MOULDS
69, ST. MARKS ROAD, HANWELL, LONDON, W.7

Hobbies

WEEKLY

CONTENTS

	Page
Child's Desk & Chair	257
A Fruit & Vegetable Peeler	258
'Pusher' Model	259
Aeroplane	260
Replies of Interest	260
The Yacht Race	261
Pull-along Toy	262
Sand-Cart	263
Cape Cod Chair	264
Simple Metal Work	264
Knobs and Handles	265
House Telephone	266
Many Purpose Stool	267
Frame	268
Stamp Collecting	268
'Pusher' Model	271
Aeroplane Patterns	271
DESIGN SHEET FOR DOLL'S HOUSE	

August 8th, 1951

Price Fourpence

Vol. 112 No. 2910

For young folk - a CHILD'S DESK AND CHAIR

THE amount of wood required for the making of these two items is not very considerable, and the finished appearance and usefulness amply repay the time and money spent on making them.

A good quality hardwood would be unsuitable for either the desk or chair, but a softwood finished with paint or enamel looks very well indeed. It is often possible to 'salvage' quite useful pieces of deal from a large packing case, and it may be possible to do the greater part of the work with such timber.

Definite sizes have been given below, but these can be varied to suit individual requirements.

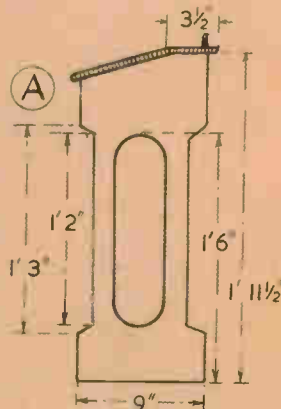
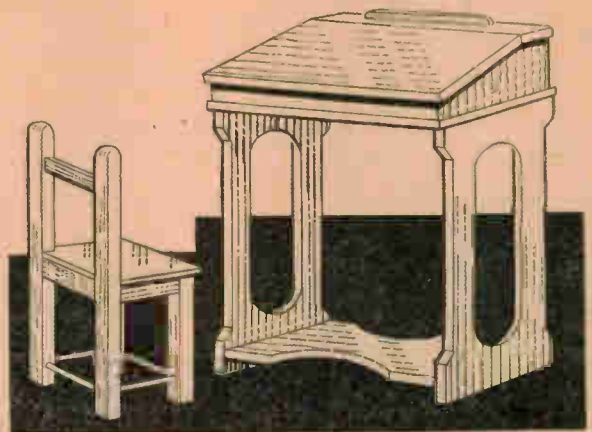

Dimensions for the sides

The desk is the first item to be constructed.

The sides of this are of $\frac{3}{4}$ in. or $\frac{1}{2}$ in. thickness and are 9 ins. wide by 1 ft. 11 $\frac{1}{2}$ ins. high. An opening 4 ins. wide by 1 ft. 2 ins. long is cut in each, the tops and bottoms of these being semi-circular in shape, with the bottom of the lower shaping at 4 ins. from the bottom of the side (see drawing A). To take out the shapings a hole is bored in the waste wood, the blade of a pad- or compass-saw is inserted through the hole, and the outline is sawn round to within $\frac{1}{8}$ in. of the pencilled marking, final cleaning of the shape being done with chisel and glasspaper.

At the top of each side a sloping cut is made from a point 2 $\frac{1}{2}$ ins. from the back edge to 2 ins. down from the front corner. By means of sloping cuts on the edges, the lower part of each side is thinned down to leave a bar 1 $\frac{1}{2}$ ins. wide at each side of the shaping, the finished side appearing as at (A).

Bottom Cross-Rail

The bottom cross-rail is 9 ins. wide, $\frac{1}{2}$ in. thick and 1 ft. 3 ins. long. This is simply shaped to the outline shown at (B) and is then screwed between the sides so that its lower edge is at 1 $\frac{3}{4}$ ins.

from the bottom of them. All screw heads should be well countersunk and the holes made good with plastic wood.

Three pieces of wood are required to make the box portion of the desk, all being $\frac{1}{2}$ in. thick and 1 ft. 3 ins. in length. The base is 9 ins. wide, the back 4 ins. high, and the front slightly more than 2 ins. high, so that its top edge can be planed off to conform with the slope on the side.

Screws are driven through the base into the two upright members, and the composite box piece is screwed between the tops of the legs so that the top edge of the back upright is level with the top back edge of the side (drawing C). As before, all screws should be well countersunk and the holes treated with plastic wood.

A strip 3 $\frac{1}{2}$ ins. wide, $\frac{1}{4}$ in. thick and 1 ft. 5 ins. long is screwed across the flat parts at the top of the sides, overhanging the back and outside edges of this by 1 in. A narrow strip of wood about 10 ins. long can be given a half-round shaping on the ends and is glued towards the back edge of this strip to act as a pencil stop. If two porcelain ink-wells of the school-desk types are available, holes for these can be drilled towards the ends of the horizontal member.

All correspondence should be addressed to The Editor, Hobbies Weekly, Dereham, Norfolk.

The lid is also of $\frac{1}{2}$ in. wood and projects about $\frac{1}{2}$ in. beyond the front edge of the side, being given a slight shaping to take off the sharp edges. According to preference, plain butt or fancy decorative hinges can be used.

Neat Moulding

The finished appearance of the desk will be greatly improved if a small moulding is neatly mitred round the sides to cover the bottom edges of the base of the box.

For the chair, wood of 1 in. square end-section will be needed for the legs, the back legs being 1ft. 7ins. long and the front legs 1ft. The top edges of the two back legs are given a slight shaping with chisel and glasspaper.

The back legs are connected into a framework by means of two rails and a dowel. Both rails

similar depth and are $\frac{1}{2}$ in. wide, having their bottom edges 11ins. and 1ft. 4ins. from the bottom of the leg. Tenons $\frac{3}{4}$ in. long are cut at the ends of each rail, and the extreme ends of these, and of the dowel, are cut across at a mitre angle. The framework is then glued and cramped together.

Dowel holes in the front legs are bored in positions corresponding to those on the back leg, while at the extreme top of the smaller legs a $\frac{1}{2}$ in. wide, 1 in. deep slot is cut to a depth of $\frac{1}{2}$ in. One rail and one dowel are prepared to the same dimensions as before, and these are glued and cramped into position.

The back and front frames are con-

necting mitre angle so that they will meet correctly in the legs, and the rails and dowels are glued and cramped into place to complete the main chair framework.

The Seat

For the seat, a 9ins. long by $8\frac{1}{2}$ ins. wide panel of $\frac{1}{2}$ in. thick wood can be used. Solid timber is preferable to plywood, boards being glue-jointed edge to edge to gain the required width, if this should be necessary. The top outside edges are slightly chamfered to remove the sharp corners, small pieces are cut out of the back

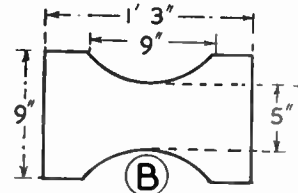

Details of the bottom cross-rail

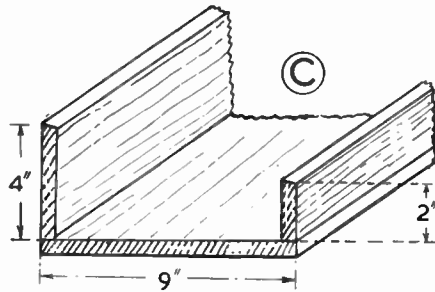

The top of the desk without its lid

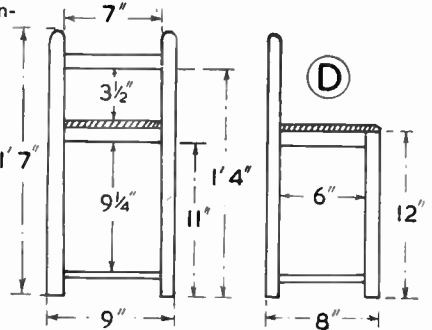

Measurements of the chair

are $8\frac{1}{2}$ ins. long, 1 in. wide and $\frac{1}{2}$ in. thick, the dowel being of the same length and $\frac{1}{2}$ in. diameter.

Holes for the dowels are $1\frac{1}{2}$ ins. from the bottom of the leg and are drilled to a depth of $\frac{3}{4}$ in. The mortises are of

edges so that they will fit round the back legs, and the seat is nailed into place. Oval-headed panel pins should be used for the nailing. The main dimensions of the chair are given on drawing (D). (350)

connected by a rail and a dowel at each end, these being 8ins. long. Holes, mortises and slots are cut in the correct positions on the appropriate faces of the back and front frames, the ends of the side rail tenons and dowels are cut across at a

edges so that they will fit round the back legs, and the seat is nailed into place. Oval-headed panel pins should be used for the nailing. The main dimensions of the chair are given on drawing (D). (350)

A Fruit and Vegetable Peeler

THE preparation of meals is a problem in most households and anything that helps to lighten that task is sure of a welcome. The subject of this article is one of these labour saving devices, and was designed to simplify the peeling of fruit and certain vegetables.

Versatile

It can be used equally well for apples, pears, potatoes, cucumbers and beans, and will also slice runner beans efficiently.

The cutter is a razor blade that has seen service as such, and is ready for a



aluminium are quite suitable. Cut a piece of 16 gauge metal 4ins. long and $1\frac{1}{2}$ ins. wide to the pattern shown in Fig. 1. Shears may be used to cut the outside shape, but these are liable to distort the metal somewhat, and it is better to use a metal cutting fretsaw for the job.

The slot for the razor blade should not be cut out until the metal has been bent to the proper curve as shown in Fig. 2. This can be done by hammering it on a round rod or tube having a similar curve. Now we can cut the slot, the bottom of which is $\frac{7}{16}$ in. from the edge. Make it $1\frac{1}{2}$ ins. long and $\frac{3}{16}$ in. wide.

The adjustment to the blade is carried out by means of the two short slots just below the long one already cut. These are just wide enough to take an $\frac{1}{8}$ in. metal screw, and if made $\frac{3}{8}$ in. long will allow of ample adjustment to be made.

The best way to make these two slots is to drill holes at each end and then to join up by means of a fretsaw. The centre of these slots is $\frac{1}{2}$ in. from the bottom edge, and they are $\frac{7}{16}$ in. apart.

The screws to hold the blade in position are $\frac{3}{16}$ in. round headed, or the equivalent 5 B.A. size can be used. The heads of the screws should be shallow so as not to interfere with the cutting surface.

Before placing the razor blade in position a washer is needed on each screw between the holder and the blade. Otherwise, when tightening up the thin blade will be bent so that the cutting edge will not protrude through the slot.

A better method is to place a narrow strip of metal here instead of the washers. Make it the full length of the blade and about $\frac{1}{4}$ in. wide. The thickness of the washers or bar will depend upon the size of the curve of the holder.



Fig. 2—Showing the curve of the head

The wooden handle for the tool need not be more than 4ins. long and about $\frac{3}{4}$ in. square. Plane off the sharp corners and well smooth with glasspaper. The metal holder is fitted on to the handle by bending the metal round the wood and finally fixing with two wood screws. (362)

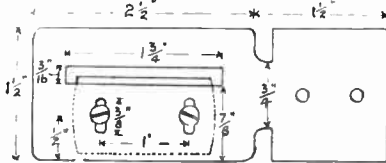

Fig. 1—Dimensions of the head, which is cut from sheet brass

further period of usefulness before throwing away. The blade can be easily adjusted to give various widths of cut, and it can also be replaced by a new blade quite quickly.

Sheet brass is the best material to use for the holder, although copper or

Plans on page 271 for this 'PUSHER' MODEL AEROPLANE

THIS model aeroplane does not follow conventional lines, but has the propeller behind the wings, with the tailplane carried on twin booms. This layout is a very efficient one in full scale practice, and equally successful in model size. An excellent and most realistic performance is possible once the model has been trimmed correctly. It will take off the ground under its own power and land again at the end of the flight without turning over, provided the surface is reasonably smooth.

The plans are reproduced $\frac{1}{3}$ rd full size and should be scaled up accordingly.

Start construction with the centre section of the wings. Pin the spars in place, after first shaping and notching the trailing edge member. Then cut the wing ribs and cement in place. Leave pinned down until the cement has set. The tailplane, and then the two outer wing panels can be built in a similar manner. In the case of the outer wing panels, each rib is a different size and care must be taken to cut these accurately.

The booms are hollow. The sides are cut from $\frac{1}{8}$ in. sheet and are cemented

together with two lengths of $\frac{1}{4}$ in. square balsa cemented in between. Choose light balsa for the booms, otherwise they will come out too heavy.

When both booms have been built you can assemble the wing centre section, booms, and tailplane as an integral unit. Make sure that the assembly is true. With the booms and tailplane flat on the table the wing should have a slight upward tilt, given by the tapered front underside portion of the booms. This difference in angular setting is necessary for stability. Wings and tailplane are covered with tissue, water-shrunk and given two coats of clear model dope.

The fins are cut from soft $\frac{1}{8}$ in. sheet balsa, glass papered down slightly with edges rounded off, and then cemented in place to the outside of each boom.

Check that these line up accurately.

Fuselage construction is conventional. Two side frames of $\frac{3}{8}$ in. square balsa are built, one on top of the other directly over the plan. When set, remove, separate, and

then join with cross spacers to complete the 'box'. Sheet in the two end bays with $\frac{1}{8}$ in. balsa for additional strength.

The nosewheel leg and mainwheel legs can then be bent from 18 S.W.G. wire and bound and cemented in place. All three wheels are 1 in. in diameter. These are slipped over the stub axles and retained by bending up the wire at right angles. A noseblock and propeller block should then be made from two laminations of $\frac{1}{4}$ in. balsa, or balsa block, with a $\frac{1}{2}$ in. thick piece a plug fitted in the ends of the fuselage. The noseblock has a wire fitting to take the rubber motor and a loop for winding. The propeller block is pushed to take the propeller shaft.

The fuselage is tissue covered, water-shrunk and given three coats of clear dope. The colour glazing is thin celluloid.

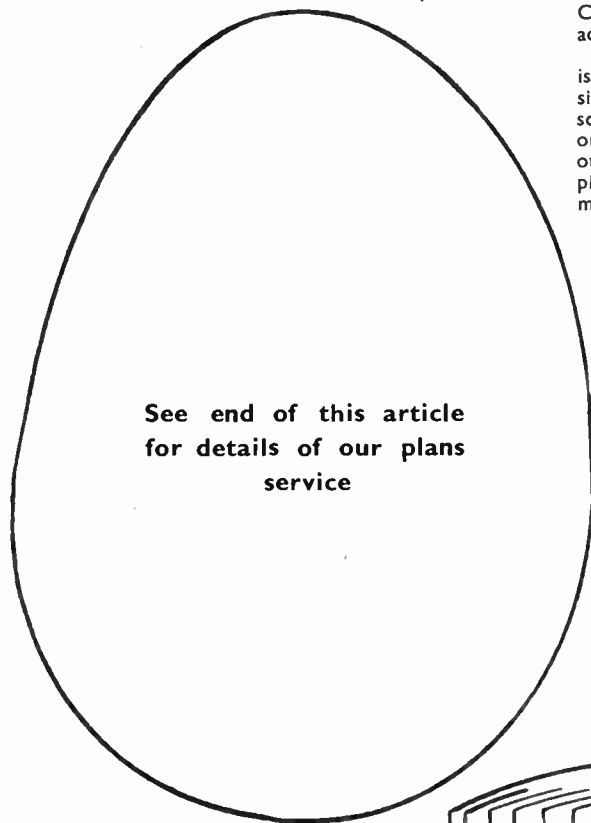
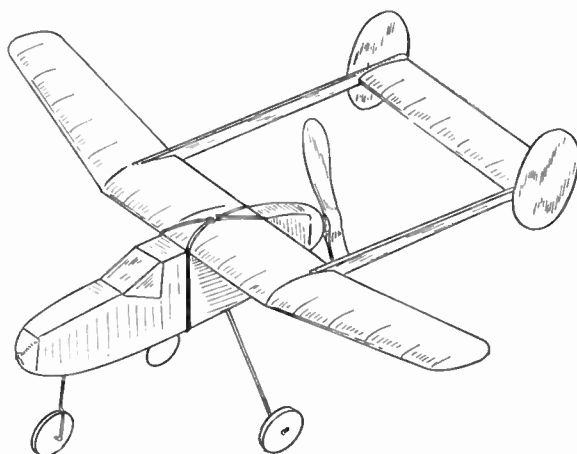

See end of this article
for details of our plans
service

Full size patterns for the fins and other important parts

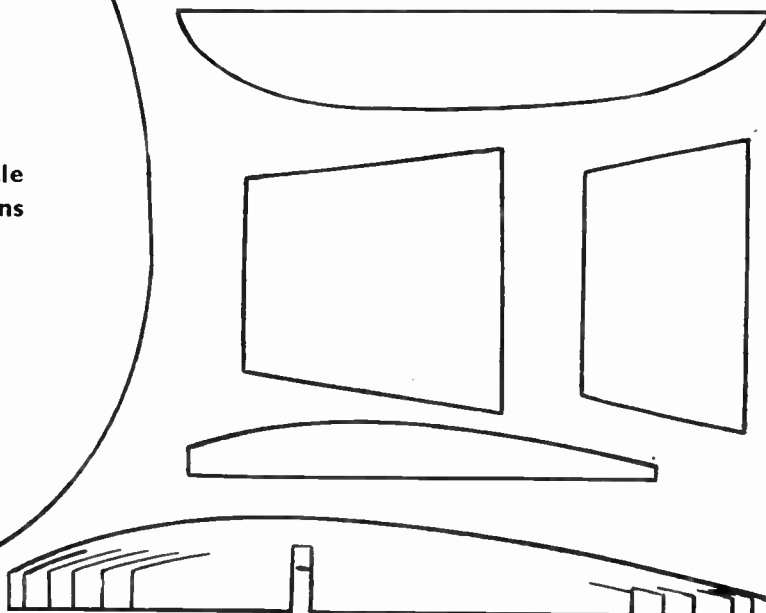

The Propeller

The propeller itself is 8 ins. in diameter and can either be bought as a finished article or carved from the block layout shown on the plan. A simple type of freewheel is fitted.

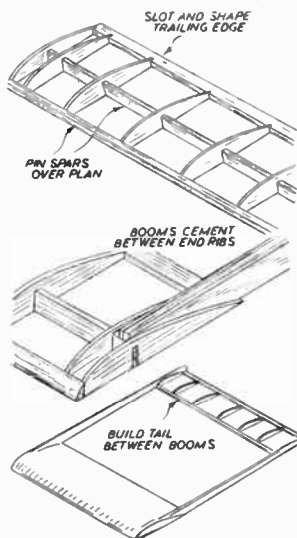

Drawings showing stages in assembly

Four to six strands of $\frac{1}{4}$ in. strip rubber should be ample power for this model, depending on the total weight. With the motor in place, the wings should be slid along the top of the fuselage to a point where the model will balance horizontally when supported under the centre of the wings. Allowance is made in the design for a range of adjustment to take care of possible different weights for the boom assembly.

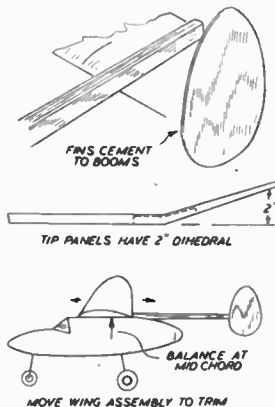

With the model completely assembled, test first for glide trim by launching into wind, slightly nose down. Shift the wing backwards to cure any nose-up tendency (stalling), or forward to cure a dive. Power flights may then be attempted, using about 150 turns on the motor for a start.

The model should climb away smoothly on this number of turns. Warp one of both fins around slightly to give a right hand turn under power and glide. Further turns to the motor can then be added progressively. If the model misbehaves—and the glide trim is correct—this can be dealt with by altering the thrust line.

To cure a stall under power, pack the top of the propeller block downwards slightly. If the model refuses to turn to the right, but tends to fly to the left, or straight, pack the side of the propeller block around to the right. Never use more than $\frac{1}{8}$ in. packing at a time, and make only one adjustment at a time and observe the result. (370)

This model was designed by R. H. Warring, well known aeromodeller. $\frac{1}{3}$ rd. full size plans appear on page 271, and should be scaled up.

Those who wish can obtain full-size plans, price $\frac{3}{6}$ post free on application to The Editor, Hobbies Weekly, Dereham, Norfolk.



Transformer Query

I HAVE a small transformer of $\frac{1}{2}$ -amp. which is used to light a lamp 20 watt in a home cinematograph projector. Now I see the makers have brought a 20 volt 20 watt lamp out. I have been told I will have to buy a new transformer of 1 amp., but am hoping you can tell me of a way of altering my existing transformer to take the new lamp. (W.S.—Catford).

If your transformer is built to deliver $\frac{1}{2}$ -amp. maximum, it will overheat if 1 amp. is taken; the windings may also be damaged. Thicker wire on both primary and secondary is required, and it is likely insufficient space exists for this to be accommodated. Any but the smallest transformer should deliver 1 amp. easily, but if your transformer was particularly made for the 10 watt lamp, its windings may be unsuitable for anything requiring heavier current. It, therefore, appears that a larger transformer is necessary. One obtained from an ex-service stores might be far less costly than a proprietary article.

Wallpaper Problem

WHEN I was wallpapering a room, some paste found its way on to the design side, and completely spoils the look of the job. Could you tell me how to remove these stains? (J.H.—Dollar).

IT may prove rather difficult to remove the paste stains, without damaging the design on your wallpaper. Make up a lump of dough with plain flour and water, then rub this vigorously over the stains. This should at least remove the dirt. Obstinate parts should then be swabbed generously with benzine, and when dry, the paste left may be rubbed away or scraped carefully off with a small knife, not too sharp. Admittedly this may prove a rather tiring job, but, unfortunately, it is the best that can be suggested, as almost any solvent would remove the design as well as the stain.

Motor for a Boat

I HAVE purchased a small boat of aluminium alloy construction, fitted for an inboard engine and built to carry four persons. The original engine is not with the boat, and I am unable to find out what type it was. I have, however, an old 500 c.c. m/cycle engine, water cooled, which I wish to adapt for the purpose. Could you tell me if this would be all right with a direct drive, or would it require gearing? Also could you give me particulars about the weight, as the engine mountings are in the bows of the boat. The dimensions of the boat are 12ft. long and 3ft. at beam. (L.G.L.—Willenhall).

THE 500 c.c. engine should do excellently; this H.P. is more than is usual with such a small boat, but it will doubtless be quite a light engine, and need not be run on full throttle. A gear-box with clutch (to permit starting) and occasionally with a reverse-gear, is usual, and some reduction is normal between engine and propeller. A propeller of low pitch could be driven directly, but would be less efficient; if the engine has sufficient power when running at a comparatively low speed, an ordinary propeller would be suitable. When a propeller runs above a certain speed, its grip on the water is lost, and forward thrust reduced. For a 12 to 15ft. boat, a 150 to 250 engine is usual, with a reduction of 1:2 or 1:3 or so.

Imitation Coal Effect

I AM constructing an electric fire, and I would like to make the imitation coal fire effect. Would you please instruct me in the correct method? (T.H.—Swansea).

THE imitation coal effect in electric fires is usually made of moulded glass, and it is difficult to imagine any more suitable material. Unfortunately it is almost impossible for the amateur to make such material. The only suggestion is to use fireproofed silk, soaked in a starch solution, and press it into desired form. When dry, colour it with transparent spirit colours and dense black for the 'solid' parts. The flickering light effect is obtained by means of a red or orange coloured electric bulb, above which is mounted a 3-bladed propeller, which rotates with the uprising hot air, and the shadows cast by the moving fan blades give the flickering effect.

A game for the summer— THE YACHT RACE

HERE is an interesting table game that can be played in the summer as well as in winter. By picturing yachts and a rough sea, and an anchored 'buoy', the game would almost seem a typical summer pastime.

It is really a race game, and our illustration Fig. 1 shows the layout of the game, and the manner in which it is played. The board is cut through at the centre and hinged to fold over, making a compact box. The face of the board is divided into three distinct roads or 'runs' up which the yachts travel, the dividing strips being marked off into spaces which denote the progress made.

The Game

There are two little miniature yachts cut from fretwood and having card sails. The pointed bow is set to the lines of the marked out divisions. The sketch of the game in progress shows the general

reaches 'home' first wins the race and is awarded the 'cup'.

To make up the game, some pieces of $\frac{1}{2}$ in. by $\frac{1}{2}$ in., and some $\frac{3}{8}$ in. by $\frac{1}{2}$ in. stripwood will be needed, together with some stout card measuring 10 ins. by 8 ins. and a pair of small brass strap hinges. At Fig. 2 we see a view of the board with the framing strips round. The $\frac{1}{2}$ in. square stripwood must be firmly glued to the card, and some brass fret pins or small large-headed tacks are put through the card as an extra fixing. If some plywood can be obtained, then this should be used in preference to the card.

Now cut off four lengths of the $\frac{3}{8}$ in. by $\frac{1}{2}$ in. stripwood 16 ins. long, and glue two of the pieces just inside the edging

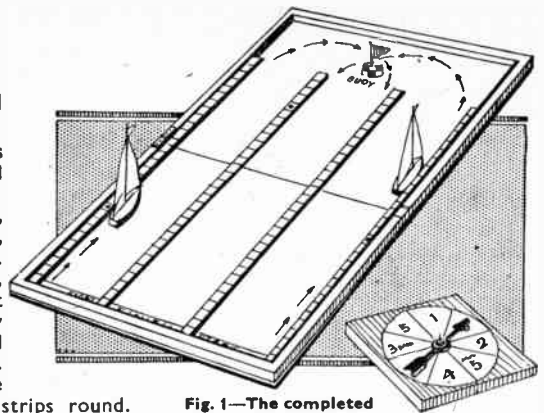

Fig. 1—The completed game

strips, and the two remaining pieces $1\frac{1}{2}$ ins. away from them, making the three distinct divisions as seen in Fig. 3. A pencil line must next be drawn across the centre of the board and the six strips of wood. Cut along this line with the fretsaw, and, still keeping the two pieces together, screw on a pair of small brass strap hinges as seen in Fig. 2 and in the enlarged detail.

The $\frac{1}{2}$ in. spaces on the $\frac{3}{8}$ in. faces of the stripwood can be next marked in ink and afterwards varnished over. The two starting spaces and the 'finish' can be set across as seen in Fig. 3 and the wording done in ink or heavy pencil and afterwards varnished.



Fig. 4—The 'buoy'

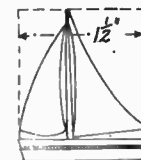
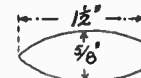

Fig. 5—Dimensions of the 'yachts'

At the top of the board, and in the position shown in Fig. 3, a 'buoy' is anchored, and the way of making it is shown in Fig. 4. A small cork may be cut down and the edges painted in black and white squares. In the top is pushed a pin with a small red painted flag. The cork is glued to the board.

The Yachts

The two little racing yachts are simply made from wood and card, and the plan and side view (Fig. 5) give the necessary detail. Cut the boat to the plan measurements from wood $\frac{1}{4}$ in. thick and glasspaper it all smooth. Mark out the two sails and the mast on a piece of stiff card and bend up a gluing tab about $\frac{1}{8}$ in. wide for fixing to the boat. A little paint will make for realism, while the addition of varnish to

(Continued foot of page 262)

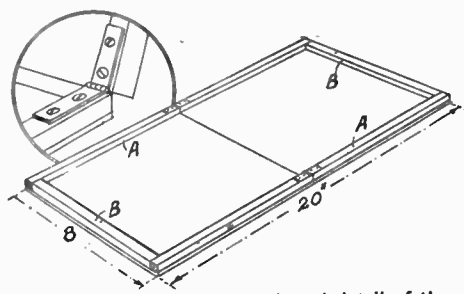

Fig. 2—Layout of the board, and detail of the hinges

construction. A small piece of board with a pattern of crossed and numbered divisions and an arrow head loosely pivoted in the centre is used to determine progress.

To play the game, two persons take part, and each chooses a particular yacht. Each yacht is stood at the foot of the board at the starting line and the arrow is spun by the first player. If the arrow-head stops at, say, 3, he moves forward that number of spaces.

The next player spins and moves his yacht, and so on until the top of the board is reached. Here is 'anchored' the buoy round which the yachts must 'sail' and come in line with the marked strips next-but-one to that of the starting point. The arrows marked on the board show the route each yacht must take to get on to the run home. The finishing points are at the lower end of the board and in line with the starting point.

Should the arrow come to rest at, say, '4 back', the unfortunate competitor has, of course, to move back four divisions. Again, if a division is reached upon which a dot appears, he must go right back again and start from the foot of the board. Naturally, the yacht that

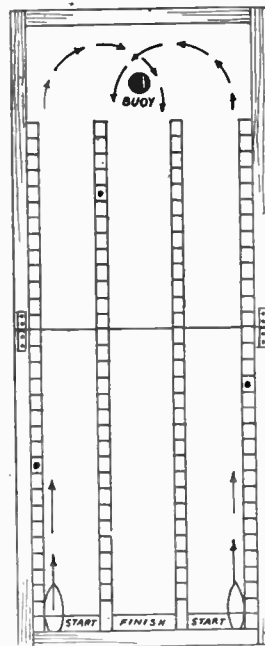

Fig. 3—How the board is marked out

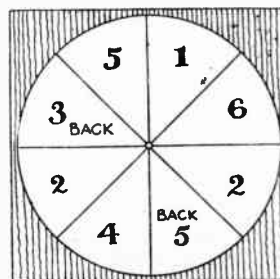

Fig. 6—The scoring dial

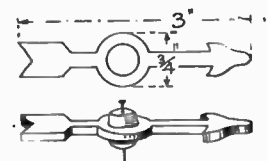

Fig. 7—Details of the pointer

Children will love this PULL-ALONG TOY SAND-CART



THE little cart illustrated here is just the thing for the lucky youngster who has a pile of sand in the garden. It can be helpful to father, too, on occasion, especially when weeding the garden. The young 'horse' can be harnessed and can pull the cart along, collecting the weeds and delivering them to the bonfire or compost heap.

The construction is quite simple and should not give any trouble to the average handyman. Figs. 1 and 2 show that it consists of a plain box on which are fixed the turntable and wheels. We suggest $\frac{1}{2}$ in. wood if possible, but this need not be strictly adhered to.

The bottom of the box measures 17 ins. by 8 ins. and to this are glued and screwed the sides and ends.

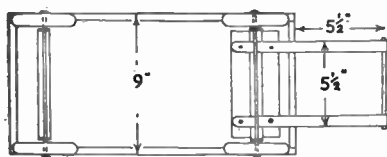

Fig. 3—Plan of the underside

The wheel supports are made from strips of 1 in. wide metal, as shown in the detail in Fig. 5, and $\frac{1}{4}$ in. thick metal should be quite strong enough. The axles consist of steel rods of $\frac{1}{4}$ in. diameter, with a head on one end and a split pin and washer at the other.

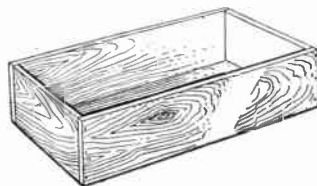

Fig. 2—The construction of the box

Washers must also be inserted between the wheels and the wheel supports.

The Shafts

The shafts are also made from 1 in. wide metal and a metal rod inserted as shown in Figs. 1 and 3. The shafts can be bent to almost any angle required. If you would rather have the irons made, we suggest you take the diagrams along

to the nearest blacksmith, who will soon knock the parts into shape for you.

The wheels shown in the diagrams are 4 ins. wooden wheels and are supplied by Hobbies Ltd., Dereham, Norfolk, at the price of 3/- per set of four (post free). The centre hole must be carefully enlarged to take the $\frac{1}{4}$ in. axle and a washer inserted on each side of the wheel when assembling.

Painting

Before the wheel supports are screwed in place they must be given two coats of paint. Black is most suitable for these, since very little will be seen of them. The cart itself should be painted some bright colour such as red or green, and

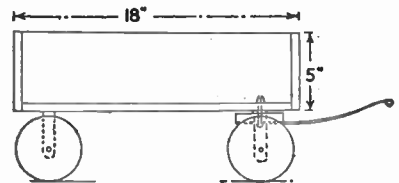

Fig. 1—Side elevation

the sides could have a yellow line round them as shown in the picture of the finished thing. The wheels can also be painted if desired.

Assembly

When all parts are dry, they can be assembled and the heads of the screws painted over. Add a length of strong twine to the shafts and the kiddies' play-cart is complete. (381)

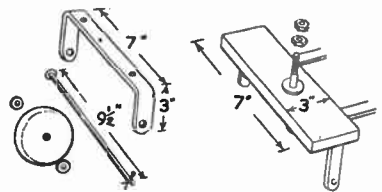

Fig. 4—The rear axle and support

Fig. 5—The turntable

Yacht Race—(Continued from page 261)

the sails and the boat will protect it while handling.

The Dial

The dial on which the arrow will be fixed and played consists of a piece of wood, say, $\frac{1}{4}$ in. thick and 3 $\frac{1}{2}$ ins. square. In Fig. 6 is shown the manner of marking out the divisions and numbering, etc. It would be best to reproduce Fig. 6 on stout paper, making ink lines, and later sticking it down to the wood. It may then be painted up in bright colours.

Making the Pointer

A simple outline for the pointer is

given in Fig. 7, and it may be cut out with the fretsaw from $\frac{1}{8}$ in. or $\frac{1}{16}$ in. wood. The hole in the middle is $\frac{3}{16}$ in. diameter to take a $\frac{1}{4}$ in. length of round rod which is glued in. The rod is rounded at the lower end and has a hole bored through it to take a fine wire nail or a stout pin. See that the nail fits loosely in the hole so that the arrow revolves freely when the nail is driven into the $\frac{1}{4}$ in. board. A small piece of waste wood can be glued centrally on the underside of the board to take the point of the nail, and narrow strips of wood are then glued to two edges to raise the board as seen in Fig. 1.

Round the 'Buoy'

At the top end of the playing board two semi-circles must be struck and arrow heads marked on at intervals as shown in Fig. 3. The lines go round the 'buoy' and are intended to direct the yachts when leaving their side strips to meet the strips on the downward passage home. The two arrows at each starting point also indicate the direction of the yachts. Both boards may be varnished or they may be painted or enamelled in attractive colours. Light blue is suggested for the 'sea' and black and white for the 'buoy'. Other colours are optional. (392)

A straightforward design for a CAPE COD CHAIR

THE Cape Cod chair is typical of an American style of furniture. The design is quite straightforward, with the accent on the sloping seat and spreading back.

Basic dimensions of the chair are given in Fig. 1. These measurements will be useful for reference. The slope of the back itself is 60 degrees, and that of the rear legs 17 degrees.

Frame parts are detailed in Fig. 2. Two side frames are required, each of three pieces of 2ins. by 1/2in. stock. Make the joints carefully and glue and screw each frame together.

desired, although in most of the Cape Cod designs this particular feature is kept to a minimum.

The Seat Back

The seat back is the remaining component. This is outlined in Fig. 5. It can be made either from a single piece of material or four panels glued together. Using separate panels, or where the material is thin, it should be re-inforced with battens screwed to the back, as shown in broken lines. Minimum

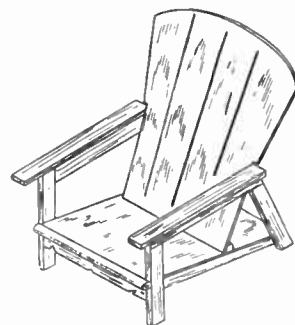

material thickness for the back is 1/2in. The side frames are assembled as shown in Fig. 6, and it should be noted

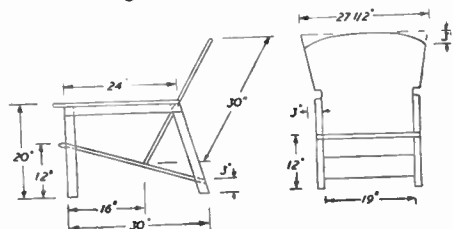

Fig. 1—Measurements of the chair

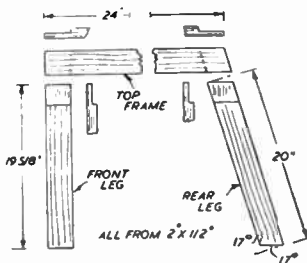

Fig. 2—The parts of the frame

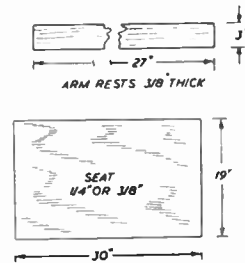

Fig. 3—Dimensions of the seat and armrests

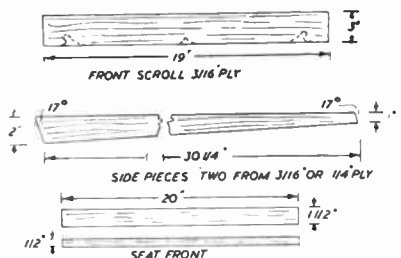

Fig. 4—Details of the front scroll, side pieces and seat front

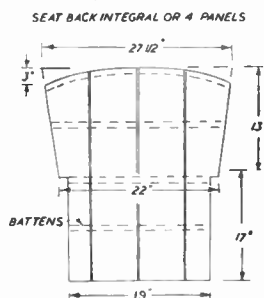

Fig. 5—Outline of the back

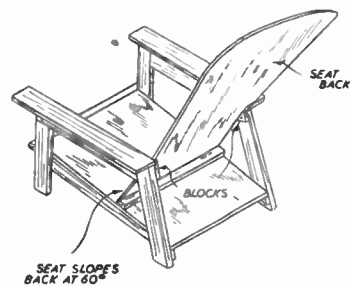

Fig. 8—How the back is supported

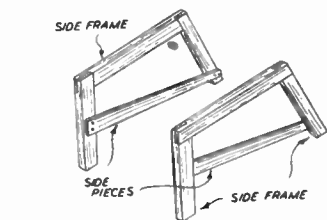

Fig. 6—How the side frames are assembled

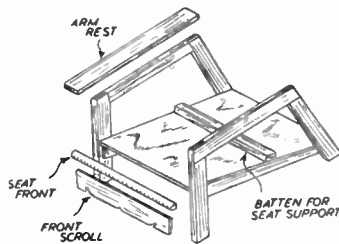

Fig. 7—A further stage in assembly

Seat and armrests are detailed in Fig. 3. The two armrests are cut from 1/2in. material, and the seat can be 1/4in. or 3/8in. thick, depending on the material to be used. Hardboard would be sufficient, if the final seat is to be covered with a cushion.

Front Scroll

The front scroll, side pieces and seat front are shown in Fig. 4. The scroll pattern fretted out is a very simple one and can be drawn in by eye. More elaborate scroll work can be used, if

how the side pieces are added—dimensions from Fig. 1—and screwed in place. These pieces actually support the seat panel. The basic assembly is completed by the addition of the seat, seat front, front scroll and armrests, as in Fig. 7. A batten is tacked across the seat, 16ins. from the front.

Finishing

The seat back can then be assembled against this batten and supported at the rear of the side frames by small blocks glued to the main assembly (Fig. 8). An overall glasspapering down and rounding off of the seat front should then complete the chair.

Enamel is Usual

It can be left in natural wood finish, although common practice is to enamel or paint white. There is no reason, of course, why the completed chair should not be stained and polished to match any existing scheme. (377)

DOLL'S HOUSE

For making the attractive Doll's House from the Design No. 2910 presented with this issue, we supply the necessary wood, hinges and catches, etc., metal windows and doors, stairs, fireplaces and chimneys, with brick, tile, lino and interior paper, price 45/10 inc. purchase tax, post free.

Practical help with SIMPLE METAL WORK

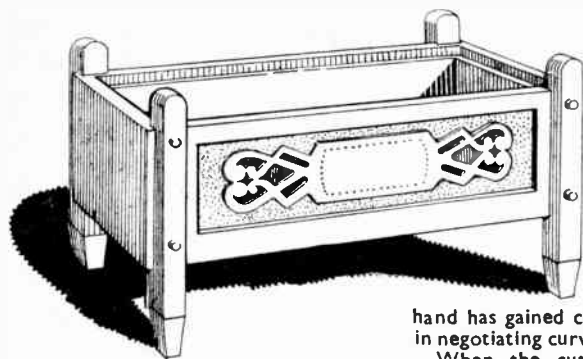

ON looking round, one often sees good examples of embossed copper and brass work. On furniture, in panels of cupboards and wardrobes, and in smaller articles such as finger plates, etc.

Only the expert metal worker could hope to copy such work as that carried out by our old master craftsman, but there is satisfaction in reproducing something of a more simple nature—and with less intricate tools than were used years ago.

Fascinating Hobby

There is an easy method of working in copper, aluminium or similar soft metals, which provides an interesting and fascinating hobby. Nearly all these metals are, however, difficult to get now, but any odd scraps that are obtainable might well be put to good use in experimental work of a decorative nature.

We show at Fig. 1 a finger plate of simple design with which the worker might commence. No hard and fast sizes need be adhered to, but a length of about 8 ins. may be given as a guide.

The metal must be beaten flat, and the design traced upon it by means of carbon paper. If the nature of the material used does not allow this process, then the design may be made on thin tracing paper and stuck down with gum to the metal. In Fig. 2 (A) and (B), we show enlargements of the ends of the finger plates. Only these portions need be reproduced, the remaining straight central part of the plate being simply drawn in with pencil or lined in with a pointed steel scriber.

It will be noted on the diagrams (Fig. 2) that only one half of each has been squared over with $\frac{1}{2}$ in. squares taken from the centre line. When these squares have been reproduced full size on paper, and the design enlarged on it, this half may be traced on thin paper and that then turned over and the corresponding side drawn over it, thus completing the whole outline ready for transferring to the metal. A special type of metal-cutting fretsaw blade should be used for the frets and the outline.

Holes will have to be drilled to admit the saw in just the same manner as with ordinary fret-cutting in wood. The actual work of cutting the metal, of course, will be slower than that for wood, and some little patience will, therefore, be necessary at first until the hand has gained confidence and practice in negotiating curves and corners.

When the cutting has been done, certain parts will possibly need the attention of the file, but do not file or scratch the face of the metal. Having

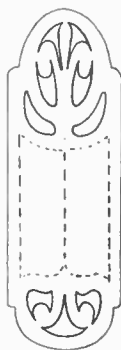

Fig. 1—A simple design for a finger plate

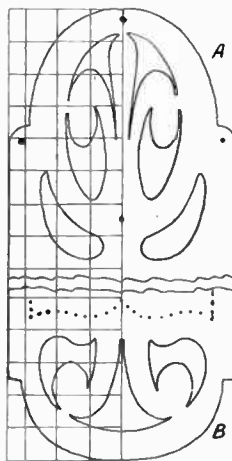

Fig. 2—The ends of the plate enlarged

done, perhaps, the most difficult part of the work, it only remains to add the punched work which at once gives refinement and a tone of finish to the metal.

Metal Working

A few nails of various thicknesses and a light hammer or mallet are needed. If, however, one or two steel punches are included in the worker's outfit of tools, so much the better, as they are easier to handle than the nails. The points in any case must not be sharp. While a finer edge or point will be used for the design shown in Fig. 4, a more rounded edge can be used for the plate given in Fig. 1.

In working the punches, it is simply a matter of following round the lines, shown dotted in each case. A point to remember, however, is that the plate must rest on a solid surface before the hammering is commenced. Hold the punch upright with the left hand, allowing the little finger to rest on the metal alongside the punch, so the latter is guided evenly and truly during the

hammering. Keep the hammering as consistent as possible so that all the indentations are of the same depth, and keep equal distances between the 'dots' as far as possible.

The Box

In our sketch we show an attractive little box, suitable for bulbs, perhaps, which has been decorated with a metal panel on its side. Both sides, of course, should be treated alike.

There are two sides, two ends and a floor all screwed together with brass screws. Then at the ends of the two sides of the box there are shaped uprights forming feet and thus raising the box well off the table. These uprights are square in section and are recessed so that they fit on to the sides in the manner shown in Fig. 3, which is an enlarged detail of one corner of the box with the leg ready for attachment by screws or hard wood dowel pins.

In the sides of the box a sunk panel is formed by cutting out an oblong with the fretsaw and screwing on inside another panel of wood about a $\frac{1}{2}$ in. or so larger than the opening all round. The face of this sunken panel should be matted all over with a matting punch specially made for the work. Then, finally, there is a worked metal panel carried out by the processes previously

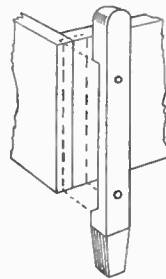

Fig. 3—Details of how the legs are fitted to the box



Fig. 4—A suitable design for the box panel

mentioned. At Fig. 4 a suitable design for the panel is given. The sizes of the sunken panel are set out on a sheet of paper, and the outline for the metal panel laid out proportionately.

If the box has been made from mahogany, then the metal panel should consist of brass. Or again, if beech or oak has been adopted for the box, then copper or any other suitable metal could be used. If brass has been used, the edges must be carefully cleaned after cutting, and the surface polished before the panel is fixed to the box. Small

(Continued foot of page 265)

How to make KNOBS AND HANDLES

THE importance of fitting the correct knob or handle to a piece of furniture cannot be overestimated. Many hours may be spent in designing and making an attractive article, and then, by careless fitting of the wrong type of handle, the complete harmony may be lost.

Easy To Make

Knobs and handles are so easy to make that it is a good idea to spend a little time and to design something in keeping with the pattern and period of the piece of furniture being made. There is such a wide range of materials

wood about 1 in. square and $\frac{3}{4}$ in. thick and drill a hole in the centre of one piece large enough for a wood screw. Countersink this so that the screw head is level with the top of the wood.

Cut a groove about $\frac{1}{4}$ in. on either side of the screw and level with the slot, which now has a piece of wire fitted to keep the screw from turning. Glue the two blocks together, and, when dry, the knob may be cut to shape.

The finished knob at (A) is quite easy to shape, while (B) shows a neat eight-sided design, most of which can be filed to shape.

The same method is adopted when

even four, different colours could be used. Best effects, however, are obtained by using not more than two kinds.

Use of Dowel Rod

Dowel rod can be used effectively, as shown in (G) and (H). For (H), the rod is sawn down the centre and the screws inserted, while spacing washers made of thinner rod keep the handle a certain distance from the cabinet.

Drop handles are useful and can look quite attractive on some types of furniture. (J) shows the method of making these, and here again there is a wide range of designs that would

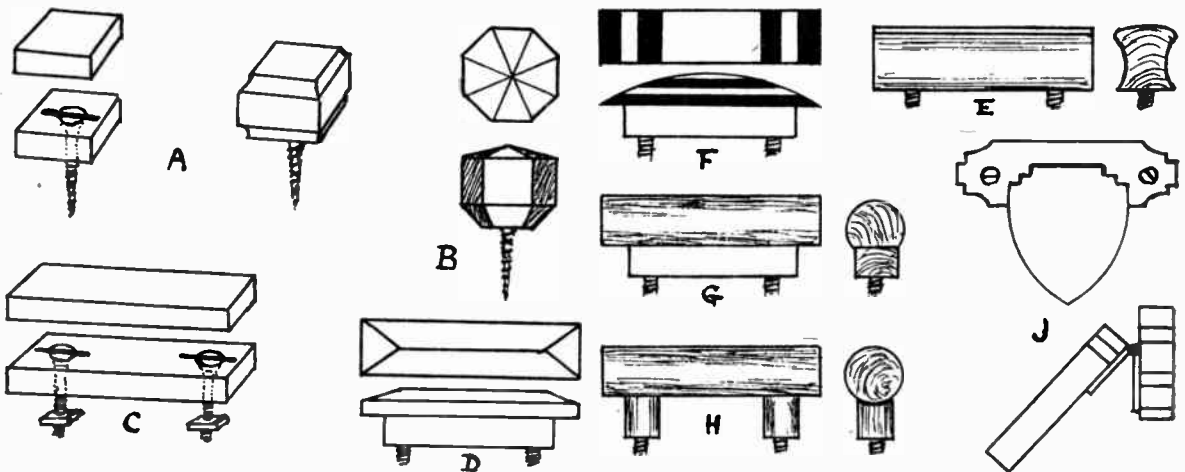

Suggested handle designs

available that it is quite a simple matter to make a pleasing job.

Plastics are popular now and can be worked up into some attractive designs. They fit in nicely with woodwork that has been painted or enamelled, but seem rather out of place on the natural wood. Brass, on the other hand, has much more harmonious associations, and was much favoured by many of our old craftsmen, some of whom used particularly ornate brasswork to decorate their furniture.

Knobs may be fixed on to furniture by several methods. Screwing on from the front is unsightly and amateurish, and is not to be recommended. It is better to insert the screw from inside the article and into the back of the knob.

The best way, however, is with either a screw and nut, or with a tapered wood screw. Fig. A shows how a knob is built up. First, cut two pieces of hard-

wood about 1 in. square and $\frac{3}{4}$ in. thick and drill a hole in the centre of one piece large enough for a wood screw. Countersink this so that the screw head is level with the top of the wood. Cut a groove about $\frac{1}{4}$ in. on either side of the screw and level with the slot, which now has a piece of wire fitted to keep the screw from turning. Glue the two blocks together, and, when dry, the knob may be cut to shape.

In (D), the top plate is slightly larger than the base and is suitable for light work. (E), on the other hand, is designed for heavier work and needs to be somewhat deeper.

Different Woods

Pleasing designs can be made up by using two or more different coloured woods, and (F) is a good example of this. The top is formed by gluing four thin pieces of wood together, and then cutting so as to show them to the best advantage. Although light and dark woods were used for this, three, or

harmonize effectively. The drop is secured to the back plate by a suitable sized hinge firmly fixed as shown at (J).

The wood carver will find wide scope for his craft in the making of some beautiful knob and handle designs.

This article has given a rough idea how to produce some attractive knobs and handles, and the keen designer will be able to make some quite novel articles by this method.

Although wood is the only material used for making these examples, it is possible to employ a wide range of other materials that can be cemented together. Do not embark on too ambitious a scheme, however, for it is often the simple designs that prove to be the most effective.

For the final finishing, wooden knobs and handles can be french polished, wax finished or enamelled in pleasing colours to match the piece of furniture. (260)

Simple Metal Work—(Continued from page 264)

round-head brass screws are used for fixing.

If the finished box is to be used for bulbs as suggested, then the earthenware

pots obtainable from any art dealer should be used, or again a well-made zinc lining could be made wherein the earth and bulbs can be deposited. As a

further suggestion, ordinary small 3 in. flower pots could stand in the box, the latter being designed to take, perhaps, three such pots. (399)

Concluding our article on a home-made HOUSE TELEPHONE

THE first article in this series described the making of the electro-magnetic buzzer and the various components that make up the microphone for one of the two telephone sets.

To assemble the microphone, take the small carbon rod that is hollowed out at the top and push it down the hole in the $\frac{1}{2}$ in. thick block of the container so that it rests against the back plate. It is held in position here by one of the small nuts and bolts, to the end of which is attached one of the leads for the instrument.

The second piece of carbon rod is screwed to the centre of the diaphragm by means of the second bolt. When this

is 2 ins. in diameter and $\frac{3}{8}$ in. thick, with a $\frac{1}{2}$ in. diameter hole bored in the centre of it. A rim of $\frac{1}{4}$ in. thick wood $\frac{3}{8}$ in. wide is glued at the back of this, and a short length of $\frac{1}{2}$ in. diameter dowel fits through this hole and has a thin brass flange at the back of it. Two narrow contact arms are cut from thin sheet brass and are fixed on the inside of the push by small brass screws. One contact arm is against the brass flange, while the other is at a short distance from it so that an electrical circuit cannot be made until the wooden rod is pressed down. Leads for the push are connected to the brass screw holding each contact arm. A sectional view through the push is given at (C).

The telephone must be mounted on a

connected direct to the earth terminal, while the second goes to the solitary screw on the bracket.

Another wire is connected between the earth and battery terminal. From the second battery terminal one wire goes to one of the contact arms of the push while a second goes to one of the connections of the mouthpiece. The other contact on the mouthpiece is connected to one of the contacts on the earpiece, while the second side of the push is connected to the upper contact of the bracket switch. Another lead runs from this upper contact to the second lead of the ear-piece. From the lower contact of the bracket switch a lead is carried to the line terminal.

This completes the wiring of the set

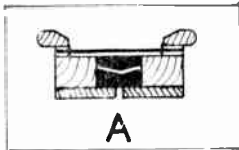

Sectional view through the completed microphone

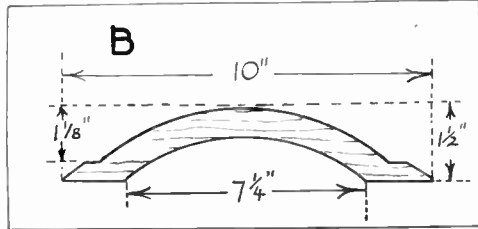

The arm for the receiver and mouthpiece

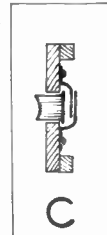

Section through bell push

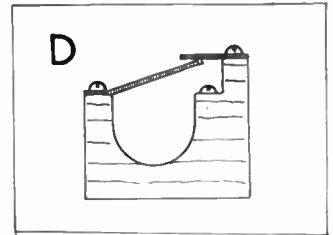

View of the telephone cradle

diaphragm is in its correct position, there will be a distance of slightly more than $\frac{1}{8}$ in. between the two carbons. This space must be about half-filled with the carbon granules.

After the granules have been poured in, one of the cardboard washers is put into place, followed by the diaphragm and the second washer. The mouth-piece goes on as the final item, and is held in place by two small screws. These can be recessed into the wood, and to one of them the second microphone lead is fastened.

Drawing (A) gives a sectional view through the completed microphone.

The Receiver

It would be possible to have a home-made receiver, but the making of this is not a job for anyone except the near-expert. A pair of headphones can be obtained from Government surplus stores for between 5/- and 7/6, and this sum will, therefore, provide the two receivers needed.

The receiver and microphone must be mounted at each end of a wooden holder. This is cut from wood $\frac{3}{8}$ in. thick and 10 ins. long, and the main shaping is shown at (B). The wood must be rounded over throughout the length to make a comfortable grip. Screws are used to fasten the microphone in place, while two small holes will have to be drilled in the case of the receiver, so that it can also be screwed into position.

A 'push' is required to operate the buzzer to call a person to the 'phone, and again this can be home-made.

The baseboard can be circular in shape,

fairly large wooden panel, which can also hold the buzzer and bell push. Simple shaped brackets screwed into place from the back form the cradle that holds the telephone, and one of these arms is used to hold an automatic switch.

This last consists of an upper plate of thin sheet brass and a lower plate of similar material which is bent so that it makes electrical contact with the upper. Immediately beneath the upper contact is a brass screw. The weight of the receiver should force down the springy plate so that it touches the bottom screw, but when the receiver is lifted the longer contact arm should spring up to connect with the upper arm (see drawing D).

Two battery terminals, a line and an earth terminal are fitted on the panel, and the set is ready for wiring with 22 S.W.G.

Small holes should be drilled through the panel so that the wires may be passed through to the back where they will not be seen. For the benefit of readers not electrically minded, the circuit is detailed above.

One of the wires from the buzzer is

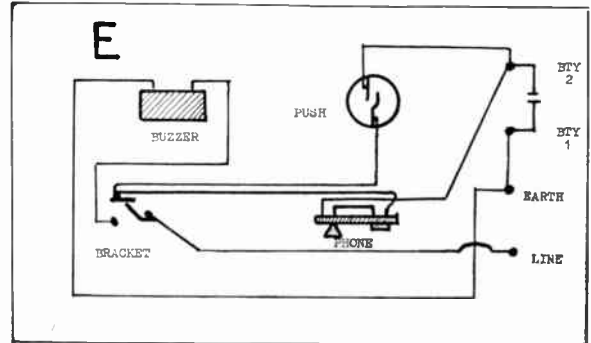

The complete wiring

which is shown in simple form at (E).

Testing

Before fastening the bracket permanently to the wall it is advisable to test out the set, using double-cotton covered bell wire. Run a wire to earth from the earth terminal on the set and connect up a 4.5 volt dry battery to the battery terminals. One lead is fitted between the line terminals on the two sets and another between the earth terminals.

The set can be tested by lifting one of the phones from the cradle and pressing the push. This operates the buzzer, and when the receiver is lifted at the other end it is possible to carry on an ordinary telephone conversation.

(Continued foot of page 267)

How to construct a MANY-PURPOSE STOOL FRAME

THIS stool, although simple to make, incorporates rather unorthodox construction, particularly in regard to the 'L-section' legs. The simple rectangular frame from 2ins. by 1/2in. stock is fitted with tapered legs cut from 1/2in. ply, these legs being secured directly to the insides of the end members.

To give sufficient rigidity, the legs are then braced by side legs of 1/2in. or 3/4in. ply, gluing to corner blocks under the frame. A simple false frame inside the main frame then supports a basic seat, allowing space for the addition of a padded seat or cushion to build up the stool to correct height.

Fig. 1 shows the general arrangement of the parts and the dimensions for the

bottom. Add the four triangular corner pieces over this, gluing and pinning through to the legs.

Turn the assembly over to stand on the legs, and check that the stool is resting square. Then add the cross pieces of the false frame, tacked to the legs and the filler blocks at each corner. A seat panel of suitable material can then be

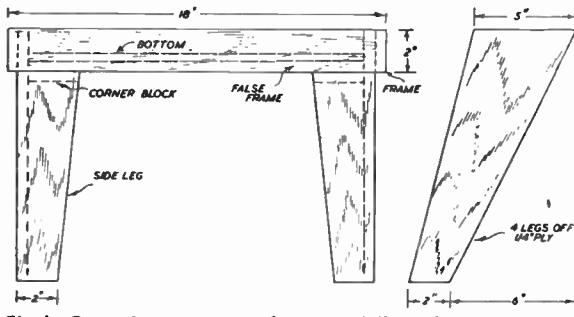

Fig. 1—General arrangement of parts, and dimensions of main legs

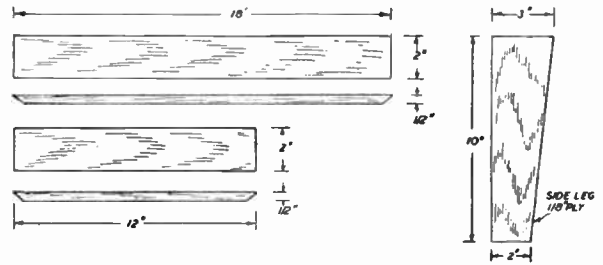

Fig. 2—Details of the other main components

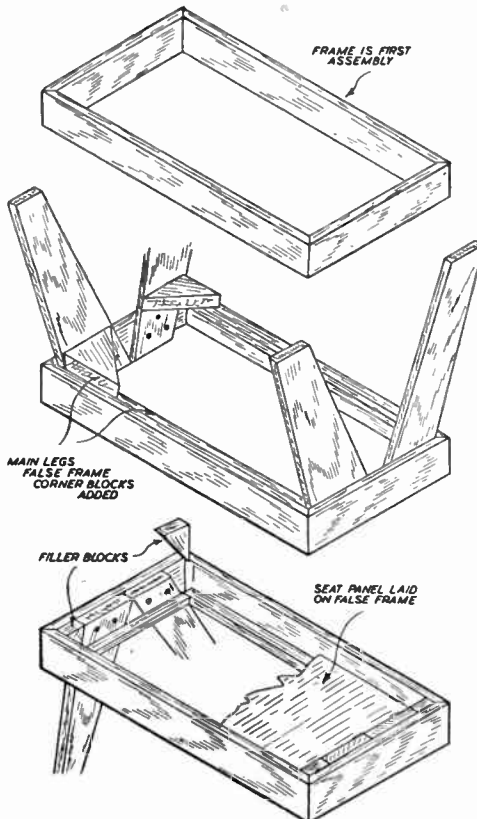

Fig. 3—Stages in assembly

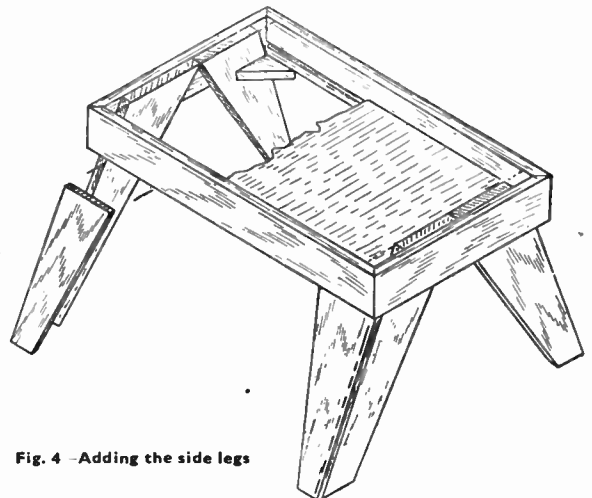

Fig. 4—Adding the side legs

main legs. Dimensions of the other main components are detailed in Fig. 2, and stages in the assembly are detailed in Fig. 3.

Mitred Corners

The frame is built up first with mitred corners. To the end members are attached the four main legs, screwing in place from the inside. The two false frame side pieces of 1/2in. square or similar material can then be tacked in place to the long sides of the frame, flush with the

cut to size and laid on and secured to the false frame.

The Side Legs

It now remains to add the side legs, as shown in Fig. 4. Cut out accurately and then glue and pin in place, making sure that each joint is a good one. When dry, the whole assembly can be glasspapered down, rounding off the corners of the 'L-shaped' legs slightly for improved appearance. Glasspaper and round the top edges of the frame. After staining and polishing, a suitable padded seat can be added. (325)

House Telephone—(Continued from page 266)

It is advisable to fix the panel to the wall permanently and to conceal the line wiring along the top of a picture

rail, etc. If the layout on the panel has been neat there is nothing objectionable about the appearance of the telephone,

though it can be improved by having a small polished wooden buzzer covering. (344)



Introduction to The Postage Stamp

(Continued)

As time went on, the penny post became less and less efficient, due in great measure to the fact that people were employed who were unable to do the work either through old age or extreme youth. As a result, fewer people sent letters and consequently the revenue went down. To remedy this, the cost of sending a letter went up and up, the charge being based on the distance the letter had to go. As there were few posts other than to and from London, a letter which had only to go a

At the beginning of the nineteenth century, the cost of the London penny post was increased to twopence, while the charge for long distances was very considerable. For instance, a letter going 15 miles would cost fourpence, while one going 300 miles would be charged over a shilling—and this for a single sheet of paper. Look at the illustration of the letter which came from India. The charge was no less than 6/8 and the letter took six months to cover the journey. Remember, too, that

up the letter. Now, as we have just mentioned, the cost was considerable, so that a man who in those days might have had to support a wife and family on about 12/- a week, would not like to have a letter very often. Frequently, those who had to correspond would make up some sort of code, say, by writing the address in a certain way, so that the recipient could see what the message was without opening the letter. Then, having seen the message, the recipient would refuse to pay for the letter, as the inside was simply a blank sheet of paper. The postman would then not be able to collect a fee for the letter at all. This, of course, was a loss to the revenue and also a waste of the postman's time.

Contraband Letters

Another way in which money was lost to the rightful authority was through letters being carried by private people. This was really illegal, but as the cost of sending them in the right way was so heavy, the risk was taken. Letters sent in this way were called contraband letters.

The next illustration is chosen because it shows three points. First notice in the bottom left hand corner the words

'Double only'. These were put on by the sender, as there was more than one sheet, but he did not want to have the letter charged as though there were three sheets. Immediately above the 'Double only' you can see written the cost that has to be collected, namely 1/2, and thirdly the illustration shows a 'Mileage Mark'.

The letter was posted at or near

Aylesbury, 48 miles from London.

The difficulty of the question of mileage led to an Act of Parliament of 1801, the fifth clause of which authorised certain village posts so that letters might be brought into the towns which had a normal postal service. Letters being posted in accordance with this Act were stamped with the name of the town, followed by the words 'Fifth Clause Post', as is shown in the sketch.

(To be concluded)

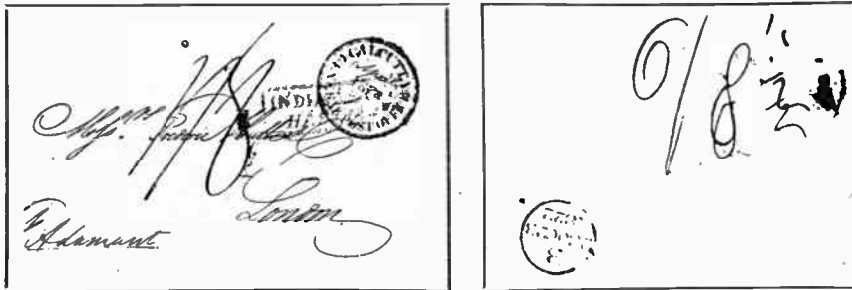

Fig. 3—The front and back of a letter from India. It cost 6/8

few miles across country, would sometimes be sent up to London by one road and then down again by a different one, so that the total distance the letter went was quite out of proportion to the distance it needed to go. The cost of sending such a letter was, therefore, out of proportion to the actual distance the sender was from the recipient.

Cross Country

In 1720, the Postmaster of Bath—a man named Ralph Allen—was allowed to organise a cross post to save some of these long journeys, and for 45 years he worked at these with considerable success. It must be remembered, of course, that in those days the roads were not like they are today. Many were mere tracks, so that journeys took quite a long time. And even when mails changed from being carried on horseback to going by post cart, and later even by the stage coach, the time from London to Bristol, for example, was 17 hours. Today two hours is sufficient.

Remember also that footpads were a very real danger. To try to stop these desperados, the penalty was made very severe. In fact, for letter stealing the penalty was death, and this penalty was paid as late as 1832.

SHEPHERD MALLETT
5-Clause Post

Fig. 5—Stamp for the 'Fifth Clause Post'

6/8 in those days was worth far more than it is today.

If it was suspected that the letter consisted of more than one sheet, then it was held up in front of a candle. If it was

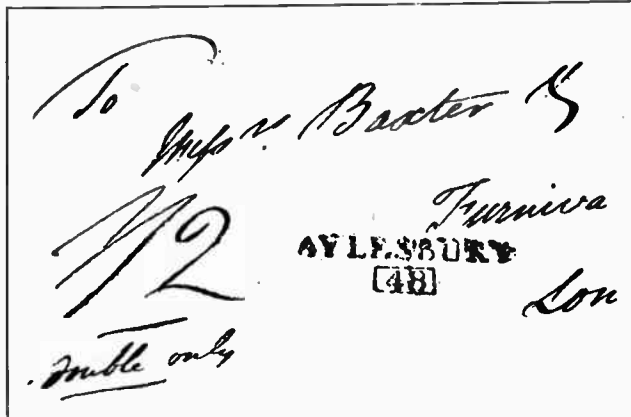

Fig. 4—Note the 'Double only' and the 'Mileage Mark' on this letter

found to be two pages, then the charge was doubled, if three pages, then the charge was trebled, and so on. This is why one finds all very old letters folded with one flap tucked into the other and a dab of sealing wax to keep it closed—an envelope would have counted as another sheet of paper and doubled the charge.

In those days, the sender of a letter did not have to pay the postage at the time of posting. It was left for the postman to collect the fee when he gave

TOOLS FOR THE HANDYMAN



TOOL CLIP

For holding any handled tool. Spring steel. Holed for hanging.

7d. each

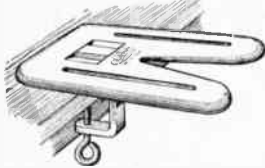

STEEL CUTTING TABLE

With clamp for easy fixing to bench. 6ins. by 4ins., strong and light. 3/.

BENCH STOP

3 1/2 ins. by 2 ins. — Spring loaded top. 6/-



SINGLE HANDED SCREWDRIVER

5 ins. long. Ideal for small work. 1/8



MODEL MAKER'S BENCH VICE

Strong, light and rigid, 2 1/2 in. opening. 6/3

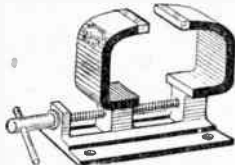

Obtainable from Hobbies Branches in London, Glasgow, Manchester, Birmingham, Leeds, Sheffield, Hull, Southampton, Bristol and ironmongers everywhere. Or post free from Dept. 99, Hobbies Ltd., Dereham, Norfolk.



FRETWORK HAMMER

8 ins. long. Strong and light for small work. 1/4

See the latest advances in

MODEL ENGINEERING

- ★ FINE COMPETITION MODELS OF ALL TYPES.
- ★ LATEST TOOLS AND WORKSHOP EQUIPMENT.
- ★ GRAPHIC WORKING MODEL OF THE SINKING OF THE 'EGYPT'—a triumph of the 'Model-makers' craft.
- ★ EXPERT DEMONSTRATIONS of Brazing, Soldering and Woodwork.

Don't miss this finest opportunity of meeting fellow-enthusiasts and discussing problems and techniques.

MODEL ENGINEER EXHIBITION

HORTICULTURAL HALL
WESTMINSTER,
LONDON, S.W.1

August 22nd to
September 1st

Admission 2/9d.
under 14. 1/6d.

WEBLEY AIR PISTOLS



Marvellously accurate for target practice. No licence required to purchase for use on enclosed premises.

Senior Mark I
Junior Webley Air Rifle
Write for List. **WEBLEY & SCOTT LTD.**
166 WEAMAN STREET, BIRMINGHAM, ENG.

KITS for OLD TIME SHIPS

Hobbies range of Ship Models includes Elizabeth Jonas, Cutty Sark, Victory, Mayflower, etc. Complete kit of wood, sail material, guns, pulleys, cord, etc., with full size pattern of parts and planed wood ready to cut out, shape and construct. A fascinating pastime. Kits for models 12 1/2 ins. long and upwards.

Ask for free illustrated lists at Hobbies Branches or from Hobbies Limited, Dereham, Norfolk.



BRANCHES

- LONDON**
78a New Oxford St., W.C.1
(Phone MUSEum 2975)
87 Old Broad Street, E.C.2
(LONDON Wall 4375)
117 Walworth Road S.E.17
(RODney 5509)
- GLASGOW**
326 Argyle Street
(Phone CENTral 5042)
- Head Office & Factories—**HOBBIES LTD., DEREHAM, NORFOLK**

- MANCHESTER**
10 Piccadilly
(Phone CENTral 1787)
- BIRMINGHAM**
14 Bull Ring
- SHEFFIELD**
4 St. Paul's Parade
- LEEDS**
10 Queen Victoria Street
(Phone 28639)
- HULL**
10 Paragon Square
- SOUTHAMPTON**
25 Bernard Street
- BRISTOL**
30 Narrow Wine Street
(Phone 23744)

Tommy Trump says:— "You'll like

DOUBLE ACE

The ACE of cigarettes"

10 for 1/3 1/2 A WINNER EVERY TIME!



MASK...MAKE...

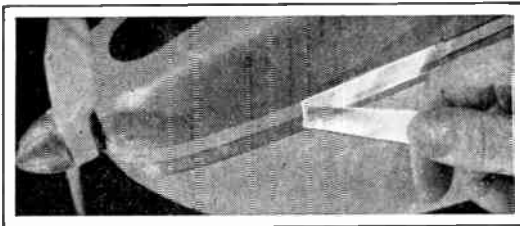

MEND...WITH

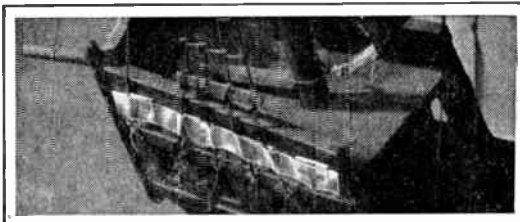

Sellotape

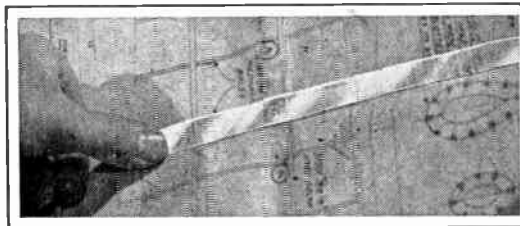

Whatever your hobby, Sellotape is your greatest ally. For masking paintwork, holding parts while gluing, protecting plans—and a thousand other useful jobs—it's Sellotape every time. It sticks at a touch without moistening. It fits evenly on a curving surface. There's coloured Sellotape for easy indexing, for recognition tags, and decorating. You just can't do without it. Get some today—and remember, if it doesn't SAY Sellotape —it isn't!

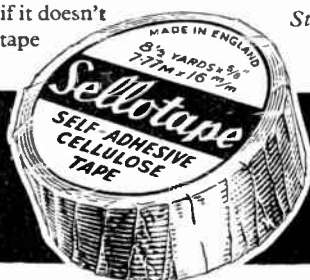

Stocked by all Stationers

G & G

**MAKE YOUR OWN
SKYLON
FESTIVAL SOUVENIR**

Here is a realistic, accurately scaled reproduction of the famous Festival Symbol, and another worthy addition to Modelcraft's attractive range of Micromodels. Printed in full colour on card, and easily made up.

MODELRAFT "SKYLON" complete with instructions **9p.** in coloured wrapper, from all model shops.

In case of difficulty send direct for MODELRAFT "SKYLON" and the latest Modelcraft lists, post free **1/-**
A MICROMODEL BY

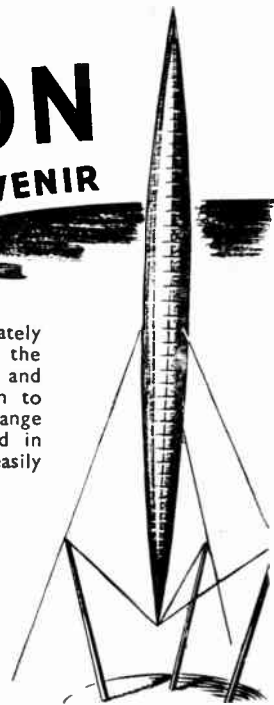

MODELRAFT

77 (F.) GROSVENOR ROAD, LONDON, S.W.1

**'KARLENITE'
PLASTIC MARBLE**

The entirely new Art Stone for casting Bookends, Ashtrays, Wall Vases, Statuettes, etc. 'KARLENITE' sets granite-hard with scintillating crystalline structure which very closely resembles marble or alabaster. It is enormously strong, highly resistant to heat, and impervious to water. Literally any type of natural 'veining' can be simulated in any colour and a wide range of pigments is available for this purpose.

**MAKE YOUR OWN
FLEXIBLE MOULDS**

with 'Elastomould' Synthetic Rubber Solution. By means of this simple technique, you can easily prepare permanent elastic moulds for repetition casting, plaques, bookends, etc., in quantities of thousands.

'Elastomould' will faithfully reproduce even the most minute details of ornamentation and surface texture.

It is incredibly simple to use, and moulds can be prepared from any type of pattern including Wood, Metal, Plaster, Stone, Glass, Ivory, etc.

Such moulds are ideally suitable for casting in Plaster, Cement and Karlenite.

Start your Own Business. Send 1s. for full details of this easy, fascinating and profitable hobby.

MONEY REFUNDED TO BONA FIDE ENQUIRERS

Dept. H.3, Karlena Art Stone Company, Ltd.,
55 Deansgate Arcade, Deansgate, Manchester, 3.

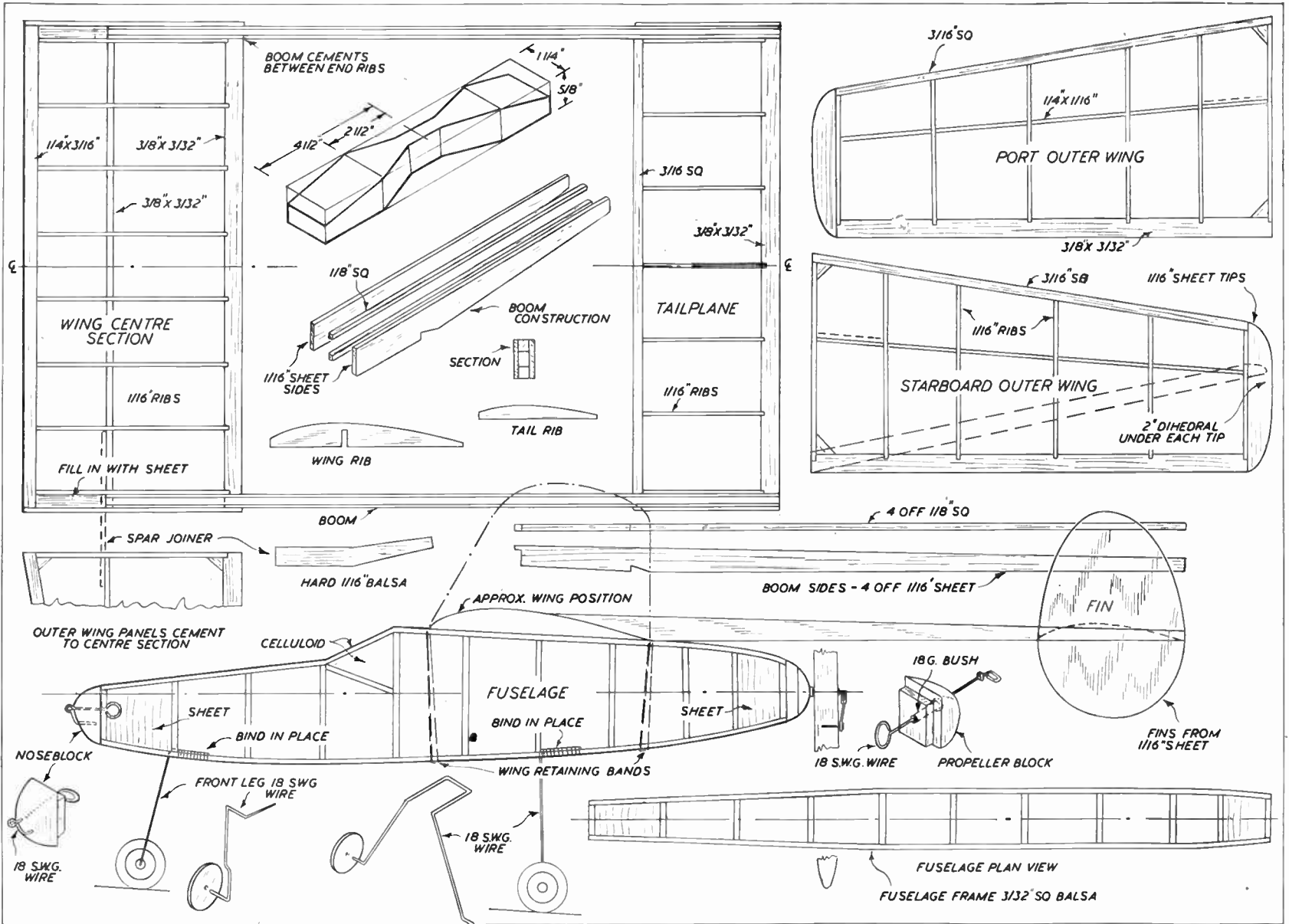

FOR A FIRST-CLASS MODEL . . .

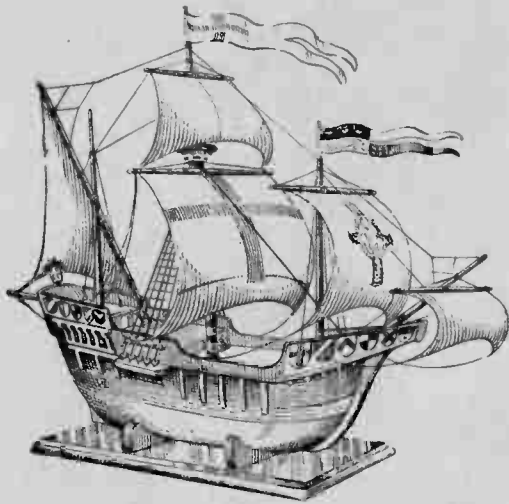

**. . . Use a
First-Class
Tool . . .**

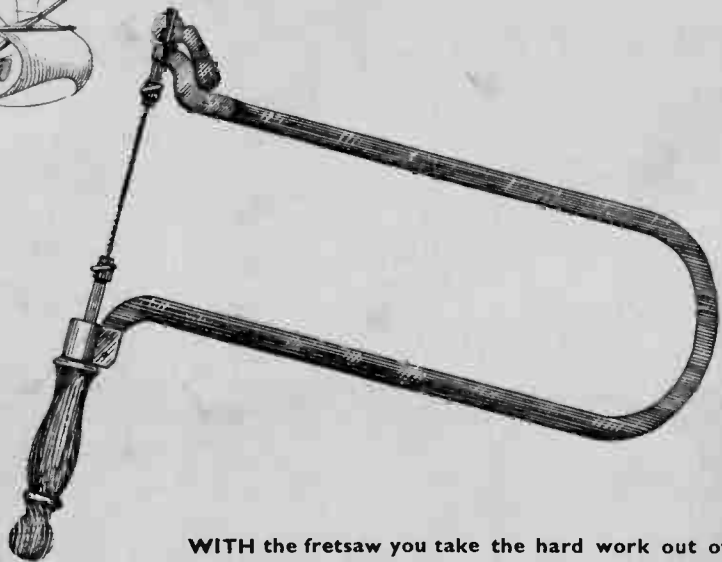

WITH the fretsaw you take the hard work out of model making. It cuts the pieces in less than half the time taken by any other method; it cuts cleanly and accurately; in fact it has no substitute. And when you are not model making you will find it equally useful for light woodwork and those 101 odd jobs you have to do about the house. Cuts wood, light metal, leather, plastics, etc.

MADE BY . . .



GET yours now and join the ranks of real model craftsmen. But remember - insist on Hobbies or you may be disappointed. Prices from 5/3 to 15/3. The saw illustrated is our famous 14in. Lever Frame; price 14/-.

From Stores and Ironmongers everywhere, "Hobbies Branches, or post-free from Dept. '99," Hobbies Ltd., Dereham, Norfolk. Free leaflets on request.

DEREHAM, NORFOLK

Hobbies

WEEKLY

CONTENTS

	Page
Sundial for the Garden	273
Model Television Set	275
Methods of Fruit	
Bottling	276
A Modern Book Stand	277
'Comical Cooks' Cruet	278
Automatic Switch for	
Doll's House	278
Camping on Warm	
Nights	279
Puncture Preventing	
Idea	280
Books for Shipmodellers	280
The Craft of Netting	281
'Pictorial' Holiday Snaps	282
Replies for Radio Fans	283
Home Chemistry	284
'Corhical Cooks' Cruet	
Patterns	287

August 15th, 1951

Price Fourpence

Vol. 112 No. 2911

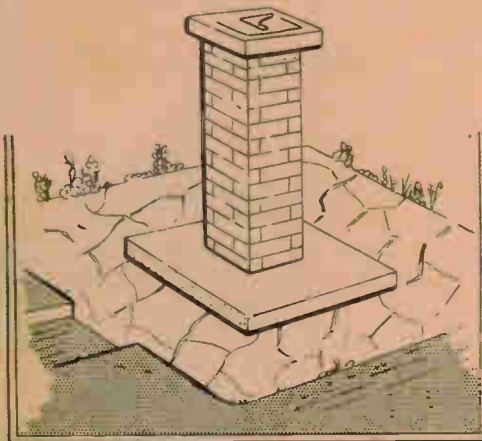

You can make a SUNDIAL FOR THE GARDEN

A SUNDIAL is often regarded as an ornament suitable only for the 'Old World' type of garden, yet it will merge well even with the most modern garden lay-out. It can be placed at the end of a path or grass walk, at the junction of paths, or, as is more often the case, in the centre of a lawn.

The important thing to remember is, of course, that a sundial must have an open site, so that it is quite free from shade.

The Style or Gnomon

The actual dial can often be picked up quite cheaply in a second-hand shop, or it can be bought new, with or without a supporting plinth.

The vertical part of the dial which throws the shadow on to the clock face is called the Style or Gnomon. This is often adjustable and must be at an angle which has the same number of degrees as the latitude of the place in which the dial is to be set up.

New dials will be correct for the place in which they are sold, but care must be taken in buying second-hand dials to see that they are of the adjust-

able type. It is hardly likely that a fixed-style second-hand dial will be correct for the local area.

The latitude of any area can be obtained with reasonable accuracy from most atlases.

The following table gives some examples.

London—Bristol	... 51½ degrees
Towyn—Birmingham	...
Lowestoft	... 52½ degrees
Newcastle-under-Lyme—	
Nottingham	... 53 degrees
Newcastle-on-Tyne	... 55 degrees

The style must be set to the correct angle by means of a protractor.

The Plinth

The dial is set on a plinth so that the finished height is about 2ft. 9ins. or 3ft.

The plinth must be made to fit in with the surroundings and there is room here for originality in design. It can be made of brick or paving stone, or it can be cast in cement. A concrete plinth is apt to look rather bare at first but it mellows in due course.

A Concrete Plinth

Fig. 4 shows how to cast a concrete plinth with fluted corners. Nail together a box of the required size and fasten strips of squared timber into the corners of the box.

A suitable mixture is as follows:

- 1 part cement
- 2 parts sharp sand
- 2 parts shingle

Mix the cement and sand first. This is best done by shovelling the heap from one spot to another and then back again. Repeat the process until the mixing is complete. Now mix in the shingle in the same way. Finally, spray the heap with water and keep turning it until it has the right consistency; it should 'flow' easily off the shovel.

Pour the concrete into the wooden mould a little at a time and ram down each successive layer. The plinth can be strengthened by having iron rods running down the centre of the mould.

Allow three or four days for drying and then remove the boards. The plinth can be given a smoother finish by 'painting' it with the following mixture:

- 1 part cement
- 2 parts sand.

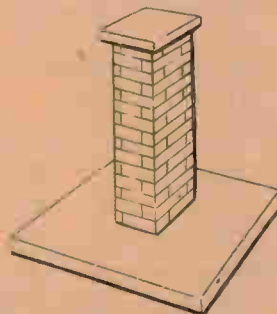

Fig. 1 A straightforward design

All correspondence should be addressed to The Editor, Hobbies Weekly, Dereham, Norfolk.

Add enough water to make the mixture flow easily.

The Base

Mark out the site for the sundial and ram the ground until it is level and quite firm. Now place the plinth into position. Nail together a wooden frame and place this around the base of the plinth. The frame is filled with the same cement mixture as was used for the plinth. If desired, smooth pebbles can be sunk



Fig. 2—Suggested way of laying bricks for ordinary square plinth



Fig. 3—cast concrete plinth

into the surface of the base while the cement is still wet or it can be marked in the crazy paving style.

The base of the plinth can also be made of brickwork or paving stone, the latter being set in regular fashion or broken and used as crazy paving.

A number of designs can be worked out for building the plinth from bricks. A suggested arrangement is shown in Fig. 2. It might be possible to get hold of smaller bricks than the usual 3ins. size.

The top of the plinth must be finished

with a firmly cemented paving stone, or other such stone, of the necessary size. Too big a 'table top' will give the sundial an untidy top-heavy look.

Setting the Dial into Position

The dial must be placed in its correct position on the top of the plinth or it will never show the correct time. A rough and ready method is to wait for the B.B.C. time signal, and, if the sun is shining, turn the dial round until the shadow from the style falls on to the correct figure.

The dial is now pressed into its bed of wet cement and left. Some dials are provided with bolts which fasten them into position.

This method of setting the dial is somewhat hit or miss and the results are hardly likely to be accurate—even for a sundial.

Solar Time

On only four days in the year is Sun

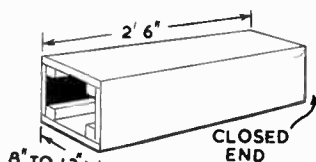

Fig. 4—The box from which the concrete plinth was cast

Time the same as Greenwich Time. At all other times the sun is either clock-fast or clock-slow. To set a watch to

local Solar Time the longitude of the locality must first of all be found from an atlas. The watch is made one minute fast for every $\frac{1}{4}$ degree east of Greenwich, or one minute slow for every $\frac{1}{4}$ degree west of Greenwich. Swansea in South Wales, for example is 4 degrees West of Greenwich, so Swansea time is 16 minutes slow of Greenwich time.

A further adjustment must be made to the watch before the dial is set into its final position. The further number of minutes by which the watch is made faster or slower is given by what is called the Equation of Time. This is given in the Nautical Almanack, a copy of which is in most libraries. The equation must be taken for the actual date on which the dial is being set, and it might mean making the watch anything up to 13 minutes faster, or up to 16 minutes slower, so this Equation of Time is not something that can be safely ignored if the sundial is to be accurate as well as ornamental.

All that remains now is to turn the dial round until the shadow from the style indicates the same time as the correctly adjusted watch. (400)

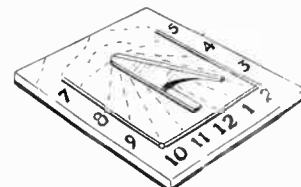

Fig. 5—The style

Model Television Set—(Continued from page 275)

favourite cartoon characters. Drawings in black and white show up best, though colour can, of course, be used if put on lightly. Heavy colours merely show up as black when lit from behind.

To guide the film, close up to the viewing aperture, cut two pieces of stiff wire $6\frac{1}{2}$ ins. long, bend them to a right-angle $\frac{1}{4}$ in. from each end, and fix them into small holes drilled above and below the opening, as seen at Fig. 2. When the film has been made ready, it must be threaded between the top front spindle and the pressure discs, and down through these wires, before the ends are joined together.

The Lighting

The lighting is carried on a strip of wood $3\frac{1}{2}$ ins. wide fixed horizontally across the inside of the case as shown at Fig. 2. On the top side of this strip is glued a bracket to which a flashbulb holder is screwed, and behind it three strips to form a holder for a two-cell battery. On the underneath side, a short piece of the $\frac{1}{4}$ in. dowel is held between two brackets. On this spindle are glued the shaded disc that gives the focusing effect, and also a pulley wheel by which it is rotated.

The disc is cut from transparent paper, $3\frac{1}{2}$ ins. in diameter, with a narrow strip of card glued across the middle to strengthen it. Divide it into eight segments and, leaving three of them

perfectly plain, shade the others with gradually increasing density, as shown at Fig. 4.

Glue the strut of cardboard across and then glue the disc on to the front of the spindle. The pulley wheel is made up of three discs of cardboard sandwich fashion, the middle piece being $\frac{1}{4}$ in. in diameter less than the outer two. Make a similar wheel for the long spindle at the bottom of the case, bore them both with a $\frac{1}{4}$ in. bit, then glue them into position and when dry fix a belt of string between them, as seen at Fig. 2. Position the bottom pulley carefully before gluing down, so that when the front knob is rotated it turns the shaded disc smoothly. Make a little paper hood to fix over the lamp holder, so that all the light is thrown through

the disc on to the screen opening.

Details of the switch are shown at Fig. 5. Cut a piece of the dowel $1\frac{1}{2}$ ins. long and glue a disc of wood on to one end for the knob. Cut a piece of plywood $1\frac{1}{2}$ in. by $\frac{1}{2}$ in., bore it for the dowel, then fix it by another piece $\frac{1}{2}$ in. by $1\frac{1}{2}$ in. to the inside front corner of the case, immediately over the spindle hole. Drill the dowel with a fine hole and put a flat-pointed screw through it, so that, when in position, the end of the screw collides with another screw placed in the piece of wood above, as shown. Adjust these two screws so that the turn of the knob is stopped when these two screws touch each other, to make the electrical contact.

The circuit can then be wired up, and is simply—from lamp holder to screw in dowel; from the fixed screw to the battery; and from the other battery terminal to the other side of the lamp holder. Make sure that the wires are left long enough to be fixed out of the way of the film as it revolves inside the case.

Finishing Off

When all the working parts have been glasspapered until they work smoothly, hinge on the lid, and finish off the outside of the case to resemble a modern set. If the viewing screen is covered with some transparent material, this helps to protect the film and adds a final touch of realism to the model. (278)

MODEL ENGINEER EXHIBITION

Readers in and around London—and others who can possibly manage the journey to town—should make a point of visiting the always-popular Model Engineer Exhibition to be held at the Horticultural Hall, Westminster from Aug. 22nd. to Sept. 1st. The very latest in model making practice will be on view, many of the stands demonstrating model making in a very wide range of subjects.

Up-to-date children will want this MODEL TELEVISION SET

THE little working model shown here will delight any youngster, not only because it provides a very good imitation of the real thing, but also because it is something rather different from the child's usual playthings.

At the turn of a switch the screen lights up. There are seven alternative

pictures, changed by the 'tuning' knob at the side; and a variable 'focusing' effect is produced by turning the knob on the right. Lighting is provided from a torch battery and bulb inside the case, illuminating the pictures from the back. The pictures are actually simple drawings on an endless strip of transparent paper.

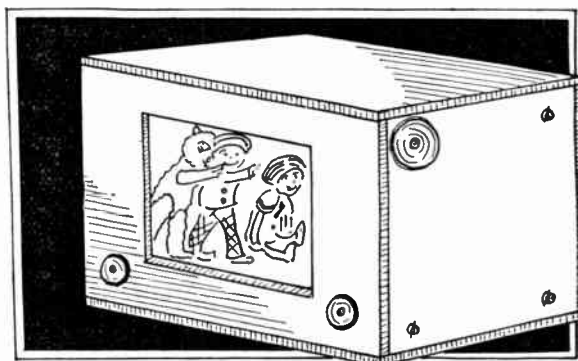

knobs are wooden discs of 1 in. diameter, glued on (with $\frac{1}{8}$ in. holes through them) when the model is complete.

Film Winding Mechanism

The sides of the case measure $7\frac{1}{2}$ ins. by $6\frac{1}{2}$ ins. and, as will be seen at Fig. 2, a $\frac{1}{8}$ in. hole is bored near each corner to take four pieces of the $\frac{1}{8}$ in. dowelling. These go right through the case, and are held in position with a neat pin on the outsides.

The top front one is $\frac{1}{8}$ in. longer than the others, to carry a disc of wood 2 ins. in diameter. This forms the knob for turning the film, which is rotated round these four spindles, as shown at Fig. 2. Glasspaper the ends of the dowelling until they turn smoothly in the holes.

To ensure that the film turns regularly when the driving spindle is rotated, two discs of about $\frac{1}{8}$ in. diameter are mounted on another shorter spindle fixed at the top front edge of the case, as shown at Fig. 3. This spindle is held in two bearers glued to the top front inside edge of the case; but the best plan is to cut these pressure discs a little bigger than will be needed and rub them down later until they make just the right contact with the main spindle, between which the film will pass.

The Film

The film itself consists of a strip of transparent paper about 25 ins. long (allowing $\frac{1}{8}$ in. for lapping) and 5 ins. wide. This can be made up from more than one piece if desired, but in this case the joints should be arranged to fall between two adjacent pictures. The pictures measure $4\frac{1}{2}$ ins. by $3\frac{1}{2}$ ins., and it will be seen that the strip allows for seven such rectangles, with a little space between each.

There is no need for a great deal of artistic ability when drawing these pictures, but they should be of subjects that a child will appreciate. In the writer's case, he made seven tracings from a picture book of the child's

(Continued foot of page 274)

CUTTING LIST (for wood of $\frac{1}{4}$ " thickness)

No. of pieces	Description	Size
2	Base and Lid	8" x 8"
2	Front and Back	7 $\frac{1}{2}$ " x 6 $\frac{1}{2}$ "
2	Sides	6 $\frac{1}{2}$ " x 7 $\frac{1}{2}$ "
1	Lighting Board	7 $\frac{1}{2}$ " x 3 $\frac{1}{2}$ "
2	Battery Case	
2	Sides	3 $\frac{3}{4}$ " x 1 $\frac{1}{4}$ "
2	Ends	2 $\frac{3}{4}$ " x 1 $\frac{1}{4}$ "
2	Disc Spindle	
2	Brackets	1" x 1"
1	Switch Spindle	
1	Bracket	1" x $\frac{1}{2}$ "
1	Switch Spindle	
1	Bracket	1" x $\frac{3}{8}$ ths
2	Film Pressure	
2	Disc Brackets	1" x $\frac{3}{8}$ "
2	Film Pressure	
2	Discs	$\frac{3}{4}$ " diameter
2	Switch and Focusing	
2	Knobs	1" diameter
1	Film Winding	
1	Knob	2" diameter
2	Pulley Wheels	$\frac{3}{4}$ " diameter
3	Film Rollers	8 $\frac{1}{2}$ " x $\frac{1}{4}$ " dowel
1	Film Rollers (for knob)	9" x $\frac{1}{4}$ " dowel
1	Disc-Driving	
1	Spindle	8 $\frac{1}{2}$ " x $\frac{1}{4}$ " dowel
1	Switch Spindle	1 $\frac{1}{2}$ " x $\frac{1}{4}$ " dowel
1	Film Pressure-Disc Spindle	6 $\frac{1}{2}$ " x $\frac{1}{4}$ " dowel

Construction

The case is simply a wooden box measuring externally 8 ins. long, 8 ins. deep and 6 $\frac{1}{2}$ ins. high, with the top hinged on to form a lid. The measurements given allow for wood of $\frac{1}{4}$ in. thickness being used, but this can, of course, be varied as required. In fact, stout cardboard could be used if reinforced at the corners. Fig. 1 shows a view of the front, from which it will be seen that a rectangle 4 $\frac{1}{2}$ ins. by 3 $\frac{1}{2}$ ins. is fretted out to form the screen, and two holes of $\frac{1}{8}$ in. diameter are bored for the spindles carrying the switch and focusing knobs. These spindles are cut from $\frac{1}{4}$ in. dowel. The one for the focusing arrangement goes right through the case, and needs to be 8 $\frac{1}{2}$ ins. long. The other is only 1 $\frac{1}{2}$ ins. long, and forms part of the switch as described below. The

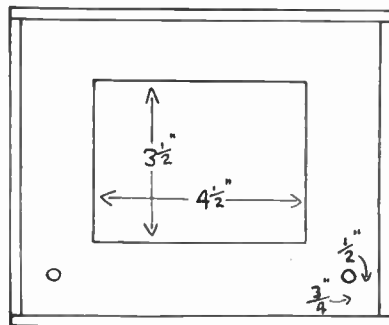

FIG. 1

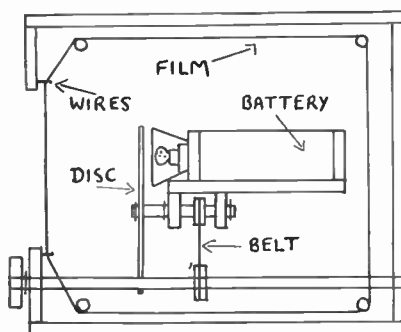

FIG. 2

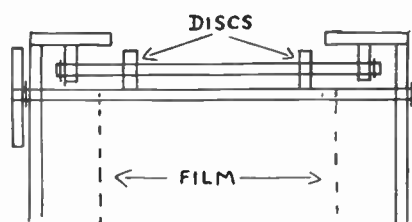

FIG. 3

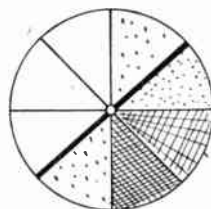

FIG. 4

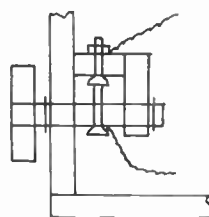

FIG. 5

Details of dimensions and working parts

Practical advice on METHODS OF FRUIT BOTTLING

IN 1795 a Mr. Appert experimented with the heating of fruit in glass bottles; in 1895 our grandmothers preserved their plums in the sulphur box; in 1951 we have the choice of sixteen methods and we, naturally, choose those most suited to our purse, to our fruit varieties, to our present apparatus and, of course, to our personal whims.

So let us take our choice. For those who desire perfection in this world (and never find it), then the 'best' method is the water bath, because the

in cold water just to cover the bottles and put in the thermometer.

Heating times and temperatures are important. Heating must be slow, so that in 1½ hours (not before) the temperature shows 165 degrees F. (for all except those below) at which it is kept for 10 minutes; for halves or unripe fruits or for 3lb. bottles 165 degrees F. for 20 minutes; for mixed fruit 175 degrees for 10 minutes; for all currants and cranberries 180 degrees for 15 minutes; for cherries, pears and quinces 190 degrees for 15 minutes and for tomatoes 190 degrees for 30 minutes.

Having heated correctly, take out the bottles one by one and seal by screwing down. Next day test for sealing by removing the spring clips or screw bands and noting that the glass or brass cap is held on securely (No. 2 photo). Store in a dark cool dry place, and in the winter you will be surprised at the wide variety of luscious fruits.



Fig. 1—Packing the fruit tightly, using a long-handled wooden spoon

resultant fruit holds its shape, colour, flavour, appearance and aroma.

You will want the proper bottling jars whether screw cap or spring clip, a long handled spoon or stick (for packing), a thermometer (a floating dairy one is best) and a sterilizer. If you have ample funds, worry will be saved by buying a proper sterilizer with handled false bottom, but if not, then equally good results can be had by using any vessel deep enough to allow of covering the bottles with water, provided a false bottom of bent-over and flattened wire netting is used to stand the bottles upon.

Pack Bottles Full

Briefly, then, the method is to pack the bottles full of selected firm-ripe fruit (No. 1 photo), pour in cold water or syrup (sugar ½lb. to the pint water), affix spring clip right down but screw bands unscrewed half a turn, stand in the sterilizer on the false bottom, pour



Fig. 2—After sterilization and cooling, the jars are tested for sealing

The 'Oven' Method

So much for that. Now, suppose you do not want to spend any money but to use the jars and utensils you have in the kitchen; then you adopt the 'oven' method. Here is how. Pack the clean jam jars (2lbs. for preference) with the selected fruit, add no water but cover each jar with a saucer. Put into a cold oven and warm up gradually so that in 1 hour (at 240 degrees F.) the fruit starts to shrink and change colour. Now take out a jar (shut the oven door), pour in, to ¼ in. of the top, boiling water or syrup and seal down at once. Then carry on with the other jars one by one.

The seal is important, as it must be

airtight. Take a sheet of greaseproof paper, paste hot water starch upon it, place over another greaseproof sheet, paste that and then another sheet to make a treble thickness. You can keep this in store for use when wanted. Here is how to use it. Cut out a circle 6ins. diameter, paste one side and immediately each heated jar is filled with boiling water, put over the paper cap, press out evenly (No. 3 photo) and tie on. When dry, the paper should be as tight as a drum, and if care is taken that the liquid does not get on to the paper from inside the jar, it will keep safely for a year or more.

As a variety of this method, you can fill the jars with cold water before putting them in the oven, in which case at the end of 1½ hours bubbles should be seen on the fruit. Sealing is as given above.

In both these 'cheap' methods, ordinary bottling jars may be used as well as jam jars.

Using Chemicals

If you want a 'chemical' method, then you use 'Campden' tablets (from your chemist), but I regard this as useful in an emergency and not as a substitute for a heating method. Simplicity, speed and cheapness are its three virtues but the fruit must be cooked, and cannot be turned out and used as a cold fruit. Moreover only plums, apricots, peaches, raspberries, red currants and apples are satisfactory.

The method is to pack the selected fruits in the jars to within 1in. of the brim, pour on the preserving solution to



Fig. 3—Pressing round the paper cap after filling with boiling water

(Continued foot of page 277)

It is easy to make A MODERN BOOK STAND

THIS modern book stand is quite simple to make and can be stained and polished to fit in with the colour scheme of any room.

Start by cutting a front and back from $\frac{1}{8}$ in. ply to the dimensions shown in Fig. 1. Cut the slots accurately and smooth out with glasspaper. The lower corners may be slightly radiused, if desired. These sides are then assembled on a base, tent-fashion, as in Fig. 2, and so

face, as in Fig. 3. These strips must be located parallel to one another and exactly $5\frac{1}{2}$ ins. apart.

The cap is made from a $12\frac{1}{2}$ ins. by $\frac{3}{4}$ in. by $\frac{1}{2}$ in. strip trimmed to the section shown in Fig. 4. All the components may then be assembled with glued joints as shown in Fig. 5. Accurate fitting is required for a good finished appearance.

Shaping the Cap Strip

When this assembly has set, round off

scratching of any polished surface on which the stand is rested.

Books fit in the stand as shown in the final drawing—Fig. 7. The lower slots are to the front, and if each book is placed in position with the backs facing outwards, an attractive display is assured, with all the titles easily read. The original dimensions given in Fig. 1 can be varied, if required, for closer spacing of the books in order to get more in a single stand. The slots can be widened

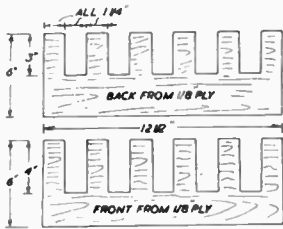

Fig. 1

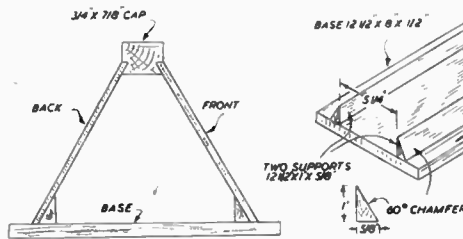

Fig. 2

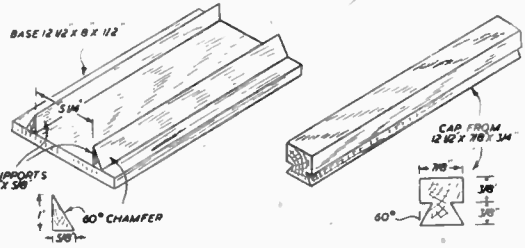

Fig. 3

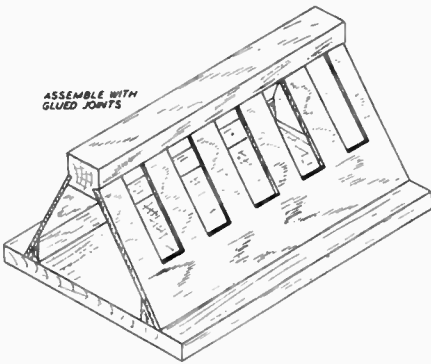

Fig. 5

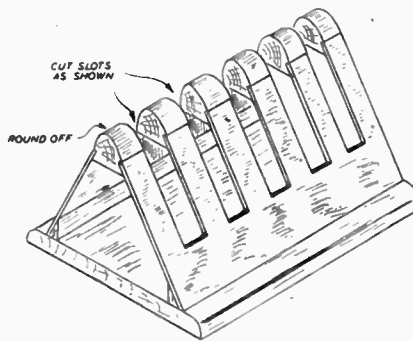

Fig. 6

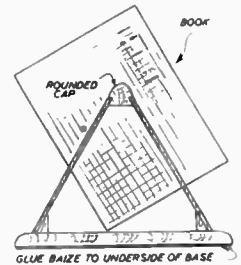

Fig. 7

the lower edges of front and back require chamfering to fit flush on the base.

The Base

The base is a rectangle $12\frac{1}{2}$ ins. by 8 ins., at least $\frac{1}{2}$ in. thick, for preference. To this are pinned and or glued two supporting strips, $12\frac{1}{2}$ ins. long and chamfered off to a 60 degree angle on one

the cap strip as shown in Fig. 6, carving and glasspapering smooth. Then cut through the cap strip at each slot position to open up each slot from front to back. A final light glasspapering, rounding off the corners of the base, and the book stand is ready for polishing and finishing. A square of baize or similar material glued to the underside of the base is a wise addition to prevent

to take thicker books, or the whole stand can be lengthened to take more books.

'Tailor Made'

It is an excellent idea, for example, to 'tailor make' a stand to take a series of volumes—four, five or six books, say, of the same size and subject. Fig. 7 will act as a guide to proportioning such a stand to any given size of book. (324)

Fruit Bottling—(Continued from page 276)

fill and put on the caps (metal ones should not be used) and store in a cool place. That is all you do. There is no heating.

To make the solution 1 tablet is dissolved in $\frac{1}{2}$ pint of warm water and this is correct for each 1 lb. of fruit (not more). There will be noticed a smell of sulphur when the preserved fruit bottle is opened but this is driven

off after cooking. If sugar is to be added, then do this after the cooking.

As to the other schemes, each has a drawback not found in the methods suggested above. A pressure cooker can be used for bottling fruit, although space is limited in the cooker. The packed, filled and capped bottles are placed in the cooker with enough water to cover the bottom. The lid is fixed

and heating is gentle until pressure rises to 5 lbs. (giving a temperature of 228 degrees F.). Reduce the heat and keep at 5 lbs. for 12 minutes, then remove heat, allow pressure to drop to zero, open up and seal bottles.

And if you want a final word of advice, keep to these methods, because they are the best for the circumstances detailed. (405)

An easily-made novelty— THE 'COMICAL COOKS' CRUET

THESE amusing fellows will add a touch of gaiety to any kitchen, as well as serving a useful purpose, if hung in some handy place near the cooker. Full-size patterns for cutting out will be found in this issue, and apart from the small piece of wood, the only other requirements are the two pepper and salt holders (which fit into holes made for them in the base) and some brightly-coloured enamels.

The pepper and salt holders shown in the sketch are in gaily-coloured plastic and cost 7d. each from a local chain stores. They measure $1\frac{1}{2}$ ins. in diameter at the base and are $2\frac{1}{2}$ ins. high. The exact size is not important, but it is as well to purchase a suitable pair before setting to work, to make sure that the holes cut for them are sufficiently large to allow them to be lifted in and out easily.

Cutting Out

The patterns allow for a piece of $\frac{3}{8}$ in. plywood being used, which is best if available; but if it is more convenient to use thin boxwood, which is often a little thicker than this, it only involves a slight reduction in the length and breadth of the two pieces marked 'end', and is easily allowed for. The patterns can be pasted direct on to the wood or (since this is just the sort of thing for which a 'repeat order' is so often called for) they can be used to make tracings and the original retained for future use.

Note that two of the pieces have to be duplicated. The base is the same as the top piece but without the two holes, and the front is identical with the

bottom part of the fretted back. If preferred, the top piece can be cut out first and used as a template for marking out the base; but the front needs either a tracing to be made or the measurements carefully taken from the pattern with a ruler and the size drawn direct on to the wood.

When cutting round the design with the fretsaw, take extra care near the delicate parts such as the spoons and the sticks under the cauldron, so as not to break the wood. Make saw cuts along the lines that indicate the cooks' arms, but it is as well to leave the expression marks on their faces to be put in with the paint brush. Clean up all the edges well with glass-paper and remove all traces of pattern from the surface, then glue or screw the pieces together. The base and the fretted top fit inside the front and back, and the two ends fit flush inside the four surrounding pieces.

Finishing Off

With this type of work the finishing off is always very important. It is not so much the colours chosen that matter (although they should be as appropriate as possible) but the neatness with which

Full-size patterns for this novelty are on page 287

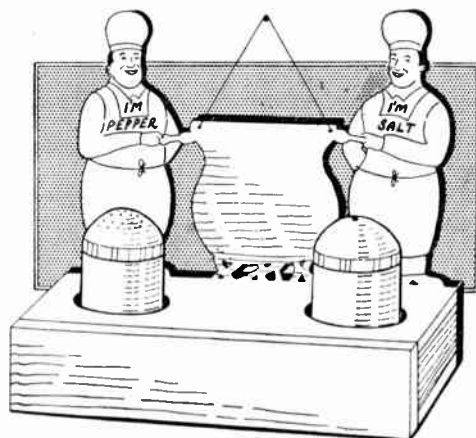

they are put on. The colour for the bottom part will need to tone with the colour of the pepper and salt pots. The cooks, except for their face and hands, look well in white enamel, and this makes a good background for the words 'I'm Pepper' and 'I'm Salt' to be neatly lettered on, in black or red, using a very small camel hair brush.

Make the cauldron and the spoons black, and the faces and hands pink, with a touch of scarlet on the noses. Use the scarlet, too, to add a realistic appearance to the sticks under the cauldron, and a few careful touches of black, in very thin lines, to indicate the features and hair.

When the last of the painting is dry, drill two small holes at the top corners of the cauldron and suspend the work with a piece of string or dull-coloured wire. (403)

Automatic Switch for a Doll's House

AN automatic switch such as the one described has a variety of uses. It can be fitted to the door

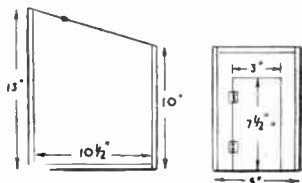

Dimensions for the coalhouse described

of a toy cupboard, to the door of the coal bunker or coal place, to the garage of a doll's house and so on. No doubt you will be able to adapt it to your own use.

The one shown here was made for an outside coal place for a fairly large doll's

house. The light is switched on when the door is opened and switched off automatically when the door is closed.

The Framework

Construct the framework first from wood $1\frac{1}{2}$ in. by $\frac{1}{2}$ in. to the measurements

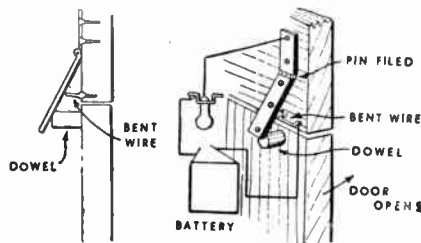

How the switch works

given. Cover the sides with hardboard (or plywood), hinging the sloping roof so that it can be opened for purposes of inspection and battery renewal.

To make the switch, proceed as follows. File the pin of a long hinge to make it work easily and screw this inside the coal house just above the door so that the lower leaf drops by its own weight and projects slightly behind the door. When the door is opened this lower leaf rests upon a length of brass wire bent as shown and fixed to the hardboard above the door. A piece of dowel rod is fastened to the door so that it pushes the hinge inwards as the door is closed.

The lamp is fitted into a bulb holder screwed to the back of the coal place and wired as shown. The circuit is completed as the door opens since the hinge drops on to the strip of wire. (361)

You can enjoy economical CAMPING ON WARM NIGHTS

ECONOMICAL camping for the cyclist—or hiker—can be enjoyed when the summer nights are warm and weather settled. Provided that you can count on such conditions some week-end, the expense of a 'posh' tent need not handicap you. Here is a simple 'bivvy' that anyone can rig up. It takes up less room than a bivouac tent, and is easily erected. Cost is modest.

All you require for the purpose consists of a piece of good waterproof canvas, a few tent pegs, a few lengths of rope for guy lines, and a couple of poles 5ft. or so high. For that matter, it is

other length of rope fastened near the tops of the poles, pull the ends of the sheet out to form a sort of V-shaped tent, and peg each corner down and also peg down the centre of each side by the loops you have sewed on. This, then, will give you an open-ended tent of the inverted V type. During warm summer nights it makes an ideal shelter, and you do not swelter under it, as you may do on hot nights in a walled type of bivouac tent.

Use wooden pegs—metal pegs make a hole, wear it larger, and are liable to pull out in a bit of wind. Iron pegs are easy to drive in the turf, but heavy to

edge rests in the middle of the other blanket. The outer blanket now folds over the inner one and is pinned in the same way. All that is now necessary to do is for the end to be turned up 3ins., and secured with three blanket pins. You will have a kind of bag and cold draughts will never find their way in to disturb the sleeper.

Straw or Hay

Or, even more economical, try and get a bundle of *clean* straw or hay to spread over your groundsheet, and make your bed on it, with just one blanket as covering. It is the cold that strikes up from the ground you want to avoid. So always lay down a waterproof groundsheet whether you use a sleeping bag or not. Old newspapers are also serviceable for putting between groundsheet and blanket, to prevent damp striking up.

To save expense, you can cook on a wood fire. But take all precautions when lighting an outdoor fire, and be quite sure it is thoroughly stamped out before leaving the site. Take as much food as you require from home. For a week-end, with one, or at most two nights in 'bivvy' it is easy to manage without having a lot of cooking to do. Fruits, salads, and cheese save a lot of cookery. Tinned stuff, as sardines, etc., are also helpful—but do not forget the tin-opener! Use your own discretion. You can take your mid-day meal—dinner if you like—at a village café or refreshment house, provided such a spot is nearby.

No Frills

When 'bivouacking' for two or three nights in summer you may cut out all the frills, and make do with improvising in various ways. Carry your stuff on a rear carrier of your cycle or, if hiking, in a pack on your back. By so practising economy you can spend some interesting and enjoyable week-ends in hot weather at low cost—and yet get plenty of fun.

(431)

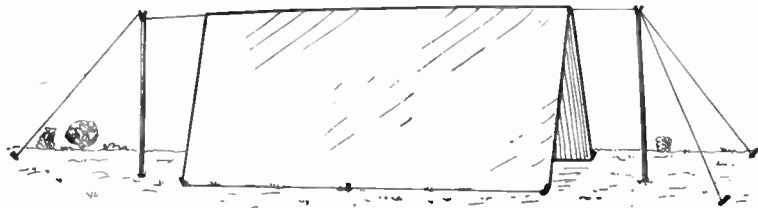

Fig. 1—An open-ended 'Bivvy'

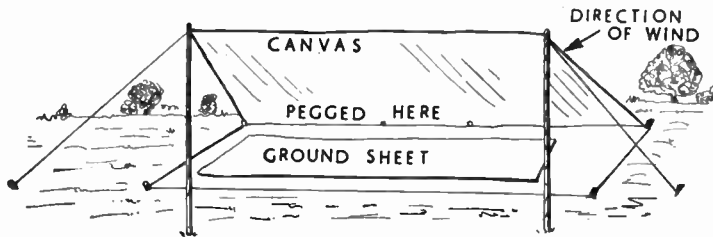

Fig. 2—Open shelter for a hot night

possible to rig up a satisfactory shelter with or without poles. The writer has passed nights under a 'bivvy' made of three groundsheets—one for laying on the grass, the other two laced together to form slanting sides when stretched over a length of rope supported by two stout sticks.

Simple Shelter

To make a simple shelter, procure a sheet of good waterproof material about 7ft. or 8ft. square. Anywhere about that size will do nicely. Bind the edges of the sheet with tape 1in. wide and sew loops of same material at the corners and in the centre of each side when the sheet is folded over. Then you need a few yards of rope or strong blind cord, and ten or twelve wood tent pegs. These latter you can cut out of serviceable pieces of timber. Some campers recommend iron pegs, but they tend to pull out easily in a strong wind, especially if the ground is sandy.

Now, having reached the camping site, erect the two poles provided, secure with the ropes intended to act as guys, stretch the canvas sheet over the

carry. Wood pegs wedge themselves into the ground and hold well—they should be driven in the turf at an angle. When using makeshift pegs, do not take the timber from hedges, fences, or cut them from growing trees. You can generally find something useful lying around.

Another method of utilizing a sheet of canvas is shown in Fig. 2. There are other ways of rigging up simple shelters, but these are only advised if the weather is settled and warm.

To Cut Expenditure

It is more than ever necessary to cut expenditure in these days, and you will be wise to make use of kit that can be procured without buying direct from camping stores. You will need two blankets, for instance. Well, see if two good old blankets can be 'wangled' from home. Make a sort of sleeping bag. Stretch the blankets on the ground, fold one in half, and turn the edge over about 2ins. and fix with a couple of blanket pins, obtainable from camp outfitters. Now turn the blanket already arranged, so that the pinned

IMITATION CONCRETE

When sawing fretwork or woodwork, put a tin beneath the saw and catch the sawdust. Then when building a fort or castle, coat the model with glue and throw the sawdust on to form a rough coat. Paint and you have imitation concrete or stone.

Cyclists—here's a simple PUNCTURE-PREVENTING IDEA

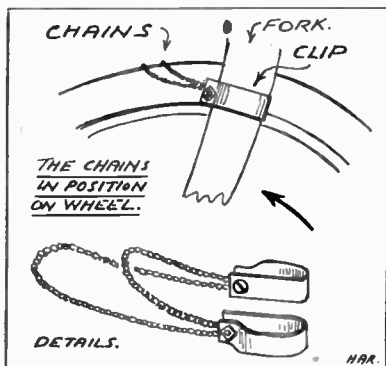

A drawing showing how the gadget works

THIS last year a cycle gadget has been put on the market for the preventing of punctures through thorns, pieces of glass, etc. This consists of a light wire which, bent to a part circle, lies across, and is in contact with the tyre. The basic idea is that sharp objects caught up by the rubber seldom if ever puncture on their first journey round, but only after they have been driven in by several revolutions of the wheel. If, therefore, they can be removed during the first revolution when only slightly embedded, no harm is done. The wire of the new gadget effects this pulling out.

All this is no fresh idea, for, many years ago before the days of the tarmac, when road surfaces always seemed covered with thorns and sharp points, one could purchase lengths of very pliable chain which, when draped across the covers, also did the trick.

Not Hard to Make

It is not hard to make your own puncture preventers following the older arrangement, and they really are very useful if much riding has to be done in the heart of the country and off the beaten track; especially if an amount of it will be after dark.

Necessary in the making are two lengths of chain and two fork clips such as found on the end of some mudguard extensions. If you cannot get these, however, clips are very easily made with a strip of tin and bolt. The chain is the most important item, however, for this must be of a very pliable and close-linked variety. Stiff, long-linked chain is quite useless.

As will be seen by the diagram, the chains are attached to the clips and draped over the tyre one in front of the other. The clips are taken round the front forks as shown, and sufficient chain must be allowed to let it hang to a certain extent down the walls of the tyre, as glass, etc., may not be exactly in the tread centre. The sketch shows how the idea is applied to a front wheel (the

brake is not shown but the chains go inside the stirrup). Adaption to the back wheel is just the same, the seat stays here taking the clips and the chains hanging down inside the mudguard.

On both front and back wheels the chains, it will be found, are quite inconspicuous, and being so light and pliable do not create even the least 'drag'.

A quick precaution against thorns and glass splinters can be taken by stretching a length of fine wire across the front

forks and seat stays and just missing the tread of the tyre when fully blown up. Any projection then higher than the clearance, is at once contacted and pulled out. The wires are held in position by giving several tight winds round the forks or stays and finishing by several twists back on to itself. This idea has the advantage of taking but a few minutes to rig up, but it is not quite as efficient as the loose chains, as only the tread of the tyre is dealt with, anything which gets caught in the side being missed. (385)

Books for Shipmodellers

(Reviewed by 'Whipstaff')

The Shape of Ships

By Wm. McDowell

IF you are a lover of the sea and ships, whether you are actually a shipmodeller or not, here is a book you will find a delight to read.

Although it has been written mostly for the older schoolboy, its appeal is very much wider; its text, sketches and illustrations in colour will be found of fascinating interest to readers of all ages.

The author is not only a man with wide practical experience of actual shipbuilding, he is also a superb marine artist and has the gift of embodying his practical knowledge of ships in his sketches and paintings. This will become obvious the more you study the details of his work.

It is this authentic sketching of details that can be of real help to

shipmodel makers. To mention only one example, his excellent sketches of old-time guns show many details of real assistance to the modeller.

The text, well written in non-technical language, gives a concise history of ships from the earliest times to the present day. Many of those details that the model maker frequently asks for are given.

Most model ships enthusiasts like to include details of tonnage, etc., on the name plate of their model, and for many well-known vessels this book will provide the answers.

It is one of today's better book values.

Published by Hutchinsons & Co., Ireland Yard, E.C.4—Price 8/6

The Royal Navy

By L. W. Sharpe

HERE we have a book published for artists, and all who love to sketch, but which, at the same time, can be of invaluable help to the shipmodeller interested in warships of our modern Navy.

Both the text and numerous illustrations and sketches are very clear and show how to distinguish the main details of the various classes of naval ships. They will provide inspiration for adding those touches of detail to the model that are so essential to an authentic finish.

Hobbies kits for H.M.S. Vanguard and other Navy vessels all lend themselves to the addition of authentic detail by the keen modeller,

and this handbook will help in the finding of that detail and making it true to type.

The modeller of waterline types of ship models will be well repaid by a study of the sketches of the sea in varying moods, and the scenic model maker will find much help in the hints on perspective, and guidance in the amount of detail to incorporate to make his model look right at the particular scale to which it is built.

A most useful book for the shipmodel maker.

Published by The Studio Ltd., 66 Chandos Place, London, W.C.2—Price 3/-

You can soon master THE CRAFT OF NETTING

NETTING is one of the oldest known crafts. Fragments of nets dating back to the Stone Age have been found in Switzerland, and they are frequently depicted on ancient Greek and Egyptian monuments. In those days, no doubt, nets were made principally to enable the men of those early civilisations to capture prey of various kinds and provide animal food for their families. Nowadays, with nearly the same tools, and using exactly the same process, we can put this ancient craft to many useful purposes.

Shopping bags and bags in which to hang up vegetables, little hammocks on which to dry woollen garments flat, cot nets to prevent the too active youngster falling over the side, rabbit nets for the

hang it over a knob or hook of convenient height for working. This is called the stirrup. Tie a second, rather smaller loop of string into the stirrup, so that it can move round freely, tie the loose end of string from the shuttle firmly to this foundation loop. You are then ready to cast on.

To do this, place the mesh stick immediately under the knot attaching the shuttle string to the foundation loop, holding it horizontally in the left hand between the thumb and second finger. (Some people hold it between the thumb and first finger, but the writer finds it much easier to have the first finger on top of the stick to steady it when making the knot). Holding the shuttle in the right hand, unwind about two lengths of string, *, bring it down in

loops (Fig. 3). Now turn the work over from right to left, and then, placing the mesh stick under the outside lefthand loop, continue working in exactly the same manner as in casting on, but making one knot only at the bottom of each loop of the previous row.

Turn the work over at the end of each row, and continue until you have a piece of netting approximately square, trying all the time to make your knots as even as possible. Finish by making a double knot before cutting the string at the end of the last row, then cut the foundation loop and draw it out, leaving a row of knots, which can easily be unpicked and will fall into loops (Fig. 4).

This diamond mesh, as it is called, is the foundation of most netted articles, and once it has been mastered, even the

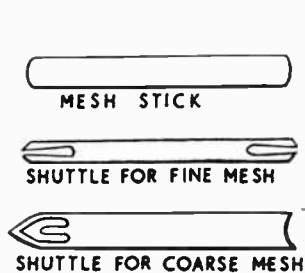

Fig. 1

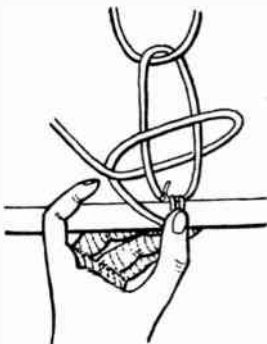

Fig. 2

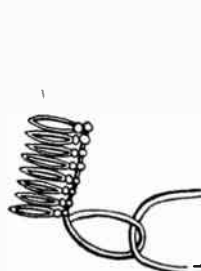

Fig. 3

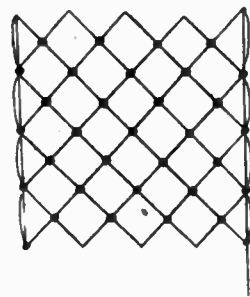

Fig. 4

farmer—all these can be made quickly and cheaply at home once the actual process of netting, which is simplicity itself, has been learned.

The only tools required are a mesh stick (these are generally made in $\frac{1}{2}$ in., 1 in., and $1\frac{1}{2}$ ins. sizes) and a wooden or bone shuttle which must be slightly smaller in girth to allow it to pass through the meshes when fully loaded (see Fig. 1). There is no definite rule as to the size of the mesh used, but usually the coarser the string the larger the mesh. A shopping bag, for instance would, obviously, need to be made in a finer mesh than a cot net. The 1 in. stick and corresponding shuttle will answer most purposes, however, and is a good size with which to start.

Practice Square

It is a good plan to make a practice square first to get used to the actual knotting, and, incidentally, it is handy to keep this sample as a means of estimating size when making other articles.

Begin by taking some fairly fine smooth string, and load the shuttle by winding it as tightly as possible up and down the length of the shuttle, between the prongs, until the shuttle is full without bulging too much on either side. If it is too full, it will catch easily in the mesh. Now make a loop from an 18 ins. length of any kind of string and

front of the mesh stick, then up and through the back of the foundation loop, pull tight and hold the string against the mesh stick with the left thumb. Next carry the string in a circular movement, first towards the left, then to the right over the front of the foundation loop, left again behind the foundation loop, finally bringing the shuttle through between the left side of the foundation loop and the first loop of the circle just made (see Fig. 2). Draw up tight, let go string with left thumb, and the first knot is complete.

Starting again from * repeat, working always to the right, until you have eight stitches on the mesh stick. Slip the stick out of the stitches, leaving a row of

beginner need have no fear of tackling any of the articles suggested in a subsequent article.

It should be noted that many netted articles are attached to rings or bars of some sort, and stitches are frequently cast directly on to these fittings. It is, therefore, best to buy them at the same time as the string, etc.

When a join has to be made in the work, it should be done with a weaver's knot. Having re-loaded the shuttle, loop each end to be joined, holding one with the thumb and forefinger of each hand. Pass the left loop through the right loop, then cross the ends of the right loop and push the loose end down through the top of the left loop. Hold all four strings securely and pull very tight. (402)

MODEL SEATS

From a reader comes this idea for making realistic model seats from scraps of wood and card, and old matches or panel pins. The sketch makes the construction quite clear, and such seats will be found easy to 'mass-produce'.

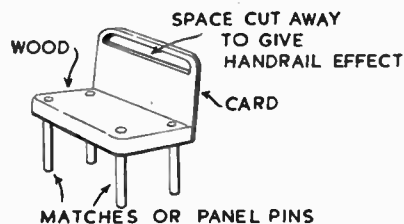

More expert advice about 'PICTORIAL' HOLIDAY SNAPS

In my last article I dealt mainly with the type of holiday spent by many thousands at one of the fashionable and popular seaside resorts, a holiday which includes some days on the beaches and others in the country round about. Underlying the hints and pieces of advice, I endeavoured to show you how to avoid the commonplace by using more care and giving some thought to the selection of subject, preventing errors of exposure by the use of an exposure meter, studying the lighting and, generally, cultivating a knowledge of composition.

For those who have yet to go on a holiday, let us consider those to be spent further afield and in districts that present a different type of scenery. The same 'snags' are there and have got to be contended with if really good results are to be obtained.

Where to ?

Some readers may be visiting The Lakes, or Wales, and others may journey still farther in order to see the beauties of Scotland. Whichever spot you are contemplating, be sure to pack a good number of spools in your kit and try to get them all of one brand—and that a well-known one. If they are of one make and type, then they will be of one speed and that will save at least one alteration in your exposure calculations.

It has often been said that the Lakes are a miniature Wales and Wales a miniature Scotland. In the Lake district the views are rather more compact and my own personal opinion as a photographer is that, if you cannot get good results and splendid pictures there, you had best give up trying. For the whole place teems with pictures and the lighting and clouds are ever ready to help you. Walking is, of course, the best way of holiday-making, and the next best is the use of a private motor car, giving you the opportunity of stopping every few yards or whenever some special view catches the eye. Also it enables one to visit many more of the lakes than could otherwise be done.

The views can be of the extensive type with foreground of reeds on the lake side, using the lake for middle distance and peaks in distance or background; but, generally speaking, you will find these views are not so extensive as the same type in Wales or Scotland. Their character, however, is such that one need not hesitate to make exposures, because their very boldness of detail breaks up any idea of monotonous open space such as one experiences in country like Devonshire or southern parts of England.

Mention has been made of the lighting, and it is just as well to remind you that, in all districts where mountains and plenty of water prevail, clouds will also be present on most days, and these

conditions do tend to give 'soft' lighting. This, in my opinion, is ideal for picture-making. Full sunshine can make the subject appear too contrasty, though it can be quite useful at times where a number of trees are in the immediate foreground or when reflections in the water are a special feature of the scene.

Do not be too keen on taking an extensive view from the top of a mountain or even a high hill. In most instances, the best photographic view is from a spot two or three hundred feet up, but the general outlay of the immediate country around must be your guide. And do remember to find some interesting object to occupy a foreground position; it helps so much in the composition of any long distance view.

We must not get the idea that the only place for taking good snaps in Lakeland is from the high ground. On the contrary, I am quite sure that the majority of exposures are made from the banks of the lakes, because it is surprising how much time is spent by the water's edge. It is there that pictures catch the eye at every turn of the road. It is perfectly easy to use a couple of spools on the walk from Keswick to Seatoller by way of that marvellous bit of scenery. The jaws of Borrowdale, and back through Grange and the Catbells, or over the hills via Rosethwaite and Watendlath.

Not all Lakes

Then again, there is no need to think that all our views must include a lake, or even a portion of one, for some of the delightful towns and villages offer splendid opportunities. One has only to keep one's eyes open, and some charming little 'bits' of Old English Country Life can be recorded among your memories of the holiday.

But, of course, what is to be found in Keswick, Grasmere or Ambleside is also to be seen in beautiful Wales. Probably there are many more quaint villages there and in Bonnie Scotland than in Cumberland and Westmorland, with picturesque corners and buildings which simply shout with history and demand the attention and interest of every one visiting the neighbourhood for the first time.

If a holiday is to be spent in N. Wales, then mountain scenery will absorb most

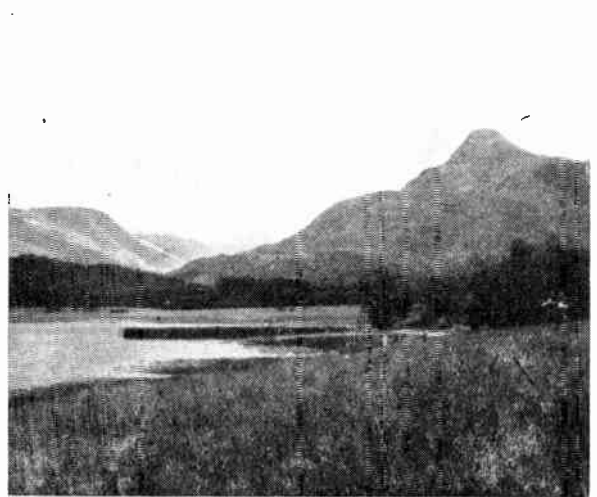

A picture taken at the entrance to the Pass of GLENCOE, with the head of LOCH LEVEN in the foreground

of the time and films, and it will be natural to attempt some shots a couple of thousand feet or more above sea level. Before making any exposure, try to select a view that will, when the negative is printed, convey a very clear impression to your friends that you were actually well up on a very high mountain when you took the snap. One of the best ways to achieve such an effect is to include the summits of other mountains as a background to your picture. Be sure to find out the names of those other mountains, and also their heights. Make a note of this information on the back of the print, and you will be very surprised how much more interesting that print will become.

Everyone visiting N. Wales has to make a trip to Bettws-y-coed and procure a snap of the Swallow Falls, and probably waste a film on an endeavour in the Fairy Glen. Make use of your exposure meter, for correct exposure is absolutely necessary when taking waterfalls and particularly in such dark glens. In any case, these are what must be termed 'record' pictures—a record of a pleasant day spent in a beautiful spot.

Mid-Wales

Those folk who choose mid-Wales for their holiday will find a greater variety of subjects for their cameras. The district in and around such a town as Barmouth simply teems with the picturesque, as a jaunt in the car or a day's ramble anywhere will prove, but I feel bound to issue a small warning. When selecting your views, try to visualise the scene without any colour—simply black and white. I have not mentioned this point before, but one of the features of this part of Wales is the amount of colour on the hills, especially up the valley and on the banks of the river Mawddach. It is so

very striking that sometimes, especially at sunset, cameras are constantly clicking and, unfortunately, many failures are produced.

Abundant Seascapes

Seascapes and coast scenery are to be found in abundance by those who spend some time either on the N.W., S.W. or the South Coast of this part of Great Britain. There are lovely stretches of sandy beach and also some really good rocks to be included, and interesting studies of waves and spray. But be careful to select a spot where it is safe both for yourself and camera, and where you can be sure that the result will be picturesque.

Now for a few remarks about Scotland. From the photographer's point of view, the West Coast is, undoubtedly, the best, and I envy those who visit the Clyde district or that around Fort William for the first time. The scenery in the Firth of Clyde is grand, and the steamer trips in and out of the lochs are the best medium for seeing it. Most of these trips are conducted to enable visitors to see the mountains in the background, but are close enough to enable some charming views to be taken of the villages and other interesting spots that are situated on the banks of the lochs. So, that with a spool of fast film, a short exposure of 1/50th or even 1/100th of a second, and the use of a

suitable stop, exposures can be successfully made from the side of the boat without getting movement. Clouds are usually present to help and, as indicated, the lighting is generally very strong, so it is advisable to make a calculation with the meter before making the first shot. This calculation should then prove satisfactory for all others on that particular trip, provided you keep to the same stop and time.

In the season a good deal of yachting takes place on these waters, and a boat in full sail is a splendid foreground object.

Much bolder scenery is the characteristic of the district farther north. The lochs are larger, and the mountains higher, which means that the scenery generally is more extensive, but, owing to the 'bigness' of the landscape details



On the banks of Loch Lomond at the foot of Ben Lomond

and the lighting, this need not deter you from spending some of your films. My experience and my results show that,

because the skyline in these parts is so broken, it is possible to avoid straight lines on almost every occasion and to get most picturesque results with objects so well placed in the foreground, middle distance and background, that perfect composition is quite frequently 'nature provided'.

Care of the Camera

Should you be tempted to take your camera when climbing a high mountain, be sure to carry it in such a position that much knocking or jolting is avoided. And keep a look-out for views as you climb, for usually the best are a few hundred feet up. Of course, one wants a record of the summit, and here it is up to you to include some detail or object that indicates you have reached the top.

Now, in all these holiday places, coach trips are the main means provided for visitors to see the 'spots' worth seeing, and I would like to give a tip that has on many occasions proved extremely useful. Have a friendly chat with the driver before starting, tell him that you are a very keen photographer, and that you want his help to get some really good shots. If he knows of any specially nice view or object of historical or other interest on the journey would he be good enough to stop the coach for a few seconds? As a rule, these men like to be helpful.

My final piece of advice concerning pictorial holiday snapshots is—take, and use at all times, a filter on your lens. I do not advocate any deeper than a 2 or 3 times, which I have always found is right for bringing out any clouds, thus avoiding 'baldheads'. Stronger filters tend to make the sky too dark and, in my opinion, unnatural. Remember that the exposure time as given on the meter will require to be multiplied either 2x or 3x whenever a filter is used. (433)

Replies for Radio Fans . . .

Conversion

COULD you please tell me how to convert my wireless set which has an accumulator and eliminator (battery set) into an electric set? (G.B.—Ferry Hill).

AMPLION Ltd., 230 Tottenham Court Rd., London, W.1, manufacture units which will provide H.T. and L.T. current directly from the mains. The re-building of your set as a mains-operated one, would require that the valves and holders be changed to suitable types, and various components in the set will require to be changed, while a rectifier and power-supply section will have to be added. The actual modifications required, would depend upon your type of set, and whether you have A.C. or D.C. mains, and could scarcely be carried out except by someone with a fair knowledge of radio. Normally, the tuning system and

associated coils, etc., may be retained, but the whole remaining part of the circuit will require changing.

Transformer

THE article *Bedside Crystal Set* advocates the use of a suitable output transformer, with a 6½ ins. speaker. I have purchased a Goodman 6½ ins. P.M. (M.C.) speaker without a transformer. The impedance is about 5 ohms, so, perhaps, you could suggest a suitable ratio, and impedance for a transformer, to have the required effect. The earphones I am using at present, are of a 4,000 ohms impedance. (G.K.—Sutton).

THE exact ratio to match 5 ohms to 4,000 ohms, works out at 30:1 (square root of load impedance, divided by speech coil impedance). However, this will not be critical in the case

mentioned, and any speaker matching transformer would only cost very slightly more, and different impedance can be tried by using the various tags provided. Most speaker transformers are for a 2 to 3 ohm speech coil, and be sure you do not use one of these.

3-Valve to Portable

IS it possible to convert a 3-valve, long and medium waveband set into a portable—if so, how? (R.C.—Pontypridd).

THE set may be converted by using a frame aerial instead of the first coil. If the set is of the detector 2-L.F. type, this frame aerial should also have a reaction winding. If the set has a R.F. stage, no reaction will be required here. About 75ft. of wire will be required for medium waves, with 200ft. or so for long waves. Reaction between the two (if used), can consist of about 50ft. of wire. The number of turns this gives will, naturally, depend upon the perimeter of the cabinet.

Experiments with water glass in HOME CHEMISTRY

A PART from its reliability as an egg preservative and as a cement finish, water glass has many other properties of interest to the home chemist.

It is chemically known as sodium silicate and is a relative of ordinary glass. Water glass is made by fusing together sodium carbonate and ground flints or sand; ordinary glass by using a smaller proportion of sodium carbonate,

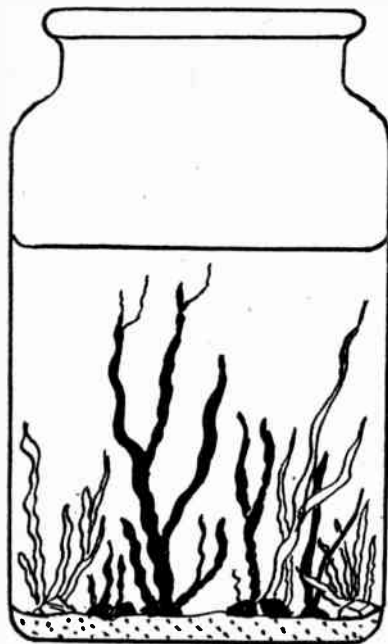

Fig. 1—A silica garden

plus the addition of small quantities of the other substances, according to the use to which the glass is to be put.

Fascinating Experiment

One of the most fascinating experiments to watch is the growth of a silica garden in water glass solution. To make the silica garden, take a clean 1lb. jam jar. Fill it to one quarter its depth with water glass, pour in water until the jar is three-quarters full, and then stir until all the water glass has dissolved.

Drop in enough sand to lightly cover the bottom of the jar and allow it to settle. Now drop in crystals of cobalt chloride, copper sulphate, nickel sulphate, ferrous sulphate, strontium nitrate, lead acetate, uranyl nitrate.

In a few moments tiny bubbles form on some of the crystals. Now watch closely, for the show is about to begin!

The bubbles start to move upwards in little jerks, rather like a man climbing a ladder and having a rest on every rung.

Attached to the bubbles you will see various coloured stems. These grow steadily upward through the solution, slowly or quickly, according to the salt from which they are growing.

Cobalt chloride is a quick grower and gives deep blue stems. The others are slower. But in a few hours the bottom of the jar will look like a tropical sea floor of coloured weeds (Fig. 1). Copper sulphate gives a blue 'plant', nickel sulphate a green, ferrous sulphate a dark green, strontium nitrate a transparent, colourless one, lead acetate a white, and uranyl nitrate a bright yellow.

In about twenty-four hours the growth will have stopped. These silica gardens make pretty ornaments if grown in small gold fish bowls. They must, however, be left undisturbed, for the slightest jerk usually causes the delicate stems and fronds to break and fall to the bottom of the bowl.

The 'plants' of the silica garden consist of the insoluble silicates of various metals and are produced by double decomposition. They 'grow' by capillary attraction.

The insolubility of the metallic silicates gives us the clue to the preparation of specimens of these compounds. We can prepare them by precipitation, potassium, sodium, ammonium and lithium silicates being the only common exceptions.

To produce copper silicate mix copper sulphate and water glass solutions. A blue precipitate will form. Like most silicates, it is rather gelatinous and hence cannot be washed conveniently on the filter. Therefore, to free it from soluble salts, wash it by decantation several times with large volumes of water. Then filter and dry it in the oven.

You can prepare the silicates of many other metals by repeating the last experiment, but using soluble salts of the respective metals instead of copper sulphate.

For instance, white calcium silicate (a constituent of the hard glass used for laboratory oxygen tubes), white barium and strontium silicates, white lead silicate (a constituent of the highly refractive flint glass used for optical instruments), buff ferric silicate, grey-green chromium silicate, yellow silver silicate, yellow uranyl silicate; blue cobalt silicate (a constituent of blue glass), which becomes lavender coloured during the washing; and cinnamon-brown mercuric silicate, but not mercurous silicate, for this, a dirty yellow precipitate, quickly darkens and decomposes.

If you add dilute hydrochloric acid to a moderately strong solution of water glass a thick jelly will form. This is silicic acid and in this condition is insoluble in water.

Now repeat the experiment after diluting some water glass solution with

several times its bulk of water and using excess of hydrochloric acid. No jelly forms. The silicic acid has formed a colloidal solution, and has the curious property of being unable to pass through parchment paper, whereas the sodium chloride also formed in the reaction will.

Using this principle we can separate the two. Cut off the bottom of a jam jar by filing a notch and then starting and leading a crack right round with a heated glass rod. Tightly bind a sheet of parchment paper over the mouth of the jar, invert it mouth down, and pour in the colloidal silicic acid solution.

Now immerse the mouth in a bowl of water, as shown in Fig. 2. In a few hours test the water with silver nitrate. It will give a white precipitate of silver chloride—not a yellow one of silver

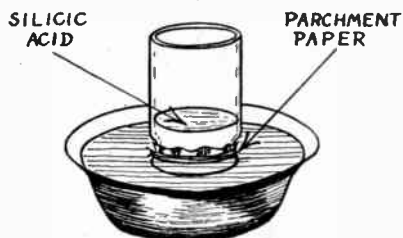

Fig. 2—Separating silicic acid and sodium chloride

silicate, thus proving the silicic acid is still in the jar.

Change the water in the bowl every few hours until silver nitrate produces no precipitate. A limpid liquid will be left in the jar, which is silicic acid. If you leave it a few days it begins to pass into the jelly-like form, and soon the colloidal solution entirely gives place to the insoluble jelly. This parchment paper method of separating colloidal solutions is known as dialysis.

Now pour this jelly into an evaporating basin and boil it to complete dryness. Remove it from the basin and heat it to redness in a crucible. Steam will be evolved and a gritty white powder will be left.

This is silicon dioxide, or silica. Free, or combined with other substances, it makes up the major portion of the earth's crust, and is the essential constituent of sand. Opals, too, flint, quartz, kieselguhr (used for mixing with nitroglycerine to make dynamite), consist of silicon dioxide. In combination with aluminium oxide it forms clay, and if with magnesium it occurs in nature as talc, mica, meerschaum (for pipe stems), and asbestos.

Silicon dioxide resists heat and only melts at a very high temperature. It is much used for making crucibles, tubes, and evaporating basins. Such apparatus withstands rapid temperature changes. Indeed, a red hot silica crucible may be dropped into cold water without cracking!

(380)

MISCELLANEOUS ADVERTISEMENTS

The advertisements are inserted at the rate of 4d. per word prepaid. Name and address are counted, but initials or groups, such as E.P.S. or £11/1/6 are accepted as one word. Postal Order and Stamps must accompany the order and advertisements will be inserted in the earliest issue. Announcements of fretwork goods or those shown in Hobbies Handbook are not accepted. The charge for use of a Box No. is 1/- extra. Orders can be sent either to Hobbies Weekly, Advert. Dept., Dereham, Norfolk, or Temple House, Tallis St., London, E.C.4

MODELS. You can make lasting stone-hard models with Sankey's Pyruma Plastic Cement. Supplied in tins by Ironmongers, Hardwaremen and Builders' Merchants. Ask for instruction leaflet.

LEARN Shorthand by 15th September (one hour's study nightly). First lesson, 2/3d. stamp.—Duttons (Dept. HB), 92 Great Russell Street, London, W.C.1.

DUPLEX self-adhesive Transfers for decorating fancy goods, trays, plastics, etc. List and samples, 3d.—H. Axon Harrison, Jersey.

DOLL'S House fittings and papers; send S.A.E. for list. Doll's house plan special; send 2/6. Trade supplied.—Zimplan, 88 Ware Road, Hoddesdon.

LORRY Kits, 4 mm. and 7 mm. scale. Also large range of spare parts from which to build to your own design. Send for fully illustrated catalogue. Price 1/-.—Wilson's Lorries Ltd., 6 Gt. Winchester Street, London, E.C.2.

PLYWOOD offcuts. Birch and Gaboon in various thicknesses. Handy sized parcels for the cabinet, toy, model maker, and all handicrafts. Parcels made up in £1 and 10/- lots. Carriage paid. Send P.O. to—Reeves, Plywood and Timber Merchant, 33 Front Street, Monkseaton, Whitley Bay, Tel. W.B. 4677. Parcels are now despatched on day of receiving order.

HOMEWORKERS required, either sex, light Assembly, part or full time. S.A.E.—Esprey, Box 18, 41 Wade Street, Lichfield.

NOVEL Calendar Designs painted on Plywood for cutting out, with date cards. Inexpensive gifts. Profitable to sell. Sample, 2/-. Half dozen, 11/-. including postage.—Cleaver (H.W.), 50 Windsor Road, London, N.W.2.

9.5 POPULAR Film Hire Library. 3d. stamp lists.—Wayland, 223 Longley Road, Tooting, London.

BUILD your own saw bench, shafts from 28/6. Pulleys, Belts, Motors, saws supplied. S.A.E. list.—Sullivan, 19 Allen Road, Wednesbury.

WONLEY? Then write Secretary, U.C.C.—5 B.B. Hay St., Braughing, Herts. Genuine. Est. 1905.

AMERICA'S famous hobby magazines. One Year's supply. Popular Mechanics, 32/-; Popular Science, 28/6; Homecraftsman, 16/6; Popular Homecraft, 18/-. Free Booklet listing all others sent on request.—Willen Ltd. (Dept. 57), 101 Fleet Street, London, E.C.4.

CONJURING and Magic. New tricks and Crockpot novelties every month. Lists, 4d.—Roboati, Magician, 363 Sandycroft, Kew Gardens.

PROFITABLE spare-time employment for everybody. Clerical, assembly, toymaking, etc. 100 firms.—'Spare-Timer' (1/-), 43 Douglas Avenue, Heanor, Derbyshire.

HOME Watch and Clock Repair Outfit. Includes watchmaker's magnifying eyeglass, tweezers, screwdrivers, oilers, oil, brush, dusting powder, plus illustrated explanatory book. Watch and clock repairing simplified. In container, 12/9 inclusive.—D. Bolster (Dept. H), 5a Station Parade, Ashford, Middlesex.

HAVE you got your Juneero Riveting Jig yet? From all Hobby shops or post free from—Juneero Ltd., Stirling Corner, Boreham Wood, Herts.

STAMPS Free. Empire packet including Pictorials and Victorians free to approval applicants.—Robert J. Peck, 7A Kemp Road, Bourne-mouth, Hants.

INTERESTING work available for all in spare-time. Experience unnecessary. Send S.A.E. for details to—Leathaweave Co. (Dist. 37), 2 Tudor Road, Leicester.

WHEELS for toys, etc., in Hardwood, Plastic and Rubber Tyred Metal. Doll's House fittings and papers. Doll's Cot and Pram fittings. Decorative Transfers. Beads for Counting Frames and other Toy accessories. Fine Art Pictures for Jig-saws, etc. Stamp for lists. Trade supplied.—Joyden Toy Co., 193 Chase Side, London, N.14.

BLUSHING, shyness, nerves, self-consciousness, fears ended. Details under plain cover, 1d.—Stebbing Treatment, 28 (HB) Dean Road, London, N.W.2.

BE Taller in 14 days or money back. Details, 1d.—Stebbing System, 28 (HB) Dean Road, London, N.W.2.

£5 to £20 Weekly earned at home, running your own Mail Order business. Details, 1d.—Stebbing Publications Ltd. (HB), Naphill, High Wycombe.

EARN £££s weekly with '114 ways to be your own boss'. 5/6 only. Money back if dissatisfied.—Stebbing Publications Ltd., Naphill, High Wycombe.

USE Spare time on profitable homework making fancy goods. Write for free booklet.—(Area 544), 54 Southgate Street, Leicester.

TRICKS for everyone. Vanishing candle, 1/3; tightrope ball, 2/6; cut and restored rope, 1/3; window mystery, 1/3; eastern mystery, 1/3; rising card, 1/6; it's off, 2/3; phantom cigs., 1/6. Free trick to all spending 5/-.—Magician's Den, Wimborne Road, Winton, Bournemouth.

GENUINELY interested persons required to undertake light, clean assembly work in their own homes. Good rates of payment.—Dept. 918, Universal Products, 5 Cornhill, Lincoln.

PLYWOOD offcuts. Nothing under 12ins. x 12ins. x 3/4 in. 15 sq. ft. parcel, 7/6, post paid. Quick delivery.—B. & M. Sales, 16 Hamm Moor Lane, Weybridge, Surrey. Weybridge 3311.

INTRODUCTIONS. Pen friends, companionship or marriage.—V.C.C., 34 Honeywell Road, London, S.W.11.

3 NEW Hungarian Animal stamps free. 3 Stamped addressed envelope request approvals.—Jeffreys, 2 Bay View, Craigavon, Port Talbot.

MONSTER Mystery packet stamps free! Request approvals. Postage.—Alphyl Publications, Heanor, Derbyshire.

STAMPS FREE!! Twenty unused (2jd.).—S.G. H. Barnett, Limington, Somerset.

STAMPS. Special summer bargains. 100 large Spicitorials, 6/-. 50—3/-. 10 U.S.A. Commemoratives, 1/-. Free gift to approval applicants. Postage appreciated.—W. E. Tucker, 6 Higher Church St., Barnstaple, Devon.

100,000 Bargains for the Model Maker and Handyman. 1/6th H.P. 200/250v. A.C. mains electric motors, intermittent duty, wonderful value, 39/6, post 1/6. 24v. A.C./D.C. motors with powerful reduction gear (ratio 43 to 7), 12/6, post 1/6. Aluminium rivets, approx. 1lb. assorted, 2/6, post 6d. Strong elastic cord, 1/2 dia., multi-core, ideal upholstery, hammocks, etc., 10 yds., 3/6, post 10d. Spirit levels in 8" varnished hardwood body, 2/11, post 6d. Sample Parcels, guaranteed to contain at least 15/- worth of assorted electrical and other useful items, in useful wooden box, 5/-. post 1/6. Send 3d. stamp for full Mail Order catalogue. Money Back Guarantee.—Milligan's, 24 Harford Street, Liverpool, 3.



**EYELETS!
EYELETS!
EYELETS!**

Ideal for Handicraft and Model Making. Eyelets consisting of one fibre washer, one aluminium washer and one eyelet. 3/8" wide.

1/6 PER GROSS
(Post Free)

WRITE TODAY

C. & G. S. TRADING CO.
1-3 Mill Hill, Griffin Hotel Buildings,
LEEDS, 1. Tel. Leeds 29021/2

**AMAZING
COWBOY FILM STRIPS**

featuring
**Bob Steele in
'SIX GUN MAN'**

**Buster Crabbe in
'WILD HORSE PHANTOM'**

**Tex Ritter in
'THE WHISPERING SKULL'**

**Hopalong Cassidy in
'SUNSET TRAIL'**

These thrilling Western Dramas 1/- each



This Cineviewer gives perfect cinema screen picturisation for all Strip films 2/9

**FOWDEN FILM &
OPTICAL SERVICE**

2 HASTINGS ST., LUTON, BEDS.

Send 4/- to cover Post and Packing of your selected Film Strip and Cineviewer

HOBBIES BRANCHES

LONDON

78a New Oxford St., W.C.1
(Phone MUSEum 2975)
87 Old Broad Street, E.C.2
(LONDON Wall 4375)
117 Walworth Road, S.E.17
(RODney 5509)

GLASGOW—326 Argyle Street
(Phone CENTral 5042)

MANCHESTER—10 Piccadilly
(Phone CENTral 1787)

BIRMINGHAM—14 Bull Ring

SHEFFIELD—4 St. Paul's Parade
(Phone 26071)

LEEDS—10 Queen Victoria Street
(Phone 28639)

HULL—10 Paragon Square

SOUTHAMPTON—25 Bernard St.

BRISTOL—30 Narrow Wine Street
(Phone 23744)

One plastic material MAKES MANY PERMANENT MODELS



and utility objects, from simple instructions in illustrated Booklet—please read below.

**ONLY 4^D
IN STAMPS
BRINGS BOOK**

... showing how such models as those above, and many others, can be made, without skill or special tools, from Sankey's PYRUMA Plastic Cement. Ready for immediate use in its plastic state, Pyruma sets or bakes to stone-hardness, and can be painted or enamelled in all colours according to instructions.

Pyruma is inexpensive, and easily obtainable in tins from Ironmongers, Art Material Dealers and Hobbies Shops. Send 4d. in stamps for illustrated Instruction Book.



J.H. SANKEY & SON, L^{TD}
ILFORD Est. 1857

ESSEX

TOOLS FOR THE HANDYMAN



TOOL CLIP

For holding any handled tool. Spring steel. Holed for hanging.

7d. each

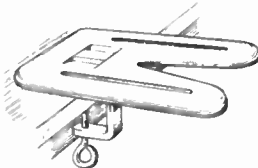

STEEL CUTTING TABLE

With clamp for easy fixing to bench. 6ins. by 4ins., strong and light. 3/-

BENCH STOP

3½ins. by 2ins. — Spring loaded top. 6/-



SINGLE HANDED SCREWDRIVER

5ins. long. Ideal for small work. 1/8

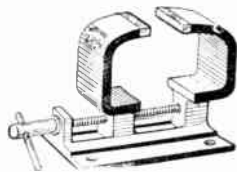

MODEL MAKER'S BENCH VICE

Strong, light and rigid. 3in. opening. 6/3

Obtainable from Hobbies Branches in London, Glasgow, Manchester, Birmingham, Leeds, Sheffield, Hull, Southampton, Bristol and ironmongers everywhere. Or post free from Dept. 99, Hobbies Ltd., Dereham, Norfolk.



FRETWORK HAMMER

8ins. long. Strong and light for small work. 1/4

BE TALLER

I Guarantee to increase your height in 12 days or return your money. New gland and spinal discovery increases height 2 to 5 inches.

'I have gained 4½ inches in height and feel fresher first thing in the morning. My weight increased from 9-stone 4-lb. to 10-stone 3½-lb.'—P.D., Witham. 'Since taking your Course I have increased in stature from 5 feet 1 inch to 5 feet 4 inches, a matter of 3 inches'.—H.G., Chesterfield. 'My increase is 2 inches and I really do feel ALIVE'.—E.T.

Guaranteed harmless. Full Course 10/- post free, Air Mail 14/-. Details free for 1d. stamp. Sent under plain cover.

J. H. MORLEY

(H/83), TERRY HOUSE, NAPHILL, HIGH WYCOMBE, ENGLAND

Established 1936

**EVERY CAR THAT PASSES
YOU WILL FIND THE INDEX MARK
ALPHABETICALLY ARRANGED IN
WHERE'S THAT CAR FROM?**

Price 6d.

from all Booksellers or from the Publishers (1½d. postage)

RALEIGH PRESS, EXMOUTH

OVER MALAYAN

JUNGLES ...

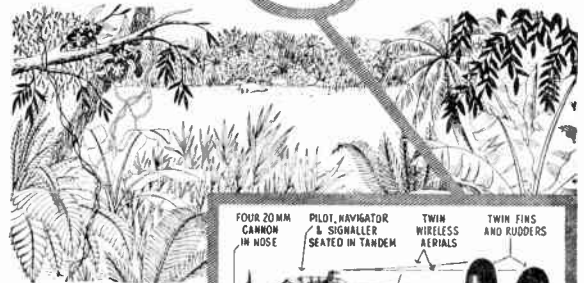

BRISTOL BRIGAND

Carries a crew of 3. Max. speed: 358 m.p.h. at 16,500 ft. Armed with four 20 mm. cannon and one machine-gun, it can carry 3,000 lb. of bombs or rocket projectiles. Wing span: 72 ft. 4 ins.

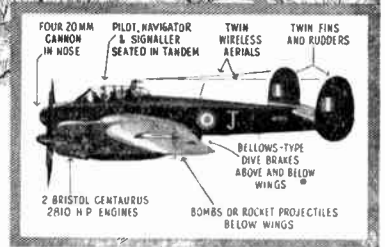

Flying calls for nerve and brains, so the R.A.F. keeps a weather eye open for really bright boys. Under the Apprenticeship Scheme they join one of the R.A.F.'s fine residential schools, without cost and with good pay. And there Apprentices get the education and training that will fit them for their future as key men in the R.A.F.

There's a place
for YOU in the **R.A.F.**

If you are over 14 this coupon brings you free a 26-page illustrated book about thrilling careers in the R.A.F.

If you are 12 to 14 it brings you full details about the A.T.C.

TO: ROYAL AIR FORCE (HS. 54), VICTORY HOUSE, LONDON, W.G.2



NAME

ADDRESS

AGE

DATE OF BIRTH



END

END

I'M
PEPPER

I'M
SALT

CUT TWO

(BASE CUT TO
OUTLINE ONLY)

FRONT

STUDY
AT
HOME

IN YOUR
SPARE
TIME

THE BENNETT COLLEGE

*will set you on the right
course for success*

You make sure of planned progress in the career of your choice when you let the most progressive, most successful Correspondence College in the world coach you through the post. By friendly, individual training we equip you with the specialized knowledge you must have for a well-paid key position. Make the first move **TODAY**—post the coupon below!

**ALL TEXT BOOKS ARE
FREE!**

to Students of The Bennett College Ltd., we send as many volumes as the subject demands and they become your personal property.



IS YOUR CAREER HERE? IF NOT, WRITE FOR FREE ADVICE

- | | | |
|--|--|--|
| Accountancy Exams. | Engineering. | Radio Service Eng. |
| Agriculture | All branches. Sub- | Radio (Short Wave) |
| Applied Mechanics | jects and Exams. | Road Making and |
| Aviation (Engineering and Wireless) | General Certificate of Education Examination | Maintenance |
| Blue Prints | General Education G.P.O. Eng. Dept. | Salesmanship |
| Boilers | Heating and Ventilating | Sanitation |
| Book-keeping. Accountancy, and Modern Business Methods | Institute of Municipal Engineers | School Attendance Officer |
| Builders' Quantities. Building, Architecture, and Clerk of Works (A.R.I.B.A. Exams.) | Journalism | Secretarial Exams. |
| Carpentry and Joinery | Languages | Sheet Metal Work |
| Chemistry | Mathematics | Shipbuilding |
| Civil Engineering | Metallurgy | Shorthand(Pitman's) |
| Civil Service | Mining. All Subjects | Short Story Writing |
| All Commercial Subjects | Mining. Electrical Engineering | Short Technical Courses |
| Commercial Art | Motor Engineering | Speaking in Public |
| Common Prelim. E.J.E.B. | Naval Architecture | Structural Eng. Surveying (R.I.C.S. Exams.) |
| Concrete and Structural Engineering | Plastics | Teachers of Handicrafts |
| Diesel Engines | Play Writing | Telecommunications (City and Guilds) |
| Draughtsmanship. Electrical or Mechanical | Plumbing | Television |
| Estate Agency | Police, Special Course | Transport Inst. Examinations |
| | Preceptors, College of Press Tool Work | Viewers, Gaugers Inspectors |
| | Pumps and Pumping Machinery | Weights and Measures Inspectors |
| | Quantity Surveying —Inst. of Quantity Surveyors Exams. | Wireless Telegraphy and Telephony Works Managers |

COUPON. CUT THIS OUT

IF YOU ATTEND TO THIS NOW
IT MAY MAKE A WONDERFUL
DIFFERENCE TO YOUR FUTURE.



To Dept. 62
THE BENNETT COLLEGE LTD.
SHEFFIELD

Please send me (free of charge)

Particulars of.....
(Cross out line which does not apply.)

Your private advice
about
PLEASE WRITE IN BLOCK LETTERS

Name.....
Address.....
Age if under 21.....

FOR EVERY PURPOSE

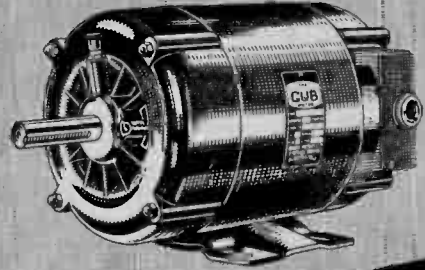

IN THE SMALL HOME WORKSHOP.

(... use a BROOK 'CUB' Fractional h.p. motor). Single, two or three phase supply. 0.166 to 1 H.P. Supplied with or without feet. Flange and Resilient Mounting types available.



BROOK MOTORS LIMITED

EMPRESS WORKS • HUDDERSFIELD

1.KS.206

USE THIS FOR DEVELOPING
YOUR HOLIDAY SNAPSHOTS

UNITOL

CONCENTRATED LIQUID
FINE GRAIN DEVELOPER



JOHNSON J-20 TANK

For developing size-20 roll films in daylight. Takes 10½-oz. of solution. Easy-to-load, sturdy one-piece spiral. Pouring lip for splash-free emptying. Triple light-trapped lid. Complete with new Two-Way Agitation movement and a Calculator Disc.

Price 25/-

Always ready for instant use. No filtering or dissolving needed. Fresh, active solution for every film. One ounce of Unitol, suitably diluted, is used once to develop one film and the solution is poured away. No trouble, no waste. Gives wonderful negatives. A simple calculator is also sold, giving developing times for all dilutions from 6 to 25. Unitol is ideal for the tank development of roll films.

225cc. (8-oz.) ... 3/6
570cc. (20-oz.) ... 6/6

Unitol Calculator ... 4d.

JOHNSONS OF HENDON

LONDON, N.W.4 EST. 1743

Hobbies

WEEKLY

CONTENTS

	Page
Knockabout Boat	- 289
Running Models	
from Mains	- 291
Tool-Shed and Seat	- 292
Keeping Lizards as 'Pets'	293
Toy Pistol	- 294
Replics of Interest	- 294
Novel Bedside Light	- 295
A Garden Trug	- 296
Folding Table	- 297
Plaster Mould Making	298
'Shuffling Sam'	- 299
Collecting Stamps	- 300
Pipe-Rack and Spill Holder	- 301
Toy Pistol Patterns	- 303

DESIGN SHEET FOR
BISCUIT BOX

August 22nd, 1951

Price Fourpence

Vol. 112 No. 2912

Build this Kiddies'

KNOCKABOUT BOAT

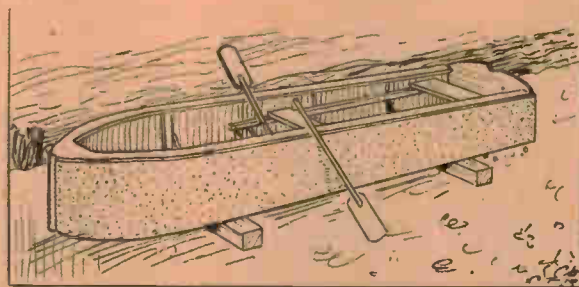

WHERE access can be had to a shallow pond or stream, where nothing worse can happen to young children than a wetting, the knockabout boat illustrated would give hours of fun and amusement. It is flat-bottomed, reasonably safe, and easy to construct, as no troublesome wood bending is involved and a building board is not necessary. It can be propelled by paddles or home-made oars, as preferred, and will stand some rough usage.

Plan and side views are given in Fig. 1, with details and measurements. Make the bottom of the boat from $\frac{1}{2}$ in. planking, tongued and grooved if available. If the edges are just square, see the boards are straight enough to join up together without leaving awkward gaps. Cut enough boards to make up the width, and 4 ins. longer than the length given. Lute the edges with thick lead paint, and join together tightly with $1\frac{1}{2}$ ins. wide battens at each end to keep all together. These battens are not removed until later on.

Mark the length and at the distances indicated by dotted lines, square pencil lines across. On these lines the frames are to be fixed in due course. At the stem end a post is to be fitted, as at (A). This is cut to 12 ins. long from a piece of 3 ins. by 4 ins. timber, and is shaped up as shown at (B) in Fig. 2. Fix this in position, truly central and vertical, with screws from underneath. Now cut the long sides of the vessel, which run the whole of the straight portion of the bottom. Slope the top edge, as in the side view, and at the front edges saw and chisel out a rebate 1 in. wide and as deep as the thickness of plywood to be used for the curved ends of the boat.

The wood for these sides can be $\frac{1}{2}$ in. or thereabouts, and a strip is cut away each side of the edges of the bottom to sink

the sides level with the rebate. Say the rebate is $\frac{1}{4}$ in. deep, and the wood sides $\frac{1}{2}$ in. thick, then the cutaway strips will be $\frac{1}{4}$ in. wide, and extend to the stern. This will allow the plywood portions, when fitted on, to come level with the sides, as in detail (D) in Fig. 2. Lute the edges of the bottom with the paint, and nail the sides firmly to them.

Stern Board

A stern board should be cut, the actual length of which will be measured across the sides, and is 12 ins. wide. This is nailed between the sides, and to the bottom, all joints being well luted with the paint. The top edge of the stern board, appearing above the sides, is cut to a smooth curve, and a good idea here is to saw out a semi-circular notch at its centre, in which a paddle can rest for steering the boat, when such steering becomes necessary.

The front, uncovered portion of the bottom, between the sides and stem post, is now pencilled to a curve. Be sure here to get both sides alike. A good method is to mark out the curve on to stiff paper, cut out, and then lay it on the bottom and run a pencil round the curved edge of the paper. The paper is then reversed, and laid on the opposite side and the curve pencilled round as before.

Four wood frames are now to be made. These are made to the same dimensions each, and shown at (C) in Fig. 2. The bottom strips are 1 in. by 2 ins., and

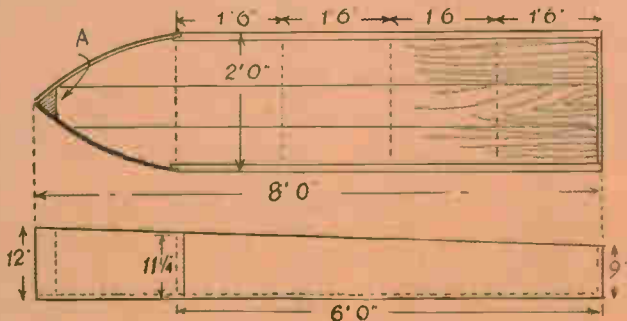

Fig. 1 - Plan and side views

All correspondence should be addressed to The Editor, Hobbies Weekly, Dereham, Norfolk.

reach across from side to side. Measure this from the boat. The uprights are cut from 1in. by $\frac{1}{2}$ in. wood, and jointed to the bottom strips, as shown in the detail. The whole are kept firmly together with side brackets cut from $\frac{1}{2}$ in. wood, and measuring 6ins. high, and 4ins. wide. They must be cut true rightangles, and be screwed to the uprights, and bottom strips. Screw these frames across both to the bottom

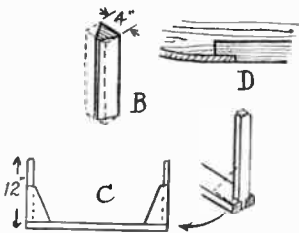

Fig. 2—Details of the stem post and frames and the method of letting in the ply bow pieces

and sides of the boat, on the pencilled lines. Now cut the curved ends of the boat, and saw off the surplus of the bottom boards, level with the stern.

Plywood Sides

A bendable piece of plywood is required for the curved side parts of the boat. Measure the exact length of these from the ends of the rebate to the tip of the stem post. Cut the plywood to the length at the rebate, and to 12ins. at the stem end, so that its top edges slope in conformity to the sides. Lute the edges and surfaces where the plywood contacts, at stem and rebates, also at the edges of the bottom, of course, and nail in place. Screw it in the rebate, to prevent it breaking away under the stress of bending.

Now saw away the surplus portions of stem, and upright strips of the frames, level all round with the sides and stem. It may be added here that all screws used should be of brass, and the nails copper. Plane the front edges of the plywood level with the edge of the stem post, to leave a 'flat'. The appearance of the forward ends of the boat will then be as shown in Fig. 3, which will help to make the details clear.

Strips of $\frac{3}{8}$ in. thick wood, 1in. wide,

are to be bent round, and screwed to the plywood on the inside, to make the ply approximately level with the inside face of the sides of the boat. These extend between where the ply joins the sides to where it is screwed to the stem, as shown at (E) in Fig. 3. A strip of wood $\frac{3}{8}$ in. square and 12ins. long is to be screwed to the stem to cover the cut edges of the plywood. Its outer edges are planed to a curve. This also is shown in Fig. 3. Screw it temporarily, as it has to be removed when the covering is

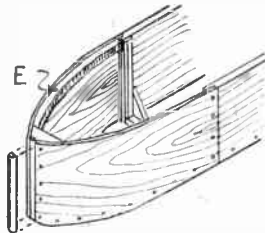

Fig. 3—Further details of the bow

fitted to the sides of the boat, dealt with later on.

A gunwale strip, of $\frac{1}{2}$ in. wood $1\frac{1}{2}$ ins. wide, is now prepared, and screwed to the top edges of the vessel. It should overlap, outside and inside, $\frac{1}{4}$ in. Straight pieces will be wanted, naturally, for the straight portions of the boat; but for the curved ends the pieces should be cut from $\frac{1}{2}$ in. board, the curves being marked on by laying pieces of the board over and running a pencil round the boat to mark the curves on the board. Cut a separate piece of the board to cover the top of the stem, and see a neat close joint is made between it and the ends of the curved portions of the strips. These pieces should be marked with a pencil,

CUTTING LIST

Stem post—1ft. by 4ins. by 3ins.
Stern—2ft. by 12ins. by $\frac{1}{2}$ in.
Bottom (3)—8ft. 4ins. by 8ins. by $\frac{1}{2}$ in.
Sides (2)—6ft. by $11\frac{1}{2}$ ins. by $\frac{1}{2}$ in.
Sides (2)—2ft. 4ins. by 12ins. by $\frac{1}{2}$ in. plywood
Frames, bottom strips (4)—2ft. by 2ins. by 1in.
Frames, uprights (8)—1ft. by 1in. by $\frac{1}{2}$ in.
Gunwale coaming— $\frac{1}{2}$ in. by $1\frac{1}{2}$ ins. by 12ft. run.
Bottom slips— $\frac{3}{8}$ in. by $1\frac{1}{2}$ ins. by 30ft. run
Remainder from scrap wood.

and can then be removed for permanently fixing after the covering is put up.

Turn the boat over, and cut and screw on pieces of $\frac{3}{8}$ in. wood to the bottom of the boat, against the edges, as in detail given in Fig. 4 (one side only being shown). Now the covering, mentioned before, can be got ready, and fixed. For this a material like calico

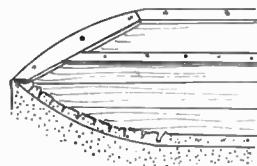

Fig. 4—Preparing the bottom for its covering

would serve excellently. Strips should be cut 14ins. wide, for the sides, and long enough to fold over at stem and stern. Do one side at a time. Lightly tack to the stem, then paint the side of the boat, and lay the material on. Press it well in contact, and tack temporarily to the stern. Do the other side similarly. Cut a piece to cover the stern board to the level of the sides, fold the ends of side and stern material together, and tack down. Fold the meeting ends at the stern and tack down there.

Fold over the top edges to the inside of the boat and rescrew the gunwale strips to cover all. Turn the boat bottom upwards, and fold the material over. It will be necessary to snip it a little at the curved portions, as in Fig. 4. Then replace the bottom strips. Cut away any surplus material sticking out from these covering strips. Finally, cover the joints of the bottom boards with $1\frac{1}{2}$ ins. wide strips of wood, well luted with the paint, and nailed securely over.

A strip of wood is nailed across the uprights inside the boat, on which seat boards, 8ins. wide, can be supported. These are seen in the general view of the completed vessel. Varnish or paint the interior of the boat. Size the outside, and paint with a good lead paint, any colour preferred. The gunwale and stem strip look nice if painted a contrasting colour, or stained and varnished.

A pair of paddles or simple oars will complete the outfit. (396)

Running Models from Mains—(Continued from page 291)

Current Requirements

The transformer used should be capable of delivering the current required by the lamps, motor, or other units. For example, small 'bell' transformers only deliver about $\frac{1}{2}$ amp., and would only be suitable for a very small motor, or a small number of low-consumption bulbs.

Moderate-sized transformers capable of delivering 4 to 8 amps. or so are quite cheap, and will give ample current for most ordinary models. It is not necessary to take all the current, the

rating being only the *maximum* figure, which should not be exceeded. If the transformer grows hot after a period of

Readers are reminded that Design Sheets are given free with alternate issues of Hobbies Weekly, but not with back numbers

use this shows that too much current is being taken from it.

Finally, proper care should be taken in all wiring, etc., where mains voltages are present. Many mains-supply wall sockets have a third, large socket for earthing, and if a lead is taken from this to the metal framework (if any) of the motor or other model, this assures that no shocks will arise, from touching the latter, even if the transformer breaks down, or a short circuit arises bringing one mains supply lead into contact with the model or its wiring. (401)

An expert tells you about RUNNING MODELS FROM MAINS

THOUGH batteries have their advantages, it is far more economical to use mains supplies to drive models, when possible, while the inconvenience involved in renewing the battery when it is found to be discharged is avoided. With a suitable mains-supply circuit the model is always ready for use, and can be operated for long periods at almost negligible cost, as the current consumption is very small, compared with most ordinary domestic equipment.

To reduce the mains voltage of 200 to 250 to the low figure required by model motors, bulbs, and similar items, a mains transformer is the best method. Good ex-service transformers may be cheaply obtained from ex-government equipment stores. The primary should have a rating suitable for the mains supply, while the secondary will deliver the low voltage required by the model. As the secondary is electrically isolated from

this type. If the motor has a permanent magnet for the field (usually of horse-shoe shape) a rectifier circuit is required, as will be explained, as these motors will only operate from direct current.

Model Lighting Circuits

In some models (for example, a doll's house) a number of small torch bulbs are used, and these can also be driven from a transformer, which is an economical and trouble-free method. Various possible circuits are shown in Fig. 2.

If the transformer secondary gives an output suitable for the voltage of the bulbs, all the latter are wired in parallel as shown at (A). A 4 volt secondary could supply 3.5 volt bulbs, or 6 volt bulbs, if a strong light is not required. With a 6 volt secondary 6.3 volt bulbs (used for radio receiver dial lights, etc.) could be used. 12 volt screw-in type torch bulbs are also obtainable, and could be used with a 12 volt transformer. Bearing this in mind, a transformer already in hand and used for driving a motor, may prove suitable.

Unfortunately this circuit is slightly more critical than those previously mentioned, because a voltage drop will arise in the rectifier, and this must be allowed for by having a secondary which delivers rather more voltage than the motor actually requires. The actual voltage drop depends upon the characteristics of the rectifier and the current taken by the particular type of motor used. The rectifier should have a voltage-working rating suitable for the output required—usually 6 or 12 volts. (A rectifier can be used on a smaller voltage than that at which it is rated, which is the *maximum* figure). It should also be able to handle the current taken by the motor.

Current Consumption

With the better-class model motors, the current consumption is usually marked on them, or given in accompanying data or instructions. Frequently it is about 2 to 3 amps., and a 2 to 3 amps. rectifier can, therefore, be used. If the consumption is not known, it may be measured with a meter.

It is also possible to arrive at a suitable circuit by experiment. If the rectifier grows hot and the motor is sluggish, insufficient current is being provided. If the motor runs too fiercely, the voltage and current are too high, and may be reduced by a wire-wound resistor of low value in one lead. Transformers with secondary tappings giving outputs in steps of 2 volts or so are obtainable. With these, tappings may be selected which give best results.

Charging Circuit

If an accumulator is already used for a D.C. type motor, the above difficulties may be overcome by retaining the accumulator, and charging it by means of the circuit given in Fig. 4. This has the advantage that the current output is not in any way critical—if this is low, it will merely be necessary to leave the unit operating longer, to charge the accumulator.

The meter is optional, but can be obtained for a few shillings and shows the charging rate. The resistor is primarily to prevent a complete short circuit if the accumulator is wrongly connected, but also governs the charging rate. The higher its value, the lower will the rate become. With a tapped or variable resistor, any accumulator from 2 volts upwards can be charged, if the rectifier delivers 12 volts. As a small current is satisfactory, a small rectifier can be used: one delivering up to about $\frac{3}{4}$ amp. would cost about 4 to 5 shillings; a transformer would be a few shillings more. This avoids the large rectifier necessary in Fig. 3, even if the motor consumes a heavy current.

(Continued foot of page 290)

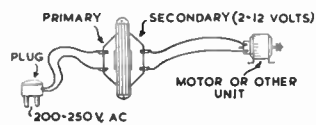

Fig. 1 — A transformer steps voltage down

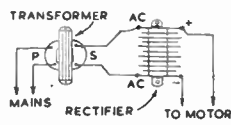

Fig. 3 — Circuit for permanent magnet motors

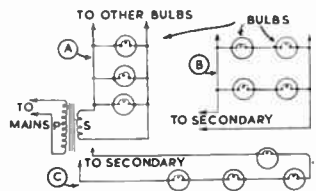

Fig. 2 — Series and parallel connections for lamps

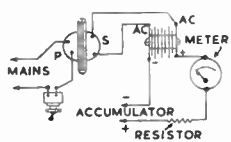

Fig. 4 — An accumulator trickle charger circuit

the primary, no danger of shocks is present when handling the secondary connections, or items connected to them, unless the transformer breaks down, which is not likely.

Transformer Circuit

Such a circuit is shown in Fig. 1. The primary connections, of course, will have the full mains voltage, and so a proper mains-plug must be used, with good quality insulated flex. With some transformers an insulated cover conceals the primary terminals or tags. If this is not so the transformer should be situated in a safe place, or enclosed in a box to prevent the primary tags being touched. (Some ventilation should be allowed).

It is important to note that a transformer can only be used on alternating current mains (most parts of the country are wired with this type of supply). The output is also A.C. and the type of motor with a wound field and armature must be used. Again, most motors are of

considerably increased. The bulbs should be of similar type.

Similar bulbs may also be wired in series, to make up any required voltage, as at (C). Four 3.5 volt bulbs (making up 14 volts) could be driven from a 12 volt secondary, and so on. Any number of bulbs required may be wired in series in this way.

With these various circuits it will usually be possible to arrange something using transformers and bulbs already available.

For D.C. Motors

D.C. type motors are largely used in model railways because the train can be reversed by reversing the polarity of the supply, and a circuit suitable for driving such motors is shown in Fig. 3. A full-wave metal rectifier changes the A.C. output of the transformer into D.C. for the motor. The rectifier should be mounted so that air can circulate round it; if it is in a box, this should have rows of ventilating holes.

You can build this garden TOOL-SHED AND SEAT

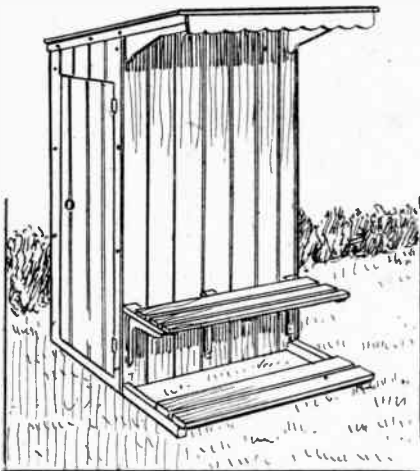

THIS is a combination of two useful articles, a handy shed for tools, and a garden seat. The construction is quite within the scope of any handyman, no difficult joints being encoun-

place, in fact, it would be safer to nail this across before fixing the roof timber on top, to better ensure the verticals being parallel with each other.

In one end frame only (the left side one), make up a door, as shown, of similar wood to that used for the rest. In the other end frame, just nail a rail across the opening, about midway. The brackets are cut to the shape from $\frac{3}{4}$ in. board, and screwed in the upper angle to support the overhanging roof. While on this part of the job, cut a third roof timber, notching it like the end ones. This will be fitted across the complete framing later, to make a middle roof rafter to support the roof.

Fig. 2 shows the front and rear frames, half of each being represented to save space. These are almost identical, the only difference being in height, the rear frame being lower than the front one, to slope the roof upwards, so that rain trickles down to the back of the shed. The position of the horizontal middle rail can be amended, as if asbestos sheet be used to cover, these rails should be placed to suit the width of sheet, the

CUTTING LIST M

- End frames, verticals (2)—5ft. 4ins. by 2ins. by $1\frac{1}{2}$ ins.
- End frames, verticals (2)—5ft. 7 $\frac{1}{2}$ ins. by 2ins. by $1\frac{1}{2}$ ins.
- End frames, ground rails (2) 4ft. 6ins. by 2ins. by $1\frac{1}{2}$ ins.
- End frames, roof timbers (2)—4ft. 9ins. by 2ins. by $1\frac{1}{2}$ ins.
- End frames, horizontal rails (2)—2ft. 5ins. by 2ins. by $1\frac{1}{2}$ ins.
- Front frame, verticals (2)—5ft. 7ins. by 2ins. by $1\frac{1}{2}$ ins.
- Front frame, ground and top rails (2)—4ft. by 2ins. by $1\frac{1}{2}$ ins.
- Front frame, middle rail—3ft. 9 $\frac{1}{2}$ ins. by 2ins. by $1\frac{1}{2}$ ins.
- Rear frame, verticals (2)—5ft. 3 $\frac{1}{2}$ ins. by 2ins. by $1\frac{1}{2}$ ins.
- Rear frame, ground and top rails (2)—4ft. by 2ins. by $1\frac{1}{2}$ ins.
- Rear frame, middle rail—3ft. 9 $\frac{1}{2}$ ins. by 2ins. by $1\frac{1}{2}$ ins.

Door frame, middle parts, etc. —40ft. run of above.

- Roof sides— $\frac{3}{4}$ in. by 2ins. by 9ft. run.
- Board (D)— $\frac{3}{4}$ in. by 4ins. by 4ft. 5ins. approx.
- Seat boards— $\frac{3}{4}$ in. by 3 $\frac{1}{2}$ ins. by 13ft. run.
- Foot boards— $\frac{3}{4}$ in. by 4ins. by 9ft. run.
- Odd items from scrap wood.
- Matchboarding or asbestos sheeting to cover.
- Felt for roof.

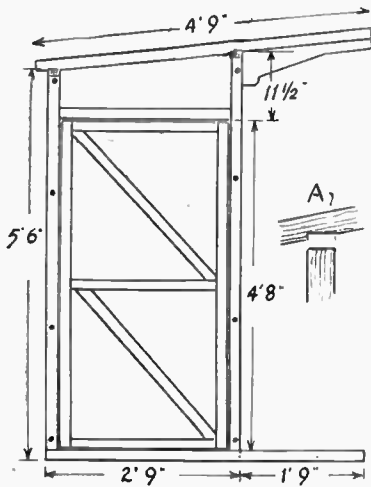

Fig. 1—The end frames

tered anywhere. It consists of a framing, covered with matchboarding, or asbestos sheeting if the former is not available, and it will be seen that the seat is provided with an overhead canopy as a shelter.

The end frames, Fig. 1, are made up from $1\frac{1}{2}$ ins. by 2ins. deal. Join up the verticals to the ground rails, then lay the roof timber across, and mark off the places where the verticals come, and here cut out notches, as in inset (A) for the verticals to 'sit' in. All joints are just butted and nailed together. It will be wise here to bore preliminary holes for the nails with a gimlet, to avoid splitting the wood. Nail the cross rail in

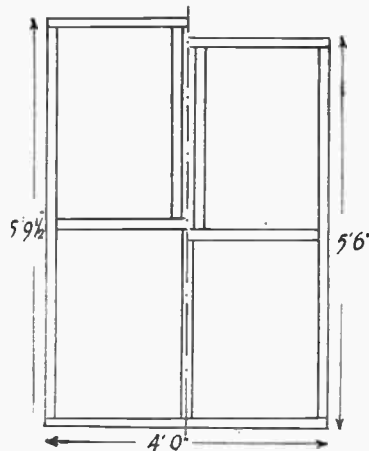

Fig. 2—Front and rear frames

butted edges of which need to come over them for nailing. Purchase the sheets beforehand, then the rails can be fitted to suit and waste of material averted. The middle verticals are not in line, one being central and the other to one side, to make nailing simpler.

An important point in the con-

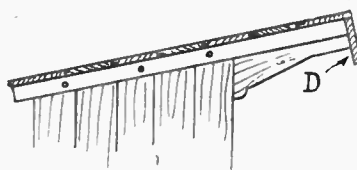

Fig. 4—The roof

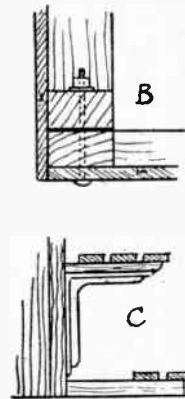

Fig. 3—Details of the way the frames are joined, and the seat arrangement

Important Point

struction of these front and rear frames needs stressing here. The wood should be framed up so that the broad sides of the timber meet with the broad sides of the end frames, as at (B) in Fig. 3, as the whole four will be bolted together to make the shed portable. All frames should now be bolted together, the position of the bolts being indicated in Fig. 1. Bore the bolt holes first through the end frames, then place together and with the drill bit through the holes bored, complete the boring through the front and rear frames. This should make the framing quite firm.

(Continued foot of page 293)

You may be interested in KEEPING LIZARDS AS 'PETS'

It is in summer that you find much fun in discovering various kinds of creatures to keep as 'pets'. Lizards, for instance. They are interesting, because only few people seem to have seen them in their natural habitat. Yet they are far from uncommon. 'Come and see my lizards!' is an invitation that is sure to be accepted. Your friends will certainly be pleased to get a close-up of such fascinating pets.

Unusual and Pretty

They are unusual and pretty, and such species as the wall lizard, and the eyed lizard are hardy. Of lizards commonly found in this country the Green Lizard, and the Sand Lizard are adaptable to confinement.

Let us take the latter first. You will find it on heaths, sandy wastes, commons, and open spaces. It has a way of sliding quickly under herbage and ground vegetation when disturbed. It feeds chiefly on flies and small insects, and is quick and lively in its habits.

The Viviparous Lizard grows to 6 or 7 ins., and in colour is brown or reddish-brown above, and orange below; but it is a variable species, having darker or lighter spots with sometimes a dark, yellow-edged band on the sides.

The Green species is very pretty, emerald green being the prevailing colour, with yellow underparts and a bluish throat; it has a long tail. Its habitat is in rocky places, and this lizard is more common in the Channel Islands, as also is the Wall Lizard, which, as its name indicates, has a liking for living in old walls.

The Common Lizard is, perhaps, the

best kind to keep in confinement, while the Green requires more attention and care. Lizards are not particularly 'faddy' about food, eating insects of various kinds, earthworms, snails, and similar creatures.

Habits

All these lizards have similar habits. They are mostly inactive in cold weather. But in summer, especially in hot sunny weather, they become very lively and flick off when disturbed as quickly as a flash. At night they incline to become torpid. If handled when in their lively mood they take some holding, and will try to make a quick getaway, and often succeed. Failing to do this, they will shed their tails, leaving the skin in your hand, most probably. Minus a tail a lizard loses its beauty—much of it, anyway.

It is advisable to keep the different species apart, having a separate vivarium for each. They do not always agree.

When hunting lizards on the sandy banks, heaths, and stony wastes, the best way to catch them is by means of a thread-noose attached to a thin, pliant wand, such as a willow slip, or longish hazel twig. Catching them with your hands is seldom quite satisfactory.

The Vivarium

A vivarium for keeping lizards need not be an expensive item. All you need for the smaller kinds is a wooden box about 2ft. by 18ins. by 12ins. Knock out one side of the box and replace with a sheet of glass. Set the box so that the pane is in front. If you can fix the glass so that it can be made to slide in and out at

will, so much the better. In the sides of the box, bore a number of small holes and fasten over them small sheets of perforated zinc, or similar material. This affords good ventilation, and such a box will do for three or four of the same species, as the Sand Lizard.

Or you can have a door made of perforated zinc in one side of the box, and a fixed glass front.

For larger species the box should be about 4ft. long, 2ft. high and 2½ft. wide.

It is unnecessary to paint the inside of box, but it is as well to give the outside a coat of green paint, to keep out rain, if the vivarium is in the open. Stand the box a little way off the ground, on stones or bricks. The bottom of the vivarium should be strewn with sand, about 1in. deep with a little shingle among it, and a heap of moss placed in one corner. A tree branch to fit at one end of box will be an advantage, and a piece of cork or similar material to afford the creatures a retreat should be rigged up.

Love the Sun

Remember, lizards are true sun-children, loving warmth, so that the vivarium should always be placed in a sunny spot to get the maximum of sunshine. A small pan or saucer of clean water must be kept inside the box.

Writing of lizards, by the way, reminds us that on occasion it is possible to obtain from the pet shops one of those near relatives of the lizard family, the gecko, which has sucker-like pads on its feet, enabling it to run at fast speed even when upside down. The gecko is an interesting creature and amenable to captivity. (340)

Tool-Shed and Seat—(Continued from page 292)

Now cover the frames with the matchboarding or asbestos sheeting. Cover the front and rear ones first, then the ends, removing the bolts, temporarily, of course, the matchboarding in the latter case, covering the cut ends of the boarding of the front and rear frames also. The door frame will, of course, be covered separately. Nail the material only to its own frame, not the adjoining ones, or the shed will not come apart, obviously. Fit the door in place with 2ins. iron butt hinges, and fit also a convenient lock to the door to secure the contents of the shed against possible theft. Note that the hinges are to be fitted to the right hand side, so that the diagonal braces rise upwards and not the reverse way.

The middle rafter, already mentioned, is now fixed across. This is not to be nailed, but is secured across with metal brackets, screwed inside to the top

cross rails of the frame. It may be possible to get a couple of metal ties for this job, such as are used in most portable buildings to fit the roof rafters in place, and allow for their easy removal at any time.

Fitting the Roof

For fitting the roof, cut two pieces of 3in. wood, to the same length and width as the roof timber. These are bolted to the roof timbers, as in Fig. 4, level with the tops of the frames. A board of wood (D) is now prepared. It should be the outside length of the hut, and is screwed to the ends of roof timbers. The bottom edge of this can be scalloped, as in the general view. Now nail the roof boards to the roof middle rafter, and the end bolted on rafters, not to the frames or board (D). It will be seen that the roof could now be lifted off if the end timbers are removed and

the middle rafter unscrewed. Cover the roof with roofing felt.

The seat arrangement is detailed in Fig. 3 (C). Obtain a pair of metal shelf brackets, the 12ins. by 14ins. size, and screw these to the front of the shed, one near each end. An extra one for screwing to the middle might be added also to strengthen the seat. To these, screw top boards of 1in. wood, 3ins. wide, and across these seat boards as shown. A pair of footboards, screwed across the ground rails, as in the drawing, will complete the work.

The underside of the ground rails, and bottom rails of the front and rear of the shed should be creosoted. The remainder can be painted as desired. A concrete base for the shed to rest upon would be an advantage, but if this is not provided, the shed could well be erected on a layer of crushed cinders, well rolled down. (422)

Small boys will love this TOY PISTOL

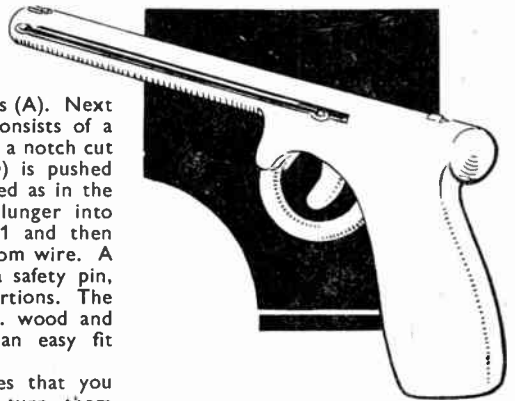

THE realistic toy shown here is made almost entirely from wood, and the power is derived from elastic. It fires wooden pellets with sufficient force to make it attractive, yet without power enough to do any damage. It has no loud report as with 'cap' guns, and so will not be a nuisance to the family.

Full size patterns are given on page 303 and these should be traced on to $\frac{1}{4}$ in. wood and carefully cut out with the fretsaw. Piece (B) is rather fragile until it has been glued between pieces (A), so take care when cutting and glasspapering.

The first step in making up is to glue

piece (B) to one of the pieces (A). Next make the plunger, which consists of a piece of $\frac{1}{4}$ in. round rod with a notch cut in as shown. The wire (D) is pushed through and two eyes formed as in the small sketch. Drop the plunger into position as shown in Fig. 1 and then proceed to make a spring from wire. A good suggestion is to use a safety pin, cutting off the unwanted portions. The trigger (C) is cut from $\frac{1}{4}$ in. wood and rubbed down until it is an easy fit between the sides (A).

Now take the two pieces that you have glued together, and turn them over so that (A) is uppermost. Drive two $\frac{1}{4}$ in. fretpins into the positions marked 1 and 2. Turn the pieces over

again and drop the spring and trigger on to the pins as shown in Fig. 1. Next smear the remaining side with glue and place in position, pressing it on to the two fretpins firmly. Make sure the plunger is in place before assembly. Two screw eyes are now put in at the position marked (3) on the piece (A). Move the plunger forward as far as it will go, and then tie elastic round the screw eyes and the hooks (D). To load the gun, pull back the plunger until it engages with the trigger, and then slide the wooden pellet down the muzzle.

Finishing

To give a good appearance to the toy, it may be rounded off wherever practicable, and then painted with two or three coats of quick-drying black enamel. (404)

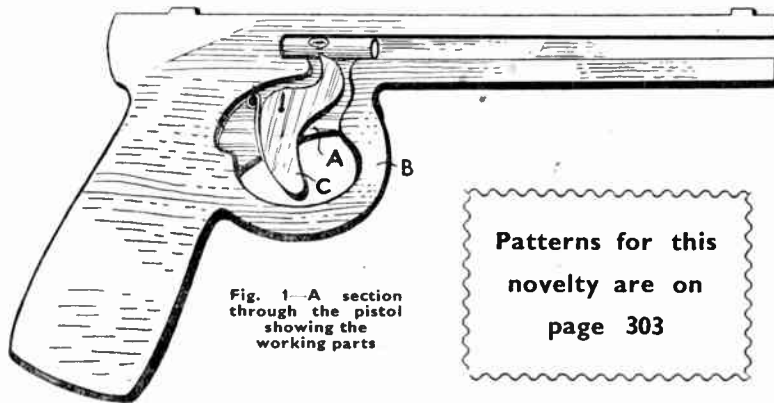

Fig. 1 - A section through the pistol showing the working parts

Patterns for this novelty are on page 303



Transmitting

HAVE you at any time published a simple plan for an amateur's elementary transmitter, range of the British Isles? Also, can you recommend a book, something like *Radio for Beginners transmission stuff?* (D.W.—Poplar).

NO transmitter circuits have been given in *Hobbies Weekly* because it is illegal to transmit without a special licence. The latter may only be obtained after the applicant has passed a severe examination in radio theory and practice, and also a Morse sending and receiving test, by arrangement, and even if speech only is to be employed. Full details of these tests, etc., may be obtained from The Engineer-in-Chief, Radio Branch, W.5/5, G.P.O., London, E.C.1. As a guide, it may be noted that a very high standard of knowledge is

required. George Newnes Ltd., Tower House, Southampton Street, Strand, W.C.2 are publishers of technical books, and have many on various aspects of radio, including transmitting.

Chromium Query

IWONDER if you have given in any of your issues, how to chrome the handle-bars of a bicycle. The handle-bars of my bike are rusty and the chrome is peeling off. Can you give details how to give them a fresh coating of chromium? (J.F.—Wakefield).

IT is impossible for you to re-chrome your handle-bars because chromium plating requires a good deal of special apparatus, is a dangerous process and can only be done under properly con-

trolled industrial conditions. You can obtain from most good cycle dealers, a silver plating solution, which you can use quite easily, but if applied in patches will show different colours. Alternatively you could highly polish the rusty parts and then coat them with colourless lacquer, or the dope sold by model aeroplane shops. This looks very well in practise as a working substitute for the real thing.

Gelatine Moulds

IWISH to make some novelty moulds from gelatine; can you please tell me how to do this? (P.F.—Newcastle).

THE usual way of making gelatine moulds is to place the article to be modelled, in a suitable cardboard or other container, and then pour the gelatine over it and leave to solidify, after which, the model can be removed. The gelatine can be melted under gentle heat in the usual way. The number and arrangement of moulds for any one article is, of course, determined by its shape and the amount, if any, of undercutting, having due regard to the degree of flexibility of the gelatine.

Don't be 'left in the dark'—make this NOVEL BEDSIDE LIGHT

THIS novel light is just the thing to rest on a bedside table. It gives enough illumination to enable one to see the time during the night, and works entirely from a self-contained No. 8 battery. Alternatively, it could be placed besides a child's bed, and would inspire confidence in a timid youngster with the knowledge that a light is there, if wanted.

Of course, the illumination is not brilliant, and only of the 'flash' variety, as the small battery employed would not permit of a spell of light. But in most cases just the flash is sufficient.

·Venetian Gondola'

The body part has a suggestion of a Venetian gondola, and is quite easy to model. Construction is of the usual

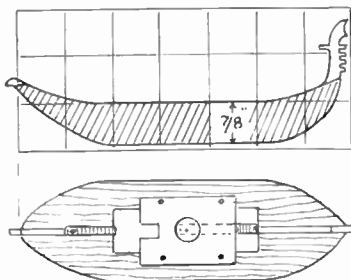

Fig. 1 Plan and side views with 1 in. squares

kind, being a central part, with additions either side glued to it, and shaped up. A side view and plan of the body are given in Fig. 1. The side view is drawn over 1 in. squares, and should be copied on thin paper. Draw the whole outline, transfer it through carbon paper to 1/4 in. fretwood, and saw out. Now trace the shaded portion above on to 1 in. thick deal, and cut out two of the same.

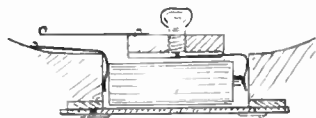

Fig. 4 Showing the arrangement of the bulb and battery

These latter parts have their outlines, plan and side ones pencilled on, and remember they must be 'paired', as it were, and if marked left and right, no mistake should occur. On the inner face sides of each, saw out a groove, 3 ins. long and 1/4 in. deep, as in sketch, Fig. 2, and leave the parts at top and bottom marked with an (X) flat during the shaping. Then cut to shape and glue to the middle piece, one each side. That portion of the middle piece, running across the opening, made by the grooves, should be sawn away, to leave a clear space, 1/2 in. wide, to house the battery in.

Now shape up the vessel, which is

quite easy to do, as only the sharp angles need to be rounded off. Take care when shaping up, to leave enough 'flat' at the bottom, round the battery space, for gluing to the base. For the base, cut two pieces of 1/4 in. fretwood, one 5 ins. long, and 3 ins. wide, with an opening cut from the centre to the same size as that in the body of the vessel.

The second piece is cut 1/4 in. larger all round, with a middle opening the same width as the first piece, but 1/4 in. longer. The piece cut out of this will serve later on as a cover to keep the battery in place.

Glue these two parts together, and then glue the body of the vessel to them, taking care that the openings in all three are in alignment. A good

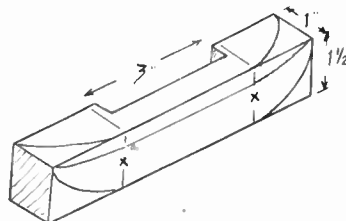

Fig. 2—Making the sides

rubbing over with glasspaper should make all smooth and shapely. Fit a pair of thin metal clips to the bottom of the base to keep the cover in position.

Now cut a piece of 3/4 in. wood to the size given at (A) in Fig. 3. Where shown by the arrow, cut out a slot, 1/4 in. wide and 1/2 in. deep, and in the centre

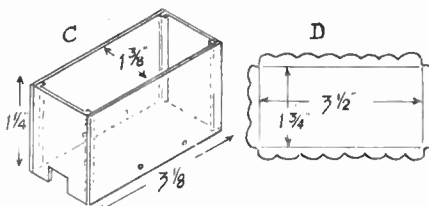
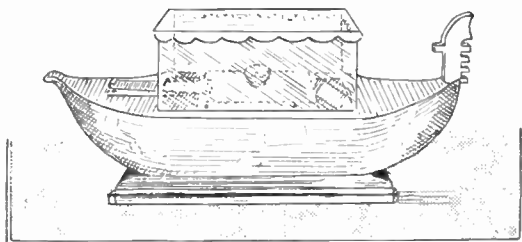

Fig. 5—Details of the canopy

bore a 3/4 in. hole through for the bulb. Underneath, glue a 1/4 in. wide slip of 1/4 in. wood along each side of the central hole. At the end of the slot bore a small hole, and in it drive a thin brass screw. This should penetrate the central hole, and contact the screw part of the bulb, when the latter is in position. Screw this part across the battery opening (as shown in plan view, Fig. 1).

For the battery contacts, cut two 1/4 in. wide strips of thin springy brass, 3 ins. long. To both, bend a piece 1/4 in. long at right angles. The right contact is now secured in place with a small screw, so that its long arm will come just under



the bulb and make connection to it. The left contact is now fitted, being secured with a screw to the deck, at its further end. The short arms, in the battery house, are bent a little, to better press the terminal ends of the battery. These details are made clear in the sectional detail at Fig. 4, which shows the battery, and lamp, in position, with the spring contacts arranged as mentioned. Fit in a bulb, and a battery, ready for testing.

A switch arm (B) Fig. 3, is cut from springy metal. To the screw contacting the threaded portion of the bulb, connect a piece of D.C.C. copper wire. The switch arm is screwed over the slot in (A), and the free end of the wire, leading from the screw, soldered to it, or twisted under the head of one of the screws holding the switch arm in

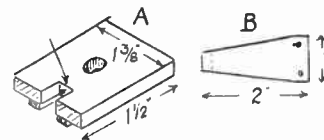

Fig. 3—The bulb holder and switch arm

position. The opposite end of the switch is curled over a bit, and as positioned, should, on being pressed down, contact the springy brass strip, screwed to the deck, as in Fig. 4. All being in order, on pressing the switch the bulb should light up. Any failure here would be due to inefficient connection, either to the bulb or the battery, and should, of course, be put right.

Finish

This completes the main part of the work, and a suitable finish should be employed to make it pleasing to the view. The hull could be enamelled black, with decks left plain, and the battleaxe prow coated with silver or aluminium paint. The base should be blue, and as a neat addition, the edges black. Of course, if some gayer colour scheme would be preferred, by all means adopt it; with a model of this kind almost any colour treatment will suit.

For the canopy part of the vessel, a thin plastic, say, 1/16 in. thick, would suit nicely. This can be quite clear, but if a

(Continued foot of page 296)

For picking fruit, you'll need A GARDEN TRUG

THE trug design of garden basket is hard to beat for general utility and holding capacity, coupled with comparative lightness. A simple form is illustrated, which can be easily made by any handyman with the cheapest of materials. Deal can be used throughout for construction; in fact, if a decent quality of grocer's box can be obtained, one of the type employed for imported apples for example, the trug could well be made from it.

The sides and ends are drawn in Fig. 1. Wood of $\frac{3}{4}$ in. thickness or a little more could be used here, free from knots and with a smooth outside surface. The inside is not so important, but the rougher kind of timber should be well glasspapered, to lessen danger of splinters. The bottom of the side pieces (A) is cut to a smooth curve, which can be described either by the old

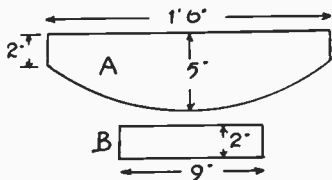

Fig. 1—The sides and ends

fashioned method of a length of string, tied to a nail, and a pencil held against the string as it is swung round, or by running a pencil along a flexible strip of thin wood, bent to the curve.

Cut two end pieces (B) to length given from similar wood to the sides, then securely nail them across, adding a little glue to the joint to strengthen it. As the trug is to be used outdoors mostly, and rain is not unknown in these islands, a waterproof casein glue is to be preferred to the ordinary variety.

Forming the Bottom

The actual bottom of the trug is formed by nailing thin wood slats across. These can be $1\frac{1}{2}$ ins. wide and long enough, of course, to stretch between the sides. A wood, $\frac{1}{8}$ in. to $\frac{3}{8}$ in. thick will serve, and some of the grocer's boxes referred to have sides of a hard wood just about right for this job. It may

be necessary, when nailing these slats across, to ensure a good fit, to rasp the curved edges of the bottom flat, where each slat comes. Two nails to each will be enough, and $1\frac{1}{2}$ ins. wire nails about the right kind and size to hold them firmly.

Some weight comes on the slats, as the trug can hold quite a lot of stuff, and some additional security is assured by wiring them to the bottom, as well as nailing. For this two lengths of tinned iron or galvanised wire will be needed, and a number of small staples, such as can be bought at the ironmongers. Twist one end together to form a small 'eye', and secure this end to one of the side pieces, near to the top edge. Now draw the wire tightly over the slats, and fasten it to the bottom, between each slat, with a staple, as in detail sketch, Fig. 2. Finish each side by twisting the free ends of the wires to form 'eyes', and screwing through these to the opposite ends of the basket.

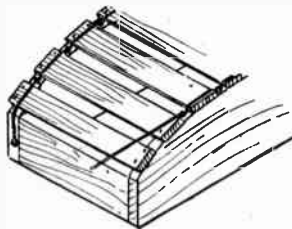
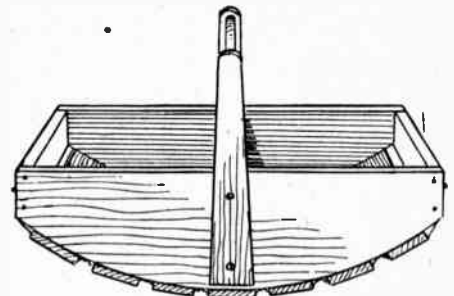

Fig. 2—Making the bottom secure

Hammer the wire closely to each slat, as the work progresses, and then drive in a staple over the wire to fix it to the middle of each slat in turn. No fear then of any of the slats breaking away when the trug is loaded to capacity. A good rub over with glasspaper can now be given to remove roughness, and splinters.

The handle arrangement is drawn in Fig. 3. The side pieces of it (C) can be cut from any available wood, not too thick. About $\frac{1}{2}$ in. will be ample. The cross piece (D) is cut to the overall width of the trug, with enough at each end for a tenon to enter parts (C). Cut it $1\frac{1}{2}$ ins. wide, and shape up as shown;



make the tenons $\frac{3}{4}$ in. long, and cut mortise slots in parts (C) to correspond. Fix parts (C) with screws to the sides of the trug, truly central; then remove one side, glue part (D) across, and rescrew in position. A good plan is to drive a thin nail through at the top of (C), to enter the tenon, and so lock the joint, as at (E).

The handle or at least that part of it to be gripped by the hand, should have

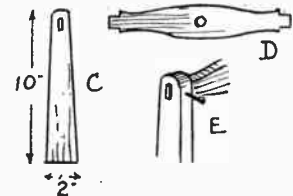

Fig. 3—Details of the handle

its sharp edges glasspapered quite smooth, for a comfortable hold. A $\frac{1}{2}$ in. hole might be bored through the middle of it, as in sketch (D), then a hook can be inserted, by means of which the trug can be suspended from a branch of a tree during fruit picking. This will be found most valuable, as it will leave both hands free to pick and fill the trug, not to mention liberty to clutch occasionally at a branch when balance becomes uncertain.

No cutting list is included here, as the trug can be built from any available wood, and sizes and widths may be amended to suit. The completed article would look and wear better if treated to a coat of varnish. (421)

Novel Bedside Light—(Continued from page 295)

little loss of light is not important, an opal or pink plastic would be more pleasing. The effect is quite pretty when the lamp 'flashes' through the coloured material. Whichever is adopted, cut and fix four pieces together to make the shape in Fig. 5 (C), and saw out at one end a piece 1 in. long and $\frac{1}{2}$ in. wide for the switch arm to protrude through. The material can be easily cut with the

fretsaw, and the end pieces, which have a strip each side turned inwards for cementing to the long sides of the shape, are easily bent by gentle heating. It is important that the inside width, given in the drawing, should be that shown, so that the completed canopy can be fitted over part (A), and fixed with a small nail or screw each side.

The canopy top (D) is cut to the

interior dimension given, plus a $\frac{1}{2}$ in. strip for bending over all round. This is scalloped along its edges. File the top edges of the canopy flat, and cement the top in position. This completes the work. If you have to purchase the fretwood, a panel of $\frac{1}{2}$ in. wood, 7 ins. wide and 14 ins. long will be ample. The remainder can be cut from scrap pieces of wood available. (379)

How to make a useful

FOLDING TABLE

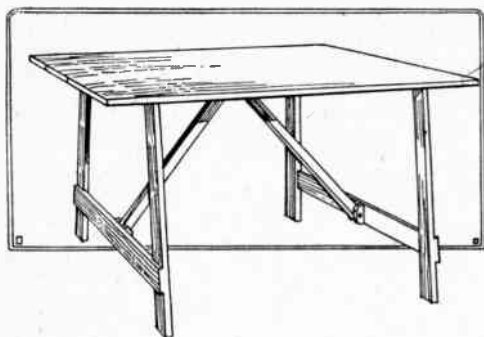

A TABLE for indoor use as well as outdoor, and one that can be taken apart, stored, or changed from place to place may be made at very little expense.

Such a table is described here, and the sketch shown gives a good idea of how it looks. The size of the table top is 36ins. long, and 22ins. wide, and the height from floor to top surface is

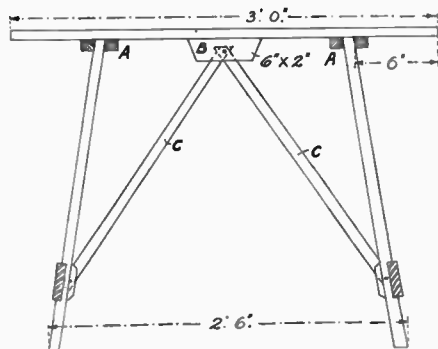

Fig. 1—General dimensions

27ins. Good sound deal should be used throughout, and, when finished, the wood may be either left in its natural state or may be stained or painted.

The method of erecting the table is shown in Fig. 1. There is a perfectly plain top with cross battens on the underside so spaced that they form recesses into which the leg trestles rest. The latter are held rigidly by cross braces.

At the junctions between the braces and the table top, there is a slightly tapered dowel pin to be driven through the bracket pieces which are fixed to the underside of the table top and through the holes in the tops of the braces. The lower ends of the braces are permanently pivoted to brackets framed on to the lower cross rails of the leg trestles. Thus the whole table may be taken apart in three distinct sections, and folded or laid together flat for transport or storage.

The table top is formed from four pieces of $\frac{1}{2}$ in. grooved and tongued matchboarding, cut in 36ins. lengths and knocked together as shown in Fig. 2. The groove along one edge, and the tongue

along the corresponding edge has to be planed away to present properly squared edges. To hold these boards well together, and to form the recesses for the legs, there must be four pieces of 1in. square stuff, 20ins. long, screwed to the underside at the distance shown in Fig. 1.

Each pair is spaced $1\frac{1}{2}$ ins. apart to allow ample room for the insertion of the legs. To the underside of the top, also, there are screwed two shaped bracket pieces (B) 6ins. long, 2ins. wide and $\frac{1}{2}$ in. thick. They must be put $1\frac{1}{2}$ ins. apart to allow for the two braces which will come between them, and which will eventually be held by the tapered dowel. Make quite certain to get these brackets central both ways or the table will not stand rigid when erected.

Bore a $\frac{1}{4}$ in. hole through the two pieces and enlarge one of them to almost $\frac{3}{8}$ in. to take the tapered dowel,

figure showing the top rail jointing and the latter the halving of the lower rails into the legs. The joints may be fastened either by countersunk screws or by $\frac{1}{4}$ in. dowel pins properly bored for, and glued and knocked well home. Clean off the ends of the cross rails flush with the legs, and then cut and fit the small pivot brackets (G) on the lower cross rails.

These brackets are shown in detail in Fig. 6. They are cut in pairs and each from $\frac{1}{2}$ in. stuff 3ins. long and $1\frac{1}{2}$ ins. wide, including the tenon. If the brackets are housed into the rails for a depth of, say, $\frac{1}{2}$ in., a stronger joint is made, but this is not wholly necessary, as the tenon alone makes a stiff joint. The small tenon on each bracket must be accurately marked out, and can be cut with the fretsaw. In getting the correct places for them on the rails, do not forget to take into account the fact that the braces which go between them are brought up side by side to the underside of the table top.

The brackets will, therefore, be $\frac{1}{2}$ in. or

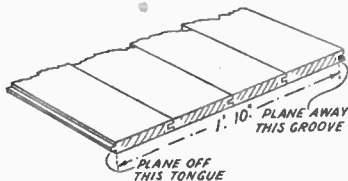

Fig. 2—The tongued and grooved top

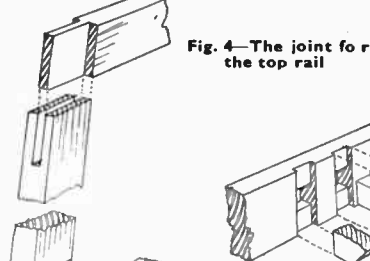

Fig. 4—The joint for the top rail

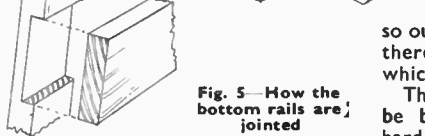

Fig. 5—How the bottom rails are jointed

which should be of hardwood $\frac{3}{8}$ in. diameter glasspapered off slightly towards one end. The top finished so far may be laid aside and the legs proceeded with.

There is a little more work in these, such as the open slotting or open halving joints to the top rails, and the half-cut through recesses for the lower rails. The general arrangement of the legs and rails is shown in Fig. 3, where (D) is the legs 27ins. long, $1\frac{1}{2}$ ins. wide and $\frac{3}{4}$ in. thick, (E) the top rails 18ins. long, $1\frac{1}{2}$ ins. wide and $\frac{1}{2}$ in. thick, and (F) the lower rails 21 $\frac{1}{2}$ ins. long, 3ins. wide and $\frac{1}{2}$ in. thick. The jointing together of these parts is shown in Figs. 4 and 5, the former

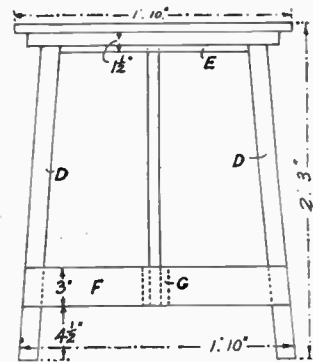

Fig. 3—Arrangement of the legs and rails

Fig. 6—Details of the brackets

so out of centre on the rails each way, so there will be no strain on the pivot pins which hold the braces to the brackets.

The pivot holes in the brackets should be bored $\frac{1}{4}$ in. diameter to take $\frac{1}{4}$ in. hard wood dowelling. The braces are each about 27ins. long by 1in. by $\frac{1}{2}$ in. thick, and are bored near the ends for the tapered pins and the pivot pins, as shown in the sketch and in the elevation of the table Fig. 1. Shape the ends of the braces suitably and see that they move freely round the pins. (398)

EGYPTIAN STYLE BISCUIT BOX

The necessary panels of wood for making the Biscuit Box from this week's free Design (No. 2912) are obtainable from Hobbies Ltd., Dereham, Norfolk, for 11/2 including purchase tax, post free.

All you need to know about PLASTER MOULD MAKING

AT this time, florists are full up with plaster vases of all shapes and sizes, for display purposes as well as for sale. Those intended for cut flowers hold a sheet metal water-container, since plaster does not hold water. The coating of cellulose paint would not hold it for long and it is difficult for the paint sprayer to guarantee the corners inside. Those which are used for bulbs do not need this container.

Simple Method

When the method of producing these ornamental vases is understood, one finds them surprisingly simple to make. The hardest part of all, in fact, is in making the mould from which the vases are cast, yet even this is simpler than

along the forward edge on top as can be seen at (a) and (c) and rounded dents are impressed in the clay at intervals with some appropriate tool.

Now oil the front surface and the clay with a soft brush. Prepare enough plaster in your mixing bowl to make a fairly thick case against the front of the vase, by adding the necessary quantity to some water. Two cups of plaster to one of water may prove a good consistency but a lot depends on the plaster used. Mix into a thick cream and when it begins to lose its liquid consistency, push it up against the vase surface. Hold the back of the vase steady and make sure you cover all points with about the same thickness of plaster. The thicker the plaster the stronger your mould, but it need not be more than about 1½ ins. thick.

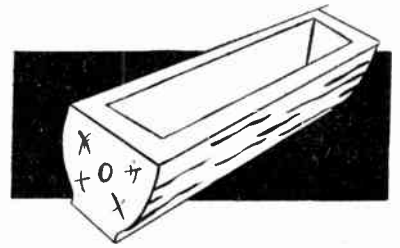

When the centre is set hard, remove the rope and prise the sections apart. The centre-piece will be inside the model. Make sure you extract this in one piece, even at the expense of the model.

Next give the three sections a coating of shellac. Smooth the centre-piece as much as possible with glasspaper and give it as many coats of shellac as you like. All air-holes should be filled as you go, with fresh plaster pressing in with the knife-end.

Directions for Casting

Oil inside the two side pieces and lay them side by side. Oil the centre-piece and lay it in position on one of the side pieces. Place the other piece over the two and tie them together without passing the rope underneath. Now turn the mould upside-down and it is ready. Mix up your plaster and pour it inside the bottom opening (which is now at the top), while it is still in its liquid form. Fill to the brim and leave to set. When hard enough, untie your rope, open the mould and take out what is your very

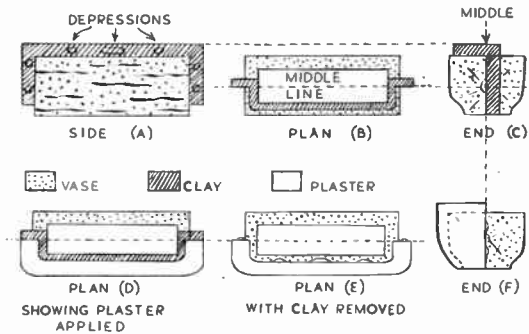

Fig. 1

may at first appear. There are two kinds, flexible and inflexible moulds. The flexible mould, made with gelatine or a rubber solution, is necessary for producing the more elaborate kind of vase, with designs on the sides, and for making statuettes, etc. Here are the basic instructions for making a mould from which one of those rustic looking 'tree-trunk' vases may be cast.

Provided you wish to make straightforward vases like this, the principle is always the same. If you have one that you would like to reproduce a few dozen times these instructions will still be of use.

A mould can only be made from a model. To make this particular mould you must either get hold of one of these vases or make one from modelling clay or solid block of plaster. Assuming that you either possess one or have modelled one, the necessary materials will be as follows: some good quality plaster, some modelling clay, either bought from an artists' suppliers or dug from the nearest field, a bottle of boiled oil, a tin of shellac, a mixing bowl for your plaster, a knife, a strong piece of wire, and a length of rope.

Stand your vase or clay model on a flat surface and build a continuous wall of clay as illustrated in Fig. 1. It comes

along the forward edge on top as can be seen at (a) and (c) and rounded dents are impressed in the clay at intervals with some appropriate tool. The oil is needed to stop the plaster from adhering. Apply another mixture of plaster as before to this new surface and allow to dry.

When dry, clean up all the outside with the knife so that the two halves meet flush with one another and there are no bits overlapping. Now remove the clay from inside the top and tie the two sections together securely.

To make the centre-piece, simply brush oil all over the inside of your model and inside the top edges. Try not to let the oil form in pools, as this will cause the plaster to flake. Mix up enough plaster to fill up the centre and pour it straight in, filling level with the top of the two sides.

While it is setting, bend your piece of wire to make the handle and press the ends down into the centre-piece. Do not let them push through against the model, and do not let any of the handle protrude from the top. Let the plaster set over it, then cut away the plaster round the handle itself until it is exposed sufficiently for you to get a grip. The mould is turned upside-down for casting, so if the handle protrudes, it would not stand evenly.

When it has set hard enough remove the clay and clean up the edges with your knife. The impressions in the clay will now be seen as convex protrusions in the plaster, and you now have one side of your mould completed.

To make the second half is a little easier. It is similar to the method just outlined, except that you now only need clay along the top forward edge. The plaster down the sides now does the work of what was the

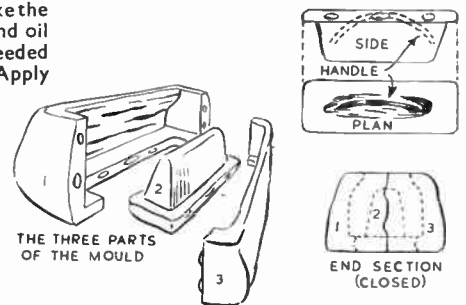

Fig. 2

first cast. The centre-piece will again be inside. Wait until it loosens before removing it by pulling carefully on the handle.

You can repeat the process indefinitely. If your mould holds out you should be able to reproduce any amount of vases from the one mould. The duration of the mould itself is the only limit. But always remember to use the oil-brush before every fresh cast.

Dry them out before painting. Remove any signs that it has come from a

(Continued foot of page 299)

You'll please the kiddies with 'SHUFFLING SAM'

THIS is a toy of the good old-fashioned kind which will be going strong long after many modern, very expensive, toys have been neglected, trodden on or have fallen to pieces. Many modern toy manufacturers turn out wonderful pieces of precision die casting, but these are a poor substitute for the robust toys that, with occasional repainting and minor repairs, used to last, literally, several generations of children.

The present toy can, if necessary, be made of wood of the 'firewood' order. Though very much of an 'action' toy, no great precision is required in the laying out. As this article is being written up with an actual model lying in front of the writer, it would be quite easy to give some actual dimensions and, possibly, patterns for squaring off. But much of the charm of this type of toy is in its oddness. The reader who 'cannot draw a line' is more likely to make a success of this than one who, passably good at figure drawing tries to make the whole thing too life-like.

Wooden Jointed

For Shuffling Sam is a wooden jointed figure held at the end of a rod (Fig. 1). By jerking the hand slightly, Sam will do a kind of tap dance (with a 'snake hips' effect) to the tune of a gramophone, the child's singing or the like. If you make his legs too long or his head too small, this only increases the odd effect.

Do not have Sam too small, nor, of course, too large, since the larger he is, the heavier, and this would be a strain on young children's hands. About 12 ins. tall would be an average size. Wood just over $\frac{1}{2}$ in. thick could be used. In Fig. 1 the model has been shown with square edges for convenience in illustrating, but one can easily whittle away such sharp edges.

The base of the body will be about 2 ins. across, and the legs, upper and lower, are about $\frac{3}{4}$ in. wide and $\frac{3}{4}$ in. thick. The head is cut with the body. The body can be made with a series of straight cuts, and the head also started thus, as suggested by the chain lines. From head to waist the body will be about 6 ins. long, but, as already suggested, make it more or less whatever you fancy. Note that where the arms are to come, the wood is left square (point X).

The arms are made from $\frac{1}{4}$ in. plywood. They are, in due course, screwed loosely to the body, with round-headed screws. A washer is placed under the head of the

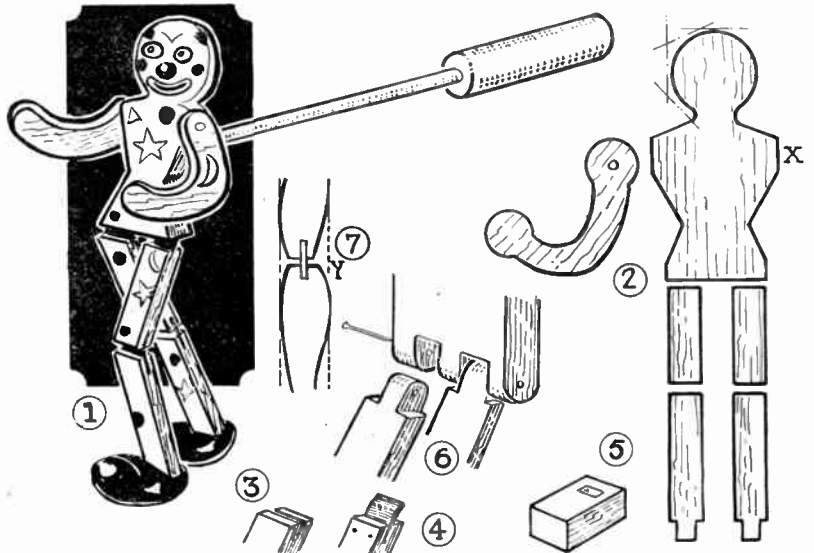

The completed toy, and constructional details

screw and also between the arm and the body. The screw is driven tightly into the body, but a fairly generous hole is drilled in the top of the arm so that the arm hangs freely and, when the model is jerked, the arms swing to and fro.

To make the leg joints, leather hinges are used. A saw-cut is made in the top of the leg (Fig. 3) and a slip of leather glued in (Fig. 4). Another slot is made and the other half of the leather glued in, taking care to leave enough free leather to make for a freely-moving joint. A few very small panel pins may also be driven in to hold the leather better. These are indicated in Fig. 4. In the case of the bottom of the body, a slot for the leather hinge is made right across.

Another Method

Fig. 6 shows another method, though for this 'knuckle joint' business you need rather good hardwood. This method has much to recommend it and Fig. 6 should more or less speak for itself. Holes are so drilled that whilst the pin passes tightly through the upper (body) part, it passes freely through the leg parts so as to secure free action.

It is possible to cut the legs from a wooden dowel, aiming at a comparatively realistic shape (Fig. 7). In this case, take care to ensure that the legs can move backwards freely, by cutting a large V shaped recess behind the knees (Point Y). It is anatomically accurate, the lower leg should not be allowed to bend

forward, only backwards, but in a simple model, as originally envisaged, 'anything goes'.

The feet are first cut from solid blocks of wood, provided with mortises into which the ends of the legs are tenoned (Fig. 5). Afterwards they are shaped, with a penknife, etc., into bulbous boots. Take care that the boots do not get in each others way.

The rod seen in Fig. 1 had best be of metal, as a thin wooden dowel would soon snap. The handle can be, for example, an old tool handle, cotton reel or the like. A hole is drilled in the body to take the rod. One can either provide a permanent fixture here, or a detachable rod. The latter, though more convenient, has the disadvantage that the handle can easily get lost.

Glasspaper all parts well and then paint in gay colours. Do not imitate the worst features of cheap-jack modern toys with their indifferent-looking sprayed-on finish. Give a priming coat and then, say, two coats of light green for Sam's suit (lightly papering down between coats). The face will be light pink, as are the hands. The lips, nose and cheek patches will be bright red and the eyes blue. The stars, dots, crescents, etc., on his costume are painted with yellow, red and blue. The boots are blue-black. The handle can be bright red and the rod, yellow. A coat of clear varnish will give a good effect and save the toy from premature scratches. (290)

Plaster Mould Making—(Continued from page 298)

mould by glasspapering, or scraping with the edge of your knife. It is a good idea to smooth round the top edges of the completed vases, too. They can be dried either in a low oven or out in the

If your friend doesn't read *Hobbies Weekly*, tell him about it. He won't be sorry for the introduction.

sun—if any. Paint with cellulose and there will be no difference between your own vases and those on display along the High Street. (394)



Introduction to The Postage Stamp

(Concluded)

What you have read so far should indicate to you the necessity for reform, and so thought one, Rowland Hill. Born in 1795, he started life as a schoolmaster in his father's school, but gave that up in 1833 and became a secretary, which gave him time to study and formulate his ideas for cheap postage.

Opposition

He printed a paper on the subject. It appeared in 1837 and was sent to members of Parliament. But, in those days, members of the two Houses had the right to 'frank' letters; that is, they could sign their names on the letters which would then go through the post without any fee at all. They had had this right since the Franking Act of 1764. An

'The Post Circular', especially printed, explaining the scheme and exposing the shortcomings of the existing service. In those days newspapers had to pay a tax, and this tax entitled them to be conveyed free of cost by the stage coach. So that the mail coach was carrying the papers which had been prepared for destroying it. Rather a curious position wasn't it?

Rowland Hill's idea was to make the postage rate so cheap that people would find it did not pay to defraud the Post Office. Moreover, by making people pay the postage

was knighted in 1860, and when he retired in 1864 he was given a lump sum of £20,000 and a pension of £2,000 a year. He died in 1879 and was buried in West-

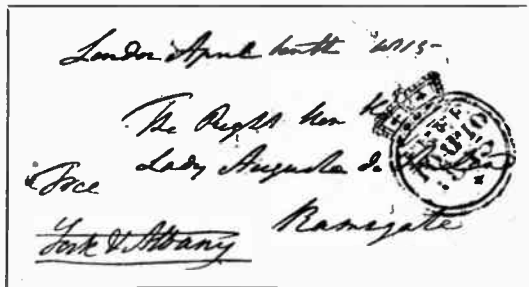

Fig. 6—A 'franked letter', which went free of charge

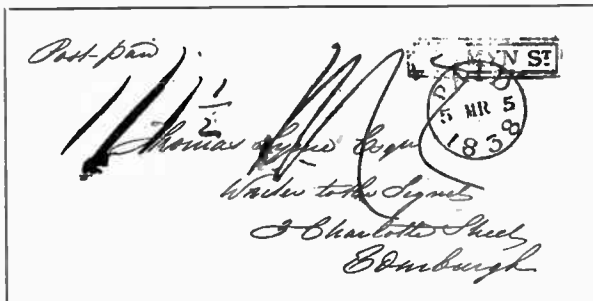

Fig. 7—Letter showing how postage rates were rising before the appointment of Rowland Hill



Fig. 8—Stamp of the London Circular Delivery Company

illustration shows one such franked letter. It was franked by the Duke of York, or, as it appears on the letter, 'York and Albany'. Then you can see the handstamp—a circle with a crown on the top, and, inside the circle, the word 'free', together with the date—10 Ap. 10, 1815. This letter is sealed at the back with the royal seal.

Now, since M.P.s could frank letters, why should they interest themselves in changing what was, for them, an excellent institution? It is said that one member of Parliament received £300 a year from one firm for franking their letters. The Chancellor of the Exchequer turned the scheme down, as he did not think that the reduction to 1d. in the cost of sending a letter, irrespective of the distance that it had to go, would lead to the extra number of letters that Rowland Hill anticipated, and make up the revenue.

The Press and the merchants of London took up the scheme and had a paper,

before the letter was conveyed, there would not be any returned letters, and this would also save the time of the postman, because he would only have to hand in the letter instead of having to wait anything up to five minutes each time he delivered while people found the money necessary to pay for the letter he had brought. At last the reform was passed and Rowland Hill was given a post in the Treasury at a salary of £1,500 a year. He

minster Abbey.

Postage rates had been going up very fast, increases having been made in 1797, 1801, 1805, 1812, and the next illustration will give you some idea of this. It shows a cover which was sent from London to Edinburgh on March 5th, 1838, and the charge was no less than 1/1½. This sum had to be paid before the letter was sent—notice the handstamp PAID 5 MR 1838 all in the circle. The ½d. was a toll for letters going to Scotland.

Big Reduction

In December, 1839, postage was fixed at 4d. per ½oz. and then on January 10, 1840, it was reduced to 1d. per ½oz. People had to take their letters and pay their money at the office. This took up considerable time, and the next thing was the production of an adhesive label which could be stuck on the letter and so show that the postage had been paid. The label had to satisfy certain conditions: it had to be artistic, be fairly easy to manufacture and yet at the same time, not easy for an unauthorised person to manufacture.

The result was the famous 'PENNY BLACK' and the not quite so well known 'Twopenny blue'. The design of these two was the same, the difference being only a matter of colour and value. The design was the Queen's Head, taken from a medal called the Wyon Medal which had been prepared to commemorate a visit of the Queen to the Guildhall.

In order to make it harder for anyone to copy the stamp, the bottom corners were left clear and afterwards letters were filled in. The first stamp of the top line had the letters A A, the second stamp of that line A B, and so on. On the second line it would be B A, B B, etc., and the third line C A, C B, etc., and thus for the twenty lines, so that the

(Continued foot of page 301)

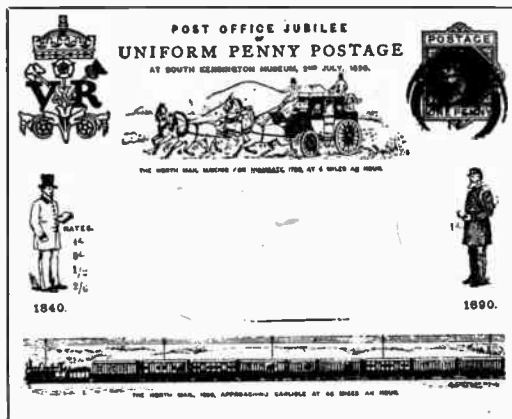

Fig. 9—The 1890 Jubilee envelope

A simple-to-make PIPE-RACK AND SPILL HOLDER

THE circular pipe-rack shown is built around a rectangular spill box, and the pipes and the spills (or pipe cleaners) are thus kept conveniently together.

The assembly is shown in Fig. 1, with

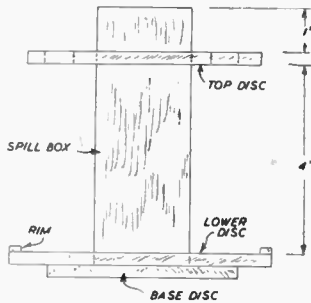

Fig. 1—Outline of assembly

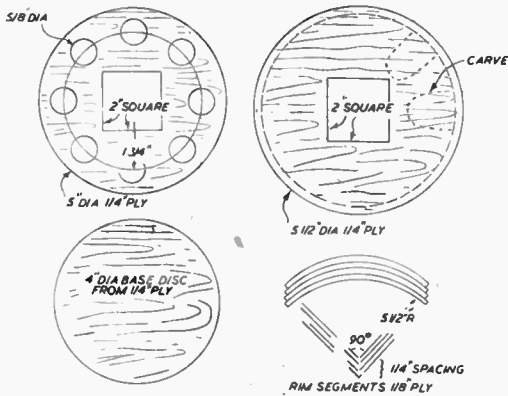

Fig. 2—The various circular parts

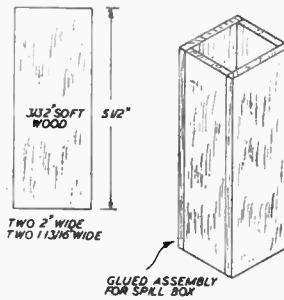

Fig. 3—The spill box

the various parts detailed in Figs. 2 and 3. Three discs should be cut from $\frac{1}{4}$ in. ply, 4 ins., 5 ins. and $5\frac{1}{2}$ ins. in diameter. The two larger discs each have a 2 in. square hole fretted out of the centre and the 5 in. disc is also drilled or fretted out with a number of $\frac{3}{8}$ in. diameter holes, as indicated. This is the top disc, the pipe stems fitting through the holes.

The larger disc is fitted with a rim of $\frac{1}{8}$ in. ply. This rim can be cut in four segments, as shown, to economise on material, and each is glued to the disc. Appropriate hollows should be carved out of the disc to take the pipe bowls. The hollows can be quite shallow and of rectangular shape with the inner edge rounded.

Spill Box

The spill box is made from four pieces of softwood, $\frac{3}{4}$ in. thick. Each piece is $5\frac{1}{2}$ ins. long; two are 2 ins. wide and the other two $1\frac{1}{16}$ ins. wide. Glue together

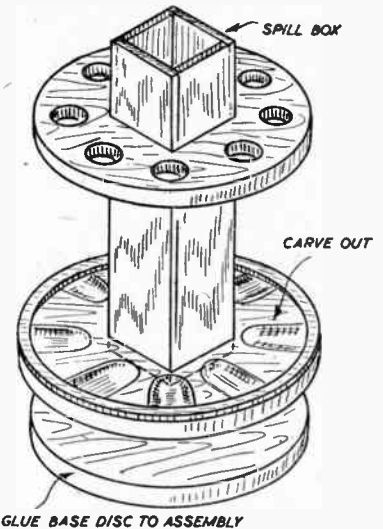

GLUE BASE DISC TO ASSEMBLY

Fig. 4—The completed article

to make the spill box as shown in Fig. 3. The top and lower discs can then be slipped in place and also glued. These will hold the box square, provided the centre (square) holes have been cut accurately. Check that the top disc is 1 in. from the top of the spill box.

Completing The Assembly

The lower end of the spill box is finished flush with the bottom surface of the lower disc, and to this is now glued the base disc to complete the assembly (Fig. 4). All sharp edges may be rounded off by glasspapering, if desired, and the whole article should be given a stained finish. (326)

Introduction to the Postage Stamp—(Continued from page 300)

last stamp would be T L. Therefore, if any tried to forge stamps, they would have to make 240 dies, or else run grave risk of being found out. On the same date as the stamps appeared, May 6th, 1840, there were two envelopes on sale called Mulready envelopes from the name of the artist who designed them. As a prevention against copying these there were two threads through the paper. If you look at a pound note of the present day you will see a thread through that. These Mulready envelopes were received with derision and soon withdrawn.

That gives you the introduction to the postage stamp, but there are a few interesting items which must be dealt with. Many private posts have been started but as nearly all have infringed the rights of the Postmaster General, they have been suppressed. For example, for a time the Oxford and

Cambridge Colleges had their own stamps, and the Oxford Union Society had the current 1d. stamp overprinted O.U.S.

Then there were various delivery companies started, such as the Court Bureau. This was a company formed to collect letters from clubs, hotels, etc., on Sunday evenings and early mornings and had 1d., $1\frac{1}{2}$ d., and 3d. stamps of its own which had to be put on the letters in addition to the usual charge. Other companies were called circular delivery companies and we illustrate the London Circular Delivery Company stamp.

The last illustration is of the 1890 Jubilee envelope. You see the postman of 1840 and also of 1890, the mail coach and the mail train, and also the charges of 1840 and 1890. Most of you will have the set of stamps which were issued in 1940 for the centenary of the adhesive

stamp, so that we do not illustrate them here.

This short description takes account of only the collection, transport, and delivery of letters, yet if you pause to think for a few moments, you must be struck by the enormous number of other services performed by the Post Office—the Savings Bank dept., issue of licences, telegrams, health and unemployment insurance stamps and old-age pensions, to name just a few. Yet all this lot have really developed through the fear of invasion many years ago.

Most of the items that have been used to illustrate these articles are quite cheap. Specimens can be purchased for a few pence—except the Dockwra mark, that would be pounds—so that anyone can make up a small but extremely interesting collection for quite a small outlay. (367)

The bristles won't come out!



Harris—the paint brush with a name to its handle

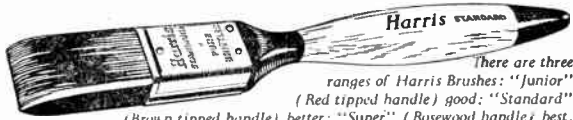

There are three ranges of Harris Brushes: "Junior" (Red tipped handle) good; "Standard" (Brown tipped handle) better; "Super" (Rosewood handle) best.

L. G. HARRIS & CO. LTD., STOKES PRIOR, WORCESTERSHIRE
CRC28

TOOLS FOR THE HANDYMAN



TOOL CLIP

For holding any handled tool. Spring steel. Holed for hanging.

7d. each

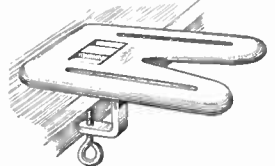

BENCH STOP

3½ ins. by 2 ins. — Spring loaded top. 6/-



SINGLE HANDED SCREWDRIVER

5 ins. long. Ideal for small work. 1/8

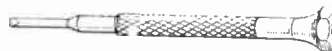

STEEL CUTTING TABLE

With clamp for easy fixing to bench. 6 ins. by 4 ins., strong and light. 3/-

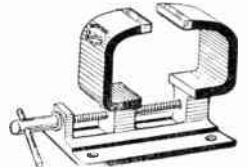

MODEL MAKER'S BENCH VICE

Strong, light and rigid, ½ in. opening. 6/3



FRETWORK HAMMER

8 ins. long. Strong and light for small work. 1/4

Obtainable from Hobbies Branches in London, Glasgow, Manchester, Birmingham, Leeds, Sheffield, Hull, Southampton, Bristol and ironmongers everywhere. Or postfree from Dept. 99, Hobbies Ltd., Dereham, Norfolk.

SPONGE RUBBER SLABS

16" x 9" x 3" blue sponge or red crepe rubber. New ex-Gov. Limited quantity only. Worth treble. Post 10d.

4/9

AMMETERS

New, moving coil, 0-1 amp. 2" round dial.

6/6



ELECTRIC MOTORS

New Ex-R.A.F. 24V Reference No. 5U/2705 Over all size 5" x 2" x 2"

8/6

VOLTMETERS, 0-20 v. 2" square dial. Post 7d

8/6

New Ex-Gov. Plastic Backed CANVAS. Superior quality, brown, non-crease, non-crack. Extremely tough, waterproof, dust-proof. Easy to sew or stick. Ideal hood covering for prams, cars, etc. 36" wide. Post 1/3 per yard

9/3



Illustrated Catalogue Free

PRIDE & CLARKE LTD., (Dept. P.W.)
STOCKWELL ROAD, LONDON, S.W.9. BR1xton 6251



Every time this door slams a little more of the mortar or putty drops out. Why? Because it sets hard and shrinks and does not really stick.

They should have used Seelastik.

Seelastik forms a watertight, airtight seal and remains flexible and elastic when set; it sticks tenaciously even to highly polished surfaces, such as glass, as well as to any combination of brick, cement, stone, plaster, wood, metal, tiles, glazed earthenware...

A Seelastik seal costs ¼d. to 1½d. a foot, depending on its width. It is light-coloured, and can be painted 24 hours after it is put on.

You can buy Seelastik — packed in handy cartridges, and applied by the Expandite gun (50/- with two nozzles) — or in 2/- and 3/- tubes, which are self-contained sealing tools.

Seelastik SEALS THE GAP 

EXPANDITE LTD., CUNARD ROAD, LONDON, N.W.10



BRANCHES

LONDON

78a New Oxford St., W.C.1 (Phone MUSEum 2975)
87 Old Broad Street, E.C.2 (LONDON Wall 4375)
117 Walworth Road, S.E.17 (RODney 5509)

GLASGOW

326 Argyle Street (Phone CENTral 5042)

Head Office & Factories—HOBBIES LTD., DEREHAM, NORFOLK

MANCHESTER

10 Piccadilly (Phone CENTral 1787)

BIRMINGHAM

14 Bull Ring

SHEFFIELD

4 St. Paul's Parade

LEEDS

10 Queen Victoria Street (Phone 28639)

HULL

10 Paragon Square

SOUTHAMPTON

25 Bernard Street

BRISTOL

30 Narrow Wine Street (Phone 23744)

Toy Pistol

(See page 294)

B CUT ONE $\frac{1}{4}$ IN

C CUT ONE $\frac{1}{4}$ IN.

D CUT ONE FROM WIRE

PLUNGER. CUT ONE FROM $\frac{1}{4}$ IN. ROUND ROD

A CUT TWO $\frac{1}{4}$ IN.

PELLETS. CUT FROM $\frac{1}{4}$ IN. ROUND ROD

FOR A FIRST-CLASS MODEL . . .

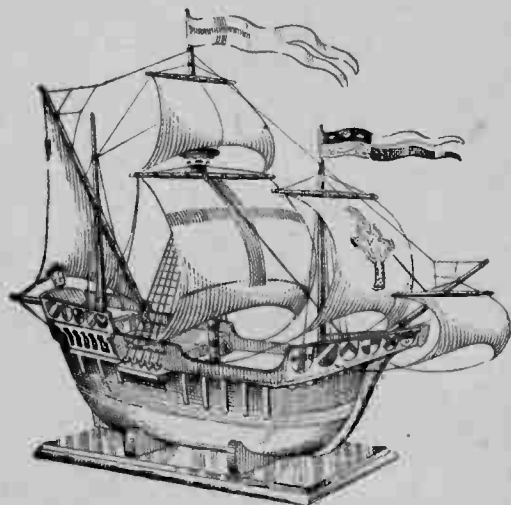

**. . . Use a
First-Class
Tool . . .**

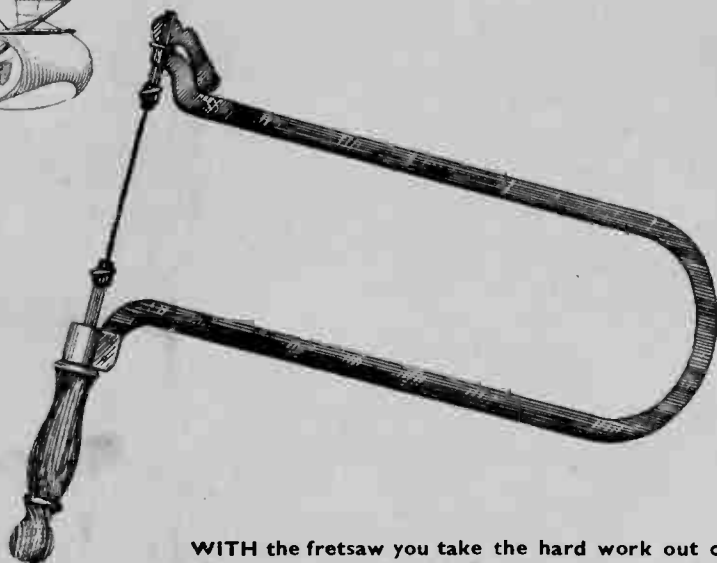

WITH the fretsaw you take the hard work out of model making. It cuts the pieces in less than half the time taken by any other method; it cuts cleanly and accurately; in fact it has no substitute. And when you are not model making you will find it equally useful for light woodwork and those 101 odd jobs you have to do about the house. Cuts wood, light metal, leather, plastics, etc.

MADE BY . . .



GET yours now and join the ranks of real model craftsmen. But remember - insist on Hobbies or you may be disappointed. Prices from 5/3 to 15/3. The saw illustrated is our famous 14in. Lever Frame; price 14/-.

From Stores and Ironmongers everywhere, Hobbies Branches, or post-free from Dept. 99, Hobbies Ltd., Dereham, Norfolk. Free leaflets on request.

DEREHAM, NORFOLK

Hobbies

WEEKLY

CONTENTS

	Page
Control-Line Model 'Plane	305
Making a Garden Pool	307
A 'Skylon'	
Table Lamp	308
Fishing at the Seaside	309
Made from	
Cotton Reels	310
To Divide Roll Film	311
A Box Ottoman	312
A Novel 'Book' Case	313
Model Railway Matters	314
Replies of Interest	315
Decorations from	
Poppy Heads	316
Control-Line Model 'Plane Patterns	319

August 29th, 1951

Price Fourpence

Vol. 112 No. 2913

Here it is—a simple CONTROL-LINE MODEL 'PLANE

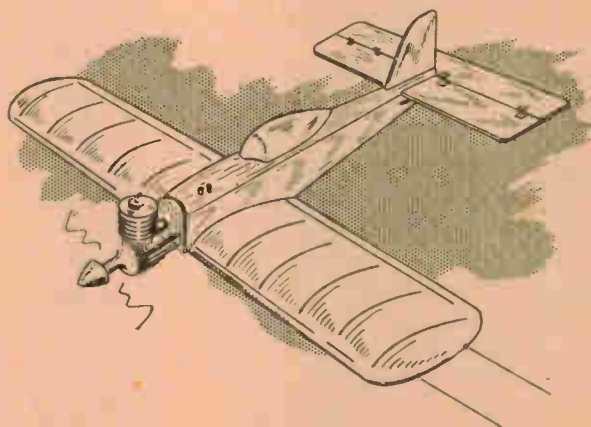

HERE is the model a great number of our aeromodelling readers have been eagerly awaiting—a control-line model of simple design and easy to build, yet capable of putting up a flying performance equal to that of models of much more intricate design. It is suitable for motors of 1c.c. to 1.5c.c.

The plans are reproduced one-third full size and the first step is to draw up full size plans of the wings, over which these will be built. The other components can be marked out directly on to sheet balsa for cutting out. Commence building with the wings.

Wing Construction

Draw out a template of the wing rib on to $\frac{1}{16}$ in. or 1mm. ply, working from the dimensions shown on the plan, and cut out. Use this template to cut eighteen ribs from $\frac{1}{8}$ in. sheet balsa and two from $\frac{1}{4}$ in. sheet balsa. Pin a length of $\frac{1}{2}$ in. square balsa over the spar position on the wing drawing and cement the ribs in place over this. The trailing edge is then shaped from $\frac{1}{4}$ in. by $\frac{1}{4}$ in. balsa, notched to take the ribs and then cemented in place. Small wood blocks under the trailing edge will hold this in the correct position clear of the plan. The $\frac{1}{4}$ in. square top spar can then be cemented in place, also the $\frac{1}{8}$ in. square leading edge. Leave the assembly pinned out over the plan until set.

The wing tips are cut from $\frac{1}{8}$ in. sheet and cemented to the end ribs. The port tip is drilled out and two short metal tubes fitted to take the lead-out wires. The complete control assembly is included in the wing before covering.

Cut the bellcrank from aluminium sheet (or fibre or ply) and mount on a ply plate which fits between the two centre ribs. The 22 S.W.G. lead-out wires are attached to this bellcrank, also the 16 S.W.G. wire push rod. A balsa fill-in beneath the ply plate makes a firm assembly.

The centre section of the wing is then covered with thin sheet balsa, the push rod emerging from a suitable slot cut in this. Check for free movement, make off the ends of the lead-out wires and then cover the whole wing, top and bottom, with tissue. Waterspray to make taut and then give about three coats of dope.

Plans for this model are reproduced 1/3rd full size on page 319. Those who wish can obtain full-size plans, price 3/6 post free, on application to The Editor, Hobbies Weekly, Dereham, Norfolk.

The fuselage can be made next. The two sides are cut from $\frac{1}{16}$ in. sheet, to the dimensions shown. They are assembled on rectangular formers cut from $\frac{1}{4}$ in. sheet balsa, with hardwood bearers glued securely in place. The front former is of $\frac{1}{4}$ in. ply.

At this stage the fuselage can be trimmed to fit over the wings. Holes—or a slot—are cut in the formers to clear the push rod, which finally emerges from the side of the fuselage just in front of the tail. Cement the fuselage to the wings and add the $\frac{1}{8}$ in. sheet fuselage bottom.

Tail and Elevators

The tailplane and elevators are cut from $\frac{1}{8}$ in. sheet balsa, to the dimensions shown on the plan. Round off the corners with glasspaper. The two are then hinged together with strips of tape, as shown in the assembly sketches. An elevator horn is cut from tinplate or thin brass, passed through a slit in the elevators and sewn and cemented in place. The tailplane can then be cemented in place on the fuselage and the horn hooked up to the push rod. Check for free easy movement.

Next, the fin is cut from $\frac{1}{8}$ in. sheet glasspapered down lightly and cemented

All correspondence should be addressed to The Editor, Hobbies Weekly, Dereham, Norfolk.

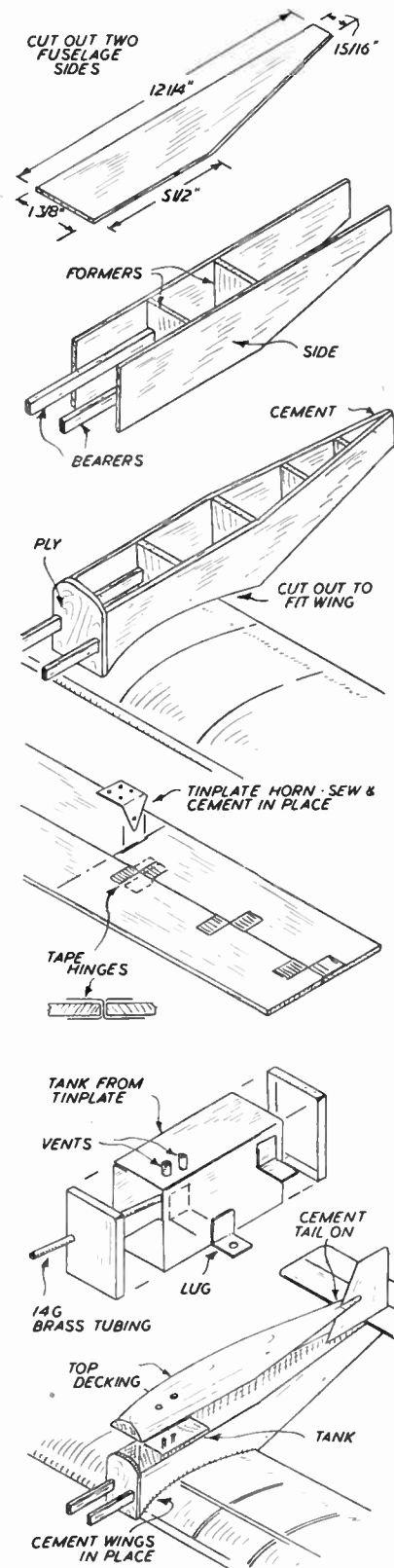
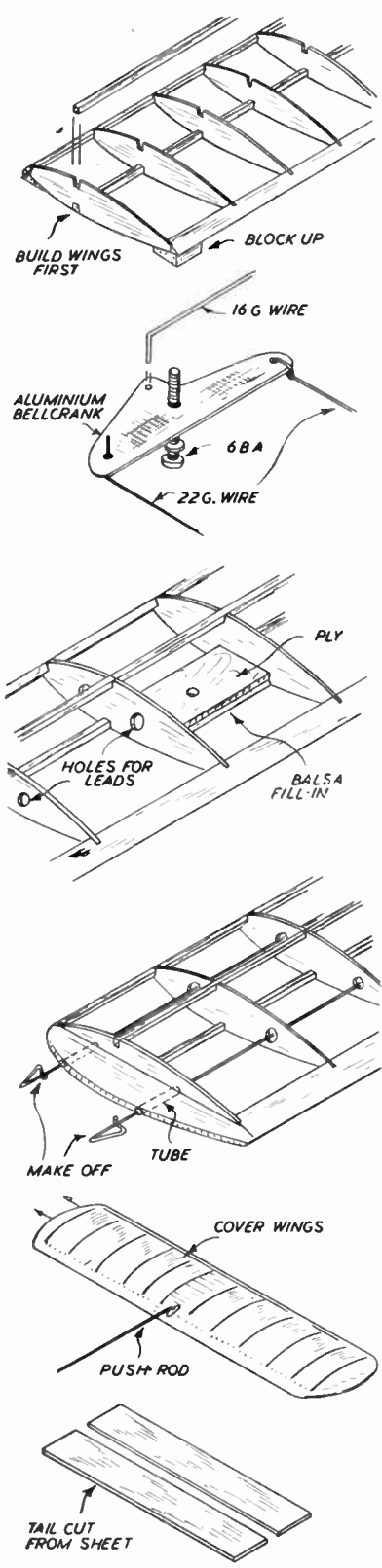

to the tailplane. It is an advantage to cut a rudder portion and offset this to the right about $\frac{3}{8}$ in.

At this stage the model is virtually complete, with the exception of the power unit and the top decking of the fuselage. The latter cannot be added until the fuel tank is mounted.

The tank is made from tinplate, to the dimensions given. Solder together as shown, using 14 S.W.G. brass tube for the feed and vent pipes. Note that the vent pipes project upwards to pass through the fuselage decking and allow for filling.

Suitable Motor

A suitable size of motor is 1c.c. to 1.5c.c. Bearer dimensions may have to be adjusted slightly for different motors, those on the plan being proportioned for the E-D 'Bee'. Bolt the motor in place close up to the plywood former with the intake tube passing through a hole in this former. The tank is screwed inside the fuselage and the fuel pipe connected to the motor with a short length of plastic tubing. Cut a hole in the starboard fuselage side, as necessary, to give access to the intake tube for choking for starting. When this assembly is satisfactory, the top decking of the fuselage can be added.

This decking is carved from $\frac{1}{8}$ in. balsa sheet and then cemented in place. Glasspaper down smooth and then cover the whole fuselage with tissue. Give four or five coats of dope. A bubble canopy can be added to give a semi-scale effect, if desired.

Simple Undercarriage

Normally no undercarriage would be used on a model of this size, the machine being hand launched each time. However, a simple wire undercarriage can be bolted to the ply nose former, if desired, for rising-off-ground flights and normal landings. Bend from 14 S.W.G. wire and use $1\frac{1}{2}$ ins. diameter streamlined wheels. Preferably attach them to the former with 'J' bolts.

This model will give its best performance on about 40ft. lines, but longer lines could be used in calm weather. For stunt work it is advisable to add a counterweight to the outboard tip to balance out the weight of the lead-out lines, etc. This consists of a strip of solder, bent up as shown on the plan and cemented to the starboard wing tip. This weight would, of course, have to be added before the wing is covered. It is not really necessary to use this weight on a sports model.

Tip for Stunting

Another good tip for stunt flying is to offset the motor slightly to the right, so that it is pulling outwards all the time against the natural flight circle. This helps to keep the lines taut and maintain control during intricate manoeuvres. Apart from such details, the real secret of successful stunt flying is plenty of practice.

(426)

These drawings will make the stages in construction perfectly clear

Suggestions and methods for MAKING A GARDEN POOL

A WELL designed pool is a most attractive garden feature. Its construction is quite straightforward and complete success is assured if certain basic rules are followed.

Choosing the Site

Choosing the position of the pool is a matter which must be given the most careful consideration. The pool must fit naturally into the garden lay-out and, at the same time, its site must be an open one, free from overhanging trees. Walnut and Laburnum trees must be particularly avoided, as their leaves are poisonous and considerable fouling of the water might result. A further

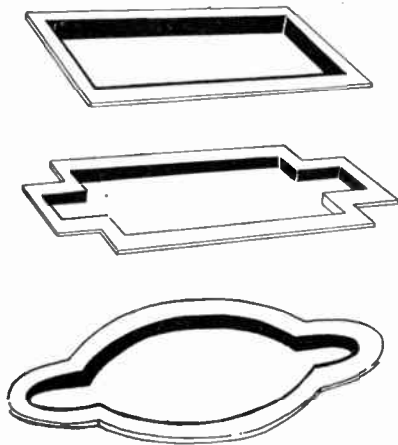

Fig. 1—Some suggested pool designs

danger from having the pool too near any kind of tree is that the growing and spreading roots might easily cause cracks to appear in the cement lining.

In spite of its open situation the pool must have some shade and when choosing the site the possibility must be kept in mind of having a low wall or rockery on the North-East 'side' of the pool. If this is not possible, then shade can be provided by planting a small group of tall aquatic plants in this part of the pool.

Choosing the Design

The next thing is to plan the design of the pool. This can be formal—having a definite geometric shape—or informal—having an irregular shape. Some suggestions are given in Fig. 1. The reader is strongly advised to decide quite definitely upon his design and then draw a plan of it to scale.

At the same time it will be well to decide upon the nature of the pool surround, its exact size and whether it is to be grass, regular paving stones, irregular crazy paving, smoothly finished concrete or brick.

Excavating the Pool

Mark out the exact shape of the pool

on the chosen site and for a small pool excavate to a depth of 18ins. The soil can be used for making up a rockery or it can be distributed over the garden.

Large pools should have an uneven floor varying in depth from 1ft. to 2ft. or even 3ft. (Fig. 3).

Ram the bottom of the pool until it is quite firm and even, and then cover it with a 3ins. layer of clinker or ashes. During dry weather the soil cracks and this layer of clinker is intended to stop the cracks spreading to the concrete lining of the pool.

The next step is to fit in a waste pipe so that the pool can be easily emptied. This can be a vertical metal pipe, complete with stopper, placed in the lowest part of the pool, or, alternatively, half a quart-size bottle fitted with a screw stopper (Fig. 2).

The Cement Mixture

The cement mixture can vary slightly according to what materials are available. Either one of the following two mixtures will suit admirably.

- 1 part cement
- 2 parts gravel
- 2 parts river sand.

OR

- 1 part cement
- 3 parts sand.

Use a wooden base for the mixing. First tip the gravel into a heap; over this put the sand and finally the cement. The easiest way to do the mixing is to shovel the heap over on to another spot and then shovel it back again. Keep this up until the mixing is complete and the heap is of a uniform grey colour.

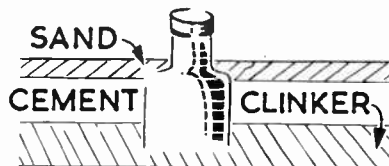

Fig. 2—Using a screw-stoppered bottle for a waste pipe



Fig. 3—Remember that large pools need an uneven base

Now sprinkle with water from a watering can and repeat the mixing process until there are no dry pockets of material left in the heap.

Do not wet the heap too much. It should be just sufficiently moist to pack down well and allow a smooth finish to its surface.

The cement mixture must cover the

bottom of the pool to a depth of 3ins. For large pools the base must be 6ins. thick.

Use a trowel to mark a shallow line around the freshly cemented floor of the pool, 6ins. away from the earth sides. This line will act as a 'key' to the walls.

Now place the wooden 'false' walls in position. This is a rectangle of boards 3ins. smaller than the pool in length and breadth but having a slightly greater depth (see Fig. 4).

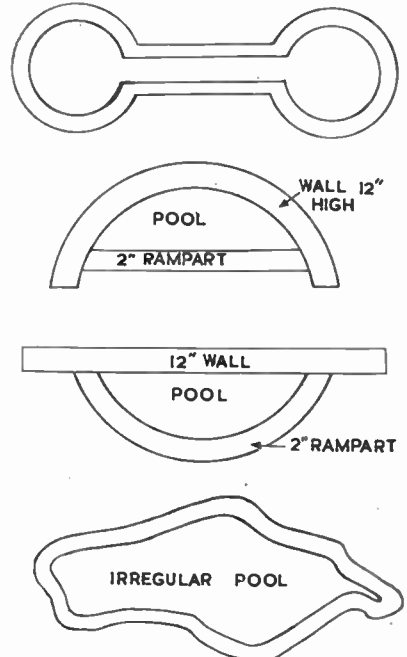

Fig. 1b—Further designs for pools

Pour the moist cement mixture down into the gap between the earth walls and the wooden frame; put in a little at a time and ram this down firmly, taking special care to see that the corners are well filled and packed down. Give a smooth finish to the top of the walls.

Cover the whole of the work with sacking and leave for two days. Now moisten the surface of the concrete and 'paint' or trowel on a $\frac{1}{2}$ in. thickness of one of the following mixtures:

- 1 part cement
- 2 parts sand

OR

- 1 part cement
- 2 parts sand

$\frac{1}{2}$ part Pudlo waterproofing powder.

Either mixture must be moistened until it has the consistency of cream.

When this has been done, leave the pool for 48 hours and then fill it with water, as the concrete will harden better in this way. Leave this for one week, then empty and re-fill the pool.

Add some crystals of Potassium permanganate until the water is stained a pale red. This will help to neutralize the chemicals released by the fresh concrete. During the next fortnight repeat this process of changing the water another three times.

Before giving the final filling, put in a 3in. layer of coarse sand or loam. If water-lilies are to be grown with any measure of success instead of the sand put in a 4ins. layer of heavy fibrous loam, or better still, a mixture of 5 parts of turfy loam and 1 part cow manure, the latter being not less than a year old.

The final filling of the pool is best done with rain water. If tap water has to be used, this must be left exposed to the sun and air for a month before introducing any fish.

Stock with Plants and Snails

The fish are not likely to survive unless the pool is well stocked with plants to provide oxygen for the water, and with snails to act as scavengers. In fact the fish should not be put in until the plants are established. There must be a natural balance between the plant life and the fish life and the great danger is that of overstocking with fish. A safe

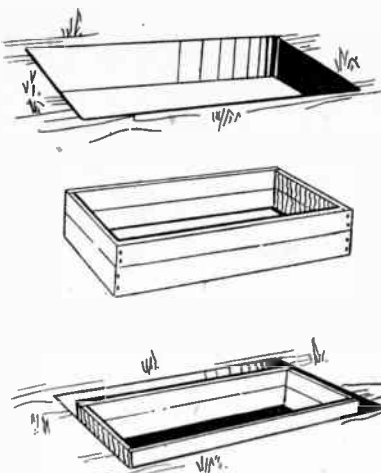

Fig. 4—Preparing for the concrete surround to a rectangular pool

rule is to allow 1in. length of fish to every gallon of water.

Suitable Plants

These plants will do well in 12ins. of water or less:

- Limnanthemum (Fringed Golden Buck Bean), flowering July—August.
- Alisma (Water Plantain).
- Sagittaria (Arrow Head), flowering June—October.
- Calla Palustris (Bog Arum), flowering June—August.
- Butomus Umbellatus (Flowering Rush), June—August.
- Pontederia Cordata (Water Plantain), June—October.
- Pond Weed, May—October.

There are water lilies available for all sizes of pools and any horticulturist will advise on the stocking of your own particular pool.

Introducing the Fish

Suitable fish include the Minnows, Golden Orfe, Crucian Carp, Golden Carp and Tench.

Do not merely pour fish and water from the container into the pool, but first of all stand the can by the side of the pool for half an hour or so until the fish become settled. Now lower the can gently into the water until the fish swim up and over into the freedom of the pool.

From now on feed the fish at the same time every day, preferably in the early evening, and feed them from the same spot each time. (432)

A 'Skylon' Table Lamp

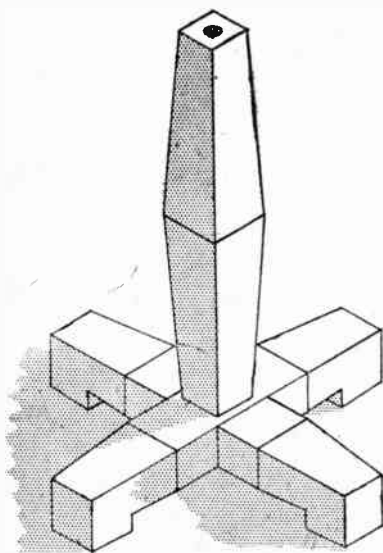

FROM the boys of a Hampstead school, through their master, Mr. C. A. Perry, comes this idea for a Festival 'Skylon' table lamp. It is constructed from a 2ft. length of 1½ins. quartering, and its making is simple enough to need no details.

Dimensions are given in Fig. 1 and Fig. 2 shows how the various parts fit together. The sketch of the finished lamp is without bulb holder and shade, and we would suggest that the latter be of modern design and not too bulky, to preserve the slim lines of the 'Skylon'.

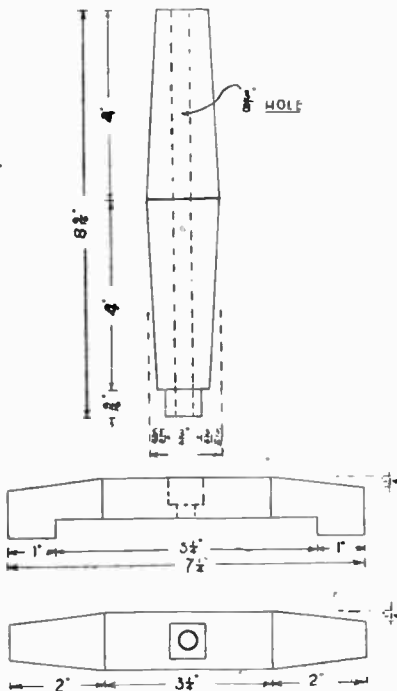

Fig. 1

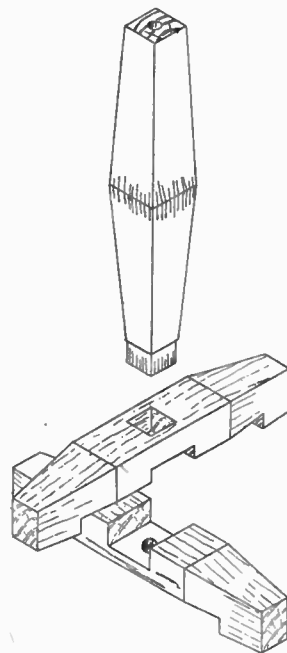

Fig. 2

You can enjoy yourself

FISHING AT THE SEASIDE

THOSE who have access to the seaside—including those lucky people who have yet to take their holidays—can enjoy a bit of fishing from the pier or the beach. It is not expensive sport, and charges for angling from the beach are nil, and from the piers either free or just a nominal fee for a ticket to go on it.

A great many of the popular resorts around our coasts offer excellent facilities for fishing from piers; some are better than others, but at most there is a chance of fun with one kind or other of sea-fish that come inshore, and the actual fishing can be carried on under pleasant conditions.

Pier Fishing

For pier fishing a useful outfit consists of a sea-rod 8ft. to 10ft. long with a 5ins. sea-reel carrying 80yds. of line. A useful tackle is the paternoster, consisting of a wire or gut substitute trace, with a weight at the end, and two or three hooks fastened to the trace at varying distances; a box brass swivel, size 1½ins. should be used at each end of the trace. Paternosters can be bought ready-made from the tackle dealers, complete with swivels.

When using the paternoster tackle you should be able to cast out 20yds. to 30yds. from the pier-head, if necessary. One method of casting is to draw off a length of line from the reel, with the weight or lead about 10ft. from tip of rod, swing it out over the water in the direction where you want to fish, and immediately the baited hook touches the surface, let out further line, so that it is not dragged back, and the advantage of distance lost.

Kinds of Fish

The fish likely to be caught from piers include whiting, pollack, flat-fishes, mackerel, conger, etc. The bass is a very sporting fish that may be taken also from some piers.

Baits for pier-fishing include ragworm, lugworm, sand eel, mussel, shrimps and strips of fish.

When seeking the sporty bass you can fish with float tackle, using a sliding float so as to permit of casting out or landing a fish. With a float you can fish at varying depths, adjusting it at the depth the float is required to work. Single hooks can be used.

Baits for Sea-fish

These are many and varied. Worms are the best all-round bait. Ragworms, obtained by digging in the mud on the shore, or bought locally from bait-sellers are useful. 'King' ragworm is a larger kind, and owing to its toughness, makes a really capital bait, either on float tackle or the paternoster. Large

ragworms are found under stones and in rock crannies.

Lugworms are commonly found by digging in the sand below highwater mark, just after the tide has ebbed. They can be kept in a bait-can in wet sand and seaweed for a few hours, but do not keep fresh long.

It is, perhaps, better to buy your worms from the bait-merchants, if possible.

To bait with ragworms take two and insert point of hook through the heads.

Sand-eels are excellent baits for all kinds of larger sea-fish; they are obtained

buy one from the fishmonger—cut so as to be half-blue and half-silver, about 3ins. long and ¼in. wide; such a strip is known as a 'last' or 'lask'. Threaded on a hook it makes a useful trolling bait. What kinds of fish are likely to take various baits can be briefly summarised:

Cod and codling: lugworm, prawn, crab, mussels, whelks, etc.

Bass: prawn, sand eel, soft crab, ragworm, mussel, lugworm, etc.

Flat-fish: piece of crab taken out of shell, crushed and softened.

Dabs and flounders: shell-fish or worms.

Whiting: lugs, rags, small live-bait.

Pollack: prawn, ragworm, king rag, mackerel 'lask'.

Mullet: rags, maggots, peeled raw shrimps, green silk-weed, etc.

Best Times for Sport

As the pier is often well occupied all the forenoon and afternoon with holiday-makers in general, the angler will do better to be astir at early dawn or at sunset, which are more likely times for sport than in the daytime; good fun is often enjoyed some two hours previous to high water, and at high water level.

Advantages of pier fishing over other methods of sea-angling are its inexpensiveness and comfort, especially to those who cannot stand the rolling and tossing of a boat, or the strenuous long-distance casting from the beach or shore. Perhaps fish do not run so big around a pier, but you do get variety.

The novice will much benefit by seeking information on the spot as to kinds of fish to be caught, baits, best times, etc. One can pick up many a wrinkle by just watching other and more experienced anglers and then emulating them, especially noting the methods of those who are, apparently, experts at pier-fishing. You will likely soon drop across a friendly fisher who knows the ropes.

You cannot expect to catch all the kinds of fish mentioned at any one resort; a lot depends upon the sort of bottom where you are fishing. Then, different fish are caught in summer than in winter. But in holiday-time, at many resorts, you may catch such kinds as bass, mackerel, whiting, pout, rockfish, pollack or billet, mullet, codlings, flat-fish, and even small congers. And surely that list is enough to set you longing for a rod when at the seaside. (430)

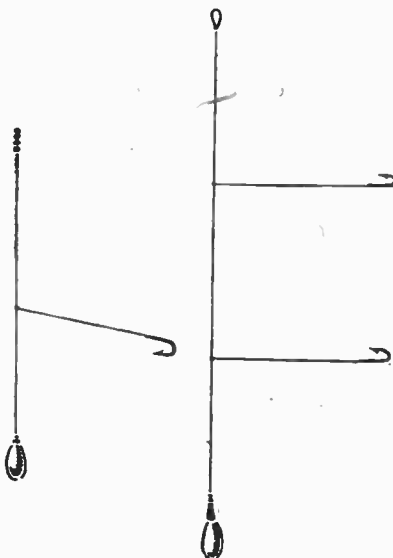

Tackle for bass and similar fish

A two-hook paternoster

by digging in the sand with a fork or rake at low tide; they take some catching as they are very slippery customers. These baits are good for bass, pollack, and mackerel, especially when trailing a bait behind a boat or when spinning.

Prawns are useful for catching bass, coalfish, and pollack from the shore; they can be caught up from pools and rocky hollows with a pool-net.

Mackerel 'last' or 'lask' is another good bait for mackerel itself, cod, whiting, turbot, the bait being a strip of mackerel—first catch your mackerel or

Important to Photographers

At the end of last month Agfa announced the introduction into this country of their long-awaited Agfacolour negative/positive process of colour photography. This is an event of some importance, as it means that for the first time in Great Britain it is now possible for every professional and amateur photographer, using ordinary cameras, to secure beautifully natural coloured prints on paper at a cost within the reach of all. No specialised technical skill is required to expose the film, and ample supplies are available throughout the country. Your local dealer will be able to tell you about it.

A few suggestions for things MADE FROM COTTON REELS

EXPECT everyone has looked at cotton reels some time or the other and thought what a pity it is that such nicely turned items should have to be thrown away. Really, this need not be the fate of reels, for there are quite a number of useful things that can be made with them, and a few are outlined here.

Simple Pen Rack

First let us consider the simple pen rack shown in Fig. 1. To make this we require a base (A), 6ins. by 2ins., and a cotton reel with fairly deep lips (reels vary a lot in this respect). Held in some suitable way, the reel is halved, and the sections so formed glued to the base after a good contact has been made with glasspaper. The halves, as will be seen by the sketch, are placed $\frac{1}{4}$ in. from either

audience for minute examination if desired.

Like most effective tricks, the secret is extremely simple. Although apparently going right through, the string is doubled and the loops so formed fastened together with a little weak cotton (after the reels have been threaded in position). The three bobbins are then adjusted so that the middle one hides this join and the trick starts.

Under the cloth the thread is broken by a pull on the string. This, of course, releases the reels which are laid on the table. The string is then given a double twist and the loops so formed pulled out from under the cloth and held up for observation. Finally, the cloth itself is

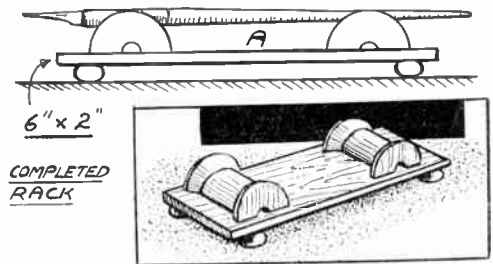

Fig. 1 A pen rack

removed showing the three reels.

A very simple candlestick can be made by using two fairly strongly waisted reels for the upright and a half reel for the handle. Fig. 3 shows the idea. The top reel is bored out as indicated (A) to take the end of a standard candle and upright and handle are secured with

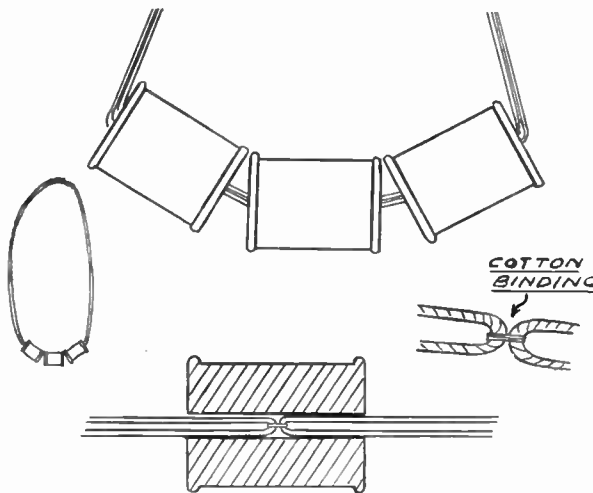

Fig. 2 Details of a trick with cotton reels

end. Reel and base are now stained or painted and varnished and a rectangle of baize fastened to the bottom so that the article can sit safely on any polished surface. If desired, however, four 'button' feet can be attached instead of the baize. This, if anything, gives a better finish.

For the Conjurer

The conjurer will find reels handy in the trick given in Fig. 2. Three reels are required and they are threaded on to a double strand of pliable string (white for preference). Apparently it is impossible to get the reels off, but the conjurer asks someone to place a cloth over his hands. A few movements take place, and in a second or so he holds out the circle of string unbroken but with the reels removed. These are found on the table above which he has performed his trick and can be passed round the

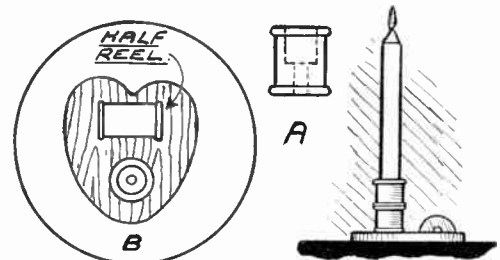

Fig. 3 An easily made candlestick

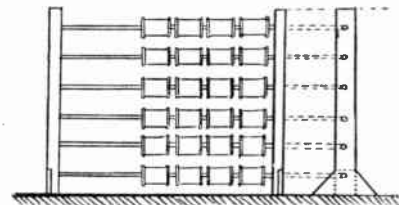

Fig. 4 Child's counting frame

glue to either a rectangular or other nicely shaped base. A heart design is very good for this, as (B).

Tall Candlesticks

With a number of reels fastened one above the other, candlesticks of the tall variety can be readily made and look very nice indeed if stained and polished. Glue is the only adherent necessary to join cotton reels together, and if properly made such joints are as strong as any held with nails or screws. The ends of the reels should be heated both before and after the glue is applied and then brought rapidly together and left to dry if possible under some sort of pressure. The heating of the surfaces is very important.

Reels are very useful also in the making of decorations. They are painted gilt or silver and then have a

(Continued foot of page 311)

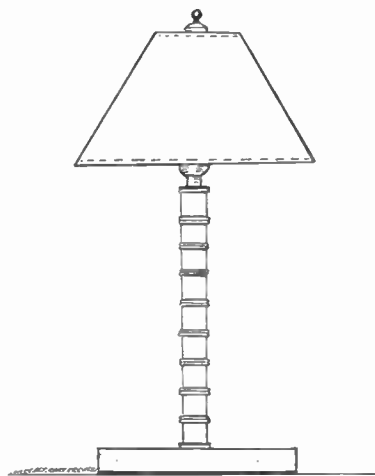

Fig. 5 A cotton reel table lamp

It's handy to know how TO DIVIDE ROLL FILM

HAVE you ever wanted to use exposures on a roll film not completely exposed? Here is a proved and successful way to divide the roll, and leave the unexposed part of the film in the camera.

You Lose One Exposure

If you are prepared to forfeit one exposure in this operation, you will be completely satisfied with the division. The print of the boy on the telephone was made from such a piece of cut roll film. The negative was next but one

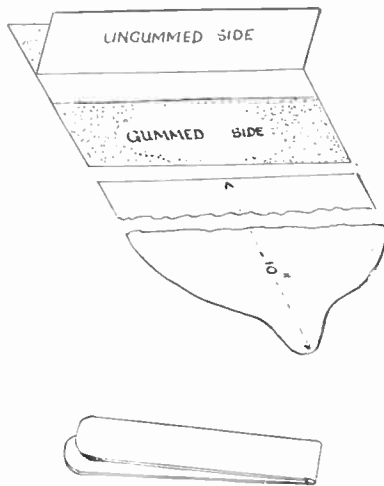

Fig. 1—The threading strip and tin template

from the cut. I needed it immediately to illustrate an article, and there were nine more exposures out of the sixteen to be made. I lost one exposure to gain a few guineas.

Your first task is to make a 'threading-strip' with 10ins. of backing-paper from

a previously developed film, and two pieces of passe-partout as long as the backing-paper is wide. Fold one of the pieces of passe-partout lengthways to make a crease down its middle. Trim the edges of the passe-partout each side of the crease to a width of $\frac{1}{4}$ in.

Stick one of these $\frac{1}{4}$ in. edges to the other piece of passe-partout on the gummied side along the middle of its length as shown in Fig. 1. Now stick the piece of passe-partout marked 'gummied side' to the straight edge of the backing paper, as again in Fig. 1. The other end of the backing paper will be pointing to insertion into the spool.

Leave this paper-work for a while to make a thin tin template to trap the film and the backing-paper so that you



Fig. 2—How the threading strip is used

can cut the two at the same time squarely along the template edge, which is to guide your scissor work in the dark room.

You must make this template large enough to fold over, and be equal in the length of the fold to a little more than the width of the film; and the template must be made dead square.

Now you are ready to operate.

In the dark-room open up the camera, and slightly draw up the film. Pass the template under the film, and over the backing-paper, feeling all the time that

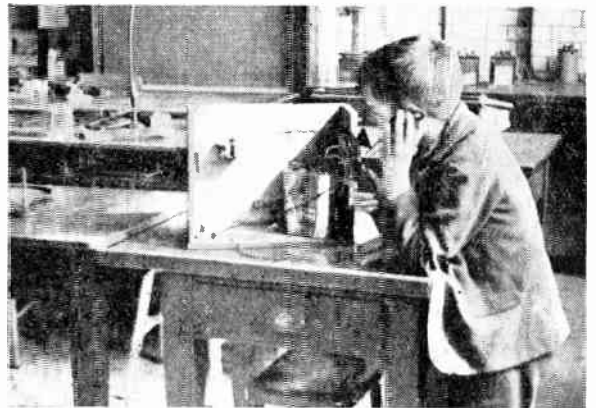

A print made from the next but one negative to the cut in a divided roll film

the position is square. Hold this position securely with one hand, and then cut the film on the side next to the winding spool, using the edge of the template as the guide for your scissors.

All you have to do now is to wet the gum between the leaves of the 'threading-strip', then slide the template back, away from the winder, and place the sticky leaves in position on the film and backing-paper as shown in Fig. 2.

Hold this position for a few moments to allow the gum to harden, and afterwards thread up the film in the usual style.

With everything ready-to-hand, the whole operation can be done in total darkness in five minutes.

It is a sound practice to make several 'threading-strips' at a time, for many reasons, not the least of which is to be ready with the extra one in case of a 'first-time' blunder. But the possibility of such a dilemma can almost be ruled out if you have a thorough rehearsal with about 20ins. of spare border paper instead of film. (389)

Made from Cotton Reels—(Continued from page 310)

small sprig of some evergreen glued into the central hole. Another way of colouring is to cover the wood with a surround of crepe paper. This can be held with a touch of glue. Decorations of this nature look well on mantelshelves and other places during times of festivities.

In toy-work, reels do nicely for the chimneys and domes of model engines, while it is possible to make a quite realistic doll's table from a reel of the very thin-waisted variety—the bottom lip being cut away and the top covered with a circle of some material to hide the hole.

An elaborate item with reels is a child's counting frame. Here twenty-four reels of the same kind are collected and

the simple frame shown in Fig. 4 put together, the bars being lengths of dowelling of a diameter that will comfortably pass through the central holes. The side uprights are drilled to take the ends of these pieces, and to give good standing the frame is supplied with two triangular feet. To give brightness the reels are painted in a variety of colours. With the parts fitted well together and strongly glued, the counting frame is very sturdy.

And finally a really ambitious article made with reels is a table lamp (Fig. 5). This is very effective. About eight or nine reels especially chosen for their good finish are strongly glued one above the other and a batten lamp-holder with switch attached screwed on to the

top. The column so formed is then fastened to a suitable base in which a hole has been drilled to take the flex which comes down the centre borings. By a second channel on the underside of the base the flex is led outward, and after securing with one or two flex clips the whole of the underside is covered with baize firmly glued in position.

The socket above holds the wire frame for the shade, which in its turn takes the parchment. A lamp of this nature, when carefully stained, looks very well and stands up to a good amount of handling. One made by the writer some considerable time ago now and in continuous service is as good as the day it was put together. (384)

A useful piece of furniture is A BOX OTTOMAN

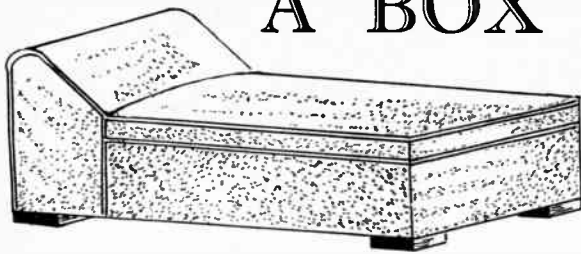

THE box ottoman is a piece of furniture that is sometimes thought to be rather old-fashioned, but, judging by the current furniture displays, its usefulness is again being appreciated. For the modern small house or flat it is an ideal item. The box provides valuable storage space, while the top makes a good seat or lounge.

Simple Woodwork

Actually, very little woodwork is involved in its making, the most important part being the upholstery. It is not suggested that the woodwork be done carelessly or haphazardly, but it is true to say that the upholstery will cover minor defects in sawing or planing. In addition, it is possible to use a poorer quality of timber than would be permissible if the wood was seen.

The sides and ends should be of $\frac{7}{8}$ in. thick wood. Each side is 4ft. 9ins. long overall and is 11ins. wide for the greater part of its length. At one end of each long side a piece 1ft. 1in. long by 9ins. high is glue-jointed, and when the glue

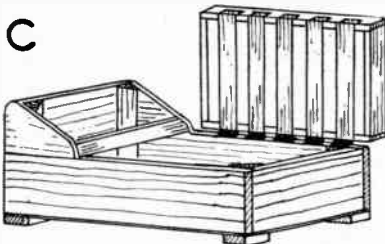

The completed box

has set hard, the board is shaped out as shown at (A).

Both end pieces are 1ft. 9 $\frac{1}{2}$ ins. long and are fitted between the sides by being glued and screwed, the screw-heads being well countersunk. The top edge of the wider side will have to be gently rounded over to conform to the shaping of the long sides.

A 4 $\frac{1}{2}$ ins. wide bar is also fitted between the sides at the front of the head-rest shaping, this also being rounded off on the top edge.

The four corners of the box are strengthened with triangular fillets with 2ins. long sides, and a bottom (either of solid timber or plywood) is made to fit flush with the outside edges of the framework.

A square block is put on each corner so that the box is lifted clear of the

ground. These feet are 4ins. square by 2ins. thick with their outside edges flush with the sides of the framework, being held in place by screws through the bottom of the box.

The lid is made to outside measurements of 3ft. 8ins. long by 1ft. 11 $\frac{1}{2}$ ins. wide from 3ins. by $\frac{3}{4}$ in. material set on edge. On the under side of this, five 4ins. wide by $\frac{3}{4}$ in. thick rails are fitted between the two long sides, being spaced at equal distances apart. Half-lap joints are used to secure the rails to the sides, glue and screws being used as the fixing agents. When completed it is hinged to the back edges of the box,

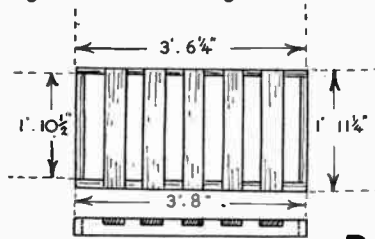

Plan and side views of the lid

while, to prevent its opening too far, a stout upholstery webbing strap is fixed between the inside of the narrower end of the box and the inside of the lid at the same end.

Drawing (B) shows a plan of the completed lid and (C) the assembled box, but in the latter the strap has been omitted for the sake of clearness.

The Springs

To the upper surface of each bar of the lid three upholstery springs about 5ins. deep are fastened. These are simply stapled into place at the bottom, while they are tied together at the top with lengths of stout cord so that they are limited to a downward movement only when any weight is put on them.

A piece of hessian is strained rather tightly over the tops of the springs and is tacked down to the top edges of the lid. The hessian is not cut off close to the edge, a spare piece about 3ins. wide being left there.

The spare hem of hessian on each edge is then neatly rolled up into a tight little 'piping' which is tacked down just inside the extreme edge of the box lid. Using stout twine as thread, two or three stitches are made round the top coil of each spring to secure it to the hessian.

Fibre, flock, or other padding material is then placed over the top of the hessian, and a few loops of thin twine are tacked across the flock to hold it in position. The padding material should be spread out evenly and moulded to shape.

A final covering of hessian is then passed over all the exterior woodwork of the lid, being tacked down on the inside.

Four pieces of webbing are tacked across the shaped portion of the head-rest in the manner shown on drawing (D). They must be interlaced and strained tightly before being tacked down. A piece of hessian is put over the webbing, followed by a layer of padding and a final covering of hessian.

The two sides of the head-rest and the

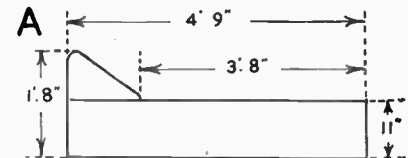

Dimensions of the sides

back are then lined down to the level of the bottom of the box, putting the padding close to the edges of the wood but not actually passing round the corners.

Lining the Box

If it is decided to line the inside of the box this will become the next stage. The work is started by covering the triangular strengthening pieces in the corners. The hessian can then be cut in the form of four panels which are first tacked along the bottom edge, the packing material is put into place, and

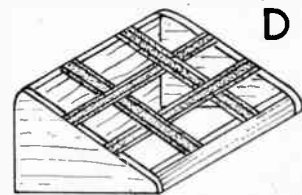

Details of the headrest

the hessian is then strained tight and nailed on the top edges.

The remaining long sides and the narrower end are similarly padded, but care should be taken not to over-pad here. The finished sides should be almost vertical with only a slight tendency to bulge at the centre.

When completed to this stage the final fabric covering is put on.

In all cases the hem is tacked down just inside the box and is strained over the hessian and nailed on the bottom. As the straining on the nails will tend to tear the fabric it is advisable to put a small cardboard washer under each tack-head.

The final step is to put a piece of silk piping round the top edges of the lid, around the head-rest, etc., in the manner shown on the sketch of the finished item. Each piece of this is held temporarily by a tack at each end, and is then sewn to the fabric, the tacks being pulled out when the piping is secure. (373)

File your cuttings in A NOVEL 'BOOK' CASE

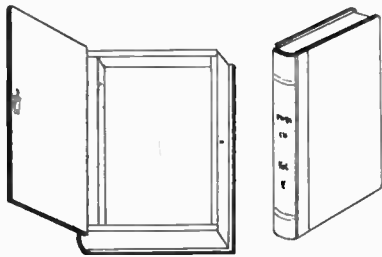

THE real craftsman is always on the look out for ideas to help him in his work. One day he sees an article in a magazine showing him how to do a certain operation easier, and, perhaps, a few days later a friend gives him a little booklet on the care of certain tools.

As the process of collecting goes on, and the cuttings accumulate, it becomes a job to know how and where to keep them so that they are always handy for reference when required.

The little 'book' case described in this article solves the problem in an efficient manner. It is in reality a small case in the

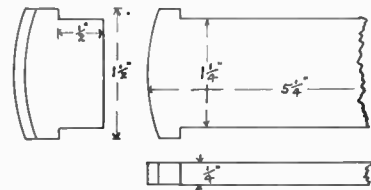

Fig. 3

Fig. 4

shape of a book, and can take its place on the bookshelf with the other volumes. The front cover opens and instead of the usual pages, there is a space for quite a large number of loose cuttings and pamphlets.

As your collection increases, the matter can be subdivided and housed in other cases, thus making a very useful set of 'volumes'.

The case can be made entirely of cardboard or wood, or else a combination of the two. In any case, it would be best to make the back of the book or 'spine', as it is called, of wood, because this is the foundation on which the entire case is built up.

Size to Suit

The size of the case can be made to suit your individual requirements, but in order to fit in with other average sized books on the shelf, it could be about 8 ins. tall, 5 1/2 ins. deep and 1 1/2 ins. thick.

We will assume that this is the size you are going to make the case, and that it is to be an all wood construction.

Commence by making the spine and then fitting all the other pieces to it. Oak or walnut would be best for this, although it is possible to use almost any

kind of wood for the purpose. Cut a piece 8 ins. long, 1 1/2 ins. wide and 1 in. deep, and plane the front to a slight curve like the front of a book, as shown in Fig. 3. This could be left flat, but it certainly looks much more realistic if curved, and it is quite easy to do this really well.

Next, cut the recess down each side of the spine, to take the covers of the case. Figs. 2 and 3 show this recess which is 3/4 in. wide and 1/8 in. deep. The spine must also be cut away at both ends to a depth

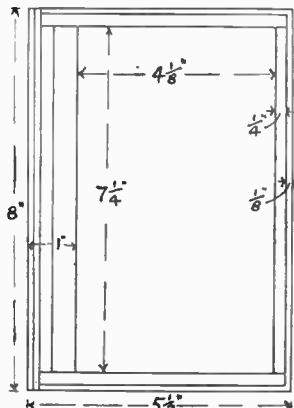

Fig. 1

of 3/8 in. to form a seating for the end strips of the case. One end is clearly shown in Fig. 2. Be very careful when forming this recess not to damage the curved front of the 'book', as the thickness here will be only 1/8 in., but if this is cut slowly, no difficulty should be experienced.

The Covers

Cut the two covers from 1/2 in. plywood 8 ins. long and 5 ins. wide, and glue the bottom one in to the 1/8 in. recess of the spine. When the glue is dry, the case ends and side can be made and fitted to the spine and bottom cover.

Fig. 1 shows the case work in detail, and it will be noted from this drawing that the covers project 1/8 in. beyond the case, which is the amount usually allowed for book covers.

The two ends of the case are 5 1/2 ins. long, 1 1/2 ins. wide and 1/2 in. thick. Part of the width is cut away to a depth of 1/8 in. on each side, leaving a projection which fits the spine as shown in Fig. 4. Cut the long side for the case, which goes opposite to the spine 7 1/4 ins. long, 1 1/2 ins. wide and 1/2 in. thick.

Glue these three pieces to the bottom cover and spine, using fine panel pins at the corners if thought necessary.

The front cover or lid of the case can now be fitted, and the best way of doing this is to glue a narrow strip of canvas or, better still, leather to form a hinge along the whole length.

Efficient Clip

A piece of springy brass cut to the shape and bent up as shown in Fig. 5 will make a very efficient clip to keep the lid closed. It is fastened to the lid with two small screws, or if the wood is too thin for screws, two small rivets may be used instead. A small pin in the side of the case is sufficient for the clip to snap into.

The case may be finished in quite a variety of ways. After glasspapering, it may be stained and given a coat of french

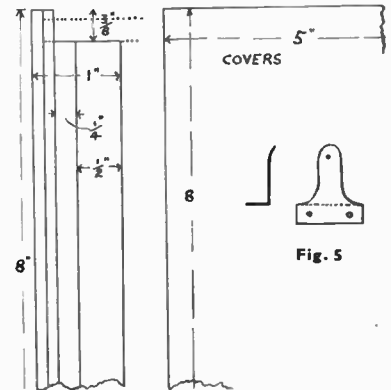

Fig. 2

Fig. 5

polish or a wax finish. A good idea is to enamel it to match the usual coverings of other books in red, green or blue. If enamel is used, the woodwork should first be given a coat of size and then lightly glasspapered.

The case can be covered to match other books, using book paper or cloth for the sides, with either cloth or leather over the hinge and spine.

There are many other uses that the case can be put to besides holding news cuttings. It could, for instance, form a useful container for writing paper and envelopes. The stamp enthusiast might use it to keep his duplicates in, or he could even house his entire collection in a set of cases, putting the stamps on neat sheets of paper cut to fit the case. This would make a splendid loose leaf album of each case, and if the collection is quite large, certain countries could have a case to themselves.

The case would form an excellent present if fitted out to hold needles and cottons or embroidery materials. Neat lettering on the spine would indicate the contents, and give a finish to a really useful article. (388)

Tell your friends about Hobbies Weekly, and introduce them to the magazine which gives hours of pleasure—and profit—to the man who can use a few simple tools.

Model-Railway Matters

MAKING THE BEST OF TINPLATE TRACK

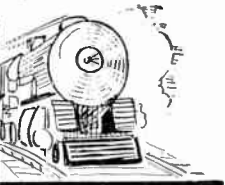

TINPLATE track is certainly handy and there is a lot of it about, but, unfortunately, it is not very realistic, having only three sleepers to a 9in. or 10in. length and standing much too high. Still, it is convenient, being easily pegged together and, at one time, it had the advantage of cheapness. Now, however, prices have risen sharply, but even now this rail is much cheaper than the scale product.

It is in appearance that tinplate track mainly fails to give satisfaction, but by treating as described here, it can be made to look very much like the real thing. Also, if one or two points are watched carefully, the running quality of the rail can be brought to quite a high degree of efficiency.

Let us take the latter aspect first.

for that distance, there is, in tinplate, two places at least where alignment may be not quite correct or joints very well made.

Therefore, the first thing in getting the best out of tinplate track is to watch alignment and see that the pegs at joints are pushed right home. It is hard to obtain perfect alignment by the eye alone and the best thing to get the desired straightness is to use a string

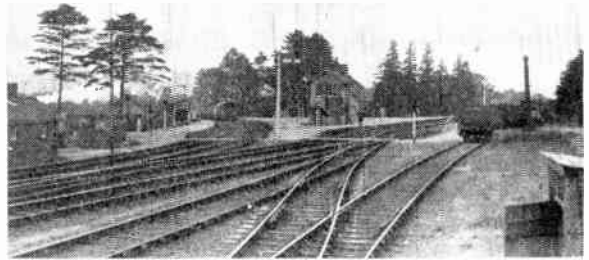

A photograph of real trackwork. Note how the sleepers are not too obvious

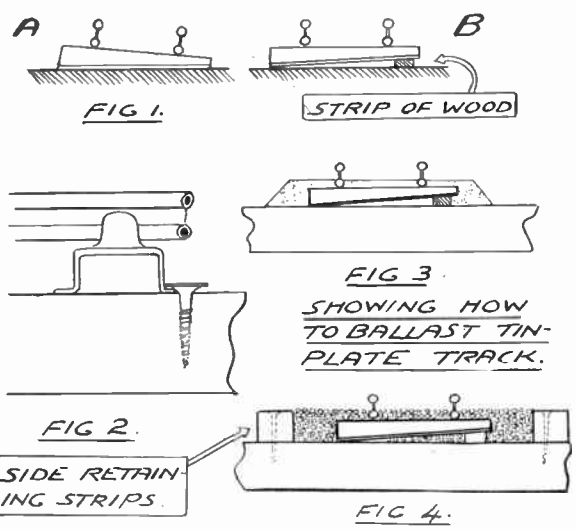

Scale track scores in being built up in lengths of 3ft. With a corresponding distance of tinplate there are three or more separate pieces. Thus, while scale track is jointless and dead straight

sleeper edge here and there catches under their heads. Only in this way can your perfect alignment remain permanent.

is to use a string stretched between two pins pushed into the baseboard. A number of lengths of tinplate pieces just put together quickly may look straight enough, but put your eye down to rail level at one end and you will be surprised at the angles that the sections make to one another. Using the string takes out all these kinks and produces a dead straight track which helps to prevent derailments and gives smoother running.

If possible, tinplate rails should be clipped down to the underlying base, if only with small screws put so that a

With an idea of going into an oval and leading on to a circle, the sleepers of much tinplate straights are thinner at one side than the other, so as to preserve the super-elevation of the curve, see (A) Fig. 1. This is all right for small oval running, but for good lengths of straight on more ambitious layouts it means that the trains are running

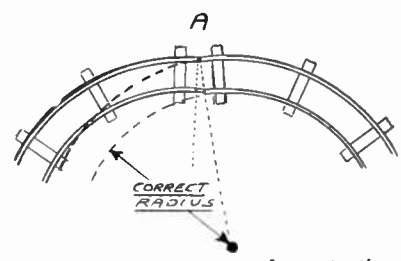

Fig. 5—See that a curve conforms to the correct radius

slightly tilted to one side. To cure this, insert a strip of wood under the thinner side of the sleeper as (B), which, if the track is screwed down, need only be a tiny piece. If it is loose laid this piece

(Continued foot of page 315)

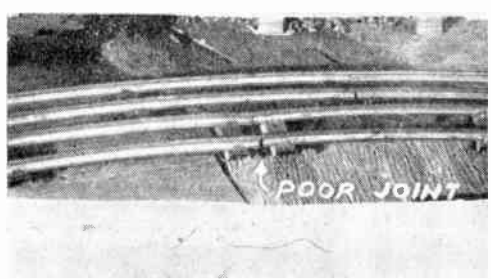

Fig. 6—A poor joint, brought about by straining

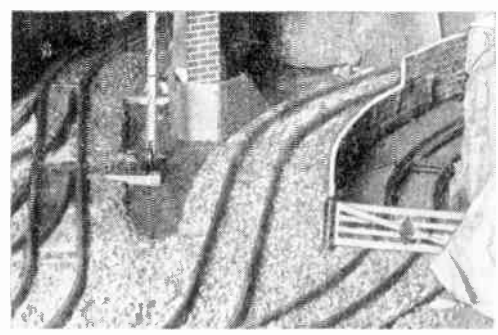

Fig. 7—Ballasted tinplate. Compare with the picture of the real thing



A Frame Aerial

I AM constructing a small 4-valve A.C. T.R.F. receiver, for medium waves only, the cabinet of which measures approximately 10ins. by 6ins. by 5ins., and I should like to incorporate a frame aerial. If this is possible, could you give me the number of turns required for the frame aerial, also information with regard to connections of same to receiver. The T.R.F. receiver employs a medium wave coil and no earth connection is required. (A.R.H.—Accrington).

FOR a receiver in which the frame is to be for M.W. only, for use with the R.F. stage, only a single winding is needed, and this will be connected to receiver chassis and R.F. valve control grid. If ganged tuning is used, the frame should gang with the detector tuning coil, and should have the same inductance as the latter. The number of turns will depend upon whether a flat frame is to be used, or a spacewinding is possible. If the turns are close together, fewer will be required. 22 turns of 28 S.W.G. wire, turns spaced by approximately the diameter of the wire, on the 10ins. by 6ins. frame, would be approximately correct. It may be necessary to add or remove a turn or two to match the particular coil, for best results, or use a trimmer across the winding, unless separate tuning condensers are used.

Rectifier Panel

I HAVE in mind the construction of a rectifier panel, delivering three different voltages. The transformer I will be using is a 230v. one, giving outputs of 32v.—1.5a., 20v.—3a., and 14v.—5a. Must I purchase a separate rectifier for each voltage, or will one be sufficient? Please inform me how I should wire up the transformer and the rectifier, and also any necessary condensers and/or chokes? Also, what are the final voltages I am likely to obtain, please?

A 32v. 5a. rectifier would handle the maximum voltage and current you will employ, and could be used. A rectifier may be used on lower currents or voltages than its rating, which is for maximum current and voltage. One such rectifier would, therefore, do. The particular secondary connections are taken to the 'A.C.' tags of the rectifier (sometimes these are marked 'S'). The D.C. output will then be obtained from the positive and negative tags, marked red and black, or with positive and negative signs. A 3-way switch could be used to transfer the 14, 20 and 32v. outputs to the rectifier, if a 32v. rectifier is used. The same rectifier will work on 100 or 50 cycles. However, the turns-ratio of the transformer will depend upon the frequency, and a transformer suitable for 100 cycles would not be suitable for 50 cycles, as it stands. The

final voltages will depend wholly on the current taken. A voltage drop of about 30 per cent is usual; this will be more heavy load, and may be less if only a slight current is taken. For motors, no smoothing will be required. Motors with wound armatures and fields will work from A.C.

Good Surface For Hardboard

I WOULD like to know the procedure to bring up a good enamel finish on plasterboard or compressed hardboard. Would a finish with varnish paint be better than enamel? (J.H.—Edinburgh).

THE normal procedure to build up a glossy surface on wallboard, is first to apply two or three coats of any good priming paint or under-coating paint to fill the surface. Then rub down thoroughly with coarse glasspaper, give a tinted undercoat and follow by one or two coats of enamel or synthetic finish paint. Each coat must be allowed to dry and set hard before applying the next.

Soundbox to Violin

WHAT is required to have a horn or wood box fitted to an ordinary violin, and how is it fitted? Do you know a firm which could supply suitable timber for a violin? (M.H.C.—Duleek).

IT is not considered advisable to fit an ordinary fiddle with a sound box and horn. This will definitely destroy the tone quality of the instrument. With regard to timber, we suggest you apply to S. A. Hurren, Music Trade School, Northern Polytechnic, Holloway Road, London, N.7, who will, no doubt, be pleased to help, as the timber which is imported, is in short supply.

Making the best of Tinplate Track—(Continued from page 314)

should be quite a long strip and put in parallel to the rail above.

Joints in tinplate track should form almost continuous rail, but with many peggings in and out the opposite side to the peg can become a bit opened out. To remedy this the offending piece should have a neighbouring length attached to it, the tin round the peg then being gently tapped and finally given a touch with a file to ensure smoothness. This file work must be of the least, as the last thing you want to do is to make the tin thin at that point, although more liberties can be taken if the joint is to be permanent.

Tinplate sections on a curve should be pegged together with especially great care to see that the intended radius is maintained throughout. If there is any attempt to make the curve bigger by pulling the ends apart, the joints become poor and strained and take on a 'knuckle' shape as in Fig. 5 (exaggerated for clarity) and in the photograph Fig. 6. This makes for derailments or at least rough riding at a place where the utmost smoothness is required.

Quite apart from trying to make a

curve bigger, curved sections often get 'pulled' inadvertently, so keep an eye on these important lengths of track.

The making of tinplate track to look like the real railway is purely a matter of camouflage, for the scattered sleepers and inordinate height still remain. If a stretch of actual full-size line is examined, it will be noted that the sleepers are not very obvious. Indeed, if the track is viewed from some little distance, the impression is that the rails are lying directly on some flat surface. This impression can be well obtained with tinplate sections by covering the sleepers entirely with some suitable ballast, so that only the rail-heads are showing. An appearance then as the accompanying photograph (Fig. 7) is given. The siding beyond the gate in the picture is still unballasted and it is interesting to compare this with the ballasted part outside. The better appearance of the latter is obvious. Small cork chippings that come in fruit barrels make excellent ballast, and this is what was used on the stretch of line shown.

Ballasting, again, is best effected when the track is permanently laid. The

material can be put down loose if the line is supplied with side strips (Fig. 4), but if not it should be soaked in a thin glue solution before laying. Treat a big quantity at once in a pan and stir about till a kind of 'mash' is obtained. Patchy ballasting with small quantities is not good.

Placed along the track, the damp ballast can then be pressed to a level surface with a block of wood and built up to a nice shape either side (Fig. 3). When dry, although only a modicum of glue has been used, ballast of this type holds very well in position. Another material that can be employed is sandstone broken down to small pieces, or actual chippings can be used pounded till no piece is greater than $\frac{1}{4}$ in. across, and from which all dust has been sieved.

Well fixed to the base, carefully aligned and ballasted, tinplate track both looks and runs well, and in an ensuing article we will have something to say about tinplate points and how the best can be got out of them. (382)

(To be continued)

An interesting pastime is making DECORATIONS from POPPY HEADS

YOU will soon have the chance to pick and store poppy heads for decorative purposes. You should leave the green seed-pods in the garden until they have swelled to their fullest and have changed their grey-green for a pale russet shade. Then, before they have a chance to scatter their seeds, pull up the plants, tie in bundles and hang upside down in the garden shed. Tie a large paper bag over the heads and you will catch the ripened seeds. These you can use for next spring sowing.

You will also have the heads ready for the winter evenings and you can start on your craftwork.

Many people only paint the heads in

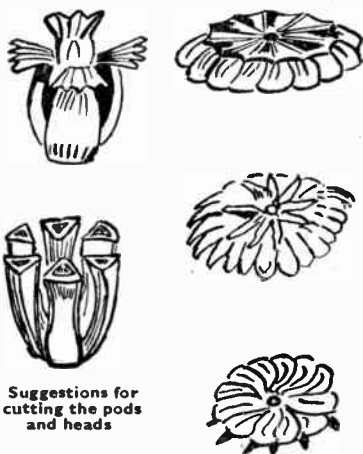

Suggestions for cutting the pods and heads

poster colours or enamels. Most art enamels will do, and some very effective ideas can be made with the addition of metallic paints in silver, bronze, gold and deep gold. These mix well with scarlet.

For small rooms the heads may appear too massive and a little unsightly. You can get some variations with any old razor blade.

In the illustrations you will see the

poppy head cut into four, six or twelve segments. The portions are bent gently backwards without breaking them right off. When set you can hold with a little sealing wax or some glue. Keep them tidily apart so that they look neat. You can now use the poppy head, perhaps, in another colour and fit this in with a little thin wire.

Effective Design

Actually the poppy heads in themselves have a very effective design and make most fascinating flowers on their own.

Cut some from the pod tops, pressing a pin through each centre so that a small piece of wire can be used as a 'stalk'. You will find they are attractive used either way up. If, when cutting up, you leave a narrow piece of the actual pod, another interesting pattern is formed.

Whatever design your cutting has taken, all that remains now is to paint the shapes with either poster or oil colours and then you have a miniature bouquet which can be arranged in a small bowl. Its beauty will astonish your visitors.

A Sound Foundation

A piece of clay or cork or a slice of potato will make you a sound foundation on which you can set them. Plasticine can also be used. If you require leaves, then use the poppy stalks which have been beheaded. Slice them down the middle, sharpen to a point and you will have a reed-like foliage.

Another use can be made of these sliced heads for decoration on any art bowls. Make some gesso-paste by mixing plaster of paris with cold water until a thick paste is obtained. Before it has time to set, add some fish glue or similar adhesive in the ratio of one teaspoon of glue to a tablespoon of plaster. Mix well with a knife and then thickly coat the jar with which you intend to work, either covering the

whole surface or putting on decorative bands. Now take your poppy heads or caps and stick them into the gesso. Groups of heads can be put on, if desired.

Leave for a couple of days, and then the handiwork can be suitably painted.

This is not the only use to which this craft can be put. I have seen it used on book-ends, jewel cases, cardboard boxes and wall plaques.

Another little idea is to plan the poppy heads in a group to be coloured in bright enamels. Leaves of the lily-of-the-valley type can then be designed and set on the article with sealing wax or priola barbola paste. This you can get at



Another way of cutting a head

most art and craft shops in tins. It is a putty-like substance which will adhere to most surfaces, and you often see it as a decoration on the ornamental mirrors. It will enamel and a coat of fine art varnish will finish it off. It can be 'built' on to a good depth, and makes a very effective finished design when used with the poppy heads. (443)

The advertisements in *Hobbies Weekly* will always repay your careful attention.

**EVERY CAR THAT PASSES
YOU WILL FIND THE INDEX MARK
ALPHABETICALLY ARRANGED IN
WHERE'S THAT CAR FROM?**

Price 6d.

from all Booksellers or from the Publishers (1½d. postage)

RALEIGH PRESS, EXMOUTH

KITS for OLD TIME SHIPS

Hobbies range of Ship Models includes Elizabeth Jonas, Cutty Sark, Victory, Mayflower, etc. Complete kit of wood, sail material, guns, pulleys, cord, etc., with full size pattern of parts and planed wood ready to cut out, shape and construct. A fascinating pastime.

Kits for models 12½ ins. long and upwards.

Ask for free illustrated lists at *Hobbies Branches* or from *Hobbies Limited, Dereham, Norfolk.*

STOP SMOKING

You can overcome the smoking habit in 3 days or money back. Safe, pleasant, permanent. The only scientific way. No Will Power necessary. "Conquered the habit in 2½ days. Am delighted".—F.C. "Within 2 days I was free from the tobacco habit".—W.G. "Was a smoker for 2 years and broke the habit in 2 days".—F.N. "I haven't smoked a cigarette for 5 weeks".—J.E. "I used to smoke 20 a day . . . now I have no desire to smoke".—J.M. Recommended by "Health and Efficiency Magazine". Complete course 6/6. Details 1d. stamp. Sent under plain cover.—**STEBBINGS, 28 (H/100), Dean Road, London, N.W.2. Established 1928**

EARN £££'s WEEKLY 114 WAYS TO BE YOUR OWN BOSS

114 tested ways of earning a second income at home, with little or no capital. Many are earning £5-£20 weekly. Money back if not delighted. Post free, only 5/6. Details 1d. Catalogue of Money-making Hobby Books and courses, 2d. **STEBBING PUBLICATIONS LTD., 28 (H/100), Dean Road, London, N.W.2**

MISCELLANEOUS ADVERTISEMENTS

The advertisements are inserted at the rate of 4d. per word prepaid. Name and address are counted, but initials or groups, such as E.P.S. or £1/11/6 are accepted as one word. Postal Order and Stamps must accompany the order and advertisements will be inserted in the earliest issue. Announcements of freework goods or those shown in Hobbies Handbook are not accepted. The charge for use of a Box No. is 1/- extra. Orders can be sent either to Hobbies Weekly, Advert. Dept., Dereham, Norfolk, or Temple House, Tallis St., London, E.C.4

100 DIFFERENT stamps free (including Triangular and Pictorials) to all genuine collectors who apply for my approval selections. Please enclose 2½d. postage.—N. Johnson (Dept. H), 19 Hillside, Slough, Bucks.

STAMPS. Special summer bargains. 100 large Pictorials, 6/- 50-3/-. 10 U.S.A. Commemoratives, 1/-. Free gift to approval applicants. Postage appreciated.—W. E. Tucker, 6 Higher Church St., Barnstaple, Devon.

RADIO Constructors crystal set—wiring diagram, instructions, coil of wire for tuning coil, crystal and catwhisker, all 3/- post free. Satisfactory volume guaranteed. List 1½d.—Alexstone Co., Hillworth, London, Glou.

DOZEN only hardwood panelled doors, 12x12x3 ins. 2/6 each carriage paid. Blank P.O.'s. to—BM/SARAC, W.C.1.

HYPNOTISM—a most amazing course that all can afford. 5/- post free! Descriptive leaflet, 3d.—BCM/NEWDALE, London, W.C.1.

STAMPS FREE!! Twenty unused (2½d.).—SG. H. Barnett, Limington, Somerset.

10 SMASHING airmails free! Request approvals. Postage.—Alphyl Publications (A-stamps), Heanor, Derbyshire.

FASCINATING home plan—£5 weekly easily earned. 1/6 per copy (limited number).—BCM/NEWDALE, London, W.C.1.

PERSPEX. Clear cutouts in ½ in., ¾ in., and 1 in. All useful sizes. Bargain parcels, 10/- and £1. C.W.O. (refunded if dissatisfied).—R.L.R. Plastics, Wembley Park Middlesex.

PRIVATE Christmas Cards—spare-time agents (either sex) wanted. Sample book contains beautiful designs. Splendid opportunity for enterprising and bona fide applicants to make money without outlay. Write—Hamilton & Co., Manufacturers, 'Orient' Works, Blackburn, Lancs.

INTRODUCTIONS. Pen friends, companionship or marriage.—V.C.C., 34 Honeywell Road, London, S.W.11.

BE Taller in 14 days or money back. Details, 1d.—Stebbing System, 28 (HB) Dean Road, London, N.W.2.

BUILD your own saw bench. Shafts from 28/6. Pulleys, Belts, Motors, Saws supplied. S.A.E. list.—Sullivan, 19 Allen Road, Wednesbury.

CONJURING and Magic. New tricks and pocket novelties every month. Lists, 4d. Roboati, Magician, 363 Sandycombe, Kew Gardens.

MODELS. You can make lasting stone-hard models with Sankey's Pyrama Plastic Cement. Supplied in tins by Ironmongers, Hardwaremen and Builders' Merchants. Ask for instruction leaflet.

DUPLEX self-adhesive Transfers for decorating fancy goods, trays, plastics, etc. List and samples, 3d.—H. Axon-Harrison, Jersey.

DOLL'S House fittings and papers; send S.A.E. for list. Doll's house plan special; send 2/6. Trade supplied.—Zimplan, 88 Ware Road, Hoddesdon.

LORRY Kits, 4 mm. and 7 mm. scale. Also large range of spare parts from which to build to your own design. Send for fully illustrated catalogue. Price 1/-.—Wilson's Lorries Ltd., 6 Gt. Winchester Street, London, E.C.2.

PLYWOOD Offcuts. Birch and Gaboon in various thicknesses. Handy sized parcels for the cabinet, toy, model maker, and all handicrafts. Parcels made up in £1 and 10/- lots. Carriage paid. Send P.O. to—Reeves, Plywood and Timber Merchant, 33 Front Street, Monkseaton, Whitley Bay. Tel. W.B. 4677. Parcels are now dispatched on day of receiving order.

BLUSHING, shyness, nerves, self-consciousness, fears, ended. Details under plain cover, 1d.—Stebbing Treatment, 28 (HB) Dean Road, London, N.W.2.

£5 to £20 weekly earned at home, running your own Mail Order business. Details, 1d.—Stebbing Publications Ltd. (HB), Naphill, High Wycombe.

AMERICA'S famous hobby magazines. One year's supply. Popular Mechanics, 32/-; Popular Science, 28/6; Homecraftsman, 16/6; Popular Homecraft, 18/-. Free booklet listing all others sent on request.—Willen Ltd. (Dept. 57), 101 Fleet Street, London, E.C.4.

EARN £5—£20 Weekly dealing in stamps. Booklet testimonials, 1d.—M. Stebbing, Terry, Naphill, High Wycombe.

USE sparetime on profitable homework making fancy goods. Write for free booklet.—(Area 544), 54 Southgate Street, Leicester.

HOME Watch and Clock Repair Outfit. Includes watchmakers magnifying eyeglass, tweezers, screwdrivers, oilers, oil, brush, dusting powder, plus illustrated explanatory book. Watch and clock repairing simplified. In container, 12/9 inclusive.—D. Bolster (Dept. H.), 5a Station Parade, Ashford, Middx.

LOVELY? Then write Secretary, U.C.C.—15 B.B. Hay Street, Braughing, Herts. Genuine. Est. 1905.

HAVE you got your Juneero Riveting jig yet? From all hobby shops or post free from—Juneero Ltd., Stirling Corner, Boreham Wood, Herts.

STAMPS Free. Empire packet including Pictorials and Victorians free to approval applicants.—Robert J. Peck, 7A Kemp Road, Bournemouth, Hants.

WHEELS for Toys, etc., in Hardwood, Plastic and Rubber Tyred Metal. Doll's House fittings and papers. Doll's Cot and Pram fittings. Decorative Transfers. Beads for Counting Frames and other Toy accessories. Fine Art Pictures for Jig-Saws, etc. Stamp for lists. Trade Supplied.—Joyden Toy Co., 193 Chase Side, London, N.14.

HOMEWORKERS required; either sex. Light Assembly. Part or full time. S.A.E.—Esprey, Box 18, 41 Wade Street, Lichfield.

NOVEL Calendar Designs painted on plywood for cutting out, with date cards. Inexpensive gifts. Profitable to sell. Sample, 2/-; half dozen, 11/-, including postage.—Cleaveley (H.W.), 50 Windsor Road, London, N.W.2.

9.5 POPULAR Film Hire Library. 3d. Stamp lists.—Wayland, 223 Longley Road, Tooting, London.

TRICKS for everyone. Vanishing candle, 1/3; tightrope ball, 2/6; cut and restored rope 1/3; window mystery, 1/3; eastern mystery, 1/3; rising card, 1/6; it's off, 2/3; phantom cigs, 1/6. Free trick to all spending 5/-.—Magicians Den, Wimborne Road, Winton, Bournemouth.

PROFITABLE spare-time employment for everybody. Clerical, assembly, toymaking, etc. 100 firms! 'Spare-timer', 1/-. S.A.E.—43 Douglas Avenue, Heanor, Derbyshire.

100,000 Government Surplus Bargains. ¼th H.P. motors, 200/250 volts A.C., intermittent duty, 2,500/3,000 r.p.m., brand new, 39/6, post 1/6. Good selection of other motors from 9/6. Transformers, 230/12v. 10 amps., 25/-, post 1/6. Aluminium rivets, approx. 1lb. assorted, 2/6, post 6d. Sponge rubber strip, 1½" x ½", 1/- yd., post 3d. (Max. single length 6yds.). Strong elastic cord, multi-core, ¼" dia., 10yds., 3/6, post 10d. Metal ammunition boxes, 12" x 7" x 6" with hinged lid, ideal tools, etc., 2/6, post 10d. Spring loaded plunger switches, ideal foot switches, etc., 1/-, post 3d. Hundreds of other bargains. Send 3d. stamp for Mail Order catalogue. Money back guaranteed.—Milligan's, 24 Harford Street, Liverpool, 3.



YOU can build this GARAGE

WITH BRICKPLAYER

BRICK & MORTAR BUILDING KIT

It enables you to build Houses, Inns, Railway Stations, Signal Boxes, or from your own imagination. All railway models will fit 'O' gauge scale. Buildings can be permanent, or dismantled by merely soaking in water and the bricks used again and again.

BRICKPLAYER KITS AT 28/6 AND 52/6 ARE AVAILABLE FROM GOOD TOYSHOPS, HOBBY SHOPS, AND DEPARTMENTAL STORES.

ACCESSORY PACKS

No.	Contents	Price
100	100 Full size Bricks	3/-
101	52 ¾-Bricks and 72 ¼-Bricks	3/-
102	Gable and Peak Bricks	3/-
111	Capping and Roof Tiling	2/6
112	Concrete Roofing	2/6
114	Bag of Brickplayer Cement	1/3
115	Roofing Cement	9d.
8107	2 Bay Windows with 31 Splay Bricks	3/9

METAL WINDOW AND DOOR FRAMES

F1 F2 F3 F4 F6 F8 F10
8½d. 6½d. 7½d. 5d. 4d. 6d. 7½d.
8108 Sheets of Glazing, 1½" x 6" (Plastic) 1½d.
If your dealer cannot supply, write for address of nearest stockist to:

J. W. SPEAR & SONS LTD.
(Dept. H) ENFIELD MIDDLESEX

HOBBIES BRANCHES

LONDON

78a New Oxford St., W.C.1

(Phone MUSEUM 2975)

87 Old Broad Street, E.C.2

(LONDON Wall 4375)

117 Walworth Road, S.E.17

(RODney 5509)

GLASGOW—326 Argyle Street

(Phone CENTral 5042)

MANCHESTER—10 Piccadilly

(Phone CENTral 1787)

BIRMINGHAM—14 Bull Ring

SHEFFIELD—4 St. Paul's Parade

(Phone 26071)

LEEDS—10 Queen Victoria Street

(Phone 28639)

HULL—10 Paragon Square

SOUTHAMPTON—25 Bernard St.

BRISTOL—30 Narrow Wine Street

(Phone 23744)

At last! realism to your Model Railway

**"00" GAUGE
PLATFORM ACCESSORIES**

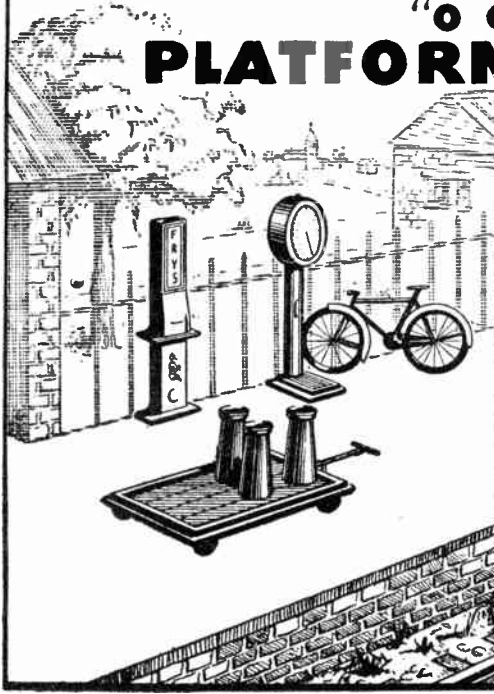

This set of intriguing platform accessories is just what you need to add realism to your model railway.

Die cast and hand painted in bright colours, this set, No. 7, is '00' Gauge scale, and consists of a four-wheel porter's trolley, bicycle, chocolate machine, three milk-churns and weighing-machine. Price 2/6 complete set, including post and packing. Send now for this set.

We have a complete range of '00' Gauge model railway accessories. Send stamped addressed envelope for descriptive list.

TRADE ENQUIRIES ALSO INVITED

R.B.N.CO.
 (Dept. H), 180, BROADHURST GDNS., WEST HAMPSTEAD,
 Telephone: MAIDA VALE 1070 LONDON, N W 6

A high-speed lathe
 for the
Home Craftsman

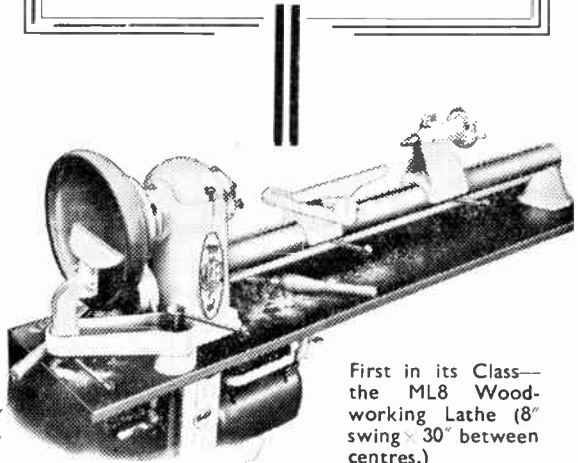

First in its Class—the ML8 Woodworking Lathe (8" swing x 30" between centres.)

MYFORD

ENGINEERING CO. LTD., Beeston, Nottingham

For wood,
 card,
 plastic,
 leather,
 metal etc.

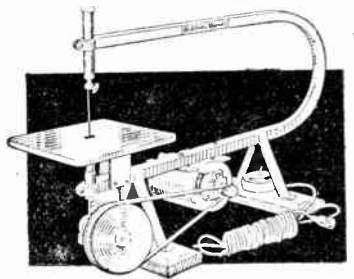

**TREADLE
 OR MOTOR
 FRETSAWS**

Whatever the handyman or craftsman is cutting or making, one of Hobbies Fretmachines will help with the job. For toy making, fretwork, model making, it provides easy and speedy cutting in all kinds of material. A pleasure to use, a factory for output, a lifetime of service. **FROM**

80/- to £11 - 2 - 6

Ask to try one at any Hobbies Branch or good class ironmonger or hardware stores. Or free illustrated leaflets on request to:

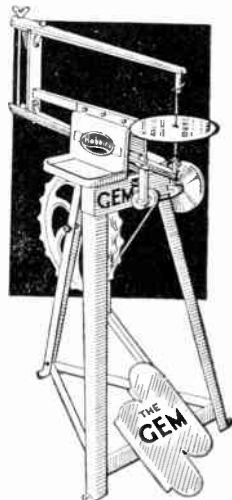

HOBBIES LIMITED, DEREHAM, NORFOLK.

STUDY
AT
HOME

IN YOUR
SPARE
TIME

THE BENNETT COLLEGE

*will set you on the right
course for success*

You make sure of planned progress in the career of your choice when you let the most progressive, most successful Correspondence College in the world coach you through the post. By friendly, individual training we equip you with the specialized knowledge you must have for a well-paid key position. Make the first move TODAY—post the coupon below!

**ALL TEXT BOOKS ARE
FREE!**

to Students of The Bennett College Ltd. We send as many volumes as the subject demands and they become your personal property.



IS YOUR CAREER HERE? IF NOT, WRITE FOR FREE ADVICE

Accountancy Exams.
Agriculture
Applied Mechanics
Aviation (Engineering and Wireless)
Blue Prints
Boilers
Book-keeping.
Carpentry and Joinery
Chemistry
Civil Engineering
Civil Service
All Commercial Subjects
Commercial Art
Common Prelim.
E.J.E.B.
Concrete and Structural Engineering
Diesel Engines
Draughtsmanship.
Electrical or Mechanical
Estate Agency

Engineering.
All branches. Subjects and Exams.
General Certificate of Education Examination
General Education
G.P.O. Eng. Dept.
Heating and Ventilating
Institute of Municipal Engineers
Journalism
Languages
Mathematics
Metallurgy
Mining. All Subjects
Mining Electrical Engineering
Motor Engineering
Naval Architecture
Plastics
Play Writing
Plumbing
Police, Special Course
Preceptors, College of
Press Tool Work
Pumps and Pumping Machinery
Quantity Surveying
—Inst. of Quantity Surveyors Exams.

Radio Service Eng.
Radio (Short Wave)
Road Making and Maintenance
Salesmanship
Sanitation
School Attendance Officer
Secretarial Exams.
Sheet Metal Work
Shipbuilding
Shorthand (Pitman's)
Short Story Writing
Short Technical Courses
Speaking in Public
Structural Eng.
Surveying (R.I.C.S. Exams.)
Teachers of Handicrafts
Telecommunications (City and Guilds)
Television
Transport Inst.
Examinations
Viewers, Gaugers
Inspectors
Weights and Measures
Inspectors
Wireless Telegraphy and Telephony
Works Managers

COUPON. CUT THIS OUT

IF YOU ATTEND TO THIS NOW
IT MAY MAKE A WONDERFUL
DIFFERENCE TO YOUR FUTURE.

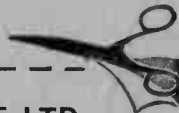

To DEPT. 62
THE BENNETT COLLEGE LTD.
SHEFFIELD

Please send me (free of charge)

Particulars of..... (Cross out line which does not apply.)

Your private advice
about

PLEASE WRITE IN BLOCK LETTERS

Name

Address

Age if under 21



— HAVE YOU EVER
SEEN ANYTHING
SO SIMPLE
— SUCH VALUE
FOR MONEY ?

You buy a Wolf Cub Electric Drill for only £5.10.0

You add a few low-cost parts,
and presto — a Saw Kit.

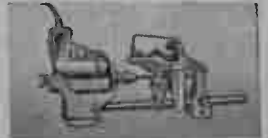

Add a few more — now it is
a Lathe Kit.

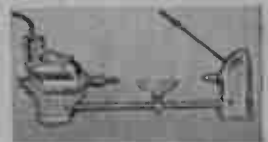

For a few shillings you have
now a Drilling, Grinding &
Polishing Kit!



— AND THAT'S NOT ALL THE STORY!

Write at once for large size, fascinating fully pictured
folder, "Profitable Pleasure."

KILL RADIO INTERFERENCE

FIT A
SURATEL
SUPPRESSOR



Specially designed for use with Wolf Cub Drills. Supplied ready to attach to "Cub" lead. Conforms fully with official regulations. Only 23/6.

Television Suppressors also available for fitting by Wolf Service Engineers. 8/6 inclusive.

★ Prices and descriptions are subject to alteration without notice.

WOLF ELECTRIC TOOLS LTD.

PIONEER WORKS, HANGER LANE, LONDON, W.3

Telephone: PERisval 5631-4. BRANCHES: BIRMINGHAM · MANCHESTER · LEES · BRISTOL · GLASGOW