

Hobbies

WEEKLY

May 3rd, 1944.

Price Twopence.

Vol. 98 No. 2533

MODEL LIGHTSHIP

CERTAIN Lightships round our coast are now manless vessels which can be left unattended for months. They are sturdy vessels with a lantern tower in which there is a powerful beacon light, whilst on the deck of the vessel there is also a warning fog bell.

Our model contains an electric lamp in its tower and a battery in the "hold" or hull of the ship, and the details given should make the construction clear. The size of the ship is 9ins. long and 6ins. high.

It would be a good thing to provide a base as the ship would thus stand firm when the switch for putting on and off the light is being used. The top of the base should be painted realistically to represent the sea with green, blue and white paint or enamel.

The Hull

The hull is made from three separate pieces of wood cut to shape with the fretsaw and afterwards glued together (see Figs. 1 and 2). The three pieces to be glued up are shown as B, C and D, the lowermost piece A being made detachable to get to the battery compartment.

Two panels of wood, each 9ins. by 4ins., one $\frac{3}{4}$ in. thick and one $\frac{1}{4}$ in. thick are cut to the simple outline and measurements shown in Fig. 1. The "well"

for the battery is cut in both these pieces while piece A is cut to the outline only.

The top layer of wood D, $\frac{1}{4}$ in. thick, after being cut to the same outline as pieces B and C, is hollowed out, as shown. This piece can be glued down to piece C. It would in fact make the surface shaping of piece D easier to deal with if it were glued down to C before the shaping was commenced.

Piece A need be only $\frac{1}{4}$ in. thick, and if a separate base is to be fitted, then piece A can be omitted altogether and the base screwed to B direct.

In Fig. 2 a useful scale is included from which certain parts can be scaled off direct to obtain correct positions. When the hull is together the shaping of the sides and deck may be finished off. A rounded effect should be got where the deck meets the sides of the hull.

The construction of the lantern tower is seen in Figs. 3 and 4. To form the hollow column supporting the lantern, either a piece of $\frac{3}{4}$ in. dowelling with a $\frac{1}{4}$ in. hole bored through it, or a piece of cardboard tubing answers the purpose. As the

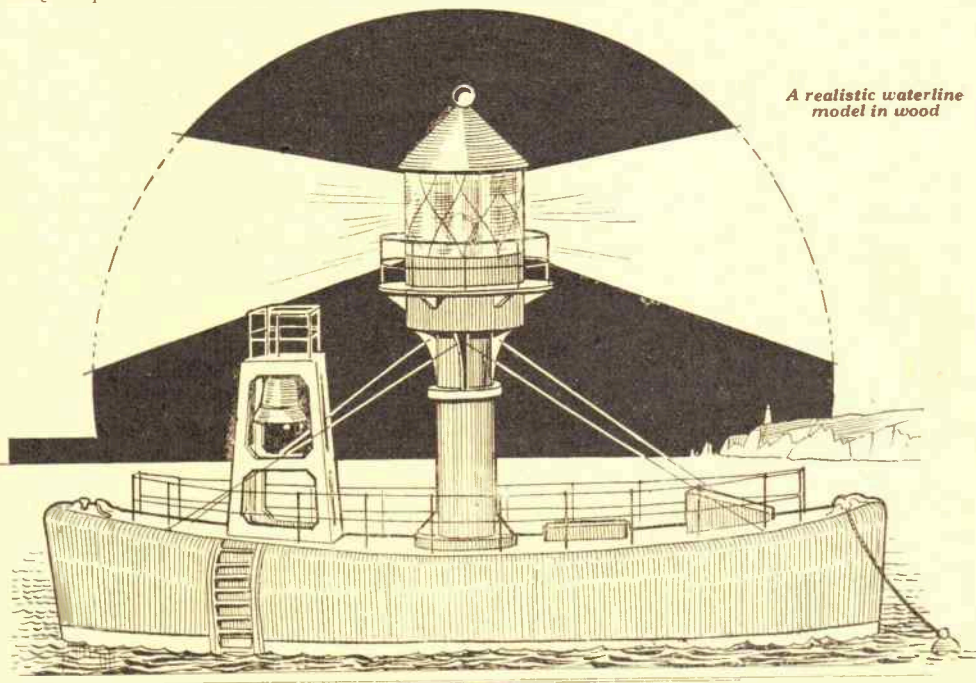

A realistic waterline model in wood

length of the column is only $2\frac{1}{2}$ ins. it should not be found difficult to bore the hole.

The hollow column is for the wiring connecting the lamp above with the battery and switch in the hull. The column will fit into the hole in the deck and be glued, a ring or collar (E) of wood fitting round it. A second collar, F, of less outside diameter than collar E, is glued $\frac{3}{4}$ in. down from the top of the column.

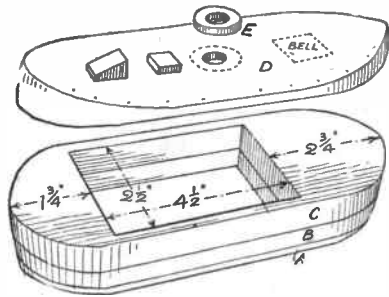

Fig. 1—How hull and deck are formed

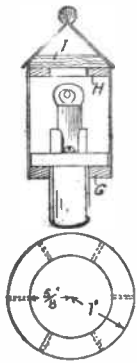

Fig. 4—Lantern parts

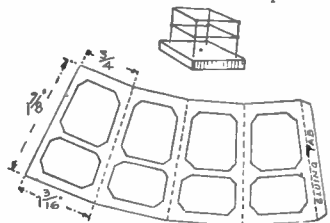

Fig. 6—Bell tower shape and rails above

Lantern Windows

At Fig. 3 we see two more collars, G and H, both $1\frac{1}{2}$ in. diameter, with G having a hole to fit the top of the column. Round these two discs must be bent and glued a piece of transparent material, or a piece of stout oiled paper. The width of this material must be $1\frac{1}{2}$ ins.

A capping disc I is next glued to the top of H, a chamfer being worked round the former to take the cone of the lantern. A simple cone may be formed from card and glued to I, a ball terminal being glued on as a suitable finish.

A balcony to the lantern is formed from card (see Fig. 4), little cardboard brackets K being glued beneath as support. The whole lantern is made removable from the column on account of the wiring to the bulb inside the holder of which must be

inserted before the celluloid is fixed.

The five thin wood brackets J must be glued to the column, the lantern fitting down on to them later. The section through the lantern, Fig. 4, gives the positions of most of the parts.

The bulb holder, it should be noted, is fixed to disc C by two small screws, the holes for which are, of course, already prepared in the bakelite holder.

A simple switch arrangement is formed on one side of the model just

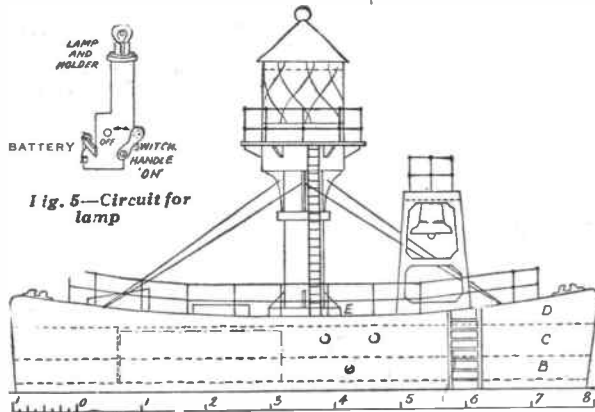

Fig. 5—Circuit for lamp

Fig. 2—Section of model with scale

in front of the battery to make the wiring connections. The dotted lines in Fig. 2 show where the battery will be placed in its "well," and the two studs and the fixing screw of the switch handle are seen also here. This together with the wiring diagram Fig. 5, should make it clear as to the final wiring connections, etc.

The Bell Tower

The bell tower is made from stout card, all four sides being in one piece angled up and glued to square blocks of wood. In

Fig. 6 the complete sections are shown, one section being dimensioned as guide for setting out.

When the one section has been outlined, a tracing of it should be made and the three remaining attached to it as shown, the dotted lines indicating where the card must be lightly scored with a sharp knife to facilitate bending. An $\frac{1}{8}$ in. thick square of wood fits the top $\frac{3}{4}$ in. opening of the tower and another square of wood $1\frac{3}{16}$ in. fits the base.

After the card has been bent round the two extreme edges are connected by the gluing tab shown, the whole being bound round with cotton until the glue has hardened.

If a small brass bell could be obtained for hanging in the tower, it would be better than an improvised one made in wood and coloured up. The position is shown in the hull

diagram, Fig. 1.

Wire Handrails

Realistic railings to go on top of the tower platforms, and sides of the deck are made from wire. The upright standards are pointed at one end and driven into the wood. With a finer wire or even coarse thread these are connected up, the wire or thread being bound round the uprights once and dabbed with glue. When they are painted blue-grey they look very

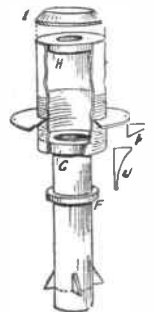

Fig. 3—The lamp tower

well.

There only remains certain minor additions to put in hand and fix to the model. A realistic ladder can be made from wire. Blocks of wood should be glued to the deck as shown in Fig. 1, and a boarding-ladder each side of the model.

Bollards are carved from hard wood and added to the deck at bow and stern (see Fig. 2). In painting the model care must be taken with the lantern. Note from Fig. 3 and also in Fig. 1 that the paint extends half way, the top half being clear. Most of the colouring should be in blue-grey, relieved in places by red or green.

It only remains now to remove the floor A of the hull and drop the battery in place. Wedge it with a couple of thin wood wedges at the sides and connect up.

Solution to Last Week's Cross Word

F	I	L	M	S	R	O	D
M	E	M	O	R	Y	A	D
A	P	M	O	D	E	S	
C	R	O	P	P	I	E	
U	L	T	I	M	A	T	U
P	E	S	T	T	M	I	T
I	S	S	H	E	S	S	
D	S	C	Y	A	L	E	
	M	A	N	T	I	R	E
C	O	U	P	O	N	S	Y

Add a lily pond to decorate the lay-out of A FORMAL GARDEN

THE subject of this article will appeal to all who are contemplating some definite scheme for their garden, for there must be quite a number of readers capable of doing a bit of amateur bricklaying and concrete work. If the pond suggested here is to be incorporated into the scheme, then the brickwork should not be beyond the skill of the average

A narrow flower border is suggested in front of the cross trellis, then there is a grass pathway which really forms a part of the lawn itself.

A brick-paved court measuring about 12ft. 6ins. by 7ft. 6ins. is then laid in the lawn, with the pond made centrally, as seen in the plan.

On three sides of the court there is an herbaceous border, the earth for it being carried up fairly high,

The plan of operations should be set out and pegs driven in to mark certain positions. Care must be taken to get right angles to the brick court edging, etc., and to the excavation for the pond.

Commence work then by digging out for the latter to a depth of 15ins. and keeping the bottom even and level all over with the sides vertical and true as possible. If the ground, after the excavation has been dug, is loose and soggy it may be necessary to put in a hardcore consisting of broken brick and stones well rammed.

Overflow water

At this stage it will be necessary to consider the making of an overflow for the water should our worker later on contemplate adding a fountain to his garden scheme. It would hardly be worth while laying drain pipes to carry away any superfluous water from so small a pond.

In one corner of the pond hole therefore, we must dig a hole to form a "soakaway" about 2ft. 6ins. deep by about 18ins. square and in it put some pieces of broken brick or stone or clinker. Do not let the openings between these stones etc. get covered up or filled with loose

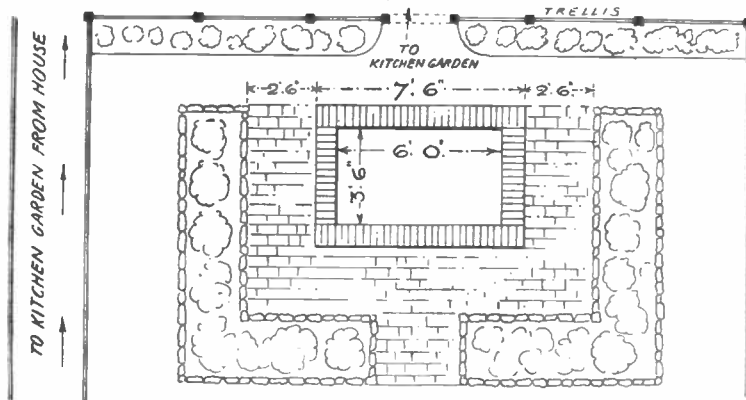

Fig. 1—A plan showing the lay-out and general dimensions

man-about-house, and the material is now not so difficult to get.

Looking at the plan Fig. 1 we get an idea of the layout for the lawn and garden of an ordinary semi-detached or detached house. The lower end of the plot is set aside as a kitchen garden and divided from the top end laid out for flowers and a lawn.

Trellis Background

A bird's-eye view of the arrangement is seen in Fig. 2 and here it will be noted that the division between the lawn and kitchen garden is made by bays of square trellis work nailed to posts which can be capped neatly and creosoted.

In the middle of the length of trellis there is an opening which leads to the kitchen garden from the lawn. The main access to the garden

the unwanted earth dug away for making the pond being deposited here.

The edging to the border may consist of stones or be made of concrete lumps made by the same process as that to

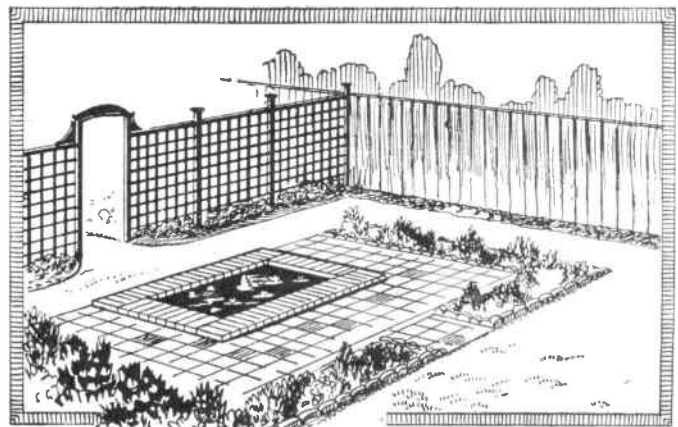

Fig. 2—What the garden looks like completed

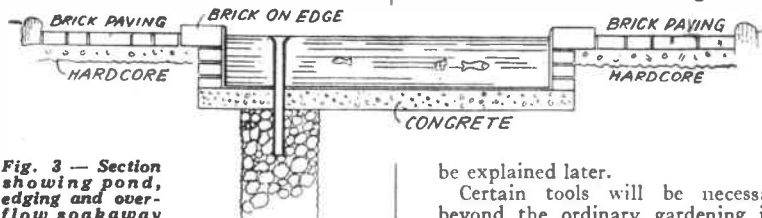

Fig. 3—Section showing pond, edging and overflow soakaway

however, is by a path leading by the side of the lawn, trellis work here again being adopted perhaps as the dividing link.

grit or earth, but keep the joints well open to allow the overflow water to soak away into the sub-soil beneath the lawn.

At Fig. 3 we see a sectional diagram through the pool and the soakaway and overflow pipe. The overflow pipe can be of small diameter, with its top expanded as shown and let into the loose brick and stone and made secure until the concrete is laid.

The concrete should consist of six parts of broken stone or shingle to

(Continued foot of next page)

be explained later.

Certain tools will be necessary beyond the ordinary gardening implements. A bricklayer's trowel and chisel and a hammer are needed, and also a wooden platform about 6ft. square on which the mortar and concrete can be mixed.

A good job of whittling can be done easily in CUTTING BIRD STICKS

FOR those who like bird sticks there is a chance to do a real whittling job which will far surpass those just sawn out of $\frac{1}{4}$ in plywood. The whittled bird really looks like one, regardless of which way it is faced. Most of the larger birds can be whittled out of from 2 to 3 in. thick wood.

Living in the country the author has enough real birds around his house, but he made the kingfisher shown to guard the outdoor goldfish pond. He does not care for any more visits from real kingfishers who seem to think that 3 and 4 in. goldfish are good delicacies.

He therefore whittled a realistic kingfisher who acts as a guard. A kingfisher as a rule takes complete charge of certain territories along rivers and streams and woe to any other of his kind that trespass. Therefore the whittled kingfisher.

To make the wooden kingfisher, use wood about 3 ins. thick. White pine is generally used but any soft wood free from sap or knots will do. Make a drawing of the kingfisher as shown at

Fig. 1 on a piece of cardboard and cut out a template.

Mark out the shape on the wood, then bore the $\frac{3}{8}$ in. hole for mounting the bird on the stick and cut out carefully to the lines as shown at Fig. 2. Mark on the sawn model the position of the wings, the eyes, and the few lines which are to guide you in shaping.

The preliminary roughing out can be done with a knife, following the general shape shown at Fig. 3. The final finish should be done with a wood rasp or a half round file. Then

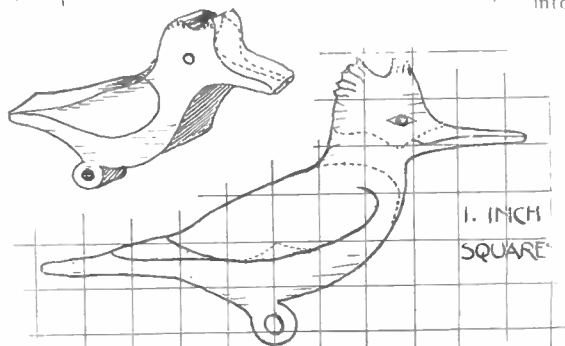

Fig. 1.—Outline in 1 in. squares and Fig. 2 (above) the shape to cut

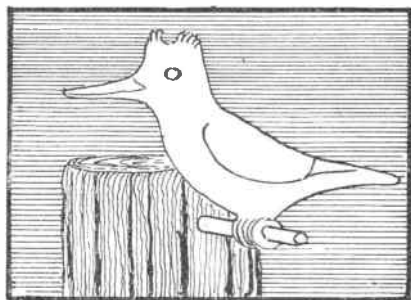

Fig. 3.—The bird in place before painting.

of course, comes the cutting of such features as the comb, the eyes, and the wings. There is some more finishing to do once those features are cut out, after which the bird is ready for painting.

To colour the kingfisher give the entire body a coat of white. Then paint the parts shaded in the illustration with lines a bluish-grey. The bill, eyes, shoulder spots, wing tips and feet are black.

A good plan is to get some coloured

pictures of the kingfisher and follow as closely as possible, using dull flat paints. Glass eyes may be obtained from the taxidermist or from a fish and tackle shop. Good substitutes and probably more durable are brass-headed upholstery tacks which can be painted to imitate eyes.

Other birds that the whittler may wish to make can easily be drawn out or traced from one of the many bird books available.

Usually birds for bird sticks are mounted on a $\frac{3}{8}$ in. dowel fitted into a $\frac{3}{8}$ in. hole placed where the feet are; this saves a lot of trouble. So in the kingfisher a hole is drilled crosswise as shown in Fig. 2, and a round stick glued into it to give it a natural appearance.

Then another hole is drilled in the post, as shown at Fig. 3. This post in turn is set into the ground at the edge of the pool, thus giving the kingfisher a natural roost for the goldfish guard.

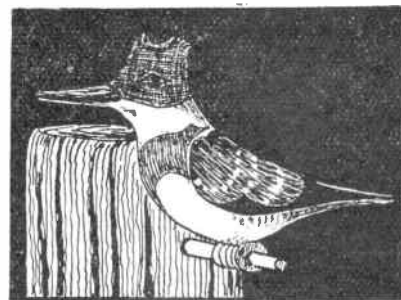

Fig. 4.—Suggested shading and coloring

Formal Garden (Continued from previous page)

one part cement. An ordinary household pail would make a suitable measure when getting out these correct proportions.

A pail of sand will be needed perhaps as an addition to the above so that the "pores" of the concrete are suitably filled.

The mortar for jointing the brickwork, when it comes to doing this should be in the proportions of 4 parts sand to 1 part cement. When the "rendering" or coating of cement on the floor and walls of the pond is being done then the proportions should be 2 parts sand to 1 part cement.

In mixing the concrete and the mortar be sure to mix the ingredients thoroughly when dry before adding

the water. Do not make the mixture sloppy or again, not too dry, and do not mix up more than can be used in one operation of mixing, throwing in and levelling up.

When the concrete which should be about 4 ins. thick has set hard, build up three courses of bricks all round the opening to form the sides of the pond. The wall will thus be 4 $\frac{1}{2}$ ins.

To hold the water, the whole surface inside the pond must be coated with the cement and sand, this coating being carefully flanged up round the soakaway pipe.

To form an attractive and efficient finish to the top of the pool or pond a border of bricks laid on edge is formed as shown in the section Fig. 3 and in the plan Fig. 1. Trowel the

joints neatly and of course use the cement mortar for this work.

The next item to see to is the paving round the pool. The space to be covered must first be levelled and rammed after about 3 ins. of the soil has been removed and replaced by a hardcore of brick and stone well rammed down.

Ordinary bricks laid flat and "bonded" in the courses make an excellent paving or again if some old 9 in. square paviers can be obtained these are quick to lay.

The paving may be jointed in cement mortar if desired. The bordering to the beds surrounding the paving may consist of brick or of concrete lumps laid firmly in place with or without cement joints.

If you have a gramophone you may need to make a HOME-MADE SOUND BOX

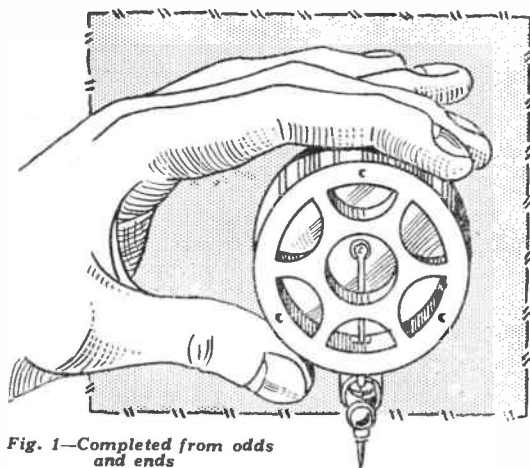

Fig. 1—Completed from odds and ends

NEW sound-boxes cost a lot of money these days. In giving you details of a simple, home-made sound-box, however, we are thinking chiefly of those of you who may live in out-of-the-way, desolate quarters where new sound-boxes cannot be bought. You will, with nothing more than odds and ends, be able to construct a sound-box that is sensitive enough for fair reproduction.

We have built a model on the lines suggested and found it to work with surprisingly good results. An "auxiliary" sound-box of this nature will get you over a difficulty for a time, alternatively, you may want it for a toy gramophone,

Making the Box

The box is made from various layers of shaped fretwood, as detailed at Fig. 2. The parts should, for preference, be cut from 3/16in. birch plywood or slightly thinner stuff. The

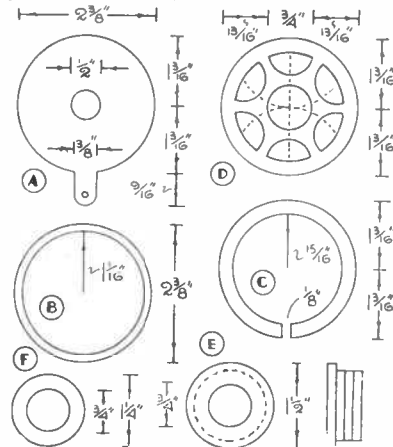

Fig. 2—Box parts to be cut out

writer used 5/32in. thick plywood,—1/32in. thicker than 1/4in. stuff.

You require a back piece (A), a flange ring (B), a covering ring (C), a back ring (E) and three smaller rings (F), all being cut from the same thickness of wood. The face, or overlay piece (D) may be cut from wood, but in order to give the box weight, it should be cut from 1/4in. sheet lead. It is, by the way, possible to "cast" the shape by making a special wooden mould.

To make this mould, get three pieces of wood 4ins. square. Mark out the overlay shape on two pieces. One piece is cut up to provide the six small segments and central disc which comprise the "openings" in the overlay. These seven pieces are glued upon the marked out piece. The 2 3/8in. diam. hole cut in the second piece of wood forms the "outside" of the overlay when the wood is attached to the first piece.

Assembly of Parts

A small inlet hole, cut after the style of the 1/4in. gap in the covering ring (C) should be made in the second piece so the lead can be poured in. The third piece of wood is nailed down on top, this completing the mould. The inside of the mould should be "sooted" with a candle flame prior to use.

To assemble the parts, glue the flange ring (B) to the back piece (A), as shown at Fig. 4. The back tone-arm rings (F) are glued together, glasspapered evenly when dry, then glued to the larger ring (E).

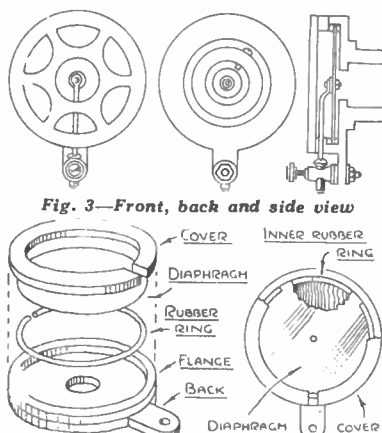

Fig. 3—Front, back and side view

Fig. 4—Assembly of the parts

At this stage, you need a suitable diaphragm. Suitable material is thin aluminium sheeting, tin or mica. The last-mentioned is not unlike thin Celluloid in appearance; thin Celluloid could be used, incidentally. If tin is employed, an excellent "compressed" diaphragm can be made from the end of a tin, such as condensed milk tin.

The diameter of the diaphragm is 2 1/2ins. When cut out, a tiny hole is drilled in the centre. Now, the diaphragm must be "sandwiched" between two rubber rings. These rubber rings can be made from the fine insulating rubber tubing on standard flexible electric wire. It is only a matter of removing the braided cord and the strands of wire.

The Diaphragm

One rubber ring (inner) is curled around the inside of the flange, then the diaphragm set on top. The cover is glued on top of the flange. When dry, the second (outer) rubber ring is tucked beneath the space formed by the cover piece so the diaphragm is nicely "packed" in place (refer to front, cut-away view at Fig. 4).

Having that much accomplished, glasspaper the edges of the sound box smooth, then adhere the tone-arm fitting to the back of the work, dead in the centre (see back view, Fig. 3). A small "lug" screw is driven into the tone-arm fitting so it engages with the slot in the tone-arm. Note the leaning angle of the lug screw in relation with the perpendicular of the needle-holder and sound post.

Sound Post and Needle Holder

To make the sound-post and needle holder, you need a 1d. bicycle wheel spoke, complete with nipple. You also need a small wireless terminal of the type shown at Fig. 5. It may be

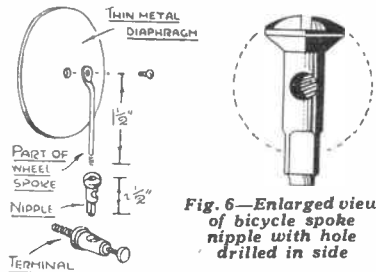

Fig. 6—Enlarged view of bicycle spoke nipple with hole drilled in side

Fig. 5—Assembly of diaphragm parts

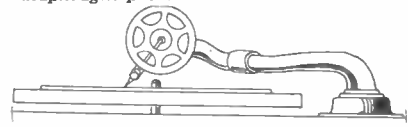

Fig. 7—General view, showing correct angle of needle

necessary to drill the pin socket hole (already drilled in the side of the terminal) with a 3/16in. drill so the spoke nipple fits in tightly.

Having forced the nipple into the terminal, the latter is screwed into a piece of wood (or gripped in a vice) in order to drill a hole in the side of the nipple (see Fig. 6). This hole is wanted for the terminal screw so its point enters the nipple and will thus screw against a gramophone needle when inserted.

Fitting the Nipple

Having drilled the hole in the nipple it may be necessary to enlarge it with a slightly thicker drill. The terminal screw threads do not permit a proper size of drill to be used at the start. Having bored a hole in the side of the nipple, the nipple is removed from the terminal and the hole enlarged, as explained.

Force the nipple back into the terminal again and try the terminal screw in place to see whether it will enter the nipple and hold a needle firmly when tightened. If the drilling has been carried out accurately, it will do so.

The sound-post is part of the wheel spoke. The threaded end of the spoke must be retained. The length of the sound-post, as you can see at Fig. 5, is about 1½ins. long. It is necessary to flatten the opposite end of the post so a small rivet hole can be drilled in it.

Note—from the sectional side view at Fig. 3—how the top of the sound-post must be bent to rest level with the surface of the diaphragm. Screw the post into the nipple until tight, then attach the terminal to the "lug" provided in the back of the box.

A rubber washer must go between the terminal and the lug, with a second rubber washer behind the fixing nut. The hole in the leg must not be a tight fit for the terminal screw shank. The post, you must understand, must be able to move slightly, i.e., vibrate, the vibration being set up by the needle as it runs over the sound track in a record.

The rubber washers ensure sufficient freedom, yet keeps the needle holder firm. Suitable rubber washers can be cut from a piece of motor car air tube.

Final Details

The sound-post is now attached to the diaphragm, doing so by means of a tiny bolt and screw. It is advisable to base the head of the screw with a tiny washer, including the nut. That means a small washer at each side of the diaphragm.

If desired, the sound-post could be fixed by means of a small rivet. This, however, means hammering (and possible destruction to the diaphragm). A tiny screw and nut is the best thing to use. The sound post must be tightly fixed to the diaphragm to cut out unwanted vibration noises.

The lead-cast overlay is then affixed to the work with three small roundhead screws or nails. If you have cut the face piece from wood, it is only necessary to adhere it on with glue.

Fix the completed sound-box on the tone-arm of the gramophone. Compare the "leaning" angle of the sound-post with that shown at Fig. 7. Do not worry if your angle is not exactly the same; so long as the angle is not too steep or too acutely sloped, the sound-box will be O.K.

Try out a record. The tone, you will find, will be somewhat subdued, but not imperfect. Much depends on the sort of diaphragm you are using. Aluminium diaphragms are the most sensitive. Tin is a good second choice with mica a third.

An all-wood sound-box, while reproducing sound, does not do it with good effect, being rather light in weight. Thus, weight is all-important for proper reproduction. The lead overlay ensures weight. If you have cut the overlay from wood a weight of some sort will have to be added to the box, perhaps a "ring" of lead screwed to the back of it.

If the reproduction seems "dead" and dull, the terminal may be too tightly screwed to the box lug. Slacken the nut slightly. Make sure that the needle is a firm fixture in the needle holder.

Use a standard steel needle, that is to say, a loud tone needle. If there is undue rattling, vibration noises, the sound-post must be slack fixture on the diaphragm.

Patterns on Cover iv for making a SIMPLE INKSTAND

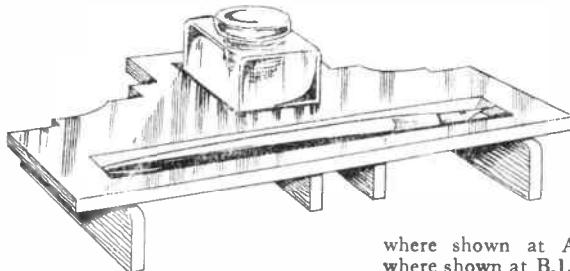

the pens to be lifted out of the tray much easier.

Glue parts A and B to the underside of the stand, where shown by the dotted lines, the parts A

where shown at A.1. and parts B where shown at B.1.

See the edges of the slots in these come level with the edges of the openings for ink bottle and pen tray, so that the bottoms of these parts, already sawn out of the pattern, can rest on them.

Fitting the Parts

The cross sections in Fig. 1 show these, the upper one showing parts A, and how the bottoms of the inkwell and tray rest on them, and the lower one part B, supporting the tray bottom only.

A few fretwork nails should be added to strengthen the glued joints at B, and for A, owing to the small parts left to be glued, a round-headed brass screw is added to each. Bore holes for these to avoid splitting the wood.

The bottoms of the inkwell and tray are then glued to these parts, with perhaps the addition of a few



Fig. 1—Helpful sectional views

nails. Finish off with a good glass-papering and polish or varnish.

An added neatness to the finish can be gained here by staining the edges of the stand, inkwell and tray with black before polishing.

AN inkstand is useful in most households, for personal use, or as an acceptable present. The design of inkstand shown can be cut without waste from a 4in. by 9in. panel of ½in. fretwood.

A full-size pattern is given on Cover iv from which it will be seen that every bit of the panel is used up; no waste pieces left whatever. It makes quite a decent sized article from a small piece of fretwood.

Cutting Hints

Cut the pattern out and paste it to the panel of wood. Note, that owing to limitation of space, the pattern is published in two parts. Paste these together on the fretwood lines A.A.—a.a. being joined together.

These will fill up the panel. Use a fine fretsaw and cut on the lines of the pattern, not inside, or outside, as is the more usual practice.

The parts A and B form the under pieces which raise the stand up and also support the bottoms of the inkwell, C, and pen tray, D. Clean up the edges of these parts smooth.

The edges of the openings left at C and D are bevelled outwards a little with a file. This improves the appearance of them and also allows

Some interesting jottings for all from the EDITOR'S NOTEBOOK

A SUGGESTION for a novel way of using those animal cut-out figures which appeared on our Design No. 2512 recently is made by a woodwork centre instructor in Mewbridge, Mon. He has added them along the top rail of a child's play pen, with stupendous results. The animals are a constant source of interest to the occupants, and probably form the foundation ideas for a budding zoologist! I was going to suggest they could be put around the cot also, but perhaps the shapes might become too night-marish to a tiny tot drifting into slumberland. In any case the figures should be cut from $\frac{1}{2}$ in. wood to withstand the smash and grab propensities of the caged youngster.

BY the way, the author of this suggestion, Mr. C. Caffull, mentioned how keen are the boys of his centre on our models, and recalls that a school effort raised £84 for charity with a replica of our Blenheim Bomber. Another interesting point he makes "You may be interested" he says "that I have a huge pile of Hobbies and a quick glance has revealed they date back to 1908. Thirty-five years is a good record and I doubt if many schools in the country can beat it!" I wonder if they can?

A NOTHER veteran hobbyite is Mr. Charles Rolfe, Manningtree, Essex, who at the age of 84 still "tinkers about" making alarm clocks from various "bits and pieces" he collects, searches for, and "scrounges." Mr. Rolfe is a retired engine driver and has assembled hundreds of alarms as a result of his interesting hobby.

I N some of our models we have recommended the use of a clockwork motor, but Mr. C. H. Ramsden, of Bolton Rd., Bradford, tells me he has been able to substitute an alarm clock movement instead, into the tractor model published. "Wasn't my nephew delighted with his Xmas present—I'll say he was." You see what a little thought and ingenuity can do.

W HEN you are wandering around in strange countries or even places in your own country, how nice it seems to hit against something to remind you vividly of home. You can then understand the feeling of the army man who came across a fretsaw in the Egyptian desert. Mr. W. L. Gunning relates some interesting experiences in Tunisia, in—"The News Basket," a periodical published by W. H. Smith and Sons, for their

staff. Speaking of the extraordinary contrasts in that country of Northern Africa he says, "Up in the Tunisian Mountains I actually saw an Arab sitting in his yard using a fretwork machine from Hobbies of Dereham. He was using it to cut small strips of wood and I think he was making small pegs or wedges." As Mr. Gunning was living near Dereham before the war, you may imagine how delighted he was with the incident.

T HAT excellent Annual of photography "The British Journal Photographic Almanac" has now been published for 1944 and should be in the hands of all who take photography seriously. It has 384 pages and a 32 page section of pictorial photogravure. An entirely new feature is a glossary of technical terms, whilst new processes, methods and gadgets are described in a special chapter. Serious articles written by experts on technical work and a wide range of formulae are also included. The Almanac costs 3/6 and is obtainable from Henry Greenwood and Co., Ltd., 24 Wellington St., London, W.C.2.

I SEE that a Mr. S. F. Speight has told a Dewsbury Youth Club that the word "hobby" was originally used in the Middle Ages in connection with "hobby-horse" meaning a horse on which people rode to enjoy themselves. Later, he says, the horse was dropped (figuratively, of course), and the word hobby remained. Gradually it covered any pastime. Well, I imagine Mr. Speight has it the wrong way round because a dictionary gives the derivation of "hobby" as "an ambling nag; a hobby-horse" as well as "a favour-

ite pursuit, occupation, or object." So the word hobby would seem to cover the hobby-horse, although, of course, that quaint looking article was popular last century. You have probably seen in very old prints, top hatted gentlemen in silk knee breeches or colourful trousers, striding along "riding" their big-wheeled hobby horse. * * *

A REAL hobby-horse, by the way and in case you do not know, was a thick strong stick with a wheel at the lower end and a cross handle at the other. A board fixed across served as a seat. By sitting on this and holding the handle you could trundle yourself along with your feet. In pre-war days they served as toys for children but originally adults used them as a means of locomotion. * * *

A S a matter of interest, too, a hobby is also a migratory falcon which occurs as a breeding species in some parts of England. The wings are long, the tail short and the plumage is dark grey above and mottled beneath.

The Editor

RECONSTRUCTION

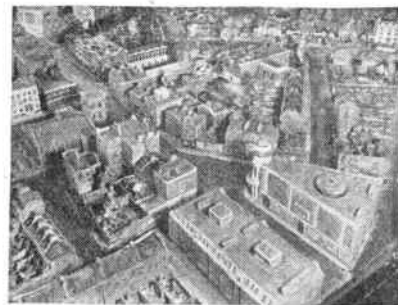

Just as model builders have used Pyruma Putty Cement to build tactical models for war purposes, so will they and others build models for town-planning and reconstruction.

Pyruma is the home plastic which bakes stone hard, ready to be assembled, sized and painted in natural colours. Illustrated Instruction Sheet explains how to model in Pyruma, obtainable from 1/3 a tin, from your local Ironmonger, Hobbies Shops, Bassett-Lowke Depot and many Art Material Dealers.

J. H. SANKEY & SON, L^{TD}

ILFORD

ESSEX

See page 38 for details of construction

