

Hobbies

WEEKLY

April 29th, 1942

Price Twopence

Vol. 94. No. 2428

WATERLINE MODEL CARGO STEAMER

SOME few weeks ago (in our issue of April 1st) in these pages we gave details and instructions on the making of a model dockside crane. This crane was designed as the first item of a quayside layout, where, on a table of good size, a quay wall could be erected and loading berths built for cargo and passenger liners.

The quay walls could be constructed of card with the stonework marked or painted on realistically.

With the aid of books or shallow boxes these walls would fold over and form the parapet and wall and the roadway and rails on which the crane would travel.

So now we take the next item—the cargo steamer. It measures 13½ ins. in length overall

and is 3 ins. in width—or beam. It has a hollow hull for cargo and three hatches for loading and unloading. The hull, too, is so made that it can run on four small wheels concealed behind the ship's sides.

Like this the steamer can be easily moved about on the "sea" and berthed just like a real one, with quay-side bollards holding the ropes attached to the stem and stern.

Only those parts are added as top

hamper to the ship which are absolutely necessary to make a realistic toy, all minute detail being omitted. Many of our model makers will, however like to add some of these smaller details so their ship can be as complete as possible.

We print on a separate sheet all the parts of the model ready for transferring to the wood and card which go to make it up. These printed sheets are obtainable from the Editor,

price 3d. each, and we strongly recommend the worker to get one of these to facilitate construction.

It should, however, with a little patience, be possible to build the model from the details and instructions here given. A very useful plan of the hull of the ship is given with positions of all hatches, cabins, boats, etc. clearly marked.

Above this

A complete chart of full-size patterns obtainable for 3d. post free from the Editor.

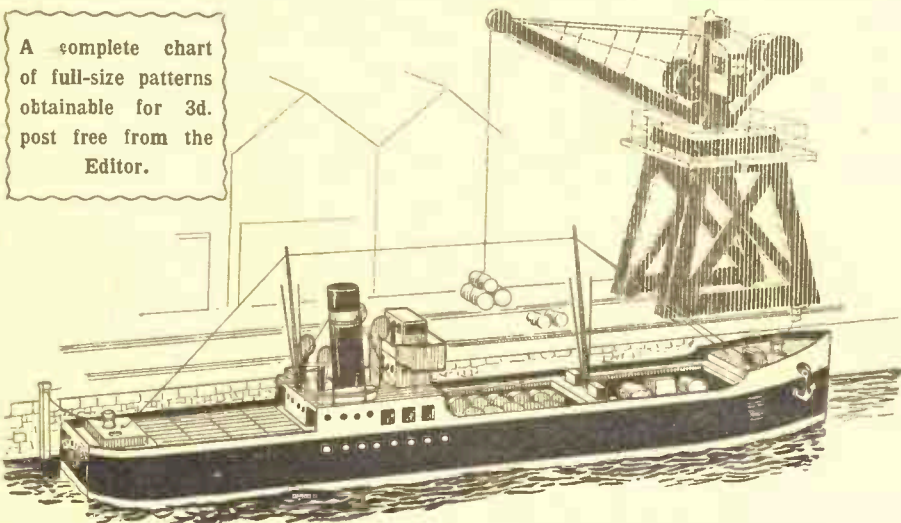

Letters to the Editor should be addressed to Hobbies Weekly, Dereham, Norfolk. Address orders for goods to Hobbies Limited.

plan is a side view which must be followed in conjunction with the plan, and it will be understood that almost all the parts can be scaled off for size from the scale which has been included just beneath the plan. We are going to describe and construct the boat just as if we had the fully detailed sheet in front of us, but seeing the smaller details here included are all numbered, the two can be worked from independently if necessary.

The First Part

The lower deck (No. 1) is a plain piece $\frac{3}{16}$ in. thick and shaped only at the bow and stern. Four recesses are

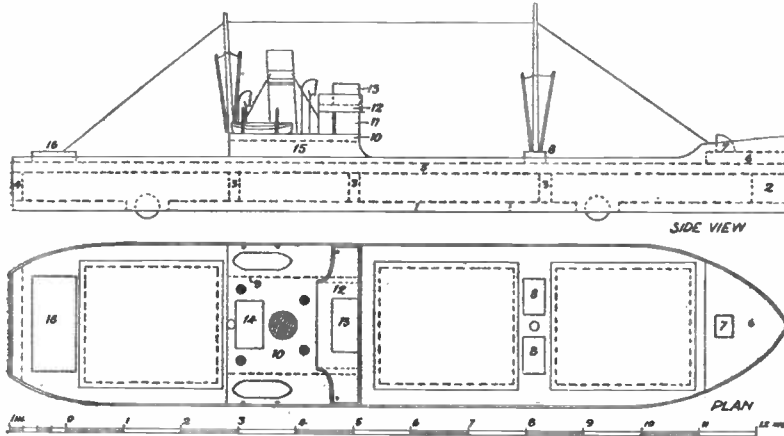

cut in this piece, two "forrard" and two "aft" to take the $\frac{7}{16}$ in. diameter wheels to be nailed in. These recesses measure $\frac{3}{4}$ in. long by $\frac{1}{4}$ in. wide.

When the wheels are fitted, the sides of the ship will stand over them, and thus only about $\frac{1}{4}$ in. of each will be visible below the sides. This is illustrated by the side view of the ship.

At the bow end of No. 1 there is a pointed block of wood cut from a piece measuring $1\frac{3}{8}$ ins. by $\frac{3}{8}$ in. by $\frac{1}{2}$ in. thick or two pieces $\frac{1}{4}$ in. glued together. This bow block and the additional spacing pieces (Nos. 3 and 4) are all shown in the detail Fig. 1.

Pieces No. 3 are $2\frac{1}{2}$ ins. long by $\frac{1}{2}$ in. wide, and piece No. 4 2ins. by $\frac{1}{2}$ in. wide, the latter piece must have its ends chamfered to suit the sides which are bent round to it, see Fig. 1.

Upper Deck

The upper deck (No. 5) is shown full-size on the sheet of diagrams, but as it is to the same outline as piece No. 1, it can be drawn on the wood direct by drawing round that piece. The positions of the hatchways can be scaled off from the plan.

The two squares of wood cut from the hatchways are reused as hatch covers, pieces of stout card being glued to the tops of them and slightly overlapping the edges all round as can be clearly seen in the little detail in

Fig. 1. The solid lines round the dotted hatchway lines on the plan give the exact size the card is to be cut.

Care must be taken in gluing piece No. 5 to the cross pieces Nos. 3 and 4 to see that it fits on exactly to allow the sides to fit evenly all along.

Piece No. 6 represents the raised deck at the bow and its size can be got from the scale plan or, of course, on the design sheet it is given full size.

Hull Sides

The sides are of stout card, or of thin ply-wood. The exact length of the side can best be obtained by bending the material card round and

trimming off at the stern afterwards. The width of the card is $\frac{15}{16}$ ins. throughout, excepting just at the bow where it rises to $1\frac{1}{8}$ ins. Glue the sides to parts Nos. 1 and 5 and if necessary, drive in a few fine fret pins.

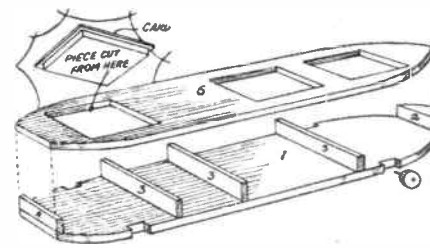

Fig. 1—General construction of hull

On top of this block the upper deck (No. 10) will be glued, and it is to the edges of this piece that the upper sides No. 15 of the ship will be glued. The perspective diagram Fig. 2 makes clear the positions of those parts. Fig. 3 is also helpful in showing the above parts with No. 15 drawn away and ready for gluing up.

Referring again to Fig. 2 we turn to parts Nos. 11, 12 and 13. No. 11 represents the cabins, etc., immediately under the bridge which is part 12. Two pieces of wood $1\frac{1}{2}$ ins. by $\frac{3}{4}$ in. and $\frac{3}{16}$ in. thick are glued together and fixed centrally on the top deck No. 10, the front edge being flush with the front of this deck as seen in the two details Figs. 2 and 3.

The Bridge

Part No. 12—the bridge, is a shaped piece of $\frac{1}{4}$ in. wood, and almost completely round its edges is glued a strip of stout card to form the railing or upright edging to the bridge. The length of card required for this is $5\frac{1}{2}$ ins., and $\frac{5}{16}$ in. wide. The bottom edge of the strip of card is level or flush with the bottom edge of piece 12.

The chart room and wheel house are No. 13 on the plan, and consist again of two pieces $\frac{3}{4}$ in. by $\frac{1}{4}$ in. glued together. The skylight No. 14 is just a plain square of $\frac{3}{16}$ in. wood cut to the size shown on plan and afterwards painted as a glass skylight.

No. 16 is another $\frac{3}{16}$ in. overlay glued to the upper deck No. 5 at the stern. There are two more small overlays (No. 8) to be cut from $\frac{3}{16}$ in. stuff and glued on each side of the forward mast.

The funnel and the ventilators are shown shaded on the plan, and each

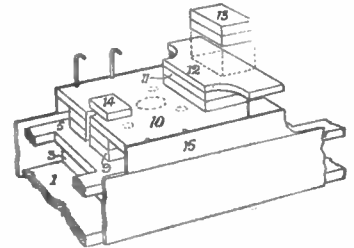

Fig. 2—Detail of raised centre portion

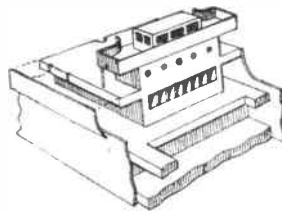

Fig. 3—Bridge, showing construction and windows, etc.

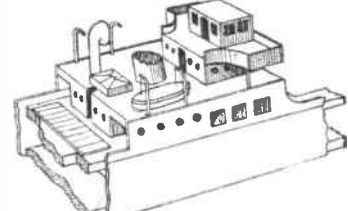

Fig. 4—Showing painted portion of super-structure with boats, vents, etc.

We now build the upper structure of the ship—the cabins, bridge, etc. piece No. 9 forms the deck cabin made in two thicknesses of $\frac{3}{16}$ in. wood glued together. It measures $2\frac{1}{2}$ ins. by $1\frac{1}{2}$ ins. and the dotted lines give its position on the deck.

may be made from round dowelling or shaped up from odd pieces of wood. There are two lifeboats, and each is made from $\frac{3}{16}$ in. wood shaped as shown on plan and carved to form keel and curved top.

(To be concluded)

A novel article you can make with a few parts is this FOUNTAIN PEN LIGHTER

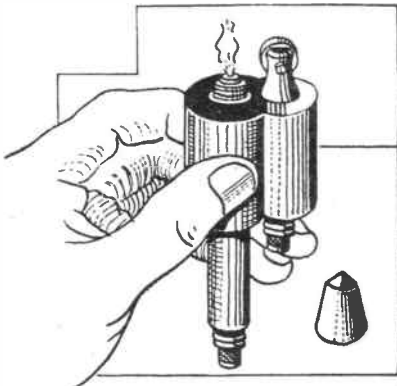

THE novel lighter illustrated herewith was produced and found to be most satisfactory in every way—in fact, it is just as good as any you can buy at the fancy black-market prices, and it cost nothing to make, moreover!

The chief difficulty in making a petrol lighter is the tank. This, of course, must be absolutely air-tight and, in consequence, water-tight, otherwise the petrol would very quickly evaporate.

Materials Needed

The lighter can be easily made from an old fountain pen (the stud-filling style) and a flint wheel, plus a few pieces of wood and two wireless plugs. One good feature about the lighter, too, is that it is quite air-tight, or rather, gas-tight, thanks to the screw cap over the wick. It will not, therefore, contaminate the hands or clothes with the odour of petrol.

And as you know, fountain pens are made from bakelite, so you will find this easy to work with, particularly in respect to the holder for the flint wheel. Filing this slot in metal tubing and drilling tiny pivot holes is always a great drawback, but it's easy with bakelite.

Preparing the Tank

Assuming you have an old stud-filling fountain pen, remove the screw-off top part having the pocket clip, as this is not wanted. The main part you want for the tank is shown at Fig. 1.

Screw the finger grip portion off and remove the nib, stopper and rubber sac from it, as shown by the exposed view in the drawing. The compression device in the stem of the pen holder will drop out. Now for the bottom end of the stem, i.e., the proposed tank.

First, screw off the cap, then with the pincers, screw out the threaded

collar. The unwanted filling stud can then be easily removed from the collar which is afterwards replaced in the tank.

Now, to understand what has happened, you must turn the tank upside down, as at Fig. 2. If you like, by the way, you could reduce the length of the tank a trifle by cutting away the threaded portion on the outside, this having been threaded for the top of the fountain pen (see dotted lines at Fig. 1).

Plugging the Tank

You can cut the unwanted threaded end away by filing around with a flat, half-round file, using the edge. The rim is later filed quite flat and smooth. It is then "plugged" with the grip part of a wireless plug, although you may have to file and fit this in soundly. It must be a neat, tight fit, but beware cracking the bakelite tank in the process—gently, stage by stage, does it successfully.

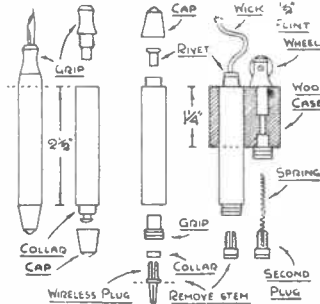

Fig. 1—The pen in pieces

Fig. 2—The various parts put together

To ensure that the plug is in water-tight, a smearing of rubber repairing solution should be applied to the filed stem end of the grip prior to forcing it home. The writer was able to "screw" the stem of the plug into the tank owing to the latter being partly threaded inside. This is preferable to tapping home with a hammer.

The Wick End

Regarding the wick end, the hole in the collar needs to be plugged with a neatly-fitting rivet, the type having a hole running right through it.

Failing this, however, a small key might serve, using the business end portion; it means drilling the hole a bit deeper and cutting away the tumbler shifters, the result being a small metal pipe $\frac{1}{8}$ in. long or so, same being forced into the collar to project $\frac{1}{4}$ in. or more.

You could at this point fit in the wick and stuff the tank with cotton wool. Do not have the cotton wool

tightly rammed in the tank, otherwise it will not hold much petrol. In other words, by ramming the wool in tight, you make a wool *plug* in the tank, have it squeezed to such an extent that there is no room for the spirit.

Flint Wheel Holder

The flint holder is made from the finger grip, as you can see. It is filed and slotted as shown at Fig. 3. Do it to suit the flint wheel in your possession. A $\frac{1}{2}$ in. wheel was used by the writer, but a $\frac{3}{8}$ in. diam. one will serve just as well.

The slot, first of all, was made with a file having a blade $\frac{1}{4}$ in. wide by $1/16$ in. thick. Both edges of the file could be used, apart from the sides. The wheel pivot holes were drilled with a beheaded panel pin fitted to the chuck of a fretwork drill, but use a $1/16$ in. drill if you possess one.

Fit in the wheel, then pivot it in place by means of a small screw, the diameter of which suits the hole in the wheel. The threads on the holder should be filed away so a plain shank is left as shown. The diameter of the shank is approximately $\frac{1}{4}$ in., the same as that on the wireless plug grips.

The Casing

Now for the case which holds the parts together. It is built up from four shaped layers of $\frac{1}{4}$ in. wood, such as plywood if you have it. Of course, you can use $\frac{1}{8}$ in. or $3/16$ in. stuff, providing you build up a case $1\frac{1}{2}$ in. deep.

The case shape is shown at Fig. 4, with alternative shapes at Fig. 5.



Fig. 3—Wheel holder



Fig. 4—Case shape

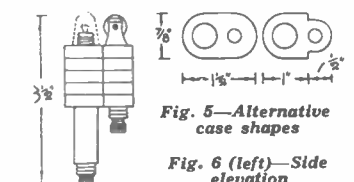

Fig. 5—Alternative case shapes

Fig. 6 (left)—Side elevation

Incidentally, do not have the tank and wheel holder holes too far apart. The wheel should be as near to the wick as possible, otherwise the sparks will not ignite the wick, having lost their lighting power before combustion can take place.

When cutting out the five $\frac{1}{4}$ in. thick case layers, a top and bottom one should be marked and the holes cut slightly smaller than the others. Fit the top one over the top end of the

tank, then fit on the wheel holder and make sure that the wheel points directly towards the centre of the wick. Glue on the other three layers, then fit on the bottom case piece; like the top piece, this must be a neat fit so the three middle layers are held sandwiched tightly between.

When dry, rasp, file and glasspaper the case parts as neatly as you can. If desired, the top and bottom of the casing could be covered with shaped pieces of black celluloid, such as xylonite. Rub one side of this with glasspaper so the glue adheres properly. A good case can be turned out from 3/16in. thick ebonite, five shaped layers glued together sufficing.

Spring and Plugs

Nothing wears a flint away so quickly when it is in a rather large spring channel. It bends over with the wheel which, of course, cuts a slant on it. Naturally, nearing the

lower end, the flint becomes a wedge and so causes the wheel to stick and be bothersome.

To prevent this, the channel hole running from the flint holder down to the plug grip should be filled up with plastic wood, then when dry, an 1/8in. hole bored right through, centrally. A better idea, perhaps, is to make a paper tube and glue it in.

A Suitable Tube

To make such a tube, get a strip of brown paper and glue it around an 1/8in. drill, then press the drill out. A spring is made to fit freely in the tube. Quite good serviceable springs are made by winding (tightly) steel mandolin strings around a darning needle. When the free end is released, the spring will widen out sufficiently; the heavy, brass-covered strings are the best to use.

One could use the small spring (it is 3/16in. long) from the contact of a

standard lamp holder fitting. A match is inserted tightly at one end to make up the required length. A hole is drilled at the bottom end to take the spring easily; it is the match that pushes against the flint, by the way.

The plugs for the spring and tank are as we have said, made from two wireless plug parts. The collar part is screwed tightly against the pin (stem) part, after which the pin is removed and the end filed smooth. The cavity in the tank plug will serve to hold extra flints.

Finishing Off

Complete the work by coating the holder with black drawing ink. When dry, smooth any roughness away by rubbing with the fingers, then rub in black shoe polish. This serves to make the case waterproof. Rub plenty in and let it dry a little before shining with a soft dry cloth.

There are several processes to use when you need WOOD COLOURED BLACK

THERE is some demand among certain classes of woodwork for a black polished surface which often appeals more than the ordinary finish. One sees baseboards for models, small trinket boxes, cigarette caskets, etc., as well as for the popular cut-out figures which appeared recently, and it is quite possible for the amateur to obtain this finish by using the special materials supplied by Hobbies Ltd.

Flat or Polished

The process is very much the same as the ordinary staining and polishing, except, of course, that the wood is made jet black. The wood used in such articles should have a perfectly smooth even surface.

The wood, of course, should be treated before metal catches, mirrors or any similar additions are made, and the worker should experiment first on an odd piece of waste stuff.

There are four varieties of colouring which can be taken, and all are equally effective. Hobbies Colour Polish stains and polishes at one operation. Ebonising Solution is a special preparation which dyes the wood very deeply. Eggshell Black is really intended for ironwork, but can be used to obtain a jet black on wood also. Powder Dye or Water Stain are both the ordinary method of getting the wood to the shade required.

Colour Polish

The Colour Polish is perhaps the best, because staining and polishing are done at one operation. A piece of clean linen is wrapped tightly into a "bob" or rubber, and lightly

saturated with the polish.

Rub it round and round on the surface of the wood, varying the direction with an up-and-down stroke to cover the whole surface. Do not press hard, but keep the rubber moving evenly and lightly over the surface.

When the first coat has been put on, leave it to soak in, say, half an hour, before putting on a second. It depends on the surface of the wood how many coats will be required.

It is a good plan to fill the wood first to save so much repetition of the polishing process. Gradually a highly-polished surface will appear, but this should be left about a week or even longer before the final polish should be given.

An Ebony Solution

Ebonising solution is applied with a brush. It is a liquid which will soak quickly into the wood and dyes deeply. Allow each application to dry before applying the next coat. Several coats will make the wood black, and when completed, the surface must be rubbed hard with a clean duster.

This will take some of the black off, but still leave the wood dyed. Or the surface can be rubbed with a damp cloth and again left to dry thoroughly.

A Water Stain

Water stain is another liquid applied with a brush until the wood is jet black. It should be allowed to dry thoroughly between each coat. One objection to water stain is that it raises the grain, and a light rubbing with glasspaper must be given to take away this trouble.

Powder dye is, of course, a stain in crystal form, and can be obtained for water or for spirit. The latter dries more quickly and evenly. The powder to be mixed with water is dissolved to the depth of colour required, and put on with either rubber or brush.

If the crystal is for spirit, it is mixed with methylated spirit (if you happen to have any), to the shade required and applied quickly and evenly with a brush. It is very quickly dried and needs no further treatment before polishing.

An Eggshell Surface

Eggshell Black is a spirit thicker than colour polish, and is more of a varnish consistency. It is put on with a brush but takes a considerable time to dry. It has a perfectly dead flat, dull black surface, and the application of polish over it is not recommended. If polish is put on it takes some of the black away, but at the same time leaves the wood with a rather striking colour effect which may be pleasing to some workers.

Blackboard Black

Blackboard Black, as its name implies, is specially made for use on toy blackboards, but can be used for other purposes where a flat dull surface is needed. Its use for blackboards is essential as chalk can be used on it where it cannot on the other preparations mentioned.



When you have made this original game you can PLAY "TANK ACTION"

An up-to-date checker-board for two players or teams



IF you spend an evening or two making up this game, you will have plenty of exciting actions in return for your trouble, as the tanks manoeuvre for position, attack, withdraw, attack again in a realistic struggle for mastery. The game is after the style of draughts with moves and manoeuvres of an intriguing nature.

Let us begin with the board, and then, while the glue is drying, we can turn our attention to the tanks and dice. For the board you will need two pieces of stout card cut to measure $5\frac{3}{4}$ ins. by $10\frac{1}{2}$ ins. To cut

them true, use a set-square to mark out the right-angles correctly, and do not attempt to slash through the card at one go. It is much better to draw a sharp penknife down your pencilled outlines several times, using a steel rule to prevent the knife from slipping.

Joined Card Pieces

The two pieces of card must now be joined by means of a double hinge, which may be of cloth or stout paper and comprises two strips measuring $12\frac{3}{4}$ ins. by 3 ins., and $10\frac{1}{2}$ ins. by 2 ins. respectively. The longer strip is for the outside. It should be glued or pasted on when the two halves of the board are lying on top of one another,

1 in. will project at top and bottom and must be turned over and stuck down inside when the board is open. The inner hinge, that is the shorter strip of cloth, has now to be pasted down inside.

This is also done when the board is open, care being taken to see that the strip is exactly $\frac{1}{4}$ in. short of the top and bottom edges of the board.

Cover Material

Fig. 1 illustrates the position of these strips and also shows the cover-papers projecting beyond the edges of the card. These cover-papers—there are two of them, each measuring $5\frac{3}{4}$ ins. by $12\frac{3}{4}$ ins.—may be of brightly coloured imitation leather or stout paper. After pasting down outside, the over-lap appearing in the diagram must be folded and stuck down inside. Trimmed to an angle of 45 degrees, the corners turn in quite neatly.

When a large piece of paper has to be treated in this way, position-lines should first be ruled on the reverse side before applying the paste with a broad brush.

The paper must then be brought into close contact with the board by rubbing with a circular motion from the centre outwards to expell air and surplus paste. It is as well to lay a sheet of paper over the work to protect the surface during this operation.

Inside Squares

The inner papers, which have to be divided into squares, should be fairly smooth and white. They each measure $5\frac{1}{4}$ ins. by $10\frac{1}{2}$ ins., which allows a margin of $\frac{1}{4}$ in. round the edges of the board and a gap, equal to the thickness of the hinge, down the

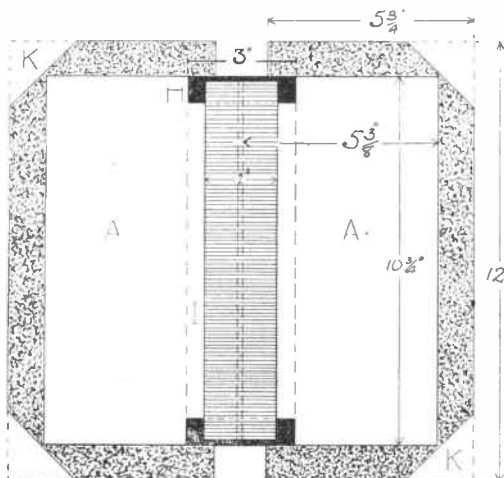

Fig. 1—The card (A) joined by hinge (I) and with cover paper (K) ready to turn in for binding

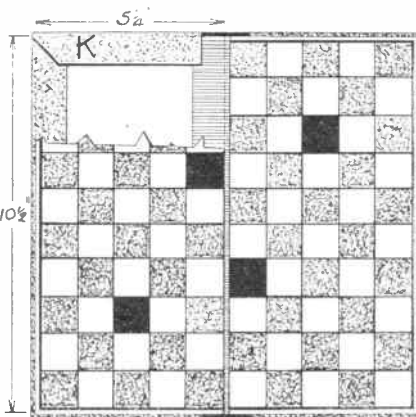

Fig. 2—The finished board with top corner piece cut away to show folded edging

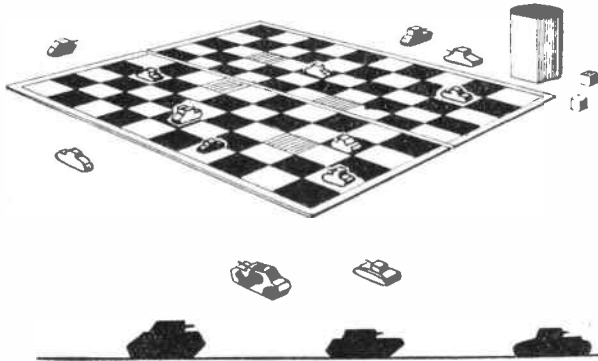

Fig. 3—Front of board, with name squared for enlarging

centre. When dry, these inside papers must be ruled up and painted.

There are a hundred squares all told. After painting them in alternate light and dark colours, with the mine-fields done in red, it would be a good thing to apply a coat of clear dope in order to render the surface more durable.

Figs. 1 and 2 should help to make all the points we have been dis-



curring quite clear. Fig. 2 shows the actual position of the mine-fields in black, while a part of the inner paper has been removed at the top left-hand corner to show how the cover papers are folded in.

Now all that is needed to complete the board in a workman-like manner is to paint the title of the game on the front cover. To help you with this, the words 'TANK ACTION' have been squared-up, so if you rule a sheet of paper in the same way, making each square $\frac{1}{4}$ in., you will be able to enlarge the letters in the right proportions before tracing them on to the cover in the position indicated in Fig. 3. The squares, of course, do not appear on the finished work.

Dice and Pieces

We can now turn our attention to the pieces and the dice. Two sets, each consisting of two heavy, three medium and five light tanks, will be required. Here are three suggestions for making them.

Taking the simplest first, beg or borrow some buttons of different sizes to represent the three types of tanks, and two distinctive colours to distinguish the two sets.

A little more ambitious way would

be to trace the examples given in Fig. 4 on to small circles of card—a 'thrifty' measures $\frac{1}{2}$ in. and would act as a guide.

But if you have the patience and are good at model-making, by far the best plan is to fret small tanks out of pieces of hard wood measuring $\frac{1}{2}$ in. by $\frac{1}{4}$ in. After trimming up with glasspaper, stout pins may be inserted to represent guns and the two sets painted in distinctive camouflage colours.

Two Dice

Dice and dice-box you may already have from some discarded game. If not it would probably be simpler to buy them than to make them. You will need two dice. Leave

one as it is, but paint the other red and green—three sides red, three sides green. This coloured dice is called the 'FORTUNE' and it plays an important part in the game. Its use is explained in the rules which follow.

These are the rules which you should copy or cut out and paste on a piece of card. TANK ACTION is a game of skill and chance for two players—or sides. Each player—or side—opens play with 2 Heavy, 3 Medium and 5 Light Tanks disposed in whatever order the player chooses on the first two rows on opposite sides of the board.

How to Play

The object of each player is to clear the board of his opponent's forces. In the event of a deadlock, the player with the larger remaining force is the winner. For the purpose of estimating this strength, count one point for each light tank, two for each medium and three for each heavy tank still left on the board.

Players take turns to move one piece at a time in accordance with the number thrown on the dice and the following rules govern the movement of the pieces. A player must

move if he can do so. But he misses his turn if he can only move *over* another tank or *over* a mine-field. If he is forced to move *onto* a mine-field, he loses his piece, which is removed from the board.

A player may move Heavy and Medium Tanks in *straight* lines only—up, down and across the board in the case of a Heavy Tank; up, down, across and diagonally over the board in the case of a Medium Tank.

A Light Tank, however, may zig-zag in any direction. Thus a Light Tank, forced by the throw of the dice to move six squares, may yet engage an opposing tank, which is only two squares away, by zig-zagging towards it.

Engaging the Enemy

A player may engage an opponent's tank when a throw of the dice would carry a suitable piece of his own on to a square occupied by his opponent. But he must observe the following points:

- Tanks of *equal* size may engage on *any* square.
- Heavy Tanks may engage Medium and Light Tanks on *any* square.
- Medium Tanks may engage Light Tanks on *any* square.
- Medium or Light Tanks may only engage a Heavy which is on a *dark* square.
- Light Tanks may only engage Medium Tanks which are on a *light* square.

The "Fortune" Throw

When a player engages his opponent he must throw the 'FORTUNE' or coloured dice. If he throws green, he has fought a successful action and removes his opponent's tank from the board, putting his own in its place. Should he throw red, however, he has lost the first round and the initiative passes to his opponent, who may, by throwing green, win the action and remove the challenging tank from the board.

On the other hand, red may turn up again. In that case the initiative reverts to the first player. In fact, the 'Fortune' may change hands several times before each individual issue is decided. The game will provide an exciting interest the more you play it and gather the moves you can make.

Bird Houses—(Continued from opposite page)

supports, can most easily be split lengthways into sections.

Six of these sections are removed each being about 2 ins. wide and the ends cut square across with the fretsaw. A rail of stouter wood about $1\frac{1}{4}$ ins. wide by about $\frac{3}{8}$ in. thick was nailed across one end of the curved pieces while the other ends of these were nailed to the back rail of the table.

All that remains to be done is the cutting and fixing of the two sloping

roof supports. These consist of natural branch wood firmly nailed through. A square of rough and thicker wood is finally nailed on the underside of the table to provide a firm hold for the nails put through into the upright post.

All the wood of this little table can be creosoted except, of course, the upright post which is allowed to retain its natural bark.

You must, of course, allow the creosote on the actual feeding table

to dry thoroughly before use, or the food may become poisonous to birds.

If you have not a tree handy for hanging the tables upon, you can easily erect a post. Have it set firmly into the ground and fix the table securely on its top. Put metal brackets underneath to prevent it being blown or knocked off.

Put the whole thing in a quiet spot and particularly away from a dog kennel or a cat's favourite walk and you will find bird watching interesting.

The habits of birds can be studied by making SIMPLE BIRD HOUSES

WE are showing our workers this week how to make up two bird houses and a feeding stand to go in the garden. Every flower garden, be it ever so small, should be provided with a shelter of some sort for the birds in summer, and they can be encouraged, too, by having a nest house in some secluded corner of the garden. Feeding trays also should be set up as well.

In the sketch at Fig. 1 on this page we show a picturesque little house that can easily be made from odd pieces of wood and hung on a tree in the corner of a lawn or garden.

Wood about $\frac{3}{4}$ in. thick would answer well, and if desired, the whole could be covered with pieces of bark to give it its natural appearance. Or the wood could be treated with some suitable wood preservative or even painted up.

Simple Construction

In the details of the house (Fig. 2) the front and sides only are shown and the side roof supports or stiffeners. These parts alone are shaped and are therefore given in detail and measurements. The floor, back and roof of the house being of plain square-cut pieces are not shown.

Set out the front to the measurements given and cut the opening and the curved lower edge with a fretsaw, using a coarse blade and finishing with glasspaper. Next mark and cut the two sides with sloping top edge to take the roof. Nail the front to the sides and the back also to the sides as given in the detail at the top of Fig. 2.

Floor and Supports

The floor measures $6\frac{1}{2}$ ins. by 6 ins., and the back 9 ins. by 7 ins. Note how the floor is let in between sides and front and back and note how the roof supports are added or nailed to the sides of the house. The supports may be about $1\frac{1}{2}$ ins. wide with the lower ends shaped off with the fretsaw.

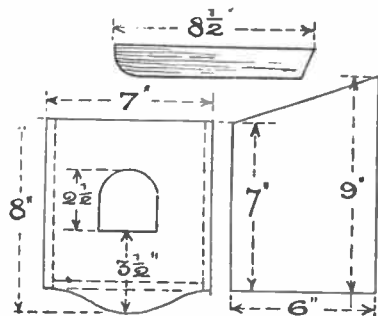

Fig. 2—Details of construction and shape of parts



Fig. 1—An artistic type of house

The roof can be made of one plain square of wood 9 ins. by 9 ins. and covered with a piece of ruberoid or odd lino, paint being afterwards applied in the latter case.

A Slatted Roof

A better appearance can be given to the roof by laying on narrow slats of wood about $\frac{1}{2}$ in. thick as shown in the sketch. These slats should be laid to a lap of about $\frac{1}{2}$ in., the one at lower edge of the roof being, of course, laid flat and nailed firmly. Those above this are lapped and nailed along their back edge so the nails are hidden from view and protected from the rain. Two strong iron eyes should be screwed into the back of the house and wire carried round a tree and fastened either side as shown in the sketch.

Short pieces of branch wood may be added to sides and front as perches.

Another Type

A cosy type of nesting box is shown in detail in Fig. 3. Here there are two shaped sides—all necessary measurements being given for draughting out onto the wood, and a shaped sloping front. The back is again a plain oblong piece of wood as also is the sloping roof.

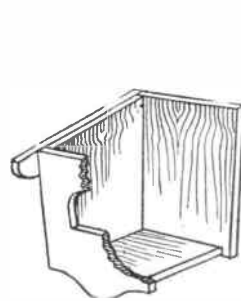

Fig. 3—Another type with side shape and measurement

A piece of dowel rod forms the perch and connects the two sides, while inside the box a shallow nesting shelf may be added as shown by the dotted lines. The sloping front and the roof should overhang the sides by $\frac{1}{2}$ in.

This nesting box would be suitable again for hanging on a tree, or it could be attached to a post and put in a secluded position among the



Fig. 4—An easily made feeding table shrubs of the flower garden.

A Simple Table

A unique kind of food table for the sparrows and other birds is shown in Fig. 4. As selected wood was difficult to obtain, this table had to be made from odd pieces of box wood.

The table itself consisted of a flat piece of wood which was first of all coated with creosote. Along three edges of this piece was nailed narrow rails to stiffen the table and to form the holding for the roof and its uprights.

The unusual type of roof can be successfully made from an old circular cheese box. This as is known, consists of thin stringy wood bent round and nailed to a thicker circular floor piece and top. This thin stuff, when once removed from its stouter

(Continued foot of opposite page)



SHIPS OF WAR ON STAMPS

IT would be difficult to find anyone who has not had first-hand experience of one of the many Warships Weeks which have been a feature of the whole country during the past months. Those of you who are philatelists should be able to make a good exhibition on your own.

Considering the present-day circumstances, one of the most striking stamps which could be placed first in the list is the 1927 stamp of Japan. The six and the ten sen values were issued to commemorate the 50th anniversary of the entry of Japan into the Postal Union.

Japan's Dove of Peace!

The design shows a map of the world with the Pacific Ocean in the centre. Above this there is a dove flying and this dove has a letter in its beak. The corner of the letter nicely overlaps the north-east corner of Australia!

There are also two warship stamps coming from the same country. First is the September, 1921 stamp, which commemorates the return of the Crown Prince from an European tour. On this the two warships Katori and Kashima are shown, and the stamp is illustrated here. Secondly on the stamp which was issued in April, 1935, one sees the forepart of the cruiser Hiyei.

Roumanian Navy

In 1931 Roumania brought out separate sets illustrating her Navy, Army and Air service. The Naval set of four stamps used three designs. The ten and the sixteen lei both gave views of the Monitors Lascar Catargiu and Ardeal, while the twenty lei

showed the destroyer Regele Ferdinand. The most beautiful of all, however, is the six lei, which shows the Naval Cadet ship Mircea.

This stamp is one of the best that has been printed, showing a sailing boat in full sail, although another very fine example comes from the Argentine. This is the 1939 issue which shows the frigate President Sarmiento, which was also a sailing Cadet ship. The issue commemorates the last voyage of this ship. The Roumanian stamp is, however, the better; for one thing the colouring is more beautiful.



Japanese Warships

A Roumanian Submarine

Part of the Iranian Fleet

The Mircea also appears on the set which came out in October, 1936, to commemorate the First Marine Exhibition, held in Bucharest. Other views on this set are the S.S. Regele Carol and the submarine Delfinal, the latter being the second illustration here.

France contributes two stamps which should appear. One was issued in 1918 and carried a premium of 5 centimes for the Red Cross. This one shows a bombed hospital ship sinking.

The second is the 1935 stamp which commemorated the Maiden Voyage of the S.S. Normandie. This vessel,

French and Russian fleets when they gained a victory over the Turkish and Egyptian fleets.

The Turkish fleet is represented on the 1913 set by the Cruiser Hamidie on the two piastres stamp. Quite a number will know this vessel from the Iraq set, as it is the same stamp overprinted "Iraq—in British Occupation" and surcharged six annas.

Other Selections

Other countries than those at war have also depicted ships of war on their stamps. From Tunis with its Carthaginian galley, to Paraguay with an excellent picture of the gunboat Paraguay and its aeroplane flying overhead.

The Iranian set commemorating the 10th anniversary of Shah Pahlavis Accession shows the Iranian gunboat Palang and this stamp is also shown here. Iran maintains a small fleet in the Persian Gulf.

The stamps mentioned are those which show ships of war in one sense or the other, but there are many more stamps which might be added to any exhibition of stamps that you may like to prepare. Russia in particular seems to have produced enough stamps which alone would create interest.

Look out for details of stamps on aeroplanes, ready for the National Aeroplane Weeks to be launched shortly. It will be very helpful.

SOME TYPES OF NAILS

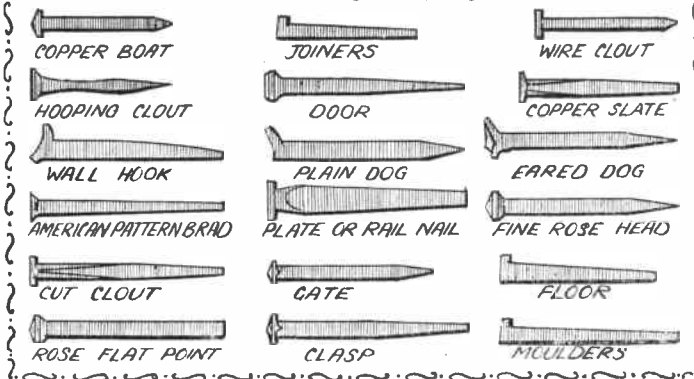

The handyman can easily make this splendid CHILD'S RUNABOUT CAR

THIS is a new idea in run-about cars for kiddies. Children can push themselves about with it or they can be pulled along. Of course, these cars are only intended for tiny toddlers. We are not thinking only of the size of the run-about to be described, but the fact that 2in. wagon castors are used for wheels. The 2½in. size of castor is much stronger and better to use, if you have some old ones knocking about.

Even so, however, they could not stand up for long to extremely heavy burdens, such as older children. It is the case with all run-about cars. After all, wagon castors are meant for wagons, i.e., dumb waiters, etc. For the toy in hand, at least, they are ideal and last for a long time.

Making the Base

Not much wood is required in the construction. We have purposely designed the various pieces small in size so that cuttings may be used up. The only exception is the baseboard, which measures 28ins. long by 14ins. wide.

Nevertheless, narrow boards could be easily rub-joined together to make up the necessary width. If you decide on this plan, allow the glue to dry and then clean over the surfaces with a smoothing plane. Run a central pencil line down the top surface and, with the compasses, scribe a 3in. circle at the front end.

The Foothole

With a square, mark off a cross-line 8ins. distant and then rule lines from the edges of this line up to the radii lines of the 3in. circle. A 10in. circle is then scribed in the position shown (see Fig. 4, top plan).

The wood is cut to shape with a panel saw, the large circle being cut away with a keyhole saw. To do

this, of course, a suitable hole for the saw blade is bored at the inside of the radii line, following which the point of the sawblade is inserted and the sawing commenced.

Thick Wood

So far, we have not stated any thickness of the wood to be used. This depends largely on what thickness of stuff you can manage to obtain. The toy has been set out for ¾in. thick wood, but a few minor adjustments and ½in. or ⅝in. wood could be used.

Complete the base by cutting out a front strengthening board. This is cut from 8in. wide stuff and attached by nailing, or screwing, from the

MATERIALS REQUIRED

- 1 base board, 28 by 14ins. by ½in.
- 1 cross piece, 14 by 8ins. by ½in.
- 1 seat back, 14 by 11ins. by ½in.
- 2 side pieces, 7 by 9ins. by ½in.
- 2 back support pieces, 8 by 5ins. by ½in.
- 1 seat piece, 13 by 7ins. by ½in.
- 2 seat rests, 6½ by 2½ins. by ½in.
- 3 wagon castors, 2½in. diam. wheels.
- 1 large screw-eye and braided cord.
- 1 ball foot, 1½ins. in diameter.

underside of the base board. At the nose of this, on top, goes a 3in. disc of ¾in. or ½in. wood. Just glue it on, then drive in a large screw-eye which is needed for the towing rope.

The Bucket Seat

A form of bucket seat makes up the body of the car, so get the pieces prepared as detailed at Fig. 3. The seat back (A) is made first. Shape the top edge as shown, then check the ends to take the thickness of the side pieces (B).

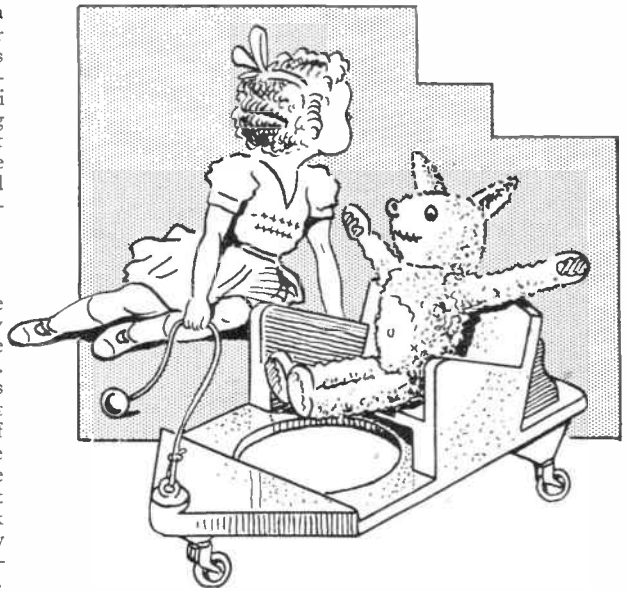

Having cut out the sides, glue and nail them on the edges of the back piece, keeping them flush at the rear side. It will be found necessary to bevel the bottom edge of the seat back level with the bottom edge of the sides so the work rests quite flat.

The Seat and Rests

The seat, so far, is set on the base board in the approximate position to be judged from the diagrams and attached with screws. The seat itself measures (in the case of ¾in. thick sides) about 12½ins. by 7ins. by ½in. thick. The front edge is rounded over to prevent any likelihood of chafing the skin.

The seat rests on wedge-shaped pieces of wood (D) as detailed at Fig. 2. When cut out, glue them to the inside of the sides, then place the seat on top and drive nails into the ends from the outside of the sides. To give extra strength to the seat back, brackets are cut to the shape shown (C) at Fig. 3. These are best fixed in position by means of screws rather than nails; note from the top plan that they sit in about 1in. from the outside of the sides.

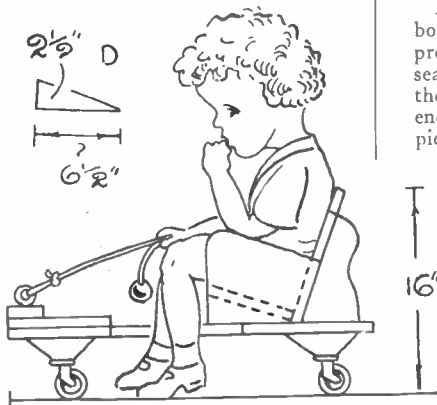

Fig. 2—A flat cut-away side detail

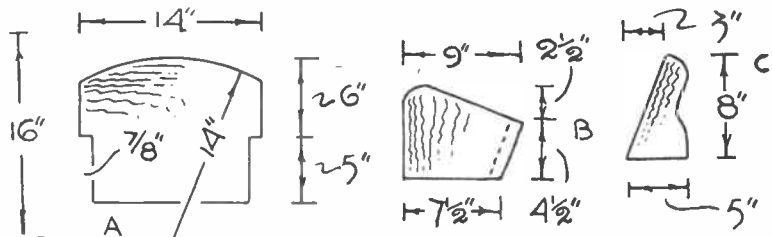

Fig. 3—Some of the body part shapes and dimensions of each

Unlike other run-about cars, the one shown runs on three castors, not four which contributes to the general cheapness. The castors are of the pull-out variety, i.e., a metal socket is provided with them, a hole being drilled in the wood to take the socket tightly. There is a bead-like tip on the stems of the castors which grip on the tips of the sockets when forced home.

Support blocks are thus wanted, these being fixed at the underside of the base. The size can easily be judged from the drawings. The thickness should be 1½ ins. or so. Consequently, two pieces of ¾ in. stuff cut out and glued together would make the supports.

When glued and screwed in position, bore ¾ in. holes in top, in the centre, for the entry of the sockets. These are tapped home with a hammer; two small holes are usually provided in the serrated rim for a couple of nails, so put these in, too, then push in the castors.

Enamel paint makes the best kind of finish for toys of this nature. Bright colours are highly desirable,

such as pillar-box red, light green, blue, yellow, orange, etc. One bright colour is all that is necessary. Two coats of enamel should be applied, if no priming paint has been applied for a foundation. Complete the car by attaching a length of rope like ¼ in. braided cord or skipping cord to the screw-eye.

Suitable Ending

A loop could be made at the opposite end for the fingers, but a much better idea is to obtain a large ball foot about 1½ ins. in diameter and drill a hole through the centre for the entry of the cord.

To hide the knot to be tied at the end, a larger hole could be drilled about ½ in. deep so that the knot becomes embedded in the hole not unlike blind cord in a tassel. Blind cord, plus a tassel of heavy design, could be adopted, by the way.

Now, the car, as it has been made, can move about in any direction because of the swivel movement of the wagon castors. If desired, the rear castors could be prevented from swivelling about by screwing a small

block of wood against the support so that it touches against the "prongs" of the castors. Screw such blocks to

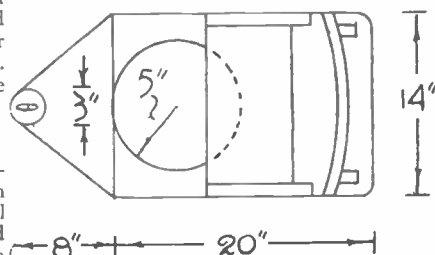

Fig. 4—Top plan showing baseboard

the inside of the supports so they cannot be seen.

Oiling

Having completed the toy, apply a good lubricating oil to the castors. To prevent damage to furniture and walls, a few rubber buffers could be attached to the back end, sides and at the front edges of the base—five buffers altogether thus being required, as shown at Fig. 4.

FROM ODDS AND ENDS



CRUMBS, when on a tablecloth, cannot be wiped off on to a tray—they have to be brushed off, hence the idea of combining a brush with a tray. A novel arrangement is shown and this Crumb Set is made from the brush and shovel of an old companion set!

The finished article sits on a sideboard in the dining-room—and a very distinctive, attractive article is the result if the parts are chromium-plated. One can get this done cheaply enough, by the way.

An excellent alternative is to polish the metal bright and preserve it by coating with a clear varnish. On the other hand, a periodical cleaning with metal polish could be adopted, for the metal parts generally are made from brass.

The shovel part serves for a tray.

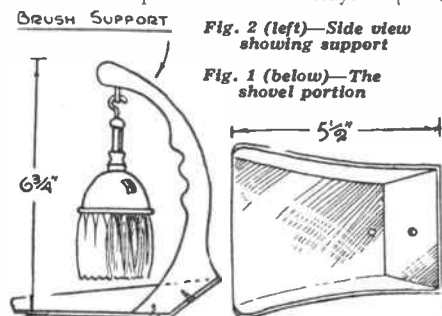

Fig. 2 (left)—Side view showing support

Fig. 1 (below)—The shovel portion

This is shown at Fig. 2 and it is usually fixed to a metal handle by means of rivets. File off the heads of the rivets, therefore, and punch the stems out from the metal, then countersink the rivet holes on the outside for the flathead screws which hold the brush support to the tray.

The brush support (refer to Fig. 1) is cut to shape from ¾ in. wood. The length is approximately 6½ ins. as detailed, but much depends on the size of the brush; if too long—or rather if the bristles are too long, they could be reduced by trimming with the scissors.

This in any case may be essential if the bristles are badly twisted and matted at the ends.

Having made the support and fitted it to the bottom and back end of the tray, screw it in position. A tiny brass screw-eye is affixed to the end of the support for the hook affixed to brush handle end.

The Brush Part

The metal handle is attached to the brush by a threaded stem, with a nut going on the end. Now, if desired, the metal stem can be cut off short, then flattened out for a drilled hole which would take a small brass hook, the latter being screwed to the support in place of a screw-eye (see illus-

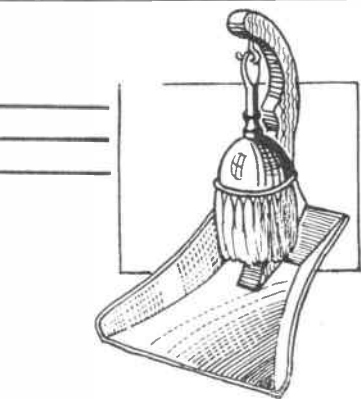

tration of finished article).

However, the stem can be completely removed and a piece of dowelling fixed into the head of the brush. Use a piece of ¾ in. dowelling and cut a stem which fits the brush head, the stem being glued in.

A small brass collar can be attached to the wooden handle, following which a hook is driven into the end. The metal dome and collaring is loosely attached to most companion set brushes, so these can be polished up (or chromium-plated) prior to finally attaching.

Besides, the bristles of the brush might require washing and combing. When dry, trim the hairs neatly. The best way to do this is to encircle the bristles with the forefinger and thumb of the left hand and press the hairs tightly together, then trim.

Regarding the wooden support, this is best stained and polished ebony. It could be waxed ebony black, by the way, using boot polish as the waxing agent, or you could enamel it black. Black goes well with bright brass or chromium.

HINTS & TIPS

WORTH KNOWING

Miniature Ship Guns

WHILE making the model of the Cruiser "Southampton" I discovered a good method of making the small guns on the top rear deck. I took a small neck stud, the type one finds in a new shirt, and put a fine saw-cut across the top. Into this I soldered a small piece of wire and turned the end down at the handle. It forms a realistic little model.—(J. Logan, Glasgow).

A Dart Plane

I HAVE an idea how to make a miniature plane with a dart. First cut off the flight of the dart,

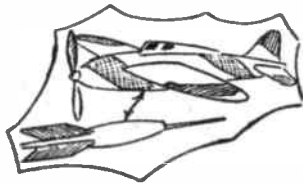

extract the point and round off with glasspaper. Then add cabin wings and tail. If you like you can add two engines and make it into a bomber. The cabin, etc., are, of course, painted on.—(C. Vial, Dagenham).

Making Plastic Wood

ALL you need is some sawdust and a tube of glue. Mix the sawdust and glue together and form a paste. When it is dry it can be sandpapered and stained.—(D. S. Hughes, Oxford).

Needle Uses

MODEL ship makers will find that old gramophone needles can be used as many small details on a ship. Such as taffrails, torpedoes, small guns, flag-staffs,

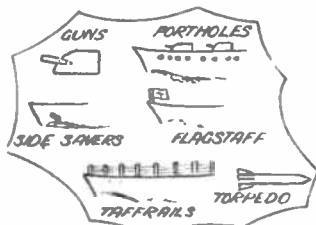

side-savers for yachts, etc. For port-holes they are driven well into the sides of the ship with only the top showing so as to look like the round window of the port-hole. The illustration gives pictures of their uses, as mentioned.—(G. Farrar, Bradford).

Marking Awl

I BROKE the end off my small Iscrewdriver so I filed it to a sharp point and found it made a very good and useful burnishing awl. It is useful for marking out position of holes before drilling, also for marking out position of screws.—(J. J. Neen, Parton).

Simple Small Shelves

HERE is a little tip which I would like to give to other modellers for small shelves. First of all obtain a piece of wood 9ins. by 3ins. by 1/4in., and make smooth with glasspaper. Now take another piece of wood, say 6ins. by 3ins. by 1/4in., and cut from it 3 pieces of wood 3ins. by 2ins. We now want six long flat headed nails. Nail two of them 1/2in. from the bottom and then another two 3ins. above them and the last two 3ins. above them. Take the three shelves and lay them on top of the nails, glue one edge with "Hob-



bes" glue and glue to the base. Bore two small holes near the top and screw to a convenient place. The shelves are ideal places to put six Hobbies tins of enamel, and will not fall off easily.—(N. Lumley, Stokesley).

Novel Small Guns

OTHER readers may be interested in my method of representing small guns on model warships. Several old centre pieces from miniature bayonet lamp holders were obtained and the brass plungers

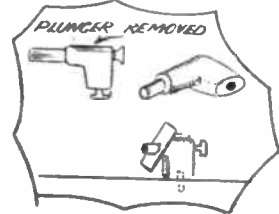

removed intact as shown. The screw was then removed and a small round piece of wood fitted in the gun position, entered hole. Glue on to wood and "gun" before fitting. Paint black or grey, with card or tin shields, and very realistic guns result. A model warship with several of these for the smaller guns looks most workmanlike.—(R. E. Dobson, Malvern Link).

Statuette Figure Hint

A LITTLE while ago I made one of the novel statuette figures in Hobbies Weekly into a newly designed pencil rack. I cut a piece of wood 2 1/2ins. square and 1/2in. thick, and on to one end of this I glued the figure. Then I cut two pieces of 1/2in. round rod, both 2 1/2ins. long, and slightly flattened them. One of these pieces I glued 1/4in. away from the figure, the other one 2ins. away from the figure. When painted it is quite attractive, and very useful.—(M. Hollingsworth, Uplume).

A Worker and his Models

THIS is Master H. Bowman of Cokermonth, Cumberland, and some of the splendid pieces of work he has completed from Hobbies designs. The frame of France and Britain was published early in the war when the two countries were fighting side by side. Such a design would not be so popular now! The long barrelled model 4.2 heavy gun was made from our design No. 2317 which is still obtainable for 4d.

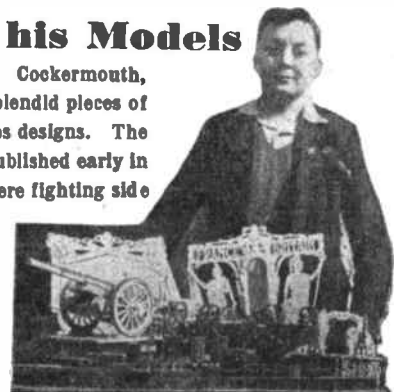

TWO USEFUL SUGGESTIONS

A simple Coat Hanger and Radio Voltage Adjustments

WE think more of coat-hangers these days than we did when, as regular customers, our tailor gave us them as a gift. And now that we have to take extra care of our pet suit—the one having a double-breasted coat, with turn-ups on the trousers and umpteen pockets all about it and the waistcoat—coat-hangers will be wanted more than ever—become a cherished article in fact.

A Use for Cane

When you have none and cannot buy one, you can make one easily enough. After all it is only a matter of cutting out a bow-shaped piece of wood, fixing a length of dowelling at the drooping ends, then fix a hook of wire in the centre of the wood.

That takes time, however, so here is a good "emergency" tip. If you have a piece of $\frac{3}{4}$ in. cane, the ends (when you have cut the cane to the proper length, this being about 16ins. long) are drawn in to bend the cane into shape by means of a piece of cord tied at the ends.

This gives you a "bow" you could almost throw darts with. Now, for hanging purposes, a loop of cord is

tied in the centre of the cane—and there you are!

The cane must be fairly strong stuff, and bamboo is probably the best thing to use. You may have an old bamboo curtain rod that could be used up in this way. The bent cane, of course, is for holding the coat and waistcoat, with the trousers folded over the string that stretches from one end to the other.

On the other hand, you could use a piece of flat wood measuring 16ins. long by $\frac{3}{4}$ in. wide by $\frac{3}{4}$ in. thick. This will bend easily enough *fairly*, and it is only a matter of drilling holes near the ends, the latter being rounded to prevent tearing the lining of the coat, then the string tied on as explained.

ELECTRICAL radio sets must be adjusted to suit the known supply of current in the home. This is often from 110 up to 245 volts. Now, instructions are apt to get lost, and if one has moved into a new house and found that the voltage is different from that in the old house, you are in a bit of a mess.

Here is the usual course, there

being two adjustments in the case of an all-mains set, one on the converter and one on the receiver, thus:

The Mains End

On the Converter: At the mains cord end of the converter will be found a connecting block having two lugs. The range of voltage to which the converter is set is one seen on the serial plate, being either 110, 130, 200 to 245 volts. To make the adjustment, pull the block off the contact pins, turn it round and replace it, so that the desired range is exposed with the unwanted range masked by the block. Try to get the range nearest to the voltage of the mains supply.

On the Receiver: Receivers are generally adjusted for 245 volts. If exceeding the supply, remove the back of the receiver and look for the small black disc on which the different voltages (about six) are engraved. Adjust the voltage by pulling out the disc until free and rotate it until the voltage desired is showing at the top, then push the disc back in place again gently. Having replaced the back, see that—in the process—the mains connector makes proper contact.

MISCELLANEOUS ADVERTISEMENTS, etc.

The advertisements are inserted at the rate of 2d. per word or group of letters prepaid. Postal Order and Stamps must accompany the order, and the advertisements will be inserted in the earliest issue. Fretwork goods or those shown in Hobbies Handbook not accepted. Orders can be sent to Hobbies Weekly, Advertisement Dept., as below.

MONOMARK. Confidential London Address. Letters redirected immediately. 5/- p.a.—Write BM/MONO28, W.C.1.

KEYHOLE SAW. Should be in every kit. Complete with 8in. blade 1/3. Post 4d.—Hobbies Ltd., Dereham.

BE TALLER!! Quickly!! Safely!! Privately!! Details 6d. stamp.—Malcolm Ross, Height - Specialist, BM/HYTE, London, W.C.1.

STAMPS FREE!! Twenty Unused (2½d.)—G. H. Barnett, Limington, Somersct.

FRETWORK MACHINES. Hobbies supply Bench and Treadle Machines from 37/6. Every machine guaranteed to give lasting service. Send 2d. for Booklet.—Hobbies Ltd., Dereham.

LONELY? Then write Secretary; U.C.C., 5B.B. Hay St., Braughing, Herts. Genuine. Est. 1905.

Hobbies Weekly—2d. every Wednesday—Subscription Rate 14/- per year or 7/- half year. Editorial Offices, Dereham, Norfolk, Advertising Dept., Dereham or Temple House, Tallis Street, London, E.C.4. Hobbies Branch shops at 78a New Oxford Street, London, W.C.1. 37 Old Broad Street, London, E.C.2. 326 Argyle Street, Glasgow. 10 Piccadilly, Manchester. 4 St. Paul's Parade, Sheffield. 10 Queen Victoria Street, Leeds. 14, Anlabv Road, Hull. 14 Bull Ring, Birmingham.

SAVE COUPONS. Ladies' Stockings Repaired.—Beresford, 42 Queen Street, Belper, Derbyshire.

CUT STRAIGHT LINES with the Fretsaw. Hobbies Straight Edge enable anyone to cut a dead straight line easily and quickly. 4in., 1¼; Postage 3d.—Hobbies Ltd., Dereham.

STAMPS! Send P.C. for Approval Books, postage free.—James Bishop, 9 Bryson Place, Bathgate, Scotland.

FRETWOOD is now very scarce, and normal supplies cannot be offered. Some timbers, however, are still offered in planed boards, but your needs and date of delivery should be enquired first.—Hobbies Ltd., Dereham.

ATTRACTIVE Small Pink Parrot, accept 40/-, another beautifully coloured 70/-. Approval, particulars, stamp please.—Rees, 70 Cotswold Road, Bristol.

OO GAUGE RAILWAY. Designs for making an Engine Shed, Signal Box, Footbridge, Railway Station, Fencing, etc., 8d. the set, post free.—Hobbies Ltd., Dereham.

FREE STAMPS. No rubbish to approval applicants. Postage appreciated.—Martin, 67 Machon Bank Road, Sheffield 7.

FRETSAWS. Hobbies Saws are the best you can buy. They outlast all others. 6d. and 8½d. dozen. Postage 2d.—Hobbies Ltd., Dereham.

FRETWORK OUTFITS. Prices from 2/6 to 28/6. Every tool British. The name of Hobbies is your guarantee of good value.—Hobbies Ltd., Dereham.

FRETSAW Handframes still available in small quantities. Ask if in stock before ordering.—Hobbies Ltd., Dereham.

Printed by BALDING & MANSELL, London and Wisbech, and Published for the Proprietors, HOBBIES LTD., by HORACE MARSHALL & SON, LTD., Temple House, Tallis Street, E.C.4. Sole Agents for Australia and New Zealand: Gordon & Gotch (A'sia) Ltd. For South Africa: Central News Agency Ltd. Registered for transmission by Canadian Magazine Post.