

HI FI YEAR BOOK

Pickups/Motors/Tuners
Amplifiers/Microphones
Recorders/Speakers/Cabinets

1970



for the closest approach to the original sound
Acoustical Manufacturing Co. Ltd. Huntingdon (0480) 2561/2

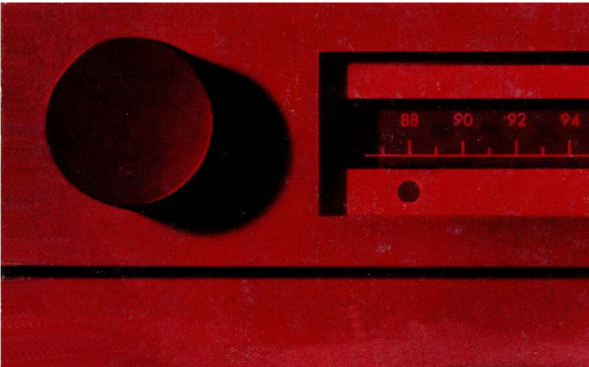
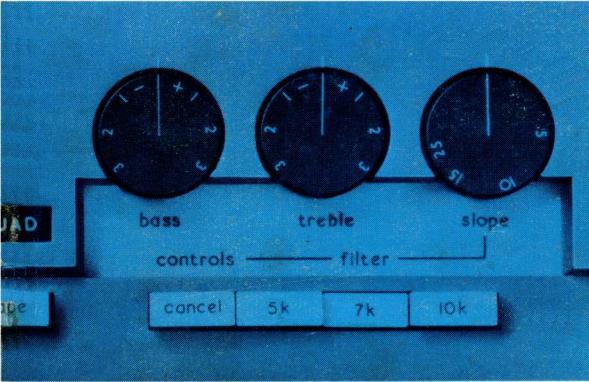

CoID
design award
1969

HI-FI YEAR BOOK 1970

Editor: COLIN SPROXTON

Published by
IPC Electrical-Electronic Year Books Ltd.
Dorset House, Stamford Street, London S.E.1;
telephone: 01-928 3333,

Printed in Great Britain by
Portia Press Ltd., Whitchurch, Hants.

Contents

Articles		Page
Putting Separates Together	<i>By John Borwick</i>	... 5
Speaker Enclosures	<i>By R. C. Norris</i> 10
Records—A Basic Collection	<i>By W. A. Chislett</i>	... 16
Care and Storage of Records	<i>By A. C. Williams</i>	... 22
Tape Recorders and Recording	<i>By H. W. Hellyer</i>	... 25
Stereo Radio—How it works	<i>By Roy Prince</i> 33
Radio Tuners	<i>By Gordon J. King</i>	... 39
 Directory Sections		
Pickups and Arms	55
Pickup Accessories	77
Motor Units...	89
Radio Tuners	105
Tuner/Amplifiers	123
Amplifiers and Control Units	155
Tape Recorders	189
Tape decks	213
Tape units	214
Tape Amplifiers and Mixer Units	221
Tape Accessories and Components	225
Magnetic Tape	241
Test Tapes and Discs	247
Constructional Kits	249
Microphones	263
Speaker Drive Units	295
Speaker Accessories	314
Speaker Enclosures...	319
Hi-Fi Cabinets	367
FM/VHF Aerials	383
Complete-System Hi-Fi	395
Hi-Fi Headphones	406
Directory of Hi-Fi Dealers...	415
VHF Radio Map	430
Advertisers' Index	431

INTRODUCTION

This latest edition of the *Hi-Fi Year Book* follows the same pattern as the previous issues. It presents in concise form detailed specifications and up-to-date prices for almost every item of hi-fi equipment currently available on the British market.

In the following pages will be found details of over 2,000 different pieces of equipment from more than 300 manufacturers or importers. Over 700 models are illustrated.

But while the general formula remains the same there are, nevertheless, a number of important changes. The first of these concerns the publishers. Since the last edition the ownership of the *Hi-Fi Year Book* and companion *Radio Year Book* has changed hands and both books are now published by IPC. Electrical-Electronic Year Books Ltd. However, the same editorial staff as before has compiled the entries, thereby ensuring continuity of ideas and the availability of the same close knowledge of the audio industry.

One change that regular readers will notice is the disappearance of the familiar black 'blob' alongside stereo equipment. Nowadays nearly all hi-fi equipment is stereo, so that over the years since it was first introduced the symbol has lost much of its earlier usefulness. But another sign, a star, is introduced this year. This mark alongside a model indicates that the particular item is illustrated.

Another change is to be found in the tape recorder section which last year was restricted to machines costing £100 or over. Most enthusiasts agreed with this arbitrary division but at the same time it has become apparent that many recorders costing well below this figure are bought for use in hi-fi systems. In this edition therefore the range is extended to take in machines with prices of £50 and upwards.

Another section where entries are governed by a price qualification is the one dealing with microphones. In this case only models with a retail price of £5 or over are listed.

The useful and popular tape accessory section appears again in full. Also in this section are grouped various items of equipment that do not conveniently fit into any other main category.

Since resale price maintenance on radio and electrical goods is now abolished manufacturers are no longer able to control the prices at which their goods may be sold. All the prices quoted in this book therefore are recommended prices. Actual selling prices may vary slightly from place to place. Wherever possible purchase tax is shown separately, but in certain instances inclusive prices only were obtainable from the makers.

Due to the extent of the hi-fi equipment on the market only separate items

are listed in the Year Book. No attempt has been made to catalogue the vast range of unit audio systems now available from almost every manufacturer.

The performance and specification data printed in this book is that supplied by the makers or distributors of the equipment concerned. The publishers call attention to the fact that no testing of any kind has been undertaken to verify the figures given.

Although every effort is made to persuade manufacturers to quote performance figures in the same units this is never completely successful, due often to the differing standards in the countries of origin of the equipment.

Every care has been taken in compiling the information to ensure the accuracy of the data and prices quoted, but the publishers regret they are unable to accept responsibility for any errors that may have occurred.

Readers who are interested in obtaining similar information covering radios, radiograms, record players, lower-priced recorders, monochrome and colour television are referred to the companion volume, the *Radio Year Book 1970*, available from the same publishers.

PUTTING SEPARATES TOGETHER

By John Borwick

Equipment for reproducing gramophone records and radio broadcasts, and for recording and reproducing magnetic tapes, seems to multiply each year. A glance through the directory sections of this Year Book will confirm that an almost bewildering choice is presented to the intending purchaser. Besides choosing the individual units, he must also take good care that these separate units are matched to each other in technical performance. A mistake at this stage can be costly and frustrating as, for instance, when a good quality pickup and amplifier cannot be heard at their best because they are used with inferior loudspeakers.

Another difficulty facing newcomers to audio (or high fidelity, or just hi-fi) is that it seems to have a language of its own. This hardly mattered in the early days when addiction to good quality sound reproduction was confined to a relatively small band of enthusiasts who were technical enough to build their own sets. They used hi-fi jargon as naturally as a Cockney talks in rhyming slang—and were as unintelligible to the uninitiated.

WHAT IS HIGH FIDELITY?

Dating from just before the 1939–45 war there has been a steady improvement in the quality of sound reproduction. Gramophone records themselves have improved, first on 78 r.p.m. shellac pressings, then on 33½ r.p.m. and 45 r.p.m. vinyl plastic, and then in stereo. Radio broadcasts too have become technically better, thanks to better microphones, the move into the v.h.f. f.m. waveband and, for a few programmes daily, the introduction of stereo. Tape recording has progressed from a specialised wartime technique to a daily activity in thousands of homes, schools and offices.

At any given moment, only some of the

equipment sold to the public has been capable of reproducing records etc. to their full advantage. This we can call high fidelity equipment, which gives us an acceptable definition of high fidelity as 'reproducing sounds with as much faithfulness to the original as the present state of the art allows'. In other words, high fidelity is not a fixed property but something which, in the best designs, is continually reaching in terms of technical excellence and, in consequence, listening pleasure. The pity is that most domestic radios and record players (and TV sets) lag so far behind.

The separate units which go to make a stereo high fidelity system are outlined in **fig 1**. The advantages of stereo are now so well established that mono need hardly be considered except for very small rooms and tight budgets. The units may all be bought individually and connected together or, a habit which is increasing, some of the units may already be joined together (integrated). If you are new to audio, it will be easier to install integrated units and so avoid the need to fuss with connecting cables and match units of equivalent performance. Even so, some knowledge of the separate units is useful so here are brief notes on the way the different units are described in the literature, with special reference to their matching requirements.

PICKUP CARTRIDGES

This is the business end of the pickup (see cutaway model in **fig 2**). It carries the stylus (we used to call it the needle) whose tip traces the record groove. This, in following the recorded wiggles, generates a tiny electric voltage which appears across the pins or terminals at the rear. Pickup styli may have diamond or sapphire tips: diamond lasts much longer than sapphire, about 1,000 hours compared with only

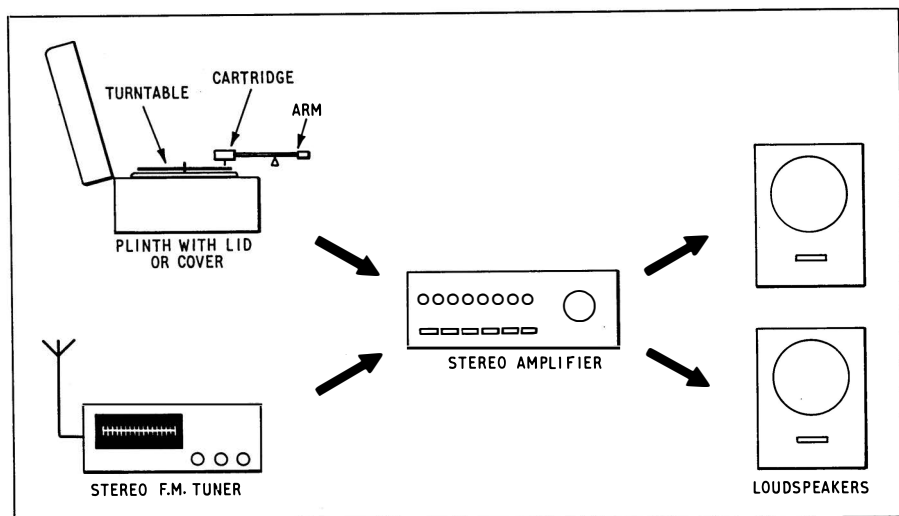

Fig 1 The essential units in a stereo high fidelity system. They may be purchased as "separates" or "integrated".

about 40 hours, but naturally it costs more.

Stylus dimensions are quoted in terms of the radius of the spherical tip: 0.0025 in. (or 2.5 thou.) is right for 78 r.p.m. records, 0.001 in. (1 thou.) is right for mono LP records. Stereo records need a 0.0005 or 0.0007 in. (0.5 or 0.7 thou.) stylus, and this type will also play mono LPs perfectly satisfactorily. Special elliptical styli are now very popular, though expensive. They give good quality and improved tracking of stereo and mono records. The usual dimensions are 0.0007 × 0.0003 in. (0.7 × 0.3 thou.).

Three basic types of mechanical/electrical generator are used in pickup cartridges: crystal, ceramic and magnetic. Crystal pickups are best described as 'cheap and cheerful'. They produce a strong signal—up to 1 volt—and are commonly fitted in domestic record players and radiograms. But their quality is limited and they do not really belong in high fidelity. Ceramic cartridges are a refinement of the crystal principle. They produce about 0.05 to 0.1 volt (50–100 millivolts) and are good enough to be considered at least in a low-budget high fidelity system.

Magnetic cartridges—variously described as moving magnet, moving coil, variable reluctance, etc.—are the main hi-fi types. They generally have a smooth and extended response over the whole range of audible sounds with very low distortion. Against this must be set

their relatively high price—though some cheaper magnetics are beginning to come on the market—their low sensitivity, about 1 millivolt, and the fact that they faithfully reproduce the disc recording characteristic (which rises steadily from bass to treble) and so must be 'corrected' in the amplifier.

PICKUP ARMS

Most modern pickup arms, even the ones built on to medium price turntable units, are 'universal' in application; that is, they can be used with almost any cartridge. One example is shown in **fig 3**. They all possess some means of adjusting the playing weight, which must be carefully set within the range specified by the cartridge manufacturer, and should have very low pivot friction in all planes.

It is helpful too if the arm has a built-in raise/lower device, as most people find it difficult to handle modern pickups, tracking at a mere 2 or 3 grammes, without the risk of damage. A supplementary fitment, particularly useful with good quality stereo cartridges, is a side-thrust, or bias, compensator. This is designed to counteract the force, inherent in all pivoted arms, tending to pull the pickup towards the centre of the record. It may take the form of a weight on a nylon thread, a biased lever, or a pair of opposing magnets.

RECORD TURNTABLES

Transcription turntables used to be chosen exclusively for high fidelity, that is to say, comparatively heavy duty types with full 12-inch

platters and no frills or attachments of any kind. Now, however, one finds that the technical standards of integrated turntable/arm units with automatic start and stop facilities come close to those of the true transcription turntable, so that a wide choice of units is available.

The principal speeds to look for are $33\frac{1}{3}$ and 45 r.p.m. (revolutions per minute), the former for mono and stereo LPs, the latter for 7-inch popular records. You will want 78 r.p.m. only if you have old shellac records in your collection. The remaining speed, available on some turntables, is $16\frac{2}{3}$ r.p.m.—for which there are virtually no records! Fine adjustment of the running speed is provided on the better turntables, but this is only really useful if you have absolute pitch hearing or want to accompany records on a musical instrument.

Steadiness of the motor speed is quoted as a wow and flutter percentage. You should look for values of 0.2% or less.

TYPES OF AMPLIFIER

High fidelity amplifiers differ considerably in the facilities they offer, such as bass and treble tone controls, filters, stereo balance, etc. But these are incidental questions of personal taste. The vital considerations when building up a matching system are the input and output ratings (see typical socket panel in **fig 4**).

For example, if a magnetic pickup cartridge is to be used, as in most hi-fi equipment worthy of the name, it is important to choose an amplifier with a magnetic pickup input. This will have a rating of about 3 millivolts at 50,000 ohms (or one of the preferred resistor values, 47,000 or 68,000 ohms). This input will also be provided with the frequency equalisation already mentioned. In the same way it is necessary to check that other sources one plans to use, such as radio tuner or tape recorder, are approximately matched to the amplifier rating.

The amplifier amplifies, or boosts, these incoming signals to produce a stated maximum amount of electrical power rated in watts, which will be achieved only if loudspeakers of a specified impedance (in ohms) are employed. Regrettably, manufacturers have begun to quote their amplifier power capabilities in various ways. The rating to look for is the continuous (or r.m.s. or sine wave) power. This most accurately describes the unit's ability to drive the loudspeakers. If some other specification is used, like music rating, I.H.F.M. etc.—you will need to guess the true power as being about one half or two-thirds of the figure given. Ten watts per channel is a suitable specification for a medium-sized room.

The impedance, or ohms, rating is not unduly

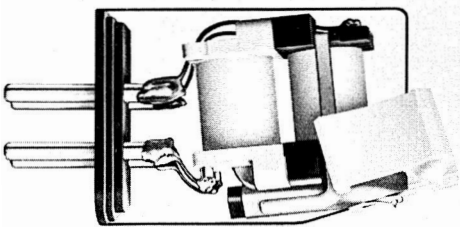

Fig 2 Cutaway model of a moving magnet pickup cartridge (Elac 244-17) showing slide-out stylus assembly (lower right), and coils and connecting pins.

critical. Valve amplifiers used to have terminals giving a range of impedances (15, 7 and 3.5 ohms in U.K.; 16, 8 and 4 ohms in U.S.A.) and these would match any loudspeaker. Transistor amplifiers, which have now practically ousted the valve models, work most efficiently into a load of about 4-8 ohms. They therefore tend to have a single outlet at this impedance, and more and more loudspeakers, here and abroad, are being made to the 4 or 8 ohms rating. The matching is in fact not very critical, but you should try to avoid running 15 ohm loudspeakers from a 4 ohm amplifier, as efficiency will be low.

LOUDSPEAKERS

However objective we are about the choice of amplifiers, etc, personal likes and dislikes

Fig 3 Example of a universal pickup arm (S.M.E. 3009) which will accept any cartridge and has integral calibrated playing weight, hydraulic raise/lower and side-thrust compensator (weight and thread).

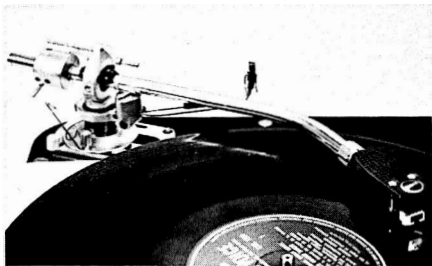

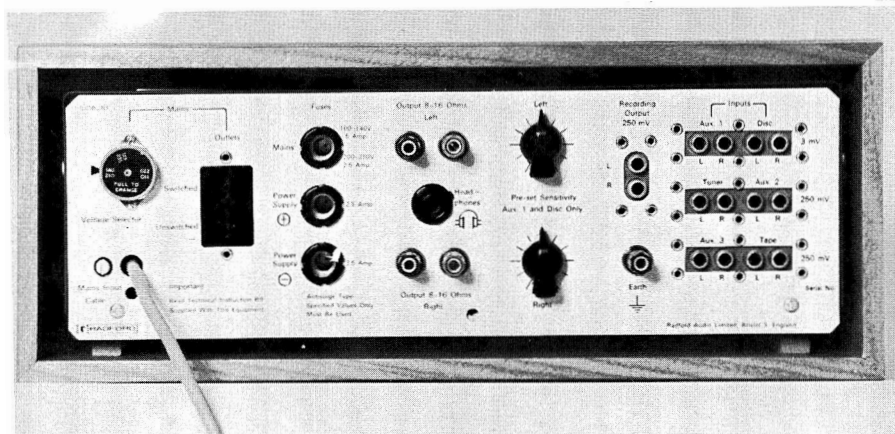

Fig 4 Rear panel of a typical stereo amplifier (Radford STA25) showing flexible range of connections provided.

dominate when it comes to loudspeakers. These must always be selected on the basis of a listening test on several kinds of music and speech. Even today, the quality of sound from different makes of loudspeaker varies enormously.

Apart from the listening test and decisions about the size and appearance, you need only check whether the power handling capacity of the loudspeakers is enough for your chosen amplifier. Connecting 5 watt loudspeakers to a 30 watts-per-channel amplifier would be safe enough in the ordinary way, because normal listening levels do not use the full power available. But a domestic accident, such as knocking the pickup when the volume control had inadvertently been left full up, could do permanent damage to the loudspeaker mechanism.

Modern loudspeakers, of which one example is shown in **fig 5**, frequently use two or more drive units to cover the audible spectrum ('tweeter' for treble, 'woofer' for bass, etc.). But the number of units is relatively unimportant. What matters most to the user is the overall sound quality.

RADIO TUNERS

Radio transmissions on the v.h.f./f.m. (very high frequency/frequency modulated) waveband are so much better than those on the ordinary broadcast bands (long, medium and short:

amplitude modulated) that they are an obvious first choice for a high fidelity system. You should therefore choose an f.m.-only tuner or, if you want to tune in foreign stations and BBC Radio 1, a combined f.m./a.m. tuner.

Stereo tuners, or the add-on stereo decoders, cost about £8-£20 extra, but they are a good investment despite the small number of stereo

Showing separate audio units neatly fitted in a Record Housing Hi-Flex cabinet and Shelfframe assembly.

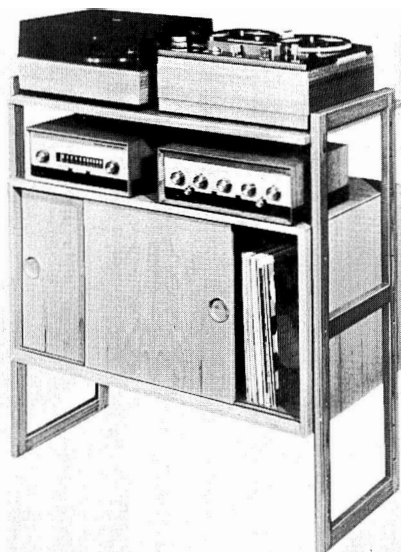

transmissions available at present. Stereo is relayed to listeners in the BBC's South-East, Midland and North regions and can be of excellent quality. A sensitive tuner is required, say about 2 microvolts or less, and you should put up as good an aerial as is practicable.

No problems should arise in matching the tuner to the amplifier. The sound (audio) output from the tuner will normally be at about 0.1 to 1 volt, and this should suit the amplifier's radio or auxiliary input. As for impedance, it is enough if the amplifier rating is about the same as that quoted for the tuner, or higher.

HI-FI PRICE MATCHING

I began by emphasising the need to match the technical performance of audio units bought as separates. And the above notes should guide you through the major terminological pitfalls.

A different, but highly sensible, approach is to match the units in terms of price. As in other commodities, you tend to get what you pay for: top price speakers, for instance, should usually be connected to top price amplifiers, and so on. A very good clue can be got by estimating what proportion of your total budget should be spent on each item.

Table 1 shows in rounded-off figures the minimum and maximum prices of the separate units now on the market (omitting a few luxury models which would throw any more modest scheme badly out of balance). Adding the entries in these first two columns produces minimum and maximum budgets of £99 10s. and £577 10s. respectively. (Note that stereo is assumed throughout, including stereo radio.)

The last column of Table 1 shows very approximately the average percentage of the total budget which each unit represents. If you read the figures in the last column as £s instead of percentages, you will see—though remember the figures are very approximate—what the components of a £100 system should cost. You

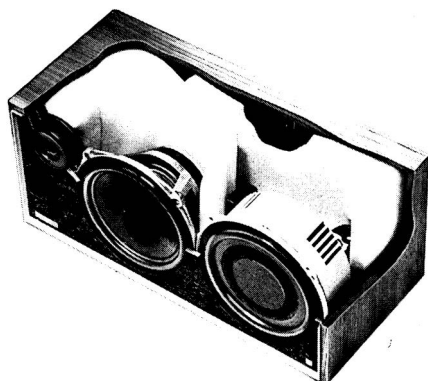

Fig 5 Cutaway model of a three-element loudspeaker (Celestion Ditton 15) showing the tweeter (left), woofer (centre) and bass 'slave' radiator (right).

can then double these prices for a £200 budget and so on. As an example, the separate parts of a stereo high fidelity system to cost £250 complete would roughly work out as follows:

					£
Cartridge	25
Arm	25
Turntable	25
Amplifier	50
Tuner	50
Loudspeakers (two)	75
Total					£250

This Year Book lists many units under each of these headings at about the prices shown. So literally hundreds of possible £250 combinations exist. Whatever your budget, I hope these notes will help you to put the right separates together to give many hours of listening pleasure.

Table 1. Balancing Budgets

Item	Minimum			Maximum			Average (approx.)
	£	s	d	£	s	d	
Cartridge (stereo)	2	10	0	45	0	0	10 per cent
Arm	3	0	0	36	10	0	10 per cent
Turntable	12	0	0	46	0	0	10 per cent
Amplifier (stereo)	20	0	0	120	0	0	20 per cent
VHF/FM tuner (stereo)	30	0	0	120	0	0	20 per cent
Loudspeakers (two)	32	0	0	200	0	0	30 per cent
Total	£99	10	0	£577	10	0	100 per cent

SPEAKER ENCLOSURES

By R. C. Norris

Although the cabinet or other enclosure of a speaker drive unit (or units) may appear a simple bit of carpentry, and often is, don't be deceived. As the final coupling, the one to the room, it is no less important than any other section of the hi-fi system.

Why an enclosure? Because the conventional drive unit (we exclude the full-range electrostatic type) produces sound at both sides of the diaphragm. As the diaphragm makes, say, a high pressure one side, a low pressure is produced the other side. The two sound waves are opposites, 180 degrees out-of-phase. One has to be eliminated, or at least controlled.

In addition, the enclosure should direct the sound into the room efficiently and secure equal distribution of the various frequencies, high, middle and low.

The enclosure is also required, in the average home, to present acceptable appearance, not take up too much room and not cost too much. These practical and commercial considerations result in drive units often being designed to suit their 'box' rather than vice versa.

Much experimental and mathematical study of the problems of coupling drive units to their surroundings has taken place since the earliest days of radio. About forty years ago the Science Museum in London demonstrated a carefully-designed horn. It was some 30 ft long!

New ideas still come along. Recent years have been particularly fruitful. Here is a field in which the amateur can play an active part, whether he wishes only to house units inexpensively or to try for perfection and, perhaps, to build his house around them!

For valid original work it is essential to study the subject in depth. However, makers of drive units are usually ready to provide design details of some suitable enclosures, and there are numerous books giving guidance, both general and specific. Even people in the market for

complete loudspeakers need to know something of the pros and cons of the various types on offer.

One fundamental point has already been made: the need to eliminate or control the sound from one side of the diaphragm. We need to associate with this the fact that diaphragms do not radiate low and high sounds in quite the same way.

Since molecules constituting air are already oscillating and colliding (this thermal agitation is a cause of atmospheric pressure) the extra sound energy imparted by each 'point source' of a speaker diaphragm is transmitted in all

Wye Electronics model 1300 is an example of a column speaker. Dimensions are 15 in. wide, 7½ in. deep and 36 in. high.

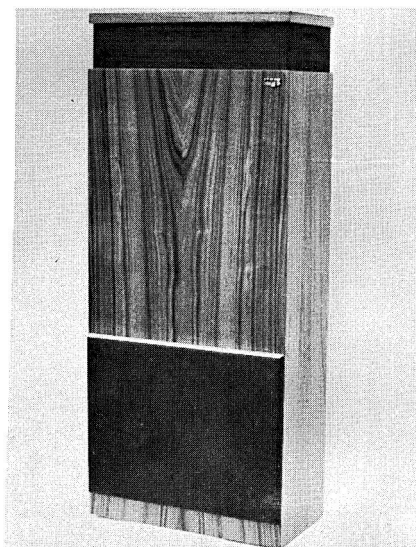

directions. At low frequencies, in the absence of an enclosure this scattered energy would travel, virtually instantaneously, from one side of the diaphragm to the other. Sound moves at 1,100 ft per second, and covers, say, 20 ft during a single diaphragm oscillation at a low frequency.

With an enclosure-less drive unit, at low frequencies, the two sides of the diaphragm would be practically in the same place. The diaphragm simply could not set up pressure differences; without any loading by the air it would vibrate excessively until at least some of the energy was absorbed by the suspension system, which could be damaged.

Things would be different at high frequencies. Partly because they would not have time to circulate, but mainly for the reason that their energy is beamed outward. This results from the fact that their wavelengths lie around the actual width dimension of the diaphragm.

Those waves (coming from point sources) that pass at a low angle across the face of the diaphragm interfere with each other and largely cancel out. In this instance the energy 'surplus' is added to those waves that are going forward, marching in step.

MULTIPLE DRIVE UNITS

At really high frequencies it may be necessary for the beam to be broadened or directed—for instance, by use of two or more 'angled' high-note units (tweeters), by little horns, or other devices built into the enclosure.

About here it is as well to digress a moment to recognise the fact that hi-fi enclosures generally house at least two drive units, one for the lower frequencies, the other for the high. Sometimes there are two or more tweeters. Many speakers split the range further, with separate bass, middle-frequency and tweeter units.

There are drive units which are virtually two-in-one. Within the bass diaphragm there may be a small free-edge cone for the 'highs', this being coupled (mechanically) so that it has an independent role. In one design, a horn-type 'high' unit is built within the magnetic system of the large bass unit.

At the relatively slow rate of movement for low notes a diaphragm needs to be large and to have a big swing. It can be comparatively heavy. But the rapid small-amplitude vibrations of the 'highs' can accelerate only a very light, small diaphragm.

Single-unit speakers are designed for the diaphragm to 'break up' and vibrate differently in various areas. Not an easy matter to engineer with precision, with cross-modulation of the various frequencies all too possible. Hence the popularity of the assembly of specialised units,

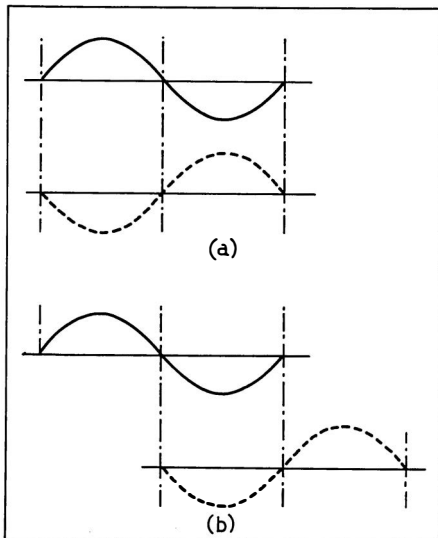

Fig 1 (a) The sound waves produced simultaneously at the two sides of a diaphragm are opposites, that is, 180 degrees out-of-phase. But when one is delayed by a half a cycle while travelling around the two sides of a $\frac{1}{4}$ -wave baffle, it meets a newly-generated in-phase wave, as represented in (b), and adds to it.

each fed—through an electrical filter—with only its own particular band of frequencies.

Returning to enclosures and their role at the lower frequencies, the simplest device to prevent immediate short-circuiting around the rim of the unit is a flat mounting board, or baffle. One can see that, however large such a baffle, the out-of-phase waves will still meet at the edges and cancel. But provided that cancellation occurs some distance from the diaphragm, the latter will be little affected by such a remote event and will be able to work into a useful volume of room air.

However, it can be supposed that cancellation will not be anything like 100% and that some of the waves will reach the opposite side of the diaphragm. Now, if a wave travels half its own wavelength (baffle dimension being $\frac{1}{4}$ -wave from centre to edge) it will encounter—at the other side—a wave being generated half-a-cycle later. This will be in-phase, and the two will reinforce each other. This is shown in **fig 1**. At path distances rather less or more than $\frac{1}{2}$ -wavelength the addition is not so favourable.

A baffle for $\frac{1}{2}$ -wave working at about 50 Hz would have to measure some 10 ft across, hardly

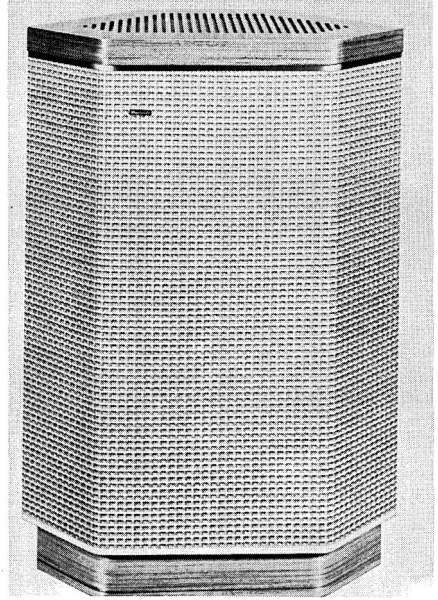
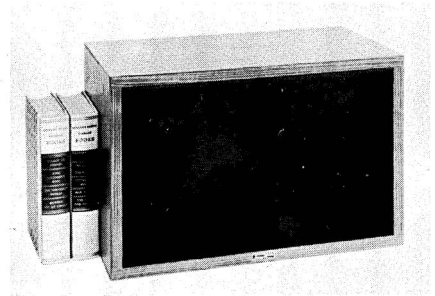
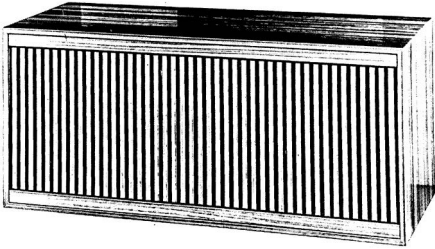

Top, Grundig Box 300 infinite baffle enclosure. Lower, Jordan Watts Juliet bookshelf speaker. Right, Wharfedale Airdale three-speaker enclosure which features acoustic resistance loading.

practicable in the home! One can see that horns and open-back boxes can be regarded as folded baffles. These have the extra advantage of focusing the sound and giving increased air loading, at least on one side of the diaphragm. But they introduce resonances in both the enclosed air and in their own structures. Enclosure design is largely concerned with the control of these resonances.

TUNED ENCLOSURES

Designers sometimes seek to make an advantage of these effects. Some have gone as far as treating unit and enclosure as a musical instrument comparable to a piano frame and its sounding board. Generally, the aim is to get the enclosure to load the unit(s) exactly as required and to dispose of, or control, rearward radiation in a planned manner, without its contributing anything of its own making.

It will already be clear that the role of the enclosure is most critical at low frequencies. At these frequencies, the enclosure dimensions are most closely related to the sound wavelengths. Again, there is more energy in a low-frequency sound than a high-frequency (for given intensity) and the difficulty in disposing of this, when not wanted, is greater. At the same time, every

consideration must be given to the handling of the middle and upper registers.

Back radiation at all frequencies can be troublesome, if let free, since it can be reflected from the walls into the room and then interfere with the main radiation. Absorption is not too difficult, thanks to new spongy plastics, but some energy must be taken into the cabinet structure. So this should be built so that it

Fig 2 Typical reflex enclosures. One, shown in section, is rectangular with single front-facing port. The other, a corner standing design, has a port on either side.

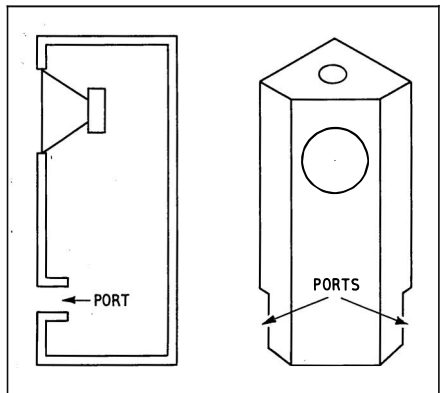

dissipates this energy without breaking into sympathetic vibrations—not in whole, in sections or even in little parts (if possible!).

As for the air, in any enclosure of convenient size this is sure to resonate at certain wavelengths and their harmonics. Different modes of sound-wave oscillation can occur within a space of given dimensions.

One sort of resonance is like that which occurs when one blows across the mouth of a bottle. The frequency of the resulting note is determined by the relative sizes of bottle and neck, the air in the bottle acting like a spring and the air in the neck like a weight.

BASS REFLEX TYPE

The bass-reflex type of enclosure, which is a 'box' with a small port open to the room, as shown in **fig 2**, can be likened to a bottle. The inevitable resonance is turned to advantage by tuning it—mainly by control of port size—to occur at the same frequency as the free-air natural bass frequency of the low-frequency drive unit. At first sight this technique should build up a super—and disastrous—oscillation, but this is not so, thanks to a phenomenon that occurs when two similar resonances are closely coupled.

To radio technicians this is known as the bandpass effect. When two resonant electrical circuits are tuned to the same frequency and arranged to interchange energy the result is not one 'frequency hump' (see **fig 3**) but two, spaced either side of the tuned frequency. Similarly, with unit and enclosure, the free resonant frequency disappears and two others appear, one of them extending the bass response even lower.

In practice the two responses are not as well defined or equally balanced as in the diagram. More important, and as in an electrical band-pass tuned circuit, these resonances can be reduced in amplitude, and in effect widened in frequency response, by the addition of resistance loading (damping). Losses in the cabinet provide such loading and, in some designs, an acoustic resistance is fitted into the port—a panel pierced with holes and devised to abstract energy from the sound passing through.

Another feature of this ported-enclosure design is that the internal sound path is related to the bass wavelength so that phase reversal occurs. As already mentioned in connection with the simple baffle, reinforcement then takes place between the direct radiation and the rear radiation, the latter now appearing at the port.

PIPES AND COLUMNS

When the ratio between the different dimensions exceeds about 4:1 an enclosure ceases to

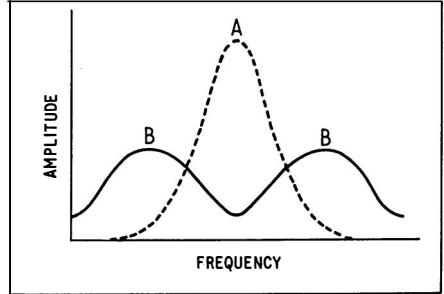

Fig 3 Illustrating how combined speaker and cabinet resonances improve overall response.

be a simple resonator and becomes a 'pipe'. In this the springiness and mass of the enclosed air are distributed rather than separate (as in bottle and neck) and the modes of oscillation are more complex. The principle of the pipe is used in column-type enclosures (the floor-standing hi-fi type, not the PA multi-unit type) and in other designs under various names.

With a pipe closed at one end the fundamental resonance is at a wavelength four times the length of the pipe. Odd harmonics of this are readily stimulated. **Fig 4** represents some of the resonant modes—the waves shown are most simply interpreted when seen as sections of a length of rope with one end anchored, the other end being shaken up and down.

At the closed end (rope tied) air movement is impossible but variation of pressure (stress in rope) is at maximum. At positions of greatest

Fig 4 Fundamental resonance and the formation of harmonics in a pipe closed at one end.

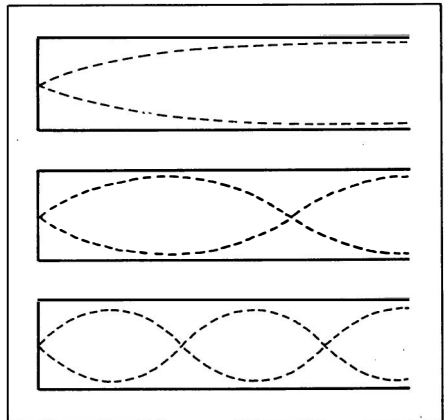

swing, air movement—to and fro *along* the pipe—is maximum, but pressure is minimum. Such a position is always found at the open end.

Column speakers, which may be round or square in section, usually have a length that is a quarter of the wavelength of a frequency just below the bass resonance of the drive unit. When the unit is at one end, as shown in **fig 5**, the open-end output reinforces the direct output at the bass frequency—as we now come to expect.

In practice the width of pipe has an effect on the exact length. Sometimes, as seen in **fig 5**, an acoustic resistance is included to control (damp) the resonance, or perhaps a particular harmonic.

Another approach puts the driver about one-third the length along the pipe at the antinodal point of the third harmonic, the idea being to 'kill' the least-pleasant of harmonics without much change of performance at the fundamental frequency.

HORN SPEAKERS

Improvement is sometimes sought by giving the pipe a changing cross-section. This brings it toward that early—and seemingly elementary but actually sophisticated design—the horn.

Confined in a horn, the air more effectively loads the diaphragm. Moreover, the gradual increase of cross-section gives a transformer action, matching the small-area high-pressures at the diaphragm to large-area low-pressures at

the mouth. As with the baffle, the main problem is sheer size. In round figures, to work down to 50 Hz a horn would have to be some 15 ft long and 10 ft across the mouth. In such designs that have been, and are, used in the home, dimensions are reduced by folding the horn up on itself and, usually, by placing it in a corner so that the room serves as an extension of the horn.

Folding the horn exacts penalties in the shape of interference and delay effects due to the curvation of the sound path. Unplanned resonances of the structure and the air column can arise. A way of avoiding some of these effects, at least on the middle and upper frequencies, is to take the direct radiation straight into the room, the horn being fitted to the rear of the drive unit.

Sometimes a chamber is interposed between such a rear horn and the unit. Comparable to a low-pass electrical filter, the chamber serves to 'smooth' the mid- and high-frequencies out of the backward radiation.

The horn provides a highly efficient system (relatively speaking), good room volume being obtainable at under 1 watt input. This underlines the importance of effectively loading the diaphragm. It is, of course, of little value to load one side only. So units with a horn on one side sometimes have a chamber of some sort on the other side in an endeavour to equalise pressures and linearise diaphragm movement.

This applies to little high-note drivers as well as full-range speakers. Talking of tweeters, when of horn-type these operate on the principles described, the 'low-frequency' cut-off (as determined by the $\frac{1}{2}$ -wave function) now being at the bottom of the HF range.

Besides giving loading, an HF horn can control the distribution. It may be flattened slightly, or even rectangular, at the mouth, with the larger dimension vertical. This later shape curtails radiation in the vertical plane and reinforces the sound in the horizontal plane. Besides spreading the 'highs' over a wider seating area in the room, it cuts down unwanted reflections from ceiling and perhaps floor.

Incidentally, the functioning of a shaped horn in this way can be likened to that of the 'point sources' mentioned previously. The PA 'column' speakers consisting of several drive units one above the other also utilise the cancellation effect (vertical) to obtain a reinforced horizontal spread.

Coming back once more to low-frequency enclosures, it will be appreciated that what has been said about bass-reflex, pipe and horn types is fundamental to a wide variety of designs—most of which are pure, modified or hybrid versions of these. One such is the

Fig 5 Column type enclosure with acoustic filter to absorb middle and upper frequencies.

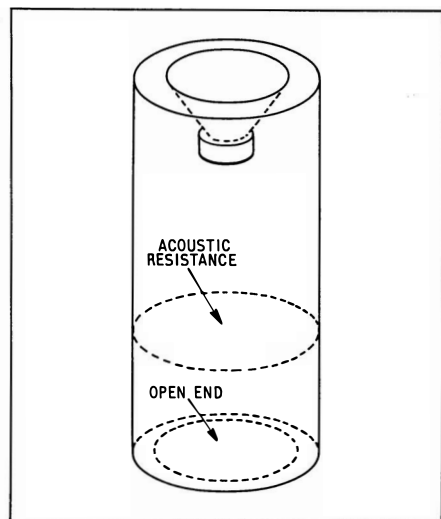

labyrinth type, which sets out to act as an infinitely long pipe, with absorbent material taking up the back radiation until, at the end, nothing is left. The end may, therefore, be open or closed.

There is an approach here to the ideal concept, the infinite baffle. Obviously, if the surround of a unit could be extended infinitely there could be no interference between front and rear radiations, and with the two sides of the unit working into similar volumes, the loading would be balanced. From the early days, some enthusiasts have come close to this ideal by mounting a unit in a hole in the wall between two rooms.

Few people are able to do this and, anyway, now that most installations are for stereo such a solution is less feasible. Instead, the need has been for enclosures to get smaller. So, in recent years, we have seen a conjuring trick—the infinite enclosure presented in boxes small enough to lie on bookshelves!

If an enclosure is complete (sealed) then, since the front and rear radiations can never meet, it may fairly be described as an infinite baffle. There are, naturally, problems. Obviously, the internal air will have resonances—and in the important middle and upper frequencies. But especially, the trapped air will act as a spring, resisting the inward movement of the diaphragm, acting like a stiffened suspension and so raising the bass resonance of the unit.

Reflex principle is employed in Philips GL561 enclosure. Dual-cone 8 in. unit will handle up to 15 watts.

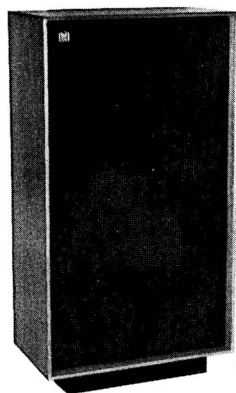
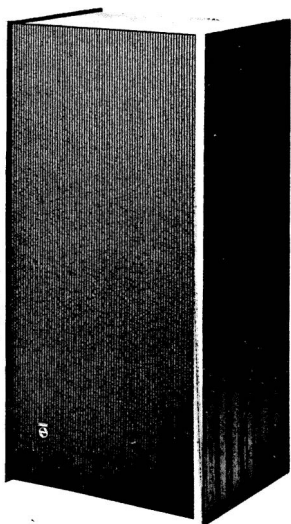

Mordaunt-Short MS400 has three separate drive units for covering bass, middle and treble frequencies.

New materials and techniques have brought the answers. First, separate low and high frequency units can be made with sufficient precision to be small enough to fit together in a little cabinet. The two can be divided from each other (at the rear) and the higher frequencies in particular quite easily absorbed into energy-dissipating plastic foam or the like.

To offset the stiffness of the enclosed air, the bass unit is made with extremely compliant suspension and very low natural resonance (30 Hz or so). To work against the resistance of the air the diaphragm must be stiff and therefore small—but we want a small one, anyway. To do its job at low frequencies a small diaphragm must have high amplitude of movement. This, again, can be achieved by up-to-date methods.

Such speakers do need more power input than larger and 'older' types, but this is no great handicap when generous powers are obtainable from relatively inexpensive, and certainly cheap-to-run, solid-state amplifiers.

From what has been said it will be evident that it is impossible to generalise about the relative merits of the many enclosure designs available. Much depends on the skill of the individual designer or design team and of the competence with which ideas have been put into practice. Also, a great deal depends on the quality of the apparatus as graded on a price basis.

Technical considerations are not the only ones involved—at either production end or purchasing end. For the home, the appearance, size and cost of an enclosure all have to be weighed along with the quality of the sound.

RECORDS

A Basic Collection

By W. A. Chislett

A few years ago I was given the very agreeable commission of selecting the initial classical stock for a very large firm which was about to enter the record business for the first time. I was given an entirely free hand, within the limits only of the very generous sum of money set aside for the purpose. I pointed out at the outset to the firm employing me that it is rare indeed, where there were several versions of the same work, that any one of them could be unhesitatingly ranked as the 'best'. Any great work is capable of more than one valid interpretation, and that they differ does not necessarily make one better than another, although individuals may well have, and are entitled to, their preferences.

Much as we have to be grateful today for the vast quantity and variety of records that are available to us in fine performances and splendid recordings, there is a danger of coming to regard by frequent hearing and familiarity a particular performance as 'right' and others as 'wrong' instead of merely validly different. This is not to say that there are no 'wrong' performances on record. There are, plenty of them. If not there would be little need of the advice offered here.

A record collection, like a library of books, is a very personal thing. Ideally it consists of as comprehensive a collection as funds will permit, specialising in the field or fields of music in which its owner is most interested but including a proportion of outstanding works in other fields, not only for the enjoyment of one's friends but also to prevent the owner of the collection from becoming musically hidebound. My aim therefore is to indicate as many outstanding performances and recordings in as many fields of music as the available space permits, from which readers may select with a view of forming a basic collection to suit their individual tastes. Having made an initial choice, those wanting to increase their collection in this field or that are referred to the booklet '*Recommended Record-*

ings' published by *The Gramophone* at 3s. 6d., which is revised and brought up to date every spring and autumn.

In my selections I have tried to maintain a fair balance between the desirabilities of the performances and the qualities of the sound as such, leaning towards the former when in doubt. I have also not ignored the price factor. Finally I have endeavoured to be as objective as human frailties permit but I have no doubt that some personal predilections have crept in.

The record numbers given are primarily those of stereo recordings. Where the records recommended are available in mono as well, their number is given also, but as is stated elsewhere, stereo records can be played quite safely and satisfactorily on mono equipment if suitable precautions are taken. Where records are only available in mono this is stated.

CONCERTOS AND SYMPHONIES

The first choice of most people is the orchestral music of some part or all of the last two-and-a-half centuries or so, so let us start with Johann Sebastian Bach. Menuhin and the Bath Festival Orchestra give finely sensitive accounts of the six *Brandenburg Concertos* (HMV. ASD327-8) and the four *Orchestral Suites* (HMV. ASD404-5), and of the former there is the cost-saving alternative of the set by Harry Newstone and the Hamburg Chamber Orchestra. The performances are excellent and the sound is good if a degree of top-cut is applied (Saga STXID5031-2).

Of Bach's concertos a happy grouping couples the *Violin Concertos Nos. 1 and 2*, with David Oistrakh both playing the solo parts and directing the Vienna Symphony Orchestra. With them on the same disc is the *Double Concerto* in which Igor Oistrakh is joint soloist with his father, and Eugene Goossens conducts. The last is not quite the equal of the first two

either in playing or recording, but is first class by any other standards (DGG, SLPM138820).

Of Bach's immediate contemporaries Telemann and Vivaldi stand out. To the former a record of *Concertos for Flute and Oboe, Three Violins and Two Horns* respectively played by the Schola Cantorum Basiliensis directed by by Weinzierer is an ideal introduction (Archive SAPM198368) and of Vivaldi's well known *Four Seasons* one of the cheapest is also one of the best recordings. It is that by the Wurtemberg Chamber Orchestra conducted by Jörge Faerber, with Susanne Lauchtenbacher as the violin soloist (Turnabout TV340405).

Bach's son Carl Philipp Emanuel, although neglected today, is a very important link between his father's music and that of the symphonic school headed by Haydn, and four of his strangely powerful *Sinfonias* as played by the English Chamber Orchestra conducted by Raymond Leppard is as near perfection as we have any right to expect (Philips SAL3689).

Of Haydn's Symphonies the choice is rather bewildering. I am inclined to plump for two records which between them combine the familiar with the lesser-known. The first couples the early *No. 22 (The Philosopher)* with the mature *No. 90 in C* played with fine strength and sturdiness by Ansermet and the Suisse Romande Orchestra (Decca SXL6226). The second presents Beecham, a rare Haydn conductor, in his best form with the Royal Philharmonic Orchestra in *No. 101 (The Clock)* and *No. 102 in B flat* (HMV. ASD340). Beecham may have touched up the scores a bit, but if so this is of no moment compared with the superb musicianship of his performances. To add to these the *Cello*

Attractive and protective record sleeves usually include interesting information about the music.



Concerto with Maurice Gendron as soloist and Leppard conducting not only provides a lovely piece but also adds to our list of composers one of Haydn's contemporaries, Luigi Boccherini, whose *Cello Concerto in G* (on the reverse side) is not the one we usually hear, although Grützmacher stole its middle movement for his hotch-potch version of the more familiar work (Philips SAL3636).

Of Mozart's forty-one *Symphonies* we can include four as they are conveniently coupled, a pair from the middle years and two of the last three great works. The former are *No. 29 in A* and *No. 33 in B flat* played by Klemperer and the New Philharmonia Orchestra (Col. SAX5256) and the latter are *Nos. 40 in G minor and 41 (Jupiter)* in which Bruno Walter directs the Columbia Symphony Orchestra (CBS. SBRG 72005). These are two glorious records, and to them I would add *Les Petits Riens* ballet music and that from *Idomeneo* most affectionately played by Willi Boskovsky's Vienna Ensemble (Decca SXL6275).

Of concertos by Mozart there are legion. For piano perhaps the first choice lies between *Nos. 19 in F* and *26 in D* with Haebler as the soloist and Colin Davis conducting (Philips SGL5813) and *Nos. 20 in D minor* and *23 in A* with Barenboim both conducting and playing the solo parts (HMV. ASD2318). The former is much the cheaper. For violin concertos there is no need to look further than *Nos. 1 in B flat* and *4 in D*, gloriously played in classical style by Grumiaux with the London Symphony Orchestra conducted by Colin Davis (Philips SAL3440). There I must leave Mozart for the time being, albeit with regret. There is so much more that could have been included.

Beethoven now looms large, and again I fear I must be rather cheeseparing. Of the nine symphonies perhaps we can contrive to include two. One must obviously be *No. 5 in C minor* and despite the extravagance of occupying two full sides the recommendation must be the electrifying performance by Karajan and the Berlin Philharmonic Orchestra (DGG, SLPM138804). The other is *No. 3 (Eroica)* in which Sir John Barbirolli and the BBC Orchestra are even more desirable than Klemperer in his recording of a few years earlier. No-one in my experience has ever played the *Funeral March* more movingly (HMV. ASD2348).

Of the Piano Concertos I am tempted to pass over the ever-popular *Emperor* in favour of *No. 3 in C minor* and *No. 4 in G* economically coupled together with Arthur Rubinstein as the almost incredible soloist and Leinsdorf conducting. Two such performances on one disc is a bargain indeed (RCA. SB6787). For the

Violin Concerto in D I turn again to Arthur Grumiaux with the New Philharmonia Orchestra conducted by Galliera (**Philips SAL3616**), but I cannot forbear to mention also the excellent performance and recording in which Alfredo Campoli and John Pritchard combine and which can be had for little more than half the price (**HMV. SXLP20043**). Those tempted by a group of Beethoven's Overtures are referred to half a dozen directed by Klemperer (**Col. SAX2570**) or the imaginative coupling of the four which are associated with the opera *Fidelio* brilliantly played by Maazel and the Israel Philharmonic Orchestra (**Decca SXL6025**).

Of Schubert's great *Symphony in C* there is Karl Böhm's wonderful performance with the Berlin Orchestra (**DGG. SLP138877**); and a very good substitute at little more than half the price is that by Krips and the London Symphony Orchestra (**Decca SDD153**). The other essential Schubert Symphony is the *Unfinished*, and it is very economical to be able to have with it the delightful *No. 5 in B flat* in a caressing and beautifully played performance by Böhm and the Berlin Orchestra (**DGG. SLP139162**).

An equally economical and satisfying coupling is that of Mendelssohn's *Scotch* and *Italian* Symphonies, both in first rate performances by Abbada and the London Symphony Orchestra and recordings that despite their length do not deteriorate towards the centre (**Decca SXL6363**). Alternatively the former is available coupled with the *Hebrides Overture* with Maag in charge at a price which more than balances the shorter playing time (**Decca SDD145**).

Another marvel of compression is a coupling of the Mendelssohn and Tchaikovsky Violin *Concertos* in brilliant performances by Stern and the Philadelphia Orchestra conducted by Ormandy (**CBS. SBRG72083**). Those who feel that they would like more romance in the Mendelssohn concerto are referred to Campoli and Boulton, who couple it with the *Scottish Fantasia* of Max Bruch. Again the lower price compensates for the shorter playing time (**Decca SDD110**).

Schumann's most popular work is probably the *Piano Concerto*, and despite being dubbed from 78s of 20 or more years ago Lipatti's performance with Karajan and the Philharmonia Orchestra is still my favourite, and the sound is surprisingly good as such. Moreover it has the advantage of being coupled with the Grieg *Piano Concerto* by the same artists and in an almost equally lovely performance. It is a rare bargain (**HMV. XLP30072**, mono only). Another record on the same modest-price label couples Schumann's *Symphonies Nos. 3 and 4*, with Cantelli conducting (**HMV. XLP30030**,



Records are high precision products that should be handled and stored with great care.

mono only), but many will consider that Solti's Viennese recording of the same pair of symphonies to be worth the extra cost (**Decca LXT6536** mono; **SXL6536** stereo). Of Grieg's other music a coupling of the two *Peer Gynt* suites and the four *Symphonic Dances* with Susskind conducting stands out (**HMV. SXLP 30105**).

When we think of Berlioz today the first name that comes to mind is Colin Davis, and he conducts memorable performances of the *Symphonie Fantastique* (**Philips SAL3441**) and a group of five overtures (**Philips SAL3573**). The first choice for Brahms might well be the highly economical coupling of the *Symphony No. 3* and the *St. Anthony Variations* in which Sir John Barbirolli secures some heavenly playing from the Vienna Philharmonic Orchestra (**HMV. ASD2432**). Another economical and eminently sensible coupling is that of the two Liszt *Piano Concertos* with Richter as the soloist and Kondrashin conducting (**Philips SABL207**).

Of the Dvorák symphonies the obvious first choice is the *New World*, of which there are numerous excellent versions, but my own first choice is the *Symphony in G* (No. 8, but for long known as No. 4) for its airy freshness and the beautiful performance directed by Kertesz (**Decca SXL6044**). It also offers the bonus of a brilliant performance of the *Scherzo Capriccioso*. A Rachmaninov *Piano Concerto* is a 'must', and let it be *No. 2*, with John Ogdon as the soloist, which also includes a group of the same composer's *Preludes* for piano solo (**HMV. ASD492**). For Sibelius I am inclined to choose a group of shorter pieces rather than a symphony.

Five of these are played by Barbirolli and the Halle Orchestra (HMV. ASD2272).

There are countless versions of the three best known symphonies of Tchaikovsky, but whether one's preference be for *No. 4*, *No. 5* or *No. 6* there is no need to look further than those by Karajan and the Berlin Philharmonic Orchestra (DGG. SLP13097, 13098 and 13892 respectively). For the *Piano Concerto No. 1* the choice is that of John Ogdon in partnership with Barbirolli, not only for the combined qualities of playing and recording but also because they contrive to include also Franck's *Symphonic Variations* (HMV. ASD542).

For the Russian nationalist composers of the later nineteenth century I plump for a record in which Glinka, Mussorgsky and Borodin are all heard in an exciting performance directed by Solti (Decca SXL6263). I must be similarly cheeseparing about Debussy and Ravel and be satisfied with a record which couples the former's *L'Après-midi d'un Faune* and *La Mer* with the latter's second *Daphnis et Chloe suite* with Karajan in charge (DGG. SLP138923).

On similar economical lines Richard Strauss's *Don Juan* and *Tod und Verklärung* played by Maazel and the Vienna Orchestra are to be had on one disc (Decca SXL6134). Of Mahler's symphonies the best-loved is *No. 4* and choice lies between records directed by Szell (Col. SAX5283) and Kletski (HMV. SXP30054). The latter is considerably the cheaper.

A great renaissance of English music was led by Elgar, Holst and Vaughan Williams. For the first my choice is Sir Adrian Boult in the *Symphony No. 2* (Lyrita SRC540) and the *Violin Concerto* with Menuhin as the soloist (HMV. ASD2259). For the second I suggest Barbirolli in the *London Symphony* (HMV. ASD2360) and Prévín in the *Symphonies Nos. 6 and 8* (RCA. SB6767) and Holst's *Planets* is given the performance of its life by Boult (HMV. ASD2301). There I had perhaps better leave the orchestra, without venturing into the field of twentieth century music in general.

OPERATIC WORKS

Next comes opera, both complete works and excerpts. Pride of place must go to the complete 'Ring' of Wagner, on twenty-two superb records directed by Solti, both for quality and the sheer magnitude of the undertaking (Decca RING22). Fortunately each of the four music dramas which constitute *The Ring* can be had separately, and on balance perhaps the first choice should be *Die Walküre* (SET312-6). If this is too much there is a single LP of excerpts from it (SET390). Of other complete works by Wagner, high on the list are Solti's *Tristan und Isolde* (Decca

SET204-8) and Klemperer's *Flying Dutchman* (Angel SAN207-9). And we must not forget, for those who merely want purple patches in orchestral form, Klemperer's two-disc album of the best-known excerpts (Col. SAX2347-8).

Coming to Mozart, the first choice for most people will vary between the three best-known operas, *Don Giovanni*, *The Marriage of Figaro* and *The Magic Flute*. Safe recommendations I think are the Klemperer recording of the last (Angel AN137-9 mono; SAN137-9 stereo); and Giulini's of the second (Col. 33CX1732-5 mono; SAX2381-4 stereo) and first (Col. 33CX1717-20 mono; SAX2369-72 stereo). Sutherland is the heroine in *Don Giovanni* and the delicious Schwarzkopf in the other two. For those content with less there is a single disc of highlights from this recording of *The Magic Flute* (HMV. ALP2314 mono; ASD2314 stereo). And for those who want a selection of Mozart Overtures of these three and other operas, all superbly played under Klemperer, they are to be had on one disc (Col. SAX2587).

Continuing with German opera, although there are two complete recordings of Richard Strauss's *Der Rosenkavalier* I have an idea that we may be about due for another, but those to whom Hi-Fi for its own sake is not essential should not overlook a dubbing onto two LPs of an abridged version first issued on thirteen 78s. There has never been a greater Marschallin than Lotte Lehmann, and with her are Elizabeth Schumann, Marie Olszewska and Richard Mayr, a marvellous cast (HMV. COLH110-11). Of modern recordings of other operas, two which stand out are *Salome* (Decca MET228-9 mono;

Records make available in the home the pick of the world's finest artists and music.



SET228-9 stereo) and *Elektra* (Decca MET354-5 mono; SET354-5 stereo) both brilliantly directed by Solti, with the glorious Nilsson in both casts.

Turning to Italian opera, both Verdi and Puccini are very generously represented in the catalogues. Among the best of the former are Solti's *Don Carlos* (Decca MET305-8 mono; SET305-8 stereo), the Bernstein *Falstaff* (CBS. SBRG72493-5), the Kubelik *Rigoletto* (DGG. SLPM138931-3) and the Prêtre *La Traviata* (RCA. RES5564-6 mono; SER5564 stereo). First choice of Puccini could well be the famous Beecham *La Bohème*, a wonderful performance and still very good sound despite its age (HMV. ALP1409-10 mono only) or Barbirolli's most affectionate *Madame Butterfly* (HMV. ASD 373-5). Los Angeles heads both casts.

Rossini's *The Barber of Seville* with Gui conducting (Angel SAN114-6) and the quite uproarious *L'Italiana in Algeri* with Varviso conducting (Decca SET262-4) are not likely to be improved upon for a long time, and for those wanting a selection of his sparkling overtures Gamba conducts the London Symphony Orchestra in five of the best (Decca LXT2266 mono; SXL2266 stereo).

We must include an opera by Bellini and one by Donizetti. For the former *Norma* is suggested, with either Callas (Col.33CX1766-8 mono; SAX2412-4 stereo) or Sutherland (RCA. RE 5524-6 mono; SER5524-6 stereo) in the name role, and for the latter there could be nothing better than the lively *Daughter of the Regiment*, another winner for Sutherland (Decca MET 373-4 mono; SET373-4 stereo). France and England may well be represented respectively by Gounod's *Faust* with Cluytens in charge (HMV. ASD307-10) and Britten's *Peter Grimes* conducted by the composer (Decca LXT2150-2 mono; SXL2150-2 stereo).

Of operatic recitals there are legion, and one must be guided primarily I think by the singers of one's choice; but on no account should the dubbings from old 78s in HMV's *Golden Voice* and *Great Recordings of the Century* and other similar series be overlooked. Vocally many of these are superb, though the accompaniments may be a bit thin.

GERMAN LIEDER

The choice of German lieder is also vast. Of the singers, Fischer-Dieskau and Elizabeth Schwarzkopf are outstanding, and their joint two-disc album in honour of and made with Gerald Moore, supreme accompaniment, is a treasure beyond compare (Angel SAN182-3). Taking the most important composers, a very good start would be Fischer-Dieskau in Schubert (HMV. ALP2273 mono; ASD2273 stereo),



Choice of recorded music is almost limitless and every taste is catered for, whether high or low brow.

Schumann (DGG. SLPM139110) and Brahms (DGG. SLPM138011) and Schwarzkopf in songs by Richard Strauss (Col. CX5258 mono; SAX5258 stereo) and Hugo Wolf (Col. SAX 2589). But there are many others, by other singers as well as these and including mixed recitals that are equally desirable.

German lieder should not be allowed to dominate a song collection, as is the tendency. Souzay's recital of Duparc's songs is a treasure (Philips SAL3434), as is his recital of songs by other French composers (Philips SAL3480). Similarly Victoria de los Angeles is inimitable in a collection of Andalusian songs (Angel SAN194), while English songs sung by Janet Baker (Saga STXID6213) and John Shirley-Quirk (Saga STXID5211) are incredible bargains at 14s. 6d. each. Those with a penchant for the romantic and passionate songs of Naples need look no further than an anthology of established favourites sung by Giuseppe di Stefano (Decca LXT6176 mono; SXL6176 stereo).

CHORAL MUSIC

Choral music is very much in the English musical tradition. Starting with Bach, there are the *Mass in B minor* with Klemperer conducting (Angel SAN195-7) and the *St. Matthew Passion* under Munchinger (Decca MET288-91 mono; SET288-91 stereo). Of the latter the much older, and cheaper, recording with Reginald Jacques conducting should be remembered, if only for the rare beauty of Kathleen Ferrier's singing (Decca ACL109-11 mono only). Of Haydn's *Masses*, that known as the *Nelson Mass*

directed by David Willcocks would be an excellent first choice (**Argo RG325** mono; **ZRG5325** stereo); as would the Colin Davis version of Mozart's *Requiem* (**Philips SAL3649**).

Two versions of Beethoven's mighty *Mass in D* compete for first place. They are those by Klemperer (**Angel SAN165-6**) and Karajan (**DGG. SLPM139208-9**). To Berlioz's sensitive *L'Enfance du Christ* in the version by Cluytens (**Angel SAN170-1**) I would add the magnificent *Te Deum* of which Colin Davis gives a quite magnificent account (**Philips SAL3724**). Coming to today, Britten has given his own authoritative account of the *War Requiem*, a work which the British public somewhat surprisingly took to its heart immediately (**Decca MET252-3** mono; **SET252-3** stereo).

Of the great choral composers this still leaves Mendelssohn and Handel. Of the latter's *Messiah* my choice would be the Colin Davis recording, either complete (**Philips SAL3584-6**) or in highlights form (**Philips SAL3623**). Mendelssohn's *Elijah* has never been better presented, either on record or in the flesh, than in the recording conducted by the Spanish composer De Burgos (**Angel SAN210-12**).

INSTRUMENTAL RECORDINGS

The piano is the favourite solo instrument and probably today the organ and the guitar come next. The piano composer supreme is Chopin, and I assert unequivocally that one simply cannot go wrong with any of his records played by veteran Artur Schnabel. Probably the *Waltzes* and *Nocturnes* are the best loved, so let these be the first choices (**RCA. SB6600** and **SB6731-2** respectively). Liszt may be represented either by the *Sonata in B minor* and three shorter pieces played by Curzon (**Decca LXT6067** mono; **SXL6067** stereo) or six shorter pieces of his last and best years played by John Ogdon (**HMV. ASD2283**). Three of Beethoven's piano sonatas on one disc is generous measure indeed, but it is to be had, and in magnificent performances by Barenboim. They are the *Moonlight*, *Appassionata* and *Pathétique* (**HMV. HQS1076**). Schubert's Sonatas present some difficulties because so many excellent records have been deleted from the catalogues in recent times. A safe choice, however, is Emil Gilels in the *Sonatas Nos. 14 and 17* (**RCA SB6668**) and as we must have something by Brahms add to this the brilliant *Handel* and *Paganini Variations* played by Katchen (**Decca LXT6218** mono; **SXL6218** stereo).

For organ perhaps we can find room for three records. My first is a group of Bach's *Choral Preludes* played by John Webster on the beautiful little organ of University College,

Oxford (**HMV. HQM1116** mono; **HQS1116** stereo); and the second is a group of Bach's larger scale works played by Helmut Walcha (**Archive SAPM198304**). To represent the later and more romantic school of organ composers, add to these works of Cesar Franck and others played by Simon Preston (**Argo RG339** mono; **ZRG5339** stereo).

Three had also better be the number of selected guitar records, to enable us to savour the artistry of three of its greatest living exponents in agreeably mixed programmes. They are Andre Segovia (**MCA. MUCS106**), the sound of whose playing is a little marred by close recording, which magnifies the mechanical noises inseparable from the guitar, Julian Bream (**RCA RB16281** mono; **SB2150** stereo) and John Williams (**CBS. SBRG72339**). The last two are almost entirely free from these undesirable mechanical noises.

CHAMBER MUSIC

Now comes the vexed question of chamber music. Despite being the Cinderella of music with most record buyers the choice is immense, and it is a form of music which records exceptionally well. The best thing to do I think for present purposes is to be content with a selection of music which is so attractive at first hearing that it may encourage listeners to explore further in a field that is sadly neglected. So here goes: the Schubert *Octet* played by the Melos Ensemble heads the list (**HMV. ASD2417**); and then follow Mozart's *Clarinet Quintet*, played by members of Willi Boskovsky's Vienna Octet and coupled with a charming *Divertimento* (**Decca LXT6087** mono; **SXL6087** stereo); and Franck's *Piano Quintet* in which Clifford Curzon is joined by members of the Vienna Philharmonic Orchestra (**Decca LXT5640** mono; **SXL2278** stereo).

High in the list of string quartets are the *Op.18, Nos. 5 and 6* by Beethoven, and Haydn's *Op.77, Nos. 1 and 2* played by the Amadeus Quartet (**DGG. SLPM13890**). All are calculated to whet the appetite. For piano trios there could be nothing better than that by Schubert in *B flat*. A modern recording of excellent quality by the Suk Trio can be had at a bargain price, but despite its age my first choice is still the famous recording by Casals, Cortot and Thibaud for the glorious spontaneity of their playing (**HMV. COLH12** mono only).

That in this list there are sins of omission I am very conscious. It could not be otherwise when discussing an almost limitless subject in limited space. But I can claim with complete confidence that no record unworthy of any collection, basic or otherwise, has been included.

THE CARE AND STORAGE OF RECORDS

By A. C. Williams

When the first LP records were issued 19 years ago, and for a long time after, the manufacturers made the great mistake of stressing their indestructibility. That they are virtually indestructible is quite true, but they are easily damaged, far more easily in fact than were the old shellac 78s, although the latter were all too easy to break.

I had a salutary lesson when I allowed one of my first LPs to slip from my fingers. Having been brought up on 78s I instinctively made a grab and succeeded in catching it before it reached the floor. But in doing so I scarred the surface with my finger nails, with fatal results. Had I let it fall no damage would have been done, whereas a 78 would most probably have broken. On the other hand my nails would have done little if any damage to the surface of a 78.

We are, I think, still paying for this image of indestructibility. I am often appalled by seeing expensive records left lying about on floors and chairs for the baby to bite and the cat to sit on. Few precision made objects are as ill treated by so many people.

RECORD WEAR

The greatest enemy of the LP is dust. When it leaves the factory it is usually meticulously clean and it is housed in a polythene inner sleeve, which is virtually dust proof, and a stouter outer sleeve, and for the rest of its life it should be so kept except when actually being played. Unfortunately when most records leave the factory they are also quite highly charged with what is usually called static, a condition which seems to be inherent in the material of which they are made and which tends to increase rather than decrease with playing unless effective counter measures are taken. The discovery of a suitable permanently static free material seems so far to have defied the wit of man.

The effect of static is to attract and hold dust

much as a magnet attracts and holds iron filings. A dusty record quickly becomes a damaged record, and the damage is audible. Dust is an abrasive, and it can literally be ground permanently into the surface of a record. This is particularly the case if the weight of the stylus on the disc is too great, when the friction between stylus and record surface can raise the stylus tip to a temperature high enough to melt the surface of the record, even although this may be maintained only for a fraction of a second, so that any dust that is present is permanently welded into the record surface.

In the proper care of records, therefore, the first requisite is to keep them meticulously clean, and even the ideal of removing any dust both before and after playing is really very little trouble. To do so quickly becomes as instinctive and automatic a habit as changing gear in a car. There are many proprietary products on the market for which greater or lesser claims are made and some manufacturers advise no more than a light circular wiping of the record surface with a soft and slightly damp cloth.

Of the proprietary products the best known are the Dust Bug invented by the late Cecil Watts and his later Preener, both of which I have found eminently satisfactory if used strictly in accordance with the maker's instructions. Each is entitled to his or her own ideas as to what is simplest and most effective. All that matters is that when a record is played it should be free from any dust that might abrade or be ground into the surface. I myself have found that after treatment with a Preener nothing else is necessary for some time other than the habitual use of a Dust Bug, provided that after playing the record it is promptly replaced in its inner and outer sleeves.

Not only is there danger from static. There is also danger from mishandling. Records should always be handled by their groove-free rims and

centre labels. However dry one's hands may seem to be, fingers are always greasy to some extent, and there should be no finger marks on the record surface. If there are they will surely retain any dust there may be. Incidentally, it is also good practice to have handy a small brush with which to remove the fluff and other debris that tends to accumulate on the stylus, and which affects the quality of the sound and may even cause unnecessary wear. A child's cheap paint brush is admirable for this purpose.

WEAR FROM PICKUP

Another major cause of wear is an unsuitable pickup. This can cause wear in several ways. Bad tracking is the cause of rapid wear. There is little one can do about this, but even the cheapest of modern players are better in this respect than

Two popular Record Housing units. Top, Fiesta cabinet will hold approximately 150 records. Bottom, Foldaway cabinet with sliding doors and space for up to 225 records.

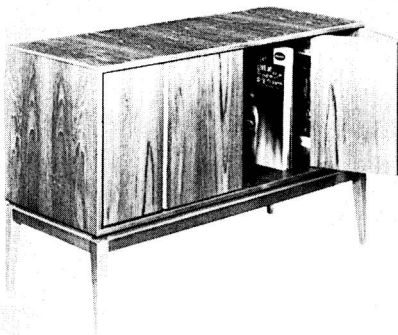
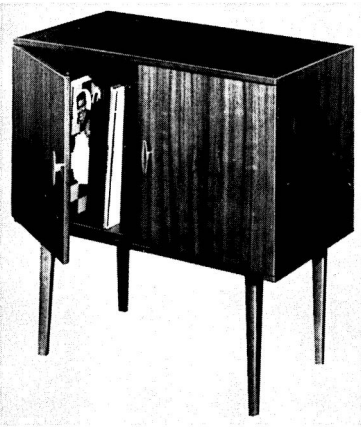

they were at one time. Next there is the question of the weight on the stylus point. The effect of too great a weight is obvious. The nearer one can get to, say, a desirable 2 grammes the better. With many pickup arms weight adjustment is a simple matter, either for a dealer or the owner himself. Weighing devices can be bought very cheaply and they are a very good investment.

Then there is the actual design of the pickup cartridge. One often reads on record sleeves that stereo records can be used on mono equipment safely and satisfactorily, but without stereo effect, if a suitable cartridge wired for mono reproduction is used. This is perfectly true, but a novice is advised to consult a knowledgeable dealer as to the suitability of his cartridge and as to any adjustments to it that may be desirable. Even the neophyte can hardly fail to realise that by their very nature stereo records need extra care, but this is neither the time nor place to go into the abstruse technicalities as to why this is so.

Still on the subject of pickups, manufacturers caused a good deal of misapprehension when in the early days of LPs they used words such as 'permanent' to describe the stylus which they used. Not even a diamond is 'permanent', but it will last a very long time fitted to good equipment and used on clean records. A sapphire is much less 'permanent'. Indeed its life is so short that now diamonds are so much cheaper than they were I would go so far as to say that the best thing anyone with a sapphire stylus can do is to scrap it immediately in favour of a diamond of suitable size.

Yet another frequent cause of damage is the careless placing of the stylus on the record. It should be placed gently on the record surface, taking advantage of the blank run-in grooves with which most records are furnished at the beginning of each side. A greater problem arises when wanting to play a piece in the middle of a record. Some of the blank dividing bands are very narrow and it is far from easy to place the stylus there with precision, and it is well to remember that a 'dig' in the surface which would affect a mere couple of grooves or so in a 78 will affect far more grooves on an LP. For those whose hands are not very steady one of the devices designed to drop the stylus gently and with precision just where it is required is an excellent investment.

RECORD STORAGE

This brings me to another aspect of record care, that of storage. This too is of far more importance than is often realised. Here it is perhaps a question of what should be avoided rather than precisely what should be done. The

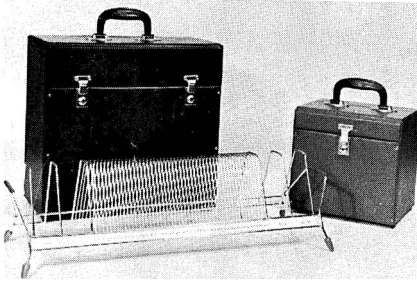

Philips record accessories include a wide range of portable carrying cases and storage racks.

thing to avoid above all else is stacking records one on top of another, in piles. Not only is the plastic material of which LPs are made so soft that groove edges are easily squashed, with disastrous results, but records are easily warped, with less permanently disastrous but very undesirable results.

For once convenience and economy go hand in hand. The best way to store records is book-wise on their edge, and placed so closely together that each exerts a degree of side pressure on its neighbours, but not so much as to make withdrawal difficult, to prevent risk of warpage. There is no need for anything elaborate. A simple shelf or shelves is all that is necessary. These may be subdivided by straight-sided uprights at reasonable intervals to maintain side pressure when each section is filled.

There will always be, of course, a section that is not filled, and to maintain the desirable side pressure something will be needed for this. A handful of the cardboard squares with which records are commonly packed will serve admirably, and if not enough are available to fill the vacant space the surplus can be filled with books, on the opposite side of the squares to the records. A useful gadget for those without dividing uprights every few inches is a heavy block of wood in the shape of a right-angled triangle cube, with the supporting face twelve inches square and a base of about six inches.

This will maintain sufficient pressure to prevent warpage.

How best to arrange a record collection for ready reference is really outside the scope of these notes, but for a small collection, as details of records are now almost invariably printed on the spines of the outer sleeves, grouping under such headings as orchestral, opera, light music and so on is normally sufficient. For larger libraries the simplest satisfactory way is to add records seriatim as they are acquired regardless of content, give each a number and maintain a catalogue, either in book or card index form, and list them under composers or as best suits the taste of the owner of the collection.

STORING TAPES

Finally a few words about tapes, which now seem to be making substantial progress, although less quickly than was thought likely at one time. As with discs, storage on edge of shelves is easy and economical. Tapes are less susceptible to damage than discs, but even so they should not be treated carelessly or left lying about. The two main things to guard against are excessive heat and stray magnetic fields. Many a tape has been spoiled if not ruined by being put on a shelf over a radiator, or even being left on a car shelf in full sunlight. I also know of a man who wondered what had happened to one of his tapes until he found that for some reason his wife had stood the telephone on the box containing it. So, keep tapes away from such things as mains transformers, loudspeakers and the like. A few inches away is enough. And keep them in a reasonable temperature.

There is always some danger of through-print, although this tends to be exaggerated. None the less it is very good practice to store tapes with the leader in the centre, so that the first operation is always to spool the tape to get it into playing position. Finally, the periodical cleaning of the tape head should not be neglected, and for this the Bib tape cleaning kit is admirable and reasonably priced.

TAPE RECORDERS AND RECORDING

By H. W. Hellyer

Valdemar Poulsen began it all with his Telegraphone, which he showed in his native Copenhagen in 1898. This recorder used steel wire originally, with a purely acoustic amplifier. Later, Poulsen employed flat steel tape, and in 1920, taking advantage of Lee de Forest's invention of the triode valve in one of its first applications, the American Telegraphone Company brought out a commercial version, using Poulsen's ideas but reverting to steel wire again and recording for 30 minutes at a speed of 7 ft per second.

The first real tape recorder, very similar in principle to modern machines, was the A.E.G. Magnetophone, introduced at the German Radio Fair of 1935. Pflueger's patent of seven years earlier specified paper tape with a metal oxide coating.

Good example of modern styling and advanced technical design seen in the Bang and Olufsen 2,000K stereo tape unit.

Tape developments went on apace in those years and, surprisingly, Japan was not idle. Tape oxide patents were published by Kato and Takei as long ago as 1933. But developments were slow, and the AC bias innovation of Carpenter and Carlson, back in the U.S.A. was not fully exploited until better materials were available. Braunmühl and Weber patented a system for applying bias to oxide-coated tape in 1940, and this, allied to the use of the ring-type recording head in 1940, was a stepping stone to modernity.

After World War II, taking advantage of Germany's work on the Magnetophone, the Tonschreiber and both wire and paper tape techniques, America applied her business capability to the research and soon came up with coated plastic tapes. Dr. W. W. Wetzel and C. Hegdal of Minnesota Mining and Manufacturing Co., supposedly working on tapes for packaging, developed a sideline of magnetic tape, modifying an old Brush steel-tape recorder and demonstrating an amazing increase in



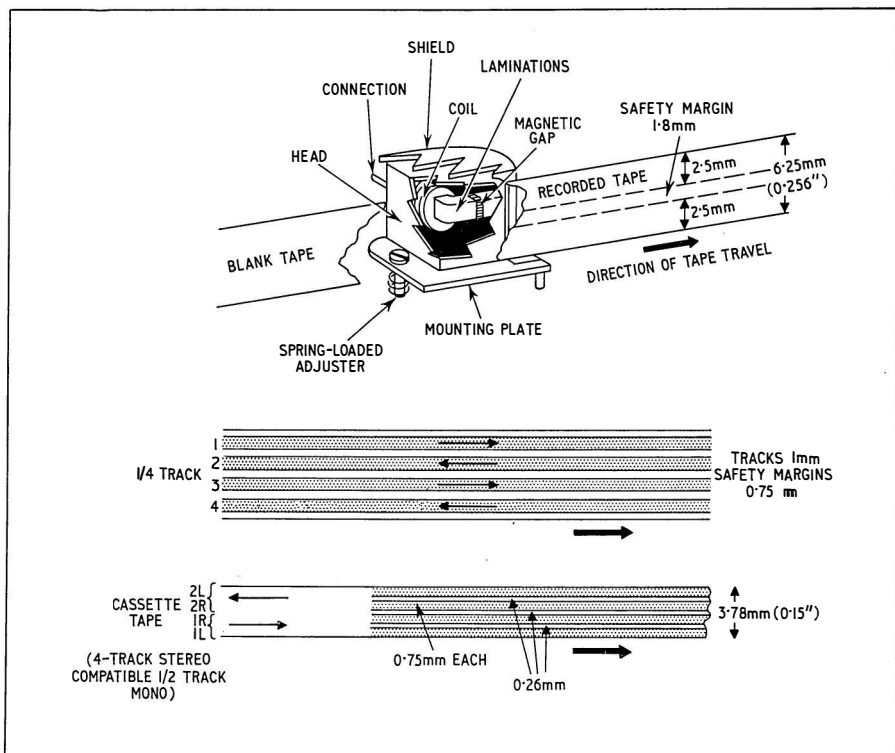

Fig. 1. Tape and track dimensions. Upper view shows head cut away to reveal construction of typical ring-type half-track head. The front gap will be filled with a non-magnetic shim and for this kind of playback head may be only 5/10,000 inch wide.

Stacked heads, with windings above each other, are used for four-track and for stereo recording and replay. The alternate tracks on the tape then form the stereo pairs in reel-to-reel recorders, but in the accepted cassette design (Philips), to retain half and quarter-track, mono and stereo compatibility, the adjacent tracks form the stereo pairs.

frequency response and an improved signal-to-noise ratio.

Collectors of historic curiosities will be well aware of Edison's first recorded words on his wax cylinder of 1877: 'Mary had a little lamb.' Tape recording has its curio, too. The first practical demonstration by the 3M engineers was of a song entitled: 'Who put the overalls in Mrs. Murphy's chowder?'

TAPE SPEEDS

Recording standards for tape have evolved painfully. Originally tape speeds had to be high to achieve a reasonable frequency response, and 30 in. per second became something of a standard. Subsequent improvements to tapes and heads have enabled the speed to be reduced, so we now find sub-multiples of this early recording speed, with 15 in. per second still demanded by quality-conscious enthusiasts, who do not mind expenditure on tape. 7½ in. per second is the 'fast' speed on most semi-professional machines, and 3¾ in. per second has been recognised for a few years as a reasonable compromise between tape length (playing time) and frequency response.

Most machines prior to the cassette revolution were constructed to run at 3¾ i.p.s. Halve this again, and we have the 1⅞ i.p.s. speed used widely for speech. Some tape recorders have gone one better and halved this for an additional gimmick speed of ⅞ i.p.s., but the advent of cassettes has now stabilised the lower tape speed at around 2 in. per second. Recent developments in tape quality auger well for future response figures and a low noise level

Top: Chassis view of Grundig TK340 four-track stereo tape recorder. Circuit employs six valves and 12 transistors. Output is 8W per channel.

Bottom: Neat design is feature of Uher tape recorders. Seen here is the 4,000 Report L model with top plate removed. Pencil indicates the unusual but effective spool carrier braking arrangement.

even at this slow speed, provided that mechanical drawbacks can be overcome to reduce wow and flutter.

But even this is not the slowest speed used. The Ranger 9 spacecraft, which notched up another tape 'first' with the moonshot, had a machine that worked at 1/100 in. per second. Camera pictures were converted to digital 'bits' at the rate of 8.33 per second, and transmitted

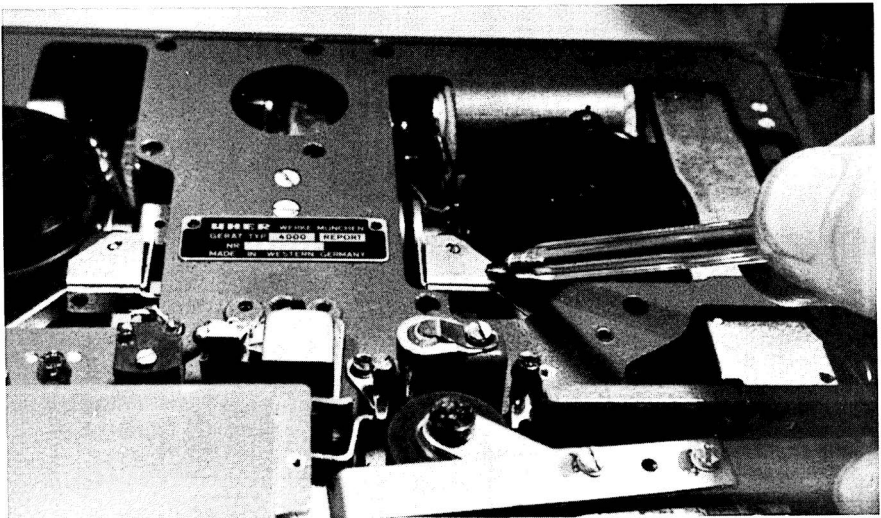
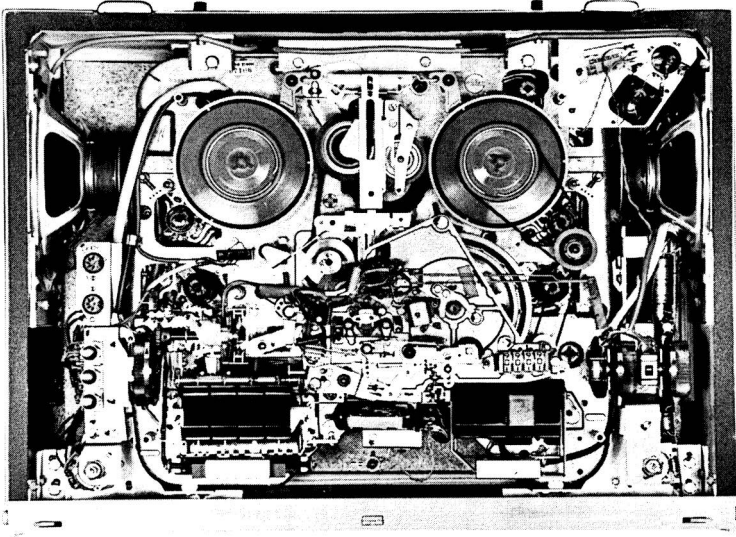

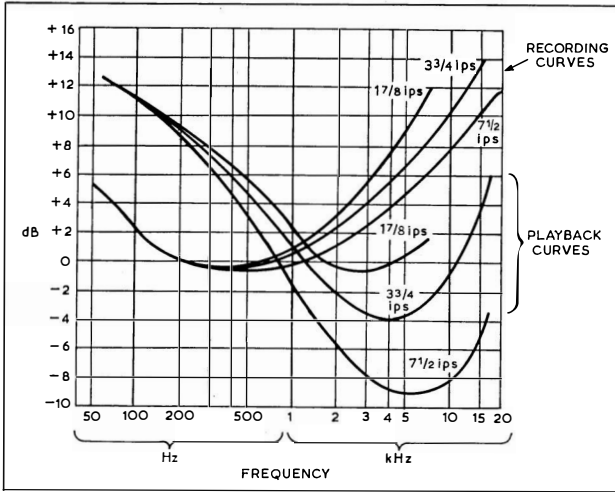

Fig. 2. Recording and Playback compensation curves which correct for non-linearity in the process of magnetic recording, and allow for differences due to change of speed and unavoidable losses.

to earth for reassembly. The Mariner 4 space- shot to Mars, a mere 150 million miles away, transmitted pictures via tape at 2 bits per second. Its 330 ft tape took 8 hours 20 minutes for each picture—surely the record for long exposures?

RECORDING TECHNIQUES

Tape recording techniques have advanced tremendously since the early days, but the same basic principles are in use. Briefly, the system depends on two magnetic factors, one 'hard' and the other 'soft'. They are (1) the ability of a tape to accept and retain a magnetic pattern: that is its remanence, measured in Gauss, which allows it to accept magnetic induction, and its coercivity, measured in Oersteds, which allows it to retain it until required for replay; and (2) the ability of the recording and replay head to accept a rapidly changing recording current (or, on replay, a rapidly changing flux) without this same retention. So the tape is magnetically hard while the heads are magnetically soft.

The head is constructed so that there is a 'gap' at the face, across which the tape runs. Magnetic flux concentrates at the gap of the recording head and patterns are induced in the tape oxide. When these pass across the face of a replay head, the varying patterns induce minute currents in the windings, which are amplified and processed to reappear as the original signals.

Erasure is obtained (on all but the cheapest machines, which use a small permanent magnet) by 'wiping' the tape with a rapidly varying flux applied by a special erase head. The high power needed for this operation is supplied by an oscillator, from which the supersonic bias

needed to obtain distortion-free recordings is also derived.

HF, or supersonic, bias is carefully chosen to match the characteristics of the tape oxide, and should, ideally, be reset for each change of tape. In practice, an optimum setting of frequency and amplitude is generally determined by the manu-

Close-up of Bang and Olufsen 2,000K control panel showing how pushbutton operation provides versatility and neatness.

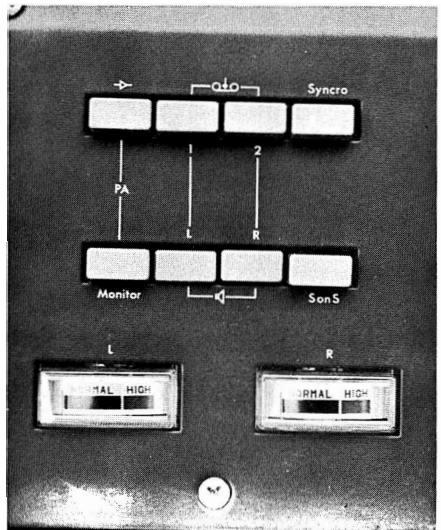

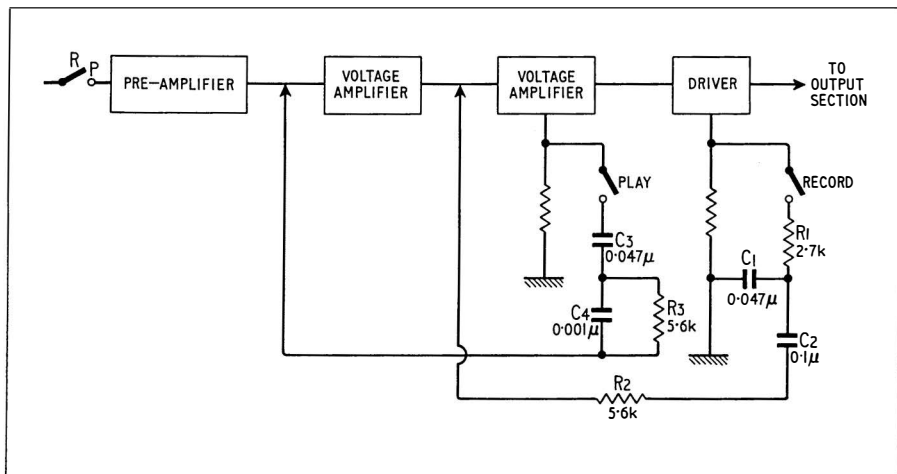

Fig. 3. Equalisation (see Fig. 2) is achieved by a frequency-conscious feedback system in most tape recorders. Typical of the basic design for a single-speed machine is this block diagram of the first Philips cassetted portable. R1, C1 form a frequency-selective potential divider. The higher the frequency, the less the feedback, giving some top emphasis. A little bass boost is introduced by C2 and R2 flattens the peaks. This network applies during recording.

During replay, C3 with C4/R3 form the loop and the lower the frequency the less the feedback, giving treble attenuation, as shown in the curves of fig. 2. Basic slope of the treble reduction curve is 6dB per octave, but this is modified by head characteristics, losses, etc.

factorer to suit the tape sold with the machine. It is not merely commercial acumen that causes a tape recorder maker to recommend a specific brand of tape.

Usual practice is for the bias to be combined with the signal at the recording head, but several forms, notably Akai and Tandberg, use separate bias heads placed nearly opposite the recording head, on the opposite, i.e. polished, side of the tape. Crossfield recording, X-heads, or back-bias are the terms one finds referring to this technique, which is aimed at improving the noise and distortion figure of the machine.

Because conversion from magnetic to electrical energy, or vice versa, is not a linear function, different frequencies being transduced by different amounts, correction is applied in the amplifying circuits, making a tape recorder amplifier a very special piece of design. This 'tailoring' of

the signal is called pre-emphasis during recording, and equalisation during replay.

Frequency compensation for head losses and to allow for the fact that the impedance of the head increases as the frequency rises makes pre-emphasis necessary, although many cheaper machines dispense with this refinement. Equalisation compensates for the rising output as frequency increases when a tape is replayed. The losses and their compensation depend on a number of variables, including the type of head used, the HF bias, the tape and the speed at which it is played.

High frequency response depends upon the alignment of the recording and playback heads, among many other factors. Provision is always made for this azimuth alignment and the position of the head is critical. It is quite easily determined, even without the aid of instruments, by replaying a white noise test tape and aligning for maximum sound, although greater exactitude will be possible if the output from the replay amplifier is measured.

TYPES OF RECORDER

A rapid glance through the pages of this Yearbook will soon reveal, that there are many variations on the basic tape recorder, with many facilities that extend its scope and widen its application. Most machines will have inputs suitable for microphone and radio, diode, gramophone or high impedance sources. Often these can be mixed, by the use of separate gain controls. If not, an external mixer will be needed, and some of the popular models will also be found in the accompanying pages.

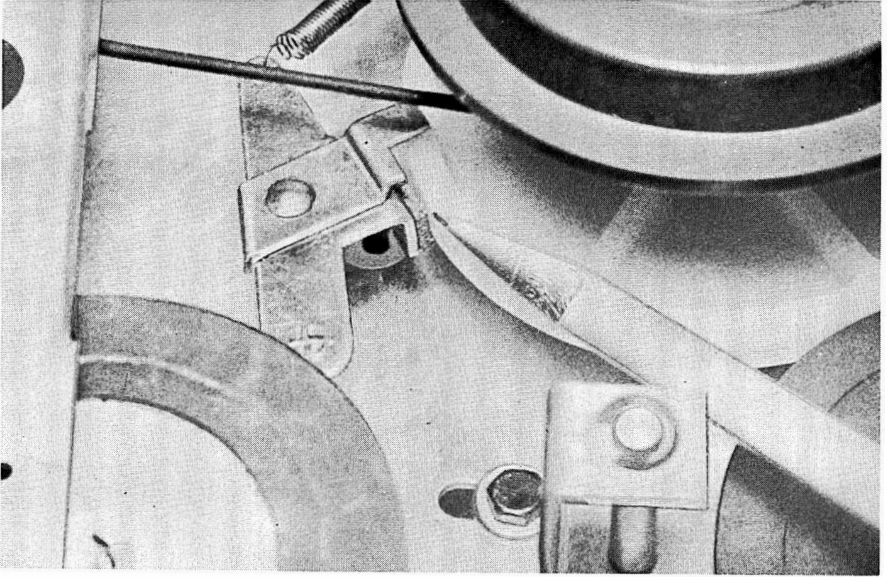

Above: Smooth and efficient braking of tape carriers plays a vital part in the satisfactory operation of a tape deck. The Magnavox 363, used in many well-known British machines, employs cork brake pads on pivotted brackets.

Below: Tape heads and guides on Ferrograph recorder being cleaned and polished. Regular maintenance is essential if a recorder is to give its optimum performance.

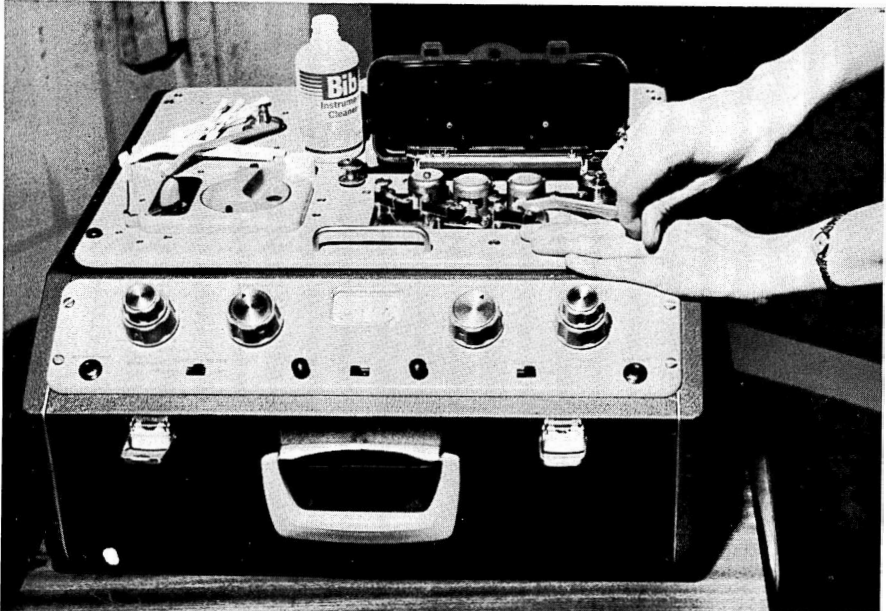

One of the problems in matching inputs is the provision of correct leads and terminations. Some standards exist, and practices are hardening into standards, and one or two enterprising companies can now supply leads, plugs and adaptors that will couple practically any known combination of plug and socket, as well as many varying impedances and levels.

At the output end we find other regular facilities. It is normal for a high impedance output to be provided to enable the user to couple his tape recorder directly to a high fidelity amplifier or to another tape recorder. In the better class machines, a low impedance output, from a cathode follower or its transistorised equivalent, will provide a standard output at 'line' level, permitting the use of long cables without the bugbear of hum and noise.

Many tape decks are now available with this facility, thus dispensing with the output stages and designed to be combined with a high fidelity amplifier and loudspeakers. Others have output stages with inbuilt loudspeakers which are nevertheless low-powered and only intended for monitoring. But even the completely self-contained machines, thanks to development in transistorised circuits, can have output sections with a respectable power and frequency response, capable of true hi-fi quality when fed to external loudspeakers.

Of the special functions, mention must be made of sound-on-sound, sound-with-sound, track transfer and echo, which facilities are made possible by the use of tape recorders with separate amplifiers and separate record and play sections. In the cheaper machines a single amplifying section may be switched for recording and replay, precluding such facilities. Various titles will be found, including multiplay, duoplay, synchro-play, track-dub, etc., and a careful study of the maker's brochure is necessary to ensure that the machine of your choice will actually do what you anticipate. Space limitations prevent a full discussion of this interesting aspect of the art of tape recording.

Other features that may influence one's choice include the ability to operate the deck vertically or horizontally, the use of separate reels or tape cassettes, magic eye or meter indicators, (of which there are two quite distinct types, the peak programme meter and the volume unit meter, each with its proponents), autostops and automatic recording.

Whether a machine is directly operated or operated via solenoids, has belt or idler drive, is single motor or three-motor design, may also determine the ultimate selection. It is a mistake to think that one type of design is necessarily 'better' than another. Modern motors and deck

machinery are so good that there is little to choose between the better class tape recorders.

Automatic recording has been mentioned, and may need underlining. The system regulates the gain of the recording channel according to

Popular with many enthusiasts, the Sony TC800 is a servo-controlled mains or battery recorder with facility for manual or automatic level control.



Rotating drive components in tape transport systems must be manufactured to extreme close tolerances. Picture shows dismantled pressure roller, fixing screw and dust cap from Akai recorder.

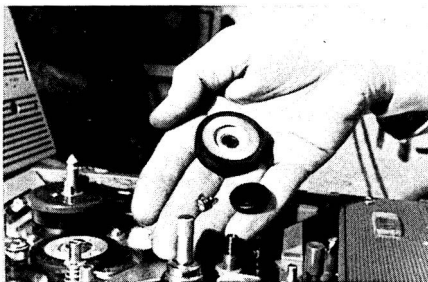

Head assembly of four-track stereo deck. Erase head is on left and record/playback head on right. Accurately machined tape guides are also shown.

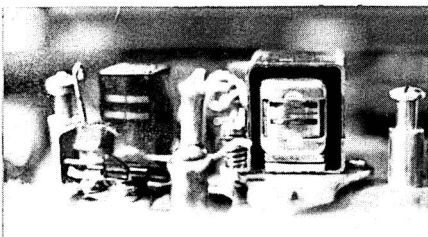

the level of the source signal. But there are some rudimentary systems that do not allow the best signal-to-noise ratio to be obtained under adverse conditions, while others employ quite sophisticated devices to determine the best recording conditions and regulate the machine automatically. For the best choice, an automatic-manual switch is needed, to allow the operator to regain personal control of his recording level settings if he wishes.

For some years the choice of two or four-track recorders did not exist for the true enthusiast. Nowadays, the high quality of heads and circuits makes narrow-track recording a feasible proposition, and half-track recording is only necessary if the highest quality is required. Most stereo machines are now four-track, and pre-recorded stereo tapes are four-track. It should be remembered that while a four-track machine will replay a two-track tape, with only a slight loss of output and quality, a two-track machine cannot replay four-track tapes.

Cassette-loaded machines have gained great popularity, on the grounds of portability and convenience. While it is never possible with cassette designs to achieve a specification comparable with a reel-to-reel machine, because of the drive system, the slow speed of operation and the narrowness of the tracks, the advent of greatly improved low-noise tape has given quite acceptable results. There are now machines

Miniaturisation and precision engineering call for a high degree of skill on the part of service technicians. Here a Grundig EN7 "electronic notebook" undergoes routine maintenance.

available that can load a number of cassettes in magazine form for long-term replay programmes. In the car, the supermarket, the hotel and other places where constant attention to the machine is not practicable, these machines are a very useful tool and not to be despised.

ROUTINE ATTENTION

Finally, having obtained our tape recorder, we must maintain it properly to prolong its life and get the best results from it. Accessories are available that make this much easier to do, from inexpensive packs of head cleaning tools and fluids to head defluxing units and bulk erasers, which remove residual magnetism and allow us to enjoy noise-free recording. Regular head cleaning is necessary both to maintain good high-frequency response and to avoid abrasive wear. Modern low-noise tape (and the prospect of chromium-dioxide tape to come) makes it all the more imperative that regular maintenance be carried out. The modern machine is worthy of an extra touch of attention.

We have come a long way since Valdemar Poulsen. In the near future we can expect to see a greater use of servo-controlled DC motors, freeing us from the vagaries of supply voltage and frequency; integrated circuitry, which reduces even more the possibility of electronic faults, improved head design, diminishing still more distortion and noise levels; and tapes that will enable us to get a performance from machines at slow speeds that are now only possible at tape-consuming velocities which considerably limit programme time and inflate cost.

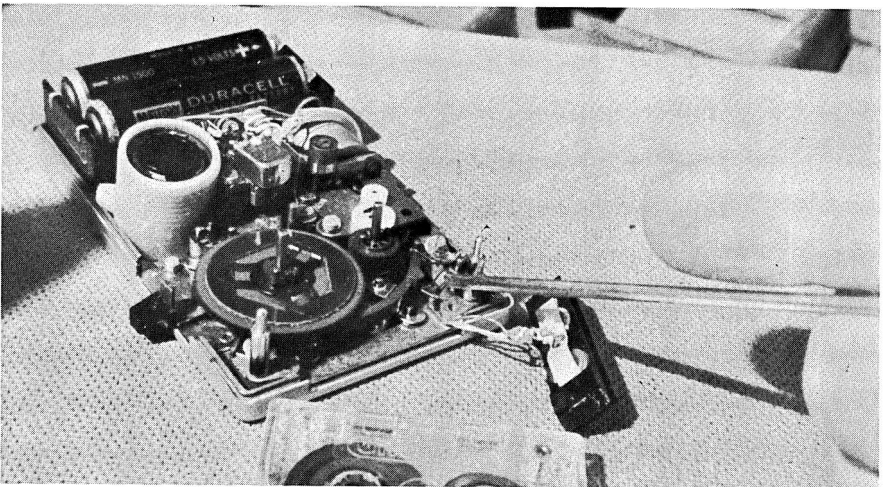

STEREO RADIO

How it works

by Roy Prince

Nowadays most medium-fi radiograms and unit audio packages—as well as genuine hi-fi tuners—cater for stereo radio. Therefore enthusiasts, especially those already within reach of stereo signals, are likely to come up against different circuits and new problems. So the time is ripe to investigate the stereo radio system as a whole and to explore some of the latest decoding circuits.

At the transmitter the two stereo channels are processed into a single signal by a clever system of 'scrambling' or, more technically, multiplexing. In this article we will examine how this is achieved and how the two audio channels are unscrambled and separated again at the set.

One of the main features of the stereo-by-radio system is that it is compatible. This means that a stereo signal received by an ordinary FM set or tuner will be handled in exactly the same way as a mono one and give properly balanced mono reproduction.

From the transmitting point of view this is easy. All it means is that the left and right channels are added together at the modulator to give an integrated $L+R$ audio signal, which of course is mono. The problem then remains of transmitting the stereo information along with the mono information, which is where multiplexing comes in.

Since $L+R$ equals mono, it follows that the stereo information must be the difference between the two channels, namely $L-R$. It was on this basis that the designers of the system worked. It is possible, of course, to transmit two-channel stereo over a pair of separate radio circuits, and this was tried experimentally using an FM transmitter for one channel and a TV sound transmitter for the other one. Such a system, however, is not only wasteful of radio space, but also it can never be truly compatible, for a mono set will only reproduce one 'half' of the programme material—the left or the right half.

Since our interest lies at the receiving end

there is no need to get too involved with transmitter detail: nevertheless, a basic understanding of how two-channel signals are scrambled, or encoded, helps us to understand how they are unscrambled, or decoded, at the tuner.

The fundamental elements of a transmitter are given in **fig 1**. This shows that both left and right signals are applied simultaneously to an 'adder' and 'subtractor', giving $L+R$ and $L-R$ respectively. The added signals, giving correctly balanced mono information, are fed to a mixer. The subtracted, or stereo signals, are fed to an AM submodulator which is based on a carrier frequency of twice 19 kHz, or 38 kHz. The subcarrier is derived from a 19 kHz generator, which provides a pilot tone signal, also delivered to the mixer.

Submodulation produces a pair of AM sidebands in the usual way, and a network almost completely deletes the subcarrier proper, leaving only upper and lower sidebands of the $L-R$ information for application to the mixer. Thus the mixer receives three signals: (i) $L+R$ mono. (ii) $L-R$ stereo sidebands and (iii) 19 kHz pilot tone, yielding the multiplexed signal for frequency-modulating the v.h.f. carrier of the Band II transmitter.

Fig 2 shows the three signals spread across the modulation spectrum, from low bass frequencies up to about 53 kHz. Maximum depth of modulation is also shown. It is noteworthy that the pilot tone takes up 10% of the total transmitter's modulation depth, leaving 90% for the transmission of the $L+R$ and $L-R$ sidebands. A v.h.f. transmitter handling mono signals only, of course, runs to a maximum of 100% modulation, corresponding to ± 75 kHz on the BBC, and this maximum cannot be exceeded when the transmitter is stereo-encoded. Thus the remaining 90% of the modulation depth is divided equally between the maximum $L+R$ and $L-R$ information.

At an instant when there is no stereo informa-

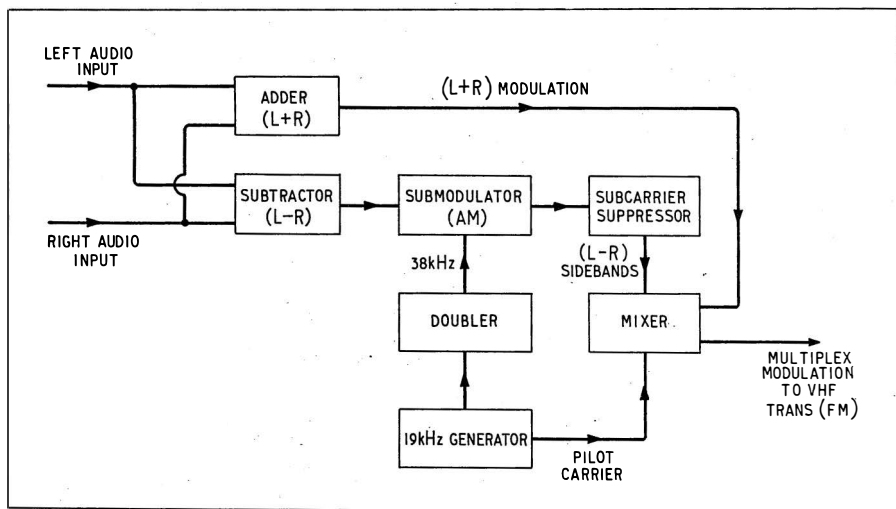

Fig. 1. Block diagram of stereo radio encoding system.

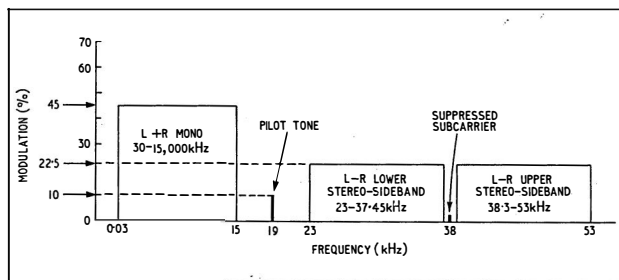

Fig. 2. Multiplex signal components showing frequencies and relative modulation percentages

tion present on the modulation of a stereo transmitter, 90% modulation depth is available for the mono (e.g. L+R) information, but during the times when stereo information is present the available depth for the L+R information is reduced by the range of modulation taken by the L-R information. In this way, therefore, the total modulation never exceeds 100%, but the cost of this is some impairment in signal/noise ratio, mentioned later. Fig 2 shows the transmitter fully modulated on stereo, with the L+R information accounting for 45%, the pilot tone for 10% and each L-R sideband for 22½%. On a normal transmission, the level of the stereo information often falls as the level of the mono information rises, and vice versa.

Now, if we have an ordinary mono tuner and remove the de-emphasis network from the output of the detector, a received stereo transmission will produce signals in the spectrum of fig 2. We should get the ordinary mono information, the pilot tone and the stereo sidebands.

However, as mono sets and tuners have a de-emphasis network normally fitted directly

following the detector, the pilot tone and stereo sidebands are attenuated. Thus such a receiver responds only to the mono information and gives a normal mono audio signal. This illustrates the aspect of compatibility.

Because the signal/noise performance of any FM receiver is related to the depth of modulation—the greater the modulation, the better the performance—it follows that a slight impairment in signal/noise ratio is inevitable when a mono tuner takes its signal from a stereo-encoded transmission. This is because the mono information corresponds to a maximum of 90% modulation, instead of the normal 100%. The impairment is barely detectable, though, and works out to something like 4 dB. An FM aerial that is doing its job properly easily outweighs this. It is a different story when a stereo tuner is working from a stereo-encoded transmission, as we shall learn anon.

DECODING CIRCUITS

A stereo receiver is fundamentally the same as a mono one up to and often including the

FM detector. But from the detector into the audio channels we have a circuit called a stereo decoder. Another important difference is that the de-emphasis is removed from the detector output so that the decoder receives all the signals of **fig 2**. From these its job is to produce separate left and right audio outputs, corresponding to the audio inputs of **fig 1**.

Fig 3 shows one way that this can be achieved. The multiplex signal from the FM detector is first amplified and then the 19 kHz pilot tone extracted by a tuned amplifier. The suppressed subcarrier, which now needs to be reformed for stereo detection, is generated locally by a 38 kHz oscillator. This local oscillator is locked in phase and frequency to the subcarrier at the transmitter by the 19 kHz pilot tone, which can thus be considered as a subcarrier sync signal.

The synchronised locally-generated 38 kHz subcarrier is then applied to two switching transistors, along with the L+R and L-R signals. **Fig 4** shows the main features of the decoder circuit used in the latest Heathkit AR-14 tuner-amplifier, matching the block diagram in **fig 3**.

TR1 is the multiplex amplifier which delivers the full range of signals from its collector to the base of TR2. The collector of this transistor is tuned by L1 and C1 to the 19 kHz pilot tone frequency. This is fed, via the phasing system, to the base of TR3, the 38 kHz oscillator transistor. Oscillation is produced by feedback from the collector to the emitter in relation to L2, tuned to 38 kHz by C2.

The oscillatory signal, coupled from L2 to L3, is applied in a push-pull fashion to the bases of the switching detector transistors, TR4 and TR5. At the same time L+R and L-R signals from the emitter of TR2 are fed via S2 (which is normally closed) to the emitters of TR4 and TR5. Thus the two switching transistors receive

both the mono and stereo signals plus the sub-carrier, reformed in the decoder.

The waveforms in **fig 5** reveal how the system works. Let us assume the left channel is modulated with a sine wave three times the frequency of the sine wave modulating the right channel. Then the type of waveform communicated to the emitters of TR4/5 is shown at (a). This is composed of L+R and L-R signals from the emitter TR2.

The locally-generated 38 kHz subcarrier is shown at (b). When this is correctly phased into the L-R signal—to replace the missing subcarrier—we get signal (c). In other words signal (a) exists at the emitters of TR4/5, while signal (b) is applied push-pull to the bases of the same transistors.

It will be seen from waveform (c) that one modulation envelope corresponds to the waveform of the audio in the left channel and the other to the audio in the right channel, and these are separated into their respective channels by the switching action of the pair of transistors. The switching is controlled by the 38 kHz subcarrier. On one half-cycle of subcarrier (b) TR5 conducts while TR4 is cut-off, on the next half-cycle TR4 conducts and TR5 cuts-off. This switching action continues as long as the subcarrier is present. The effective result of which is that the left and right modulation envelopes of waveform (c) are 'sampled' alternately at the switching rate (well above audio), so that the outputs at the collectors of TR4 and TR5 correspond respectively to the original left and right audio signals, (d) and (e).

Normal de-emphasis is applied at each output, and there are usually filters which, helped by the de-emphasis, clear most of the pilot and subcarrier signals from the audio.

Clearly, the system will switch correctly only when the reformed subcarrier is accurately phased to that suppressed from the L-R sidebands at the transmitter. The pilot tone—since the original subcarrier was derived from this

Fig 3. Decoder using phased 38KHz subcarrier generator

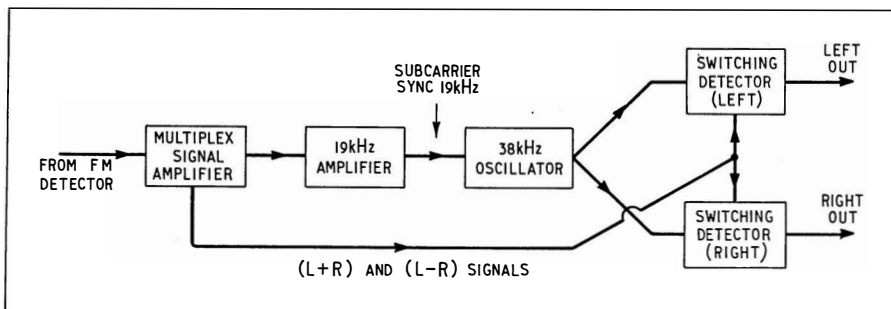

(see Fig 1)—gives the correct phasing, as we have already seen, but the relative phase is also dependent on the tuning and adjustments of the decoder circuits.

Phasing is neatly handled in the Heathkit circuit by the phase control P1 (see Fig 4). When S2 is switched to 'Adjust' the bandpass circuit comprising L4 and C3 is introduced into the L+R and L-R circuit. This allows only the 38 kHz subcarrier to pass to the detectors. When the phasing is correct, maximum sound is heard in the subcarrier signal.

The idea is to adjust P1 by listening for maximum output of programme with S2 in 'Adjust' position. Phasing is then optimised. Correct stereo (with minimum crosstalk) is achieved by switching S2 back to 'Normal' position.

This method of phasing would not be possible without L4/C3 in circuit, for the slight sound signal in the subcarrier would be swamped by the audio signals (L+R and L-R) from the emitter of TR2.

To avoid beat interference on mono, the oscillator is muted by opening switch S1. The mono signal is conveyed normally to TR4/5 emitters so that the outputs of the signal occur at both collectors. This happens because the detector transistors conduct even when there is no 38 kHz switching signal at their bases.

A different scheme is shown by block diagram in fig 6. Here the pilot tone is tuned out and amplified as before, but instead of using it to phase the signal from a subcarrier generator in the decoder, it is doubled in frequency to yield the subcarrier from itself.

The subcarrier is then amplified to drive a synchronous switching system of diodes, and

since the diodes also receive L+R and L-R signals from the first stage, the outputs carry the left and right audio signals as before.

The circuit is given in fig 7. TR1 is the multiplex amplifier which is loaded by a 19 kHz transformer T1 at the collector. The pilot tone is amplified by TR2, while diodes D1 and D2, driven by the tuned circuit T2, also at 19kHz, double the frequency and pass it on to the base of TR3. Here it is developed in the tuned transformer T3 of the collector.

The synchronous switching detector system, D3, D4, D5 and D6, receives both 38 kHz drive from TR3 and L+R and L-R signals from the emitter of TR1. There are variations of this general circuit to be found in the majority of modern stereo receivers. Sometimes diodes D1 and D2 are omitted, the doubling then taking place in the base circuit of the 38 kHz driver transistor.

There is not a great deal of difference between the switching detector and the so-called 'envelope detector'. The first takes its name from the switching action and the second from the left and right signal envelopes which become separated by the addition of the 38 kHz signal, and integrations of the two schemes are not uncommon.

However, there is a type of decoder that is somewhat different from the other two, called the 'matrix decoder'. This works in the reverse way to the transmitter matrix (Fig 1). The L+R signal is applied to 'adder' and 'subtractor' stages via a low-pass 0-15 kHz filter (the feed sometimes incorporating the de-emphasis), while the L-R signal is applied via a 23-53 kHz bandpass filter to which the synchronised 38 kHz subcarrier has been added.

Fig 4. Circuit of system shown in fig 3. This arrangement is used in the latest Heathkit AR-14 stereo tuner-amplifier.

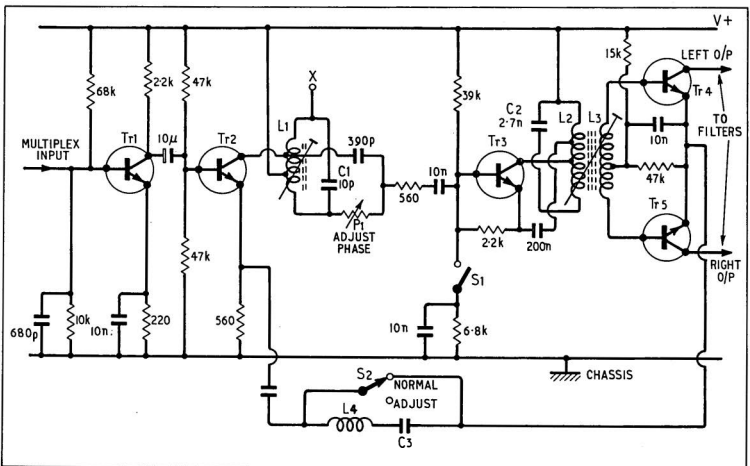

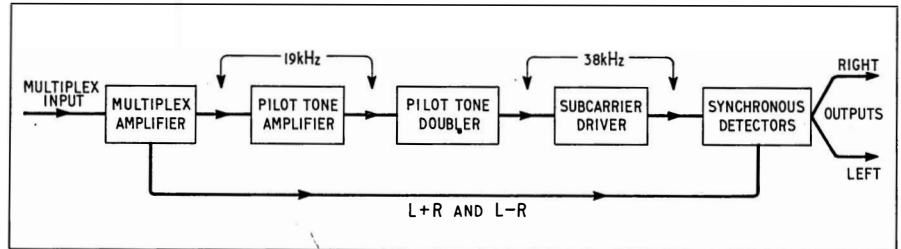
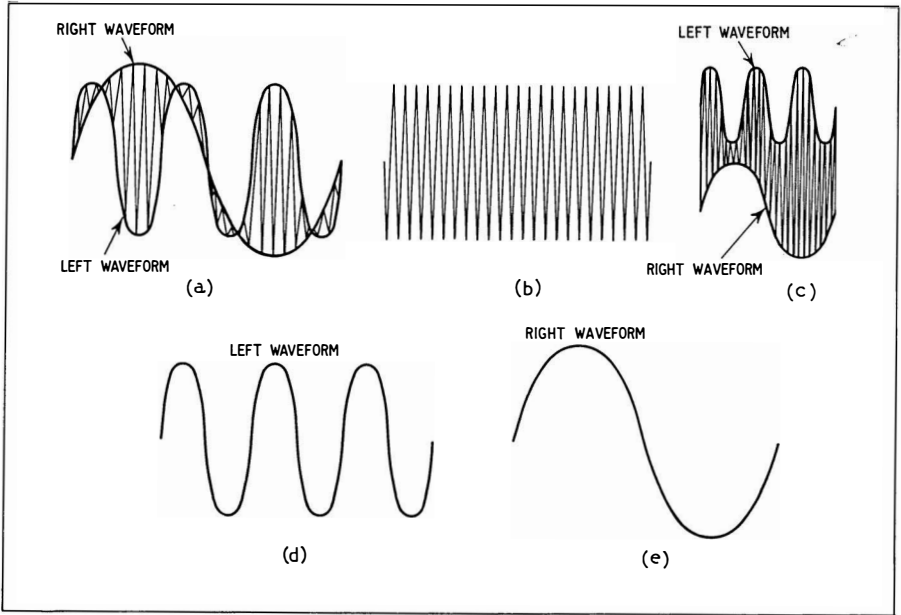

Fig 5. Waveforms showing decoder action. (a) composite stereo signal, (b) 38KHz subcarrier, (c) subcarrier and L-R signal, (d) and (e) left and right audio outputs

Fig 6. Block diagram of stereo radio system in which 19KHz pilot tone is frequency-doubled to form subcarrier

All systems exhibit some degree of inter-channel crosstalk, and various circuit artifices are used to reduce the effect. The RC high-pass filter in the subchannel circuit of **fig 7**, for example, removes the high frequencies of the L-R signal, which helps matters in this connection. The resistor is adjusted to obtain minimum break-through of the speaking channel in the non-speaking channel. Another idea takes the form of preset resistors which adjust the levels of signals from the two channels and connects them back to the opposite channels

after their phases have been reversed. The accuracy of tuning of the 19 kHz and 38 kHz circuits also affects the crosstalk.

REVERSE COMPATIBILITY

Less ambitious systems use only two diodes in the synchronous detector, instead of the four shown in **fig 7**. However, when there are only two detector diodes the decoder might have to be by-passed on mono to allow the receiver (or tuner) to operate properly. Four diodes not only give reverse compatibility—letting through mono signals without switching—but also significantly reduce the levels of the pilot tone and subcarrier signals at the left and right audio outputs. The diodes are arranged to have forward conduction even when there is no 38 kHz switching signal.

The detector action is similar to that already discussed. The four diodes can be looked upon

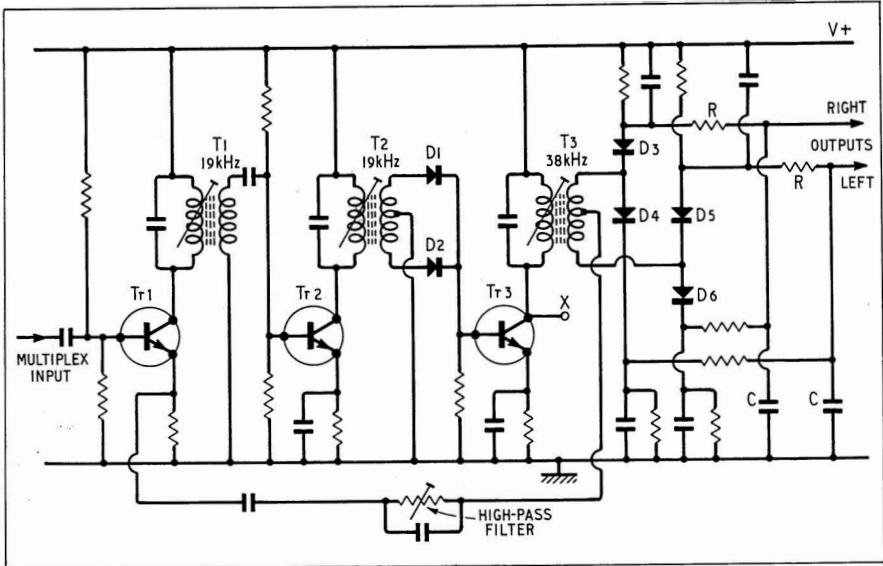

Fig 7. Circuit diagram of the system shown in block form in fig 6. Diodes D1 and D2, driven at 19KHz by tuned transformer T2, produce frequency-doubling effect. Signal is amplified by TR3 and passed via 38KHz tuned transformer (T3) to synchronous detectors. Many modern stereo receivers employ this type of circuit or a variation of it

as two pairs, each pair being driven from opposing halves of T3 secondary, since this is centre-tapped. When one pair is conducting, therefore, the other pair is cut-off. The pilot carrier and subcarrier thus tend to cancel out because they are in phase opposition across the loads. In fig 7, R and C in each output channel give the necessary de-emphasis—50 μ S for the British FM system.

It is noteworthy that while pilot tone and subcarrier do not normally affect direct reproduction, they can cause havoc when the stereo outputs are applied to a tape recorder. This is because they sometimes beat with the bias oscillator.

The effect takes the form of a whistle recorded with the programme material. The de-emphasis circuits usually attenuate any residual signals of this kind, but in the simple type of decoder additional 19 kHz and 38 kHz filtering is sometimes necessary—such as a filter in each audio channel from the decoder. Several firms make fast cut-off filters, using transistors in a parallel-T circuit.

Finally, a word about the stereo beacon. This is usually a small bulb somewhere on the tuning dial, or behind the tuning indicator, which illuminates when the receiver is tuned to a stereo-encoded transmission. This simply works from a pair of switching transistors.

The beacon indicator lamp is connected in the collector circuit of one of the transistors (Fig 8) and it is energised when a pilot tone or subcarrier signal is applied to the base of the other. When switched on the resulting collector current passing through the beacon lamp causes it to glow when a stereo signal is being received.

Fig 8. Basic circuit of stereo beacon. Presence of subcarrier at base of TR1 switches on TR2 and lights lamp

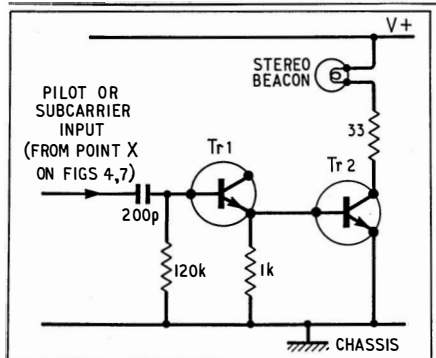

RADIO TUNERS

By Gordon J. King

Field effect transistors, integrated circuits and piezoelectric resonators are some of the more recent of solid state devices that are finding application in the latest generation of hi-fi tuners and in the tuner sections of integrated tuner-amplifiers. Only the f.m. system, of course, can provide true hi-fi reception, but to widen their markets a fair number of firms have evolved designs to embrace one or more of the a.m. bands in addition to Band II, the v.h.f./f.m. band. Indeed, some tuners are 'all-wave'—even high quality models—covering one or two short wavebands, the medium waveband and the long waveband as well as v.h.f. More commonly, though, there is just the medium waveband extra to v.h.f.

Field effect transistors are confined to the f.m. front-end in most models, while i.c.s. and piezoelectric resonators are found in the i.f. sections on both f.m. and a.m. The a.m. front-end is entirely independent from the f.m. front-end, and in some tuners the design of the former is little more exacting than that of ordinary radios—the idea seemingly being to secure the addition of a.m. as economically as possible.

Indeed, it is not at all uncommon to find the transistor portable type of ferrite rod aerial attached to the rear of the tuner or tuner-amplifier by means of an adjustable bracket. The windings on this aerial serve to tune the input circuits on the long and medium wavebands in conjunction with ganged capacitors, and the rod can be orientated with the tuner in situ for maximum response of the wanted a.m. programme, consistent with the best signal/interference ratio.

Sometimes the aerial is fitted to the top of the chassis inside the cabinet, thus making it necessary to turn the whole equipment to obtain the best reception. Internal location of the aerial, however, is not possible when the cabinet

is made of metal owing to the screening effect this has on the signals.

Ferrite rod aerials work most efficiently on the long and medium waves, so for short-wave reception an outside aerial is generally needed. There have been designs for v.h.f. ferrite rod aerials, but for the best reception on this service—especially when the best stereo reception is required—a proper f.m. aerial should be used. Some of the larger-cabinet type of tuners and tuner-amplifiers embody compressed f.m. dipoles inside the cabinets, but these are not very efficient.

A few designs incorporate an arrangement for switching out the ferrite rod and switching in ordinary aerial tuning coils, thereby allowing an external a.m. aerial to be used for reception of the more distant stations. When a ferrite rod aerial is not employed signals can often be coupled to the a.m. section from the v.h.f. aerial, connecting it via a switchable low-pass filter. The filter avoids the a.m. and f.m. front-ends interacting due to the common aerial coupling.

FIELD EFFECT TRANSISTORS

Field effect transistors provide excellent sensitivity and noise performance while possessing a high overload capacity. They are also more easily gain-controlled than are bipolar ones. For these reasons designers started by using an f.e.t. in place of a bipolar transistor in the r.f. stage of the f.m. front-end. Such front-ends thus consisted of an f.e.t. first stage with bipolar transistors serving as the mixer (or self-oscillating frequency changer) and local oscillator.

It has since been discovered that f.e.t.'s. also have certain advantages operating in the mixer and local oscillator stages, so some of the very recent models have f.m. front-ends equipped with three f.e.t.'s., with possibly a fourth, bipolar, transistor acting as an f.m. i.f. amplifier.

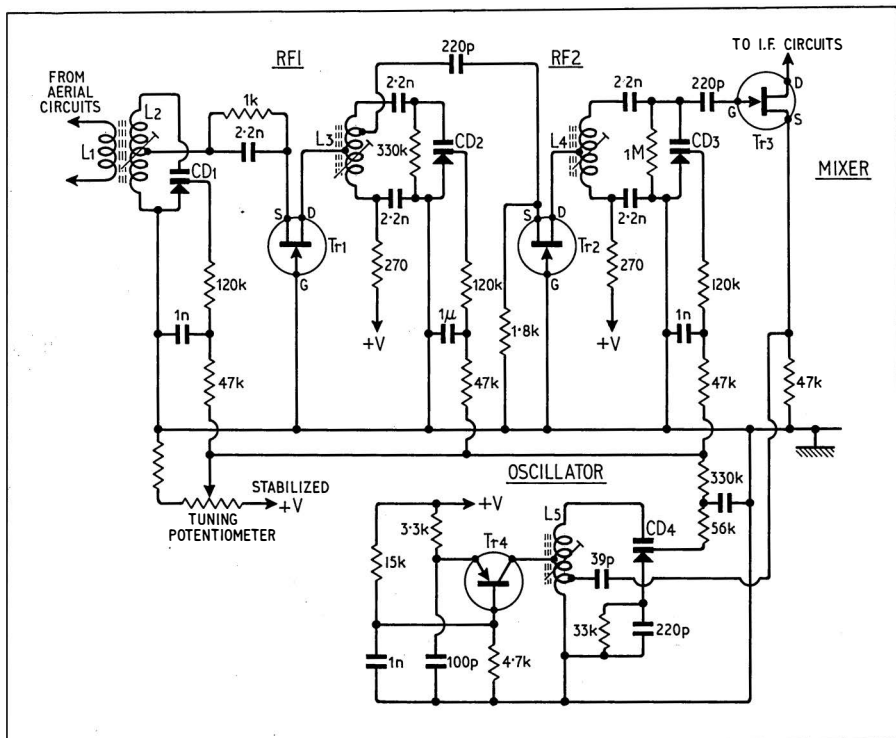

Fig 1. Modern f.m. front-end using f.e.t.'s. in two r.f. stages and in the mixer, with a bipolar transistor as the local oscillator

One advantage of an f.e.t. local oscillator is that frequency drift can be kept to very small limits, sufficient to make automatic frequency correction unnecessary.

Tuning of the f.m. circuits is mostly accomplished by the ordinary ganged capacitors, and the older idea of permeability tuning—where iron-dust cores are caused to traverse the coil formers as the tuning control is operated—appears to be fading. Sometimes the f.m. tuning-gang is integrated with the a.m. tuning-gang, the one tuning control then operating both systems, but the more expensive models still have independent a.m. and f.m. tuning arrangements. The capacitor-diode method of f.m. tuning is fast gaining popularity with some European, American and Japanese designers, but the majority of their British counterparts appear to be sticking to the capacitor-gang arrangement for the time being.

A.m./f.m. tuners with f.m. capacitor-diodes usually feature a capacitor-gang for the a.m.

bands, and the two systems may be independent with separate scales, pointers and tuning knobs; or they may be coupled to a common knob and pointer in conjunction with a composite scale carrying both a.m. and f.m. calibrations. The latest Grundig tuner (Model RT100) differs in that it has a solitary tuning knob but two scales, each with its own pointer, one for f.m. and the other calibrated for a multiplicity of a.m. bands. When any of the a.m. bands is selected the a.m. tuning-gang and pointer are automatically engaged, while the f.m. pointer and tuning potentiometer are disengaged, and conversely when the f.m. band is selected. With this scheme, therefore, it is possible to tune an a.m. station and then change to f.m. and tune over Band II without disturbing the a.m. tuning, and *vice versa*, in spite of there being just the one tuning knob.

DIODE CAPACITANCE TUNING

Any junction diode in reverse-bias has a value of capacitance across its terminals due to the action of the so-called 'depletion layer'. The greater the reverse-bias the smaller the capacitance, because the increased bias widens the

depletion layer, so to speak. The effect is analogous to the fall in value of an ordinary capacitor when the distance between the two sets of plates is increased. Capacitor-diodes are junction diodes specially constructed to take full advantage of the capacitance phenomenon, and in each circuit of the f.m. front-end where a tuning-gang section would normally be used, a capacitor diode is used instead.

F.m. tuning is then accomplished by a single tuning potentiometer, the wiper of which is coupled to the tuning mechanism. It is wired to regulate the reverse-bias applied simultaneously to all the capacitor-diodes, and it thus takes the place of the tuning-gang of conventional circuits. The circuit of an advanced f.m. front-end of this kind is shown in basic form in **fig 1**. Here two r.f. stages are used, each using a field effect transistor TR1, TR2, with a third f.e.t. TR3 operating as the mixer and a bipolar transistor TR4 as the local oscillator.

L1/L2 is the aerial coupling transformer and winding L2 is tuned by capacitor-diode CD1. The tuned signal at a suitable impedance point is coupled to the source of TR1 via the 2.2 nF capacitor with the 1k resistor providing d.c. continuity for the source circuit. The 'gate' G is earthed and the amplified signal appears across L3 which is tuned by the second capacitor-diode CD2. The signal is now coupled to TR2 via the 220 pF capacitor, again to the 'source' S with the gate earthed. These two stages are akin to valves in earthed-grid mode, or bipolar transistors in common-base configuration.

The r.f. signal is finally tuned by L4 and the third capacitor-diode CD3 and then applied to the gate of the mixer f.e.t. TR3. The 'drain' D goes to the i.f. tuned circuits, while the source is returned to chassis through the 47k resistor, and it is at this electrode that the local oscillator

signal is injected, from the oscillator coil L5, via the 39pF capacitor. L5 is also tuned by a capacitor-diode CD4, and all four diodes are returned, via individual decoupled circuits, to the slider of the tuning potentiometer. One side of this is returned to chassis via a padding resistor and the other side is connected to a supply of stabilised voltage, generally obtained from a Zener diode. Thus as the slider is moved from the 'earthy' end of the track to the positive end, so the reverse-bias applied to each diode increases. This reduces the capacitance and thus increases the tuned frequency.

It is not uncommon to find the d.c. load of the f.m. detector returned to the capacitor diode circuit in some way. This neatly provides automatic frequency correction, for as the local oscillator drifts from the frequency required for tuning a station, so a positive or negative potential is developed at the detector load, and this can be fed back in such a way as to alter the capacitance of the diodes to restore the tuning. An on/off a.f.c. muting switch allows the control potential to be removed for initial tuning.

INTEGRATED CIRCUITS

Integrated circuits, or i.c.s, have the advantage of very high gain, since each circuit embodies a number of transistor elements in cascade along with resistive elements and capacitors formed by reverse-biased diodes. The gain is adjusted by negative feedback and the response of the integrations is tailored by external tuned circuit, such as the i.f. transformers.

Quite a few of the imported models—tuners and tuner-amplifiers—are based on i.c. i.f. channels, and some British designers are also adopting them. The latest Truvox tuner (Model FM2001C, shown in **Fig 2**) uses two i.c.s encapsulated in ten-lead packages conforming to TO-5 dimensions (just a little larger than ordinary transistors).

Both are RCA devices. The first is a CA3012

Fig 2. Truvox FM2001C tuner. This uses two i.c.'s in the i.f. channel.

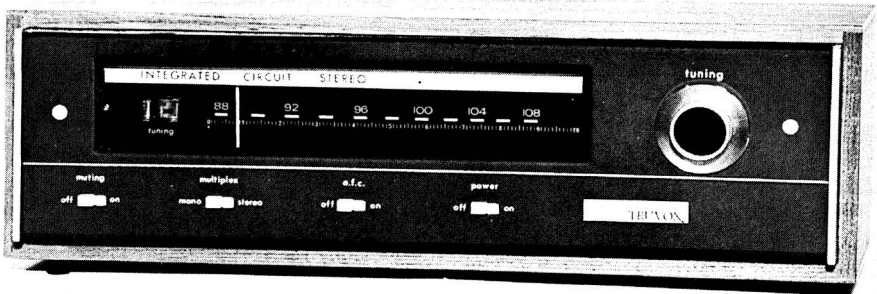

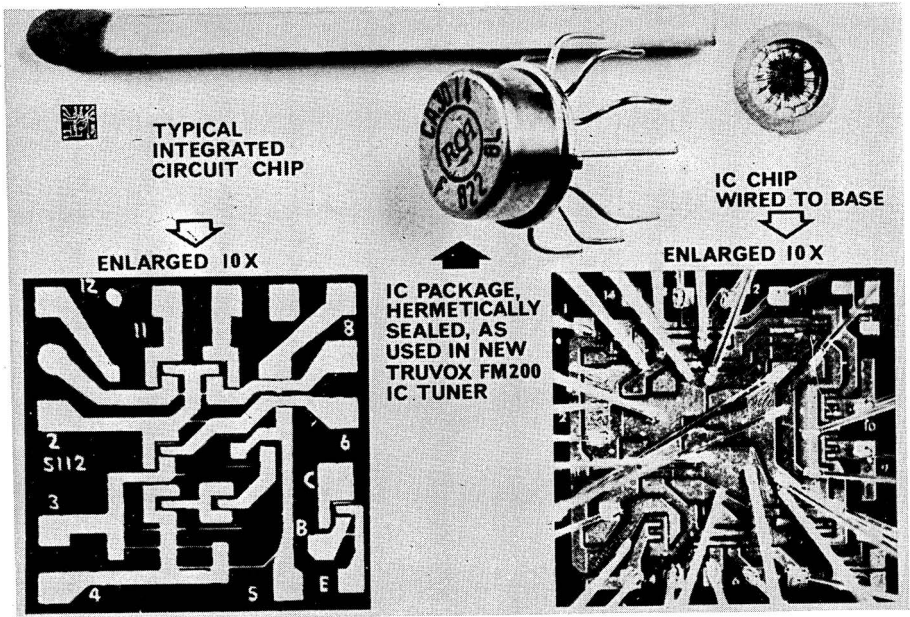

Fig 3. Several aspects of the RCA i.c.s. used in the Truvox tuner

working as a wideband i.f. amplifier and containing no fewer than ten transistor elements and a multiplicity of diodes, leading to three d.c.-coupled differential amplifiers in cascade, an emitter-follower output and power supply regulation. This device alone yields a gain of some 65 dB at 10.7 MHz—the standard f.m. i.f.

The second is a CA3014, consisting of a three-stage d.c.-coupled amplifier/limiter, power regulating diodes, ratio detector diodes and a Darlington pair output stage. This, too, has a very high overall gain, and some idea of the size (which is the same as the CA3012) and internal construction can be gleaned from fig 3.

Some American and Japanese models use four or more i.c.s, but of a different type from the RCA devices just mentioned, containing fewer transistor elements. However, they allow a greater number of tuned circuits to be dispersed along the i.f. channel, thereby easing some of the problems involved in securing adequate selectivity.

These less complex i.c.s also have fewer diode elements and associated components, making it necessary for the designer to use more ordinary components on the circuit board.

Moreover, while the RCA i.c. has built-in ratio diodes and capacitors for 'average' detection, models using the other type generally feature separate detector diodes and associated components. A camera's view of the inside of a recent tuner using i.c.s is reproduced in fig 4. One of the i.c.s can just be seen in the i.f. strip at the bottom of the picture.

PIEZOELECTRIC RESONATORS

Piezoelectric resonators are not new, and such devices made of ceramic have been used in portable radios. Specially prepared ceramic, polarised with an electrostatic field during manufacture, exhibits piezoelectric effects. That is, when subjected to a signal they resonate at the frequency to which they are cut and, conversely, they generate electricity (e.g., piezoelectricity) when stressed—like the elements of ceramic pickup cartridges. To some extent they are similar to the quartz crystals that are used as i.f. filters in communications sets and to control the frequency of radio transmitters and oscillators.

Specially designed piezoelectric resonators can thus be used to replace the conventional transformers and tuned circuits in the i.f. channels. Indeed, by judicious electro/mechanical coupling introduced during their manufacture they can be made to simulate the primary and secondary windings of an ordinary transformer

with bandpass characteristics, and when applied in this way they have the advantages of not requiring critical alignment and of consistently providing good selectivity with an essentially flat response within the designed-for bandwidth.

Some of the very latest tuners use such resonators in both the f.m. and a.m. i.f. channels, when the design is for separate channels. Quite a few f.m./a.m. tuners and tuner-amplifiers, however, adopt a composite i.f. channel of the kind found in many f.m./a.m. radios, with series-connected i.f. transformers, one tuned to the standard f.m. i.f. of 10.7 MHz and the other to the a.m. i.f. of 470 kHz, and this design generally dictates the use of conventional i.f. transformers and couplings, although i.c.'s. may represent the active devices. All f.m./a.m. versions, though, use entirely separate front-ends, one designed to tune the a.m. bands and the other optimised for v.h.f. reception. That is to say, to provide the best possible signal/noise performance within the economic structure of the equipment.

As already mentioned, hi-fi cannot be obtained on the a.m. bands, so when these are

provided by the tuner their design not uncommonly appears to be secondary to the chief and most important v.h.f./f.m. section. There are exceptions, of course, and some makers take great pains to secure the best possible reception from the interference-laden and crowded a.m. bands by carefully designing the i.f. transformers and by providing switchable filters for regulating the i.f. bandwidth. Grundig, for example, is one firm which specialises in this sort of design.

STEREO RECEPTION

All a.m./f.m. and f.m.-only tuners and tuner-amplifiers are either stereo-ready (e.g., equipped with a decoder) or designed for easy fitting of a decoder. Typical in this respect is the latest Armstrong tuner which incorporates a wired-in edge-connector to accommodate a plug-in decoder printed circuit board when required. This model is also available in the stereo-ready condition.

While it may seem to be economically unwise to purchase a stereo-ready tuner or tuner-amplifier for use in an area not yet within the normal range of stereo transmissions, many enthusiasts so placed get a great deal of enjoyment in tuning in the more distant stereo stations, not only those of the BBC but also the European stations, such as the France Musique

Fig 4. Inside of stereo tuner using an i.c. i.f. strip. One i.c. can just be seen in the printed circuit board at the bottom of the picture.

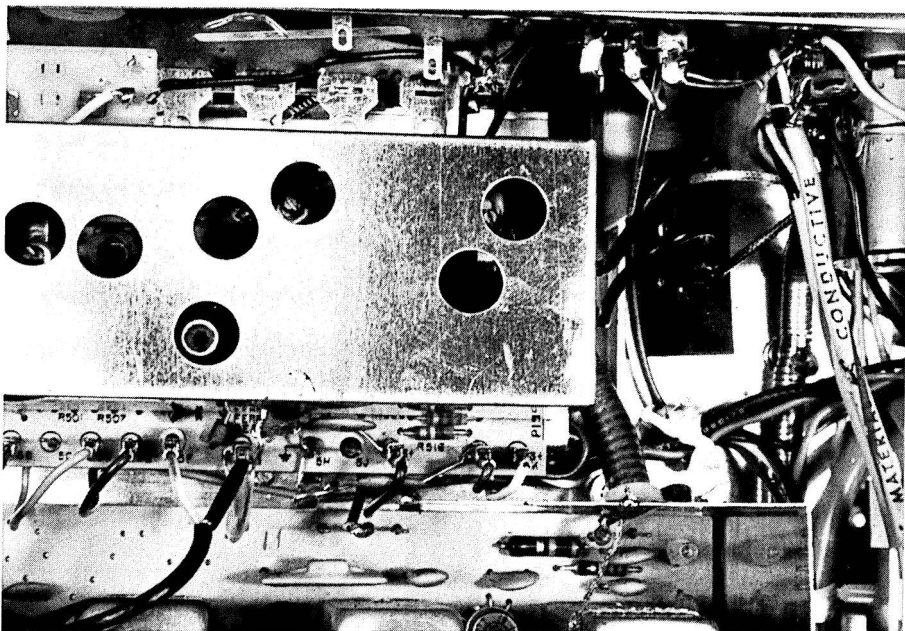

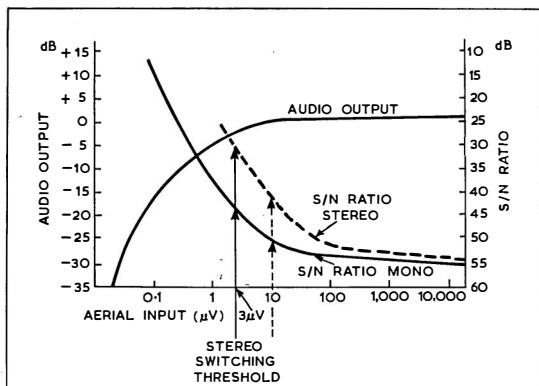

Fig 5. Important characteristics of a stereo tuner. These are all considered in the text.

station. France Musique delivers quite a fair amount of stereo material at extremely high quality, and is well worth tuning into when reception conditions permit. During the spring and summer, when there is a spell of settled weather, even relatively insensitive tuners can bring in some of the European stations in certain parts of the country almost as well as they do the locals. For example, at a fairly screened site little more than 60 ft above sea level on the South-West coast I have picked up a number of French stations on a wide variety of tuners, ranging from mediocre-sensitivity designs to exotic models employing f.e.t.'s. and i.c.'s., in conjunction with a simple, home-made dipole aerial (e.g. no directors or reflector) during such reception conditions.

For more consistent reception of distant stations, though, a high-gain (multi-element) aerial accurately 'beamed' to the required station is essential. This should have maximum possible altitude, while the tuner should have a high useable sensitivity and good noise performance.

By the use of such a combination it is also possible to receive reasonably consistently stereo signals from some of the BBC stations well outside the accepted service areas, provided that there is a fair separation between the distant stereo-encoded station's frequency and the frequency of the local station. If the tuner's selectivity is insufficiently good, a powerful local station within 200 kHz or so of a weak stereo transmission will be 'captured' by the tuner and the weak, wanted station will be effectively rejected. This is a function of the f.m.'s 'capture effect'.

A similar effect can happen if the tuner is running with automatic frequency correction, the a.f.c. then locking on to the more powerful

transmission within the correction range and thus detuning the local oscillator from the weak transmission. For this reason a tuner for distant-station reception must either be devoid of a.f.c. or possess an a.f.c. on/off switch.

Noise performance mostly depends on the f.m. front-end, while sensitivity and selectivity are governed by the i.f. channel design. It is also possible to improve both the sensitivity and the noise performance, however, by using two r.f. amplifier stages in the front-end instead of the usual one, especially if these are based on f.e.t. devices. At least one domestic tuner—the Grundig RT100—employs a front-end of such a design (see the basic circuit in Fig 1).

However, if there is just one r.f. stage an extra (external) preamplifier can be introduced between the aerial feeder and the tuner's aerial input for long-distance work. Several firms make low-noise battery-powered preamplifiers like this, including Transistor Devices Limited of Newton Abbot in Devon and Holdings Audio Centre of Blackburn.

SELECTIVITY AND STEREO

It often happens that the wanted weak stereo transmission is only about 200 kHz (standard f.m. channel) away from a more powerful signal, thus making it necessary for the tuner's i.f. channel to have a very sharp skirt response without unduly inhibiting the essentially flat-response requirement within the channel. This requirement can only be achieved by the use of a multiplicity of tuned circuits (e.g. i.f. transformers) in the i.f. channel or by the use of ceramic resonators.

Of recent months another effect has been observed when a stereo transmission, received on certain stereo tuners, occupies an adjacent channel carrying a transmission in stereo or mono. For example, suppose that Radio 3 is

being received from a local station while the same programme is being transmitted from a more distant transmitter in the next channel up or down (e.g. 200 kHz from the local station's frequency) then, under certain conditions, the stereo reception from the local station can be very severely interfered with. The interference takes the form of a 'bubbling' noise during the whole of the time that the local station is stereo-encoded.

This could be termed the 'Northampton effect', for it was in this area that the effect was first examined, since the local reception conditions are such that while the local v.h.f. relay station accounts for about 1 mV or so of feeder signal, the Wrotham transmitter, which is exactly 200 kHz removed in frequency, also causes a smaller feeder signal.

In some tuners this produces a 200 kHz beat-frequency which in turn beats with the fifth-harmonic of the regenerated subcarrier signal or modulated components thereof, which works out to 190 kHz, thereby creating a 10 kHz

Fig 6. Power amplifier section of a tuner-amplifier, showing the heat-sink-mounted power transistors, mains transformer and ferrite rod aerial at rear for the a.m. bands

background note on the reception which is affected by the subchannel modulation. When there is no modulation the tone is constant, the 'bubbling' effect starting with the modulation.

I have just been listening to a tape recording of this phenomenon kindly loaned to me by Austin Uden, the well known *FM Diary* contributor of *Hi-Fi News*, who has had a great deal to do with practical investigations of the problem. Mr. Uden processed the tape himself at a site in Northampton, and with one type of tuner stereo reception was rendered virtually useless, even though the Wrotham signal field accounted for no more than 5 μ V of aerial signal, the reception, of course, being taken from the 1 mV of local relay station signal! With a different tuner, though, the disturbance was not at all apparent.

It is noteworthy that the background became almost perfectly quiet when the first tuner's decoder was muted—that is, when the tuner was switched from stereo to mono—thereby giving the stereo transmission in mono. Indeed, it is understood that some stereo radiogram combinations just cannot be used on stereo radio in the Northampton area in spite of the local relay station providing stereo transmissions, all because of the adjacent channel Wrotham signal.

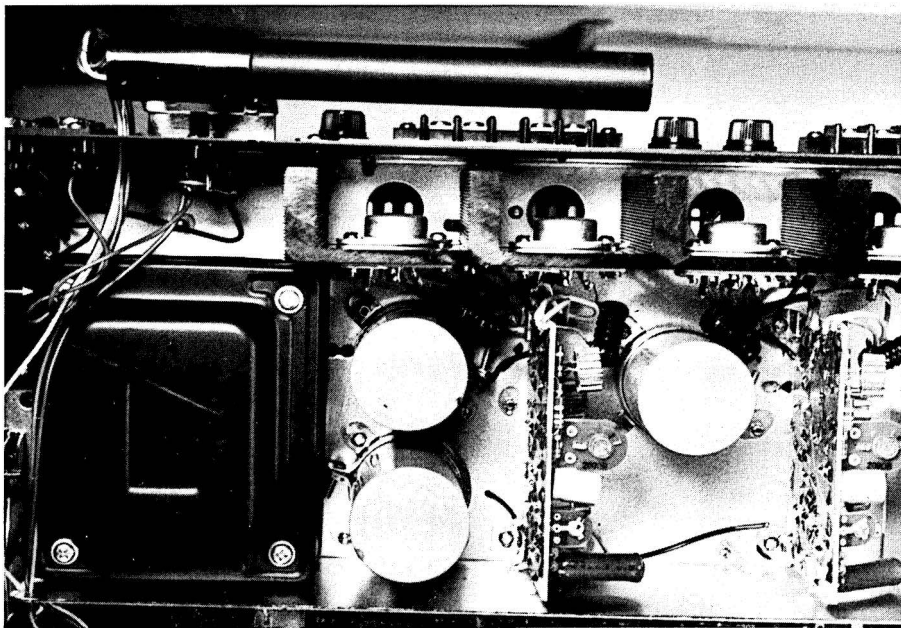

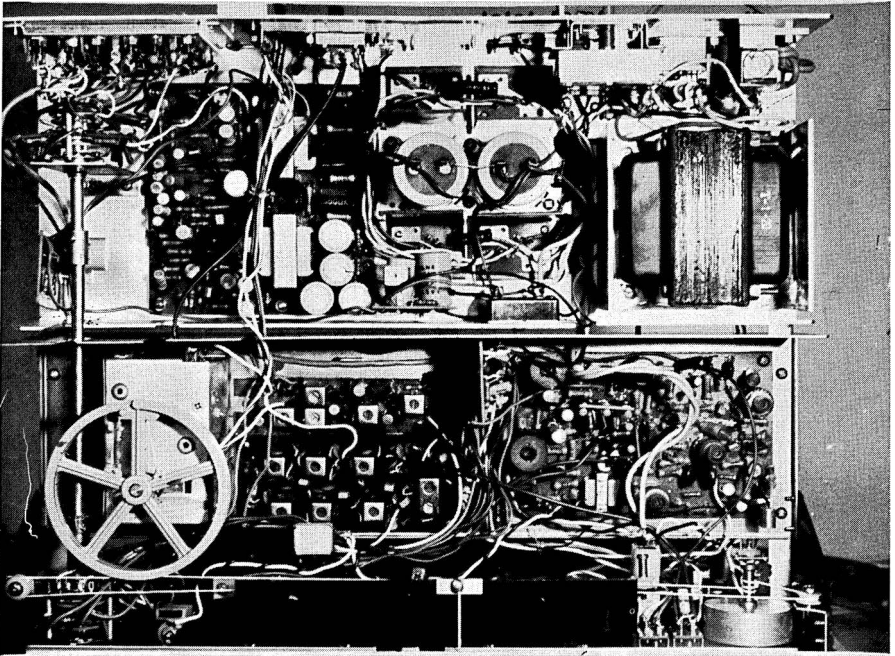

Fig 7. The stereo decoder printed circuit board of the stereo decoder can be seen in the bottom right-hand corner of the picture, with the r.f. and i.f. circuits at the left and the amplifier section at the top.

The solution to the problem lies in tuner design, the prime requirements being good i.f. selectivity, low-pass filtering between the tuner's f.m. detector and stereo decoder input, and good f.m. detector linearity over the entire deviation range and *parts* of the range, for I have discovered that the linearity can tend to worsen as the f.m. deviation is *reduced* in some tuners.

Although the Northampton effect can inhibit good stereo reception, depending on the design and adjustment of the tuner employed, it is by no means typical of stereo reception generally, for in the vast majority of those areas of the country within range of the stereo-encoded BBC transmitters even very basic tuner/decoder designs can yield excellent stereo reception.

However, the effect is well worth taking note of since it might be observed when a simple design of tuner/decoder combination is used for the reception of distant stations during settled cyclonic conditions as earlier noted, for some of the normally-out-of-range stereo transmissions

occupy channels adjacent to those of powerful less-distant stations. Thus enthusiasts proposing long-distance stereo reception should select their tuners with great care.

CHANNEL SEPARATION

Quality of stereo reproduction and the degree of separation between the two stereo channels—main amplifiers apart—are influenced by the design of the decoder and the bandwidth/phase characteristics of the tuner's i.f. channel and f.m. detector.

Quite a few decoders are based on the 'switching' or 'envelope' detector principle, where the decoder ends up by amplitude-modulating the left channel on one envelope and the right channel on the other envelope of the a.m. waveform, whose carrier is effectively that regenerated by a 38 kHz oscillator and 'locked' by the 19 kHz pilot tone or that produced by direct 'doubling' of the 19 kHz pilot tone. The remainder of the decoder then works by alternately switching synchronous a.m. demodulators between the left and right envelopes at the subcarrier frequency (e.g. at 38 kHz).

In this manner the left audio is separated from the right audio, and when everything is correctly adjusted and working properly the crosstalk between the two stereo channels should be at

least 30 times down (about -30 dB) at 1 kHz. The 19 kHz and 38 kHz subchannel components (not directly contributing to the audio information) are deleted by low-pass filters in the decoder outputs. The de-emphasis also helps to get rid of the unwanted frequencies above audio.

Crosstalk compensation is sometimes applied to balance out right signal in the left channel and left signal in the right channel. This is made necessary because the switching is based on a quasi-sinewave signal rather than a squarewave signal. The phasing of the regenerated subcarrier is also very important from the crosstalk point of view, for without correct phasing the switching is incorrectly synchronised.

The 'switching' or 'synchronous' detectors might be either diodes (in a bridge circuit) or a pair of transistors. There are many, almost equally as effective, decoder schemes, but the more elaborate might feature five or six transistors, and the least complex two transistors and four or six diodes. These would comprise four in the synchronous detectors and, possibly, two in the 19 kHz 'doubler'.

It is fairly common now for the first stage to accept the whole of the multiplex signal from the f.m. detector and to separate the pilot tone from the subchannel components, subsequent stages then amplifying and doubling the former and 'phasing' the latter into the synchronous detectors. The circuit of the first stage is arranged to load the f.m. detector as little as possible.

MONO/STEREO SWITCHING

Many stereo tuners are automatic in switching to the stereo condition, the tuners working normally on mono yet working properly on stereo from a stereo signal. There is generally a mono/stereo switch, though, making it possible to receive a stereo transmission in terms of mono reproduction. This feature is handy since a weak stereo transmission can produce excessive background noise when reproduced in stereo, whereas by switching to mono the noise is significantly reduced at the expense of the stereo effect.

When the aerial signal is weak the background

noise accompanying a stereo programme can be several times as great as the noise accompanying a mono programme of a similar signal strength, but the margin between the two noise conditions diminishes with increasing signal strength. This is revealed in **fig 5** which, in addition to audio output, shows mono and stereo signal/noise ratios. With an aerial input of about $3 \mu\text{V}$ the mono S/N ratio is about 45 dB, while on stereo at the same input it is down to about 30 dB, which is worse by about 15 dB.

The $3 \mu\text{V}$ point corresponds to the stereo switching threshold, and since this can often be adjusted in modern tuners and tuner-amplifiers the S/N ratio margin at the lowest input for stereo could be above or below 15 dB. It is commonly about 10 dB, which in **fig 5** would occur if the stereo switching threshold line were shifted up to $10 \mu\text{V}$, as indicated by the chain-dot line (mono S/N ratio about 50 dB; stereo 10 dB worse at about 40 dB).

As the level of the aerial signal rises so the S/N ratio improves, and the margin almost completely disappears at high inputs. The stereo S/N ratio curve reveals the need for the best possible aerial system in areas of weak stereo signal. Traffic and electrical interference also shows up more on stereo when the signal is weak.

The output curve in the diagram shows how well the tuner 'limits'. Here maximum limiting is reached with an input of about $10 \mu\text{V}$, this being signified by the flattening out of the audio output at that signal level.

It is noteworthy that tuners with useable sensitivity of about $1.5 \mu\text{V}$ (S/N ratio about 50 dB relative to ± 75 kHz deviation) are becoming available. They are certainly not inexpensive, as might well be guessed, but they are making it possible for people well outside the normal stereo reception area to enjoy—albeit when reception conditions permit—the thrills of stereo by radio. For the lucky ones within reach of a BBC stereo station, then a 'fair' stereo tuner in conjunction with a stereo amplifier system is all that is called for. . . .

COLTON take care of your records

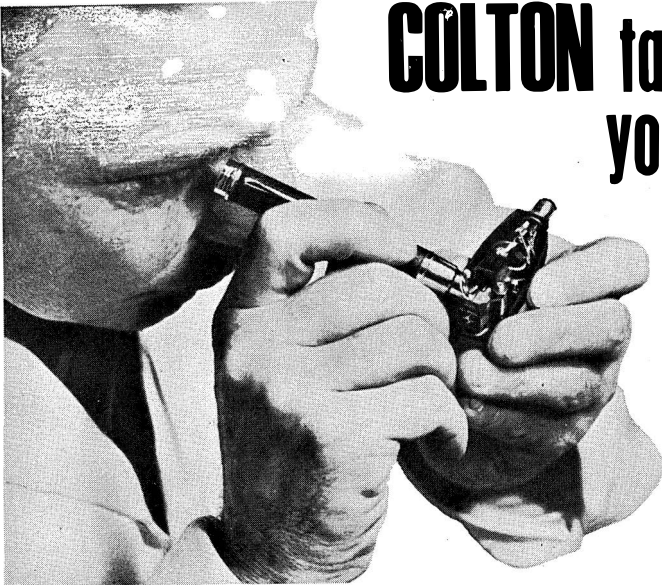

**Complement
high class
equipment
with well
designed
quality
accessories.**

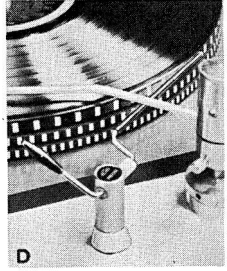
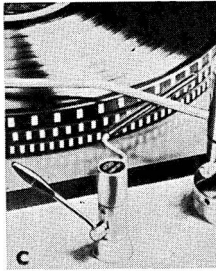
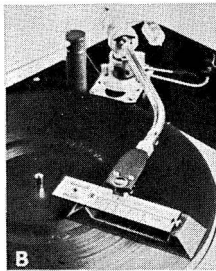

A. MAGNALIFT. Centre Lift off for non-auto pick-ups. When the pick-up has completed the playing cycle the Magnalift will lift and hold it clear of the record thereby obviating unnecessary stylus wear. Price: 62/7 Inc. P. Tax.

B. VARISCALE. Tracking Force Indicator for determining stylus pressure from 0-5 grams, a range adequate to cover all modern lightweight pick-ups. Price: 20/10 Inc. P. Tax.

C. VARILIFT. Damped descent Pick-up Control completely overcomes the possibility of dropping the pick-up and the disastrous effect on records resulting from this type of accident. Price: 75/- Inc. P. Tax.

D. PRECISE Manual Pick-up Lift suitable for use with practically any Hi-Fi turntable/pick-up combination. Price: 34/11 Inc. P. Tax.

E. STYLUS LIFE TIMER. The magnetically actuated precision-made mechanism registers in playing hours on a scale from 0-250 a convenient multiple for any stylus from sapphire to diamond. Price: 48/2 Inc. P. Tax.

F. TIMES FIFTY Pocket Microscope of X50 magnification suitable for all close inspection including stylus. Price: 17/6 No Tax.

The above is just a selection from our range of record care and gramophone accessories. See them at your record or Hi-Fi Centre or write for illustrated folder:-

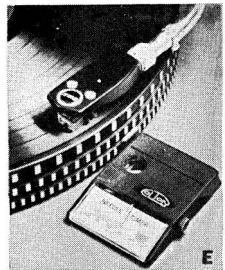

COLTON AND CO (LAPIDARIES) LTD - THE CRESCENT · WIMBLEDON · LONDON · S.W.19

A Wealth of Audio

THORENS

Renowned throughout the world for precision transcription turntables offering top performance and utmost reliability.

Ortofon

A range of stereo cartridges famed for their faithful reproduction of the original performance.

STANTON

A new range of stereo cartridges from U.S.A. competitively priced and covering every application.

metrosound

Great Britain's largest range of tape and audio accessories each one designed to enhance your listening pleasure.

Compact AUDIO SYSTEMS

Offering high quality high fidelity reproduction at a reasonable price.

SLOT STEREO

An amazing stereo playback system using 8 track stereo tape cartridges.

Available from all dealers or write direct for full details of any product

metrosound group of companies

Audio Works, 35/37, Queensland Road, London, N.7.
Telephone 01-607 0351/2/3.

Goldring

Goldring-Lenco GL75 Transcription Unit

Integrated transcription motor unit and arm, built to instrument standards of quality and appearance. The drive system is the unique Goldring-Lenco constant velocity 4-pole motor with conical shaft coupled to the underside of the turntable by a knife-edged idler (automatically disengaged by the on/off switch, which is fully click-suppressed and also operates a turntable brake).

The turntable is die-cast from non-ferrous material, weighs 9 lb. and is dynamically balanced.

Speed is continuously variable from 80-30 r.p.m. and from 18-15 r.p.m., with adjustable positive stops for the four standard playing speeds. There is only 0.2% change of speed for 10% mains voltage change. The GL75 is available in chassis form, or as the GL75/P mounted on an attractive teak base for which a clear plastic dust cover is available as an optional extra. The transcription arm is the Goldring-Lenco L75 which is lowered onto the record by a viscously damped lowering device.



Recommended List: GL75—£29.8.0. plus £7.0.2. P.T. GL75/P—
£36.5.6. plus £8.12.11. P.T. Plinth 75—£6.17.6. plus £1.12.10. P.T.
Lid 75 for GL75/P—£3.8.0. plus 16/3 P.T.

Goldring-Lenco GL69 Transcription Unit

The Goldring-Lenco GL 69 follows in the tradition of previous Goldring-Lenco Transcription Turntables in terms of quality and facilities. Its speeds can be continuously varied from 30 r.p.m. to 86 r.p.m. and there are pre-set click-in stops at 16 $\frac{1}{2}$, 33 $\frac{1}{3}$, 45 and 78 r.p.m. The mains on/off switch is fully suppressed, and the idler wheel is automatically disengaged from both turntable and drive as the unit is switched off. The GL69 is fitted with the L69 Arm which can be lowered onto the record by a viscously damped lowering device. The GL69 is available in chassis form or as the GL69/P, mounted on a very attractive teak base for which a clear plastic dust cover is available as an optional extra.



Recommended List: GL69—£20.5.0. plus £4.16.6. P.T. GL69/P—
£27.2.6. plus £6.9.3. P.T. Plinth 69—£6.17.6. plus £1.12.10 P.T.
Lid 69—£3.8.0. plus 16/3 P.T.

Transcription Unit Goldring G99

A transcription unit for those who prefer to mount, separately, an arm of their own choice. Incorporating the unique Goldring-Lenco continuously variable speed and vertical drive features, with less than 1% speed change for 13% mains voltage variation, this unit has an 8 lb. non-magnetic turntable and built-in neon-lit stroboscope. It is switched by push-buttons coupled to the idler disengagement mechanism. There are adjustable click-in positions for the four standard playing speeds. 200/250V A.C. 50Hz. 15 VA. Dimensions: 14 $\frac{1}{2}$ " x 13 $\frac{1}{2}$ ".



Recommended List: G99—£19.19.0. plus £4.15.0. P.T. C99 American
Walnut cabinet illustrated has detached panel for arm mounting, and clear
plastic dust cover. *Recommended List:* £8.19.6. plus £2.2.10. P.T.



Goldring Manufacturing Co. (Great Britain) Ltd.,
486-488 High Road, Leytonstone, London, E.11.
Tel: 01-539 8343.

Goldring

Goldring range of Free-Field cartridges

The Goldring 800 series of True Transduction cartridges has been developed on the unique 'Free Field' principle which allows even the most delicate groove-stored signals to be accurately relayed and re-created with uncompromising precision. The minimum-mass sensing element is precisely pivoted at its centre of gravity to provide fine transients and eliminate the thick, hazy lack of definition associated with the indeterminate pivoting of conventional cantilevers. Each cartridge in the Goldring 800 'Free Field' series tracks unerringly at low forces to re-create the finer, subtler shades of sound.

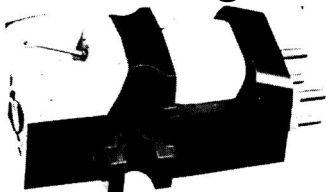

Goldring 800/H

The 800/H is designed for inexpensive changers to track between $2\frac{1}{2}$ -3 $\frac{1}{2}$ grams and has a high output of at least 8 mV.

Goldring 800

The 800 is designed for standard arms and changers where the requirements of high fidelity and robustness usually conflict.

Goldring 800/E

The 800/E is designed for transcription arms and a micro-elliptical diamond is fitted to a finer cantilever, end damped against natural tube resonances, and is accurately terminated in a special conical hinge to give pin-point pivoting.

Goldring 800 Super E

The 800 Super E is for those to whom perfection is barely good enough. Extraordinarily low mechanical impedance for ultimate tracking capabilities is achieved by a duo-pivoting arrangement, membrane controlled to avoid any longitudinal or torsional modes which could blemish its exceptionally smooth and extended response. Each cartridge is supplied with its individual curve and calibration certificate.

Recommended List: 800/H—£8.12.6. plus £2.1.3. P.T. 800—£10.10.0.
plus £2.10.0. P.T. 800/E—£15.4.6. plus £3.12.7. P.T. 800 Super E—
£21.0.0. plus £5.0.0. P.T.

Goldring-Lenco L75 Transcription arm *

**(as fitted to the GL75 Transcription Unit)*

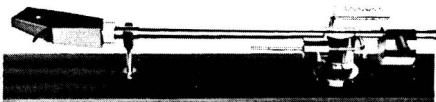

With single-hole fixing for arm and single hole fixing for rest, plus simple full height adjustments, this is an easy-to-fit high quality arm of Swiss design and manufacture. Knife-edge bearings ensure virtually frictionless movement and the rear counter-balance is used to achieve both arm balance and freedom from lateral swing. Stylus pressure is adjustable by the outrider, calibrated in steps of 0.5 gram from 0.5 to 5 grams. 'Anit-skating' (bias compensation) is achieved by a small suspended weight positioned to suit stylus tip radius and playing weight. An ultra light-weight interchangeable headshell, fixing to the arm by screw locking collar, takes all standard fitting cartridges, and has provision for moving the cartridge backwards or forwards ($\frac{1}{2}$ " movement) to achieve accurate stylus positioning.

Recommended List: £10.2.6. plus £2.8.4. P.T.

Goldring-Lenco L69 Transcription arm



This new light-weight pick-up arm has a removable plug-in shell which can accommodate all standard fixing cartridges for both mono and stereo reproduction. Both the height of the arm and the position of the stylus in the headshell can be adjusted to give optimum tracing. The stylus pressure is adjustable by sliding counterweight.

Recommended List: £7.10.0. plus £1.15.9. P.T.



Goldring Manufacturing Co. (Great Britain) Ltd.,
486-488 High Road, Leytonstone, London, E.11.
Tel: 01-539 8343.

Connoisseur Precision in Sound

THE BIG 4-FOR THE ENTHUSIAST

B.D.2. COMBINED TURNTABLE & PICK-UP QUALITY PERFORMANCE AT A REALISTIC PRICE

Featuring:

- ★ Belt drive turntable with S.A.U.2 arm operated by hydraulic lift and with lowering device.
- ★ 33 $\frac{1}{3}$ and 45 rpm
- ★ Virtually silent
- ★ Anti-vibration springs
- ★ Available as chassis only or in teak plinth.

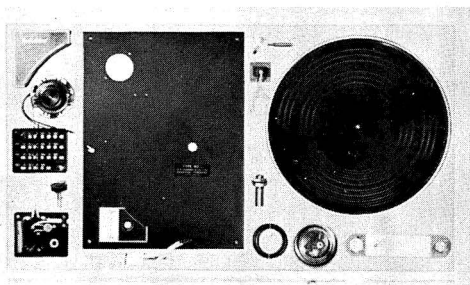

TURNTABLE KIT

Something new from Connoisseur—a Kit of the world famous B.D.1 Turntable. Construction is simplicity itself—the only tools required being a small screwdriver and a pair of pliers apart from the special spanner which is included. No soldering is required.

The B.D.1 Turntable operates at 33 $\frac{1}{3}$ and 45 rpm incorporating a flexible belt drive system, virtually eliminating vibrating and transmission noise and giving a performance that will meet the requirements of the discerning enthusiast.

S.A.U.2 PICK-UP ARM

This is one of today's most advanced pick-up arms and has:

- ★ Auto-bias compensator
- ★ Precision balance and many other features
- ★ Hydraulic lowering device



S.C.U.1 STEREO CARTRIDGE

This is the cartridge for the person who really cares about his equipment.

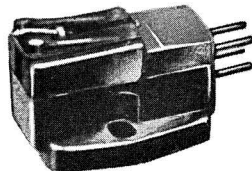

Fullst details of all Connoisseur Equipment on request to:

A. R. SUGDEN & CO. (ENGINEERS) LTD.

Market Street, Brighouse, HD6 1DX, Yorkshire.

Tel. 2142



Royal Festival Lounge a Shure presentation

The clarinets cluster by the sideboard. The violins crowd the fireplace. The whole orchestra seems to be there in the room with you, so lifelike is the music, so clear and true the sound, when you play your favourite record with a Shure cartridge. Listen with Shure and you'll hear what we mean. Shure stereo cartridges are suitable for both mono and stereo records.

Shure M75 Type II Series Hi-Track for high trackability at minimum tracking pressures and competitive prices.

M75E - Elliptical Stylus. $\frac{3}{4}$ -1 $\frac{1}{2}$ grammes

M75EJ - Elliptical Stylus. 1 $\frac{1}{2}$ -3 grammes

M75G - Spherical Stylus $\frac{3}{4}$ -1 $\frac{1}{2}$ grammes

M75-6 - Spherical Stylus 1 $\frac{1}{2}$ -3 grammes

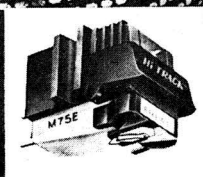

SHURE

*Shure Electronics Limited,
84 Blackfriars Road, London, S.E.1.
Tel: 01-928 3424*

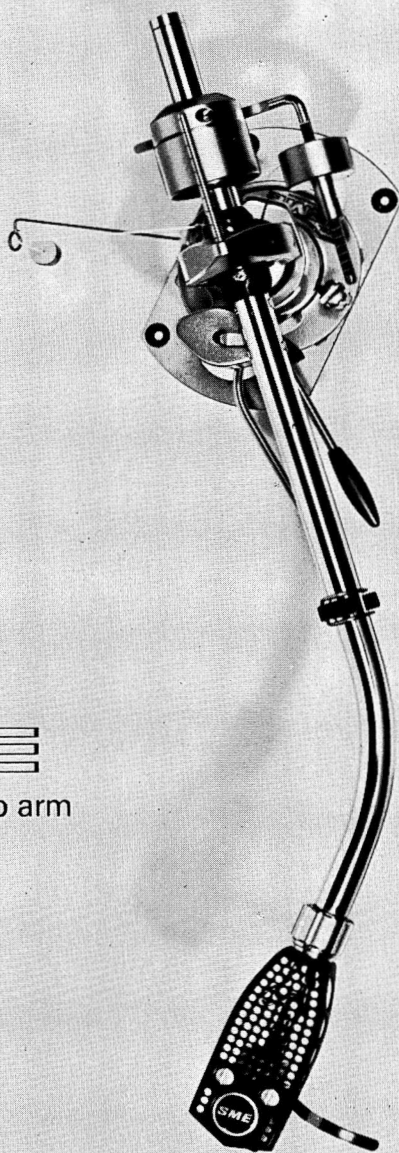

SME

The best pick-up arm
in the world

Write to SME Limited · Steyning · Sussex · England

DIRECTORY OF PICKUPS AND ARMS

In the abridged specifications of this directory, the following abbreviations are used for economy of space: **Pw**=recommended playing weight; **mg**=milligram; **gm**=gram; **Rec load**=recommended resistive load; **mV**=millivolt. In all cases where decibel limits for frequency response and frequency for stated separation are given by manufacturer, these are included. Output is usually referred to a recorded velocity of 1 cm/sec; this figure should be multiplied by five for the practical music output. ★ indicates model is illustrated.

ACOS—Cosmocord Ltd., Eleanor Cross Road, Waltham Cross, Herts. Tel: Waltham Cross 27331. Telex: 24294.

★**91-1 SC**. Mono/stereo compatible crystal cartridge. Turnover dual stylus. Pw 3-6 gm. Tip mass 2.5 milligram (sapphire), 2.8 milligram (diamond). Dynamic compliance: vertical 2×10^{-6} cm/dyne, lateral 4×10^{-6} cm/dyne. FR 50 Hz-12KHz. Output: 178 mV. Min load 1 megohm. Price: (sapphire/sapphire) £1 7s. 6d. (plus 6s. 6d. PT); (diamond/sapphire) £1 16s. 1d. (plus 8s. 7d. PT).

GP92. Mono ceramic cartridge. Turnover stylus assembly. LP 0.8 thou diamond or sapphire, 78 2.5 thou sapphire. Pw 4-10 gm. Tip mass 2.5 mg dynamic. Compliance 2.5×10^{-6} FR 150 Hz-16 KHz ± 3 dB, 12 dB down at 30 Hz relative to 1 KHz. Output: 100 mV. Load impedance 1 megohm. Low temperature co-efficient. Price: (sapphire/sapphire) £1 10s. (plus 7s. 2d. PT); (diamond/sapphire) £2 (plus 9s. 6d. PT).

★**GP93**. Stereo crystal cartridge. Turnover dual stylus. Stylus 0.6-0.7 thou diamond or sapphire, 2.5 thou sapphire. Pw 4-8 gm. Tip mass 2.5 mg dynamic. Compliance: vertical 2.2×10^{-6} cm/dyne, lateral 2.2×10^{-6} cm/dyne. FR flat 250 Hz-18KHz 3 dB down at 100 Hz relative to 1 KHz. Output: 250 mV. Rec load 1 megohm. Low temperature coefficient. Price: (sapphire/sapphire) £2 (plus 9s. 6d. PT); (diamond/sapphire) £2 10s. (plus 11s. 11d. PT).

★**GP94**. Stereo ceramic cartridge. Turnover dual stylus. Stylus 0.6-0.7 thou diamond or sapphire, 2.5 thou sapphire. Pw 2-4 gm. Tip mass 2.5 mg dynamic. Compliance: lateral 5×10^{-6} cm/dyne, vertical 6×10^{-6} cm/dyne. FR Flat 100 Hz-12 KHz, 7-8 dB down at 30 Hz relative to 1 KHz. Separation 20 dB at 1 KHz, 8 dB at 10 KHz, minimum. Output: 80 mV minimum. Load impedance: 1 megohm each channel. High capacity ceramic elements (1,000 pF). Low temperature co-efficient. Price: (sapphire/sapphire)

£2 5s. (plus 10s. 9d. PT); (diamond/sapphire) £2 15s. (plus 13s. 1d. PT).

GP95. Specification and price as GP93. Stylus (LP) 0.5-0.6 thou; (stereo/LP) 0.6-0.7 thou.

GP96. Specification and price as GP94. Stylus (LP) 0.5-0.6 thou; (stereo/LP) 0.6-0.7 thou.



AUDIO AND DESIGN LTD. Distributors: Keith Monks (Audio) Ltd., 54 Rounton Road, Church Crookham, near Aldershot, Hants. Tel: Fleet 3566.

★**Laboratory 9**. 9 in. pickup arm designed for low-mass ultra-high compliant cartridges tracking at very low stylus pressures. Damped uni-pivot arm with no lead-out wires. Bias correction and lifting device incorporated. Lathe base all fully adjustable by finger locking levers. Price: £25 (plus £6 2s. 6d. PT).

Laboratory 12. 12 in. version for professional use available to special order. Price on request.



AUDIO DEVELOPMENTS. U.K. distributors: B. H. Morris & Co. (Radio) Ltd., 84-88 Nelson Street, Tower Hamlets, London, E.1. Tel: 01-790 4824.

AD76K. Moving magnet stereo cartridge for stereo and LP only. FR 20Hz-20KHz. Sensitivity 5 mV at 1KHz. Diamond stylus. Channel balance within 2 dB. Separation 20 dB. Compliance 10×10^{-6} cm/dyne. Tracking force 0.5 gm. Weight: 5 gm. Dimensions: $30 \times 10 \times 16$ mm with standard $\frac{1}{2}$ in. centres. Price: £4 10s. (including PT).

AD86K. Moving magnetic stereo cartridge for stereo and LP only. FR 20Hz-20KHz. Sensitivity 5 mV at 1 KHz. Diamond stylus. Separation



Acos GP91-ISC

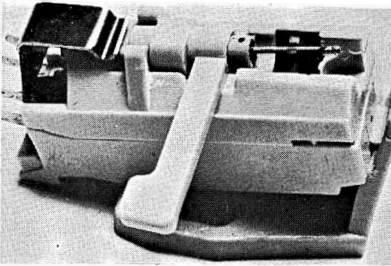

Acos GP93 crystal stereo

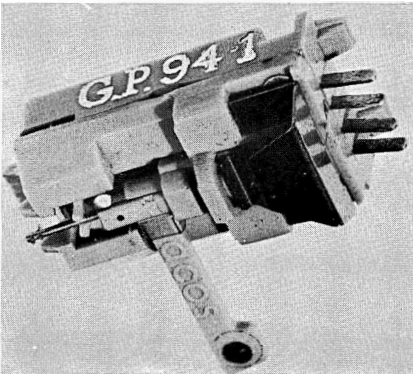

Acos GP.94-1 cartridge

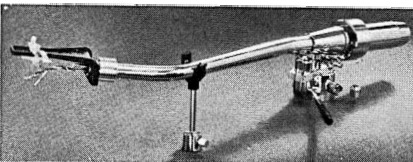

Audio and Design M9BA

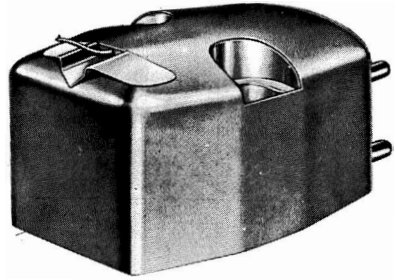

ADC 10/E Mk II

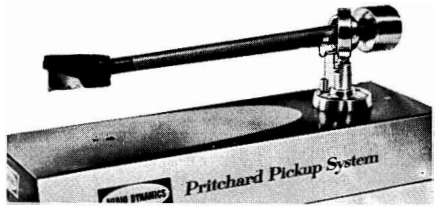

ADC 40 Mk II

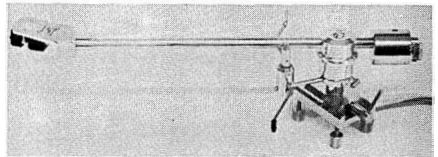

Audio Technica AT-1007



Bang & Olufsen ST/L-15

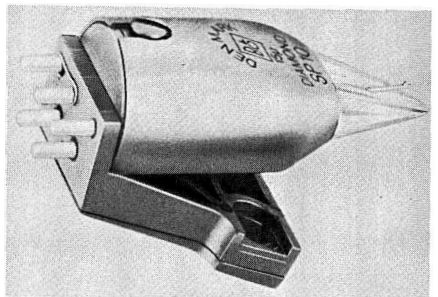

Bang & Olufsen SP10

tion 25 dB. Compliance: 10×10^{-6} cm/dyne. Tracking force 3 gm. Weight: 8.5 gm. Dimensions: $38 \times 19 \times 14$ mm with standard $\frac{1}{2}$ in. centre. Price: £6 2s. 6d. (including PT).

AD96K. Moving magnet stereo cartridge with diamond stylus. Price £5 18s. 6d. (including PT).

AD309K. $11\frac{1}{2}$ in. precision counterbalanced arm. Chrome plated on brass with needle bearings and weight adjustment. Complete with arm rest and base. Supplied with AD76K cartridge. Price: £9 19s. 6d. (including PT).



AUDIO DYNAMICS CORPORATION, New Milford, Conn., U.S.A. Sole U.K. agents: KEF Electronics Ltd., Tovil, Maidstone, Kent. Tel: Maidstone 57258. Cables: KEF, Maidstone.

★**ADC 10/E Mk. II.** Stereo cartridge. Induced magnet. Sensitivity 4 mV at 5.5 cm/sec. Separation 30 dB, 50 Hz-10 KHz. FR 10 Hz-20 KHz ± 2 dB. Stylus 0.7×0.3 diamond. Vertical tracking angle 15° . Pw $\frac{1}{2}$ - $1\frac{1}{2}$ gm. Compliance 35×10^{-6} cm/dyne. Cartridge weight 7 gm. Designed for use only with the ADC 40 arm. Price: £37 10s. (plus £8 14s. 2d. PT).

ADC 660. Stereo cartridge. Induced magnet. For use with all high grade arms. Stylus 0.5 thou diamond. Sensitivity 7 mV at 5.5 cm/sec. FR 10 Hz-20 KHz ± 3 dB. 15° vert angle. Pw $1\frac{1}{2}$ -4 gm. Compliance 20×10^{-6} cm/dyne. Weight: 7 gm. Separation 30 dB 50 Hz to 8 KHz. Price: £13 5s. (plus £3 1s. 6d. PT).

ADC 660/E. Similar specification to ADC 660 but with elliptical stylus 0.3×0.7 thou. Pw $1\frac{1}{2}$ -3 gm. Price: £18 5s. (plus £4 4s. 10d. PT).

ADC 220. Stereo magnetic cartridge. Induced magnet. Stylus 0.7 thou. Sensitivity 5 mV at 5.5 cm/sec. FR 10 Hz-18 KHz ± 3 dB. Channel separation 20 dB. 50 Hz-8 KHz. Vertical tracking angle 15° . Pw 2.5 gm. Compliance 15×10^{-6} . Price: £7 10s. (plus £1 14s. 10d. PT).

★**ADC 40 Mk II.** Complete low inertia arm with side thrust compensator and anti-drag lead out arrangement. Single-thrust ball bearings used at four points. Accurately machined walnut non-resonant arm. Adjustable counter-weight. Plug-in head shell accommodates nearly all cartridges. Easy installations. Built-in arm rest. Arm length $10\frac{3}{8}$ in. overall. Pivot to stylus tip 9 in. Rear overhang $1\frac{1}{4}$ in. Price: £15 15s. (plus £3 13s. 2d. PT).

ADC 550E. Magnetic stereo cartridge. Induced magnet. Sensitivity 5 mV at 5.5 cm/sec record velocity. Pw $\frac{3}{4}$ - $2\frac{1}{2}$ gm. FR 10 Hz-20 KHz ± 3 dB. Channel separation 20 dB 50 Hz-8 KHz. Compliance 28×10^{-6} . Elliptical stylus tip: contact radius 0.3 thou; lateral radius 0.7 thou. Vertical tracking angle 15° . Recommended load impedance 47K. Price: £16 10s. (plus £3 16s. 6d. PT).



AUDIO-TECHNICA. Distributors: Shiro (U.K.) Ltd., 8 Bush Lane, Cannon Street, London, E.C.4. Tel: 01-626 4711/3. Cables: Shiro, London, E.C.4.

AT-21. Stereo moving magnet cartridge. Du-exciting principle. Tracking angle 15° . Pw $\frac{1}{2}$ -2 gm. Compliance: 30×10^{-6} cm/dyne. Output: 4 mV at 1 KHz 5 cm/sec. Separation: 30 dB at 1 KHz. FR 10 Hz-25 KHz ± 2 dB. Stylus: 0.5 or 0.7 thou diamond. Price £8 14s. 8d. (inc PT). Replacement stylus AT21-7D (grey) £5 19s. 1d. (inc PT).

AT-21X. Similar to AT-21 but with 0.3×0.7 diamond stylus. Price: £15 9s. 11d. (inc PT). Replacement stylus for AT-21X £12 14s. 9d.

AT-33. Stereo moving magnet cartridge. V-magnet principle. Tracking angle 15° . Pw $\frac{1}{2}$ - $2\frac{1}{2}$ gm. Compliance: 23×10^{-6} cm/dyne. Output: 5 mV at 1 KHz 5 cm/sec. Separation: 27 dB. FR 10 Hz-20 KHz ± 2 dB. Stylus: 0.7 thou diamond. Price: £10 14s. 3d. (inc PT). Replacement stylus (0.7, 0.5 and 2.5 thou available) AT33-7D (grey) £5 9s. 5d. (including PT).

AT-35. Stereo moving magnet cartridge. V-magnet principle. Tracking angle 15° . Pw $\frac{1}{2}$ - $2\frac{1}{2}$ gm. Compliance: 23×10^{-6} cm/dyne. Output: 5 mV at 1 KHz 5 cm/sec. Separation: 30 dB. FR 10 Hz-25 KHz ± 2 dB. Stylus: 0.5 or 0.7 thou diamond. Price: £18 11s. (inc PT). Replacement stylus AT35-5D (0.5 thou yellow) £13 6s. 2d. (inc PT); AT35-7D (0.7 thou grey) £13 6s. 2d. (inc PT).

AT-35X. Similar to AT-35 but with 0.3×0.7 diamond stylus. Price: £24 4s. 9d. (inc PT). Replacement stylus: £18 19s. 11d.

AT-66. Stereo moving magnet cartridge. Du-exciting principle. Tracking angle 15° . Pw $\frac{1}{2}$ -2 gm. Compliance: 30×10^{-6} cm/dyne. Output: 4 mV at 1 KHz 5 cm/sec. Separation: 25 dB at 1 KHz. FR 10 Hz-20 KHz ± 2 dB. Stylus: 0.7 thou. diamond. Price: £6 4s. 8d. (inc PT). Re-

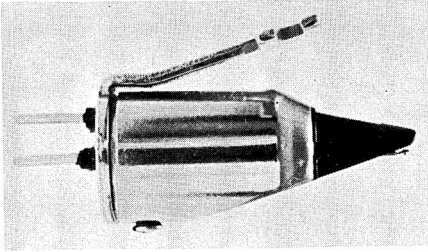

Bang & Olufsen SP6

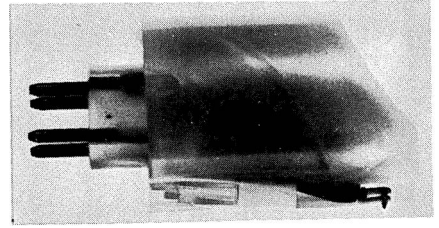

Decca Deram cartridge

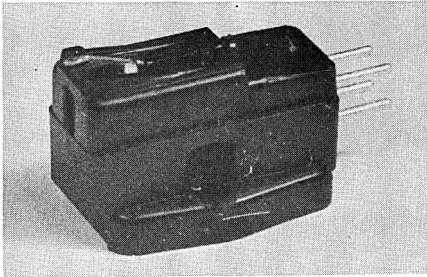

Connoisseur SCUI

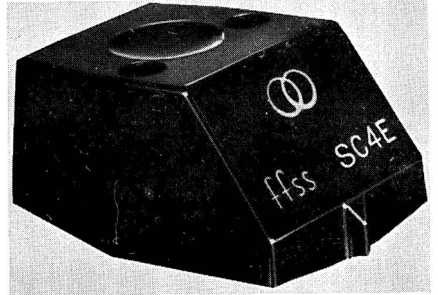

Decca SC4E Super cartridge

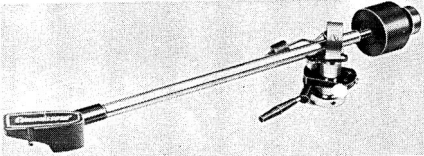

Connoisseur SAU2

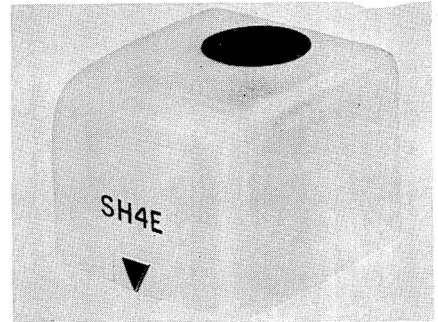

Decca SH4E Super head

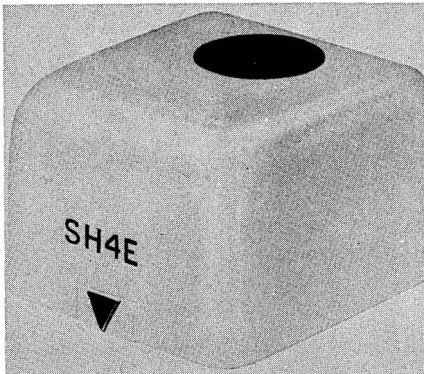

Decca SH4E Mk 4

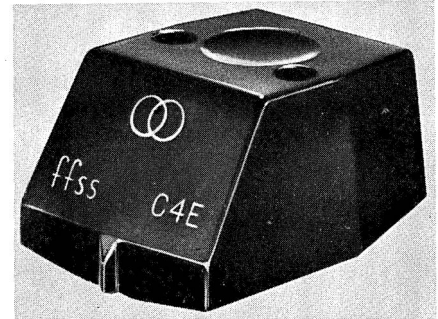

Decca C4E cartridge

placement stylus AT66-7D (grey) £3 9s. 9d. (inc PT).

Lower compliance version of AT-66 also available, compliance 20×10^{-6} cm/dyne. Replacement stylus as for AT-66. 0.7, 0.5 or 2.5 thou.

★ **AT1007.** Transcription pickup arm. £23 0s. 7d. (inc PT).

★

BANG & OLUFSEN U.K. DIVISION, Eastbrook Road, Gloucester. Tel: Gloucester 21591.

SP.1, SP.2. Stereo cartridges. Moving iron. Plug-in. Stylus: 0.6 thou diamond, 3 thou available. Pw 1.5-3 gm. Range: 30 Hz-15 KHz ± 2 dB. Separation: 22 dB min. Output: 7 mV. Rec load 47K. Price: £4 15s. 6d. (plus £1 4s. PT). Replacement styli 0.6 and 3.0 thou (diamond). Price: £2 18s. 6d. (plus 14s. 6d. PT).

★ **SP6, SP7, SP8, SP9.** Stereo cartridges. Moving iron. Pw 1.5-2 gm. Tip mass 1.5 mg. Compliance $12-15 \times 10^{-6}$ cm/dyne. FR 20 Hz-20 KHz ± 2.5 dB. Separation approx 20 dB at 1 KHz. Output: 7 mV per channel at 5 cm/sec. Rec load 47K. Diamond stylus. Fully shielded. Stylus protected against damage if arm dropped on record. Replaceable stylus assembly. SP6 for standard $\frac{1}{2}$ in. fixing centres. SP7 plug-in fitting for B & O arms. SP8 and SP9 similar to SP6 but with elliptical stylus and gold plated. Price: SP6 and SP7 £6 7s. 6d. (plus £1 12s. PT); SP8 and SP9 £10 7s. 6d. (plus £2 12s. PT).

★ **SP10, SP12.** Stereo cartridges. Moving iron. Pw 1-1.5 gm. Compliance: 25×10^{-6} cm/dyne. FR 15 Hz-25 KHz ± 3 dB. Separation: > 25 dB at 1 KHz. Output: 5 mV per channel (1 mV/cm/sec. Rec load 47K. Spherical or elliptical diamond stylus. Effective tip mass < 1 mg. Price: on request.

★ **ST/L.** pickup arm. Price: with SP7 cartridge £13 17s. 6d. (plus £3 9s. 6d. PT).

Pickup lift for ST/L 15° arm. Gives hydraulically controlled lowering. Price: £2 18s. (plus 14s. 6d. PT).

ST/P arm. Professional 12 in. arm. Price: on application.

GF2, GF3 Pre-amplifiers for above. See Pickup Accessories section.

BSR LTD., Monarch Works, Cradley Heath, Warley, Worcs. Tel: Cradley Heath 69272. Telex 33282.

C.1. Ceramic stereo turnover cartridge. Stylus: sapphire or diamond, .0007 LP/stereo, .0025/78. Pw 2-6 gm. Lateral and vertical compliances 5×10^{-6} cm/dyne and 3×10^{-6} cm/dyne. FR 20 Hz-10 KHz ± 2 dB. up to 15 KHz - 6 dB. Output: 0.11V ± 2 dB. Load impedance: 2 megohms 100 pF. Price: (sapphires) £2 10s. (plus 12s. 1d. PT); (diamond LP) £3 2s. 6d. (plus 15s. 2d. PT).

★

BURNE-JONES & COMPANY LTD., 18 Brunswick Road, Sutton, Surrey.

B.J. Tan/II arm. Designed to overcome tracking error. Total tracking error less than $\frac{1}{2}$ degree. Height adjustable. Price: £2 2s.

B.J. Super 90 Mk. II pickup arm. Two models. 12 in. and 16 in. Price (including plug-in shell to carry standard cartridges) £8 8s.

★

CONNOISSEUR. A. R. Sugden & Co. (Engineering) Ltd., Market Street, Brighouse, Yorkshire. Tel: Brighouse 2142. Cables: Connoisseur, Brighouse.

★ **SCU1.** Stereo ceramic cartridge with $\frac{1}{2}$ in. fixing centres. Stylus diamond 0.5-0.6 thou or 1 thou for mono. Pw 2-4 gm. Tip mass 1 mg. Compliance: lateral 12×10^{-6} cm/dyne; vertical 8×10^{-6} cm/dyne. Range: 25 Hz-18 KHz ± 3 dB. Separation (1 KHz) 25-30 dB; (10 KHz) 18 dB. Output with rec. load of 100K, 50 mV per channel, RIAA equalisation required. Output with 2 megohm load, 150 mV per channel, no equalisation required. Features: Four-terminal output, easily replaceable diamond stylus. Price: £4 14s. 6d. (plus £1 2s. 3d. PT).

★ **SAU2.** Pickup arm with gimbal mountings on ball bearings set at 45/45. Automatic bias compensator. Hydraulic lowering device. Decoupled counterbalance weight. Additional weight supplied to accommodate different cartridges. Single hole fixing. Height adjustable from 1 in. to 2 ins. Lightweight shell with $\frac{1}{2}$ in. fixing centres. Five-pin plug connection to base of pickup. Low resistance self-cleaning contacts. Supplied with set of leads and separate precision balance with range 0-6 gm. Price: £11 (plus £2 11s. 10d. PT). Extension stem for use with high turntables: 7s.

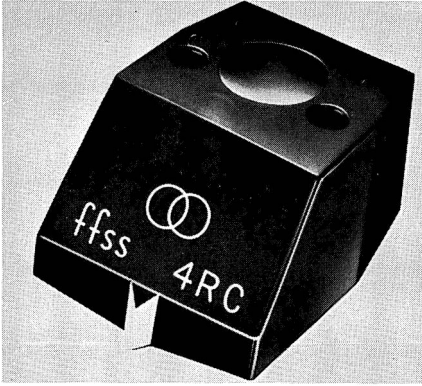

Decca 4RC cartridge



Decca H4E head

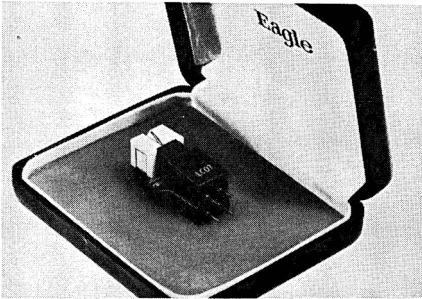

Eagle LC07

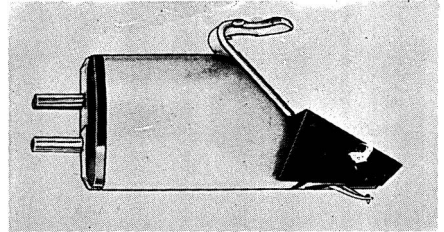

Empire Scientific 808

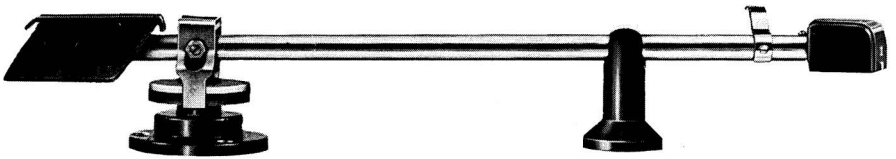

Decca Mk I Super arm

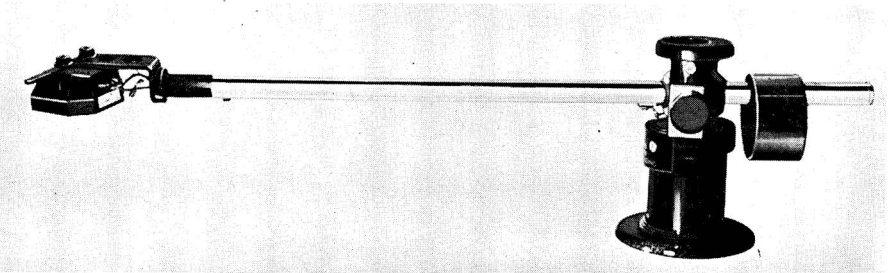

Decca International arm

COSMOCORD. See Acos.



DECCA. Decca Special Products, Ingate Place, Queenstown Road, London, S.W.8. Tel: 01-622 6677.

★**Deram ceramic.** Stereo/mono cartridge. White shell transcription quality. Pw 2.5 gm. Tip mass 0.6 mg. Compliance: 9×10^{-6} lateral, 5×10^{-6} vertical. FR 18 Hz-18 KHz ± 3 dB. Separation better than -20 dB at 1 KHz. Output: 35 mV per channel. Rec load impedance 2 megohms. Stylus 0.5-0.6 thou diamond. Price: £4 5s. (plus £1 PT).

NOTE: All Deram cartridges are of transcription quality, the black shell range intended primarily for cheaper auto-changers is discontinued.

Deram ceramic. Mono cartridge. Stylus 1 thou diamond. All other details as for stereo/mono cartridge. Price: £4 5s. (plus £1 PT).

Deram ceramic. Mono 78 cartridge. Stylus 3 thou sapphire. All other details as for stereo/mono Deram. Price: £2 11s. (plus 12s. PT).

ffss Mk II head. Variable reluctance stereo/mono head. FR 40 Hz-16 KHz. Separation -20 dB at 1 KHz. -15 dB at 50 Hz and 12 KHz. Output 1.2 mV/cm/sec per channel. Stylus 0.5 thou diamond. Pw 3.5 gm. Tip mass less than 1 mg. Compliance 10×10^{-6} lateral, 2×10^{-6} vertical. Recload 50K. Price: £12 19s. (plus £3 1s. PT).

★**ffss Mk 4 head H4E.** Variable reluctance stereo/mono head. FR 20 Hz-20 KHz (20 Hz-16 KHz ± 2 dB). Separation as for Mk II. Output 5 mV at 5 cm/sec per channel. Stylus 0.3×0.65 thou elliptical diamond. Pw 1-2½ gm. Compliance 30×10^{-6} lateral, 6×10^{-6} vertical. Rec load 50K. Output from each channel balanced within 1 dB. Price: £18 4s. 3d. (plus £4 5s. 9d. PT).

★**ffss Mk 4 head SH4E.** Variable reluctance stereo/mono head. FR 20 Hz-20 KHz ± 2 dB. Separation as for Mk II. Output 5 mV at 5 cm/sec per channel. Stylus 0.3×0.65 thou elliptical diamond. Pw 1-2½ gm. Compliance 30×10^{-6} lateral, 6×10^{-6} vertical. Rec load 50K. Output from each channel balanced within 1 dB. Price: £25 18s. 1d. (plus £6 1s. 11d. PT).

★**ffss Mk 4 cartridge C4E.** Stereo/mono cartridge. FR 20 Kz-20 KHz (20 Hz-16 KHz ± 2

dB). Separation as for Mk II. Output: 5 mV at 5 cm/sec per channel. Stylus 0.3×0.65 thou elliptical diamond. Pw 1-2½ gm. Compliance 30×10^{-6} lateral, 6×10^{-6} vertical. Rec load 50K. Output from each channel balanced within 1 dB. Price: £18 4s. 3d. (plus £4 5s. 9d. PT).

★**ffss Mk 4 cartridge SC4E.** Stereo/mono cartridge. FR 20 Hz-20 KHz ± 2 dB. Separation as for Mk III. Output: 5 mV at 5 cm/sec per channel. Stylus 0.3×0.65 thou elliptical diamond. Pw 1-2½ gm. Compliance 30×10^{-6} lateral, 6×10^{-6} vertical. Rec load 50K. Output from each channel balanced within 1 dB. Price: £25 18s. 1d. (plus £6 1s. 11d. PT).

★**ffss Mk 4 cartridge 4RC.** Stereo magnetic head. Diamond stylus 0.5/6 thou. Pw 3.5 gm. Tip mass less than 1 milligram. Compliance: 15×10^{-6} cm/dyne lateral, 4×10^{-6} cm/dyne vertical. FR 30 Hz-20 KHz (30 Hz-16 KHz ± 3 dB). Separation: better than 20 dB. Output: 1.5 mV at 1 cm/sec at 1 KHz. Rec load 47K. Price: £13 15s. 3d. (plus £3 4s. 9d. PT).

ffss Mono 78. Variable reluctance 78 equivalent of Mk II stereo/mono head. Stylus 2.8 thou diamond. Price: £18 16s. (plus £2 1s. 6d. PT).

ffss Mk 4 cartridge 78C. Mono magnetic cartridge. Diamond stylus 2.8 thou. Pw 3.5 gm. Tip mass less than 1 milligram. Compliance: 15×10^{-6} cm/dyne lateral. FR 30 Hz-16 KHz ± 3 dB. Output: 1.5 mV cm/sec. Rec load 47K. Price: £8 16s. (plus £2 1s. 6d. PT).

★**ffss Mk I 'Super'.** Transcription arm suitable for all ffss heads only. Price: £7 5s. 8d. (plus £1 14s. 4d. PT).

★**ffss 'International' Arm.** Stereo pickup arm. Jewelled uni-pivot. Pw ½-3½ gm. Constantly variable magnetic bias compensation. Suspended on magnetic cushion. Provision for damping lateral and vertical resonances. Price: £21 9s. (plus £5 1s. PT).

NOTES: Decca maintains that head and arm should be designed as an entity for optimum results. For this reason Decca ffss arms and heads have an exclusive head fitting, which also ensures accurate alignment. All ffss heads will fit all ffss arms, but heads with elliptical stylus should be used only with 'Professional' arms, or arms reaching the 'Super' specification. Original Mk I arms not reaching 'Super' specification can be converted for £3 3s.

Deram heads are suitable for use with amplifiers having a sensitivity of 100 mV.

Diamond styli for all Deram pickup heads, including 78 heads, are £1 7s. 6d. each including PT. Replacement Deram elliptical styli are now available at £2 10s. each inc. PT.

Decca *ffss* pickup heads can be inspected for a charge of 12s. 6d. When the stylus is worn on a Decca *ffss* head it must be returned to the maker for replacement. The service offered is complete replacement of the head with a reconditioned head having a new stylus. Performance is guaranteed to be as new. Prices for this service are as follows: Mk III elliptical styli £7. Mk I and II spherical styli £5 10s. Mono LP and 78 styli £5. Mk 4 H4E and C4E elliptical styli £7 10s. Mk 4 SH4E and SC4E elliptical styli £10. Mk 4 78C spherical styli £5. All prices include PT.

Mk I *ffss* heads are no longer in production, but existing ones can be modified to Mk II specification for £2 4s. 0d.



EAGLE PRODUCTS. Distributors: B. Adler & Sons (Radio) Ltd., Coptic Street, London, W.C.1. Tel: 01-636 9606. Cables: Reldab, London.

★**LC 07.** Stereo cartridge. Moving magnet. LP and stereo. FR 20 Hz-21 KHz. Compliance 15×10^{-6} cm/dyne. Separation 28 dB at 1 KHz. Output: 7 mV per channel. Rec load 47K. Price: £5 11s. 9d. (plus £1 7s. 9d. PT).



ELAC. Electroacoustic GmbH, Kiel, West Germany. U.K. sales (magnetic cartridges): Unilet Products Ltd., Compton House, Malden Road, New Malden, Surrey. Tel: 01-942 9567.

All cartridges listed are moving magnet types and have $\frac{1}{2}$ in. fixing centres. There is no trade distribution, sales are made direct to consumers only. All prices quoted include PT.

STS 244-17. Stylus 0.7 thou diamond. Pw 1.5-3 gm. Compliance 18×10^{-6} cm/dyne. FR 20 Hz-20 KHz. Crosstalk damping 22 dB at 1 KHz. Output: 7.5 mV. Rec load 47K. Price: £7 17s. 6d.

S.244-65. Sapphire stylus for 78 r.p.m. for 244 series cartridges. Price: £4 14s. 9d.

STS 344-17. Stylus 0.7 thou diamond. Pw 1.2 gm. Compliance 25×10^{-6} cm/dyne. FR 20 Hz-22 KHz. Crosstalk damping 24 dB at 1 KHz. Output: 5 mV. Rec load 47K. Price: £11 19s.

STS 444-12. Stylus 0.5 thou diamond. Pw 0.75-1.5 gm. Compliance 33×10^{-6} cm/dyne. FR 10 Hz-24 KHz. Crosstalk damping 26 dB at 1 KHz. Output: 5 mV. Rec load 47K. Price: £16 5s. 6d.

STS 444-E. Similar specification but with 0.2×0.8 thou elliptical stylus. Price: £22.



EMPIRE SCIENTIFIC. Distributors: Cosmocord Ltd., Acos Works, Eleanor Cross Road, Waltham Cross, Herts. Tel: Waltham Cross 27331. Telex: 24294.

999VE. Stereo-mono cartridge. 0.2×0.7 thou bi-radial elliptical hand polished diamond. Compliance 30×10^{-6} cm/dyne. FR 6 Hz-35 KHz. Price: £37 10s. (plus PT).

888VE. Stereo-mono cartridge. 0.2×0.7 thou bi-radial elliptical hand polished diamond. Compliance 30×10^{-6} cm/dyne. FR 6 Hz-32 KHz. Price: £23 14s. (plus PT).

888TE. Stereo-mono cartridge. 0.2×0.7 thou bi-radial elliptical hand polished diamond. Compliance 25×10^{-6} cm/dyne. FR 6 Hz-32 KHz. Price: £20 2s. 9d. (plus PT).

888E. Stereo-mono cartridge. 0.4×0.9 thou bi-radial elliptical hand polished diamond. Compliance 25×10^{-6} cm/dyne. FR 10 Hz-30 KHz. Price: £13 19s. (plus PT).

★**888.** Stereo-mono cartridge. 0.7 thou diamond. Compliance 10×10^{-6} cm/dyne. FR 10 Hz-24 KHz. Price: £10 3s. 3d. (plus PT).

808E. Stereo-mono cartridge. 0.4×0.9 thou elliptical diamond. Compliance 12×10^{-6} cm/dyne. FR 10 Hz-25 KHz. Price: £11 2s. 3d. (plus PT).

★**808.** Stereo-mono cartridge. 0.7 thou diamond. Compliance 8×10^{-6} cm/dyne. FR 10 Hz-20 KHz. Price: £7 13s. 5d. (plus PT).



EUPHONICS. Distributors: Farnell-Tandberg Ltd., Hereford House, North Court, Vicar Lane, Leeds 2. Tel: Leeds 39834.

Miniconic. Semiconductor stereo cartridge. Crystalline silicon element treated so that changing pressures produced by stylus vary the resistance. FR 20 Hz-20 KHz ± 2 dB. Pw 0.5 gm.

Tracks up to 40 KHz. Stylus 0.2×0.7 elliptical diamond. Compliance 25×10^{-6} cm/dyne horizontal and vertical. Output dependent on setting of power supply unit and adjustable between 8 mV at 47K to 400 mV at 500K. Also supplies 100 mV at 600 ohms. Must have external power source which may be from a separate unit or derived from associated equipment. Price: U15-LS, £21 10s. (plus £5 1s. 2d. PT); U15P, £12 12s. (plus £2 19s. 3d. PT).

Miniconic PS-15 Power Supply. Supplies 6 mA polarising current to each element at 14V DC inverts phase of one element to provide normal in-phase output signals. Matches impedance and levels to suit any type of pre-amplifier input. Price: £9 9s.



GOLDRING MANUFACTURING CO. (GREAT BRITAIN) LTD., 486-488 High Road, Leytonstone, London, E.11. Tel: 01-539 8343. Cables: Echovox. London.

★**Goldring/Lenco L75.** Transcription pickup arm. Calibrated stylus pressure adjustment. Removable plug-in shell with adjustable stylus position. Anti-skating bias compensator. Price: £10 2s. 6d. (plus £2 8s. 4d. PT).

Goldring/Lenco L69 pickup arm. Stereo. Low mass tubular arm. Removable plug-in shell with stylus position adjustment. Sliding counterweight stylus pressure adjustment, height adjustment. Price: £7 10s. (plus £1 15s. 9d. PT).

★**CS90.** Stereo ceramic cartridge. Stylus 0.5 or 0.7 thou diamond. Pw 2 gm. Compliance 8×10^{-6} cm/dyne. FR 30 Hz-18 KHz. Separation: 25 dB at 1 KHz, 10 dB at 10 KHz. Output: 50 mV. Rec load 1-2 megohms. Price: £4 4s. (plus £1 PT).

CS91E. Stereo/LP ceramic cartridge. Stylus: elliptical diamond. Pw $1\frac{1}{2}$ -3 gm. Tip mass 1 mg. FR 20 Hz-20 KHz. Separation 25 dB. Output: 20 mV. Rec load 2 megohms. Price: £6 6s. (plus £1 10s. 1d. PT).

MX4L. Turnover stereo compatible mono crystal cartridge. Pw 3-5 gm. Stylus: sapphire or diamond 0.7 and 3 thou. Compliance 7×10^{-6} cm/dyne lateral, 5×10^{-6} cm/dyne vertical. FR 20 Hz-15 KHz. Output: 200 mV. Rec load 1 megohm. Price: £1 1s. (plus 5s. PT).

MX4M. Turnover stereo compatible mono crystal cartridge. Pw 4-6 gm. Stylus: sapphire or

diamond 0.7 and 3 thou. Compliance 5×10^{-6} cm/dyne lateral, 3×10^{-6} cm/dyne vertical FR 20 Hz-15 KHz. Output: 400 mV. Rec load 1 megohm. Price (with sapphire): £1 1s. (plus 5s. PT).

★**'800'.** Stereo magnetic cartridge. Stylus 0.5 thou diamond. Pw 1-3 gm. Tip mass less than 1 mg. Compliance 20×10^{-6} cm/dyne. FR 20 Hz-20 KHz ± 3 dB. Separation 20 dB at 1 KHz, 15 dB at 10 KHz. Output: 1 mV. Rec load 47K. Price: £10 10s. (plus £2 10s. PT).

G800E. Stereo magnetic cartridge. Stylus: 0.3×0.8 diamond. Pw $\frac{3}{4}$ - $1\frac{1}{4}$ gm. Tip mass: less than 1 mg. Compliance 30×10^{-6} cm/dyne lateral and vertical. FR 10 Hz-25 KHz. Separation: 25 dB at 1 KHz, 15 dB at 10 KHz. Output: 1 mV. Rec load 47K-100K. Price: £15 4s. 6d. (plus £3 12s. 7d. PT).

★**G800E Super E.** Stereo magnetic cartridge. Single-sided with elliptical diamond, 0.3×0.8 thou replaceable. Pw $\frac{1}{2}$ - $1\frac{1}{4}$ gm. Tip mass less than 1 mg. Compliance 35×10^{-6} . FR 10 Hz-23 KHz. Channel separation 25 dB (1 KHz) and better than 15 dB (10 KHz). Output voltage 0.8 mV. Rec load 47K. Price: £21 (plus £5 0s. 1d. PT).

Goldring G800/H magnetic stereo cartridge. Single-sided with 0.7 thou tip radius diamond. Replaceable. Pw $2\frac{1}{2}$ - $3\frac{1}{2}$ gm. Tip mass 1.2 mg. Compliance 18×10^{-6} . FR 20 Hz-20 KHz. Separation 20 dB at 1 KHz, 10 dB at 10 KHz. Output: 1.6 mV. Rec load 47K. Price: £8 12s. 6d. (plus £2 1s. 3d. PT).



G. F. C. HADCOCK, Audio Division. The Old Vicarage, Doveridge, Derby, DE6 5NN. Tel: Uttoxeter 2452.

★**GH Unipoise Mk 3 arm Series A.** Finely engineered tubular metal arm with slotted head shell. Accepts all lightweight cartridges down to $\frac{1}{2}$ gm. Standard $\frac{1}{2}$ in. fixing centres. Simplicity of Unipivot design permits ease of mounting and operation. Bias adjustment included. Easily adjusted calibrated playing weight 0.3 gms. GH Uni-lift lowering device available separately (see Pickup Accessories Section). Dimensions: length $13\frac{1}{4}$ in., height 2.4 in., pivot to stylus point $9\frac{3}{4}$ in., pivot to centre of turntable 9.1 in., rear overhang clearance required $3\frac{1}{4}$ in. Price: £14 9s. 6d. (plus £3 8s. 1d. PT).

GH Unipoise Mk 3 arm Series B. Satin finish similar to Series A apart from dimensions. Size:

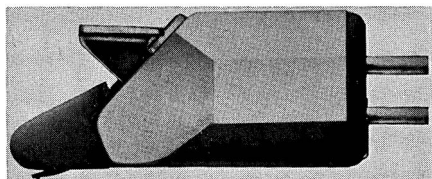

Empire Scientific 888SE

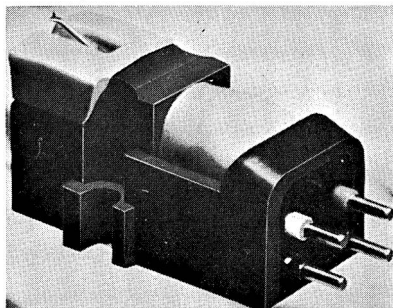

Goldring G800/E cartridge

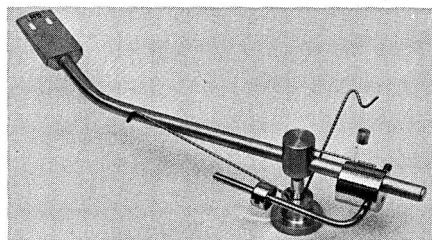

GH Unipoise Mk 3

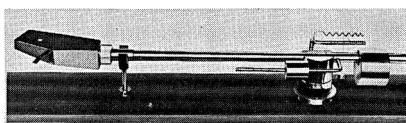

Goldring L75 pickup arm

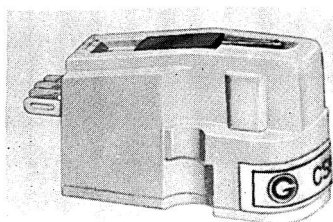

Goldring CS90 stereo ceramic cartridge

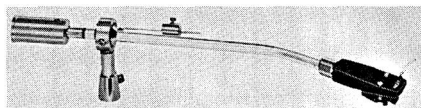

Neat G30

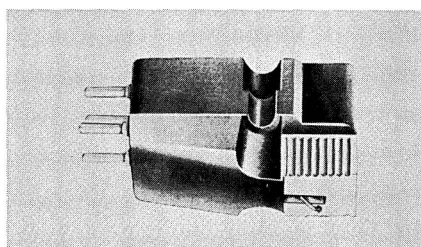

Neat V70

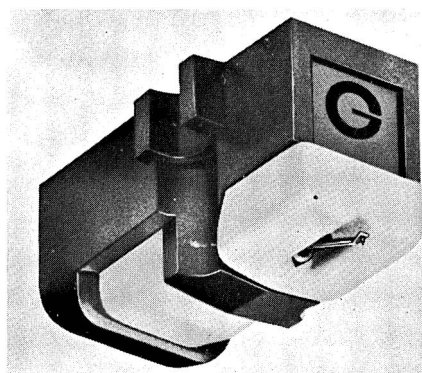

Goldring 800 cartridge

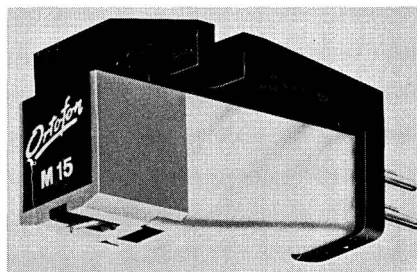

Ortofon M15

length 12.5 in., height 2.4 in., pivot to stylus 9 in., pivot to centre of turntable 8.38 in., rear overhang clearance required 3.25 in. Price: with bias-adjustment £11 11s. (plus £2 14s. 4d. PT); without bias-adjustment £10 10s. (plus £2 9s. 5d. PT).



NEAT CORPORATION. Distributors: Howland-West Ltd., 2 Park End, South Hill Park, London, N.W.3. Tel: 01-794 6666 and 6033.

★**G30.** Transcription arm and shell. Wired for mono or stereo. Easy mounting. Accommodates all standard cartridges. Adjustable tracking weight. Supplied with aluminium head shell, pickup rest, pressure gauge and plug-in leads with phono plugs. Vertical balance by miniature ball bearings, horizontal balance by jewelled pivots. Decoupled balance weight at rear of arm provides coarse adjustment of playing weight, rider weight at side of arm provides fine adjustment. Screw collar permits height adjustment. Pivot to stylus 9 $\frac{3}{4}$ in. Arm length 13 in. Leads 56 in. Height (adjustable) 1 $\frac{3}{4}$ -3 $\frac{1}{4}$ in. Mounting hole $\frac{1}{2}$ in. dia. Cartridge fixing $\frac{1}{2}$ in. centres. Price: £9 10s. 6d. (plus £2 4s. 1d. PT).

Lift. Optional oil lift for G30 arm. Price: £3 (plus 13s. 11d. PT).

★**V70.** Magnetic stereo cartridge. Stylus 0.5 thou diamond. Pw 1 $\frac{1}{2}$ -3 gm. Separation 30 dB at 1 KHz. Rec load 50K. Output: 5 mV at 100 Hz 5 cm/sec. Price: £4 5s. (plus 19s. 8d. PT).

V70E. Stereo magnetic cartridge. Elliptical diamond 0.2×0.7 thou. Pw 1.5-3 gm. Compliance 5×10⁻⁶. FR 18 Hz-22 KHz. Channel separation 30 dB at 1 KHz. Output voltage: 5 mV. Load impedance: 50K. Price: £6 6s. (plus £1 9s. 3d. PT).



ORBIT. Distributors: Highgate Acoustics, 184-188 Great Portland Street, London, W.1. Tel: 01-636 2901.

NM22. Magnetic stereo cartridge with diamond stylus. FR 20 Hz-20 KHz. Channel separation 20 dB at 1 KHz. Output: 5 mV. Load: 50K-100K. Playing weight: 2-3 gm. Price: £5 3s. 3d. (plus £1 2s. 9d. PT). Replacement diamond stylus: £2 11s. 8d. (plus 11s. 4d. PT).



ORTOFON. Fonofilm Industri A/S Copen-

hagen. Distributed in the U.K. by Metro-Sound Audio Products Ltd., Cartersfield Road, Waltham Abbey, Essex. Tel: Waltham Abbey 31933.

Type C (without shell). Moving coil head. Diamond stylus. Output voltage LP 0.3 mV. Range 20 Hz-20 KHz linear. Pw 3 gm. Load impedance 2 ohms (transformer required). Price: £13 5s. (plus £3 2s. 4d. PT).

Type CE. As type C but with elliptical stylus. Price: £18 5s. (plus £4 5s. 11d. PT).

Transformer. For use with above pickups. Price: £3 5s.

★**M15.** Moving magnet cartridge. Replaceable styli (elliptical or conical). Output at 1 KHz 0.9 mV/cm/sec ±1 dB per channel. Load 47K. FR 20 Hz-20 KHz ±2 dB. 30 dB sep at 1 KHz. Tracking angle 15°. Tip mass 0.4 mg. Stylus pressure: min $\frac{3}{4}$ gm. recommended 1 $\frac{1}{2}$ gm. Price: M15E (elliptical) £27 10s. (plus £6 9s. 5d. PT), M15 (conical) £22 10s. (plus £5 5s. PT).

MF15. As M15 above except stylus pressure: min 1 gm. rec 2 gm. Price: MF15E (elliptical) £22 10s. (plus £5 5s. PT), MF15 (conical) £17 10s. (plus £4 2s. 4d. PT).

Replacement styli for M15 and MF15. Price: M15E: grey, £12 10s. (plus £2 18s. 10d. PT); red, £10 (plus £2 7s. PT); M15: blue, £9 (plus £2 2s. 4d. PT); black, £7 10s. (plus £1 15s. 4d. PT).

S15TE. Moving coil cartridge with 15 degree angle and wider compliance than previously obtained. Effective tip mass 0.9 mg. Pw 1-2 gm. Stylus 0.7 thou diamond. Tracking angle 15 degrees. Compliance 20×10⁻⁶ cm/dyne. Separation 20-30 dB. FR 20 Hz-20 KHz ±2 dB. Shielded against magnetic fields. Built-in transformers. Weight (including transformers) 18.5 gm. Output impedance 15K. Rec load 47K. Output 2 mV. Price £27 10s. (plus £5 16s. PT).

Shells. Type M metal shells for 15 Series cartridges. Price: £1 5s. (plus 5s. 10d. PT).

★**SL15/E.** Moving coil stereo cartridge. Pw 1-2 gm. Tip mass 0.9 mg. Compliance 25×10⁻⁶ cm/dyne. FR 10 Hz-40 KHz. Separation 20-30 dB. Output 0.04 mV/cm/sec (loaded). Output impedance 2 ohms. Matching transformer required for most amplifiers (see transformer below). Stylus diamond 0.6×0.3 thou. Tracking angle 15 degrees. Price: £24 (plus £5 12s. 11d. PT).

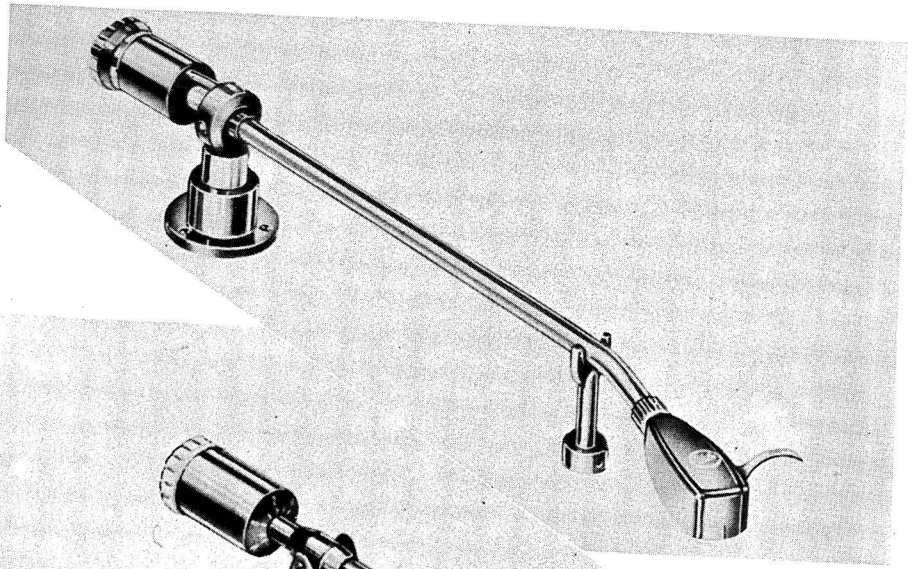

Ortofon RMG 309 arm

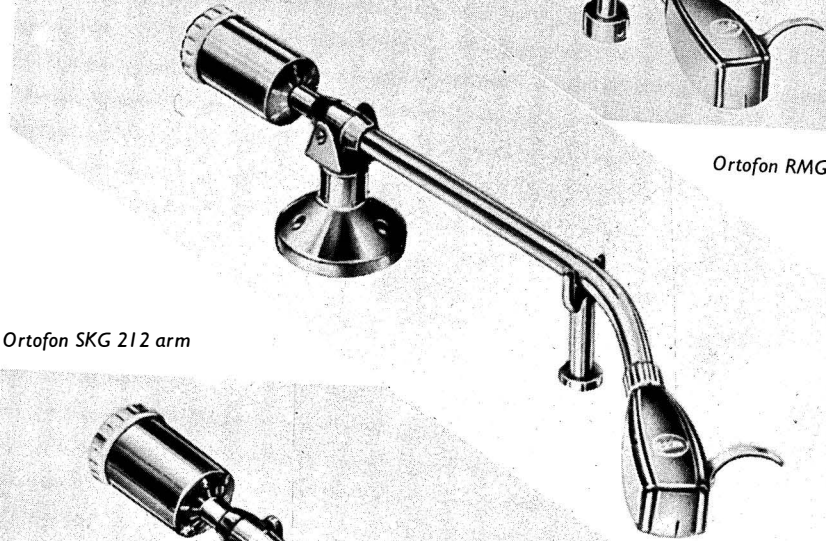

Ortofon SKG 212 arm

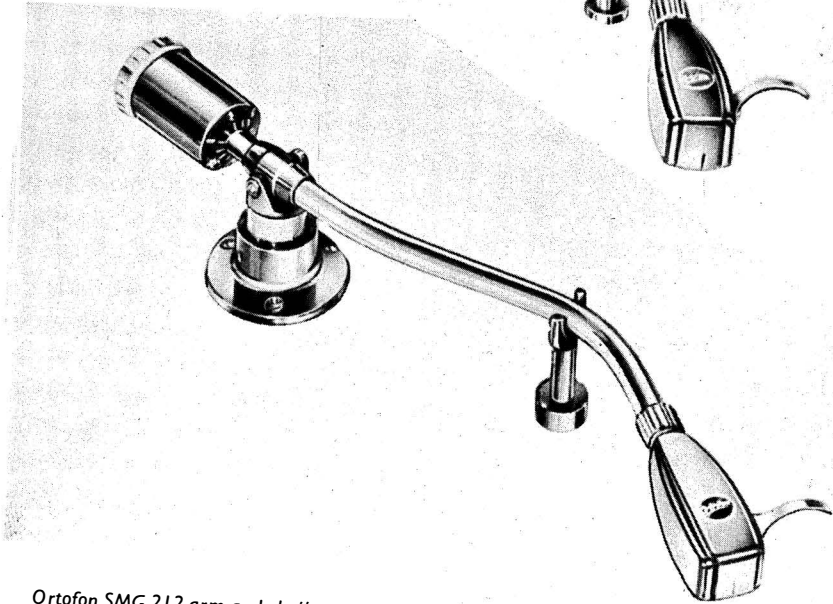

Ortofon SMG 212 arm and shell

SL15. Similar specification to SL15/E but with spherical 0.6 thou diamond stylus. Price: £18 5s. (plus £4 15s. 11d. PT).

Transformer module. Primary impedance 2 ohms. Secondary impedance 15K. Load 10K to 50K without change in frequency response. FR 20 Hz-40 KHz. Price: £7.

SPU (without shell). Moving coil stereo cartridge. Diamond stylus 0.65-0.7 thou. Output voltage 0.05 mV. Range 20 Hz-20 KHz. Separation 20-25 dB. Pw 2 gm. Rec load 2 ohms. Price: £13 5s. (plus £3 2s. 4d. PT).

SPU-T (without shell). Moving coil cartridge with built-in transformers. Diamond stylus. Channel separation 20-25 dB. Range 20 Hz-20 KHz. Load imp 50K ohms. Pw 2 gm. Output voltage 2 mV. Available with pure stereo 0.5 or 0.65 thou diamond for use with mono/stereo. Price: £15 5s. (plus £3 11s. 9d. PT).

SPU-E (without shell). Stereo cartridge. Moving coil. Stylus elliptical diamond 0.9 × 0.3 thou. Pw 2 mg. Tip mass 1 mg. Compliance 10×10^{-6} cm/dyne. Range 20 Hz-20 KHz. Separation 25 dB. Rec load 2 ohms. Output voltage 0.05 mV. Price: £18 5s. (plus £4 5s. 11d. PT).

★ **SPU-T/E (without shell).** Stereo cartridge with built-in transformers. Output voltage 2 mV. Rec load 50K. Other details as for SPU-E. Price: £20 5s. (plus £4 15s. 4d. PT).

Shells. Type G shells for SPU and C Series cartridges. Price: £1 (plus 4s. 8d. PT).

★ **SKG/212.** 12 in. pickup arm with adjustable playing weight. Price: £7 (plus £1 12s. 11d. PT).

★ **SMG/212.** 12 in. pickup arm for stereo and mono cartridges. Playing weight adjustable from 0-12 gm. Price: £11 (plus £2 11s. 10d. PT).

★ **RMG/309.** 16 in. pickup arm. Details as for SMG/212. Price: £21 (plus £4 18s. 10d. PT).

RS212. Similar to RMG arm but with the addition of automatic anti-skating device. Length of arm 11.8 in. Centre of arm base to turntable centre $8\frac{3}{8}$ in. Height adjustable $1\frac{3}{8}$ - $2\frac{3}{8}$ in. Arm base 2 in. dia. Centre of base to stylus tip 9 in. Off-set angle 22.7 degrees. Stylus pressure adjustable 0.4-5 gm. Suitable for cartridges weighing 7-19 gm. Hi-Jack cueing device built in. Ratio between stylus pressure and anti-skating force is factory adjusted to suit Ortofon cartridge with elliptical stylus. Ratio adjustment

screw provided to alter for other cartridges. Price: £25 (plus £5 17s. 7d. PT).



PHILIPS ELECTRICAL LTD., Century House, Shaftesbury Avenue, London, W.C.2. Tel: 01-437 7777.

GP200. Plug-in stereo ceramic turnover head. Stylus: diamond 0.7 thou. 78 sapphire 3 thou. Pw 3-6 gm. Compliance lateral 2.5×10^{-6} , vertical 1.3×10^{-6} . FR 50 Hz-18 KHz ± 3 dB. Output voltage 65 mV. Rec load $\frac{1}{4}$ -1 M. Price: to be announced.

GP410. Plug-in stereo magneto dynamic head. 45/LP only. Stylus 0.6 thou. Pw 2-4 gm. Effective tip mass: 1 mg. Compliance lateral 10×10^{-6} , vertical 8×10^{-6} . FR 30 Hz-18 KHz ± 3 dB. Channel separation >20 dB at 1 KHz. >12 dB at 10 KHz. Output voltage: 1 mV. Rec load 68K. Price: £11 7s. 6d. (plus £2 13s. 7d. PT).

GP411. Stereo magneto dynamic cartridge. 45/LP only. Standard $\frac{1}{2}$ in. mounting centres. Stylus 0.6 thou diamond. Pw 2-4 gm. Effective tip mass 1 mg. Compliance lateral 10×10^{-6} , vertical 8×10^{-6} . FR 30 Hz-18 KHz ± 3 dB. Channel separation >20 dB at 1 KHz. >12 dB at 10 KHz. Output: 1 mV. Rec load 68K. Price: £10 10s. 5d. (plus £2 9s. 7d. PT).

GP412. Stereo magneto dynamic cartridge. 45/LP only. Standard $\frac{1}{2}$ in. mounting centres. Stylus: 0.3 × 0.7 thou bi-radial diamond. Pw 0.75-1.5 gm. Effective tip mass <0.75 mg. Compliance lateral >20 nominal 25; vertical >15 nominal 20. FR 20 Hz-20 KHz ± 2 dB. Channel separation >25 dB at 1 KHz. >16 dB at 10 KHz. Output: 0.8 mV. Rec load 47K. Price: £31 11s. 5d. (plus £7 8s. 7d. PT).



PICKERING. Distributors: Highgate Acoustics, 184-188 Great Portland Street, London, W.1. Tel: 01-636 2901.

Pickups. Full range of magnetic (including moving magnet) cartridges. Stereo. Sapphire, diamond, spherical, and elliptical replacement styli available. FR 10 Hz-20 KHz and 10 Hz-25 KHz. Channel separation 35 dB. Outputs: 4.4 mV-8 mV. Prices: £8 12s. 6d.-£16 10s. (plus £2 2s. 2d.-£4 0s. 8d. PT).

Styli. Full range of replacement styli includes sapphire, diamond spherical, elliptical and 78 rpm types. Prices: £3 3s.-£12 12s. (inc. PT).

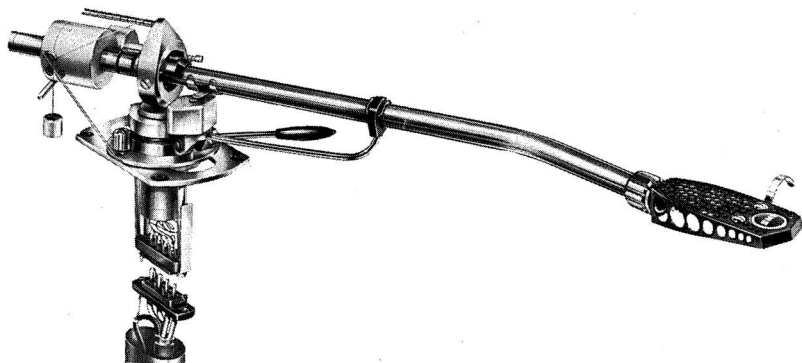

SME Series 2 precision pickup arm and shell

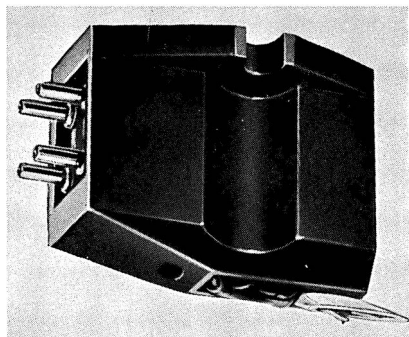

Ortofon SL.15/E

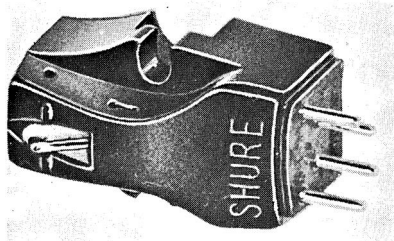

Shure M3D-M cartridge

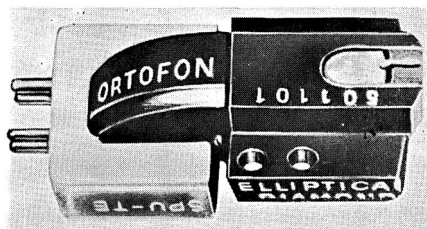

Ortofon SPU-T/E cartridge

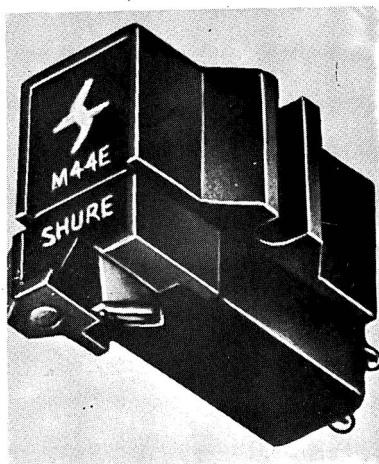

Shure M44-E

S.M.E. LTD., Steyning, Sussex BN4 3LN.
Tel: Steyning 2228.

★ **Model 3009** (9 in.). Series II precision pickup arm. Extremely low vertical and lateral friction. Side-thrust compensation. Hydraulically damped lowering control. Tracking force applied precisely, without the need for a gauge. Rapidly adjustable for a wide range of cartridges and heads. Price (with S.2 ultra lightweight shell): £25 3s. 3d. (plus £6 3s. PT).

Model 3012 (12 in.) Series II precision pickup arm. Details as above. Price (with S.2 ultra lightweight shell): £26 16s. 3d. (plus £6 11s. PT).

S.2 ultra lightweight shell. Weighs only 6 gm with mounting hardware. Price: £2 (plus 9s. 9d. PT).



SHURE ELECTRONICS LTD., 84 Blackfriars Road, London, S.E.1. Tel: 01-928 6361.

★ **M3D-M.** Stereo Dynetic cartridge. Moving magnet. $\frac{1}{2}$ in. fixing centres. Stylus 0.7 thou diamond. Pw 3-6 gm. Compliance 4×10^{-6} cm/dyne. FR 20 Hz-15 KHz. Separation 20 dB at 1 KHz. Output: 1 mV. Load impedance 47K. Price: £7 8s. 3d. (including PT).

M31E. Stereo Dynetic cartridge. Moving magnet. $\frac{1}{2}$ in. fixing centres. Elliptical stylus. Pw 1-2 gm. Recommended for use with transcription automatic changers. Price: £12 19s. 5d. (including PT).

M32E. Stereo Dynetic cartridge. Moving magnet. $\frac{1}{2}$ in. fixing centres. Elliptical stylus. Pw $2\frac{1}{2}$ -5 gm. Recommended for use with automatic turntables. Price: £12 0s. 11d. (including PT).

M32-3. Moving magnet cartridge for 78 rpm records only. For collectors who wish to own a separate cartridge for this purpose. Price: £11 2s. 4d. (including PT).

M44-C. Stereo Dynetic cartridge. Moving magnet. $\frac{1}{2}$ in. fixing centres. Stylus 0.7 thou diamond (1 thou and 3 thou styli available). Pw 3-5 gm. Compliance 7.5×10^{-6} cm/dyne. FR 20 Hz-20 KHz. Separation 25 dB at 1 KHz. Output: 1.8 mV. Load impedance 47K. Price: £10 3s. 10d. (including PT).

★ **M44-E.** Stereo Dynetic cartridge. Moving magnet. $\frac{1}{2}$ in. fixing centres. Stylus 0.7 × 0.4 thou bi-radial diamond (3 thou stylus available). Pw

$1\frac{3}{4}$ -4 gm. Compliance 15×10^{-6} cm/dyne. FR 20 Hz-20 KHz. Separation >25 dB at 1 KHz. Output: 1.8 mV. Rec load 47K. Price: £14 16s. 6d. (including PT).

★ **M44-5.** Stereo Dynetic cartridge. Moving magnet. $\frac{1}{2}$ in. fixing centres. Stylus 0.5 thou diamond (1 thou and 3 thou styli available). Pw $\frac{3}{4}$ -1 $\frac{1}{2}$ gm. Compliance 25×10^{-6} cm/dyne. FR 20 Hz-20 KHz. Separation 25 dB at 1 KHz. Output: 1.2 mV. Load impedance 47K. Price: £11 2s. 4d. (including PT).

★ **M44-7.** Stereo Dynetic cartridge. Moving magnet. $\frac{1}{2}$ in. fixing centres. Stylus 0.7 thou diamond (1 thou and 3 thou styli available). Pw $1\frac{1}{2}$ -3 gm. Compliance 20×10^{-6} cm/dyne. FR 20 Hz-20 KHz. Separation 25 dB at 1 KHz. Output 2.1 mV. Load impedance 47K. Price: £10 3s. 10d. (including PT).

★ **M55-E.** Stereo Dynetic cartridge. Moving magnet. $\frac{1}{2}$ in. fixing centres. Stylus 0.7 × 0.2 thou elliptical diamond (3 thou stylus available). Pw $\frac{3}{4}$ -1 $\frac{1}{2}$ gm. Compliance 25×10^{-6} cm/dyne. Output: 1.3 mV. Load imp 47K. Price: £16 13s. 6d. (including PT).

★ **M75-E. Type 2.** Stereo Dynetic cartridge. Moving magnet. $\frac{1}{2}$ in. fixing centres. Stylus 0.7 × 0.2 thou bi-radial diamond (3 thou stylus available). Pw $\frac{3}{4}$ -1 $\frac{1}{2}$ gm. Trackability (see note at end) at 1 gm in SME 3009 arm: 400 Hz 20 cm/sec. 1 KHz 28 cm/sec. 10 KHz 18 cm/sec. FR 20 Hz-20 KHz. Separation at 1 KHz >25 dB. Output: 1 mV. Rec load 47K per channel. Price: £25 18s. 10d. (including PT).

M75-6. Type 2. Stereo Dynetic cartridge. 15 degree angle. Moving magnet. $\frac{1}{2}$ in. fixing centres. Stylus 0.6 thou conical diamond (3 thou stylus available). Pw $\frac{3}{4}$ -3 gm. Trackability (see note at end) at 2 gm in SME 3009 arm: 400 Hz 28 cm/sec. 1 KHz 35 cm/sec. 10 KHz 20 cm/sec. FR 20 Hz-20 KHz. Separation >25 dB at 1 KHz. Output: 1 mV. Rec load 47K per channel. Price: £16 13s. 6d. (including PT).

M75E-D19 Type 2. Cartridge supplied ready-mounted for use with Dual models 1019, 1009SK, 1010S and 1016. Gard-a-matic retractile safety suspension. Price: £27 15s. 11d. (including PT).

M75E-95G. Type 2. Cartridge supplied ready-mounted and wired in slide-in carrier for use with Garrard SL95 turntable. Gard-a-matic retractile suspension. Price: £27 15s. 11d. (including PT).

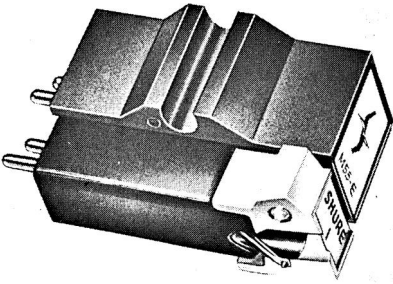

Shure M55-E cartridge

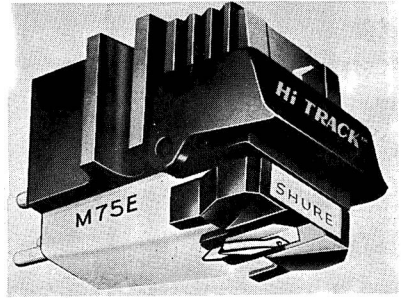

Shure M75-E

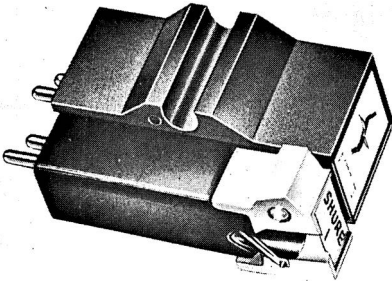

Shure M44-7 cartridge

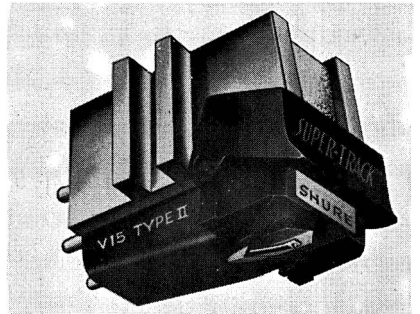

Shure V15-II

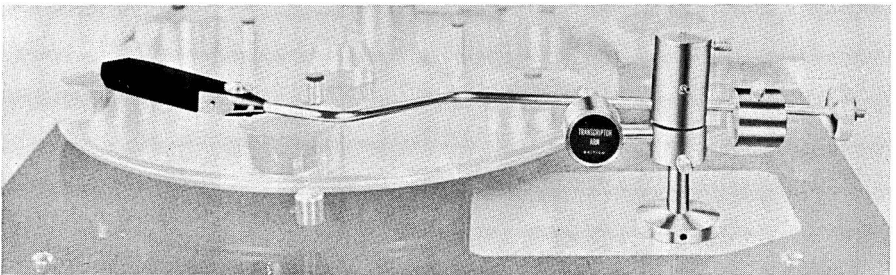
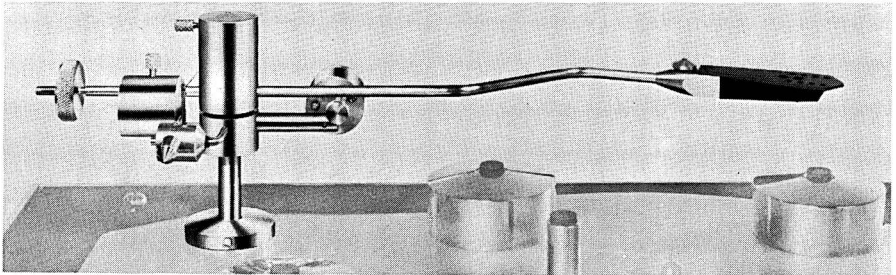

Transcriptors Fluid Arm

M75-G. Type 2. Stereo Dynetic cartridge. 15 degree angle. Moving magnet $\frac{1}{2}$ in. fixing centres. Stylus 0.6 thou conical diamond (3 thou stylus available). Pw $\frac{3}{4}$ -1 $\frac{1}{2}$ gm. Trackability (see note at end) at 1 gm in SME 3009 arm: 400 Hz 20 cm/sec, 1 KHz 28 cm/sec, 10 KHz 18 cm/sec. FR 20 Hz-20 KHz. Separation >25 dB at 1 KHz. Output: 1 mV. Rec load 47K per channel. Price: £17 12s. 1d. (including PT).

M75EJ Type 2. Stereo Dynetic cartridge. Stylus 0.7 × 0.4 thou bi-radial diamond. Pw 1 $\frac{1}{2}$ -3 gm. Trackability at 2 gm in SME 3009 arm 400 Hz 28 cm/sec, 1 KHz 35 cm/sec, 10 KHz 20 cm/sec. Price: £24 1s. 9d.

★ **V15-11.** Stereo Dynetic cartridge. 15 degree angle. Moving magnet. $\frac{1}{2}$ in. fixing centres. Stylus 0.7 × 0.2 thou bi-radial diamond (3 thou stylus available). Pw $\frac{3}{4}$ -1 $\frac{1}{2}$ gm. Trackability (see note at end) at 1 gm in SME 3009 arm: 400 Hz 28 cm/sec, 1 KHz 35 cm/sec, 5 KHz 30 cm/sec, 10 KHz 22 cm/sec. FR 20 Hz-25 KHz. Separation >25 dB at 1 KHz, >17 dB at 500 Hz-10 KHz. Output: 0.7 mV. Rec load 47K. Price: £40 15s. 3d. (including PT).

NOTE: Trackability is a term introduced by Shure to give a measure of the total performance of a cartridge. It takes into account the mechanical design parameters of tip mass, inertia, compliances throughout the system, tracking pressure, recorded velocity, etc. Explanatory leaflet available on request.

★

SONOTONE. Brush Clevite Co. Ltd., Thornhill, Southampton, Hants. SO9 1QX. Tel: Southampton 45166.

2T. Monaural ceramic cartridge with turnover stylus. Stylus sapphire 2.5 thou (78), 0.7 thou (LP). Pw 8-10 gm. Compliance 1×10^{-6} cm-dyne. Output: 180 mV/cm/sec at 1 KHz. Capacitance 650 pF. Serviceable under all climatic conditions and compatible for 33 $\frac{1}{2}$, 45 and 78 rpm records. Price £1 5s. (plus 5s. 10d. PT).

8TA. Stereo ceramic cartridge with turnover stylus. Sapphire, 2.5 thou (78), 0.7 thou (LP). Pw 4-6 gm. Compliance 1.4×10^{-6} cm/dyne. Separation 25 dB at 1 KHz. Output: 90 mV/cm/sec at 1 KHz. Capacitance 650 pF. Price: £1 15s. (plus 8s. 3d. PT).

8TAD. Similar specification to 8TA but with diamond stylus. Price: £2 10s. (plus 11s. 9d. PT).

9TA. Stereo turnover ceramic cartridge. Sapphire stylus. Pw 2-4 gm. Tip mass 3.5 mg. Compliance 5.3×10^{-6} cm/dyne. FR 30 Hz-15 KHz ± 3 dB. Separation 27 dB. Output voltage: 80-120 mV. Load imp 2 megohm. Price: £2 10s. (plus 11s. 9d. PT).

9TAD. Similar specification to 9TA but with diamond stylus. Price: £3 5s. (plus 15s. 4d. PT).

9TAHC. Stereo turnover ceramic cartridge. Choice of both sapphire styli or sapphire 78/ diamond stereo LP. FR 20 Hz-20 KHz ± 3 dB from 1 KHz. Rec load 2M. Sensitivity 55-85 mV/cm/sec at 1 KHz. Lateral compliance 8.5×10^{-6} cm/dyne. Separation 25 dB at 1 KHz. Pw 1-3 gm. Tip mass 2.5 mg. Capacitance 800 pF. Price: with sapphire stylus £2 10s. (plus 11s. 9d. PT); with diamond stylus £3 5s. (plus 15s. 4d. PT).

19T. Stereo turnover crystal cartridge. Stylus sapphire 2.5 thou (78), 0.7 thou (LP). Pw 7-9 gm. Compliance 1.2×10^{-6} cm/dyne. Separation 20 dB at 1 KHz. Output: 270 mV/cm/sec at 1 KHz. Capacitance 1,200 pF. Price: sapphire stylus £1 12s. 6d. (plus 7s. 11d. PT); diamond stylus £2 7s. 6d. (plus 11s. 2d. PT).

20T. Stereo crystal cartridge. Sapphire styli. FR 20 Hz-15 KHz ± 4 dB from 1 KHz. Rec load 2M. Sensitivity 270-535 mV/cm/sec at 1 KHz. Compliance 1×10^{-6} cm/dyne. Separation 20 dB at 1 KHz. Pw 8 gm. Capacitance 1,200 pF. Price: sapphire stylus £1 12s. 6d. (plus 7s. 7d. PT); diamond stylus £2 7s. 6d. (plus 11s. 2d. PT).

2109. Mono Rochelle cartridge. Output at 1 KHz 700 mV/cm/sec. Capacitance 800 pF. Compliance 1.5×10^{-6} cm/dyne. Tracking +12 dB at 5 gm. FR 100 Hz-8 KHz ± 3 dB. Rec stylus force 6-8 gms. Price: £1 7s. 6d. (plus 6s. 6d. PT).

2539. Stereo Rochelle cartridge. Output at 1 KHz 550 mV/cm/sec. Capacitance 800 pF. Channel difference less than 3 dB. Separation at 1 KHz better than 12 dB. Tracking +9 dB at 9 gms. FR 100 Hz-8 KHz. Rec stylus force 8-10 gm. Price: £1 19s. (plus 9s. 7d. PT).

3509. Stereo ceramic cartridge. Output at 1 KHz: 140 mV/cm/sec. Channel difference less than 3 dB. Separation at 1 KHz: better than 15 dB, typically 20 dB. Capacitance 600 pF. Tracking +12 dB, typically +15 at 5 gm. FR 100 Hz-8 KHz ± 3 dB. Rec stylus force 5-7 gms. Price: £2 5s. (plus 11s. PT).

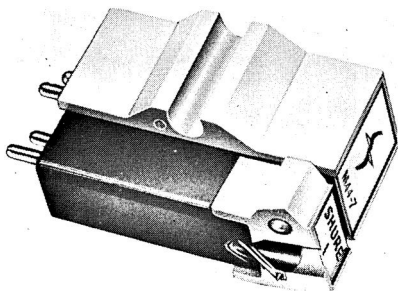

Shure M44-5 cartridge

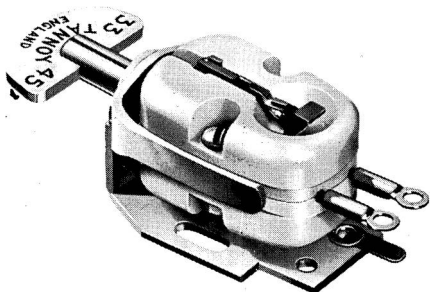

Tannoy Variluctance cartridge

SONY (U.K.) LTD., Ascot Road, Bedfont, Feltham, Middx. Tel: Ashford 50021.

★**Sony VC-8E.** Stereo moving coil cartridge. Stylus 0.2×0.8 thou diamond. Pw 0.5-2 gm. Lateral and vertical compliance 10×10^{-6} cm/dyne. FR 10 Hz-25 KHz. Separation 30 dB at 1 KHz, 20 dB at 10 KHz. Output: 4 mV ± 2 dB. Rec load approx 40 ohms at 10 Hz-25 KHz. Price: £29 10s. (plus £4 12s. 3d. PT).

★

STANTON. Distributors: Metrosound Audio Products Ltd., Cartersfield Road, Waltham Abbey, Essex. Tel: Waltham Abbey 31933.

500A. Magnetic stereo cartridge with diamond stylus. FR 20 Hz-10 KHz ± 1 dB, 10 Hz-20 KHz ± 2 dB. Channel separation 35 dB. Output: 0.8 mV. Load: 47K. Playing weight: 2-5 gm. Tip radius 0.7 thou. Weight of cartridge 5 gm. Price: £10 (plus £2 7s. PT).

500AA. Magnetic stereo cartridge with diamond stylus. Details as for 500A. Tip radius 0.5 thou. Playing weight: $\frac{3}{4}$ -3 gm. Price: £12 (plus £2 15s. 6d. PT).

500E. Magnetic stereo cartridge with elliptical diamond stylus, 0.4×0.9 thou. Playing weight: 2-5 gm. Price: £15 (plus £3 10s. 7d. PT).

★

SUGDEN. See Connoisseur.

★

TANNOY PRODUCTS LTD., West Norwood, London, S.E.27. Tel: 01-670 1131. Cables: Tannoy, London.

★**Variluctance.** Turnover cartridge. Output voltages: LP: 10-12 mV; 78 18-20 mV. Range 20 Hz-16 KHz ± 2 dB. Pw 5-6 gm (less with professional arms). Load imp 50K ohms. Price (with 2 diamonds): £12 (plus £3 3s. 6d. PT); (with 1 diamond and 1 sapphire): £9 10s. (plus £2 10s. 4d. PT); (with 2 sapphires): £7 (plus £1 17s. 1d. PT). Compatible styli available £3 (plus 15s. 11d. PT).

Single stylus version of Variluctance for LP also available. Price (with diamond): £6 15s. (plus £1 10s. 4d. PT).

★

TRANSCRIPTORS LTD., 551 Holloway Road, London, N.19. Tel: 01-272 6419.

★**Transcriptor fluid arm.** Stereo or mono low-mass arm with fluid Uni-pivot mount. Modular counter-weight system with fine balance adjustment. Suitable for all cartridges with compliance of 15×10^{-6} cm/dyne or above, tracking at not more than 2.5 gm. Hydraulic lowering device with manual over-ride control. Incorporates precise cueing system. Single hole fixing. Integrated leads. Plug-in head shell. Roller-

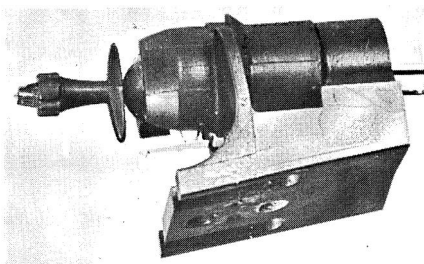

Walton M. 1. cartridge

action adjustable bias compensation. British made. Price: £15 9s. (plus £3 13s. 8d. PT).

★

TRIO. U.K. distributors: B. H. Morris & Co. (Radio) Ltd., 84-88 Nelson Street, Tower Hamlets, London, E.1. Tel: 01-790 4824.

Supreme 20. Photoelectric pickup cartridge which eliminates the magnets and coils found in the conventional type of moving coil cartridge. It uses a lamp and screen attached to the cantilever to which is fitted the stylus together with photo-electric diodes and a pre-amplifier. The low moving mass of the Trio cartridge (0.55×10^{-3} gm) is less than most other cartridges. FR 20 Hz-20 KHz ± 2 dB. Separation 30 dB at 1 KHz, 26 dB at 50 Hz-10 KHz. Compliance 25×10^{-6} cm/dyne at 100 Hz (horizontal and vertical). Tracking force 1-2 gm. Stylus type: elliptical (0.3×0.8 thou). Head shell and pre-amp included. Price: £64 4s. 1d. (plus £13 15s. 11d. PT).

★

WALTON. Distributor: Lennard Develop-

ments Ltd., 497 Green Lanes, London, N.13. Tel: 01-886 3723.

★**M.1.** High quality stereo-compatible cartridge for record players and radiograms. Mono cartridge incorporating 'decoupled stylus' system which plays all types of record without distortion-producing groove damage. Crystal unit. Turn-over type. Stylus: (diamond) $0.5/6$ thou; (sapphire) $0.6/7$ thou. Pw 5 gm. Tip mass 1.6 mg. Vertical and horizontal compliances: 2.5×10^{-6} cm/dyne. 4.0×10^{-6} cm/dyne. FR 40 Hz-12 KHz. Output: 250 mV. Rec. load 1 megohm or greater. Price: £3 5s. (including PT).

★

WORDEN AUDIO DEVELOPMENTS LTD., 54 Chepstow Road, London, W.2. Tel: 01-229 4996.

Worden articulated arm Mk III. Radially operative single arm with articulated head piece. Tracking correct to $\pm 1/4^\circ$. Vertical and lateral friction less than 50 mg. Adjustable counter-balance weight. Height adjustment. Detachable head-shell accepts all standard $1/2$ in. centre fixing cartridges. No resonances above 10 Hz. Extra head shells available. Built-in lowering and lifting device. Price: to be announced.

If you think Mozart's good, you should hear our assistants.



Our assistants are no musicians.

But they're still worth hearing. If you think Mozart's (or anyone's) music should be heard at its best, they'll tell you all about the hi-fi equipment you need.

They're hi-fi experts. Every one of them.

They know the technicalities. From tuners to tweeters, from wows to woofers.

And they don't only talk.

They demonstrate.

Working in our fabulous new two-floor, air-conditioned hi-fi store, they've got all the equipment. Right there at hand. They'll take you to the demonstration rooms: new, carpeted rooms as plush as living rooms, with shelf upon shelf of tuners, amplifiers, speakers, turntables,

recorders and mixers. Rooms with brilliant electronic layouts for switching from one system to another in a matter of seconds. Rooms where you'll sit in comfort. And look, listen and compare until you find precisely what you want.

Try us. You've got everything to gain. Not only is our equipment the finest on the market, but there's a complete after-sales service on everything you buy from us - a tremendous advantage you'll find nowhere else, and an indication of the confidence we have in the high quality of our equipment.

Come along.

Opening hrs. 9-6 Mon.-Sat., Thurs. till 7 p.m.
(If you can't stand Mozart, don't worry: we've got everyone from Sibelius to Tiny Tim.)

LIND-AIR Appointed Agents for: Akai, Armstrong, Audia Technica, Arena, Bang & Olufsen, Dual, Garrard, Goldring-Lenco, Goodmans, Grundig, Jordan Watts, K.E.F., Koas, Klinger, Leak, National Philips, Quad, Rola Celestion, Sansui, Shure, Sinclair, S.M.E., Sony, Teleton, Thorens, Tripletons, Wharfedale and hundreds more.

LIND-AIR AUDIO

18 Tottenham Court Road, London W.1. Tel. 01-580 2255

choose it from

THE 1970

HI-FI YEAR BOOK

buy it from

MODERN ELECTRICS

**the well-stocked hi-fi shop directly
opposite the Columbia Cinema in
Shaftesbury Avenue**

**AMPLIFIERS · TUNERS · SPEAKERS · MOTORS
PICK-UPS · RECORDERS · BINSON ECHO UNITS
ACCESSORIES · SERVICE**

**MODERN ELECTRICS (RETAIL) LTD.,
120, SHAFTESBURY AVENUE, LONDON, W.IV 7DJ**

Telephone 01-437 9692 Cables MODCHAREX LONDON Nearest Underground
LEICESTER SQUARE



DECCA

the world's leading manufacturer of records and the means of playing them

'We shall be pleased to send you full details of any of these pick-ups'.

The range of Decca ffss magnetic pick-ups – the world's leaders in top quality reproduction – all featuring exclusive Positive Scanning.

Mark II

Mark III (with elliptical stylus)

Mark 4 series: for the first time the ffss system in universal fitting cartridges

Mark 4 series: traditional ffss style heads

The world's leading pick-up for budget stereo
The Decca Deram Ceramic pick-up head

'Pick-ups – the key to hi-fi is a fascinating book by John Walton who designed the Deram pick-up. Copies are available from us price 10s 6d including postage.'

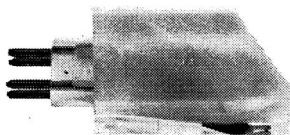
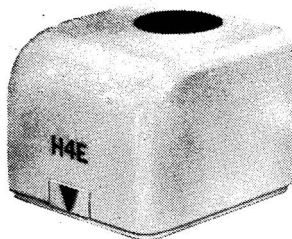
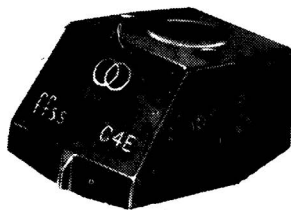

NOTE: All these stereo pick-ups are also admirable for playing mono LPs

Decca ffss and Deram are registered trademarks of the Decca Group
Decca Special Products Ingate Place Queenstown Road London SW8

DECCA

PICKUP ACCESSORIES

ARENA. Distributors: Highgate Acoustics, 184-188 Great Portland Street, London, W.1. Tel: 01-636 2901.

Arena FS.1 preamplifier. Preamplifier F.1 combined with 240V AC mains power pack. Suitable for use with any stereo amplifier. Two matched silicon transistors in each channel. Matches magnetic pickup into amplifier having crystal or ceramic input only. Price: £7 7s.

★

AUDIO AND DESIGN. Keith Monks (Audio) Ltd., 54 Rounton Road, Church Crookham, nr. Aldershot, Hants. Tel: Fleet 3566.

★ **Professional record cleaning machine.** Details on request. Price: £213 6s. 8d.

★

AURIOL (GUILDFORD) LTD., Farnham Trading Estate, Farnham, Surrey. Tel: Farnham 3366.

Auriol pickup control. This unit eliminates accidental damage to the record by the stylus, the control provides air cushioned lowering and positive vertical lifting and lowering of the stylus. The supporting arm is serrated and calibrated for accurate positioning of the stylus at any pre-selected position within 1-2 microgrooves. Three cursors are provided to mark starting positions and an indexing clip is supplied to suit any specified pickup arm. Price: £3 1s. 10d. (plus 14s. 8d. PT).

★ **Auriol pickup control Mk II.** This is dimensionally similar to the above but the arm will swing clear of the turntable to allow its use with the Autochanger/Manual player units. Price: £3 13s. 11d. (plus 17s. 7d. PT).

★

BIB. Multicore Solders Ltd., Maylands Avenue, Hemel Hempstead. Herts. Tel: 0442 3636.

★ **Stylus and turntable cleaning kit.** Includes: cleaning cloth, non-inflammable anti-static cleaning fluid and small nylon brush applicator. Brush can be fastened to board by small suction pad. Price: 5s 6d. (plus 1s. 4d. PT).

B. & W. ELECTRONICS. Bowers & Wilkins Electronics Ltd., Littlehampton Road, Worthing, Sussex. Tel: Worthing 66830.

SE/A. A special equaliser for the Shure V15/11 and similar cartridges designed for use with SME Series II pickup arms.

★

BURNE-JONES & CO. LTD., 18 Brunswick Road, Sutton, Surrey.

★ **Alignment protractor.** For measuring the tracking accuracy of all pickup assemblies. Made in plastic ivory. Price: 10s.

★

CLENDISC (MAIL ORDER) LTD., 7 Trinity Court, Gray's Inn Road, London, W.C.1. Tel: 01-837 9088.

★ **Clendisc.** An anti-static cleaner and preservative for records, photographic and optical lenses, copying machines, tape heads and computers. 4 fl oz bottles. Price: 4s 1d.

★ **Clendisc Cleaning Pad.** Pad impregnated with Clendisc fluid which assists in the removal of dust and dirt and also neutralises any electrostatic charges present. Price: 3s. 4d., including tax.

★

COLTON & CO. (LAPIDARIES) LTD., The Crescent, Wimbledon, London, S.W.19. Tel: 01-946 9401.

★ **Antistaticcloth.** A soft cloth impregnated with an anti-static material, for cleaning records. Price: 2s. 6d.

Colton E.P. record centre adaptors (45 rpm). Small plastic centre pieces which enable E.P. records to be used again on slim spindle changers after the large centre piece has been removed. Price: 3s. per packet of one dozen (plus 9d. PT).

★ **Varilift Mk II.** Fluid damped pickup lift and lowering device, lever operated. Replaces the previous button operated hydraulic device, and is basically smaller, neater and utilises an offset



Audio and Design record cleaning machine



Clendisc cleaning fluid



Auriol Mk II pickup control

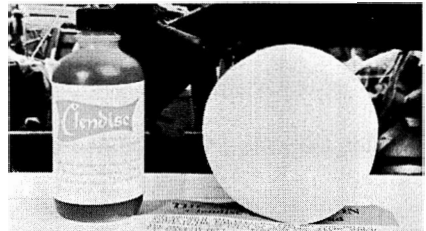

Clendisc cleaner and pad

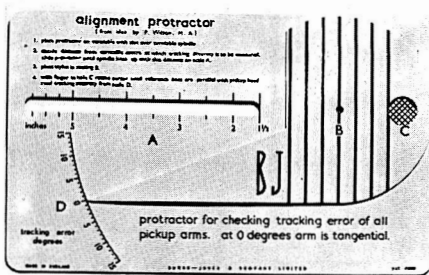

B-J alignment protractor



Bib stylus and turntable cleaning kit

fixing bracket permitting it to be fixed directly under pickup in the most effective position. Price: £3 (plus 14s. 1d. PT).

★**Precision level.** Circular bubble-type spirit level in white plastic case $1\frac{3}{8}$ in. diameter, $\frac{1}{2}$ in. high. Three fixing holes provided or it may be fixed with adhesive. Ensures accurate levelling in all directions. Price: 6s. 9d.

★**Antistatimat.** All-rubber 12 in. turntable mat. Accurately balanced and moulded with guard edge recess. Introduction of certain materials into the rubber renders it conductive to static charges on micro-groove records. When a record is placed on the mat static charges are dispersed freeing the record from induced noises without use of sprays, etc. Price: 10s. 6d. (plus 2s. 6d. PT).

Plastisleeves. Made from 200-gauge polythene and designed to protect microgroove records from dust and damp. Supplied in packets of 12. Prices: 7 in. round bottom 2s. 4d., 12 in. round bottom 5s.

Plasticovers. Made from 200-gauge polythene and designed to protect record sleeves against rubbing and scratching. Supplied in packets of 12. Price: 7 in. square bottom 1s. 3d., 12 in. square bottom 3s. 1d.

★**Times-Fifty.** Miniature pocket microscope with stylus locating slot and adjustable focus. Gives clear picture of stylus tip at X50 magnification. $4\frac{1}{2}$ in. long and fitted with pen clip. Price: 17s. 6d.

★**Magnalift.** Centre lift off device. Fixes beside pickup and automatically lifts arm off record at end of playing cycle. Finished in black wrinkle and satin chrome. Price: £2 10s. 8d. (plus 11s. 11d. PT).

★**Variscale.** Tracking force indicator. Simple and accurate stylus balance measuring from $\frac{1}{2}$ to 6 gm. Finish: black wrinkle and satin chrome. Price: 16s. 11d. (plus 3s. 11d. PT).

★**Precise.** Manually operated pickup lifting device. Simple precise movement. Single hole mounting. Finish: satin chrome. Price: £1 8s. 3d. (plus 6s. 8d. PT).

★**Superactive.** New formula anti-static fluid. For cleaning and neutralising static in records and other plastic surfaces. Can be applied with sponge or cloth, leaves no sticky deposit. Suitable for recharging anti-static devices. Supplied

in dispenser with dropper nozzle. Price: ($\frac{1}{2}$ oz) 2s. 6d., (1 oz) 4s. 6d.

★**Stylus Life Timer.** This unique device measures only $2 \times 2\frac{3}{4} \times \frac{3}{8}$ in. The magnetically actuated precision mechanism registers in playing hours on a scale 0-400. At 400 hours it can be reset to 0. Finish: black with silver dial. Price: £1 19s. (plus 9s. 2d. PT).

Gripex. Anti-slip dressing. A spirit suspended solution supplied in 1 fl oz bottles with brush. Applied thinly to drive surface of belts or friction wheels, it dries in 10-15 minutes. Price: 5s. per bottle.

Coltonian record racks. Heavy gauge steel wire welded at all joints. Available plated or plastic coated, gilt, copper, black, red, grey or blue and fitted plastic feet. Price: from 6s. 9d. (plus 1s. 7d. PT).

Record carrying cases. Three basic sizes: 12 in. \times 50, 12 in. \times 25 and 7 in. \times 50. Finish: padded PVC in red, blue, black and brown. Prices: from £1 7s. 10d. (plus 6s. 7d. PT).

★

CONNOISSEUR. See A. R. Sugden and Co. Ltd.

- ★

DECCA. Decca Special Products, Ingate Place, Queenstown Road, London, S.W.8. Tel: 01-622 6677.

Magnetic bias compensator. Neat, simple, unobtrusive device using magnetism precisely to neutralise the forces which draw a pickup towards the centre of the turntable. Type A for Mk I and Mk I "Super" *ffss* arms, and for Deram ARI arm. Type B for current Decca "Professional" arm. Prices: Types A and B £1 0s. 2d. (plus 4s. 10d. PT).

Centre locator. Fits on *ffss* arm like *ffss* head. Pickup arm is correctly positioned when the locator moulding fits the turntable centre spindle. Price: 5s. 3d. (plus 1s. 3d. PT).

★**Decca Microlift.** A device for raising and lowering a manual pickup arm at any point on the record for minimising risk of damage either to record or stylus through handshake. Easy to fit to most types of back-pivoted pickup. It does not hinder record handling by over-lapping the turntable. Price: £1 8s. 4d. (plus 6s. 8d. PT).



Colton antistaticloth

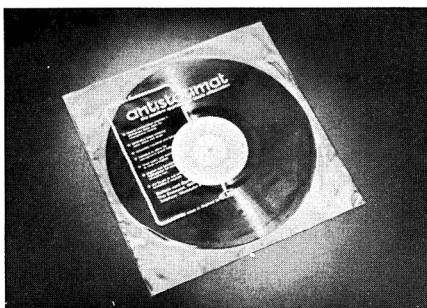

Colton Antistatimat

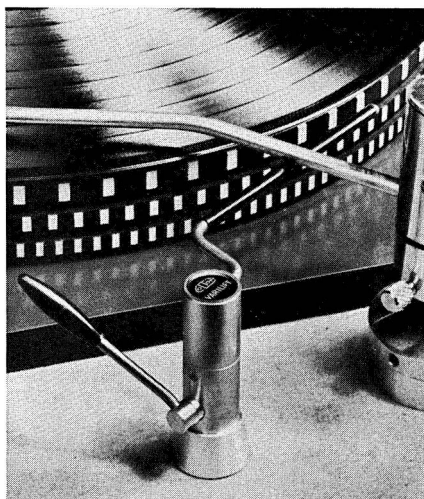

Colton Varilift

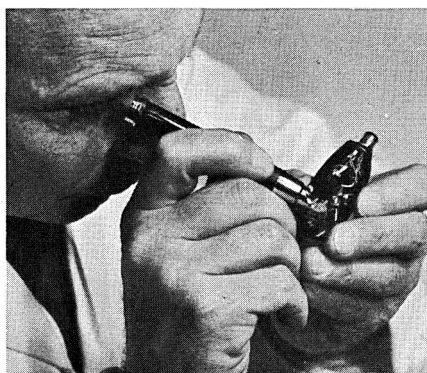

Colton Times-Fifty stylus viewer



Decca Microlift



Colton Precise lift

PICKUPS



Colton Magnalift



Colton stylus timer

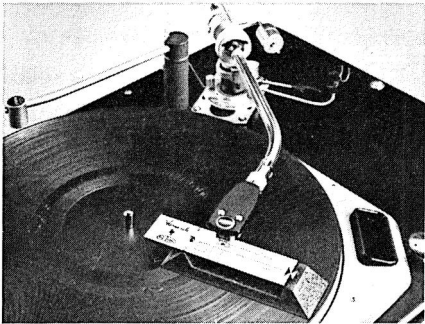

Colton Variscale

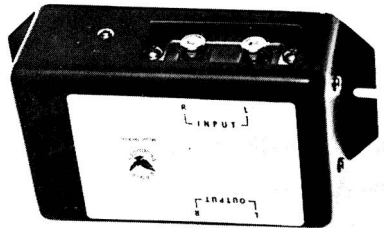

Eagle PRE402 pickup preamp



Colton Antistatic fluid



Colton Precision level

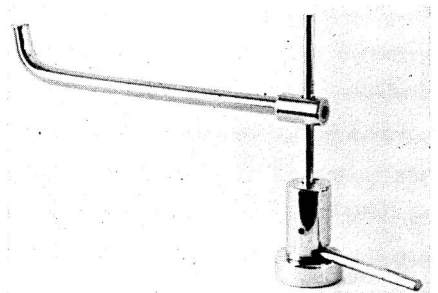

Hadcock GH Uni-lift

Deccalift. Motorised lifting and lowering device which can be controlled at the turntable and/or remotely. Requires 6.3V AC. Transformer optional extra. Price: £6 17s. 7d. (plus £1 12s. 5d. PT).



EAGLE PRODUCTS. Distributors: B. Adler & Sons (Radio) Ltd., 32a Coptic Street, London, W.C.1. Tel: 01-636 9606/7.

★ **PRE 402.** Mains powered stereo pick-up pre-amplifier for magnetic cartridges including Eagle LC07. Provided with dual phono sockets. Price: £4 19s. 6d.



ELAC. Electroacoustic GmbH, Kiel, West Germany. U.K. sales (magnetic cartridges): Unilet Products Ltd., Compton House, Malden Road, New Malden, Surrey. Tel: 01-942 9567.

Replacement styli. A full range is available for Series 244, 344 and 444. Also styli available for earlier Elac 200, 210, 220, 222, 240, 300, 310 and 322 series cartridges.



EXPERT PICKUPS LTD., 74 Brownlow Road, New Southgate, London, N.11. Tel: 01-888 5350.

Expert moving coil pickups serviced. Full details on request.

Replacement stylus service. For detachable cantilever systems using client's own stylus assembly. Radius to choice; from 0.5 thou (stereo) to 4 thou (78 oversize). Ellipticals where suitable. Radius checked using X 500 magnification.

Grade A. Finest quality, highly polished, giving minimum background noise and optimum results.

Grade B. Commercial standard, 0.5 thou to 2.5 thou only. Oversize sapphires and diamonds (Grade A only) for Pathe and Edison reproducers formed and fitted. Expert Pickup diamonds are manufactured only to customers' specifications.

Special quotations and prospectus on request.



M. B. FITCH. U.K. Distributors: Metrosound Audio Products Ltd., Cartersfield Road, Waltham Abbey, Essex. Tel: Waltham Abbey 31933.

"Hi-Jack" Model "D". A raising and lowering device specially designed for direct attachment to the Decca *ffss* pickup pedestal. All metal chrome plated construction, positive stops in fully raised and lowered positions. Price: £1 1s. (plus 4s. 8d. PT).

"Hi-Jack" Model "U". A raising and lowering device specially suited for use with the Garrard 4HF motor unit for which no extra fixing hole is required. 1½ in. height adjustment by means of sliding head. All metal chrome plated construction. One ⅜ in. hole needed for fixing. Price: £1 1s. (plus 4s. 8d. PT).



GOLDRING MANUFACTURING CO. (GREAT BRITAIN) LTD., 486/488 High Road, Leytonstone, London, E.11. Tel: 01-539 8343. Cables: Echovox, London.

Lenco STB.2. Stylus pressure balance. A simple and accurate device, not relying on springs. Price: 13s. 9d. (plus 3s. 4d. PT).

Lencoclean. Record cleaning device mounted on turntable. Tracks in front of the pickup, dispensing a narrow band of special fluid. Leaves no deposit on record, cleans the groove and cools the point contact. Keeps stylus point clean. Price: £2 2s. (plus 10s. 1d. PT).



G. F. C. HADCOCK, Audio Division, The Old Vicarage, Doveridge, Derby, DE6 5NN. Tel: Uttoxeter 2452.

★ **GH Uni-lift.** Raising and lowering device suitable for use with all pickup arms. Two-hole fixing for stability. Ensures accurate lowering and easy cueing. Allen key provided for height adjustment of horizontal arm. Finish: chromium plated brass. Price: £1 19s. 3d. (plus 9s. 3d. PT).



LENNARD DEVELOPMENTS LTD., 497 Green Lanes, London, N.13. Tel: 01-886 3723.

Play-fair Stylus Timer. Manually operated device which indicates when stylus is due for replacement. Self-adhesive to attach to motor board if desired. Swiss mechanism. Neat plastic case with instructions. Two models: one for sapphires, one for diamonds. Price (either model): 16s. 3d. (plus 3s. 6d. PT).

Play-fair Cleaning Pad. Anti-static. Price: 2s.

Play-fair Stylus Cleaners. Cleaning fluid with separate brush. In presentation case. Price: 6s. (plus 1s. 6d. PT).

Play-fair Antistatic Cleaning Fluid. 30cc polythene bottle. Price: 4s. 6d.

Play-fair Discoda. Record sleeve indexing device for quick identification of records. Price: 3 for 2s. 6d., 12 for 8s.

Micro-Diamond replacement styli. Comprehensive range. Also retipping service. Price: on application.



M. A. C. Electronic Co., Ripley, Surrey. Tel: Dunsfold 310.

★**AAU-3.** Audio adaptor unit for connecting three pickups to a common amplifier input, also suitable for microphones, tuners, tapes, etc. Two phono inputs at rear alternately switched to front DIN sockets for feeding other equipment. Fitted with 24 in. leads with phono plugs, or with DIN plugs (AAU-3Q). Provision for fitting attenuator or load resistors internally. Dimensions: 3 × 3 × 3 in. Finish: jaguar silver. Price: £4 2s. 6d.



METROSOUND. Metrosound Audio Products Ltd., Cartersfield Road, Waltham Abbey, Essex. Tel: Waltham Abbey 31933.

M.2. Record Cleaning Sponge. Special soft texture for cleaning of records. Price: 2s. 6d. (plus 7d. PT).

M.3. Record Care Kit. Comprising bottle of Metro-Spray spirit-based anti-static record cleaning fluid; special texture sponge applicator with moulded handle; and soft stylus cleaning brush. Price: 6s. (plus 9d. PT).

★**M. 10. Metro-Mat.** Ribbed rubber full transcription size anti-static turntable mat, complete with separate stroboscope. Price: 10s. 6d. (plus 2s. 6d. PT).

★**M. 11. Hi-Fi Stylus Cleaning Kit.** Bottle of specially developed mild solvent fluid. Moulded plastic retaining clip on bottle for soft nylon cleaning brush. Price: 6s. (plus 1s. 5d. PT).

M. 14. Ortofon Hi-Jack Mark II. For use

only with Ortofon arms, silicon damped lowering and raising device. All metal chromium plated. Construction based on a special hydraulic friction system which provides air cushioned lowering and a positive vertical lifting and lowering of a manual pickup arm at any point on the record. Price: £3 5s. (plus 15s. 4d. PT).

M. 15. Ortofon Hi-Jack Mark IV. Similar to M. 14, but for use with most other pickups where no raising or lowering device is provided. Price: £3 5s. (plus 15s. 4d. PT).

M.21. Metro Scale Stylus Balance. Works on knife edge balance principle. Supplied with eight plastic weights enabling checking from $\frac{1}{4}$ gm to 4 $\frac{1}{8}$ gm. Price: 6s. (plus 1s. 5d. PT).

M.22. Disc Key. For use in placing 45 r.p.m. records on record changers. Plated metal construction. Two "ears" protrude through slots of record centres to key discs together to prevent slip. Price: 2s. (plus 6d. PT).

★**M.24. Lubricating Kit.** Suitable for transcription turntables and mechanical moving parts. Comprises small bottle each of R.O.B. and R.O.G. oil and container of Starfax. Price: 6s.

M.28. High Fidelity Maintenance Kit. Designed for optimum maintenance of transcription record players and discs. Contents: ioniser, hi-fi cleaning kit, Metro Scale stylus balance, lubricating kit, and spirit level. Price: £1 10s. (plus 2s. 9d. PT).

M.31. Thorens anti-skating device. For use with T.P.13 pickup arm as supplied with Thorens T.D.150A and T.D.150AB transcription turntables. Price: £1 5s. (plus 6s. 7d. PT).

M.26. Ioniser. High fidelity record cleaner. Permanently anti-static, humid soft velvet enclosed in plastic moulding. Price: 7s.

★**M.23. Spirit level.** Plastic spirit level for use on turntables, etc. Price: 6s.

M.27. Anti-static cleaning cloths. Permanently impregnated anti-static record cleaning cloth. Price: 2s. 6d.



MILLBANK ELECTRONICS, Hartfield, East Sussex. Tel: Hartfield 445.

Input preamplifier modules. Compact printed circuit modules. Connector or solder connec-

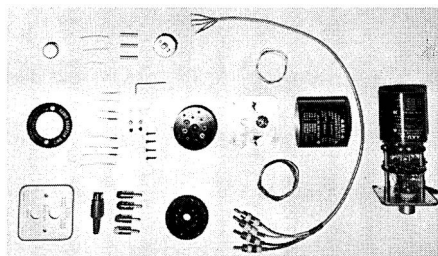

M.A.C. AAU-4 pickup switching kit

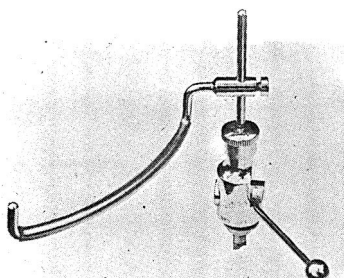

Ortofon "Hi-Jack"



Metro-sound spirit level



Metro-sound stylus cleaning kit



Metro-sound lubrication kit

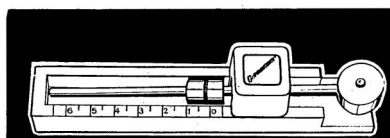

Connoisseur stylus balance



Metro-sound metro-mat

tion. Psn: 20-24V DC. Type 050: Suitable for magnetic pick-up cartridges, 100K input, 3-5 mV sensitivity, frequency correction to British Standard for microgroove recordings. Type 051: Suitable for tape heads requiring high impedance termination, 3 mV sensitivity. Frequency correction to CCIR standards for $3\frac{3}{4}$ i/s. Other corrections to special order. Type 054: For 30 ohm balanced microphones, sensitivity 100 μ V, variable preset gain adjustment. Other impedances to special order. Price: (050 and 051) £3 14s. 1d. (054) £5 10s. 7d.



ORTOFON A/S. Distributors: Metro-Sound Audio Products Ltd., Cartersfield Road, Waltham Abbey, Essex. Tel: Waltham Abbey 31933.

★**Ortofon "Hi-Jack".** Pickup arm lift/lowering device. All metal chromium plated. Special spring-loaded friction system for "air cushioned" lowering. Adjustable lowering speed. Positive-positioning on record. Works independently of weight of cartridge or stylus force. Mk II model for use with Ortofon arms. Mk IV model free-standing for use with any arm. Price: £3 5s. (plus 16s. 4d. PT).



A. R. SUGDEN & CO. (ENGINEERS) LTD., Market Street, Brighouse, Yorkshire. Tel: Brighouse 2142. Cables: Connoisseur, Brighouse.

★**Connoisseur Stylus Balance.** Precision stylus balance with sliding weight adjustment. Scale calibrated 0-6 gm. Simple operation giving accurate stylus pressure settings. Price: 17s. 6d. (plus 4s. 2d. PT).



TRANSCRIPTORS LTD., 551 Holloway Road, London, N.19. Tel: 01-272 6419.

★**Transcriptors Stylus Scales.** Precision scales in polished aluminium with jewelled pivot. Sensitive to less than 0.01 gm. Accuracy better than 0.02 gm. Measures 0.5 gm in increments of 0.05 gm. Bubble read-out. Supplied with reference calibration check weights. British made. Price: £2 5s. (plus 10s. 8d. PT).

★**Transcriptors Sweep Arm.** Record cleaning device for permanent fixing. Height adjustable over $3\frac{1}{2}$ in. Tracks at $\frac{1}{4}$ - $\frac{1}{2}$ gm. Balance cursor. Integrated parking device. Precision unipivot construction. Polished aluminium. British made. Price: £2 10s. (plus 11s. 11d. PT).

★**Transcriptors Stylus Brush.** For permanent installation. Comprises squirrel hair brush for cleaning stylus. Adjustable for height. Single hole fixing. Polished aluminium construction. British made. Price: £1 10s. 6d. (plus 7s. 6d. PT).



WAL. Sole distributor: A. C. Farnell Ltd., Consumer Division, Farnell House, 81 Kirkstall Road, Leeds LS3 1HR. Tel: Leeds 35111.

Universal WAL Gain stereo pre-amplifier unit. For amateur tape, cine and professional sound recording. RIAA equalisation for magnetic cartridges. Flat response pre-amp for low impedance microphones. Equalised inputs for magnetic pickups for transfer to sound on film. Equalised CCIR built-in correction, for tape heads, 2 or 4 track. Monitoring pre-amp for use direct from tape head to enable one track to be synchronised with another. Transfer from tape deck mechanism to tape recorder. Track-to-track transfer equalised to CCIR for transferring information on 4-track tape recording equipment. Mixer for low impedance microphones, gramophone or tape, RIAA, CCIR, or flat response. Headphone monitoring facilities. Psn 220-245V. Price: £10 19s. 6d.



CECIL E. WATTS LTD., Darby House, Sunbury-on-Thames, Middx. Tel: Sunbury 3252.

★**The "Dust Bug".** Claimed to be the most efficient method of removing static and dust from records as they are played. Instantly fitted, suitable for all types of records. Record quality is improved, surface noise and wear reduced. Price: 18s. 9d. (plus 4s. 5d. PT).

"**Parostatik**" regd. **Disc Preener.** For record maintenance where anti-static agents are not desirable (where stylus force is less than 2 gm). Price: 6s. 9d.

★**Manual Parastat.** Manual Model Parastat record cleaning machine. For the cleaning and application of anti-static agents to LP records. Price: £2 5s.

Manual Parastat. As above, but complete with Humid Mop for cleaning the bristles and velvet pads. Price: on application.

Hi-Fi Parastat Model Mk 4. Gramophone record maintenance and stylus cleaning kit. Designed for use on records in new condition, which are played with pickups requiring very

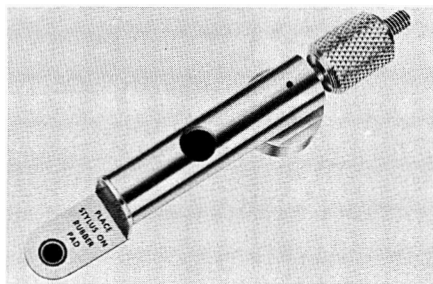

Transcriptors stylus scales

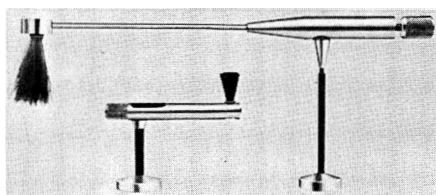

Transcriptors sweep arm and stylus brush



The "Dust Bug"



Manual Parastat

low tracking pressures. Price: £2 2s. 6d. (plus 1s. 3d. PT).

Watts Stylus Cleaner. As included with Hi-Fi Parastat kit. Price: 5s. (plus 1s. 3d. PT).

Spares and replacements. Dust Bug nylon bristle and plush pad. Price: 1s. 9d. New Formula dispenser. Price: $\frac{1}{2}$ oz. 2s. 6d., 1 oz. 4s. 6d. Parastatik wicks. Price: 2s. (packet of four). Manual Parastat brush. Price: 12s. 6d. Parastat nylon velvet pad covers. Price: 2s. Parastat white PVC sponge. Price: 1s. Humid Mop for use with manual Parastat. Price: 4s. 6d. Replacement sponges. Price: 2s. 6d. set. Hi-Fi Parastat: distilled water dispenser 4s.; pad cover and ribbons 1s. 9d.

WILSON STEREO LIBRARY LTD., 104-106 Norwood High Street, London, S.E.27. Tel: 01-670 6394.

W.S.L. Blank Disc. Highly polished blank vinyl disc for adjusting side thrust and alignment. Indicates the amount of side thrust to be corrected. Mirror-like surface reflects underside of cartridge and stylus and assists in accurate alignment. Supplied with instructions for correcting side thrust. Price: 13s. 6d. postage and packing included.

W.S.L. Side Thrust Corrector. Pulley device which may be fitted to any pickup to correct side thrust. Should be used in conjunction with W.S.L. Blank Disc for precise elimination of side thrust. Price: 8s. (including PT).

'This is a superbly designed and produced integrated piece of equipment... it is difficult to fault.'

Stanley Kelly, The Gramophone, January 1969

PS-2000 transcription unit, recommend retail price £169:15:6

SPECIFICATIONS

Model PS-2000

Weight 21lb 4 oz (9.7 kg) **Dimensions** 18 $\frac{3}{4}$ " (w) × 8 $\frac{7}{16}$ " (h) × 15 $\frac{3}{8}$ " (d) **Accessory** Screw driver

Turntable TTS-3000

Turntable Aluminium diecasting 12" 3 lb 5 oz **Motor** Servo-controlled direct current motor **Speed** 33 $\frac{1}{3}$ & 45 rpm **Speed regulation system** Frequency generator/frequency discriminator servo control **Speed control range** ±5% **Driving system** Polyurethane belt drive. Reduction ratio: 10:1 **Starting response** Within 1 sec **Wow & Flutter** Less than 0.05% rms **S/N** Over 60 db (NARTB std.) **Turntable waving** Within ±0.05mm **Power requirement** 100, 117, 220, 240V, 50/60Hz **Power consumption** 4VA **Weight** Approx. 12 lb 11 oz (5.8 kgs) **Dimensions** 14 $\frac{9}{16}$ " (w) × 5 $\frac{1}{8}$ " (h) × 15" (d) **Accessory** Adaptor for 45 rpm.

Tonearm PUA-237

Arm length Overall 13 $\frac{3}{8}$ " Pivot to stylus tip 9 $\frac{1}{2}$ " **Tracking error** Max. 1°44' **Cartridge off-set angle** 22°13' **Arm resonance (with VC-8E)** Vertical 9 Hz, Lateral 11 Hz **Stylus pressure** 0~3 grs with direct reading gauge **Overhang** 9 $\frac{1}{16}$ " **Acceptable cartridge weight** 6~18 grs **Cartridge mount** EIA standard **Stereo cartridge VC-8E**

Type Moving coil type stereo cartridge **Frequency response** 10~25,000 Hz **Channel separation** 30db at 1,000 Hz; 20 db at 10,000 Hz **Channel balance** ±0.5 db at 1,000 Hz **Output voltage** 4mV ±2 db at 1,000 Hz (50 mm/sec) **Impedance** Approx. 40 ohms at 10~25,000 Hz **D.C. resistance** Approx. 40 ohms **Load impedance** 47k ohms (10~100k ohms applicable) **Compliance** 10 × 10⁻⁶cm/dyne (for vertical and horizontal) **Stylus** 0.2 × 0.8 mil elliptical diamond **Stylus pressure** 0.5~2 grs (1.5 grs mostly recommended) **Weight** Approx. 0.55 oz **Mounting dimension** EIA standard



SONY

PERFECTION IN SOUND WITH

Garrard



You're looking at three of the finest turntable units available. Any one of these Garrard models will bring you closer than ever before to your ideal in sound reproduction – and at the price you want.

Garrard 401

With its heavily-shielded 4-pole induction motor, precise speed control, anti-static mat, non-magnetic diecast turntable, built-in stroboscopic light and contemporary styling, the 401 is the ultimate in transcription turntables. It meets the most exacting requirements of radio, television and recording studios throughout the world and of hi-fi enthusiasts everywhere. Each unit is supplied with its own individual test report.



Garrard AP 75

A high-fidelity single record-playing unit with many advanced features. Aluminium pick-up arm and slide-in cartridge carrier. Non-magnetic turntable. Calibrated fine stylus force adjustment and pick-up arm bias compensation. Cue and pause facility. As well as manual control, this unit offers the additional facility of automatic play of single records. A single operation starts the turntable, lifts the pick-up arm and lowers it on to the record, and when playing is finished, returns the pick-up arm to rest and stops the turntable. A single control lever selects both record size and turntable speed for 12" records (78 rpm) 7" (45 rpm) and 12", 10" and 7" (33½ rpm). Optional extras: Wood base and rigid clear plastic cover.



Garrard SP 25 Mk. II

A single-play unit of outstanding quality – the Garrard SP25 Mk II is designed to give exceptional performance at moderate cost. A special feature is the integral cueing device, which provides the facility for raising or lowering the pick-up at any point on the record. This cueing is coupled with the switch-on control which has three positions – Off, Play and Lift. On completion of a record, the pick-up arm automatically lifts and returns to its rest and the motor switches off. The unit also includes bias compensation and integral calibrated stylus force adjustment. Optional extras: Wood base and rigid clear plastic cover.

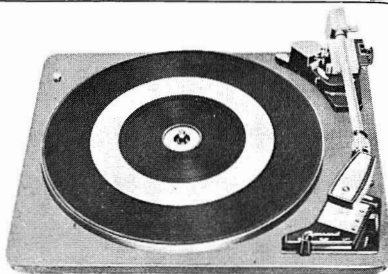

Garrard Engineering Limited
Newcastle Street · Swindon · Wiltshire · Tel: Swindon 5381

Garrard

a PLESSEY quality product



DIRECTORY OF MOTOR UNITS

BANG AND OLUFSEN (UK) LTD., Eastbrook Road, Gloucester. Tel: Gloucester 21591.

★ **Beogram 1000.** Plinth mounted motor unit with arm and cartridge. Speeds: 78, 45 and 33½ rpm with 12% vernier adjustment. Wow: ±0.2% peak. Rumble > 32dB below 10 cm/sec PU output. Belt drive. B and O ST/L 15° arm with microlift. Anti-static mat with strobe disc. Anti-microphonic suspension. Built-in 45 rpm disc insert. Power supply and socket for GF3 preamp. Price (teak): £33 7s. 6d. (plus £8 7s. 6d. PT). GF3 preamp £6 5s.

★

BSR LTD., Monarch Works, Cradley Heath, Warley, Worcs. Tel: Cradley Heath 69272. Telex: 33282.

★ **MA70.** Manual/automatic motor unit with pickup. Speeds: 78, 45, 33½, 16½ rpm. 11 in. diameter deep-rim turntable. Pulley drive. Four-pole induction motor. Tubular counter-balanced pickup arm with coarse and fine adjustments. Detented and calibrated stylus pressure control. Adjustable anti-skate control. Automatic pickup lock. Interchangeable spindles. Automatic shut-off. Price: (without cartridge) £11 19s. 6d. (plus £2 17s. 6d. PT).

★ **MA75.** Automatic/manual motor unit with pickup arm and shell. Heavy diecast non-ferrous alloy. Interchangeable spindle for manual or automatic. Cartridge holder takes all standard cartridges. Arm locked when not in use. Low mass counter-balanced arm. Cue/pause lever to raise or lower arm precisely. Calibrated bias control. Calibrated stylus pressure selector. Suppressed switching. Muting on automatic. Plinth available as extra. Price: £14 9s. 6d. (plus £3 9s. 11d. PT).

Plinth. To suit MA70 and MA75 motor units above. Price: £5 5s. (plus £1 5s. 4d. PT).

Plastic Cover. Strong, durable, transparent cover. Smoke tinted styrene. Price: £3 19s. 6d. (plus 19s. 2d. PT).

★

BRAUN AG. Distributors: Fi-Cord Interna-

tional, Charlwoods Road, East Grinstead, Sussex. Tel: East Grinstead 21351.

PS410. Turntable, pickup arm, cartridge, mounted on plinth with plexiglass lid. Speeds 16½, 33½, 45, 78 rpm with ±3% fine adjustment. W and F less than 0.02%. Rumble better than -56 dB. Turntable 10¼ in. 5 lb. Stepped spindle, friction wheel, intermediate roller and drive belt. Four-pole synchronous motor. Tubular cranked metal pickup arm. Lowering and raising device. Cueing for 7 in., 10 in. and 12 in. records. Tracking error: less than ±2 degrees. FR (Shure M75-6 cartridge) 20 Hz-20 KHz. Size: 6⅝ × 14½ × 11 in. Price: £71 11s. 7d. (including PT).

★ **PS52-E** stereo turntable for studio music systems. Ingenious drive assembly with friction wheel and belt transmission to eliminate motor vibrations. Speeds: 16½, 33½, 45 and 78 rpm. Pickup arm with interchangeable Shure SME shell. Balanced by adjustable counterweight. Mechanical cueing device. Standard version equipped with Shure M75-EM (M75E) magnetic cartridge. Base: wood with graphite finish, perspex lid. Dimensions: 8 × 15¼ × 12⅝ in. Price: £156 4s.

PS500 stereo turntable for studio music systems. Chassis vibrations are damped oil-hydraulically, pickup fully balanced by adjustable counterweights. Speeds: 16½, 33½, 45 and 78 rpm. Anti-skating device, semi-automatic lowering device and shut-off disengageable, built-in stroboscope, fine speed control. Shure M75-MB (M76-6) magnetic cartridge. Cabinet: steel with charcoal wrinkle lacquer, cover plate aluminium, lid in perspex. Dimensions: 6⅝ × 16⅞ × 12⅝ in. Price: £110 5s. 2d.

★ **PS1000.** Four-speed motor unit with pickup arm. Speeds: 78, 45, 33½, 16½ rpm. Speed adjustment ±3%. W. and F. below 0.1%. Rumble -60 dB. Pickup arm balanced horizontally by two adjustable counterweights. Tracking adjustable down to 0.4 gm. Hydraulic lowering device, relay-operated by feathertouch button. Automatic photo-electric shut-off. Size: 17¼ × 6⅞ × 12⅞ in. Price: £183 10s. 2d. (including PT).

★

CONNOISSEUR. A. R. Sugden & Co. (Engineers) Ltd., Market Street, Brighouse, York-

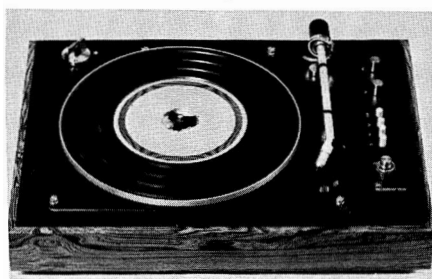

Bang & Olufsen 1500



Braun PCS-52E motor and pickup



Bang & Olufsen 1000

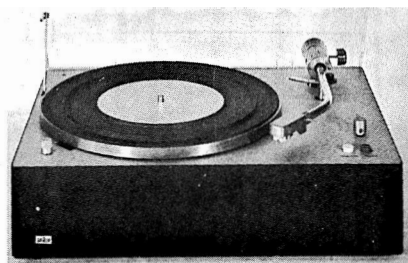

Braun PS-1000 motor and pickup



B.S.R. MA70



Connoisseur Craftsman II



B.S.R. MA75 turntable



Connoisseur Craftsman III

shire. Tel: Brighthouse 2142. Cables: Connoisseur, Brighthouse.

★**Craftsman' two speed transcription motor.** Operates at 33 $\frac{1}{3}$ and 45 rpm fixed speeds. Full 12 in. turntable of non-ferrous material. All bearings are adjustable throughout the life of the unit. Synchronous motor. Price: £15 15s. (plus £5 3s. 9d. PT).

★**Craftsman' three speed transcription turntable.** Requires minimum mounting space. Heavy non-ferrous 12 in. turntable. 33 $\frac{1}{3}$, 45 and 78 rpm. 4% variation on all speeds. Neon lit stroboscope fitted. Dynamically and electrically balanced synchronous motor. All bearings are adjustable. Price: £21 (plus £5 3s. 9d. PT).

★**Craftsman plinth assembly.** Available with Craftsman 2-speed or 3-speed motor with SAU-1 or SAU-2 arm with lifting device and head shell fitted with SCU1 cartridge. Size: 16×14×7 $\frac{1}{2}$ in. Finish: satin polished wood plinth, black base and with grey motor mounting board and Perspex cover. Prices from: 2-speed: £39 12s. 9d. (plus £9 15s. 9d. PT).

★**BD1.** Two-speed motor unit supplied as motor only or plinth mounted with any Connoisseur arm. Two fixed speeds, 33 $\frac{1}{3}$ and 45 rpm. Wow <0.1%. Flutter <0.1%. Rumble: -50 dB measured at RIAA characteristics ref 7 cm/sec at 1 KHz. No change in speed for 20% variation in supply voltage. 10 $\frac{1}{4}$ in. non-ferrous lathe-turned turntable. Precision ground belt drive. Unique drive arrangement eliminates transmission noise. Simple manual speed change. Low hum field. Slim line construction. Only 1 $\frac{3}{4}$ in. required below mounting platform. Mains: 100-120V and 200-240V, 50 or 60 Hz. Price: £12 1s. 6d. (plus £2 16s. 10d. PT). Price of assemblies on application.

★**BD2.** Integrated transcription unit. Includes a BD1 motor unit (mounted on a larger platform) and a type SAU2 pickup arm. Hydraulic arm lift operated from front. Anti-vibration springs. Supplied either chassis only or plinth mounted. Perspex cover optional. Size: 12 $\frac{1}{4}$ ×14×4 $\frac{3}{4}$ in. (2 in. below and 2 $\frac{3}{4}$ in. above the platform. Price: (chassis only) £22 1s. (plus £5 3s. 9d. PT).

★

DECCA. Decca Special Products, Ingate Place, Queenstown Road, London, S.W.8. Tel: 01-622 6677.

★**Studio turntable.** Combination of Decca Mk

4 ffs cartridge and Garrard AP75 three-speed single record playing unit. Speed 33 $\frac{1}{3}$, 45 and 78 rpm. Automatic motor switch off and return of pickup at end of record. Cue and pause facility, calibrated pickup arm bias compensation, calibrated stylus weight adjustment. Price: £32 6s. (plus £7 12s. PT).

★**Decadec de luxe.** Motor unit with Deram transcription head and arm including all fittings for cabinet mounting. Speeds: 16 $\frac{2}{3}$, 33 $\frac{1}{3}$, 45, 78 rpm with no fine adjustment. 10 $\frac{1}{2}$ in. non-magnetic turntable. Pulley drive. Garrard motor. Automatic motor switch off and return of pickup at end of record. Built-in anti-rumble filter. Lifting and lowering device and bias compensation. Price: £15 15s. 8d. (plus £3 14s. 4d. PT).

★

DUAL. Dual Electronics Ltd., Radnor House, London Road, Norbury, S.W.16. Tel: 01-764 9465/6.

★**1019.** Transcription turntable with automatic changing facility. Speeds: 78, 45, 33 $\frac{1}{3}$, 16 $\frac{2}{3}$ rpm. Variable speed adjustment $\pm 6\%$. Dynamically balanced low-mass arm with direct dial stylus pressure (0.5 gm) and direct dial bias compensation. Dynamically balanced non-ferrous turntable weighing over 7 $\frac{1}{2}$ lb. Cueing control. Rotating single-play spindle. Continuous pole motor with low stray field. Radially elastic suspension. Friction-damped rubber-cushioned spring suspension. Rumble virtually eliminated. Accepts any standard cartridge with $\frac{1}{2}$ in. fixing centres. Price: with Shure M75-MG cartridge £45 6s. 2d. (plus £11 3s. 10d. PT). Base and cover CKH6 available. Price: £10 7s. 3d. (plus £2 11s. 3d. PT).

★**1015/F.** Transcription turntable with automatic changing facility. Counter-balanced pickup arm. Three speeds. Variable speed control. Direct dial stylus pressure adjustment (0.5 gm). Direct dial bias compensation. Cueing control. Full specification on request. Price: with Shure M75-MG cartridge £35 7s. 3d. (plus £8 14s. 9d. PT). Base and cover CKH6. Price: £10 7s. 3d. (plus £2 11s. 3d. PT).

1210. Turntable providing manual operation or automatic record playing. Three speeds: 78, 45, 33 $\frac{1}{3}$ rpm. Tubular metal PU arm. Two-pole induction motor. Pitch control. Turntable 3.2 lb, 10 $\frac{5}{8}$ in. dia. Stereo crystal cartridge CDS640 recommended. Full details on request. Price: (less cartridge) £23 2s. 8d. (plus £5 14s. 4d. PT).



Connoisseur SAU2 arm and plinth



Decca Studio



Connoisseur BD1

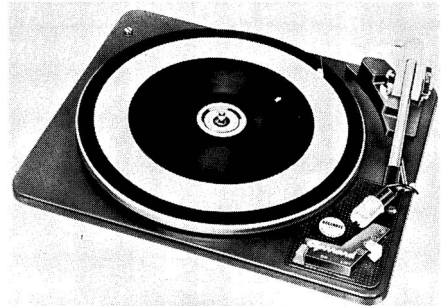

Deccadec de Luxe



Connoisseur BD1 on plinth



Dual 1015 turntable unit



Connoisseur BD2



Dual 1019 turntable unit

1209. Transcription turntable with automatic changing facilities. Speeds: 78, 45, 33½ rpm. Four-pole high torque synchronous motor. Turntable: 4 lb, 10⅝ in. dia. Metal (tubular) PU arm with low mass. Cueing facilities and pitch control. Continuously variable tracking weight adjustment. Full details on request. Price: (less cartridge) £36 9s. 9d. (plus £9 0s. 3d. PT). With Shure M75-MG cartridge, £42 18s. 10d. (plus £10 11s. 2d. PT). Base and cover CKH6, £10 7s. 3d. (plus £2 11s. 3d. PT).

1219. Professional transcription turntable with automatic play facility. Speeds: 78, 45, 33½ rpm. Synchronous continuous pole motor. Turntable: 6.9 lb, 12 in. dia. PU arm on gimbal suspension. Cueing facilities, anti-skating device, pitch control (6% range on speed) and continuously variable tracking weight adjustment. Full specification on request. Price: (less cartridge) £51 3s. 8d. (plus £12 12s. 10d. PT). With Shure M75-MG cartridge £61 3s. 6d. (plus £15 1s. 6d. PT). Base and cover CK20 available; details and price on application.

★

EMT WILHELM FRANZ KG. Sole U.K. agents: F. W. O. Bauch Ltd., Holbrook House, Cockfosters, Barnet, Herts. Tel: 01-440 3277.

★**EMT 930st.** Professional transcription turntable fitted with pickup arm and equaliser amplifier, chassis construction. Speeds: 33½, 45 and 78 rpm with fine speed control. W and F max: 0.075%. Rumble: referred to a peak velocity $V = 10 \text{ cm/s}$ at 1 KHz 58 dB (weighted) (0 dB = 0.775V). Speed constancy: max $\pm 0.15\%$. Turntable: 13 in. dia. heavy cast non-magnetic with light perspex auxiliary turntable on top. Drive: pulley. Motor: EMT manufacture with artificially aged shaft. Pickup arm: S-shaped Ortofon Type RMA 229. Features: stroboscope, quick start, remote start, pickup illumination, scratch filter and equalisation control on deck, headphone sockets, pickup lowering device. Price on application.

★

ELAC. Electroacoustic GmbH, Kiel, West Germany. Distributors: (Motor units) Nilnet Products Ltd., Compton House, Malden Road, New Malden, Surrey. Tel: 01-942 9567.

Complete range of motor units. Specifications and prices of motor units available on application.

FARNELL. A.C. Farnell Ltd., Consumer Division, Farnell House, 81 Kirkstall Road, Leeds LS3 1HR. Tel: Leeds 35111.

3100 AB. 2-speed transcription unit with pickup arm in teak plinth with detachable black base and transparent perspex dust cover. Speeds: 33½ and 45 rpm. Psn: 220-240V 50 Hz. Consumption 27W. Drive: rubber belt directly from motor to turntable without idler wheels. Rumble: -45 dB. S/N: -57 dB. W and F: better than 0.07% DIN. Turntable: anti-magnetic, multi-pertinax, dia 11⅝ in., weight 3½ lb. All-balance pickup arm Type 2400, 9 in. Pickup lift: viscosity principle, slowness adjustable. Controls: speed selector, fine speed adjustment, mains switch and lift lever. Dimensions: $6\frac{9}{16} \times 16\frac{3}{4} \times 14\frac{7}{16}$ in. Weight: 18¾ lb. Price: £50 (plus £13 4s. 7d. PT).

3100A. Transcription turntable unit only (with arm only). £44 10s. (plus £11 15s. PT).

3100. Transcription turntable chassis. Price: £36 (plus £9 10s. 6d. PT).

3100/SME. Transcription turntable unit with correct mounting holes drilled for SME 9 in. arm. Price: £36 (plus £9 10s. 6d. PT).

3100SG. Transcription turntable unit with facilities for mounting 12 in. pickup arm. £40 (plus £10 12s. PT).

★

FERGUSON. British Radio Corporation Ltd., 284 Southbury Road, Enfield, Middlesex. Tel: 01-366 1155.

★**Ferguson 202RP.** Record unit in cabinet to match Unit Audio equipment. Turntable: Garrard SP25S Mk II with bias compensation, cueing device and interchangeable head. Cartridge: Sonotone stereo ceramic 9TA with diamond stereo LP and sapphire 78 styli. Mains: 200-250V AC 50 c/s. Output socket: 3-pin DIN for stereo pickup. Supplied with 5 ft. lead for connecting to Unit Audio amplifiers. Size: $16\frac{1}{4} \times 14 \times 8\frac{1}{2}$ in. Finish: teak with transparent Perspex lid. Price: £25 14s. 11d. (plus £5 10s. 1d. PT).

★

GARRARD ENGINEERING LTD., Swindon, Wiltshire, England. Tel: Swindon 5381. Cables: Garrard, Swindon.

★**Model 401.** Transcription motor. Three speeds: 33½, 45, 78 rpm. Adjustable by eddy current brake. 6 lb. machined aluminium turntable with gear-cut illuminated strobe markings



Garrard SP25 Mk II turntable unit

EMT 930st



Ferguson 202RP



Garrard 401 motor unit



Garrard SL95 turntable unit



Garrard SL75 turntable unit



Garrard AP75 turntable unit



Goldring GL75 with plinth and cover

on rim. Statically balanced. Die-cast aluminium unit plate. Completely screened spring-mounted shaded-pole motor. Anti-static turntable mat. Styled by Eric Marshall and finished in metallic charcoal with chrome relief. W. and F. less than 0.05% RMS. Rumble almost non-existent. Mains: 110-125V and 220-250V, 50 or 60 Hz according to pulley fitted. Size: $13\frac{3}{4}$ in. wide, $14\frac{5}{8}$ in. front to rear, $2\frac{3}{8}$ in. above motor board, $3\frac{1}{16}$ in. below lower edge of unit plate. Price: £25 9s. 7d. (plus £6 4s. 7d. PT).

★**SP25 Mk II.** High quality single record playing unit. Die-cast non-magnetic turntable. Four speed. Magnetically screened motor. Cueing device to raise or lower pickup arm where required. Counter-balanced tubular aluminium arm. Plug-in head. Integral calibrated stylus pressure adjustment. Bias compensator. Automatic trip and return. Wired for stereo and mono. Mains: 100-130V, 200-250V, 50 or 60 Hz according to pulley. Size: $15\frac{1}{16}$ in. wide, $12\frac{1}{2}$ in. front to rear, $2\frac{7}{8}$ in. above, $2\frac{3}{4}$ in. below lower edge of unit plate. Plus clearances. Price: £12 10s. 8d. (plus £3 1s. 3d. PT).

WB1. Wood base for SP25 Mk II. Price: £2 13s. 9d. (plus 13s. 2d. PT).

SPC1. Rigid transparent plastic dust cover for WB1. Price: £2 12s. 3d. (plus 12s. 9d. PT).

WB5. Wood base for SP25 Mk II. Price: £4 7s. 6d. (plus £1 1s. 5d. PT).

SPC Mk II. Rigid transparent plastic cover for WB5. Allows SP25 Mk II to be played with cover in position. Price: £3 9s. 6d. (plus 17s. PT).

SL95B. Transcription turntable with auto-change facility and automatic single record play. Combined record size and speed selector. $11\frac{1}{2}$ in. aluminium turntable. Afrormosia pickup arm set into aluminium. Gimbal mounted. Counter-balanced. Calibrated fine stylus force adjustment. Calibrated bias compensator. Slide-in cartridge carrier accepts most makes and types. Cue and pause facility. Retractable record platform. Wired for mono and stereo. Synchro-Lab constant speed motor. Size (including rear and side overhang of pickup arm): $15\frac{7}{16}$ in. wide, $14\frac{1}{2}$ in. front to rear, $4\frac{1}{8}$ in. above, $2\frac{1}{16}$ in. below lower edge of unit plate. Plus clearances. Price: £36 10s. 6d. (plus £8 18s. 7d. PT).

WB4 Mk II. Wood base for SL95B. Price: £4 7s. 6d. (plus £1 1s. 5d. PT).

SPC4 Mk II. Rigid transparent plastic dust cover for SL95B. Price: £3 9s. 6d. (plus 17s. PT).

SL75B. Transcription turntable with auto-change facility and automatic single record play. Combined record size and speed selector. $11\frac{1}{2}$ in. diameter aluminium turntable. Diecast aluminium pickup arm. Counterbalanced. Calibrated fine stylus force adjustment. Calibrated bias compensator. Slide-in cartridge carrier accepts most makes and types. Cue and pause facility. Wired for stereo and mono. Synchro-Lab constant speed motor. Size (including rear and side overhang of pickup arm): $15\frac{1}{16}$ in. wide, $14\frac{1}{16}$ in. front to rear, $4\frac{1}{8}$ in. above, $2\frac{5}{16}$ in. below lower edge of unit plate. Plus clearances. Price: £28 12s. 5d. (plus £6 19s 11d. PT).

WB4 Mk II. Wood base for SL75B. Price: £4 7s. 6d. (plus £1 1s. 5d. PT).

SPC4 Mk II. Rigid transparent plastic cover for SL75B. Price: £3 9s. 6d. (plus 17s. PT).

SL72B. Transcription turntable with auto-change facility and automatic single record play. Combined record size and speed selector. Non-magnetic turntable. Aluminium pickup arm is weight counterbalanced, fitted with slide-in cartridge carrier and features gimbal type pivots. Calibrated stylus force adjustment. Calibrated bias compensator. Cue and pause facility. Wired for stereo and mono. Size (including rear and side overhang of pickup arm): $14\frac{9}{16}$ in. wide, $12\frac{11}{16}$ in. front to rear, $4\frac{1}{8}$ in. above and $2\frac{1}{16}$ in. below lower edge of unit plate, plus clearances. Price: £24 3s. 9d. (plus £5 18s. 3d. PT).

WB4 Mk II. Wood base for SL72B. Price: £4 7s. 6d. (plus £1 1s. 5d. PT).

SPC4 Mk II. Rigid plastic cover for SL72B. Price: £3 9s. 6d. (plus 17s. PT).

★**AP75.** Single record playing unit. Manual or automatic play of single records. Combined record size and speed selector. $10\frac{1}{2}$ in. diameter aluminium turntable. Aluminium pickup arm. Counterbalanced. Calibrated fine stylus force adjustment. Calibrated bias compensator. Slide-in cartridge carrier accepts most makes and types. Cue and pause facility. Wired for stereo and mono. Four-pole induction motor. Size (including rear and side overhang of pickup arm): $15\frac{9}{16}$ in. wide, $14\frac{1}{16}$ in. front to rear, $2\frac{3}{8}$ in. above, $2\frac{1}{16}$ in. below lower edge of unit plate. Plus clearances. Price: £19 3s. (plus £4 5s. 1d. PT).

WB4 Mk II. Teak finish wood base for AP75. Price: £4 7s. 6d. (plus £1 1s. 5d. PT).

SPC4 Mk II. Rigid transparent plastic dust cover for AP75. Price: £3 9s. 6d. (plus 17s. PT).



GOLDRING MANUFACTURING CO. (GREAT BRITAIN) LTD., 486/488 High Road, Leytonstone, London, E.11. Tel: 01-539 8343/5.

★ **Goldring-Lenco GL75.** Integrated turntable and pickup arm. Four speeds, infinitely variable. Wow <0.2%. Flutter <0.2%. Speed change less than 1% for 13% voltage change. 12 in. diameter diecast zinc turntable, 8 lb. Vertical pulley drive. Four-pole 15W induction motor. L75 pickup arm. Counter-balance weight adjustment, knife-edge bearing, plug-in shell. Hydraulic lowering device. Price: £29 8s. (plus £7 0s. 2d. PT). Available on plinth as GL75/P. Price: £36 5s. 6d. (plus £8 12s. 11d. PT).

★ **Goldring G99.** Transcription motor only. Infinitely variable speeds 30-80 rpm. Wow 0.1%. Speed remains constant with 13% voltage change. Turntable 12 in. die-cast zinc. Vertical idler wheel with provision for disengagement. Four-pole motor. Built-in illuminated strobe. Pushbutton on-off. Price: £19 19s. (plus £4 15s. 1d. PT).

Goldring-Lenco GL69. Integrated turntable unit complete with pickup arm. Available also mounted on plinth as GL69/P. Infinitely variable speed adjustment with click-in positions for 16 $\frac{2}{3}$, 33 $\frac{1}{3}$, 45 and 78 rpm. Wow and flutter: 0.12%. Speed constancy: 0.3% for a 10% change in voltage. Turntable: 12 in. pressed steel, weight 3 lb. Drive: vertical pulley, running on conical motor spindle. Motor: induction 15VA. Pickup arm: L69, sliding counterweight stylus pressure adjustment, knife-edge bearings, lightweight pickup headshell with adjustment for stylus position. Price: £20 5s. (plus £4 16s. 6d. PT). Price of GL69/P £27 2s. 6d. (plus £6 9s. 3d. PT). Plastic dust cover £3 8s. (plus 16s. 3d. PT).



GOODMANS. Goodmans Loudspeakers Ltd., Axiom Works, Lancelot Road, Wembley, Middlesex. Tel: 01-902 1200. Cables: Good-axiom, Wembley.

★ **MT1000.** Complete record unit comprising turntable, pickup arm, plinth with hinged cover, and plug-in connection panel. Motor and arm details as Thorens TD150A unit. Cartridges: Shure M75-MB aligned and tested by Goodmans. Polished wood housing with perspex-

fronted lid. Finish: teak or walnut. Designed to match Goodmans Audio Suite equipment. Size: 15 $\frac{7}{8}$ in. wide, 13 $\frac{3}{8}$ in. deep (closed), 16 $\frac{1}{2}$ in. deep (open), 5 $\frac{3}{4}$ in. high (closed), 16 $\frac{1}{2}$ in. high (open). Price: £58 6s. 6d. (plus £15 8s. 9d. PT).

Goodmans 3025. Single play record turntable with pickup head and stylus. Speeds: 16 $\frac{2}{3}$, 33 $\frac{1}{3}$, 45 and 78 rpm. Weight counterbalanced and bias compensated pickup arm. Calibrated fine stylus force adjustment. Cue and pause control. Switch click suppressor fitted. Automatic trip and return. Motor: 4-pole induction. Turntable: 10 $\frac{1}{2}$ in. dia. Pickup arm: tubular aluminium with plug-in cartridge shell. Psn 110-130V and 200-250V, 50 or 60 Hz. Cabinet finish: teak. Dimensions: 7 $\frac{3}{8}$ × 16 $\frac{3}{4}$ × 14 $\frac{1}{2}$ in. Price: £37 14s. 9d. (including £7 18s. PT).



JAPAN PHONO MOTOR CO. LTD., Distributors: Howland-West Ltd., 2 Park End, South Hill Park, London, N.W.3. Tel: 01-794 6666 and 6033.

JP T-425. Turntable only. Speeds: 33 $\frac{1}{3}$ and 45 rpm. W. and F: 0.05%. Rumble: -47 dB. Double turntable, alloy 6 $\frac{1}{4}$ lb, 12 in. dia. Belt drive. Motor: 8-pole 32 coil synch. Price: £41 (plus £9 10s. 5d. PT).

JP T-500. Turntable only. Speeds: 33 $\frac{1}{3}$ and 45 rpm, fine speed control. W and F: less than 0.1%. Rumble: -42 dB. Turntable: 12 in. alloy, 3 $\frac{3}{4}$ lb. Belt drive. Motor: 4-pole synch. On-off pilot light. Price: £30 (plus £6 19s. 4d. PT).



H. J. LEAK & CO. LTD., 57-59 Brunel Road, East Acton, London, W.3. Tel: 01-749 1641. Cables: Sinusoidal, Ealux, London.

★ **Truspeed.** Transcription turntable. Two speed, 33 $\frac{1}{3}$ /45 rpm. Low speed (250 rpm) synchronous 12-pole hysteresis motor. 100/130V or 200/250V AC. <1.15% wow. <0.02% flutter. Neoprene drive belt decouples the turntable and pickup from motor vibrations reducing rumble level below audibility. Isolated pickup platform and balanced turntable mounting plate reduce the effects of acoustic feedback and shock excitation. PU raising and lowering device. Bias compensation. Adjustable counterweight. $\frac{1}{2}$ in. cartridge fixing centres. Mu-metal shielded 15° magnetic cartridge. Effective tip mass <1 mg. Elliptical diamond stylus. Output: 5 mV/5 cm/sec. FR: resonance free 20 Hz-20 KHz. Channel separation >25 dB at 1 KHz.

Teak plinth. Perspex cover. Price: with plinth £65 13s. 3d. (incl. PT); less plinth £61 11s. 6d. (incl. PT); Perspex cover £3 9s. (incl. PT).



PHILIPS ELECTRICAL LTD., Century House, Shaftesbury Avenue, London, W.C.2. Tel: 01-437 7777.

★**GA146.** Autochanger with arm, head, plinth and lid. Speeds: $16\frac{2}{3}$, $33\frac{1}{3}$, 45 and 78 rpm. W and F: <0.15% (DIN). Rumble: <-35 dB (DIN 'A'). Turntable: $10\frac{1}{4}$ in. steel with diecast rim. Drive: pulley. Motor: 6W asynchronous. Arm supplied fitted with GP200 pickup. Viscosity damped pickup lowering for manual operation. Price: £24 0s. 8d. (plus £5 18s. 10d. PT).

★**GA202.** Transcription unit with arm, pickup, plinth (teak veneered) and lid. Speeds: $33\frac{1}{3}$, 45 and 78 rpm with individual fine control $\pm 2\%$. W and F <0.13% (DIN). Rumble <-60 dB (DIN 'B'). Electronic control maintains speed over normal mains voltage variations. Long term drift better than $\pm 0.2\%$. Turntable: $11\frac{1}{4}$ in. steel, $2\frac{1}{2}$ lb. Electronic control obviates need for large flywheel. Drive: two-stage belt drive. DC motor with transistor regulator circuit. Pickup arm: lightweight tubular, gimbal mounted, decoupled counterweight, stylus pressure and side thrust adjustment. Standard $\frac{1}{2}$ in. head shell. Full electronic control for start, stop and speed control. Light beam operated autostop. Viscosity damped pickup manipulator (cueing device). Price: £51 6s. 5d. (plus £12 13s. 7d. PT).

★**GA217.** Two-speed single record player with arm, head, plinth and lid. Speeds: $33\frac{1}{3}$ and 45 rpm. W and F <0.2%. Rumble <-55 dB (DIN). Speed constancy dependent on supply frequency. Turntable: $10\frac{1}{4}$ in. steel. Drive belt. Motor: 1.7W synchronous. Lightweight tubular arm, gimbal mounted, decoupled counterweight, stylus pressure adjustment. Fixed side thrust compensation. GP200 pickup supplied. Viscosity damped pickup lowering device. Price: £25 13s. 9d. (plus £6 7s. PT).

★**GA228.** Automatic single record player with arm, head, plinth and lid. Speeds: $16\frac{2}{3}$, $33\frac{1}{3}$, 45 and 78 rpm. W and F <0.2% (DIN). Rumble -30 dB (DIN 'A'). Turntable: $7\frac{7}{8}$ in. steel. Drive: pulley. Motor: 9W asynchronous. Arm supplied fitted with GP200 pickup. Push button automatic operation for single discs. Price: £16 0s. 4d. (plus £3 19s. 2d. PT).

PIONEER. Distributors: Shiro (UK) Ltd., 8 Bush Lane, London, E.C.4. Tel: 01-626 4711.

PL-41. Transcription belt-drive turntable with 4-pole hysteresis synchronous motor. $12\frac{1}{2}$ in. aluminium alloy, $45/33\frac{1}{3}$ rpm speed deck. W and F less than 0.08%. To order only.

PL-11. Transcription 2-speed ($33\frac{1}{3}/45$ rpm) turntable. 4-pole synchronous motor. W and F less than 0.12%. Sound to noise ratio more than 40 dB. Arm tracking error $\pm 1.5^\circ$. Magnetic 0.6 thou diamond cartridge. Pw 2.5 gm. Output: 5 mV. Walnut base, hinged cover. Price: £47 12s. (inc. £10 5s. 4d. PT).

PL-30. Transcription belt drive 2-speed ($33\frac{1}{3}/45$ rpm) turntable. 4-pole synchronous motor. W and F less than 0.1%. Sound to noise ratio more than 43 dB. Tracking error ± 1 deg. Magnetic 0.6 thou diamond cartridge. Pw 2.5 gm. Auto arm return. Walnut base, hinged cover. Price: £95 10s. 10d. (inc. £20 12s. 2d. PT).



SANSUI. Sole U.K. importer: Brush Clevite Co. Ltd., Thornhill, Southampton SO9 1QX. Tel: 0703 45166. Distributors for Scotland, North and Midlands: Audio Distributors, 4 Lion Street, Kidderminster. Tel: 0562-3293.

★**SR4040.** Plinth mounted motor and pickup arm with dust cover. Speeds: 45 and $33\frac{1}{3}$ rpm. Wow and flutter <0.08%. Rumble -46 dB. Two-piece turntable, 8 in. inner, 12 in. outer. Zinc alloy turntable, $5\frac{1}{2}$ lb. Belt drive. Four-pole motor, capacitor start. Static balanced tubular arm. Tracking error <0.1%. Anti-static mat. Hydraulic cueing device. Magnetic cartridge available. Price: £80 0s. 6d. (plus £19 11s. 3d. PT); (without cartridge) £68 11s. 1d. (plus £15 4s. 8d. PT); (cartridge) £11 3s. 4d. (plus £2 9s. 8d. PT).

★**SR3030.** Turntable, arm, cartridge, with cover and plinth. Speeds: $33\frac{1}{3}$ and 45 rpm. W and F less than 0.09%. Turntable: $12\frac{1}{4}$ in., 4 lb, aluminium alloy. Belt drive. Motor: 4-pole hysteresis synchronous capacitor starting. Static balanced tubular arm. Oiled damped arm lifter. Anti-static mat. Price to be announced.



SANYO. Sanyo Marubeni, Sanyo House, Bushey Mill Lane, Watford, Herts. Tel: Watford 25354/6.



Goldring G99-S



Philips GA202

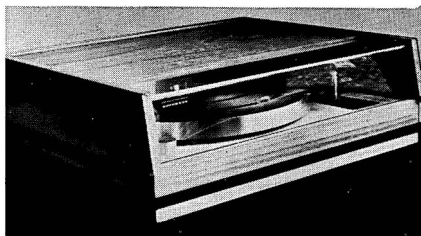

Goodmans MT1000



Leak Truspeed



Philips GA217



Sansui SR 4040

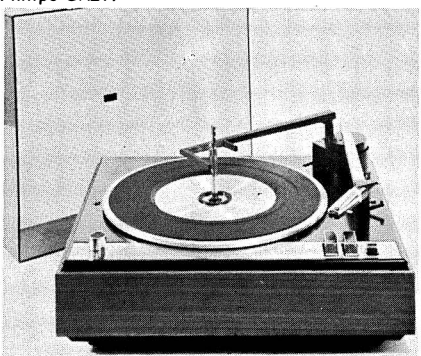

Philips GA146



Sansui SR3030 on plinth

TP-70. Turntable with PU and arm on base with Perspex hinged cover. 2-speed belt drive. 4-pole induction motor and automatic PU arm return. Cueing facility. Wow and flutter less than 0.1%. Static balance arm with counterbalance weight and lateral balance. Interchangeable cartridge. Supplied with magnetic cartridge MG15 5mV. FR 20 Hz-20 KHz. Tracking 0.3 gm. Price: £90 15s. (incl. PT).

TP-78. Turntable with PU and arm on base with tinted Perspex cover. 2-speed, 4-pole motor. Wow and flutter less than 0.3%. Static balance arm with counterbalance weight and lateral balance. Cueing system. Magnetic cartridge MG15 5 mV. FR 20 Hz-20 KHz. Tracking 0.2 gm. Price: £67 5s. (incl. PT).



SONY (U.K.) LTD., Ascot Road, Bedfont, Feltham, Middx. Tel: Ashford 50021.

★**TTS-3000.** Turntable and motor unit only. Speeds: 33½ and 45 rpm. Fine speed control ±5%. W and F <0.05% RMS. Signal/noise ratio over 60 dB. Speed constancy: 0.05%. 12 in. diameter die-cast aluminium turntable. Weight: 3 lb 5 oz. Belt drive. Servo-controlled DC motor. Illuminated strobe. Built-in spirit level indicator. Price: £65 3s. 3d. (plus £164s. 9d. PT).

PS1800. Turntable and motor unit on plinth. Size: 19¾ × 16¼ × 7½ in. Fine speed control. 12 in. diameter turntable. Speeds: 33½ and 45. Other details similar to TTS-3000. Price: £93 3s. 6d. (plus £23 16s. 6d. PT).



THORENS. Distributors: Metrosound (Sales) Ltd., Cartersfield Road, Waltham Abbey, Essex. Tel: Waltham Abbey 31933.

★**TD.124 Series II.** Transcription turntable. Four speeds, variable ±3%. Neon lit stroboscope with mirror. Double turntable (non-ferrous flywheel as standard but cast-iron available to order), with clutch action, four-pole motor. Belt plus idler drive system. Inbuilt levelling device with spirit indicator. Total W and F 0.15% p-p. Rumble — 35 dB. New NAB stereo standards. Price: £37 (plus £9 15s. 10d. PT).

TD.224. Transcription turntable and arm with autochange facility. Four speeds, variable ±3%. Built-in neon lit stroboscope. Incorporates BTD-12S arm. Total W and F 0.15% p-p Rumble — 35 dB. New NAB standards. Auto-change facility with record stacking before and after play separate from turntable. Each record placed on turntable individually and removed after playing. Price: £70 17s. 6d. (plus £18 15s. 2d. PT).

★**TD.150.** Transcription turntable. Two speeds, 33½ and 45 rpm. Low-speed synchronous motor (375 rpm). Belt drive. 12 in. non-ferrous 7½ lb turntable. Spring-mounted damped support for turntable bearing and pickup wooden panel. Total W and F 0.2% p-p. Rumble — 35 dB. New NAB stereo standards. Price: £23 5s. (plus £6 3s. 1d. PT).

TD.150A Mk II. Transcription turntable with integrated pickup arm. Two speeds, 33½ and 45 rpm. New lowering device, controlled from front panel, and anti-skating device, fitted. Patented plug-in shell with adjustable vertical tracking angle. Stylus pressure adjustable ¼-4 gm. Rumble — 65 dB DIN. Price: £33 (plus £8 14s. 9d. PT).

★**TD.150AB Mk II.** Details as for TD.150A Mk II, but plinth mounted. Price: £36 (plus £9 10s. 7d. PT).



BLACK KNIGHT SERVICES

ASHTON-UNDER-LYNE, LANCS., ENGLAND
HI-FI AND PUBLIC ADDRESS SPECIALISTS



Now offer Patented RUMBLECURE PRODUCTS to cure RUMBLE & ACOUSTIC FEEDBACK
Also "UNIVERSAL" COLUMN SPEAKER STANDS (light and heavy. Variable to suit conditions)

CONSULT THE EXPERTS

Our services include equipment advice visits to your home or premises, anytime, at your convenience. Many years of experience have resulted in our 'Rumblecure' Patents, these confirm the need for advice in the rooms involved. We supply any type of Cabinet/Shelving, and can make cabinets to match existing furniture. Comprehensive guarantee with ALL outfits. Also Full Service Facilities on any equipment. (If we can help, we will.)

Write above address, or telephone; S.T.D. 061 330 2836 or 330 3991.

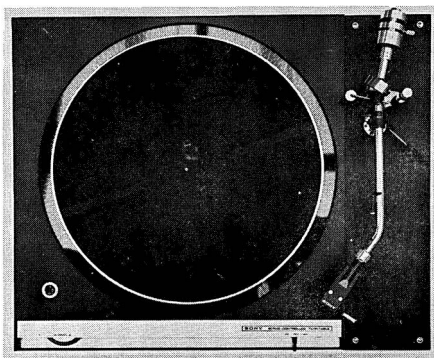

Sony turntable TTS 3000

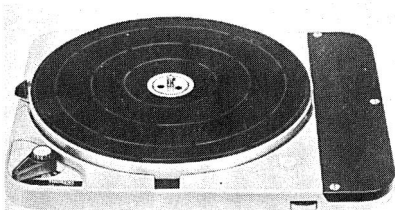

Thorens TD124

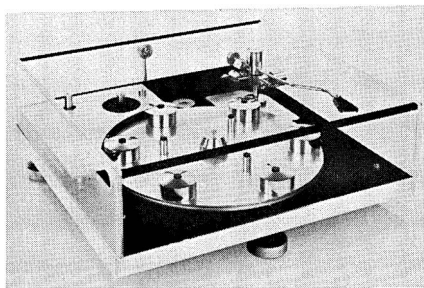

Transcriptors Reference turntable with cover

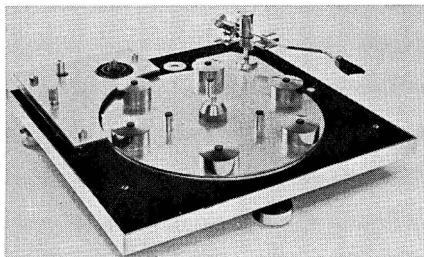

Transcriptors Reference turntable

TD.125. Transcription turntable. Three speeds: $33\frac{1}{3}$, 45 and $16\frac{2}{3}$ rpm. With $\pm 2\%$ electronic speed control. Low speed synchronous motor, belt driven. Motor is transistor governed. Neon-lit strobe. 12 in. non-ferrous turntable. W and F 0.09%. Plinth and cover available, also mounting frame if cabinet mounted. Price: £55 (plus £14 11s. 2d. PT).

Teak plinths. Suitable for TD.124 and TD.125 units. Price: £5 10s. (plus £1 9s. 2d. PT).

Perspex covers. Suitable for TD.124 and TD.125 units. Price: £4 (plus £1 1s. 2d. PT).

Teak plinth (special). Suitable for TD.124 fitted with S.M.E. 3012 arm. Price: £6 10s. (plus £1 14s. 5d. PT).

Perspex cover (special). Suitable for TD.124 fitted with S.M.E. 3012 arm. Price: £5 10s. (plus £1 9s. 2d. PT).



TRANSCRIPTORS LTD., 551 Holloway Road, London, N.19. Tel: 01-272 6419.

★ **Hydraulic reference turntable.** Self-standing unit, on adjustable acoustic feedback legs, level incorporated. Speeds: $33\frac{1}{3}$ and 45 only, $\pm 3\%$ fine speed adjustment by the incorporated hydraulic speed stabiliser. Soft rubber belt, drives 11 lb non-ferrous platter via a neon idler stroboscope from a synchronous motor. Strobe geared up 6:1 ratio, resulting in indications more accurate than any measuring instrument. Slipping clutch recoil start motor operated via a vacuum switch. P.T.F.E. main bearing, solid brass gold-plated platter weights. Fabricated Perspex top hinged at rear with swing leg support. Finish Black and Aluminium. All mains voltages and frequencies available. Rumble not measurable. Speed stability 0.005% short term, 0.01% long term. Size: 17×17×7 in. Price: (including PU arm) £63 15s. (plus £17 17s. 6d. PT).



Thorens TD150AB/11

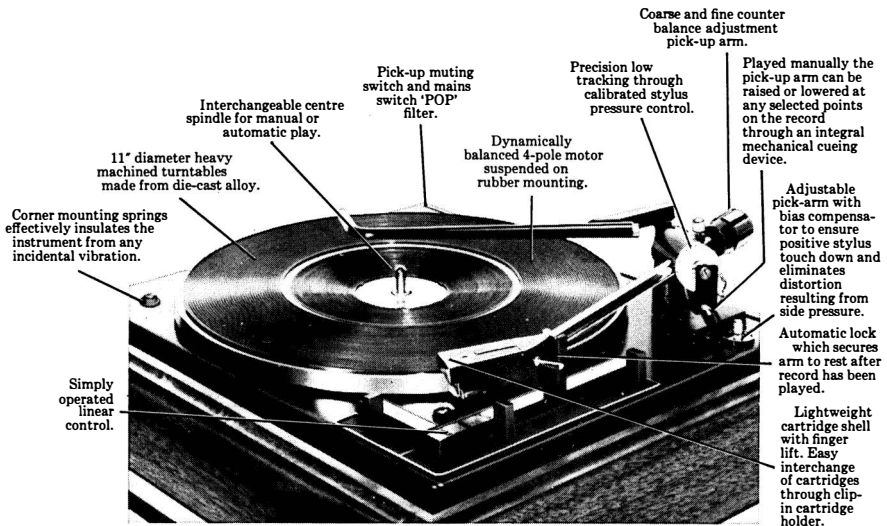

The grand plan to perfect sound

The BSR MA75. Perfection. Perfection. All the way.
And that's no idle boast.

Because BSR is already the world's leading manufacturer of record playing equipment. With a solid reputation based on precision engineering. Craftsmanship. And a total commitment to perfecting sound reproduction where it begins. On the turntable.

The BSR MA75 more than lives up to that reputation. It enhances it.

In fact your problem will be finding the tuners, amplifiers, speakers and what have you to do it justice.

Happy tracking.

BSR Limited, Monarch Works, Cradley Heath, Warley, Worcs., England.

Telephone Cradley Heath 69272 Telex 33282.



Introducing the fabulous new Imflex mini-trolley from Imhofs

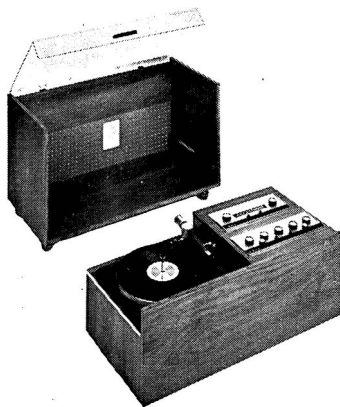
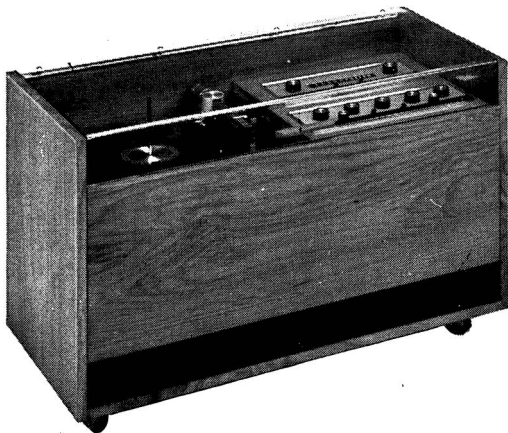

It takes the combined skills of Imhofs craftsmen/technicians to devise a cabinet so ingenious as the new Imflex mini-trolley. The clean elegant lines are typical of what has come to be expected in any Imhof cabinet but our engineers believe that a hi-fi cabinet should be more than just a pretty face. The mini-trolley, which has been specially developed for the new generation of transistorised hi-fi units, incorporates the new Imflex equipment module. This module can be completely removed from the cabinet (by simply undoing two screws) to allow installation or maintenance to be carried out the easiest and most economical way. The equipment shown here is the Garrard LAB 80 motor; the Leak Stereo 30 amplifier and the matching Leak Trough Line 3 tuner. Other suitable units include the following: Nikko TRM 40, Quad 303, Rogers Ravens-

bourne, Armstrong 421, Medley MM 25 and Goodmans Maxamp 30 amplifiers; Nikko FAM/12, Quad FM, Rogers FM, Armstrong 423-4, Eddystone EB 35 and Goodmans Stereomax tuners; Goldring GL 75, Thorens 150 AB, B and O Beogram 1000, Garrard SP 75, Garrard SP 75 Mk II and Dual 1019 Automatic motors. The mini-trolley is finished in Teak veneer. For full technical information on the Imflex mini-trolley, send 2/6d today for your copy of 'This Year of Hi-Fi'. In it, you will find details of all other Imhof hi-fi cabinets together with information on all the worthwhile hi-fi equipment that is currently available. Each copy of 'This Year of Hi-Fi' contains a voucher for £1 which is valid against any purchase of equipment over £20. For people living overseas, we will send a copy free and post free but the voucher is not included.

Some of the other exclusive cabinets recently added to the Imhof range which are fully described in 'This Year of Hi-Fi'

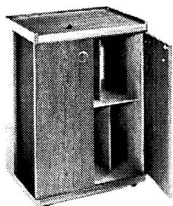

HFU/22RS record storage cabinet finished in a choice of either Teak, Walnut or Sapele Mahogany veneers



Imhof/Quad Unit to house the new Quad stereo system. Finish in Sapele Mahogany veneer

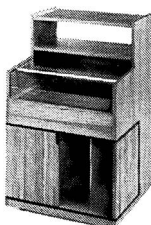

HFU/22 hi-fi cabinet Teak veneer finish

IMHOFS

Dept. 00. 112-116 New Oxford St, London WC1
telephone 01-636 7878

Please tick appropriate squares

I enclose cheque/postal order/stamps for 2/6d —
please send me a copy of 'This Year of Hi-Fi'

Living overseas I would like a free copy of
'This Year of Hi-Fi'

Please send me, free of charge, details of:
monthly record accounts
guaranteed export service
Eddystone communication receivers

name _____

address _____

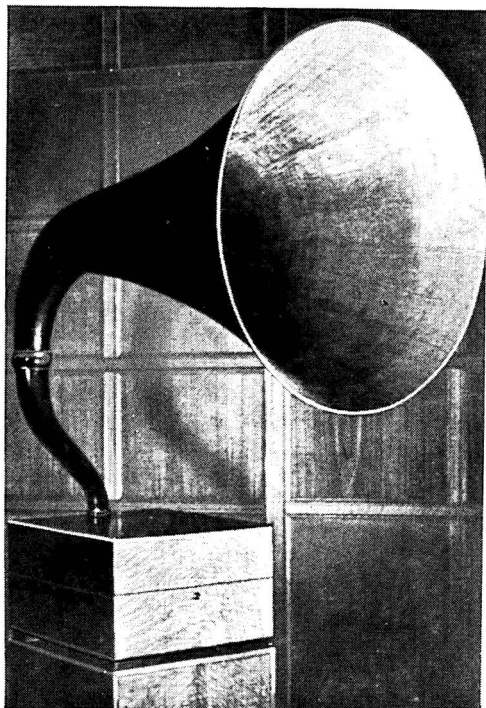

**this was
hi-fi
when
E.M.G.
made it
40 years
ago**

In 1929, this machine demonstrated E.M.G.'s unwillingness to compromise when it came to getting the best possible reproduction from records, and for many years, this instrument reigned supreme.

Electronic techniques overtook it eventually, and when they were good enough, E.M.G. skills and experience applied them to the design and production of equipment accordingly. Today's standards are miracles compared with what was exciting in the early thirties. E.M.G. go on maintaining their uncompromising standards. They stemmed originally out of a desire to supply the best possible equipment on which to play the records E.M.G. sold in their shop.

The policy goes on to this day. *Records for lovers of classical modern and serious music from the record shop, equipment and service from the equipment department, and the E.M.G. Monthly Letter (21/- a year post free) to help you choose from the new releases.*

IN 1970 IT IS STILL **E · M · G FOR
RECORDS. EQUIPMENT AND SPECIAL
PUBLICATIONS**

E.M.G. HANDMADE GRAMOPHONES LTD., 26, SOHO SQUARE, LONDON, W-1

Nearest Underground — Tottenham Court Road : Telephone 01-734 4311

RAVENS BROOK AND RAVENSBOURNE



RAVENS BROOK FET FM Tuner.



RAVENS BROOK Stereo Amplifier.



RAVENSBOURNE Stereo Amplifier and FET FM Tuner.

ROGERS

Stocked and Demonstrated by all leading Hi Fi Dealers

Full colour literature describing the RAVENS BROOK
and RAVENSBOURNE Stereo Systems available on request

ROGERS DEVELOPMENTS (ELECTRONICS) LTD.

4-14 BARMESTON RD, CATFORD, LONDON, S.E.6 Telephone: 01-698 7424/4340

DIRECTORY OF RADIO TUNERS

In the abridged specifications of these directory entries the following abbreviations have been used: **Psn**=Power supply needed; **AFC**=Automatic frequency control; **AGC**=Automatic gain control; **ind**=Indicator; **disc**=Discriminator; **imp**=Impedance; **det**=Detector. ★ indicates model is illustrated.

ACOUSTICAL MFG. CO. See Quad.

★

ARENA. Distributed by: Highgate Acoustics Ltd., 184-188 Great Portland Street, London, W.1. Tel: 01-636 2901.

★ **Arena F211.** Transistorised stereo FM tuner. Range: 88-108 MHz. Five preset stations. Modular construction. Sensitivity: 2.5 μ V. Three aerial tuned circuits, four IF filters. 11 silicon transistors. Finish: teak or rosewood. Size: $10\frac{1}{2} \times 3\frac{3}{8} \times 7\frac{3}{4}$ in. Designed for use with Arena F210 stereo amplifier. Suitable for operation also with other hi-fi amplifiers. Price: £36 15s. (including PT): multiplex decoder £7 7s. extra.

★

ARMSTRONG AUDIO LTD., Warlters Road, London, N.7. Tel: 01-607 3213.

★ **Model 523.** AM/FM tuner. Range: VHF 86-109 MHz, MW 185-590 metres, LW 1000-2000 metres. Variable tuning. FM ratio detector. Meter tuning indicator. Sensitivity: FM 1.5 μ V for 30 dB quieting, AM 5 μ V for 20 dB quieting. Aerial input: 75 ohms coaxial and 300 ohms balanced. Output: 0-1V variable. Stereo multiplex decoder optional (see M8 Decoder below). FM quiet-tuning control. Stereo indicator light. Edge connector for plug-in decoder. Mains: 100-125V and 200-250V AC. Size: $11\frac{1}{2}$ in. wide, $10\frac{3}{8}$ in. deep, $4\frac{5}{8}$ in. high. Price: £41 19s. (plus £10 10s. PT).

★ **Model 524.** FM tuner. Range: 86-109 MHz. Variable tuning. Ratio detector. Meter tuning indicator. Sensitivity: 1.5 μ V for 30 dB quieting. Aerial input: 75 ohms coaxial and 300 ohms balanced. Output: 0-1V variable. Stereo multiplex decoder optional extra (see M8 Decoder below). Quiet-tuning control. Stereo indicator light. Edge connector for plug-in decoder. Mains: 100-125V and 200-250V AC. Size: $11\frac{1}{2}$ in. wide, $10\frac{3}{8}$ in. deep, $4\frac{5}{8}$ in. high. Price: £32 3s. 6d. (plus £8 1s. PT).

Model M8. Plug-in stereo multiplex decoder for 523 and 524 tuners. Price: £9 10s.

★

BANG & OLUFSEN U.K. DIVISION, Eastbrook Road, Gloucester. Tel: Gloucester 21591.

★ **Beomaster 5000.** Transistor stereo FM tuner. FM/VHF only. Variable tuning. Ratio detector. Meter tuning indicator. Sensitivity: 0.8 μ V for 20 dB quieting. Aerial input: 75 ohms coaxial and 300 ohms balanced. Output: 55 mV-1V adjustable. Stereo multiplex decoder incorporated. AFC. Inter-station muting. Mains supply. Automatic stereo/mono switching. Matches Beolab amplifier. Teak or rosewood finish. Size: $18\frac{1}{2} \times 4 \times 9\frac{3}{8}$ in. Price (teak): £75 14s. 9d. (plus £19 0s. 3d. PT).

★

BRAUN AG. Distributors: Fi-Cord International, Charlwoods Road, East Grinstead, Sussex. Tel: East Grinstead 21351.

CE250. FM stereo tuner. Sensitivity: 1.2 μ V for 30 dB quieting, at 40 KHz deviation. Distortion: 0.5% at 1 KHz and 40 KHz deviation. Limiting point 1.5 μ V. Selectivity: 46 dB for 400 KHz (IHF Standard). Separation: 35 dB at 1 KHz and 40 KHz deviation. Output: 0.5V. Size: $10\frac{1}{4} \times 4\frac{1}{4} \times 12\frac{5}{8}$ in. Price: £101 7s. (including PT).

CE500. AM/FM tuner. VHF, MW and LW. 18 transistors, 20 diodes. Stereo multiplex decoder and indicator. AFC. Distortion: 0.5% at 1 KHz and 40 KHz modulation. Sensitivity (VHF): 1.2 μ V for 30 dB signal to noise at 40 KHz deviation. Separation: 35 dB at 1 KHz and 40 KHz. Output: FM 0.5V. Characteristics exceed requirements of DIN 45 500. Size: $10 \times 4 \times 12\frac{1}{2}$ in. Finish: grey wrinkle steel case with aluminium front panel. Price: £151 6s. (including PT).

★ **CE1000.** All-transistor tuner. LW, MW, SW and FM/VHF. Stereo multiplex fitted. Push-

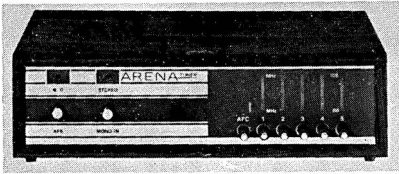

Arena F211



Braun CE-1000 tuner



Armstrong Audio 523 AM-FM

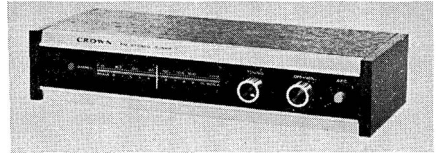

Crown FM-300

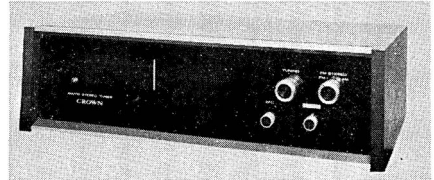

Crown FM-500

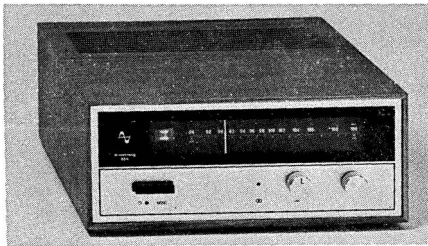

Armstrong Audio 524 FM

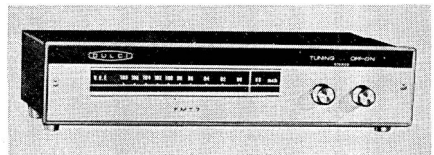

Dulci FMT7-S

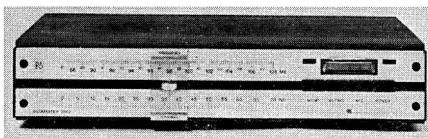

Bang & Olufsen 5000

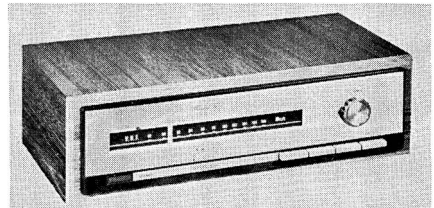

Dulci FMT9



Bush A747



Dynaco FM-3

button operation. Separate dials and drives for AM and FM. Meter tuning indicator. AFC, automatically switches off when hand touches tuning knob. Variable AM selectivity. 30 transistors, 2 nuvistors, 18 germanium diodes, 9 silicon diodes, 2 photo-electric cells. Switchable FM noise suppression. Internal ferrite rod for MW and LW. FM sensitivity: 0.8 μ V for 30 dB quieting. MW/LW sensitivity: 5 μ V for 6 dB quieting. Limiting level 1 μ V. AM suppression better than 50 dB. FM bandwidth: 120 KHz below and 240 KHz above limiting level. Detector bandwidth 1 MHz. Distortion factor <0.5%. Output: approx. 0.5V. Black steel cabinet with aluminium front plate. Size: 16 \times 4 $\frac{3}{8}$ \times 13 $\frac{3}{8}$ in. Price: £348 4s. 2d. (including PT).



BRYAN AMPLIFIERS LTD., St. John's Court, Jane Street, Workington, Cumberland. Tel: Workington 3776.

1500. Stereo FM tuner. Range: 88.5-108 MHz. Variable tuning. FM detector: ratio. Tuning indicator: meter. Sensitivity: 2 μ V. Aerial impedance: 80 ohms coaxial. Output voltage: 150 mV at 30% modulation. Multiplex decoder fitted. AFC. Mains powered. Dimensions: 13 $\frac{3}{4}$ \times 5 $\frac{1}{2}$ \times 10 $\frac{5}{8}$ in. Price: £42 13s. (plus £10 10s. 8d. PT).



BUSH. Rank Bush Murphy Ltd., Power Road, Chiswick, London, W.4. Tel: 01-994 6491.

★ **Bush A747** tuner operates on 88-108 MHz, 187-570 m and 1,070-1,900 m. Variable tuning. FM ratio detector. Tuning indicator: illuminated scale and meter, auto beacon for stereo. Sensitivity: 3 μ V for 26 dB quieting. Aerial: internal ferrite AM, 75 ohm unbalanced FM. Output voltage: 2.2V max AM, 1.5V max FM. Multiplex fitted, actuated automatically on reception of stereo broadcast. AFC on FM. Psn H.T. Dimensions: 4 $\frac{3}{8}$ \times 16 \times 9 $\frac{3}{16}$ in. All sockets recessed to avoid cable clutter. Price: £27 13s. 7d. (plus £6 10s. 3d. PT).



CHAPMAN. Chapman division, Reslosound Ltd., Reslo Works, Spring Gardens, Romford, Essex. Tel: Romford 61926 (three lines).

Chapman SD.1166 decoder. Free-standing unit in metal case. Self-powered for operation from 200-250V 40-60 Hz. (100-125V to order). Complete with plugs and cables. Price: £14 10s.

Chapman FM2005 tuner operates on 86-108 MHz, 182-570 m, 670-2,000 m, 15-50 m and 50-150 m. Variable tuning with tuning meter. Sensitivity: 2 μ V AM, better than 5 μ V FM. Aerial impedance: coaxial 75 ohms FM. AFC. Dimensions: 15 \times 7 \times 7 $\frac{1}{2}$ in. Fitted stereo decoder. Price: £67 (plus £17 19s. 3d. PT).



CROWN. Crown Radio Co. Ltd., 137-149 Goswell Road, London, E.C.1. Tel: 01-253 1971/2.

★ **FM-300.** Solid state stereo tuner. Range: 87-108 MHz. Aerial impedance: 300 ohms. AFC. Output: 0.5V 10K. Stereo indicator glows automatically. Psn: 117-220V, 50-60 Hz. Finish: oiled walnut. Dimensions: 2 $\frac{5}{8}$ \times 11 $\frac{5}{8}$ \times 4 $\frac{3}{8}$ in. Weight: 2 $\frac{1}{2}$ lb. Price: £25 5s. 9d. (plus £6 5s. 4d. PT).

★ **FM-500.** Solid state stereo tuner. Range: 87-108 MHz, 525-1,605 KHz. AFC. Output: 0.5V 10K. Stereo indicator glows automatically. Finish: oiled walnut. Dimensions: 4 $\frac{15}{16}$ \times 15 $\frac{3}{16}$ \times 10 $\frac{1}{2}$ in. Weight: 8 $\frac{1}{4}$ lb. Price: £42 8s. 11d. (plus £10 9s. 8d. PT).



DUAL. Dual Electronics Ltd., Radnor House, London Road, Norbury, London, S.W.16. Tel: 01-764 9465/6.

CT14. Transistorised stereo tuner. Range: 87.2-104.3 MHz (VHF), 5.85-10.3 MHz (SW), 510-1,630 KHz (MW), 350-145 KHz (LW). Sensitivity: VHF/FM, 1.5 μ V; SW, 8 μ V; MW, 40 μ V; LW, 78 μ V. FM limiting: 40 μ V. FR: 40 Hz-15 KHz \pm 1.5 dB. HD: <1%. S/N: >65 dB on FM. Push-button selection of wavebands. FM aerial impedance: 240 ohms. Tuning meter. Tuning: variable, with meter. Psn: 110-220V 50 Hz. Dimensions: 16 $\frac{1}{2}$ \times 4 $\frac{1}{4}$ \times 11 in. Weight: 7 $\frac{1}{2}$ lb. Price: £62 5s. (plus £15 7s. 6d. PT).

CT16. Transistorised stereo tuner. Range: 87-108 MHz (VHF), 6.7-15.4 MHz (SW1), 5.5-6.6 MHz (SW2), 500-1,650 KHz (MW), 150-350 KHz (LW). Sensitivity: FM, 1.5 μ V (max); SW, 10 μ V; MW, 20 μ V; LW, 50 μ V. FR: 40 Hz-15 KHz \pm 1.5 dB. HD: <1%. S/N: >70 dB FM. Push-button selection of wavebands and switchable AFC. Tuning: variable, with meter. Psn: 110-220V 50 Hz. Dimensions: 16 $\frac{1}{2}$ \times 4 $\frac{1}{4}$ \times 11 $\frac{1}{2}$ in. Weight: 8.4lb. Price: £78 7s. 9d. (plus £19 7s. 3d. PT).

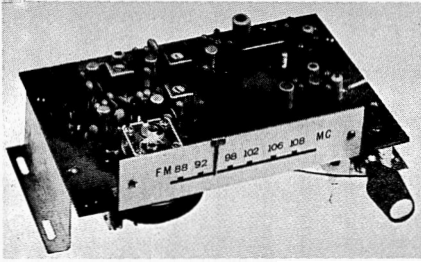

Eagle FMT.41

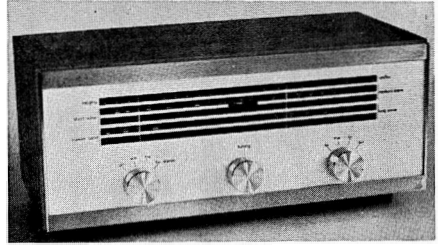

Chapman AM/FM stereo tuner

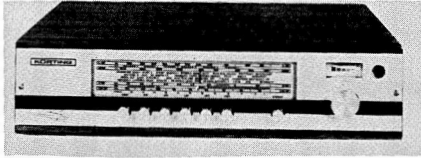

Korting T500

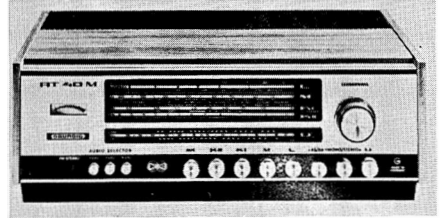

Grundig RT40M

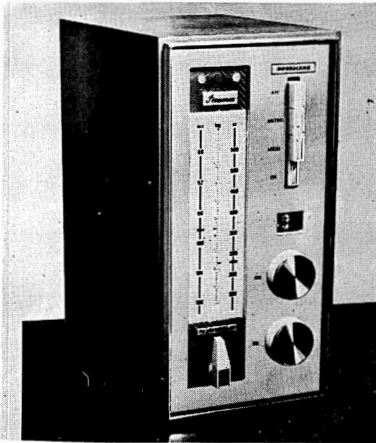

Goodmans Stereomax AM/FM

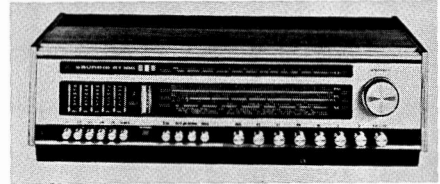

Grundig RT100



Eagle AM/FM stereo tuner

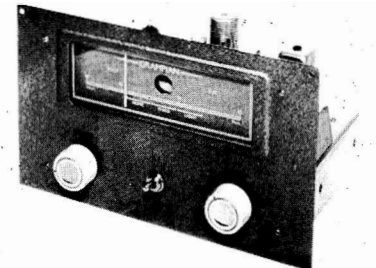

Grampian 571 FM tuner



Leak Stereofetic

DULCI. Lee Products (Great Britain) Ltd., 10-18 Clifton Street, London, E.C.2. Tel: 01-247 6711.

★**FMT7, FMT7S.** FM tuner. Range: 88.5 to 108.5 MHz. Variable tuning. Ratio detector. Aerial input: 80 ohms coax. Output: 100 mV. Multiplex decoder in model FMT7S. AFC. Size: $13\frac{3}{4} \times 2\frac{3}{4} \times 7$ in. Price: FMT7 £18 12s. 5d. (plus £4 7s. 7d. PT), FMT7S £25 1s. 11d. (plus £5 18s. 1d. PT).

★**FMT-9.** VHF tuner. Range: 88-108 MHz. Push-button AFC, quieting, mono/stereo switches. Tuning: variable. Pre-set volume control. Output: 200 mV. Stereo separation: 25 dB at 1 KHz. Tuning meter fitted. Dimensions: $15 \times 4\frac{1}{2} \times 8\frac{1}{2}$ in. Psn: AC mains. Price: £41 13s. 5d. (including PT).

MPX-7. Multiplex decoder unit for model FMT-9. Price: £7 9s. 7d.

★

DYNACO. Distributors: Howland-West Ltd., 2 Park End, South Hill Park, London, N.W.3. Tel: 01-794 6666 and 6033.

★**FM-3.** Variable tuned VHF/FM tuner for shelf mounting or building in. Synchronous balanced-bridge detector. Twin indicators for tuning and stereo transmissions. Sensitivity $4 \mu\text{V}$ for 30 dB quieting. Output 2V. Multiplex decoder fitted. Four IF stages with progressive limiting. Completely stable without AFC. Can be fully aligned without use of test instruments. Size: $13\frac{1}{2} \times 4\frac{1}{2} \times 8$ in. Mains power unit. Price: (assembled) £63 18s. 4d. (plus £16 13s. 4d. PT); (kit) £53 5s. 3d. (plus £13 18s. 4d. PT).

★

EAGLE PRODUCTS. Distributors: B. Adler & Sons (Radio) Ltd., Coptic Street, London, W.C.1. Tel: 01-636 9606/7. Cables: Relead, London.

★**FMT 41 FM tuner.** Range: 88-108 MHz. Transistorised. Variable tuning. Aerial input: 75 ohms coaxial. Sensitivity: $10 \mu\text{V}$ input for 10 mV output. Supply: 9V at less than 9 mA. Six transistors, three diodes. Chassis model for building in. Single tuning control and slide rule scale. Price: £8 4s. 10d. (plus £2 3s. 11d. PT).

AFM 200. AM/FM tuner. VHF/FM 88-108 MHz, MW 187-560 m. Variable tuning. Foster Seeley. Magic eye indicator. Sensitivity $2 \mu\text{V}$

for 20 dB quieting. Aerial input 300 ohms unbalanced. Socket for adding multiplex decoder. AFC. Mains 240V AC. 11 valves (including magic eye). Price: £28 14s. 4d. (plus £7 4s. 6d. PT).

★**AFT.60.** Transistorised AM/FM stereo tuner. Range: FM 88-108.5 MHz, MW 187-500 m. Variable tuning. Meter tuning indicator. Stereo beacon. Sensitivity: FM $2 \mu\text{V}$, AM $500 \mu\text{V}$. Aerial input: 75 ohms coaxial. Output: 50-200 mV variable. Decoder included. Four double-tuned IF stages. Switchable AFC. 13 silicon transistors. Mains: 220/240V AC. Size: $12\frac{3}{4} \times 4\frac{1}{2} \times 9\frac{1}{2}$ in. Price: £42 7s. 8d. (plus £10 17s. 11d. PT).

★

GOODMANS LOUSPEAKERS LTD., Axiom Works, Lancelot Road, Wembley, Middlesex. Tel: 01-902 1200. Cables: Goodaxiom, Wembley.

★**Stereomax.** All-silicon transistor AM/FM stereo tuner. Ranges: VHF 87.5-108 MHz, MW 186-550 metres. Variable tuning with separate dials and drives for AM and FM. Ratio detector on FM. Meter tuning indicator, lamp stereo indicator. Sensitivity: $2 \mu\text{V}$ for 30 dB quieting. Aerial input: FM/VHF 70 ohms coaxial, 300 ohms balanced. Output: 250 mV for 30% modulation. Multiplex decoder fitted but version without decoder available. AFC on both wavebands. Controls: AM tuning, FM tuning, wave-change switch including mono/stereo, on/off push-button, AFC, local-distant switch, quiet tuning switch. Mains: 105, 120, 200, 220, 240V AC. 40-60 Hz. Size: $5\frac{1}{2}$ in. wide, $10\frac{1}{2}$ in. high, $7\frac{1}{4}$ in. deep. Finish: teak or walnut. Price: £65 5s. (plus £17 5s. 5d. PT).

★

GRAMPIAN REPRODUCERS LTD., 19 Hanworth Trading Estate, Feltham, Middx. Tel: 01-894 9141. Cables: Reamp, Feltham.

★**FM tuner 571.** Free-tuned. Range: 85-98 MHz. Ratio det. Magic eye ind. Psn 300V at 35/40 mA; 6.3V at 2.5 amps. Size: $10\frac{1}{4} \times 5\frac{1}{2} \times 6\frac{1}{4}$ in. Price: £23 (plus £5 13s. 8d. PT).

★

GRUNDIG (GREAT BRITAIN) LTD., Hi-Fi Division, 15 Orchard Street, London, W.1. Tel: 01-935 4898.

★ **RT40M.** AM/FM tuner. Ranges: VHF 87-108 MHz, MW 185-587 m, LW 858-2,000 m, SW1 49 metre band, SW2 18.5-55.6 m. Variable tuning. Independent selection of AM and FM stations. Tuning meter. Stereo indicator beacon. Sensitivity: VHF 1.4 μ V, AM 10 μ V (for 10 mV audio). Stereo multiplex decoder incorporated. Switched AFC. 27 transistors, 19 diodes. IFs 470 KHz and 10.7 MHz. Output: FM 1V, AM 0.8V for 30% modulation. FR 30 Hz-15 KHz. Distortion factor < 0.5% per 75 KHz. Variable selectivity: 3, 5 and 9 KHz. Outlet for amplifier and recorder. Mains: 110, 130, 220, 240V 50-60 Hz. Consumption: 11W. Shelf or cabinet mounting. Size: 15 $\frac{3}{8}$ \times 10 $\frac{1}{2}$ \times 6 in. Finish: light walnut or teak. Price: \pounds 96 15s. (plus \pounds 22 15s. 3d. PT).

★ **RT100.** Stereo tuner. Preselection of 5 VHF stations. AM bandwidth selection. Duplex fly-wheel tuning. Tuning indicator. Multiplex decoder. Inter-station noise suppression. Outputs for tape recorder. F.E.T. VHF front end. Bands: VHF, LW, MW, SW1, SW2. Sensitivity: 1.5 μ V FM, 8 μ V AM. Output: .65V FM, .8V AM. Output impedance: 2K. Mains: Psn 110-240V 50-60 Hz. Oiled teak finish. Size: 20 \times 6 \times 12 in. Price: \pounds 171 7s. 11d. (including PT).

★

HEATHKIT. See Constructional Kits section.

★

HENRY'S RADIO. See Constructional Kits section.

★

KNIGHT-KITS. See Constructional Kits section.

★

KORTING. Distributors: Europa Electronics Ltd., Howard Place, Shelton, Stoke-on-Trent, ST1 4NW. Tel: Stoke-on-Trent 29316.

★ **T500, Type 29813.** Stereo tuner. Has 4-stage IF amplifier with automatic bandwidth control dependent on field intensity on AM with silicon transistors. Tuning indicator with measuring instrument and compensated detector/amplifier. Ranges: VHF/FM 87.5-104 MHz; SW 5.85-7.4 MHz (41 and 49 m band); MW 510-1,620 KHz; LW 145-355 KHz. Sensitivity: FM 3 μ V. It has 12 transistors, 11 diodes and one rectifier. Ferrite aerial with double parallel coils for MW and LW. Stereo decoder with automatic indi-

cator. Low cabinet has natural walnut colour with satin finish. Size: 3 $\frac{1}{2}$ \times 24 \times 9 in. Price: \pounds 44 15s. (including PT).

★

L. & H. Distributors: Britimpex Ltd., 16-22 Great Russell Street, London, W.1. Tel: 01-636 7600. Cables: Britron, London.

★ **Signalmaster Mk III 6087.** Self-contained battery-operated FM/VHF tuner. Will also operate from 32V from L & H Audiomaster amplifier. Plug-in V aerial. Socket for 70 ohm external aerial. Push-button on/off and AFC illuminated tuning scale. Transistors. Range 86-104 MHz. PP9 or equivalent battery. Consumption 9 mA. Teak case. Size: 11 $\frac{1}{4}$ \times 3 $\frac{1}{2}$ \times 7 $\frac{1}{8}$ in. Price: \pounds 25 18s. (plus \pounds 5 11s. 1d. PT).

Stereo decoder module. Plug-in type suitable for Signalmaster Mk III. Fits inside case. Channel separation better than 32 dB at 1 KHz. Consumption 3 mA. Automatic stereo beacon. Price: \pounds 7 17s. 6d. Connecting lead with 5-pin plug. Price: 15s.

★

LAFAYETTE. U.K. distributors: Barnet Factors Ltd., 4 Lisle Street, London, W.C.2. Tel: 01-437 2723.

Lafayette LT-425T. AM/FM stereo tuner. Range 88-108 MHz and 550-1,600 KHz. Variable tuning with indicator meter. Sensitivity: 1.6 μ V. Aerial impedance: 300 ohm balanced. Output: 1V. Multiplex decoder fitted. AFC. Psn: 220-240V. Dimensions: 13 \times 3 $\frac{7}{8}$ \times 9 $\frac{1}{2}$ in. Fully automatic stereo indication, muting control, noise filter, built-in AM/FM aeriels. Front and rear tape output jacks. Utilises integrated circuits. Price: \pounds 47 8s. 1d. (plus \pounds 13 0s. 8d. PT).

Lafayette LT-225. AM/FM stereo tuner. Range 88-108 MHz, 540-1,605 KHz. Variable tuning with indicator meter. Sensitivity 3 μ V. Aerial impedance 300 ohms balanced. Output voltage: 1V. Stereo multiplex decoder fitted. AFC. Psn: 220-240V A.C. Dimensions: 11 \times 4 $\frac{1}{4}$ \times 8 $\frac{11}{16}$ in. FET front end. Built-in AM and FM aeriels. Price: \pounds 41 0s. 4d. (plus \pounds 11 5s. 8d. PT).

★

H. J. LEAK & CO. LTD., Brunel Road, East Acton, London, W.3. Tel: 01-749 1641. Cables: Sinusoidal, Ealux, London.

★ **Stereofetic** transistorised FM stereo tuner. Variable tuning. Range: 87-108 MHz. Sensitivity: 2.5 μ V for 30 dB signal to noise. 75 ohms unbalanced aerial input. Output: 0.9V rms per channel. Distortion: <0.5% for full deviation. Tuning meter. Price: chassis model £56 11s. (including PT), in wood case £64 14s. 4d. (including PT).

★

LL ELECTRONIC SALES LTD., 5 Shakespeare Road, London, N.3. Tel: 01-346 3332.

Nova tuner operates on 88-108 MHz and 150-550 m. Tuning: variable. FM detector: ratio. Sensitivity: 10 μ V. Aerial impedance: 75 ohms coax. Output voltage: 150 mV. Multiplex decoder fitted. AFC switch. Psn 200-250V 50 Hz. Size: 14 \times 9 \times 3½ in. Price to be announced.

★

LOWTHER MANUFACTURING CO., Lowther House, St. Mark's Road, Bromley, Kent. Tel: 01-460 5225. Cables: Lowther, Bromley.

FM tuner Mk V self-powered. Twin gang tuning, horizontal scale. Range 87.5-108 MHz. AFC. Foster-Seeley disc. Switched ind 50 c/s injection. Self-powered. Size: 13¼ \times 5½ \times 5 in. Price: £24 10s. (plus £5 16s. 4d. PT).

★ **FM tuner Mk V.** Variable tuning. Range 87.5-108 MHz. AFC. Foster-Seeley disc. Switched AFC and hum check ind. Psn 250V 30 mA; 6.3V 2 amps. Size: 10¼ \times 4¾ \times 7 in. Price: £22 (plus £5 4s. 6d. PT).

Stereo decoder GL2. Multiplex decoder suitable for Mk V tuners. Price: £18.

FM tuner Mk VI. Range 87.8-101 MHz. Variable tuning. Switched AFC. AGC. Aerial input: 70/80 ohms coaxial. Output: 0.75V RMS. Self-powered. Mains: 200-240V AC. All transistor. Size: 10¼ \times 7 \times 4¾ in. Price: £35 (plus £8 13s. 8d. PT).

Stereo decoder GL1. Multiplex decoder suitable for Mk VI tuner. Price: £16.

★

LUX. Distributors: Shiro (U.K.) Ltd., 8 Bush Lane, Cannon Street, London, E.C.4. Tel: 01-626 4711/3.

WL515. Solid state radio tuner with FET devices. Range: 76-90 MHz, FM; 525-1,605 KHz, MW. Tuning: variable. Tuning indicator: meter. Multiplex decoder and AFC fitted. Output: 770 mV. Psn: 240V 50 Hz. Dimensions: 5¾ \times 17 \times 10⅞ in. Price: £87 (plus £21 5s. 3d. PT).

WL313. Solid state radio tuner. Range: 88-108 MHz, FM; 525-1,605 KHz, MW. Tuning: variable. Tuning indicator: meter. Multiplex decoder and AFC fitted. Aerial: 300 ohms balanced. Output: 770 mV. Psn: 180-250V 50Hz. Dimensions: 7½ \times 18¾ \times 7 in. Weight: 25 lb. Price: £115 10s. (plus £28 4s. 7d. PT).

VL70T. Solid state radio tuner. Range: 76-90 MHz. Tuning: variable. Tuning indicator: meter. Multiplex decoder and AFC fitted. Aerial 300 ohms balanced. Output: 300 mV. Psn: 240V 50 Hz. Dimensions: 5⅞ \times 14⅞ \times 8¾ in. Price: £64 12s. 3d. (plus £15 16s. PT).

★

MARTIN ELECTRONICS LTD. See Constructional Kits section.

★

MEDLEY MUSICAL LTD., 4 Felltram Way, Charlton, London, S.E.7. Tel: 01-858 3426.

1600T tuner. Range: 88-108 MHz. Variable tuning. FM detector: ratio. Tuning indicator: continuous. Sensitivity: 12-15 μ V. Aerial impedance: 60 ohms. Output: 100 mV. Multiplex decoder fitted if specified. Switchable AFC. Psn: 200-250V. Size: 4½ \times 14 \times 6 in. Finish: teak. Price: to be announced.

★

NIKKO ELECTRIC MFG. CO. LTD. Distributors: Howland-West Ltd., 2 Park End, South Hill Park, London, N.W.3. Tel: 01-794 6666 and 6033.

★ **Nikko FAM-12F.** AM/FM transistorised tuner. Range: VHF 88-108 MHz, MW 182-566 metres. Variable tuning. Meter indicator. Sensitivity: 2 μ V for 20 dB quieting. Output: 0.5V. Stereo multiplex decoder fitted. Switchable AFC. Mains: 200-240V 50/60 Hz. Local-distance control. Noise filter. Stereo indicator. 17 transistors, 16 diodes. Size: 12 \times 10 \times 3½ in. Weight: 7¾ lb. Price: £55 (plus £13 18s. 3d. PT).



L & H Signalmaster 6087



Nikko FAM-14

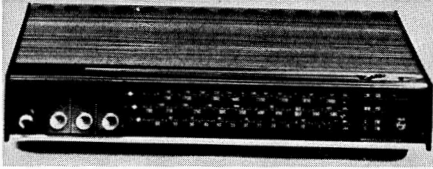

Philips RH690

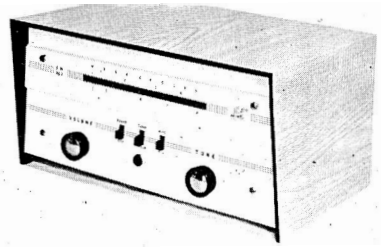

Lowther FM tuner Mk V

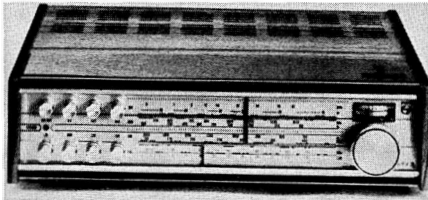

Philips RH691

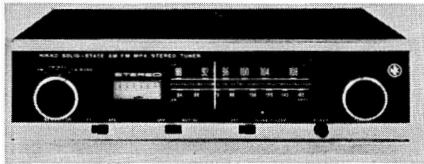

Nikko FAM-12F



Quad FM Stereo

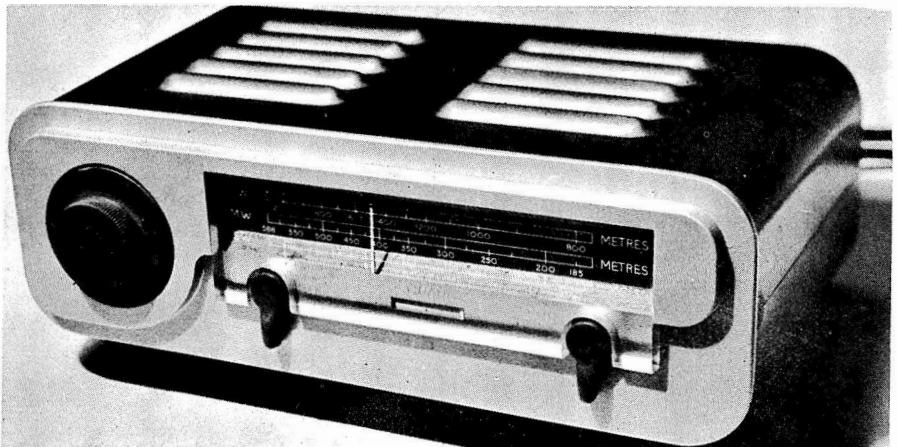

Acoustical AM tuner covering short, medium and long-wave bands

★ **Nikko FAM-14.** AM/FM tuner. Range: 88-108 MHz, 530-1,605 KHz. Variable tuning with meter indicator. Sensitivity: 1.8 mV. Output: FM 1.2V; AM 0.5V. Multiplex decoder fitted. AFC. Mains powered. Dimensions: $13 \times 9\frac{1}{2} \times 3\frac{3}{4}$ in. Panel dimmer control. Stereo output 10mV. Price: £77 (plus £18 15s. 6d. PT).

★

PEAK SOUND (Harrow) Ltd., 32 St. Judes Road, Englefield Green, Egham, Surrey. Tel: Egham 5316.

Olympus. Range: 87.5-108.5 MHz. Variable and preset tuning. Wide band ratio detector. Tuning meter. Sensitivity: 2 μ V for 30 dB quieting. Aerial: 75 ohms coax. or 300 ohms balanced. Output: 150 mV. Multiple decoder. AFC with manual override. Psn mains. Voltage tuned front end using 4 double diodes, 2 dual gate FET. Silver clad chassis. Matches Olympus amplifier. Size: $16 \times 10 \times 4$ in. Price: on application.

★

PHILIPS. Philips Electrical Ltd., Century House, Shaftesbury Avenue, London, W.C.2. Tel: 01-437 7777.

★ **RH690.** Three waveband tuner. 87.5-104 MHz, 187-577 m and 1,154-2,000 m with variable tuning and ratio FM det. Sensitivity: 7 μ V (VHF) for 26 dB quieting; 500 μ V (AM). Aerial 300 ohm balanced and ferrite rod (switchable) with indicator lamp. AFC. Output: 250 mV, 10K. Psn: 110, 127, 220, 240V AC. Dimensions: $13\frac{3}{8} \times 2\frac{7}{8} \times 8\frac{1}{2}$ in. Price: £31 5s. 6d. (plus £7 14s. 6d. PT).

★ **RH691.** Four waveband tuner: 87.5-104 MHz, 187-571 m, 750-2,000 m, 16.2-50.8 m. Variable tuner with duplex flywheel control and tuning indicator meter. Ratio FM det. Sensitivity: 7 μ V (VHF) for 26 dB quieting; 90 μ V (AM). Aerial 300 ohm balanced and switchable ferrite rod. Decoder with indicator lamp. Switchable AFC. Outputs: 1.4V (FM), 600 mV (AM), 10K. Psn: 110, 127, 220, 240V AC. Dimensions: $14\frac{1}{8} \times 3\frac{7}{8} \times 10\frac{3}{8}$ in. Price: £66 11s. 2d. (plus £16 8s. 10d. PT).

★

PIONEER. Distributors: Shiro (UK) Ltd., 8 Bush Lane, London, E.C.4. Tel: 01-626 4711.

TX-500 AM/FM FET transistorised tuner. Multiplex decoder. Multiplex filter. Sensitivity: 2.5 μ V. S/N: 50 dB. Image rejection: 55 dB (98 MHz). Multiplex separation: 35 dB. AM section: 10 μ V sensitivity. Image rejection: 47 dB (1 MHz). Built-in ferrite aerial. Range: 88-108 MHz, 525-1,605 KHz. Fine tuning meter. Automatic mono/stereo switching. Size: $5 \times 13 \times 13\frac{1}{2}$ in. Psn: 110-240V. Price: £71 19s. 5d. (including £15 10s. 6d. PT).

★

QUAD. Acoustical Manufacturing Co. Ltd., St. Peter's Road, Huntingdon, Hunts. Tel: Huntingdon 2561/2. Cables: Acoustical.

★ **Quad A.M. II tuner** (European). Variable tuning. Ranges: 800-2,070 m, 185-588 m, 5.8-18.5 MHz. Magic eye indicator. Output 100 mV nominal for 30% modulation. Output resistance 15K. Filter rejection 9 KHz. Psn 330V at 35 mA; 6.3V at 1.2 amps. Size: $10\frac{1}{2} \times 3\frac{1}{2} \times 6$ in. Price: £24 (plus £6 12s. PT).

★ **Quad A.M. II tuner.** (Overseas.) Variable tuning. Ranges: 185-588 m, 2.2-6.6 MHz, 5.8-18.5 MHz. Filter rejection 10 KHz. Magic eye indicator. Output 100 mV nominal for 30% modulation. Output resistance 15K. Psn 330V at 35 mA; 6.3V at 1.2 amps. Size: $10\frac{1}{2} \times 3\frac{1}{2} \times 6$ in. Price: £24 (plus £6 12s. PT).

★ **Quad FM stereo tuner.** Range: 87.5-108 MHz. Variable tuning. Foster-Seeley detector. Twin neon tuning indicator. Sensitivity: 2 μ V for 20 dB quieting. Aerial input: 75 ohms coaxial. Output: 100 mV for 30% modulation. Multiplex decoder fitted. AFC. Mains. Automatic stereo-mono switching. Separate mono output in addition to stereo. Stereo beacon. Size: $10\frac{1}{4} \times 3\frac{3}{8} \times 7\frac{7}{8}$ in. Price: £40 (plus £11 PT).

★

RADFORD. Radford Electronics Ltd., Ashton Vale Estate, Ashton Vale Road, Bristol, 3. Tel: Bristol 662301.

FMT2MPX. All-silicon transistor FM tuner. Range: 87.5-108.5 MHz. Variable tuning. Foster-Seeley discriminator. Meter tuning indicator. Sensitivity: 3 μ V for 30 dB signal-to-noise. Aerial input: 75 ohms coaxial or 300 ohms balanced. Output: up to 2V at 100% modulation. AFC. Mains: 110-250V 50-60 Hz. Size: $10\frac{1}{2} \times 3\frac{1}{4} \times 12\frac{5}{8}$ in. Weight: 15 lb. Built-in multiplex stereo decoder. Price: £47 10s. (plus £10 13s. 8d. PT).

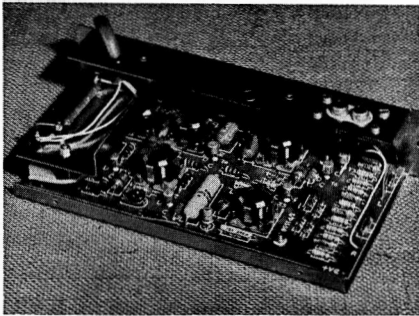

Rogers stereo decoder

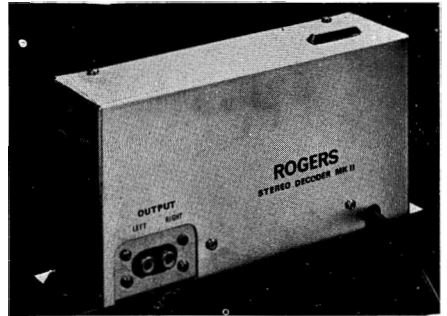

Rogers stereo decoder



Rogers Ravensbourne 2 FET



Rogers FM tuner (switched)

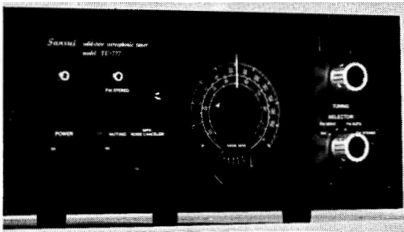

Sansui TU 777



Sansui TU555

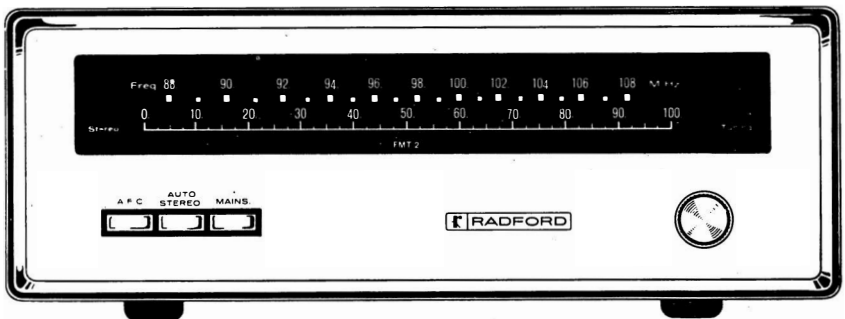

Radford FMT 2 FM tuner

★**FMT.2.** All-silicon transistor FM tuner. Range: 87.5-108.5 MHz. Variable tuning. Foster-Seeley discriminator. Meter tuning indicator. Sensitivity: 3 μ V for 30 dB signal-to-noise. Aerial input: 75 ohms coaxial or 300 ohms balanced. Exceptional signal/noise and distortion characteristics. Weight: 15 lb. Dimensions: 10 $\frac{3}{4}$ \times 4 $\frac{1}{4}$ \times 13 $\frac{1}{2}$ in. Price: £45 (including PT).

FMT.3. Transistor FM tuner. Range: 87.5-108.5 MHz. Variable tuning. Ratio det. Sensitivity: 2 μ V for 30 dB signal-to-noise. Multiplex stereo decoder available. AFC fitted. Aerial input: 75 ohms coaxial or 300 ohms balanced. S/N 70 dB. Weight: 20 lb. Dimensions: 15 \times 6 $\frac{1}{4}$ \times 14 $\frac{1}{2}$ in. Price: £76 (including PT).

★

RADON. Radon Industrial Electronics Co. Ltd., Brooklands Trading Estate, Orme Road, Worthing, Sussex. Tel: Worthing 34904/5/6.

Series 404. Solid state FM tuner, Range: 87-106 MHz. Sensitivity: 15 μ V, 3 μ V for limiting. AFC. Aerial: 75 ohms coaxial. AGC: 6 dB for 60 dB input change. Fuse protected power pack. Modular construction. Controls: tuning, on-off, AFC. Cabinet finish: blond oak or teak with satin lacquer.

404 Mk. 1. FM mono tuner with AFC. Price: £23 10s. (plus £5 10s. PT).

404 Mk 2. VHF/FM tuner with stereo decoder and AFC. Price: £31 16s. 8d. (plus £8 1s. 4d. PT).

404 Mk 3. VHF/FM/AM tuner with stereo decoder and AFC. In addition to FM band, medium waveband 180-550 m is included. Price to be announced.

★

ROGERS DEVELOPMENTS (ELECTRONICS) LTD., 4-14 Barmeston Road, Catford, London, S.E.6. Tel: 01-698-7424/4340. Cables: Rodeyco, London, S.E.6.

★**Mk III switched FM tuner Series III.** Range: 87-96 MHz. AFC. Ratio detector. Stereo beacon. Multiplex conversion facilities. Aerial imp 70-90 ohms. Output 0.25V RMS. Self-powered. Cathode follower output. Size: (chassis model) 11 \times 6 $\frac{1}{2}$ \times 4 $\frac{1}{2}$ in.; (case model) 11 \times 7 $\frac{1}{4}$ \times 5 $\frac{3}{8}$ in. Suitable for un-powered multiplex decoder. Price: (chassis model) £16 16s. (plus £4 4s. 1d. PT); (cabinet model) £19 10s. (plus £4 17s. 7d. PT).

★**Multiplex stereo decoder Mk II.** Designed for use with Rogers FM tuners but also suitable for operation with other makes of tuner. Un-powered and self-powered versions. Automatic electronic switching for stereo broadcasts. Mullard Vinkor tuned circuits. Seven silicon planar transistors. Selective anti-noise filter. High degree of filtering permits tuner to be connected to tape recorder without interference (input impedance to recorder must be over 100K). Stabilised 12V supply. Input signal level: 0.5-1V. Input imp 30K approx. Output: 700 mV RMS for input of 350 mV RMS per channel. Separation: better than 30 dB at 1 KHz. Total spurious output (including 19/38 KHz): better than -50 dB. Mains: 105-125V, 200-250V AC 3W. Size: (less power supply) 7 $\frac{3}{8}$ \times 2 \times 4 in.; (with power supply) 9 $\frac{1}{4}$ \times 2 \times 4 in. Weight: (un-powered) 1 lb 6 oz; (powered) 2 lb 1 oz. Price: (un-powered) £15; (powered) £17.

★**Ravensbourne 2 FET tuner, Series II.** Range: 88-108 MHz. Variable tuning. Wide-band ratio detector. Centre-zero tuning meter. Sensitivity: 2.7 μ V for 30 dB quieting. Aerial impedance: 75 ohms coaxial and 300 ohms balanced. Output: 200 mV average for 30% modulation. Integrated circuits in I.F. strip. Multiplex decoder. Switched AFC. FET front end. Inter-station noise suppression. Mains: 200-250V AC. Consumption: 8W. Size: (chassis) 11 $\frac{1}{2}$ \times 11 \times 4 in.; (case) 12 $\frac{1}{2}$ \times 11 $\frac{1}{2}$ \times 5 $\frac{1}{4}$ in. Prices: (chassis with decoder) £49 10s. (plus £12 7s. 9d. PT); (cabinet model with decoder) £53 10s. (£13 7s. 9d. PT). Case alone, £5 (plus 9s. 5d. PT).

★

ROTEL. U.K. distributors: Pullin Photographic, Rank Aldis Ltd., P.O. Box 70, Great West Road, Brentford, Middx. Tel: 01-568 9222.

Rotel 120-ST. Solid state AM/FM stereo tuner. Range: 88-108 MHz, 535-1,605 KHz. Variable tuning with indicator meter. Sensitivity: FM 2.5 μ V, AM 3 μ V. Output: FM 1.200 mV; AM 400 mV. Multiplex decoder fitted. AFC. Dimensions: 12 \times 3 $\frac{3}{4}$ \times 10 in. FET on FM front end. FM mono/stereo switching. Price: £49 10s.

★

SANSUI. Sole UK importer: Brush Clevite Co. Ltd., Thornhill, Southampton, SO9 1QX. Tel: Southampton 45166.

★**Sansui TU70.** AM/FM multiplex stereo tuner. Range: VHF 88-108 MHz. MW 186-560 metres.

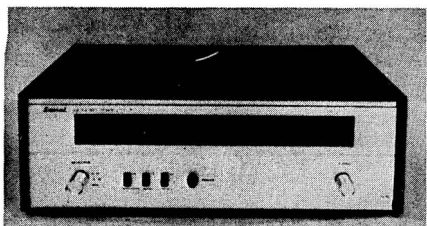

Sansui TU70

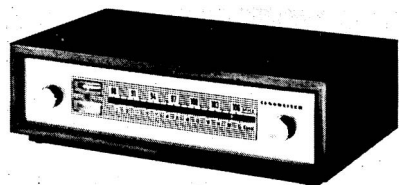

Sennheiser EFM 303

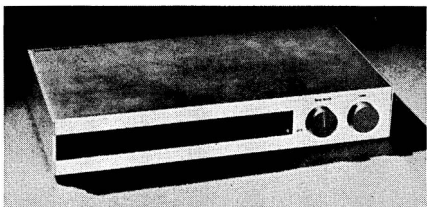

Sinclair 2000

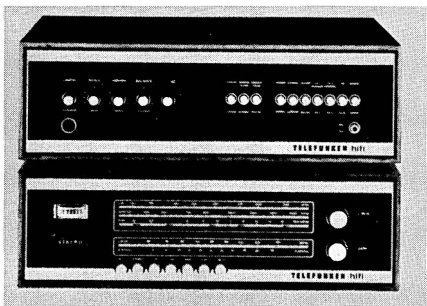

Telefunken T201

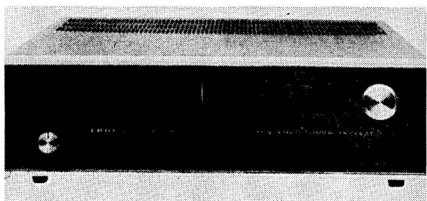

Trio TK359T

Variable tuning. Ratio detector. Magic eye tuning indicator. Sensitivity: 1.2 μ V for 20 dB quieting. Aerial input: 300 ohms balanced. Output: 1.2V. Fitted with stereo decoder. Switchable AFC. Stereo indicator. Switchable quiet tuning. Noise filter. Mains: 100, 117, 240V AC 50/60 Hz. Size: 12 $\frac{5}{8}$ \times 15 $\frac{3}{8}$ \times 5 $\frac{1}{2}$ in. Price: £83 1s. 4d. (including £16 6s. 4d. PT).

★ **Sansui TU555.** Stereo AM/FM tuner. Range: 88-108 MHz. 535-1,605 KHz. Variable tuning with indicator meter. FM detector: ratio. Sensitivity: FM 2.0 μ V \pm 3 dB (20 dB quieting). Aerial: coaxial and balanced. Output voltage: greater than 1.5V. Multiplex decoder fitted. Psn: 100-240V AC, 10W. Dimensions: 4 $\frac{3}{8}$ \times 11 $\frac{1}{2}$ \times 11 $\frac{1}{2}$ in. FET front end. Noise muting circuit. Price: £62 4s. 10d. (plus £15 4s. 4d. PT).

★ **Sansui TU777.** Stereo AM/FM tuner. Range: 88-108 MHz. 535-1,605 KHz. Variable tuning with indicator meter. FM detector: ratio. Sensitivity: 1.4 μ V \pm 3 dB (20 dB quieting). Aerial: coaxial and balanced. Output voltage: 0.2V variable. Multiplex decoder fitted. Psn: 100-240V AC, 10W. Dimensions: 6 $\frac{1}{2}$ \times 13 $\frac{9}{16}$ \times 13 $\frac{1}{8}$ in. Circular tuning dial. FET front end. FM local/distant switch. Stereo noise canceller. Price: £75 15s. 6d. (plus £18 10s. 5d. PT).



SCOTT. Distributors: A. C. Farnell Ltd., Consumer Division, Farnell House, 81 Kirkstall Road, Leeds LS3 1HR. Tel: Leeds 35111.

312-D. Solid state tuner with multiplex decoder. FM front end: three FET. Sensitivity: 1.7 μ V. Stereo separation: 40 dB. S/N: 65 dB. Computer type push-button switches. Interstation muting. Price to be announced.

315-B. Solid state tuner with multiplex decoder. FM front end: FET. Sensitivity: 2.2 μ V. Stereo separation: 36 dB. Signal to noise ratio: 60 dB. Price to be announced.



SENNHEISER ELECTRONICS. Distributors: Audio Engineering Ltd., 33 Endell Street, London, W.C.2. Tel: 01-836 0033.

★ **EFM.303 Stereo Tuner.** Range: 87.5-108.5 MHz. Variable tuning. Two meters for tuning indication. Sensitivity < 2 μ V for 20 dB quieting. Output \approx 5V. Built-in multiplex decoder. Automatic stereo transmission indicator. Interstation noise suppression. Switched AFC. Mains: 200-

240V 50 Hz. Size: 15×4×9 in. Price: £121 10s. (including PT).



SHIRLEY LABORATORIES LTD., 23 Ripley Road, Worthing, Sussex. Tel: Worthing 49098.

FM tuner SB/V16. Variable tuning. Standard range. Ratio det. Magic eye ind. Psn 200-300V 15 mA; 6·3V 2·5 amps. Price: £20 (plus £3 15s. PT).



SINCLAIR RADIONICS LTD., 22 Newmarket Road, Cambridge. Tel: Cambridge 52996.

★**System 2000.** Transistorised mono or stereo FM tuner. Range: 86-108 MHz. Variable tuning with facility for remote operation. Pulse counting discriminator. Electronic fine tuning. Electronic tuning indicator. 11 silicon transistors. Interstation muting. AFC. Plug-in multiplex decoder. Automatic stereo switching. Stereo beacon. Output: 500 mV low impedance. FR 10 Hz-20 KHz ±1 dB. Sensitivity 5 µV for full limiting. Mains: 200-250V 50 or 60 Hz. 100-125V versions available. Separate aerial inputs for low-level and high-level signals. Aerial inputs 75 ohms coaxial. Finish: cabinet and all controls solid aluminium. Size: 12×6×2 in. Price: (mono) £26 5s. (including PT); (stereo/mono) £30 9s. (including PT); (plug-in decoder) £4 4s.



SONY (U.K.) LTD., Ascot Road, Bedfont, Feltham, Middx. Tel: Ashford 50021.

ST-5000W. Stereo transistorised FM tuner. Range: 87-108 MHz. Variable tuning. Sensitivity: 2 µV for 20 dB quieting. Aerial impedance: 300 ohms balanced, 75 ohms coaxial. Output: 700 mV and 0·2V variable. Multiplex decoder fitted. AFC. Mains: 100, 117, 220 or 240V 50/60 Hz. Size: 5 $\frac{3}{4}$ ×15 $\frac{3}{8}$ ×12 $\frac{1}{4}$ in. Price: £147 16s. (plus £33 4s. PT).

ST-80W. Stereo transistorised FM tuner. Range: 87-108 MHz. Variable tuning. Sensitivity: 2·5 µV for 20 dB quieting. Aerial impedance: 300 ohms balanced. Multiplex decoder. AFC. Mains: 117, 220V 50-60 Hz. Size: 5 $\frac{1}{8}$ ×8 $\frac{7}{8}$ ×6 $\frac{5}{8}$ in. Price: £39 12s. 8d. (plus £9 15s. 4d. PT).

STEREOSOUND PRODUCTIONS LTD., Capital Works, Wakefield Road, Brighouse, Yorkshire. Tel: Brighouse 1755.

88 tuner. All-transistor AM/FM tuner with stereo multiplex decoder. Designed to match Stereosound 88 amplifier/player and tape recorder system. Full specification and price on request.



TELEFUNKEN. Distributor: A.E.G. (Great Britain) Ltd., Lonsdale Chambers, 27 Chancery Lane, London, W.C.2. Tel: 01-2429944. Cables: Allgem, London.

★**T201.** Tuner. Ranges: VHF 87·5-104 MHz, MW 515-1,610 KHz, LW 150-350 KHz, SW 51-18·7 MHz. Ratio FM detector. Frequency meter. Sensitivity: 1·2 µV for 26 dB FM, 6 µV for 10 dB S/N AM. Aerial: 240 ohms balanced. Output: 900 mV at 4 KHz deviation. Multiplex decoder. AFC. Psn: 110-240V AC. Meets DIN 45,500 standard. Separate AM/FM flywheel tuning. Excellent cross modulation characteristics. Size: 18 $\frac{1}{4}$ ×6×12 $\frac{3}{8}$ in. Price: £58 13s. (plus £13 16s. PT).

T250. Tuner. Ranges: VHF 87·5-104 MHz, MW 520-1,620 KHz, LW 150-350 KHz, SW 16-49 m. Separate tuning controls for AM and FM 5 preset FM. Ratio FM detector. AM/FM tuning indicator. FM frequency meter and deviation meter. Sensitivity: 0·8 µV with 25 KHz deviation and 26 dB S/N (FM), 8 µV for 10 dB S/N (AM). Aerial: balanced. Multiplex decoder. AFC. Psn: 110-240V AC. Interstation noise suppression on FM. Bandwidth selection on AM. Automatic switching with stereo signal. Size: 18 $\frac{1}{2}$ ×5×13 in. Price: £174 14s. 6d. (plus £41 2s. 3d. PT).



TRIO. Distributors: B. H. Morris & Co. (Radio) Ltd., 84-88 Nelson Street, Tower Hamlets, London, E.1. Tel: 01-790 4824.

★**TK-350T.** Solid state stereo tuner. Wavebands: MW 187-576 m, VHF 88-108 MHz. Variable tuning. Ratio detector. Tuning meter. Stereo indicator lamp. Sensitivity: FM 2 µV, AM 10 µV. Output voltage: FM 2V (400 Hz 100% modulation), AM 0·4V (400 Hz 30% modulation). Decoder fitted. Automatic mono-stereo switching. Four-gang tuning. Five IF stages with four limiters. Noise filter. FR (FM) 20 Hz-20 KHz ±2 dB. Signal-to-noise: FM



Trio KT-7000



Tripletone Series 3

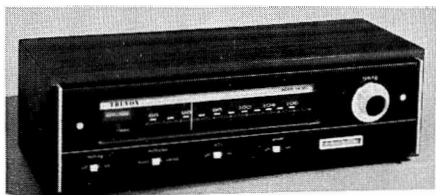

Truvox FM200

60 dB, AM 45 dB. Stereo separation: 38 dB (at 400 Hz). Output impedance: 1K. Mains: 110-120V or 220-230V 50/60 Hz. Consumption 15W. Size: $12\frac{1}{2} \times 4\frac{1}{8} \times 9\frac{1}{4}$ in. Weight: $9\frac{1}{4}$ lb. Price: £62.

★**KT-7000.** Solid state AM/FM stereo tuner using front end FETs, four ICs and two crystal IF stages. Ranges: VHF and MW. Inter-station muting. Signal strength meter. Centre-zero tuning indicator. Automatic stereo/mono switching with indicator. Aerial: 300 ohms (balanced) and 75 ohm. FM sensitivity: $1.5 \mu\text{V}$. FR 20 Hz-15 KHz, ± 2 dB; HD: mono, $< 0.3\%$; stereo, $< 0.6\%$; S/N better than 70 dB at $30 \mu\text{V}$. Output: 1.5V. AM sensitivity: $15 \mu\text{V}$ (ext. aerial). Output: 0.4V. Dimensions: $5\frac{3}{2} \times 16\frac{1}{8} \times 11$ in., to match KT-6000 amplifier. Weight:

18 lb. Psn: 110-120V, 220-240V, 20W. Price: £132.

KT1000 solid state AM/FM multiplex stereo tuner. Ranges: 88-108 MHz; 187-556 m. Sensitivity, IHF: FM $3 \mu\text{V}$; AM $30 \mu\text{V}$ (ext. aerial terminal), $300 \mu\text{V}$ (bar aerial). HD (at 400 Hz, 100% modulation: mono, less than 0.8%, stereo less than 0.9%. S/N (at 100% modulation): better than 60 dB. Aerial input: 300 ohms balanced and 75 ohms unbalanced. Output impedance: 200 ohms. Consumption: 15W. Dimensions: $4\frac{3}{8} \times 10\frac{1}{4} \times 9\frac{3}{8}$ in. Weight: 8.5 lb. Price: £52.



TRIPLETONE MANUFACTURING CO. LTD., 241a The Broadway, Wimbledon, S.W.19. Tel: 01-542 1189.

★**FM tuner Series 3.** Variable tuning. Range: 86-104 MHz. AGC and interstation quieting. Ratio detector. Aerial input 70-80 ohms coaxial. Output: 0-500 mV cathode follower. Mains: 200-250V AC. Size: $11 \times 6\frac{1}{2} \times 3\frac{3}{4}$ in. Price: £16 7s. (plus £3 19s. 11d. PT).



TRUVOX LTD., Hythe, Southampton. Tel: Hythe 3265.

★**FM200.** Transistorised mono FM tuner in teak cabinet or for panel mounting. Range: 87.5-108.5 MHz. FR 20 Hz-20 KHz. ± 1 dB. FM. Sensitivity: $1.5 \mu\text{V}$ for 20 dB quieting. Aerial inputs: 75 ohms coaxial, 300 ohms balanced. Switched AFC. Centre-zero tuning meter. Inter-station muting. Output: 0-1V variable via emitter follower. Mains: 100-120V, 200-250V 50/60 Hz. All silicon transistors. Size: $16 \times 6\frac{7}{8} \times 5\frac{1}{2}$ in. Panel cut-out: $15 \times 3\frac{3}{4}$ in. Price: £37 12s. 11d. (including PT).

FM200 I.C. stereo tuner. Range: 87.5-108.5 MHz. Variable tuning. FM detector: ratio. Tuning indicator: meter. Sensitivity: $2.0 \mu\text{V}$ for 30 dB. Aerial impedance: unbalanced 75 ohms, balanced 300 ohms. Output voltage: variable 0-0.7V RMS for 75 KHz deviation. Multiplex decoder fitted. AFC. Psn mains. Dimensions: $16 \times 6\frac{7}{8} \times 5\frac{1}{2}$ in. Integrated circuits, MOS-FET front end. Price: £48 11s. 9d. (plus £12 0s. 1d. PT).

Choice in amplifiers
Choice in tuners
Choice in tuner-amplifiers
Choice in record players
Choice in tape equipment
Choice in loudspeakers
Choice in accessories

To help you choose wisely we provide balanced facilities for comparison together with expert staff to advise you ; and to ensure your complete satisfaction and enduring pleasure we also provide "after sales service" second to none.

In our specialised high fidelity showrooms: 42-45, Tottenham Court Road, London, W.1. (probably the largest in Europe devoted exclusively to Hi-Fi) and also 118, Edgware Road, London, W.2. you will find an unrivalled wealth of the World's finest equipment from which to make your choice.

If you are unable to call personally, please write to us at 3-15, Cavell St., London, E.1. and we will be pleased to send our quotation for your equipment requirements ; and remember, "Lasky's Package Deal Plan" offers you the opportunity of obtaining a worthwhile cash saving when you purchase a complete system.

High Fidelity Audio Centres

42-45 Tottenham Court Road, London, W.1. Tel.: 01-580 2573

Open all day, 9 a.m.—6 p.m. Monday to Saturday

118 Edgware Road, London, W.2. Tel.: 01-723 9789

Open all day Saturday, early closing 1 p.m. Thursday

Branches

207 Edgware Road, London, W.2. Tel.: 01-723 3271

33 Tottenham Court Road, London, W.1. Tel.: 01-636 2605

Open all day, 9 a.m.—6p.m. Monday to Saturday

152/3 Fleet Street, London, E.C.4. Tel.: 01-353 2833

Open all day Thursday, early closing 1 p.m Saturday

ALL MAIL ENQUIRIES TO:—

3-15 Cavell Street, London, E.1.

Tel.: 01-790 4821

Choice in sound

Lasky's



PRESENT

The 'COMPACT SOUND' FOR THE' 70s

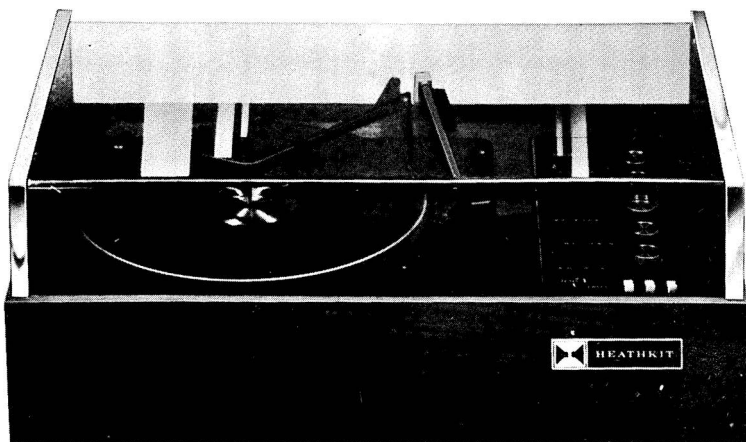

There's always something new in the Heathkit Hi-fi range. We have taken the outstanding Solid-state stereo amplifier AD-17, matched it with a precision turntable and put both in a handsome teak or walnut veneered cabinet. For those who require the addition of FM radio the AD-27 fulfils this requirement admirably. Add two Heathkit speaker systems for outstanding performance for price:

See all the Heathkit Hi-fi audio range and models for home entertainment and hobbyists in the FREE CATALOGUE obtainable from THE HEATHKIT HI-FI CENTRE, TOTTENHAM COURT ROAD, LONDON, or THE HEATHKIT HI-FI CENTRE, ST. MARTINS HOUSE, BIRMINGHAM, and THE FACTORY AND MAIL ORDER CENTRE at:—

DAYSTROM LTD.

Dept. HY, GLOUCESTER,
ENGLAND. Tel: 29451

tripletone **SERIES 3 MKII**



SOLID STATE 8+8 FET INPUT from £29 19 6

"We have long admired the Tripletone amplifiers and tuners, as representing exceptional value for outlay".

Audio & Record Review

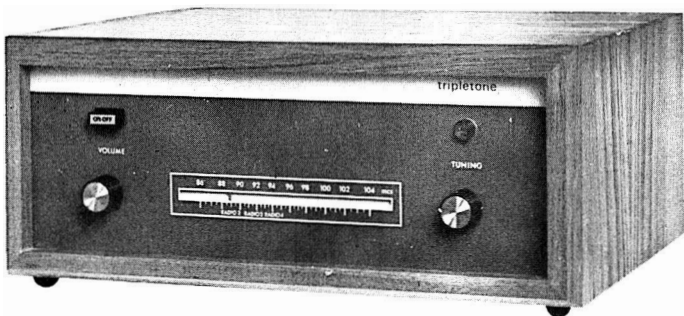

SOLID STATE STEREO F.M. FET INPUT £29 16 0 excl. P.Tax

tripletone

241A THE BROADWAY, LONDON S.W.19

Tel.: LIBerty 1189

Telefunken Concertino. A few well-chosen words.

Superb sound defies the description of mere words. But they're all we have, so here are a well-chosen few.

Concertino is a hi-fi stereo tuner/amplifier giving 15 watts per channel.

The radio receives LW, MW, SW and FM, and FM stations can be pre-set for push button selection.

Built-in stereo decoder, AFC (automatic frequency control) for FM and performance characteristics that are excellent.

And it conforms to DIN 45 500.

But don't take our words for it hear it yourself at your dealers.

AEG/Telefunken
27 Chancery Lane
London WC2

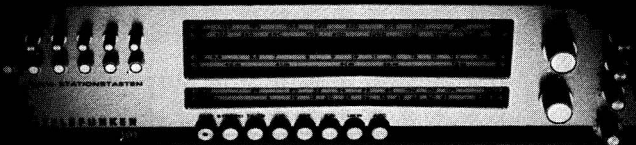

DIRECTORY OF TUNER/AMPLIFIERS

★ The abbreviations used in this section are defined at the beginning of the Tuner and Amplifier Sections.

AKAI. U.K. distributors: Pullin Photographic (Rank Organization), P.O. Box 70, Great West Road, Brentford, Middx. Tel: 01-568 9222.

★ **Akai 8000.** Stereo AM/FM. Range: 88-108 MHz, 530-1.605 KHz. Variable tuning with indicator meter. Sensitivity: FM 2 μ V; AM 20 μ V. Aerial impedance: FM 300 ohms, 75 ohms; AM ferrite with external socket. Multiplex decoder fitted. AFC. Remote control facilities for tape recorders having remote control. FET. Inputs: tape 150 mV, noise level 75 dB; pickup 3 mV, noise level 65 dB; aux 150 mV, noise level 75 dB. Controls: Bass \pm 10 dB; loudness +6 dB at 100 Hz; treble \pm 10 dB. Psn 100-240V, 50 or 60 Hz, 30W. Power output: 90W RMS. HD 0.2% at 45W. FR 20 Hz-50 KHz $-$ 3 dB. Output impedance (speaker) 8 ohms. Dimensions: $5\frac{1}{2} \times 18\frac{3}{8} \times 14$ in. Price: £185 (including PT).

★

ARENA. Distributors: Highgate Acoustics Ltd., 184-188 Great Portland Street, London, W.1. Tel: 01-636 2901.

★ **T.2400.** All-transistor. Constructed on miniature module system. Range: FM/VHF 87.5-105.5 MHz. Push-button selection of up to five FM stations. AFC. Electronic station scanning. Inputs: tape recorder, PU.1, PU.2. Output: 15W each channel. Outlets: four speakers, one headphone. Sockets for FM aerial feeder. Size: $19\frac{3}{4} \times 9\frac{3}{8} \times 3\frac{7}{8}$ in. Price: £89 5s. (including PT); multiplex decoder £7 7s. extra.

★ **T.2500F.** All-transistor. Constructed on miniature module system. Five wavebands: LW, MW, SW1, SW2, VHF/FM. Push-button selection of up to five FM stations. Electronic station scanning on FM. Duplex tuning. Sockets for recorder and pickup. Output: 15W each channel. AFC. Finish: teak or rosewood. Size: $17\frac{1}{4} \times 8\frac{1}{2} \times 5\frac{3}{8}$ in. Price: £99 15s. (including PT); multiplex decoder £7 7s. extra.

★ **T.1500F.** Transistorised stereo. Range: FM/VHF, LW, MW, 49-metre band. Controls: volume, bass, treble, tuning, mode, wavechange. Inputs for PU and recorder. Outlets for speakers

and recorder. Module construction. 28 silicon transistors, 21 diodes. Vari-cap FM tuning. Output: 8W RMS per channel. Sensitivity: AM 10 μ V, FM 1 μ V. Available with ceramic or magnetic pickup input. Price: £72 9s. (magnetic); £70 7s. (ceramic). Multiplex decoder £7 7s. extra.

T.9000. All-transistor tuner/amplifier constructed on extended module system. Range: VHF 87.5-108.5 MHz, MW 1 500-1,000 KHz (tuned RF stage) MW II 950-2,000 KHz (tuned RF stage). Tuning scale, meter and AFC. Silent tuning on VHF. Multiplex decoder. Sensitivity: better than 1 μ V for 30 dB (FM) 20 dB (AM). S/N ratio and 40 KHz frequency deviation. FR 10 Hz-40 KHz \pm 3 dB at 75W RMS all outputs. HC 75W per channel RMS 8 ohms. Inputs: pickup, tape recorder, mic, two aux. Outputs: four speakers. 64 silicon transistors, 39 diodes, MOS FET transistors. Tuning silicon diode on both VHF and AM. Cabinet is in rosewood. Size: $5\frac{7}{8} \times 20\frac{1}{4} \times 11\frac{3}{4}$ in. Weight: 44 lb. Price: £303 9s. (including PT).

★

ARMSTRONG AUDIO LTD., Warlters Road, London, N.7. Tel: 01-607 3213.

★ **Model 525.** FM. Range: VHF 86-109 MHz. Variable tuning. Ratio detector. Meter tuning indicator. Sensitivity: 1.5 μ V for 30 dB quieting. Aerial impedance: 75 ohms coaxial and 300 ohms balanced. Plug-in stereo multiplex decoder optional extra (see Radio Tuner Section). Quiet-tuning control. Stereo indicator light. Inputs: PU(1) 60 mV 100K, PU(2) 3.5 mV 50K, tape play 400 mV 100K. Noise level: PU $-$ 55 dB, tape $-$ 70 dB. Controls: balance (maximum to zero each channel), bass \pm 10 dB, treble \pm 10 dB, loudness (two volume levels with loudness contours at low level), rumble filter $-$ 5 dB at 30 Hz, treble filter (1) 6.5 KHz $-$ 3 dB, 10 KHz $-$ 25 dB, treble filter (2) 4.5 KHz $-$ 3 dB, 9 KHz $-$ 40 dB. Output: 25W RMS per channel. Output impedance 4-16 ohms. HD $<$ 0.5% at rated output. FR 20 Hz-20 KHz $-$ 1 dB at 25W RMS. Transistorised. Mains: 100-125V and 200-250V AC. Size: $17 \times 10\frac{3}{4} \times 4\frac{3}{8}$ in. Price: £70 5s. (plus £17 11s. 9d. PT).

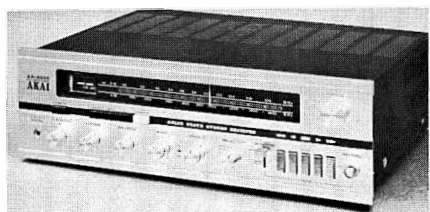

Akai AA-8000

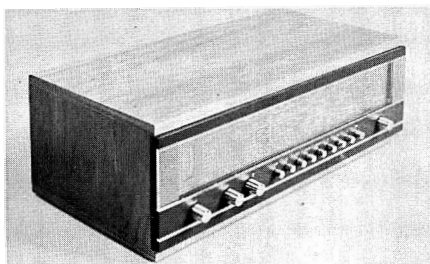

Bang & Olufsen Beomaster 900M

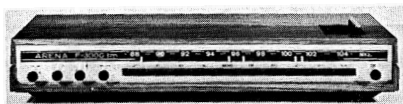

Arena T2400

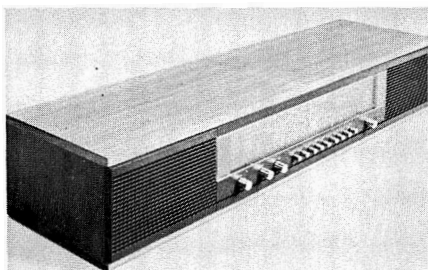

Bang & Olufsen Beomaster 900K

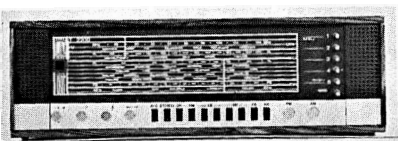

Arena T2500F

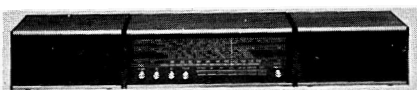

Arena T1500H plus two HT21 speakers

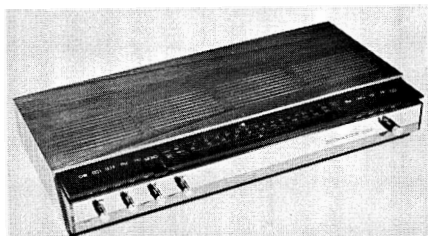

Bang & Olufsen Beomaster 1000

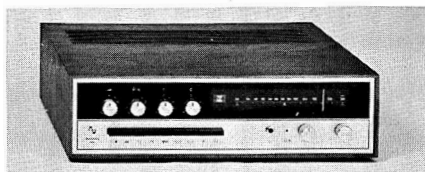

Armstrong Audio 525



Dynaco Dyna-Scan 3000



Ferguson 205STA

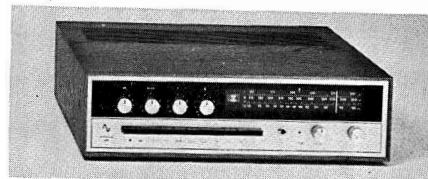

Armstrong Audio 526

★ **Model 526.** AM/FM. Range: VHF 86-109 MHz, MW 185-590 metres, LW 1,000-2,000 metres. Variable tuning. FM ratio detector. Meter tuning indicator. Sensitivity: 1.5 μ V for 30 dB quieting on VHF, 5 μ V for 20 dB quieting on AM. Aerial impedance: 75 ohms coaxial and 300 ohms balanced. Plug-in stereo multiplex decoder optional extra (see Radio Tuner Section). FM quiet-tuning control. Stereo indicator light. Inputs: PU(1) 60 mV 100K, PU(2) 3.5 mV 50K, tape play 400 mV 100K. Noise level: PU -55 dB, tape -70 dB. Controls: balance (maximum to zero each channel), bass \pm 10 dB, treble \pm 10 dB, loudness (two volume levels with loudness contours at low level), rumble filter -5 dB at 30 Hz. Treble filter(1) 6.5 KHz -3 dB, 10 KHz -25 dB, treble filter(2) 4.5 KHz -3 dB, 9 KHz -40 dB. Output: 25W RMS per channel. Output impedance: 4-16 ohms. HD <0.5% at rated output. FR 20 Hz-20 KHz -1 dB at 25W RMS. Transistorised. Mains: 100-125V and 200-250V AC. Size: 17 \times 10 $\frac{3}{4}$ \times 4 $\frac{1}{2}$ in. Price: £79 (plus £9 15s. 6d. PT).

★

BANG & OLUFSEN (U.K.) LTD., Eastbrook Road, Gloucester. Tel: Gloucester 21591.

★ **Beomaster 900M and 900K.** Stereo. 5W per channel. Range: 87.5-108 MHz, 578-188 m, 880-2,040 m, 38.5-51 m. Variable tuning. Ratio detector. Tuning meter. Sensitivity: 2.8 μ V for 26 dB quieting. Aerial impedance: 75 ohms coax. Multiplex decoder available. AFC. FR 30 Hz-16 KHz \pm 3 dB. Output impedance 4 ohms. Inputs: gram 500 mV 470K, tape 450 mV 250K. Controls: volume, bass, treble, on/off, gram, tape, aerial and AFC, mono, band select, tuning. Mains 10-65W. Size: M version 15 \times 5 $\frac{1}{2}$ \times 9 in.. K version with built-in speakers 29 $\frac{1}{4}$ \times 5 $\frac{1}{4}$ \times 9 in. Teak or rosewood. Price (teak): M version £59 15s. (plus £15 PT), K version £66 2s. 9d. (plus £16 12s. 3d. PT).

★ **Beomaster 1000.** Stereo 15W per channel. Range: 87.5-108 MHz. Variable tuning. Ratio detector. Tuning meter. Sensitivity: 2.5 μ V for 26 dB quieting. Aerial impedance: 75 ohms coax. Multiplex decoder. AFC. A-B monitoring. FR 30 Hz-20 KHz \pm 2 dB. Amplifier noise level -53 dB at 50 mW. Output impedance 4 ohms. Inputs: gram I 200 mV 470K, gram II 4 mV 47K, tape 200 mV 470K. Controls: on/off, speakers, hi filter, low filter, mono, tuner, AFC, gram I and II, tape, volume, bass, treble, balance, tuning. Psn mains. Size: 19 $\frac{3}{4}$ \times 3 $\frac{1}{2}$ \times 10 in. Price (teak): £81 6s. 6d. (plus £20 8s. 6d. PT).

Beomaster 1400 M and K. Stereo. 15W per channel. Range: 87.5-104 MHz, 188-578 m, 857-2,040 m, 16-49 m, 66.6-200 m. Variable tuning with 4 preset controls on VHF. Ratio detector. Tuning meter. Sensitivity 2 μ V for 26 dB quieting. Aerial impedance: 75 ohms coax. Multiplex decoder. AFC. FR 30 Hz-25 KHz \pm 1 dB. HD <1% 40 Hz-12 KHz at 15W. Noise level -53 dB at 50 mW. Output imp. 4 ohms. Inputs: gram 4 mV 47K, tape 200 mV 470K, speaker input 4 ohms. Controls: volume, bass, treble, balance, tuning, on/off, speakers, mono, gram, tape, aerial, AFC, band select. Psn mains. Size: M version 16 $\frac{1}{2}$ \times 4 $\frac{3}{8}$ \times 9 $\frac{5}{8}$ in., K version with speakers 29 $\frac{1}{4}$ \times 4 $\frac{3}{8}$ \times 9 $\frac{5}{8}$ in. Price (teak): M, 89 6s. 6d. (plus £22 8s. 6d. PT), K, £97 14s. 3d. (plus £24 10s. 9d. PT).

★

BRAUN AG. Distributors: Fi-Cord International, Charlwoods Road, East Grinstead, Sussex, Tel: East Grinstead 21351.

TS45. Stereo. Transistorised. VHF 88-108 MHz, MW 188-545 m. Variable tuning. Foster-Seeley discriminator. Meter indicator. Sensitivity: 1.5 μ V for 26 dB quieting. Aerial 300 ohms balanced twin. Optional multiplex. AFC switchable. Output: 12W each channel. Distortion less than 1% at 1 KHz for 12W output. FR 30 Hz-20 KHz. Output impedance: 4 ohms. Mains: 240V AC. Size: 19 $\frac{1}{4}$ \times 11 $\frac{1}{4}$ \times 4 $\frac{3}{8}$ in. Price: £145 9s. 5d. (including PT).

Régie 500. All transistor design. FM, MW, LW. 30W per channel RMS output at 4 ohms. Distortion: less than 0.5%. FR 30 Hz-30 KHz. Automatic FM control, stereo indicator, separate FM and AM control knobs, ferrite aerial for MW and LW. New-style transmitter-maximum indicator. Separate balance, bass and treble controls, switch for off-tape monitoring, rumble filter, linear volume control, four AF inputs. Outputs: speakers 4-16 ohms, headphones 200, 400 ohms. Cabinet: steel with charcoal wrinkle lacquer finish, aluminium front panel. Dimensions 4 $\frac{1}{4}$ \times 15 $\frac{3}{4}$ \times 12 $\frac{3}{8}$ in. Price: £279 1s. 9d.

★

BRYAN AMPLIFIERS LTD., St. John's Court, Jane Street, Workington. Tel: Workington 3776.

6000. Solid state stereo tuner/amplifier. Range: 88.5-108 MHz. Variable tuning with meter indication. FM detector: ratio. Sensitivity: 2 μ V. Aerial impedance: 80 ohms coaxial. Out-

put voltage: 150 mV at 30% modulation. Multiplex decoder fitted. AFC. Power output: 20W per channel RMS, 4-15 ohms. HD 0.25%. FR 35 Hz-33 KHz at 1W \pm 1 dB. Feedback - 60 dB. Inputs: magnetic pickup, 3 mV, 50K, noise level - 60 to 70 dB; ceramic pickup, 40 mV, 100K, noise level - 52 to 60 dB; radio, tape and aux, 75 mV, 50K, -60 to 70 dB. Controls: volume and on-off; balance; bass; treble; selector; mode; monitor; rumble filter. Psn mains. Dimensions: 17 $\frac{1}{4}$ \times 12 \times 5 $\frac{3}{4}$ in. Price: £82 15s. 10d. (plus £20 4s. 9d. PT).

★

DUAL. Dual Electronics Ltd., Radnor House, London Road, Norbury, London, S.W.16. Tel: 01-764 9465/6.

CR40. Transistorised tuner amplifier. Power output: 16W RMS per channel, 20W music power. HD < 0.3% at 15W RMS. Power bandwidth: 20 Hz-30 KHz (DIN). FR 15 Hz-30 KHz \pm 1.5 dB. Range: as for CT16 stereo tuner. S/N: better than 50 dB below 50 mW. Inputs: magnetic PU 3 mV at 47K, equalised CCIR; tape 400 mV at 470K flat; ceramic PU 400 mV at 470K flat. Controls: tuning, volume/loudness, bass \pm 14 dB at 40 Hz, treble \pm 14 dB at 15 KHz. Switchable loudness compensation. Push-button selector, wave change and AFC. Tuning: variable. Psn 110-240V 50 Hz. Dimensions: 16 $\frac{1}{2}$ \times 4 $\frac{1}{2}$ \times 11 $\frac{1}{4}$ in. Weight: 12.8 lb. Price: £146 5s. 9d. (plus £36 2s. 9d. PT).

★

DYNACO. Distributors: Howland-West Ltd., 2 Park End, South Hill Park, London, N.W.3. Tel: 01-794 6666 and 6033.

★ **Scan-Dyna 3000.** Solid state stereo AM/FM tuner/amplifier. Range: 87-108 MHz, 550-1,660 KHz. Variable tuning with indicator meter. Sensitivity: 1.2 μ V mono, 8 μ V stereo. Aerial impedance: 75 ohms unbalanced, 300 ohms balanced. Multiplex decoder. AFC. Power output: 30W into 8 ohms, 50W into 4 ohms. HD 0.2% at 40W. FR 20 Hz-20 KHz \pm 0.5 dB at 8 ohms. Noise level: 100 dB. Inputs: magnetic pickup, 3 mV, 47K ohms; crystal pickup, tape and aux, 200 mV, 1M ohm each. Controls: on-off volume, function, loudness, high and low filter, bass, treble, balance, speaker on-off or set A and B, monitor, muting, AFC. Psn mains. Price: £95 (plus £23 3s. 3d. PT).

★

DYNATRON. Dynatron Radio Ltd., St. Peter's

Road, Maidenhead, Berks. Tel: Maidenhead 23331.

★ **TRV20.** Tuner/amplifier. Wavebands: 87-108 MHz, 185-570 m and 1100-2000 m. Multiplex decoder with beacon indicator. FM sensitivity: 2 μ V 16 dB, 6 μ V 30 dB, 12 μ V 40 dB quieting. AM sensitivity: 10 μ V for 20 dB. S/N (average) MW, 15 μ V for 20 dB S/N (average) LW. Full limiting at 16 μ V or better. Stereo gating: closes at 6 μ V at 30 dB S/N ratio. Stereo separation: better than 23 dB. AFC: pull-in range \pm 300 KHz, hold-in range \pm 350 KHz. AGC action: 70 dB for 6 dB change in audio. Separate RF and IF channels for AM and FM (14 transistors). 16 transistors in amplifier section. Output: 10W RMS per channel. Distortion: less than 1%. H and N better than -65 dB. FR 30 Hz-25 KHz -3 dB. Inputs: tape, 30 mV for 10W at 1 KHz; pickup: magnetic, 4.5 mV for 10W at 1 KHz; ceramic 60 mV. Loudness filter: +15 dB at 50 Hz. Scratch filter: -10 dB at 10 KHz. Controls include bass (\pm 10 dB at 100 Hz relative to 1 KHz), treble (\pm 10 dB at 10 KHz relative to 1 KHz), balance, tuning, function selector, waveband, volume, AFC, loudness filter and scratch filter. Sockets: output (3-15 ohms), tape recorder, external FM and AM aerials. Shuttered mains socket for tape recorder, etc. Psn 190-250V 50 Hz. Dimensions: 5 $\frac{1}{8}$ \times 19 \times 14 in. Price: £78 10s. (inc. PT).

★

FERGUSON. British Radio Corporation Ltd., 284 Southbury Road, Enfield, Middlesex. Tel: 01-366 1155.

★ **205STA.** Transistorised stereo. Range: VHF 87.5-101 MHz, MW 185-566 m, LW 1 $\frac{1}{2}$ -20,025 m, SW 16-51 m. Variable tuning. Meter tuning indicator. Sensitivity: VHF 15 μ V for 20 dB limiting, MW 420-500 μ V for 20 dB S/N. Aerials: built-in 8 in. ferrite rod for MW and LW, sockets for SW and VHF. Stereo multiplex decoder built-in. Stereo indicator lamp. Switchable AFC. 26 transistors, 16 diodes. Inputs: PU 20 mV 50 K, tape 50 mV 60K. Outlets: ext speakers 8 ohms, tape 120-200 mV 4-7K. Output: 4W per channel. HD < 5% at rated output. FR 30 Hz-20 KHz \pm 6 dB. Controls: volume (bass compensated), bass +14 dB -12 dB, treble \pm 10 dB at 10 KHz, tuning, AFC on-off, mode, wave-change, pickup balance (on rear). Mains outlet sockets. Mains: 200-250V AC 50 Hz. Consumption 20W. Size: 16 $\frac{3}{4}$ in. wide, 9 $\frac{3}{8}$ in. deep (11 in. overall), 8 $\frac{3}{8}$ in. high. Finish: teak. Designed to match Ferguson Unit Audio system. Price: £48 18s (plus £10 9s. PT).

★**206STA.** Transistorised FM/VHF stereo. Range: 87.5-105 MHz. Preset tuning with five press-buttons, each button tunes entire range. Sensitivity: 20 μ V for 20 dB limiting. Stereo multiplex decoder fitted. Stereo indicator light. Switchable AFC. 27 transistors, 12 diodes. Inputs: PU 16 mV, tape 140 mV 54K, radio 16 mV 6-8K. Controls: mains on-off, bass \pm 14 dB, treble \pm 10 dB at 10 KHz, balance, volume. Output: 6W per channel (RMS). HD <2% at rated output. FR 30 Hz-20 KHz \pm 3 dB. Outlets: ext speakers 8 ohms, tape 70 mV 68K, two mains outlets. Mains: 200-250V AC 50 Hz. Consumption: 20W. Size: 19 $\frac{1}{4}$ in. wide, 11 $\frac{1}{2}$ in. deep, 5 in. high. Designed to match Ferguson Unit Audio system. Finish: teak. Price: £44 19s. 7d. (plus 12s. 5d. PT).



FISHER RADIO CORPORATION. Distributors: Getz Bros. & Co. Inc., 2 Harewood Place, London, W1R 0DD. Tel: 01-499 6901.

160-T. Stereo. Five vertical dials covering FM band with five pre-selected station push buttons. Stereo beacon ind. Usable sensitivity (IHF standard): 2.2 μ V. AFC. FM stereo separation at 1 KHz 35 dB. RMS output power at 1 KHz: 15W per channel. FR 25 Hz-20 KHz \pm 2 dB. H and N (volume at minimum): 85 dB below rated output. Input sensitivity: PU1 2.5 mV; PU2 7.5 mV; aux 250 mV. Price: £140 14s. (inc. PT).

175-T. Stereo. Wavebands: 88-108 MHz and 530-1,600 KHz (MW). Incorporates FETs and integrated circuits. Sensitivity: FM 2 μ V, AM 10 μ V. S/N ratio: 65 dB. Selectivity (alternate channel): 45 dB. Stereo separation: 35 dB. Power output: 20W RMS per channel. FR 20 Hz-20 KHz \pm 2 dB. Input sensitivities: as 160-T. Price: £190 1s. (inc. PT).

250-T. Stereo. Wavebands as 175-T with two separate modes of tuning. Push buttons for five FM stations and flywheel dial for AM. Sensitivity: FM 2 μ V, AM 10 μ V. S/N ratio: 65 dB. HD: 0.5%. Stereo separation: 38 dB. Power output: 30W RMS per channel. FR 20 Hz-20 KHz \pm 2 dB. Sensitivities: as 160-T. Price: £229 19s. (inc. PT).

★**400-T.** Stereo. Wavebands as 175-T, with push-button tuning for five FM stations, flywheel tuning for AM. Stereo beacon ind. Auto mono/stereo switching and a d'Arsonval tuning meter. AFC. Sensitivity: FM 2 μ V, AM 10 μ V. S/N ratio: 65 dB. HD: 0.5%. Stereo separation:

38 dB. Power output: 50W RMS per channel. FR 20 Hz-25 KHz \pm 2 dB. Input sensitivities as 160-T. Price: £270 18s. (inc PT).

800-T. Stereo. Wavebands as 175-T with four methods of tuning; RK-30 AutoScan signal-seeking with remote control, flywheel tuning, AutoScan Touch Tuning and Tune-O-Matic push button memory tuning. Crystal FM-IF filter and dual gate RF MOS FETs. Sensitivity: FM 1.7 μ V; AM 10 μ V. HD 0.4%. Stereo separation: 38 dB. Power output: 65W RMS per channel. FR 20 Hz-25 KHz \pm 1.5 dB. Input sensitivities: PU1 2.5 mV, PU2 10 mV; aux 250 mV. Price: £338 2s. (inc PT).



GOODMANS LOUDSPEAKERS LTD., Axiom Works, Lancelot Road, Wembley, Middx. Tel: 01-902 1200.

Model 3000. Solid state stereo. Range: 87.5-108 MHz. Five push buttons. Multiplex decoder. Switchable AFC. Sensitivity: 3 μ V for 26 dB signal/noise ratio. HD less than 0.5%. Power output: 15W per channel RMS into 4 ohms. FR 30 Hz-20 KHz \pm 3 dB. Tone controls: 0 dB at 1 KHz; bass \pm 14 dB at 50 Hz; treble +12 dB to -15 dB at 10 KHz. Aerial impedance: 240 ohms balanced. Record player socket (DIN 5-pin) magnetic pickup input 6.8 mV into 47K. Ceramic pickup input 220 mV into 1.2 M. Tape socket (DIN 5-pin) input 300 mV into 56K; VHF output 60 mV at 68K with 1 μ V input. Aux socket (DIN 5-pin) input 20 mV into 6.8K. Stereo headphone socket (automatic speaker muting), recommended impedance 300-600 ohms. Overall dimensions: 4 \times 21 $\frac{3}{4}$ \times 10 $\frac{3}{4}$ in. Weight: 14 lb. Psn 120, 220 and 245V, 50 Hz, 20-80W. Price: £77 14s. 7d. (inc. £16 5s. 4d. PT).



GRUNDIG (GREAT BRITAIN) LTD., Hi-Fi Division, 15 Orchard Street, London, W.1. Tel: 01-935 4898.

★**RTV650.** Transistorised stereo. Ranges: VHF 87.5-108 MHz, LW 680-2050 m, MW 185-587 m, SW1 34-99 m, SW2 13.5-35 m, SW3 band-spread \pm 60 KHz of SW bands. Sensitivity: FM 1.5 μ V, AM (MW) 6.5 μ V. IFs: 460 KHz and 10.7 MHz. AFC. Noise level: -70 dB at 40 KHz deviation. Distortion factor: <0.5%. FR 40 Hz-15 KHz \pm 2 dB. Stereo decoder with automatic switching and stereo beacon. Separation: better than 40 dB at 2 KHz. Aerials: inter-

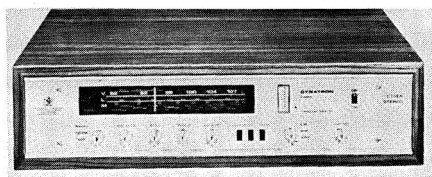

Dynatron TRV20

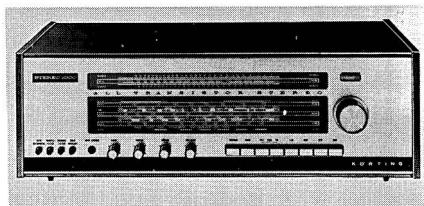

Korting Stereo 1000

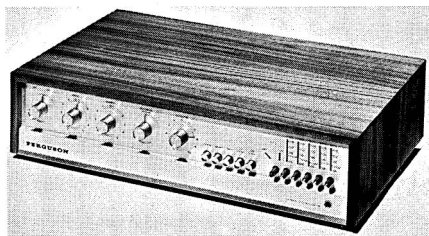

Ferguson 206STA



Lux HQ555



Fisher 400 FM stereo tuner amplifier



Nikko ST501

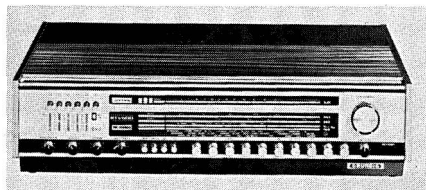

Grundig RT650

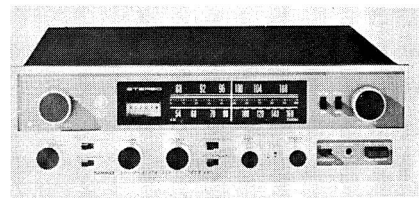

Nikko ST701LA

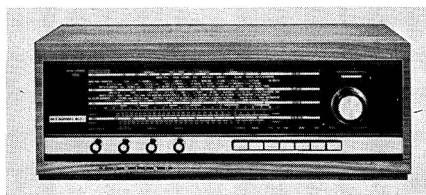

Korting Stereo 400



Philips RH790

nal ferrite rod, FM dipole 240 ohms. 3 KHz and 5 KHz treble filters. Output: 20W RMS per channel. FR (audio stages) 20 Hz-20 KHz ± 1.5 dB. Inputs: mag PU 3 mV 47K, tape 200 mV 470K. Output impedance: 4-16 ohms. Automatic overload cut-out. Bass control: -20 dB + 15 dB at 20 Hz. Treble control: -20 dB + 15 dB at 20 KHz. Mains: 110, 130, 220, 240V 50-60 Hz. Consumption (no load): 30W. Size: 24 \times 6 \times 12 in. Price: £230 0s. 10d. (incl. PT).

★

HMV. British Radio Corporation Ltd., 284 Southbury Road, Enfield, Middlesex. Tel: 01-368 1155.

2404. Stereo tuner with integrated amplifier. Range: 87.5-108 MHz. Tuning: Five switched channels. Switched AFC. Multiplex decoder. Power output: 15W RMS per channel. FR 30 Hz-20 KHz ± 3 dB. HD <1%. Output impedance: 4-15 ohms. Controls: on/off, volume/loudness, balance, treble, bass. Dimensions: 21 $\frac{1}{8}$ \times 10 $\frac{1}{4}$ \times 4 in. Price: £65 (including PT).

★

HEATHKIT. See Constructional Kits section.

★

KIRKSAETER. A. C. Farnell Ltd., 81 Kirkstall Road, Leeds, 3. Tel: Leeds 35111

Range of high quality tuner amplifiers. Specifications and prices on application.

★

KNIGHT-KITS. See Construction Kits Section.

★

KORTING. Distributors: Europa Electronics Ltd., Howard Place, Shelton, Stoke-on-Trent, ST1 4NW. Tel: Stoke-on-Trent 29316.

★**Stereo 400T, Type 30476.** Stereo. In natural walnut colour cabinet with satin finish. Ranges: SW, MW, LW, VHF/FM. Tuning indicator with measuring instrument and compensated detector/amplifier. FM sensitivity: 3 μ V, band width approximately 140 KHz. Ferrite aerial for AM. Multiplex decoder with indicator. AFC. It has 23 transistors, 11 diodes and one rectifier. Output: 8W per channel. Controls: bass, treble, balance and push button waveband selection. Sockets for aerials, earth, magnetic pickup, tape recorder (and crystal pickup),

speakers. Size: 22 \times 4 $\frac{1}{2}$ \times 7 in. Price: £75 15s. 0d. (including £15 0s. 2d. PT).

Stereo 700, Type 29478. Stereo, with natural walnut, satin finish. Ranges: SW, MW, LW, VHF/FM. Tuning indicator. Sensitivity: FM 1.5 μ V, AM 10 μ V. Ferrite aerial for MW and LW. Multiplex decoder with automatic indicator. AFC. It has 35 transistors, 15 diodes and one rectifier. Controls: bass, treble, balance, push button waveband selection. Output: 10W per channel. Sockets for aerials, earth, crystal, ceramic and magnetic pickup; tape recorder, speakers; earphone or headphone. Dimensions: 6 \times 25 \times 9 $\frac{1}{2}$ in. Price: £109 15s. 0d. (including £21 14s. 10d. PT).

★**Stereo 1000L, Type 29480.** Stereo, in natural walnut cabinet with satin finish. Ranges: SW, MW, LW and VHF/FM. Tuning indicator with measuring instrument in a compensated bridge circuit. Sensitivity: FM 1.5 μ V, AM 10 μ V. Ferrite aerial for MW and LW. Multiplex decoder with automatic indicator. AFC. It has 39 transistors, 16 diodes and two rectifiers. Output: 25W per channel. Controls: treble, bass, balance, push button wavechange. Sockets for aerials, earth, magnetic, crystal or ceramic pickup; tape recorder, earphone, speakers. Dimensions: 25 \times 6 \times 9 $\frac{1}{2}$ in. Price: £129 15s. 0d. (including £25 14s. 0d. PT).

★

LAFAYETTE. Barnet Factors Ltd., 4 Lisle Street, London, W.C.2. Tel: 01-437 2723.

Lafayette LR-99. Solid state stereo, AM/FM. Range: 88-108 MHz, 540-1.605 KHz. Sensitivity: FM 3 μ V. Stereo separation: 32 dB at 400 Hz. Aerial: 75 ohms unbalanced (FM); built-in ferrite (AM). Power output: 10W per channel RMS at 8 ohms. FR 20 Hz-20 KHz ± 2 dB at 1W. HD 0.5%. H and N -50 dB on magnetic pickup. Input: magnetic pickup 3 mV; ceramic 80 mV; auxiliary 250 mV. Bass control at 50 Hz. ± 20 dB. Treble at 10 KHz. ± 20 dB. Loudness control: 10 dB at 50 Hz, 4.5 dB at 10 KHz. Output impedance: 4, 8 and 16 ohms; low impedance stereo headphone. Size: 4 $\frac{7}{16}$ \times 13 $\frac{13}{16}$ \times 10 in. Price: £60 12s. 5d. (plus £16 13s. 5d. PT).

Lafayette LR-500T. Solid state AM/FM stereo. Range: 88-108 MHz, 535-1.605 KHz. Sensitivity: FM 1.8 μ V. S/N ratio: 67 dB. Distortion: 0.5% at full mod. Stereo separation (tuner): 35 dB at 400 Hz. Power output: 4-16 ohms; 20W per channel RMS at 4 ohms. FR

22 Hz-40 KHz. HD less than 1% at full output. Inputs: magnetic pickup 2.2 mV; aux 270 mV; tape 500 mV. Four integrated circuits. Cabinet size: 5×15×12 in. Price: £74 2s. 3d. (plus £20 7s. 8d. PT).

Lafayette LR-1000. Solid state AM/FM stereo. Sensitivity: FM 1.65 μV. Tuner stereo separation: 38 dB at 400 Hz. Signal-to-noise ratio: 68 dB. HD 0.4% at full mod. FM aerial impedance: 300 ohms. Power output: 40W per channel RMS at 4 ohms. FR 22 Hz-20 KHz ±1 dB. HD less than 1%. H and N: tape head -57 dB; pickup (high) -57 dB; aux -75 dB. Inputs: tape head 2.5 mV; pickup (high) 2.2 mV; pickup (low) 7 mV; aux 270 mV. Output impedance: 4-16 ohms; low impedance stereo headphones. Computer-matic TM protective circuitry for audio power stages. Integrated circuits. FET in tuner front end. Separate bass and treble controls. Cabinet size: 4 $\frac{3}{8}$ ×15 $\frac{3}{8}$ ×11 $\frac{3}{8}$ in. Price: £94 16s. 1d. (plus £26 1s. 5d. PT).



LUX. Distributors: Shriro (U.K.) Ltd., 8 Bush Lane, Cannon Street, London, E.C.4. Tel: 01-626 4711/3.

★**HQ555.** AM/FM multiplex stereo. Transistorised. Range: 76-90 MHz, 525-1.605 KHz. Tuning: variable. Tuning indicator: meter. H and N: better than -60 dB on pickup 1. FR 20 Hz-20 KHz ±1 dB. HD <1% at 50W. Inputs: tape 2 mV 100K, pickup 1.2 mV 50K, pickup 2.50 mV 500K. Aux 250 mV 150K. Controls: volume, balance, treble, bass, tuning, loudness, mode, HP filter, LP filter, selector, speaker/phones switch. Psn 240V 50 Hz. Special features include FET devices in tuner. Dimensions: 5 $\frac{3}{8}$ ×17 $\frac{3}{8}$ ×12 $\frac{5}{8}$ in. Price: £125 8s. 10d. (plus £34 9s. 11d. PT).



LUXOR. Distributors: Luxitone, 84 Bolsover Street, London, W.1. Tel: 01-636 2901.

4888. Stereo tuner/amplifier. Transistorised. Power output: 20W RMS per channel into 4 ohms. HD 2% at rated output. FR 20 Hz-20 KHz ±2 dB. Inputs: crystal pickup 150 mV; magnetic pickup 4 mV; tape 50 mV; mic 1.5 mV. Range: 87-101 MHz. Tuning: pre-set and variable. Sensitivity: 4 μV. AFC and multiplex decoder fitted. Dimensions: 52.5×25×11.5 cm.

4887. Stereo tuner/amplifier. Transistorised. Power output: 7W RMS per channel into 4 ohms. HD 3% at rated output. FR 35 Hz-18

KHz ±2 dB. Inputs: crystal pickup 250-mV, 47K. Tape: 250 mV 47K. Range: 87-101 MHz. Tuning: pre-set and variable. Sensitivity: 4 μV. AFC and multiplex decoder fitted. Dimensions: 46×21×7 cm.



MEDLEY MUSICAL LTD., 4 Felltram Way, Charlton, London, S.E.7. Tel: 01-858 3426.

1010. Solid state stereo. Range: 88-108 MHz. Variable tuning. AFC. Controls: volume, on/off; balance; treble; bass; gram, radio, Aux, stereo, mono, tuning. Power output: 5W per channel RMS. FR 30 Hz-20 KHz. Distortion: less than 1%. Motor unit: Garrard SP25 or 3000. Pickup cartridge: Sonotone 9TA. Overall dimensions: 14 $\frac{1}{4}$ ×13 $\frac{3}{4}$ ×4 $\frac{1}{4}$ in. Speakers recommended: Maxi. Price: auto £45 (plus £10 9s. PT); transcription £47 15s. (plus £10 19s. 5d. PT).

FMTA 1515. Solid state stereo AM/FM with decoder. Range: 88-108 MHz, 535-1,620 KHz. Sensitivity: FM (98 MHz) 10 μV (IHF); AM (S/N 20 dB, 1 MHz) 20 μV (IHF). FR 30 Hz-12 KHz -3 dB down. HD FM 2.5% max (1 KHz 100% dev); AM 4% max (1 KHz 30% Mod). Power output: 5W per channel (1 KHz 8 ohms, load 5% THD). Inputs: pickup 260 mV (1 KHz, 8 ohms load). H and N (volume control min) 10 mV max. AFC. Controls: tuning, volume with SW, bass, treble, balance, selector, pickup, multiplex FM, AFC, FM, AM. Psn 250V 50 Hz. Price to be announced.



NATIONAL. U.K. distributors: Unamec Ltd., P.O. Box 1, United Africa House, Blackfriars Road, London, S.E.1. Tel: 01-928 2070.

National SA-57. Solid state stereo FM. Range: 88-108 MHz. Variable tuning with Luminaband indicator. FM detector: Foster-Seeley. Sensitivity: 1.8 μV. Aerial: 300 ohms balanced. Output: 32W per channel. Multiplex decoder. AFC. Psn mains. Dimensions: 5 $\frac{1}{8}$ ×19 $\frac{3}{4}$ ×14 in. FETs. Full range controls: high/low filter, muting, loudness, ceramic filter, three switched aux, power sockets, ceramic-magnetic input. Price: £121 16s. (plus £32 4s. PT).



NIKKO ELECTRIC MFG. CO. LTD. Distributors: Howland-West Ltd., 2 Park End, South Hill Park, London, N.W.3. Tel: 01-794 6666 and 6033.

★**Nikko ST501.** Transistor AM/FM. Range: VHF 88-108 MHz, MW 182-565 m. Variable tuning. Meter tuning indicator. Sensitivity: 1.8 μ V for 20 dB quieting. Aerial input: 300 ohms balanced. Multiplex decoder fitted. AFC. Inputs: mag PU 28 mV 50K, tape head 1.8 mV 250K, aux (1) 200 mV 250K, aux (2) 500 mV 1 megohm. Noise level: PU -60 dB, tape -55 dB, aux -65 dB. Controls: selector, tuning, volume, speaker on/off, mode, tape monitor, loudness, balance, bass (left and right), treble (left and right), mains on/off, local/distance. Output: 18W RMS into 8 ohms. HD 0.8% at rated output. FR 20 Hz-20 KHz \pm 1 dB at full power. Output impedance: 4-16 ohms. Mains: 117-240V 50/60 Hz. Size: $15\frac{1}{4} \times 12\frac{3}{4} \times 4\frac{3}{4}$ in. Price: £98 (plus £23 17s. 11d. PT).

★**Nikko ST701-LA.** Transistor AM/FM. Range: VHF 88-108 MHz, MW 182-565 m. Variable tuning. Field effect transistor FM detector. Meter tuning indicator. Sensitivity: 1.8 μ V for 20 dB quieting. Multiplex decoder fitted. Switched AFC. Inputs: PU (mag) 2.8 mV 50K, tape head 1.8 mV 200K, aux 200 mV 250K, aux 500 mV 800K. Controls: mode, function, volume, balance, bass (one on each channel), treble (one on each channel), tape monitor, loudness, scratch filter, rumble filter, muting, AFC, speaker on/off, mains on/off. Output: 25W RMS per channel at 8 ohms. HD <0.3% at 20W. <0.8% at 25W. FR 15 Hz-50 KHz. Noise level: tape -55 dB, mono -60 dB, aux -65 dB. Output impedance: 4-15 ohms. Mains: 117-250V 50/60 Hz. Automatic circuit breaker. Size: $15\frac{1}{2} \times 4\frac{1}{2} \times 12\frac{3}{4}$ in. Price: £109 10s. (plus £26 13s. 11d. PT).

★

PHILIPS ELECTRICAL LTD., Century House, Shaftesbury Avenue, London, W.C.2. Tel: 01-437 7777.

★**RH790.** Solid state stereo AM/FM. Range: 87.5-104 MHz, 187-571 m, 1,154-2,000 m, 16.7-50.4 m. Tuning: AM variable; FM variable and pre-set. Ratio FM detector. Tuning indicator: meter. Sensitivity: FM 8 μ V; AM 100 μ V. Aerial: 300 ohms balanced. Multiplex decoder with indicator lamp. Switchable AFC. Touch tuning electronically switched presets on FM with varicap tuner unit. Power output: 20W per channel RMS into 8 ohms. HD <0.2% at 15W per channel. FR 20 Hz-50 KHz 3 dB below 20W. Noise level: 80 dB below 20W. Output: 20W RMS at 1 KHz, 8 ohms (provision for 4 ohms at reduced power). Output transistors: four BDY20. Psn 110, 127, 220, 240V. Inputs:

magneto/dynamic pickup 4 mV, 50K; crystal pickup 70 mV, 150K; tape 100 mV, 120K. Controls: volume, bass +16 to -14 dB at 50 Hz; treble \pm 14 dB at 10 KHz; scratch -12 dB/octave -3 dB at 4 KHz (switchable); low level bass compensation +12 dB max at 50 Hz (switchable). Dimensions: $4\frac{3}{8} \times 20\frac{3}{4} \times 10\frac{3}{4}$ in. Price to be announced.

★**RH781.** Solid state stereo AM/FM. Range: 87.5-104 MHz, 213-580 m, 800-2,000 m, 30.6-50.4 m. Tuning: AM variable; FM adjustable preset. Ratio FM detector. Tuning indicator: meter. Sensitivity: FM 7 μ V; AM 70 μ V. Aerial: 300 ohms balanced. Multiplex decoder, with indicator lamp. AFC. Output: 4.8 ohms; 6.5W per channel RMS into 4 ohms. HD 2% at 4.5W per channel. FR 50 Hz-20 KHz -3 dB. Distortion: 10%. Noise level: 47 dB below 6.5W. Output transistors: two AD161/162. Psn 240V. Inputs: crystal pickup 150 mV, 300K; tape 70 mV, 200K, -47 dB noise level. Controls: volume (loudness) +12 dB at 80 Hz, +6 dB at 12 KHz; bass +15 to -5 dB at 80 Hz; treble +9 to -14 dB at 12 KHz; balance. Dimensions: $4\frac{3}{8} \times 20\frac{1}{4} \times 8\frac{3}{8}$ in. Price: £60 2s. 5d. (plus £14 17s. 1d. PT).

★**RH881.** Solid state stereo AM/FM. Range: 87.5-104 MHz, 213-580 m, 800-2,000 m, 30.6-50.4 m. Tuning: AM variable; FM adjustable preset. Ratio FM detector. Tuning indicator: meter. Sensitivity: FM 7 μ V, AM 70 μ V. Aerial: 300 ohms balanced. Multiplex decoder with indicator lamp. AFC. Output: 4.8 ohms; 6.5W per channel RMS into 4 ohms. HD 2% at 4.5W per channel. FR 50 Hz-20 KHz -3 dB. Distortion: 10%. Noise level: 47 dB below 6.5W. Output transistors: two AD161/162. Psn 240V. Inputs: crystal pickup 150 mV, 300K; tape 70 mV, 200K; -47 dB noise level. Controls: volume (loudness) +12 dB at 80 Hz, +6 dB at 12 KHz; bass +15 to -5 dB at 80 Hz; treble +9 to -14 dB at 12 KHz; balance. Dimensions: $4\frac{3}{8} \times 23\frac{3}{4} \times 11$ in. Stereo Compact cassette recorder incorporated. Price: £79 7s. 9d. (plus £19 12s. 3d. PT).

★

PIONEER. Distributors: Shiro (UK) Ltd., 8 Bush Lane, Cannon Street, London, E.C.4. Tel: 01-626 4711/3.

★**SX-440.** AM/FM with FET tuner. FM section: 2.5 μ V sensitivity. S/N ratio: 50 dB. HD 0.5%. Range: 87-108 MHz. Multiplex separation: 35 dB. Automatic mono/stereo switching. AM section: 8 μ V sensitivity. Range: MW 187-

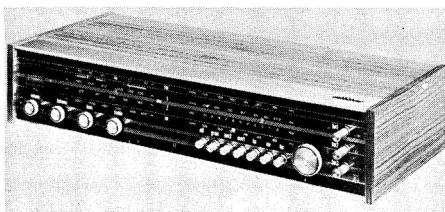

Philips RH781

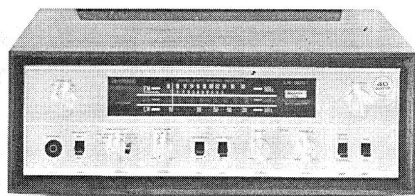

Pioneer LX-300TW

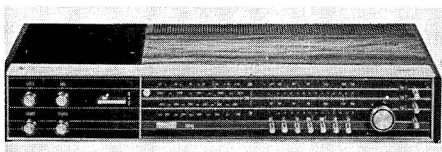

Philips RH881



Pioneer SX-1000TD

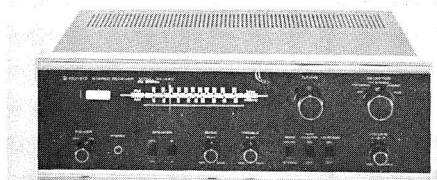

Pioneer SX-440

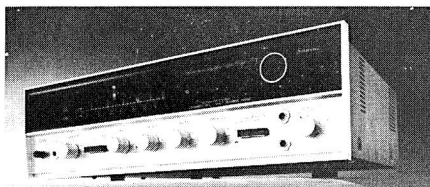

Sansui 5000



Sansui 350



Sansui 800

572m 525-1,605 KHz. Ferrite aerial. Audio section: output 12W RMS per channel at 8 ohms. HD <1%. FR 20 Hz-70 KHz ± 3 dB. H and N 75 dB (magnetic). Damping factor: 25. Inputs: pickup, 3 mV; tape monitor, 130 mV; aux 130 mV; Recording output: 230 mV. Main/extra speakers. Headphone jack. Controls: bass ± 13 dB; treble ± 10 dB. 10 KHz; loudness. Fine tuning meter. Size: $5\frac{1}{2} \times 15\frac{3}{8} \times 15$ in. Psn 110-240V. Price: £97 9s. 5d. (inc. £21 0s. 6d. PT).

★**LX-300T.** AM/FM stereo. MW, LW, VHF. FM sensitivity 2.6 μ V. Signal to noise: 50 dB. MW: 18 μ V sensitivity. Ferrite rod. Multiplex separation 35 dB. Automatic mono/stereo switching. AFC. Tuning meter. Inputs: pickup. 2.3 mV/45 mV; tape 220 mV; aux 160 mV. Controls: bass ± 13 dB (50 Hz); treble +9 dB, -11 dB (10 KHz); loudness; headphones; tape monitor. Output: 4-16 ohms. 12W RMS at 8 ohms per channel. FR 20 Hz-20 KHz ± 1 dB. HD less than 1%. H and N better than 85 dB. Damping factor 25. Mains outlets. Size: $5\frac{1}{4} \times 16 \times 12\frac{1}{2}$ in. Psn 110-240V. Price: £120 2s. 7d. (inc. £25 18s. 2d. PT).

SX-700T. AM/FM transistor stereo. FM section: sensitivity 2 μ V; S/N ratio 60 dB. Multiplex separation 35 dB. Range: 88-108 MHz. AM section: MW 525-1,605 KHz; sensitivity 18 μ V. AFC. Tuning meter. Inputs: magnetic pickup (two), 3.5 mV; tape head, 1.6 mV; tape monitor, 250 mV; aux, 250 mV. Controls: bass, treble, high filter -10 dB at 10 KHz. Output: 25W RMS per channel at 8 ohms. HD 0.5%. FR 25 Hz-50 KHz. ± 1 dB. H and N 85 dB. Damping factor: 35. Phone jack. Main and extra speakers. Mains outlets. Size: $5\frac{1}{2} \times 16\frac{1}{2} \times 13\frac{3}{8}$ in. Psn 110-240V. Price: £154 17s. 10d. (inc. £33 8s. 2d. PT).

★**SX-1000TD.** AM/FM stereo with FETs and ICs. FM section: sensitivity 1.7 μ V; range 87-108 MHz. S/N ratio 65 dB. Multiplex separation 38 dB. Automatic mono/stereo switching. AM section: 20 μ V sensitivity; range 525-1,605 KHz. Internal ferrite aerial. Tuning meter for AM/FM. Amplifier section: output 50W RMS per channel at 8 ohms. FR 20 Hz-50 KHz ± 1 dB. HD 0.1% (30W, 8 ohms, 1 KHz). H and N >80 dB (magnetic). Inputs: pickup 1, 2.4 mV 50K; pickup 2, 51 mV 90K; tape head, 1.5 mV 120K; tape monitor, 200 mV 100K; aux 200 mV 100K. Controls: separate bass and treble each channel; loudness control +6 dB at 50 Hz. +10 dB at 10 KHz. Main and extra speakers. Headphone jack. Facility for two turntables. AFC. Interstation muting. 4-track monitoring. Tape head equalisation. $7\frac{1}{2}$ and $3\frac{3}{4}$ i/s. Mains

outlets. Size: $5\frac{1}{2} \times 15\frac{3}{8} \times 13\frac{3}{8}$ in. Psn 110-240V. Price: £175 13s. 5d. (inc. £37 17s. 10d. PT). Case extra.



ROTEL. U.K. Distributors: Pullin Photographic, Rank Aldis Ltd., P.O. Box 70, Great West Road, Brentford, Middx. Tel: 01-568 9222.

FAX-130. Solid state AM/FM stereo. Range: 88-108 MHz, 535-1,605 KHz. Variable tuning with indicator meter. Sensitivity: FM 2.5 μ V; AM 15 μ V. Multiplex decoder. AFC. FETs. Power output: 8W per channel RMS. HD 0.3%. FR 25 Hz-15 KHz ± 1.5 dB. Psn: AC, 240V. Inputs: magnetic pickup, 2 mV, noise level 60 dB; crystal pickup 160 mV, noise level 60 dB; aux, 160 mV, noise level 75 dB. Controls: bass, treble, balance, loudness and on-off, tuning, function selection, mode and AFC. Dimensions: $4\frac{1}{2} \times 16 \times 9\frac{1}{4}$ in. Price: £79 (inc. PT).

FAX-330. Solid state AM/FM stereo. Range: 88-108 MHz, 535-1,605 KHz. Sensitivity: FM 2.5 μ V; AM 15 μ V. S/N ratio: 67 dB. HD 1.5%. Stereo separation: 35 dB. Power output: 17W per channel RMS at 8 ohms. HD 0.3%. FR 25 Hz-20 KHz ± 1.5 dB. Input sensitivity: magnetic pickup, 2 mV; crystal pickup and aux, 160 mV. H and N: pickup, 60 dB; aux 75 dB. Dimensions: $4\frac{3}{8} \times 15\frac{3}{8} \times 11$ in. Weight: 13.5 lb. Price: £95 (inc. PT).

FAX-550. Solid state AM/FM stereo with FET front end. Range: 88-108 MHz, 535-1,605 KHz. Sensitivity: FM 2.2 μ V; AM 20 μ V. Variable tuning with indicator meter. S/N ratio: 67 dB. Stereo separation: 53 dB. Power output: 21W per channel RMS into 8 ohms. HD 0.2%. FR 15 Hz-35 KHz ± 1.5 dB. Input sensitivity: magnetic pickup 2 mV; crystal pickup, 30 mV; aux, 110 mV. H and N: pickup 60 dB; aux 75 dB. Dimensions: $4\frac{3}{8} \times 15\frac{3}{8} \times 12\frac{1}{2}$ in. Finish: walnut. Weight: 14.5 lb. Price: £119 (inc. PT).

FAX-660. Solid state AM/FM stereo, with FET front end. Range: 88-108 MHz, 535-1,605 KHz. Sensitivity: FM 2.2 μ V; AM 25 μ V. S/N ratio 67 dB. Variable tuning with indicator meter. Signal to noise ratio: 67 dB. Stereo separation: 35 dB. Output power: 30W RMS per channel at 8 ohms. HD 0.2%. FR 15 Hz-35 KHz 1.5 dB. Input sensitivity: magnetic pickup, high 2 mV, low 5 mV; aux 270 mV. H and N: pickup 60 dB; aux 75 dB. Dimensions:

$6\frac{1}{4} \times 17\frac{3}{8} \times 13\frac{1}{2}$ in. Weight: 17.5 lb. Price: £128 (inc. PT).



SANSUI. Sole U.K. importer: Brush Clevite Co. Ltd., Thornhill, Southampton. SO9 IQX. Tel: Southampton 45166.

★ **Sansui 250.** AM/FM stereo. Range: VHF 88-108 MHz, MW 186-560 m. Variable flywheel tuning. Ratio detector. Magic eye. Sensitivity: $2.5 \mu\text{V}$ for 20 dB. Aerial input: 300 ohms balanced. Switchable AFC. Stereo decoder fitted. Inputs: tape mon 660 mV 500K, tape rec 660 mV 500K, PU 3 mV 50K, aux 150 mV 2.2 megohms. Noise level -70 dB. Controls: volume, balance, bass boost and cut, treble boost and cut, tuning, input selector, speakers on-off, noise filter, loudness, tape mon, mode, AFC. Valves and transistors. Output: 10W per channel. HD 1.5% at 8W per channel. FR 30 Hz-20 KHz ± 2 dB. Output impedance: 8 or 16 ohms. Size: $17\frac{3}{8} \times 12\frac{5}{8} \times 5\frac{1}{4}$ in. Price: £80 5s. 7d. (plus £19 12s. 4d. PT).

★ **Sansui 350.** AM/FM multiplex stereo. Solid state. Range: 88-108 MHz, 535-1,605 KHz. Variable tuning with meter indicator. Sensitivity: $2.5 \mu\text{V} \pm 3$ dB (20 dB quieting) FM; $25 \mu\text{V} \pm 3$ dB at 1 MHz on AM. Inputs: pickup 2.2 mV ± 3 dB; aux 150 mV ± 3 dB; tape monitor 150 mV ± 3 dB; H and N: pickup 60 dB, aux 65 dB. Power output: 18W per channel ± 1 dB at 8 ohms. FR 30 Hz 20 KHz. Distortion: 1%. Dual speaker system. Aerial: 75 and 300 ohms. Controls: tuning, bass, treble, volume, balance, selector, switches for speakers, multiplex noise canceller, loudness, mono mode and tape monitor. Psn 100, 117, 220 and 240V 50 or 60 Hz. Size: $4\frac{1}{2} \times 15\frac{3}{8} \times 13\frac{1}{8}$ in. Weight: 19.5 lb. Price: £103 14s. 9d. (plus £25 7s. 1d. PT).

★ **Sansui 800.** AM/FM multiplex stereo. Solid state with a new FET front end. Range: 88-108 MHz, 535-1,605 KHz. Sensitivity: FM 2 $\mu\text{V} \pm 3$ dB (20 dB quieting); AM 22 $\mu\text{V} \pm 3$ dB at 1 MHz. Power output: 28W per channel RMS, ± 1 dB at 4 ohms. HD less than 1.0%. Inputs: pickup 2.2 mV ± 3 dB; aux, tape monitor (pin and DIN) 150 mV ± 3 dB. Damping factor: 60 at 8 ohms. Short-free output terminals for two speaker systems, new type of noise canceller, automatic FM mono/stereo switching with indication. Psn 100, 117, 220 and 240V, 50 or 60 Hz. Consumption: 18VA (zero signal) 110VA (max signal). Dimensions of case only: $4\frac{1}{2} \times 15\frac{3}{8} \times 13\frac{1}{8}$ in. Weight: 23 lb. Price: £117 6s. 1d. (plus £28 13s. 6d. PT).

Sansui 2000. AM/FM stereo. Range: VHF 88-108 MHz, MW 186-560 m. Variable tuning. Ratio detector. Meter tuning indicator. Sensitivity: $1.4 \mu\text{V}$ for 20 dB quieting. Aerial input: 75 ohms coaxial. Multiplex decoder fitted. AFC. FET front end. Inputs: PU 2.2 mV 50K, tape head 2 mV 100K, aux 150 mV 100K, tape monitor 150 mV. Noise level: -70 dB on PU, -75 dB on other inputs. Controls: speakers A or B, bass/treble cut, bass (each channel), treble (each channel), loudness, muting, tape monitor, reverse stereo, mono. Output: 32W RMS per channel. FR 15 Hz-40 KHz ± 1.5 dB. Output impedance: 4-16 ohms. Mains: 240V 50 Hz. Consumption: 150VA. Size: $16\frac{3}{8} \times 14\frac{7}{8} \times 13\frac{1}{4}$ in. Price: £130 6s. 10d. (plus £31 16s. 2d. PT).

★ **Sansui 3000A.** AM/FM solid-state stereo. Range: VHF 88-108 MHz, MW 186-560 m. Variable tuning. FM ratio detector. Meter tuning indicator. Sensitivity: $1.4 \mu\text{V}$ for 20 dB. Aerial input: 300 ohms balanced. Stereo multiplex decoder fitted. Switchable AFC. Inputs: PU 2.5 mV 50K, tape head 1.8 mV 500K, record 180 mV 250K, tape monitor 150 mV 250K, aux 180 mV 250K. Noise level -75 dB. Controls: tuning, wavechange, selector, balance, bass boost and cut, treble boost and cut, volume, speakers on-off, low-pass filter, high-pass filter, loudness, tape monitor, mode, muting, AFC. Stereo indicator. Quiet tuning. Switchable noise filter. Built-in FM aerial. Output: 48 RMS per channel. HD 0.8% at 40W per channel. FR 20 Hz-20 KHz ± 1.5 dB. Noise level -70 dB. Output impedance: 4, 8-32 ohms. Damping factor 15. Size: $18\frac{3}{8} \times 15 \times 6\frac{7}{8}$ in. Price: £150 12s. 9d. (plus £36 15s. 8d. PT).

★ **Sansui 5000.** AM/FM multiplex stereo. Solid state with FET and IC circuitry. Range: 88-108 MHz, 187-561 m. Sensitivity: $1.4 \mu\text{V} \pm 3$ dB (20 dB quieting) on FM; $15 \mu\text{V} \pm 3$ dB at 1 MHz on AM. Power output: 75W per channel ± 1 dB at 4 ohms. FR 15 Hz-30 KHz at 8 ohms. Distortion: less than 0.8%. Will handle three speaker systems and four tape recorders at same time. Inputs: pickup 2.5 mV ± 3 dB; tape head 2 mV ± 3 dB; aux 150 mV ± 3 dB; tape monitor 200 mV ± 3 dB. H and N (below rated output) volume minimum, better than 80 dB. Damping factor: 15 and 50 at 8 ohms. Psn 100, 117, 220 and 240V, 50 or 60 Hz. Dimensions: $4\frac{1}{2} \times 17\frac{1}{4} \times 14\frac{1}{2}$ in. Weight: 29 lb. Price: £167 15s. 7d. (plus £40s. 5d. PT).



SANYO. Sanyo Marubeni, Sanyo House, Bushey Mill Lane, Watford, Herts. Tel: Watford 25354/6.

★**Sanyo DC-60.** Transistorised stereo integrated tuner/amplifier. Range: 87.5-108 MHz, 186-550 m. Variable tuning. Ratio detector. Meter tuning indicator. Aerial input 300 ohms balanced. Multiplex decoder fitted. AFC. Inputs: PU (crystal) 400 mV 470K, PU (mag) 5 mV 50K, tape head 25 mV 50K, aux 200 mV 100K. Controls: bass ± 8 dB at 100 Hz, treble ± 8 dB at 10 KHz, noise filter -10 dB 10 KHz, rumble filter -10 dB at 50 Hz. Output: 30W RMS per channel. HD $< 1\%$ at rated output. FR 20 Hz-20 KHz ± 1 dB. Output impedance: 4-16 ohms. AC mains. Size: $18 \times 11\frac{1}{2} \times 6$ in. Price: £101 5s. (including PT).

DC-434. Transistorised stereo integrated tuner/amplifier. Range: 88-108 MHz, MW 186-550 m. Variable tuning. Ratio detector. Meter tuning indicator. Aerial input 75 ohms coaxial. Multiplex decoder fitted. AFC. Inputs: PU 5 mV 75K, tape head 2.5 mV 85K, aux 100 mV 90K, tape play 250 mV 150K. Controls: bass ± 12 dB at 100 Hz, treble ± 12 dB at 10 KHz, noise filter, rumble filter, loudness, separate controls for each channel. Output: 16W RMS per channel. HD 0.5% at total output. FR 20 Hz-20 KHz ± 1 dB. Output impedance: 8 ohms. AC mains. Fitted transcription motor, pickup arm and cartridge. Size: $24\frac{1}{2} \times 16 \times 11\frac{3}{4}$ in. Price: £175 15s. (including PT).

Sanyo DC-534. Transistorised stereo integrated tuner/amplifier. Range: VHF 87.5-108 MHz, MW 186-550 m, variable tuning. Ratio detector. Meter tuning indicator. Aerial input 75 ohms coaxial. Multiplex decoder fitted. AFC. Inputs: PU 5 mV 50K, tape head 3 mV 50K, tape play 1V 1K. Controls: bass ± 10 dB at 100 Hz, treble $+10$ dB at 10 KHz, noise filter -10 dB at 9 KHz, rumble filter -10 dB at 60 Hz. Output: 12W RMS per channel. FR 20 Hz-20 KHz ± 1 dB. Output impedance 8 ohms. Includes transcription motor, pickup arm and cartridge. Price: £135 15s. (including PT).

★

SCOTT. Distributor: A.C. Farnell Ltd., Consumer Division, Farnell House, 81 Kirkstall Road, Leeds LS3 1HR. Tel: Leeds 35111.

344-C. Solid state with multiplex decoder. FM front end: FET. Sensitivity: 1.9 μ V. Tuner stereo separation: 36 dB. S/N ratio: 65 dB. Dual loudness control. Computer type push button switches. Five pairs of external stereo inputs. Pickup sensitivity: 4 and 8 mV. Stereo mike front panel input jacks. Inter-station muting. Loudness volume compensation switch. Mono/stereo and stereo balance switches. Power

output: 32W per channel at 8 ohms. Distortion: 0.8% FR 15 Hz-30 KHz ± 1 dB. H and N -55 dB. Price: to be announced.

342-C. Solid state with multiplex decoder. FM front end: FET. Sensitivity: 1.9 μ V. Tuner stereo separation: 40 dB. S/N ratio: 60 dB. Crystal filter. Balance control. Computer type push button switches. Four pairs of external stereo inputs. Pickup sensitivity: 4 mV. Chassis stereo threshold control. Inter-station muting. Loudness volume compensation switch. Power output: 28W per channel RMS at 8 ohms. Distortion: 0.8%. FR 20 Hz-20 KHz ± 1 dB. H and N -55 dB. Price to be announced.

382-C. Solid state, with multiplex decoder. AM and FM front end: FET. Sensitivity: 1.9 μ V. Tuner stereo separation: 40 dB. S/N ratio: 60 dB. Crystal filter. Wide range AM. Balance control. Computer type push button switches. Four pairs of external stereo inputs. Pickup sensitivity: 4 mV. Chassis stereo threshold control. Inter-station muting. Loudness volume compensation switch. Power output: 28W per channel at 8 ohms. Distortion: 0.8%. FR 20 Hz-20 KHz ± 1 dB. H and N -55 dB. Price to be announced.

★

SONY (U.K.) LTD., 11 Ascot Road, Bedfont, Middx. Tel: Ashford 50021.

STR-6040. Stereo. HD $< 0.5\%$ of rated output. FR 20 Hz-50 KHz. 4, 8, 16 ohms output 15W per channel. Psn 100, 117, 220, 240V 50/60 Hz. Range 87-108 MHz, 195-550 m. Tuning meter. 2 μ V input/20 dB quieting. Multiplex decoder. Tape, pickup, and auxiliary inputs. Size: $15\frac{3}{8} \times 5\frac{1}{8} \times 12\frac{1}{4}$ in. Price: £90 4s. 6d. (plus £22 5s. 6d. PT).

STR-6050. Stereo. HD $< 0.2\%$ of rated output. FR 20 Hz-50 KHz. 4, 8, 16 ohms output, 30W per channel. Psn 100, 117, 220, 240V 50/60 Hz, 220W. Range 87-108 MHz, 195-550 metres. Tuning meter. 2 μ V input/20 dB quieting. Multiplex decoder. Tape, phono, and auxiliary inputs. Size: $17\frac{7}{8} \times 5\frac{1}{8} \times 13\frac{3}{8}$ in. Price: £117 13s. 4d. (plus £28 18s. 8d PT).

STR-6060. Stereo. HD $< 0.2\%$ of rated output. FR 20 Hz-60 KHz. 4, 8, or 16 ohms, 45W per channel. Psn 100, 110, 220, 240V 50/60 Hz. Range 87-108 MHz, 195-550 m. Tuning meter. 1.8 μ V input/20 dB quieting. Multiplex decoder. Tape, tape head, pickup and auxiliary inputs. Size: $17\frac{7}{8} \times 5\frac{1}{8} \times 13\frac{3}{8}$ in. Price: £150 16s. (plus £37 5s. 6d. PT).

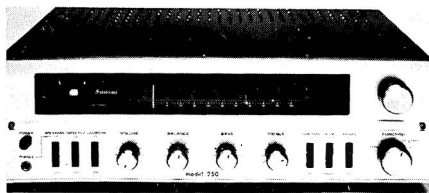

Sansui 250

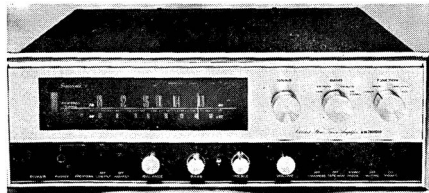

Sansui 3000

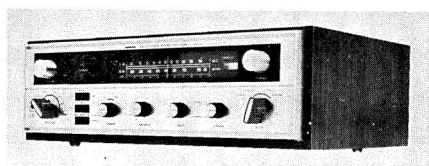

Sanyo DC-60

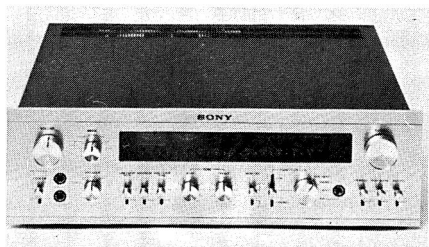

Sony STR6120

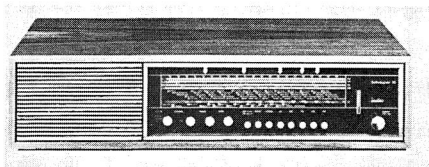

Farnell-Tandberg Solvsuper 10 (SS1070)

★**STR-6120.** Integrated stereo tuner amplifier. Wavebands: FM 87-108 MHz 187-565 m (MW). Power output: 50W RMS per channel into 8 ohms. HD <0.2% at 50W RMS. FR 15 Hz-120 KHz ± 0.5 dB. H and N 70 dB below 50W RMS on PU. Sensitivities: FM 1.5 μ V, MW 20 μ V. Aerial impedance 300 ohms balanced. Multiplex decoder. AFC. Tuning: variable. Features: FET devices in RF unit and crystal filters. Inter-station quieting. Psn 100-117V 60 Hz or 220 240V 50 Hz. Dimensions: 19 \times 16 \times 15 $\frac{7}{8}$ in. Price: £323 10s. 6d. (plus £63 10s. 6d. PT).



TANDBERG. Distributor: Farnell-Tandberg Ltd., Hereford House, Vicar Lane, Leeds, LS2 7NS. Tel: Leeds 39834.

★**Solvsuper 1070.** Stereo AM/FM hybrid. Range: 87.5-104 MHz, 857-2,000 m, 186-590 m, 51.3-186 m, 13-51.3 m. AFC on FM. FR 30 Hz-20 KHz -3 dB. Output power: 8W. Bass and treble controls. Crystal or ceramic input. Eight push buttons for tuning. Speaker selector switch. Psn 240V, 50 Hz, 48W. Finish: teak. Dimensions: 5 $\frac{1}{4}$ \times 21 $\frac{1}{2}$ \times 9 in. Price: £61 (inc. PT).

★**Solvsuper 1071.** Stereo. Identical to the 1070, but does not contain loudspeakers. Dimensions: 5 $\frac{1}{4}$ \times 14 $\frac{3}{4}$ \times 8 $\frac{11}{16}$ in. Price: £76 (inc. PT). Optional extra: Tandberg decoder, £9.

Solvsuper 1072. Stereo. Range: 87.5-104 MHz, 857-2,000 m, 186-590 m, 51.3-186 m, 13-51.3 m. Power output: 6W per channel. Provision for magnetic or crystal cartridges. Two built-in loudspeakers in special pressure chambers. Tape input. Extension loudspeaker sockets. Finish: teak. Dimensions: 5 $\frac{1}{4}$ \times 21 $\frac{3}{4}$ \times 9 in. Price: £83 (inc. PT). FM multiplex decoder optional, £9.

Huldra 9 De-Luxe. Stereo AM/FM. Range: 87.5-108 MHz, 10.9-27.3 m, 27.3-66.5 m, 66.5-187 m, 187-580 m, 1,000-2,000 m. Separate tuning for AM and FM. Band spread on SW3. Interference filter 9 KHz on AM. Built-in ferrite aerial. AFC on FM. Push button selection on FM for five preset stations. Multiplex decoder. FM aerial: 300 ohms and 75 ohms. Speaker selector switch has six positions. Crystal, ceramic or magnetic cartridge inputs, equalized to RIAA. Tape replay and record. Psn 240V, 50 Hz, 77W. Power output: 15W per channel RMS. Crosstalk with stereo decoder at 1 KHz, better than 35 dB. Stereo headphone socket, 8 ohms. HD less than 1%. FR 30 Hz-30 KHz.

Hum — 83 dB. Signal-to-noise ratio from magnetic pickup, better than 70 dB. Dimensions: $5\frac{1}{2} \times 21\frac{1}{4} \times 10\frac{3}{8}$ in. Finish: teak or rosewood. Price: £138 10s. (inc. PT).



TELEFUNKEN. Distributor: A.E.G. (Great Britain) Ltd., Lonsdale Chambers, 27 Chancery Lane, London, W.C.2. Tel: 01-242 9944. Cables: Allgem, London.

★ **Operette Hi-Fi.** Stereo. FM: 87.6-104 MHz; 860-2,000 m, 184-580 m, 18-51 m. 24 transistors, 16 diodes. Bass and treble controls, balance control. Sensitivity: FM 1.3 μ V (for 25 dB S/N and 40 KHz deviation); AM 10 μ V for 50 mV of output power. 15W output per channel. FR 35 Hz-20 KHz ± 1.5 dB. Swivel mounted ferrite rod aerial for MW and LW. Auxiliary aerial for FM and SW. Sockets for PU, recorder, aerial, and earth. Price: to be announced.

★ **201 Concertino Hi-Fi.** Stereo. 15W per channel. HD 1%. FR 20 Hz-20 KHz ± 1 dB. Output impedance 4 ohms. Psn 110/240V. Inputs: PU 25 mV sensitivity, recorder 25 mV sensitivity. Amplifier controls: balance, treble, bass, volume. Ranges: VHF 87.5-104 MHz. MW 184-580 m, LW 860-2,000 m, SW 51-18.7 metres. Flywheel tuning and five preset FM. Ratio detector. Tuner sensitivity 1 μ V for 26 dB. Aerial: balanced 240 ohms. Multiplex decoder. AFC. Frequency meter, stereo indicator, signal strength meter. Earphone socket. Size: $24\frac{3}{8} \times 6\frac{3}{4} \times 7\frac{1}{2}$ in. Price: £84 3s. (plus £19 16s. PT).



TRIO. Distributors: B. H. Morris & Co. (Radio) Ltd., 84-88 Nelson Street, Tower Hamlets, London, E.1. Tel: 01-790 4824.

TK-20T. Solid state automatic AM/FM multiplex stereo. Range: FM 88-108 MHz, MW 187-556 m. Sensitivity: (IHF standard): FM 2.5 μ V, AM 10 μ V. FR FM 20 Hz-40 KHz ± 2 dB; amplifier 25 Hz-50 KHz. S/N ratio: 60 dB. HD 0.7% (1 KHz 100% mod). FET 3-gang tuning condenser front end. Automatic stereo/mono silent switching circuit with stereo light indicator. Output: 4, 8, or 16 ohms, 24W RMS (0.5% THD). Inputs: PU 2 mV, aux 140 mV, tape play 140 mV. Damping factor: 20. High filter: 6 KHz roll-off. Bass control: ± 10 dB at 100 Hz. Treble: ± 10 dB at 10 KHz. Psn 110, 120, 220-230V. Consumption: 60W at full

power. Circuit breaker protects power transistors. Finish: walnut. Dimensions: $4\frac{3}{4} \times 14\frac{3}{8} \times 11\frac{1}{4}$ in. Weight: 15 $\frac{1}{2}$ lb. Price: £85 (inc. PT).

TK-40LT. Solid state FET stereo. Range: FM 88-108 MHz, LW 860-2,000 m, MW 187-556 m. Multiplex decoder with automatic stereo/mono silent switching circuit with stereo light indicator. Variable tuning with illuminated meter. Sensitivity (IHF): FM 2.5 μ V; MW 10 μ V; LW 20 μ V. FR: FM 20 Hz-20 KHz ± 2 dB; amplifier 20 Hz-50 KHz. S/N ratio: 60 dB. Output: 4, 8 and 16 ohms; 32W total RMS (0.5% THD). Inputs: PU 2 mV; aux 150 mV, tape 150 mV. Damping factor: 20. Noise filter: 6 KHz roll-off. Bass control: ± 10 dB at 50 Hz. Treble control: ± 10 dB at 10 KHz. Psn 220-230V 50 or 60 Hz. Dimensions: $5 \times 16\frac{1}{2} \times 12$ in. Weight: 19.8 lb. Price: £110 (inc. PT).

TK-66T. Solid state automatic AM/FM multiplex stereo. Range: FM 88-108 MHz, MW 187-556 m. Tuning meter. Sensitivity (IHF standard): FM 2 μ V; AM 10 μ V. FR: FM 20 Hz-20 KHz ± 2 dB; amplifier 20 Hz-50 KHz ± 1 dB. S/N ratio: 60 dB. FET 4-gang tuning front end. Automatic FM stereo/mono silent switching circuit with stereo light indicator. Output: 4, 8 and 16 ohms. 20W RMS per channel (0.9% HD). Inputs: PU 2 mV; tape head 2.5 mV; aux 150 mV; tape 150 mV. Damping factor: 23 at 8 ohms. Low filter: 80 Hz roll-off. High filter: 6 KHz roll-off. Bass control: ± 10 dB at 50 KHz. Treble control ± 10 dB at 10 KHz. Psn 110, 120, 220-230V, 50 or 60 Hz; 90W at full power. Dimensions: $5\frac{1}{2} \times 16\frac{1}{2} \times 12$ in. Weight: 23 lb. Price: £122 (inc. PT).

TK-140X. Solid state stereo. Range: FM 88-108 MHz, MW 187-556 m. Sensitivity (IHF): FM 1.7 μ V; AM 15 μ V at 1 KHz. HD: 0.5% at 400 Hz 100% mod. S/N ratio: better than 65 dB. Four ICs IF circuit, three FETs, 4-gang tuning condenser front end. Inter-station muting circuit. Heavy flywheel tuning dial. Tuning meter with stereo indicator. Aerial: 300 ohms and 75 ohms. Power transistor protection circuit. Low and high filters. Power consumption: 250W at full power, 34W at no signal. Output: 4, 8 and 16 ohms, 53W RMS per channel at 8 ohms. Inputs: magnetic pickup 2 mV; tape head 2.2 mV; aux 160 mV; tape (pin or DIN) 160 mV; main 100 mV. H and N: pickup 65 dB, tape head 63 dB. aux and tape 75 dB. Damping factor: 28 at 8 ohms. Bass control: ± 10 dB at 100 Hz. Treble control: ± 10 dB at 10 KHz. High filter: 3 KHz cut-off. Low filter: 200 Hz cut-off. Loudness control: +6 dB at 100 Hz. Outputs: two pairs of speaker terminals, centre

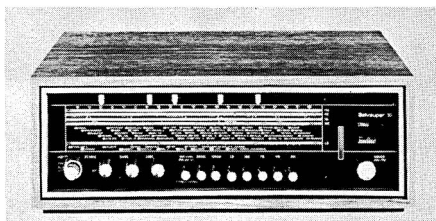

Tandberg-Farnell SS1071

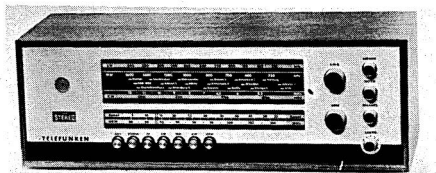

Telefunken Operette

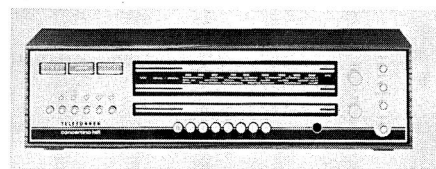

Telefunken 201

channel output (low level), pre-amp, tape recording, headphone jack, AC outlet. Dimensions: $5\frac{1}{2} \times 16\frac{1}{2} \times 12\frac{1}{4}$ in. Weight: $28\frac{1}{2}$ lb. Price: £172 (inc. PT).



WIEN-TOKAI. Distributors: H. O. Thomas

Electronics Ltd., 26-27 Avenue Chambers, Vernon Place, London, W.C.1. Tel: 01-405 9569.

FMX18. AM/FM stereo. Range: FM 88-108 MHz, MW 187-561 m. Variable tuning. Sensitivity: (FM) $40 \mu\text{V}$ for 30 dB quieting, (AM) $400 \mu\text{V}$ for 20 dB quieting. Multiplex decoder fitted. Ferrite rod aerial for AM, provision for external aerials. Output: 5W RMS per channel. Output impedance: 8 ohms. FR 100 Hz-15 KHz ± 2 dB. 18 transistors, 9 diodes, 1 vari-cap. Bass ± 10 dB at 100 Hz. Treble ± 15 dB at 10 KHz. PU input 500 mV. S to N better than 48 dB. Mains: 220-240V AC. Price: £43 1s. (including PT).

FMX23. AM/FM stereo. Range: FM 88-108 MHz, MW 187-561 m. Variable tuning. Sensitivity: (FM) $4 \mu\text{V}$ for 30 dB quieting, (AM) $300 \mu\text{V}$ for 20 dB quieting. Multiplex decoder fitted. Automatic stereo beacon. Output: 14W RMS per channel into 8 ohms. Output impedance 8 ohms. FR 30 Hz-20 KHz ± 1 dB. 23 transistors, 10 diodes, 1 vari-cap. Ferrite rod for AM. Provision for external aerials. Bass +15 dB - 12 dB at 100 Hz, treble +15dB - 12 dB at 10 KHz. PU input (mag) 4 mV, PU input (crystal) 40 mV. S to N better than 62 dB. Mains: 220/240V AC. Price: £64 1s. (including PT).

FMX24. AM/FM stereo. Range: FM 88-108 MHz, MW 187-561 m. Variable tuning. Sensitivity: (FM) $4 \mu\text{V}$ for 30 dB quieting, (AM) $300 \mu\text{V}$ for 20 dB quieting. Multiplex decoder. Tuning meter. Automatic stereo beacon. Output: 24W RMS per channel. FR 50 Hz-20 KHz ± 2 dB. 23 transistors, 10 diodes, 1 vari-cap. Ferrite rod aerial for AM, provision for external aerials. Bass +14 dB - 15 dB at 100 Hz, treble +15 dB - 13 dB at 10KHz. Inputs: PU (mag) 4 mV, PU (crystal) 40 mV, tape 100 mV. S to N better than 62 dB. Mains: 220/240V AC. Price: £74 11s. (including PT).



HENRY'S RADIO LTD.

303-309 EDGWARE ROAD,
LONDON, W.2.

HI-FI DEPT. 309 EDGWARE ROAD, W.2. 01-723 6963
COMPONENTS, ELECTRONIC ORGANS AND
MAIL ORDER: 303 EDGWARE ROAD, W.2. 01-723 1008/9

*** THE BEST IN HIGH FIDELITY EQUIPMENT
COVERING BUDGET STEREO
AND
DE LUXE EQUIPMENT
ON DEMONSTRATION –
ALL AT SPECIAL LOW PRICES.**

*** SEE AND HEAR AND COMPARE INDIVIDUAL
UNITS**

*** DISCOTHEQUE AND PUBLIC ADDRESS
EQUIPMENT**

*** TWO DEMONSTRATION ROOMS –
SUGGESTED SYSTEMS TO COVER ALL
PRICE RANGES**



Audio and High Fidelity Catalogue

- * 120 FULLY DETAILED AND ILLUSTRATED PAGES
COVERING ALL ASPECTS OF AUDIO AND HIGH FIDELITY
- * NEW LOW INDIVIDUAL PRICES
- * EXTRA SYSTEM DISCOUNTS
- * FREE 12/6 PURCHASE VOUCHER

SHOP HOURS: MONDAY TO FRIDAY 9 am to 6 pm.
THURSDAY 9 am to 1 pm. SATURDAY 9 am to 6 pm.

PRICE
5/-
p.p.1/-

(Each Catalogue includes
one 12/6 Extra Discount
Voucher for use with
purchases above £10).

Two **NEW** Tuner amplifiers from **Armstrong**

Here they are. The tuner amplifiers everyone has been waiting for, completing the Armstrong Series 500.

You already know about the 521 Amplifier hailed by press, trade and public for both its technical and musical performance. You also know about the 523 and 524 AM-FM and FM Tuners, already established as leaders in their field and chosen by many famous names for use in relay, public address, language laboratory and continuous music systems where performance, stability and reliability are absolutely crucial.

Put them together and what have you got? the 526 Tuner amplifier, shown below, which combines the circuitry and features of the 521 Amplifier and the 523 AM-FM Tuner and what a formidable combination this is. Fifty watts of audio power, all the facilities expected in a top class amplifier, stereo and mono FM, coverage of the medium and long wavebands, and all backed up by the best after sales service available. If there is a better buy we don't know of it; as a technical reviewer in the October 1968 Hi Fi News wrote of its predecessor, the 426: "Better tuner amplifiers there may well be, but there are none to my knowledge in this price range".

The 525 Tuner amplifier is identical to the 526 except that it does not include the medium and long wavebands. In other words, it is a combination of the 521 Amplifier and the 524 Tuner.

Both models come complete with teak veneered case for which there is no extra charge.

Yes, indeed. Here they are. Two great new models from Armstrong, the acknowledged leader in the manufacture of tuner amplifiers in Great Britain.

Armstrong Series 500 recommended retail prices:

521	Stereo Amplifier	£52 0 0	525	FM Tuner amplifier	£87 16 9
523	AM-FM Tuner	£52 9 0	526	AM-FM Tuner amplifier	£98 15 6
524	FM Tuner	£40 4 6	M8	Stereo Radio Decoder	£9 10 0

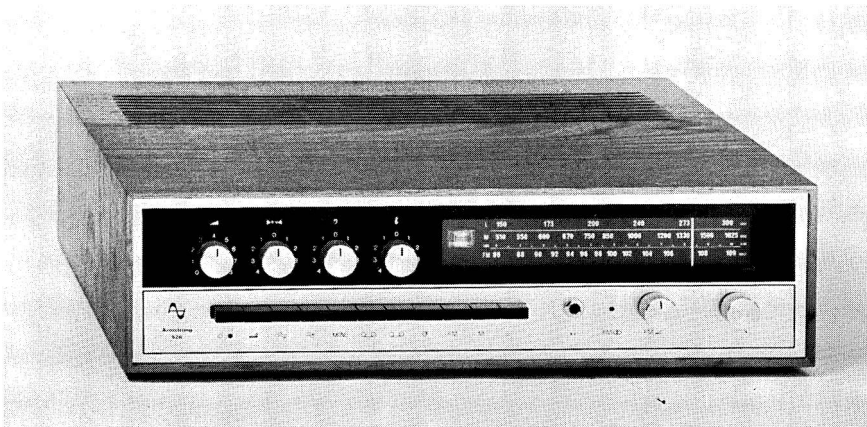

Armstrong Audio Limited, Walthers Road, London N7

telephone 01-607 3213

Grampian for sound ***sound equipment***

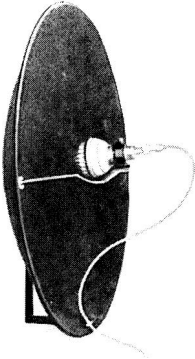

Grampian Parabolic reflector

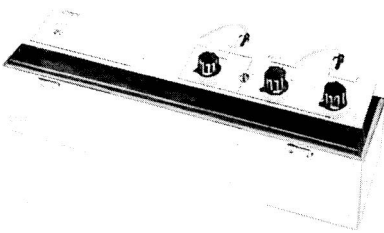

Grampian reverberation unit

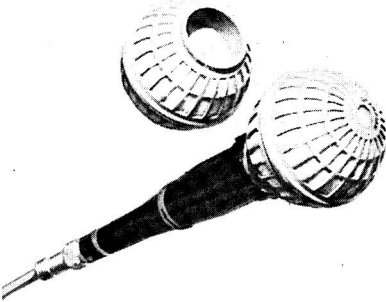

Grampian DP4 and windshield

The Grampian range of products has been thought out, and added to, over a period of 34 years to meet and keep pace with the needs of sound recording. They are in use in their tens of thousands, all over the world, in film and broadcast studios, by reporters and serious tape enthusiasts, in industrial plants, airports, etc. etc.—in fact in all circumstances where *sound* sound equipment is essential. They are robust, efficient and offer the best price for quality and value. Details of many Grampian products will be found in the directory sections of this book, but we shall be pleased to send illustrated literature on request.

**GRAMPIAN REPRODUCERS LTD.,
HANWORTH TRADING ESTATE, FELTHAM, MIDDLESEX.
Telephone: 01-894-9141 Telegrams: Reamp, Feltham.**

stereo "70"

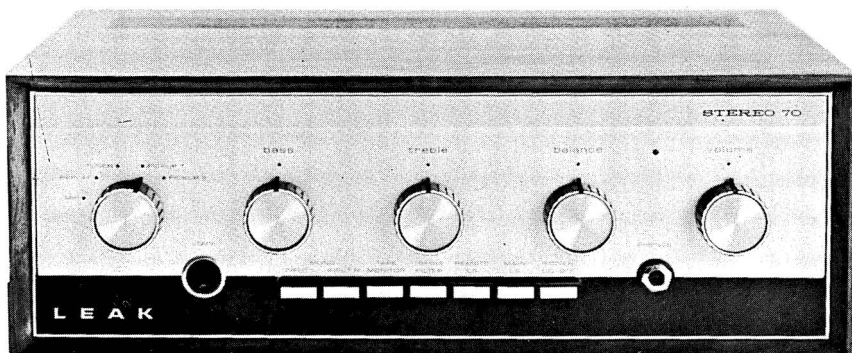

Chassis model E63.0.0
In teak case £69.10.0

The new big gun from Leak. The amplifier in which distortion dies of fright. The Leak Stereo 70 will thrill you with the clearest, most exciting sound ever reproduced by an amplifier.

It is full of latent power—up to 35 watts r.m.s. per channel. This is not power for power's sake, (though there may be times when you'll need it) but rather the means to perfect reproduction. In addition, this extra output enables a pair of loudspeakers to be connected

apart from the two in the main listening room. Other brand-new features are a stereo headphone socket for personal listening as an alternative to loudspeakers, a DIN record/replay socket for a portable tape recorder and facilities for the use of twopick-ups with front panel selection.

All this, backed by the famous Leak craftsmanship and reliability makes the Stereo 70 the most technically advanced amplifier available.

And it sounds it.

LEAK 

H. J. Leak & Co. Ltd., Brunel Road,
London, W3. Tel: 01-743 1173.

thoroughbreds

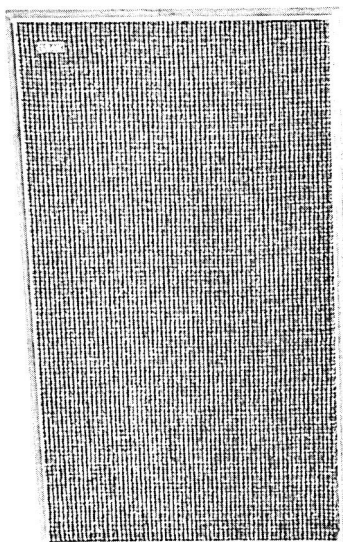

Sandwich
Loudspeaker
£43.10.0
Size 26" x 15" x 12"

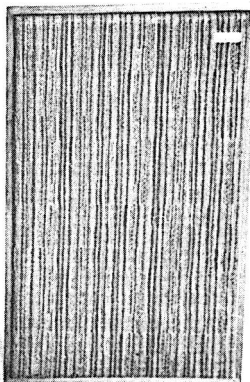

Mini-Sandwich
Loudspeaker
£29.15.0
Size 18½" x 11" x 7"

These two beauties are capable of reproducing any sound fed into them...faithfully and to perfection. The secret is the light and rigid cones, constructed from two skins of aluminium separated by expanded polystyrene. These rigid piston-action cones give a smooth response over the entire audio frequency range and are totally free

from mechanical breakup and associated distortion. The cabinets are designed to blend harmoniously into any room setting, and are available in teak, walnut or mahogany. For those with limited space, Leak have developed the Mini-Sandwich Loudspeaker, which is manufactured to the same exacting standards as its big brother.





7 1/2
3 1/2

1-4 B
STEREO B
3-2 P

THREE HEADS | ONE MICRON HEAD

TAPE

SOURCE MONITOR

LEFT

RECORD LEVEL

VU

RIGHT

MONO

RECORD LEVEL

REC

STOP

SOLID STATE



Introducing the Akai 4000D with new one-micron head.

Result: Another 2000Hz at $3\frac{3}{4}$ I.P.S.

This impressive increase in frequency response from 14000Hz at $3\frac{3}{4}$ i.p.s. on the previous 3000D model to 16000Hz on the new 4000D is a direct result of the new one micron gap head.

Of the 3000D, the reviewers in the March

68 edition of Tape Recording Magazine said: 'It can claim to achieve a standard of technical performance far in excess of that indicated by its price.'

All of which makes the new Akai 4000D even better value at

£87.10.0 (recommended), and almost certainly the best tape deck in Britain for under £100. And don't forget the 4000D is just one of Akai's range—the most comprehensive range of tape recorders in Britain.

PERFORMANCE SPECIFICATIONS

TAPE SPEED	2 speeds... 3.3/4 and 7.1/2 ips
WOW AND FLUTTER	Less than 0.15% RMS at 7.1/2 ips Less than .20% RMS at 3.3/4 ips
FREQUENCY RESPONSE	30 to 22,000 Hz : 3db at 7.1/2 ips 30 to 16,000 Hz : 3db at 3.3/4 ips
SIGNAL TO NOISE RATIO	Better than 50db
LEVEL INDICATOR	2 VU meters.
RECORDING SYSTEM	4 track stereo/monaural system
FORWARD/REWIND TIME	150 seconds using 1,200 foot tape at 50 cycles

SPECIAL FEATURE

3 heads for off-the-tape monitoring. Plus sound-on-sound recording.



AKAI®



For further details, write to:

AUDIO PRODUCTS

PULLIN PHOTOGRAPHIC-RANK ALDIS

P.O. Box 70,

Great West Road, Brentford, Middx.



PEAK SOUND

*high-quality
modules
economically
priced*

AMPLIFIERS

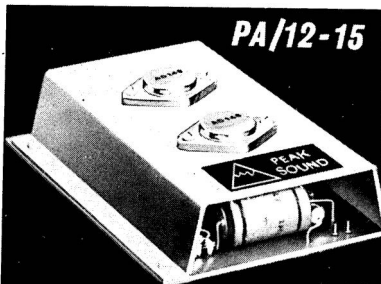

PA. 12/15 Power Amplifier in kit or built form. 12 watts R.M.S. into 15 ohms. SLU. 400 Pre-amp. and tone control unit 15 gns. PA. 25/15 Power Amplifier delivering 25 watts into 15 ohms. Stereo 10-10 Economy stereo amplifier. ENGLEFIELD Stereo amp. Leaflets on request.

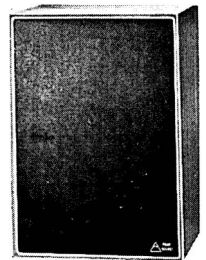

MODULES FOR TUNERS SPEAKERS ETC.

Modules for building the "Wireless World" Baxandall speaker design. Front end modules (two types) for FM tuners, also IF strip and decoder. Power pack units for driving Peak Sound assemblies. Leaflets on request.

"CIR-KIT" the world's most versatile circuit building system. Special adhesive copper strip which enables you to work swiftly, accurately and economically. In 50' spools, $\frac{1}{16}$ " wide—2/-.

**PEAK SOUND MODULES HAVE BEEN SPECIFIED FOR DESIGN
IN WIRELESS WORLD, HI-FI NEWS, PRACTICAL WIRELESS,
PRACTICAL ELECTRONICS.**

AVAILABLE FROM YOUR DEALER OR DIRECT IN CASE OF DIFFICULTY.

peak sound

PEAK SOUND (HARROW) LTD., 32, ST. JUDE'S ROAD, ENGLEFIELD GREEN, EGHAM, SURREY
Telephone: EGHAM 5316

£ 39 $\frac{1}{2}$ Gns Recommended Retail Price,
Inc. P.T.

sells the latest Videorama Stereo 88 Separates

Distributed through Selected Master Wholesalers



Take a good, hard look at the Videorama Stereo 88 . . . it could be Britain's biggest selling Audio Separates Representing a major price breakthrough in the field of Stereo Separates.

The Videorama Stereo 88 is elegantly styled in selected Tola/Teak Veneers. What's more, it isn't just a good looker . . . we've spent time designing a modular Solid State Stereo Amplifier to give a very useful 4 watts output per channel. This, plus the Garrard 1025 Autochange unit and a high gain Stereo Cartridge ensures a most acceptable quality of Sound Reproduction.

The Videorama Stereo 88 comes as a complete outfit with two matched speaker enclosures and plastic dust protector. (Not Illustrated).

Videorama Ltd International House Garden Street Stafford

Tel: 3940

amplify (am-pli-fi) *r.t.* to extend;
to enlarge:— **amplification** *n.*
—**amplifier** *n.* an apparatus which
increases the volume of sound.



**THE LUX
AMPLIFIER**
*more than
fulfills the
definition*

If you are considering the purchase of a Hi-Fidelity System visit your local dealer to hear the Lux range. This manufacturer is a major supplier of Audio equipment to the Japanese Broadcasting Corporation and the exacting standards required are reflected in their products. Comprehensive literature incorporating full technical data is yours for the asking from any good Hi-Fidelity dealer or direct from Shiro (U.K.) Ltd.

Take any AUDIO-TECHNICA cartridge...

... and you take an important step towards perfection in stereo reproduction

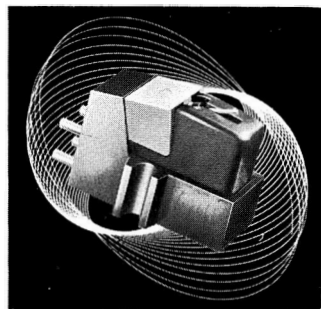





AUDIO-TECHNICA

**moving magnet
stereo cartridges
are good ... very good**



The Audio-Technica is an outstanding stereophonic cartridge featuring a series of unique concepts which are considered to be the key to good performance in high fidelity cartridges. Among its many features is the fact that stylus replacement is extremely simple. It provides superb frequency response and extremely low cross-talk, while due to its light mass and high compliance, perfect tracking is maintained even at very low stylus pressure.

				
Model	AT.66	AT.33	AT.21	AT.35
Frequency Response ± 2 db Hz.	20-20000	20-20000	20-25000	20-25000
Channel Separation at 1 KHz.	25 db	27 db	30 db	30 db
Output Voltage at 1 KHz, 5 cm/sec.	4 mV	5 mV	4 mV	5 mV
Static Compliance cm/dyne	30 × 10 ⁻⁶	23 × 10 ⁻⁶	30 × 10 ⁻⁶	23 × 10 ⁻⁶
Tracking Force-gms.	0.5-2.0	0.5-2.5	0.5-2.0	0.5-2.5
Tracking Angle	15°	15°	15°	15°

Distributors:

**Shiro (UK) Limited · 8 Bush Lane · Cannon Street · London · EC4
Telephone: 01-626 4711**

Choose Perfection...



PIONEER HEADPHONES

PERFECT STEREO LISTENING — IN PRIVATE. Pioneer Perfection I Perfect stereo listening in private — in comfort! Full volume, dynamic stereo sound all to yourself. Softly cushioned headphones enclose your ears, prevent the intrusion of all external noise. Flexible, padded headband and overall light weight, ensures comfort for hours of listening. If your equipment is without a headphone socket, we can supply a suitable adaptor.

MODEL SE 30 Recommended retail price 14 gns

MODEL SE 2P Recommended retail price £6.1.4

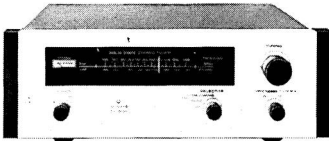

PIONEER TUNER

AM/FM F.E.T. Tuner, 2.5 mV (50 dB S/N) sensitivity, Auto Mono/Stereo switching, Tuning Meter, MPX Noise Filter and Output Level Control.

MODEL TX 500

69½ gns

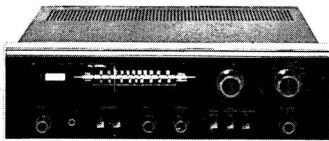

PIONEER RECEIVER

Pioneer Perfection SX 440 all rounder, FET F.M. mono and stereo receiver. In station-crowded areas the SX 440 delivers clear, interference-free reception. Instrumentation panel in lustrous black with power illumination to give crystal clear readings.

MODEL SX 440

93 gns



PIONEER TURNTABLE

Get the best from your records before amplification. 2-Speed 33½/45 4-pole synchronous motor (wow and flutter < .12%, S/N < 40dB), oil-damped tone arm, heavy die-cast 12" turn-table, diamond stylus magnetic cartridge, Walnut cabinet with transparent hinged dust cover.

MODEL PL 11

45½ gns

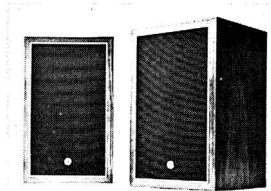

PIONEER SPEAKER

Bookshelf or wall, Bass-Reflex Speaker. 6½" bass, 2½" treble units, FR 45 — 20,000 Hz, 12W R.M.S. H.C. size 13½" H. 8½" W. 8½" D.

MODEL CS 52T

24½ gns

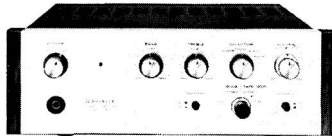

PIONEER AMPLIFIER

Pioneer Perfection SA 500. Stereophonic amplifier with high-accuracy tone control. Fully equipped with speaker outputs, tape recording/playback connector stereo, 4-track mono, loudness contour and stereo headphone jack. Satin-finished instrumentation with rosewood end-trims styled as a matching set with the Pioneer TX 500 tuner.

MODEL SA 500

52 gns

MODEL SA 700

87 gns



PIONEER®

Perfection

SWISSTONE LTD., Sole Distributors SHRIRO (UK) LTD HI FI DIVISION 8 BUSH LANE, LONDON, EC4
SHOWROOM: 100 COOMBE LANE, LONDON, S.W.20 • DEALER ENQUIRIES INVITED.

Now, in one masterful stroke, Zenith obsoletes all would-be imitations with the most ingenious integration of power, sensitivity, and tuning versatility ever designed into the world's most famous multi-band portable radio!



Introducing the new Royal 7000 Zenith Trans-Oceanic in a new design, with a new chassis...with more bands, more features for finer performance than ever before!

Receives Medium Broadcast, FM, European Longwave... Marine, Weather, Ship-to-Ship and Ship-to-Shore, Time Signals... Amateur, CW and SSB signals...plus the new VHF crystal-controlled Weather Band. Tunes bandspread on the most popular 31, 25, 19, 16 and 13 meter International Shortwave Bands!

Also new in the Royal 7000 Trans-Oceanic are a Beat Frequency Oscillator, a "Norm-Sharp" IF switch, and an Automatic Gain Control that can be manually adjusted for navigational direction finding.

New, too, in this radionic marvel by which all other multi-band portables are judged, are a plug-in earphone, tuning meter, battery level indicator, azimuth bearing indicator, tilt-out chart light, a logging scale with adjustable hairline for most accurate indexing, and a tuner output jack.

In addition, a built-in AC power supply lets you operate the new Royal 7000 Trans-Oceanic on either 115V or 230V AC current with batteries automatically disconnected.

Stop in, see for yourself, and test-listen. Or write, if you prefer, for a complete description and the name of your nearest Zenith representative.

all-new
Zenith
TRANS-OCEANIC®
Royal 7000



Rugged new cabinet of diecast zinc in Ebony color, high impact Cyclocac® with padded vinyl sides. 9-3/8" high; 13-3/4" wide; 6-1/4" deep. Model Royal 7000Y

United Mercantile Company, Ltd.
13-14 Queen Street, Mayfair
London, W.1. GROsvenor 4901-3



Zenith Radio Corporation, International Division, Chicago, 60639 U.S.A.
The Royalty of television, stereophonic high fidelity instruments, phonographs, and radios.

Vortexion

THE VORTEXION 50/70 WATT ALL SILICON AMPLIFIER WITH BUILT-IN
4 WAY MIXER USING F.E.T.s.

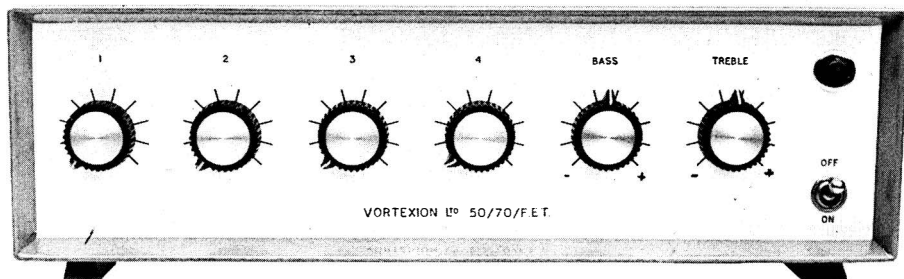

Size 14" × 11" × 4½"

100 μ V on 30/60 ohm mic. input
100 mV to 100 volts on gram/auxiliary
input 100 K Ω

Weight 20lb.

This is a high fidelity amplifier (0.3% intermodulation distortion) using the circuit of our 100% reliable—100 Watt Amplifier (no failures to date) with its elaborate protection against short and overload, etc. To this is allied our latest development of F.E.T. Mixer amplifier, again fully protected against overload and completely free from radio breakthrough. The mixer is arranged for 3-30/60 Ω balanced line microphones, and a high impedance line or gram. input followed by bass and treble controls. Since the unit rectification distortion of ordinary transistors, this unit gives that clean high quality that has tended to be lost with most solid state amplifiers.

CP50 AMPLIFIER. An all silicon transistor 50 watt amplifier for mains and 12 volt battery operation, charging its own battery and automatically going to battery if mains fail. Protected inputs, and overload and short circuit protected outputs for 8 ohms—15 ohms and 100 volt line. Bass and treble controls fitted.

Models available with 1 gram and 2 low mic. inputs. 1 gram and 3 low mic. inputs or 4 low mic. inputs.

100 WATT ALL SILICON AMPLIFIER. A high quality amplifier with 8 ohms—15 ohms and 100 volt line output for A.C. Mains. Protection is given for short and open circuit output over driving and over temperature. Input 0.4 V on 100 K ohms.

ELECTRONIC MIXERS. Various types of mixers available. 3-channel with accuracy within 1 dB Peak Programme Meter. 4-6-8-10 and 12-way mixers. Twin 2,3,4 and 5 channel stereo. Built-in screened supplies. Balanced line mic. input. Outputs: 0.5 V at 20 K or alternative 1 mW at 600 ohms, balanced, unbalanced or floating.

VORTEXION LIMITED, 257-263 The Broadway, Wimbledon, S.W.19

Telephone: 01-542 2814 and 01-542 6242/3/4 Telegrams: "Vortexion London S.W.19"

THE WELBROOK

all silicon intergrated stereo amplifier

INTRODUCING A NEW ALL SILICON TRANSISTORISED HI-FI AMPLIFIER INCORPORATING TWO INDEPENDENT POWER SUPPLIES TO GIVE VERY LOW CROSSTALK AND A **UNIQUE DESIGNED CIRCUIT** WHICH ELIMINATES DISTORTION RISE AT LOW LEVELS. POWER-OUTPUT IS 15 WATTS R.M.S. INTO A $8\ \Omega$ LOAD AND 10 WATTS R.M.S. INTO A $15\ \Omega$ LOAD. INPUT FACILITIES TO COVER ALL TYPES OF PICK-UP, TUNER AND TAPE.

SPECIFICATION AND PERFORMANCE FAR IN EXCESS OF PRICE RANGE. DETAILED ILLUSTRATED LITERATURE AVAILABLE ON REQUEST. TRADE ENQUIRIES INVITED.

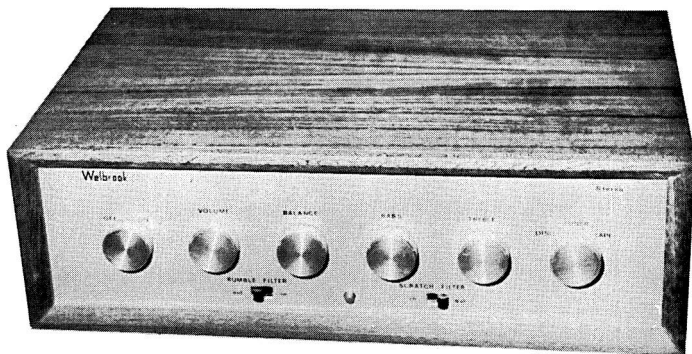

PATENT APPLIED FOR

RECOMMENDED RETAIL PRICE £48

Completely enclosed panel Mounting Teak cabinet £4 extra.

Also available in a lower powered version at a recommended retail price of £42, including teak cabinet.

ALSO AVAILABLE:

Amplifier P.C.B. modules as used in the above amplifier. Built and tested.

MONO AML 103 £8-0-0 STEREO AMP 103 £15-0-0

FERRANTI Hi-Fi Audio design booklet available 5/- each. Complete with WELBROOK price-list.

WELBROOK ENGINEERING ELECTRONICS **LTD**
BROOKS STREET, HIGHER HILLGATE, STOCKPORT,
CHESHIRE. 061-480 4268

Stentorian SPEAKER SYSTEMS

These superb speaker systems make available even higher standards of performance in sound reproduction and uphold the high reputation gained by Whiteley Stentorian speakers throughout the world. Attractively designed and soundly constructed, they are available in either Teak or Rosewood finish.

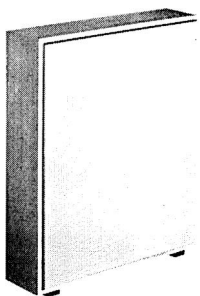

LC 93

A 19" x 12½" x 8½" completely enclosed acoustically loaded cabinet housing a 9" graded melamine paper cone with siliconized cambric suspension giving a frequency response of 60Hz to 20KHz.

LC 94

A 29½" x 23¾" x 6⅛" acoustic Labyrinth enclosure fitted with acoustic resistance in the pipe, using the same highly efficient 9" speaker unit used in the LC 93. Frequency response 45Hz to 20KHz.

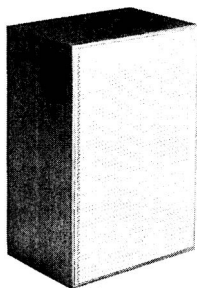

LC 95

The LC 95 Loudspeaker system is an acoustically loaded Bass Reflex cabinet, measuring 31½" x 20¾" x 13½" fitted with two loudspeakers and a crossover network. The bass loudspeaker being used is a newly developed 12" unit having a melamine treated paper cone with a cambric surround. The middle and high frequency unit is a new 8" loudspeaker having a melamine treated paper ribbed cone and surround.

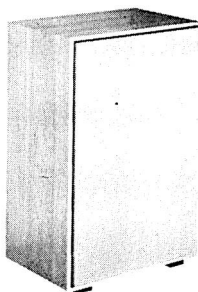

WHITELEY ELECTRICAL RADIO CO. LTD.

MANSFIELD · NOTTS · ENGLAND · Tel: Mansfield 24762

London Office: 109 Kingsway, W.C.2. Tel: HOLborn 3074

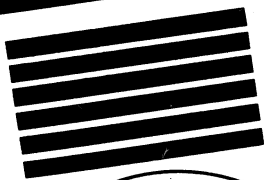

**YOUR
FIRST
CHOICE**

**Hi-Fi Amplifiers,
Tuners, Speakers,
Microphones,
Accessories,
Components, Intercoms,
Test Equipment.**

The finest range of Equipment
available today -

**See them at your usual dealer
or write for Eagle Catalogue to**

B. ADLER & SONS (RADIO) LTD

Coptic Street, London, W.C.1.

Telephone: 01-636 9606/7

DIRECTORY OF AMPLIFIERS & CONTROL UNITS

The following abbreviations are used in this directory section: **HD**=Harmonic Distortion; <=less than; **H** and **N**=Hum and Noise; **Pat**=Power supplies available for tuner; **RMS**=root mean square; **NL**=Noise level; **Sel**=Selector switch; **Psn**=Power supply needed; ★ indicates model is illustrated.

ACOUSTICAL MFG. CO. LTD. See Quad.

★

AKAI. U.K. distributors. Pullin Photographic (Rank Organization), P.O. Box 70, Great West Road, Brentford, Middx. Tel: 01-568 9222.

★ **Akai 5000S.** Solid state stereo amplifier. Power output: 35W per channel RMS, 8 ohms HD 1%. FR 20 Hz-35 KHz ± 1 dB. Psn: 100-240V, 50 or 60 Hz, 160VA. Inputs: tape head, 1.5 mV; pickup 3 mV; aux, tape monitor and tuner, each 400 mV. Controls: bass +10 dB; treble +9 dB to -14 dB; low filter -8 dB; high filter -8 dB; loudness +8 dB. Dimensions: $17 \times 5\frac{3}{8} \times 10\frac{3}{8}$ in. Price: £85.

★

A/R/D. Audio Research and Development Ltd., P.O. Box 73, Hounslow, Middlesex. Tel: 01-570 0471.

★ **2000.** Solid state stereo amplifier. Power output: 10W RMS into 15 ohms. HD: 0.4% at 10W RMS. FR: 20 Hz-20 KHz ± 0.5 dB. Controls: bass ± 12 dB at 50 Hz; treble ± 12 dB at 10 KHz; volume, balance. Push-buttons for on/off, radio tape record. Inputs: PU sockets with DIN duplicates for tape and radio; tape record, tape play, radio tuner, ceramic pickup, magnetic pickup, with RIAA equalisation. Psn: 190/255V 50 Hz or 110-120V 60 Hz. Dimensions: $7 \times 4\frac{1}{4} \times 12$ in. Price on request.

★

ARENA. Distributed by: Highgate Acoustics Ltd., 184-188 Great Portland Street, London. W.1. Tel: 01-636 2901.

★ **Arena F210.** Transistorised integrated stereo amplifier. Inputs: PU 0.3 mV 50K, PU 35 mV 500K, radio 1.2 mV 18K, tape 14 mV 200K. Controls: balance ± 6 dB, volume, bass ± 10 dB at 100 Hz, treble ± 15 dB at 10 KHz, selector. Output: 10W RMS per channel. Output im-

pedance 4 ohms. Size: $10\frac{1}{2} \times 2\frac{7}{8} \times 7\frac{3}{4}$ in. Module construction. Price: £36 15s.

★

ARMSTRONG AUDIO LTD., Warlters Road, London, N.7. Tel: 01-607 3213.

★ **Model 521.** Integrated stereo transistor amplifier. Inputs: PU(1) 60 mV 100K, PU(2) 3.5 mV 50K, radio 100 mV 100K, tape play 400 mV 100K. Noise level: PU -55 dB, radio -60 dB, tape -70 dB. Controls: balance (maximum to zero each channel), bass ± 10 dB, treble ± 10 dB, loudness (two different volume levels with loudness contours at low level), rumble filter -5 dB at 30 Hz, treble filter(1) 6.5 KHz -3 dB, 10 KHz -25 dB, treble filter(2) 4.5 KHz -3 dB, 9 KHz -40 dB. Output: 25W RMS per channel. Output impedance: 4-16 ohms. Output transistors: AL102. FR 20 Hz-20 KHz -1 dB at 25W RMS. Mains: 100-125V and 200-250V AC. Size: $11\frac{1}{2}$ in. wide, $10\frac{3}{4}$ in. deep, $4\frac{5}{8}$ in. high. Price: £52.

★

ASTRONIC. Associated Electronic Engineers Ltd., Dalston Gardens, Stanmore, Middlesex. Tel: 01-907 4474.

Series 1700. Modular amplifying equipment, enables a special system to be built up from standard units.

Type 1701. Basic 10W amplifier with 8 ohms output. Source impedance: 1 ohm. Inputs: impedance 1,000 ohms; sensitivity: 0.5V. FR: 40 Hz-40 KHz +1 dB, 40 Hz-12 KHz +2 dB. Noise: -75 dB. Distortion: 1%. Psn: 200-250V 40-60 Hz, 30VA. Dimensions: $5 \times 7 \times 6\frac{1}{2}$ in. Weight: 7 lb. Input connections by single coax plug/socket. Output connection by terminal block. Price: £16 13s. 4d.

Various types of pre-amplifier modules available. Full details on request.



Akai AA-5000

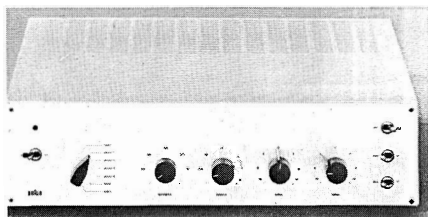

Braun CSV13/60 integrated stereo amplifier

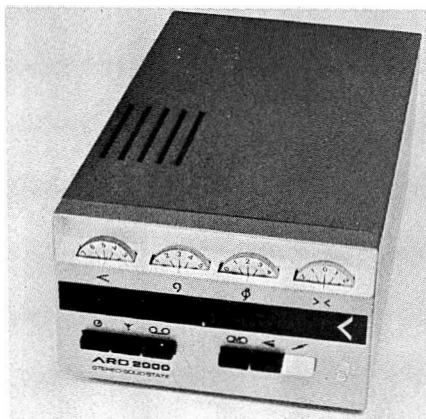

ARD 2000

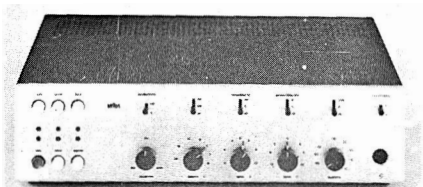

Braun CSV1000 integrated stereo amplifier

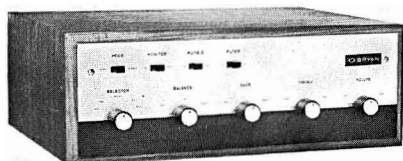

Bryan 9000

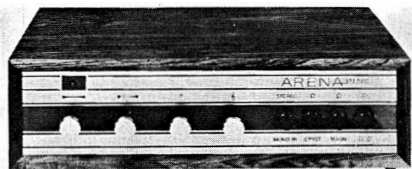

Arena F210

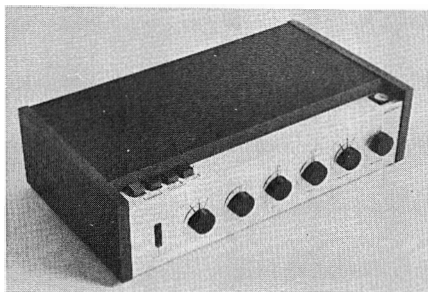

Bush A746

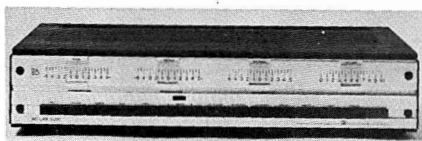

Bang & Olufsen Beolab 5000



Armstrong Audio 521



Cambridge Audio P80

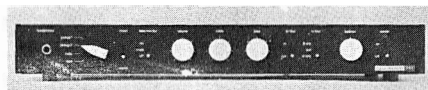

Cambridge Audio P40

BANG & OLUFSEN (UK) LTD., Eastbrook Road, Gloucester. Tel: Gloucester 21591.

★ **Beolab 5000.** Integrated stereo amplifier. 60W per channel. 4 ohms. HD 0.2% at 1 KHz, 0.6% at 20 Hz-20 KHz 60W. FR 20 Hz-20 KHz ± 1.5 dB. Noise 90 dB below 60W with volume control at minimum. Four 2N3055 output transistors. Inputs: mic 150 μ V 200 ohms, gram 200 mV 1 Meg, gram 1.3 mV 47K, tuner 200 mV 470K, tuner 6 mV 47K, Aux 200 mV 470K, tape 200 mV 470K. Controls: bass, treble, balance, volume, mic, gram, tuner, aux, tape, mono, low filter, hi filter, loudness, speakers, test buttons, on/off. Mains consumption: 4W-325W. Size: $18\frac{1}{2} \times 4 \times 9\frac{7}{8}$ in. Teak or rosewood. Price (teak): £140.

Beolab 6006 Spread Unit. Provides connection for a centre speaker from Beolab amplifier. Connects between amplifier and speaker. Single control to vary width of stereo effect. Can also be used as headphone output from Beolab amplifier. Price: £6 10s.

★

BRADMATIC LTD., 338 Aldridge Road, Streetly, Sutton Coldfield, Warwickshire. Tel: 021-353 3171.

SSP2. Solid state amplifier. Output: 100W RMS into 4 ohms. HD less than 1%. S/N ratio: 86 dB below 100W. Input sensitivity: 250 mV into 10K for 100W. Psn 220-250V or 105-115V, 50 or 60 Hz, 150VA at 100W. Provision for feeding auxiliary apparatus via an octal socket outlet. Positive or negative 32V at 100 mA unsmoothed available. Will operate in ambient temperatures between -10 and +62°C. Output stage open-and-short-circuit proof. Dimensions: $6\frac{1}{4} \times 4 \times 12\frac{1}{4}$ in. Weight: 17 lb. Price: £46.

★

BRAUN AG. Distributors: Fi-Cord International, Charlwoods Road, East Grinstead, Sussex. Tel: East Grinstead 21351.

★ **CSV 60.** Integrated stereo valve amplifier. Output: 30W. Distortion 0.8% for 30W at 1 KHz. FR 20 Hz-30 KHz ± 3 dB, 40 Hz-15 KHz ± 1 dB. Inputs: magnetic PU 1.5 mV, crystal PU 3 mV, mic 10 mV, radio 200 mV, tape 200 mV. Output imp 4, 8, 16 ohms and electrostatic. Mains: 110-240V AC. Size: $16 \times 12\frac{3}{8} \times 4$ in. Price: £112 5s. 1d.

CSV 250. Integrated stereo transistor ampli-

fier. Inputs: radio, mag pickup, tape, aux. Controls: volume, treble, bass, balance, stereo/mono switch, PB tape control. Output: 15W RMS per channel. Distortion: <0.5% at 1 KHz. Cross talk damping: >40 dB at 1 KHz. Noise level: 70 dB. Output impedance: 4 ohms. Finish: grey wrinkle steel case with aluminium front panel. Size: $10 \times 4 \times 12\frac{1}{2}$ in. Price: £90 11s. 6d.

CSV 500. Integrated stereo amplifier. Output: 45W RMS per channel. FR 10 Hz-35 KHz. Distortion: <0.5% (4 ohms); <0.3% (8 ohms). Rumble and treble filters. Compensated volume control. Presence boosting. Separate bass and treble filters each channel. Inputs: PU, tape, radio, mic, aux. Outputs: speakers 4-16 ohms, headphones 400 ohms. Size: $15\frac{3}{4} \times 4\frac{1}{4} \times 12\frac{3}{8}$ in. Price: £170 7s. 1d.

★ **CSV 1000.** Integrated stereo amplifier. All transistor. 55W RMS output per channel. FR 20 Hz-30 KHz. Distortion <0.3% at 1 KHz. 45 silicon transistors, 13 silicon diodes, 2 zener diodes, 1 silicon rectifier. Five inputs with adjustable sensitivities. CCIR equalisation. Output impedance 4-16 ohms. Black steel cabinet with aluminium front panel. Size: $16 \times 4\frac{3}{8} \times 13\frac{3}{8}$ in. Price: £305 17s.

★

BRYAN AMPLIFIERS LTD., St. John's Court, Jane Street, Workington, Cumberland. Tel: Workington 3776.

★ **9000.** Integrated amplifier and control unit. Power output: 10W per channel RMS into 15 ohms. HD 0.25%. FR 35 Hz-33 KHz at 1W ± 1 dB. Feedback -60 dB. Output impedance 4-15 ohms. Inputs: magnetic pickup, 3 mV, 50K, noise level -60-70 dB; ceramic pickup, 40 mV, 100K, noise level -52 to -60 dB; radio, tape and aux. 75 mV. 50K, noise level -60 to -70 dB. Controls: volume and on-off; balance; bass; treble; selector; mode; monitor; rumble filter. Mains powered. Dimensions: $13\frac{3}{4} \times 5\frac{1}{2} \times 10\frac{5}{8}$ in. Price: chassis £44; in wood cabinet £48.

★

BUSH. Rank Bush Murphy Ltd., Power Road, Chiswick, London, W.4. Tel: 01-994 6491.

★ **Bush Sound System A746.** Solid state stereo amplifier. Output: 11W per channel, 4-15 ohms. HD <0.5%. FR 40 Hz-20 KHz. ± 3 dB. Feedback: 30 dB. Noise level: -36 dB rel. to 50 mW. Input voltage RMS: 14 mV. Output transistors: AL103. Psn mains. Dimensions: $4\frac{3}{8} \times 16 \times 9\frac{3}{8}$ in. Price: £31 11s.

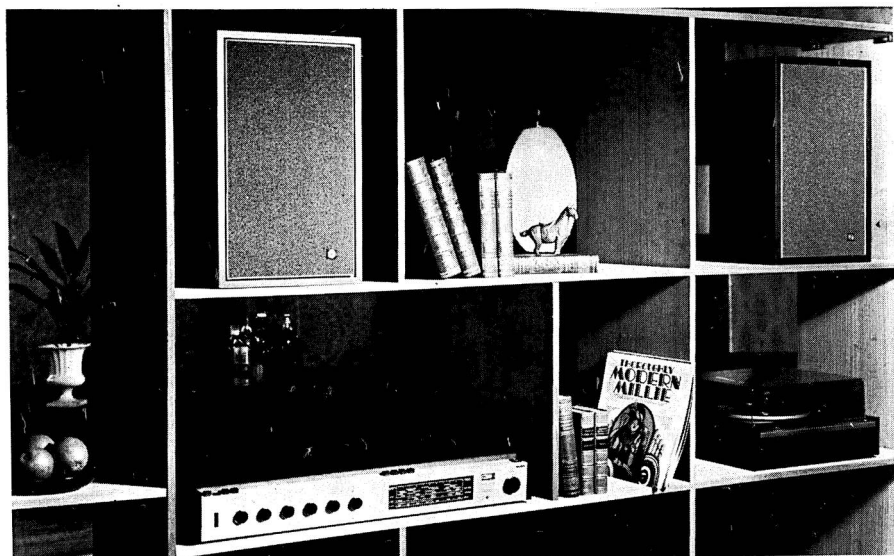

Bush Sound System



Crown Radio SHC-51

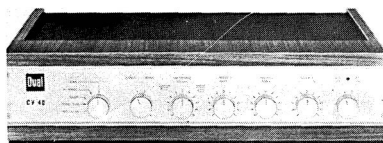

Dual CV40

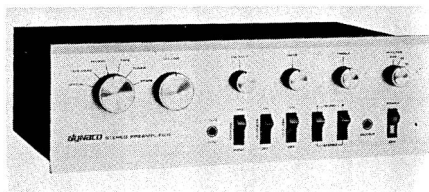

Dynaco PAT-4

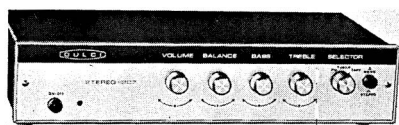

Dulci 207

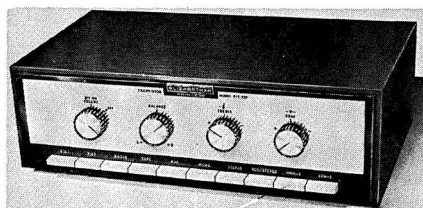

Dulci 220



Dynaco SCA-35

BUSH NELSON LTD., Bush House, 6 Yattendon Road, Horley, Surrey. Tel: Horley 5983.

Integrated transistor stereo amplifier. Controls: on/off, mono/stereo, volume, balance, bass, treble. Output: 5W RMS per channel into 8 ohms. FR: 40 Hz-20 KHz. HD -52 dB re 5W. Size: $15\frac{3}{4} \times 9\frac{1}{2} \times 3\frac{7}{8}$ in. Price: £40.



CAMBRIDGE AUDIO LABORATORIES LTD., 5 Queen Street, Mayfair, London, W.1. Tel: 01-629 2687.

★**Cambridge Audio P.40** solid state stereo amplifier. Output: 20W per channel, 8 ohms. HD <0.1%. FR 25 Hz-25 KHz 0.5 dB at 1W. Noise level: <-80 dB (unweighted). Input voltage RMS: 400 mV. Output transistors: complementary pairs. Psn mains. Inputs (unweighted): pickup 1, low level gram, 3 mV, 47K, <-60 dB; pickup 2, high level gram, 100 mV, 100K, <-65 dB; Aux, 50 mV, 100K, <-65 dB; radio, 100mV, 100K, <-70 dB. Controls: volume, function selector, bass, treble, low and high filters, stereo/mono, balance. Size: $16\frac{1}{2} \times 9\frac{5}{8} \times 2$ in. Price: £64 10s.

★**Cambridge Audio P.80.** Solid state stereo amplifier. Output: 40W per channel, 8 ohms. HD <0.1%. FR 25 Hz-25 KHz ± 0.5 dB at 1W. Noise level: <-80 dB (unweighted). Input voltage RMS: 300 mV. Output transistors: complementary pairs. Psn mains. Inputs: pickup 1, low level gram, 3 mV, 47K, <-60 dB; pickup 2, high level gram, 100 mV, 100K, <-65 dB; aux, 50 mV, 100K, <-65 dB; radio, 100 mV, 100K, <-70 dB. Controls: volume, function selector, bass, treble, low and high filters, stereo/mono, balance. Size: $16\frac{1}{2} \times 9\frac{5}{8} \times 2$ in. Price: £92 15s.



CROWN INTERNATIONAL. Distributor: Carston Electronics Ltd., 71 Oakley Road, Chinnor, Oxon. Tel: Kingston Blount 8561.

D-40 stereo power amplifier. Output: 45W RMS into 4 ohms, 30W into 8 ohms, 20W into 16 ohms (per channel); 80W RMS into 8 ohms (mono). HD <.05% at rated output. FR 5 Hz-50 KHz ± 1 dB at rated output. Damping factor >200. H and N 100 dB below 30W. Input 0.6V for full output. Psn: 117-240V, 50/60/400 Hz. Size: $19 \times 1\frac{3}{4} \times 7\frac{5}{8}$ in. Weight: 8½ lb. Fully protected against short circuit or mismatch. Headphone monitor socket. Price: £110.

DC-300 stereo power amplifier. Output: 340W RMS into 4 ohms, 190W RMS into 8 ohms. FR 0.30 KHz. HD <0.2%. H and N >100 dB below 150W. Size: $19 \times 7 \times 9\frac{3}{4}$ in. Weight: 38 lb. Price: £320.



CROWN. Crown Radio Co. Ltd., 137-149 Goswell Road, London, E.C.1. Tel: 01-253 1971/2.

★**SHC-51.** Integrated stereo amplifier, with cassette tape recorder. Output: 15W RMS per channel into 8 ohms. FR: 30 Hz-20 KHz. Controls: volume, balance, bass, treble. VU meters and digital tape counter provided. Two dynamic microphones and cassette tape provided. Push-button operation of tape unit. Headphone jack and speaker button. Dimensions: $4\frac{15}{16} \times 15\frac{5}{16} \times 10\frac{1}{2}$ in. Weight: $14\frac{3}{4}$ lb. Price: £81 9s. 3d. (plus £20 2s. 4d. PT).



DUAL. Dual Electronics Ltd., Radnor House, London Road, Norbury, London, S.W.16. Tel: 01-764 9465/6.

★**CV40.** Solid state integrated amplifier. Power output: 12W RMS per channel, 18W music. HD: 0.3% at 15W RMS. Power bandwidth: 15 Hz-40 KHz (DIN). FR: 10 Hz-45 KHz ± 1.5 dB. Input jacks: magnetic pickup, equalised to CCR, 4 mV at 47K; mic 3 mV at 47K flat; tape 350 mV at 470K flat; tuner 350 mV at 470K flat. Controls: volume/loudness, balance, selector, on/off, bass (± 17 dB at 40 Hz), treble (± 17 dB at 18 KHz). Outputs: two separate speaker outputs, 4-16 ohms. S/N: >50 dB below 50 mW. Psn: 110-240V 50 Hz. Dimensions: $16\frac{1}{2} \times 11\frac{1}{4} \times 4\frac{1}{2}$ in. Weight: 14.3 lb. Price: £64 10s.

CV80. Solid state integrated amplifier. Power output: 32W RMS per channel, 45W music. HD: <0.2% at 25W RMS. Power bandwidth: 15 Hz-60 KHz. FR: 10 Hz-80 KHz ± 1.5 dB. Input jacks: magnetic PU (equalised to CCR) 4 mV at 47K; mic 3 mV at 47K flat; tape 350 mV at 470K flat; tuner 350 mV at 470K flat. Controls: volume/loudness, balance, selector, on/off switch, mono/stereo switch, monitor switch, L.S. switch, bass (± 17 dB at 40 Hz), treble (± 17 dB at 18 KHz). PU socket. Outputs: two separate speaker outputs, 4-16 ohms. S/N: better than 52 dB below 50 mW. Psn: 110-240V 50 Hz. Dimensions: $16\frac{1}{2} \times 11\frac{1}{4} \times 4\frac{1}{2}$ in. Weight: 17 lb. Price: £97 5s. 6d.

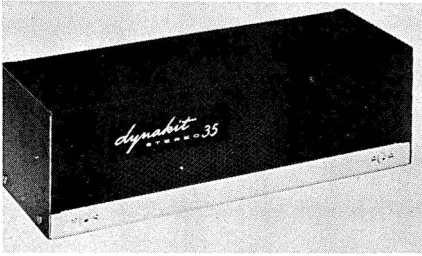

Dynaco ST-35

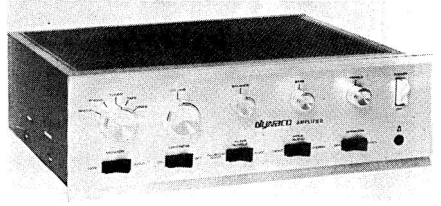

Dynaco SCA-80

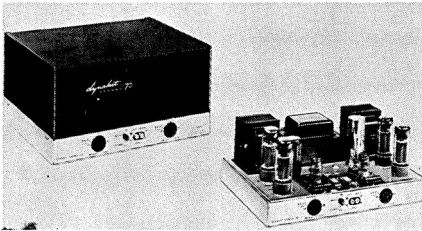

Dynaco ST-70



Eagle SA100

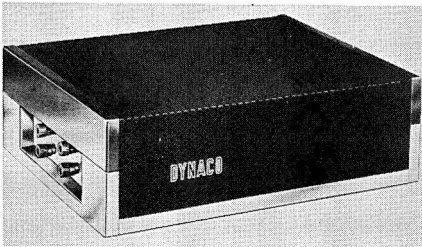

Dynaco ST-120



Eagle VTA40

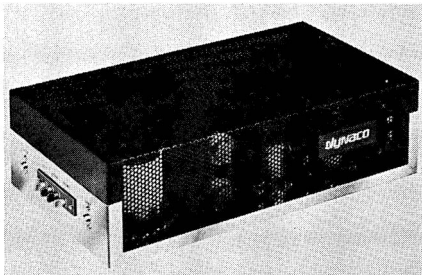

Dynaco ST-80

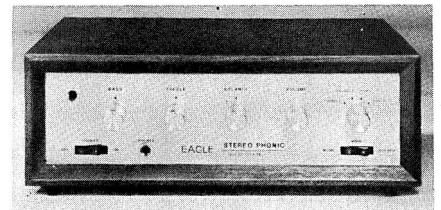

Eagle TSA60

DULCI. Lee Products (Great Britain) Ltd., 10-18 Clifton Street, London, E.C.2. Tel: 01-247 6711.

★**Dulci 220.** Silicon transistor integrated amplifier. Inputs: PU(1) 3.5 mV 47K, PU(2) 35 mV 47K, radio 100 mV 250 K, tape 2.5 mV 47K. Controls: volume, balance, treble, bass, low pass filter, rumble filter. Output: 10W RMS per channel. HD 0.25%, FR 25 Hz-20 KHz at 10W output. Output impedance 15 ohms. Size: 15 × 4½ × 8½ in. Price: £48.

★**Dulci 207.** Transistor integrated amplifier. Inputs: radio 100 mV 500K, tape 100 mV 500K, PU 100 mV 500K. Controls: on/off, volume, balance, bass, treble, selector, mono/stereo. Output: 7W RMS per channel. HD 2% at 7W. FR 45 Hz-20 KHz ±2 dB. Feedback: 15 dB. Noise level: 58 dB at 7W output. Output imp. 4 ohms for rated power, 15 ohms at reduced power. Two matched pairs AD161/2. Mains: 110-240V 50/60 Hz. Dimensions: 13¾ × 2¾ × 7 in. Price: £25.

★

DYNACO. Distributors: Howland-West Ltd., 2 Park End, South Hill Park, London, N.W.3. Tel: 01-794 6666.

★**PAT.4.** Transistorised stereo control unit. Inputs: PU (low level), PU (high level), tape head, tape amplifier, radio, aux (high level), aux (high level) to socket on front panel. Noise level: -70 dB on low level inputs, -85 dB on high level inputs. Controls: selector, volume, balance, bass (left and right), treble (left and right), filter, loudness, tape monitor, bass filter, mode, on/off. Mains: 120-240V 50-60 Hz. Designed for use with Dynaco Stereo 120 or other similar high quality amplifiers. Size: 13½ × 4¼ × 9 in. Price: (assembled) £64 1s.; (kit) £51 9s.

★**SCA-35.** Integrated mono/stereo valve amplifier. Seven pairs of inputs covering high and low-level PU (50K), tape head NAB 100K, radio, tape and auxiliary. Controls: selector, volume, balance, bass, treble, stereo-mono switch, loudness switch, HF filter switch, on/off switch. Output: 17½W per channel. Distortion: less than 1% over whole range ±0.25 dB of 17½W per channel. FR 20 Hz-20 KHz ±0.25 dB. Noise: 70 dB below 10 mV input on low-level inputs, 80 dB below on high-level inputs. Output imp 8 and 16 ohms and centre channel. Mains supply. Size: 13½ × 4¼ × 10 in. Price: (assembled) £59 17s.; (kit) £52 10s.

★**ST-35.** Stereo valve main amplifier. Output: 17½W per channel. FR 10 Hz-40 KHz ±1 dB. Distortion: less than 1% from 20 Hz-20 KHz within 1 dB of 17½W each channel. Noise: more than 80 dB below. Input voltage for 17½W output. IV. Output imp 8 and 16 ohms. Suitable for use with pre-amplifiers PAT.4 or other similar units. Size: 13 × 5½ × 4 in. Price: (assembled) £40 19s.; (kit) £34 13s.

★**ST-70.** Stereo valve main amplifier. 35W per channel. FR 10 Hz-40 KHz ±0.5 dB. Distortion less than 1% from 20 Hz-20 KHz within 1 dB of 35W output per channel. Noise more than 90 dB below 35W on each channel. Input voltage for 35W output. 1.3V. Output imp 4, 8 and 16 ohms. Mains power unit. Size: 13 × 9½ × 6½ in. To operate with PAT.4 or any other similar pre-amplifier. Price: (assembled) £59 17s.; (kit) £52 10s.

★**Stereo 120.** Transistor stereo power amplifier. Output: 35W RMS per channel. HD less than 0.25% up to 60W 20 Hz-20 KHz. FR 5 Hz-100 KHz ±0.5 dB. Noise: 95 dB below stated output (unweighted). Input: 1.5V for stated output. Output impedance: 4-16 ohms. Output transistors: selected RCA 2N3055. Mains: 220-240V AC. Size: 13 × 10½ × 4 in. Designed for use with Dynaco PAT.4 or any other similar high quality stereo control unit. Price: (assembled) £102 18s.; (kit) £87 3s.

★**SCA-80.** Solid state stereo amplifier. Power output: 50W per channel RMS, 4-16 ohms. HD less than 0.5%. FR 15 Hz-50 KHz ±1 dB. NL: better than -60 dB. Inputs: pickup, 3 mV, 47K. Controls: tape monitor switch, blend, treble for each channel, rumble filter, bass for each channel, balance, volume, loudness. Mains powered. Dimensions: 13½ × 4¼ × 10 in. Price to be announced.

★**ST-80.** Solid state stereo amplifier. Power output: 50W per channel RMS, 4-16 ohms. HD less than 0.5%. FR 15 Hz-50 KHz ±1 dB. NL: better than -60 dB. Mains powered. Dimensions: 13½ × 4¼ × 9 in. Control unit: Dynaco PAT-4, or others. Price to be announced.

★

EAGLE PRODUCTS. Distributors: B. Adler & Sons (Radio) Ltd., 32a Coptic Street, London, W.C.1. Tel: 01-636 9606/7. Cables: Reldab, London.

★**SA.100.** Integrated stereo amplifier. Output: 5W RMS per channel. FR 40 Hz-20 KHz ±1

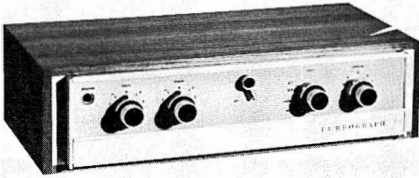

Ferrograph F307

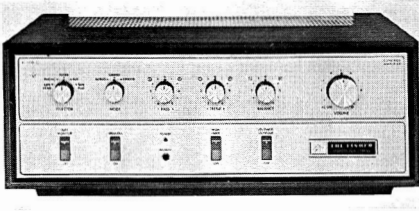

Fisher X-100-A integrated stereo amplifier

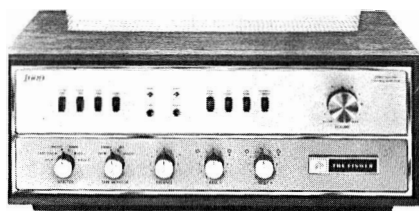

Fisher TX1000

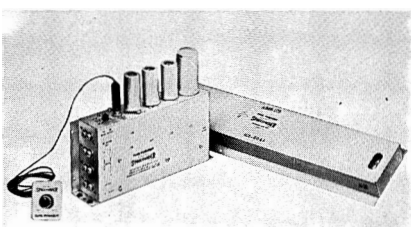

Fisher K-10 reverberation amplifier

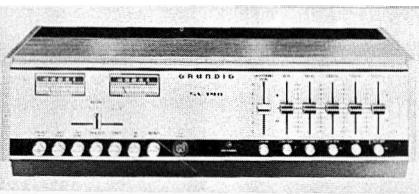

Grundig SV140



Goodmans Maxamp

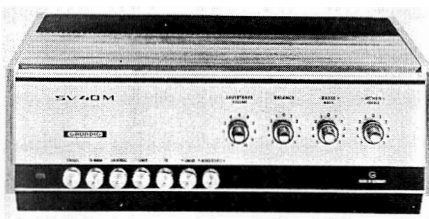

Grundig SV40M

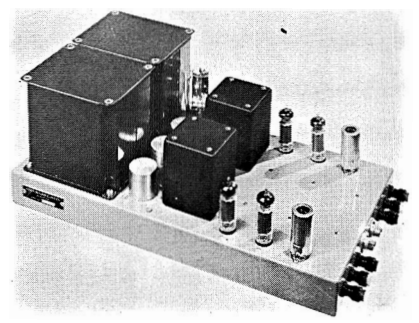

Kerr, McCosh CWA 2/12 stereo amplifier

dB. HD <1% at full output. HN -58 dB. Inputs: PU 300 mV, radio 300 mV, aux 300 mV. Separation at 1 KHz better than 40 dB. Controls: input selector, mode, left channel volume, right channel volume, left channel tone (-14 dB at 10 KHz), right channel tone (-14 dB at 10 KHz). On-off switch. Output imp 4, 8, 16 ohms each channel. Mains: 240V AC. Size: $9\frac{1}{4} \times 4\frac{1}{2} \times 7$ in. Price: £22 11s. 6d.

SA.200. Integrated stereo amplifier. Inputs: mag PU 5 mV, crystal PU 100 mV, radio 100 mV, tape 5 mV, mic 5 mV. Output: 7.5W per channel. Controls: selector, mode, volume, bass, treble, loudness, speaker/phones, on/off. Distortion less than 1% at 15W at 1 KHz, less than 0.25% at 1W at 1 KHz. FR 50 Hz-20 KHz ± 2 dB. Output impedance: 4, 8, 16 ohms. Valves. Size: $12\frac{1}{4} \times 4\frac{3}{4} \times 8\frac{1}{4}$ in. Price: £33 1s. 6d.

TSA.20. Integrated transistor stereo amplifier. Output: 10W RMS per channel at 8 ohms, 20W RMS per channel at 3 ohms. FR 30 Hz-20 KHz ± 2 dB. HD <1% at 5W. Output imp 4-16 ohms. Inputs: PU (mag) 3 mV (RIAA), PU (cer/crystal) 100 mV (RIAA), radio 150 mV, aux 250 mV. SN better than 50 dB (mag PU), better than 60 dB (aux). Crosstalk better than -45 dB. 12 transistors, two diodes. Silicon transistors in pre-amplifier. Size: $10 \times 4\frac{1}{2} \times 8\frac{1}{2}$ in. Price: £27 11s. 3d.

★ **TSA.60.** Transistorised stereo integrated amplifier. Inputs: PU(1) 5 mV 47K, PU(2) 100 mV 1 megohm, tape(1) 250 mV 100K, tape(2) 150 mV 50K, radio 100 mV 100K. Bass control ± 10 dB at 100 Hz, treble control ± 10 dB at 10 KHz. FR 30 Hz-20 KHz ± 2 dB. HD <1% at 9W RMS. Output: 15W RMS per channel at 8 ohms. Output impedance: 4-16 ohms. 14 transistors, 4 diodes. Mains: 220/240V AC. Size: $12\frac{3}{4} \times 4\frac{1}{2} \times 9\frac{1}{2}$ in. Price: £41 9s. 6d.

★ **VTA.40.** Integrated stereo amplifier. Output: 10W RMS per channel. FR 20 Hz-20 KHz, ± 2 dB. HD 1% at 8W. S/N ratio: better than 54 dB. Inputs: tape head 2 mV NARTB; phono 3 mV RIAA; tuner 100 mV; aux 300 mV; tape 160 mV. Controls: function selector, volume, bass, treble, balance, loudness, mono/stereo tape monitor, speaker on/off. Price: £41 9s. 6d.

★

E. K. ELECTRONICS (I.A.) LTD., Brotherton Hall, Brotherton, Knottingley, Yorks. Tel: Knottingley 2081.

Hi-Fi 20. Integrated mains operated valved

mono power amplifier, 20W (music); 15W RMS, 8 or 16 ohms. HD <10%. FR: 30 Hz-17 KHz ± 3 dB. 12 dB feedback. S/N -70 dB (input 1); -60 dB (input 2). Inputs: 300 mV (input 1); 2.5 mV (input 2). Output stage: $2 \times$ EL 34. Psn: 200/240V. Dimensions: $12 \times 9\frac{1}{4} \times 6$ in. Price: £25.

T615. Mains/battery 15W power amplifier using 6 transistors. HD 2% at 10W. FR: 35Hz-7KHz ± 3 dB. 12 dB feedback. Inputs: Mic, 2 mV 1.2 K; gram, 200 mV 50K. Output impedance: 15 ohms; Psn: 10-15V; 12V nominal. Dimensions: $9 \times 5\frac{1}{2} \times 6\frac{1}{2}$ in. Weight: 7 lb. Price: £18.

★

FERROGRAPH CO. LTD., Mercury House, 195 Knightsbridge, London, S.W.1. Tel: 01-589 4485.

★ **F307.** Stereo amplifier. Styled to match the Ferrograph series 7 recorder. 15W per channel RMS into 15 ohms, 25 Hz-25 KHz; 20W per channel RMS into 8 ohms, 30 Hz-25 KHz. Total HD: 1 KHz <0.25%. Damping factor: 15 ohm/50, 8 ohm/27. H and N: Magnetic PU <-60 dB; other inputs <-65 dB. Inputs: stereo 150 mV, mono 200 mV 50K; magnetic PU 3 mV for 15W/0.5% total HD, impedance selector switch on rear panel; ceramic PU, tuner, and auxiliary, 120 mV for 15W/0.5% total HD. Crosstalk: record/replay and inter-channel better than -65 dB. Tone control range: ± 15 dB at 50 Hz, ± 13 dB at 15 KHz. Push-button selected low pass filters: -3 dB at 10 KHz, 7 KHz, and 5 KHz. Psn 200 -250V 50 Hz. Price: £56.

★

FISHER RADIO CORPORATION, Long Island City 1, New York, U.S.A. Distributors: Getz Bros. and Co. Inc., 2 Harewood Place, London, W1R 0DD. Tel: 01-499 6901.

★ **X100-A.** Integrated stereo amplifier. 20W per channel. HD 0.8%. Response 20 Hz-20 KHz ± 1 dB. NL better than -90 dB with vol control at minimum. Inputs for mono and stereo PU, tape head, tuner, aux, tape monitor. High-pass filter. Independent tone controls for each channel. Output stages EL184s. Psn 200-240V AC. Price (in chassis form): £64 1s. (including PT). Also available in cabinet form.

★ **TX-1000.** Transistorised stereo amplifier and control unit. Output: 50W RMS per channel.

HD 0.8% at rated output. H and N; 90 dB below rated output. FR 20 Hz-40 KHz ± 1.5 dB. Mains: 105-250V 50/60 Hz. Size: $15\frac{1}{8} \times 4\frac{3}{4} \times 12\frac{3}{4}$ in. Walnut cabinet optional extra. Price: £159 12s.

★ **Spacexander K-10.** Reverberation amplifier for use with radio, records or tape. Mono or stereo. 3 valves, single control. Price: £38 17s.



A. R. FRANKLIN (Audio Engineer), 4 Birch House, Penge, London, S.E.20.

6W Amplifier. Transistorised stereo amplifier unit. 6W per channel output into 8 ohms. HD <0.3%. FR: (3 dB) 20 Hz-30 KHz, 3W 15 ohms. Input voltage for rated output: 4 mV RIAA. AD161 output transistors. Psn 240V 50 Hz. Inputs: PU 4 mV, 47K, <-55 dB noise; tuner 100 mV, 47K, <-60 dB noise; aux. 100 mV, 47K, <-60 dB noise; tape 100 mV, 47K, <-60 dB noise. Output: $6\frac{1}{2}$ V (8 or 15 Ohms), 2V (600 ohms). Controls: volume, stereo-blend, selector (including 10 KHz and 6 KHz filters), balance, bass, treble, off/on, headphone/speakers. Can also be used as input to larger power amplifiers. Size: $13\frac{1}{2} \times 3 \times 6$ in. Price: £39 10s.



GOLDRING MANUFACTURING CO. (G.B.) LTD., 486-488 High Road, Leytonstone, London, E.11. Tel: 01-539 8343.

Goldring/Lenco VV7 stereo pre-amplifier. All transistor. Input: magnetic cartridge, 1 mV sensitivity, 47K, NL -60 dB. Output: 100 mV RMS. Psn 200-240V 50 Hz. Dimensions: $4\frac{3}{4} \times 2 \times 1\frac{1}{2}$ in. Price: £8 10s.



GOODMANS LOUDSPEAKERS LTD., Axiom Works, Wembley, Middx. Tel: 01-902 1200. Cables: Goodaxiom, Wembley.

★ **Maxamp 30.** Integrated stereo transistorised amplifier. Inputs: pickup 3.5 mV 47K or 50 mV 100K, radio 100 mV 100K, tape 140 mV 50K, aux 3 mV 50K. Controls: input selector, volume, balance, bass, treble, P-B tape play, P-B LF filter, P-B HF filter, P-B mono/stereo mode, P-B on/off. Indicator light when on. Output: 30W RMS (15W per channel) into 8 ohm load, 20W RMS (10W per channel) into 4 or 15 ohm load. HD less than 0.3% for 15W per

channel into 8 ohm load at 1 KHz. FR 20 Hz-20 KHz $\pm \frac{1}{2}$ dB. Output impedance: 4, 8, 15 ohms. High level signal for tape recorder. Mains: 105, 120, 200, 220, 240V AC 40-60 Hz. Size: $10\frac{1}{2} \times 5\frac{1}{2} \times 7\frac{1}{4}$ in. Price: £54.



GRAMPIAN REPRODUCERS LTD., 19 Hanworth Trading Estate, Feltham, Middlesex. Tel: 01-894 9141.

Grampian 666 Ambiphonic unit. Enables one to four small speakers to be fed with amplified and delayed signal from main amplifier output. Delay device consists of two parallel springs and transducers as used in Grampian reverberation unit. Provides echoes similar to those produced by room 32×42 ft. Volume of delayed signals controllable by listener. Twin high-impedance line-bridging input connection. Output: $2\frac{1}{2}$ W push-pull power amplifier with 5 ohms and twin 600-ohm outputs. Fully transistorised. Mains: 100-125V or 200-250V. Consumption: 8W. Size: $18 \times 4\frac{3}{4} \times 5\frac{1}{4}$ in. Weight: 7 lb. Price: £59.



GRUNDIG (GREAT BRITAIN) LTD., Hi-Fi Division, 15 Orchard Street, London, W.1. Tel: 01-935 4898.

★ **SV40M.** Transistor stereo integrated amplifier. Inputs: 3 mV 47K, radio/tape 200 mV 470K, aux 200 mV at 1 megohm. Controls: volume, stereo balance, bass and treble. Output: 15W RMS per channel. Distortion: <0.5% at rated output. FR 20 Hz-20 KHz ± 1 dB. SN -60 dB at 50 mW, -85 dB at 15W. Output impedance: 4-16 ohms. 25 transistors, 13 diodes. Transformerless output stages. Separation: better than 46 dB. Size: $16 \times 11 \times 5\frac{7}{8}$ in. Weight: $17\frac{1}{2}$ lb. Finish: natural matt walnut or teak, with satin aluminium front panel. Price: £88 4s.

SV85. Transistor integrated stereo amplifier and control unit. Inputs: mic 7 mV at 100K, PU (mag) 5.5 mV 47K, PU (crystal) 220 mV-3V 1 megohm, radio/tape 250 mV 470K. Controls: volume, stereo balance, bass ± 18 dB at 30 Hz, treble ± 18 dB at 15 KHz, push-button selector, scratch filter, rumble filter, tape monitoring, slope 1, slope 2, presence. Output: 30W RMS per channel. Distortion <0.5%. Outlets: two speakers 4-16 ohms, two 300-ohm phone sockets. Stabilised supply to pre-amplifier stages. Mains: 110, 130, 220, 240V 50-60 Hz. Consumption 120W maximum. FR 20 Hz-20 KHz ± 1 dB. Size: $20 \times 6 \times 12$ in. Finish: teak. Price: £138 18s. 9d. (including PT).

★**SV140.** Transistor integrated amplifier. Slider controls for balance, volume, and five tone ranges. Overload and mismatch protection. Moving coil meters. Inputs: mic, PU (2), universal, tuner, tape, tape monitor. Outputs: 600 ohm 1V line, headphones, speakers. Mains: 110-240V 50-60 Hz. 50W per channel output, 5 ohms. Damping factor 20. FR 20 Hz-20 KHz ± 1 dB. $<0.5\%$ distortion. Oiled teak finish. Size: $20 \times 6 \times 12$ in. Price: £187 10s. (including PT).

★

HART ELECTRONICS, 321 Great Western Street, Manchester 14. Tel: Rusholme 2212-3. Cables: Alloys, Manchester.

Bailey 20W amplifier. See Constructional Kits Section for full details.

Dinsdale 10W amplifier. See Constructional Kits Section for full details.

★

HEATHKIT. See Constructional Kits Section.

★

HENRY'S RADIO. See Constructional Kits Section.

★

KERR McCOSH & CO. LTD., 435 Sauchiehall Street, Glasgow, C.2. Tel: 041-332 0988.

★**DSI.** Stereo control unit. Inputs: pickup and tape head 4 mV; crystal pickup and tape 140 mV; mic 1.5 mV. Controls: sel. switch, on/off, separate vol., treble, bass for each channel, flat/tone control. Tape record sockets. Size: $12\frac{1}{2} \times 4\frac{1}{2} \times 10\frac{1}{4}$ in. Price: £34.

★**CWA 2/12.** 12W per channel. Distortion 0.1% at 12W. Noise level -95 dB. Response 25 Hz-30 KHz ± 0.2 dB. Output imp 7.5 and 15 ohms. Input sensitivity 1V. Designed to operate with DSI pre-amplifier. Size: $20 \times 7 \times 8$ in. Price: £48.

★**CWA 40.** Mono amplifier. 40W peak continuous sine wave. Distortion 0.1% at 38W. Noise level -98 dB. FR: 25 Hz-30 KHz ± 0.2 dB. Output imp 7.5 and 15 ohms. Input sensitivity 1V. Designed to operate with DSI pre-amplifier. Size: $20 \times 9 \times 8$ in. Price: £45.

KIRKSAETER. A. C. Farnell Ltd., 81 Kirkstall Road, Leeds 3. Tel: Leeds 35111.

Range of high-quality amplifiers. Specifications and prices on application.

★

KNIGHT-KITS. See Constructional Kits Section.

★

KLINGER CONTROLS LTD., 10 Friar Street, Carter Lane, London, E.C.4. Tel: 01-236 1811.

★**K.C.35.** Integrated power amplifier. Transistorised. Power output: 6W RMS per channel. HD: $<1\%$. FR: 40 Hz-18 KHz ± 3 dB at 6W. S/N 52 dB. Output impedance: 15 ohms. Controls: volume, balance, bass, treble, selector, on/off, stereo/mono. Bass: ± 15 dB at 40 Hz. Treble: $+15$ dB to -20 dB at 14 KHz. Inputs: PU1, 4 mV at 47 K RIAA. PU2, 40 mV 47K. Radio and tape, 100 mV 10K flat response. Psn: 200-250V 50 Hz. Dimensions: $17\frac{1}{2} \times 4 \times 7\frac{1}{2}$ in. Weight: 10 lb. Price: £30 9s. (including PT).

★

KORTING. Europa Electronics Ltd., Howard Place, Shelton, Stoke-on-Trent ST1 4 NW. Tel: Stoke-on-Trent 29316.

★**A500, Type 29833.** Stereo amplifier with 21 transistors. Push-buttons for stereo, scratch, tape, pickup 1 and 2, tuner and on/off. Controls: treble, bass, balance and volume, with indicator lamp. Sockets: diode output for tuner; crystal, ceramic or magnetic pickup; tape recorder; speakers. Output: 10W per channel. Drift power transistors and triple negative feedback. Cabinet in natural walnut colour, satin finish. Size: $3\frac{1}{2} \times 14 \times 9$ in. Price: 39 gns.

★

LAFAYETTE. U.K. distributors: Barnet Factors Ltd., 4 Lisle Street, London, W.C.2. Tel: 01-437 2723.

Lafayette LA85T. Solid state stereo amplifier. Power output: 3-16 ohms; 60W total RMS at 4 ohms. HD less than 1%. FR 22 Hz-20 KHz ± 1 dB. NL: tape head and pickup -57 dB; aux and tuner -75 dB. Input voltage RMS: aux and tuner 270 mV; tape head and pickup 2.5 mV. Psn 220-240V. Dimensions: $3\frac{3}{8} \times 13 \times 9\frac{1}{4}$ in. Price: £49 10s.

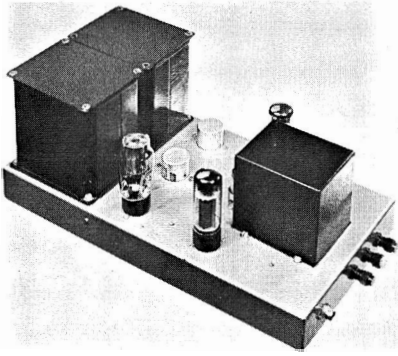

Kerr, McCosh CWA 40 amplifier

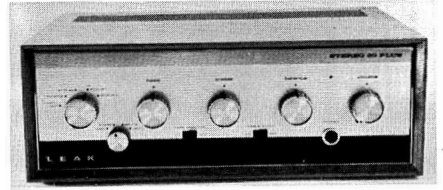

Leak Stereo 30 Plus

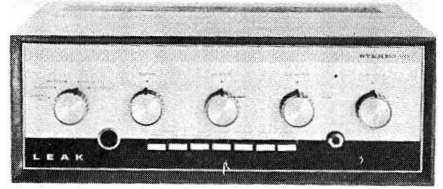

Leak Stereo 70

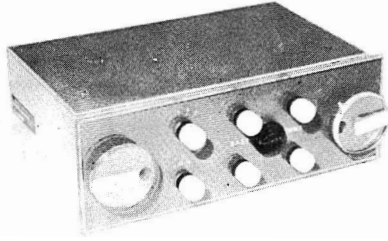

Kerr, McCosh DSI stereo control unit

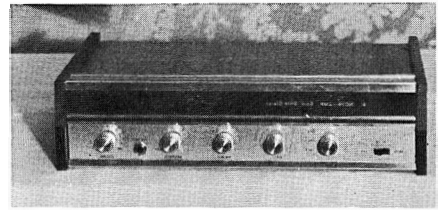

LL Electronics Nova-Amp

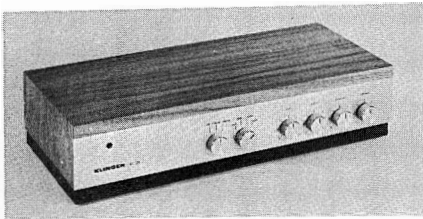

Klinger K35

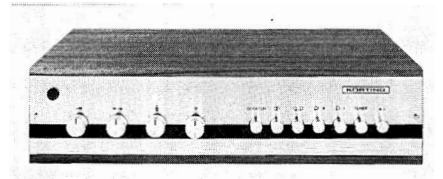

Korting A500

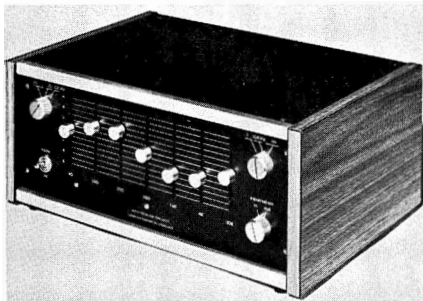

Leavers-Rich A501

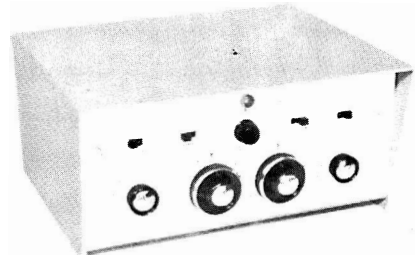

Lowther stereo control unit

Lafayette LA-224. Solid state stereo amplifier. Power output: 3-16 ohms; 10W per channel. HD 1% or less. FR 30 Hz-20 KHz ± 2 dB at 1W. NL: -50 dB. Input voltage RMS: 3 mV or 250 mV. Psn 220-240V AC. Dimensions: $10\frac{1}{4} \times 3\frac{9}{16} \times 7\frac{3}{16}$ in. Price: £28.

Lafayette LA-450. Solid state stereo amplifier. Power output: $16\frac{1}{2}$ W per channel, 3-16 ohms. HD 1% or less. 20 Hz-20 KHz ± 1.5 dB. NL: -53 dB. Input voltage RMS: 3 mV or 250 mV. Psn 220-240V AC. Dimensions: $10\frac{1}{2} \times 3\frac{7}{8} \times 8\frac{11}{16}$ in. Price: £40.



LAMPITT ELECTRONICS LTD., 48 Princess Street, Manchester, MI 6HR. Tel: 061-236 3652/3.

Sunderland A101. Integrated Amplifier and Control Unit. Mono. Power output: 10W RMS. HD 0.1%, FR: 12 Hz-18 KHz. Output impedance: 15 ohms. Inputs: mic 3 mV; gram 150 mV. 1.5M: tape 1 mV 47K; aux. 150 mV. 100K. Controls: Volume/on-off, selector, bass (-11 dB to +18 dB at 30 Hz); treble (-13 dB to +15 dB at 15 KHz). Psn 230-240V AC. Dimensions: $10\frac{1}{2} \times 6 \times 4\frac{1}{2}$ in. Price: £17 17s.



H. J. LEAK & CO. LTD., Brunel Road, East Acton, London, W.3. Tel: 01-749 1641. Cables: Sinusoidal, Ealux. London.

★**Stereo 30 Plus.** Transistorised integrated amplifier. Inputs: PU(1) 2 mV 47K; PU(2) Hi sensitivity 10 mV 33K; Lo sensitivity 30 mV 100K; tuner/mic 25 mV 47K; tuner(2) Hi sensitivity 60 mV 50K; Lo sensitivity 250 mV 50K; replay 400 mV 47K. Output: 15W per channel 8 ohms. 10W per channel 15 ohms. 20W per channel 4 ohms. Controls: input, bass, treble, balance, filter, volume, tape monitor. 6 KHz filter. Headphone socket. H and N 87 dB. HD 0.1% up to 12W at 1 KHz into 8 ohms. Mains: 110-250V 40-60 Hz. Size: $13 \times 4\frac{1}{4} \times 8\frac{3}{8}$ in. Price: Chassis Model £53, Cabinet Model £59 10s.

★**Stereo 70.** Transistorised integrated amplifier. Inputs: PU(1) 2 mV 47K RIAA. PU(2) 10 mV 33K RIAA, radio 25 mV 47K or 2 mV 47K, aux 60 mV 50K or 250 mV 50K, tape replay 400 mV 47K. Controls: bass ± 16 dB at 50 Hz, treble +16 dB at 14 KHz, volume, balance (zero to max on each channel), input selector, push-buttons for mode, tape monitor, treble filter,

speaker, on/off. Output: 35W RMS per channel into 8 ohms. 28W RMS per channel into 15 ohms. HD 0.1% all powers up to 25W RMS. FR 30 Hz-20 KHz ± 1 dB. Mains: 110, 117, 130, 210, 230, 250V 40/60 Hz. Consumption: 150 volt-amps. Size: (chassis) $13 \times 4\frac{1}{4} \times 8\frac{3}{8}$ in.; (cabinet) $13\frac{1}{2} \times 4\frac{3}{4} \times 9\frac{3}{8}$ in. Panel cut-out $12\frac{1}{2} \times 4$ in. Price: (chassis model) £63; (cabinet model) £69 10s.



LEEVERS-RICH EQUIPMENT LTD., 319 Trinity Road, Wandsworth, London, S.W.18. Tel: 01-874 9054/6. Cables: Leemag, London, S.W.18.

★**7 Band Audio Equaliser Model A501.** Wide range equaliser covering spectrum in 6 separately adjustable and overlapping bands, suitable for use in transcription to match widely differing recordings to a common quality standard. Price: £175.



LL ELECTRONIC SALES LTD., 5 Shakespeare Road, London, N.3. Tel: 01-346 3332.

★**Nova-Amp.** Solid state integrated stereo amplifier. Output: 10W per channel RMS. 4 ohms. HD <1%. FR 40 Hz-20 KHz ± 3 dB at 1W. Noise level: -55 dB at 10W. Psn mains. Size: $14 \times 9 \times 3\frac{1}{2}$ in. Has inputs for magnetic pickup 3 mV 47K; ceramic pickup 150 mV 500K; radio 60 mV 47K; tape 60 mV 47K; each -55 dB. Controls: bass, treble, balance, mono-stereo, and selector for disc-radio-tape. Price: £30 9s.



LOWTHER MANUFACTURING CO., Lowther House, St Mark's Road, Bromley, Kent. Tel: 01-460 5225. Cables: Lowther, Bromley.

Mk V control unit. Inputs: mic 3 mV; pickup 3 mV-300 mV; radio and aux 100 mV. 5-pos sel, vol, bass, treble, filter, equalisation. Filters: 4.5, 7 and 9 KHz. HD <0.5%. H and N -65 dB. Output cathode follower 1V RMS. To operate with Lowther L18 amplifier. With A-B test facility. Size: $10\frac{1}{4} \times 4\frac{5}{8} \times 7$ in. Price: £25.

L18 amplifier. 18W. Distortion <0.1%. Input for specified output 0.75V. Response 20 Hz-40 KHz ± 1 dB. Feedback 20 dB. Noise level -85dB. Output impedance 16 ohms with adjustment. Output: EL506 distributed load circuitry. Pat. Size: $12 \times 6 \times 6$ in. To operate with Mk V control unit. Price: £25 10s.

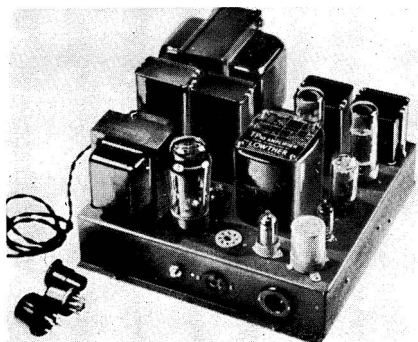

Lowther LL26 amplifier

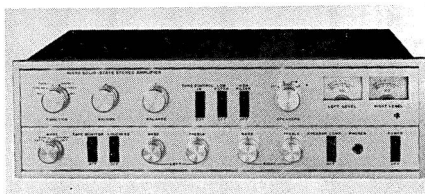

Nikko TRM-120



Peak Sound SA8-8

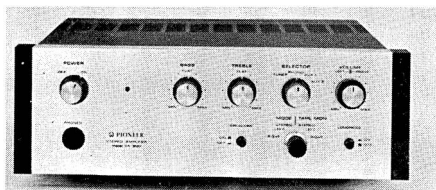

Pioneer SA-500



Lux SQ77

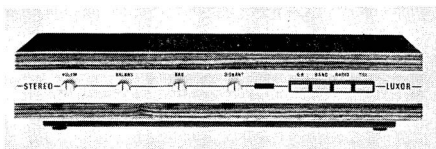

Luxor 4886

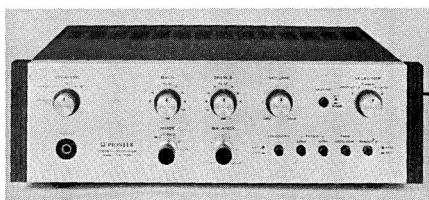

Pioneer SA-700

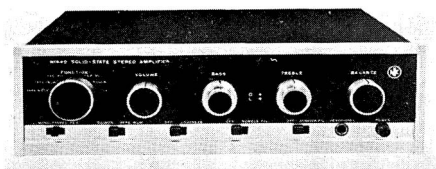

Nikko TRM-40B



Quad Q33 control unit



Nikko TRM-50

★**LL26 Mk II amplifier.** 26W. Dist $<0.1\%$. Input for spec output 0.75V. Response 20 Hz-70 KHz ± 1 dB. Feedback 22 dB. NL -90 dB. Output imp 16 ohms with adjustment. Output: EL34s. Lowther Linear. Size: $11 \times 12 \times 7\frac{1}{2}$ in. Weight: 33 lb. To operate with Mk IV control unit. Price: £47.

★**Mk II stereo control unit.** Input as for master control unit Mk V. Tape input sockets. HD 0.1% . Dual low-pass filters. Dual output balanced and balance controls between channels. Size as Mk V. To operate with L18S power amp. Price: £45.

L18S stereo amplifier. 18W output on each channel. Distortion 0.1% . Input for specified output 0.75V. Response 20 Hz-40 KHz. ± 1 dB. Noise level -85 dB. Output imp 8.4 or 16 ohms. Output EL 506 ultra linear. Size: $11 \times 12 \times 7\frac{1}{2}$ in. To operate with Mk II control unit. Price: £47.

★

LUX. Distributors: Shiro (U.K.) Ltd., 8 Bush Lane, Cannon Street, London, E.C.4. Tel: 01-626 4711/3.

★**SQ77T.** Integrated stereo amplifier. Power output: 30W RMS per channel into 8 ohms. HD: $<0.5\%$ at 20W. FR: 10 Hz-50 KHz. $+0$ to -3 dB. HN: better than -65 dB. Inputs: tape. 1.8 mV 100K; phono. 1.8 mV 50K; aux (1), 200 mV. aux (2), 800 mV. Controls: volume, balance, bass, treble, selector, mode, phones, speaker/phones switch. Dimensions: $15 \times 8\frac{3}{4} \times 6$ in. Price: £64 10s.

SQ1220. Integrated stereo amplifier. Output: 50W RMS per channel into 8 ohms. HD: $<0.1\%$ at 40 W at 1 KHz. FR: 10 Hz-50 KHz ± 1 dB. NL: -60 dB (pickup); -75 dB (aux 1 and 2); -60 dB (tape). Inputs: pickup 2 mV 50K; or with plug-in transformer, 0.2 mV, 30K, 50K or 100K. Aux 1, 110 mV 50K. Aux 2, 750 mV 100K. Tape, 2 mV 100K. Controls: volume, balance, bass, treble, selector, mode, phones, L.S. switch, tape monitor, frequency selector. Dimensions: $18\frac{3}{4} \times 7 \times 7\frac{1}{8}$ in. Price: £123 18s.

SQ505. Integrated stereo amplifier. Output: 30W RMS per channel into 8 ohms. HD: $<0.2\%$ at 30W at 1 KHz. FR: 10 Hz-50 KHz ± 1 dB. NL: -60 dB (pickup); -60 dB (tape head); -70 dB (aux 1 and 2). Inputs and controls as for SQ1220. Dimensions: $17\frac{3}{4} \times 10\frac{9}{16} \times 5\frac{3}{16}$ in. Price: £94 16s.

LUXOR. Distributors: Luxitone, 84 Bolsover Street, London, W.1. Tel: 01-636 2901.

★**4886.** Transistor stereo amplifier. Power output: 7W RMS per channel into 4 ohms. FR: 35 Hz-20 KHz. Inputs: crystal pickup, tape, radio. Controls: volume, balance, bass, treble, on/off. Dimensions: $13\frac{1}{4} \times 6\frac{1}{2} \times 2\frac{3}{4}$ in. Price: £30 9s. (including PT).

★

MARTIN ELECTRONICS LTD. See Constructional Kits Section.

★

MEDLEY MUSICAL LTD., 4 Felltram Way, Charlton, London, S.E.7. Tel: 01-858 3426.

1600. Solid state stereo amplifier with 8W RMS output per channel. HD $<1\%$. FR 30 Hz-35 KHz (2 dB) at 1W, tones level. NL: -55 dB full output. Input voltage RMS: 3 mV. Output impedance: 15 ohms. Psn 200-250V, 25W. Dimensions: $16\frac{1}{2} \times 14 \times 8\frac{1}{4}$ in. Price: £29 12s. 6d.

★

NIKKO. Nikko Electric Mfg. Co. Ltd., Distributors: Howland-West Ltd., 2 Park End, South Hill Park, London, N.W.3. Tel: 01-794 6666 and 6033.

★**TRM-40B.** Integrated stereo transistor amplifier and control unit. Inputs: tape head 2 mV, PU (mag) 4 mV, radio 500 mV, PU (crystal) 300 mV. Controls: function, volume, bass (each channel), treble (each channel), balance, mode, tape monitor, loudness, rumble filter, scratch filter, on/off, stereo headphone jack. Output: 15W RMS at 8 ohms. HD $<1\%$ at stated output. FR 15 Hz-20 KHz ± 1 dB. Noise level better than 60 dB. Output impedance 4-15 ohms. Mains supply. Size: $11\frac{1}{2} \times 9\frac{1}{2} \times 3\frac{3}{8}$ in. Price: £46 10s.

★**TRM-50.** Solid state stereo amplifier. Power output: 4-16 ohms, 17W per channel RMS. HD less than 0.9% . FR 10 Hz-50 KHz $\pm 1\frac{1}{2}$ dB. Noise level -65 dB. Mains powered. Dimensions: $8.4 \times 6.5 \times 2.4$ in. Price: £59.

★**TRM-120.** Integrated transistor stereo amplifier. Inputs: mic 3 mV 50K, tape head 1.7 mV 200K, radio 200 mV, PU(1) 2.8 mV 50K, PU(2) 2.8 mV 50K, aux 500 mV 500K. Noise level: mic -60 dB, tape -55 dB, PU -60 dB, others

-65 dB. Controls: function, volume, balance, tone controls in/out, low filter, high filter, speaker switching, mode, tape monitor on/off, bass right, bass left, treble right, treble left, on/off, meter level control, loudness. Output: 45W RMS into 8 ohms. HD 0.9% at rated output. FR 15 Hz-35 KHz ± 1 dB at 30W. Output impedance: 4-16 ohms. Mains: 117-240V 50/60 Hz. Size: $15\frac{1}{2} \times 4\frac{3}{4} \times 12\frac{3}{4}$ in. Price: £95.

ST301. Solid state stereo amplifier. Power output: 4-16 ohms, 10W per channel RMS. FR 20 Hz-50 KHz ± 1 dB. NL: -60 dB. Mains powered. Inputs: magnetic pickup 2.8 mV, 50K; tape, 1.8 mV, 200K; aux, 200 mV, 33K. Price: £80 (plus £19 10s. 2d. PT).



PEAK SOUND (Harrow) Ltd., 32 St. Judes Road, Englefield Green, Egham, Surrey. Tel: Egham 5316.

Olympus. Stereo amplifier. 25W into 15 ohms. HD: 0.1%. FR 20 Hz-20 KHz -1 dB at 20W. NL -80 dB. Inputs: PU (mag) 2.5 mV RIAA equalised 68K 70 dB. NL, PU (ceramic) 5 mV low impedance equalised 68K 70 dB NL, tuner 60 mV 80K 70 dB NL, tape 60 mV 80K 70 dB NL. Controls: Volume, balance, treble, bass, filter, push-button selector. Matches Olympus tuner. Size: $16 \times 10 \times 4$ in. Price on application.

★ **SA/8-8.** Stereo amplifier. 8.5W per channel into 5 ohms. HD: 0.5%. FR ± 3 dB at 1W, 15 Hz-30 KHz; ± 3 dB at 8.5W, 20 Hz-14 KHz. Inputs: 50 mV 1M. Controls: volume, treble, bass, on/off, select. Size: $12 \times 8 \times 3$ in. Also available in kit form. Price: £21.

SA/10-10. Stereo amplifier. 10W per channel into 8 ohms. HD: 0.5%. FR ± 3 dB, 12 Hz-30 KHz at 1W, 12 Hz-15 KHz at 10W. NL -50 dB. Inputs: 80 mV 1M at -50 dB NL. Controls: volume, treble, bass, on/off, selector. Size: $12 \times 8 \times 3$ in. Also available in kit form. Price: £24 3s.



PHILIPS ELECTRICAL LTD., Century House, Shaftesbury Avenue, London, W.C.2. Tel: 01-437 7777.

RH-580. Solid state stereo amplifier. Power output: 6W per channel RMS into 8 ohms; provision for 4 ohms (reduced power). HD < 1.5% at 5W per channel. FR 50 Hz-20 KHz 3 dB down for 6W. Noise level: 55 dB below 6W (overall).

Input voltage: magnetic pickup 3 mV; other inputs 100 mV; for 6W at 1 KHz. Output transistors: two AD161/162. Psn 110, 127, 220, 240V. Inputs: magneto/dynamic pickup 3 mV, 47K; crystal pickup 100 mV, 60K; tuner and tape 100 mV 140K; all -55 dB overall for 6W. Controls: volume (with bass compensation +8 dB max. at 65 Hz); bass ± 13 dB at 65 Hz; treble +11 to -10 dB at 10 KHz; balance. Dimensions: $2\frac{7}{8} \times 13\frac{1}{8} \times 8\frac{1}{2}$ in. Price: £26.

RH590. Solid state stereo amplifier. Power output: 10W per channel RMS into 8 ohms (4 ohms at reduced power). HD < 1%. FR 25 Hz-15 KHz 3 dB down. Distortion: 1%. NL: 80 dB below 10W. Output transistors: four AD149. Psn 110, 127, 220, 240V. Dimensions: $3\frac{7}{8} \times 14\frac{1}{8} \times 10$ in. Inputs: magneto/dynamic pickup 3 mV, 47K; crystal pickup, tape and tuner 100 mV, 100K each, -80 dB overall for 10W out. Controls: volume (with bass compensation +8 dB max. at 50 Hz); treble +14 dB at 10 KHz; bass +16 to -14 dB at 50 Hz; balance; rumble 12 dB/octave 3 dB down at 100 Hz; scratch 12 dB/octave 3 dB down at 6 KHz. Dimensions: $3\frac{7}{8} \times 14\frac{1}{8} \times 10$ in. Price: £49.

RH591. Solid state stereo amplifier. Power output: 20W per channel RMS at 8 ohms (4 ohms at reduced power). HD 0.2% at 15W per channel. FR 20 Hz-50 KHz 3dB below 20W. NL: 80 dB below 20W. Output transistors: four BDY20. Psn 110, 127, 220, 240V. Inputs: magneto/dynamic pickup 3 mV, 50K; tape, tuner, aux/ceramic pickup 100 mV, 500K. Output: 20W RMS at 1 KHz. Controls: volume (2-position loudness); bass ± 16 dB at 50 Hz; treble +14 to -16 dB at 10 KHz; rumble 12 dB/octave 1-3 dB at 80 Hz; scratch 12 dB/octave -3 dB at 10 KHz. -3 dB at 5 KHz; loudness 1, 3 dB at 10 KHz, 7 dB at 50 Hz; loudness 2, 7 dB at 10 KHz, 16 dB at 50 Hz; presence (switchable) +3 dB at 3 KHz. Psn 110, 127, 220, 240V. Dimensions: $3\frac{3}{8} \times 16\frac{1}{2} \times 10\frac{3}{8}$ in. Price: £73.



PIONEER. Distributors: Shiro (UK) Ltd., 8 Bush Lane, London, E.C.4. Tel: 01-626 4711.

★ **SA-500.** Silicon transistor stereo amplifier. Power output: 4-16 ohms, 13W RMS per channel at 8 ohms. HD 0.5% at 1 KHz. FR 20 Hz-50 KHz ± 1 dB. S/N ratio: 90 dB (aux). Damping factor: 40 dB. Inputs: magnetic pickup, 2.5 mV 47K; tuner 200 mV 100K; tape monitor, 200 mV 100K. Aux, 200 mV 100K. Controls: bass ± 13 dB 50 Hz; treble -11 dB

+5.5 dB, 10 KHz; loudness; tape monitor (stereo/4-track mono). Headphone jack. Residual noise: 0.7 mV at 8 ohms. Size: $4\frac{5}{8} \times 13 \times 12\frac{1}{4}$ in. Price: £54 8s.

★**SA-700.** Silicon transistor (inc. FET) stereo amplifier. Power output: 4-16 ohms, 34W RMS per channel at 8 ohms. HD 0.08% at 10 KHz. FR 20 Hz-40 KHz ± 1 dB. Damping factor: 40. Residual noise: 0.7 mV at 8 ohms. S/N ratio: 85 dB. Inputs: pickup 1, 3 mV; pickup 2, 0-12 mV; main 500 mV; tuner, tape monitor and aux, 200 mV. Controls: bass (3 dB steps); -9 dB to +12 dB at 100 Hz; treble (3 dB steps) -12 dB to +9 dB at 10 KHz. Filters: low -8.4 dB at 50 Hz; high -7.8 dB at 10 KHz; loudness +13 dB (50 Hz) +4 dB (10 KHz). Crosstalk: 49 dB (magnetic). Main/extra speakers. Headphone jack. Pre-amp and centre channel outputs Mains outlets. Size: $4\frac{5}{8} \times 14\frac{5}{8} \times 12\frac{3}{8}$ in. Psn 110-240V. Price: £91 2s. 3d.

SR-202. Double scatter transistorized reverberation amplifier. Suitable for studios, musicians, tape recorders and hi-fi systems. Output: 330 mV at 1 KHz for 200 mV input (reverb. min.). Max. input: 3V (reverb. min.). HD 0.2% at 1 KHz, 330 mV output. FR 20 Hz-35 KHz ± 2 dB (min.), 20 Hz-50 KHz ± 10 dB (max). S/N ratio: 65 dB, 330 mV output. Reverberation time: 1.9-3.2 sec, 1 KHz. Input impedance: 300K. Reverberation indicator on front panel. Facilities for two tape recorders and immediate reverberation defeat. Psn 110-240V, 8W. Size: $4\frac{1}{2} \times 11\frac{1}{4} \times 9\frac{3}{4}$ in. Price: £39 2s. 3d.



QUAD. Acoustical Manufacturing Co. Ltd., St. Peter's Road, Huntingdon, Hunts. Tel: Huntingdon 2561/2. Cables: Acoustical.

★**Quad 33 control unit.** Transistorised mono/stereo control unit. Inputs: PU from 2 mV, radio(1) 100 mV 100K, radio(2) 100 mV 100K, tape from 100 mV 40K. Signal-to-noise level: -70 dB on PU, -85 dB on all other inputs. Output: 0.5V. Controls: volume, balance, bass, treble, filter slope, filter frequency. Mains powered. Designed for use with Quad 303 amplifier but suitable for operation with other high quality equipment. Size: $10\frac{1}{4} \times 3\frac{5}{8} \times 6\frac{1}{2}$ in. Price: £43.

★**Quad 50/E.** High quality transistor power amplifier primarily intended for professional and industrial use. Input: 500 mV RMS into 14 to 50K according to gain control setting for 50W output, or standard 600 ohm line bridging input.

Output: 50W RMS. Output transformer secondaries linked by output connector to provide for 4 to 300 ohm loads. Damping factor 10. Total harmonic distortion: 0.1% at 1 KHz at any level up to 50W output. Hum better than 80 dB. Consumption: 24-150W depending on power output. Mains: 100-127V or 200-250V 50-60 Hz. Size: $12\frac{3}{4} \times 6\frac{1}{2} \times 4\frac{3}{4}$ in. Weight: 24 lb. Price on application.

★**Quad 303 power amplifier.** Transistorised stereo power amplifier. Output: 45W into 8 ohms. HD: 0.03% at 70 Hz and 700 Hz, 0.1% at 10 KHz. FR -1 dB 30 Hz-35 KHz into 8 ohms, -1 dB 20 Hz-35 KHz into 16 ohms. Noise Level: -100 dB. Sensitivity: 0.5V. Output impedance: 4-16 ohms. Output transistors: High voltage 2N3055. Mains. Designed for use with Quad 33 control unit but can be used with other high quality equipment. Size: $4\frac{3}{4} \times 6\frac{1}{4} \times 12\frac{3}{4}$ in. Price: £55.



RADFORD. Radford Electronics Ltd., Ashton Vale Estate, Ashton Vale Road, Bristol, 3. Tel: Bristol 662301.

MA.25. Mono power amplifier using valves. Output: 35W RMS. Output matching: 4, 8 and 16 ohms, switched. Input sensitivity: 500 mV. HD: <1% at 35W. Psn: 100-250V 50-60 Hz available. Dimensions: $8\frac{3}{4} \times 10\frac{3}{4} \times 8\frac{1}{2}$ in. Weight: 20 $\frac{1}{2}$ lb. Price: chassis £35.

STA.25. Stereo power amplifier using valves. Technical details per channel as for MA.25. Dimensions: $14 \times 10\frac{3}{4} \times 8\frac{1}{2}$ in. Weight: 36 lb. Price: £60.

SC22P. Stereo control unit preamplifier employing valves and transistors. Inputs: PU 2 mV 68K, mic 1.5 mV 68K, radio 115 mV 1 megohm, aux(1) 115 mV 1 megohm, aux(2) 115 mV 1 megohm. Output: 1.5V RMS. Controls: volume, bass, treble, selector, balance, rumble filter, mode, 4 KHz filter, 7 KHz filter, 10 KHz filter, tape monitor, mains on/off. Mains input. Size: $10\frac{1}{4} \times 3\frac{3}{8}$ in. (cut-out); $12\frac{7}{8}$ in. deep. Price: £50.

STA.100. Stereo valve power amplifier. Output: 100W RMS per channel. HD: less than 0.1% at 1 KHz at rated output. FR 20 Hz-20 KHz -1 dB +0 dB. Noise level: -95 dB at 60W. Input: 350 mV. Output impedance: 8-16 ohms. Output valves: KT88's. Mains supply. Designed to operate with SCP22P control unit or other similar high quality units. Price on application.



Quad 50E power amplifier

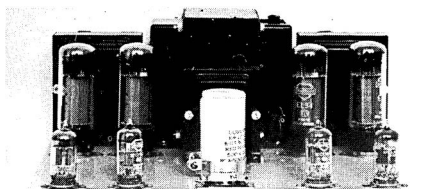

Richardson Power Amplifier



Rogers Ravensbourne



Quad 303 power amplifier



Rogers Ravensbrook

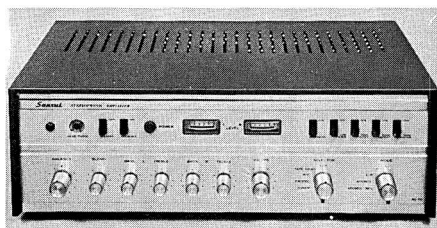

Sansui AU-70

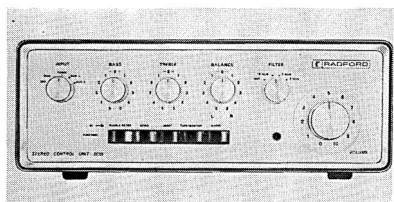

Radford SC22 stereo control unit

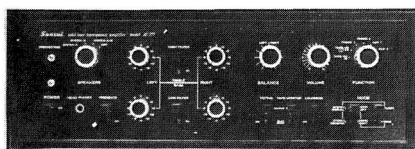

Sansui AU 777

SCA.30. Transistor integrated stereo amplifier. Inputs: mic 1.5 mV 68K, PU 1.8 mV 68K, radio 115 mV 1 megohm, tape 115 mV 1 megohm, aux 115 mV 1 megohm. Controls: volume, bass, treble, selector, balance, rumble filter, mode, 4 KHz filter, 7 KHz filter, 10 KHz filter, tape monitor, mains on/off. Output: 30W RMS per channel. HD: less than 0.1% at rated output. FR: flat 20 Hz-70 KHz at 38W into 12 ohms. Noise level -75 dB. Output impedance: 3.5-16 ohms. Mains input. Size: 14 × 5 × 12 in. Price: £106.

STA.100B. Details as for STA.100, but fitted with balanced input transformers for 200/600 ohm line bridging. Input impedance: 5K between 30 Hz and 20 KHz. Price on application.

★ **SC22.** Stereo control unit pre-amplifier employing valves and transistors. Details as for SC22P except no power supply included. Price: £36 10s.

★

R.E.W. (EARLSFIELD) & CO. Distributors: Direct Electrical Supplies (Wholesale) Ltd., 5 Selkirk Road, London, S.W.17. Tel: 01-672 9175.

CE6000. 60W solid state stereo amplifier. Power output: 20W RMS per channel. Scratch filter: -10 dB at 10 KHz. Rumble filter: -10 dB at 50 Hz. Tone control circuit cancelling switch. Two VU meters. Two system speaker selector switch. Control for stereo, stereo reverse, mono left and mono right. Bass and treble controls. Inputs: pickup 1, 2.5 mV (magnetic); pickup 2, 2.5 mV (magnetic) or switchable to 50 mV (ceramic); tape head 2.5 mV 50K; mic 2.5 mV 50K; tuner 100 mV 50K; aux 100 mV 50K. Tape monitor switch: 100 mV 50K. Stereo headphone jack: 8 ohms. Damping factor control. Loudness control: +12 dB at 50 Hz, +4 dB at 10 KHz. Crosstalk: -40 dB. Output transistor safety circuit. Dimensions: $16\frac{1}{4} \times 10\frac{3}{4} \times 5\frac{1}{4}$ in. Price: £51 9s.

★

fl. RICHARDSON ELECTRONICS LTD., 57 Jamestown Road, London, N.W.1. Tel: 01-794 2268.

SCP 2P. Stereo self-powered control unit. Modular construction with pluggable circuits. FET high Z input. Silicon semiconductors.

Stabilised power supply. Low noise and distortion 0.01% for 1V output. Bass ±20 dB. Treble ±16 dB. Rumble filter on disc. Quiet listening tape monitor. Mag pickup 2 mV inputs (two); high Z 2M ohms 50 mV; aux 250 mV (two). Size: 14-375 × 4-375 × 10.5 in. Psn 200-250V 50 or 60 Hz. Price: £50 with metal case.

SIA 100. Integrated silicon amplifier. Output: 40W RMS per channel for 0.01% distortion at 400 Hz into 8 ohms. Complementary output. Shortcircuit proof. Stable for any load. Controls and size as SCP 2. Psn 200-250V 5£ or 60 Hz. Price: £120 with metal case.

★ **MA 135 II.** Mono power amplifier. Output: 4, 8 or 16 ohms; 30W RMS for 0.1% distortion; 35W RMS for 0.25% distortion at 1 KHz. Power bandwidth 25 Hz-20 KHz for <0.5% distortion at 30W. Frequency response at half power: +0.5 dB. 15 Hz-25 KHz. Damping factor greater than 20. S/N ratio: 90 dB. Size: 12 × 7 × 8.5 in. Price: £40.

MA 135B II. Mono power amplifier with balanced input and volume control as MA 135 II. Price: £47 10s.

SA 170 II. Stereo power amplifier as MA 135 with two channels. Size: 12 × 12 × 7 in. Price: £65.

★

RLG. Sunderland Electrics Ltd., 48 Princess Street, Manchester M1 6HR. Tel: 061-236 3652.

A101. Solid state integrated amplifier. Transistors: 3xBC184, 2xBC182, 2xTIS61, 2xAD149. FR: 20 Hz-30 KHz ±1 dB. Sensitivity: (at 1 KHz) PU, 150 mV; mic, 3 mV; tape, 1 mV; aux, 150 mV. Controls: bass, +18 dB to -11 dB at 30 KHz; treble +15 dB to -13 dB at 15 KHz. Feedback: 43 dB (main amp). Output: 10W RMS into 15W (15W music). Price: £16 16s.

★

ROGERS DEVELOPMENTS (ELECTRONICS) LTD., 4-14 Barmeston Road, Catford, London, S.E.6. Tel: 698-7424/4340. Cables: Rodeveco, London, S.E.6.

Cadet III. Stereo main amplifier and control unit. Inputs: radio 100 mV 470K, mag PU 3.8 mV 68K, crystal PU 65 mV 2 megohms, tape 600 mV. FR 20 Hz-20 KHz ±2 dB. Bass control ±13.5 dB at 40 Hz. Treble control +13.5 dB -16 dB at 10 KHz. High-pass filter 60 Hz 10 dB/octave. Low-pass filter 6.5 KHz

10 dB/octave. Crosstalk -42 dB at 1 KHz, 26 dB at 10 KHz. Signal-to-noise: radio 60 dB, mag PU 54 dB, ceramic PU 52 dB. Balance control 9 dB range. Valves. Size: (control unit) $10\frac{3}{4} \times 4\frac{3}{4} \times 4\frac{3}{8}$ in., front panel $11\frac{1}{4} \times 4\frac{1}{2}$ in. Output 10W each channel. Distortion 0.25% at 5W at 1 KHz, 0.8% at 10W at 1 KHz. H and N -80 dB. Output impedance 3-5 ohms and 12-16 ohms. Mains: 110-122-220-244V 50/60 Hz. Size: (main amplifier) $10 \times 6\frac{1}{2} \times 4$ in. Prices: (chassis model) £33 15s.; (cabinet model) £37 10s.; (case alone) £3 15s. (plus 7s. 6d. PT).

★ **Ravensbourne** solid state stereo amplifier and control unit. Power output: 4, 8 and 16 ohms; 25W per channel RMS. HD 0.1% average (0.06% at 15W). FR 25 Hz-25 KHz ± 1 dB at 25W. Feedback: 36 dB. N/L: -80 dB. Output transistors: 2N3055. Power consumption: quiescent 40W; at 25W+25W into 15 ohms 110W. Inputs: disc, sensitivity 4/8/100/200 mV, impedance 50K, noise level -60/65 dB; aux, radio and tape, sensitivity 200 mV, impedance 100K, N/L: -75 dB. Controls: push-button input selector, volume, bass and treble, balance, low pass filter and slope, function, headphone. Dimensions: case $14\frac{3}{8} \times 10\frac{1}{4} \times 5\frac{1}{4}$ in.; chassis $13\frac{3}{8} \times 10\frac{1}{8} \times 4$ in. Price: (chassis model) £59 10s.; (cabinet model) £64; (case alone) £5.

★ **Ravensbrook** solid state stereo amplifier and control unit. Power output: 10W per channel into 15 ohms, 15W per channel into 8 ohms. HD less than 0.1% at 10W into 15 ohms. FR 20 Hz-50 KHz -3 dB. Noise level: disc -53 dB, radio -8 dB. Power consumption: quiescent 22W; 10W/15 ohms 50W. Inputs: disc, sensitivity 2/4/25/50 mV, impedance 47K, noise level: -53 dB. Controls: push-button input selector, function, bass and treble, balance, high pass filter switch, low pass filter/slope. Dimensions: cabinet $14\frac{3}{8} \times 9\frac{3}{8} \times 5$ in.; chassis $13 \times 9\frac{3}{4} \times 3\frac{1}{4}$ in. Price: (cabinet model) £47 10s.; (chassis model) £42 10s.; (case alone) £5.

★

ROTEL. U.K. distributors: Pullin Photographic (Rank Aldis Ltd.), P.O. Box 70, Great West Road, Brentford, Middx. Tel: 01-568 9222.

Rotel 100-AMP. Solid state stereo amplifier. Power output: 4 or 8 ohms; 15W RMS per channel. HD 0.4% at 10W. FR 25 Hz-15 KHz ± 1.5 dB max. Output transistors: silicon. Input sensitivity: magnetic pickup, 4 mV; aux 200 mV; tuner, 100 mV. H and N: pickup -60 dB; aux and tuner, -70 dB. Bass control +11 to -14 dB. Treble control +13 to -10 dB. Dimensions: $4 \times 12\frac{1}{4} \times 8\frac{1}{2}$ in. Price: £45 10s.

Rotel RA-840. Solid state stereo amplifier. Power output 42W per channel RMS at 8 ohms. Input sensitivity: magnetic pickup, 2 mV; tape head, 1.5 mV; crystal pickup, tape, aux and tuner, 100 mV each. FR 6 Hz-40 KHz +0 to -1 dB. HD 0.1% at 35W. H and N: pickup -60 dB; tape head, -55 dB; aux and tuner, -70 dB. Bass control +15 dB to -15 dB at 50 Hz. Treble control +15 dB to -12 dB at 10 KHz. High filter: -10 dB at 10 KHz. Dimensions: $5\frac{1}{8} \times 14\frac{1}{2} \times 10$ in. Weight: 16 lb. Price: £75.

★

SANSUI. Sole UK importer: Brush Cleve Co. Ltd., Thornhill, Southampton, SO9 1QX. Tel: Southampton 45166.

★ **Sansui AU70**. Stereo integrated amplifier. Valves and transistors. Inputs: PU (mag) 1.1 mV 50K. PU (crystal) 36 mV 100K, tape 0.9 mV 50K, mic 0.9 mV 50K, aux 50 mV 500K, radio 50 mV 500K. Controls: balance, blend (continuous mono to stereo), bass boost and cut (independent left and right) treble boost and cut (independent left and right), volume, selector, mode, speaker on-off, presence, loudness, low-pass filter, high-pass filter, tone circuits on-off, tape monitor. Output: 25W RMS per channel. HD 0.15% at 20W per channel. FR 10 Hz-80 KHz ± 1 dB at 1W. Feedback 26 dB. Noise level -60 dB. Output impedance: 8 or 16 ohms. Damping factor: 18. Size: $15\frac{3}{8} \times 12\frac{5}{8} \times 5\frac{3}{8}$ in. Price: £76 1s. 4d.

★ **Sansui AU777**. Transistorised stereo integrated amplifier. Inputs: PU(1) 2 mV 47K, PU(2) 2 mV 100K, tape head (fast) 1.5 mV 200K, tape head (slow) 1.3 mV 200K, aux(1) 140 mV 100K, aux(2) 140 mV 100K, tape monitor 140 mV 100K. Output: 25W RMS per channel. HD <0.5% at rated output. FR 20 Hz-100 KHz. Output impedance: 8-16 ohms. AC mains. Consumption 165 VA. Size: $17\frac{1}{8} \times 6\frac{1}{8} \times 13\frac{1}{8}$ in. Price: £115 15s. 3d.

★ **Sansui AU222**. Solid state stereo amplifier. Power output: 18W per channel ± 1 dB at 8 ohms. HD: less than 0.8%. FR 20 Hz-20 KHz at 8 ohms. Damping factor: 20 at 8 ohms. H and N, volume at minimum, -80 dB. Inputs: pickups 2 mV (47K and 100K); tape head 1.5 mV (200K); aux (two) 150 mV (100K); tape monitor 150 mV (40K). Psn 100, 117, 220 and 240V, 50 or 60 Hz. Dimensions: $4\frac{3}{8} \times 11\frac{1}{2} \times 10\frac{1}{2}$ in. Weight: 12.8 lb. Price: £62 17s. 7d.

★ **Sansui AU555**. Solid state integrated stereo amplifier. Power output: 25W per channel

± 1 dB at 4 ohms. HD less than 0.5%. Distortion: less than 0.8%. FR 20 Hz-30 KHz. H and N: better than -100 dB. Damping factor: 12 and 45 at 8 ohms. Inputs: pickup 2 mV (47K and 100K); tape head 1.5 mV 200K; aux 200 mV (100K), mic 3.8 mV (10K) and 140 mV (100K); tape monitor 150 mV (100K). Psn 100, 117, 220 and 240V, 50 or 60 Hz. Dimensions: $4\frac{3}{8} \times 15 \times 10\frac{7}{8}$ in. Weight: 17.4 lb. Price: £80 9s. 7d.



SCOTT. Distributor: A. C. Farnell Ltd., Consumer Division, Farnell House, 81 Kirkstall Road, Leeds, LS3 1HR. Tel: Leeds 35111.

299-F. Solid state stereo amplifier. Power output: 22W per channel at 8 ohms. Distortion: 0.8%. FR 18 Hz-25 KHz ± 1 dB. H and N: -55 dB. Dual loudness control. Four pairs of external stereo inputs. Phono sensitivity: 4 and 8 mV. Loudness volume compensation switch. Mono stereo plus stereo balance switches. Price to be announced.

260-B. Solid state stereo amplifier. Power output: 40W per channel at 8 ohms. Distortion: 0.8%. FR 15 Hz-30 KHz ± 1 dB. H and N (phono): -55 dB. Balance control, computer type push-button switches; tone control by-pass, rumble filter; six pairs of external stereo inputs. Phono sensitivity: 3, 5 and 9 mV. Stereo mike front panel input jacks. Loudness volume compensation switch. Seven position stereo selector. Price to be announced.



SENNHEISER ELECTRONIC. Distributors: Audio Engineering Ltd., 33 Endell Street, London, W.C.2. Tel: 01-836 0033.

★ **VRS.303 Philharmonic.** Armchair control unit. Transistorised stereo pre-amplifier designed to operate with VKL.303 main amplifier and VMS.303 mixer. Controls: bass, treble, balance, volume, stereo width. Power supplied from power amplifier. Size: $4 \times 9 \times 3$ in. Price: see VKL.303.

★ **VMS.303 Philharmonic.** Stereo transistorised mixer unit for use with VRS.303 armchair control unit and VKL.303 amplifier/speaker units. Inputs: mic (1) 2 mV 50K, mic (2) 2 mV 50K, pick-up (crystal), pick-up (magnetic) 2.5 mV 50K, radio (1) 2 mV 50K, radio (2) 500 mV 120K, equalised tape 220 mV 100K. Outputs: tape 2×15 mV low Z, tape 2×300 mV high Z, headphones $2 \times 1V$ 100 ohms. Controls: HF filter 15 dB/octave (3 dB at 6 KHz), LF filter

15 dB/octave (3 dB at 60 Hz), sensitivity control for each of three channels. Power drawn from main amplifier VKL.303. Size: $9 \times 9 \times 3$ in. Price: see VKL.303.

★ **VKL.303 Philharmonic.** Transistorised power amplifiers built-into speaker enclosures. Designed to operate with VMS.303 mixer and VRS.303 armchair control unit. Power output: 30W RMS per channel. HD 0.1% at 20W 30 Hz-10 KHz. FR (including speakers) 50 Hz-15 KHz + 3 dB. Feedback > 65 dB for all inputs. Noise level < 85 dB (power amplifier only). Mains: 220-240V AC. Infinite baffle enclosures with LF and HF units. Variable equalisers to compensate for speaker position, room acoustics and stereo symmetry. Price (VRS.303, VMS.303, two VKL.303): £484.



SHIRLEY LABORATORIES LTD., 23 Ripley Road, Worthing, Sussex. Tel: Worthing 49098.

★ **"Jupiter" SB/1-15E.** Integrated mono amplifier. 12W (17W peak). Dist 0.2% at 10W 1 KHz. FR 45 Hz-25 KHz ± 1 dB. NL -80 dB. Inputs: radio/tape 100 mV; gram to suit pickup in use. LS matching, 15 ohms. Controls: bass, treble, vol, sel. Pat 300V, 30 mA; 6.3V, 1.5 amps. Output stages EL84s. Self-powered. Front panel 12×3 in. Price: £23 2s.

SBS/15 integrated stereo amplifier. 12W per channel (17W peak). Dist 0.1%. FR 45 Hz-25 KHz ± 1 dB. NL -85 dB. Inputs: radio 100 mV; gram (RIAA) 5 mV; mic 2 mV; tape from head 3 mV; tape recorder 100 mV. Output stages EL84s. Controls: variable vol, bass, treble, balance, switched sel, tape speed equalisation, mono/stereo. Self-powered. Pat 300V, 45 mA; 6.3V, ct, 2 amps. Equalisation for two or three tape speeds. Facility for playing on both channels from monaural source. Price: £63. (See also tape amplifiers.)



SHURE ELECTRONICS LTD., 84 Blackfriars Road, London, S.E.1. Tel: 01-928 6361.

★ **Solophone SA-2E.** Provides personal stereo listening for one or two people. Gives sufficient amplification to accept output from any high quality cartridge (for example Shure Stereo Dynetic range), tape deck or FM tuner. There are input selector switch, separate volume controls for each channel and two headphone jacks mounted on the front panel. Size: $10\frac{1}{4} \times 3\frac{1}{2} \times 3$ in. Weight: 2 lb. Mains: 240V 50 Hz. Price: £21.

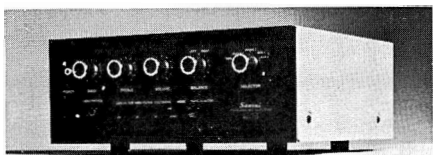

Sansui AU-222

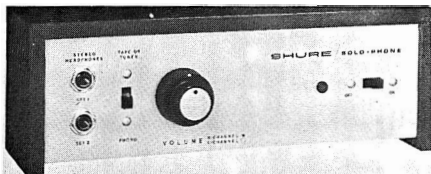

Shure Solo-phone SA-2E

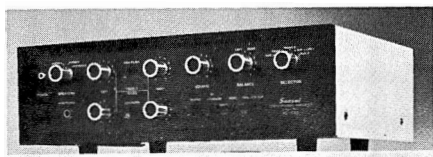

Sansui AU-555

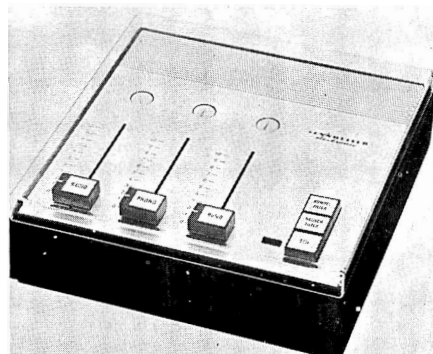

Sennheiser VRS303

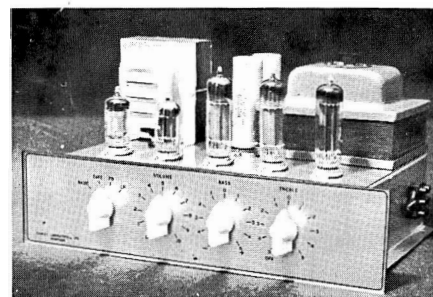

Shirley Jupiter SB/1-15E

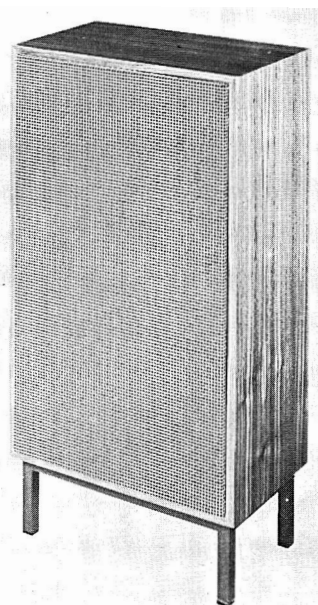

Sennheiser VKL303



Sennheiser VMS303

★**M61 Series.** Stereo pre-amplifiers designed to permit magnetic cartridges and tape heads to be used with amplifiers not having the necessary input sensitivity. M61 Series amplifiers provide amplification and equalisation for tape and discs, also suitable for mic. FR 25 Hz-15 KHz ± 2.5 dB. Input impedance: 47K at 1 KHz. Output impedance: low < 1 K at 10 KHz. Separation > 50 dB at 1 KHz. H and N $- 50$ dB. Size: $5 \times 5\frac{1}{2} \times 2$ in. Price: (M61-2 mains operated) £14; (M61-3 battery operated) £12.



SINCLAIR RADIONICS LTD., 22 Newmarket Road, Cambridge. Tel: Cambridge 52996.

Sinclair Z-12. Transistorised mono amplifier. Eight transistors. Output into 3 ohm load: 5W RMS at 12V. 8W RMS at 15V. 13W RMS at 18V. Output into 1.5 ohm load: 10W RMS at 12V. 16W RMS at 15V. FR 15 Hz-50 KHz ± 1 dB. Sensitivity: 2 mV into 2K. Signal-to-noise: better than 60 dB. Total distortion less than 1%. Size: $3 \times 1.8 \times 1.3$ in. Quiescent consumption on 12V: 15 mA. DC supply required 6-20V. Price: £4 9s. 6d. (ready built). PZ4 power supply unit: Price £4 19s. 6d. extra.

★**Neoteric 60.** Transistorised stereo integrated amplifier. Inputs: PU(1) 2.7 mV 47K. PU(2) 2.7-160 mV 10K. radio 17 mV 1 megohm. tape head 2.5 mV 47K. Noise level: better than $- 60$ dB all inputs. Controls: 10 KHz HF filter. 4 KHz HF filter. LF filter 12 dB/octave below 50 Hz. HF filter at 6 KHz. Volume, balance, bass, treble, on/off. Output: 15W RMS per channel into 8 ohms. HD 0.08% into 15 ohms at rated output. FR 20 Hz-100 KHz ± 1 dB. Output impedance: 5-15 ohms. 28 transistors. Mains: 110-240V AC. Size: $8\frac{1}{2} \times 2\frac{1}{8} \times 9\frac{1}{4}$ in. Price: £57 15s.

★**System 2000.** Transistorised stereo integrated amplifier. Inputs: PU(1) 3 mV 68K. PU(2) 30 mV 220K. tape(1) 1.5 mV 100K. tape(2) 1 mV 100K. aux 500 mV 100K. radio 100 mV 100K. mic 2.5 mV 50K. Controls: push-button input selector. volume, balance, treble ± 14 dB at 15 KHz. bass ± 13 dB at 70 Hz. Output: 35W RMS total. Output impedance 3-15 ohms. HD $< 0.5\%$ at all powers. FR 15 Hz-30 KHz ± 1 dB. 18 transistors (12 silicon). Transformerless output. Mains: 200-250V 50 or 60 Hz (100-120V version available). Finish: cabinet and control knobs solid aluminium. Size: $12 \times 6 \times 2$ in. Price: £30 9s.

SONY U.K. DIVISION, Ascot Road, Bedfont, Feltham, Middx. Tel: Ashford 50021.

★**TA-1080.** Transistor stereo integrated amplifier. Inputs: tape 0.7 mV 100K. PU(2) 2.3 mV 47K. tuner 120 mV (variable) 100K. aux 120 mV 100K. Controls: volume, balance, treble ± 10 dB at 10 KHz. bass ± 10 dB at 100 Hz. mode, input selector, tone-control cut-out to give flat response, monitor. Output: 30W per channel. FR 30 Hz-100 KHz ± 2 dB. HD $< 0.15\%$ at rated output. Damping factor: > 40 . Noise: $< 0.05 \mu\text{V}$ with 8 ohms load. Signal/noise: > 70 dB average. 30 silicon transistors. 21 diodes. Output impedance: 8-16 ohms. Mains: 100, 117, 220, 240V 50/60 Hz. Consumption: 25W at no signal. 200W at maximum output. Mounting bracket and oiled stained case optional extras. Size: $15\frac{3}{4} \times 12\frac{1}{4} \times 5\frac{3}{4}$ in. Price: £120.

★**TA-1120.** Transistor stereo integrated amplifier. Inputs: PU(1) 5 mV 47K. PU(2) 1 mV 47K. tuner 200 mV 100K. tape head 1 mV 500K. mic 2 mV 500K. Noise level: tuner $- 90$ dB. PU 70-80 dB. tape $- 70$ dB. mic $- 65$ dB. Controls: volume, balance, bass ± 20 dB at 100 Hz. treble ± 20 dB at 10 KHz. tone control cancel switch, mode, selector, low-pass filter, high-pass filter, monitor switch. Output: 50W per channel. Output impedance: 8-16 ohms. HD 0.1% at rated power. FR 10 Hz-100 KHz $- 1$ dB at rated output. 46 silicon transistors. 23 diodes. Mains: 100, 117, 220, 240V 50/60 Hz. Consumption: 30W at no signal. 200W at maximum output. Oiled stained case optional extra. Size: $15\frac{3}{4} \times 12\frac{1}{4} \times 5\frac{3}{4}$ in. Price: £160.

★**TA-2000.** Control preamplifier. Inputs: tape 1.2 mV 500K. tuner 120 mV 100K. phono 1.2 mV 47K. tape 120 mV 100K. Controls: bass (100 Hz ± 10 dB), treble (10 KHz ± 10 dB), high filter (12 dB/oct. above 9 KHz), low filter (12 dB/oct. below 50 Hz). Mains: 110, 117, 220, 240V 50/60 Hz. Size: $15\frac{3}{4} \times 5\frac{3}{4} \times 12\frac{1}{4}$ in. Price: £129.

★**TA-3120.** Transistorised amplifier. Output: 8 or 16 ohms; 50W per channel at 8 ohms. HD $< 0.1\%$ of rated output. FR 30 Hz-100 KHz $- 1$ dB of rated output. Noise $- 110$ dB. Mains: 100, 117, 220, 240V 50/60 Hz. 250W. Size: $7\frac{1}{8} \times 5\frac{3}{8} \times 17\frac{1}{2}$ in. Price: £90.

★**TA-4300.** Transistor 3 channel frequency divider. Stereo. Divides the audio signal into 3 frequency ranges for a 3-way amplifier/speaker system. 4-step selection of two crossover frequencies per channel. Controls: bass turnover, bass boost level, on/off, low frequency level (2), mid-range level (2), high frequency level (2).

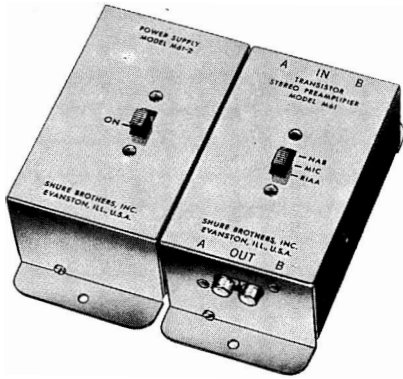

Shure M61/2



Sony I120

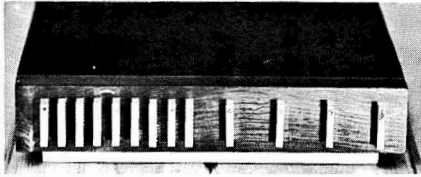

Sinclair Neoteric 60



Sony I080



Sinclair System 2000

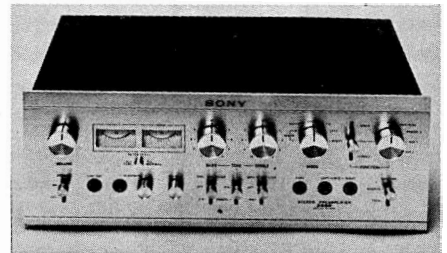

Sony TA2000

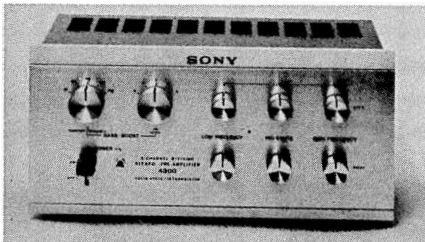

Sony TA4300

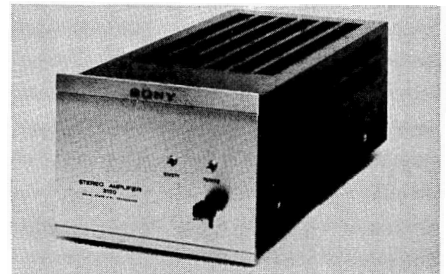

Sony TA3120

Output impedance: $<5K$. Distortion: $<0.1\%$ at 3V output. $<0.5\%$ at 5V output (for signals within the passband). Mains: 100, 110, 220, 240V 50/60 Hz. Size: $5\frac{7}{8} \times 11\frac{1}{8} \times 6\frac{1}{2}$ in. Price: £72 10s.



SOUNDTRACKS LTD., Decibel House, Charlwoods Road, East Grinstead, Sussex. Tel: East Grinstead 21332.



J. E. Sugden A21

SCS1010 solid state stereo amplifier. Power output: 7W, 4 ohms. HD 0.3% at 0.5W. 1.5% at 7W. FR 50 Hz-18 KHz + 3 dB at 0.5W. Feedback: 80 dB. N/L: -65 dB. Input voltage RMS: 200 mV. Output transistors: AD161/162. Psn 240V 50 Hz. Dimensions: $16 \times 7\frac{1}{2} \times 3\frac{1}{2}$ in. Inputs: gram, 100 mV 2M; aux, 100 mV 1M; tape, 100 mV 2M; each has noise level -65 dB overall. Controls: volume on/off, treble, bass, balance, input selector, scratch filter. Price: £34 3s. 5d.

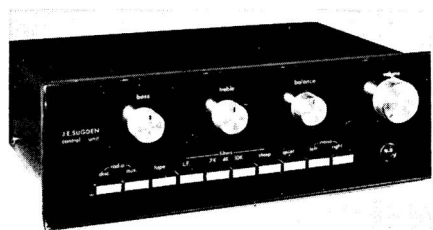

J. E. Sugden C51

SCS7074. Solid state stereo amplifier. Power output: 4W RMS, 12 ohms. HD 0.3% at $\frac{1}{2}$ W. FR 60 Hz-14 KHz ± 3 dB at 4W. Feedback: 60 dB. N/L: -55 dB. Input voltage RMS: 200 mV. Output transistors: AC128/176. Psn 240V 50Hz. Inputs: gram, 200 mV 1.8M; aux, 200 mV 1M; tape, 200 mV 1.8M; each at noise level -55 dB overall. Controls: volume, treble, bass, balance, input selector, on/off. Dimensions: $16 \times 7 \times 2\frac{1}{2}$ in. Price: £26 7s. 7d.



J. E. SUGDEN & CO. LTD., Bradford Road, Cleckheaton, Yorks. Tel: Cleckheaton 2501.



J. E. Sugden A51

★ **A21 SERIES TWO**. Transistor stereo integrated amplifier with class A output stages. Inputs: radio 150 mV 200K; tape 150 mV 200K; aux, 150 mV 200K. PU1, 2.5 mV 68K; PU2, 50 mV into special input circuit. Controls: bass ± 14 dB at 40 Hz; treble ± 14 dB at 10 KHz; treble filter 12 dB/octave above 7 KHz. Rumble filter 12 dB/octave below 45 KHz. Balance ± 6 dB for 180 degree rotation. Volume ± 1 dB per channel. Push-button selection for input and operating mode. Power output: 12W RMS per channel into 8 ohms, at clipping level. HD 0.25% at 10W. FR: 20 Hz-20KHz ± 1 dB. S/N 80 dB on radio, tape and aux., 70 dB on disc. Outlet to recorder: 150 mV. Size: $15\frac{1}{2} \times 5 \times 9$ in. Weight: 24 lb. Price: £56.

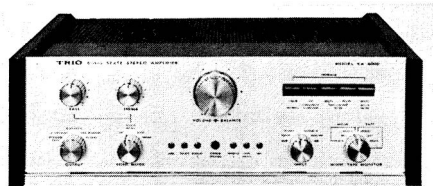

Trio KA-6000

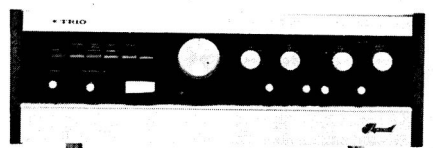

Trio Supreme I

★ **C51 control unit**. Transistorised stereo control unit designed for use with A51 power amplifier. Inputs: radio, tape and aux., each 150 mV into

250K flat response. PU1, 2.5 mV 68K. PU2, plug-in input adaptor for ceramic cartridge. Special input 250 μ V equalised to RIAA. Controls: bass ± 16 dB at 40 Hz, treble ± 12 dB at 10 KHz, volume ± 1 dB per channel, balance ± 6 dB for 180 degrees rotation. Rumble filter: 12 dB/octave below 30 Hz. Treble filter: 4 KHz, 7 KHz and 10 KHz. Treble filter slope: gradual 6 dB/octave, steep 18 dB/octave. HD better than 0.1% at rated output. S/N better than 85 dB on 150 mV inputs, better than 75 dB on PU2 input. Push-button selection of inputs and operating mode. Power: obtained from A51 power amplifier. Size: 10 \times 4 \times 6 in. Weight: 6 lb. 3 oz. Price: $\pounds 42$.

★**A51.** Power amplifier with Class A output stages designed for use with C51 control unit. Transistors. Output 25W per channel into 15 ohms. HD at 20W better than 0.1%. FR: 30 Hz-20 KHz ± 0.5 dB. S/N 90 dB 10K source. Sensitivity for 25W output: 600 mV. Input impedance 200K. Size: 13 $\frac{1}{2}$ \times 8 $\frac{1}{2}$ \times 10 in. Weight: 22 lb. Price: $\pounds 65$.

★

TELEFUNKEN. Distributor: A.E.G. (Great Britain) Ltd., Lonsdale Chambers, 27 Chancery Lane, London, W.C.2. Tel: 01-242 9944. Cables: Allgem. London.

V201. Stereo amplifier. 25W per channel at 4 ohms. HD: 0.3% at 1 KHz. FR: 20 Hz-22 KHz ± 1 dB, 17 Hz-35 KHz ± 3 dB. S/N ratio: 57 dB at max. volume. Headphones: 100-400 ohms. Output transistors: 2x2N2148 per channel. Psn 110-240V. Inputs: PU 320 mV, 500K; 7 mV, 60K; mic. 5 mV, 60K; tuner 320 mV, 500K; tape (record) 0.6 mV per kilohm; tape (playback) 320 mV, 500K. Controls: rumble filter, noise filter, linearity, stereo, extreme (stereo), on/off, input select buttons, volume, bass, balance, headphone/speaker. Size: 18 $\frac{1}{4}$ \times 6 \times 12 $\frac{3}{4}$ in. Price: $\pounds 153$ 19s. 4d.

V250. Stereo amplifier. 35W per channel at 4 ohms. HD 0.2% at 1 KHz. FR: 20 Hz-18 KHz ± 1.5 dB, 10 Hz-20 KHz ± 3 dB. Headphones: 100-400 ohms. Psn. 110-240V AC. Inputs: PU 300 mV 470K, 4.5 mV 47K; mic (2) 1.5 mV 47K; tuner 300 mV 470K; tape (record) 0.36 mV per kilohm; tape (playback) 300 mV 470K; tape monitor 300 mV 47K. Controls: rumble filter, noise filter, linearity, mic. mixing slide (2), bass slide (2), treble slide (2), volume slide (2), input select buttons. Size: 18 $\frac{1}{2}$ \times 5 \times 13 in. Price: $\pounds 89$ 5s.

TRIO. Distributed by: B. H. Morris & Co. (Radio) Ltd., 84-88 Nelson Street, London, E.1. Tel: 01-790 4824.

KA2500. Solid state integrated stereo amplifier. Inputs: PU(1) 2 mV, PU(2) 2 mV, tape head 2.5 mV, radio tuner 150 mV, aux 150 mV, tape play 150 mV. LF filter 80 Hz roll-off, HF filter 6 KHz roll-off. Bass control ± 11 dB at 50 Hz. Treble control ± 11 dB at 10 KHz. Volume control tracking error, within 3 dB. Output: 60W music at 4 ohms, 50W music at 8 ohms. 20W RMS per channel. HD 0.8%. FR 20 Hz-50 KHz ± 1 dB. Signal-to-noise: PU -60 dB, tuner -70 dB. Output impedance: 4, 8 or 16 ohms. Centre channel output. Automatic mains circuit breaker. Mains: 110-120V or 220-230V 50/60 Hz. Consumption 110W at full power. Size: 12 $\frac{1}{2}$ \times 4 $\frac{1}{8}$ \times 9 $\frac{1}{4}$ in. Weight: 13 lb. Price: $\pounds 52$.

★**Supreme I.** Solid state integrated stereo amplifier. Each channel employs separate bass, mid-range and high frequency amplifiers. Bass amplifier: 33W RMS per channel, FR 10 Hz-100 KHz. Mid-range amplifier: 23W RMS per channel, FR 100 Hz-100 KHz. High-frequency amplifier: 15W RMS per channel, FR 1-100 KHz. Total output: 142W RMS, 165W music. HD 0.5%. Signal-to-noise: 90 dB. Bass control: ± 12 dB at 100 Hz. Treble control: ± 12 dB at 10 KHz. LF filter, HF filter. Electronic cross-over network. Full details and specification on request. Price: $\pounds 298$.

★**KA2000.** Solid state integrated stereo amplifier. Power: 13W per channel (0.5% THD); 4, 8 or 16 ohms. IM distortion: 0.5% 3 dB. FR: 20 Hz-50 KHz ± 1 dB. S/N ratio: pickup 65 dB, aux 75 dB. Inputs: pickup 2.1 mV, aux 130 mV, tape play 130 mV. Damping factor: 40 (at 16 ohms), 20 (at 8 ohms). Bass control ± 11 dB at 100 Hz. Treble ± 11 dB at 10 KHz. Psn: 220-230V, 50 or 60 Hz, 20W with no signal, 55W at full power. Automatic circuit breaker protects power transistors. Dimensions: 4 $\frac{1}{8}$ \times 10 $\frac{1}{4}$ \times 9 $\frac{3}{8}$ in. Weight: 10 lb. Price: $\pounds 36$.

KA4000. Solid state stereo amplifier. Power output: 41W per channel at 4 ohms, 32W per channel at 8 ohms. HD less than 0.5%. FR: main amp, 18 Hz-50 KHz ± 1 dB; high level input 20 Hz-50 KHz ± 1 dB. Sensitivity at 8 ohms: pickups 1 and 2, 2 mV; tape head, 2.3 mV; mic, 2 mV; aux, tuner, tape play, 200 mV each; main amp input, 100 mV. S/N ratio: pickups 65 dB; tape head 63 dB; mic 67 dB; aux, tuner, tape play 77 dB. Output impedance at speaker terminal: 0.29 ohm at 1 KHz.

0.52 ohm at 50 Hz, 0.29 ohm at 10K. Damping factor: 55 at 16 ohms load; 27.5 at 8 ohms load. Low filter: 80 Hz cut-off, 12 dB per octave. High filter: 8 KHz cut-off, 12 dB per octave. Bass control: ± 10 dB at 100 Hz with 2 dB step switch. Treble control: ± 10 dB at 10 KHz with 2 dB step switch. Outputs: two pairs speaker outputs (4-16 ohms); pre-amp outputs, headphone jack, low level mono output, tape recording outputs, DIN standard tape rec/play connector, switched and unswitched AC outlets. Controls: input selector switch, mode/tape monitor switch, output selector switch, volume, balance, bass, treble, muting switch (-20 dB), loudness contour switch, low and high filter switches. Power consumption: 13W quiescent, 180W at full power. Dimensions: $5\frac{3}{8} \times 16\frac{5}{16} \times 11\frac{3}{8}$ in. Weight: 17.6 lb. Price: £78.

KA-6000. Stereo solid state integrated amplifier. FR: 20 Hz-20 KHz. Inputs: PU1, 2 mV, 50K, S/N 65 dB; 0.5 mV or 0.05 mV, 200 ohms, S/N 54 dB; PU2, 50K, S/N 65 dB; tape, 100K, S/N 63 dB; mic, 100K, S/N 67 dB; aux, 100K, S/N 77 dB. Main amp. input 300K. Switched controls; PU1: level selector, mode, tone, output, bass, treble, muting, loudness, low filter, high filter. Variable: volume, balance. Output (per channel): 64W at 4 ohms; 58W at 8 ohms; 42W at 62 ohms. Dimensions: $5\frac{5}{8} \times 16\frac{5}{16} \times 11\frac{1}{8}$ in., to match KT-7000 tuner. Weight: 24.5 lb. Psn: 110-120, 220-230V, 18-190W. Price: £105.

★

TRIPLETONE MANUFACTURING CO. LTD., 241a The Broadway, Wimbledon, S.W.19. Tel: 01-542 1189.

★**Gemini Series 3.** Integrated stereo amplifier. Inputs: PU 150 mV 1 megohm, radio 150 mV 1 megohm, tape 150 mV 1 megohm. Controls: bass ± 15 dB at 50 Hz, middle ± 12 dB at 400 Hz, treble ± 15 dB at 10 KHz. Volume, function selector, push-button on/off. Output: 4W RMS per channel. Output impedance: 2-3 and 15 ohms. FR 30 Hz-20 KHz ± 1.5 dB. Feedback 20 dB. Tape outlet: 1V 100K. H and N -70 dB. Two ECC83, two 6BW6, one EZ80. Size: $11 \times 6\frac{1}{2} \times 3\frac{3}{4}$ in. Weight: 10 lb. Price: £19 10s. (optional extra teak ends) £2 16s. 3d.

★**Hi-Fi Major Series 3.** Integrated mono amplifier. All transistor. Inputs: PU 80 mV 2 megohms, tape 80 mV 100K, radio 200 mV 200K. Controls: bass ± 18 dB at 30 Hz, middle ± 12 dB at -15 dB at 1 KHz, treble ± 18 dB at

10 KHz. Filter 7 KHz turn-over, 6 dB/octave slope. Output: 10W RMS. HD $<0.2\%$. FR 30 Hz-20 KHz $+1.5$ dB. Noise level: -60 dB. Output impedance: 15 ohms. Mains: 200-250V AC. Size: $11 \times 7\frac{1}{2} \times 3\frac{3}{4}$ in. Weight: 8 lb. Output transistors: two AD149. Price: £19 18s. 6d.

★**Solid State Stereo 8+8 Mk. II.** Integrated design with pre-amps, controls, twin power amplifiers. Inputs for disc, tape recorder and radio in stereo and mono. Top cut, low pass filter, treble, middle and bass controls. Output: 8W RMS per channel into 15 ohms, 10W RMS per channel into 8 ohms. Distortion: less than 0.2%. FR 30 Hz-20 KHz ± 1.5 dB. Sensitivity for 8W: pickups, ceramic, 80 mV into 2M; magnetic, 3.5 mV into 47K; tape, 80 mV into 100K; radio, 200 mV into 100K. Tape output: 200 mV into 100K ± 1 dB 15 Hz-30 KHz. H and N better than -60 dB all inputs. Size: chassis, $11 \times 7\frac{1}{2} \times 3\frac{3}{4}$ in.; cabinet, $13 \times 9 \times 5\frac{1}{2}$ in. Prices: chassis model for ceramic cartridge: £29 19s. 6d.; in case, £32 10s. Chassis model for ceramic or magnetic cartridge, £33 10s.; in case £35 17s. 6d.

Transistorised pre-amplifier Series 3. Mono or stereo version. Inputs for magnetic cartridges or tape heads. Various tape/disc combinations. S/N 70 dB. Equalisation ± 2 dB (RIAA or CCIR curve). Psn 200-300V or 40V DC. Octal plug or B9G connector. Size: $5 \times 2 \times 2$ in. Price (mono): £3 17s. 6d.; (stereo): £5 10s.

★

TRUVOX. Truvox Ltd., Hythe, Southampton. Tel: Hythe 3265.

★**TSA200.** Transistorised integrated stereo amplifier in teak cabinet or for panel mounting. Inputs: PU(1) 50 mV 100K, PU(2) 3.5 mV 50K, tape 100 mV 100K, radio 100 mV 100K, aux 100 mV 100K. Tape output: 200 mV into 22K. FR 20 Hz-20 KHz ± 1 dB at 10W. Bass control ± 15 dB at 50 Hz, treble control ± 15 dB at 14 KHz. Output 10W (RMS) per channel. HD $<0.25\%$ at 10W. Treble filter -10 dB at 12 KHz, bass filter -10 dB at 20 Hz. Mains: 100-120V, 200-250V 50/60 Hz. Size: $16 \times 6\frac{7}{8} \times 5\frac{1}{8}$ in. Weight: 13 lb. All-silicon transistors. Price: £54 12s.

★

VORTEXION LTD., 257/263 The Broadway, Wimbledon, London, S.W.19. Tel: 01-542 6242/3/4 and 2814. Cables: Vortexion, London, S.W.19.

CP50 Amplifier. A.C. Mains and 12-volt. The



*Tribo KA-2000 (top) with
KT1000 below*

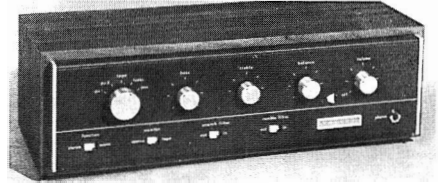

Truvox TSA200

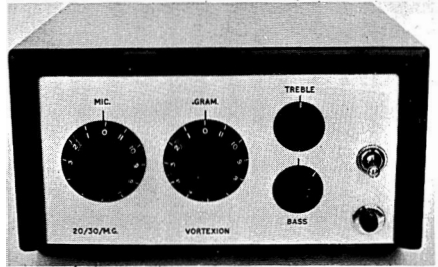

Vortexion 20/30W

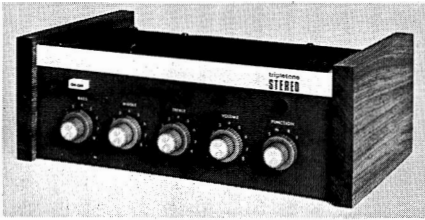

Tripletone Gemini

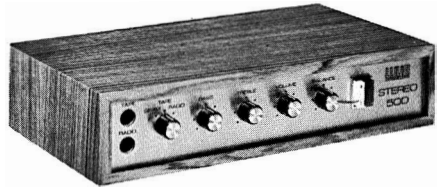

Wye Electronics Stereo 500

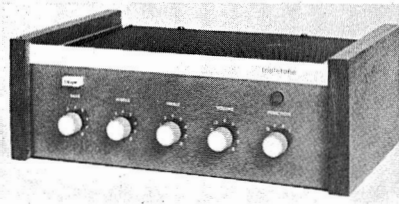

Tripletone Hi-Fi Major (Series 3)

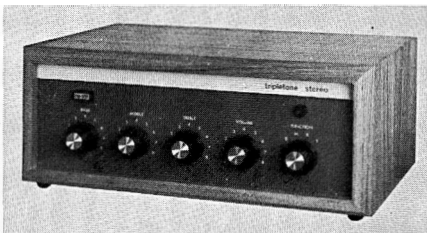

Tripletone Stereo 8+8 Mk II



Whiteley Stereo 30

CP50 is an all silicon transistor amplifier for mains and 12-volt battery use, with 8 Ω -15 Ω and 100-volt line output. The amplifier itself has overload or short circuit protection and all inputs have reasonable overload protection. Very large heat sinks are used with good ventilation and it is quite cool running on speech or music peaking 50 watts and even with over 40 watts of continuous sine wave the temperature conditions are not exceeded. The reservoir capacitor has been divided into 4 parts, each fused. The frequency response is within 3 dB from 25 Hz to 20 KHz and bass and treble controls are fitted, of 26 dB sweep each. This is housed in our durable steel case. Size: 18 \times 6 \times 11½ in. Battery consumption 3 amps. Weight: 35 lb. Prices: 1 PU and 2 low Mic. inputs £84. 1 PU and 3 low Mic. inputs £90. 4 low Mic. inputs £92.

★ **All Silicon Mixer Amplifier 20/30 Watt.** This is a high fidelity 'minimised' distortion transistor amplifier made possible by the latest types of silicon transistors. Since it gives 20 watts at 0.1% harmonic and 0.2% intermodulation distortion and less than 3 times this at 30 watts on 7½ it is suitable for high quality P.A. or High Fidelity use. No output transformer is fitted in this instance, but full overload protection is provided for this cool running amplifier which is suitable for continuous night and day operation and has a quiescent consumption of less than 4 watts from the mains. In the event of overload the output is instantly switched off until it ceases without blowing any fuses, the circuit operates far faster than any fuse. The response is within 1 dB from 20 Hz-20 KHz and feedback bass and treble controls have a total range of 24-26 dB each. It can be supplied for balanced line low impedance microphone (or high impedance at reduced prices) and the normal auxiliary or gram at 50 mV on 100K. Price: £35.

30/50 Watt Amplifier. Can deliver 50 watts of speech and music or over 30 watts of continuous sine wave. Main amplifier has response of 30 Hz-20 KHz \pm 1 dB; 0.15% distortion. Outputs 4, 7.5, 15 Ω and 100-volt line. Models are available with two, three, or four mixed inputs for low impedance balance line microphones, pick-up or guitar. Price with 4 mixed inputs: £88.

100 Watt All Silicon Amplifier. This is a high-fidelity amplifier for Audio frequencies featuring a new principle protection circuit, which is automatic on output overload, far faster than any fuse, and of course resetting when the signal is reduced. In addition a thermal cut-out is fitted which automatically switches off should

it be possible for any reason to take the heat sinks beyond the safe limits. The large heat sinks are funnel cooled to add efficiency, and when supplying 100 watts power at low to medium frequencies the output transistors only have to dissipate some 18 watts each and they are capable of over 100 watts each. These transistors also have a voltage rating double that required. Large output transistors are not satisfactory above 20 KHz, and since it is not required for audio purposes, the overload limits the power capacity to the safe power available at high frequencies. The response is level from 30 Hz to 15 KHz and 3 dB maximum down at 20 KHz. Outputs are for 8-15 ohms and 100-volt line. Harmonic distortion does not tell the whole story with transistor amplifiers, so in this case only the intermodulation distortion is given which is less than 0.5%. The input required is less than 0.5 volt on 100K Ω . Price: £70.

200 Watt Amplifier. Can deliver its full audio power at any frequency in the range of 30 Hz-20 KHz \pm 1 dB. Less than 0.2% distortion at 1 KHz. Can be used to drive mechanical devices for which power is over 120 watt on continuous sinewave. Input 1 mW 600 Ω . Psn: 100-120V or 200-240V. Additional matching transformers for other impedances are available. Price: £135.



WELBROOK. Welbrook Engineering & Electronics Ltd., Brooks Street, Stockport, SK1 3HT, Cheshire. Tel: 061-480 4268.

W.30. Stereo all-silicon transistor amplifier. Output: 15W per channel, 0.25 ohms. HD: 0.1% maximum at all output levels. FR: 30 Hz-30 KHz -1 dB. Feedback: 34 dB. Noise level: -60 dB. Input voltage RMS: 100 mV into 100K. Output transistors: four 2N3055. Psn: 210-240V, 50 Hz. Dimensions: 4½ \times 15 \times 9½ in. Inputs: PU, sensitivity adjustable up to 3 mV, 100K. NL: -60 dB; radio, sensitivity 100 mV, 100K, NL -70 dB; tape recorder, sensitivity 100 mV, NL: -70 dB. Controls: on/off rotary switch, volume, balance, bass (\pm 14 dB at 30 Hz), treble (\pm 14 dB at 15 KHz), input selector, rumble filter (12 dB per octave), scratch filter (12 dB per octave). Price: £48 plus £4 for cabinet.

AMP103. Mono or stereo solid state amplifier. HD: <0.1% at all levels. FR: 30 Hz-30 KHz -1 dB. Feedback: 34 dB. NL: -80 dB. Input voltage RMS: 100 mV into 100K. Output: 15W. Impedance: 0.25 ohms. Output transistors: two 2N3055. Psn: 45V at 0.7A. Dimen-

sions: $6\frac{1}{2} \times 3 \times 2\frac{1}{2}$ in. (stereo version). Control unit: any having 100 mV output. Prices: mono £8; stereo £15.



WHITELEY ELECTRICAL RADIO CO. LTD., Radio Works, Victoria Street, Mansfield, Notts. Tel: Mansfield 24762.

★**Stereo 30.** Stereo integrated amplifier. Power output: 15W per channel RMS into 15 ohms. Inputs: tape (3-pin DIN socket) 100 mV, 50K; microphone (2-pin jack socket) 15 mV, 50K; crystal pick-up, 100 mV, 120K; magnetic pick-up, 10 mV, 50K; radio, 150 mV, 50K. Output: tape (3-pin DIN socket) 1V. FR 20 Hz-20 KHz ± 1 dB. Distortion: less than 0.2% at 1 KHz. Damping factor: 100. Hum: 50 Hz-70 dB; 100 Hz -65 dB. Noise: -65 dB. Crosstalk: -65 dB. Tone controls: bass (50 Hz) +11 dB, -7 dB; treble (10 KHz) +10 dB -13 dB. Push-

button selection, on/off, mono stereo, reverse, microphone, tape, disc, radio. Price: chassis £63 15s. 6d.; with teak sleeve £66 6s.



WYE ELECTRONICS LTD., Queen Street North, Chesterfield, Derbyshire. Tel: Chesterfield 51116.

★**Stereo 500.** Transistorised integrated stereo amplifier. Inputs: tape, radio, ceramic pickup. Sensitivity: 50 mV into 1 megohm at 1 KHz for 10W output on all inputs. Output: 10W RMS per channel. Distortion: 1.5% at 10W into 4 ohms. Separation: 40 dB at 1 KHz and 10 KHz at 10W. Bass control +8 dB, -12 dB at 40 Hz. Treble control +3 dB, -8 dB at 12 KHz. FR 40 Hz-30 KHz ± 3 dB (tone controls level). 14 transistors. Output impedance: 4-15 ohms. Finish: rosewood or teak veneered shelf mounting cabinet. Size: $15 \times 9 \times 3\frac{1}{2}$ in. Price: £30 9s.



Floor shows at Largs!



GLARENDON—
Sheraton style by Largs. Rich curled mahogany finish. 3' 2½" long, 3' 1" high, 1' 7" deep. For extensive Hi-Fi equipment with ample record storage. Price (cabinet only) £98.

Certainly. Not the sort of words may suggest, but, quite literally, three separate floor shows—non-stop, with frequent changes of programme!

On our lower ground floor the show is *custom-built* Hi-Fi: probably the finest assembly ever under one roof of turntables, tape decks, pickups, amplifiers and speakers. Through our magnificent **COMPARATOR CONSOLE** you listen to countless combinations of different makes of them, varying the combination endlessly at the touch of a switch, till you infallibly settle on *the* link-up that fully satisfies you.

This is the show de luxe for the real Hi-Fi enthusiast. It includes the superlative Tannoy 'Autograph' speakers—the only stereo pair in any showroom in the country. (£335 the pair, incidentally).

On the ground floor, one show features radiograms and a variety of speakers to partner them. Our new 'Mini-Comparator' allows you to compare, at a split second's interval, the performances of up to 25 different pairs of speakers with any particular 'gram.

Another section of the ground floor shows conventional radiograms, with their own built-in speakers. 'Package deals', of course: no variations of the link-ups is practicable. But every one of them has been stringently tested and passed by our technicians.

And, as well as these 'sectionalised' shows, on both floors you'll find many examples of the beautiful furniture we make to house your custom-built Hi-Fi.

Come along to Largs and look and listen!

Delivery and normal installation are free within 20 miles of London: so is Largs technical know-how for any servicing required within 12 months. Send for our booklet "Traditional Furniture" (or, if you have modern tastes, ask for our "Contemporary" brochure).

LARGS

of Holborn for High Fidelity

Now probably the best showrooms in the world for choosing a good radiogram.

76-77 HIGH HOLBORN, LONDON, W.C.1.
01-242 2626 (PBX)

SIMPLY SUPERB!

the new brenell...

MODEL ST STEREO

Probably the most important new recorder of the year!



The new ST400/200 recorders are different from all previous Brenells. All transistorized electronics; shelf-mounting cabinet; simplified controls. Sound quality is even better than ever—as good as you can hear. Three-motor deck performance and reliability; quality components throughout. All usual facilities are available.

ST400/200 recorders are designed to give you exactly what you expect from a Brenell today.

Only the price is less than you may expect . . . £145 recommended. You pay no import duties . . . no high selling costs . . . only for a top-quality recorder, well made. It's a fine formula!

- Mono or stereo operation
- Choice of 2 or 4-track models
- 3 outer-rotor motors
- 3 tape speeds
- 2 recording level meters
- Full input/output and control facilities

A range of Brenell mono and stereo recorders is available, together with Brenell deck and tape-link.

brenell

BRENELL ENGINEERING COMPANY LTD.

231/5 Liverpool Road, London, N.1. Telephone: 01-607 8271

NATO, RN, NASA, BBC, use Uher tape-recording equipment.

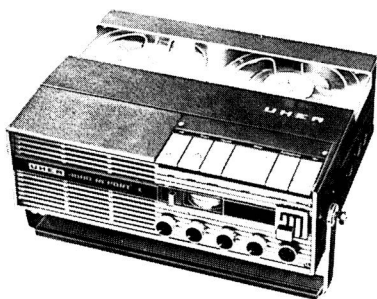

4000 REPORT SERIES

Three different models of the Uher 'Report' are now available.

4000 Report-L 2 Tracks to international standards. Reels diam.—5". Speeds (ips) $\frac{1}{8}$, $1\frac{7}{8}$, $3\frac{3}{4}$, $7\frac{1}{2}$. Frequency range (cps) 40-4, 500; 40-10,000; 40-16,000 and 40-20,000. Wow and flutter (max \pm %) 0.2 at $7\frac{1}{2}$ ips. Record/playback half-track mono. Power output one watt. Monitoring via headphones or speaker. VU meter + three digit tape counter. Tape stop-start remote control, electronically controlled motor. Power supply from 6V, 12V, 24V car battery, from rechargeable accumulator or 5 type L.P. U2 batteries or mains unit. 17 transistors. Inputs: Microphone :- .1mv at 200 ohms. Radio :- 2mv at 47K ohms. Pick up :- 30mv at 1 megohm. Weight 6 lbs (approx.) 127 gns. incl. P.T.

4200 Report Stereo Affording all the advantages of the successful 4000 Report-L in size, style and specifications—plus stereo. 155 gns. incl. P.T.

4400 Report Stereo Again with all the advantages of the 4000 Report-L—plus stereo and maximum economy of tape on four tracks without deterioration of reproduction quality. 155 gns. incl. P.T.



ROYAL DE LUXE STEREO

Horizontal or vertical operation. Optimal hi-fi quality. Four track operation (convertible to two track). 2 x 10 watts power output. Straight through amplifier operation. Built-in dia pilot for automatic slide projection. Switchable A-B monitoring. Mixing and echo facilities. Multi-play Syncro-play and physiological volume control. Four speeds—to mention some of its facilities. 242 gns. incl. P.T.

UHER

DISTRIBUTED IN THE U.K. BY

BOSCH

Hear it all- on the Grundig SV 140 amplifier and the RT 100 tuner

Designed with the true sound connoisseur in mind, these two magnificent instruments incorporate all the latest developments in electronic sound engineering.

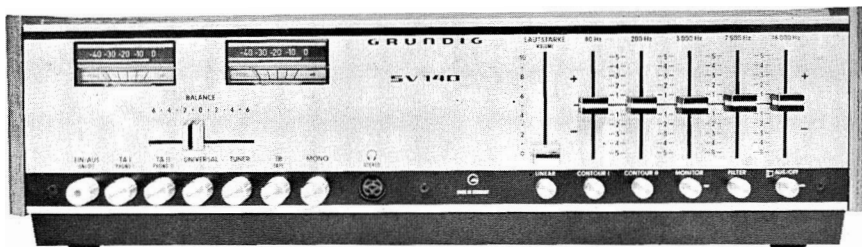

The SV 140, equipped with 51 transistors, 20 diodes and three rectifiers, is a hi-fi amplifier of unprecedented performance. Delivering 2 x 50 W continuous rating (2 x 70 W music power) it gives you the whole sound, the full sound—with a distortion factor of *less than 0.5%* at full power, over the full frequency range.



The RT 100 is a multi-band hi-fi tuner with a total of 45 transistors, 35 diodes and 2 rectifiers. It has five wavebands—LW, MW, 2 SW and VHF (FM). The separate AM and FM sections are designed for maximum efficiency, and the RT 100 also features the unique Grundig Super Tunoscope, automatic frequency control, short wave fine tuning, AM bandwidth selection and built-in AM and FM aerials.

The SV 140 and RT 100 are at your local Grundig showrooms now. Go along and hear it all.

Hear it all on



Grundig (Great Britain) Ltd., London SE26.
A member of the British Industrial Holdings Group.

DIRECTORY OF TAPE RECORDERS

★ The abbreviations used for the specifications in this directory are as follows: **FR**=frequency response; **i/s**=inches per second; **Psn**=power supply needed; **>**=better than; **ME**=magic eye; **W** and **F**=wow and flutter; **Replay char**=replay characteristic; **H** and **N**=hum and noise. ★ indicates model is illustrated.

AKAI. U.K. distributors: Pullin Photographic (Rank Organization), P.O. Box 70, Great West Road, Brentford, Middx. Tel: 01-568 9222.

★**M9.** Stereo tape recorder. $\frac{1}{4}$ -track. Speeds: $1\frac{7}{8}$, $3\frac{3}{4}$, $7\frac{1}{2}$ and 15 i/s. Max spool capacity: 7 in. W and F $7\frac{1}{2}$ i/s 0.1%; $3\frac{3}{4}$ i/s 0.13%; $1\frac{7}{8}$ i/s 0.2%. H and N -50 dB. FR $7\frac{1}{2}$ i/s 30 Hz-23 KHz ± 3 dB; $3\frac{3}{4}$ i/s 30 Hz-18 KHz ± 3 dB; $1\frac{7}{8}$ i/s 30 Hz-9 KHz ± 3 dB. Replay characteristics: NARTB. Level indicator: two VU meters. Rewind time: 1,200 ft 90 sec. Inputs: microphone, 0.5 mV; line, 60 mV; DIN, low 5 mV, high 50 mV. Outlets: line, DIN, headphone. Audio output: 10W per channel RMS. Speakers: two 4 in. monitor. Transistorised. Motor: hysteresis synchronous 2-speed. Tape deck: own. Dimensions: $20 \times 13 \times 9\frac{1}{2}$ in. Weight: 41.8 lb. Superimposing. Pause. Position indicator: digit. Straight through amplifier. Monitoring. Input mixing. Parallel track replay. Crossfield head. Auto stop. Auto shut off. Auto pinch wheel release. Tape cleaner. FM multiplex ready. Vertical or horizontal operation. Psn 100-240V, 50 or 60 Hz. Price: £155 19s. 5d. (plus £39 0s. 7d. PT).

★**X-330.** Stereo tape recorder. $\frac{1}{4}$ -track. Speeds: $1\frac{7}{8}$, $3\frac{3}{4}$ and $7\frac{1}{2}$ i/s. Max spool capacity: $10\frac{1}{2}$ in. W and F $7\frac{1}{2}$ i/s 0.04%; $3\frac{3}{4}$ i/s 0.07%; $1\frac{7}{8}$ i/s 0.15%. H and N -50 dB. FR $7\frac{1}{2}$ i/s 30 Hz-25 KHz ± 3 dB; $3\frac{3}{4}$ i/s 30 Hz-18 KHz ± 3 dB; $1\frac{7}{8}$ i/s 30 Hz-9 KHz ± 3 dB. Replay characteristics: NARTB. Level indicator: meter. Rewind time: 1,200ft 75sec. Inputs: microphone, 0.5mV; line, 50 mV; DIN, 10 mV. Outlets: line, DIN, headphone. Audio output: 12W per channel RMS. Speakers: two 6 x 4 in. Transistorised. Motors: one hysteresis synchro 3-speed and two 6-pole eddy current. Tape deck: own. Dimensions: $14\frac{3}{4} \times 17\frac{1}{8} \times 9\frac{3}{8}$ in. Weight: 48.4 lb. Superimpose. Position indicator: digit, programme. Straight through amplifier. Monitoring. Input mixing. Parallel track replay. Auto continuous reverse by program sensing tape reverse. Input for magnetic PU cartridge. Magnetic brake auto stop. Auto shut off. Remote control. Standard or low noise tape selector. Psn 100-240V. Price: £259 19s. (plus £65 1s. PT).

★**X-360.** Professional stereo tape recorder. $\frac{1}{4}$ -

track. Speeds: $1\frac{7}{8}$, $3\frac{3}{4}$ and $7\frac{1}{2}$ and 15 i/s. Max spool capacity: 7 in. W and F $7\frac{1}{2}$ i/s 0.04%; $3\frac{3}{4}$ i/s 0.07%; $1\frac{7}{8}$ i/s 0.15%. H and N -50 dB. FR $7\frac{1}{2}$ i/s 30 Hz-23 KHz ± 3 dB; $3\frac{3}{4}$ i/s 30 Hz-18 KHz ± 3 dB; $1\frac{7}{8}$ i/s 40 Hz-11 KHz ± 3 dB. Replay characteristics: NARTB. Level indicator: two meters. Rewind time: 1,200 ft 75 sec. Inputs: microphone, more than 0.5 mV; line more than 50 mV; DIN, low 5 mV, high 50 mV. Outlets: line and DIN. Audio output 15W per channel RMS. Speakers: two 5 in. Transistorised. Motors: one 3-speed hysteresis synchronous, two 6-pole eddy current, outside rotor. Tape deck: own. Dimensions: $17\frac{1}{2} \times 16 \times 10$ in. Weight: 61.6 lb. Superimpose. Position indicator: digit. Straight through amplifier. Monitoring. Input mixing. Parallel track replay. Crossfield head. Auto reverse by timing clock. Comput-o-Matic recording. Warning light when heads require cleaning. Remote control. Tape cleaner. Headphone jack. Auto stop. Auto shut off. Magnetic brakes. Psn 100-240V, 50 or 60 Hz. Price: £287 2s. 10d. (plus £71 17s. 2d. PT).

★**X-1710W.** Stereo tape recorder. $\frac{1}{4}$ -track. Speeds: $1\frac{7}{8}$, $3\frac{3}{4}$ and $7\frac{1}{2}$ i/s. Max spool capacity: 7 in. W and F $7\frac{1}{2}$ i/s 0.12%; $3\frac{3}{4}$ i/s 0.15%. H and N -50 dB. FR $7\frac{1}{2}$ i/s 50 Hz-15 KHz ± 3 dB; $3\frac{3}{4}$ i/s 40 Hz-14 KHz ± 3 dB. Replay characteristics: NARTB. Level indicator: meter. Rewind time: 1,200 ft 150 sec. Inputs: microphone, 1.5 mV, 2.2 ohms; line 700 mV, 100K. Outlets: line and headphone. Audio output: 2W per channel RMS. Speakers: two 7 x 5 in. Hybrid valves/transistors. Induction motor. Tape deck: own. Dimensions: $14\frac{1}{8} \times 13\frac{1}{2} \times 7\frac{1}{2}$ in. Weight: 33 lb. Pause. Position indicator: digit. Monitoring by headphones. Input mixing. Vertical or horizontal operation. Psn 100-240V, 50 or 60 Hz. Price: £87 3s. 8d. (plus £21 16s. 4d. PT).

★**X-1800.** Stereo tape recorder. $\frac{1}{4}$ -track. Speeds: $3\frac{3}{4}$ and $7\frac{1}{2}$ i/s. Max spool capacity: 7 in. W and F $7\frac{1}{2}$ i/s 0.12%; $3\frac{3}{4}$ i/s 0.15%; cartridge $3\frac{3}{4}$ i/s 0.25%. H and N -50 dB, cartridge -45 dB. FR $7\frac{1}{2}$ i/s 50 Hz-15 KHz ± 3 dB; $3\frac{3}{4}$ i/s 40 Hz-14 KHz ± 3 dB. Replay characteristics: NARTB. Level indicator: meter. Rewind time: 1,200 ft 180 sec. Inputs: microphone, 1 mV 50K; line, 60 mV. Outlets: line and headphone. Audio

AMPLIFIERS · TUNERS · DRIVE UNITS · ENCLOSURES

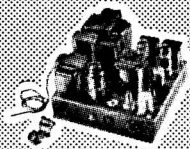
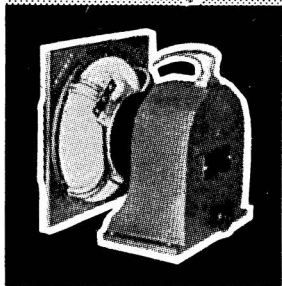
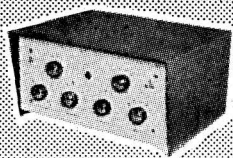

**DESIGNERS AND
MANUFACTURERS
OF HIGH QUALITY
SOUND
REPRODUCING
EQUIPMENT
SINCE
1932**

LOWTHER

THE LOWTHER MANUFACTURING COMPANY

LOWTHER HOUSE · ST. MARK'S ROAD · BROMLEY · KENT · TELEPHONE RAVENSBORNE 5225

TRIO

Amplifiers-Tuners-Tuner-
Amplifiers-Tape Equipment

TEAC

PROFESSIONAL AND SEMI-
PROFESSIONAL TAPE RECORDERS

AUDIO DEVELOPMENT

Magnetic Cartridges-Pick up arms

SONICS

HIGH FIDELITY LOUDSPEAKERS

Please see the respective sections of this book for the current range of units by each of these manufacturers. Ask at your local stockists for news of new models or write to us for full information on the equipment which interests you.

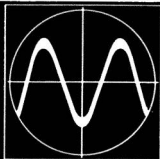

exclusive United Kingdom distributors

b. h. morris & co. (radio) ltd

84-88 Nelson Street, London E.1 Tel: 01-790 4824

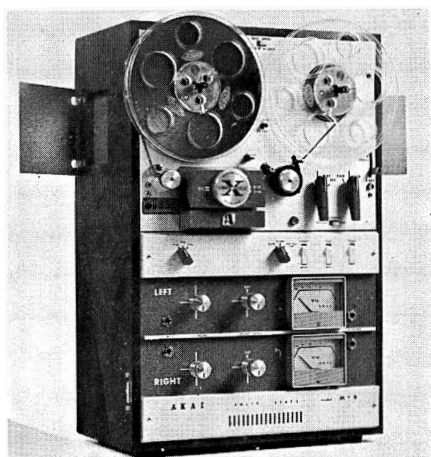

Akai M-9

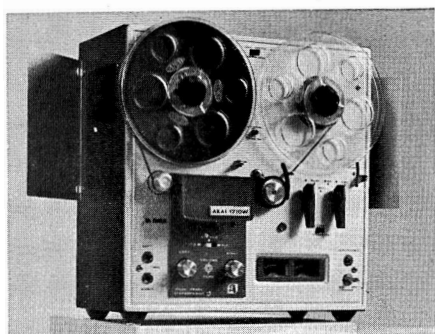

Akai 1710W

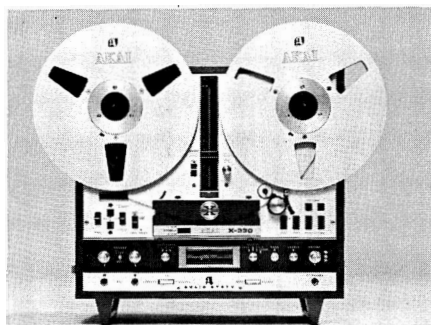

Akai X-330

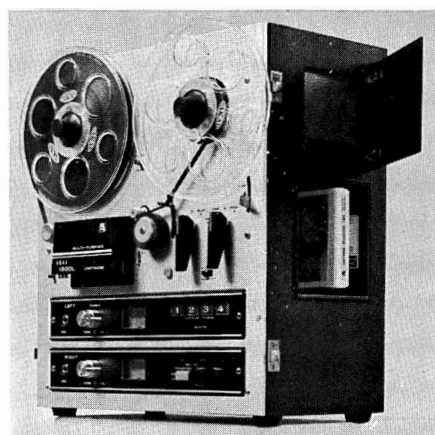

Akai 1800



Akai A360D



Akai 1800

TAPE RECORDERS

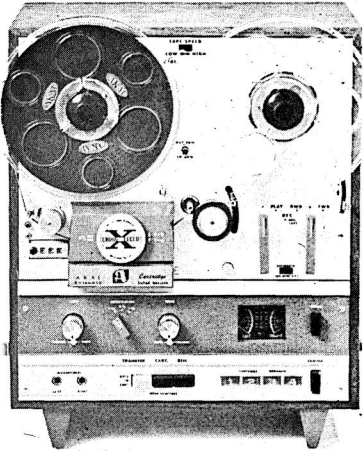

Akai X-1800SD

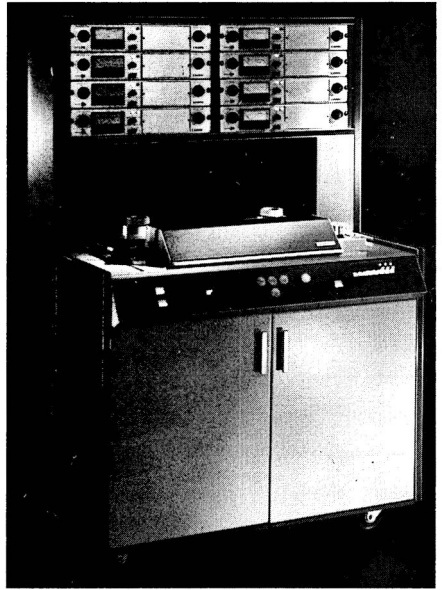

Ampex MM1000

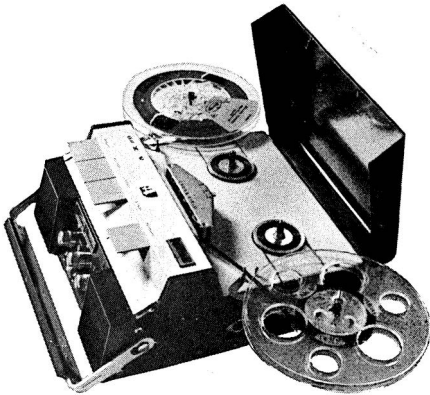

Akai X-V

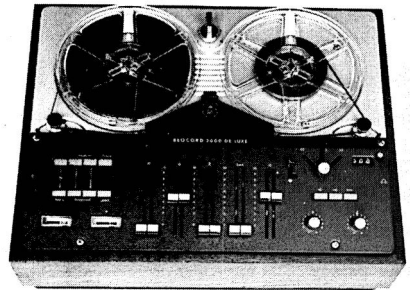

Bang & Olufsen 2000 de luxe



Ampex AG440B

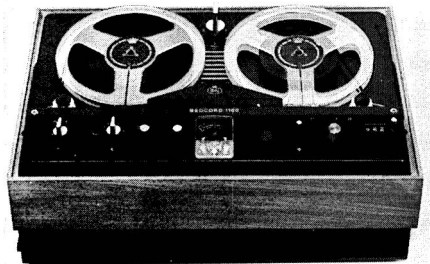

Bang & Olufsen Beocord 1100

output: 2W per channel RMS. Speakers: two 4 in. Hybrid valves/transistors. Induction motor. Tape deck: own. Dimensions: $15\frac{3}{8} \times 13\frac{3}{4} \times 10\frac{1}{2}$ in. Weight: 36.3 lb. Pause. Position indicator: digit. Monitoring headphone. Input mixing. Includes record and replay facilities for 8-track cartridges in addition to reel-to-reel. Reel to cartridge transfer. FM multiplex ready. Price: £126 7s. 6d. (plus £31 12s. 6d. PT).

★**X-1800SD.** Stereo tape recorder. $\frac{1}{4}$ -track. Speeds: $1\frac{7}{8}$, $3\frac{3}{4}$, $7\frac{1}{2}$ and 15 i/s with adaptor. Max spool capacity: 7 in. W and F $7\frac{1}{2}$ i/s 0.12%; $3\frac{3}{4}$ i/s 0.15%; $1\frac{7}{8}$ i/s 0.2%; cartridge 0.25%. FR $7\frac{1}{2}$ i/s 30-23 KHz ± 3 dB; $3\frac{3}{4}$ i/s 30 Hz-18 KHz ± 3 dB; $1\frac{7}{8}$ i/s 30 Hz-9 KHz ± 3 dB; cartridge 50 Hz-17 KHz ± 3 dB. H and N -50 dB. Replay characteristics: NARTB. Level indicator: VU meter. Rewind time: 1,200 ft 150 sec. Inputs: microphone 0.5 mV, 50K; line, 60 mV. Outlets: line and headphone. Audio output: 4W per channel RMS. Speakers: two 4 in. Transistorised. Motor: 2-speed induction. Tape deck: own. Dimensions: $15 \times 13\frac{1}{2} \times 9\frac{1}{2}$ in. Weight: 37.4 lb. Pause. Position indicator: digit. Straight through amplifier. Monitoring. Input mixing. Record and replay facilities for 8-track cartridges in addition to reel-to-reel. Reel to cartridge transfer. FM multiplex ready. Cross-field head. Walnut cabinet. Psn 100-240V, 50 or 60 Hz. Price: £159 3s. 5d. (plus £39 16s. 7d. PT).

★**X-V.** Stereo mains/battery tape recorder. $\frac{1}{4}$ -track. Speeds: $\frac{1}{8}$, $1\frac{7}{8}$, $3\frac{3}{4}$ and $7\frac{1}{2}$ i/s. Max spool capacity: 5 in. (7 in. with extension arms). W and F $7\frac{1}{2}$ i/s 0.15%; $3\frac{3}{4}$ i/s 0.17%; $1\frac{7}{8}$ i/s 0.25%; $\frac{1}{8}$ i/s 0.35%. H and N DC -50 dB; AC -45 dB. FR $7\frac{1}{2}$ i/s 40 Hz-20 KHz ± 3 dB; $3\frac{3}{4}$ i/s 40 Hz-17 KHz ± 3 dB; $1\frac{7}{8}$ i/s 30 Hz-11 KHz ± 3 dB; $\frac{1}{8}$ i/s 30 Hz-5 KHz ± 3 dB. Replay characteristics: NARTB. Level indicator: meter. Rewind time: 600 ft 90 sec. Inputs: microphone, 0.1 mV, 600 ohms; line 60 mV, 250K; DIN. Outlets: line and earphone. Audio output: 1W per channel RMS. Speakers: two 3 in. Transistorised. Motor: brushless DC micro. Tape deck: own. Dimensions: $5\frac{5}{8} \times 11 \times 12$ in. Weight: 12.1 lb. Position indicator: digit. Monitoring by earphone. Crossfield head. Stereo record/playback. Psn 100-240V or DC battery. Price: £143 19s. 5d. (plus £36 0s. 7d. PT).

★

AMPEX. Ampex Great Britain Ltd., 72 Berkeley Avenue, Reading. RG 6HZ. Tel: Reading 55341.

★**Ampex AG-440 Series.** Transistorised professional recorders. Console, portable or rack mounted. Tape transport accommodates $\frac{1}{4}$ in. and $\frac{1}{2}$ in. tape. Modular construction allows mono machine to be built up to four-track $\frac{1}{2}$ in. unit. Speeds: $15\frac{7}{8}$ i/s and $7\frac{1}{2}/3\frac{3}{4}$ i/s. Three motors. $10\frac{1}{2}$ or $11\frac{1}{2}$ in. spools FR 30 Hz-18 KHz ± 2 dB. H and N -68 dB (full track unweighted). W and F <0.08% RMS. Eight-track versions on 1 in. tape available. Prices on application.

Ampex AG-600. Transistorised professional portable recorder. Speeds: $7\frac{1}{2}$ and $3\frac{3}{4}$ i/s. One motor. 7 in. spools. FR 40 Hz-10 KHz ± 2 dB. Large scale VU meter. H and N -60 dB full track, -55 dB half track. W and F less than 0.15%. Size: $16\frac{1}{2} \times 13\frac{3}{4} \times 8$ in. Weight: 28 lb. Price on application.

Ampex AG-600-2. Stereo version of Ampex AG-600. Size: $24\frac{1}{2} \times 13 \times 8$ in. Weight: 42 lb. Price on application.

AG-500. Transistorised professional recorder. Stereo or mono versions. Full or half-track. $\frac{1}{4}$ -track version available shortly. Speeds: 15 and $7\frac{1}{2}$ i/s or $7\frac{1}{2}$ and $3\frac{3}{4}$ i/s. W and F 15 i/s 0.1%; $7\frac{1}{2}$ i/s 0.13%; $3\frac{3}{4}$ i/s 0.17%. H and N -60 dB at 15 and $7\frac{1}{2}$ i/s full track. FR: 15 i/s, 30 Hz-15 KHz ± 2 dB; $7\frac{1}{2}$ i/s, 30 Hz-12 KHz ± 2 dB. Replay char NAB/CCIR (15 i/s only) with plug-in equalisers. Various inputs by plug-in transformers and preamps. Outlet from preamp +4 dBm into 600 ohms. One motor. 7 in. spool. Rewind $1\frac{1}{2}$ mins. VU meter. Remote control. Size (transport): $19 \times 8\frac{3}{4} \times 6$ in.; (electronics): $19 \times 5\frac{1}{2} \times 5\frac{5}{8}$ in. Weight (unmounted): 44 lb; (in case) 53 lb. Price on application.

Ampex markets a full range of professional and semi-professional taperecording equipment, including decks, amplifiers, mixers, duplicators and accessories. Full details and prices available on request.

★

BANG & OLUFSEN U.K. DIVISION, Eastbrook Road, Gloucester. Tel: Gloucester 21591.

★**Beocord 2000K De Luxe.** All-transistor three-speed recorder. $\frac{1}{2}$ -track record, $\frac{1}{4}$ - and $\frac{1}{2}$ -track playback. Speeds: $7\frac{1}{2}$, $3\frac{3}{4}$, $1\frac{7}{8}$ i/s. Max spool 7 in. FR at $7\frac{1}{2}$ i/s 40 Hz-16 KHz ± 2 dB. Fast wind: $2\frac{1}{2}$ mins LP tape. Inputs: mic 50 μ V 50-200 ohms, PU 2 mV 47K, PU 40 mV 4 megohms, radio 5 mV 47K, radio 100 mV 100K, line 250 mV 50K. Outlets: line 600 mV 10K, speakers 4 ohms.

phones: 5-500 ohms. Output: 8W RMS per channel. Output impedance 4 ohms. Available in portable carrying case or on plinth. Price: (portable) £132 10s. (plus £33 5s. PT); (plinth) £127 13s. 9d. (plus £32 3s. 9d. PT).

★**Beocord 1100.** $\frac{1}{2}$ -track mono recorder. 7 in. spools. Speeds: $7\frac{1}{2}$, $3\frac{3}{4}$, $1\frac{7}{8}$ i/s. FR at $7\frac{1}{2}$ i/s 40 Hz-16 KHz ± 2 dB. DIN 1962 replay char. VU meter. Fast rewind 150 sec/1,800 ft. Inputs: mic 35 μ V 50/200 ohms. Radio 1.6 mV 47K, gram 2 mV 47K or 75 mV 2.2 M. Outputs: ext speaker 10W 4 ohm. radio 0.6V max 4.7K. Int L.S. 3W 3×8 in. Pause. 3 digit counter. straight-through amplifier. Auto or manual record level. Bass and treble controls. Dust cover. Mains: 110.130. 220.240V 50 Hz. Size: $17\frac{7}{8} \times 11\frac{7}{8} \times 7\frac{1}{2}$ in. Weight: 28 $\frac{1}{2}$ lb. Price: (teak) £67 14s. 9d. (plus £17 0s. 3d. PT).

Beocord Trolley. For mounting Beocord tape recorders. Stainless steel with castors and single column stem. Price: £11 13s. 3d.



BRAUN AG. Distributors: Fi-Cord International, Charlwoods Road, East Grinstead, Sussex. Tel: East Grinstead 21351.

TG.60. Semi-professional stereo tape recorder. Speeds: $3\frac{3}{4}$, $7\frac{1}{2}$ i/s. Three motors. Automatic tape tension fine adjustment. Servo brakes. Capstan drive motor and head-support rigidly mounted on robust diecast bridge. $\frac{1}{2}$ -track record and playback. Three heads. Separate dual channel record and playback amplifiers. All transistor. Pushbutton operation via relays and magnetic circuits. Operates in any position. FR 20 Hz-20 KHz at $7\frac{1}{2}$ i/s. Distortion at full recording level below 3%. SN better than 55 dB. W and F below 0.1%. Size: $6\frac{5}{8} \times 16\frac{1}{2} \times 11$ in. Mains 220V 50 Hz. Price: £303 (including PT).

TG502. Half-track stereo unit. Full details and specification on request. Price: £345 2s.

TG504. Quarter-track stereo unit. Full details and specification on request. Price: £345 2s.

TG502/4. Half-track unit with additional quarter-track playback head. Full details and specification on request. Price: £358.

TG550. stereo tape recorder. Fully transistorised. Design and performance follow TG502/4. with additional connection for remote control of all functions. Multiplay, mixable inputs for microphone, radio and pickup, out-

puts for amplifier (radio) and headphones. Cabinet, steel with charcoal wrinkle lacquer finish, cover plate in aluminium. lid in perspex. Dimensions: $6\frac{5}{8} \times 16\frac{7}{8} \times 12\frac{5}{8}$ in. Accessories: remote control TGF2. Price: £383 9s. 11d.



BRENNEL ENGINEERING CO. LTD., 231-5 Liverpool Road, London, N.1. Tel: 01-607 8271 (5 lines).

★**Mk 5. Type M. Series 3.** Speeds: 15, $7\frac{1}{2}$, $3\frac{3}{4}$, $1\frac{7}{8}$ i/s. Three motors. $8\frac{1}{4}$ in. spools. FR 15 i/s, 40 Hz-20 KHz; $7\frac{1}{2}$ i/s, 40 Hz-18 KHz; $3\frac{3}{4}$ i/s, 40 Hz-13 KHz; $1\frac{7}{8}$ i/s, 40 Hz-6 KHz. Level meter. H and N -45 dB. W and F $1\frac{7}{8}$ i/s, <0.25%; $3\frac{3}{4}$ i/s, <0.15%; $7\frac{1}{2}$ i/s, <0.1%; 15 i/s, <0.05%. Outlet from pre-amp. Mixing. Superimposing. Tape monitoring. Input monitoring. Size: $18 \times 18 \times 9$ in. Weight: 40 lb. Price: £107 8s. (plus £26 17s. 6d. PT).

Mk 5. Series 3. 15, $7\frac{1}{2}$, $3\frac{3}{4}$ and $1\frac{7}{8}$ i/s. Three motors. $8\frac{1}{4}$ in. spools. FR 15 i/s, 40 Hz-15 KHz ± 2 dB; $7\frac{1}{2}$ i/s, 40 Hz-14 KHz; $3\frac{3}{4}$ i/s, 40 Hz-11 KHz; $1\frac{7}{8}$ i/s, 40 Hz-6 KHz ± 3 dB. ME level ind (Meter available). H and N -45 dB. W and F 0.05% at 15 i/s. Hi-fi outlet 500 mV into 47K. Straight-through amp. Switched frequency correction. Pause control and monitoring. Size: $18 \times 18 \times 8$ in. Weight: 38 lb. Price: £85 9s. (plus £21 7s. 7d. PT); (with meter) £91 5s. (plus £22 16s. 8d. PT).

STB2. Stereo/mono recorder. See Tape Units

★**ST200.** Transistorised tape recorder for general-purpose (mains) use. Speeds: $1\frac{7}{8}$, $3\frac{3}{4}$ and $7\frac{1}{2}$ i/s. 2-track. Stereo. W and F $7\frac{1}{2}$ 0.08%. $3\frac{3}{4}$ 0.1% $1\frac{7}{8}$ 0.12%. H and N $7\frac{1}{2}$ -59 dB, $3\frac{3}{4}$ -56 dB, $1\frac{7}{8}$ -53 dB. FR $7\frac{1}{2}$ 40 Hz-14 KHz, $3\frac{3}{4}$ 40 Hz-11 KHz, $1\frac{7}{8}$ 40 Hz-5 KHz, each ± 2 dB. CCIR. Two meters. Rewind time: 1.200 ft 60 secs. Inputs: microphone, 50 μ V, 200 ohms; radio 40 mV, 220K. Outlets: hi-fi 200 mV into 47K; monitor 2V, 100 ohms; extension speaker 6W RMS, 15 ohms. Output: 6W RMS. Speaker: $3\frac{1}{2}$ in. Three Papst motors. Own tape deck. Dimensions: $15\frac{3}{4} \times 17\frac{3}{4} \times 8\frac{1}{4}$ in. Weight: 33 lb. Pause facility. Press-button reset revolution counter. Straight through amplifier on mono. mono monitoring of input signal. Bass and treble cut and lift on recording and replay. 210V, 240V, 110V, 80W. Price: £116 (plus £29 PT).

★**ST400** is the 4-track version of the previous model. Specification is the same except for: H



Brenell Mk 5 Series 3 Type M

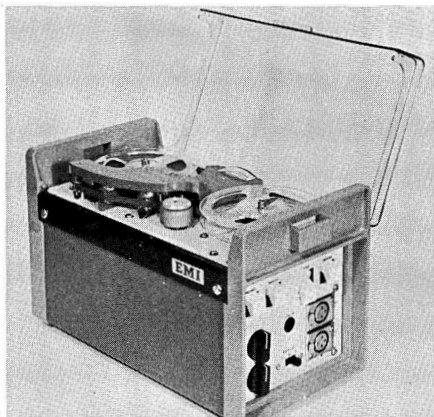

EMI L4



Brenell ST200/ST400

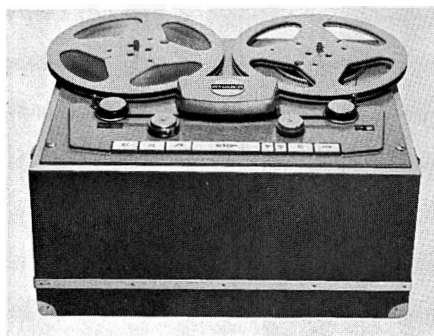

EMT-Studer A62



Crown 800

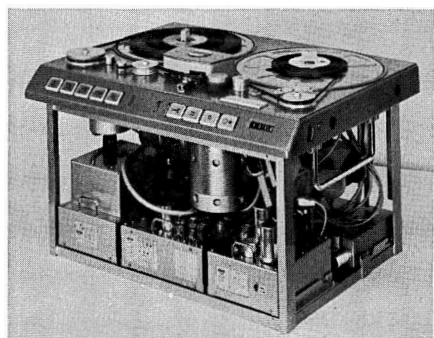

EMT-Studer C37

and N 7½-56 dB; 3¾-53 dB; 1⅞-50 dB. Price: £116 (plus £29 PT).



CHILTON. Magnetic Tapes Ltd., Chilton Works, Garden Road, Richmond, Surrey. Tel: 01-876 7957.

100S. Transistorised stereo ¼ or ½-track recorder. Speeds: 7½, 3¾, 1⅞ i/s. Inputs: mic 150 µV 50-200 ohms, gram 5 mV 47K (alternative input for ceramic or crystal PU). Outputs: two line at 1V 600 ohms, two 10W RMS at 8 ohms or two 7W RMS at 15 ohms. Full remote control. Two PPM calibrated in dBs. Solenoid operation by light touch buttons. Interlocked controls. Tension rollers. Auto-stop. Heavy flywheel. Stabilised power supply with automatic overload protection. Finish: teak cabinet with stainless steel trim and grey deck. Available also as portable model. Price: £152 5s. (including PT). Also available in chassis form with or without power amps. Price: from £130 4s. (including PT).



CINECORDER. Murray Electronics Ltd., 5 Selkirk Road, Tooting, London, S.W.17. Tel: 01-672 8267.

Cinecoder Model A. Mono recorder with BSR deck. ½-track. Speed: 3¾ i/s. W and F 0.4%. FR 60 Hz -10 KHz. Replay char CCIR. Two channel mixing with two inputs per channel. 4W, 15 ohms output. One motor. 5¾ in. spools. 10 in. elliptical speaker housed in detachable lid with 24 ft cable. Separate bass and treble controls. Boost and cut. Superimposition. 'Shift-track' tape control for dual recordings. Tapelift/Pause control for cueing. cross-fading. Remote control. Accessories: mic and ext cables, perforated Cinetape, tape sprockets. Size: 16½ × 14 × 8½ in. Weight: 28 lb. Price: £61 19s. (plus £15 2s. PT).



CROWN INTERNATIONAL. Distributors: Carston Electronics Ltd., 71 Oakley Road, Chinnor, Oxon. Tel: Kingston Blount 8561.

Crown International 800 Series. ¼-track and ½-track mono and stereo professional recorders. Speeds: 15, 7½, 3¾ i/s. Max. spool: 10½ in. W and F 15 i/s 0.06%. 7½ i/s 0.09%. 3¾ i/s 0.18%. H and N 15 i/s better than 60 dB. 7½ i/s better than 60 dB. 3¾ i/s better than 55 dB. FR 15 i/s 50 Hz-30 KHz ±2 dB. 7½ i/s 30 Hz-20 KHz ±2 dB.

3¾ i/s 30 Hz-10 KHz ±2 dB. Replay char NAB or CCIR. Level indicator: 5 in. VU meter each channel. Rewind time: 1.200 ft 38 secs. 2.400 ft 58 secs. Inputs: line or high Z mic -25 dB (45 mV) 100K, high Z mic -70 dB 0.2 mV 100K, low Z mic -85 dB or 80 dB 50 ohms or 250 ohms. Outlets: line 0.7V 5K unbalanced, line +26 dB 600 ohms bal or unbal, monitor +8 dBm 50 ohms. Audio output: 0.5W. Transistorised. Three AC torque capacitor motors. Superimpose. Inching. Input mixing. Treble and bass boost and cut each channel. Individual channel bias adjustment. A-B monitoring and source and tape mixing. Echo. Size: 17½ × 19 × 8 in. Weight: 50 lb. Mains: 117 or 230V 50 or 60 Hz. Consumption: 230W. Price: £550 to £1.300.



EMI. EMI Electronics Ltd., Hayes, Middlesex. Tel: 01-573 3888.

★**L4.** Transistorised 2-speed tape-recorder for mains/battery operation with level indicator. 4½ in. spools 7½, 3¾ in./sec. FR: 50 Hz-12 KHz ±12 dB. W and F: better than 0.2% RMS at 7½ in./sec; better than 0.3% RMS at 3¾ in./sec. Inputs: Mic 50V for PRL 1K (suitable for 3/50 microphone); Mic 2: as for Mic 1; Line in. 270 mV for PRL. 20K (bridging); Line out 0dBm (0.775V) for PRL; 40 ohms into 200 ohm and 600 ohm lines. Replay characteristics: IEC 70S or MAB 50S at 7½ in./sec only. A-B monitoring. ½ or full-track. Neopilotone version available. Audio output: 200 mW RMS. Speaker: 3 in. Own deck with DC motor. Fully tropicalised. Mic. bass-cut switch. Remote motor on/off on ½-track version. Dimensions: 7 × 11¾ × 5¾ in. Weight: 10¾ lb. Rechargeable battery or mains via charger. Price: L4a (½-track version) £120; L4b (full-track version) £130; L4c (full-track and sync) £165. Free of tax.



EMT WILHELM FRANZ GMBH, Switzerland. Sole U.K. Agents: F. W. O. Bauch Ltd., Holbrook House, Cockfosters, Herts. Tel: 01-440 3277.

★**Studer A62.** Professional transistorised studio recorder. Stereo/mono. Full track or ½-track. Speeds: 15, 7½ i/s. Replay char. CCIR or NARTB (either by request). Outlet from pre-amp. Three motors. Mains: 110, 117, 125, 150, 220 and 250V 50 or 60-Hz as ordered. Consumption: 130W maximum. Tape timer: calibrated in minutes and seconds. W and F: 7½ i/s ±0.1% peak. 15 i/s ±0.05% peak. Signal to

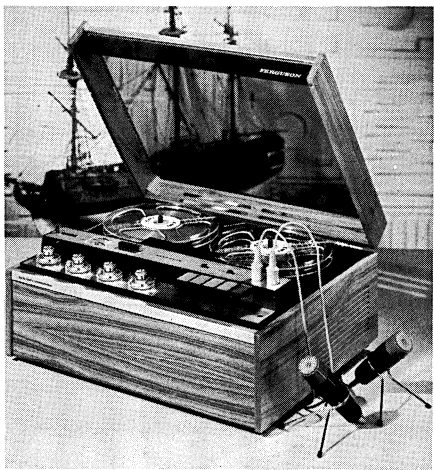

Ferguson 3232



Ferrograph Series Seven



Ferguson 3244



Grundig TK149



Ferguson 3238



Grundig TK247

noise: $7\frac{1}{2}$ i/s -64 dB, 15 i/s -66 dB. Inputs: adjustable between 200 mV and 4.4V (-10 dB to +15 dB) balanced >20K. Output: adjustable between 700 mV and 4.4V into 200 ohms or greater. FR: 15 i/s. 30 Hz-15 KHz +1 dB. -2 dB: $7\frac{1}{2}$ i/s. 40 Hz-15 KHz +1 dB. -2 dB. Spool size: $10\frac{1}{2}$ in. (cine or NAB). Rewind time $1\frac{1}{2}$ minutes. Horizontal or vertical operation. No power amplifier or speaker. Size: $19 \times 14 \times 8\frac{1}{4}$ in. Weight: $61\frac{3}{4}$ lb. Price on application.

★ **Studer C37.** Professional studio recorder. Interchangeable head blocks: full-track, stereo and switchable. Erase head stereo, also available with pilot tone head. Speeds: 15, $7\frac{1}{2}$ i/s. W and F 15 i/s $\pm 0.015\%$, $7\frac{1}{2}$ i/s $\pm 0.025\%$. SN 15 i/s -68 dB RMS lin. $7\frac{1}{2}$ i/s -64 dB RMS lin. FR 30 Hz-15 KHz +1 dB. -2 dB. Separate equalisation for $7\frac{1}{2}$ and 15 i/s CCIR and NAB. Output from preamp. Three Papst motors. Rewind time: 2 mins for 2,400 ft. Input: adjustable 0.7 to 7.0V (-1 dB to +19 dB) balanced 16K. Equalisation: switchable from CCIR to NAB. Spool size: 12 in. (3,300 ft). Tape timer: calibrated in minutes and seconds. Spool adaptors for DIN, cine and NAB. No power amplifier or speakers. Size: $21 \times 26 \times 17$ in. Weight: 172 lb. Price on application.

★

FERGUSON. British Radio Corporation Ltd., 284 Southbury Road, Enfield, Middlesex. Tel: 01-366 1155.

★ **3232.** $\frac{1}{4}$ -track stereo recorder. 3 speeds. 7 in. reels. W and F: $7\frac{1}{2}$ i/s 0.15%, $3\frac{3}{4}$ i/s 0.2%, $1\frac{3}{8}$ i/s 0.25%. H and N: -45 dB. FR (6 dB): $7\frac{1}{2}$ i/s 40 Hz-18 KHz. Replay char: CCIR. Level meter. Rewind time: 3 min 20 sec 1,800 ft. Inputs: mic. PU (high impedance), gram (low impedance). Outputs: ext. speakers 5W 8 ohms, ext. amps 500 mV 10K. 5W output from 5×3 in. speakers. Track transfer switch. Solenoid operated remote pause and auto stop. Mains 45W. Size: $16\frac{1}{2} \times 14\frac{1}{2} \times 7\frac{1}{2}$ in. Price: £75 9s. 8d. (plus £17 15s. 4d. PT).

★ **3244.** As model 3232.

3238. Mono $\frac{1}{4}$ -track tape recorder. Speeds: $7\frac{1}{2}$ i/s. $3\frac{3}{4}$ i/s. $1\frac{3}{8}$ i/s. W and F: 0.15%, $7\frac{1}{2}$ i/s; 0.2%, $3\frac{3}{4}$ i/s; 0.25%, $1\frac{3}{8}$ i/s. FR: 40 Hz-18 KHz $7\frac{1}{2}$ i/s; 40 Hz-7 KHz $1\frac{3}{8}$ i/s. Meter indicator. Rewind time: 1,200 ft in $2\frac{1}{2}$ min. Inputs: radio 1.5 mV 68K, PU 180 mV 200-500K; mic 1.5 mV 10M. Outputs: ext amp 1V 22K. L.S. 3W 3 ohms. Psn: AC mains. Dimensions: $16\frac{1}{4} \times 4\frac{1}{4} \times 7$ in. Price: £48 4s. 11d. (plus £11 7s. 1d. PT).

FERROGRAPH. CO. LTD., Mercury House, 195 Knightsbridge, London. S.W.7. Tel: 01-589 4485.

★ **Ferrograph 713.** Semi-professional mains mono recorder. $\frac{1}{2}$ -track. Speeds: $7\frac{1}{2}$, $3\frac{3}{4}$, $1\frac{3}{8}$ i/s. Max spool $8\frac{1}{4}$ in. W and F: $7\frac{1}{2}$ i/s 0.08%, $3\frac{3}{4}$ i/s 0.15%, $1\frac{3}{8}$ i/s 0.2%. H and N: $7\frac{1}{2}$ i/s better than 52 dB. FR: $7\frac{1}{2}$ i/s 30 Hz-17 KHz ± 2 dB. $3\frac{3}{4}$ i/s 40 Hz-14 KHz ± 3 dB. $1\frac{3}{8}$ i/s 50 Hz-7 KHz ± 3 dB. Replay char DIN. VU meter (auxiliary PPM available). Rewind time less than one minute for 1,200 ft. Inputs: mic 150 μ V to 15 mV at 250-2,000 ohms. line 75 mV to 10V at 2 megohms. Outlets: 600 ohms. 300 mV 10K. 8-16 ohms 10W. Output: 10W RMS. Two 6×4 in. speakers. Transistorised. Three motors (synchronous hysteresis capstan motor and shaded pole spool motors). Pause. Four-digit gear driven tape indicator. Straight-through amplifier. Monitoring. Input mixing. Vertical or horizontal operation. Single knob control. Fast wind continuously variable in either direction. Remote start/stop of tape, also time-switch operation. Removable head block. Straight line tape loading. Automatic stop. Reel retainers. Retractable carrying handle. A-B comparison switch. Separate bass and treble controls with cut or lift. Meter indicates signal level on record and playback. Meter switchable to indicate bias. Bias continuously adjustable. Supplied in two styles. Suffix P: portable wood case leathercloth covered; Suffix W: wooden case, natural wood finish; Mains: (Suffix U) 200-250V 50 Hz; (Suffix A) 117V 60 Hz. Price: £174 13s. 6d. (including PT).

Ferrograph 713H. Similar specification to 713M except tape speeds 15, $7\frac{1}{2}$, $3\frac{3}{4}$ i/s. FR at 15 i/s 30 Hz-20 KHz ± 2 dB. Price: £182 4s. 4d. (including PT).

Ferrograph 722. Similar specification to 713 except $\frac{1}{2}$ -track stereo version. Track to track transfer switch. Switchable echo. Records mono on upper or lower tracks. Channel separation: stereo approx 45 dB. mono better than 60 dB. Price: approximately £204 16s. 9d. (including PT).

Ferrograph 722H. Similar specification to 722 except tape speeds 15, $7\frac{1}{2}$, $3\frac{3}{4}$ i/s. FR at 15 i/s 30 Hz-20 KHz ± 2 dB. Price: approximately £212 7s. 6d. (including PT).

Ferrograph 702. Similar specification to 722 except tape unit with preamps only. Additional low level output adjustable 0-300 mV. Price: £194 15s. 8d. (including PT).



Grundig TK 245

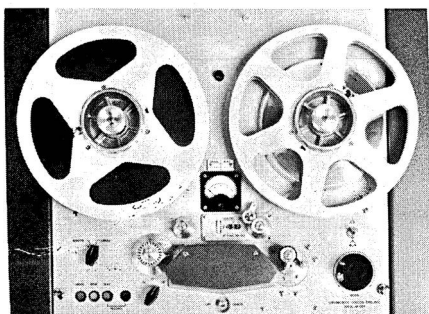

Leavers-Rich Basic E Series V deck



Leavers-Rich G858



Marconiphone 4238

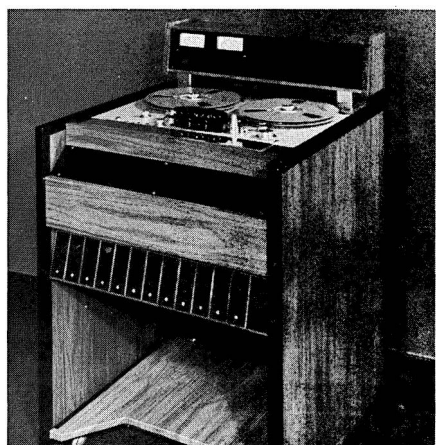

Leavers-Rich E252M S/E



Marconiphone 4218

Ferroglyph 702H. Similar specification to 702 except tape speeds 15. 7½. 3¾ i/s. FR at 15 i/s 30 Hz-20 KHz. Price: approximately £202 6s. 6d. (including PT).

Ferroglyph 724. Similar specification to 722 except ¼-track version. Price: £204 16s. 9d. (including PT).

Ferroglyph 704. Similar specification to 702 except ¼-track version. Price: £194 15s. 8d. (including PT).

★

GRUNDIG. Grundig (Great Britain) Ltd., Newlands Park, Sydenham, London, S.E.26. Tel: 01-778 2211.

★**TK149.** Single speed ¼-track recorder. Automatic recording or manual with level meter. 2.5W. S and N -45 dB. 6 × 4 in. speaker. FR 40 Hz-12 KHz. Speed: 3¾ i/s. W and F 0.2%. 4 digit position indicator. 5¾ in. reels. Earphone monitor. Input: mic 2 mV 1.5M. Outputs: 500 mV 15K. speaker: 5 ohms. Mains: 50 Hz. Teak finish. Size: 15½ × 11½ × 7 in. Price: £55 18s. (including PT).

★**TK245.** Two speed ¼-track stereo recorder. mono playback. Stereo playback with external amplifier. Automatic recording or manual with level meters. Speeds: 7½ i/s and 3¾ i/s. W and F 0.12% at 7½ i/s 4W. S and N -46 dB. 6½ × 3¾ in. speaker. 2¼ in. tweeter. FR 40 Hz-16 KHz at 7½ i/s. 4-digit position indicator. 7 in. reels. Earphone monitor. Inputs: mic (2) 2 mV 1.5. PU (2) 90 mV 1M. tuner (2) 4 mV 44K. Output: 1V 22K. speaker: 5 ohms. Mains 50 Hz. Teak finish. Size: 16¼ × 13 × 7¾ in. Price: £105 10s. (including PT).

★**TK247.** Two speed ¼-track stereo recorder. Multi-synchronous recording and input mixing. Speeds: 7½ i/s and 3¾ i/s. VU meters. W and F. 12% at 7½ i/s. 4W per channel. S and N -48 dB. Speakers: 6¾ × 3¾ in. and 2¼ in. tweeter. FR 40 Hz-16 KHz at 7½ i/s. 4-digit position indicator. 7 in. reels. Monitor. Inputs: mic (2) 1 mV 100K. PU (2) 30 mV 1M. tuner (2) 1 mV 33K. Outputs: (2) 0.8V 22K. speakers (2) 4 ohms. Psn mains. Auto stop. Size: 17½ × 13 × 7¾ in. Price: £112 10s. (including PT).

★

HEATHKIT. See Constructional Kits section.

★

KINGSTEREO. Distributors: Lionel Murray Ltd., 7 West Halkin Street, Belgrave Square, London, S.W.1. Tel: 01-235 6424-5-6.

XAR500. 4-track record/playback tape player. Price: £139 17s. 8d. (including PT).

HW12. 4 and 8 track stereo cartridge tape player. FR: 50 Hz-10 KHz. W and F: <0.3%. Power output: 4W (music) into speakers supplied. Finish: mahogany. Dimensions: 13¼ × 8¼ × 3¾ in. Price: £88 11s. (including PT).

Wide range of 4 track stereo pre-recorded tape cartridges is available for this equipment.

★

LEEVERS-RICH EQUIPMENT LTD., 319 Trinity Road, Wandsworth, London, S.W.18. Tel: 01-874 9054. Cables: Leemag, London, S.W.18.

Series E ¼ in. professional recorders. Available in rack mounting (R), console (M), or studio console(s).

★**E151, E252.** Speeds: 15 and 7½ i/s. or 30 and 15 i/s. or 7½ and 3¾ i/s. Spool 11½ in. Three motors. Full track, half track or dual track. FR 30 Hz-18 KHz ±2 dB at 15 i/s. Noise: full track -62 dB, half track -58 dB. W and F better than 0.1%. VU level meter. PPM to order. Plug-in record, replay fully transistorized amplifiers. Prices from £665.

★**Series G.** Professional recorders. 4, or 8 tracks on 1 in. tape. Speeds: 15 or 7½ i/s (other speeds to order). NAB 10½ in. spools. Three motors. FR to BS1568: 1960. NAB to special order. Prices: 8 track master recorder £4,825; component sections can be supplied from £1,500.

★

MARCONIPHONE. British Radio Corporation Ltd., 284 Southbury Road, Enfield, Middlesex. Tel: 01-366 1155.

★**4238.** Mono ¼-track tape recorder. Speeds: 7½ i/s, 3¾ i/s, 1⅞ i/s. W and F: 0.15% 7½ i/s; 0.2% 3¾ i/s; 0.25% 1⅞ i/s. FR: 40 Hz-18 KHz 7½ i/s; 40 Hz-7 KHz 1⅞ i/s. Meter indicator. Rewind time: 1.200 ft in 2½ min. Inputs: radio 1.5 mV 68K. PU 180 mV 200-500K; mic 1.5 mV 10M. Outputs: ext amp 1V 22K. L.S. 3W 3 ohms. Psn: AC mains. Dimensions: 16¼ × 14¼ × 7 in. Price: £48 4s. 11d. (plus £11 7s. 1d. PT).

★**4218.** Stereo ¼-track tape recorder. Speeds: 7½ i/s, 3¾ i/s, 1⅞ i/s. W and F: 0.15%, 7½ i/s; 0.2% 3¾ i/s; 0.25% 1⅞ i/s. FR: 40 Hz-18 KHz 7½ i/s; 40 Hz-7 KHz 1⅞ i/s. Two meters. Rewind



Nagra Series IV



Pye 9123

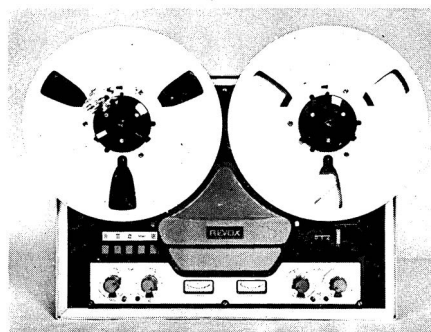

Revox

time: 1,800 ft in 3 min 20 sec. Inputs: mic/radio 250 mV 4-7K; gram 100 mV 100K; PU 50 mV 1M. Outputs: ext amp 500 mV 10K; L.S. 5W into 8 ohms. Psn: AC mains. Dimensions: $16\frac{1}{4} \times 14\frac{1}{4} \times 7$ in. Price: £72 9s. 10d. (plus £17 1s. 2d. PT).

★

MARTIN ELECTRONICS. See Constructional Kits section.

★

NAGRA. Distributed by: Hayden Laboratories Ltd., East House, Chiltern Avenue, Amersham, Bucks. Tel: Amersham 5511.

★**Series IV.** Professional battery portable tape recorder. Full track mono. Front panel controls. 5-step low frequency roll-off attenuator. Modular assembly, changeable to meet requirements. Changeable internal pre-amps for special microphones. AR indicator of correct operation. All-silicon transistors. Automatic level control. Automatic overload reduction. Fade in and out for start and stop. Self powered. Prices include batteries, tape, microphone and leather carrying case.

IV A. Automatic machine for reporting. It has single speed $7\frac{1}{2}$ i/s or 15 i/s. One microphone input with automatic level control. Price: £388.

IV B. As model IV A, but with two microphone inputs, and no automatic level control. Price: £381.

IV BL. As model IV B, but with the Neopilot synchronous system. Price: £443.

IV D. Three speed model ($3\frac{3}{4}$, $7\frac{1}{2}$ and 15 i/s). Two microphone inputs with manual and automatic level control. FR 15 i/s 30 Hz-20 KHz ± 2 dB; $7\frac{1}{2}$ i/s 30 Hz-15 KHz ± 2 dB; $3\frac{3}{4}$ i/s 30 Hz-7 KHz ± 3 dB. Signal to noise ratio: 69 dB. Price: £533.

IV L. As IV D, but fitted with the Neopilot synchronous system. Price: £595.

★

NATIONAL. Distributed by: United Africa Mechanical & Electrical Ltd., P.O. Box 1, United Africa House, Blackfriars Road, London, S.E.1. Tel: 01-928 2070.

National RS-790S. Semi-professional dual-capstan tape recorder. Speeds: $7\frac{1}{2}$, $3\frac{3}{4}$, $1\frac{1}{8}$ i/s. Max spool 7 in. $\frac{1}{4}$ track. W and F: $7\frac{1}{2}$ i/s < 0.09%. $3\frac{3}{4}$ i/s < 0.18%. $1\frac{1}{8}$ i/s < 0.22%. FR: $7\frac{1}{2}$ i/s 30 Hz-20 KHz. $3\frac{3}{4}$ i/s 30 Hz-14 KHz. $1\frac{1}{8}$ i/s

30 Hz-9 KHz. Replay char DIN. Two level meters. Inputs: mic(2) - 67 dB 20K, aux(2) - 20 dB 100K. Outlets: speakers (2) 8 ohms, line(2) 10K, phones 8 ohms 15 mW. AC mains 100-250V 50/60 Hz. All transistor. Output 10W music per channel. Bias frequency 50 KHz. Signal-to-noise ratio >52 dB. Four-digit tape indicator. Sound-on-sound recording. Internal speaker 7 x 5 in. Automatic tape reversing. Size: 17 x 8½ x 16½ in. Full specification on request. Price: (machine only) £183 15s.; (with speakers) £235 4s. (including PT).

National RS-760S. ¼-track three-speed transistorised stereo recorder. Tape speeds: 7½, 3¾, 1⅞ i/s. Max spool 7 in. Output: 4W music per channel. Bias frequency 53 KHz. VU meters. Rewind time 3½ mins 1.200 ft tape. W and F: 7½ i/s <0.1%, 3¾ i/s <0.2%, 1⅞ i/s <0.25%. FR: 7½ i/s 40 Hz-17 KHz, 3¾ i/s 40 Hz-10 KHz, 1⅞ i/s 50 Hz-5 KHz. Inputs: mic(2) - 74 dB 10K, aux(2) - 20 dB 680K. Outlets: line(2) 10K, speakers(2) 8 ohms, phones 8 ohms. Internal speakers: two 6 x 4 in. Size: 14 x 13½ x 7 in. Weight: 22 lb. Full specification on request. Price: (machine only) £102 18s.; (with speakers) £131 5s. (including PT).

National RQ-501S. Mono tape recorder, mains/battery powered. ½-track. Speeds: 1⅞ and 3¾ i/s. Max spool capacity: 5 in. Level indicator: meter. Inputs: microphone, 74 dB, 20K; aux, 20 dB, 100K. Extension speaker, 8 ohms. Audio output: 1.2W. Speaker size: 3½ in. Transistorised. One motor. Dimensions: 11⅞ x 3⅞ x 10 in. Weight: approx. 6⅞ lb. Pause. Position indicator: 3-digit reset counter. Monitoring. Tone control. Four heads. Auto record. Reverse-a-Track. Psn 9V battery, 250V AC. Price: £43 0s. 3d. (plus £10 7s. 8d. PT).

National RQ-504. Mono tape recorder, mains/battery powered. ¼-track. Speeds: 1⅞ and 3¾ i/s. Max spool capacity: 5 in. FR: 3¾ i/s 50 Hz-12 KHz; 1⅞ i/s 50 Hz-7 KHz. Level indicator: meter. Rewind time: 600 ft 3 min. Inputs: microphone, -73 dB, 200 ohms; aux, -20 dB, 100 ohms. Extension speaker, 8 ohms. Audio output: 2.5W max RMS. Speaker size: 4 in. Transistorised. Electronic control motor, variable speed control. Dimensions: 12⅞ x 4⅞ x 10¾ in. Weight: 6½ lb. Pause. Monitoring. Auto record. Psn 9V battery, 250V AC. Price: £46 6s. 3d. (plus £11 8s. 9d. PT).



PHILIPS ELECTRICAL LTD., Century House, Shaftesbury Avenue, London, W.C.2. Tel: 01-437 7777. Cables: Phillamps, London.

EL3312. Stereo cassette recorder. Output: 2W RMS per channel into speaker units supplied. Socket for connection to Philips Audio Plan and other hi-fi equipment. Price: £67 17s. 1d.

N4308. 4-track reel-to-reel mono recorder. Speeds: 3¾ i/s 1⅞ i/s. Output: 4W RMS into self-contained loudspeaker. Mixing and stereo playback facilities by addition of EL3787 pre-amplifier. Socket for connection to hi-fi equipment. Price: £60.

N4404. 4-track stereo reel-to-reel recorder. Output: 2½W RMS per channel from self-contained loudspeakers. Speeds: 7½ i/s, 3¾ i/s. Socket for connection to hi-fi equipment. Price: £80.

N4407. 4-track reel-to-reel stereo recorder. Speeds: 7½ i/s, 3¾ i/s, 1⅞ i/s. Output: 4W RMS per channel into self-contained loudspeakers. Built-in multiplug and duoplay facilities. Socket for connection to hi-fi equipment. Price: £103 15s. 4d.

4408. ¼-track stereo mains recorder. Speeds: 7½, 3¾, 1⅞ i/s. Max spool 7 in. W and F ±0.2%. SN >45 dB. FR 7½ i/s 40 Hz-18 KHz. Two level indicators (meters). Rewind time <180 secs 1,800 ft. Inputs: two mic 0.25 mV 2K, two radio 2 mV 20K, two PU 100 mV 500K. Outlets: radio 1V, phones 0.1-5V 1K, two speakers 6W 4-8 ohms. Output: 6W per channel. Own deck. One motor. Pause. Straight-through amplifier. Monitoring. Input mixing. Parallel track replay. Vertical or horizontal operation. Mains 110, 127, 200-250V AC. Size: 19 x 13 x 8¾ in. approx. Price: £110 5s. (plus £23 11s. 8d. PT).

N4500. 4-track stereo reel-to-reel deck. Three heads. Three speeds, 7½ i/s, 3¾ i/s and 1⅞ i/s. Multiplay and duoplay facilities. Socket for connection to hi-fi equipment. Price to be announced.

PRO12. Professional recording deck with three motors and three heads. Dubbing and cueing levers. Multiplay and echo effects built in. Connection to hi-fi equipment possible. Price: £239 0s. 7d.



PYE. Pye Radio and Television Ltd., St. Andrews Road, Cambridge. Tel: Cambridge 58985.

★ **9123.** 4-track recorder. Speeds: 3¾ i/s, 1⅞ i/s. Reel size: 7 in. max. Duoplay, multiplay and

stereo playback facilities with suitable accessories. Output: 4W. L.S.: 6×4 in. Price: £48 12s. 1d. (plus £11 8s. 9d. PT).

9137. Stereo 4-track recorder. Full specification on request. Price: £84 (plus £19 15s. 4d. PT).



REPS. REPS (Tape Recorders) Ltd., 11 Colville Road, Acton, London, W.3. Tel: 01-992 4141.

HW10. General purpose $\frac{1}{4}$ -track and $\frac{1}{2}$ -track; mains operated. Speeds: $7\frac{1}{2}$, $3\frac{3}{4}$, $1\frac{7}{8}$ i/s. W and F: 0.15% at $7\frac{1}{2}$ i/s, 0.25% at $3\frac{3}{4}$ i/s. FR: 40 Hz-16 KHz ± 1 dB at $7\frac{1}{2}$ i/s; 40 Hz-10 KHz ± 2 dB at $3\frac{3}{4}$ i/s. 50 Hz-6 KHz ± 3 dB at $1\frac{7}{8}$ i/s. NL: $\frac{1}{2}$ -track -55 dB at $7\frac{1}{2}$ i/s; $\frac{1}{4}$ -track -50 dB at $7\frac{1}{2}$ i/s. Level indicator: meter. Replay characteristic: CCIR. Rewind time: 1.200 ft. in 3 min. Inputs: mic 0.8 mV 1M; radio 60 mV 0.5M. Outputs: loudspeaker: 10W RMS into 15 ohms, line output 0.5V at 1K. Tape deck: Magnavox 363. Monitoring, input mixing and parallel track replay facilities. Psn: 200/240V 50 Hz. Dimensions: 20×16×9 in. Weight: 40 lb. Price: £60 8s. 6d. (plus £14 18s. 6d. PT) to £66 19s. 2d. (plus £16 10s. 10d. PT), according to finish.



REVOX. Distributors: C. E. Hammond & Co. Ltd., 90 High Street, Eton, Windsor, Berks. Tel: Windsor 63388. Telex: 84316.

★**Series 77.** Silicon transistor stereo tape recorder available in various versions. $\frac{1}{2}$ -track or $\frac{1}{4}$ -track. Speeds: $7\frac{1}{2}$, $3\frac{3}{4}$ i/s. Max spool 10 $\frac{1}{2}$ in. W and F: $7\frac{1}{2}$ i/s 0.08%, $3\frac{3}{4}$ i/s 0.1%. FR: $7\frac{1}{2}$ i/s 30 Hz-20 KHz +2 -3 dB, $3\frac{3}{4}$ i/s 30 Hz-16 KHz +2 -3 dB. Record char NAB, playback char NAB and IEC (switchable). Two VU meters. Inputs: mic 0.15 mV 50-600 ohms or 2 mV up to 100K (switchable), radio 2 mV 33K, aux 40 mV 1 megohm. Outputs: line 2.5V 600 ohms, 1-2V 2.5K. Output: 8W RMS per channel. HD better than 1%. Three-motor deck electronically governed. Electronic speed change. Vertical or horizontal operation. Plug-in printed circuit modules. Oscillator freq 120 KHz. Remote control for all functions. Output impedance (power amplifiers) 4-16 ohms. 54 transistors, 32 diodes, 4 silicon rectifiers. Mains: 110, 130, 150, 220, 240, 250V 50/60 Hz. Weight: approximately 34 lb. Prices and variations follow.

Model 1302 or 1304. Chassis in metal enclosure for rack mounting, no output amplifiers. $\frac{1}{4}$ or $\frac{1}{2}$ track. Price: £187 19s., tax paid.

Model 1322 or 1324. As above, but with 10W output amplifiers. $\frac{1}{4}$ or $\frac{1}{2}$ track. Price: £216 6s., tax paid.

Model 1102 or 1104. Chassis in teak surround, no output amplifiers. $\frac{1}{4}$ or $\frac{1}{2}$ track. Price: £187 19s. (tax paid).

Model 1122 or 1124. Chassis in teak surround with output amplifiers. $\frac{1}{4}$ or $\frac{1}{2}$ track. Price: £216 6s., tax paid.

Model 1222 or 1224. Complete recorder in suitcase with amplifiers and four speakers. $\frac{1}{4}$ or $\frac{1}{2}$ track. Price: £223 13s., tax paid.



ROBUK ELECTRICAL INDUSTRIES LTD., 559/561 Holloway Road, London, N.19. Tel: 01-272 1022.

Regal RK5. $\frac{1}{2}$ -track three-speed mono mains recorder. Speeds: $7\frac{1}{2}$, $3\frac{3}{4}$, $1\frac{7}{8}$ i/s. Max spool 7 in. W and F: 0.2% at $7\frac{1}{2}$, 0.3% at $3\frac{3}{4}$ i/s. FR: $7\frac{1}{2}$ i/s 40 Hz-15 KHz ± 3 dB, $3\frac{3}{4}$ i/s 50 Hz-9 KHz ± 3 dB, $1\frac{7}{8}$ i/s 50 Hz-4 KHz. S/N >45 dB. Replay char CCIR. Inputs: mic 1.8 mV high Z, radio/pickup 350 mV 250K. Output: 5W RMS push-pull. Output stage two ECL82. Outlet: 15 ohms ext speaker. Internal speaker 8 in. elliptical. Magic eye level indicator (EM84 or EM87). Input mixing. Own deck. Three motors. Pause. Superimpose. Monitoring with independent control. Three-digit tape position indicator. Piano key controls. Four-track version uses Miniflux heads. Size: 20 $\frac{1}{2}$ ×14 $\frac{1}{2}$ ×8 $\frac{1}{2}$ in. Weight: 30 lb. Price: £48 16s. (plus £8 19s. PT).

Regal RK54. $\frac{1}{4}$ -track version of RK5. Similar specification. Price: £42 7s. 8d. (plus £9 19s. 5d. PT).



SANYO. Sanyo (Marubeni) U.K. Ltd., Greycaines Estate, Bushey Mill Lane, Watford, Herts. Tel: Watford 25354.

★**MR151.** $\frac{1}{4}$ -track battery or mains stereo recorder. 5 in. reels. Speeds $3\frac{3}{4}$ i/s, $1\frac{7}{8}$ i/s, $\frac{7}{8}$ i/s. FR at $3\frac{3}{4}$ i/s 100 Hz-10 KHz ± 3 dB. NAB replay char. VU meters. Rewind 2 min. Inputs: mic 0.3 mV 25K, aux 100 mV 100K. Outputs: ext speaker 750 mW 8 ohms, headphones 8 ohms 10K. Output 750 mW. 4×2 $\frac{1}{4}$ in. speakers. Two motors. Digital position indicator. Monitor Sound-with-sound. Sound-on-sound. Pause. Auto stop. Mains: 115/230V 50/60 Hz. Battery: 6 U2 cells. Size: 10 $\frac{3}{8}$ ×5 $\frac{3}{8}$ ×12 in. Weight: 17 lb. Price: £72 8s. 10d. (plus £17 5s. 11d. PT).

MR800. $\frac{1}{4}$ -track stereo tape unit. 7 in. reels. Speeds: $7\frac{1}{2}$ i/s, $3\frac{3}{4}$ i/s, $1\frac{7}{8}$ i/s. W and F 0-15% at $7\frac{1}{2}$ i/s. H and N 50 dB down at peak record level at $7\frac{1}{2}$ i/s. FR, at $7\frac{1}{2}$ i/s 30 Hz-18 KHz ± 3 dB. NAB replay char. VU meters. Rewind 2 min. 50 sec. 1200 ft. Inputs: mic 0.25 mV 50K, mag 7 mV 28K, line 12.5 mV 100K. Outputs: line 800 mV 2K, headphones 0.1V 10K. Digital position indicator. Sound-with-sound. Auto stop. Mains 35W. Size: $20 \times 10 \times 16$ in. Weight 38.6 lb. Price: £72 13s. 5d. (plus £17 19s. 9d.)

MR801. $\frac{1}{4}$ -track 3-speed tape unit. 7 in. reels. W and F: $7\frac{1}{2}$ i/s 0-15%, $3\frac{3}{4}$ i/s 0-2%, $1\frac{7}{8}$ i/s 0-3%. H and N: $7\frac{1}{2}$ i/s -45 dB unweighted -50 dB weighted. FR: $7\frac{1}{2}$ i/s 20 Hz-20 KHz ± 3 dB. Other speeds: $3\frac{3}{4}$ i/s 30 Hz-13 KHz; $1\frac{7}{8}$ i/s 30 Hz-8 KHz. Replay char NAB ($7\frac{1}{2}$ i/s). 2 VU meters. Rewind 2 min 1.200 ft. Inputs: mic 0.3 mV 50K, line 100 mV 300K, tuner 4 mV 10K. Outputs: line 800 mV, 2K amp. 800 mV 2K, headphones 8 ohms or 10K. Digital position indicator. Monitor. Sound-with-sound. Auto stop. Pause. Psn 100V, 117V, 125V, 220V, 240V, 50 Hz, 35W. Size: $15\frac{3}{8} \times 12\frac{7}{8} \times 6\frac{3}{4}$ in. Weight: 18 lb. Price: £63 15s. 10d. (plus £15 14s. 9d. PT.)

MR910. $\frac{1}{4}$ -track 2 speed recorder. 7 in. reels. W and F: $7\frac{1}{2}$ i/s 0.25%, $3\frac{3}{4}$ i/s 0.35%. H and N: $7\frac{1}{2}$ i/s -40 dB. FR: $7\frac{1}{2}$ i/s 30 Hz-15 KHz at 3 dB; $3\frac{3}{4}$ i/s 30 Hz-11 KHz. Inputs: mic 0.3 mV 25K; aux 100 mV 1.8M. Outputs: speaker 1.5W 8 ohms; headphones 8 ohms or 10K; 1.5W, 4×6 in. speaker. Sound-with-sound. Digital position indicator. Psn 90V, 100V, 117V, 220V, 240V, 50 Hz. Size: $17 \times 18\frac{1}{2} \times 7$ in. Weight: 18 lb. Price: £68 7s. 3d. (plus £16 12s. 8d. PT.)

★ **MR929.** $\frac{1}{4}$ -track stereo recorder. 7 in. reels. Speeds: $7\frac{1}{2}$ i/s and $3\frac{3}{4}$ i/s. W and F at $7\frac{1}{2}$ i/s 0.25%. H and N at $7\frac{1}{2}$ i/s 40 dB below peak recording level. FR at $7\frac{1}{2}$ i/s 30 Hz-15 KHz ± 3 dB. NAB replay char. VU meters. Rewind 3 min. Inputs: mic 0.4 mV 25K; aux 100 mV 100K. Output: line 200 mV 2K; ext speaker $2\frac{1}{2}$ W 8 ohms; headphones 8 ohms or 10K. Speakers: $2\frac{1}{2}$ W 4 in. Digital position indicator. Monitor. Sound-with-sound. Auto stop. Mains consumption 40W. Size: $14\frac{1}{4} \times 12\frac{3}{4} \times 11$ in. Price: £78 2s. 10d. (plus £19 5s. 10d. PT.)

MR939. $\frac{1}{4}$ -track stereo recorder. 7 in. reels. Speeds: $7\frac{1}{2}$ i/s, $3\frac{3}{4}$ i/s, $1\frac{7}{8}$ i/s. W and F at $7\frac{1}{2}$ i/s 0-15%. H and N at $7\frac{1}{2}$ i/s 40 dB below peak recording level. FR at $7\frac{1}{2}$ i/s 30 Hz-15 KHz ± 3 dB. NAB replay char. VU meters. Rewind 2 min 1.200 ft. Inputs: mic 0.3 mV 50K; line

100 mV 300K; rec 4 mV 10K. Outputs: 800 mV 2K, headphones 8 ohms or 10K. Speakers 4 in. Pause. Digital position indicator. Monitor. Sound-with-sound. Sound-on-sound. Autostop. Mains 50W. Size: $18\frac{1}{2} \times 6 \times 13\frac{3}{4}$ in. Price: £89 18s. 10d. (plus £22 2s. 1d. PT.)

★ **MR990.** $\frac{1}{4}$ -track stereo recorder. 7 in. reels. Speeds: $7\frac{1}{2}$ i/s, $3\frac{3}{4}$ i/s, $1\frac{7}{8}$ i/s. W and F at $7\frac{1}{2}$ i/s 0-15%. H and N at $7\frac{1}{2}$ i/s 45 dB below peak recording level. FR at $7\frac{1}{2}$ i/s 30 Hz-16 KHz ± 3 dB. NAB replay char. VU meters. Rewind 2 min 50 sec 1.200 ft. Inputs: mic 0.3 mV 50K, line 100 mV 200K, 5 mV 10K. Outputs: line 800 mV 2K, ext speaker 5W 8 ohms. Speaker 5W 4 in. Digital position indicator. Sound-on-sound. Sound-with-sound. Auto stop. Monitor. Pause. Mains 55W. Size: $20 \times 10 \times 16$ in. Price: £106 8s. 5d. (plus £26 5s. 6d. PT.)



SCOPETRONICS LTD., Crown Works. Church Road. Kingston-upon-Thames. Surrey. Tel: 01-546 1275 and 4135.

1151. Stereo tape recorder. Speeds: $7\frac{1}{2}$, 15 i/s. Max spool capacity $11\frac{1}{2}$ in. W and F: <0.08% both speeds. H and N: -57 dB. FR: 40 Hz-15 KHz $\pm \frac{1}{2}$ dB (either speed). Replay characteristics: CCIR. Level indicator: meter. Rewind time: 2.400 ft in 1 min 45 sec. Inputs: microphone, -75 dB 600 ohms. Line bridging, -14 dB 50 K. Outlets: line, up to 18 dBm, 50 ohms or 600 ohms line. Monitor amp. 2W at 15 ohms. Transistorised. 3 Papst motors, with ext. Rotor. Tape deck: own. Superimpose, pause and inching facilities. Straight through amplifier. Optical stop. Psn: 250V 50 Hz. Price: £450 (provisional).



SONY (U.K.) LTD., Ascot Road, Bedfont. Feltham. Middx. Tel: Ashford 50021.

★ **TC222.** Mono tape recorder, battery/mains. $\frac{1}{2}$ -track. Speeds: $3\frac{3}{4}$ and $1\frac{7}{8}$ i/s. Max spool capacity: 5 in. H and N $3\frac{3}{4}$ i/s -47 dB peak level. FR: $3\frac{3}{4}$ i/s 100 Hz-7.5 KHz. Replay characteristics: NARTB. Inputs: microphone, 0.195 mV, 400 ohms; line 0.0615V, 150K. Outlets: monitor 0 dB (0.775V) 100K. Audio output: 1W RMS. Speaker: $6\frac{1}{4} \times 3\frac{1}{8}$ in. Transistorised. Motor: DC servo controlled. Dimensions: $11\frac{1}{8} \times 4\frac{5}{8} \times 11\frac{7}{8}$ in. Weight: 12 lb. Psn 110, 120, 220, 240V, 50 or 60 Hz; DC 6V. Price: £43 15s. 7d. (plus £10 16s. 5d. PT.)

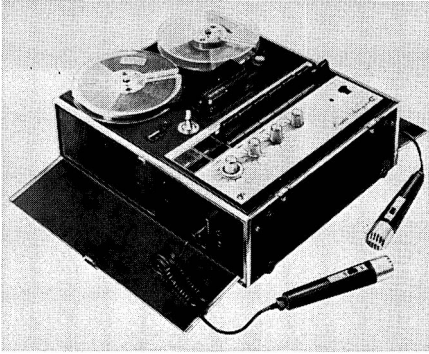

Sanyo MR151



Sanyo MR990

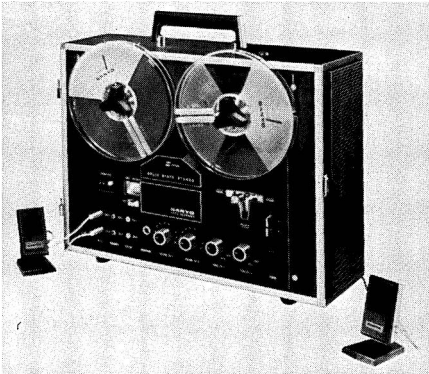

Sanyo MR910

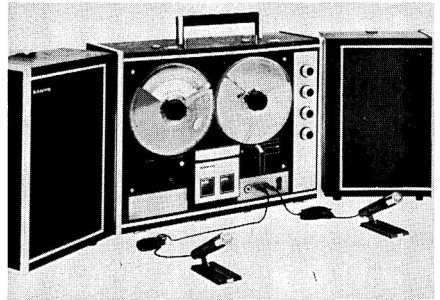

Sanyo MR939

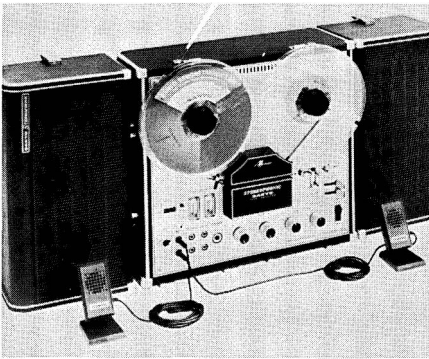

Sanyo MR929



Sony TC-222



Sony TC-230 with speakers

★ **TC230.** Stereo tape recorder. $\frac{1}{4}$ -track. Speeds: $1\frac{7}{8}$, $3\frac{3}{4}$ and $7\frac{1}{2}$ i/s. Max spool capacity: 7 in. W and F $7\frac{1}{2}$ i/s 0-17%; $3\frac{3}{4}$ i/s 0-3%; $1\frac{7}{8}$ i/s 0-4%. H and N $7\frac{1}{2}$ i/s better than 46 dB. FR: $7\frac{1}{2}$ i/s 40 Hz-18 KHz; $3\frac{3}{4}$ i/s 40 Hz-12 KHz; $1\frac{7}{8}$ i/s 40 Hz-6 KHz. Replay characteristics: NARTB. Level indicator: meter. Rewind time: 1.200 ft. 2 min 30 sec. Inputs: microphone. -75 dB (0-14 mV). 600 ohms; pickup. -52.5 dB (2 mV). 100K; tuner (aux) -25 dB (44 mV) 100K ohms. Outlets: line output record. 1 dB (0.87V) 10K; line output playback. 3 dB (1.1V) 10K; extension speakers. 11.3 dB (2.83V) 8 ohms. Audio output: 4W per channel RMS. Transistorised. Onemotor. Dimensions: $17 \times 9\frac{5}{8} \times 14$ in. Weight: 29 lb. Pause. Digital position indicator. Switchable input tape/mic. pickup and tuner. Psn 100. 110. 117. 125. 220. 240V. 50 or 60 Hz. 60W. Price: £97 9s. 8d. (plus £24 2s. 1d. PT).

TC230W. Stereo tape recorder. $\frac{1}{4}$ -track. Speeds: $1\frac{7}{8}$, $3\frac{3}{4}$ and $7\frac{1}{2}$ i/s. Max spool capacity: 7 in. W and F $7\frac{1}{2}$ i/s 0-17%; $3\frac{3}{4}$ i/s 0-3%; $1\frac{7}{8}$ i/s 0-4%. H and N $7\frac{1}{2}$ i/s better than -46 dB. FR: $7\frac{1}{2}$ i/s 40 Hz-18 KHz; $3\frac{3}{4}$ i/s 40 Hz-12 KHz; $1\frac{7}{8}$ i/s 40 Hz-6 KHz. Replay characteristics: NARTB. Level indicator: meter. Rewind time: 1.200 ft 2 min 30 sec. Inputs: microphone. -75 dB (0-14 mV). 600 ohms; pickup. -52.5 dB (2 mV). 100K; tuner (aux) -25 dB (44 mV). 100K. Outlets: record 1 dB (0.87V). 10K; playback 3 dB (1.1V). 10K; extension speaker. 11.3 dB (2.83V). 8 ohms. Audio output: 4W RMS per channel. Transistorised. One motor. Dimensions: $15\frac{3}{4} \times 7\frac{1}{2} \times 13\frac{1}{2}$ in. Weight: 22 lb. Pause. Position indicator: digital. Straight-through amplifier. Switchable input tape/mic. pickup and tuner. Psn 100. 110. 117. 125. 220. 240V 50-60 Hz. 60W. Price: £88 7s. 9d. (plus £21 17s. PT).

TC630. Stereo tape recorder. $\frac{1}{4}$ -track. Speeds: $1\frac{7}{8}$, $3\frac{3}{4}$ and $7\frac{1}{2}$ i/s. Max spool capacity: 7 in. W and F: $7\frac{1}{2}$ i/s 0-09%; $3\frac{3}{4}$ i/s 0-12%; $1\frac{7}{8}$ i/s 0-16%. H and N: $7\frac{1}{2}$ i/s -50 dB. FR: $7\frac{1}{2}$ i/s 30 Hz-22 KHz; $3\frac{3}{4}$ i/s 30 Hz-13 KHz; $1\frac{7}{8}$ i/s 30 Hz-10 KHz. Replay characteristics: NARTB. Level indicator: meter. Rewind time: 1.200 ft $2\frac{1}{2}$ min. Inputs: microphone. -72 dB (0.2 mV). 250 ohms; tuner -22 dB. (0.06V). 100K; aux. -22 dB (0.06V). 560K. Outlets: line output 0 dB (0.775V). 100K ohms; headphone. -28 dB (30 mV). 8 ohms; extension speakers. 8 ohms. Audio output: 15W per channel. Transistorised. Dimensions: $20 \times 17\frac{7}{8} \times 11\frac{1}{8}$ in. Motor: capstan drive. Tape deck: own. Weight: 46 lb. Superimposition. Pause. Position indicator: digital. Straight through amplifier. Monitoring. Sound-on-sound. Echo. Three heads. Psn 100. 110. 117.

125. 220 or 240V. 50 or 60 Hz. 40W. Price: £160 1s. 3d. (plus £39 13s. 9d. PT).



TANDBERG. Distributors: Farnell-Tandberg Ltd., Hereford House, North Court, Vicar Lane, Leeds 2. Tel: Leeds 39834/6. Grams: Elstone, Leeds.

Series 6. Stereo tape unit in $\frac{1}{4}$ - and $\frac{1}{2}$ -track versions. Speeds: $7\frac{1}{2}$, $3\frac{3}{4}$, $1\frac{7}{8}$ i/s. Max spool 7 in. W and F $7\frac{1}{2}$ i/s <0.1%, $3\frac{3}{4}$ i/s <0.15%, $1\frac{7}{8}$ i/s <0.35%. SN $7\frac{1}{2}$ i/s 62 dB. $3\frac{3}{4}$ i/s 55 dB. FR $7\frac{1}{2}$ i/s 40 Hz-18 KHz ± 2 dB; $3\frac{3}{4}$ i/s 40 Hz-14 KHz ± 2 dB; $1\frac{7}{8}$ i/s 40 Hz-8 KHz ± 2 dB. Two level indicators. Inputs: (each channel) mic 1.5 mV 5 megohms. radio/PU 50 mV 1 megohm. radio/PU 4 mV 100K. Outlets: cathode follower 1.5V at 2K. 0.5V at 50K. Centre channel output: 1V at 200 ohms. Nine valves. Two rectifiers. Own deck. Hysteresis synchro-motor. Separate record, playback and erase heads. Bias frequency: 78 KHz ± 2 KHz. Off-tape monitoring. Sound-on-sound recording. No power amplifiers or speakers. Echo effects. Input mixing. Single joystick tape transport control. Four-digit tape indicator. Push-button controls. Pause. Auto-stop. Optional remote control. Size: $6\frac{1}{2} \times 15\frac{3}{8} \times 11\frac{1}{8}$ in. Weight: 25 lb. Price: 64X $\frac{1}{4}$ -track, 62X $\frac{1}{2}$ -track. £125 18s. each (plus £31 2s. PT).

★ **Series 12.** Stereo tape recorder in $\frac{1}{4}$ -track and $\frac{1}{2}$ -track versions. Speeds: $7\frac{1}{2}$, $3\frac{3}{4}$, $1\frac{7}{8}$ i/s. Max spool 7 in. W and F $7\frac{1}{2}$ i/s <0.15%, $3\frac{3}{4}$ i/s <0.2%, $1\frac{7}{8}$ i/s <0.3%. H and N -55 dB. FR $7\frac{1}{2}$ i/s 40 Hz-20 KHz. $3\frac{3}{4}$ i/s 40 Hz-12 KHz. $1\frac{7}{8}$ i/s 40 Hz-7 KHz. Level indicators: two EAM86. Rewind time: 2 mins 1.200 ft. Inputs: two mics 1.5 mV 200 ohms. line 75 mV 1 megohm. line 7.5 mV 100K. Output: 10W RMS each channel. Outlets: amplifier 300 mV 10K (two). centre channel amplifier 750 mV 82 ohms. Speakers: two 7×4 in. (power on internal speakers limited to 3W each channel). 35 transistors. Erase and bias frequency 85.5 KHz. Stereo multiplex filter. Bass control: -12 dB at 80 Hz. Treble control: -15 dB at 15 KHz. All input connections parallel for British, American or Continental plugs. Size: $15\frac{3}{8} \times 11\frac{1}{8} \times 6\frac{1}{8}$ in. Weight: 23 lb. Price: (Model 1221X. 1241X) £119 10s. (plus £29 10s. PT).

★ **Series 11.** $\frac{1}{2}$ -track mono battery-operated semi-professional recorder. Battery 10-16V. Consumption 2-3W. 41 transistors. 10 diodes. Speeds: $7\frac{1}{2}$, $3\frac{3}{4}$, $1\frac{7}{8}$ i/s. Speed tolerance: better than 1%. FR $7\frac{1}{2}$ i/s 40 Hz-16 KHz ± 2 dB. W and F $7\frac{1}{2}$ i/s better than 0.1%. Distortion <0.5%. S



Sony TC-230

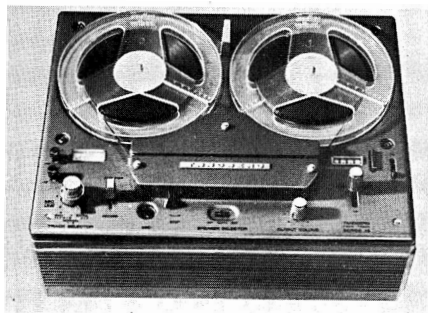

Tandberg Series 15

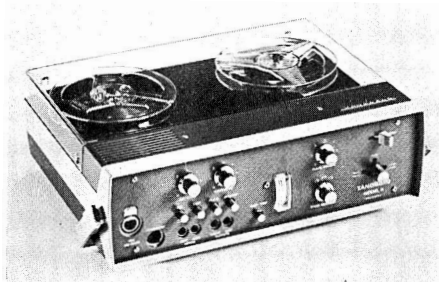

Tandberg 11-2

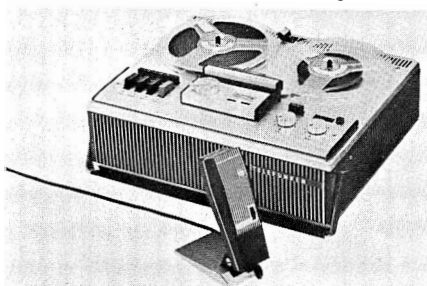

Telefunken M203 Studio

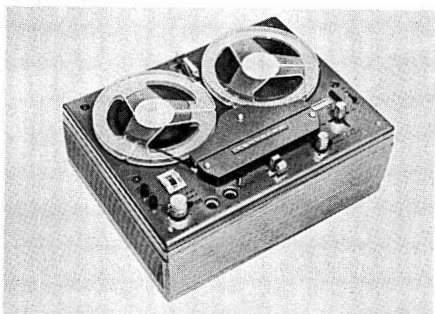

Tandberg 1241X

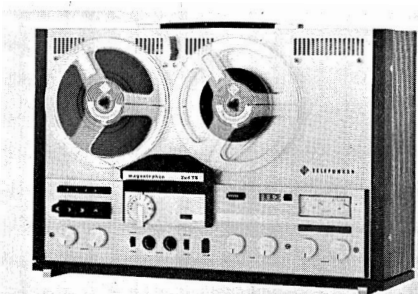

Telefunken M204TS



Tandberg 13-25

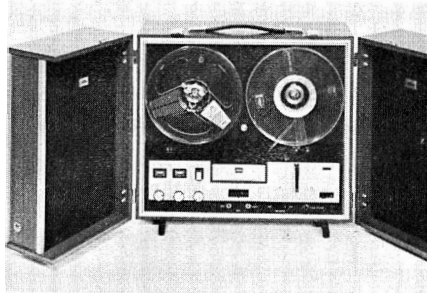

Toshiba GT-840S

to N: -60 dB. Inputs: mic 0.15 mV 200 ohms. low level 5 mV 10K. high level 125 mV 200K. Outputs: line 600 ohms. headphones 200 ohms. 0.25W 20 ohms. Size: $13 \times 4 \times 10\frac{1}{4}$ in. Weight: $11\frac{1}{2}$ lb (including batteries). Price: £130 14s. 3d. (plus £32 5s. 9d. PT).

Series 11-1 and 11-1P. Recorders for industrial and scientific use. Full track. 11-1P has neo pilot tone for film and TV use. Prices on application.

★**Series 13-25.** Single speed recorder designed for background music. Fidelipac cassettes and all cassettes which meet EIA standard RS/332 type 1. Speed: $3\frac{3}{4}$ i/s. Max tape length 1,200 ft. W and F <0.2% peak. Hum level better than -50 dB. FR 50Hz-10 KHz ± 3 dB. Power output 5W into 4 ohms. HD <1.5%. Extension speaker socket. Automatic track change. Two track record and playback. Automatic stop. Remote control. Straight-through amplifier. Inputs: mic 200 ohms. line 50K 6 mV. Slide sync socket. Price: Model 13-25 (two track record and playback) £122 (including PT); Model 13-44 (four track playback only) £109 (including PT).

Series 1200X. Crossfield stereo recorder. Dual recording level meters with 20 dB range. FR at ± 2 dB: $7\frac{1}{2}$ i/s 40 Hz-18 KHz; $3\frac{3}{4}$ i/s 40 Hz-14 KHz; $1\frac{7}{8}$ i/s 40 Hz-8 KHz. W and F: $7\frac{1}{2}$ i/s <0.1%; $3\frac{3}{4}$ i/s <0.15%; $1\frac{7}{8}$ i/s 0.35%. S/N at $7\frac{1}{2}$ i/s (DIN standard measurement) 58 dB $\frac{1}{4}$ -track. and 60 dB $\frac{1}{2}$ -track. Inputs: 200 ohm mic; equalised RIAA PU input. Inputs have a 60 dB dynamic range above specified sensitivity. Outputs: pre-amp and centre channel for headphones; internal speakers 3W RMS per channel; extension speakers 10W per channel RMS. Straight through amplifier. Bass and treble controls. Size: $6\frac{7}{8} \times 15\frac{3}{8} \times 11\frac{13}{16}$ in. Price: (in teak cabinet) 1221X (2 track with bias head) £149 (including PT); 1241X (4 track with bias head) £149 (including PT).

★**Series 15.** $\frac{1}{2}$ - or $\frac{1}{4}$ -track recorders. Output: 10W RMS. FR at ± 2 dB: $7\frac{1}{2}$ i/s 40 Hz-16 KHz; $3\frac{3}{4}$ i/s 50 Hz-9 KHz; $1\frac{7}{8}$ i/s 60 Hz-4.5 KHz. S/N: $7\frac{1}{2}$ i/s (DIN-standard measurement) 58 dB; $\frac{1}{4}$ -track model. 60 dB $\frac{1}{2}$ -track model. Input: mic 200 ohms; pickup 1M 100 mV; line. 100K 10 mV. Straight through amplification. Free head for connection to automatic slide sync. Bass and treble controls.

Educational versions. Model SL is a special educational version of Series 15 where a student listens to a master recording on the top track

and records his responses on the bottom track. Price: 1541 ($\frac{1}{4}$ -track. teak or rosewood cabinet) £81 (including PT); 1542 ($\frac{1}{4}$ -track. ABS case) £93 10s. (including PT); 1521 ($\frac{1}{2}$ -track teak cabinet) £77 (including PT); 1522 ($\frac{1}{2}$ -track ABS case) £88 10s. (including PT); 1521SL £107 (including PT); 1522SL (ABS case) £119 (including PT).



TEAC. Distributors: B. H. Morris & Co. (Radio) Ltd., 84-88 Nelson Street, Tower Hamlets, London. E.1. Tel: 01-790 4824.

Teac 4010S. Transistor $\frac{1}{4}$ -track stereo semi-professional recorder. Speeds: $7\frac{1}{2}$, $3\frac{3}{4}$ i/s. Max spool 7 in. W and F $7\frac{1}{2}$ i/s 0.12%. $3\frac{3}{4}$ i/s 0.15%. Signal-to-noise ratio 50 dB. FR $7\frac{1}{2}$ i/s 30 Hz-20 KHz. $3\frac{3}{4}$ i/s 40 Hz-12 KHz. Replay char NAB. VU meters. Rewind time: 90 secs for 1,200 ft. Four-digit tape indicator. PB reset. Three motors: one dual-speed hysteresis capstan drive. two six-pole outer-rotor reel drive. Automatic reverse play. Tape tension control. Auto shut-off. Inputs: mic 0.25 mV 10K. 140 mV 100K. Monitoring. Input mixing. Four heads. Mains 100, 117, 220-240V 50/60 Hz. Consumption: 110W. Size: $17\frac{1}{2} \times 17\frac{1}{2} \times 9\frac{3}{4}$ in. Weight: 48 lb. Price: £288 15s. (including PT).

Teac A-2060. Stereo tape recorder. Speeds: $1\frac{7}{8}$, $3\frac{3}{4}$ and $7\frac{1}{2}$ i/s. Max spool 7 in. W and F: $1\frac{7}{8}$ i/s 0.2%; $3\frac{3}{4}$ i/s 0.15%. $7\frac{1}{2}$ i/s 0.12%. FR: $1\frac{7}{8}$ i/s 40-7 KHz. $3\frac{3}{4}$ i/s 50-10 KHz ± 3 dB; $7\frac{1}{2}$ i/s 50-15 KHz ± 3 dB. Signal-to-noise ratio: 50 dB. Inputs: microphone 600 ohms; line 100K 0.10V minimum. Output: 0.5V for load impedance of 50K or more. Monitoring headphones: 8 ohms. Psn 100, 110, 115, 220V. 50 or 60 Hz. Dimensions: $16\frac{1}{8} \times 17\frac{5}{8} \times 8\frac{1}{2}$ in. Weight: 40 lb. Price: £200.



TELEFUNKEN. Distributor: AEG (Great Britain) Ltd., Lonsdale Chambers, 27 Chancery Lane, London. W.C.2. Tel: 01-242 9944.

★**203Studio.** Two-speed $\frac{1}{4}$ -track stereo recorder. Single playback amplifier. 7 in. reel. W and F: $3\frac{3}{4}$ i/s $\pm 0.3\%$, $7\frac{1}{2}$ i/s $\pm 0.2\%$. H and N: $3\frac{3}{4}$ i/s -45 dB; $7\frac{1}{2}$ i/s -50 dB. FR: $3\frac{3}{4}$ i/s 40 Hz-15 KHz; $7\frac{1}{2}$ i/s 40 Hz-18 KHz. Replay char DIN. Level meter. Inputs: tuner 0.15 mV 5K; mic 0.15 mV 5K; PU 70 mV 2.2M; tape 70 mV 2.2M. Outputs: amplifier 1V 2K; earphones 0.5V (approx) 5K load; speaker 4 ohms 6W. Function switch. Pilot light. Record light. Psn 110/240V. Size: $15 \times 6\frac{3}{4} \times 12\frac{1}{4}$ in. Weight: 20 lb. Price: £78 18s. 9d. (plus £19 10s. PT).

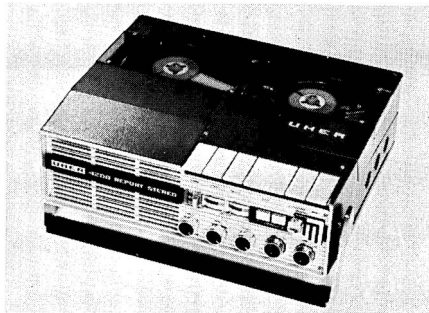

Uher 4200 Stereo

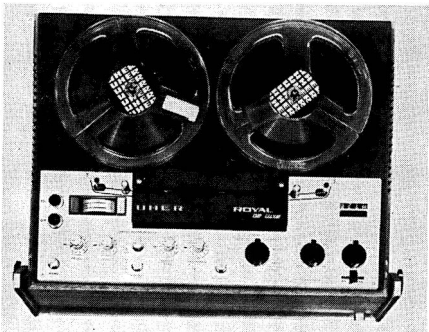

Uher Royal de Luxe

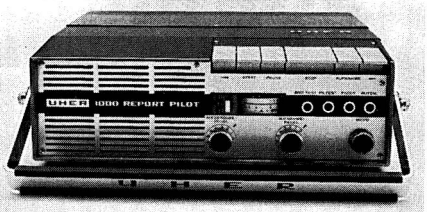

Uher 1000 Report pilot

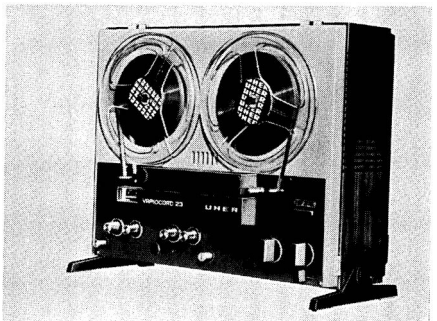

Uher Varicord 23

★**204TS.** $\frac{1}{4}$ -track stereo recorder. 3-speed. Max reel 7 in. W and F: $7\frac{1}{2}$ i/s 0.15%; $3\frac{3}{4}$ i/s 0.25%; $1\frac{7}{8}$ i/s 0.4%. H and N: $7\frac{1}{2}$ i/s -50 dB; $3\frac{3}{4}$ i/s -48 dB. FR (to DIN 45-511) $7\frac{1}{2}$ i/s 40 Hz-18 KHz; $3\frac{3}{4}$ i/s 40 Hz-15 KHz; $1\frac{7}{8}$ i/s 40 Hz-8 KHz. Replay char. DIN. Level meters (two). Inputs: mic 0.15 mV 5K. Tuner 0.15 mV 5K. PU/tape: 70 mV 2.2M. Outputs: amplifier 1.5V 8K; phones 0.5V 5K; speaker 6W 4 ohm. Speaker $7 \times 4\frac{1}{4}$ in. Sound on sound. Pause. 4 digit counter. Straight-through amplifier. Monitor. Parallel track replay. Vertical or horizontal operation. Separate controls for each channel. Track selection switch. Warning light below each meter. Transcribe track-to-track. Psn 110-240V. Price: £100 4s. (plus £24 15s. PT).

302TS. Two-speed $\frac{1}{4}$ -track recorder. Battery operation. 5 in. reels. W and F: $1\frac{3}{4}$ i/s $\pm 0.3\%$. $3\frac{3}{4}$ i/s +0.3%. H and N (DIN 45-405): $3\frac{3}{4}$ i/s -46 dB. FR (DIN 45-511): $1\frac{3}{4}$ i/s 40 Hz-8 KHz; $3\frac{3}{4}$ i/s 40 Hz-14 KHz. Replay char DIN. Level meter. Inputs: mic 0.15 mV 2.2M; PU/tape 150 mV 2.2M; tuner 0.15 mV 2.2M. Outputs: amplifier 1.5V 18K; headphones 0.4V 5K load; speaker 4.5 ohms. $4 \times 2\frac{5}{8}$ in. speaker. 1W output. Electronic speed control. Counter. Pause. Counter-rotating flywheels. One hand control operation. Psn: accumulator, U2 batteries, car or mains adapter. Size: $10\frac{1}{2} \times 3 \times 11$ in. Weight: $6\frac{1}{2}$ lb. Price on application.

★

TOSHIBA. Hanimex (U.K.) Ltd., Hanimex House, 15-24 Great Dover Street, London, S.E.1. Tel: 01-407 8161.

GT-840S. Transistorised 4-track stereo recorder. Speeds: $7\frac{1}{2}$ i/s, $3\frac{3}{4}$ i/s. FR: 70 Hz-16 KHz at $7\frac{1}{2}$ i/s, 70 Hz-12 KHz at $3\frac{3}{4}$ i/s. Power output: 5W per channel. Psn: 110-240V 50-60 Hz. Jacks for microphones and external speakers. Dimensions: $16 \times 14\frac{1}{4} \times 10$ in. Price: £103 19s. (including PT).

GT-701V. 2-track mono recorder which can be operated vertically or horizontally. Speeds: $7\frac{1}{2}$ i/s, $3\frac{3}{4}$ i/s. FR: 70 Hz-11 KHz at $7\frac{1}{2}$ i/s, 70 Hz-7 KHz at $3\frac{3}{4}$ i/s. Power output: 1.5W. Psn: 110-240V 50-60 Hz. Jacks for microphone and external speaker. Dimensions: $13 \times 7\frac{1}{2} \times 13\frac{3}{4}$ in. Price: £57 15s. (including PT).

★

TRUVOX. Truvox Ltd., Hythe, Southampton, Hampshire. Tel: Hythe 3265.

R202/4, RB202/4. Mono tape recorder in $\frac{1}{4}$ - and $\frac{1}{2}$ -track versions and in portable or teak case. Speeds: $7\frac{1}{2}$, $3\frac{3}{4}$, $1\frac{7}{8}$ i/s. W and F better than 0.1% at $7\frac{1}{2}$ i/s. Max spool 7 in. FR: $7\frac{1}{2}$ i/s 30 Hz-18 KHz ± 2 dB, $3\frac{3}{4}$ i/s 30 Hz-12 KHz ± 2 dB, $1\frac{7}{8}$ i/s 40 Hz-7 KHz ± 3 dB. S to N: better than 50 dB ($\frac{1}{2}$ track), better than 48 dB ($\frac{1}{4}$ -track). Speaker: 8×5 in. VU meter. Equalisation new CCIR. Bias oscillator 90 KHz. Inputs: mic 1 mV 50K, radio/PU 50 mV 200K. Outputs: low Z 10W, line 0-1V variable. Microphone: moving coil, semi-cardioid. Rewind time: less than 120 secs for 1,200 ft. Mains: 200-250V 50 Hz (100-120V 50-60 Hz to order). Size: approximately $16 \times 17\frac{3}{4} \times 8\frac{1}{2}$ in. Weight: approximately 35 lb. Three heads. Three motors, capstan motor outer rotor type. Off-tape monitoring. Mixing. Duo-play. Track-on-track recording. Four-digit tape indicator. Auto-stop. A-B test switch. Spool carrier hublocks. Inching and cue control. Vertical or horizontal operation. Price: £127 0s. 2d. (including PT).

★

UHER. Distributors: Bosch Ltd., Rhodes Way, Radlett Road, Watford, Herts, WD2 4LB. Tel: Watford 44233.

★ **Uher 4200.** Transistorised mains/battery stereo tape recorder. $\frac{1}{2}$ -track. Speeds: $7\frac{1}{2}$, $3\frac{3}{4}$, $1\frac{7}{8}$, $15/16$ i/s. Max spool 5 in. W and F: $7\frac{1}{2}$ i/s 0.2%, $3\frac{3}{4}$ i/s 0.25%, $1\frac{7}{8}$ i/s 0.35%, $11/16$ i/s 0.5%. H and N: $7\frac{1}{2}$ i/s -53 dB, $3\frac{3}{4}$ i/s -51 dB, $1\frac{7}{8}$ i/s -47 dB, $15/16$ i/s -43 dB. FR: $7\frac{1}{2}$ i/s 40 Hz-20 KHz ± 3 dB, $3\frac{3}{4}$ i/s 40 Hz-16 KHz ± 3 dB, $1\frac{7}{8}$ i/s 40 Hz-10 KHz ± 3 dB, $15/16$ i/s 40 Hz-4.5 KHz ± 3 dB. Replay char NARTB. Level indicator: two meters. Rewind time: 3 mins for 900 ft. Inputs: mic 0.1 mV 2K, radio 2 mV 47K, PU 30 mV 1 megohm. Outlets: line 1V 15K, speaker 4 ohms. One motor. Pause. Digital position indicator. Monitoring. Parallel track replay. Size: $11 \times 3 \times 8$ in. Weight: 7 lb. Supply: internal dry cells, rechargeable accumulator, or from 6V, 12V, 24V car battery, 110-240V AC mains with additional adaptor units. Price: £162 15s. (including PT).

Uher 4400. $\frac{1}{4}$ -track version of 4200. Specification almost identical. Price: £162 15s. (including PT).

★ **Uher Royal de luxe.** Transistorised professional mains recorder. Mono/stereo. $\frac{1}{4}$ -track. Speeds: $7\frac{1}{2}$, $3\frac{3}{4}$, $1\frac{7}{8}$, $15/16$ i/s. Max spool 7 in. W and F: $7\frac{1}{2}$ i/s 0.05%, $3\frac{3}{4}$ i/s 0.1%, $1\frac{7}{8}$ i/s

0.25%, $15/16$ i/s 0.35%. H and N: $7\frac{1}{2}$ i/s -54 dB, $3\frac{3}{4}$ i/s -54 dB, $1\frac{7}{8}$ i/s -54 dB. FR: $7\frac{1}{2}$ i/s 20 Hz-20 KHz, $3\frac{3}{4}$ i/s 20 Hz-15 KHz, $1\frac{7}{8}$ i/s 20 Hz-9 KHz, $15/16$ i/s 20 Hz-5 KHz. Replay char NARTB. Level indicators: two meters. Inputs: mic 0.2 mV-100 mV 200 ohms, radio 2 mV-1V 47K, PU(1) 50 mV 1 megohm, PU(2) 200 mV 50K. Outlets: line 775 mV 15K, speaker 4 ohms. Output: 10W RMS per channel. One Papst motor. Pause. Inching. Straight-through amplifier. Horizontal or vertical operation. Monitoring. Input mixing. Parallel track replay. Interchangeable head assemblies available as optional extras. Dia-pilot. Multiplay. Echo. Weight: $29\frac{1}{2}$ lb. Price: £254 2s. (including PT).

★ **Uher Pilot 1000.** Transistorised professional mains/battery mono recorder. Full track. Speed: $7\frac{1}{2}$ i/s. Max spool 5 in. W and F: 0.2%, H and N -52 dB. FR 20 Hz-20 KHz ± 3 dB. Replay char: CCIR, NARTB. Meter level indicator. Rewind time 3 mins 900 ft. Inputs: mic 0.3 mV 200 ohms balanced, 1-10V line. Output 1W RMS. Brushless DC motor. Pause. Digit tape indicator. Straight-through amplifier. A/B monitoring. Input mixing. Pilot tone input. Supply: internal dry cells, rechargeable accumulator, or from 6V, 12V, 24V car battery, 110-240V AC mains with additional adaptor units. For supply only to industrial or scientific users. Size: $11 \times 3 \times 8$ in. Weight: 7 lb. Price: £307.

★ **4000 Report L.** Transistorised mono battery portable recorder. $\frac{1}{2}$ -track. Speeds: $7\frac{1}{2}$, $3\frac{3}{4}$, $1\frac{7}{8}$, $1\frac{1}{16}$ i/s. W and F $7\frac{1}{2}$ i/s, $\pm 0.15\%$. H and N -55 dB. FR: $7\frac{1}{2}$ i/s 40 Hz-20 KHz, $3\frac{3}{4}$ i/s 40 Hz-16 KHz, $1\frac{7}{8}$ i/s 40 Hz-10 KHz, $1\frac{1}{16}$ i/s 40 Hz-4.5 KHz. Replay char NARTB. Inputs: mic 0.1 mV, 2K; radio 2 mV, 47K; gram 30 mV, 1 megohm. Outlet direct from pre-amp. One motor, 5 in. spool. Means of operation: mains, car battery, 1.5V cells, rechargeable accumulator. Size: $10\frac{1}{2} \times 8\frac{1}{2} \times 3\frac{1}{4}$ in. Weight: 7 lb. Price: £133 7s. (including PT). Combined mains unit and battery charger. Price: £13 7s. (plus PT).

★ **Variocord.** Transistorised mains mono recorder. Available as $\frac{1}{2}$ -track or $\frac{1}{4}$ -track. Speeds: $1\frac{7}{8}$, $3\frac{3}{4}$ and $7\frac{1}{2}$ i/s. W and F at $7\frac{1}{2}$ i/s 0.05%, FR $7\frac{1}{2}$ i/s 30 Hz-20 KHz; $3\frac{3}{4}$ i/s 30 Hz-15 KHz; $1\frac{7}{8}$ i/s 30 Hz-8 KHz. Inputs: mic 0.12 mV (200 ohms); radio 1.2 mV; gram 45 mV. Outputs: line 1.4V; speaker 2W or 6W (depending on type) into 4 ohms. Level indicator meter. Interchangeable head assemblies. Input mixing. Horizontal or vertical operation. Optional 2W or 6W output stages. Optional add-on automatic volume control module. Prices from £106 1s. (including PT).

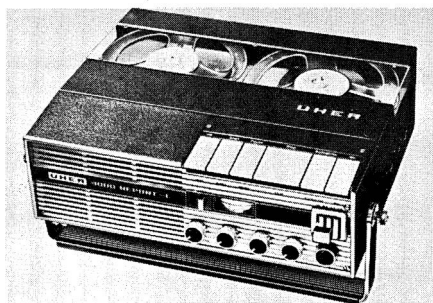

Uher 4000 Report L



Ultra 6212

ULTRA. British Radio Corporation Ltd., 284 Southbury Road, Enfield, Middlesex. Tel: 01-366 1155.

★ **6212.** Mono $\frac{1}{4}$ -track tape recorder. Speeds: $7\frac{1}{2}$ i/s, $3\frac{3}{4}$ i/s, $1\frac{7}{8}$ i/s. W and F: 0.15%, $7\frac{1}{2}$ i/s; 0.2%, $3\frac{3}{4}$ i/s; 0.25%, $1\frac{7}{8}$ i/s. FR: 40 Hz-18 KHz $7\frac{1}{2}$ i/s; 40 Hz-7 KHz $1\frac{7}{8}$ i/s. Meter indicator. Rewind time: 1,200 ft in 2 $\frac{1}{2}$ min. Inputs: radio 1.5 mV 68K, PU 180 mV 200-500K; mic 1.5 mV 10M. Outputs: ext amp 1V 22K. L.S. 3W 3 ohms. Psn: AC mains. Dimensions: $16\frac{5}{8} \times 14\frac{3}{8} \times 7\frac{1}{4}$ in. Price: £48 4s. 11d. (plus £11 7s. 1d. PT).



VAN DER MOLEN LTD., 1 Mildmay Road, Romford, Essex. Tel: Romford 41904.

VR7T recorder. 3 speed. $\frac{1}{4}$ or $\frac{1}{2}$ track mono. Max reel size 7 in. W and F: $7\frac{1}{2}$ i/s 0.15%; $3\frac{3}{4}$ i/s 0.25%; $1\frac{7}{8}$ i/s 0.35%. H and N better than 40 dB all speeds. FR: $7\frac{1}{2}$ i/s 60 Hz-15 KHz; $3\frac{3}{4}$ i/s 60 Hz-10 KHz; $1\frac{7}{8}$ i/s 60 Hz to 4 KHz. Replay char CCIR. ME level indicator. Rewind time 3 min 1,200 ft. Inputs: mic 2 mV 1 megohm; radio 200 mV 1 megohm. Outputs: 1-3V 200K; ext speaker 3W 3 ohm; int speaker 3W. Pause control, rev counter, straight through amplifier, monitor, input mixing, parallel track replay, vertical or horizontal operation. Mains 200-250V. Size: $18\frac{3}{4} \times 11\frac{1}{2} \times 7$ in. Weight: 21 lb. Price: £44 10s. (plus £11 PT).

VR2. $\frac{1}{2}$ -track mono, operates vertically. Speeds: $7\frac{1}{2}$ i/s, $3\frac{3}{4}$ i/s, $1\frac{7}{8}$ i/s. W and F: 0.15% at $7\frac{1}{2}$ i/s, 0.25% at $3\frac{3}{4}$ i/s, 0.4% at $1\frac{7}{8}$ i/s. FR: 40 Hz-15 KHz ± 3 dB at $7\frac{1}{2}$ i/s. Inputs: mic 2 mV 50K; PU 200 mV 1M; radio 30 mV 100K. Power output: 5W RMS into 8 ohms. Record level meter. Pause and mixing facilities. Dimensions: $15\frac{1}{4} \times 12\frac{1}{4} \times 7\frac{3}{4}$ in. Weight: 21 lb. Finish: teak. Price: £59 15s. (plus £14 9s. 5d. PT).

VR4. 4-track mono, operates vertically. Details as for VR2. Price: £59 15s. (plus £14 9s. 5d. PT).



VORTEXION LTD., 257-263 The Broadway, Wimbledon, London, S.W.19. Tel: 01-542 6242/3/4 and 2814. Cables: Vortexion, London, S.W.19.

Vortexion Series 7. Professional recorder with solenoid start/stop with provision for remote control and voice operated control. All silicon version provides 10-15W output per channel with less than 0.1% distortion at 10W. Low-noise FET's at all inputs for low intermodulation distortion. Full specification and prices on request.

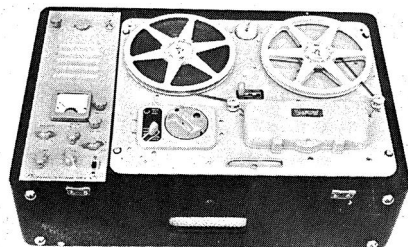

Vortexion W.V.B.

TAPE DECKS

BRENELL ENGINEERING CO. LTD., 231/5
Liverpool Road, London, N.1. Tel: 01-607
8251 (5 lines).

Mark 5 Series 3. G.P. tape deck, 15, $7\frac{1}{2}$, $3\frac{3}{4}$
and $1\frac{7}{8}$ i/s. Three motors. $8\frac{1}{4}$ in. spools. W and F
0.1% at $7\frac{1}{2}$ i/s accommodates up to four heads.
Size: $15 \times 11\frac{1}{2} \times 5$ in. Weight: 16 lb. Price:
£41 16s. (plus £10 9s. 3d. PT) with two heads.

Mark 510 Series 2. Deck mechanism. $\frac{1}{2}$ - or $\frac{1}{4}$ -
track. Speeds: 15, $7\frac{1}{2}$, $3\frac{3}{4}$, $1\frac{7}{8}$ i/s. W and F 15 i/s,
<0.05%; $7\frac{1}{2}$ i/s. <0.1%; $3\frac{3}{4}$ i/s. <0.15%;
 $1\frac{7}{8}$ i/s. <0.25%. Three motors (synchronous
type for capstan). $10\frac{1}{2}$ in. NAB spools. 60 secs
per 1,200 ft rewind. Pause. Accommodates 4
heads. Size: $15 \times 11\frac{1}{2} \times 6$ in. Weight: 16 lb. Price
(less heads): £51 15s. 3d. (plus £12 14s. PT).
(Prices with heads on application.)



FERROGRAPH. Ferrograph Co. Ltd., Mercury
House, 195 Knightsbridge, London, S.W.1.
Tel: 01-589 4485.

Series 7. Semi-professional tape deck. Speeds:
15, $7\frac{1}{2}$, $3\frac{3}{4}$ i/s or $7\frac{1}{2}$, $3\frac{3}{4}$, $1\frac{7}{8}$ i/s. Mono or stereo.
 $\frac{1}{4}$ -track or $\frac{1}{2}$ -track. Max spool $8\frac{1}{4}$ in. W and F
0.08% at 15 i/s. 0.08% at $7\frac{1}{2}$ i/s. 0.15% at $3\frac{3}{4}$ i/s.
0.2% at $1\frac{7}{8}$ i/s. Rewind time: less than one
minute for 1,200 ft. Three motors, synchronous
hysteresis capstan motor, shaded pole reel
motors. Pause facility. Single knob control.
Vertical or horizontal operation. Fast wind
continuously variable in either direction. Re-
mote start/stop facility. Removable head block.
Automatic stop at end of reel. Reel retainers
fitted to spindles. Various head arrangements.
Full specification and prices on application.



LUXOR. Distributors: Luxitone, 84 Bolsover
Street, London, W.1. Tel: 01-636 2901.

MP613. General purpose stereo tape deck.
 $\frac{1}{4}$ -track. Three speeds: $1\frac{7}{8}$, $3\frac{3}{4}$, $7\frac{1}{2}$ i/s. W and F:
 $\pm 0.35\%$ at $1\frac{7}{8}$ i/s; $\pm 0.2\%$ at $3\frac{3}{4}$ i/s; $\pm 0.1\%$ at
 $7\frac{1}{2}$ i/s. FR: 80 Hz-6 KHz at $1\frac{7}{8}$ i/s; 50 Hz-12 KHz
at $3\frac{3}{4}$ i/s; 50 Kz-19 KHz at $7\frac{1}{2}$ i/s. Spool capacity:
7 in. Digital position indicator. Pause control,
4-pole shaded motor. Dimensions: 39.5×32.5
 $\times 19$ cm ($15\frac{5}{8} \times 12\frac{5}{8} \times 7\frac{1}{2}$ in. approx.). Price:
£82 18s. 1d. (plus £18 10s. 7d. PT).

PLANET PROJECTS LTD., G o o d m a n
Works, Belvue Road, Northolt, Middlesex.
Tel: 01-845 1775.

★ **C.D.2.** Tape deck. Speed: $3\frac{3}{4}$ i/s ($1\frac{7}{8}$ i/s to
special order). W and F: Less than 0.2% at both
speeds. Miniflux heads. $\frac{1}{2}$ -track mono or $\frac{1}{4}$ -track
stereo. Two heads, one for each track. FR: de-
pendent on speed and heads. Papst hysteresis
motor. Spool size 7 in. Automatic track change
and reversal of tape direction at end of spool.
no fast rewind required. Uses standard $\frac{1}{4}$ in.
tape. Single knob control. Provides over 8 $\frac{1}{2}$
hours uninterrupted playing at $1\frac{7}{8}$ i/s. Mains
220-230V 50 Hz. Size: $14\frac{3}{4} \times 11\frac{3}{4} \times 6$ in. Weight
approximately: 10 lb. Price: £68 5s. (ex works).



SCOPETRONICS LTD., Crown Works,
Church Road, Kingston-upon-Thames, Surrey.
Tel: 01-546 1275 and 4135.

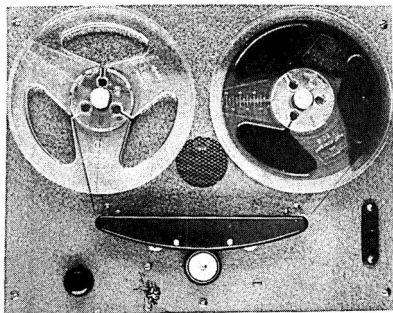

Planet CD2

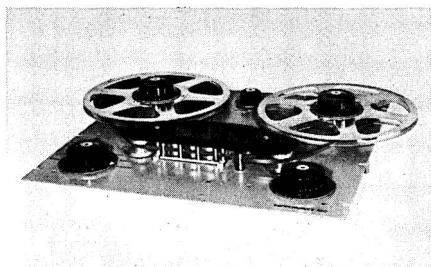

Scopetronics 1150

★**1150.** G.P. tape deck 15. $7\frac{1}{2}$ i/s. Three Papst motors with ext. rotors. Three heads. W and F: 0-14% at $7\frac{1}{2}$ i/s, 0-08% at 15 i/s. Spool capacity: $11\frac{1}{2}$ in. Pause control and inching facility. Rewind: <1 min 45 sec for 2,400 ft. Weight: 26 lb. Price: £154 10s.

★

TAPE RECORDER DEVELOPMENTS LTD., 7 King George Avenue, Bushey, Herts. Tel: 01-950 2331.

TRD.1 Series. Four-speed mono or stereo tape decks. W and F 15 i/s 0-05%, $7\frac{1}{2}$ i/s 0-08%, $3\frac{3}{4}$ i/s 0-13%, $1\frac{7}{8}$ i/s 0-2%, $\frac{1}{8}$ i/s 0-35%. Mains operated. $\frac{1}{4}$ - or $\frac{1}{2}$ -track. Accommodation for four Bogen heads. Drive motors: Papst hysteresis synchronous. Rewind motors: Papst R.O.T. Spool capacity: 3 in. cine to $10\frac{1}{2}$ in. NAB. Four-digit tape position indicator. Silicon transistor tape pre-amplifier/oscillator unit available (see Tape Units section).

TRD.1/S. Specification as above. Speeds: $7\frac{1}{2}$, $3\frac{3}{4}$, $1\frac{7}{8}$, $\frac{1}{8}$ i/s. Solenoid operation.

TRD.1/VR. Specification as above. Speeds: $7\frac{1}{2}$, $3\frac{3}{4}$, $1\frac{7}{8}$, $\frac{1}{8}$ i/s. Mechanical operation. Variable speed spooling.

TRD.1/S/15. Specification as above. Speeds: 15, $7\frac{1}{2}$, $3\frac{3}{4}$, $1\frac{7}{8}$ i/s. Solenoid operation.

TRD.1/VR/15. Specification as above. Speeds: 15, $7\frac{1}{2}$, $3\frac{3}{4}$, $1\frac{7}{8}$ i/s. Mechanical operation. Variable speed spooling.

TRD.1/S/30. To special order only. Specification as above. Speeds: 30, 15, $7\frac{1}{2}$, $3\frac{3}{4}$, i/s. Solenoid operation.

TRD.1/S/15P. To special order only. Specification as above. As TRD.1/S/15 but for $\frac{1}{2}$ in. tape.

TRD.1/VR/15P. To special order only. Specification as above. As TRD.1/VR/15 but for $\frac{1}{2}$ in. tape.

Full specifications and prices of TRD decks and electronic units on request.

TAPE UNITS

AKAI. Pullin Photographic (Rank Organization), P.O. Box 70, Great West Road, Brentford, Middlesex. Tel: 01-568 9222.

X-150D. Stereo tape unit with pre-amplifiers. $\frac{1}{4}$ -track. Speeds: $1\frac{7}{8}$, $3\frac{3}{4}$ and $7\frac{1}{2}$ i/s, 15 i/s optional. Max. spool capacity: 7 in. W and F: $7\frac{1}{2}$ i/s 0-12%; $3\frac{3}{4}$ i/s 0-15%; $1\frac{7}{8}$ i/s 0-2%. H and N 50 dB. FR: $7\frac{1}{2}$ i/s 30 Hz-23KHz ± 3 dB; $3\frac{3}{4}$ i/s 30 Hz-18KHz ± 3 dB; $1\frac{7}{8}$ i/s 30 Hz-9 KHz ± 3 dB. Replay characteristics: NARTB. Level indicator: meter. Rewind time: 1,200 ft 90 sec. Inputs: microphone 0-5 mV; line 60 mV; DIN. Outputs: line, DIN, headphone. Transistorised. Motor: 2-speed hysteresis synchro. Tape deck: own. Dimensions: $13\frac{1}{2} \times 13\frac{1}{2} \times 9$ in. Weight: 30-8 lb. Pause. Digit. Monitoring by headphone. Crossfield head. Vertical or horizontal operation. Psn 100-240V. Price: £103 19s. 7d. (plus £26 0s. 5d. PT).

★**X-360D.** Professional stereo tape unit with pre-amplifiers. $\frac{1}{4}$ - track. Speeds: $1\frac{7}{8}$, $3\frac{3}{4}$, $7\frac{1}{2}$ and 15 i/s. Max. spool capacity: 7 in. W and F: $7\frac{1}{2}$ i/s 0-04%; $3\frac{3}{4}$ i/s 0-07%; $1\frac{7}{8}$ 0-15%. H and N 50 dB. FR: $7\frac{1}{2}$ i/s 30 Hz-23 KHz ± 1 dB; $3\frac{3}{4}$ i/s

30 Hz-18KHz ± 3 dB; $1\frac{7}{8}$ i/s 40 Hz-11 KHz ± 3 dB. Replay characteristics: NARTB. Level indicator: two meters. Rewind time: 1,200 ft 75 sec. Inputs: microphone, more than 0-5 mV, 50 K; line, more than 50 mV; DIN, low 5 mV, high 50 mV. Outputs: line, DIN, headphone. Transistorised. Motors: one hysteresis synchronous 3-speed; two 6-pole eddy current, outside rotor. Tape deck: own. Dimensions: $17\frac{1}{2} \times 16 \times 10$ in. Weight: 55 lb. Superimposing. Position indicator: digit. Monitoring. Input mixing. Parallel track replay. Crossfield head. Auto reverse by timing clock. Comput-o-Matic recording. Warning light when heads need cleaning. Remote control. Tape cleaner. Headphone jack. Auto stop. Auto shut off. Magnetic brakes. 100-240V, 50 or 60 Hz. Price: £247 19s. 1d. (plus £62 0s. 11d. PT).

X-360DS. Professional stereo tape unit with pre-amplifiers. $\frac{1}{4}$ -track. Speeds: $1\frac{7}{8}$, $3\frac{3}{4}$ and $7\frac{1}{2}$ i/s. Max spool capacity: 7 in. W and F: $7\frac{1}{2}$ i/s 0-04%; $3\frac{3}{4}$ i/s 0-07%; $1\frac{7}{8}$ i/s 0-15%. H and N 50 dB. FR: $7\frac{1}{2}$ i/s 30 Hz-23 KHz; $3\frac{3}{4}$ i/s 30-18 KHz; $1\frac{7}{8}$ i/s 30 Hz-9 KHz. Replay characteristics: NARTB. Level indicator: meter. Rewind



Akai X360-D

time: 1,200 ft 75 sec. Inputs: microphone, 0.5 mV; line, 50 mV; DIN, 5 mV low, 50 mV high. Outlets: line, 1.23V; DIN, 0.4V; headphone. Transistorised. Motors: one 3-speed hysteresis synchronous; two 6-pole eddy current Tape deck: own. Dimensions: $17\frac{1}{2} \times 16 \times 10$ in. Weight: 55 lb. Superimpose. Position indicator: digit. Monitoring: A-B. Input mixing. Parallel track replay. Crossfield head. Magnetic brake. FM multiplex ready. Remote control. Tape cleaner. Psn 100-240V, 50 or 60 Hz. Price: £239 3s. 1d. (plus £59 16s. 11d. PT).

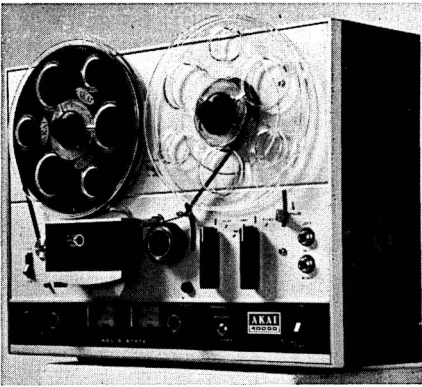

Akai 4000D

★4000D. Stereo tape unit with pre-amplifiers. $\frac{1}{4}$ -track. Speeds: $3\frac{3}{4}$ and $7\frac{1}{2}$ i/s. Max. spool capacity: 7 in. W and F: $7\frac{1}{2}$ i/s 0.15%; $3\frac{3}{4}$ i/s 0.2%; H and N 50 dB. FR: $7\frac{1}{2}$ i/s 30 Hz-22 KHz ± 3 dB; $3\frac{3}{4}$ i/s 30 Hz-16 KHz ± 3 dB. Replay characteristics: NARTB. Level indicator: Meter. Rewind time: 1,200 ft 150 sec. Inputs: microphone, 0.5 mV. 50 K; line, 50 mV; DIN, 50 mV. Outlets: line, DIN, headphone. Transistorised. Induction motor. Tape deck: own. Dimensions: $12\frac{3}{8} \times 15\frac{7}{8} \times 7\frac{1}{2}$ in. Weight: 25.3 lb. Pause. Position indicator: digit. Monitoring: A-B. Parallel track replay. One micron gap recording head. Sound on sound. Auto stop. Auto shut off. Tape cleaner. Vertical or horizontal operation. Psn 100-240V. Price: £79 15s. 8d. (plus £19 19s. 4d. PT).

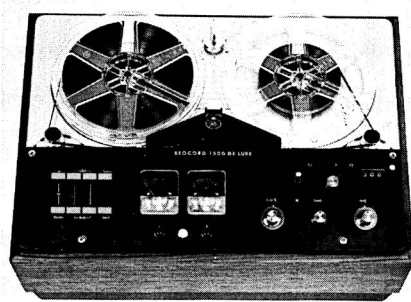

Beocord 1500 de luxe

X-330D. Stereo tape unit with pre-amplifiers. $\frac{1}{4}$ -track. Speeds: $1\frac{7}{8}$, $3\frac{3}{4}$ and $7\frac{1}{2}$ i/s. Max spool capacity: $10\frac{1}{2}$ in. W and F: $7\frac{1}{2}$ i/s 0.04%; $3\frac{3}{4}$ i/s 0.07%; $1\frac{7}{8}$ i/s 0.15%. H and N 50 dB. FR: $7\frac{1}{2}$ i/s 30 Hz-25 KHz ± 3 dB; $3\frac{3}{4}$ i/s 30 Hz-18 KHz ± 3 dB; $1\frac{7}{8}$ i/s 30 Hz-9 KHz ± 3 dB; Replay characteristics; NARTB. Level indicator: meter. Rewind time: 1,200 ft 75 sec. Inputs: microphone, 0.5 mV; line, 50 mV; DIN, 10 mV. Outlets: line, DIN, headphone. Motors: one hysteresis synchro 3-speed, and two 6-pole eddy current. Tape deck: own. Superimpose. Position indicator: digital, programme. Parallel track replay. Auto continuous reverse by programme. Sensing tape reverse. Magnetic brake auto stop. Auto shut off. Remote control. Price: £234 7s. 1d. (Plus £58 12s. 11d. PT).



BANG & OLUFSEN U.K. DIVISION. Eastbrook Road. Gloucester. Tel: Gloucester 21591.

★Beocord 1500. Stereo tape unit. $\frac{1}{2}$ track record, $\frac{1}{2}$ track and $\frac{1}{4}$ track replay. Speeds: $7\frac{1}{2}$, $3\frac{3}{4}$, $1\frac{7}{8}$ i/s. FR at $7\frac{1}{2}$ i/s. 40 Hz-16 KHz ± 2 dB. CCIR replay char. VU meters. Fast rewind 170 sec./1800 ft. Inputs (switched sensitivity): 3 mV

47 K, 100 mV 100 K. Outputs: line adjustable 0-0.6V 10K, radio 0.6V 22K. Pause, superimpose, 3-digit counter, straight-through amplifier, parallel track replay, tape slack absorbers, synchro playback. Mic input preamplifier option. Mains 110, 130, 220, 240V. Size: $17\frac{3}{4} \times 13\frac{3}{16} \times 8\frac{5}{8}$ in. Weight 32 lb. Price (teak): £100 10s. 5d. (plus £25 4s. 9d.)

★ **Beocord 1800.** Stereo tape unit. $\frac{1}{4}$ or $\frac{1}{2}$ track versions. Speeds: $7\frac{1}{2}$, $3\frac{3}{4}$, $1\frac{7}{8}$ i/s. FR at $7\frac{1}{2}$ i/s. 20 Hz-18 KHz ± 2 dB. DIN 45-513 replay char. VU meters. Fast rewind 170 sec./1800 ft. Inputs: mic 35 μ V 50-200 ohms, radio/gram 2.5 mV 47K or 50 mV 100K (switched), line 250 mV 47K. Outputs: 1.25V 25K, line 1.25V 7.5K, headphone 1.8V 470 ohms (5-500 ohm loads). Superimpose, pause, 3 digit counter, straight-through amplifier (mixing), monitor, input mixing, parallel track replay. Sound-on-sound, synchroplay, echo, mixing on inputs with tape replay. Mains: 110, 130, 220, 240V 50 Hz 50W. Size: $8\frac{7}{8} \times 17\frac{3}{8} \times 14\frac{1}{8}$ in. Weight: 35.6 lb. Price: ($\frac{1}{4}$ track, teak): £143 15s. 3d. (plus £35 19s. 9d. PT).

Beocord Trolley. For mounting Beocord tape recorders. Stainless steel with castors and single column stem. Price: £11 13s. 3d.

★

BRENELL ENGINEERING CO. LTD., 231/5 Liverpool Road, London, N.1. Tel: 01-607 8271 (5 lines).

STB2. Stereo/mono deck mechanism with pre-amplifiers. 2/2 and 2/4 playback heads. Speeds: 15, $7\frac{1}{2}$, $3\frac{3}{4}$, $1\frac{7}{8}$ i/s. W and F 15 i/s, <0.05%; $7\frac{1}{2}$ i/s, <0.1%; $3\frac{3}{4}$ i/s, <0.15%; $1\frac{7}{8}$ i/s, 0.25%. Outlet from pre-amp. Three motors, $8\frac{1}{4}$ in. or $10\frac{1}{2}$ in. NAB spools to order. Two illuminated level meters. Twin record and replay pre-amps. Tape monitoring facilities. Price: ($8\frac{1}{4}$ in. spools) £165 (plus £41 5s. 10d. PT); ($10\frac{1}{2}$ in. spools) £187 (plus £46 15s. 11d. PT).

STB2. Monitor amplifier for use with STB2 tape unit. 3W per channel. Response 40 Hz-25 KHz ± 3 dB. Noise level -60 dB. Input: IV for 3W output. Transistorised. Bass and treble controls. Output impedance 15 ohms. Complete with two 5×3 in. speakers. Price: £27 10s. (plus £6 17s. 8d. PT).

★

CROWN INTERNATIONAL. Distributor: Carston Electronics Ltd., 71 Oakley Road, Chinnor, Oxon. Tel: Kingston Blount 8561.

800 Series. Stereo unit. $\frac{1}{4}$ - or $\frac{1}{2}$ -track. Three speed 15 i/s or $1\frac{7}{8}$ i/s option. Max reel size $10\frac{1}{2}$ in. W and F: 15 i/s 0.06%; $7\frac{1}{2}$ i/s 0.09%; $3\frac{3}{4}$ i/s 0.18% (RMS). H and N: 15 i/s -60 dB; $7\frac{1}{2}$ i/s -60 dB; $3\frac{3}{4}$ i/s -55 dB (below peak level). FR (± 2 dB): 15 i/s 30 Hz-30 KHz; $7\frac{1}{2}$ i/s 30 Hz-25 KHz; $3\frac{3}{4}$ i/s 30 Hz-15 KHz. Replay char CCIR. VU meter. Rewind time 58 seconds 2,400 feet, 38 seconds 1,200 feet. Inputs: 2 mixable inputs per channel, mic or line. Sensitivity: 45 mV for 0 level (line), 0.4 mV for 0 level (mic); impedance 100K, balanced or unbalanced 600 ohms, or 50/200 ohms. Output: 600 ohms. Three motors, magnetic brakes, Logic circuitry for tape handling, all tape commands can be remote. A-B monitoring, source and tape mixing, echo, individual bias adjustment and metering. Size $17\frac{1}{2} \times 19 \times 8$ in. Weight: 50 lbs. Price: £700 to £1500.

★

DUAL. Dual Electronics Ltd., Radnor House, London Road, Norbury, London, S.W.16. Tel: 01-764 9465/6.

CTG28. Stereo tape unit. Speeds: $7\frac{1}{2}$ i/s, $3\frac{3}{4}$ i/s. Four tracks. Push-button control. Two heads. FR: 35 Hz-18 KHz at $7\frac{1}{2}$ i/s, 35 Hz-13 KHz at $3\frac{3}{4}$ i/s. W and F: 0.1% at $7\frac{1}{2}$ i/s, 0.15% at $3\frac{3}{4}$ i/s. Inputs: mic 1 and mic 2, 0.15 mV 200-700 ohms; radio, 0.15V; PU, 50 μ V at 1M. Outputs: radio, 0.775V at 18K; monitor 0.775V at 4K. Reel size: 7 in. dia. max. Rewind time: 1,800 ft in $3\frac{1}{2}$ min. Psn: 110-250V 50 Hz. Dimensions: $16\frac{1}{2} \times 7\frac{1}{2} \times 14\frac{1}{4}$ in. Dust cover provided. Finish: walnut veneer. Weight: 17 lb. Price £79 19s. 10d. (plus £19 15s. 2d. PT).

★

EAGLE PRODUCTS. Distributed by: B. Adler and Sons (Radio) Ltd., 32a Coptic Street, London, W.C.1. Tel: 01-636 9606/7. Cables. Reldab, London.

TC.450H. $\frac{1}{4}$ -track transistorised stereo record and playback tape unit. Speeds: $7\frac{1}{2}$, $3\frac{3}{4}$ i/s. FR: $7\frac{1}{2}$ i/s 30 Hz-17 KHz ± 3 dB, $3\frac{3}{4}$ i/s 30-12 KHz ± 3 dB. S to N: better than 50 dB per channel. W and F: <0.19% at $7\frac{1}{2}$ i/s, <0.25% at $3\frac{3}{4}$ i/s. HD 1% at 0 dB line output. Bias frequency: 72 KHz. Inputs: mic (two) 300 μ V 50K, radio/PU (two) 60 mV at 1 megohm. Output: 0-1V adjustable at 300 ohms. Separation better than 40 dB. Equalisation CCIR. Two VU meters. Eight transistors. Max spool 7 in. Mains: 240V AC. Size: $15 \times 13 \times 6\frac{1}{2}$ in. Price: £59 3s. 4d. (plus £15 3s. 10d. PT).

LAFAYETTE. U.K. distributors: Barnet Factors Ltd., 4 Lisle Street, London, W.C.2. Tel: 01-437 2723.

RK.870. Stereo tape unit with pre-amplifiers only. $\frac{1}{4}$ -track. Speeds: $1\frac{7}{8}$, $3\frac{3}{4}$ and $7\frac{1}{2}$ i/s. Max spool: 7 in. Wow and flutter: $7\frac{1}{2}$ i/s 0.2% RMS. FR: $7\frac{1}{2}$ i/s 40 Hz-18 KHz ± 3 dB; $3\frac{3}{4}$ i/s 40 Hz-12 KHz ± 3 dB. Level indicator: meter. Inputs: microphone, 0.15 mV 600 ohms; aux 100 mV 150K; aux 500 mV 700K. Outlets: external amplifier, 1V-2.5V variable, 5K; headphones 10K. Transistorized. Motor: 4-pole induction. Dimensions: $12\frac{5}{8} \times 11\frac{3}{4} \times 6$ in. Weight: 18 lb. Features: superimpose, pause, inching, stereo headphone monitoring. Position indicator: digital counter with reset button. Automatic equalisation for three speeds. Silicon transistors. Deluxe oiled walnut wood case. Psn 220-240V. Price: £58 6s. 1d. (plus £16 0s. 11d. PT).

★

LUXOR. Luxor Industri Aktiebolag, Motala, Sweden. UK distributors: Luxitone, 84 Bols-over Street, London. W.1. Tel: 01-636 2901.

MP613. stereo tape unit with preamps. Speeds: $1\frac{7}{8}$, $3\frac{3}{4}$ and $7\frac{1}{2}$ i/s. 4-track. Max spool capacity: 7 in. Wow and flutter: $1\frac{7}{8}$ i/s $\pm 0.35\%$, $3\frac{3}{4}$ i/s $\pm 0.2\%$, $7\frac{1}{2}$ i/s $\pm 0.1\%$ FR: $1\frac{7}{8}$ i/s 80 Hz-6 KHz, $3\frac{3}{4}$ i/s 50 Hz-12 KHz, $7\frac{1}{2}$ i/s 40 Hz-18 KHz. Replay characteristics: DIN. Rewind time: 3 min 40 sec for 7 in. DP. Inputs: microphone, 7 mV 220K; gram, 100 mV 1M; tuner, 50 mV 1M. Outlet: amplifier, 0.5V 22K. Audio output: 2W per channel RMS. Motor: 4-pole shaded. Luxor tape deck used. Pause facility. Digital position indicator. Price: £99 15s. (including PT).

★

NATIONAL. Distributed by: United Africa Mechanical and Electrical Ltd., P.O. Box No. 1, United Africa House, Blackfriars Road, London, S.E.1. Tel: 01-928 2070.

RS-766US. Four-track stereo tape deck with built-in two-channel preamplifiers. Speeds: $7\frac{1}{2}$, $3\frac{3}{4}$, $1\frac{7}{8}$ i/s. Two VU meters. Four-pole motor. Automatic switch-off. See Tape Recorder Section for full details of facilities. Full specification on request. Price: £86 2s. (including PT).

RS-768U/S. Four-track 3-head 3-speed stereo tape unit. Transistorized with built-in preamps. Two VU meters, 4-pole hysteresis synchronous motor. Integrated circuits employed

in pre-amp stages. National noise filter eliminates disturbance from non-recorded portions on tape. Auto stop, 40151T counter, sound on sound, sound with sound recording. Price to be announced.

★

PLANET PROJECTS LTD., Goodman Works, Belvue Road, Northolt, Middlesex. Tel: 01-845 1775.

C.D.2.P.A. This comprises model C.D.2. tape deck (see Tape Deck section) with built-in pre-amplifier and power supply. Power supply provides correct voltages for operating both relays and also a stabilised supply for the pre-amplifier. Pre-amplifier is three-stage direct coupled block using high frequency silicon planar transistors. Equalisation and stability is achieved with multiple feedback loops operating down to DC. Average output. 250 mV. Output impedance: 200 ohms to be fed into a load not less than 2.5K. FR: 30 Hz-12 KHz +3 dB. HD not greater than 3 dB. S/N 50 dB. Price: £80 (ex works).

★

SCOPETRONICS LTD., Crown Works, Church Road, Kingston-upon-Thames, Surrey. Tel: 01-546 1275 and 4135.

1150. Stereo tape unit. Speeds: $7\frac{1}{2}$, 15 i/s. Max spool capacity: $11\frac{1}{2}$ in. W and F: 0.08% (both speeds). H and N: -57 dB. FR: $7\frac{1}{2}$ i/s 40 Hz-15 KHz $\pm \frac{1}{2}$ dB; 15 i/s 40 Hz-15 KHz $\pm \frac{1}{2}$ dB. Replay characteristics: NARTB; CCIR Level indicator meter. Rewind time: 2,400 ft in <1 min 45 sec. Inputs: line in, 2V 100K. Line out, 1 mW 600 ohms. Valves. Motors: 3 Papst Ext. Rotor. Tape deck: own. Superimpose, pause and inching facilities. Straight through amplifier. Variable spooling. Removeable plug-in head block. Psn: 250V 50 Hz. Price: mono, £341 10s.; stereo, £493 10s. Console versions: add £75.

★

SONY (U.K.) LTD., 11 Ascot Road, Bedfont, Feltham, Middlesex. Tel: Ashford 50021.

★ **TC255.** Stereo tape unit with preamps only. $\frac{1}{4}$ -track. Speeds: $1\frac{7}{8}$, $3\frac{3}{4}$, and $7\frac{1}{2}$ i/s. Max. spool capacity: 7 in. W and F: $7\frac{1}{2}$ i/s 0.15%; $3\frac{3}{4}$ i/s 0.25%; H and N: $7\frac{1}{2}$ i/s better than 52 dB. FR: $7\frac{1}{2}$ i/s 30 Hz-20 KHz; $3\frac{3}{4}$ 30 Hz-17 KHz; $1\frac{7}{8}$ i/s 30 Hz-13 KHz. Replay characteristics NARTB.

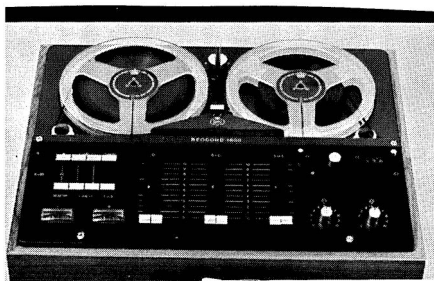

Bang & Olufsen Beocord 1800



Sony TC255



Sony TC355

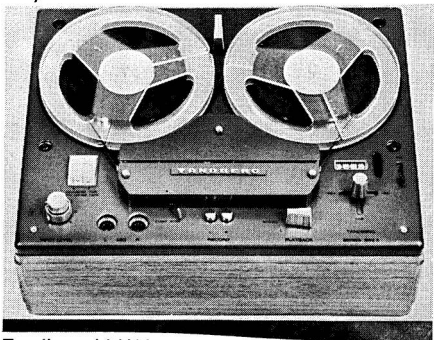

Tandberg 1641X

Level indicator: meter. Rewind time: 1,200 ft 2 min 20 sec. Inputs: microphone. —72 dB (0.19 mV) 600 ohms; aux 0—22 dB (0.06V) 100K; Outlets: line output, 0 dB (0.775V), 100K; headphones. —28.5 dB (0.029V), 8 ohms. Transistorised. One motor. Dimensions: $15\frac{3}{8} \times 7\frac{1}{4} \times 13\frac{3}{4}$ in. Weight: 18 lb. Pause. Position indicator: digital. Vertical and horizontal operation. Psn 100, 110, 117, 125, 220 or 240V, 50 or 60 Hz, 27W. Price: £66 9s. 10d. (plus £16 8s. 8d. PT).

★TC355. Stereo tape unit with preamps only. $\frac{1}{4}$ -track. Speeds: $1\frac{7}{8}$, $3\frac{3}{4}$ and $7\frac{1}{2}$ i/s. Max. spool capacity: 7 in. W and F: $7\frac{1}{2}$ i/s 0.15%; $3\frac{3}{4}$ i/s 0.25%; H and N: $7\frac{1}{2}$ i/s better than 52 dB. FR: $7\frac{1}{2}$ i/s 20 Hz-25 KHz; $3\frac{3}{4}$ i/s 30 Hz-17 KHz; $1\frac{7}{8}$ i/s 30 Hz-9 KHz. Replay characteristics; NARTB. Level indicator: meter. Rewind time: 1.200 ft 2 min 30 sec. Inputs: microphone, —72 dB (0.19 mV), 600 ohms; aux. —22 dB (0.06V), 560K. Outlets: line output, 0 dB (0.775V), 100K; headphone. —28 dB (0.031V), 8 ohms. Transistorised. One motor. Dimensions $15\frac{9}{16} \times 7\frac{1}{16} \times 14$ in. Weight: 22 lb. Pause. Position indicator: digital. Monitoring. Three heads. Psn 100, 110, 117, 125, 220, 240V, 50-60 Hz, 30W. Price: £80 5s. 7d. (plus £19 16s. 11d. PT).

TC560D. Stereo tape unit with preamps only. $\frac{1}{4}$ -track. Speeds: $1\frac{7}{8}$, $3\frac{3}{4}$ and $7\frac{1}{2}$ i/s. Max. spool capacity: 7 in. W and F: $7\frac{1}{2}$ i/s 0.15%; $3\frac{3}{4}$ i/s 0.2%; $1\frac{7}{8}$ i/s 0.35%. H and N: $7\frac{1}{2}$ i/s better than 52 dB. FR: $7\frac{1}{2}$ i/s 20 Hz-21 KHz; $3\frac{3}{4}$ i/s 20 Hz-15 KHz; $1\frac{7}{8}$ i/s 20 Hz-8 KHz. Replay characteristics: NARTB. Level indicator: meter. Rewind time: 1.200 ft 2 min 20 sec. Inputs: microphone, —72 dB (0.19 mV), 600 ohms; auxiliary. —22 dB (61 mV), 100K. Outlets: line output, 0 dB (0.775V) 100K; headphone, 29/38 dB (28/10 mV), 8 ohms. Transistorised. Two motors. Dimensions: $6\frac{11}{16} \times 16\frac{3}{8} \times 15\frac{7}{16}$ in. Weight: 28 lb 11 oz. Pause. Position indicator: digital. Monitoring. Auto reverse, plays left to right and right to left. Psn 100, 110, 117, 220 and 240V, 50 or 60 Hz, 16W, D.C. 12V. Price: £140 1s. 11d. (plus £34 17s. 4d. PT).

TC666D. Stereo tape unit with preamps only. $\frac{1}{4}$ -track. Speeds: $3\frac{3}{4}$ and $7\frac{1}{2}$ i/s. Max. spool capacity: 7 in. W and F: $7\frac{1}{2}$ i/s 0.09%; $3\frac{3}{4}$ i/s 0.15%. H and N: $7\frac{1}{2}$ i/s 59 dB. FR: $7\frac{1}{2}$ i/s 20 Hz-22 KHz; $3\frac{3}{4}$ i/s 20 Hz-15 KHz. Replay characteristics: NARTB. Level indicator: meter. Rewind time: 1,200 ft 60 sec. Inputs: microphone, —72 dB, 600K; line. —22 dB (61 mV), 100K. Outlets: monitor, 8 ohms; line output, 100K; record/playback, 10K. Transistorised. Three motors. Dimensions: $17\frac{9}{16} \times 8\frac{1}{16} \times 16\frac{3}{8}$ in. Weight: 48 $\frac{1}{2}$ lb. Position indicator: 4-position digital counter. Monitoring. Automatic reverse,

plays left to right and right to left. Psn 100, 110, 117, 125, 220, 240V, 50 or 60 Hz, 140W. Price: £212 (plus £52 10s. PT).



TANDBERG. Distributors: Farnell-Tandberg Ltd., Hereford House, North Court, Vicar Lane, Leeds 2. Tel: Leeds 38934/6. Grams: Elstone, Leeds.

★ **Series 1600X.** Crossfield bias stereo tape unit incorporating recording amplifiers and re-play pre-amps. Psn 220-240V, 50 Hz, 40W. Max reel diameter 7 in. Speeds: $7\frac{1}{2}$ i/s, $3\frac{3}{4}$ i/s, $1\frac{7}{8}$ i/s, tolerance $\pm 1.5\%$. Erase and bias frequency 85.5 KHz. Inputs: mic 200 ohms unbalanced, 0.1 mV; line 1, 100 mV; line 2 57K, 5 mV. Emitter follower outputs: Minimum load impedance 200 ohms, 900 mV per channel. FR (± 2 dB): $7\frac{1}{2}$ i/s 40 Hz-20 KHz; $3\frac{3}{4}$ i/s 50 Hz-16 KHz; $1\frac{7}{8}$ i/s 50 Hz-9 KHz. W and F: $7\frac{1}{2}$ i/s $< 0.1\%$; $3\frac{3}{4}$ i/s $< 0.2\%$; $1\frac{7}{8}$ i/s $< 0.4\%$. S/N (unweighted): $\frac{1}{4}$ -track model 55 dB. Crosstalk at 1,000 Hz to DIN 45521 in mono position, better than 60 dB; in stereo position better than 50 dB. Size: $6\frac{1}{16} \times 15\frac{3}{8} \times 11\frac{1}{8}$ in. Price: 1641X ($\frac{1}{4}$ track) £89 10s. (inc PT).



TAPE RECORDER DEVELOPMENTS LTD., 7 King George Avenue, Bushey, Herts. Tel: 01-950 2331.

600 Series. 4 speed tape units. Independent gain controls for microphones, line inputs, and line outputs. Upper and lower track function controls. Meter reads l or r channel or peak of either. Adjustable bias read on meter. Four speed equalization to DIN 45513 or NAB. Locking DIN sockets. Input mixing. See TRD1 deck information in Tape Deck section. Inputs: mic 30 to 600 ohms, 70 dBm for 600 ohms; line 600 ohms/10K bridging, -20 dBm $+10$ dBm max into 600 ohms. Output: $+10$ dB max into 600 ohms. FR: 15 i/s 40 Hz-20 KHz; $7\frac{1}{2}$ i/s 40 Hz-16 KHz; $3\frac{3}{4}$ i/s 40 Hz-8 KHz; $1\frac{7}{8}$ i/s 40 Hz-4.5 KHz (± 2 dB). Prices on application.



TEAC. B. H. Morris & Co., (Radio) Ltd., 84-88 Nelson Street, Tower Hamlets, London, E.1. Tel: 01-790 4824.

★ **A20** stereo cassette unit for Compact cassette. Speed: $1\frac{7}{8}$ i/s. Heads: two Teac Techno-Built,

erase and record/playback, 4-track, 2-channel stereo. FR: 60 Hz-10 KHz. W and F: 0.2% or less. S/N ratio: -45 dB or better. Inputs: microphone, 600 ohms, 0.3 mV minimum; line 120K 0-1V minimum. Outputs: line 50K, 0.5V; headphone 8 ohms, 0.1 mW/DIN connector. Psn 100, 115, 200, 220V, 50 or 60 Hz. Size: $9\frac{3}{4} \times 10 \times 4\frac{1}{4}$ in. Weight: 10 lb. Price: £78.

A-2010 stereo tape unit features automatic reverse for bi-directional play. Speeds $1\frac{7}{8}$, $3\frac{3}{4}$ and $7\frac{1}{2}$ i/s. Max spool: 7 in. Heads (three): forward erase, forward record-playback, reverse playback, 4-track stereo or mono. Motor: 4-pole hysteresis synchronous. W and F: $1\frac{7}{8}$ i/s 0.2%, $3\frac{3}{4}$ i/s 0.15%, and $7\frac{1}{2}$ i/s 0.12%. FR: $1\frac{7}{8}$ i/s 40 Hz-7 KHz, $3\frac{3}{4}$ i/s 50 Hz-10 KHz ± 3 dB; $7\frac{1}{2}$ i/s 50-15 KHz ± 3 dB. S/N ratio: 50 dB. Dual VU meter. Inputs: microphone 600 ohms; line 100K, 0-10V minimum. Output: 0.5V for load impedances of 50K ohms or more. Monitoring headphones: 8 ohms. Psn 100, 110, 115, 220V, 50 or 60 Hz. Dimensions: $16\frac{3}{8} \times 17\frac{7}{8} \times 8\frac{1}{2}$ in. Weight: 33 lb. Price: £165.

A-2050 stereo tape unit with bi-directional recording and playback. Speeds: $1\frac{7}{8}$, $3\frac{3}{4}$ and $7\frac{1}{2}$ i/s. Max spool: 7 in. Heads (four): forward erase, forward record-playback, reverse record-playback, reverse erase. 4-track stereo. Motor: 4-pole outer rotor hysteresis synchronous for capstan drive. W and F: $1\frac{7}{8}$ i/s 0.2%, $3\frac{3}{4}$ i/s 0.15%, $7\frac{1}{2}$ i/s 0.12%. FR: $1\frac{7}{8}$ i/s 40 Hz-7 KHz, $3\frac{3}{4}$ i/s 50 Hz-10 KHz ± 3 dB, $7\frac{1}{2}$ i/s 50 Hz-15 KHz ± 3 dB. S/N ratio: 50 dB. Input: microphone 600 ohms, line 100K 0-10V minimum. Output: 0.5V for load impedance of 50K. Monitoring headphones: 8 ohms. Editing control by pause button, automatic shut-off, 100 KHz bias oscillator; tone control, all

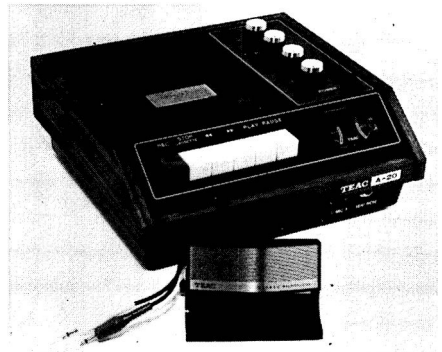

Teac A-20

silicon transistor pre-amplifiers, vertical or horizontal operation. Walnut cabinet. Psn 100, 110, 115, 220V, 50 or 60 Hz. Dimensions: $11\frac{3}{8} \times 10\frac{3}{8} \times 5\frac{1}{2}$ in. Weight: 33 lb. Price: £199.

A.3030 tape unit. Speeds: $7\frac{1}{2}$ and 15 i/s. Max spool: $10\frac{1}{2}$ in. Motors: dual-speed hysteresis synchronous for capstan drive, and two eddy current for reels. Heads: 2-track erase, 2-track record, 4-track playback and 2-track playback. W and F: $7\frac{1}{2}$ i/s 0.08%, 15 i/s 0.06%. FR: $7\frac{1}{2}$ 50 Hz-15 KHz ± 2 dB, 15 i/s 30 Hz-20 KHz ± 2 dB. S/N ratio: 55 dB. Input: microphone 10K, 0.5 mV minimum; line 300K, 0.1V minimum. Output: 1V for load impedance of 100K or more. Psn 100, 115, 200, 220 and 240V, 50 or 60 Hz. Dimensions: $20\frac{7}{8} \times 17\frac{1}{2} \times 8\frac{1}{4}$ in. Weight: 62 lb. Optional accessories include remote control. Price: £387 9s.

A-1200. $\frac{1}{4}$ -track stereo tape unit. Max spool 7 in. Speeds: $7\frac{1}{2}$, $3\frac{3}{4}$ i/s. Three motors. W and F $7\frac{1}{2}$ i/s 0.12%. Fast wind 100 secs 1,200 ft FR: $7\frac{1}{2}$ i/s 30 Hz-20 KHz. S to N 50 dB. Inputs: mic 1 mV 100K, line 100 mV 100K. Output: 1V 100K. Monitoring. Mains: 100, 117, 220V AC 50/60 Hz. Size: $16\frac{3}{4} \times 17\frac{1}{8} \times 11\frac{1}{2}$ in. Weight: 46 lb. Price: approx £185.

A-6010. $\frac{1}{4}$ -track stereo tape unit. Max spool 7 in. Tape speeds: $7\frac{1}{2}$, $3\frac{3}{4}$ i/s. Three motors. W and F $7\frac{1}{2}$ i/s 0.08%. Fast wind 90 secs for 1,200 ft. FR $7\frac{1}{2}$ i/s 30 Hz-20 KHz. S to N 55 dB. Inputs: mic 0.5 mV 10K, line 100 mV 300K. Output: 0.1V 10K. Mains: 100/117V 50/60 Hz. Consumption 100W. Size: $20\frac{3}{4} \times 17\frac{1}{8} \times 6\frac{3}{8}$ in. Weight: 46 lb. Price: £370. (plus PT).

★

TELEFUNKEN. Distributor: AEG (Great Britain) Ltd., Lonsdale Chambers, 27 Chancery Lane, London, W.C.2. Tel: 01-242 9944.

250 Hi-Fi. Two speed $\frac{1}{2}$ -track stereo tape unit. 7 in. Reels. W and F: $3\frac{3}{4}$ i/s $\pm 25\%$, $7\frac{1}{2}$ i/s $\pm 2\%$. H and N: $3\frac{3}{4}$ i/s -54 dB, $7\frac{1}{2}$ i/s -54 dB. FR: $3\frac{3}{4}$ i/s 40 Hz-15 KHz, $7\frac{1}{2}$ i/s 40 Hz-18 KHz.

Replay char DIN Standard 45-500. Level meters. Inputs: tuner 0.15 mV 2K; mic 0.15 mV 2K; PU/tape 150 mV. 2.2M. Outputs: Amplifiers 1.5V 10K; earphones 1V into 400 ohms load. Echo at $3\frac{3}{4}$ i/s. Reverberation at $7\frac{1}{2}$ i/s. Monitor combined with instruments. Parallel recording and playback. Track-to-track transcription. Function selector. Record light. Volume control for headphones. Slide control for record level. Preset level controls. Sound-on-sound. Pause. Psn 110/240Vac. Size: $18\frac{1}{4} \times 12\frac{1}{4} \times 4\frac{1}{4}$. Weight: 26 lb. Price: £128 12s. 3d. (plus £31 15s. 6d. PT).

★

TOSHIBA. Hanimex (U.K.) Ltd., Hanimex House, 15/24 Great Dover Street, London, S.E.1. Tel: 01-407 8161.

PT-850S. Stereo tape unit. Speeds: $7\frac{1}{2}$ i/s, $3\frac{3}{4}$ i/s. FR: 30 Hz-18 KHz at $7\frac{1}{2}$ i/s, 30 Hz-12 KHz at $3\frac{3}{4}$ i/s. Psn: 100/240V 50/60 Hz. Dimensions: $15\frac{3}{4} \times 13\frac{1}{4} \times 6$ in. Price: £79 4s. 3d. (including PT).

★

TRUVOX LTD., Hythe, Southampton, Hampshire. Tel: Hythe 3265.

PO202 and PO204. Stereo tape unit in $\frac{1}{4}$ - and $\frac{1}{2}$ -track versions and in teak cabinet. Speeds: $7\frac{1}{2}$, $3\frac{3}{4}$, $1\frac{7}{8}$ i/s. W and F better than 0.1% at $7\frac{1}{2}$ i/s. Max spool 7 in. FR $7\frac{1}{2}$ i/s 30 Hz-18 KHz. ± 2 dB. Signal to noise better than 50 dB. VU meter. Equalisation new CCIR. Bias oscillator 90 KHz. Inputs: mic 1 mV 50 K, radio/PU 50 mV 200K. Output: 0.1V variable via emitter follower. Rewind time less than 120 secs for 1,200 ft. Mains: 200-250V 50 Hz (100-120V 50/60 Hz to order). Size: $16 \times 16\frac{1}{2} \times 8$ in. Weight: 28 lb. Full stereo record and playback. Separate record and replay amplifiers. Compatible with all multiplex systems. Three heads. Three motors. Off-tape monitoring. Mixing. Duo-play. Track to track transfer. Four-digit tape indicator. Auto-stop. Inching/cueing control. Vertical or horizontal operation. Price: £150 11s. 7d. (including PT).

TAPE AMPLIFIERS AND MIXER UNITS

AMPEX. Ampex Great Britain Ltd., 72 Berkeley Avenue, Reading. RG 6HZ. Tel: Reading 55341.

Ampex AM-10. Transistorised stereo mixer unit. Inputs: six mics or four mics and two lines. Mics 200 ohms, line 100K bridging. Gain -67 dBm mic, -27 dBm line will produce 1V output. Up to four mixers may be coupled to give 12 input and two output channels. Output: 1V normal. 30V maximum unbalanced. FR 40 Hz-15 KHz. Signal-to-noise 65 dB for inputs of -55 dBm. Controls: six potentiometers, two-gang master gain key switches. Line/Mic AC line switch, mixer couple switch. Key switches, channel A, B or both. Four channels in, two out. Self-powered 105-125V, 30W. Size: $5\frac{3}{2} \times 19 \times 5\frac{3}{16}$ in. Price on application.

Ampex market a full range of professional and semi-professional tape recording equipment, including decks, amplifiers, mixers, duplicators and accessories. Full details and prices available, on request.

★

BINSON. See Modern Electrics.

★

BRENNEL ENGINEERING CO. LTD., 231/5 Liverpool Road, N.1. Tel: 01-607 8271 (5 lines).

Mk 5 Series 3 Record/playback amplifier. Inputs: mic 2 Series 2 mV, radio/gram 75 mV, both high imp. Outputs: 500 mV into 47K, and 3W into 15 ohms for direct connection to loudspeaker. Headphone monitoring ME level ind. or meter if required. Price: £28 12s. (plus £7 3s. 2d. PT); metered version £34 7s. (plus £8 11s. 11d. PT).

Brenell Mixer Unit. Three channel unit. High imp sources. There are 4 sockets for jack plugs for the three inputs and the output lead, each input having a volume control. Price: £3 4s.

Hi-Fi Tape Link. Stereo tape pre-amplifier and oscillator unit. 9 valves. Input (record): 75 mV stereo, 100 mV mono, into 1 megohm. Input (playback): 1.5 mV. Output: variable up to 1V at 47K. FR 40 Hz-14 KHz at tape speed $7\frac{1}{2}$ i/s + 3 dB. Equalisation to new CCIR at all speeds. Two level meters. H and N -50 dB.

Controls: Tape speed compensation switch, variable bias, record track selector, monitor original/tape, record gain, playback gain, function. Separate mains unit 110-250V. DC heater supply. Suitable for Brenell three-head stereo decks. $\frac{1}{4}$ - or $\frac{1}{2}$ -track. Sizes: tape link $13\frac{3}{4} \times 4 \times 8\frac{3}{4}$ in., front panel $15\frac{1}{2} \times 4\frac{1}{2}$ in. Power unit $6\frac{1}{2} \times 4 \times 4$ in. Weight: 18 lb. including power unit. Separate record and playback pre-amplifiers. Price: £50 12s. (plus £12 13s. 3d. PT).

STB2 Monitor amplifier. See Tape Units section.

★

DEIMOS LTD., 8 Corwell Lane, Hillingdon, Middx. Tel: 01-573 3561.

★**Deimos Tape Amplifier.** Stereo/mono Flexible tape amplifier system available with many alternative features to suit various decks and tape heads. Separate playback and record amplifiers. Basic input sensitivity: radio 50 mV, mic 0.5 mV. Cathode follower output. Equalisation for any standard speed or playback characteristic. Level indicator optional, meter or ME. Separate power supply available. Full details and prices on request.

★

ELECTRONIC & SCIENTIFIC INSTRUMENTS (WORTHING) LTD., Distributors: Shirley Laboratories Ltd., 23 Ripley Road, Worthing, Sussex. Tel: Worthing 49098.

Esimix Major. Four-channel electronic mix and signal mixer. FR at full gain: 15 Hz-20 KHz ± 2 dB. Hand N better than -50 dB. Channels 1 and 2 (mic): 2 mV input for 200 mV output; channels 3 and 4 (radio, etc): 100 mV input for 200 mV output. Cathode-follower output, permitting the use of long connecting lines without risk of hum. Self-powered. 230-250V AC. Price: £19 19s.; (4 mic version): £21.

★

A. R. FRANKLIN (Audio Engineer), 4 Birch House, Penge, London. S.E.20.

Transistorised mixers and amplifiers built to order. Quotations on request.

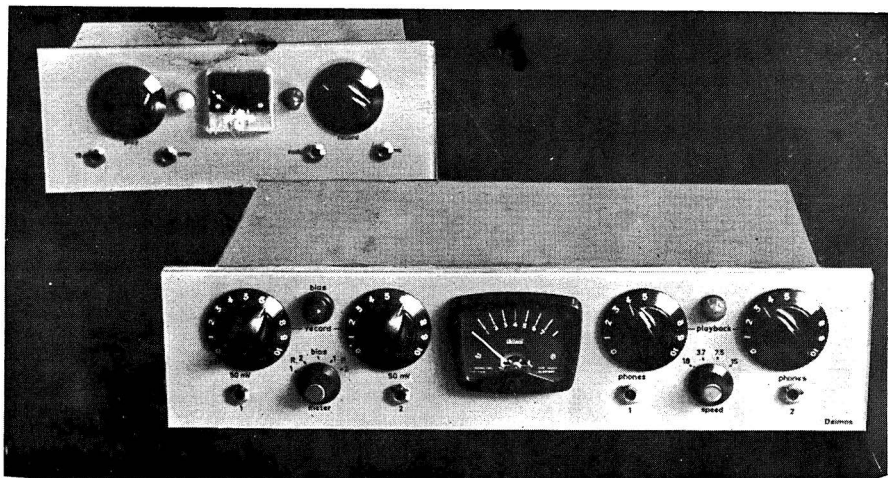

Deimos tape amplifier

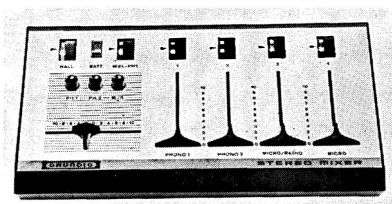

Grundig 422 stereo mixer

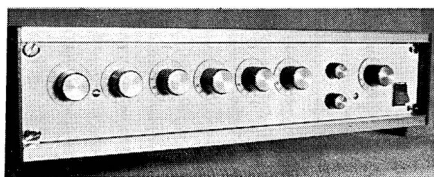

Millbank six-way

GRAMPIAN REPRODUCERS LTD., 19 Hanworth Trading Estate, Feltham, Middlesex. Tel: 01-894 9141/3. Cables: Reamp, Feltham.

Grampian 18/4. Four channel pre-amplifier mixer. Transistors. Inputs: 0.2 mV 25 ohms, 0.8 mV 600 ohms, 10 mV high impedance, 100 mV high impedance. Output: 0.775V. Output impedance: 600 ohms floating. Distortion < 1.5%. Bass control: -8 dB at 100 Hz on mic ± 8 dB at 100 Hz on aux. Treble control: +8 dB -25 dB at 10 KHz. FR 100 Hz-10 KHz ± 3 dB

(tone controls level). Noise: -60 dB. Supply: PP9 (or equivalent) 9V battery. Consumption: average 18 mA. Jack socket outlet at rear. Size: $11\frac{3}{8} \times 7 \times 2\frac{3}{8}$ in. Weight: 4 $\frac{1}{2}$ lb. Price: £36.

Grampian 16/6. Six-channel pre-amplifier mixer for professional sound engineers. Six independently controlled microphone inputs. On-off key switch for each input permits gain control to be present if desired. Master gain control normally controls all channels but there is provision for some inputs to operate independently. Sensitivity: 0.2 mV input for 0.775V output. Output meter scaled for 1V with overload warning on scale, 1 mW indicated by red marker at 0.775V. Specially damped movement. Output impedance: 600 ohms floating. Distortion: < 0.1% for 0.775V output. FR 100 Hz-15 KHz +2 dB with tone controls level. Bass cut: -10 dB at 100 Hz. Treble cut: -12 dB at 10 KHz. Treble lift: +6 dB at 10 KHz. H and N better than -65 dB. Input impedances from 200 μ V at 25 ohms to 100 mV at high impedance to order. Mains: 200-250V AC. Size: $19\frac{1}{4} \times 7\frac{1}{2} \times 6\frac{3}{8}$ in. Weight: 12 $\frac{1}{4}$ lb. Price and full specification on request.



GRUNDIG (GREAT BRITAIN) LTD., Newlands Park, Sydenham, London, S.E.26. Tel: 01-778 2211.

★422. Transistorised stereo mixer for four inputs. Three coarse level controls, directional

control and control for reverberation unit. Four microphone preamplifier fitted. Channel separation 50 dB (mic), 35 dB (PU). Response: 40 Hz-20 KHz ± 2 dB. Powered by two 9V batteries. Size: $13\frac{1}{2} \times 2\frac{1}{4} \times 7\frac{1}{2}$ in. Price: £39 18s.

420. Mono version of 422 mixer above. Price: £25 14s. 6d. Note. Grundig prices include purchase tax where applicable.

★

HEATHKIT. See Constructional Kits Section.

★

LOWTHER MANUFACTURING CO., St Mark's Road, Bromley, Kent. Tel: 01-460 5225. Cables: Lowther, Bromley.

Companion Supply Unit No. 2. HT and LT power supply suitable to power radio tuners. Pre-amp and tape bias amplifier. Output: 250V at 40 mA, 6.3V at 3 amps. Price: £8 15s.

Companion Supply Unit No. 3. HT and LT power supply suitable to power radio tuners. Pre-amp and tape bias amplifier. Output: 350V at 35 mA, 6.3V at 3 amps. Price: £8 15s.

★

MILLBANK ELECTRONICS, Hartfield, East Sussex. Tel: Hartfield 445.

★ **Audio Mixers.** 6-channel compact units with internal power supply. Available in any combination of 30 ohm microphone and high impedance inputs. Various modifications possible with printed circuit modules. Psn: 220-250V 50 Hz or 15 mA 24V DC. Output 775 mV at 10K. Mixers can be paralld. Distortion $< 0.2\%$ at maximum rated output, measured as total harmonic of 1 KHz with 10K load. Control interaction < 1 dB. Input sensitivity: mic 100 μ V at 30 ohms, high impedance 100 mV at 100K or 1V at 1M. Tone controls: 10 dB lift and cut at 100 Hz and 10 KHz. FR: 3 dB down from 1 KHz level at 30 Hz and 20 KHz. S/N 60 dB on all inputs at rated sensitivity. Size: 8.9 cm high in standard 48.2 cm rack; Case size 49.1 \times 11.9 \times 16 cm. Price: (FAS9 with tone controls) £52 13s. 3d.; (FAS10 without tone controls) £50; (FAS12 with tone controls. Rack mounting) £47 3s. 3d.; (FAS11 without tone controls. Rack mounting) £44 10s.



Binson Echorec Mk 2

MODERN ELECTRICS (RETAIL) LTD., 120 Shaftesbury Avenue, London, W.1. Tel: 01-437 9692. Cables: Modcharex, W.1.

★ **Binson Echorec Mark 2.** Pre-amplifier and echo unit. Enables echo to be imposed on any audio signal in a wide choice of timing. Facilities for the imposition of swell and reverberation. Three channels which can be selected as required. Completely portable. Operates from AC Mains supply. An exclusive design of magnetic wheel with transistorised circuitry. Price: £188 6s.

Binson Echorec Export. Simplified version of the Mark 2, for echo and swell. Price: £123 6s.

★

SANSUI. Sole UK importer: Brush Clevite Co. Ltd., Thornhill Southampton SO9 1QX. Tel: Southampton 45166.

Sansui MX10. Audio mixer-preamplifier. Transistorised. Full specification on request. Price: £61 19s.

★

SHIRLEY LABORATORIES LTD., 23 Ripley Road, Worthing, Sussex. Tel: Worthing 49098.

TW/PA4. Recording amplifier for use with high quality power amplifier. Inputs: 1.5 mV and 60 mV. Bias and erase oscillator. Full corrections. Valve voltmeter modulation level ind. For use with Wearite or Ferrograph tape decks (TW/PA4U for Planet decks), can be supplied to order for any deck. Size: $10 \times 5\frac{1}{2} \times 5\frac{1}{2}$ in. Psn from main amp or power pack can be supplied at £6 16s. 6d. Price: £34 13s.

TWA/1515HG. Complete stereo record and replay amplifier. Inputs: radio 50 mV, gram. 5 mV (RIAA), mic 2 mV, tape 3 mV. Output: 12W per channel (17W peak). FR 45 Hz-25 KHz ± 1 dB on radio input. Low distortion bias and erase oscillator included. Valve voltmeter level indicator. H and N -85 dB. Controls: bass, treble, vol., pre-set balance, meter pre-set, bias pre-set, sel, rec/replay, equalisation, mono/stereo. Heavy duty power pack on separate chassis. Size (control unit): $23 \times 7\frac{1}{2} \times 7$ in.; (power unit): $10 \times 8 \times 7\frac{1}{2}$ in. TWP/1515HG for Planet decks. TWA/1515HG for Ferroglyph decks. TWH/1515HG for Brenell and similar decks. Price: £115 10s.



SOUND NEWS PRODUCTIONS, 10 Clifford Street, New Bond Street, London, W.1. Tel: 01-734 2745.

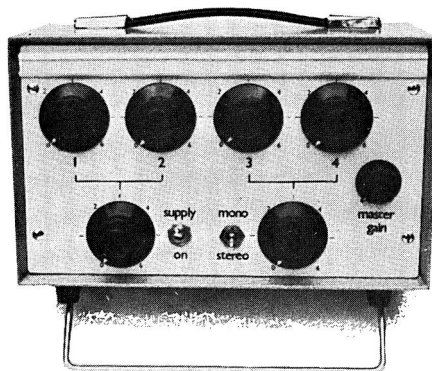

Unimixer 45

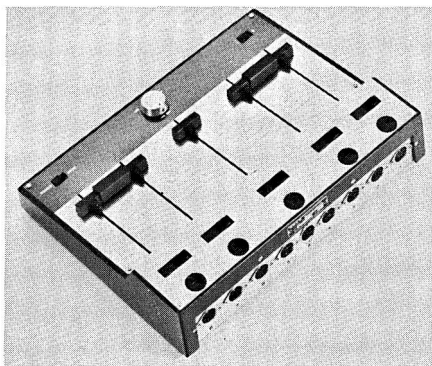

Uher A121

Unimixer 1. 3 channel unit. Channels 1 and 2 have independently controlled duplicate sockets for low or high imp mics 30 ohms or 400K approx. Recommended load imp not less than 500K ohms. FR from 30 ohm input 50 Hz-10 KHz ± 3 dB. Price: £9 9s.

Unimixer 2. 3 channel unit. Inputs as above but high imp is 5 megohms in channels 1 and 2. Power supply needed 200/300V DC at 5 mA, 6.3V at 0.3 amps balanced. Special connectors available to obtain power supplies direct from Ferroglyph or Vortexion recorders without any alteration. Price: £15 15s.

★ **Unimixer 4S.** Stereo microphone mixer. Two inputs per channel, or four inputs mono. Output: 250 mV stereo or 125 mV mono. 4V max. Two outputs per channel for $>10K$ load. FR: -2 dB, 20 Hz-20 KHz. Input for 250 mV. Output: 30 μ V 30 ohms, 80 μ V 200 ohms. Psn two PP9 batteries (18V at 25 mA). Size: $10 \times 6 \times 6$ in. Price: £39 (inland packing and postage 12s. 6d.).



UHER. Distributors: Bosch Ltd., Rhodes Way, Radlett Road, Watford, Herts. WD2 4LB. Tel: Watford 44233.

★ **A121.** Mixer unit for five channels: two stereo plus one mono or five mono channels. Inputs available for 200 ohm microphone, radio or pickup. Output approx. 30 mV. FR 20 Hz-20 KHz. Slider faders with directional control, muting switches and 1 KHz generator. Powered by PP3 battery. Price: £46 8s.



VORTEXION LTD., 257-263 The Broadway, Wimbledon, London, S.W.19. Tel: 01-542 6242/3/4 and 2814. Cables: Vortexion, London, S.W.19.

Electronic mixers. Various types of mixers available: 3-channel with accuracy within 1 dB. Peak programme meter. 4- 6- 8- 10- and 12-channel mixers. Also twin 5- 4- 3- 2-channel stereo. Tropicalised controls. Built-in screened supplies. Balanced line mic inputs. Outputs: 0.5V at 20K, or alternative 1 mW 600 ohms, balanced, unbalanced or floating. Prices on application.

TAPE ACCESSORIES AND COMPONENTS

Same abbreviations as for amplifiers. Unless otherwise stated, prices include purchase tax where applicable.

ACOS. Cosmocord Ltd., Eleanor Cross Road, Waltham Cross, Herts. Tel: Waltham Cross 27331.

R.E.6. Magnetic earpiece made in four impedances and colour coded: green 10 ohms, blue 150 ohms, violet 300 ohms and red 1,000 ohms. Each earpiece is fitted with a 3.5 mm jack plug.

Acos Stethoset for personal listening with 6 ft of lead. Price: £1 2s. 6d.



AGFA. Agfa-Gevaert Ltd., Brent House, 950 Great West Road, Brentford, Middlesex. Tel: 01-560 2072/5.

★ **Magneton accessories.** Editing accessory kit £1 10s. 9d.; splicing tape dispenser 6s.; splicing tape $\frac{1}{4}$ in. \times 80 ft 7s. 6d., $\frac{1}{2}$ in. \times 80 ft 16s.; leader-tape $\frac{1}{4}$ in. \times 80 ft in red, green, white, yellow, 3s. 6d.; silver stop foil $\frac{1}{4}$ in. \times 33 ft 6s. 6d. (all prices include PT where applicable).

Novodur boxes. Empty Novodur plastic library boxes in the following sizes: 4 $\frac{1}{2}$ in. 8s. 6d.; 5 in. 8s. 6d.; 5 $\frac{3}{4}$ in. 10s. 6d.; 7 in. 11s. 11d. (all prices include PT).

Plastic spools. Empty plastic spools in boxes in the following sizes: 3 in. 3s. 2d.; 4 in. 3s. 10d.; 4 $\frac{1}{2}$ in. 4s. 2d.; 5 in. 4s. 5d.; 5 $\frac{3}{4}$ in. 4s. 9d.; 7 in. 5s. 1d.; 8 $\frac{3}{4}$ in. 7s. 8d.; 10 in. 11s. 5d.; 10 $\frac{1}{2}$ in. £1 10s. 7d. (all prices include PT where applicable).



AKAI. U.K. distributors: Pullin Photographic (Rank Organization), P.O. Box 70, Great West Road, Brentford, Middx. Tel: 01-568 9222.

Endless Tape AE-1. Continuous spool formed by splicing together the two ends of the 200 ft tape. Price: £3 5s. 2d. (plus 1s. 4d. PT).

Head demagnetizer AH-6. Mains operated (110V or 220V) head demagnetizer. Price: £2 16s. (plus 14s. PT).

AS-3 tape splicer. Price: 18s. 5d. (plus 4s. 7d. PT).

AMOS OF EXETER LTD., Weircliffe Court, Exwick, Exeter. Tel: Exeter 72132. Cables: Amos, Exeter.

★ **Weircliffe Bulk Erasers.** Models 6, 7, and 8. Model 6 accepts reels up to 8 $\frac{1}{2}$ in. diameter of $\frac{1}{4}$ -1 in. tape. Capacity 180-400 reels per hour. Model 7 accepts 8 \times 8 in. cassettes of $\frac{1}{4}$ in. tape. Model 8 accepts reels of up to 14 $\frac{1}{2}$ in. diameter containing tape from $\frac{1}{4}$ in. audio up to 2 in. video including $\frac{1}{2}$ in. and 1 in. instrument tape and 16 and 35mm film. Capacity 100-400 reels per hour. (NATO catalogue No. 5835-99-972-5371). Sizes (Models 6 and 7): 11 $\frac{1}{2}$ \times 12 $\frac{1}{4}$ \times 7 $\frac{1}{2}$ in. Weight: 43 lb. Size (Model 8): 20 $\frac{1}{2}$ \times 20 $\frac{1}{2}$ \times 10 $\frac{1}{2}$ in. Weight: 92 lb. Prices: Models 6 and 7 £33 12s., Model 8 £94 10s. Models available for 115V 60 c/s.

Model 30. Miniature bulk eraser for tape cassettes up to 3 $\frac{3}{8}$ in. square and reels up to 3 $\frac{3}{8}$ in. diameter. Suitable for $\frac{1}{8}$ in. and $\frac{1}{4}$ in. tape. Special quantity discounts on application. Price: £12 17s. 6d.



BASF UNITED KINGDOM LTD., Knightsbridge House, 197 Knightsbridge, London, S.W.7. Tel: 01-584 5080.

Hobby Box. Contains marking pencil, cutting blade, 33 ft 0.7 in. splicing tape, 80 ft each of red, white, green leader tapes. 50 6-in. lengths of stop foil, 25 spool labels and three tape clips. £1 2s. 6d. (plus 4d. PT).

Leader Tape. Green, red or white for indicating track. 984 ft £1 10s.; 80 ft 5s.

Splicing Tape. $\frac{1}{4}$ in. blue 33 ft 4s. 6d.; $\frac{1}{4}$ in. white 33 ft 5s. 6d.; $\frac{1}{2}$ in. white 33 ft 7s. 6d.; 0.7 in. white 11s. 6d.

Splicing Set. Plastic box with bonding groove and 33 ft of splicing tape 6s. 6d.

Metalised Foil. For automatic stop or track change. Sputtered silver. 82 ft $\frac{1}{4}$ in. £1.

Leader Tape Set. Red and green leader tapes. 25 strips of metalised foil. Spare spool labels. 10s.

Splicing Adhesive LG. 1 oz bottle of splicing

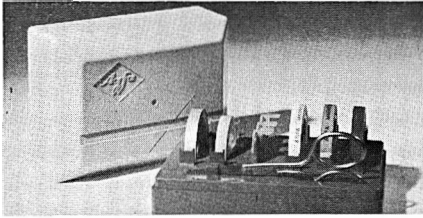

Agfa tape accessory kit

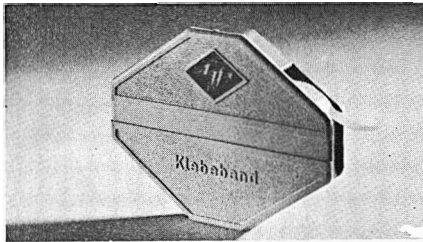

Agfa splicing tape dispenser



Bib tape head cleaning kit

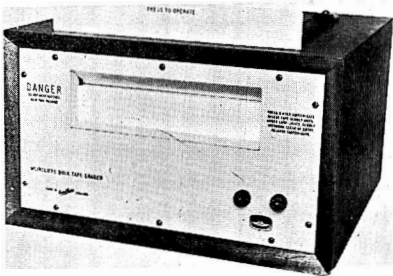

Weircliffe bulk eraser

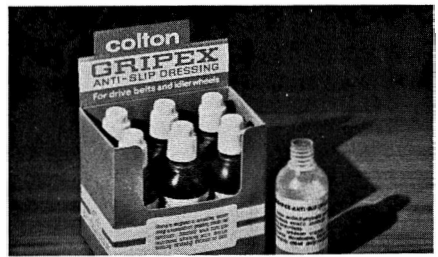

Colton Gripex



Bib splicer

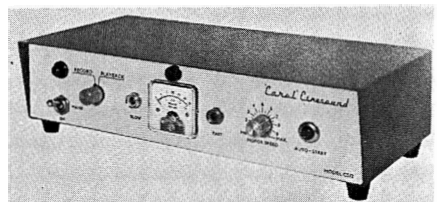

Carol Cinesound (Contronics)

fluid for PVC tapes (cannot be sent by post). 7s. 6d.

Plastic Tape Clips. Box of 10 2s. 6d.

Spare Spools (prices include PT). 2¼ in. 3s. 10d.; 3 in. 3s. 3d.; 3½ in. 3s. 10d.; 4 in. 3s. 10d.; 4¼ in. 3s. 10d.; 5 in. 4s. 6d.; 5¾ in. 4s. 9d.; 7 in. 5s. 1d.; 8¼ in. 11s. 5d.; 8¾ in. 11s. 5d.; 10 in. 13s. 11d.; 10½ in. £1 3s. 5d.



BANG & OLUFSEN (UK) LTD., Eastbrook Road, Gloucester. Tel: Gloucester 21591.

4001 Synchro Box. For synchronising slide projector to tape recorder. Records projector control pulses on one track while commentary is recorded on second track. On playback the control pulse is read and shaped to length required by the projector. Price: £18 10s. 3d. (plus £4 12s. 9d. PT).



BIB. Multicore Solders Ltd., Multicore Works, Maylands Avenue, Hemel Hempstead, Herts. Tel: Hemel Hempstead 3636.

★ **Maintenance Kit.** Tape head cleaning and maintenance kits, containing stylus and tape head cleaners, tools, polishers and cloth in plastic wallet. Prices: size J, 9s. 9d. (inc. PT); size E, 16s. 10d. (inc. PT); size K, £3 9s. 8d. (inc. PT).

★ **Model 20.** Recording tape splicer. Precision made for fast and accurate tape editing. Chrome tape clamps. Non-slip base. Razor cutter. Price: 19s. 6d.

Model 21. Enlarged version of model 20 for editing ½ in. video tape. 4 razor cutters and cleaning kit included. Price: £9 10s.



BRADMATIC LTD., 338 Aldridge Road, Streetly, Sutton Coldfield, Warwickshire. Tel: Streetly 3171.

A range of twin track high impedance sound heads, single hole fixing, pole pieces are cylindrically ground flush with caps. Screening cans available.

Type 5 RP. Combined record/replay head 0-0004 in. gap. Price: £3 5s.

Type 6 RP. Super fidelity record/replay head 0-0002 in. gap. Price: £3 15s.

Type 5R. Record only 0-0007 in. gap. Price: £3 5s.

Type D5E. Erase head. Price: £3 5s.

Full track versions of the above are also available.

Type ST-RP. Stereo record/replay head. Price with screen can, without fixing stem: £6.



COLTON & CO. (LAPIDARIES) LTD., The Crescent, Wimbledon, London, S.W.19. Tel: 01-946 9401.

★ **Gripex** anti-slip dressing. A spirit suspended solution supplied in 1 fl oz. bottles with brush. Applied thinly to drive surface of belts or friction wheels, it dries in 10-15 minutes. Price: 5s. per bottle.

Tape storage rack. Constructed in heavy gauge welded wire finished in black polythene with matching or contrasting feet. May be used for tapes and books. Accommodation for 21 tapes. Sliding 'tidy' keeps tapes upright when smaller quantity stored. Price: £1 1s. (UK purchase tax 1s. 11d.).

See also pickup accessory section.



CONTRONICS LTD., Garth Works, Deepcut Bridge Road, Blackdown, Camberley, Surrey. Tel: Deepcut 5936.

★ **Carol Cinesound** tape/film. tape/slide synchronisers enable home movies to be made with sound. The Carol Cinesound completes a sound system between the projector and tape recorder. There are three models.

Model R.1. Record only unit for projectors or cameras. In a cream plastic case, size 4 × 2 × 1⅝ in., it uses a 22.5V Ever Ready B122 battery and weighs 5½ oz complete. Pulse input: miniature jack socket. Output to tape recorder: DIN 3-way socket. Accessories included. Price: £3 15s. (plus £1 6s. 6d. tax).

Model P.1. Playback only unit for projectors. Mains operated in a steel case, size: 5¼ × 3 × 3 in., weighing 2 lb 2 oz. Projector control in/out switch. Tape input: DIN 3-way socket. Pulse input: miniature jack socket. Mains input: 3-pin fixed plug. Projector socket: 8-pin octal socket.

Accessories included. Price: £11 5s. (plus £3 19s. 5d. tax).

Model CS/2. Record/playback unit. Mains unit operated. Steel housing finished in grey and off-white stove enamel measuring $12 \times 7 \times 3\frac{1}{2}$ in. 23 silicon transistors and 15 silicon diodes. Control circuit operated via isolating transformer driving a silicon controlled rectifier in the motor control circuit. Price: £34 10s. (plus £12 3s. 6d. PT).

★

COSMOCORD. See Acos.

★

EAGLE PRODUCTS. Distributors: B. Adler & Sons (Radio) Ltd., 32a Coptic Street, London, W.C.1. Tel: 01-636 9606/7. Cables: Reldab, London.

TD.79 Tape Head Demagnetiser. 250V mains operation. Price: £1 9s. 10d. (plus 7s. PT).

T.635 Tape Splicer. Complete with cutting and trimming blades. Price: 18s. 5d. (plus 4s. 4d. PT).

★

EMI. EMI Tape Ltd., Blyth Road, Hayes, Middlesex. Tel: 01-573 3888.

Empty spools in carton. AP.93 3 in. 3s. 6d.; AP.93N $3\frac{1}{4}$ in. 4s. 3d.; AP.84 4 in. 4s.; AP.85 5 in. 4s. 2d.; AP.86 $5\frac{1}{2}$ in. 4s. 8d.; AP.87 7 in. 5s. 2d.; AP.88 $8\frac{1}{4}$ in. 10s. 10d.

Empty spools in library case. AP.143 3 in. 3s. 6d.; AP.144 4 in. 5s. 8d.; AP.145 5 in. 7s.; AP.146 $5\frac{1}{2}$ in. 7s.; AP.147 7 in. 8s. 5d.

Joining block. AP.123 10s. 6d.

Accessory Kit. AP.124 £1 17s. 6d.

Coloured leader tape. AP.38/1 white 4s. 6d.; AP.38/2 red 4s. 6d.; AP.38/3 yellow 4s. 6d.; AP.38/4 blue 4s. 6d.; AP.38/5 orange 4s. 6d.; AP.38/6 green 4s. 6d.; AP.38/7 grey 4s. 6d.

Adhesive. AP.102 $\frac{3}{32}$ in. 4s. 9d.

Metallic stop foil. AP.125 6s. 6d.

Non-magnetic scissors. AP.39 £1 0s. 4d.

Joining tape. AP.103 $\frac{1}{2}$ in. 7s. 6d.

Joining for CA base tape. AP.35 7s. 6d.

Compound for PVC base tape. AP.77 7s. 6d.

★

FERROGRAPH CO. LTD., Mercury House, 195 Knightsbridge, London, S.W.7. Tel: 01-589 4485.

Head lift transformers. Suitable for FP17, FR7A and CL7 heads. Price: £2 11s.

Defluxer. For depolarising heads, capstans and guides. Ensures maximum signal/noise ratio. Prevents hiss and protects tapes from cumulative background noise. Price: £3 15s. 5d.

Tape heads. FP16 stereo stacked. Price: £13 7s. 9d. FR7A upper track. Price: £9 7s. 5d. CL7 lower track. Price: £7 7s. 3d.

Carrying case. Waterproof canvas case with zip fastener. Price: £3 18s. (plus £1 1s. 5d. PT).

Plugs. SP7 screened plug with aluminium body and cable clamp. Price: 7s. 6d. UP7 unscreened plug with insulated body. Price: 5s.

Endless loop cassette. Permits Ferrograph to be operated continuously on an endless loop of 8 mins duration at $7\frac{1}{2}$ i/s. Price: £8 15s. 11d.

Ferrotape spools. Aluminium, anodised grey. Hublok gives instant tape attachment and locks reel on spindle to prevent chatter. Prices: 7 in. 13s. 2d., $8\frac{1}{4}$ in. 15s. 8d.

★

GRAMPIAN REPRODUCERS LTD., Hanworth Trading Estate, Feltham, Middx. Tel: 01-894 9141. Cables: Reamp, Feltham.

★ **Grampian G.7.** Matching units, consisting of double wound transformer in a Mu-metal case with jack socket on the primary and a screened lead on the secondary. Dimensions: $3\frac{3}{8} \times 1\frac{1}{4}$ in. diameter. Versions available for matching 15/30 ohms, 600 ohms and 50,000 ohms or greater. Price: £4 5s.

★ **Grampian Parabolic Reflector.** Diameter 24 in., depth 5 in. Gain 14 dB over range of 500 c/s to 5,000 c/s. To take Grampian DP4 and DP6 mics. Weight: $4\frac{3}{4}$ lb. Price: £8.

★ **Grampian Reverberation Unit.** Self-contained portable unit, transistorised and operated from internal dry batteries. Independent input channels, low level and high level. Output 1V, 600



Grampian G7 matching unit

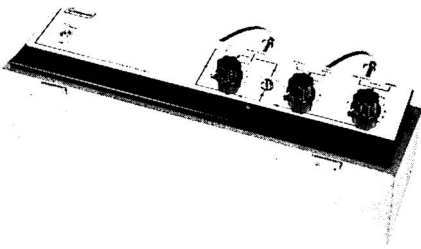

Grampian reverberation unit

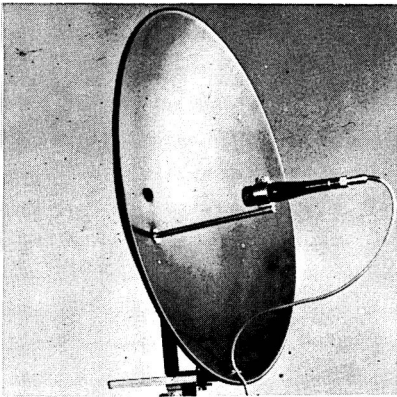

Grampian Parabolic reflector

ohms. Size (including detachable lid): $17\frac{1}{2} \times 5\frac{1}{4} \times 6\frac{1}{4}$ in. Weight: 12 lb. Price: £61 (batteries extra). Mains unit available.



GRUNDIG. Grundig (Great Britain) Ltd., Newlands Park, Sydenham, London, S.E.26. Tel: 01-778 2211.

Sona Dia. Designed to synchronise a tape recorder with automatic slide change projector. Records and reads control pulse on lower $\frac{1}{4}$ -track. Pulse frequency 100 Hz. Power consumption 3W. Price: (inc. PT) £24 12s. 6d.



HARVEY ELECTRONICS LTD., 308 Farnborough Road, Farnborough, Hants. Tel: Farnborough 41129. Cables: Harvelec, Farnborough, Hants.

A range of bulk erasers for 200-250V or 100-130V mains, 40-60 KHz. Smallest model will take $3\frac{1}{4}$ to 5 in. spools of $\frac{1}{4}$ in. tape, and the largest $3\frac{1}{4}$ to 12 in. spools of 1 in. tape. Special versions for wider tapes up to 35 mm. Prices on application.



KOSS. Tape Music Distributors Ltd., 11 Ridders Road, London, N.22. Tel: 01-888 0152.

T-1. Monitoring box for tapes from high impedance sources, such as tape recorders with pre-amps only. Impedance matching transformers: 600-10,000 ohm outputs. Equipped with two output jacks for stereophones and two RCA-type input jacks. Price: £4 10s.

T-5. Remote control station provides stereo-phone and speaker control from remote location. Jacks for two sets of stereophones. Left and right channel volume controls and speaker on-off switch. Metal cabinet. Price: £4 10s.



LENNARD DEVELOPMENTS LTD., 497 Green Lanes, London, N.13. Tel: 01-886 3723.

Dry-Slice. Precut adhesive tape for splicing and mending without the aid of a splicing block. Envelopes of 24. Price: 3s. 9d.



M. A. C. ELECTRONIC CO., Ripley, Surrey. Tel: Dunsfold 310.

AAU-TV. Audio adaptor unit provides a ready means of connecting various hi-fi equipments to a TV receiver. Built-in isolating transformer tapped 3-8-15 ohms for matching external speakers. Switchable output attenuator for matching input of tape recorder or amplifier. 3-way switching enables TV speaker to be

switched on or off. (Remote control switch available with 10 ft lead to switch speakers off-on from chair.) Size: $3\frac{1}{4} \times 3\frac{1}{2} \times 3\frac{1}{2}$ in. Solid teak case. Finish: jaguar silver. Price: £7 7s.

AAU-BOX. Connector box with facilities for various combinations of audio leads fitted with the plugs in common use. Two independent channels of: 4 mm sockets, co-ax, $\frac{1}{4}$ in. jack, miniature jack, 3-pole jack, 5-pin DIN, two pairs of phono. DIN pins selected by slide switch. Screw terminals underneath for fitting attenuator and load resistors, which can be switched in or out. Size: $4\frac{3}{4} \times 3\frac{3}{8} \times 1\frac{1}{4}$ in. Finish: jaguar silver. Price: £4 19s. 6d.

AAU-1. Audio adaptor unit providing connections for tape recorders. Provision for fitting attenuator resistors internally. 24 in. connecting leads fitted with either phono or DIN plugs. Size: $3 \times 3 \times 3$ in. Finish: jaguar silver. Front panel is fitted with two DIN sockets for record/replay. One stereo or two mono recorders can be connected to a cabinet mounted hi-fi system. Price £3 12s. 6d.

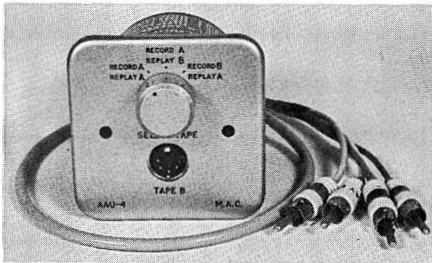

M.A.C. AAU-4 adaptor

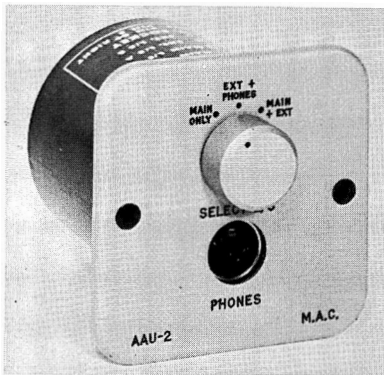

M.A.C. Adaptor Units

★**AAU-4.** As previous model, but with provision for connecting two stereo recorders to one amplifier for record/replay, one via rear phono sockets, the other via front DIN socket. 3-way switching gives various combinations for copying, etc. Price: £4 7s. 6d.

AAU-4M. As AAU-4, but fitted with additional replay leads and extra switching for use with amplifiers incorporating special tape monitor circuits. Price: £6 7s. 6d.

AAU-HP. Audio adaptor unit for connecting up to four stereo headphones to a stereo amplifier. Individual gain controls with balancing resistive networks incorporated. Fitted with 3 ft connecting cable with 3-pole jack plug. Solid teak case. Size: $3\frac{1}{4} \times 3\frac{1}{4} \times 3\frac{1}{2}$ in. Finish: jaguar silver. Price on application.

★**AAU-2.** Audio adaptor unit for connecting stereo headphones, plus two pairs of speakers. 3-way switching provides various combinations. Provision for fitting attenuator resistors internally. 4-ft connecting cable to amplifier. Size: $3 \times 3 \times 3$ in. Finish: jaguar silver. Price: £3 19s. 6d.

AAU-2X. De-luxe version of AAU-2 housed in solid teak case with pre-set gain controls for earpiece, plus resistive matching networks. Price: £6 2s. 6d.

AAU-2S. Audio adaptor unit for connecting two pairs of speakers to either of two amplifiers. Selected by toggle switch. 3-way switching gives combinations of speakers. Fitted with two 4-ft connecting cables. Size: $3 \times 3 \times 3$ in. deep. Finish: jaguar silver. Price on application.

AAU-VC. Audio adaptor unit for attenuating extension speakers. Attenuation rate: total -20 dB. in approx. 2 dB steps, with off position. Headphone jack fitted. Power handling: 20W per channel. Channel balance: within 0.1 dB. Channel separation: -85 dB. Frequency response at maximum attenuation: 20 Hz-20 KHz ± 0.2 dB. Transformers ensure negligible loss of damping. Housed in solid teak case $3\frac{1}{4} \times 3\frac{1}{4} \times 3\frac{1}{2}$ in. Finish: jaguar silver. Mono version also available. Price on application.

★

MASTERTAPE. Mastertape (Magnetic) Ltd., Prescot Road, Poyle Trading Estate, Colnbrook, near Slough, Bucks. Tel: Colnbrook 2431.

Splicing kit. Contains five reels leader tape.

one reel metallic strip, one reel adhesive, plastic splicer. Price: £1 5s. 8d. (including PT).

Empty plastic spools (boxed). 3 in. 2s. 9d.; 4 in. 3s. 8d.; 5 in. 4s. 3d.; 5½ in. 4s. 7d.; 7 in. 5s. 4d.; 8½ in. 6s. 9d.

Leader Tape. Colours: red, white, blue, yellow and green. Price: 2s. 6d.

Metallic foil. Price: 4s. 6d.

Adhesive jointing tape. Price: 4s. 6d.



METROSOUND. Metrosound Manufacturing Co. Ltd., Cartersfield Road, Waltham Abbey, Essex.

M.1 Metro-Splicer. Nylon block impervious to joining compounds, interchangeable guides and channels for use with 8 mm films. Supplied with spare cutter blades and emulsion scraper. Price: 15s. (plus 3s. 7d. PT).

★**M.4 Klenzatape kit.** Patented head cleaner. Kit comprises ribbed cleaning tape, two special spools and bottle of Klenzatape fluid. Price: 13s. 6d. (plus 3s. 3d. PT).

M.7 Tape accessory kit. Comprising Metro-Splicer, Klenzatape kit, Metro-brush on display card. Price: £1 10s. (plus 7s. 1d. PT).

★**M.9 Metro-Brush.** Designed for use with tape recorders for cleaning all surfaces except tape head. Soft nylon with plastic handle. Price: 2s. 6d. (plus 7d. PT).

★**M.12 Metro-Strobe.** Stroboscope for checking accuracy of tape recorders on all speeds at 50 Hz and 60 Hz. Price: 12s. 6d. (plus 2s. 11d. PT).

★**M.16. Tape Recorder Mechanical Maintenance Kit.** Presentation pack with Metro-Strobe, lubricating kit, Klensa-Tape kit, supply of cleaning pads, Metro-Brush. Price: £1 16s. (plus 8s. 5d. PT).

★**M.17. Metro-Splicing Block.** Professional precision metal splicing block for ¼ in. tape, supplied with non-magnetic cutter blade. Price: 9s.

M.18. Leader tapes. Choice of six colours, approximately 40 ft of leader tape, wound on to plastic mini-spool. Price: 4s. 6d. each.



Metrosound Klenzatape



Metrosound cleaning brush

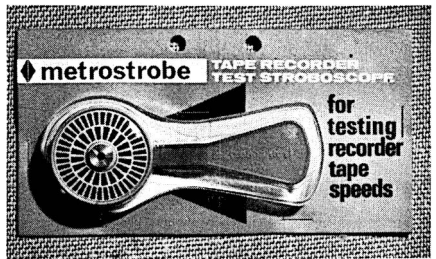

Metrosound stroboscope

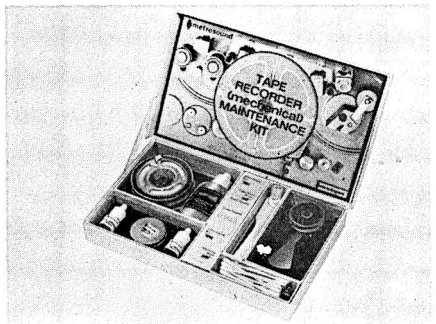

Metrosound mechanical maintenance kit



Metrosound MST17 splicing block

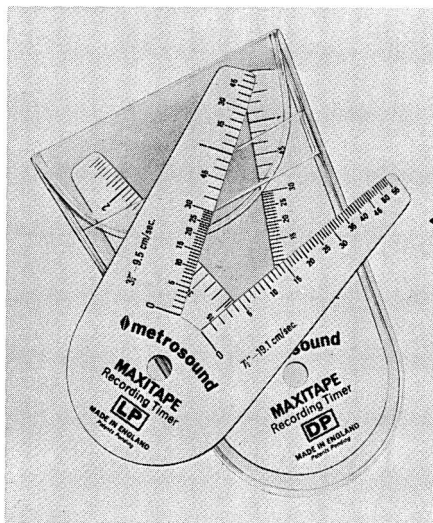

Metrosound recording timer



Metrosound editing kit

M.19. Stop foil. Metallic tape for actuating electronic auto stop mechanisms for tape recorders. Approximately 15 ft on mini-spool. Price: 4s. 6d.

M.23. Spirit level. Plastic spirit level for tape recorders and turntables, etc. Price: 6s.

M.20. Jointing tape. $\frac{1}{4}$ in. wide, approximately 12 ft on mini-spool. Price: 4s. 6d.

★ **M.29. Maxitapes Universal Recording Timer.** A set of four double-sided timing protractors for checking time of recordings on tape and time/length constant of remaining tape, at all speeds from $\frac{1}{16}$ to $7\frac{1}{2}$ i/s on standard, long-play, double-play and triple-play tapes in transparent plastic pack. Price: 12s. (plus 2s. 8d. PT).

M.24. Lubricating Kit. Suitable for tape recorders and mechanical moving parts. Comprises small bottle of each of R.O.B. and R.O.G. oil and container of Starfax. Price: 6s.

★ **M.25. Tape Editing Kit.** Comprises splicing block and cutter, one reel stop foil, one reel jointing tape; three assorted coloured leaders in cassettes with transparent dust cover, mounted on plastic base with soft plastic feet and supplied with fixing screws for bench use. Price: £1 7s.



MULTICORE. See Bib.



NORTHERNRADIO SERVICES (LONDON) LTD., 153 Fellows Road, London, N.W.3. Tel: 01-722 3314.

Hanhart time switch is powered by a watch movement with 24-hour capacity. The pre-set hours are indicated by a sub-dial viewed through a window in the main dial; minute hand rotates once per hour and can be set for a fraction of a minute. Only 'on' or 'off' at one setting, but two switches can be used in series if both functions are required. Alternatively, one can be used with another make of time switch to control the function for which accuracy is not so essential. Suitable for 200-250V. Prices: £6 15s., or per pair £13 10s.

AC1 Tape-Learning time switch, 13A or 15A, will provide three or more 'ons' and 'offs' from its 24-hour dial. Polystyrene case is mounted on a metal bracket which can be used as stand or wall bracket. Capacity: up to 3 kW. Price: £4 19s. 6d.

AC2 Pillow Speaker. The sound generator is enclosed in plastic foam and covered with soft felt envelope 4 in. square. Price: £3 3s., or £3 10s. with plug fitted.

Extension leads with plugs and sockets can be made to order for 10s. plus 1s. per yard of fine cable.

AC3 harness for two pillow speakers is fitted with two speaker sockets, 4 yd of twin cable and a plug for the recorder's speaker socket. Price: £1.

AC5 endless tape cassette by Philips gives playing time of 10 min at $3\frac{3}{4}$ i/s or 20 min at $1\frac{7}{8}$ i/s. Price: £3 10s.

AC6 endless tape cassette from America gives playing time of 15 min at $3\frac{3}{4}$ i/s or 30 mins at $1\frac{7}{8}$ i/s. Price: £4 16s.

AC7 tape splicer box contains semi-automatic splicer with spare knife and groove; 80 ft rolls each of red, green and white leader tapes; 35 ft roll splicing tape; coloured spool labels and auto stop foils. Price: £3 5s. 4d.

AC13 mains unit for cassette recorders, $7\frac{1}{2}$ V. Price: £4 15s.



OSMABET LTD., 46 Kenilworth Road, Edgware, Middlesex. Tel: 01-958 9314.

'Instant' Bulk Tape Eraser and Recording Head Demagnetizer. Operates from AC mains to provide rapid and complete erase of tapes prior to making quality recordings. Weight: 18 oz. Price: £2 2s. 6d.



PHILIPS ELECTRICAL LTD., Century House, Shaftesbury Avenue, London, W.C.2. Tel: 01-437 7777. Cables: Phillamps, London.

EL3787 pre-amplifier. Designed for use with Philips and Stella $\frac{1}{4}$ -track mono mains-operated recorders which have stereo socket and first stage input transistor circuit. The EL3787 pre-amplifier, together with additional equipment, offers the following facilities: playback of pre-recorded stereo tapes, duo-play (playback of one track while recording on parallel track), multiplay (copying from one track to another and simultaneously adding an accompaniment). Price: £6 10s.

EL1995 slide synchroniser. For use with most tape recorders and automatic slide projectors (max voltage 30V, max current 1A). Supply: 9V battery. Price: £12 12s.

N6502. Mains supply unit. Inputs: 110-245V (switchable). Outputs: 6V, 7.5V and 9V (switchable). For use with Philips/Stella battery tape recorders and radios fitted with appropriate socket.

N6705. Car mounting unit. For models EL3300, 3301, 3301T, 3302 tape recorders, 6V, 12V positive or negative earth.

Empty spools. 3 in. 2s. 6d., 4 in. 3s., 5 in. 3s. 6d., $5\frac{3}{4}$ in. 3s. 9d., 7 in. 4s.

Leader tapes. White, green, red, blue, 32 ft reels. Price: 2s. each.

Switching foil. 16 ft reels. Price: 2s. 9d.

Adhesive jointing tape. 32 ft reel. Price: 5s.

EL1901/50. Splicing kit. Contains white, green, red and blue leader tape, switching foil, adhesive tape, adhesive labels, cutting blade, splicing jig and instructions. Contained in plastic case. Price: £1 3s.

Stethoscope headphones. Various models. For use with Philips and Stella recorders. Price: (mono) £3 10s.; (stereo) £5 10s. (Hi-fi) £8 10s.



PIONEER. Distributors: Shiro (UK) Ltd., 8 Bush Lane, London, E.C.4. Tel: 01-626 4711.

JB21. Junction box enables stereo amplifiers without headphone jack to be used with any stereo headphones using standard plug. Switch provides: headphones only; speakers only; headphones and speakers. (Correct loading applied to amplifier in 'phones position.) Price: £1 12s.

JB22. Junction cord. Two jack sockets terminating in jack plug. Enables two sets of stereo headphones to be connected to stereo amplifier or JB21. Price: £1 2s. 3d.



REVOX. Distributors: C. E. Hammond & Co. Ltd., 90 High Street, Eton, Windsor, Berks. Tel: Windsor 63388. Telex: 84316.

Slide-o-matic. Transistorised accessory which enables pulses to be recorded for the remote control of automatic transparency projectors. Price: £19 12s. 6d.

SCOPETRONICS LTD., Crown Works, Church Road, Kingston-upon-Thames, Surrey. Tel: 01-546 1275 and 4135.

Tape Heads. All types of tape heads for $\frac{1}{4}$ in. tape made as standard. Also special prototype heads supplied.



SCOTCH. Minnesota Mining and Manufacturing Co. Ltd., 3M House, Wigmore Street, London, W.1. Tel: 01-486 5222. Cables: Minnesota, London.

Accessory Kit. Contains splicer, roll of No. 41 splicing tape on dispenser, roll of No. 24 white leader and timing tape, cutter, ten magnetic tape fastening clips. Price: £1 14s. 6d. Available separately: Tape clips. Price (per packet of 10): 2s. 6d. No. 24 Leader and Timing Tape. Price ($\frac{1}{4}$ in. \times 100 ft): 6s. No. 41 Splicing Tape ($\frac{1}{2}$ in. \times 150 in.): 3s. 6d., ($\frac{3}{32}$ in. \times 66 ft): 4s. 6d., ($\frac{1}{2}$ in. \times 66 ft): 6s. 6d. No. 51 Sensing Tape. Price ($\frac{3}{32}$ in. \times 150 in.): 14s.

Empty Spools. 7 in. 5s. 1d.; 5 $\frac{3}{4}$ in. 4s. 9d.; 5 in. 4s. 6d.; 4 in. 3s. 10d.; 3 in. 3s. 3d.

Self-Threading Spools. 5 $\frac{3}{4}$ in. 10s.; 7 in. 11s. 4d.



SYMPHONY AMPLIFIERS LTD., 153 Fellows Road, London, N.W.3. Tel: 01-722 3314.

Electronic start-stop control for tape recorders or other equipment. Controlled by high grade watch movement. Supplied complete with mains socket and outlet plug. Price: £6 15s.



TAPE RECORDER SPARES LTD., Harmsworth House, 9 Harmsworth Street, London, S.E.17. Tel: 01-735 9683.

Connecting cords. Cables with plug and socket terminations through the whole domestic field.

Adaptor cords. To adapt between the various standard plugs. Made to DIN and BSI standards.

Sockets. Chassis mounting and in-line.

Tape head demagnetiser. 250 V mains operated.

Tape head cleaning brush.

Plug and lead kits, 7RR, 12RR, 13RR. Ready-made interconnecting leads. Available to the trade. Price list and illustrated catalogue available on request.



TELEFUNKEN. Distributor: A.E.G. (Great Britain) Ltd., Lonsdale Chambers, 27 Chancery Lane, London, W.C.2. Tel: 01-242 9944.

Telefunken Endless Tape Cassette. Price: £3 7s. 3d.



THORN ELECTRICAL INDUSTRIES LTD., Thorn House, Upper St Martin's Lane, London, W.C.2. Tel: 01-836 2444.

Synchro-amp adaptor TA/01. Pre-amplifier unit for second channel stereo playback. Monitoring one track whilst recording on another. Automatic slide projector synchronisation. For $\frac{1}{4}$ -track machines only. Price on application.

Stereo amplifier SA100. General purpose transistor amplifier for use with $\frac{1}{4}$ -track recorders for playback of pre-recorded stereo tapes. Supplied complete with connecting leads. Price on application.

Foot switch TA/03. Facilitates use of recorder as dictating machine. Recorder runs when switch is depressed. Price on application.

Monitoring Stethoset TA/15. Stethoscope type earpiece to monitor programme during recording (7 in. spool machines only). Price on application.

The tape recorder accessories listed above are primarily for use with machines marketed under the Thorn brand names Ferguson, HMV, Marconiphone and Ultra.



TUTCHINGSELECTRONICSLTD., 14 Rook Hill Road, Friars Cliff, Christchurch, Hants. Tel: Highcliffe 2019.

Tapesponder's kit. Magnetic rubber for completely erasing tape; and 40 ft of white noise azimuth tape. Price: 5s., including postage.

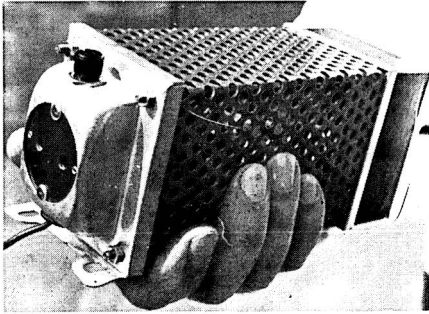

Valradio DC converter

UHER. Distributors: Bosch Ltd., Rhodes Way, Radlett Road, Watford, Herts. WD2 4LB. Tel: Watford 44233.

W211. Midget earphones. Price: £1 14s. 6d.



VALRADIO LTD., Browells Lane, Feltham, Middlesex. Tel: 01-890 4837/4242. Service agents: Vibro Supply, 57 Fortress Road, London, N.W.5. Tel: 01-485 5165.

★**DC converters.** Designed for operating tape recorders and similar mains equipment from ship's supply 110V DC and/or 220V DC. Prices from £14 14s. 6d.

Transverter B12/30S. Input 12V DC. Output: 50 Hz $\pm \frac{1}{4}$ Hz sine wave at 30W. Suitable for negative or positive earthed input. Built-in switch socket. Supplied complete with input lead. Size: 8 x 6 x 4 in. Weight: 8 lb. Price: £18.

Transverter B12/120S. Input: 12V DC. Output: 115-230V 50 Hz $\pm \frac{1}{4}$ Hz sine wave at 120W. Price: £47 2s.

Transverter B12/200S. Input: 12V DC. Output: 115-230V 50 Hz $\pm \frac{1}{4}$ Hz sine wave at 200W. Price: £67 12s.

Frequency changer. AC-AC, suitable for records, films, television programme special effects. Prices: 100W £32 6s. 9d.; 200W £52.



VAL. Sole distributor: A. C. Farnell Ltd., Consumer Division, Farnell House, 81 Kirkstall Road, Leeds, LS3 1HR. Tel: Leeds 35111.

WAL Hi-Gain pre-amplifier. Mono transistorised battery operated pre-amplifier with high amplification and built-in tape equalisation (CCIR at 7½ i/s) for playback direct from a tape head. Output obtainable from fully modulated tape approximately 100 mV. Switched equalisation permits straight line amplification for microphone, etc. Gain with input not exceeding 2,500 ohms 200 times; without equalisation, gain is 2,000 times. Price: £7 16s.; pair for stereo £15.

WAL D-Mag. Pinpoint eraser for striped film, tapes and tape heads. Nylon-cushioned probes. Weight: 9½ oz. Size: 2 in. sq x 1 in. wide. Psn 200-250V 50-100 Hz. Consumption: 110 mA at 240V. Price: £3 (plus 15s. 5d. PT).

WAL professional tape eraser will erase both sides of a 7 in. tape reel in 30 seconds and sound from 16 mm 10 in. aluminium reels. Weight: 7 lb. Size: 6½ x 4¾ x 3¾ in. Psn 200-250V 50 Hz, or 110-125V 60 Hz. Finish: oyster hammer grey. Price: £8 18s. 6d. (plus £2 7s. PT).

Take the tube to Tottenham Court Road...



... or, of course, any other means of transport. It's even worth WALKING to see our demonstration studio and hear our comprehensive range of hi-fi equipment. You can't go into your local radio shop and ask them to hook up hi-fi equipment in many different ways. In our demonstration studio, it's ALREADY hooked up in different ways! You can hear any—and all—of them at the flick of a switch. Let your ear judge—in the ideal listening conditions that you can't get in an ordinary shop. We've some pleasant surprises for that ear! And some for your pocket too! We do of course stock every leading make of equipment, Leak, Quad, Armstrong, Sanyo, Rogers, Thorens, Dulci, Nikko, Eagle, Philips, Dynatron, Bush-Murphy, Sony, Decca to name just a few. *Call in and see us next time you're in town.*

UTS

UNITED TECHNICAL SUPPLIES LIMITED.

Audio Demonstration Studio, 29, Tottenham Court Road, London, W.1.

Telephone: 01-580 5015. Open six full days a week—Thursday until 7 p.m.

The world is one great big
super-sounding
Agfa Magneton place



... and yours for the taping.

AGFA-GEVAERT

Agfa-Gevaert Limited, Magnetic Tape Division, Great West Rd, Brentford, Middlesex



TAKE CARE OF YOUR RECORDS

*Use the world's best cleaning
and maintenance devices.*

**WATTS EQUIPMENT CARES FOR YOUR
RECORDS IN ALL CONDITIONS OF USE**

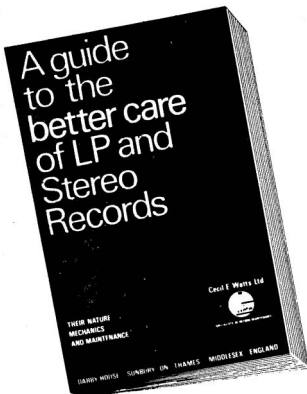

Only the user knows the local conditions in which his records will be played. A study of the Booklet "A GUIDE TO THE BETTER CARE OF YOUR L.P. & STEREO RECORDS" will, it is hoped supply the necessary information to enable him to choose the appropriate device to suit his particular requirements.

SEND IMMEDIATELY 2/6 POST FREE

**CECIL E. WATTS LIMITED
DARBY HOUSE · SUNBURY ON THAMES · MIDDLESEX**



mastertape

IN THE DISTINCTIVE TAPE BOOKS



Manufactured in England by
Mastertape (Magnetic) Limited. Colnbrook, Slough, Bucks.

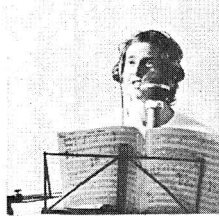

Scotch Magnetic Tape

Recording studios use it every day



3M and 'Scotch' are trademarks

DIRECTORY OF MAGNETIC TAPE

AGFA. Agfa-Gevaert Ltd., Brent House, 950 Great West Road, Brentford, Middlesex. Tel: 01-560 2072/5.

★ **Magneton PE31.** Long Play. 4 in. spool 450 ft 13s. 7d.; 4½ in. spool 600 ft £1 0s. 5d.; 5 in. spool 900 ft £1 6s. 4d.; 5½ in. 1,200 ft £1 13s. 6d.; 7 in. spool 1,800 ft £2 7s. 11d.; 8½ in. spool 2,400 ft £3 6s. 5d.; 10 in. spool 3,280 ft £4 6s. 4d.; 10½ in. spool 4,200 ft £5 8s. 11d. (All prices include PT).

Magneton PE31K. As for PE31 but in the following sizes only: 3 in. 210 ft 8s. 3d.; 4 in. 15s. 6d.; 4½ in. £1 3s. 4d.; 5 in. £1 9s. 4d.; 5½ in. £1 16s. 8d.; 7 in. £2 11s. 5d. (All prices include PT).

Magneton PE31R. As for PE31 but supplied in round clear plastic pack. In the following sizes only: 5 in. £1 3s. 11d.; 5½ in. £1 10s. 10d.; 7 in. £2 5s. 4d. (All prices include PT).

Magneton PE41. Double Play. 4 in. spool 600 ft £1 3s. 9d.; 4½ in. spool 900 ft £1 13s. 6d.; 5 in. spool 1,200 ft £2 0s. 5d.; 5½ in. spool 1,800 ft £2 14s. 6d.; 7 in. spool 2,400 ft £3 14s. 11d. 8½ in. spool 3,280 ft £5 6s. 5d.; 10 in. spool 4,600 ft £7 0s. 4d. (All prices include PT).

Magneton PE41K. As for PE41 but supplied in Novodur plastic library cases. In the following sizes only: 3 in. 13s. 3d.; 4 in. £1 6s.; 4½ in. £1 11s. 2d.; 5 in. £2 3s. 4d.; 5½ in. £2 17s. 8d.; 7 in. £3 18s. 5d. (All prices include PT).

Magneton PE41R. As for PE41 but supplied in round clear plastic pack. In the following sizes only: 5 in. £1 17s. 11d.; 5½ in. £2 11s. 10d.; 7 in. £3 12s. 4d. (All prices include PT).

★ **Magneton PE65.** Triple Play. 4 in. 900 ft £1 17s. 9d.; 4½ in. spool 1,200 ft £2 5s. 5d.; 5 in. 1,800 ft £3 0s. 5d.; 5½ in. spool 2,400 ft £4 0s. 6d.; 7 in. spool 3,600 ft £5 5s. 11d. (All prices include PT).

Magneton PE65K. As for PE65 but supplied in Novodur plastic library cases. In the following sizes: 3 in. 450 ft £1 0s. 3d.; 4 in. £2.; 4½ in. £2 8s. 10d.; 5 in. £3 3s. 10d.; 5½ in. £4 4s. 2d.; 7 in. £5 9s. 5d. (All prices include PT).

Magneton PE65R. As for PE65 but supplied in round clear plastic pack. In the following sizes

only: 5 in. £2 18s. 5d.; 5½ in. £3 18s. 4d.; 7 in. £5 3s. 4d. (All prices include PT).

Agfa Magneton PE31S. Special sound editing tape. 5 in. spool 600 ft. Price: £1 5s. (inc. PT).

Agfa Magneton PE31G. Endless tape loop 200 ft. Price: £2 18s.

Agfa Magneton PE41G. Endless tape loop. 300 ft. Price: £3.

★ **Magneton Compact Cassettes.** C60 17s. 6d.; C90 £1 5s.; C120 £1 12s. 6d. (including PT).

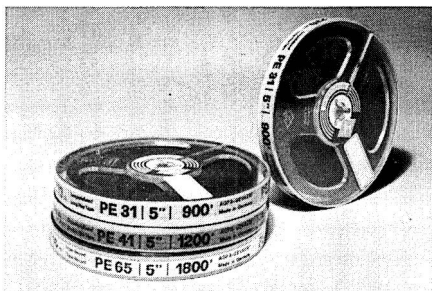

Agfa triple play tape on spools

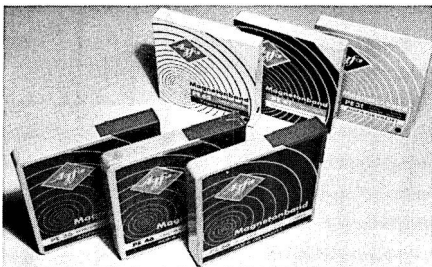

Agfa tapes in swivel boxes and library boxes



Agfa Compact cassettes

Magneton DC International Cassettes. DC 90 £1 9s. 6d.; DC120 £1 12s. 6d. (including PT).

PE36K. Long play low noise tapes. 5 in. spool 900 ft £1 12s. 2d.; 5½ in. spool 1,200 ft £2 0s. 2d.; 7 in. spool 1,800 ft £2 16s. 4d. (including PT).

PE36R. As for the PE36 but in the following sizes only: 8¾ in. 2,400 ft £3 12s. 11d.; 10 in. 3,280 ft £4 14s. 10d.; 10½ in. 4,200 ft £5 19s. 8d. (including PT).

PE46. Double play low noise tape. 8¾ in. spool 3,280 ft £5 14s. 4d. (including PT).

PE46K. As for the PE46 but in the following sizes: 5 in. £2 6s. 6d.; 5½ in. £3 1s. 10d.; 7 in. £4 4s. 2d. (including PT).

PE66K. Triple play low noise tape. 4¼ in. spool 1,200 ft £2 11s. 2d.; 5 in. spool 1,800 ft £3 6s. 11d.; 5½ in. 2,400 ft £4 8s. 3d.; 7 in. 3,600 ft £5 14s. 9d. (including PT).



BASF. BASF United Kingdom Ltd., Knightsbridge House, 197 Knightsbridge, London, S.W.7. Tel: 01-584 5080.

SP52. Standard play. In round pack. 4 in. spool 300 ft 12s.; 5 in. spool 600 ft 18s. 6d.; 5½ in. spool 900 ft £1 5s. 6d.; 7 in. spool 1,200 ft £1 12s. 6d.

SP52 Standard play. In plastic swivel box. 5 in. spool 600 ft £1 2s. 3d.; 5½ in. spool 900 ft £1 9s. 5d.; 7 in. spool 1,200 ft £1 16s. 7d.

LP35. Long play. In round pack. 3 in. spool 210 ft 7s. 4d.; 4 in. spool 450 ft 12s.; 4¼ in. spool 600 ft 18s. 6d.; 5 in. spool 900 ft £1 5s. 6d.; 5½ in. spool 1,200 ft £1 12s. 6d.; 7 in. spool 1,800 ft £2 7s. 6d.

LP35. Long play. In plastic mailing box, 3 in. spool 210 ft 9s. 6d. In plastic swivel box, 4 in. spool 450 ft 15s. 7d.; 4¼ in. spool 600 ft £1 2s. 1d.; 5 in. spool 900 ft £1 9s. 3d.; 5½ in. spool 1,200 ft £1 16s. 5d.; 7 in. spool 1,800 ft £2 11s. 7d.;

DP26. Double play. In round pack. 3 in. spool 300 ft 13s.; 4 in. spool 600 ft £1 2s. 6d.; 4¼ in. spool 900 ft £1 7s. 6d.; 5 in. spool 1,200 ft £1 19s. 6d.; 5½ in. spool 1,800 ft £2 2s. 6d.; 7 in. spool 2,400 ft £3 5s.

DP26. Double play. In plastic mailing box, 3 in. spool 15s. In plastic swivel box, 4 in. spool

600 ft £1 6s. 1d.; 4¼ in. spool 900 ft £1 11s. 1d.; 5 in. spool 1,200 ft £2 3s. 3d.; 5½ in. spool 1,800 ft £2 16s. 5d.; 7 in. spool 2,400 ft £3 19s. 7d.

TP18. Triple play. Round pack. 3 in. spool 450 ft £1 1s.; 3½ in. spool 600 ft £1 9s. 6d.; 4 in. spool 900 ft £1 16s. 6d.; 4¼ in. spool 1,200 ft £2 6s. 6d.; 5 in. spool 1,800 ft £3 3s. 6d. 5½ in. spool 2,400 ft £5 7s. 6d.; 7 in. spool 3,600 ft £5 12s. 6d.

TP18. Triple play. In plastic mailing box, 3 in. spool 450 ft £1 3s. In plastic swivel box, 3½ in. spool 600 ft £1 12s. 1d.; 4 in. spool 900 ft £2 0s. 1d.; 4¼ in. spool 1,200 ft £2 10s. 1d.; 5 in. spool 1,800 ft £3 7s. 3d.; 5½ in. spool 2,400 ft £4 11s. 5d.; 7 in. spool 3,600 ft £5 16s. 7d.

PES35LH. Low-noise high-output tape. 5 in. spool 900 ft £1 14s. 3d.; 5½ in. spool 1,200 ft £2 2s. 5d.; 7 in. spool 1,800 ft £3 0s. 1d.; 8¼ in. spool 2,400 ft £4 5s.; 8¾ in. spool 2,400 ft £4 5s.; 10 in. spool 3,600 ft £5 13s. 6d.; 10½ in. spool 4,200 ft £6 5s. 6d.

Tape Library box. Hold three tapes in separate swivel-open sections. With one LP35 tape, 5 in. £1 16s.; 5½ in. £2 4s. 6d.; 7 in. £3 2s. With one DP26 tape, 5 in. £2 10s.; 5½ in. £3 4s. 6d.; 7 in. £4 9s. 6d.

Low Noise Compact Cassette (Philips pattern) C60 30 min track 17s. 7d.; C90 45 min/track £1 5s. 1d.; C120 60 min/track £1 13s. 7d. Letter Tape, 2¼ in. spool with 150 ft long play tape in mailing container. Total weight less than 2 oz. Price: 5s. 6d.

BASF special tapes. A range of long play and double play tapes in spool sizes from 5 in. to 10½ in. is available for special requirements. Details and prices on application. Note. BASF tape prices include PT where applicable.



EMI TAPE LTD., Blythe Road, Hayes, Middlesex. Tel: 01-573 3888. Cables: Emitape, London.

'88' Standard Play. PVC base. 3 in. spool 175 ft 7s. 6d.; 3¼ in. spool 175 ft 7s. 6d.; 4 in. spool 300 ft 10s. 6d.; 5 in. spool 600 ft £1 1s.; 5½ in. spool 900 ft £1 8s.; 7 in. spool 1,200 ft £1 15s.; 8¼ in. spool 1,800 ft £2 17s. 6d.; 10½ in. spool £3 18s. 9d.; 11½ in. spool £3 13s. 6d.

'99' Long Play. PE base. 3 in. spool 210 ft 9s.; 3¼ in. spool 210 ft 9s.; 4 in. spool 450 ft

14s. 6d.; 5 in. spool 900 ft £1 8s.; 5½ in. spool 1,200 ft £1 15s.; 7 in. spool 1,800 ft £2 10s.; 8½ in. spool 2,400 ft £3 12s. 6d.; 10½ in. spool £5 10s.

'100' Double Play. Polyester base 3 in. spool 300 ft 14s.; 3½ in. spool 300 ft 14s.; 4 in. spool 600 ft £1 5s.; 5 in. spool 1,200 ft £2 2s.; 5½ in. spool 1,800 ft £2 15s. 6d.; 7 in. spool 2,400 ft £2 17s. 6d.

'300' Triple Play. Polyester base. 3 in. spool 450 ft £1 2s.; 4 in. spool 900 ft £1 18s.; 5 in. spool 1,800 ft £3 16s.

Emitape Type 60 Cassette. 60 minutes playing time. Designed for use with Philips Compact and similar tape decks. Price: 19s. 6d.

HMV Voice-Letter V2/2. 3 in. lightweight spool in special mailing pack. 40 mins playing time on ¼-track recorder at 3¼ i/s. Price: 5s.



FERRODYNAMIC INTERNATIONAL. Leda Tapes (Despatch Dept.). 17 Leigh Park Road, Leigh-on-Sea, Essex.

Standard play. Acetate base. 5 in. spool 600 ft 8s. 9d.; 7 in. spool 1,200 ft 13s. 6d.

Long play. Acetate base. 5 in. spool 900 ft 11s.; 5½ in. spool 1,200 ft 13s. 6d.; 7 in. spool 1,800 ft 16s. Polyester base. 7 in. spool 1,800 ft 21s. 9d.

Double play. Polyester base. 5 in. spool 1,200 ft 16s.; 5½ in. spool 1,800 ft 22s. 6d.; 7 in. spool 2,400 ft 25s.



GRUNDIG (GREAT BRITAIN) LTD., Newlands Park, London, S.E.26. Tel: 01-778 2211.

GT11. Triple play. 4½ in. spool 1,200 ft £2 9s. 6d.

GL15. Long Play. 5½ in. spool 1,200 ft £1 17s.

GD15. Double Play. 5½ in. spool 1,800 ft £2 14s. 6d.

GL18. Long Play. 7 in. spool 1,800 ft £2 17s. 6d.

GD18. Double Play. 7 in. spool 2,400 ft £3 17s. 6d.

DC90. Cassette. 90 minutes playing time. £1 10s.

DC120. Cassette. 120 minutes playing time. £1 15s. 6d.

Note. Grundig prices include purchase tax where applicable.



ILFORD LTD., 201/3 Wardour Street, London, W.1. Tel: 01-734 8731.

Zonatape. Standard Play. PVC base. 3 in. spool 150 ft 5s. 9d.; 3½ in. spool 175 ft 7s. 6d.; 4 in. spool 300 ft 10s. 6d.; 5 in. spool 600 ft £1 1s.; 5½ in. spool 900 ft £1 8s.; 7 in. spool 1,200 ft £1 15s.; 8½ in. spool 1,800 ft £2 17s. 6d.; 10½ in. spool 2,400 ft £3 18s. 6d.

Zonatape. Extra Play. Polyester base. 3 in. spool 225 ft 9s.; 3½ in. spool 300 ft 12s.; 4 in. spool 450 ft 14s. 6d.; 5 in. spool 900 ft £1 8s.; 5½ in. spool 1,200 ft £1 15s.; 7 in. spool 1,800 ft £2 10s.; 8½ in. spool 2,400 ft £3 12s. 6d.; 10½ in. spool 3,600 ft £5 8s.

Zonatape. Double Play. Polyester base. 3 in. spool 300 ft 13s. 6d.; 3½ in. spool 400 ft 17s.; 4 in. spool 600 ft £1 5s.; 5 in. spool 1,200 ft £2 5s.; 5½ in. spool 1,800 ft £2 17s. 6d.; 7 in. spool 2,400 ft £3 17s. 6d.; 8½ in. spool 3,600 ft £6.

Zonatape. Triple Play. Polyester base. 3 in. spool 450 ft £1 2s.; 3½ in. spool 600 ft £1 7s. 6d.; 4 in. spool 900 ft £1 19s.; 5 in. spool 1,800 ft £3 6s.; 5½ in. spool 2,400 ft £4 10s.

Splicing tape. 108 ft × ¼ in. Price: 3s. 6d.

Metallic Stop Foil. 100 ft × ¼ in. Price: 4s. 6d.



LEDA TAPE. Leda Tapes (Despatch Dept.). 17 Leigh Park Road, Leigh-on-Sea, Essex.

Standard Play. PVC base. 3 in. spool 150 ft 2s. 6d.; 4 in. spool 300 ft 4s. 3d.; 5 in. spool 600 ft 8s. 9d.; 5½ in. spool 900 ft 10s. 6d.; 7 in. spool 1,200 ft 12s. 6d.

Long Play. PVC base. 3 in. spool 225 ft 3s. 3d.; 4 in. spool 450 ft 5s. 6d.; 5 in. spool 900 ft 10s. 3d.; 5½ in. spool 1,200 ft 12s. 6d.; 7 in. spool 1,800 ft 17s. 9d.

Double Play. Polyester base. 3 in. spool 300 ft 4s. 6d.; 4 in. spool 600 ft 8s. 6d.; 5 in. spool 1,200 ft 15s. 9d.; 5½ in. spool 1,800 ft 19s. 9d.; 7 in. spool 2,400 ft 22s. 6d.

Triple Play. Polyester base. 3 in. spool 600 ft 9s. 3d.; 4 in. spool 900 ft 13s. 3d.; 5 in. spool 1,800 ft 23s. 6d.; 5½ in. spool 2,400 ft 29s. 9d.; 7 in. spool 3,600 ft 39s. 9d.



MASTERTAPE. Mastertape (Magnetic) Ltd., Prescot Road, Poyle Trading Estate, Colnbrook nr. Slough, Bucks. Tel: Colnbrook 2431.

Mastertape reels are complete with leaders, trailers and stop foils. The 3 in., 4 in., and 8¼ in. reels are packed in original carton pack. The 5 in., 5½ in., and 7 in. reels are packed in black one-piece plastic type boxes with gold lettering.

Standard, colour code red. 3 in. spool 150 ft 5s. 6d.; 4 in. spool 300 ft 10s.; 5 in. spool 600 ft £1 0s. 6d.; 5½ in. spool 900 ft £1 7s. 6d.; 7 in. spool 1,200 ft £1 13s. 6d.

Long Play, colour code yellow. 3 in. spool 225 ft 8s. 6d.; 4 in. spool 450 ft 12s. 6d.; 5 in. spool 900 ft £1 8s.; 5½ in. spool 1,200 ft £1 15s.; 7 in. spool 1,800 ft £2 10s.; 8¼ in. spool 2,400 ft £3 12s. 6d.

Super Play, colour code orange. 3 in. spool 800 ft £1 12s. 6d.; 4 in. spool 1,200 ft £2 5s.

Double Play, colour code blue. 3 in. spool 300 ft 12s. 6d.; 4 in. spool 600 ft £1 1s.; 5 in. spool 1,200 ft £2 2s.; 5½ in. spool 1,800 ft £2 15s.; 7 in. spool 2,400 ft £3 17s. 6d.

Triple Play, colour code green. 3 in. spool 600 ft £1 2s.; 4 in. spool 900 ft £1 10s.; 5 in. spool 1,800 ft £2 17s. 6d.; 5½ in. spool 2,400 ft £3 19s. 6d.; 7 in. spool 3,600 ft £5.

Mini-Voice Letter in mailing carton. 3 in. spool 100 ft Standard tape. 3s. 3d.

Senda-Message in mailing envelope. 1½ in. spool 100 ft Triple Play tape. 3s.



NORTHERNRADIOSERVICES (LONDON) LTD., 153 Fellows Road, London, N.W.3. Tel: 01-722 3314.

AC8. 3 in. Double Play 300 ft. 12s. 6d. **AC9**

5 in. Standard. 600 ft, 17s 6d. **AC10** 5 in. Long Play 900 ft, £1 1s. **AC11** 5 in. Double Play 1,200 ft £1 10s. **AC12** 5½ in. Long Play 1,200 ft £1 5s.

AC5. Endless tape cassette by Philips with playing time of 10 minutes at 3¼ i/s or 20 minutes at 1⅞ i/s. Price: £3 10s.

AC6. Endless tape cassette from America with playing time of 15 minutes at 3¼ i/s or 30 minutes at 1⅞ i/s. Price: £4 16s.



PHILIPS ELECTRICAL LTD., Electro-acoustics Division, Century House, Shaftesbury Avenue, London, W.C.2. Tel: 01-437 7777. Cables: Phillamps, London.

Audio Letter. 3 in. spool 200 ft standard play tape. Price: 6s.

Philips Hi-Fidelity Low Noise tapes:

Standard Play (Green). 4 in. spool 300 ft 10s. 6d.; 5 in. spool 600 ft £1 1s.; 5½ in. spool 900 ft £1 8s.; 7 in. spool 1,200 ft £1 15s.

Long Play (Red). 3 in. spool 210 ft 9s.; 4 in. spool 450 ft 14s. 6d.; 5 in. spool 900 ft £1 8s.; 5½ in. spool 1,200 ft £1 15s.; 7 in. spool 1,800 ft £2 10s.

Double Play (Blue). 3 in. spool 300 ft 14s.; 4 in. spool 600 ft £1 5s.; 5 in. spool 1,200 ft £2 2s.; 5½ in. spool 1,800 ft £2 15s. 6d.; 7 in. spool 2,400 ft £3 17s. 6d.

Triple Play (Grey). 3 in. spool 450 ft £1 2s.; 4 in. spool 900 ft £1 19s.; 5 in. spool 1,800 ft £3 6s.

All types of Philips tape on 5 in., 5½ in. and 7 in. spools packed in free library box.

CE.10 Endless Loop. Approximately 195 ft. Playing time 40 mins at 1⅞ i/s. Price: £3 10s.

C.30 Compact Cassette. Playing time ½ hour. Price: 10s. 6d.

C.60 Compact Cassette. Playing time 1 hour. Price: 17s. 6d.

C.90 Compact Cassette. Playing time 1½ hours. Price: £1 5s.

C.120 Compact Cassette. Playing time 2 hours. Price: £1 13s. 6d.

RCA GREAT BRITAIN LTD., Lincoln Way, Windmill Road, Sunbury-on-Thames, Middlesex. Tel: Sunbury-on-Thames 5511.

Vibrant Series Audio Tape. Standard Play, Long Play and Double Play grades are available on various base materials as detailed in the following paragraphs.

Standard Play Acetate. 5 in. spool 600 ft 15s. 6d.; $5\frac{3}{4}$ in. spool 900 ft. £1; 7 in. spool 1,200 ft £1 4s.

Standard Play Mylar. 5 in. spool 600 ft. £1 5s. 6d.; $5\frac{3}{4}$ in. spool 900 ft £1 15s.; 7 in. spool 1,200 ft £2 1s.

Long Play Acetate. 5 in. spool 900 ft 19s.; 7 in. spool 1,800 ft £1 15s. 6d.

Long Play Mylar. 5 in. spool 900 ft £1 2s.; $5\frac{3}{4}$ in. spool 1,200 ft £1 11s.; 7 in. spool 1,800 ft £2.

Double Play Tensilised Mylar. 5 in. spool 1,200 ft £1 15s.; $5\frac{3}{4}$ in. spool 1,800 ft £2 8s.; 7 in. spool 2,400 ft £3 1s.

Professional low noise tapes in $\frac{1}{4}$ in., $\frac{1}{2}$ in. and 1 in. widths. Full details and prices on application.



SCOTCH. Minnesota Mining and Manufacturing Co. Ltd., 3M House, Wigmore Street, London, W.1. Tel: 01-486 5522. Cables: Minnesota, London.

175. Standard Play. Polyester base. 5 in. spool 600 ft £1 1s. 4d.; $5\frac{3}{4}$ in. spool 850 ft £1 8s. 5d.; 7 in. spool 1,200 ft £1 15s. 6d.

215. Long Play. Polyester base. 3 in. 300 ft 9s. 7d.; 4 in. spool 450 ft 14s. 9d.; 5 in. spool 900 ft £1 8s. 4d.; $5\frac{3}{4}$ in. spool 1,200 ft £1 15s. 5d.; 7 in. spool 1,800 ft £2 10s. 6d.; $8\frac{1}{4}$ in. spool 2,400 ft £3 13s. 4d.

220. Double Play. Tensilised polyester base. 3 in. spool 400 ft 16s. 7d.; 4 in. spool 600 ft £1 5s. 3d.; 5 in. spool 1,200 ft £2 2s. 4d.; $5\frac{3}{4}$ in. spool 1,800 ft £2 15s. 11d.; 7 in. spool 2,400 ft £3 18s.

290. Triple Play. Tensilised polyester base. 3 in. spool 600 ft £1 4s. 10d.; 4 in. spool 900 ft £1 19s. 3d.

Dynarange 202. Standard Play. Polyester base. 5 in. spool 600 ft £1 4s. 4d.; $5\frac{3}{4}$ in. spool 850 ft £1 12s. 8d.; 7 in. spool 1,200 ft £2 1s. 6d.

Dynarange 203. Long Play. Polyester base. 5 in. spool 900 ft £1 12s. 7d.; $5\frac{3}{4}$ in. spool 1,200 ft £2 0s. 11d.; 7 in. spool 1,800 ft £2 18s.; $8\frac{1}{4}$ in. spool 2,400 ft £4 4s. 4d.

One-Five Special. Letter tape on 3 in. spool in handy pack ready for posting. Up to 30 minutes. Price: 5s. 3d.

271. C-60 Compact cassette with Scotch low noise tape treated with 'Superlife'. Price: 17s. 6d.

272. C-90 Compact cassette. Price: £1 5s. 1d.



SYNCHROTAPE. Sole distributors: Adastra Electronics Ltd., 167 Finchley Road, Swiss Cottage, London, N.W.3. Tel: 01-624 8164.

Standard Play. PVC base. 3 in. spool 150 ft 4s. 9d.; 5 in. spool 600 ft 15s.; $5\frac{3}{4}$ in. spool 900 ft 18s. 6d.; 7 in. spool 1,200 ft £1 2s. 6d.

Long Play. PVC base. $2\frac{3}{8}$ in. spool 200 ft 5s. 9d.; 3 in. spool 225 ft 6s. 3d.; 4 in. spool 450 ft 12s.; 5 in. spool 900 ft 18s. 6d.; $5\frac{3}{4}$ in. spool 1,200 ft £1 2s. 6d.; 7 in. spool 1,800 ft £1 8s. 6d.

Double Play. Tensilised polyester base. $2\frac{3}{8}$ in. spool 300 ft 8s. 9d.; 3 in. spool 300 ft 8s. 9d.; 4 in. spool 600 ft 18s.; 5 in. spool 1,200 ft £1 8s. 6d.; $5\frac{3}{4}$ in. spool 1,800 ft £1 16s.; 7 in. spool 2,400 ft £2 8s.

Triple Play. Tensilised polyester. 3 in. spool 450 ft 13s. 9d.; 4 in. spool 900 ft £1 7s.; 5 in. spool 1,800 ft £2 5s.; $5\frac{3}{4}$ in. spool 2,400 ft £2 17s. 6d.; 7 in. spool 3,600 ft £3 15s.

Except for $2\frac{3}{8}$ in. and 3 in. spools, all Synchro-tape tapes have leader, trailer and double metallic stop-foils.



Synchrotape

TAPE 70. Leda Tapes (Despatch Dept.), 17 Leigh Park Road, Leigh-on-Sea, Essex.

Standard Play. PVC base. 3 in. spool 150 ft 3s. 3d.; 4 in. spool 300 ft 6s. 6d.; 5 in. spool 600 ft 11s. 6d.; 5½ in. spool 900 ft 14s. 6d.; 7 in. spool 1,200 ft 17s. 6d.;

Long Play. PVC base. 3 in. spool 225 ft 4s. 3d.; 4 in. spool 450 ft 7s. 6d.; 5 in. spool 900 ft 14s. 6d.; 5½ in. spool 1,200 ft 17s. 6d.; 7 in. spool 1,800 ft 25s.

Double Play. Polyester base. 3 in. spool 300 ft 6s. 6d.; 4 in. spool 600 ft 12s.; 5 in. spool 1,200 ft 22s. 6d.; 5½ in. spool 1,800 ft 29s. 6d.; 7 in. 2,400 ft 37s. 6d.

Triple Play. Polyester base. 3 in. spool 600 ft 13s.; 4 in. spool 900 ft 17s. 6d.; 5 in. spool 1,800 ft 35s.; 5½ in. spool 2,400 ft 48s. 6d.; 7 in. spool 3,600 ft 62s. 6d.



TELEFUNKEN. Distributors: A.E.G. (Great Britain) Ltd., Lonsdale Chambers, 27 Chancery Lane, London, W.C.2. Tel: 01-2429944. Cables: Allgem, London.

Telefunken. Long Play. PVC base. 5 in. spool 900 ft £1 12s.; 5½ in. spool 1,200 ft £1 17s. 6d.; 7 in. spool 1,800 ft £2 12s. 6d.

Telefunken. Double Play. PVC base. 5 in. spool 1,200 ft £2 4s.; 5½ in. spool 1,800 ft £2 17s. 6d.; 7 in. spool 2,400 ft £4.

Telefunken Endless Tape Cassette. Price: £3 7s. 3d.



TONEMASTER TAPES. Messrs Chart Edge Ltd., 18/21 Jermyn Street, London, S.W.1. Tel: 01-734 1443.

Standard Play. PVC base. 3 in. spool 150 ft 2s. 3d.; 4 in. spool 300 ft 5s.; 5 in. spool 600 ft 6s. 6d.; 5½ in. spool 900 ft 8s.; 7 in. spool 1,200 ft 9s. 9d.

Long Play. PVC base. 3 in. spool 225 ft 2s. 8d.; 4 in. spool 450 ft 5s. 6d.; 5 in. spool 900 ft 9s. 5½ in. spool 1,200 ft 11s. 3d.; 7 in. spool 1,800 ft 13s. 9d.

Double Play. Polyester base. 3 in. spool 300 ft 5s.; 4 in. spool 600 ft 7s. 3d.; 5 in. spool 1,200 ft 13s. 3d.; 5½ in. spool 1,800 ft 17s. 9d.; 7 in. spool 2,400 ft £1 1s. 9d.

Triple Play. Polyester base. 3 in. spool 600 ft 9s. 6d.; 4 in. spool 900 ft 13s.; 5 in. spool 1,800 ft £1 5s.; 5½ in. spool 2,400 ft £1 15s.; 7 in. spool 3,600 ft £2 5s.

Leaders and stop foils on LP, DP and TP 5 in. to 7 in. All Tonemaster Tapes are British made and supplied sealed in individual boxes. 2s. 9d. postage on orders up to £3; over £3 post free. By-return postal service.



ZONATAPE. See Ilford.

DIRECTORY OF TEST TAPES & DISCS

BASF. BASF United Kingdom Ltd., Knightsbridge House, 197 Knightsbridge, London, S.W.7. Tel: 01-584 5080.

Calibration Tape 9. $3\frac{3}{4}$ i/s, 120 μ Sec (high) and $3\cdot180$ μ Sec (low) characteristics. Other details as for Tape 19. Price: £11.

Calibration Tape 19. $7\frac{1}{2}$ i/s, 100 μ Sec characteristic. Azimuth alignment section included, also an unrecorded section for adjustment of bias, etc. Price: £11.

Calibration Tape 38. 15 i/s. 35 μ Sec. characteristic. Other details as for Tape 19. Price: £11.

★

EMI ELECTRONICS LTD., Installation and Maintenance Division, Hayes, Middlesex. Tel: 01-573 3888. Cables: Emidata, London.

Type TBT.1A. Full track tape, $7\frac{1}{2}$ i/s, 100 μ Sec. CCIR characteristic. Range 40 Hz-10 KHz. Price: £4 (plus PT).

Type TBT.2A. Full track tape, $3\frac{3}{4}$ i/s, 120 μ Sec. CCIR characteristic. Range 40 Hz-8 KHz. Price: £4 (plus PT).

★

EMI RECORDS (Gramophone Co. Ltd.), EMI House, 20 Manchester Square, London, W.1. Tel: 01-486 4488.

TCS 101. 12 in. stereo (45/45) frequency test disc covering the range 30 Hz to 20 KHz, with fixed bands on alternate left and right channels. Follows RIAA curve, with level reduced by 6 dB above 10 KHz. Both sides identical. Price: £1 17s. 6d.

TCS 102. 12 in. stereo (45/45) frequency test disc covering same range as TCS 101, but with gliding tone. Side A, left channel; side B, right channel. Price: £1 17s. 6d.

TCS 104. 12 in. mono (lateral) frequency test disc covering same range as TCS 101, with fixed bands on one side and gliding tone on the other. Price: £1 17s. 6d.

TCS 105. 12 in. vertical-cut frequency test disc covering same range as TCS 101, with fixed bands on one side and gliding tone on the other. Price: £1 17s. 6d.

★

POLYDOR RECORDS LTD., 17-19 Stratford Place, London, W.1. Tel: 01-493 7401.

EP.101 497. Extended play test record for setting up stereo equipment. Price: 8s. 6d. (including PT).

★

TUTCHINGSELECTRONICS LTD., 14 Rook Hill Road, Friars Cliff, Christchurch, Hants. Tel: Highcliffe 2019.

Test Tape No. 1. Pure tones 40 Hz-10 KHz with voice identification of each band. Recorded to CCIR 70 μ Sec characteristic at $7\frac{1}{2}$ i/s. Track 2 carries continuous 7.5 KHz tone for azimuth alignment.

Test Tape No. 2. Pure tones 40 Hz-7.5 KHz with voice identification of each band. Recorded to CCIR 140 μ Sec characteristic at $3\frac{3}{4}$ i/s. Track 1 carries four identical frequency runs. Track 2 is recorded with continuous 5 KHz tone for azimuth alignment.

Test Tape No. 3. White noise, one third octave bands 40 Hz-10 KHz with voice identification of each band. Recorded to CCIR 70 μ Sec characteristic at $7\frac{1}{2}$ i/s.

Test Tape No. 4. White noise, one octave bands 100 Hz-6.4 KHz centre frequencies with voice identification of each band. Track 2 carries full range unfiltered white noise. Recorded to CCIR 70 μ Sec characteristic at $7\frac{1}{2}$ i/s.

Test Tape No. 5. Azimuth and vertical head alignment tape. Full track unfiltered white noise with track 3 blank. Can be used without test equipment at all tape speeds on two- or four-track recorders.

All tapes on 3 in. spools. Price: £1 10s. each, including postage.

Full-track recordings of any single frequency can be supplied with low wow and flutter content at £1 5s. per 3 in. reel.

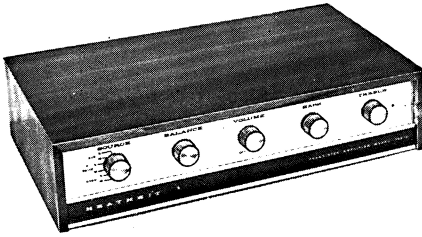

Heathkit TSA-12



Heathkit STR-1

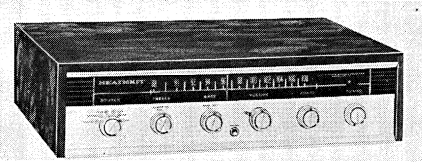

Heathkit AR14

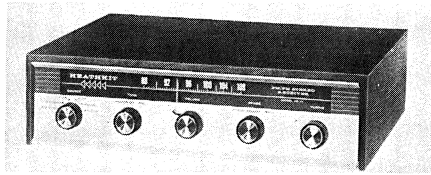
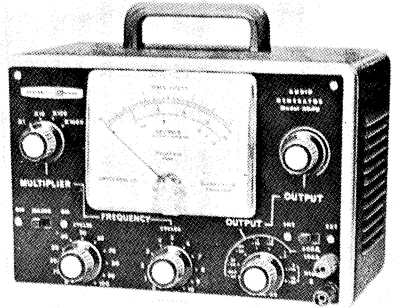

Heathkit AR17

Heathkit AG-9U audio signal generator

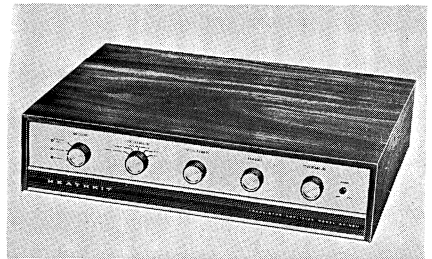
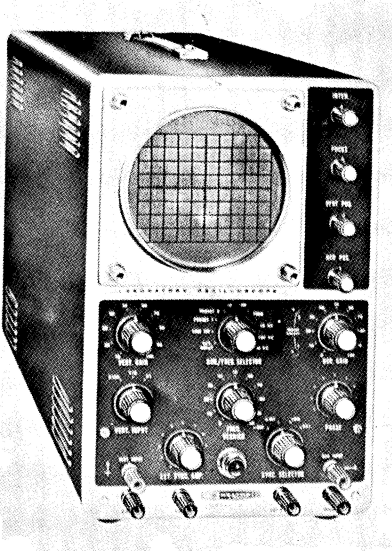

Heathkit AA-22U stereo amplifier



Heathkit AFM-2

Heathkit 10-12U oscilloscope

DIRECTORY OF CONSTRUCTIONAL KITS

★ Abbreviations: **HC**=handling capacity; **FR**=frequency range; **Rec**=recommended; **Psn**=power supply needed. ★ indicates model is illustrated.

EAGLE PRODUCTS. B. Adler & Sons (Radio) Ltd., Coptic Street, London, W.C.1. Tel: 01-636 9606. Cables: Reldab, London.

Eagle Speaker Kits are made in Denmark for Eagle. All the kits are supplied with crossover and dividing networks together with full cabinet drawings.

KIT 2-8. Two units: $6\frac{1}{2}$ in. woofer and $2\frac{1}{2}$ in. tweeter. FR: 50 Hz-18 KHz. HC: 8W. Impedance: 8 ohms. Rec. cabinet $16\frac{1}{8} \times 7\frac{3}{4} \times 11\frac{1}{8}$ in. Price: £7 12s. (plus £1 17s. PT).

KIT 3-15. Three units: $8\frac{1}{4}$ in. woofer, 5 in. mid-range unit and 2 in. tweeter. FR: 45 Hz-18 KHz. HC: 15W. Impedance: 8 ohms. Rec. cabinet $22 \times 8\frac{5}{8} \times 12$ in. Price: £11 15s. 5d. (plus £2 18s. 7d. PT).

KIT 3-25. Three units: 12 in. woofer, 5 in. mid-range unit and 2 in. tweeter. FR: 40 Hz-18 KHz. HC: 25W. Impedance: 8 ohms. Rec. cabinet $26\frac{3}{4} \times 15 \times 18$ in. Price: £19 19s.

★

EATON AUDIO FITMENTS, Leopold Street, Long Eaton, Nottingham. NG10 4QF. Tel: Long Eaton 2662/2818.

Wharfedale Unit 3 kit. Made to Wharfedale specification from $\frac{1}{2}$ in. material accurately machined for simplicity of assembly, with the main parts veneered (unpolished) in teak, mahogany and walnut. All kits are complete with screws for fixing the back and fret panel. Bolts for fixing, fret material, baffle holes cut, veneered on all four sides. Prices: small cabinet 4 in. by $9\frac{3}{4}$ in. high by $3\frac{3}{4}$ in., £4 12s. 6d.; large cabinet $11\frac{1}{2}$ in. by 21 in. high by $9\frac{1}{2}$ in., £5 8s. 6d.; Wharfedale Unit 3 speaker kit, £10 5s.

Wharfedale Pipe kits. Column cabinets using specially designed filter and absorbent pads of bonded acetate fibre. Designed for a single full range 8 in. speaker (rec. Super 8/RS/DD). FR: 40 Hz-20 KHz. Suitable for 15 ohm amplifiers; other impedances by matching transformer WMT1. Dimensions: 3 ft high by 11 in. diameter. Power handling capacity: 6W rms. Price on request.

HEATHKIT. Manufactured by Daystrom Ltd., Bristol Road, Gloucester. Tel: Gloucester 29451.

TFM-1. Tuner. Comprises TFM-T1 tuner unit and TFM-1S (stereo) IF strip and power supply. Range: 88-108 MHz. Variable tuning. Ratio detector. Sensitivity: $2 \mu\text{V}$ for 20 dB quieting. Aerial input 75 ohms coaxial. Output: 250 mV. Multiplex decoder fitted. All transistor. Mains: 200-250V 50-60 Hz. Size: $15\frac{5}{8} \times 3\frac{7}{8} \times 10\frac{1}{4}$ in. Price: £27 10s. for both units. Cabinet £2 5s. Also available ready assembled.

★ **AFM-2.** Transistor AM/FM stereo-mono tuner. Range: VHF 88-108 MHz. MW 192-555 m. LW 1,000-1,800 m. Variable tuning. Ratio detector. AFC. AGC. 18 transistors, 7 diodes. Sensitivity: $2 \mu\text{V}$ for 20 dB quieting. Aerial input (VHF): 75 ohms coaxial. Output: 300 mV with 30% modulation. Stereo multiplex decoder fitted. Automatic stereo indicator light. Edge-lit slide rule scale and flywheel tuning. Internal AM ferrite rod aerial. Pre-assembled and aligned front-end. Separate AM and FM printed boards. Walnut veneered cabinet optional extra. Mains: 105-125V, 210-250V 50-60 Hz. Consumption: 10W. Size: $15\frac{1}{2} \times 10\frac{1}{4} \times 3\frac{7}{8}$ in. Weight (less cabinet): 8 lb. Price (kit): £37 12s.

★ **TSA-12.** Integrated stereo transistor amplifier. Inputs: PU 5 mV 47K, radio 300 mV 180K, aux 300 mV 180K. Controls: selector, balance, volume, bass -15 dB +14 dB at 20 Hz, treble -12 dB and +14 dB at 20 KHz. Output: 12W RMS per channel (8 ohm load). 8W RMS per channel (15 ohm load). HD 1% or less, 20 Hz-20 KHz at rated output. Noise level: -50 dB (PU), -60 dB (radio and aux). Mains: 100-125, 200-250V 50-60 Hz. Size: $15\frac{1}{2} \times 10 \times 3\frac{3}{8}$ in. Weight: 11 lb. Price (kit): £32 16s.; (ready assembled) £43 10s.

AA-15. Transistorised stereo integrated amplifier. Power output: 150W music. Distortion: <0.5% at full output. FR: 8 Hz-40 KHz ± 1 dB at 1W. Controls: volume, balance, treble, bass, various switch functions, tuner input jack and L.S. switch. Psn: 120-240V 50 Hz. Price: (kit) less cabinet £93 5s. Walnut veneered cabinet £8 10s.

★ **AR-14.** FM stereo, with multiplex decoder.

Range: 87.5-108 MHz. Tuning: variable. Ratio detector. Sensitivity: 2 μ V. Aerial impedance: 75 ohms coaxial, 300 ohms balanced. Output voltage: 300 mV. AFC. Power output: 10W RMS per channel. HD better than 1% 20 Hz-20 KHz. FR 15 Hz-50 KHz at 10W. Feedback: 38 dB. Noise level: 80 dB (power amp). Output impedance: 4-16 ohms. Output transistors: 2N2148/40465. Psn 120 or 240V 50 or 60 Hz. Inputs: gram, 4.5 mV, 50K, 60 dB noise level; aux, 300 mV, 100K, 65 dB noise level. Controls: source, treble, bass, volume, phase, tuning. Dimensions: $3\frac{3}{8} \times 15\frac{1}{4} \times 12$ in. Price: £76 12s.; in kit form £54 2s. (including PT).

★**AR-17.** FM stereo tuner/amplifier with multiplex decoder. Range: 87-108 MHz. Ratio detector. Sensitivity: 2.5 μ V. Aerial: 75 ohms coaxial or 300 ohms balanced. AFC. Power output: 5W RMS per channel. HD better than 1% 20 Hz-30 KHz. FR 25 Hz-35 KHz ± 1 dB. Feedback: 32 dB. N/L: 80 dB (power amp). Output impedance 4-16 ohms. Output transistors: BD131, BD132. Psn 120-240V 50 or 60 Hz. Inputs: gram, 5 mV, 50K, -45 dB noise level; aux, 300 mV, 150K, -55 dB noise level. Controls: function, tuning, volume, tone. Dimensions: $3 \times 12 \times 10\frac{3}{8}$ in. Price: £60 4s.; in kit form, £39 2s. (including PT).

AA-14. Stereo amplifier. Power output: 10W per channel, 4-16 ohms. HD 0.5% or less at 1 KHz. FR 15 Hz-50 KHz ± 1 dB. Feedback: 38 dB. N/L: 80 dB power amp. Output transistors 2N2148/40465. Psn 120-240V 50 or 60 Hz. Dimensions: $3\frac{1}{2} \times 12\frac{1}{2} \times 9\frac{3}{8}$ in. Inputs: aux, 300 mV, 180K, -65 dB N/L; tuner, 300 mV, 18K, -63 dB N/L; gram, 4.5 mV, 47K, -60 dB N/L. Controls: bass, treble, source, volume. Psn 120-240V 50 or 60 Hz. Price to be announced.

AD-27. FM stereo compact system. Transistorised. Range: 87.5-108 MHz. Variable tuning. AFC. Multiplex decoder fitted. Controls: FM tune, source, volume, balance, bass, treble, phase, power on/off, speakers on/off, stereo/mono. Power output: 10W RMS per channel. FR: 6 Hz-100 KHz ± 3 dB. Output impedance: 4-16 ohms. Distortion: less than 1% from 12 Hz-60 KHz. Motor unit: BSR MA65. Pickup cartridge: Shure M44MB. Overall dimensions: $7\frac{1}{8} \times 21\frac{7}{8} \times 14\frac{11}{16}$ in. Speakers: Berkeley, Avon, Ambassador. Finish: teak or walnut. Price to be announced.

AJ-15. Transistorised stereo tuner. Features: FET devices in tuner section; crystal filters in IF stages; integrated circuits in IF stages; noise suppression circuitry; adjustable stereo phase

control; two tuning meters with variable tuning; two adjustable stereo phone outputs; outputs for amplifier and tape recorder; panel illumination. Price: (kit) less cabinet £131 12s. Walnut veneered cabinet £8 10s.

★**AA-22U.** Transistorised stereo integrated amplifier. Inputs: PU 6 mV, radio 250 mV, tape 250 mV, aux.1. 250 mV, aux.2. 250 mV. Controls: balance, selector switch, mode switch, volume, bass, treble, filter, filter (3-position; flat, 4 KHz, 8 KHz, 12 dB/octave). Noise -50 dB on PU, -65 dB all other inputs. Output: 20W per channel RMS. Distortion 0.3% at 20W. FR 15 Hz-30 KHz 1 dB. Feedback 35 dB. Output: imp 4, 8 or 16 ohms. Pre-set gain controls accessible from the front. Mains 110, 200-250V 50-60 Hz. Size: $15\frac{1}{2} \times 3\frac{7}{8} \times 12\frac{3}{4}$ in. Price (kit): less cabinet £42 16s.; cabinet £4 extra; (assembled including cabinet) £58.

★**STR-1.** Stereo tape recorder. $\frac{1}{4}$ -track. Speeds: $1\frac{3}{8}$, $3\frac{3}{8}$ and $7\frac{1}{2}$ i/s. Max spool capacity: 7 in. W and F: $7\frac{1}{2}$ i/s 0.15%; $3\frac{3}{8}$ i/s 0.25%; $1\frac{3}{8}$ i/s 0.35%. H and N: $7\frac{1}{2}$ i/s 55 dB; $3\frac{3}{8}$ i/s 47 dB; $1\frac{3}{8}$ i/s 42 dB. FR: $7\frac{1}{2}$ i/s 40 Hz-18 KHz; $3\frac{3}{8}$ i/s 40 Hz-12 KHz; $1\frac{3}{8}$ i/s 40 Hz-7.5 KHz. Replay characteristics: DIN. Level indicator: meter. Rewind time: 1,500 ft $1\frac{1}{2}$ min. Inputs: mic, 0.35 mV, 50K; aux, 50 mV, 100K. Outlets: extension speaker. 4W, 8 ohms; external amplifier, 1V, 1K. Audio output: 4W RMS. Speaker size: 8 x 5 in. Transistorised. One motor. Tape deck: TD10. Dimensions: $7\frac{7}{8} \times 19\frac{1}{2} \times 15\frac{1}{2}$ in. Weight: 30 lb. Superimposing. Straight through amplifier. Input mixing. Sound on sound. Common stacked head. Psn 220-250V 50 Hz. Price: £56 16s. 8d. (plus £16 13s. 4d. PT); in kit form £45 15s. 6d. (plus £13 8s. 7d. PT).

SSU-1. Speaker system kit. Comprises 8 in. and 4 in. matched drive units, and ducted-port bass reflex cabinet. Response 40 Hz-16 KHz ± 5 dB. Crossover frequency 3 KHz. Impedance 15 ohms. Size: $23 \times 11\frac{1}{2} \times 11\frac{3}{4}$ in. Available for horizontal or vertical mounting. Price complete (kit): £13 4s.; (legs) 16s. extra.

Cotswold. High fidelity three speaker system. Drive units are 12 in. bass, 8 x 5 in. elliptical, and pressure tweeter. Range 30 Hz-20 KHz. Two volume controls. Celotex lined enclosure. In white wood ready cut and drilled. Dimensions: $26 \times 23 \times 14\frac{1}{2}$ in. Price complete with crossover unit, etc (kit): £28 12s.

Berkeley. Infinite baffle hi-fi enclosure with speakers and cross-overs. One 12 in. low-resonance bass unit, one 4 in. middle and top

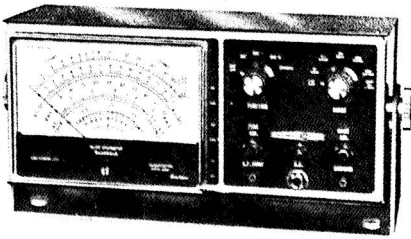

Heathkit IM-13U valve voltmeter

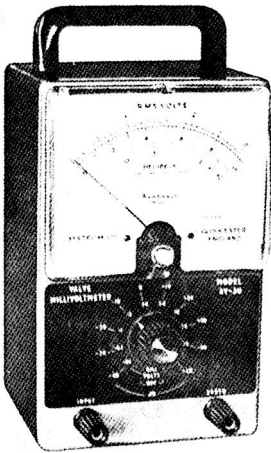

Heathkit AV-3U audio millivoltmeter

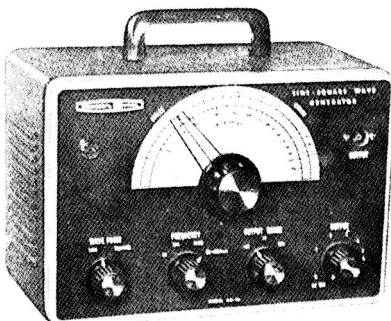

Heathkit AO-1U audio generator

unit. Inductance/capacitance cross-over at 900 Hz. Handling capacity 15W RMS. Kit includes ready finished cabinet shell. Finish: oiled walnut veneer. Size: 26 in. high, 17 in. wide, 7 $\frac{3}{4}$ in. deep. Price (kit): £19 10s.; (assembled) £21 4s.

Avon. Infinite baffle bookcase enclosure with two units. One 6 in. high compliance bass driver, one 3 in. tweeter. Fully finished walnut veneered cabinet. Size: 7 $\frac{3}{4}$ × 13 $\frac{1}{4}$ × 8 $\frac{3}{4}$ in. Price (kit): £13 8s.

C-3U. Resistance-capacitance bridge. Self-contained and powered. Capacitance range 0-00001 to 1,000 microfarads. Resistance range 100 ohms to 5 megohms. Power factor and leakage also indicated. Polarising voltage available from 5 to 450V. Price (kit): £12 8s.; (assembled) £16 14s.

★ **AV-3U.** Audio valve millivoltmeter. Measures voltages as low as 1 mV to a maximum of 300V at high impedances in 10 ranges. Frequency range 10-400,000 Hz. Uses a 4 $\frac{1}{2}$ in. meter. Cathode follower output. Price (kit): £19 16s.; (assembled) £26 6s.

309-CU. RF probe. Extends the range of a valve voltmeter to 100 MHz. Uses a printed circuit board. Price (kit): £2 4s.; (assembled) £2 18s.

AW-1U. Audio wattmeter. Uses external loads or the following internal loads: 3, 8, 15 and 600 ohms. 5 power ranges from 0-5 mW to 50 watts. 4 $\frac{1}{2}$ in. meter calibrated in watts and dB. Price (kit): £23 14s.; (assembled) £30.

★ **AO-1U.** Inexpensive audio generator covering 20 Hz-150 KHz sine wave, 20 Hz-25 KHz square wave. Output up to 10V RMS sine wave or 80V peak-to-peak square wave. Size: 9 $\frac{1}{2}$ × 6 $\frac{1}{2}$ × 5 in. Price (kit): £14 16s.; (assembled) £19 18s.

IM-12U. Low-priced audio distortion meter. Simple to use. Measures distortion at frequencies between 20 Hz and 20 KHz. Size: 13 × 7 × 8 $\frac{1}{2}$ in. Price (kit): £35 12s.; (assembled) £47 10s.

IG-82U. Audio generator covering 20 Hz-1 MHz. Sine and square wave available simultaneously. Sine wave output up to 10V RMS, square wave output up to 10V peak-to-peak. Rise time 0-15 μSec. Size: 13 × 8 $\frac{1}{2}$ × 7 in. Price (kit): £25 16s.; (assembled) £37 16s.

★ **AG-9U.** Audio signal generator. Range: 10 Hz-100 KHz. Distortion less than 0-1 % from 20 Hz to 20 KHz. Decade switching over 8 voltage ranges from 3 mV to 10V monitored.

Uses $4\frac{1}{2}$ in. meter. Price (kit): £28; (assembled) £36.

V-7A. Valve voltmeter kit. Printed circuit. Measures AC volts (0-1.5, 5, 50, 150, 500, 1,500) RMS, AC volts (0-4, 14, 40, 140, 400, 1,400, 4,000) peak-to-peak. DC volts (0-1.5, 5, 15, 50, 150, 500, 1,500). Ohms (with 10 ohms centre) \times 1, 10, 100, 1,000, 10K, 100K, 1 megohm. 0-1 ohms to 1,000 megohms with internal battery. Input resistance: 11 megohms. 200 μ A meter movement. Price (kit): £14 16s.; (assembled) £19 18s.

★**1M-13U.** Laboratory valve-voltmeter kit. Printed circuit. Gimbals mounting, for viewing from any angle. Measures AC volts (0-1.5, 5, 15, 50, 150, 500, 1,500 RMS); AC volts (0-4, 14, 40, 140, 400, 1,400, 4,000 peak-to-peak). DC volts (0-1.5, 5, 15, 50, 150, 500, 1,500). Ohms (with 10 ohms centre) \times 1, 10, 100, 1,000, 10K, 100K, 1 megohm. 0-1 ohms to 1,000 megohms with internal battery. Input resistance: 11 megohms. 200 μ A meter movement. Price (kit): £23 18s.; (assembled) £31 10s.

★**OS-2.** Service oscilloscope. $2\frac{3}{4}$ in. tube. Vertical bandwidth 2 Hz to 3 MHz. Automatic lock-in sync. Mu-metal CRT shield. Printed circuit. Switched ext/int Y plate connections. Vertical amplifier: sensitivity 100 mV/cm, input impedance: 3-3 megohms shunted by 20 pF, response 2 Hz-3 MHz \pm dB. Horizontal amplifier: sensitivity 100 mV/cm, input impedance: 10 megohms shunted by 20 pF, response 2 Hz-3 MHz. Timebase: 20 Hz-200 KHz in four steps.

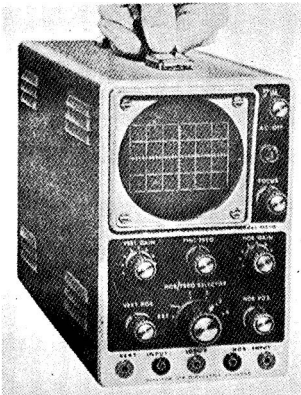

Heathkit OS-2 service oscilloscope

Size: $5 \times 7\frac{3}{8} \times 12$ in. Weight: $9\frac{1}{4}$ lb. Price (kit): £24 18s.; (assembled) £32 18s.

★**IO-12U.** General purpose oscilloscope kit. 5 in. flat face CR tube. Printed circuits. Vertical band-width 3 Hz to 4.5 MHz. Built-in 1V calibrator. Y-sensitivity 10 mV RMS per cm at 1 KHz. X-sensitivity 50 mV RMS per cm at 1 KHz. Price (kit): £38 18s.; (assembled) £49 10s.

S-3U. Electronic Switch (oscilloscope trace doubler). Converts a single beam oscilloscope to double beam. Switching rates 150, 500, 1,500, 5,000 and 15,000 Hz. Signal frequency response 0-100 KHz \pm 1 dB. Signal input range 0-1 to 1.8V RMS. Price (kit): £15 10s.; (assembled) £22.

★

HART ELECTRONICS, 321 Great Western Street, Manchester, 14. Tel: Rusholme 2212/3.

Bailey 20W amplifier. Power amplifier: 20W with total HD 0.1% at 1 KHz. H and N: -80 dB. Proof against damage by short circuits. Four transistors. Pre-amplifier: five-transistor circuit with feedback triple front end giving 23 dB overload capacity with HD less than 0.02%. Described in 'Wireless World' Nov and Dec 1966. Price: (kit for power amplifier) £7 5s.; (kit for mono pre-amp) £7 4s. 6d.; (kit for stereo pre-amp) £14 10s.; (kit for power supply) £5 10s. 6d.

Dinsdale 10W amplifier. Output: 10W per channel into 15 ohms. Printed circuit construction, six transistors per power amplifier, three transistors per pre-amp. Described in 'Wireless World' Jan and Feb 1965 (reprints available from Hart Electronics, price 5s. 6d. post paid). Price: (kit for mono pre-amp and amplifier) £9 18s.; (kit for stereo pre-amp and amplifier) £20 8s.; (kit for power supply unit) mono £4 10s. 6d., stereo £5 8s.

★

HENRY'S RADIO LTD., 303 Edgware Road, London, W.2. Tel: 01-723 1008/9.

Hi-fi 12/25. Transistorised amplifier kits. Nine models: MPA12/3, MPA12/15, MPA25, MPA12+12, MP3, SP6-2, PS24/40, MU24/40, MU60.

MP3. Mono pre-amplifier. All silicon transistor low-noise zener stabilised circuit. Full range of controls. Inputs for crystal PU, crystal or dynamic microphone, tuner, tape head and



Henry's SP6-2

pre-amp replay. Output: 250 mV. Supply: 12-60V DC. Consumption: 3 mA. Size: $9\frac{3}{8} \times 1\frac{3}{8} \times 1\frac{7}{8}$ in. Supplied ready-built on metal chassis with silver/grey front panel and matching knobs. Price: £6 19s. 6d. (post and packing 3s. extra).

★**SP6-2.** Mono/stereo pre-amplifier. Eight silicon/germanium devices. Zener stabilised. New low-noise circuit. Full range of controls and filters. Inputs: magnetic, crystal or ceramic cartridge, tuner, tape pre-amp, microphone, tape head. Input sensitivity: 3 mV. Tape record outlet socket. Output: 250 mV per channel. Supply: 9-60VDC. Consumption: 4 mA. Supplied ready-built on metal chassis with silver/grey front panel and matching knobs. Size: $12 \times 3\frac{1}{2} \times 3\frac{3}{4}$ in. Price: £15 15s. (post and packing 5s. extra).

MPA12/3 and MPA12/15. 12W low-distortion power amplifiers for use with MP3 and SP6-2 pre-amplifiers. Silicon and germanium semiconductors. Input: 100 mV for 12W output. FR: 30 Hz-20 KHz ± 1 dB. HD 0.2% at 12W RMS. High-gain stable push-pull output stage. MPA 12/3 for 3-5 ohms speakers and 24-28V supply. MPA 12/15 for 10-16 ohm speakers and 40-45V supply. Ready-built on metal chassis. Size: $5 \times 2 \times 3\frac{1}{4}$ in. Price: MPA12/3 £4 10s.; MPA12/15 £5 5s. (post and packing 2s. 6d. extra in either case).

MPA12+12. Twin amplifier for mono or stereo. Designed for use with MP3 or SP6-2 pre-amplifiers. Consists of two MPA12/15 amplifiers on single chassis. Output: 10-16 ohms. Supply: 40-45V DC. Other details as for separate amplifiers. Size: $10 \times 2 \times 3\frac{3}{4}$ in. Price: £9 19s. 6d. (post and packing 4s.).

MPA25. 25W power amplifier. 10 silicon and germanium semiconductors. Output impedance: 7.5-16 ohms. Input sensitivity: 180 mV for 25W output. Supply: 50-60V DC. Size: $8 \times 2 \times 3\frac{3}{4}$ in. Price: £7 10s.

PS24/40. Mains power supply unit. Input: 110-240V 40-60 Hz. Fully smoothed and isolated output. AC and DC fused. Output: 24V and 45V at 1A. Suitable for one MPA12-12 or one or two MPA12. Mounted on metal chassis. Price: £3 10s. (post and packing 3s.).

MU24/40. Mains power supply unit. Similar to PS24/40 but with additional choke/capacitor filtering and panel voltage selectors. Price: £4 7s. 6d. (post and packing 3s. 6d.).

MU60. Mains power supply unit. Choke smoothed output 50V 1A. Suitable for use with one or two MPA25 amplifiers. Price: £4 15s. (post and packing 4s.).

Transistorised FM Tuner. Geared slow motion full tuning. Range: 87-105 MHz. AGC. AFC. Ratio detector. Multiplex adaptor. Aerial imp 75 ohms. Output: max 80 mV for 100 μ V aerial: min $2\frac{1}{2}$ mV for 1 μ V aerial. Psn 9V. 9 mA. Size: $3\frac{1}{2} \times 2\frac{1}{4} \times 4$ in. Price (kit): £7 19s. 6d.

★

KNIGHT-KITS. Electroniques (Prop STC) Ltd., Edinburgh Way, Harlow, Essex. Tel:

★**KG765A.** AM/FM tuner. Ranges: VHF 88-108 MHz. MW 195-550 m. Variable tuning. Ratio detector. Meter tuning indicator. Sensitivity: 1.25 μ V for 20 dB quieting, 2.5 μ V for 30 dB quieting. Aerial input: 300 ohms balanced. Output: 500 mV low impedance. Multiplex decoder included. Switchable AFC. Mains: 230-250V 50 Hz. Size: $13 \times 11 \times 2\frac{3}{4}$ in. AM whistle filter. Automatic mono/stereo switching. Stereo indicator light. Price: £43 6s. 2d. (plus £2 3s. 4d. PT); teak case £4 16s. 3d. (plus 13s. 9d. PT).

★**KG790.** AM/FM tuner. Ranges: 87.5-108.5 MHz. 188-570 m. Variable tuning. Ratio detector. Meter tuning indicator. Sensitivity: 1.25 μ V for 20 dB quieting, 2.5 μ V for 30 dB quieting. Aerial input: 300 ohms balanced. Output: 500 mV low impedance. Multiplex decoder included. AM whistle filter. Automatic mono/stereo switching. Stereo indicator light. Four IF stages. Mains: 230-250V 50 Hz. Size: $5 \times 16\frac{3}{4} \times 15$ in. Price: £89 5s. (plus £3 7s. 11d. PT); teak case £7 8s. 11d. (plus £1 0s. 7d. PT).

★**KG795.** FM/VHF tuner. Range: 88-108 MHz. Variable tuning. Ratio detector. Meter tuning indicator. Sensitivity: 3 μ V for 20 dB quieting. Aerial input: 300 ohms balanced. Stereo multi-

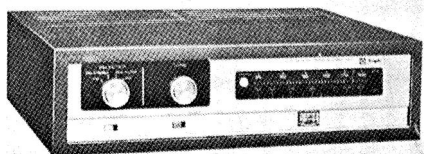

Knight Kit KG-765A



Knight Kit KG-980

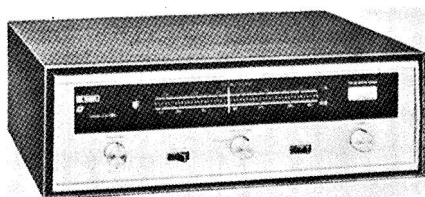

Knight Kit KG790

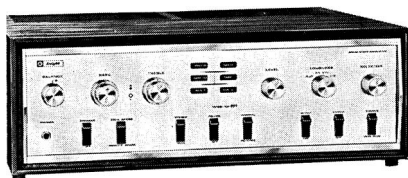

Knight Kit KG-895



Knight Kit KG-795 (top), KG865 (bottom)



Knight Kit KG-854



Knight Kit KG-964

plex decoder included. Switchable AFC. Automatic mono/stereo switching. Stereo indicator light. Two tuned RF stages. Mains: 230-250V 50 Hz. Size: 13 × 10 × 3 $\frac{3}{8}$ in. Price: £26 19s. 6d. (plus £1 12s. 8d. PT); teak case £4 14s. 5d. (plus 13s. 1d. PT).

★**KG980.** Stereo tuner amplifier. Range: 88-108 MHz. Variable tuning. Ratio detector. Meter tuning indicator. Sensitivity: 3 μ V for 30 dB quieting. Aerial impedance 300 ohms balanced. Multiplex decoder included. AFC.

Inputs: PU 2.5 mV, aux 250 mV. Controls: bass, treble, volume, balance, selector, mono/stereo, tape/source, on/off. Output: 34W. HD < 1% at full output. FR 20 Hz-20 KHz \pm 1 dB at full power. Noise level: -65 dB. Output impedance: 4-16 ohms. Automatic mono/stereo switching. Stereo indicator light. Channel separation 30 dB. Mains: 230-250V 50 Hz. Size: 16 × 13 $\frac{1}{2}$ × 4 in. Price: £61 6s. 10d. (plus £1 12s. 8d. PT); teak case £5 1s. 6d. (plus 14s. 10d. PT).

★**KG964.** AM/FM stereo tuner amplifier.

Ranges: VHF 88-108 MHz. 188-570 m. Variable tuning. Ratio detector. Meter tuning indicator. Sensitivity: 1.25 μ V for 20 dB quieting on FM. 3 μ V for 10 dB quieting on AM. Aerial input 300 ohms balanced. Multiplex decoder included. AFC. Inputs: tape 2.5 mV, PU 2.5 mV, aux 250 mV. Noise level: -60 dB. Controls: bass, treble, volume, balance, selector, plus eight switches. Transistors. Output 36W RMS. HD <1% at full power. FR 20 Hz-35 KHz \pm 1 dB at full power. Output impedance: 4, 8, 16 ohms. Mains: 220-240V 50 Hz. Automatic mono/stereo switching. Stereo indicator lamp. Size: 16 $\frac{3}{4}$ \times 15 \times 5 in. Price: £79 11s. 7d. (plus £3 7s. 11d. PT); teak case £7 8s. 11d. (plus £1 0s. 7d. PT).

★ **KG854.** Integrated stereo transistor amplifier. Inputs: tape 2.5 mV, PU 3 mV, radio 500 mV, aux(1) 250 mV, aux(2) 1V. Controls: bass, volume, balance, treble, selector, stereo reverse, loudness, bass and treble filters, mode switch. Output: 34W RMS. HD <1% at rated output. FR 20 Hz-25 KHz \pm 1 dB. Output impedance: 8, 16 ohms. Mains: 230-250V 50 Hz. Size: 13 \times 11 \times 2 $\frac{3}{4}$ in. Price: £42 9s. 0d.; teak case £4 16s. 3d. (plus 13s. 9d. PT).

KG865. Integrated stereo transistor amplifier. Inputs: PU 5 mV, radio 500 mV, aux 500 mV. Noise level -65 dB Controls: selector, balance, bass, volume, treble, mode, phones/speaker. Output: 34W RMS. HD <0.7% at rated output. FR 18 Hz-30 KHz \pm 1 dB. Output impedance: 4-16 ohms, plus stereo headphone socket. Size: 13 \times 10 \times 3 $\frac{3}{8}$ in. Mains: 230-250V 50 Hz. Price: £34 19s. 6d.; teak case £4 14s. 5d. (plus 10s. 10d. PT).

★ **KG895.** Integrated stereo transistor amplifier. Inputs: radio 250 mV, PU 2.5 mV, tape head 2 mV, tape monitor 500 mV, aux(1) 250 mV, aux(2) 250 mV. Output: 80W RMS into 8 ohms. HD <0.7% at rated output. FR 18 Hz-30 KHz. Output impedance: 8-16 ohms. Mains: 230-250V 50 Hz. Size: 16 $\frac{3}{4}$ \times 15 \times 5 in. Price: £76 1s. 11d.; teak case £7 8s. 11d. (plus £1 0s. 7d. PT).



M.A.C. ELECTRONIC CO., Ripley, Surrey. Tel: Dunsfold 310.

AAU-2, AAU-3 and AAU-4. Audio interconnecting adaptor unit kits at approx 20 per cent saving compared with commercially built models. All kits supplied with step-by-step instructions, panels ready punched and drilled,

fitted with appropriate sockets, ready cut wires, and all necessary plugs, leads, screws and nuts, etc. Prices: AAU-2 £3 2s. 6d.; AAU-3 £3 5s.; AAU4 £3 10s.

AAU-K. Audio adaptor unit kit enables dealers and enthusiasts to build their own particular switching circuits. Complete chassis includes sub-panel with 20 wiring pins, rear panel with 4 phono sockets, or with 5-pin DIN socket (AAU-KD). 3-way switch positions engraved on fascia. Price: £2 12s. 6d.



MARTIN ELECTRONICS LTD., 154-155 High Street, Brentford, Middx. Tel: 01-560 1161.

Audiokit 1/4. Transistorised mono control unit. Inputs: from 3 mV according to signal input requirements; RIAA correction on PU input. Output: 200 mV. Controls: sel. switch (tape head, mag pu, crystal pu, radio, aux, mic). Filters: bass cut and lift, treble cut and lift, low pass 20 KHz. FR 45 Hz-20 KHz. H and N -70 dB. Psn 9-15V DC. Easily adapted to stereo. To operate with Audiokit 5. Size: 8 \times 3 $\frac{1}{4}$ \times 1 $\frac{3}{4}$ in. Price: £7 2s. 6d.

Audiokit 1/4/S. Transistorised stereo control unit. Details as for 1/4. Size: 8 \times 3 $\frac{1}{4}$ \times 3 $\frac{3}{4}$ in. Price: £13.

Audiokit 5. Transistorised mono amplifier. 10W. HD 0.25%. Response 40 Hz-20 KHz. Feedback 60 dB. NL -85 dB. Input: 100 mV. LS matching 3 ohms. Psn 24V DC, 0.8 amps. To operate with Audiokits 1/2, 1/4, 2/3, 3/4. Size: 4 $\frac{1}{2}$ \times 4 \times 3 $\frac{1}{2}$ in. Price: £6 5s.

Audiokit 7. Similar to Audiokit 5 but for 15 ohms speaker. Operates from 40V. Price: £6 19s. 6d.

Audiokit 15, 16 and 17. FM/VHF tuner. Variable tuning 88-108 MHz. Ratio detector. Sensitivity 2 μ V for 20 dB quieting. Aerial input: 75 ohms balanced or coaxial. Output: 100 mV 100K. AFC. Power supply 9V battery. Consumption 12 mA. Size: 9 $\frac{1}{2}$ \times 3 $\frac{1}{2}$ \times 4 in. behind panel. Supplied as three units for home assembly into cabinet. Price: £13 17s. 4d. (plus £1 9s. 7d. PT).

Several new kits being finalised but details of specifications and prices not available at time of going to press.

A. R. SUGDEN & CO. (ENGINEERING) LTD., Market Street, Brighouse, Yorkshire. Tel: Brighouse 2142. Cables: Connoisseur, Yorkshire.

BD1 Turntable kit. Description and specification as for BD1 motor unit. (See Motor Unit section.) Easy one-hour assembly. No soldering. Price: £9 9s. (plus £2 4s. 5d. PT).



Peak Sound (Harrow) Ltd., 32 St. Judes Road, Engelfield Green, Egham, Surrey. Tel: Egham 5316.

Construction kits containing the following modules are available. Prices on application.

1-FET/3G. Tuner module. Range: 87.5-108.5 MHz. Variable tuning. Wide band ratio detector. Tuning indicator available. Sensitivity: $2 \mu\text{V}$ for 30 dB quieting when used with IFA/4S IF amplifier module. Aerial: 75 ohm coax. and 300 ohm balanced. Output for IFA/3S or IFA/4S modules. Multiplex decoder available. Switchable AFC. Psn 12V DC; power supply available. Dual gate FET 3-gang tuning capacitor. Made for Peak Sound by Dormer and Wadsworth. Size: $3 \times 2\frac{1}{2} \times 1\frac{1}{8}$ in. Price: £9 (plus £2 4s. PT).

2-FET/4G. Tuner module. Range: 87.5-108.5 MHz. Variable tuning. Wide band ratio detector. Tuning indicator available. Sensitivity: $2 \mu\text{V}$ for 30 dB quieting when used with IFA/4S IF amplifier module. Aerial: 75 ohm coax. and 300 ohm balanced. Output for IFA/3S or IFA/4S modules. Multiplex decoder available. Switchable AFC. Psn 12V DC; power supply available. Two dual gate FETs. Silver-clad chassis. Four-gang tuning capacitor. Made for Peak Sound by Dormer and Wadsworth. Size: $3 \times 2\frac{1}{2} \times 1\frac{1}{8}$ in. Price: £10 10s. (plus £2 11s. 4d. PT).

1-FA/3S. Amplifier module. Three tuned stages employing silicon transistors. AGC. Printed circuit module with edge connectors. For use with tuner modules above. 150 mV output. Size: $6\frac{1}{2} \times 2\frac{1}{4} \times \frac{3}{4}$ in. Price: £8 5s.

1-FA/4S. IF Amplifier module. Three tuned stages employing silicon transistors. AGC. Printed circuit module with edge connectors. For use with tuner modules above. 150 mV output. Size: $6\frac{1}{2} \times 2\frac{1}{4} \times \frac{3}{4}$ in. Price: £8 5s.

SCU 400. Preamplifier stereo module. Inputs: PU (mag) 2.5 mV. RIAA equalised, 68K; PU (ceramic) 5 mV. low impedance equalised, 68K;

Aux. 60 mV. 80K: for 60 dB (nominal) noise level depending on overall component layout. Output: 400 mV. Psn 20-28V DC. 5 mA. Controls: volume, balance, treble (± 12 dB at 10 KHz), bass (± 12 dB at 100 Hz), function selector, filter (9 KHz at 12 dB per octave), mono/stereo. Size: $7 \times 2 \times 1\frac{1}{4}$ in. Price: £15 15s.

PA/25-15. Power amplifier module. 25W into 15 ohms. HD below 0.1%. FR: 20 Hz-20 KHz -1 dB at 20W at less than 0.25% distortion. Noise level better than 80 dB down. Input for rated output. 500 mV. 2N5192 and 2N5195 transistors. Psn 68V DC. 1 amp. Size: $5\frac{1}{4} \times 3\frac{1}{2} \times 1$ in. Price: £11 15s.

PA/12-15. Power amplifier module. 12W into 15 ohms at 40V DC supply voltage. HD less than 0.1%. FR: -1 dB at 1W. 10 Hz-45 KHz. Feedback 43 dB. Input for rated output 400 mV. Output impedance 8 to 15 ohms. Psn 12 to 50V DC. Size: $5 \times 3\frac{3}{4} \times 1\frac{1}{2}$ in. Price: £5 19s. 6d.

ES/10-15. Enclosure kit (Baxandall). All machining completed ready for assembly. Filling material, pure silk grille cloth, screws, etc. Afrosmosia finish. FR flat from 100 Hz to 10 KHz. 10W. Size: $18 \times 9\frac{1}{2} \times 12$ in. Price: £6 3s. 6d. (plus 12s. 8d. PT).

ES/10-15. Speaker unit and equaliser. Baxandall designed full range equalised Hi-Fi speaker for ES/10-15 enclosure kit above. Paper cone, plasticised surround. 1 in. copper voice coil. 10W. FR: 60 Hz to 16 KHz. Recommended crossover, 100 Hz. Size: 9×5 in. (nominal). Price: £3 18s. 9d. (plus 10s. 1d. PT).



PEERLESS. Distributor: P. F. & A. R. Helme, Summerbridge, Harrogate, Yorks. Tel: Darley 279.

Peerless Fabrikkerne A/S of Denmark speaker kits are of 8 ohms impedance. A range of crossover networks is available ready wired and assembled on printed circuit boards. All kits are complete with crossover network or components. Infinite baffle cabinet kits comprise fully finished and polished outer shell, veneered in natural teak, set of coloured terminals, connecting wire, uncut front baffle boards, black Vynair fabric, nuts, bolts, BAF wadding, etc.

2-10 kit has a 5 in. bass and 2 in. HF units. HC: 10W. FR: 50 Hz-18 KHz. Crossover: 5 KHz.

2-8 kit has $6\frac{1}{2}$ in. bass and $2\frac{1}{2}$ in. HF units. HC: 8W. FR: 50 Hz-18 KHz. Crossover: 4 KHz.

3.15 kit has 8 in. bass, 5 in. mid-range and 2 in. tweeter. HC: 15W. FR: 45 Hz-18 KHz. Crossover: 750 Hz and 4 KHz.

3-25 kit has 12 in. bass, 5 in. mid-range and 2 in. tweeter. HC: 25W. FR: 40 Hz-18 KHz. Crossover: 750 Hz and 4 KHz.

20-2 has 8 in. bass and $2\frac{1}{4}$ in. HF units. HC: 30W. FR: 40-20 KHz. Cross-over: 2.5 KHz.

4-30 12 kit has 12 in. bass, 7×5 in. mid-range and two $2\frac{1}{2}$ in. tweeters. HC: 40W. FR: 30 Hz-18 KHz. Crossover: 500 Hz and 3.5 KHz.

Mini cabinet measures $12 \times 8 \times 7$ in. with internal volume of 7 litres. Price: £6 2s. 6d.

Mistral cabinet measures $14 \times 9 \times 7\frac{1}{2}$ in. with internal volume of 10 litres. Price: £6 17s. 6d.

Bookshelf cabinet measures $18 \times 10 \times 9$ in. with internal volume of 16 litres. Price: £8 5s.

Large bookshelf cabinet measures $20 \times 11 \times 9$ in. with internal volume of 20 litres. Price: £10 5s.

Super bookshelf cabinet measures $21 \times 11 \times 10$ in. with internal volume of 25 litres. Price: £11 17s. 6d.

Slimline cabinet measures $29 \times 21 \times 9$ in. with internal volume of 62 litres. Price: £18.

Major cabinet measures $31 \times 21\frac{1}{2} \times 12$ in. with internal volume of 100 litres. Price: £20 15s.



PIONEER. Distributors: Shriro (UK) Ltd., 8 Bush Lane, Cannon Street, London, E.C.4. Tel: 01-626 4711/3.

AS-303A. Kit of speakers and crossover networks for assembling bookshelf speaker system. Cabinet materials not included. Kit comprises: 12 in. bass unit, 5 in. mid-range unit, horn tweeter, crossover network, level control, sound absorbing material, terminal strip, wire and instructions. Specification when built: FR 40 Hz-20 KHz, impedance 16 ohms, crossover 800 Hz and 6 KHz. HC 20W RMS. Size: $26 \times 15\frac{3}{8} \times 11\frac{3}{4}$ in. Price: £26 4s. 5d.

AS-305A. Kit of speakers and crossover networks for assembling hi-fi speaker assembly. Cabinet materials not included. Kit comprises: 12 in. bass unit, 5 in. mid-range unit, two cone tweeters, one horn tweeter, crossover network with level control, connecting cables, acoustic padding, mounting hardware and instructions. Specifications when built: FR 30 Hz-20 KHz, crossover 500 Hz and 3.5 KHz, impedance 8 ohms. HC 50W. Size: $26 \times 15\frac{3}{8} \times 11\frac{3}{4}$ in. Price: £37 3s. 1d.



SME LTD., Steyning, Sussex, BN4 3LN. Tel: Steyning 2228.

Model 2000 plinth system parts available separately, as follows:

Components. Base: teak or walnut, £12 7s. (plus £3 0s. 5d. PT); rosewood, £13 9s. 6d. (plus £3 5s. 10d. PT). Motor board: teak or walnut, £3 12s. (plus 17s. 7d. PT); rosewood, £3 19s. 6d. (plus 19s. 5d. PT). Acrylic lid, £6 15s. (plus £1 13s. PT). Spring mounts (set of four), £3 3s. 6d. (plus 15s. 6d. PT). Hinge, left or right hand, £2 6s. 3d.

Accessories. P.I. spacer to adjust height difference when arm is used with a deep turntable, 15s. (plus 3s. 8d. PT). Pickup mounting boards: TD124/3009 for model 3009 on Thorens TD124, £2 17s. 6d. (plus 14s. PT); TD124/3012 for model 3012 on Thorens TD124, £3 10s. (plus 17s. 1d. PT); TD125/3009 for model 3009 on Thorens TD125, £2 17s. 6d. (plus 14s. PT); TD125/3012 for model 3012 on Thorens TD125, £3 10s. (plus 17s. 1d. PT); TD150/3009 for model 3009 on Thorens TD150, £2 17s. 6d. (plus 14s. PT); TD150/3012 for model 3012 on Thorens TD150, £3 10s. (plus 17s. 1d. PT). Mounting brackets: PS2000/TD125 for fitting Thorens TD125 to motor board, £1 2s. 6d. (plus 5s. 6d. PT).



VERO ELECTRONICS LIMITED, Industrial Estate, Chandler's Ford, Hants. Tel: Chandlers Ford 2921. Cables: Vero Chandlersford. Telex: 47551.

VEROBOARD (*Registered Trademark*). Internationally used universal wiring board.

AMK 1. Introductory kit containing: 1 Spot face cutter, 2 Veroboards $2\frac{1}{2}$ in. wide by $3\frac{3}{4}$ in. long and 2 Veroboards $2\frac{1}{2}$ in. wide by 5 in. long. Price: £1 1s. 6d.

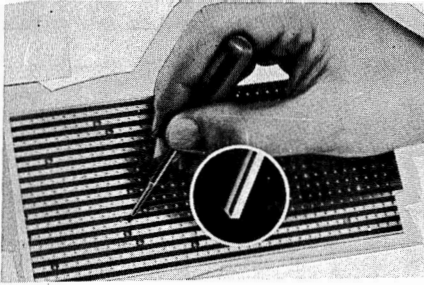

Veroboard and Vero spot face cutter

AMK 2. Pack of 5 Veroboards, $2\frac{1}{2} \times 3\frac{3}{4}$ in.
Price: 16s. 3d.

AMK 3. Pack of 5 Veroboards, $2\frac{1}{2} \times 5$ in.
Price: 19s. 8d.

Please add 2s. 6d. for postage and packing to each order.

WELBROOK ENGINEERING & ELECTRONICS LTD., Brooks Street, Stockport, Cheshire. Tel: 061-480 4268.

Ferranti equipment. Devices and printed circuit boards for all Ferranti amplifier and tape amplifier designs. Full details on request.



WHARFEDALE. Rank Wharfedale Ltd., Bradford Road, Idle, Bradford, Yorks. Tel: Bradford 612552.

Unit 3 kit. Do-it-yourself hi-fi two-speaker kit comprising 3 in. tweeter and 8 in. bass unit. Suitable for output impedance 4-8 ohms. HC 15W RMS. Crossover supplied operates at 1,750 Hz. The tweeter has Acoustiprene dome diaphragm. Acoustic wadding, mounting bolts and connecting wire, etc., are included. Price: £8 14s. 9d. (plus £2 2s. 9d. PT).



Now
hear this

Sonotone pick up cartridges

Sonotone is one of the largest manufacturers
of pick up cartridges in the World today.

Our cartridges are probably fitted by more equipment
manufacturers than any other produced in Europe.

Our 40 years experience and our direct
association with advanced research and development
in the broad field of electronics
guarantees our continued leadership.

Sansui
*Stereo tuner amplifiers,
amplifiers, tuners,
speakers, turntables,
and stereo headphones*

Sansui
*the most spectacular
sound on record*

Two famous products now marketed by the Audio Division of

BRUSH CLEVITE COMPANY LIMITED
Thornhill, Southampton SO9 1QX. Tel: Southampton 45166

CROWN INTERNATIONAL

"STATE OF THE ART" 800 SERIES RECORDERS

Advanced DESIGN

- New modular transport
- Magnetic braking (patented)
- True straight line threading
- Lifetime engraved panel
- Precision micro-gap heads
- All silicon solid state
- Complete editing accessibility

Functional FLEXIBILITY

- Push button electrical control
- Automatic stop tape sensor
- Four, microphone or line, inputs
- Two stereo headphone outputs
- Bias metering and adjustment
- 3rd head monitor with A-B switch
- Sound with Sound recording

Exacting PERFORMANCE

- Hysteresis synchronous drive motor
- Precision machined for low wow
- Preamp response is uniform
 ± 1 db. 10 to 100,000 Hz
- Preamp distortion under 0.2%
- Preamp noise below -115 dbm
- One year Warranty



The new PRO
with COMPUTER
LOGIC CONTROL

Details from Sole Agents:—

CARSTON ELECTRONICS LIMITED

71 Oakley Road, Chinnor, Oxon.
Tel.: Kingston Blount (08445) 8561

IMPORTANT MICROPHONES FROM AKG

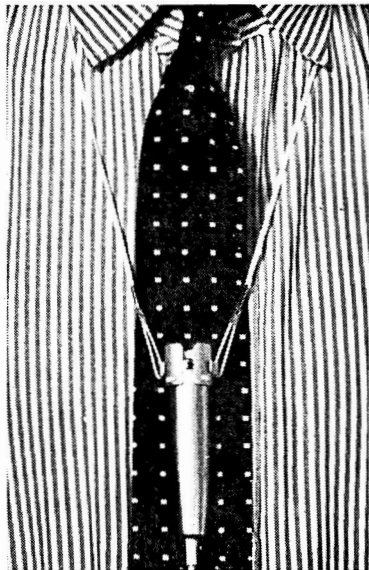
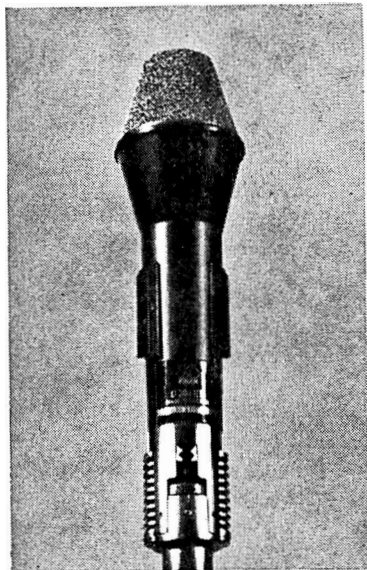

AKG D-202

New. Dynamic. Two-way cardioid design — separate high- and low-frequency systems in a single housing for powerful, directional performance, level frequency response. Front to back ratio 20db at all frequencies ensuring minimum feedback. On-off switch. Good appearance. For stage work, recording, film & TV.

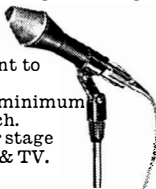

AKG D-109

New. Dynamic. Lavalier. Available with 60 or 200 Ohm impedance. With 3 metres cable. The smallest Lavalier microphone on the market, plus high-quality reproduction that compares well with others costing several times more. Use it wherever a mike is to be heard but not seen—mainly for TV, also for films, conferences, etc.

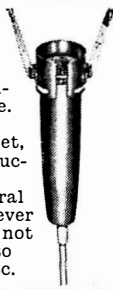

Find out more about mikes from AKG.
See your supplier, or ask us.



AKG microphones

Politechna (London) Ltd. 182-184 Campden Hill Road, London W8
Telephone: Park 0711. Telex: 23894

NEUMANN



fet condenser microphones



The U87i :-

- *switchable* ○ ∞ ∞
- *10db attenuator*
- *rumble filter*
- *200 Ω or 50 Ω impedance*
- *internal or external powering*
- *mains, battery or phantom powering*
- *3-pin XLR connector*

*send for free illustrated catalogue
to Sole U.K. Agents:-*

F.W.O. BAUCH LIMITED
Holbrook House, Cockfosters, Herts.
tel. 01-440 3277 (Pbx)

DIRECTORY OF MICROPHONES

Abbreviations: **FR**=frequency response; sensitivity is quoted in - dB (dB down) relative to 1V/dyne/cm².

ACOS. Cosmocord Ltd., Eleanor Cross Road Waltham Cross, Herts. Tel: Waltham Cross 27331.

Mic 70/1. Omni-directional moving coil. FR: 80 Hz-12 KHz (10 dB down at 50 Hz and 15 KHz) Impedance: 200 ohms. Rec load: 200 ohms-10K. Sensitivity: -80 dB re 1V/ μ b Price: £7 10s.

Mic 70/4. Omni-directional moving coil. FR: as for Mic 70/1. Impedance: 50K nominal. Sensitivity: -57 dB re 1V/ μ b. Price: £8 8s.



AKG (Akustische und Kino-gerate GmbH). Distributors: Politechna (London) Ltd., 182-184 Camden Hill Road, Kensington, London, W.8. Tel: 01-727 0711/3 and 5008.

★**C12A.** Professional condenser microphone. Variable polar diagram covering cardioid, omni, figure-of-eight and six intermediate positions. FR 10 Hz-20 KHz. Sensitivity -68 dB. Impedance 50 and 200 ohms. Rec load >150 and 500 ohms. Fitting: $\frac{3}{8}$ in. Whit, $\frac{1}{2}$ in. 26 tpi, $\frac{5}{8}$ in. 27 tpi. Metal case finished matt silver. Price: £140.

★**C24.** Stereo condenser. Sensitivity 1 mV/bar. Imp 200 or 500 ohms. Response 30 Hz-20 KHz. Omni-directional cardioid; bi-directional, hyper-cardioid. Plus 5 intermediate patterns. Sensitivity approx 1 mV per microbar (at 200 ohms output terminals) -33 dB re 1 milliwatt at a sound pressure of 10 dynes/cms. Crosstalk between channels <40 dB throughout entire range. Imp <200 ohms when delivered. 50 ohms by changing solder connections. N.24 power supply unit. Remote control unit. Twin remote control cable. Price: £270.

★**C61.** Cardioid or omni condenser microphone. FR 20 Hz-18 KHz ± 2.5 dB. Sensitivity -64 dB. Impedance 50 and 200 ohms. Rec load ≥ 150 and 500 ohms. Stand fitting: $\frac{3}{8}$ in. Whit, $\frac{1}{2}$ in. 26 tpi, $\frac{5}{8}$ in. 27 tpi. Supplied with stabilised power supply, 22 yds microphone cable, 2 yds power cable. Metal case finished matt silver. £87 10s.

★**D11D-HL.** Moving coil cardioid microphone. Incorporates adaptor to change polar response from cardioid to super- and hyper-cardioid. FR 80 Hz-15 KHz. Front-to-back ratio: 16 dB. Impedance: 500 ohms or 50K. Sensitivity: 72.5 dB at 500 ohms, 54 dB at 50K. Price: £9.

D12. Moving coil with cardioid directional pattern. Response 40 Hz-12 KHz ± 4 dB. Front to back ratio 15 dB. Sensitivity -77 dB. Imp 60 ohms, or to order. Price £30.

★**D14.** Dynamic cardioid microphone. Imp 60-40,000 ohms. Response 50 Hz-15 KHz. On/off switch. Swivel joint fits all stand threads. Supplied with $5\frac{1}{2}$ yds two-core screened lead. Weight: 8 oz. Price: £10 15s.

D19C. Moving coil with cardioid directional pattern and bass cut switch. Response: 40 Hz-16 KHz. Impedance: 60 or 200 ohms. Price: £18.

★**D19E.** Moving coil with cardioid directional pattern. Response 40 Hz-16 KHz. Built-in transformer provides 3 different impedances: 50, 200 ohms, 50K. Price: £22 10s.

★**D58.** Moving coil, close-talk microphone. Response 50 Hz-12 KHz. Sensitivity 0.1 mV/bar. Imp 60 or 200 ohms. Price: £11 15s.

★**D66.** Stereo moving coil. Cardioid diagram. FR 50 Hz-15 KHz ± 4 dB. Sensitivity -73 dB. Impedance 200 ohms. Rec load ≥ 400 ohms. Stand fitting $\frac{3}{8}$ in. Whit. Supplied with two desk stands. Microphones can be detached and used separately. Moulded cases. Price (complete with stands): £13.

★**D109.** Omni-directional moving coil. FR 50 Hz-15 KHz ± 3.5 dB. Sensitivity -98 dB. Impedance: 60 and 200 ohms. Rec load ≥ 400 ohms. Hand and lavalier type. Supplied with lavalier cord. Higher frequencies boosted when lavalier attached. Metal case nickel plated. Price: £12.

★**D119ES.** Up-rated version of D19C but with built-in transformer for 60-200 ohms and high impedance. Sand blast finish. Price: £26.



AKG D12 moving coil



AKG D501 cardioid moving coil



AKG D14 cardioid

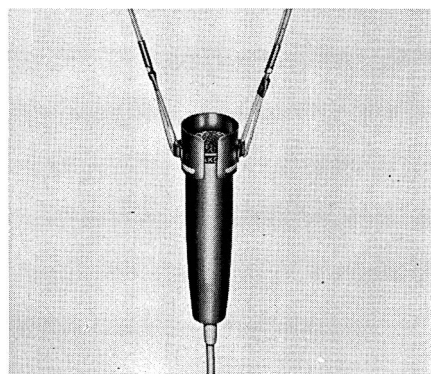

AKG D109



AKG D202CS

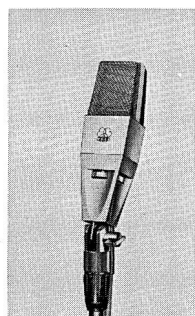

AKG C12A

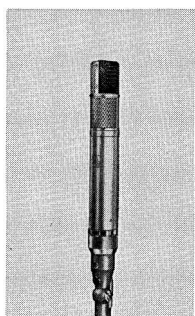

AKG C24

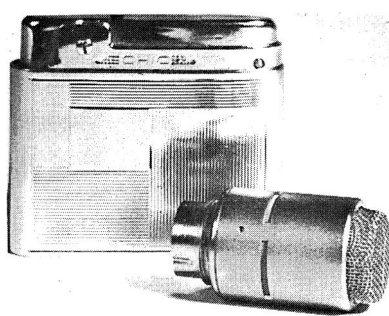

AKG D58 moving coil

MICROPHONES



AKG D119ES



AKG D19E

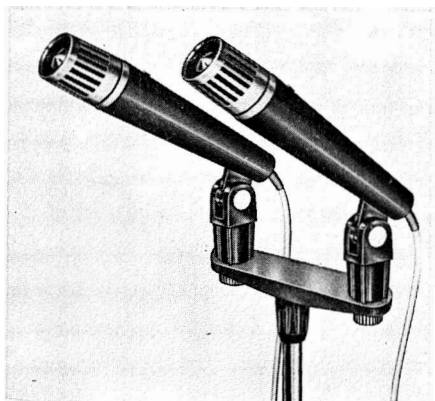

AKG D11D

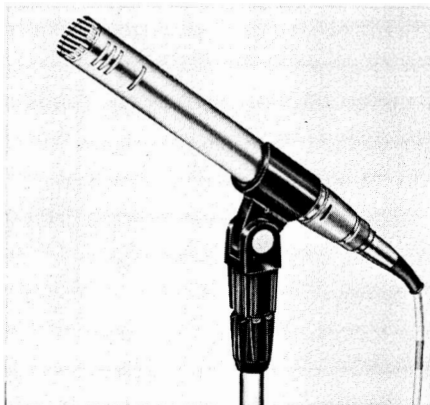

AKG D224CS



AKG C61 condenser

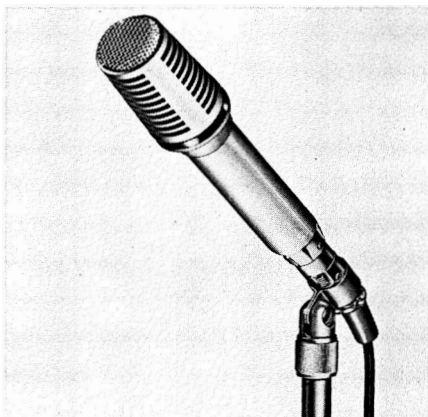

AKG D200E



AKG D707

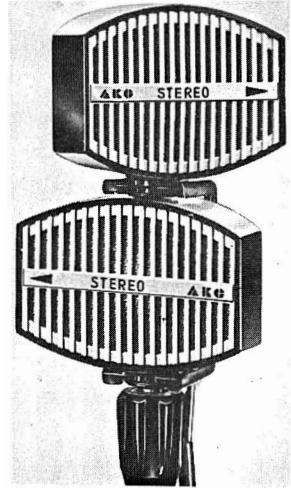

AKG D66 stereo moving coil

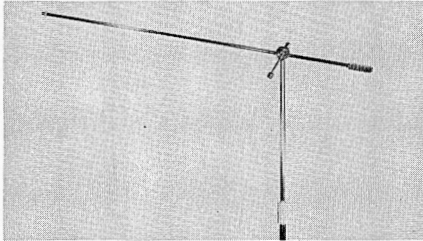

Audio and Design BA/S boom arm

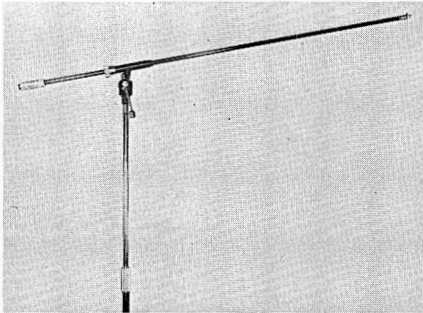

Audio and Design BA/A on MS/M stand



AKG D202 moving coil



AKG D503 moving coil cardioid



AKG D1000C

D190. Mono moving coil. Sensitivity: -73 dB re $1\text{V}/\mu\text{b}$. Cardioid response. FR: 30 Hz-16 KHz ± 3 dB. Impedance: 200 ohms. Rec. load: 500 ohms or more. Fitting: $\frac{3}{8}$ in. Whit.; $\frac{1}{2}$ in. 26 tpi; $\frac{5}{8}$ in. 27 tpi. Finish: metal satin silver. Price: £16 10s. (DIN connector); £18 5s. (Cannon).

D200C. Two-system cardioid microphone. Incorporates two moving coils, one covering the low and the other the high frequencies. FR 40 Hz-16 KHz. Sensitivity 0.16 mV/microbar. Imp 200 ohms. Price: £24 10s.

★**D.202E1.** Similar specification to D.202ES except it is supplied without on/off switch and has three-position bass attenuation step switch (0, -7 dB and -20 dB) instead of potentiometer. Individually calibrated frequency response curve supplied with each microphone. Price: £37.

★**D202ES.** Moving coil microphone with marked cardioid response (-20 dB minimum). FR 30 Hz-15 KHz ± 2 dB. Sensitivity -53 dB. Impedance 200 ohms. Rec load ≥ 400 ohms. Stand fitting swivel adaptor, $\frac{3}{8}$ in. Whit. $\frac{1}{2}$ in. 26 tpi. $\frac{5}{8}$ in. 27 tpi. On-off switch and variable bass control providing 0 to -20 dB at 50 Hz. Strong black metal case with sintered bronze grille. Price: £32.

★**D224.** Mono moving coil. Sensitivity: -78 dB re $1\text{V}/\mu\text{b}$. Cardioid response. FR: 20 Hz-20 KHz ± 2 dB. Impedance: 200 ohms. Rec. Load: 500 ohms or more. Fitting: $\frac{3}{8}$ in. Whit.; $\frac{1}{2}$ in. 26 tpi; $\frac{5}{8}$ in. 27 tpi. Features bass cut switch. Finish: metal satin silver. Price: £55 10s. (DIN connector); £57 (Cannon).

★**D501.** Moving coil cardioid and omnidirectional model. FR 50 Hz-15 KHz ± 3.5 dB. Sensitivity -73 dB. Impedance 60 or 200 ohms. Rec load. ≥ 400 ohms. Hand or stand type. Fitting: $\frac{3}{8}$ in. Whit. $\frac{1}{2}$ in. 26 tpi, $\frac{5}{8}$ in. 27 tpi. Omni/cardioid switch. Remote control switch. Built-in windshield. Quick release adaptor. Leatherette carrying bag. Moulded case with metal grille. Price: £13 10s.

★**D503.** Moving coil cardioid stand microphone. FR 50 Hz-15 KHz ± 3.5 dB. Sensitivity -73 dB. Impedance: 200 ohms or 60 ohms. Rec load ≥ 400 ohms. Fitting: $\frac{3}{8}$ in. Whit. $\frac{1}{2}$ in. 26 tpi, $\frac{5}{8}$ in. 27 tpi. Supplied with attached flexible shaft. Moulded case with metal grille. Price: £16 10s.

D505. Moving coil omni-directional hand microphone. FR 50 Hz-15 KHz ± 3.5 dB. Sensitivity -74 dB. Impedance: 200 ohms. Rec

load ≥ 300 ohms. Fitting: $\frac{3}{8}$ in. Whit. $\frac{1}{2}$ in. 26 tpi, $\frac{5}{8}$ in. 27 tpi. Remote control switch. Anti-noise. Quick release adaptor. Moulded case with metal grille. Price: £14 15s.

D507. Moving coil omni-directional stand microphone. FR 50 Hz-15 KHz ± 3.5 dB. Sensitivity -74 dB. Impedance: 200 ohms. Rec load ≥ 300 ohms. Fitting as for D505. Anti-noise. Supplied with attached flexible shaft. Moulded case with metal grille. Price: £16 10s.

★**D707.** Mono moving coil. Sensitivity: -74 dB re $1\text{V}/\mu\text{b}$. Cardioid response. FR: 80 Hz-16 KHz ± 3.5 dB. Impedance: 200 ohms. Rec. load: 400 ohms or more. Fitting: $\frac{3}{8}$ in. Whit.; $\frac{1}{2}$ in. 26 tpi; $\frac{5}{8}$ in. 27 tpi. Finish: metal satin silver. Price: £13 (DIN connector); £15 10s. (Cannon).

★**D.1000.** Moving coil cardioid microphone with three-position switch giving three different sounds. Developed especially for electronic musicians where feedback is important. Impedance 60 or 200 ohms. FR: position 1, 40 Hz-16 KHz; position 2, 70 Hz-16 KHz; position 3, 100 Hz-16 KHz. Front-to-back ratio: 20 dB. Sensitivity: -78 dB at 60 ohms. -72 dB at 200 ohms. Various finishes offered including studio grey and 24 carat gold. For high impedance inputs a lead with line transformer is available. Sensitivity at high impedance: -50 dB. Price: from £29 according to requirements.

CMS. Condenser microphone with battery/mains power unit. Choice of cardioid, omni, and 3-position directional responses. FET pre-amplifier. Sensitivity: -59 dB re $1\text{V}/\mu\text{b}$. Impedance: 200 or 50 ohms. Rec. load: 500 or 200 ohms. FR: 20 Hz-20 KHz. Fitting: $\frac{3}{8}$ in. Whit.; $\frac{1}{2}$ in. 26 tpi. $\frac{5}{8}$ in. 27 tpi. Finish: metal case with satin silver finish. Price: £45 10s. (Less power unit or cables).

ST200. Microphone floor stand. Telescopic. Height: 42 to 77 in. Three collapsible feet with main support locking device. Anti-vibration characteristics. Microphone may be clamped to face any direction. Price: £18 10s.

K58 Microphone headset. Incorporates microphone D58 and headset K50 (see Headphone Section). Price: £14 10s.



AUDIO AND DESIGN. Keith Monks (Audio) Ltd., 54 Rounton Road, Church Crookham, nr. Aldershot, Hants. Tel: Fleet 3566.

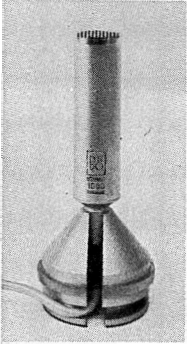

Bang and Olufsen
Beomic 1000

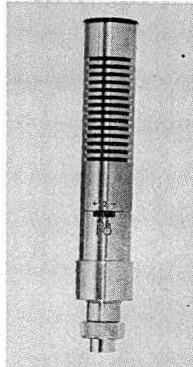

Bang and Olufsen BM6

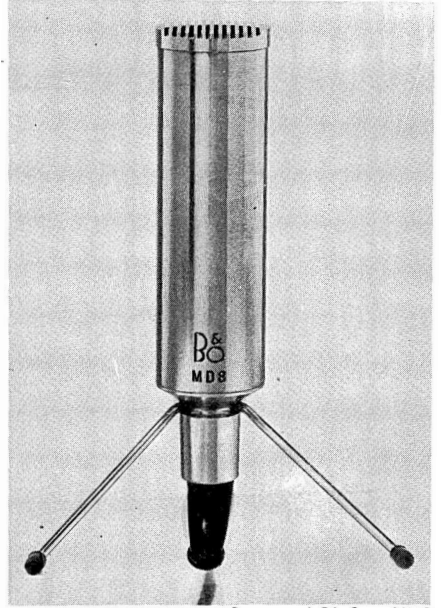

Bang and Olufsen MD8



Boyer cardioid moving coil

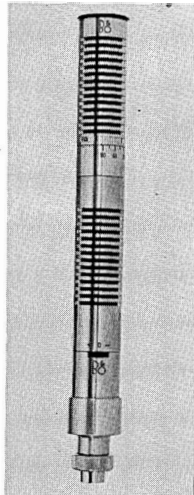

Bang and Olufsen BM5

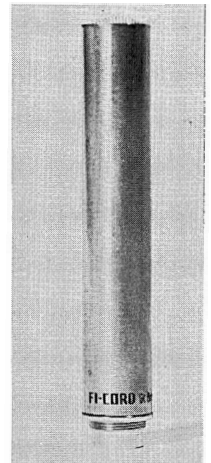

Fi-Cord 900

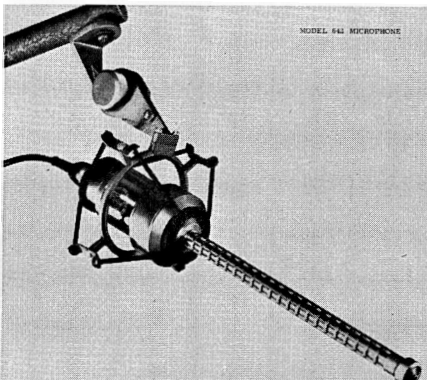

Electro-Voice 642

★ **Microphone Stands.** High quality chrome finish, detachable legs, rubber feet, nylon bushes. MS/S. 36 to 60 in. Price: £6 15s. MS/B. 44 to 67 in. Price: £7 16s. 8d. MS/M. 36 to 69 in. Price: £8 15s. MS/P. 44 to 67 in. Price: £10 15s. MS/L. 40 to 72 in. Price: £11 5s.

★ **Boom Arms.** For use with stands above. Thread adaptors available for use with other stands. BA/S. 38 in. Price: £4 7s. 6d. BA/A. 42 in. Price: £5 15s. BA/L. 64 in. Price: £8 5s. Thread adaptors. 5s.

★

BANG & OLUFSEN U.K. DIVISION, Eastbrook Road. Gloucester. Tel: Gloucester 21591.

★ **MD8.** Moving-coil omni-directional. FR: 50 Hz-17 KHz ± 5 dB. Sensitivity: 80 dB below 1V/microbar. Imp 200 ohms at 1 KHz. Supplied with desk stand and lavalier cord. Can be used as hand microphone. Price: £8 19s.

★ **BM6.** Pressure gradient ribbon microphone. Figure-of-eight. Three-position switch for speech, music and off. Impedance 180 ohms. FR: 30 Hz-13 KHz ± 2 dB. Size: 7 in. high, 1 in. diameter. Price: £21 2s. in presentation case with desk stand and lead.

BM7. Adding the BM7 microphone converts the BM6 to a BM5 mono/stereo microphone. Records in both MS and A-B method. Size: 10½ in. high, 1 in. diameter. Price: £9 19s. 6d.

★ **BM5.** Stereo microphone comprising BM6 and BM7. FR 30 Hz-13 KHz ± 2 dB. Imp 180 ohms per channel. Price: £30 9s. in presentation case with desk stand and lead.

★ **Beomic 1000.** Moving coil omni-directional. FR: 50 Hz-17 KHz (+2 dB - 5 dB). Sensitivity 80 dB below 1V/microbar. Imp 200 ohms. Hand type with removable table stand. Taper fitting for B & O floor stand and boom arm. Supplied with transparent or black container and anti-microphone table stand. Satin chrome. Price: £9 9s.

Table Stand. Tripod stand to fit B and O microphones. Price: £1 7s. 6d.

Floor Stand. Stable floor stand for B and O microphones. Black and chrome. Price: £7 15s.

Boom Arm. Adjustable boom arm to match floor stand above. Price: £4 19s. 6d.

BOUYER. Distributors: Douglas A. Lyons and Associates Ltd., 8 Ryecotes Mead, Dulwich, London. S.E.21. Tel: 01-693 2855.

★ **709.** Moving coil microphone with marked cardioid response. Rear to front attenuation 20 dB. FR 150 Hz-14 KHz ± 3 dB. Sensitivity - 63 dB reference 1V/dyne/cm². Impedance 20 ohms. Rec load 20-150 ohms. Robust construction. Stand fitting with flexible stem. Hand grip available. Price: (cardioid head) £12 10s. Fittings extra as required.

710. Similar to 709 but with extended bass response and super cardioid response pattern. Suitable for close-talking applications. Impedance 200 ohms. Price: (cardioid head) £25 10s. Fittings extra as required.

★

ELECTRO-VOICE. Electro-Voice Inc., Buchanan. Mich. U.S.A. Sole U.K. agents: KEF Electronics Ltd., Tovil, Maidstone, Kent. Tel: 0622 57258. Cables: KEF, Maidstone.

★ **642.** Moving coil. Cardiline uni-directional. FR: 30 Hz-10 KHz. Sensitivity -48 dB. Imp 50, 150, 250 ohms. Transformer fitted. Cardioid up to 500 Hz, sharply directional above. Price on application.

635A. Moving coil. Omni-directional. FR: 80 Hz-13 KHz. Sensitivity -55 dB. Imp 150 ohms or high Z. Transformer fitted. Price on application.

649B. Lavalier moving coil microphone. Omni-directional. FR: 100 Hz-9 KHz ± 3 dB. Sensitivity -61 dB. Imp 20-250 ohms. Transformer fitted. Weight only 1½ oz (less cable). Price on application.

668. Moving coil. Cardioid. FR: 40 Hz-10 KHz. Sensitivity -51 dB. Imp 50, 150, 250 ohms. Transformer fitted. Integral equaliser. Windshield and shockmount included. Designed specially for boom operation. Price on application.

643. Moving coil. Super cardioid. FR: 30 Hz-10 KHz. Sensitivity -48 dB. Imp 50, 150, 250 ohms. Transformer fitted. Super directional with in-built 100 Hz high-pass filter. Long range pick up. Windshield and shockmount included. Price on application.

RE15. Cardioid microphone. FR: 80 Hz-15 KHz. Acceptance angle: 150 deg. Impedance:

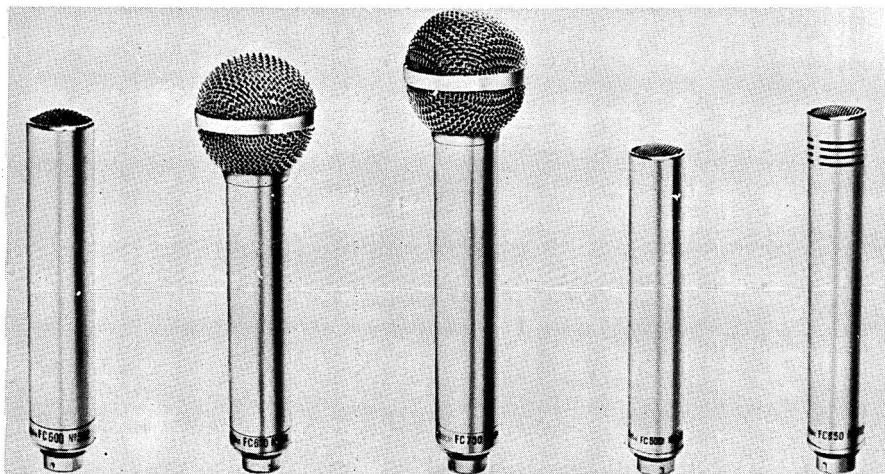

Fi-Cord condenser mics

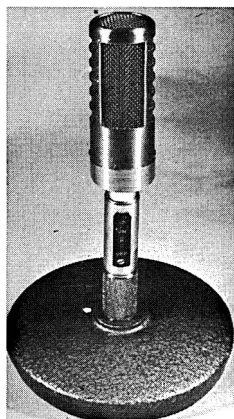

Film Industries M8S ribbon on S.6 desk stand



Film Industries M8 ribbon on S.6 desk stand

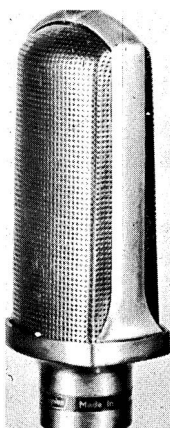

Grampian GR2 ribbon

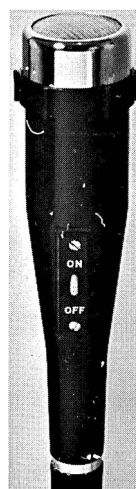

Grampian DP8

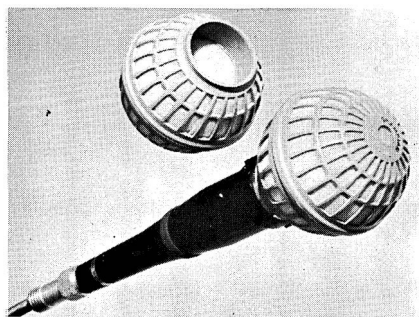

Grampian DP4 and windshield

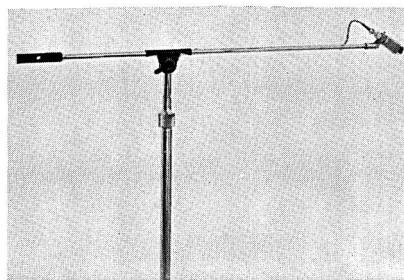

Grampian boom arm

150 ohms. Output level: -56 dB. Finish: mat satin nickel. Integral bass compensation switch. claimed to be most uniform polar pattern at all frequencies ever offered in a cardioid microphone. Price on application.

644. Unidirectional line microphone. FR: 40 Hz-10 KHz. Output: -53 dB. Acceptance angle: 90 deg. Combination cardioid and distributed front opening instrument. Impedance change without tools by moving a single pin. Price on application.

654A. Dynamic omnidirectional microphone. FR: uniform from 50 Hz-15 KHz. Sensitivity: -151 dB. Output level: -57 dB. Impedance: 50-250 ohms, line balanced to ground and phased. Finish: non-reflecting grey. Dimensions: $6\frac{15}{16} \times 1\frac{1}{8}$ in. dia. Weight (less cable) 7 oz. Price on application.

676. Dynamic cardioid microphone. FR: uniform 60 Hz-15 KHz. Impedance: 150 ohms and high impedance, selectable. Output level: -57 dB for 150 ohms. Sensitivity: -151 dB. Finish: pressure-cast zinc alloy satin chrome. Dimensions: $7\frac{3}{8} \times 1\frac{1}{4}$ in. dia. Weight (less cable): 12 oz. Price on application.

★

FI-CORD INTERNATIONAL, Charlwoods Road, East Grinstead, Sussex. Tel: 0342 21351. Telex: 95120.

★**FC600.** Omni-directional condenser microphone. FR: 40 Hz-16 KHz ± 3 dB. Sensitivity -56.5 dB. Imp. 200 ohms maximum. Rec load imp 1K ohm minimum. Stick type, hand or stand. Adaptors for all threads. Bright nickel case. Price: £20 2s. 2d.

★**FC650.** Condenser microphone with similar specification to FC600 but with cardioid response. Price: £26 16s.

FC652. Similar to FC650 with cardioid capsule. Price: £31 1s. 6d.

FC653. Similar to FC652 with hyper-cardioid capsule. Price: £34 6s.

FC700. Omni-directional condenser microphone. FR: 40 Hz-16 KHz ± 3 dB. Sensitivity -56.5 dB. Imp 200 ohms maximum. Rec load imp 1K ohm minimum. Stick type, hand or stand. Adaptors for all threads. Bright nickel case. Price: £30.

★**FC750.** Condenser microphone with similar

specification to FC700 but with cardioid response. Price: £30 15s.

★**FC800.** Omni-directional condenser microphone. FR: 30 Hz-18 KHz ± 2 dB. Sensitivity -74 dB. Source impedance 50 ohms. Rec load imp 200 ohms. Stick type, hand or stand. Adaptors for threads. Windshield available. Bright nickel case. Price: £38 12s.

FC850. Condenser microphone with similar specification to FC800 but with cardioid response. Price: £42 18s.

★**FC900.** Omni-directional condenser microphone. FR 30 Hz-18 KHz ± 2 dB. Sensitivity -62 dB. Imp 50 ohms. Rec load imp 200 ohms. Stick type, hand or stand. Adaptors for all threads. Windshield available. Bright nickel case. Price: £51 10s.

FC950. Condenser microphone with similar specification to FC900 but with cardioid response. Price: £55 15s.

FC1200. Condenser microphone with changeable cap sules giving omni-directional or cardioid response. FR 30 Hz-18 KHz ± 2 dB. Sensitivity -56.5 dB. Imp 60/6 ohms. Rec load imp 300/30 ohms. Stick type, hand or stand. Windshield. Price: £40 15s.

FC1200A. Cardioid condenser microphone. FR 40 Hz-16 KHz ± 3 dB. Sensitivity -56.5 dB. Imp 60/6 ohms. Rec load imp 300 or 30 ohms. Stick type, hand or stand. Windshield. Price: £36 10s.

★

FILM INDUSTRIES LTD., Station Avenue, Kew Gardens, Surrey. Tel: 01-940 8078.

★**M8.** Ribbon. FR: 50 Hz-13 KHz. Figure-of-eight polard diagram. Available matched to all impedances up to 57K. Plug and socket joint between microphone head and flexible. Fitted with 12 ft screened cable, other lengths to order. Table, desk and floor stands available. Price (all impedances): £10 19s. (with on/off switch): £13 1s.

M8A. Ribbon. Similar unit to M8 but without plug and socket connection between head and flexible. Small detachable desk stand provided. Other stands available. Available in all impedances up to 57K. Price: £10 10s. (with on/off switch): £12 2s. 6d.

★**M8S.** Ribbon. Similar unit to M8 but with

angled base in place of flexible. Small detachable desk stand provided. Other stands are available. Available in all impedances up to 57K. Price: £10 5s. (with on/off switch); £11 17s. 6d.

Microphone stands. Desk, table and floor stands. Grey hammer finish with cast iron bases. Stems in satin chrome. Prices from £1 5s.

Matching transformer. In mu-metal screened case for fitting into microphone lead. Impedance ratio: 30 ohms to 60K. Price: £3 10s₃

Microphone switch assembly. Suitable for use with all microphones. Price on request.

★

FOSTER. Distributors: E. R. Factors Ltd., 378 Harrow Road, Paddington, London, W.9. Tel: 01-286 9530.

DF-71C. Mono dynamic omni-directional. Impedance: 50K. FR: 100 Hz-10 KHz. Removable wind shield, stand adaptor and neck harness supplied. Finish: black enamel and satin chrome. Price: £6 6s.

DF-72BC. Mono omni-directional dual impedance dynamic. Impedance: 600 ohms or 50K. FR: 80 Hz-12 KHz. On/off switch. Wind shield and stand adaptor supplied. Price: £6 19s. 6d.

B-1402. Two-section chrome table stand. 9½ in. closed, 14 in. extended. Black enamel base. Price: £1 15s.

B-1403. Three-section floor stand. Chrome stem. Heavy cast base. 22 in. closed, 55½ in. extended. Price: £3 19s. 6d.

★

GRAMPIAN REPRODUCERS LTD., Hanworth Trading Estate, Feltham, Middx. Tel: 01-894-9141. Cables: Reamp, Feltham.

★**DP4/H.** Moving coil. FR: 50-15,000 Hz. Sensitivity -52 dB, -70 dB, -86 dB, for high, medium and low impedance. 50,000, 600 and 25 ohms. Tubular case. Price including lead: high or medium impedance: £11; low impedance £9 10s.

★**DP6.** Moving coil. Omni-directional. FR: 200 Hz-15 KHz. Sensitivity -87 dB (25 ohms), -75 dB (200 ohms), -50 dB (600 ohms), -52 dB (50K). Built-in transformer fitted

to all but low impedance model. Price (low impedance): £9 10s. (other three models): £11.

GR1. Ribbon. Unequal figure-of-eight. Response 40 Hz-15 KHz. Sensitivity -90 dB (25 ohms), -81 dB (200 ohms), -76 dB (600 ohms), -58 dB (50K). Imp 25, 200, 600 ohms. 50K. Built-in transformer. Easily replaceable ribbon. Price (including lead, swivel holder, case): £14.

★**GR2.** Details as for GR1, but equal figure-of-eight response.

★**GC1 series.** Moving coil cardioid microphones. FR: 40 Hz-12 KHz ± 5 dB. Metallic diaphragms. Interchangeable leads. Various stands and accessories. Imp GC1/L 25 ohms, rec load 15-50 ohms; GC1/X 200 ohms, rec load 150-300 ohms; GC1/M 600 ohms, rec load 500-1,000 ohms; GC1/50K, rec load 50K and upwards. Sensitivities: GC1/L -86 dB, GC1/X -75 dB, GC1/M -70 dB, GC1/H -52 dB. Prices: GC1/L £15; GC1/X, GC1/M, GC1/H £16.

★**DP8 series.** Moving coil omni-directional microphones. FR: 50 Hz-15 KHz ± 5 dB. Built-in on/off switch. Interchangeable leads. Hand type with swivel holder for stand use. Sensitivities, impedances and rec loads as for DP4 series. Prices: DP8/L £11 5s.; DP8/X, DP8/M, DP8/H £12 10s.

★**Boom arm.** Suitable for use with various types of mics and stands. The clamp, locked by a single lever, allows the reach and angle to be readily adjusted as required. Length: 34 in. Weight: 1¼ lb. Thread termination for mic $\frac{9}{16}$ in. BSF male, thread termination for stand $\frac{5}{8}$ in. \times 27 tpi female. Supplied with adaptor to $\frac{9}{16}$ in. BSF female. Adaptors for other sizes available. Price: £6 10s.

Windshields. For use with DP4, DP6 and DP8 mics. Pressure moulded cage with an inner lining and acoustic resistance network to reduce air turbulence to a low value. Size: 2¾ in. diameter. Weight: ¾ oz. Price: £1 1s.

★

GRUNDIG (GREAT BRITAIN) LTD., Newlands Park, Sydenham, London, S.E.26. Tel: 01-778 2211.

GDM317. High quality directional moving coil microphone with cardioid response. Recommended for acoustically unfavourable condi-

tions. Output impedance: 200 ohms and 22K (dual). FR: 50 Hz-12.5 KHz. Supplied with tripod table stand. Price: £10 10s.

S15 stand. General-purpose folding stand. Opens to 5 ft. Folded size: 16×2¼ in. Price: £4 14s. 6d.



ITT-STC. ITT Components Group Europe, Standard Telephones & Cables Ltd., Electro-Mechanical Product Division, West Road, Harlow, Essex. Tel: Harlow 26811.

★**4037.** Omni-directional moving coil stick microphone for field work and P.A. Extremely rugged in construction. FR: 80 Hz-10 KHz. Impedance 30 ohms or 300 ohms. Sensitivity -76 dB. Long (A) or short (C) models available. Price: £27.

★**4038.** Studio ribbon microphone. Accurate figure-of-eight response. Flat frequency response 30 Hz-15 KHz. Impedance 30 ohms or 300 ohms. Sensitivity -85 dB. Non-linear distortion 0.1%. Controlled transient response. Price: £60.

★**4104.** Broadcast quality commentator's noise-cancelling ribbon lip microphone. Output -82 dB. Impedance 30 or 300 ohms. Price: £75.

★**4105A.** Cardioid moving coil microphone specially designed for speech. Flat response 60-10,000 Hz. Impedance 30 ohms. Sensitivity -82 dB. Front to back ratio 15-20 dB. Price: £27.

★**4113.** Ribbon cardioid microphone. FR: 60 Hz-15 KHz. Specially suitable for speech and music recording. Two versions available. 4113-A: 30 ohms impedance. Output: -87 dB. 4113-B: 50K impedance. Output: -54 dB. Suitable most domestic recorders. Price: £11 11s (both models).

★**4119.** Double ribbon (for improved sensitivity) hand-held or stand-mounted microphone. High quality suitable for studio and domestic hi-fi, speech and music. Available 30-300 ohms or 50K. Complete with nine feet cable and zip case. Price: £29 (both models). 30-300 ohms model with switch. Price: £30.

4136. Condenser cardioid microphone, uniform polar frequency response. Front/back ratio better than 20 dB. FR: 40 Hz-18 KHz. Impedance 30 or 300 ohms. Sensitivity -50 dB at 300 ohms. FET head amplifier. Phantom

power supply for combined mains and battery supply unit. Complete system with windshield and connecting cable. £110.



LEM. Distributors: Douglas A. Lyons and Associates Ltd., 8 Ryecotes Mead, Dulwich, London, S.E.21. Tel: 01-693 2855. Cables: Daliona London, S.E.21.

DH80. Miniature moving coil. Omni-directional. FR 70 Hz-14 KHz ±4 dB. Imp 50 ohms or 80K. Sensitivity (low imp) -82 dB. (high imp) -52 dB. May be used as hand microphone, desk stand, or attached to floor stand. Price: (low imp) £6 5s.; (high imp) £7 18s. 6d.

★**DO35.** Miniature Lavalier moving coil microphone. Omni-directional. FR 80 Hz-12 KHz. ±3 dB. Sensitivity -80 dB. Imp 200 ohms. Can also be used as hand or stand microphone. Size: 2½ in. long, ⅞ in. diameter. Weight: 1¼ oz. Price: £18 10s.

DO21B. Studio-quality omni-directional moving coil microphone. FR 30 Hz-16 KHz. ±3 dB. Imp 50 ohms or 200 ohms. Sensitivity (200 ohms) -77 dB. Individually calibrated response curves. Suitable for hand or stand use. Price: £18 15s.

DO20. Hand or stand type moving coil microphone. Omni-directional. FR 40 Hz-15 KHz. Impedance 50 ohms, 200 ohms or 80K. Sensitivity 50 ohms -82 dB, 200 ohms -76 dB, 80K -50 dB. Internal element resiliently mounted to avoid mechanical shock. Price: £12 10s.



LONDON MICROPHONE CO. LTD., Eardley House, 182-184 Campden Hill Road, London, W.8. Tel: 01-727 0711/3 and 5008.

LM200. Dynamic mono dual impedance microphone. Cardioid response. FR: 50 Hz-15 KHz. Impedances: 200 ohms or 50K. Sensitivity: -50 dB re 1V/μb. Weight: 4¼ oz. Finish: black plastic. Price: £5 15s.

LM300. Directional microphone with sharp cardioid characteristic giving very good front/back discrimination for speech purposes. Available in 200 ohm and dual impedance (200 ohm, 50K) versions. Metal case with quick-release mounting clip. FR: 50 Hz-18 KHz. Sensitivity: -74 dB (200 ohm); -50 dB (dual impedance). Prices: 200 ohm, £11 10s.; dual imp., £12 10s.

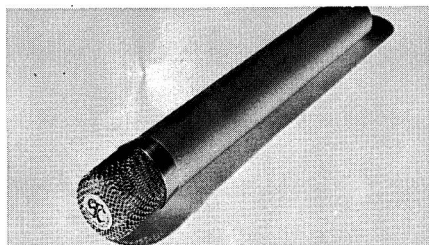

ITT 4136

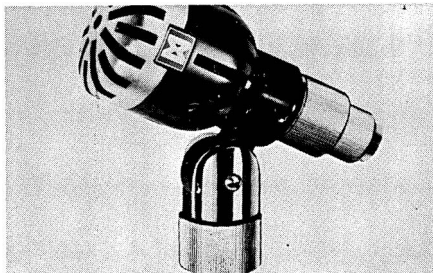

Melodium 78A

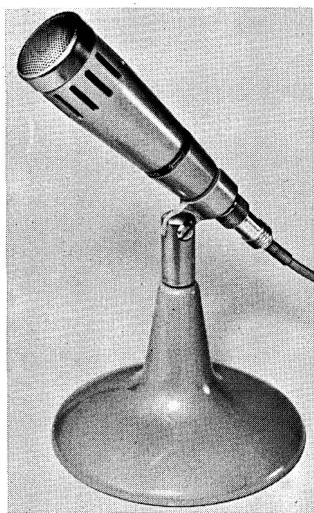

Grampian cardioid CGI



Grampian DP6

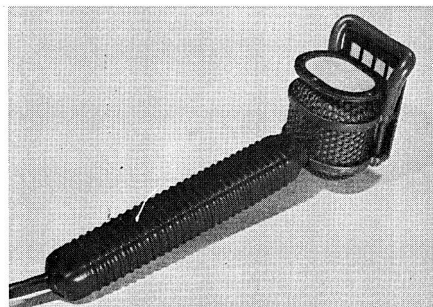

ITT 4104

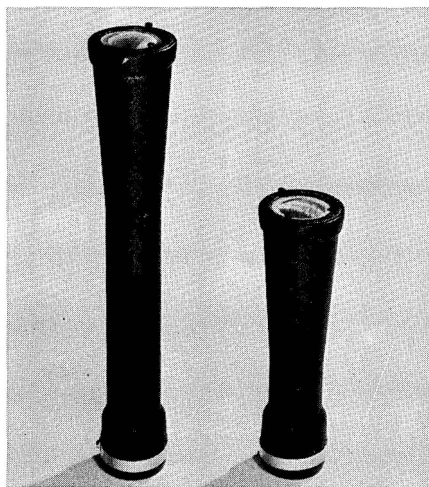

ITT 4037A and 4037C

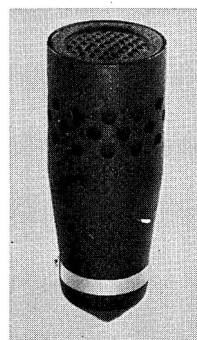

ITT 4105

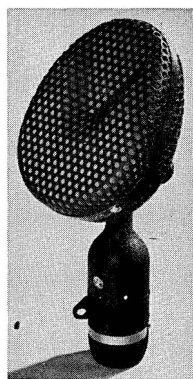

ITT 4038

LUSTRAPHONE LTD., St. George's Works, Regent's Park Road, London, N.W.1. Tel: 01-722 8844.

4-20. Mono, moving coil, omni-directional stick type with clip for stand mounting. FR: 50 Hz-15 KHz ± 5 dB. Sensitivity: -88 dB re 1V/ μ b. Impedance: multiple, 30 ohms, 200 ohms, 600 ohms or higher. Built-in windshield and anti-noise protection. Finish: black and silver anodised aluminium. Price: £15 15s.

4-30. Mono, moving coil cardioid stick type with clip for stand mounting. Sensitivity: -88 dB. Impedance: multiple, 30 ohms, 200 ohms, 600 ohms or higher. FR: 50 Hz-15 KHz ± 3 dB. Built-in windshield and anti-noise protection. Finish: black and silver anodised aluminium. Price: £20 5s.

4-50. Mono bi-directional ribbon stick type with clip for stand mounting. Sensitivity: -86 dB (at 600 ohms). Impedance: multiple, 30 ohms, 200 ohms, 600 ohms or 50K. FR: 50 Hz-17 KHz ± 3 dB. Built-in windshield and anti-noise protection. Finish: black and silver anodised aluminium. Price: £18 18s.

4-70. Mono uni-directional hand-held twin ribbon. Sensitivity: 500 μ V at 600 ohms, close distance within acceptance angle of 30°. Impedance: multiple, 30 ohms, 200 ohms, 600 ohms or 50K. FR: 50 Hz-12 KHz ± 3 dB. Built-in windshield and anti-noise protection. Finish: black and silver anodised aluminium. Price: £27 15s.

★ **VR/64.** Mono bi-directional stand-type ribbon on table base. Sensitivities: -56 dB high impedance; -90 dB low impedance. Imp: separate models for 20 ohms, 600 ohms, 50K. FR: 50 Hz-13 KHz ± 3 dB. Finish: anodised silver aluminium. Price: £9 19s. 6d.

VR/65NS. Stereo bi-directional ribbon. Sensitivity: -90 dB at 20 ohms. Impedance: separate models for 20 ohms (standard); 200 ohm, 500 ohm, or high impedance available. FR: 50 Hz-13 KHz ± 3 dB. Finish: anodised silver aluminium. Price: £19 19s.

★

MELODIUM. Distributor: Keith Monks (Audio) Ltd., 54 Rounton Road, Church Crookham, near Aldershot, Hants. Tel: Fleet 3566.

★ **76A/128.** Moving coil, cardioid, FR: 100 Hz-15 KHz (3 dB). Sensitivity: -63 dB (0 dB=

1 mW/10 microbars) 30 ohms or 600 ohms impedance. Stick type, head removable for fitting to swan neck. $\frac{1}{2}$ in. Whit. thread. Switch available on mic. or swan neck. Windshields available. Price: (head) £12 0s. 6d.; (stick, low impedance) £19 15s.; (stick, high impedance) £23 2s. 2d.

77A. Moving coil omni-directional. FR: 40 Hz-17 KHz ± 3 dB. Sensitivity: -72 dB=0.25 mV. 600 ohms impedance. Hand stick. Clamp fitting with $\frac{1}{2}$ in. Whit. Windshields available. Black plastic. Price: £40 12s. 6d.

★ **78A or 78A/128.** Moving coil cardioid, FR: 50 Hz-15 KHz ± 3 dB. Sensitivity: -67 dB (0 dB=1 mW/10 microbars, 0.042 mV/microbar). 30 ohms or 600 ohms impedance. Stick, head removable for fitting to swan neck. Clamp or swan neck fitting, $\frac{1}{2}$ in. Whit. Switch available on microphone or swan neck. Windshields available. Steel. Price: (Head) £14 16s. 6d. (Stick, Low impedance) £22 11s.; (Stick, High impedance) £25 18s. 2d.

RM6. Ribbon bi-directional. FR: 30 Hz-18 KHz ± 2 dB. Sensitivity: (200 ohms) -56 dB 0.16 mV/microbar, (50 ohms) -61 dB 0.09 mV/microbar (0 dB=1 mW/10 microbar). 50 ohms or 200 ohms impedance. Stick. Clamp fitting. Four position sensitivity and on/off switch. Steel. Price: £41 10s. 6d.

★

NEUMANN GMBH. Sole UK Agents: F. W. O. Bauch Ltd., Holbrook House, Cockfosters, Herts. Tel: 01-440 3277.

★ **U67.** Condenser. Switchable: omni-directional, cardioid, figure-of-eight. FR: 30 Hz-16 KHz ± 2 dB. Sensitivity across 1K: 2 mV/dyne/cm² in cardioid, 1.1 mV/dyne/cm² in omni-directional, 1.4 mV/dyne/cm² in figure-of-eight. Impedance 50 and 200 ohms. Built-in transformer. Special sensitivity and bass cut switches. Printed circuit. Pressure gradient mic. Price on application.

M269c. Condenser. Remote controlled: omni-directional, cardioid, figure-of-eight (continuously variable). FR: 30 Hz-16 KHz ± 2 dB. Sensitivity across 1K: 0.9 mV/dyne/cm² in omni-directional, 1.0 (1.55) mV/dyne/cm² in cardioid, 1.1 mV/dyne/cm² in figure-of-eight. Impedance 50 and 200 ohms. Built-in transformer. Special sensitivity and bass cut switches. Printed circuit. Remote controlled pressure-gradient mic. Price on application.

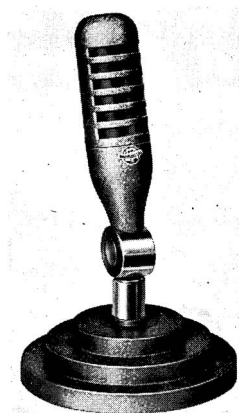

Lustraphone VR64



ITT 4119A/B/C

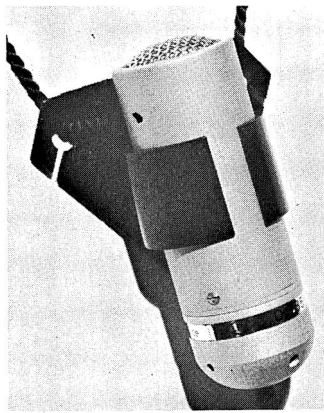

Lem DO35 moving coil

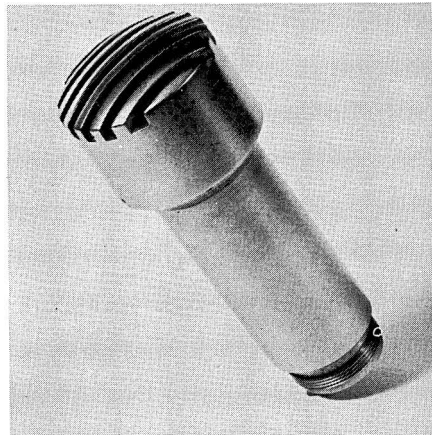

Melodium 79A

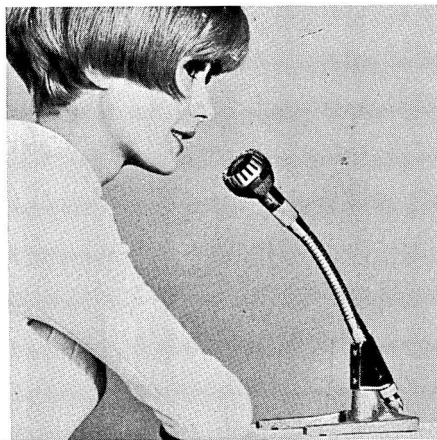

Melodium 76A

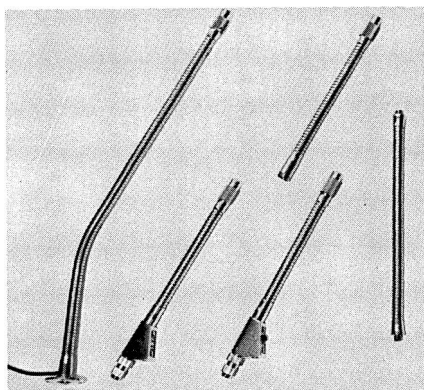

Melodium goosenecks

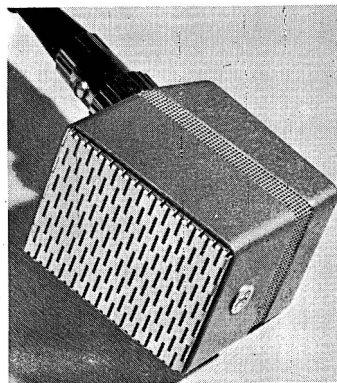

STC type 4113 ribbon

MICROPHONES



Neumann U67

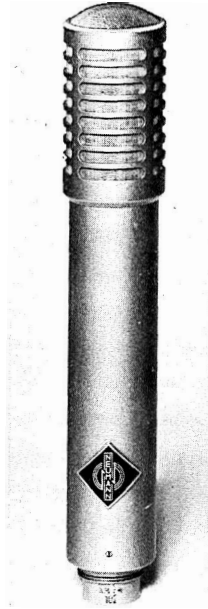

Neumann KM74



Neumann SM69



Neumann KM76

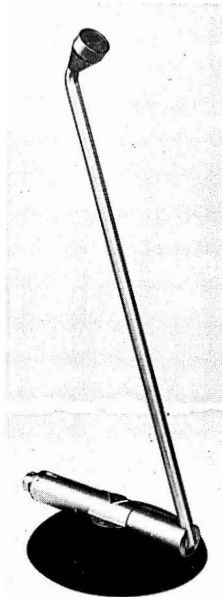

Neumann KM64P

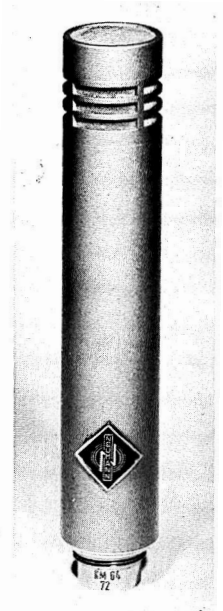

Neumann KM64

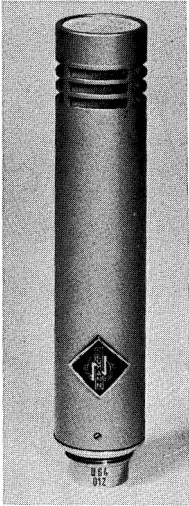

Neumann U64



Neumann KM88

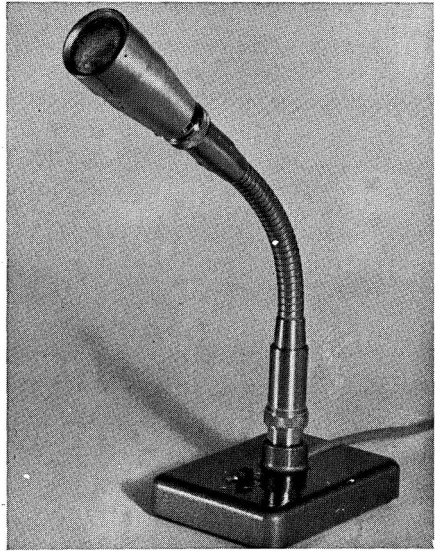

Reslo MPD/D

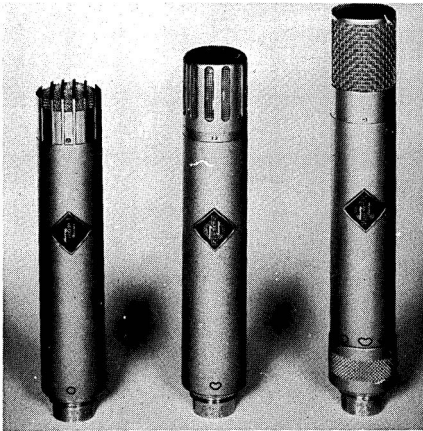

(left to right) Neumann KM53c, KM54c, KM56c



Neumann M49

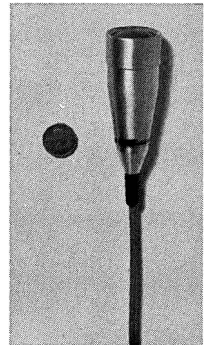

Reslo MPD2/L

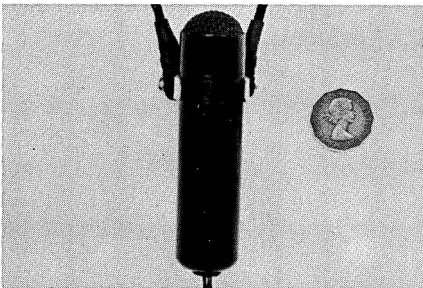

Reslo MMD/I

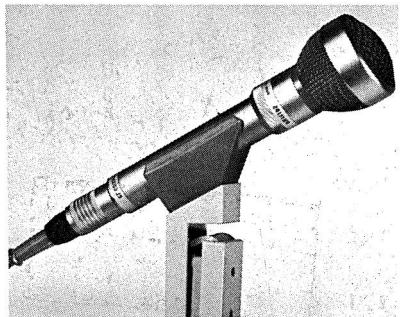

Philips EL.6033 studio moving coil

★**M49c.** Condenser. Remote-controlled: omnidirectional, cardioid, figure-of-eight (continuously variable). FR: 35 Hz-15 KHz ± 2 dB. Sensitivity across 1K: 0.7 mV/dyne/cm². Imp 50 and 200 ohms. Built-in transformer. Remote-controlled pressure-gradient mic. Price on application.

M50c. Condenser. Omnidirectional. FR: 40 Hz-16 KHz ± 2 dB. Sensitivity across 1K: 1.5 mV/dyne/cm². Imp 50 and 200 ohms. Built-in transformer. Pressure mic. Price on application.

★**KM53c.** Condenser. Omnidirectional. FR: 40 Hz-15 KHz ± 2 dB. Sensitivity across 1K: 1.5 mV/dyne/cm². Impedance 50 and 200 ohms. Built-in transformer. Printed circuit. Miniature pressure mic. Price on application.

★**KM54c.** Condenser. Cardioid. FR: 40 Hz-15 KHz ± 2 dB. Sensitivity across 1K: 1.2 mV/dyne/cm². Impedance 50 and 200 ohms. Built-in transformer. Printed circuit. Miniature pressure-gradient type mic. Price on application.

★**KM56c.** Condenser. Switchable: omnidirectional, cardioid, figure-of-eight. FR: 40 Hz-15 KHz ± 2 dB. Sensitivity across 1K: 0.8 mV/dyne/cm². Imp 50 and 200 ohms. Built-in transformer. Printed circuit. Miniature pressure-gradient mic. Price on application.

KM253, KM254, KM256. Condenser mics. RF-proof miniature microphones, otherwise specification as for KM53, KM54, KM56c.

KM63. Condenser. Omnidirectional. FR: 40 Hz-18 KHz ± 2 dB. Sensitivity across 1K: 0.9 mV/dyne/cm². Impedance 50 and 200 ohms. Built-in transformer. Special sensitivity switch (-10 dB). Printed circuit. Miniature pressure mic. Price on application.

★**KM64.** Condenser. Cardioid. FR: 40 Hz-18 KHz ± 2 dB. Sensitivity across 1K: 0.9 mV/dyne/cm². Imp 50 and 200 ohms. Built-in transformer. Special sensitivity switch (-10 dB). Printed circuit. Miniature pressure-gradient mic. Price on application.

KM64P. Announcer desk condenser microphone. Cardioid. Response up to 18 KHz with bass cut for better intelligibility. Sensitivity across 1K: 0.9 mV/dyne/cm². Impedance 50 and 200 ohms. Built-in transformer. Special sensitivity switch (-10 dB). Printed circuit. Pressure-gradient mic. Price on application.

SRM64. Condenser. Cardioid. FR: 40 Hz-

18 KHz ± 2 dB. Sensitivity across 1K: 0.8 mV/dyne/cm². Impedance 50 and 200 ohms. Built-in transformer. Special sensitivity switch (-10 dB). Printed circuit. Miniature pressure-gradient mic. Adjustable-height stand. Price on application.

KM66. Condenser. Switchable: omnidirectional, cardioid, figure-of-eight. FR: 40 Hz-16 KHz ± 2 dB. Sensitivity across 1K: 2.6 mV/dyne/cm². Impedance 50 and 200 ohms. Built-in transformer. Printed circuit. Miniature pressure-gradient mic. Price on application.

★**U64.** Condenser. Cardioid. FR: 40 Hz-18 KHz ± 2 dB. Sensitivity across 1K: 1.1 mV/dyne/cm². Imp 50 and 200 ohms. Built-in transformer. Special sensitivity switch (-10 dB). Printed circuit. Miniature pressure-gradient mic. Available with combined power units for two or six microphones. Price on application.

★**SM69.** Double or stereo condenser. Both systems separately remote-controlled: omnidirectional, cardioid, figure-of-eight. FR: 30 Hz-16 KHz ± 2 dB. Sensitivity across 1K: 1.5 mV/dyne/cm². Imp 50 and 200 ohms. Built-in transformers. Printed circuit. Pressure-gradient mics. Price on application.

KM73. Transistor (FET) condenser. Omnidirectional. FR 40 Hz-16 KHz ± 2 dB. Sensitivity across 1K: 2.5 mV/dyne/cm². Impedance 200 ohms without transformer. Printed circuit. Miniature pressure mic. Price on application.

★**KM74.** Transistor (FET) condenser. Cardioid. FR: 40 Hz-16 KHz ± 2 dB. Sensitivity across 1K: 2.5 mV/dyne/cm². Impedance 200 ohms without transformer. Printed circuit. Miniature pressure-gradient mic. Price on application.

★**KM76.** Transistor (FET) condenser. Switchable: omnidirectional, cardioid, figure-of-eight. FR: 40 Hz-16 KHz ± 2 dB. Sensitivity across 1K: 2.6 mV/dyne/cm². Impedance 200 ohms without transformer. Printed circuit. Miniature pressure-gradient mic. Price on application.

★**KML.** Lavalier transistor (FET) condenser. Cardioid. FR: 40 Hz-16 KHz ± 2 dB. Sensitivity across 1K: 0.5 mV (18V) or 1.8 mV (45V) per dyne/cm². Impedance 50 or 200 ohms. Built-in transformer. Printed circuit. Battery driven (18V or 45V). Miniature pressure-gradient mic. Price on application.

U77. Condenser FET. Switchable omnidirectional or cardioid or figure-of-eight. FR: 40 Hz-16 KHz. Sensitivity across 1K: 2.6 mV/

microbar (omni), 5 mV/microbar (figure-of-eight), 3 mV/microbar (cardioid). Impedance 200 ohms. Pressure gradient mic. Bass cut and sensitivity switch of -10 dB. Price on application.

KM83. FET condenser. Omni-directional. FR: 40 Hz-16 KHz. Sensitivity 0.5 mV/microbar. Impedance 50 or 200 ohms. Built-in transformer. Sensitivity switch -10dB. Price on application.

KM84. FET condenser. Cardioid. FR: 40 Hz-16 KHz. Sensitivity 0.5 mV/microbar. Impedance 50 or 200 ohms. Built-in transformer. Sensitivity switch -10 dB. Price on application.

KM86. FET condenser. Switchable to omnidirectional, cardioid or figure-of-eight. FR: 40 Hz-16 KHz. Impedance 50 or 200 ohms. Built-in transformer. Sensitivity switch -10 dB. Price on application.

★**U87.** FET condenser. Switchable to omnidirectional, cardioid or figure-of-eight. FR: 40 Hz-16 KHz. Impedance 50 or 200 ohms. Built-in transformer. Bass cut and sensitivity switch of -10 dB. Price on application.

★**KM88.** FET condenser. Switchable to omnidirectional or cardioid. FR: 40 Hz-16 KHz. Impedance 50 or 200 ohms. Sensitivity across 1K approx. 0.7 mV/microbar. Built-in transformer. Sensitivity switch -10 dB. Pressure gradient. Price on application.

SM69 FET. Stereo transistor condenser. Both systems separately remote controlled: omnidirectional, cardioid or figure-of-eight. FR: 40 Hz-16 KHz. Sensitivity across 1K 2 mV/microbar. Impedance 50 or 200 ohms. Built-in transformers. Pressure gradient. Price on application.

★

PHILIPS SOUND DIVISION. Pye TVT Ltd., Addlestone Road, Weybridge, Surrey. Tel: Weybridge 45511. Cables: Megacycle, Weybridge. Telex: London 262319.

Philips EL.6015/10. Moving coil cardioid microphone. FR: 90 Hz-16 KHz. Impedance 500 ohms. Sensitivity -71 dB. On-off switch. Quick-release holder for stands with $\frac{3}{8}$, $\frac{1}{2}$ or $\frac{5}{8}$ in. Whit threads. 16 ft twin screened lead. Price: £15 10s.

Philips EL.6016/10. Moving coil omnidirectional microphone. FR: 60 Hz-18 KHz. Im-

pedance 500 ohms. Sensitivity: -71 dB. On-off switch. Quick-release holder for stands with $\frac{3}{8}$, $\frac{1}{2}$ or $\frac{5}{8}$ in. Whit threads. 16 ft twin screened lead. Price: £12.

Philips EL.6025/00. Moving coil cardioid microphone. FR: 125 Hz-16 KHz. Impedance 500 ohms and 25K. Sensitivity: 500 ohms -71 dB. 25K -54 dB. Combined on-off and impedance selector switch. Fitted flexible shaft and 16 ft twin screened lead. Finish: brushed satin stainless steel head and chromium plated shaft. Fits stand with $\frac{3}{8}$, $\frac{1}{2}$ or $\frac{5}{8}$ in. Whit threads. Price: £20.

Philips EL.6026/10. Moving coil cardioid microphone. Similar specification to EL.6025/00 except for panel mounting (or stand mounting with LBC. 1201 adaptor) and single impedance (500 ohms). No on-off switch. Price: £16 10s.

★**Philips EL.6033/10.** Moving coil. Studio quality. Switchable cardioid or omnidirectional. FR: 80 Hz-15 KHz. Sensitivity: -72 dB. Source impedance 500 ohms (EL.6033/00 50 ohms). Special vibration damper optional extra. Supplied with cable and stand adaptor. Price: £26, vibration damper £3 10s.

Philips EL.6035/10. High quality moving coil cardioid microphone. FR: 60 Hz-17 KHz. Impedance 500 ohms. Sensitivity: -71 dB. On-off switch. Quick-release holder for stands with $\frac{3}{8}$, $\frac{1}{2}$ or $\frac{5}{8}$ in. Whit threads. Three-pole plug (Tuchel T3261/1) for detachable cable. Price: £26.

Philips EL.6036/10. High quality omnidirectional moving coil. FR: 50 Hz-19 KHz. Impedance 500 ohms. Sensitivity: -71 dB. On-off switch. Quick-release holder for stands with $\frac{3}{8}$, $\frac{1}{2}$ or $\frac{5}{8}$ in. Whit threads. Three-pole plug (Tuchel T3261/1) for detachable cable. Price: £20.

Philips EL.6042/05. Professional quality omnidirectional moving coil. FR: 40 Hz-20 KHz. Impedance 200 ohms. Sensitivity: -79 dB at 1 KHz reference 1V/ μ bar. Size: $5\frac{3}{8} \times \frac{3}{4}$ in. Finish: matt chrome plate. Quick-release holder-clamp for stands with $\frac{3}{8}$, $\frac{1}{2}$ or $\frac{5}{8}$ in. Whit threads. Three-pole plug for twin screened cable. Individually calibrated frequency response. Price: £32 10s.

Philips EL.6061/02. Moving coil, noise cancelling. On/off and control switch. FR: 200 Hz-10 KHz. Source impedance 500 ohms. Mounting bracket. Price: £10.

Philips LBB9001/05. Moving coil omni-

directional lavalier microphone. FR: 50 Hz-15 KHz. Impedance 200 ohms. Sensitivity: -78 dB. Suitable also for hand use. Complete with neck cord and 33 ft cable. Price: £12.

Philips EL.6037. High quality moving coil. Cardioid. FR: 40 Hz-18 KHz. Impedance 500 ohms and 25K. Sensitivity: -71 dB (500 ohms); -54 dB (25K). Rosewood body. Supplied with 10 ft cable. Quick release adaptor. Price: £28.

Philips EL.6204. Universal microphone table stand. Provided with $\frac{3}{8}$ in. Whit thread and possibility of mounting signal lamps or switches, etc. Price: £3.



RESLOSOUND LTD., Spring Gardens, London Road, Romford, Essex. Tel: Romford 61926 (three lines).

★**RBT Series.** High quality miniature ribbon. FR: 40 Hz-14 KHz ± 3 dB. Figure-of-eight, modified as required by filter pads. Sensitivity 58 dB below at 40K. Imp RBT/L 30-50 ohms; RBT/M 250 or 600 ohms; RBT/H 30-50 ohms or 40K. A switched model also available with the switch included in a slightly longer body (RBTS/L, RBTS/M, RBTS/H). Finish: Satin chrome. Acoustic filter pad for close-talking use. Prices: RBT/L, RBT/M and RBT/H £14 5s. each. For switched models add £3.

★**CR2 Series.** High quality miniature ribbon. FR: 40 Hz-16 KHz (-2 dB at 60 Hz, ± 10 dB at 16 KHz). Cardioid, figure-of-eight partially suppressed at the rear. Sensitivity 58 dB below for high-Z model. Imp: L, M and H as for RBT Series. Flexible swan neck stem. Finish: satin chrome perforated front, diecast case, silver grey hammertone enamel. Prices: CR2/L, CR2/M and CR2/H £15 5s. each.

★**SR1 Series.** Professional studio ribbon. FR: 30 Hz-20 KHz +2 dB. Nominal figure-of-eight. Damping pads available. Sensitivity -73 dB at 300 ohms. Imp: SR1/L 30-50 ohms, SR1/M 250 or 300 ohms. Developed for use by broadcasting authorities and recording studios. Finish: satin chrome. Other finishes to quantity order. Price: (both models) £35.

VRT Series. Special miniature ribbon. FR: 30 Hz-16 KHz (-2 dB at 40 Hz, +2 dB at 16 KHz). Nominal figure-of-eight. Damping pads available. Sensitivity 81 dB below at 300 ohms. Impedance: VRT/L 30/50 ohms, VRT/M 300 ohms. Developed for broadcast and recording

studios. Satin chrome finish. Price: (both models) £20.

★**MPD/2.** A special hand held version of MPD Series with direct feed cable. Price: (low impedance) £7, (high impedance) £7.

★**MMD.1.** Miniature dynamic lavalier lightweight microphone. FR: 50 Hz-17 KHz +4 dB. Presence hump between 2-5 KHz. Omni-directional. Sensitivity: -89 dB at 30-50 ohms. Dimensions: $3\frac{1}{4}$ in. long, $\frac{3}{8}$ in. diameter. Weight: 2 oz including cord clip and one yard cable. Finish: matt black stone lacquered. Impedance 30-50 ohms only. 18 ft miniature extension cable complete with DIN plug supplied. Price: £10 10s.

★**CPD Series.** Cardioid pencil dynamic microphone. FR: 15 Hz-17 KHz. Uni-directional partly suppressed at rear. Rear pick up -10-20 dB over range 200 Hz-15 KHz. Sensitivity -88 dB at 30-50 ohms. Size: $8\frac{1}{2}$ in. overall length, $1\frac{1}{2}$ in. maximum diameter (head). Impedances (switched model): L=30-50 ohms, M=dual 250 or 600 ohms, H=dual 30-50 ohms or 40K. Unswitched model in low impedance only. Finish: main case black anodised, top case natural satin anodised. Supplied with cable set and plastic stand holder. Prices: CPD/L, CPD/M and CPD/H £19 each.

★**UD.1.** Unidirectional hand or stand microphone. FR: 50 Hz-17 KHz (-4 dB at 100 Hz, +8 dB at 16 KHz). Rear pick up -10 to -20 dB between 200 Hz-15 KHz. Sensitivity -88 dB at 30-50 ohms. Output: average voice 6 in. from front of mic 150 μ V (low imp), 250-450 μ V (medium imp), 2-4 mV (high imp). Output increases approximately 10 times at one inch from microphone. Impedances: UD.1/L 30-50 ohms or 600 ohms; UD.1/M medium impedance, 200-300 ohms; UD.1/MT, 600-1,000 ohms; UD.1/H, high impedance. Finish: main case beige enamel, top case satin silver. Price: £21.

★**MPD/L.** Dynamic, omni-directional, lavalier. FR: 50 Hz-15 KHz -12 dB at 100 Hz, +4 dB at 14 KHz. Sensitivity: 88 dB below. Impedance: low. Finish: satin anodised. Price: £10.

★**MPD/D.** Dynamic, omni-directional, desk base fitted with 8 in. flexible stem. FR: 50 Hz-10 KHz. Sensitivity: 88 dB below. Impedance: low. Finish: satin anodised microphone, chrome stem, grey enamel base. Price: £10 10s.

★**SL1 Slimline.** Dynamic, omni-directional, hand type on stand. FR: 100 Hz-16 KHz. Sensi-

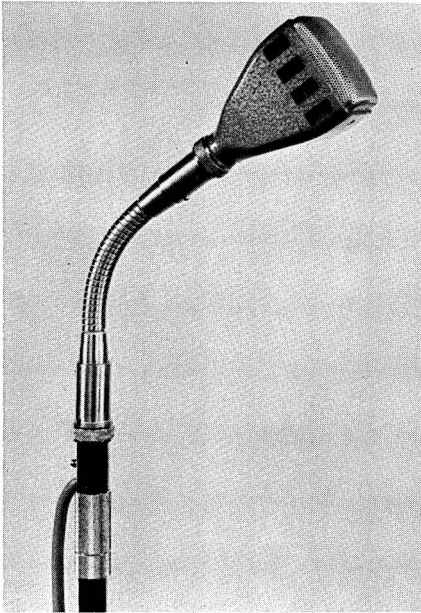

Reslo CR2



Reslo SRI

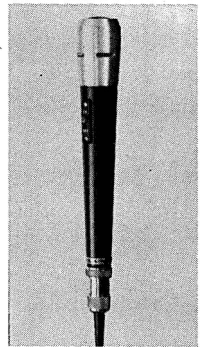

Reslo CPD/2

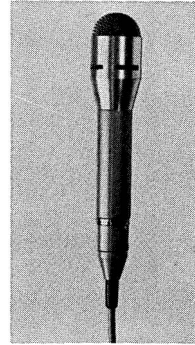

Reslo UDI

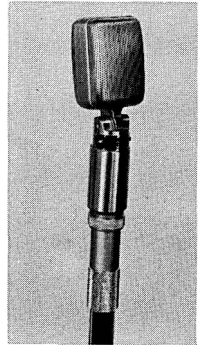

Reslo RBT

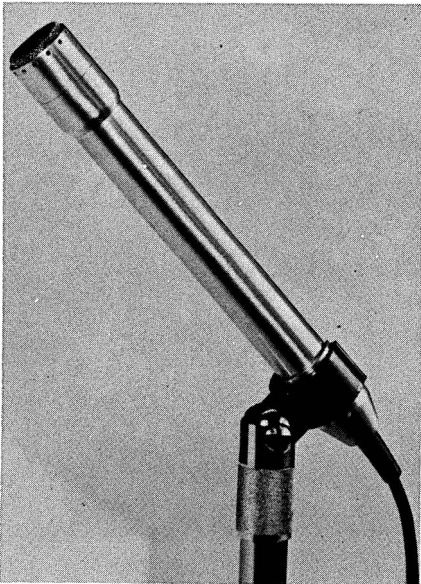

Reslo Slimline SLI

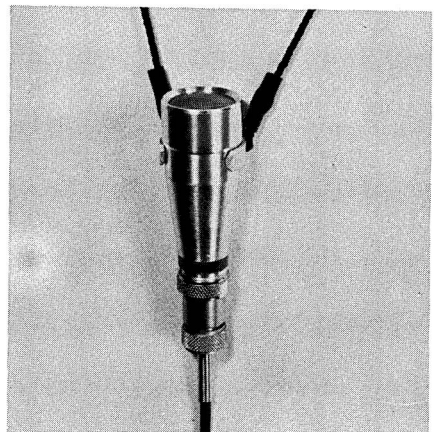

Reslo MPD/L

tivity: 84 dB below. Impedances: low, medium and high. Fitting thread: 27 TP1 $\frac{5}{8}$ in.; 26TP1 $\frac{1}{2}$ in. Finish: all brass finished satin chrome. Price: £38.

Coupler unit GE1. Suitable for use with any impedance microphone. Designed for external use adjacent to the tape recorder or amplifier. Gain 35-40 dB. FR: 50 Hz-20 KHz ± 1 dB. Fitted 36 in. screened lead and jack plug. Self-contained PP4 battery with average life of 1,500 hours. Price: £9 5s.

Coupler transformer LTU1. Designed for use between a low impedance microphone (15-50 ohms) and a high impedance microphone-input socket. Nominal input 40 ohms, nominal output 100K for valve grid circuit. Response 50 Hz-15 KHz ± 1 dB. Price: £5 5s.

Microphone transformers MT101, MT102. Designed for internal mounting in equipment having only high impedance inputs. Input imp: MT101 15-50 ohms, MT102 300-600 ohms. Nominal output imp 100K. Response 50 Hz-15 KHz ± 2 dB. Price: MT101 £3 5s., MT102 £3 5s.

MS. 100A. Adjustable floor stand. Minimum height 3 ft 4 in., maximum height 5 ft 2 in. Grey hammertone base and outer stem, chrome inner extension piece. Price: £9.

MS. 110A. Similar to the MS. 100A but with chrome stem. Price: £9.

MS. 175. Boom arm fitting available for use with Reslo floor stands. Price: £8 1s.

MS. 200. Adjustable table stand. Minimum height 1 ft 4 in., maximum height 2 ft 2 in. Grey hammertone base with chrome stem and extension piece. Price: £5.

MS. 300. Circular desk stand. Grey hammertone base fitted with 3 in. chrome stem. Price: £3.

MS. 400. Rectangular desk base. Fitted foam pads. Finished in silver grey hammertone. Mutingswitch optional extra. Price: £2 15s.; with switch £3 15s.

MS. 500. Rectangular desk base. Similar to MS.400 but fitted with rubber feet. Price: £2 15s., with switch £3 15s.

RM18/19. Transistorised battery operated radio microphone system. GPO approved. Full details and prices on request.

SENNHEISER ELECTRONIC. Distributors: Audio Engineering Ltd., 33 Endell Street, London, W.C.2. Tel: 01-836 0033.

★**MD.21HN.** Omni-directional moving coil hand or stand microphone. FR: 50 Hz-15 KHz ± 3 dB. Sensitivity -53 dB. Impedance 200 ohms and 30K. Rec load 200 ohms or 100K. Light alloy case finished hammer stove enamel. Windshield MZW22 optional extra. Price (microphone): £29; (windshield MZ-W22): £5; (desk stand MZT21): £3 15s.

★**MD.211.** Omni-directional moving coil miniature studio microphone. Hand or stand use. FR: 40 Hz-20 KHz ± 2.5 dB. Sensitivity -57 dB. Impedance 200 ohms. Rec load 200 ohms. Metal case with satin chrome finish. Windshield MZW211 optional extra. Price (microphone): £46; (windshield MZW211): £6; (small tripod desk stand MZT102): £2 15s.

★**MD.214.** Omni-directional moving coil lavalier microphone. Built-in 'natural voice' equaliser to studio standards. FR specially designed for lavalier operation. Sensitivity -59 dB. Impedance 200 ohms. Rec load 200 ohms. Metal case finished special 'non-glare' enamel. Price: £38.

★**MD.408.** Super cardioid moving coil microphone with flexible shaft. FR: 100 Hz-14 KHz ± 3 dB. Impedance 200 ohms. Sensitivity -55 dB. Case of light gauze woven wire cloth. Price: £25.

MD.411HLM. Super-cardioid moving coil mono microphone. FR: 50 Hz-14 KHz ± 4 dB. Impedance: (low) 20 ohms, (medium) 800 ohms, (high) 25K. Sensitivity: 0.12 mV/ μ bar, 0.25 mV/ μ bar, 1.25 mV/ μ bar. Rec load: (low) 50-200 ohms, (medium) 1-2K, (high) 80K. Hand and stand microphone with base fitting clip. Sound from sides and rear heavily attenuated. Case of hardened plastic round metal sleeve. Finish: matt silver. Price: £16 15s.

★**MD.420N.** Super-cardioid noise cancelling moving coil mono microphone. FR: 200 Hz-10 KHz (special response curve for noise cancellation). Impedance 200 ohms. Sensitivity 0.18 mV/ μ bar. Hand or stand microphone with goose neck and large Tuchel plug. Metal case with silver finish. Model MD.420NT has built-in switch. Price: (unswitched) £21.

★**MD.421HN.** Cardioid moving coil hand or stand microphone. Special frequency response with built-in variable bass attenuator. Imped-

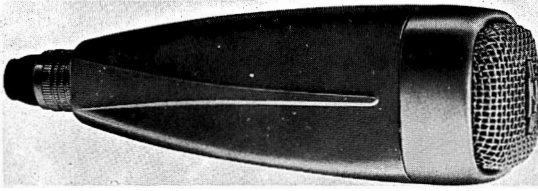

Sennheiser MD21HN

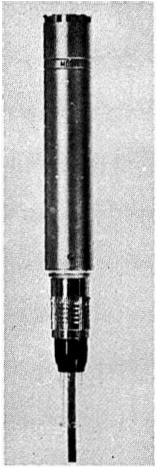

Sennheiser MD21 I

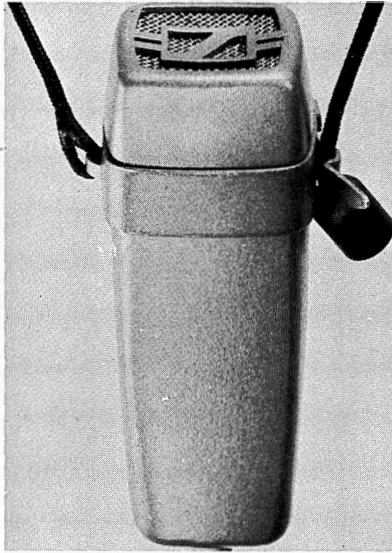

Sennheiser MD214

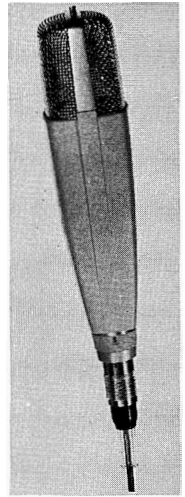

Sennheiser MD421HN

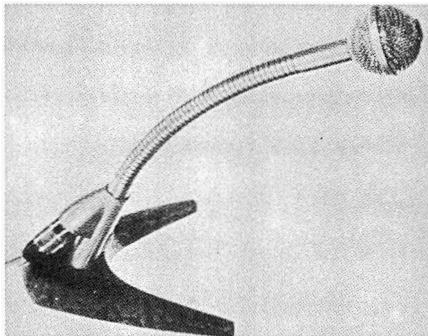

Sennheiser MD408



Shure 55S small Unidyne

MICROPHONES

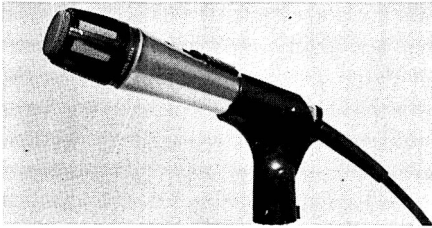

Shure Unidyne 5155A

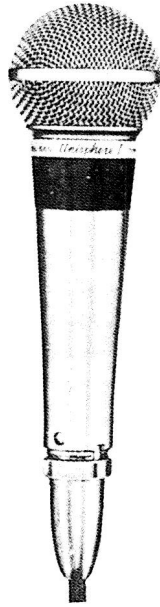

Shure 565 Unisphere I



Sennheiser MD420N

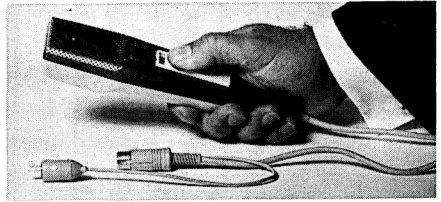

Uher MI 54



Shure 545 Unidyne III

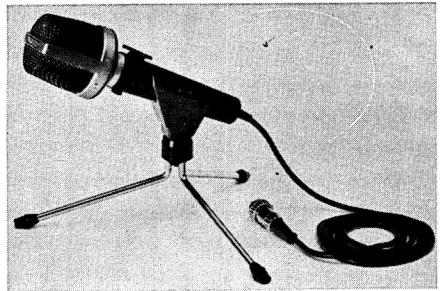

Uher M516

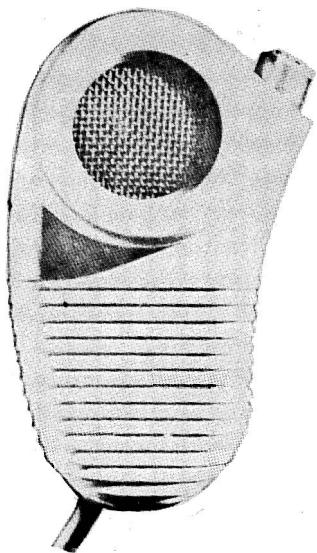

Vitavox B50 moving coil

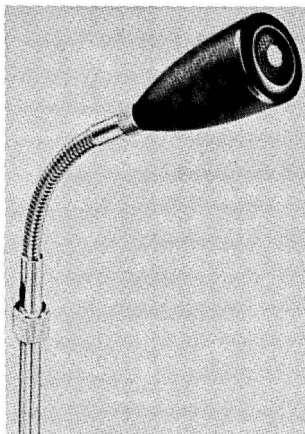

Vitavox M100

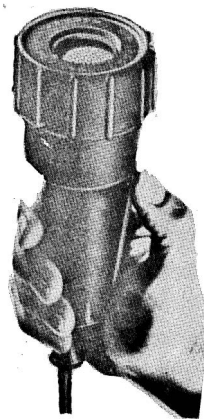

Vitavox B64 moving coil

ance 200 ohms or 24K. Rec load 200 ohms or > 50K. $\frac{3}{8}$ in. thread adaptor supplied. Light grey die-cast case. Windshield MZW22 and heavy desk stand MZT421 optional extras. Price (microphone): £40 10s.; (windshield MZ-W22): £5; (desk stand MZT421): £3 15s.



SHURE ELECTRONICS LTD., 84 Blackfriars Road, London, S.E.1. Tel: 01-928 6361.

★**55S Small Unidyne.** Cardioid moving coil. FR: 50 Hz-15 KHz. Sensitivity — 57 dB at high impedance. Source imp 35-50, 150-250 ohms, and high. Switched transformer built-in. Price: £30.

★**545 Unidyne III.** Cardioid moving coil. FR: 50 Hz-15 KHz. Sensitivity — 55 dB. Source impedance 25-250 ohms and high. Built-in transformer. Price: £31 10s.

★**565 Unisphere I.** Moving coil. Cardioid (with polar diagram uniform with frequency, symmetrical about axis). FR: 50 Hz-15 KHz. Dual impedance (50-250 ohms and high). Sensitivity: (low Z) — 78 dB, (high Z) — 55 dB. Hand or stand. Built-in wind/breath filter. Available with or without switch. Detachable 18 ft three-core screened lead. Finish: satin chrome body with plated steel grille. Size: $6\frac{1}{8}$ in. long, 2 in.

diameter over head. Price: (565 less switch) £36; (565S with switch) £37 10s.

★**588SA Unisphere A.** Moving coil. Cardioid. FR: 50 Hz-13 KHz. Impedance: high Z (low version 25-200 ohms available). Sensitivity: (high Z) — 59 dB, (low Z) — 81.5 dB. Hand or stand microphone supplied with swivel stand adaptor. Built-in switch with provision for locking on. Wind/breath filter. Detachable 15 ft cable. Finish: satin chrome with steel mesh grille. Size: $6\frac{3}{4}$ in. long, $2\frac{1}{8}$ in. diameter. Price: (588SA high Z) £22 10s.; (588SB low Z) £24.

★**515SA Unidyne.** Moving coil. Cardioid. FR: 80 Hz-13 KHz. Sensitivity — 58 dB. High impedance (low impedance version available). Hand or stand. On/off switch with lock. Size: $6\frac{1}{2}$ in. long, $1\frac{1}{2}$ in. diameter. Satin chrome body with black grille and stainless steel screens. Price: 515SA (high impedance) £16 10s., 515SB (low impedance) £15.



TTC. Distributors: E. R. Factors Ltd., 378 Harrow Road, Paddington, London, W.9. Tel: 01-286 9530.

B-1053. Mono dynamic cardioid dual impedance (600 ohms or 50K). FR: 50 Hz-12 KHz.

On/off switch. Stand adaptor supplied. Finish: satin chrome. Price: £6 19s. 6d.

B-1402. Two-section chrome table stand 9½ in. closed, 14 in. extended. Black enamel base. Price: £1 15s.

B-1403. Three-section floor stand. Chrome stem. Heavy cast base. 22 in. closed, 55½ in. extended. Price: £3 19s. 6d.



UHER. Distributors: Bosch Ltd., Rhodes Way, Radlett Road, Watford, Herts. WD2 4LB. Tel: Watford 44233.

★**M154.** Dynamic microphone with remote control switch providing: record, stop, start, rewind. FR: 50 Hz-10 KHz. Impedance 200 ohms. For use with model 5000 tape recorder. Price: £10 4s. (plus PT).

★**M516.** Dynamic cardioid microphone for use with battery portable series. Remote stop/start switch. Speech/music switch. FR: 70 Hz-14 KHz. Windshield fitted. Impedance 200 ohms. Price: £10 14s. 6d. (plus PT).

VITAVOX LTD., Westmoreland Road, London. N.W.9. Tel: 01-205 8671. Cables: Vitavox, London, N.W.9.

★**B50.** Moving coil. FR: 60 Hz-8 KHz. Sensitivity -85 dB. Source imp 25 ohms. 6 ft cable. Built-in control switch. Price on application.

B54. Moving coil incorporating built-in transformer. FR: 60 Hz-8 KHz. Sensitivity -85 dB (excluding transformer). Source imp 200, 500, 10K, 100K ohms according to transformer. Built-in control switch. Price on application.

B60. Similar specification to B50 but weather-proof version. Price on application.

★**B64.** Similar specification to B54 but weather-proof version. Price on application.

★**M100.** Moving coil incorporating tapped transformer giving choice of 25, 200, 10K ohms and high impedance. FR: 50 Hz-15 KHz ±3 dB. Sensitivity -80 dB, -71 dB, -54 dB, -44 dB according to impedance. 9 ft cable and flexible support. Price on application.

DAVIS and KAYS

have the smoothest sounds in town
come and collect

—anytime

Akai
AKG
Ampex
Armstrong
Audio Technica
Bang & Olufsen
Celestion
Decca
Dual
EMI
Fisher
Ferrograph
Garrard
Goldring
Goodmans
Grampian
Jordan Watts
Kef
Kelly
Leak
Ortofon

**Mail Order
from
Kingsway**

Pioneer
Quad
Radford
Record Housing
Revox
Richard Allan
Rogers
Sansui
Sanyo
SME
Shure
Sonotone
Sony
Staples Ladderax
Tandberg
Tannoy
Telefunken
Thorens
Trio
Uher
Yamaha

**CASH
or
H.P.**

In fact everything listed in this book is available from our branches.

**Visit our stereo
record centre at 115 Kingsway**

**ANYTHING considered
for PART EXCHANGE**

115, KINGSWAY, W.C.2.

5, TURNPIKE PARADE, N.15.

857, HIGH ROAD, N.12

4, HIGH ST., WALTHAMSTOW, E.17.

3, WEMBLEY HILL ROAD, WEMBLEY, MIDDX.

6, SEVEN SISTERS ROAD, HOLLOWAY, N.7.

169, FORE STREET, EDMONTON, N.18.

22, WOODLANDS PARADE, WATFORD, HERTS.

Tel.: 01-405 0446

Tel.: 01-888 9291

Tel.: 01-445 3319

Tel.: 01-520 4121

Tel.: 01-902 1792

Tel.: 01-272 7901

Tel.: 01-807 2807

Tel.: Watford 26602

**HELPFUL
advice
backed by
EXPERT
service**

==BIG SOUND== thats KELETRON

the name which gives you quality
and a low price in Audio Equipment

COLUMN SPEAKER ENCLOSURES & SYSTEMS

The KELETRON range of COLUMN SPEAKER ENCLOSURES have been designed for housing a large range of speakers which have been designed by leading speaker manufacturers for P.A. installations. Finished in Rexine/Leathercloth. 5 5" to 4 12" units. £10.15.0 to £19.15.0.

The KELETRON range of "PAC" General Purpose Column Speaker Systems are particularly suitable for use in Halls, Assembly Rooms, Churches, Restaurants, Cinemas, Theatres, Clubs, Discotheques, also for Bands or Groups and many other Commercial or Industrial establishments. 12 watts R.M.S. to 80 watts R.M.S. £18.15.0 to £115.15.0.



SPEAKERS & ENCLOSURES

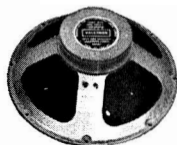

The KELETRON range of SPEAKERS are as follows:—
12" 5 watts to 18" 100 watts. £2.17.6d to £24.17.6d.

The KELETRON range of SPEAKER ENCLOSURES have been designed for the Audio Enthusiast who wants to build his own complete speaker systems to his own requirements. Finished in polished teak. 6" x 4" to 12". £4.7.6 to £9.5.0.

The KELETRON range of "KN" General Purpose 3-way Speaker Systems are housed in Handsome Slim Line Cabinets of Modern Design finished in polished teak with matching I.C.I. Vynair Grille. Models ranging from 5 watts to 20 watts. £9.10.0 to £19.19.0.

For further details write or 'phone;

K & K ELECTRONICS Ltd. 25, Roman Road, London E2

Telephone: 01-980 1936

TWO 12 in. CO-AXIAL LOUDSPEAKERS WITH

PROFESSIONAL PERFORMANCES

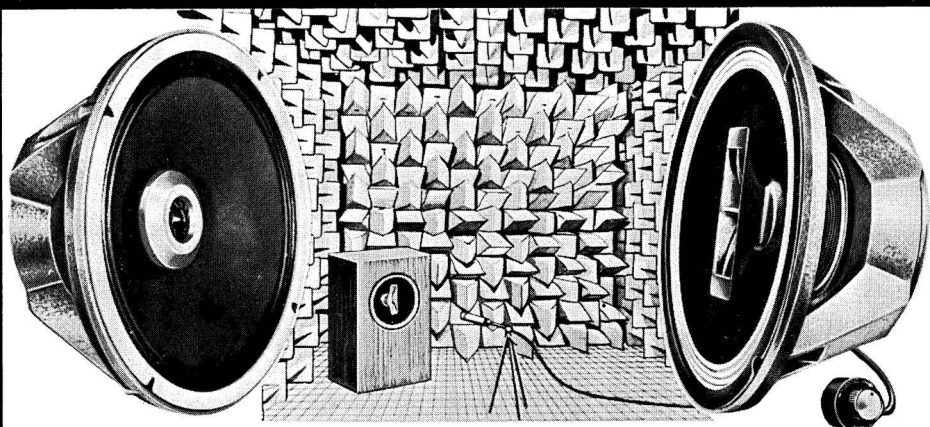

CX 1512

- PLASTAFLEX SURROUND ● COMPRESSION TREBLE UNIT ● TWO VOICE COILS ● HIGH FLUX CERAMIC MAGNETS ● RIGID DIE CAST CHASSIS ● PURE ELECTRICAL CROSSOVER

Specification

Overall Frequency Response	30-15,000 c/s
Power Handling Capacity	15 Watts R.M.S.
Fundamental Resonance Frequency	35 c/s
Crossover Frequency	4 kc/s
Impedance	15/16 ohms
Flux Density	13,000 gauss
Total Flux	88,000 Maxwells

Typical response curve of CX 1512

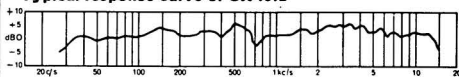

CX 2012

- HI-FLEX 'FREE' SURROUND ● TWO VOICE COILS ● COMPRESSION HORN LOADED TREBLE UNIT ● SEPARATE HIGH FLUX CERAMIC MAGNETS FOR BASS AND TREBLE UNITS ● PURE ELECTRICAL CROSSOVER ● RIGID DIE CAST CHASSIS ● HIGH FREQUENCY LEVEL CONTROL

Specification

Overall Frequency Response	30-18,000 c/s
Power Handling Capacity	20 Watts R.M.S.
Fundamental Resonance Frequency	35 c/s
Crossover Frequency	4 kc/s
Impedance	15/16 ohms
Flux Density	17,000 gauss
Total Flux	180,000 Maxwells

Typical response curve of CX 2012

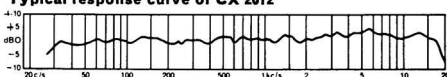

SMALLER ENCLOSURES The research and development department of Celestion has now evolved two new enclosure designs for these Co-axial loudspeakers based on a cabinet volume of only 2.5 cu. ft. and measuring $30\frac{1}{2}$ " x $17\frac{1}{2}$ " x $11\frac{1}{2}$ ".

Celestion

Studio Series

Loudspeakers for the Perfectionist

ROLA CELESTION LTD., Ferry Works, Thames Ditton, Surrey. 01-398 3402

remarkable Richard Allan...

Richard Allan high fidelity equipment is for the discriminating enthusiast. This range provides the quality of reproduction one normally expects only from equipment costing far more. Richard Allan is probably the finest value on the market today. Write for Test Report and Leaflet.

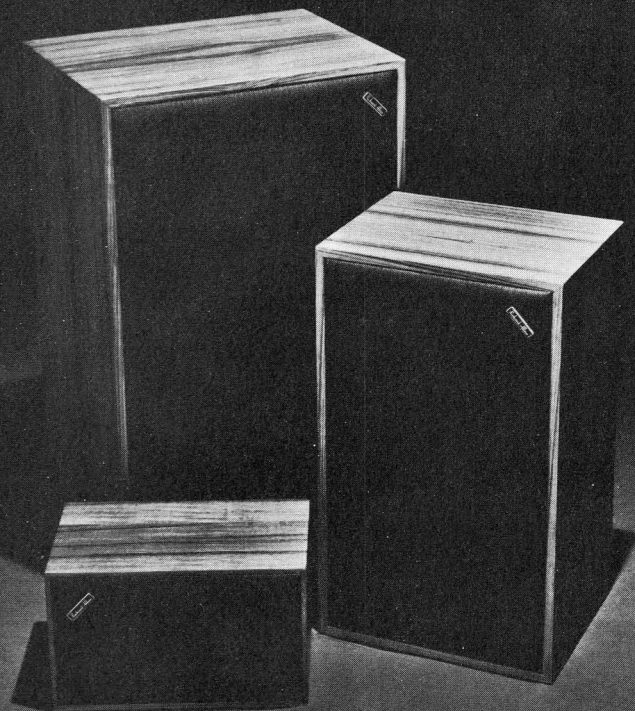

Richard Allan

**BRADFORD ROAD, GOMERSAL,
CLECKHEATON, YORKSHIRE.**
Telephone : Cleckheaton 2442

NEW SOUNDS from SCANDINAVIA

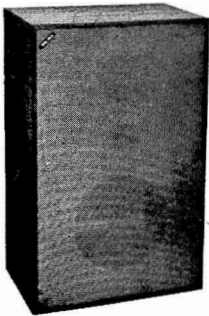

STE-MA of Denmark

Model 300 20 watts, 3 way Speaker System 4 or 8 ohms impedance. Superb Scandinavian design. Other models available in this range.



SKAND 'ELEKTRO of Norway

Model SE16 Introducing their best selling 8 watt speaker, 4 or 8 ohms impedance, in teak or Rosewood finish. Other models available in this range.

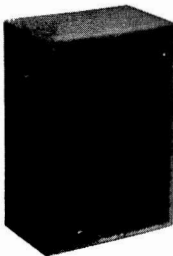

FONOPRODUKTER of Norway

Model TK7 6 watt, Bookshelf speaker, slated front cabinet in stylish teak. 4 or 8 ohms impedance.

Sole U.K. Distributors:

GROSVENOR ELECTRONICS LTD.

25 ROMAN ROAD, LONDON, E.2

Telephone: 01-980 1936

Just what is this ABR, that makes such a vital difference to the 'DITTON 15' ?

1. Studio quality high frequency unit (HF1300 Mk. 2).
2. Anechoic cellular foam wedge and lining eliminates standing waves.
3. High hysteresis panel loading material to eliminate structural resonances.
4. Auxiliary Bass Radiator (ABR)—plastic foam diaphragm of high rigidity and low mass having a free air resonance of only 8 Hz, double roll suspension allowing excursions up to $\frac{3}{4}$ " with virtual absence of distortion.
5. 8" bass unit, with free air resonance of 25 Hz, and massive Ferroba II magnet structure for optimum magnetic damping and cone treated with viscous damping layer to suppress resonances.
6. Units mounted flush to eliminate diffraction effects and tunnel resonances; covered by acoustically transparent grille cloth for maximum presence.
7. Full L-C Crossover network.

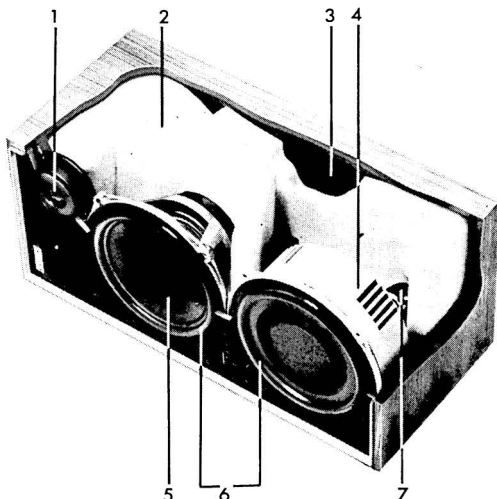

Brief specification

Overall frequency response:	30-15,000 Hz
Power handling capacity:	15 Watts R.M.S.
Impedance:	4—8 ohms
Size:	21" x 9 $\frac{1}{2}$ " x 9 $\frac{1}{4}$ " (534 x 242 x 235 mm)
Finish:	Walnut or Teak

It's an interesting story—and worth enquiring about. Send for details of the three Celestion 'Ditton' Hi-Fi Speaker systems.



Celestion Studio Series

Loudspeakers for the Perfectionist

ROLA CELESTION LTD., Ferry Works, Thames Ditton, Surrey. 01-398 3402

THE

Monitor

GOLD *

DUAL CONCENTRIC

Change should be made for improvement—not just for the sake of change. This is why the TANNOY 'Monitor' Dual Concentric loudspeaker—accepted as the 'quality standard' most specified for professional use—has remained unchanged in basic conception for the past 21 years and in detail design for the past seven years. NOW, the gradual evolution of a perfected technical specification has resulted in the refinement of this supreme 'quality' speaker into a new design—"The Monitor GOLD"—a design which again will remain intact until a change can be proved worthwhile. Send now for leaflet giving complete details and full technical specification.

The new Monitor Gold now incorporates a Treble Roll Off Control and Treble Energy Control enabling precise adjustments to be made for room acoustics and programme material.

Frequency Response

30—20,000 cps

Power Handling Capacity

15" 50 watts

12" 30 watts

III LZ 15 watts

Impedance

8Ω Nominal

5Ω Minimum

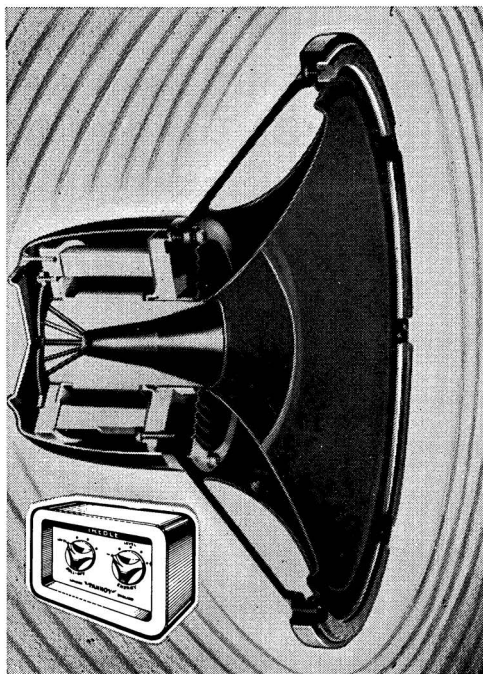

TANNOY
PRODUCTS LIMITED®

West Norwood,
London, S.E.27, England.
Tel: 01-670-1131

A MEMBER OF THE TANNAY
GROUP OF COMPANIES

DIRECTORY OF SPEAKER DRIVE UNITS

For economy of space the following abbreviations are used: **HC**=handling capacity; **FR**=frequency range; **c/o**=cut off; **vci**=voice coil impedance; **ref**=recommended crossover frequency. Dimensions quoted are generally nominal.

ADASTRA ELECTRONICS LTD., 167 Finchley Road, Swiss Cottage, London, N.W.3. Tel: 01-624 8164.

★**Top 20.** Bass speaker. 12 in. Fibre cone. vci: 15 ohms. Voice coil dia.: 1½ in. Voice coil material: aluminium. Impedance: 15 ohms. Gap flux: 12,000 lines. Total flux: 80,000 maxwells. HC: 25W RMS. FR: 25 Hz-13 KHz. Price: £6 6s.

★**Hi-Ten.** Full range speaker. 10 in. Fibre cone. vci: 15 ohms. Voice coil dia.: 1 in. Voice coil material: copper. Gap flux: 10,000 lines. Total flux: 38,000 maxwells. HC: 10W RMS. FR: 40-10kHz. Price: £2 15s. (inc. PT).



RICHARD ALLAN RADIO LTD., Bradford Road, Gomersal, Cleckheaton, Yorkshire. Tel: Cleckheaton 2442/3. Cables: Acoustics, Bradford.

460TC. 4 in. tweeter. Paper cone. Cambric surround. Voice coil ⅝ in. Gap flux 6,000 gauss. Total flux 9,000 maxwells. HC 3W. vci: 4-8 or 15 ohms. FR: 2 KHz-17 KHz. ref 5 KHz. Price: £1 3s. (plus 5s. 9d. PT).

CB8. 8 in. mid-range. Paper cone, doped cambric surround, voice coil 1 in. Gap flux 12,000 gauss. Total flux 48,000 maxwells. HC 5W. vci: 4-8 or 15 ohms. FR: 50 Hz-10 KHz. Price: £3 12s. 6d. (plus 16s. 10d. PT).

CB8T. 8 in. paper cone plus tweeter inner. Doped cambric surround. Voice coil 1 in. Gap flux 12,000 gauss. Total flux 48,000 maxwells. HC 5W. vci: 4-8 or 15 ohms. FR: 50 Hz-15 KHz. Price: £3 15s. (plus 17s. 5d. PT).

CB4 Tweeter. 4 in. paper cone. Cambric surround. Voice coil ⅝ in. Gap flux 10,000 gauss. Total flux 15,000 maxwells. HC 3W. vci: 4-8 or 15 ohms. FR: 2 KHz-17 KHz. ref 5 KHz. Price: £1 15s. (plus 8s. 1d. PT).

CG8T. 8 in. paper cone, doped cambric surround plus tweeter inner. Voice coil 1 in. Gap

flux 14,000 gauss. Total flux 56,000 maxwells. HC 6W. vci: 4-8 or 15 ohms. FR 50 Hz-17 KHz. Price: £5 7s. 6d. (plus £1 4s. 11d. PT).

CG8. 8 in. paper cone, doped cambric surround. Voice coil 1 in. Gap flux 14,000 gauss. Total flux 56,000 maxwells. HC 6W. vci: 4-8 or 15 ohms. Ceramic magnet. FR: 44 Hz-10 KHz. Price: £5 5s. (plus £1 4s. 5d. PT).

CG10. 10 in. paper cone, doped cambric surround. Voice coil 1½ in. Gap flux 14,000 gauss. Total flux 105,000 maxwells. HC 10W. vci: 4-8 or 15 ohms. FR: 40 Hz-6 KHz. Price: £7 (plus £1 12s. 7d. PT).

CG10T. 10 in. paper cone, doped cambric surround plus tweeter inner. Voice coil 1½ in. Gap flux 14,000 gauss. Total flux 105,000 maxwells. HC 10W. vci: 4-8 or 15 ohms. FR: 40 Hz-15 KHz. Price: £7 5s. (plus £1 13s. 8d. PT).

★**CG12.** 12 in. single paper cone. Doped fabric surround. Voice coil 1½ in. (copper). vci: 4-8 or 15 ohms. Gap flux 14,000 gauss. Total flux 105,000 maxwells. Ceramic magnet. HC 10W. FR: 25 Hz-9 KHz. ref 1 KHz. Price: £8.

CG12T. 12 in. paper cone plus tweeter inner. Doped fabric surround. Voice coil 1½ in. vci: 4-8 or 15 ohms. FR: 50 Hz-10 KHz. Price: £8 5s.

CG12 Super. 12 in. paper cone, doped cambric surround. Voice coil 2 in. Gap flux 14,000 gauss. Total flux 186,000 maxwells. HC 15W. vci: 8 or 15 ohms. FR: 25 Hz-5 KHz. Price: £10 10s.

CG15. 15 in. paper cone, doped cambric surround. Voice coil 2 in. Gap flux 17,000 gauss. Total flux 220,000 maxwells. HC 20W. vci: 8 or 15 ohms. FR: 20 Hz-5 KHz. Price: £17 10s.

CR5. 5 in. paper cone. Neoprene surround. Voice coil 1 in. Gap flux 14,000 gauss. Total flux 56,000 maxwells. HC 6W. vci: 4-8 or 15 ohms. FR: 30 Hz-10 KHz. Specially designed for use in small volume infinite baffle enclosure. Price: £4 12s. 6d. (plus £1 1s. 6d. PT).

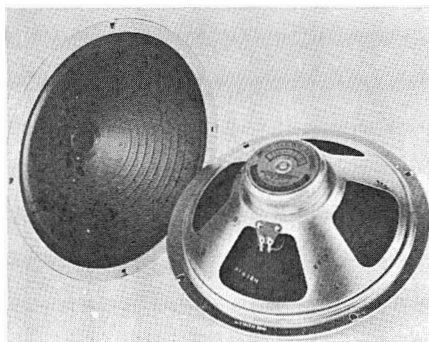

Adastra Hi-Ten

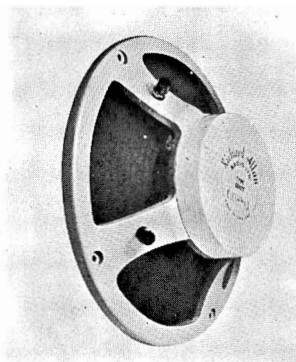

Richard Allan CG 12T

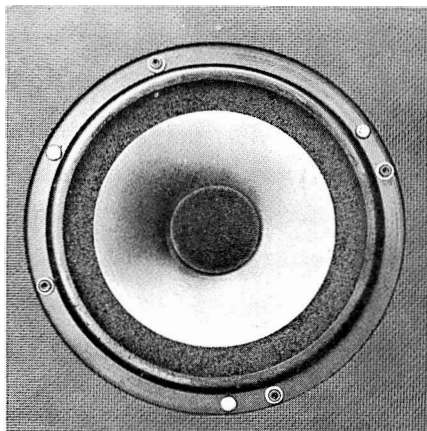

Audio and Design Hypertone

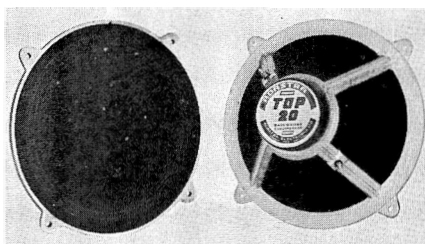

Adastra Top-20

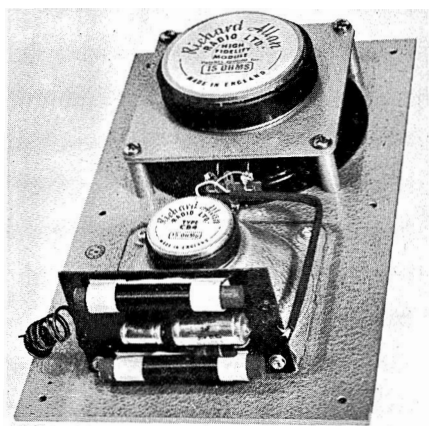

Richard Allan mid-range and HF module

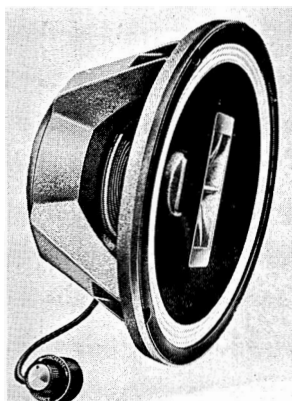

Celestion CX2012 co-axial speaker

★ Richard Allan full-range speaker modules are included in Speaker Enclosure section.

★

ALTECLANSING. Distributors: Carston Electronics Ltd., 71 Oakley Road, Chinnor, Oxon. Tel: Kingston Blount 8561.

604E. Dual coaxial full-range speaker unit. 15 in. main cone with 3 in. voice coil. HF radiator with $1\frac{3}{4}$ in. voice coil. High compliance assembly with cloth surround. LF voice coil copper. HF voice coil aluminium. Impedance: 8 or 16 ohms. Gap flux: LF 13,000 gauss. HF 15,500 gauss. HC 35 W (50W peak). FR 20 Hz-22 KHz. Crossover: built-in dual full section 1.5 KHz. Price: £110.

605B. Duplex speaker (15 in.). 3 in. LF voice coil. $1\frac{3}{4}$ in. HF voice coil. FR: 20 Hz-22 KHz. HC: 35W, 50W peak. Crossover at 1.6 KHz. vci: 16 ohms. Price: £99.

405A. 4 in. P.A. unit 1 in. voice coil. FR: 60 Hz-15 KHz. HC: 10W. vci: 8 ohms. Cone resonance 70 Hz. Flux 10,250 gauss. Price on application.

409B. 8 in. wide angle coaxial speaker. 1 in. LF voice coil. $\frac{9}{16}$ in. HF voice coil. FR: 50 Hz to 14 KHz. HC: 16W. vci: 8 ohms. 120° distribution. LF cone resonance 80 Hz. Price on application.

★

AUDIO AND DESIGN. Keith Monks (Audio) Ltd., 54 Rounton Road, Church Crookham, nr Aldershot, Hants. Tel: Fleet 3566.

★ **Hypertone.** Titanium cone speaker module. 6 in. titanium piston with cantilever suspension. $1\frac{1}{2}$ in. dia voice coil. Total flux 160,000 maxwells. Mean hemispherical power response substantially level to 15 KHz. vci: 8 or 15 ohms at 400 Hz. HC 15W RMS at and above the lower system limit (dependent upon loading conditions). 30W music rating, i.e. under normal use. Price: £18 15s.

★

BAKER REPRODUCERS LTD., Bensham Manor Road Passage, Thornton Heath, Surrey. Tel: 01-684 1665.

Stalwart. Full range 12 in. cone speaker. Paper cone with roll surround. Voice coil $1\frac{1}{2}$ in.

Copper voice coil. vci: 3 or 15 ohms. Gap flux 12,000 gauss. HC 15W RMS. FR: 45 Hz-13 KHz. Price: £6 6s.

Major. Full range 12 in. speaker with built-in tweeter cone. 14,000 gauss magnetic gap. FR: 40 Hz-14.5 KHz. HC 20W RMS. vci: 15 ohms. Cast aluminium chassis. Weight: 6 lb. Price: £8.

Deluxe Mk II. Full range 12 in. cone speaker. 15W RMS. Bass resonance 32-38 Hz. Gap flux 14,000 gauss. Copper voice coil $1\frac{1}{2}$ in. diameter. vci: 15 ohms. Paper cone with foam plastic surround. Built-in tweeter cone. FR: 25 Hz-16 KHz. Cast aluminium chassis. Depth 6 in. Weight: 6 lb. Price: £9.

Superb Twelve. Full range 12 in. speaker with built-in tweeter cone. Rubber roll surround. Coil diameter: $1\frac{1}{2}$ in. vci: 15 ohms. Gap flux 16,500 gauss. HC 20W RMS. FR: 20 Hz-17 KHz. Bass resonance 22-26 Hz. Aluminium speech coil. Diecast aluminium chassis. Weight: 10 lb. Price: £15.

Bass Auditorium 12. Medium range 12 in. cone speaker suitable for bass unit in multi-speaker system. HC 25W RMS. Bass resonance 36-45 Hz. Gap flux 15,000 gauss. Copper voice coil $1\frac{1}{2}$ in. diameter. vci: 15 ohms. FR: 25 Hz-12 KHz. Paper cone with roll surround. Cast aluminium chassis. Depth 7 in. Weight: 10 lb. Price: £12 10s.

Bass Auditorium 15. High power 15 in. speaker suitable for bass unit in multi-speaker unit. HC 35W RMS. Similar specification to Auditorium 12 except 2 in. diameter voice coil and handling capacity 35W RMS. Depth: 8 in. Weight: 15 lb. Price: £18.

Laboratory Standard 12. Full range 12 in. speaker employing patented differential wave impedance cone. Resin-impregnated paper cone with central metallic ellipse. $1\frac{1}{2}$ in. diameter aluminium voice coil. Rubber roll surround. Impedance vci: 15 ohms. Gap flux 15,000 gauss. HC 15W RMS. FR: 20 Hz-20 KHz. Bass resonance 22-27 Hz. Price: £22 10s.

Laboratory Standard 15. Medium range 15 in. speaker employing patented differential wave impedance cone. Resin-impregnated paper cone with central metallic ellipse. Foam plastic surround. 2 in. diameter copper voice coil. vci: 15 ohms. Cast aluminium chassis. Gap flux 15,000 gauss. HC 20W RMS. FR 20 Hz-12 KHz. Bass resonance 18-25 Hz. Price: £28 10s.

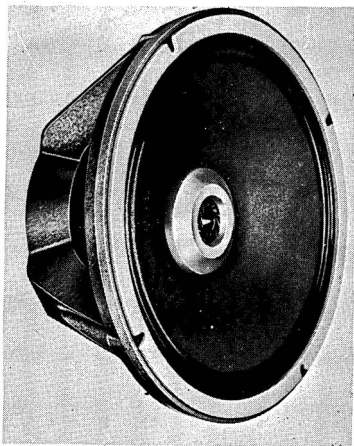

Celestion CX1512 co-axial speaker

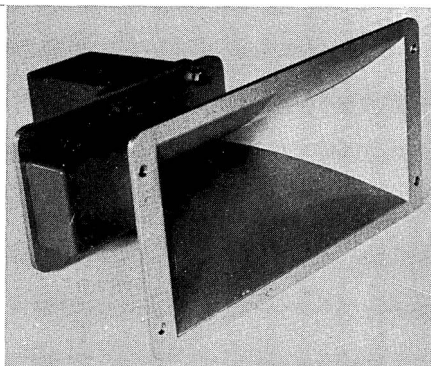

Decca DK30 Ribbon

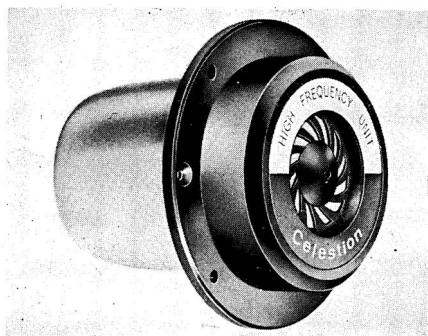

Celestion HF130C Mk 2



Eagle CT10 horn tweeter

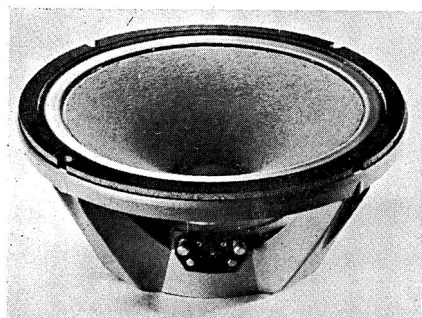

Celestion Studio 12

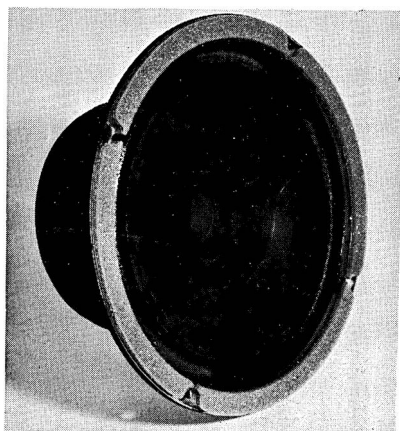

Eagle FR8

Group 25. 12 in. cone speaker with heavy duty suspension for electronic music, guitars, etc. HC 25W RMS. vci: 15 ohms. Bass resonance 80 Hz. FR: 30 Hz-10 KHz. Gap flux 12,000 gauss. Voice coil $1\frac{1}{2}$ in. Depth: 6 in. Weight: 5 lb. Price: £6 6s.

Group 35. 12 in. cone speaker with heavy duty suspension for electronic music, guitars, etc. HC 35W RMS. vci: 15 ohms. Bass resonance 80 Hz. FR: 30 Hz-10 KHz. Gap flux 14,000 gauss. Voice coil $1\frac{1}{2}$ in. Depth: $6\frac{1}{4}$ in. Weight: 6 lb. Price: £8 18s. 6d.

Group 50. 15 in. cone speaker with heavy duty suspension for electronic music, guitars, etc. HC 50W RMS. vci: 15 ohms. Bass resonance 80 Hz. FR: 30 Hz-10 KHz. Gap flux 17,000 gauss. Voice coil 2 in. Depth: 8 in. Weight: 15 lb. Price: £18 18s.

★

BURNE-JONES & CO. LTD., 18 Brunswick Road, Sutton, Surrey.

B.J. Treble 20. Omni-directional multi-horn. One 4 in. unit. Crossover built-in. FR: 1-18 KHz. Size: 6×5 in. Weight: $1\frac{1}{2}$ lb. Price: £3.

B.J. Treble Twin. Omni-directional horn. Two 4 in. drive units. Crossover included. FR: 900 Hz-18 KHz. Size: $9 \times 4\frac{3}{4} \times 6$ in. Weight: 2 lb. Price: £5 10s.

★

CELESTION LTD., Ferry Works, Thames Ditton, Surrey. Tel: 01-398 3402. Cables: Voicecoil, Thames Ditton.

★**Studio Series CX1512.** 12 in. coaxial unit comprising paper cone bass speaker and pressure driven tweeter. Plastaflex surround. Bass voice coil $1\frac{3}{4}$ in. diameter, treble voice coil $\frac{3}{4}$ in. diameter, both copper wound. vci: 15 ohms. Gap flux 13,000 gauss. Total flux 88,000 maxwells. HC 15W. FR: 30 Hz-15 KHz. Price: £12 19s. 6d.

★**Studio Series CX2012.** 12 in. coaxial unit comprising paper cone bass speaker and pressure driven tweeter. Hi-flex free surround. Bass voice coil $1\frac{3}{4}$ in. diameter copper wound, treble voice coil 1 in. diameter aluminium wound. vci: 15 ohms. Gap flux 17,000 gauss. Total flux 180,000 maxwells. HC 20W. FR: 30 Hz-18 KHz. Price: £18 18s.

★**Studio 12.** 12 in. bass drive designed specially for use with HF 1300 Mk 2 and CO3K crossover. Paper cone with ultra compliant rubber

surround. Voice coil diameter $1\frac{3}{4}$ in. vci: 15 ohms. Total flux 88,000 maxwells. HC 15W RMS. FR: 30 Hz-5 KHz. Rec crossover 3 KHz. Rigid die-cast chassis. Enclosure details on request. Price: £10 17s. 6d.

★**HF1300 Mk 2.** High frequency 3 in. tweeter. vci: 15 ohms at 10 KHz. HC 5W RMS. Suitable for use with systems up to 20W FR: 2 KHz-15 KHz. Rec crossover 3 KHz. Styled with flange to give easy and accurate mounting. Phase correction plate for improved polar response. Self-aligning diaphragm. Contoured pole piece. Damped acoustic cavity to reduce fundamental diaphragm resonance. High flux magnet. Price: £5 18s. 6d.

★

DECCA. Decca Special Products, Ingate Place, Queenstown Road, London, S.W.8. Tel: 01-622 6677.

★**DK30 Ribbon.** Horn-loaded high frequency ribbon speaker. Size: $6\frac{1}{2} \times 3\frac{1}{2} \times 2$ in. Aluminium ribbon element. Impedance 8 ohms constant. HC 30W maximum. FR: 2.5 KHz- 25 KHz. ref 2.5 KHz. Price: £12 12s.

DK1/8 Bass Unit. Cone speaker designed for bass use. Size: $12\frac{3}{4} \times 6$ in. Impregnated paper cone. Impregnated fibre surround. 2 in. voice coil. Copper voice coil. Impedance 8 ohms at 400 Hz. Gap flux 14,000 gauss. Total flux 250,000 maxwells. HC 30W. FR: 30 Hz-5 KHz. ref 2.5 KHz. Price: £14.

Mark Ten. Compact bass unit. 6 in. cone. Rigid piston diaphragm of expanded thermo-setting resin. Doped polyester concertina surround. 2 in. voice coil. Impedance 8 ohms. Gap flux 14,000 gauss. Total flux 25,000 maxwells. HC 15W. FR: 20 Hz-3 KHz. Price: £12 12s.

Kelly LF driver Mk VII. 15 in. direct radiator. Curvilinear impregnated paper cone. Doped fabric concertina surround. Imp 15 ohms at 400 Hz. Gap flux 17,000 gauss. Total flux 350,000 maxwells. HC 50W. FR: 30 Hz-5 KHz. ref 2.5 KHz. Price: £20.

★

EAGLE PRODUCTS. Distributors: B. Adler & Sons (Radio) Ltd., Coptic Street, London, W.C.1. Tel: 01-636 9066/7. Cables: Reldab, London.

8CX.50. Twin unit comprising 8 in. woofer and horn tweeter. Roll surround. vci: 16 ohms.

Woofer 10,500 gauss, tweeter 12,000 gauss. HC 15W. FR: 30 Hz-22 KHz. Resonant frequency 30 Hz. Crossover 3 KHz. Price: £10 19s. 4d. (plus £2 0s. 2d. PT).

★ **CT10 Horn Tweeter.** 3¼ in. Aluminium cone and surround. Voice coil 1 in. (aluminium), vci: 16 ohms. HC 10W. FR: 1.5-18 KHz. rcf 3 KHz. Price: £1 13s. 1d.

HT20 Rectangular Horn Tweeter. 4×2 in. Aluminium cone. Voice coil 1 in. (aluminium). vci: 16 ohms. Gap flux 13,500 gauss. HC 20W. FR: 1.5 KHz-18 KHz. rcf 3 KHz. Price: £4 19s. 9d.

FR.4. High-compliance full-range 4 in. unit. FR: 40 Hz-16 KHz. Bass resonance 60-70 Hz. HC 5W RMS. Flux density: over 10,000 gauss. vci: 16 ohms. Baffle opening: 3½ in. Depth: 2 in. Price: £3 2s. 1d. (plus 14s. 10d. PT).

FR.65. High-compliance full-range 6½ in. unit. FR: 30 Hz-18 KHz. HC 10W. Flux density: over 11,000 gauss. vci: 16 ohms. Baffle opening: 5⅝ in. Depth: 2¾ in. Price: £4 17s. 10d. (plus £1 4s. 1d. PT).

★ **FR.8.** High-compliance full-range 8 in. unit. FR: 30 Hz-20 KHz. Bass resonance 30-50 Hz. HC 15W RMS. Flux density: over 12,000 gauss. vci: 16 ohms. Baffle opening: 6¾ in. Depth: 3⅝ in. Price: £5 14s. 7d. (plus £1 8s. 8d. PT).

HT.15. High frequency horn unit. FR: 2 KHz-18 KHz. vci: 16 ohms. HC 15W music. rcf 3 KHz. Flux density 13,000 gauss. Baffle hole required 2⅝ in. Price: £3 2s. 6d.

★

ELAC. Electro Acoustic Industries Ltd., Stamford Works, Broad Lane, Tottenham, London, N.15. Tel: 01-808 0505. Cables: Elac, London, N.15.

Elac 8N/148 Mk II (8N/185). 8 in. Exponential paper cone. Paper surround, integral with cone. Voice coil 1 in. copper. vci 15 ohms. Gap flux 12,000 gauss. Total flux 48,300 maxwells. HC 5 watts. FR 40 Hz-12 KHz (loaded conditions). rcf (high frequency) 8 KHz. Price: £3 5s. (plus 13s. 11d. PT).

★

EMI. EMI Sound Products Ltd., Component Division, Blyth Road, Hayes, Middlesex. Tel: 01-573 3888.

215. Matched loudspeaker set, 14×9 in. bass unit, two 5 in. mid-range and 3⅝ in. tweeter. Impedance: 8 ohms. FR: 20 Hz-20 KHz. HC: 30W. Crossover circuit has adjustable HF and mid-range facilities. Price and recommended enclosure details on application.

315. Matched loudspeaker set. 15 in. bass unit, two 5 in. mid-range and two 3⅝ in. tweeters. Impedance: 8 ohms. FR: 20 Hz-20 KHz. HC: 35W. Crossover circuit has adjustable HF and mid-range facilities. Price and recommended enclosure details on application.

350. Matched loudspeaker set. 13½×8 in. bass unit, with coaxially mounted 3⅝ in. tweeter. Crossover frequency: 5 KHz. Impedance: 8 ohms. FR: 20 Hz-20 KHz. HC: 20W. Price and recommended enclosure details on application.

650. Matched loudspeaker set. 10×6 in. bass unit, with coaxially mounted 3⅝ in. tweeter. Impedance: 8 ohms. FR: 30 Hz-20 KHz. Crossover frequency: 5 KHz. HC: 5W. Price and recommended enclosure details on application.

750. Matched loudspeaker set. 13½×8 in. bass unit. 10×6 in. mid-range and two 3⅝ in. tweeters. Comprehensive crossover circuit has adjustable mid-range and tweeter facilities. Impedance: 8 ohms. FR: 20 Hz-20 KHz. HC: 20W. Price and recommended enclosure details on application.

950. Matched loudspeaker set. Hand-made 19×14 in. bass unit, with four HF units mounted across major axis of bass unit. Comprehensive crossover circuit has adjustable mid-range and tweeter facilities. Impedance: 8 ohms. FR: 15 Hz-20 KHz. HC: 50W. Price and recommended enclosure details on application.

★

FANE ACOUSTICS LTD., Hick Lane, Batley, Yorks. Tel: Batley 2114. Cables: Fane, Batley.

101/10. 10 in. ceramic magnet unit with 2 in. voice coil. HC 15W RMS. vci: 15 ohms. Main resonance 60 Hz. Gap flux 10,000 gauss. Total flux 100,000 maxwells. Single cone, copper voice coil. FR 40 Hz-10 KHz. Price: £5 10s. (plus £1 6s. 7d. PT).

101/10a. Similar to 101/10 but with twin cone, aluminium voice coil and FR: 40 Hz-15 KHz. Price: £6 5s. (plus £1 10s. 4d. PT).

101/12. Similar to 101/10 but with 12,000 gauss magnet. Price: £6 10s. (plus £1 11s. 4d. PT).

101/12a. Similar to 101/12 but with twin cone, aluminium voice coil and FR: 40 Hz-15 KHz. Price: £7 5s. (plus £1 15s. 3d. PT).

101/14. Similar to 101/10 but with 14,000 gauss magnet. Price: £8 15s. (plus £2 2s. 3d. PT).

101/14a. Similar to 101/14 but with twin cone, aluminium voice coil and FR: 40 Hz-15 KHz. Price: £9 10s. (plus £2 4s. 3d.).

122/10. 12 in. ceramic magnet unit with 2 in. diameter voice coil. HC 20W RMS. vci: 15 ohms. Main resonance 40 Hz or 70 Hz as required. FR: 30 Hz-5 KHz. Gap flux 10,000 gauss Total flux 100,000 maxwells. Copper voice coil. Single cone. Price: £6 16s.

122/10a. Similar to 122/10 but with twin cone, aluminium voice coil and FR: 30 Hz-15 KHz. Price: £7 13s.

122/12. Similar to 122/10 but with 12,000 gauss magnet. Price: £8 18s.

122/12a. Similar to 122/12 but with twin cone, aluminium voice coil and FR: 30 Hz-15 KHz. Price: £9 15s.

122/14. Similar to 122/10 but with 14,000 gauss magnet and HC 22W. Price: £11 3s.

122/14a. Similar to 122/14 but with twin cone, aluminium voice coil and FR: 30 Hz-15 KHz. Price: £12.

122/17. Similar to 122/10 but with 17,000 gauss magnet, 25W handling capacity and FR: 25 Hz-6 KHz. Price: £13 11s.

122/17a. Similar to 122/17 but with twin cone, aluminium voice coil and FR: 30 Hz-17 KHz. Price: £14 8s.

152/12. 15 in. ceramic magnet unit with 2 in. diameter voice coil. HC 25W RMS. vci: 15 ohms. Main resonance 32 Hz. Gap flux 12,000 gauss. Total flux 160,000 maxwells. Copper voice coil. Single cone. FR 25 Hz-2.5 KHz. Price: £14 6s.

152/12a. Similar to 152/12 but with twin cone, aluminium voice coil and FR: 30 Hz-15 KHz. Price: £15 11s.

152/14. Similar to 152/12 but with 14,000 gauss magnet. HC 27W and FR: 25 Hz-3.5 KHz. Price: £16 9s. 6d.

★**152/17.** Similar to 152/12 but with 17,000 gauss magnet. HC 30W RMS, and FR: 25 Hz-4 KHz. Price: £19 14s.

★**152/17a.** Similar to 152/17 but with aluminium voice coil, twin cone and FR: 30 Hz-17 KHz. Price: £20 19s.

153. 15 in. extra heavy duty unit with ceramic magnet and 3 in. diameter voice coil. Gap flux 14,500 gauss. Total flux 375,000 maxwells. HC 40W RMS. Copper voice coil. Single cone. FR: 30 Hz-3.5 KHz. vci: 15 ohms. Main resonance 40 Hz. Weight: 20 lb. Price: £21 15s.

183. 18 in. extra heavy duty unit with ceramic magnet and 3 in. diameter voice coil. Gap flux 14,500 gauss. Total flux 375,000 maxwells. HC 60W. Copper voice coil. Single cone. FR: 20 Hz-3 KHz. vci: 15 ohms. Main resonance 30 Hz. Weight: 22 lb. Price: £26.

301. 3 in. HF unit. Gap flux 17,000 gauss. Range: 1.5 KHz-18 KHz. vci: 8-15 ohms. HC 15W instantaneous peak. Price: £4 11s. 6d.

501. 5 in. mid-range unit. Gap flux 15,000 gauss. Total flux 60,000 maxwells. HC 20W 1 in. diameter aluminium voice coil. vci: 15 ohms. Rigid cone with neoprene surround. FR: 400 Hz-5 KHz. ref 800 Hz and 3.5 KHz. Price: £5 8s. (plus £1 6s. PT).

505. Similar to 501 but with 11,000 gauss magnet and HC 15W. Price: £3 18s. (plus 18s. 10d. PT).

502. 5 in. full-range unit for small enclosures. Gap flux 15,000 gauss. Total flux 60,000 maxwells. HC 8W. 1 in. copper voice coil. Price: £5 8s. (plus £1 6s. PT).

506. Similar to 502 but with 11,000 gauss magnet and HC 7W. Price: £3 18s. (plus 18s. 10d. PT).

★**Ionofane 601.** Ionic high-frequency speaker unit. FR: level 2.5 KHz-30 KHz. Will handle high note portion of 20W music signal. Impedance 15 ohms. Mains power required: 200/220/240V AC at 55W. Price: £29 8s.

801. 8 in. full-range unit. 1 in. pole piece with 15,000 gauss magnet. Twin cone. Aluminium voice coil. Resonance 25 Hz. Response up to 15 KHz. Price: £5 15s. 6d. (plus £1 7s. 10d. PT).

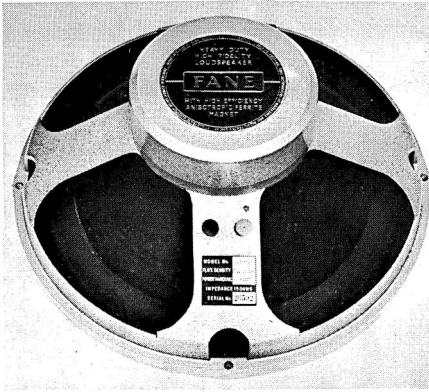

Fane 152/17A speaker

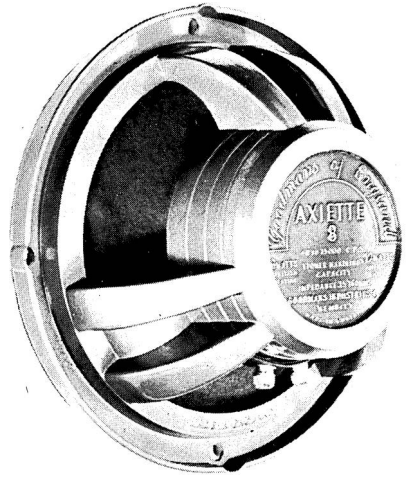

Goodmans Axiette 8

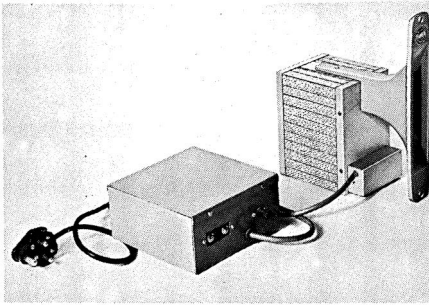

Fane Ionofane 601 HF driver

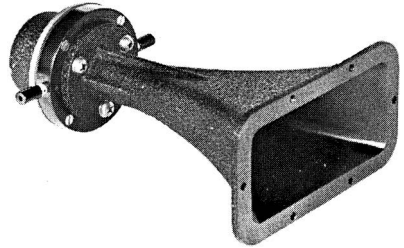

Goodmans Midax 650

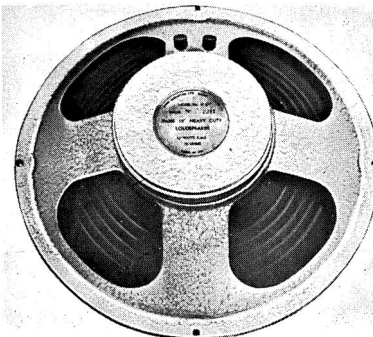

Fane model 152/17

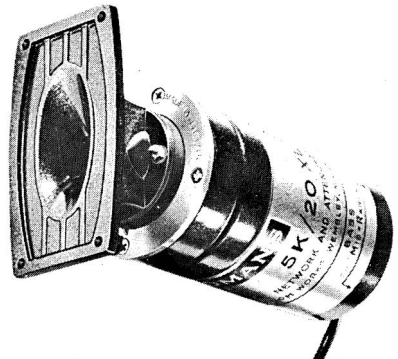

Goodmans Trebax 5K/20 XL

802. 8 in. unit similar to 801 but with single cone and copper voice coil. Resonance 70 Hz. Response up to 10 KHz. Price: £5 5s. 6d. (plus £1 5s. 6d. PT).

805. 8 in. unit similar to 801 but with 11,000 gauss magnet. Price: £4 13s. (plus £1 2s. 6d. PT).

806. 8 in. unit similar to 802 but with 11,000 gauss magnet. Price: £4 4s. (plus £1 0s. 3d. PT).

1001. 10 in. full-range unit. 1 in. dia pole piece with 15,000 gauss magnet. Twin cone. Aluminium voice coil. Resonance 22 Hz. Response up to 15 KHz. HC 10W. Price: £6 10s. 6d. (plus £1 11s. 6d. PT).

1002. 10 in. unit similar to 1001 but with single cone and copper voice coil. Resonance 60 Hz. Response up to 10 KHz. Price: £6 (plus £1 9s. PT).

1005. 10 in. unit similar to 1001 but with 11,000 gauss magnet. Price: £5 10s. (plus £1 6s. 7d. PT).

1006. 10 in. unit similar to 1002 but with 11,000 gauss magnet. Price: £5 (plus £1 4s. 1d. PT).

Special low resonance versions of 10 in., 12 in., 15 in. and 18 in. speakers are available at slightly higher prices. These are intended for use as bass units in high fidelity bass systems. They have rigid moulded fibre cones with rubber surround allowing free axial movement. Must be used in suitable reflex or infinite baffle cabinets. Not recommended for use with electric guitars or with small open baffles.

Also available are special 'Pop' versions of 10 in., 12 in., 15 in., 18 in. speakers. Designed for vocal and instrumental reproduction, and public address systems. Details on application.



GOODMANS LOUDSPEAKERS LTD.,
Axiom Works, Wembley, Middx. Tel: 01-902-1200. Cables: Goodaxiom, Wembley.

★ **Axiette 8.** 8 in. Paper cone. Plastic treated surround. Voice coil 1 in. Gap flux 13,500 gauss. Total flux 53,000 maxwells. HC 6W. vci: 15 or 8 ohms. FR: 40 Hz-15 KHz. Price: £5 15s. (plus £1 7s. 1d. PT).

★ **Twin Axiette 8.** 8 in. twin cone version. FR: 40 Hz-18 KHz. Mechanical crossover at 2 KHz.

Other details as for Axiette 8. Price: £6 10s. (plus £1 10s. 7d. PT).

★ **Axiom 10.** 10 in. Paper cone. Plastic treated surround. Voice coil 1 in. Gap flux 13,500 gauss. Total flux 53,000 maxwells. HC 10W. vci: 15 or 8 ohms. FR: 40 Hz-15 KHz. Price: £6 16s. (plus £1 12s. PT).

Axiom 80. 9½ in. Twin diaphragm paper cone, free edge surround. Voice coil 1 in. Gap flux 17,000 gauss. Total flux 62,000 maxwells. HC 6W. vci: 15 ohms. FR: 20 Hz-20 KHz. Price: £20 2s. (plus £4 14s. 1d. PT).

★ **Trebax.** Horn-loaded pressure tweeter. Aluminium diaphragm. Voice coil 1 in. HC suitable for inclusion in systems of up to 25W. vci: 15 ohms at 10 KHz. FR: 2.5 KHz-20 KHz rcf 5 KHz. Price: £7 9s.

★ **Trebax 5K/20XL.** Horn loaded pressure tweeter. Built in L/C crossover (5 KHz) and attenuator. Suitable for inclusion in systems of up to 20W. Dispersion angle 90°. Price: £8 8s.

★ **Midax 650.** Horn loaded pressure unit. Resin impregnated linen diaphragm. Diecast horn. Voice coil 1½ in. HC suitable for systems up to 25W. vci: 15 ohms. FR: 650 Hz-8 KHz. rcf 950 Hz, 5 KHz. Price: £11 4s.

★ **Audiom 51 bass.** 12 in. Paper cone. Voice coil 1½ in. (4.4 cm). vci: 15-16 or 8 ohms. Gap flux 13,000 gauss. Total flux 87,500 maxwells. HC 15W. Fundamental resonance 35 Hz. Price: £11 6s.

The Audiom 51 is available in two versions: Audiom 51 Bass—details as above, for use as bass unit in high fidelity systems. Audiom 51 Standard (50 Hz) for PA, guitars and all arduous conditions. Same price as above.

Audiom 61 bass. 12 in. Paper cone. Voice coil 1½ in. (4.4 cm). vci: 15-16 or 8 ohms. Gap flux 16,500 gauss. Total flux 185,000 maxwells. HC 20W. Fundamental resonance 35 Hz. Price: £16 7s.

The Audiom 61 is available in two versions: Audiom 61 Bass—details as above, for use as bass unit in high fidelity systems. Audiom 61 Standard (50 Hz) for PA, guitars and all arduous conditions. Same price as above.

Axiom 201. 12 in. Twin diaphragm paper cone with pure plastic roll suspension. Voice coil 1½ in. (4.4 cm) (aluminium). vci: 15-16 or 8

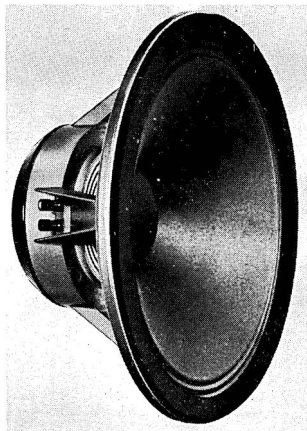

Goodmans Audiom 91 (18 in.)

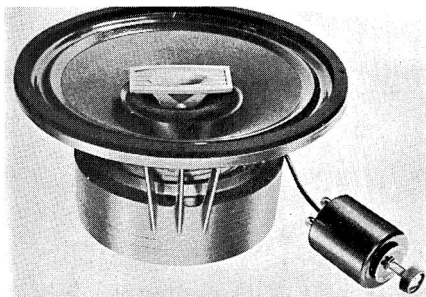

Goodmans Triaxiom 1220C

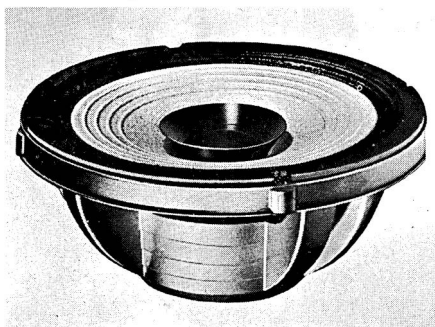

Goodmans Twin Axiette 8



Goodmans Axiom 301

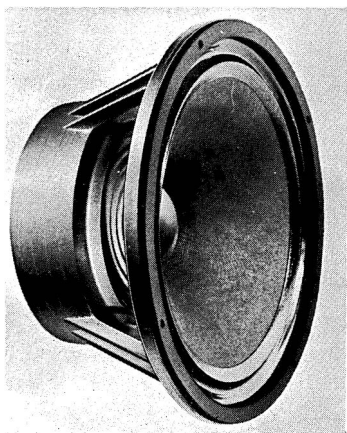

Goodmans Audiom 51

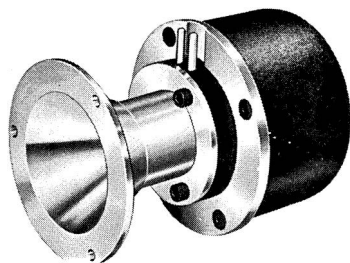

Goodmans Trebax HF unit

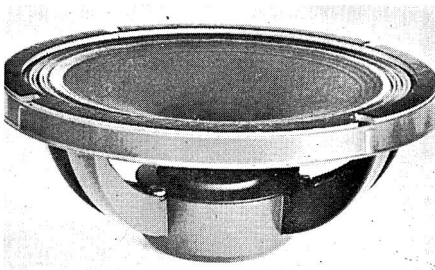

Goodmans Axiom 10

ohms. Gap flux 13,000 gauss. Total flux 87,500 maxwells. HC 15W. FR: 30 Hz-16 KHz. Built-in mechanical crossover at 5 KHz. Price: £12 10s.

★ **Axiom 301.** 12 in. twin diaphragm paper cone with pure plastic roll suspension. Voice coil 1½ in. (4.4 cm) (aluminium). vci: 15-16 or 8 ohms. Gap flux 16,500 gauss. Total flux 185,000 maxwells. HC 20W. FR: 30 Hz-16 KHz. Built-in mechanical crossover of 5 KHz. Price: £17 18s.

★ **Triaxiom 1220C.** Three-way speaker assembly comprising 12 in. bass cone, a mid-range radiator, and a pressure driven horn-loaded HF unit with independent magnet system. Bass cone paper with pure plastic edge. mid-range cone bakelised paper. HF unit aluminium horn. Bass voice coil 1½ in. diameter copper wound. HF voice coil 1 in. diameter aluminium wound. Vci: 15 ohms. Main gap flux 16,500 gauss. Total main gap flux 185,000 maxwells. HC 20W. FR: 30 Hz-20 KHz. Built-in crossover at 2 KHz to mid-range unit and at 5 KHz to HF unit. Price: £21 15s.

Triaxiom 212C. Same specification as Triaxiom 1220C but with handling capacity 15W and total main flux 87,500 maxwells. Price: £16 18s.

Audiom 81 bass. 15 in. Paper cone. Pure plastic roll suspension. Voice coil 3 in. (7.6 cm). vci 15-16 ohms. Gap flux 14,000 gauss. Total flux 269,000 maxwells. HC 25W. Fundamental resonance 30 Hz. Price: £27 12s.

The Audiom 81 is also available in 60 Hz version for special purposes.

The Audiom 81 bass (details above) with 30 Hz fundamental resonance is specially designed for use as the bass unit in a multiple system (with Midax and Trebax). In this case it must be mounted in the correct size of enclosure.

★ **Audiom 91 bass.** 18 in. Paper cone. Voice coil 3 in. diameter. vci: 15-16 ohms. Gap flux 14,000 gauss. Total flux 269,000 maxwells. HC 50W. Fundamental resonance 30 Hz. Price: £31 5s.

The Audiom 91 is also available with a resonance of 55 Hz (Standard version) for especially arduous conditions. PA, bass guitars, etc. Price as above.

★

GRAMPIAN REPRODUCERS LTD., Hanworth Trading Estate, Middx. Tel: 01-894 9141. Cables: Reamp, Feltham.

★ **Grampian 1255/15.** 12 in. Paper impregnated cone and surround. Voice coil 1½ in. Gap flux 14,500 gauss. Total flux 130,500 maxwells. HC 10W. vci: 15 ohms. FR: 35 Hz-15 KHz. Price: £12 12s.

★

ITT-STC. ITT Component Group Europe. Standard Telephones & Cables Ltd., Electro-Mechanical Product Division, West Road, Harlow, Essex. Tel: 0279-6 26811.

★ **Type 4001G, High Frequency Unit.** High frequency pressure unit. FR: 6 KHz-20 KHz. Substantially omni-directional. vci: 15 ohms. Flux density: 14,000 gauss. Size: approximately 2¾ × 1 in. Price: £5 12s. 6d.

★

JORDAN-WATTS. Distributors: Boosey & Hawkes (Sales) Ltd., Sonorous Works, Deansbrook Road, Edgware, Middlesex. Tel: 01-952 7711.

★ **Jordan-Watts Module Mk II.** 6 in. square frame. Aluminium diaphragm with plastic surround. Voice coil 1½ in. Ceramic magnet. vci: 3-5 ohms and 7½-16 ohms. HC: 12W. FR: 25 Hz-20 KHz. Price: £11.

★

KEF ELECTRONICS LTD., Tovil, Maidstone, Kent. Tel: Maidstone 57258. Cables: KEF, Maidstone.

B139. 13 × 9 in. Exp plastic and aluminium cone. Neoprene surround. Voice coil 2 in. (copper). vci: 8-16 ohms. Gap flux 10,500 gauss. Total flux 137,000 maxwells. HC 15W. FR: 30 Hz-4 KHz. ref: 1 KHz. Price: £11 10s.

T15 tweeter. 1½ in. Melinex dome. Centre pole. Alcomax magnet. Melinex surround. Voice coil 1½ in. (aluminium). vci: 8-16 ohms. Gap flux 12,000 gauss. Total flux 43,000 maxwells. HC 15W. Treble only. FR: 800 Hz-20 KHz. ref 1 KHz. Price: £6.

K2 Baffle. Two units. Baffle size 22½ × 13½ in. Unit 1: 13 × 9 in.; plastic and aluminium cone; neoprene surround; voice coil 2 in. copper. Gap flux 10,500 gauss; total flux 137,000 maxwells. Unit 2: 1½ in. Melinex dome; Melinex surround; voice coil 1½ in. copper. Gap flux 12,000 gauss. Total flux 43,000 maxwells. Both units: vci: 8-16ohms. HC 15W. FR: 30 Hz-20 KHz. ref 1 KHz. Price: £24.

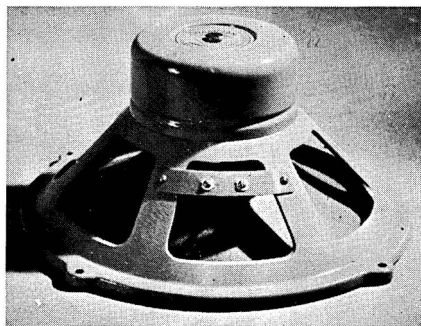

Grampian 1255/15

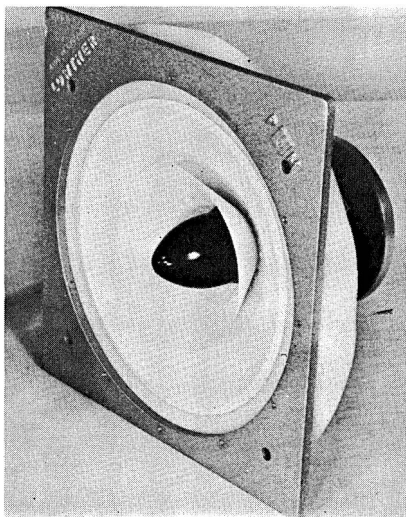

Lowther PM2 Mk 1

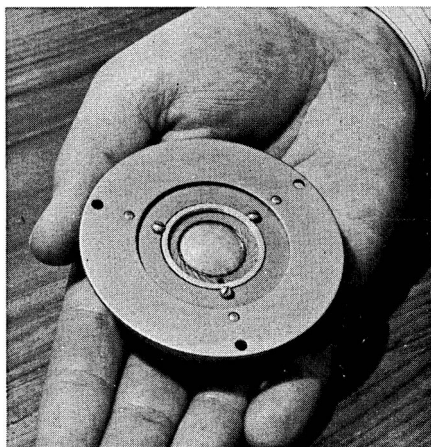

ITT 4001 HF unit

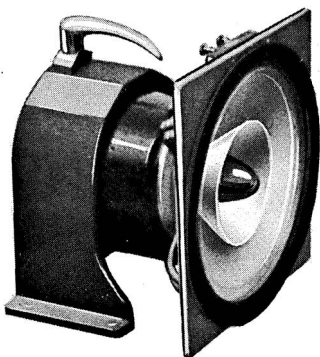

Lowther PM6

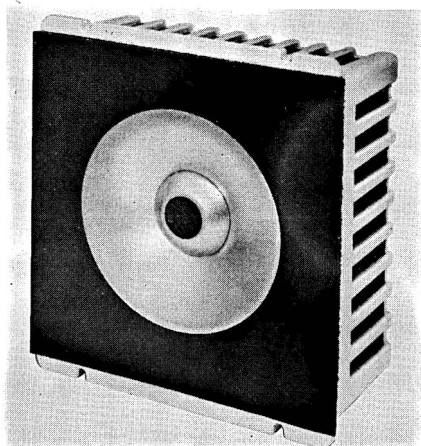

Jordan-Watts speaker drive module

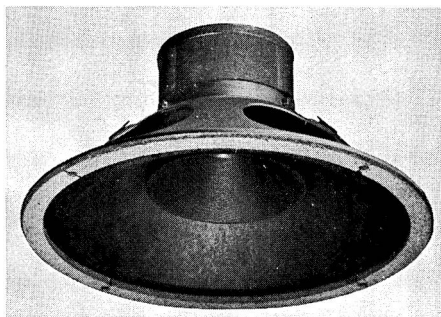

Philips 9710M

T27. High frequency unit. Melinex diaphragm. Plastic case. FR: 3-30 KHz. vci: 8 ohms. HC: 25W. Flux density: 12,500 oersted. Total flux: 24,700 maxwells. Fundamental resonance: 900 Hz. Size: $4\frac{1}{4}$ in. dia \times $1\frac{3}{8}$ in. Weight: 1 lb $6\frac{1}{2}$ oz. Price: £5. \times

B110. Suitable as bass driver in two-way system, or as a mid-range unit in three-way system. FR: 50 Hz-5 KHz. vci: 4-8 ohms. HC: 15W RMS. Flux density: 12,000 oersteds. Total flux: 64,000 maxwells. Fundamental resonance: 35 KHz. Size: $5\frac{1}{8}$ in dia \times $3\frac{1}{8}$ in. Weight: 3 lb 10 oz. Price: £7 (plus £1 12s. 7d. PT).



KELETRON. K. & K. Electronics Ltd., 24 Roman Road, London, E.2. Tel: 01-980 1936.

K126/TC. Twin cone speaker with 1 in. dia magnet pole. Flux density: 6,000 gauss. Total flux: 24,000 maxwells. HC 5W RMS. FR: 45 Hz-15 KHz. Price: £2 17s. 6d.

K1210/TC. 12 in. Twin cone. Flux density: 10,000 gauss. Total flux: 40,000 maxwells. HC 10W RMS. FR: 40 Hz-15.5 KHz. Price: £4 17s. 6d.

K1215/TC. 12 in. Twin cone. Flux density: 11,000 gauss. Total flux: 44,000 maxwells. HC 15W RMS. FR: 35 Hz-17.5 KHz. Price: £5 17s. 6d.

K1220/TC. 12 in. Twin cone. Flux density: 10,000 gauss. Total flux: 100,000 maxwells. HC 20W RMS. FR: 30 Hz-18 KHz. Price: £7 7s.

K1220/PA. 12 in. Single cone. Flux density: 10,000 gauss. Total flux: 100,000 maxwells. HC 20W RMS. FR: 30 Hz-18 KHz. Price: £7 5s.

K1525/SC. 15 in. Single cone. Flux density: 10,000 gauss. Total flux: 100,000 maxwells. HC 25W RMS. FR: 25 Hz-5 KHz. vci: 15 ohms. Price: £10 17s. 6d.

K1570/SC. 15 in. Single cone. Flux density: 17,000 gauss. Total flux: 226,000 maxwells. HC 70W RMS. FR: 25 Hz-5 KHz. vci: 15 ohms. Price: £19 5s.

K18/100. 18 in. Single cone. Flux density: 14,500 gauss. Total flux: 375,000 maxwells. HC 100W RMS. FR: 20 Hz-5 KHz. vci: 15 ohms. Price: £24 17s. 6d.

LOWTHER MANUFACTURING CO., Lowther House, St Mark's Road, Bromley, Kent. Tel: 01-460 5225. Cables: Lowther, Bromley.

★**P.M.6.** 6 in. Selected paper cone. Neoprene rubber surround. Voice coil 39 mm. Gap flux 17,500 gauss. Total flux 196,000 maxwells. HC 6W; 20W. programme material. vci: 16 ohms. FR: 30 Hz-20 KHz. Price: £20 10s.

P.M.6S. As P.M.6 but with stand mounting. Price: £20 10s.

P.M.6 Mk. 1. P.M.6 magnet assembly with a new diaphragm assembly: Lowther Special Silver speech coil, roll surround and back centring providing an improved performance. P.M.6 will still be available as a replacement unit. Price: £23 10s.

P.M.7. 6 in. Selected paper cone. Neoprene rubber surround. Voice coil 39 mm. Gap flux 19,650 gauss. Total flux 250,000 maxwells. HC 6W; 20W programme material. vci: 16 ohms. FR: 30 Hz-20 KHz. Price: £31.

P.M.7S. As P.M.7 but with stand mounting. Price: £31.

★**P.M.2 Mk I.** 6 in. Selected paper cone. Neoprene rubber surround. Voice coil 39 mm. Gap flux 21,000 lines per sq cm. Total flux 281,000 maxwells. HC 6W; 20W programme material. vci: 15 ohms. FR: 30 Hz-20 KHz. Price: £32 5s.

P.M.2 Mk II. 6 in. Selected paper cone. Neoprene rubber surround. Voice coil 39 mm. Gap flux 23,000 gauss. Total flux 350,000 maxwells. HC 6W; 20W programme material. vci: 15 ohms. FR: 25 Hz-22 KHz. Price: £43.

P.M.4. 6 in. Selected paper cone. Neoprene rubber surround. Voice coil 37 mm. Gap flux 24,000 gauss. Total flux 385,000 maxwells. HC 6W; 20W programme material. vci: 16 ohms. FR: 25 Hz-24 KHz. Price: £53 15s.

Full stabiliser for any of Lowther drive units. Price: £1 17s. 6d.



PEERLESS. Peerless Fabrikkerne A/S, Denmark. Distributer: P. F. & A. R. Helme, Summerbridge, Harrogate, Yorks. Tel: Darley 279.

MT 20 HFC. Tweeter, 2 \times 2 in. HC 5W. FR: 2.5-18 KHz.

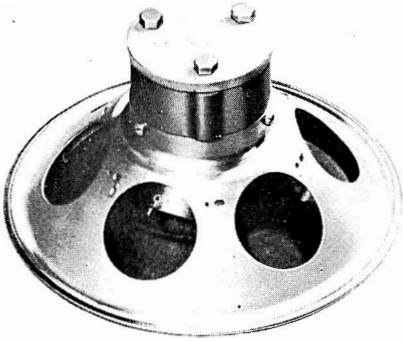

Philips 9710 M

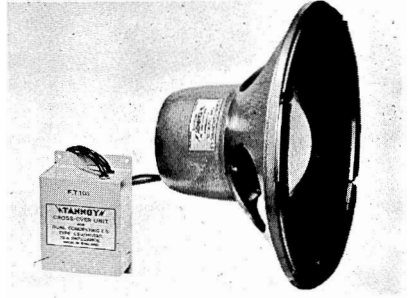

Tannoy Monitor Gold "Twelve"

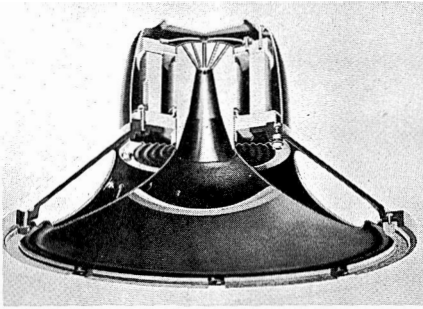

Tannoy 12-in. Gold Dual concentric

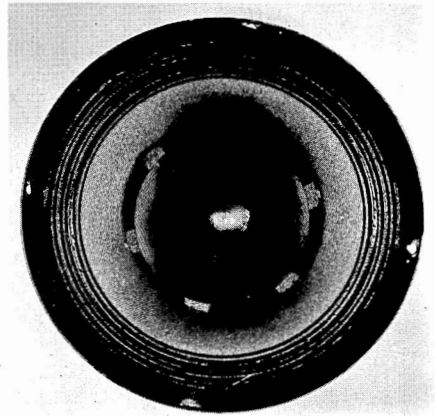

Tripletone Twin cone 8 or 10 in.

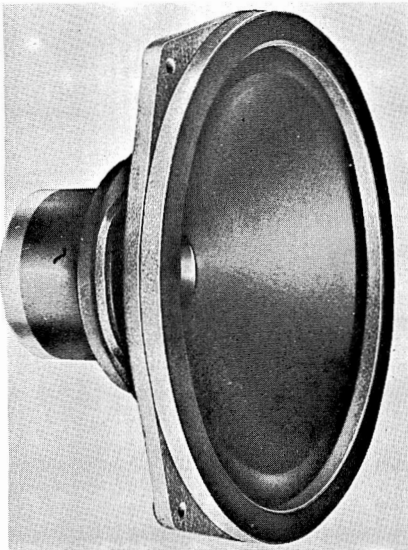

Vitavox K15/40

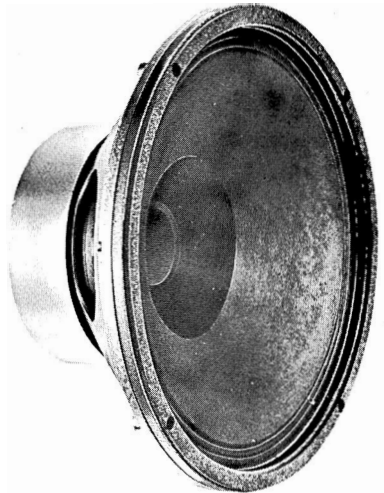

Vitavox AK124

MT 225 HFC. Tweeter, $2\frac{1}{4} \times 2\frac{1}{4}$ in. vci: 16 ohms. HC 5W. FR: 1.5-20 KHz.

MT 25 HFC. Tweeter, $2\frac{1}{2} \times 2\frac{1}{2}$ in. vci: 16 ohms. HC 5W. FR: 1.5-18 KHz.

O 525 WG. Woofer, 5 in. HC 10W. Maxwells: 54,000. Resonant frequency: 40 Hz.

B 65 WG. Woofer, $6\frac{1}{2}$ in. HC 8W. Maxwells: 54,000. Resonant frequency: 50 Hz.

610 W. Woofer, 10×6 in. HC 10W. Maxwells: 54,000. Resonant frequency: 40 Hz.

P 825 W. Woofer, 8 in. HC 12W. Maxwells: 90,000. Resonant frequency: 45 Hz.

L 825 WG. Woofer, 8 in. HC 50W. Maxwells: 64,000. Resonant frequency: 25 Hz.

L 100 WG. Woofer, 10 in. HC 50W. Maxwells: 64,000. Resonant frequency: 20 Hz.

D 100 W(Sp). Woofer, 10 in. HC 40W. Maxwells: 115,000. Resonant frequency: 25 Hz.

CM 120 W. Woofer, 12 in. HC 12W. Maxwells: 90,000. Resonant frequency: 35 Hz.

D 120 WL(Sp). Woofer, 12 in. HC 40W. Maxwells: 115,000. Resonant frequency: 25 Hz.

D 150 WL(Sp). Woofer, 15 in. HC 50W. Maxwells: 115,000. Resonant frequency: 20 Hz.

GT 50 MRC. Mid-range unit. 5 in. dia. HC 3W. FR: 800 Hz-7 KHz. Maxwells: 21,500.

G 50 MRC. Mid-range unit. 5 in. dia. HC 5W. FR: 750 Hz-6 KHz. Maxwells: 42,000.

O 570 MRC. Mid-range unit. Measures 5×7 in. HC 20W. FR: 250 Hz-4.5 KHz. Maxwells: 54,000.



PHILIPS ELECTRICAL LTD., Century House, Shaftesbury Avenue, London, W.C.2. Tel: 01-437 7777. Cables: Phillamps, London.

★**9710M.** 8 in. Dual cone. Paper corrugated surround. Voice coil 1 in. Gap flux 8,000 gauss. Total flux 97,600 maxwells. HC 10W RMS. vci: 7 ohms. FR: 40 Hz-19 KHz. Price: £4 19s. 6d. (plus £1 1s. 4d. PT).

AD5200M. 12 in. Dual cone. Paper corrugated surround. Voice coil $1\frac{1}{4}$ in. Gap flux

11,000 gauss. Total flux 134,000 maxwells. HC 20W. vci: 7 ohms. FR: 35 Hz-15 KHz. Price: £10 10s.



STENTORIAN. See Whiteley Electrical.



TANNOY PRODUCTS LTD., West Norwood, London, S.E.27. Tel: 01-670 1131. Cables: Tannoy, London.

Direct radiator. 12 in. Moulded fibre cone. Plastic treated surround. Voice coil 2 in. Gap flux 14,000 gauss. HC 15W. vci: 20 ohms. FR: 40 Hz-16 KHz. Price: £14 14s.

★**Monitor Gold III LZ.** 12 in. dual concentric. Moulded fibre cone. Plastic impregnated surround. Gap flux (LF) 10,000 (HF) 15,000 gauss. HC 10W. FR: 23 Hz-20 KHz, recommended crossover (supplied) 1 KHz. vci: 15 ohms. Price: £31.

★**Monitor Gold 'Twelve'.** 12 in. Moulded fibre cone. Plastic treated surround. Voice coils (HF and LF) 2 in. Gap flux (LF) 11,500 (HF) 15,000 gauss. HC 30W. FR: 25 Hz-20 KHz, recommended crossover (supplied) 1 KHz. Price: £34 15s.

Monitor Gold 'Fifteen'. 15 in. Moulded fibre cone. Plastic treated surround. Voice coils (HF and LF) 2 in. Gap flux (LF) 13,500 (HF) 18,000 gauss. HC 50W. FR: 23 Hz-20 KHz, recommended crossover (supplied) 1 KHz. Price: £40.



TRIPLETONE MANUFACTURING CO. LTD., 241a The Broadway, Wimbledon, S.W.19. Tel: 01-542 1189.

★**Tripletone 8 in.** Full-range hi-fi unit. 8 in. vci: 2-3 ohms or 15 ohms. Flux density 12,000 lines/sq. cm. Bass resonance 60 Hz. Twin cone. HC 6W RMS. FR: 30 Hz-17 KHz. Price: £4 (plus 19s. 6d. PT).

★**Tripletone 10 in.** Full-range hi-fi unit. 10 in. vci: 2-3 ohms or 15 ohms. Flux density 12,000 lines/sq cm. Bass resonance 55 Hz. Twin cone. HC 8W RMS. FR: 30 Hz-17 KHz. Price: £4 6s. 9d. (plus £1 1s. 3d. PT).

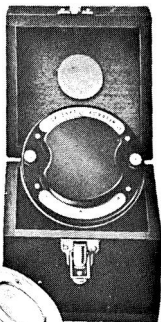

Vitavox S2

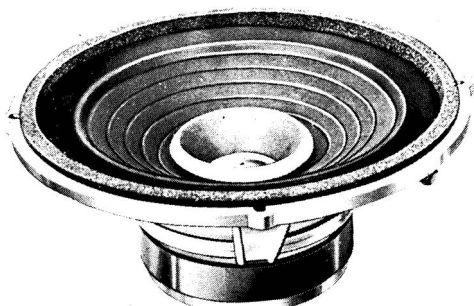

Wharfedale Super 8/RS/DD



Wharfedale Unit 3 kit

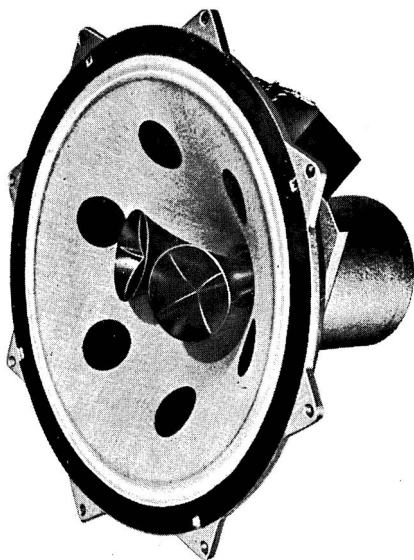

Whiteley 15 in. concentric duplex



Whiteley HF 1016

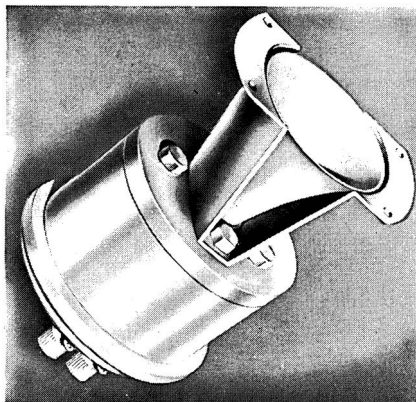

Whiteley T10 HF unit

VITAVOX LTD., Westmoreland Road, London, N.W.9. Tel: 01-205 8671. Cables: Vitavox, London, N.W.9.

Duplex coaxial DU121. 12 in. paper cone. Plastic treated paper surround. 3 in. polyester film cone and surround. Voice coil (LF) 1.78 in. (HF) 0.65 in. Gap flux (LF) 16,000 gauss. (HF) 12,000 gauss. Total flux (LF) 180,000 maxwells, (HF) 15,000 maxwells. HC 15W. vci: 15 ohms. FR: 30 Hz-15 KHz. Price: on application.

AK123 Heavy Duty. 12 in. paper cone. Paper surround. Voice coil 1.78 in. Gap flux 16,000 gauss. Total flux 180,000 maxwells. HC 20W. vci: 15 ohms. FR: 50 Hz-8 KHz. Price: on application.

★**AK124.** 12 in. paper cone. Paper surround. Voice coil 1.78 in. Gap flux 16,000 gauss. Total flux 180,000 maxwells. HC 15W. vci: 15 ohms. FR: 30 Hz-13 KHz. Price: on application.

★**K15/40.** 15 in. paper cone. Paper surround. Voice coil 2¼ in. Gap flux 14,000 gauss. Total flux 260,000 maxwells. HC 40W nominal. FR: 50 Hz-8 KHz nominal. (HC and FR determined by enclosure.) vci: 15 ohms. Price: on application.

AK150. 15 in. paper cone. Treated paper surround. Bass resonance 30-35 Hz. Voice coil 2.25 in. Gap flux 14,000 gauss. Total flux 260,000 maxwells. HC 25W nominal. FR: 30 Hz-5 KHz nominal. (HC and FR determined by enclosure.) vci: 15 ohms. Price: on application.

AK151. Driver for bass horn of dual channel system. 15 in. paper cone, paper surround. Bass resonance 40-50 Hz. Voice coil 2¼ in. Gap flux 14,000 gauss. Total flux 260,000 maxwells. DC resistance of voice coil 5.5-6.5 ohms. HC and FR determined by associated horn characteristics. Price: on application.

AK152. Driver for bass horn of dual channel system. Treated paper surround. Bass resonance 30-35 Hz. Other details as for AK151. Price: on application.

★**S2 HF pressure unit.** Diaphragm pressure-formed from lightweight aluminium alloy. Voice coil 3 in. diameter. Gap flux 16,000 gauss. Total flux 150,000 maxwells. HC above 200 Hz 10W. Nominal FR: 200 Hz-16 KHz. Rec crossover 500 Hz. Price: on application.

HF Dispersive Horn. Designed for use with S2

pressure unit. Cast in aluminium alloy. Non-resonant. Cut-off frequency 300 Hz. Price: on application.



WHARFEDALE. Rank Wharfedale Ltd., Bradford Road, Idle, Bradford, Yorkshire. Tel: Bradford 612552. Cables: Wharfedel, Idle, Bradford. Telex: 51407.

8 in. Bronze/RS/DD. Full-range 8 in. unit. Paper cone with double diaphragm. Fabric roll surround. Voice coil 1 in. (aluminium). vci: 8-15 ohms. Gap flux 10,500 gauss. Total flux 41,500 maxwells. HC 4W RMS. FR: 50 Hz-20 KHz. Price: £3 9s. 11d. (plus 17s. 1d. PT).

★**Super 8/RS/DD.** Full-range 8 in. unit. Paper cone with double diaphragm. Fabric roll surround. Voice coil 1 in. (aluminium). vci: 8-15 ohms. Gap flux 14,500 gauss. Total flux 60,000 maxwells. HC 6W RMS. 12W peak. FR: 40 Hz-20 KHz. Price: £6 0s. 6d. (plus £1 9s. 6d. PT).

Super 10/RS/DD. Full-range 10 in. unit. Paper cone with double diaphragm. Fabric roll surround. Voice coil 1 in. Gap flux 16,000 gauss. Total flux 85,000 maxwells. HC 10W RMS. vci: 8-15 ohms. FR: 30 Hz-20 KHz. Price: £10 0s. 11d. (plus £2 9s. 1d. PT).

Unit 3. See Constructional Kits.



WHITELEY ELECTRICAL RADIO CO. LTD., Victoria Street, Mansfield, Notts. Tel: Mansfield 24762. Cables: Whitebon, Mansfield.

Stentorian HF.812. 8 in. Composite (paper and cambric) cone. Cambric surround. Voice coil 1 in. Gap flux 12,000 gauss. Total flux 47,400 maxwells. HC 5W, vci: universal (3, 7.5 and 15 ohms). FR: 50 Hz-12 KHz. Price: £4 11s. 8d. (plus £1 2s. 8d. PT).

H.F.816. 8 in. Composite (paper and cambric) cone. Cambric surround. Voice coil 1 in. Gap flux 16,000 gauss. Total flux 63,000 maxwells. HC 6W. vci: universal 3, 7.5 and 15 ohms. FR: 50 Hz-14 KHz. Price: £7 10s. 10d. (plus £1 17s. 3d. PT).

H.F.912. 9 in. Composite (paper and cambric) cone. Cambric surround. Voice coil 1 in. Gap flux 12,000 gauss. Total flux 47,400 maxwells. HC 7W. vci: universal (3, 7.5 and 15 ohms). FR: 40 Hz-13 KHz. Price: £4 16s. 8d. (plus £1 3s. 10d. PT).

H.F.912/67. 9 in. die cast. Speech coil: alu-

minium. Pole dia: 1 in. Magnet system: 1·2 Webers/m². vci: 15 ohms. HC 10W. Price: £5 14s. 5d. (plus £1 8s. 3d. PT).

H.F.916. 9 in. Composite (paper and cambric) cone. Voice coil 1 in. Gap flux 16,000 gauss. Total flux 63,000 maxwells. HC 7W. vci: universal (3, 7·5 and 15 ohms). FR: 40 Hz-14 KHz. Bass resonance 45 Hz. Price: £7 16s. 1d. (plus £1 18s. 7d. PT).

H.F.1012. 10 in. Composite (paper and cambric) cone. Cambric surround. Voice coil 1 in. Gap flux 12,000 gauss. Total flux 47,400 maxwells. HC 10W. vci: universal 3, 7·5 and 15 ohms. FR: 30 Hz-14 KHz. Price: £5 10s. 3d. (plus £1 7s. 3d. PT).

★**H.F.1016.** 10 in. Composite (paper and cambric) cone. Cambric surround. Voice coil 1 in. Gap flux 16,000 gauss. Total flux 63,000 maxwells. HC 10W. vci: 3, 7·5 and 15 ohms. FR: 30 Hz-15 KHz. Price: £8 16s. 1d. (plus £2 3s. 6d. PT).

H.F.1016 Major. 10 in. Paper cone. Cambric surround. Voice coil 1 in. (aluminium). vci: 15 ohms. Gap flux 16,000 gauss. Total flux 64,000 maxwells. HC 10W. FR: 60 Hz-16 KHz or 30 Hz-16 KHz (depending upon cabinet). Price: £11 6s. 8d. (plus £2 16s. PT).

10 in. Concentric Duplex. Composite (paper and cambric) cone. Cambric surround. Voice coil 1 in. Gap flux (LF) 12,000 (HF) 13,000 gauss. Total flux 47,400 maxwells. HC 10W. vci: 15 ohms. FR: 30 Hz-14 KHz. rcf 3 KHz built-in. Price: £14 16s. 9d. (plus £3 13s. 4d. PT).

H.F.1214. 12 in. Composite (paper and cambric) cone. Cambric surround. Voice coil 1·5 in. Gap flux 14,000 gauss. Total flux 106,000 maxwells. HC 15W. vci: 15 ohms. FR: 25 Hz-14 KHz. Price: £15 1s. 8d.

H.F.1214/67. 12 in. bass loudspeaker. Speech coil: copper. Pole dia: 1½ in. Magnet system: 1·4 Webers/m². vci: 15 ohms. Price: £16 13s. 10d.

H.F.1216. Composite (paper and cambric) cone. Cambric surround. Voice coil 1½ in. Gap flux 16,000 gauss. HC 15W. FR: 20 Hz-16 KHz. Price: £23 2s. 6d.

12 in. Concentric Duplex. Composite (paper and cambric) cone. Cambric surround. Series-gap Alcomax III magnet. LF gap flux 14,000 gauss. HF gap flux 17,000 gauss. Total flux 220,000 maxwells. vci: 15 ohms. Built-in crossover. FR: 25 Hz-17 KHz. Bass resonance

35Hz. HC 15W. Pressuredie-cast Mazakchassis. HF metal diaphragm protected and loaded by central pressure horn. Price: £40 7s. 6d.

★**15 in. Concentric Duplex.** Composite (paper and cambric) cone. Cambric surround. Voice coil 2 in. Gap flux (LF) 14,000 (HF) 17,000 gauss. Total flux 350,000 maxwells. HC 25W. vci: 15 ohms. FR: 20 Hz-18 KHz. rcf 3 KHz built-in. Price: £66 1s. 5d.

H.F.1514. 15 in. Composite (paper and cambric) cone. Cambric surround. Voice coil 2 in. Gap flux 14,000 gauss. Total flux 178,000 Maxwells. HC 25W. vci: 15 ohms. FR: 25 Hz-5 KHz. rcf 1·5-3 KHz. Price: £38 3s. 3d.

★**T.10 Tweeter.** Aluminium cone and surround. Voice coil 1 in. Gap flux 14,000 gauss. Total flux 44,000 maxwells. HC 5W. vci: 15 ohms. FR: 2-14 KHz. rcf 3 KHz. Price: £6 9s. 9d.

T.12 Tweeter. Aluminium cone and surround. Voice coil 1·5 in. Gap flux 17,000 gauss. Total flux 110,000 maxwells. HC 12W. vci: 15 ohms. FR: 2-17 KHz. rcf 3 KHz. Price: £19 8s. 4d.

T.816. 8 in. Paper cone and surround. Voice coil 1 in. Gap flux 16,000 gauss. Total flux 63,000 maxwells. HC 15W. vci: 15 ohms. FR: 1·5-17 KHz. rcf 1·5 KHz. Price: £7 2s. 11d. (plus £1 15s. 4d. PT).

★**T.359.** 3½ in. Paper cone and surround. Voice coil 0·625 in. Gap flux 9,000 gauss. Total flux 14,900 maxwells. HC 15W with crossover. vci: 5 or 15 ohms. FR: 3-17 KHz. rcf 3 KHz. Price: £1 18s. 6d. (plus 9s. 6d. PT).

T812/67. 8 in. middle and high frequency loudspeaker. Speech coil: aluminium. Pole dia: 1 in. Magnet system: 1·2 Webers/m². vci: 15 ohms. ¼ section crossover unit 1 KHz. Price: £5 9s. 5d. (plus £1 7s. PT).



L. G. WOOLLETT & COMPANY LTD., 21 Anerley Station Road, London, S.E.20. Tel: 01-778 9003.

12 in. L.R. Low resonance 12 in. dynamic unit. Paper cone with foam surround. HC 16W RMS. FR: 20 Hz-5 KHz. Special unit for use with Woollett electrostatic treble speakers. Price: £12 15s.

Type C. Constant charge push-pull electrostatic. vci: 16 ohms. HC 16W RMS. FR: 1·5 KHz-20 KHz. Integral crossover. Attenuator, mains polariser. Rear sealed for mounting in bass cabinet behind horizontal 9 × 6½ in. aperture. Price: £19.

**V
A
R
I
A
T
I
O
N
S**

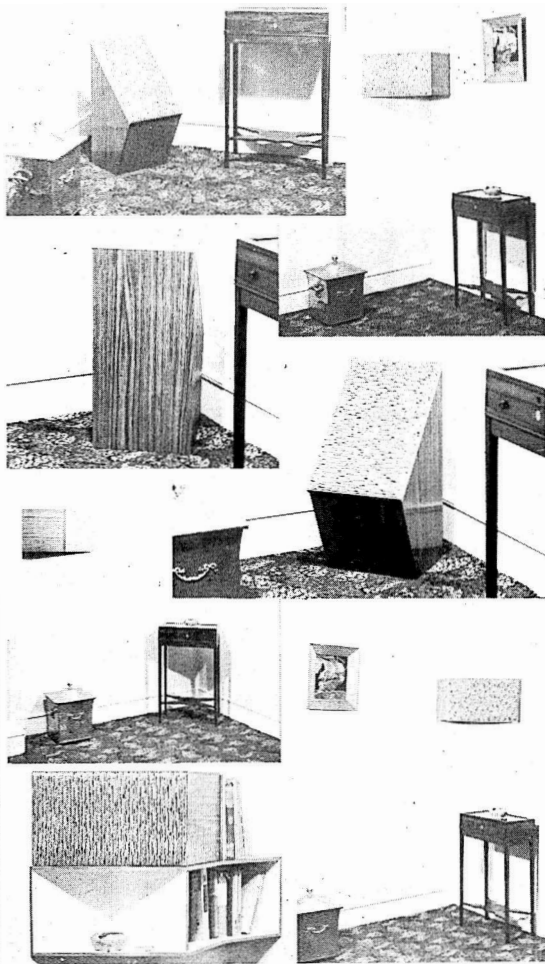

**ON AN ORIGINAL THEME
BY THE MOST VERSATILE HI-FI
LOUDSPEAKER IN THE WORLD**

**THE OMNI...
...BY RECTAVOX**

**THE RECTAVOX COMPANY
CENTRAL BUILDINGS, WALLSEND
NORTHUMBERLAND. Tel: 624845**

DIRECTORY OF SPEAKER ACCESSORIES

RICHARD ALLAN RADIO LTD., Bradford Road, Gomersal, Cleckheaton, Yorkshire. Tel: Cleckheaton 2442/3. Cables. Acoustics, Bradford.

CN.54 Crossover Unit. Two-way quarter section. Recommended for use with CR5 bass unit and 460TC tweeter. Crossover frequency 5 KHz. 4-8 or 15 ohms. Price: £2.

CN.104 Crossover Unit. A two-way half-section parallel network. Crossover frequency 5 KHz. 4-8 or 15 ohms. Price: £2 10s.

CN.1284 Crossover Unit. A three-way crossover with main crossover operating from half wave parallel network and subsidiary crossover capacity fed. Crossover frequencies 1,100 Hz and 5 KHz. 8 or 15 ohms. Price: £3 15s.

TM156. Matching transformer for matching 4-8 ohms to 15 ohms (or vice versa). HC 20W. Price: £2 15s.

★

BANG AND OLUFSEN (UK) LTD., Eastbrook Road, Gloucester. Tel: Gloucester 21591.

Beolab 6006 Spread Unit. Provides connection for a centre speaker from stereo amplifier. Connects between amplifier and speakers. Single control to vary the width of stereo effect. Can also be used as headphone output. Price: £6 10s.

★

CELESTION LTD., Ferry Works, Thames Ditton, Surrey. Tel: 01-398 3402. Cables: Voice-coil, Thames Ditton.

CO3K crossover. Designed specially for use with Studio 12 and HF1300 Mk 2 units but equally suitable for use with any efficient bass and treble combination. Air-tight terminal assembly with flange mounting. Full half-section filter network. 12 dB per octave cut-off at 3 KHz. Size: $3\frac{7}{8}$ in. long, $2\frac{7}{8}$ in. diameter of body, $3\frac{3}{4}$ in. diameter of flange. Price: £2 14s.

EAGLE PRODUCTS. Distributors: B. Adler & Sons (Radio) Ltd., Coptic Street, London, W.C.1. Tel: 01-636 9606/7. Cables: Reldab, London.

CN.23 and CN.216. Two-way speaker crossover networks. Cross-over frequency 3 KHz. CN.23, 3 ohms; CN.216, 16 ohms. Price: 17s. 4d

★ **LS.2W.** Stereo headphone control unit with provision for two sets of phones. A and B channel switching.

★

EMI SOUND PRODUCTS LTD., Hayes, Middlesex. Tel: 01-573 3888. Cables: Emi-sound, London.

Crossover network 99970B. Combines any 3 ohm LF driver with two 15 ohm HF tweeters in parallel. Price on application.

Crossover network 99970F. Combines any 15 ohm LF driver with two 8 ohm HF tweeters in series. Price on application.

Networks available for all other speaker combinations. Separate chokes and capacitors for crossover networks. Prices and details on application.

★

FANE ACOUSTICS LTD., Hick Lane, Batley, Yorks. Tel: Batley 2114. Cables: Fane, Batley.



Eagle control centre

SPEAKERS



M.A.C. AAU-HP adaptor



M.A.C. AAU-VC adaptor

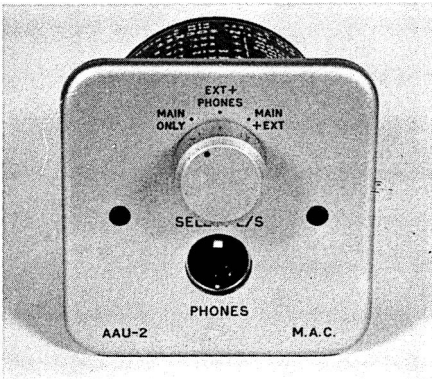

M.A.C. AAU-2 adaptor

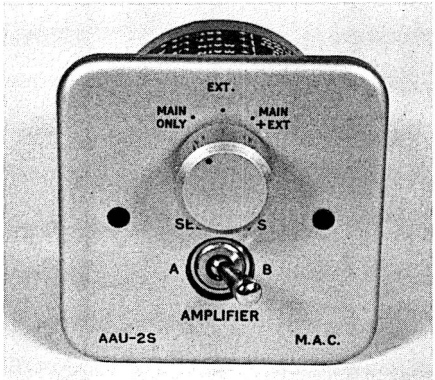

M.A.C. AAU-2S adaptor

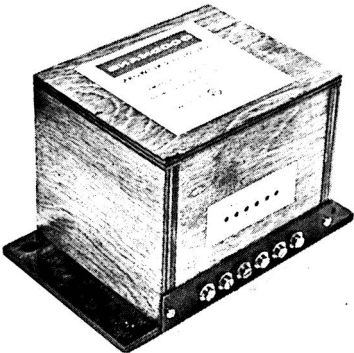

Goodmans XO/950

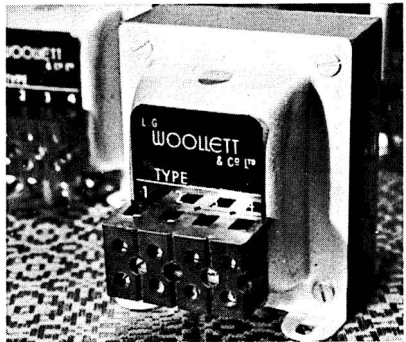

Woollett XSI and XS2

Model 2X1. Crossover unit for two-speaker system. Crossover frequency 2 KHz. 15 ohms. Cut-off 6 dB/octave. Size: $5\frac{5}{8} \times 3\frac{1}{4} \times 1\frac{1}{2}$ in. Price: £4.

Model 3X1. Crossover unit for three-speaker system. Crossover frequencies 800 Hz and 5 KHz. Impedance 15 ohms. Cut-off 6 dB/octave. Size: $5\frac{5}{8} \times 3\frac{1}{4} \times 2\frac{1}{2}$ in. Price: £5.

Model 3X2. Crossover for three-speaker system. Similar to one used in Ionofane 602 and 603. Crossover frequencies 800 Hz and 3.5 KHz. Matching impedance 15 ohms. Cut-off 12 dB/octave. Size: $6 \times 5\frac{1}{4} \times 2\frac{3}{4}$ in. Price: £6 5s.



GOODMANS LOUDSPEAKERS LTD., Axiom Works, Wembley, Middx. Tel: 01-902 1200. Cables: Goodaxiom, Wembley.

XO/5000-Crossover Unit. A two-way half-section crossover network, operating at 5 KHz. All terminations 15 ohms. Price: £2 6s.

★**XO/950-Crossover Unit.** A two-way half-section, crossover network, operating at 950 Hz. All terminations 15 ohms. Price: £6 7s. 9d.

XO/950/5000. Crossover Network. A multiple crossover network comprising four half-section LC filters. Crossover frequencies are 950 Hz and 5 KHz. All attenuation rates are 12 dB/octave. All terminations 15 ohms. Price: £8 8s. 7d.

Attenuator. 12 dB, eight steps. Price: £3 1s. 4d.

ARU.172. For use with 12 in. range. Price £3 17s. 8d.

ARU.180. For use with one Axiom 80. Price £3 17s. 8d.

ARU.280. For use with two Axiom 80s or Audiom 81 bass. Price: £3 17s. 8d.



GEOFFREY GOODWIN HI-FI LTD., 137 Hale Lane, Edgware, London, N.W.7. Tel: 01-959 2988.

GG Audio Switch. Provides headphone connections and extra speaker connections from amplifier speaker outputs. Stereo.

M.A.C. ELECTRONIC COMPANY, Ripley, Surrey. Tel: Dunsfold 310.

★**AAU2S.** Audio adaptor unit. Connects two pairs of speakers to either of two amplifiers selected by toggle switch. 3-way switching gives combination of speakers. Two 4 ft connecting cables. Size: $3 \times 3 \times 3$ in. Jaguar silver finish. Prices on application.

★**AAU-VC.** Audio adaptor unit for attenuating extension speakers. Attenuation: Total -20 dB in 2 dB steps. Off position. Headphone jack. 20W per channel. FR: 20 Hz-20 KHz ± 2 dB. Channel balance within 0.1 dB. Separation -85 dB. Negligible damping loss. Teak case. Size: $3\frac{1}{4} \times 3\frac{1}{4} \times 3\frac{1}{2}$ in. Mono version available. Prices on application.

Various other combinations of audio adaptor units are offered covering connecting and switching TV sound, headphones, etc. full details on request.



STENTORIAN. See Whiteley Electrical.



VITAVOX LTD., Westmoreland Road, London, N.W.9. Tel: 01-205 8671. Cables: Vitavox, London, N.W.9.

CN232 Crossover. Half section. Crossover 500 Hz. Attenuation 12 dB/octave. All terminations 15 ohms. Balance control giving 0.8 dB HF attenuation incorporated. Price: on application.

CN233 Crossover. Half section. Crossover 1 KHz. Attenuation 12 dB/octave. All terminations 15 ohms. Balance control giving 0.8 dB HF attenuation incorporated. Price: on application.



WHITELEY ELECTRICAL RADIO CO. LTD., Victoria Street, Mansfield, Notts. Tel: Mansfield 24762-5. Cables: Whitebon, Mansfield.

CX500 Crossover unit. A two-way half-section crossover network operating at 500 Hz. All terminations 15 ohms. Price: £2 0s. 6d.

CX1000 Crossover unit. As CX500, but operating at 1 KHz. Price: £2 18s. 11d.

CX1500 Crossover unit. As CX500, but operating at 1.5 KHz. Price £2 18s. 11d.

CX3000 Crossover unit. As CX1500, but operating at 3 KHz. Price: £2 6s. 6d.

Constant impedance volume control. T-pad type attenuator having 10 steps of attenuation. Impedance presented by the load remains constant while the volume level is varied. In three versions for 3, 8 or 15 ohms. Price: £1 12s. 4d.



L. G. WOOLLETT AND COMPANY LTD.,
21 Anerley Station Road, London, S.E.20. Tel:
01-778 9003.

XS1. Speaker matching transformer. Converts 16 ohms to 8 ohms, and 8 ohms to 4 ohms. Bifilar wound. Grain orientated laminations. Ratio 1:0.707 auto. FR: 16 Hz-30 KHz ± 0.6 dB. Price: £3 5s.

XS2. Speaker isolating and matching transformer. Converts 16 ohms to 4 ohms. Bifilar wound. Grain orientated laminations. Ratio 1:1 double wound. FR: 16 Hz-100 KHz ± 0.6 dB. May be used to attenuate -6 dB and -12 dB while maintaining heavy damping on speaker and offering correct load to amplifier. Suitable for operating stereo system comprising dual electrostatic high-frequency units with common bass driver. *Note:* Not suitable for mains isolation in live chassis equipment. Price: £3 5s.

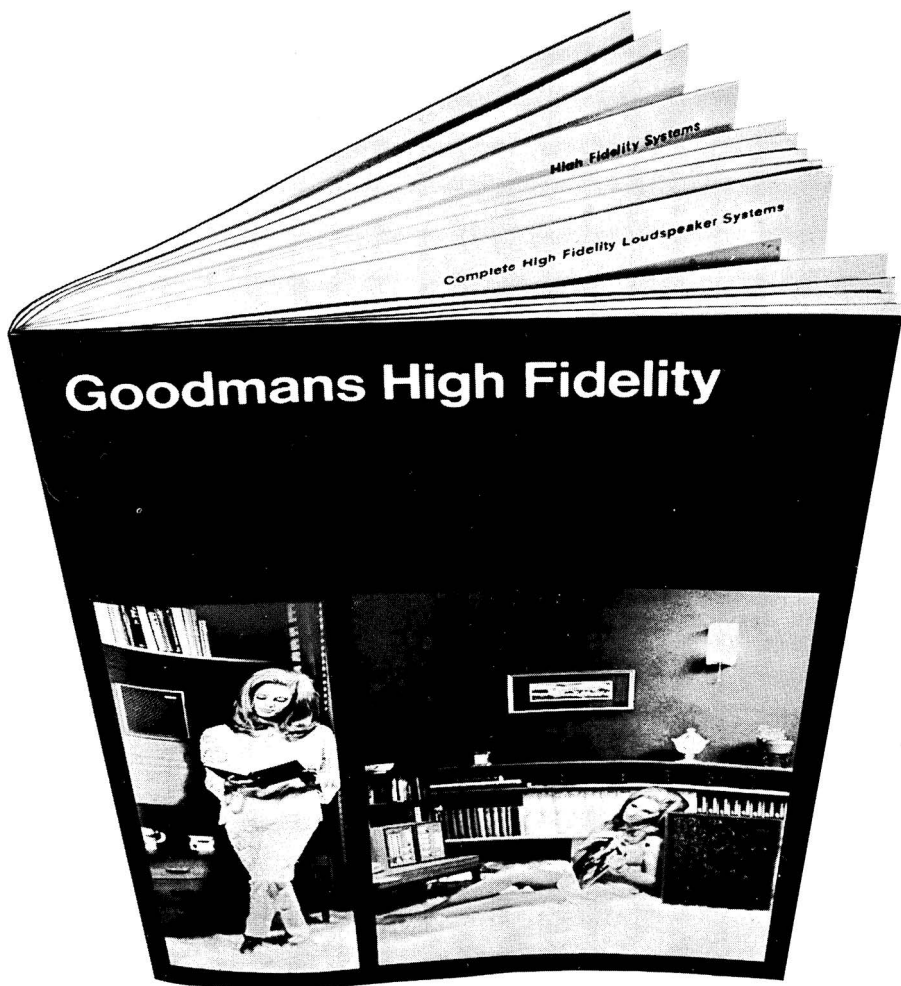

Goodmans High Fidelity

Thinking of High Fidelity? - first read **Goodmans Manual**

Goodmans High Fidelity Manual is of interest to beginners and enthusiasts alike – with articles on Stereo; an Introduction to High Fidelity; Stage-built systems; as well as full details of Goodmans High Fidelity audio products.

Send for your free copy today.

Goodmans Loudspeakers Limited

Axiom Works, Wembley, Middlesex. Tel: 01-902 1200

Please send me a free copy of
Goodmans 28 page Manual



Name

Address

.....

.....

DIRECTORY OF SPEAKER ENCLOSURES

Abbreviations: **HC**=handling capacity; **FR**=frequency range; **c/o**=cut off; **vci**=voice coil impedance; **ref**=recommended crossover frequency; **Rec**=recommended units; Height by Width by Depth are generally the order of printed dimensions. ★ indicates model is illustrated.

Acoustical Mfg. Co., See Quad.



AKAI. U.K. distributors: Pullin Photographic (Rank Organization), P.O. Box 70, Great West Road, Brentford, Middx. Tel: 01-568 9222.

SW160. Reflex speaker enclosure with 2 in. tweeter, $1\frac{3}{4}$ in. super tweeter, 2 in. horn tweeter, $5\frac{1}{4}$ in. mid-range, $6\frac{1}{2}$ in. mid-range and 12 in. bass. Crossover: 800 Hz, 5 KHz, 10 KHz, network 12 dB per octave. FR: 25 Hz-22 KHz. HC 60W. vci: 8 ohms. Dimensions: $27\frac{1}{8} \times 17\frac{3}{4} \times 11\frac{7}{8}$ in. Weight: 52.8 lb. Finish: walnut. Price: £90.

SW130. Speaker enclosure with 12 in. bass unit and 3 in. tweeter. FR: 50 Hz-18 KHz. HC 25W. vci: 8 ohms. Dimensions: $22\frac{1}{2} \times 16\frac{1}{2} \times 12\frac{1}{8}$ in. Weight: 28.9 lb. Finish: walnut. Price: £36.



RICHARD ALLAN RADIO LTD., Bradford Road. Gomersal, Cleckheaton, Yorkshire. Tel: Cleckheaton 2442/3. Cables: Acoustics, Bradford.

Minette. Infinite baffle bookshelf enclosure. 5 in. bass unit, 4 in. tweeter. FR: 50 Hz-17 KHz. HC 10W. Size: $11\frac{1}{2} \times 7 \times 6\frac{1}{2}$ in. Weight: 9 lb. Price: £13 (plus £3 3s. 5d. PT) including units.

High Fidelity Module. Integrated speaker assembly comprising 5 in. bass unit, 4 in. tweeter and crossover network mounted on aluminium alloy baffle for direct mounting into small bookshelf enclosure. Price: £8 10s. (plus £1 17s. 6d. PT).

Pavane. Full-range three-way system comprising 12 in. bass unit, 8 in. mid-range speaker and 4 in. tweeter. FR: 30 Hz-17 KHz. HC 15W. Size: $25\frac{1}{2} \times 15\frac{1}{2} \times 12$ in. Price: £32.

Chaconne. Full range two-way system comprising 8 in. bass unit and 4 in. tweeter. FR: 40 Hz-17 KHz. HC 10W. Size: $20 \times 12 \times 9$ in. Price: £15 15s. (plus £3 16s. 10d. PT).

ALTEC LANSING. Distributors: Carston Electronics Ltd., 71 Oakley Road, Chinnor, Oxon. Tel: Kinston Blount 8561.

890A Bolero. Horn enclosure with speakers and crossover. 10 in. bass driver and Altec 3000H multicellular horn and driver. Crossover: 3 KHz dual element with variable shelving control. FR: 35 Hz-20KHz. HC 20W RMS. 10 lb. magnet on bass driver. Size: $14\frac{1}{2} \times 25\frac{3}{4} \times 12$ in. Hand-rubbed walnut. Price: £77.



ARENA. Distributors: Highgate Acoustics Ltd., 184-188 Great Portland Street, London, W.1. Tel: 01-636 2901.

HT7. Pressure chamber speaker system. One $8\frac{1}{4}$ in. bass unit, one 2 in. treble unit. Impedance: 4 ohms. HC 10W RMS. FR: 50 Hz-20 KHz. Built-in crossover. Cabinet in teak or Brazilian rosewood. Size: $20\frac{1}{2} \times 9\frac{7}{8} \times 10\frac{5}{8}$ in. Price: £1919s. (including PT).

HT10. Pressure chamber speaker system. One 8 in. unit, one 2 in. unit. HC 10W RMS. FR: 40 Hz-20 KHz. Teak or Brazilian rosewood. Size: $22\frac{3}{4} \times 5\frac{1}{8} \times 16\frac{1}{8}$ in. Price: £22 1s. (including PT).

HT14. Pressure chamber speaker system. One 7×5 in. unit, one $2\frac{1}{2}$ in. unit. HC 10W RMS. FR: 60 Hz-20 KHz. Teak or Brazilian rosewood. Size: $6\frac{1}{4} \times 10\frac{5}{8} \times 11$ in. Price: £15 4s. 6d. (including PT).

HT17. Pressure chamber speaker system. One $5\frac{3}{4}$ in., one $2\frac{1}{2}$ in. units. HC 10W. RMS. FR: 70 Hz-20 KHz. Teak, Brazilian rosewood or oak. Size: $12\frac{5}{8} \times 9\frac{7}{8} \times 4\frac{3}{8}$ in. Price: £15 4s. 6d. (including PT).

HT18. Pressure chamber speaker system. One $5\frac{3}{4}$ in., one $2\frac{1}{2}$ in. units. HC 25W RMS. FR: 20 Hz-20 KHz. Teak or Brazilian rosewood. Size: $25 \times 16 \times 10\frac{1}{4}$ in. Price: £40 19s.

★ **HT20**. Pressure chamber speaker system. $8\frac{1}{4}$ in. bass driver, $2\frac{1}{2}$ in. tweeter. HC 15W RMS. FR: 30 Hz-30 KHz. Crossover 4 KHz. Finish: Teak or rosewood. Size: $16\frac{7}{8} \times 11 \times 9\frac{1}{2}$ in. Weight: $17\frac{3}{4}$ lb. Price: £32 11s. (including PT).

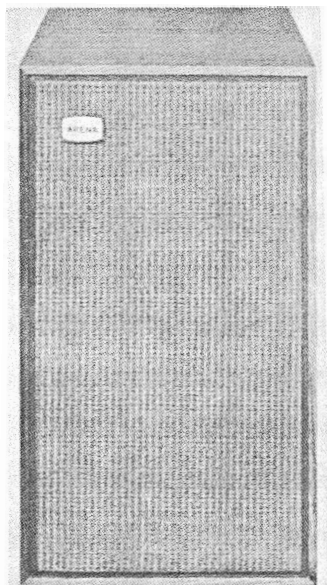

Arena HT20

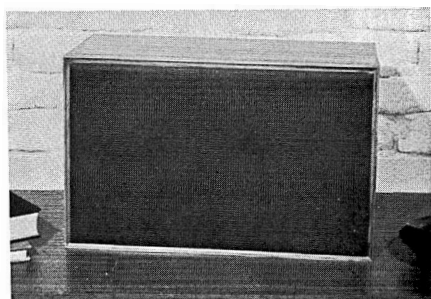

Audio and Design D15/40

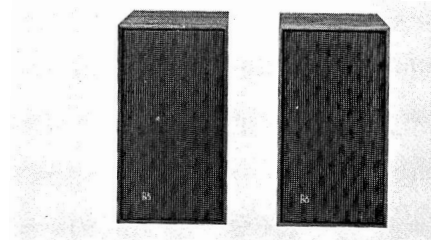

Bang and Olufsen Beovox 500

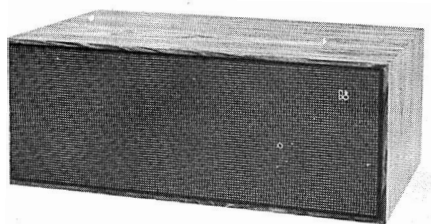

Bang and Olufsen Beovox 1000

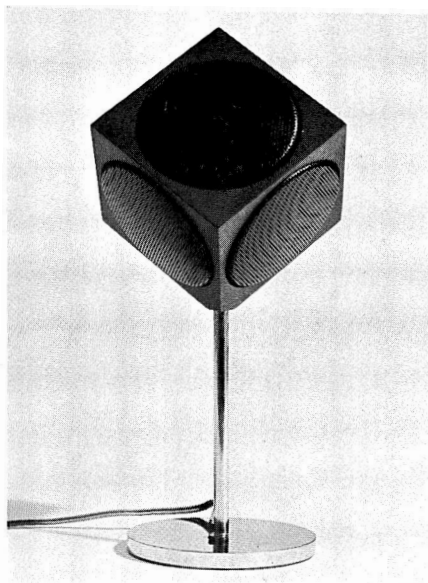
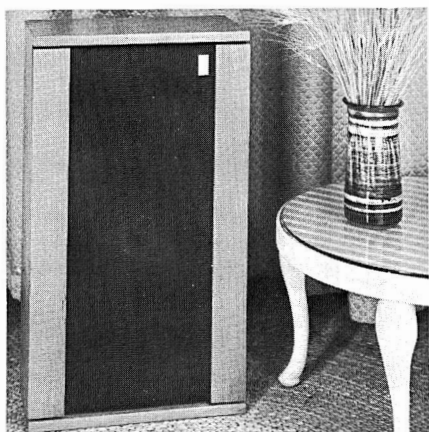

Bang and Olufsen Beovox 2500

Audio and Design D15/30

HT19. Extension speaker. One 6 in. unit. HC 3W RMS. FR: 70 Hz-18 KHz. Teak or rosewood finish. Dimensions: $14\frac{1}{2} \times 9\frac{3}{4} \times 2\frac{3}{8}$ in. Price: £7 17s. 6d. (including PT).

HT21. Pressure chamber speaker. One 6×4 in. FR: 60 Hz-18 KHz. Finish: teak or rosewood. Size: $4\frac{7}{16} \times 9\frac{3}{8} \times 7\frac{3}{8}$ in. Specially designed to match the T1500F. Price: £10 10s. (inc. PT).

HT25. Pressure chamber speaker. vci: 8 ohms. Low frequency units, two active and one passive diffuser 11×7.5 in.; mid-range units, three 4.5 in.; high frequency units, four 1 in. tweeters. HC 90W sine wave. FR: 18 Hz-20 KHz ± 6 dB. Rosewood finish. Size: 33 (on steel legs) $\times 25\frac{1}{4} \times 12\frac{9}{16}$ in. Weight: 112.6 lb. Price: £157 10s.

HT26. Pressure chamber speaker. vci: 8 ohms. One 12 in., one 7×5 in., two 2.5 in. tweeters. HC 60W RMS. FR: 20 Hz-20 KHz ± 6 dB. Rosewood finish. Size: $25\frac{1}{2} \times 19\frac{1}{16} \times 11\frac{3}{4}$ in. Weight: 50.6 lb. Price: £78 15s.



AUDIO AND DESIGN. Keith Monks (Audio) Ltd., 54 Rounton Road, Church Crookham, near Aldershot, Hants. Tel: Fleet 3566.

Titan-Minor. No-compromise bookshelf speaker system. Incorporates one TCL module. Cabinet designed as low friction phase inverter to provide optimum load to driver. HC 15W RMS over specified range (30W music rating). Finish: teak. Size: $17\frac{1}{2} \times 11 \times 8\frac{1}{2}$ in. FR: 40 Hz-22 KHz. Weight: 20 lb. Price: £29 17s. 6d.

★ **D15/30 Titan.** Free-standing home speaker system. Incorporates one TCL module. Enclosure designed to match mechanical impedance of the module to the acoustical impedance of the air load. HC 15W RMS. FR: 30 Hz-22 KHz. Finish: teak. Size: $28 \times 17\frac{1}{2} \times 7\frac{1}{2}$ in. Weight: 37 lb. Price: £39 15s.

D30/30 Titan-Major. Free-standing home speaker system. Designed for larger rooms. Electrical delay circuit to shape sound distribution. HC 30W RMS over specified range (60W music rating). FR: 30 Hz-22 KHz. Finish: teak. Size: $33 \times 19\frac{1}{2} \times 9\frac{1}{2}$ in. Weight: 51 lb. Price: £70.



BANG & OLUFSEN U.K. DIVISION, Eastbrook Road, Gloucester. Tel: Gloucester 21591.

★ **Beovox 500.** Pressure chamber with speakers

and crossover. 4×6 in. bass driver, $2\frac{1}{2}$ in. tweeter. Crossover 5 KHz. FR: 65 Hz-18 KHz. HC 5W. vci: 4 ohms. Finish: teak or rosewood. Size: $11 \times 5\frac{7}{8} \times 9\frac{3}{4}$ in. Weight: $6\frac{1}{2}$ lb. Price: (teak) £11 15s. 9d. (plus £2 19s. 3d. PT).

★ **Beovox 1000.** Pressure chamber with speakers and crossover. 6 in. bass driver, $2\frac{1}{2}$ in. tweeter. Crossover 5 KHz. FR: 55 Hz-18 KHz ± 5 dB. HC 10W RMS. Impedance 4 ohms. Finish: teak or rosewood. Size: $18\frac{1}{2} \times 7\frac{1}{2} \times 9\frac{1}{2}$ in. Weight: 11 lb. Price (teak): £16 11s. 9d. (plus £4 3s. 3d. PT).

★ **Beovox 1600.** Pressure chamber with speakers and crossover. Crossover 4 KHz. FR: 50 Hz-20 KHz. HC 15W. vci: 4 ohms. Finish: teak or rosewood. Size: $13\frac{3}{4} \times 17\frac{1}{2} \times 4\frac{1}{4}$. Price: on application.

Beovox 2200. Pressure chamber with two speakers and crossover (5 KHz). FR: 50 Hz-18 KHz. HC 10W. vci: 4 ohms. Finish: teak or rosewood. Size: $11\frac{1}{4} \times 6\frac{3}{4} \times 10$ in. Price (teak): £19 7s. 9d. (plus £4 17s. 3d. PT).

Beovox 2400. Pressure chamber with three speakers and crossover (500 Hz and 5 KHz). FR: 40 Hz-18 KHz. HC 20W. vci: 4 ohms. Finish: teak or rosewood. Connection for high frequency unit. Size: $9\frac{1}{2} \times 23\frac{1}{2} \times 10\frac{3}{4}$ in. Price (teak): £28 11s. (plus £7 3s. 6d. PT).

★ **Beovox 2500.** High frequency unit. Comprises six 2 in. tweeters, one in each face of a $3\frac{3}{4}$ in. cube. High pass filter included. FR: 2 KHz-18 KHz. HC 60W. vci: 4 ohms. Black with chrome base and stem. Size: 11 in. overall height. Price: £20 11s. 9d. (plus £5 3s. 3d. PT).

Beovox 3000 Mk II. Pressure chamber with two speakers and crossover (at 2 KHz). FR: 28 Hz-20 KHz. HC 40W. vci: 4 ohms. Roll surround bass unit, dome tweeter. Socket for external tweeter. Finish: teak or rosewood. Size: $11\frac{1}{2} \times 25 \times 12\frac{1}{4}$ in. Price: on application.

Beovox 4000. Pressure chamber with one bass unit, one elliptical mid-range unit, and two treble units in angled mounting. Crossovers at 500 Hz and 5 KHz. FR: 30 Hz-20 KHz. HC 40W. vci: 4 ohms. Mid-range attenuator adjustment. Socket for external tweeter. Teak or rosewood finish. Size: $13\frac{3}{4} \times 25\frac{1}{2} \times 11$ in. Price (teak): £55 15s.

Beovox 5000 Mk II. Horn type enclosure with roll surround bass unit, elliptical mid-range unit, and two treble units in angled mounting. Crossovers at 500 Hz and 5 KHz. FR: 30 Hz to

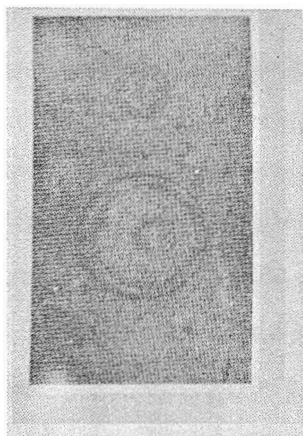

Braun L450 slimline infinite baffle

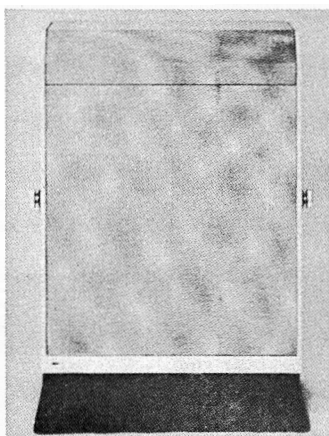

Braun LI 000 13-unit infinite baffle

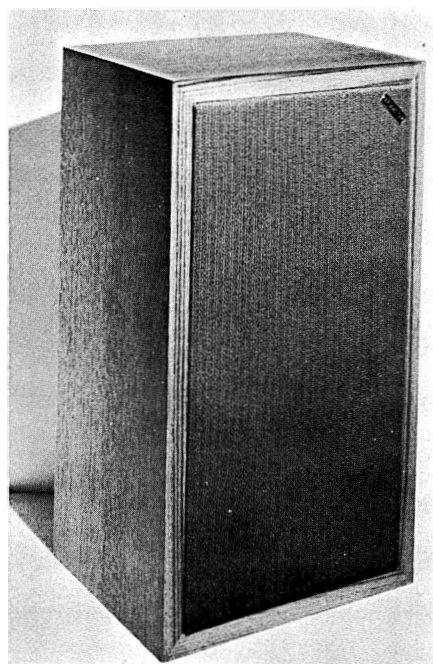

Brimham Swallow 70

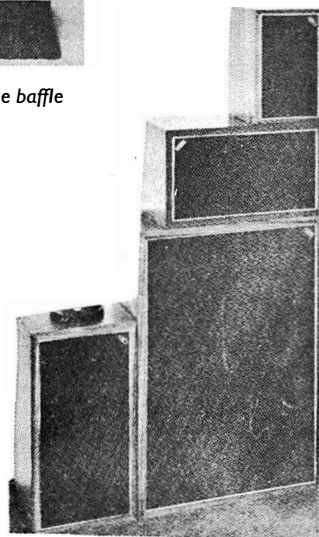

Brimham systems

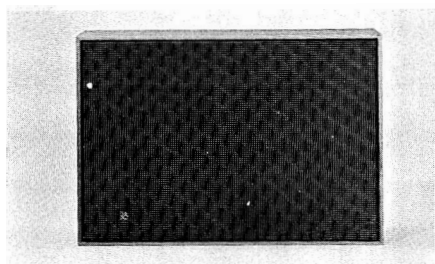

Bang and Olufsen Beovox 1600

20 KHz. HC 50W. vci: 4 ohms. Mid-range attenuator adjustment. Socket for external tweeter. Teak or rosewood finish. Size: $29 \times 18\frac{3}{4} \times 12\frac{7}{8}$ in. Price (teak): £64 15s.



BRAUN. Braun AG. Distributors: Fi-Cord International, Charlwoods Road, East Grinstead, Sussex. Tel: East Grinstead 21351.

L250. Infinite baffle. FR: 60 Hz-15 KHz. One $8\frac{1}{4} \times 3\frac{3}{4}$ in. unit. HC: 10W DIN. vci: 4 ohms. Wall or shelf-mounting. Finish: wood with white plastic or walnut veneer, anodised aluminium grille. Size: $11 \times 14\frac{1}{16} \times 4\frac{1}{8}$ in. Price: £20 2s. 5d. (including PT).

L300. Compact infinite baffle. FR: 40 Hz-20 KHz. HC: 20W RMS. vci: 4 ohms. One $5\frac{1}{4}$ in. bass driver, one $2\frac{5}{8}$ in. tweeter. Wood cabinet finished white laminated plastic or walnut veneer. Anodised aluminium grille. Provision for horizontal or vertical wall mounting. Size: $9\frac{3}{4} \times 6\frac{1}{4} \times 5\frac{1}{2}$ in. Price: £35 3s. 1d. (including PT).

L400. Speaker enclosure housing one dynamic woofer and a dynamic dome type tweeter. FR: 38 Hz-25 KHz. HC: 20W. vci: 4 ohms. Cabinet wood finished in laminated white or graphite plastic or with walnut veneer. Anodised aluminium grille. Dimensions: $8\frac{1}{16} \times 12\frac{5}{8} \times 6\frac{5}{8}$ in. Price: £34 10s. 9d.

★ **L450-2.** Slim-line infinite baffle incorporating two units. FR: 33 Hz-25 KHz. HC: 25W RMS. One $7\frac{1}{4}$ in. bass driver, one $3\frac{3}{8} \times 2\frac{3}{8}$ in. pressure chamber tweeter. vci: 4 ohms. Wood cabinet finished white or graphite laminated plastic or walnut veneer. Provision on back for horizontal or vertical wall mounting. Size: $11 \times 18\frac{1}{2} \times 4\frac{1}{8}$ in. Price: £43 9s. (including PT).

L600. Infinite baffle enclosure. FR: 30 Hz-25 KHz. HC: 30W (DIN standard). vci: 4 ohms. One bass driver, one tweeter. Finish: wood finished in laminated white plastic or walnut veneer. Anodised aluminium front grille. Size: $9\frac{7}{8} \times 17\frac{3}{4} \times 8\frac{5}{8}$ in. Price: £66 3s. 3d. (including PT).

L700-4. Infinite baffle enclosure incorporating two units. FR: 25 Hz-25 KHz. HC: 40W RMS. vci: 4 ohms. One 10 in. bass driver, one dome type tweeter. Wood cabinet finished white laminated plastic or walnut veneer. Anodised aluminium front grille. Wall mounting or free-standing. Size: $25\frac{1}{2} \times 14\frac{1}{8} \times 8\frac{5}{8}$ in. Price (enclosure with units): £76 14s. 1d. (including PT).

L800. Infinite baffle. FR: 25 Hz-25 KHz. HC: 40W DIN. vci: 8 ohms. Three speaker units comprising: 10 in. bass driver, 4 in. mid-range unit and hemispherical tweeter. Finish: wood cabinet with walnut veneer or white plastic finish with perforated anodised aluminium grille. Size: $25\frac{1}{2} \times 14\frac{1}{8} \times 11$ in. Price: £107 8s. (including PT). Set of legs (LF700) optional extra.

L910. Studio speaker system comprising one dynamic woofer, three dynamic mid-range units and one dynamic tweeter with dome-type membrane. FR: 20 Hz-25 KHz. HC: 60W. vci: 8 ohms. Finish: wood, white laminated plastic or walnut veneer. Anodised aluminium front grille. Dimensions: $33\frac{1}{2} \times 16\frac{1}{2} \times 13$ in. Optional stand LF80. Price: £191 2s. 10d.

★ **L1000.** Infinite baffle acoustically damped enclosure of over 7 cu ft. Three bass drive units, eight mid-range units (four adjustable for direction) and two pressure chamber tweeters. Crossover: 500 Hz, 4 KHz. FR: 20 Hz to beyond upper audible limit. HC: 80W RMS. vci: 8 ohms. Finish: wood cabinet finished white laminated plastic, perforated aluminium front grille. Size: $39\frac{3}{8} \times 29\frac{1}{2} \times 13$ in. Price: £475 16s. 11d. (including PT).



BRIMHAM. P. F. and A. R. Helme. Summerbridge, Harrogate, Yorks. Tel: Darley 279.

New 70 Series loudspeaker systems finished in natural oiled teak with matching speaker grille in black vinyl. Various combinations of drive units by Peerless of Denmark incorporated.

All units are infinite baffle and have 8 ohms impedance.

★ **Linnet 70.** Houses one full-range special 6×4 in. unit. HC 15W. FR: 60 Hz-20 KHz. Dimensions: $12 \times 8 \times 7$ in. Price: £12 18s. 9d.

★ **Firecrest 70.** Houses a 5 in. bass unit and 2 in. tweeter. Crossover frequency: 5 KHz. HC 10W. FR: 45 Hz-18 KHz. Dimensions: $14 \times 9 \times 7\frac{1}{2}$ in. Price: £21 16s. 6d.

★ **Swift 70.** Houses a $6\frac{1}{2}$ in. bass unit and a $2\frac{1}{2}$ in. tweeter. Crossover frequency: 4 KHz. HC 8W. FR: 50 Hz-18 KHz. Dimensions: $18 \times 10 \times 9$ in. Price: £22 15s. 2d.

★ **Swallow 70.** Houses an 8 in. bass unit and two $2\frac{1}{4}$ in. tweeters. Crossover frequency: 2.5 KHz. HC 30W. FR: 35 Hz-22 KHz. Dimensions: $20 \times 11 \times 9$ in. Price: £36 15s. 9d.

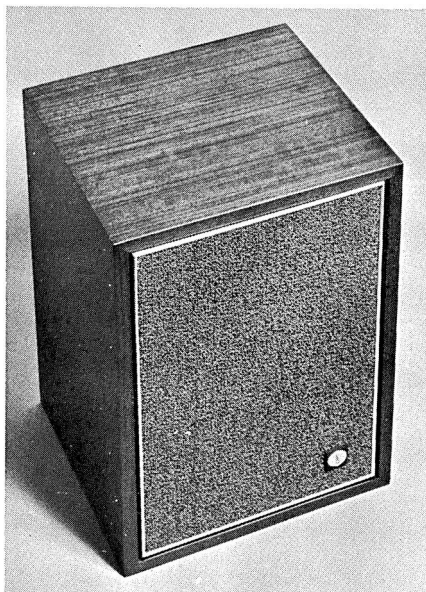

Bush A764

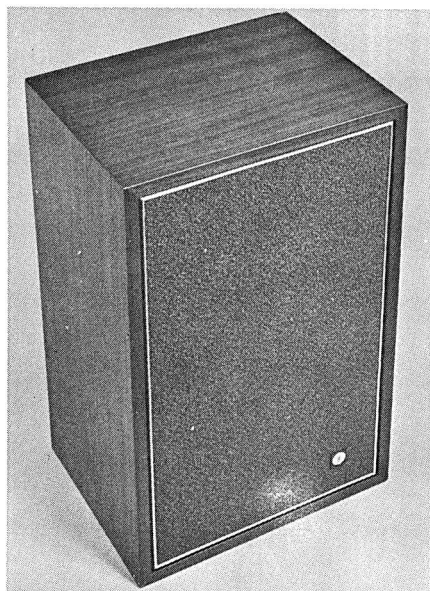

Bush A765

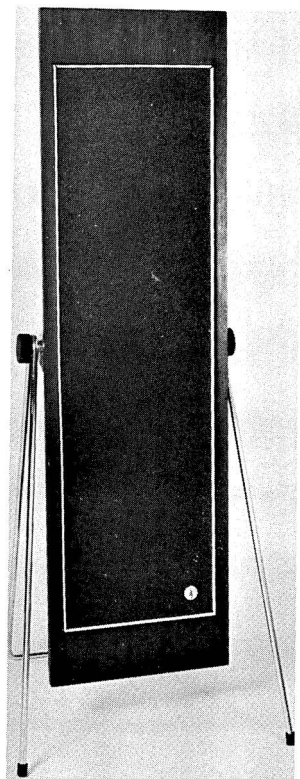

Bush A763

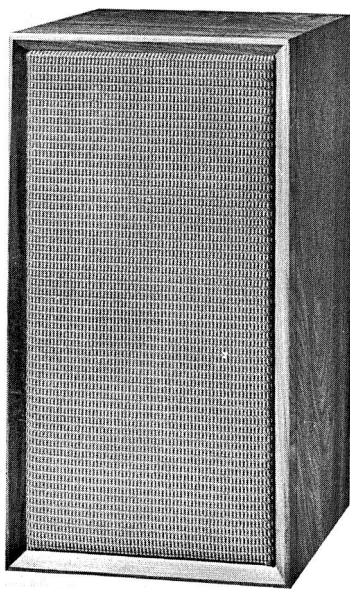

Bowers and Wilkins DM3

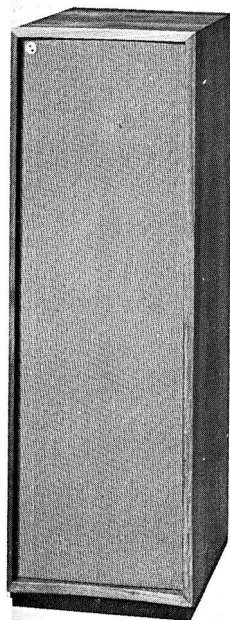

Bowers and Wilkins P2/H

Kestrel 70. Houses a 10 in. by 6 in. bass unit and a 2½ in. tweeter. Crossover frequency: 3.5 KHz. HC 10W. FR: 40 Hz-18 KHz. Dimensions: 21 × 11 × 10 in. Price: £28 13s. 8d.

Oriole 70. Houses a 12 in. bass unit, 5 × 7 in. mid-range and two 2½ in. tweeters. Crossover frequencies: 500 Hz and 3.5 KHz. HC 40W. FR: 30 Hz-18 KHz. Dimensions: 29 × 21 × 9 in. Price: £54 10s.

Prices quoted for Brimham speakers include PT where applicable.



BURNE-JONES & CO. LTD., 18 Brunswick Road, Sutton, Surrey.

B.J. Treble 20. Omni-directional multi-horn. One 4 in. unit. Crossover built-in. FR: 1-18 KHz. Size: 6 × 5 in. Weight: 1½ lb. Price: £3.

B.J. Treble Twin. Omni-directional horn. Two 4 in. drive units. Crossover included. FR: 900 Hz-18 KHz. Size: 9 × 4¼ × 6 in. Weight: 2 lb. Price: £5 10s.



BUSH. Rank Bush Murphy Ltd., Power Road, Chiswick, London. W.4. Tel: 01-994 6491.

★ **Bush Sound System A763.** Infinite baffle column speakers, with no crossover. Dimensions: 16½ in. bass and 16½ in. concentric dual cone, in parallel, both 8 ohms. vci: 4 ohms. FR: 65 Hz-14 KHz. HC 8W RMS. Dimensions: 32 in. (34¾ in. on legs) × 9 × 5 in. Weight: 8 lb. Finish: tropical olive veneer, grey silk speaker fabric. Recessed moulded back with cable bollards for extension speaker cable. Price: £24 17s. 4d. per pair (plus £6 2s. 10d. PT).

★ **Bush Sound System A764.** Infinite baffle speaker enclosure with one 8 in. and one 3 in. treble unit with plastic dome. Crossover: half section, 3 in. unit, 1.75 KHz-17 KHz, 8 in. unit 65 Hz-1.75 KHz. FR: 65 Hz-17 KHz. HC 12W. vci: 4 ohms. Dimensions: 13¾ × 9¾ × 8¾ in. Finish: tropical olive with grey speaker silk and cable bollard. Special bollards to store excess cable. Price: £27 8s. 9d. per pair (plus £6 15s. 7d. PT).

★ **Bush Sound System A765.** Infinite baffle speaker enclosure. One 12 in. rubber cone surround with 1½ in. p.o.e. one 3 in. treble unit with plastic dome. Crossover: half-section 3 in. unit

1.75 KHz-17 KHz, 12 in. unit 40 Hz-1.75 KHz. FR: 40 Hz-17 KHz. HC 12W per channel RMS. vci: 4 ohms. Dimensions: 21 × 13 × 9¾ in. Finish: tropical olive, grey speaker silk and cable bollards. Special bollards to store extension speaker cable. Price: £60 18s. per pair.



BUSH NELSON LTD., Bush House, 6 Yattendon Road, Horley, Surrey. Tel: Hor'ey 5983.

12/8. Pressure chamber system. One 13 × 8 in. bass unit, one 3 in. tweeter. FR: 40 Hz-20 KHz. Crossover 5.5 KHz. Finish: Teak. Size: 16¾ × 10¾ × 9 in. Price: £17 10s.



B. & W. ELECTRONICS., Bowers & Wilkins Electronics Ltd., Littlehampton Road, Worthing, Sussex. Tel: Worthing 66830.

★ **P2H Monitor.** Floor-standing enclosure with two units. EMI special pen-tested bass and mid-range unit, Ionic HF unit operating above 2.5 KHz. Variable bass loading, switched attenuator for HF unit. Crossover and filter network individually adjusted for each speaker. Vincer wound inductors. Each Monitor pen tested and curve supplied with enclosure. Finish: oiled teak, oiled walnut or rosewood veneers. Price: (all finishes) £94 10s.

★ **DM3.** Floor standing enclosure measuring 15¾ × 11½ × 28¼ in. with three units. EMI special pen-tested bass radiator. Wide dispersion HF and UHF transient and wave shaping units. Crossover and filter network individually adjusted for each speaker. Each monitor pen-tested and curve supplied with enclosure. Finish: as P2H monitor. Price: £63 walnut and teak; £69 10s. rosewood.

DMI. Bookshelf enclosure measuring 9 × 8 × 16½ in., 0.065 cu ft capacity. Units employed: 10 × 6 in. laminated glass cone bass/mid-frequency radiator. Pressure mid-frequency/high frequency unit and single tweeter continuing response into supersonic region. Individually pen-tested and supplied with calibration certificate. Finishes: teak, walnut and rosewood. Price: £32.

CELESTION LTD., Ferry Works, Thames

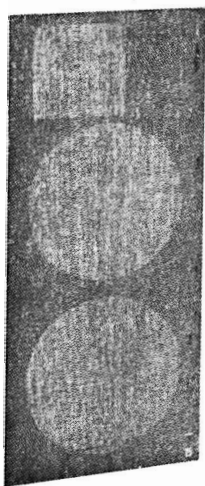

Celestion Ditton 25 (open)

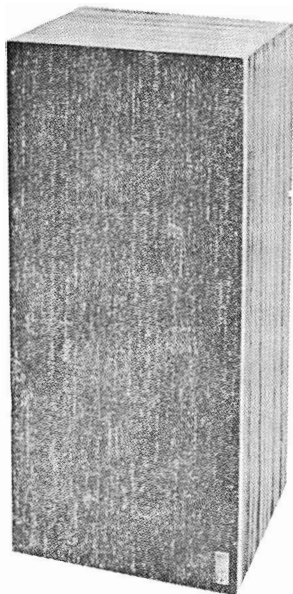
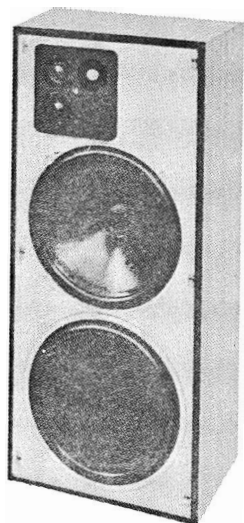

Celestion Ditton 25

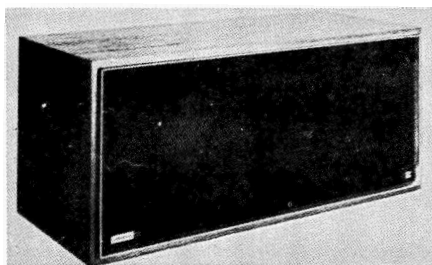

Celestion Ditton 15

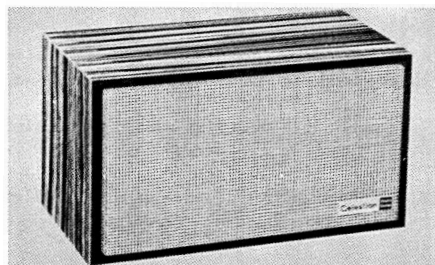

Celestion Ditton 10 enclosure

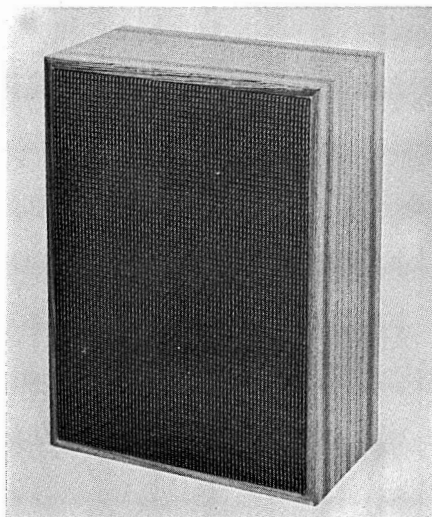

City Audio CA/12

Ditton, Surrey. Tel: 01-398 3402. Cables: Voice-coil. Thames Ditton.

★ **Ditton 10 Mk II.** Infinite baffle compact system. Long-throw 5 in. bass unit, HF 1300 Mk 2 HF unit. Built-in half-section crossover 3.5 KHz. FR: 35 Hz-15 KHz. HC 10W. Size: $12\frac{3}{4} \times 6\frac{3}{4} \times 8\frac{1}{4}$ in. Weight: 13 lb. Available in teak and walnut. vci: 4-8 ohms. Price: £16 19s. 3d. (plus £4 3s. 11d. PT).

★ **Ditton 15.** Compact infinite baffle enclosure incorporating auxiliary bass radiator. Units: 8 in. middle/bass speaker, HF 1300 Mk 2 treble radiator. FR: 30 Hz-15 KHz. HC 15W RMS. vci: 4-8 ohms. Size: $21 \times 9\frac{1}{2} \times 9\frac{1}{4}$ in. Weight: 20 lb. Finish: walnut or teak. Price: £25 (plus £6 3s. 7d. PT).

★ **Ditton 25.** Studio monitoring quality speaker enclosure with five drive units. 12 in. long-throw bass driver, two pressure type mid-range and HF units, pressure type ultra high frequency unit, 12 in. auxiliary bass radiator. HC 25W RMS. vci: 4-8 ohms. Size: $32 \times 14 \times 11$ in. Weight: 48 lb. Finish: teak or walnut. Price: £55 13s.

★

CENTRE OF SOUND. V. J. Monk Ltd., 140-141 Plumstead Road, London, S.E.18. Tel: 01-854 2369.

Paraline. Unique design by Rex Baldock. Size: $41 \times 16 \times 7$ in. Made in left-hand or right-hand versions. Recommended drive units: Elac 8N/185 or Lowther PM6. Price: in white wood £6 6s.; finished in teak or mahogany £12 12s.

Paramid. Designed by Edward Michelsen as a vertical version of the Paraline. Performance, units and prices as for the Paraline.

Paraline Tweeter Kit. Comprising special Elac tweeter with 2µF capacitor. £1 17s. 6d. complete with instructions.

A.C.E. Acoustic coupled enclosure, a new concept in column loading. Size: 36 in. high, 16 in. wide, $9\frac{1}{2}$ in. deep. FR: (with Elac 8N/185) 40 Hz-12 KHz; (with Lowther PM6) 40 Hz-17 KHz. HC 6W with high electro-acoustic efficiency. Layered damping. Full specification on request. Price: in white wood £10 10s; finished in teak £14 14s.; diffuser unit for PM6 £1 6s.

Bookshelf Horn. Small enclosure designed to give performance near to that of the Paraline. Complete with Elac 8N/185. Price: in white wood £11 11s.; ready finished £16 16s.

Bassette. A bass recorder reproducer designed by Trevor Atwell. Performance goes down below 30 Hz. Window seat type styling. Dimensions: 5 ft. 6 in. \times 17 in. \times 15 in. Drive units: 4 \times Elac 8N/185. Price complete in teak veneer: £43 1s.

Bass reflex. Popular small reflex enclosure driven by 10 in. Wharfedale Super 10RSDD. Each unit individually tuned. Dimensions: $28 \times 14 \times 12$ in. Teak veneer finish. Price: £23 10s.

A.C.E. Corner. Omni-directional corner enclosure with folded column, believed by makers to be the first of its kind. Drive unit: Lowther PM6 with specially designed stabilised diffuser. FR: 45 Hz-17 KHz. Dimensions: $30 \times 16 \times 18$ in. Teak veneer finish. Price: £39.

★

CITY AUDIO SERVICES LTD., 10 Friar Street, Carter Lane, London, E.C.4. Tel: 01-248 2421.

★ **CA12.** Sealed speaker enclosure with one 8 in. and two 4 in. drive units and $\frac{1}{4}$ -section crossover. FR: 35 Hz-20 KHz. HC: 12W, 15 ohms. Dimensions: $8\frac{1}{2} \times 13 \times 7\frac{1}{2}$ in. Finish: teak with harmonising black and gold front. Price: £18 7s. 6d.

★

CROWN. Crown Radio Co. Ltd., 137-149 Goswell Road, London, E.C.1. Tel: 01-253 1971/2.

CSP-7. Infinite baffle enclosure. $6\frac{1}{2}$ in. bass unit, $2\frac{1}{2}$ in. tweeter. FR: 30 Hz-20 KHz. Impedance: 8 ohms. HC: 20W. Dimensions: $13\frac{3}{16} \times 9\frac{1}{16} \times 10\frac{1}{2}$ in. Weight: 10 lb. Price: £15 8s. 9d. (plus £3 16s. 2d. PT).

★

A. DAVIES & CO., 56 Wellesley Road, London, N.W.5. Tel: 01-485 5775.

Sherwood type. Based on Goodmans design for Axiom speakers. Approved for Goodmans Axiom 201, Axiom 301 and Goodmans three-

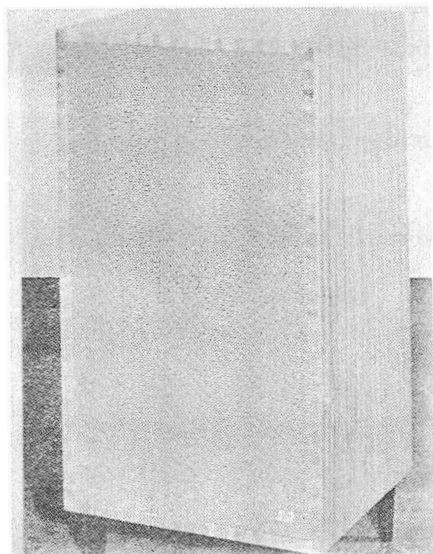

A. Davies bass reflex

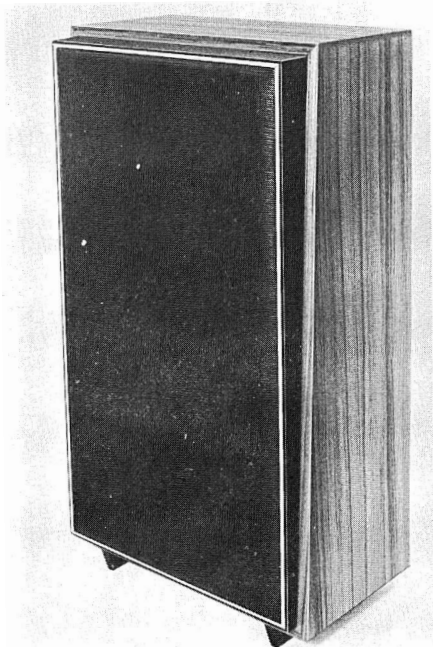

Decca Deram

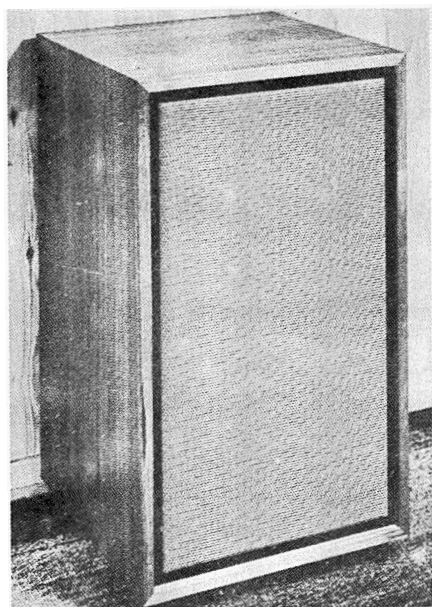

Davies AD Folded Horn

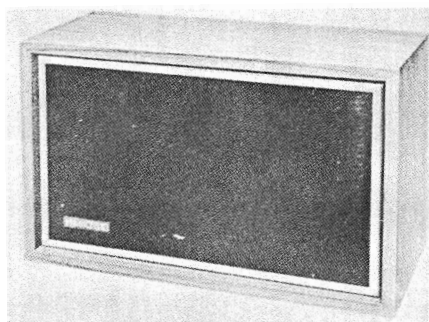

Decca-Kelly Mini

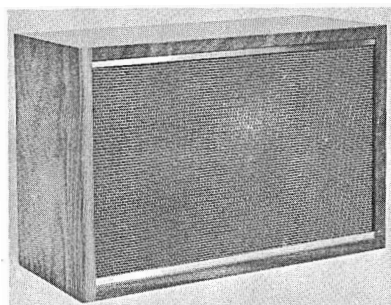

Derwent Minor Mk II

way system. Finish: Sapele, oak, walnut, teak. Full polish or satin finish. Size: $23\frac{1}{2} \times 29\frac{1}{2} \times 19\frac{1}{2}$ in. Price (without units or ARU172): £18 14s. Extra for teak: £1.

★ **Bass reflex.** Suitable for 12 in. speakers. Cabinets lined with 1 in. acoustic felt. Finish: sapele, walnut, oak, teak. Full polish or satin finish. Dimensions: $34 \times 17\frac{1}{2} \times 15\frac{1}{2}$ in. Price: standard finish £13 15s. (teak 10s. extra).

★ **A.D. Sealed Folded Horn.** Designed to house Goodmans three-speaker system; 12 in. bass, Midax and Trebax. Alternative speaker arrangements are Kelly ribbon tweeter and Goodmans Audiom 51 or Woollett electrostatic treble and Wharfedale W12/RS/PST. Suitable full-range single 12 in. speakers are Goodmans Triaxiom 1220C, 212C, Axiom 301, Axiom 201, Tannoy Monitor. Rear of cabinet ready cut for attenuators. Size: $31\frac{1}{2}$ in. high, 18 in. \times 18 in. Finish: teak or veneer of colour to choice. Front baffle sealed with black Formica (other colours to order) with neutral colour open-weave Tygan speaker grille. Price: £23; 15 in. loudspeaker version £28.

★

DECCA. Decca Special Products, Ingate Place, Queenstown Road, London, S.W.8. Tel: 01-622 6677.

★ **Decca Deram Enclosure.** Two units; 13×8 in. bass driver, 3 in. tweeter. HC 8-10W. Size: $25 \times 13\frac{1}{4} \times 8$ in. Impedance: 15 ohms. Finish: teak or rosewood. Price: (teak) £17 17s.; (rosewood) £18 18s.

★ **Decca-Kelly Mini Enclosure.** Infinite baffle miniature shelf-mounting enclosure. Solid piston direct radiator bass unit. Melinex diaphragm direct radiator HF unit. Crossover 2 KHz. FR 40 Hz-20 KHz flat to within 3 dB. HC 15W RMS. Matching of driving area to enclosure volume for high-efficiency and good bass response (British Patent 36994/64). Piston diaphragm of expanded thermo-setting resin. HF unit contoured to give omnidirectional sound distribution up to 16 KHz. Suitable for amplifiers of 8-16 ohms output impedance. Standard finish: medium teak with tygan front. Size: 10 in. high, 16 in. wide, $7\frac{1}{2}$ in. deep. Weight: 23 lb. Price: £21.

★

DERWENT. Nichols Acoustic Fitments, Church Street, Bubwith, near Selsby, Yorkshire. Tel: Bubwith 206.

Gem. Small bookshelf enclosure only. Designed and approved for use with Richard Allan Hi-Fi module. Size: $13\frac{1}{2} \times 9 \times 6$ in. Internal volume: 380 cu. ins. Sealed back panel. Detachable grille fret. Constructed from $\frac{3}{4}$ in. hardwoods. Finish: afrormosia, mahogany or teak. Price: £5 16s.

Opal Mk III. Large bookshelf enclosure. Designed for E.M.I. and Fane 13×8 in. unit or KEF 13×9 in. and T.15. Size: $21 \times 14\frac{1}{2} \times 9$ in. Internal volume: 1,850 cu. in. Special baffle support and stiffening battens. Sealed, veneered, back panel. Baffle and grille fret secured from front. Constructed from $\frac{3}{4}$ in. solid afrormosia. Price: £9 18s. 6d., plus units, carriage extra.

★ **Minor Mk II.** Compact enclosure. Designed for 12 in. bass and treble combination or ellipticals as in Opal Mk III. Size: $24 \times 15 \times 11\frac{1}{2}$ in. Internal volume: 1.71 cu. ft. Construction identical with Opal Mk III. Price: £12 10s., plus units, carriage extra.

Major. Free-standing enclosure. Designed for Celestion Studio series coaxials, Wharfedale Super 12RS/DD, etc. Suitable for most 12 in. bass and two/three way systems. Size: $31\frac{1}{2} \times 18\frac{1}{4} \times 12$ in. (including 1 in. plinth). Internal volume: 2.68 cu. ft. Sealed back panel. Finish: selected afrormosia veneers. Price: £16 15s., plus units, carriage extra.

★

DUAL. Dual Electronics Ltd., Radnor House, London Road, Norbury, London, S.W.16. Tel: 01-764 9465/6.

CL14. Infinite baffle enclosure. 8 in. bass unit and $5\frac{1}{4}$ in. mid-range/HF unit. vci: 4 ohms. HC: 35W. FR: 35 Hz-20 KHz. Crossover frequency: 1.5 KHz. Dimensions: $10\frac{5}{8} \times 18\frac{7}{8} \times 7\frac{1}{8}$ in. Weight: 14.3 lb. Finish: walnut veneer. Price: £23 2s. 8d. (plus £5 14s. 4d. PT).

CL15. Infinite baffle enclosure. $5\frac{1}{8}$ in. bass unit and $2\frac{5}{8}$ in. tweeter. HC: 25W. FR: 45 Hz-20 KHz. Crossover frequency: 1.5 KHz. vci: 4 ohms. Dimensions: $10\frac{5}{8} \times 15\frac{3}{4} \times 3$ in. Weight: 7.7 lb. Finish: walnut veneer. Price: £20 15s. (plus £5 2s. 6d. PT).

CL16. Infinite baffle enclosure. $9\frac{5}{8}$ in. bass unit and $5\frac{1}{8}$ in. mid-range/HF unit. vci: 4 ohms. HC: 35W. FR: 30 Hz-20 KHz. Crossover frequency: 1.5 KHz. Dimensions: $13 \times 23\frac{1}{4} \times 8\frac{5}{8}$ in. Weight: 23.1 lb. Finish: walnut veneer. Price: £28 15s. (plus £7 2s. PT).

CL17. Infinite baffle enclosure. $5\frac{1}{8}$ in. bass unit and $2\frac{5}{8}$ in. tweeter. vci: 4 ohms. HC: 25W. FR: 45 Hz-20 KHz. Crossover frequency: 1.5 KHz. Dimensions: $6\frac{1}{4} \times 10\frac{1}{4} \times 7\frac{7}{8}$ in. Weight: 7.3 lb. Finish: walnut veneer. Price: £18 0s. 10d. (plus £4 9s. 2d. PT).

CL18. Infinite baffle enclosure with three units: $9\frac{5}{8}$ in. woofer, $5\frac{1}{8}$ in. mid-range and $2\frac{5}{8}$ in. tweeter. vci: 4 ohms. HC: 50W. FR: 25 Hz-20 KHz. Crossover frequencies: 1.5 KHz, 8 KHz. Dimensions: $23\frac{1}{4} \times 13 \times 8\frac{5}{8}$ in. Weight: $25\frac{1}{2}$ lb. Finish: walnut veneer. Price: £41 4s. (plus £10 3s. 6d. PT).

CL20. Infinite baffle enclosure with four units: $9\frac{5}{8}$ in. woofer, two $4\frac{1}{8}$ in. mid-range and 1 in. dome tweeter. vci: 4 ohms. HC: 50W. FR: 20 Hz-25 KHz. Crossover frequencies: 1.5 KHz, 8 KHz. Dimensions: $25 \times 14\frac{1}{8} \times 9\frac{1}{2}$ in. Finish: walnut veneer. Weight: 34.3 lb. Price: £59 13s. 8d. (plus £14 14s. 10d. PT).

★

DULCI. Lee Products (Great Britain) Ltd., 10-18 Clifton Street, London, E.C.2. Tel: 01-247 6711.

AS3. Infinite baffle enclosure. 8×6 in. full range unit. Impedance: 8 ohms. HC: 6W. Finish: teak. Dimensions: $12 \times 9 \times 6$ in. Price: £9 (including PT).

AS5. Infinite baffle enclosure. 10×6 in. bass unit, $2\frac{1}{2}$ in. plastic cone tweeter with crossover. Impedance: 4 ohms. HC: 8W. Finish: teak. Dimensions: $14\frac{3}{4} \times 10\frac{3}{4} \times 6\frac{1}{2}$ in. Price: £14 (including PT).

AS7. Infinite baffle enclosure. 6 in. bass unit, 3 in. tweeter. Full crossover network. Impedance: 15 ohms. HC: 12W. Finish: teak. Dimensions: $17\frac{1}{2} \times 11\frac{3}{4} \times 8\frac{1}{4}$ in. Price: £19 (including PT).

★

DUODE LTD., Westfield Mills, Broad Lane, Leeds, 13. Tel: Pudsey 77536.

Duode-Janszen 3. Dynamic/electrostatic speaker of novel design. FR: 30 Hz to over 30 KHz. Impedance 10 ohms. HC 60W. Bass unit: modified KEF B139. Treble units: two Janszen electrostatic speakers. Crossover: 500 Hz. Power requirement: 110-250V 40-60 Hz (negligible consumption). Finish: matt teak or sapele mahogany. Dimensions: $27 \times 14 \times 12$ in. Price: £48 10s.

Duode-Janszen 6. Dynamic/electrostatic speaker of novel design. FR: 20 Hz to over 30 KHz. Impedance 10 ohms. HC 85W. Bass units: two modified KEF B139. Treble units: four Janszen electrostatic speakers. Crossover: 500 Hz. Power requirements: 110-250V 40-60 Hz (negligible consumption). Cabinet: specially designed octagonal in choice of finish. Dimensions: $36 \times 21 \times 16$ in. Price: £131 5s.

★

DYNACO. Distributors: Howland-West Ltd., 2 Park End, South Hill Park, London, N.W.3. Tel: 01-794 6666 and 6033.

Dynaco A25. Speaker enclosure with 10 in. high compoiance unit and $1\frac{1}{2}$ in. dome tweeter. Crossover: 1,500 Hz. FR: 32 Hz-20 KHz. HC 35W RMS. vci: 8 ohms. Dimensions: $20 \times 11\frac{1}{2} \times 10$ in. Weight: 22 lb. Finish: teak, walnut, rosewood. Price: £26 (plus £6 11s. 7d. PT).

★

DYNASTATIC. See Electrostatic Loudspeaker Co.

★

DYNATRON RADIO LTD., St. Peter's Road, Maidenhead, Berks. Tel: Maidenhead 23331.

LS100. Wall or shelf mounting infinite baffle enclosure containing $6\frac{1}{2}$ in. main driver unit and 3 in. H.F. unit with high-pass filter network. Impedance: 3 ohms. Dimensions: $13\frac{3}{8} \times 7\frac{1}{2} \times 8\frac{3}{4}$ in. Price: £13 15s.

LS150. Wall or shelf mounting infinite baffle enclosure containing 8 in. main driver unit and 3 in. H.F. unit with high-pass filter network. vci: 3 ohms. Dimensions: $19\frac{3}{4} \times 11\frac{7}{8} \times 9\frac{1}{4}$ in. Price: £17 6s.

LS200. Floor-standing reflex enclosure containing 8 in. main driver unit and 3 in. H.F. unit with high-pass filter. vci: 3 ohms. Dimensions: $26\frac{5}{8} \times 10\frac{1}{4} \times 15$ in. Price: £22 5s.

LS250 and **LS275.** Floor-standing infinite baffle type enclosures containing 12 in. low resonance main driver unit and 3 in. H.F. unit with high-pass filter. vci: 3 ohms. Dimensions: $27 \times 16\frac{3}{4} \times 12$ in. LS250 is in walnut with Queen Anne style legs, LS275 has mahogany finish with Chippendale plinth. Price: £30 each.

LS300. Floor-standing reflex enclosure containing 12 in. low resonance main driver unit and

two 3 in. H.F. units with high-pass filter. vci: 3 ohms. Dimensions: $31\frac{1}{4} \times 17 \times 12$ in. Price: £29 10s.



EAGLE PRODUCTS. Distributors: B. Adler and Sons (Radio) Ltd., Coptic Street, London, W.C.1. Tel: 01-636 9606/7. Cables: Reldab, London.

DL.42. Infinite baffle enclosure. FR: 40 Hz-20 KHz. HC 5W RMS. One 4 in. high compliance unit and one horn tweeter. vci: 8 ohms. Size: $10 \times 6 \times 6\frac{1}{2}$ in. Finish: teak and black front. Price: £9 7s. 2d. (plus £2 7s. 7d. PT).

DL.67. Infinite baffle enclosure. FR: 35 Hz-20 KHz. HC 10W RMS. One $6\frac{1}{2}$ in. high compliance unit and one horn tweeter. vci: 8 ohms. Size: $11\frac{3}{4} \times 8 \times 6\frac{3}{4}$ in. Finish: teak and black front. Price: £14 9s. 1d. (plus £3 14s. 1d. PT).

MS.40. Infinite baffle enclosure. FR: 40 Hz-16 KHz. HC 5W RMS. One 4 in. high compliance unit. vci: 16 ohms. Size: $8\frac{7}{8} \times 6\frac{1}{2} \times 5$ in. Finish: Rosewood with slotted front. Price: £8 7s. 9d. (plus £2 0s. 9d. PT).

MS.65. Infinite baffle enclosure. FR: 35 Hz-18 KHz. HC 10W RMS. One $6\frac{1}{2}$ in. high-compliance unit. vci: 16 ohms. Size: $10\frac{3}{8} \times 7\frac{7}{8} \times 6\frac{3}{4}$ in. Finish: Rosewood with slotted front. Price: £12 8s. 11d. (plus £3 1s. 2d. PT).

MS.80. Infinite baffle enclosure. FR: 50 Hz-20 KHz. HC 20W RMS. One 8 in. high compliance unit. vci: 16 ohms. Size: $14\frac{1}{2} \times 10\frac{3}{8} \times 8$ in. Finish: Rosewood with slotted front. Price: £14 7s. 1d. (plus £3 11s. 2d. PT).



EATON AUDIO FITMENTS, Leopold Street, Long Eaton, Nottingham, NG10 4QF. Tel: Long Eaton 2662/2818.

Trent 8. Corner reflex enclosure based on Goodmans design, suitable for any full-range 8 in. drive unit. $\frac{3}{4}$ in. acoustic chipboard. Veneered in walnut, mahogany, oak or teak. Supplied in kit form. Size: $25\frac{1}{2}$ in. high, $21\frac{1}{2}$ in. wide, 14 in. back to front. Price: (walnut, mahogany, oak) £9 2s. 6d.; (teak) £9 9s. 6d. Legs 8s. extra.

Trent 10. Similar to Trent 8 but designed for 10 in. units. Supplied in kit form. Size: $31\frac{1}{2}$ in. high, 25 in. wide, $15\frac{1}{2}$ in. back to front. Also suitable for Celestion CX1512 and CX2012.

Price: £10 3s. 6d.; (teak) £10 10s. 6d.; Legs 8s. extra.

Derwent. Bass reflex enclosure based on Wharfedale design. Two cubic feet. Supplied as kit. Suitable for any 8 or 10 in. full range units and certain 12 in. dual systems. Size: $28 \times 16 \times 10\frac{1}{2}$ in. Price: (walnut, mahogany, oak) £9; (teak) £9 8s.

Erewhash 8. One cubic foot enclosure based on Wharfedale design. Veneered on all sides. Supplied in kit form. Constructed from $\frac{1}{2}$ in. material. Suitable any 8 in. full range unit and smaller dual systems. Produced in reflex, distributed port or infinite baffle version.

Cabinets built to customers' own designs and quotations given. Standard kits include eight enclosures (five free-standing and three book-shelf). Supplied in kit form accurately machined ready for simple assembly. All kits are complete with fret material, loose fret, bolts, screws and lagging material as required. Wood is veneered but unpolished.



ELAC. Electro Acoustic Industries Ltd., Stamford Works, Broad Lane, London, N.15. Tel: 01-808 0505/9. Cables: Elac, London, N.15.

Elac E6-S. Infinite baffle compact enclosure with unit. Wide-range 6 in. speaker with long-throw suspension and moulded rubber surround of new design. FR: 55 Hz-16 KHz. HC 10W. vci: 8 and 15 ohms. Size: $11 \times 8 \times 6$ in. Weight: 7 lb. Finish: scratch resistant simulated teak or walnut. Price: £8 (plus £1 17s. 8d. PT).



ELECTROSTATIC LOUDSPEAKER MFG. CO., 82 East Barnet Road, New Barnet, Herts. Tel: 01-449 6605.

★Dynastatic Mk II. Infinite baffle enclosure. 12 in. bass unit, 2 in. voice coil, total flux 160,000 maxwells; Shackman electrostatic tweeter. Crossover: 800 Hz. HC 25W. vci: 8-16 ohms. FR: 35 Hz-20 KHz. Finish: teak. Built-in mains unit for electrostatic unit. Psn: 200-250V AC. Export model 110V if required. Size: $29 \times 11 \times 17$ in. Weight: 55 lb approx. Price: £52.

Dynasonic 2T. Infinite baffle enclosure. 13×8 in. bass unit and two 2 in. tweeters. Crossover: 2 KHz. FR: 50 Hz-25 KHz. HC 15W. vci: 8 ohms. Finish: teak. Weight: 40 lb. Price: £29 10s.

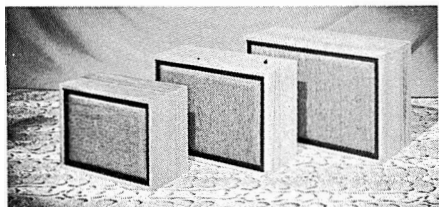

Dulci enclosures

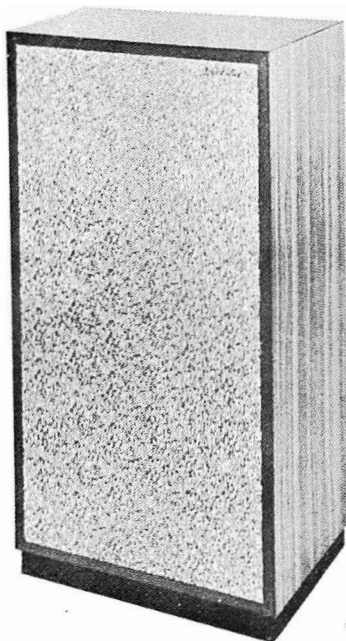

Dynastatic Mk II

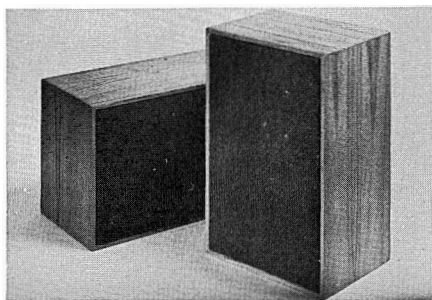

Ferguson 3407

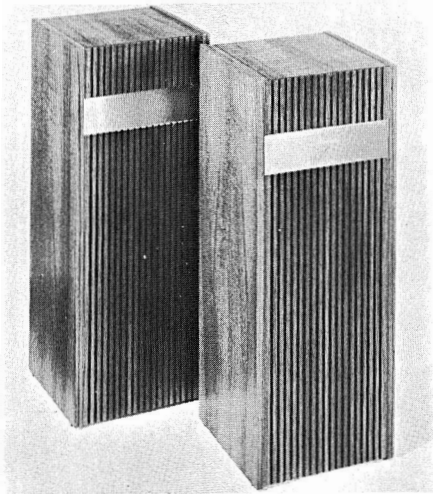

Ferguson 3402

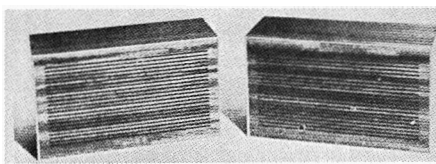

Ferguson 204SS

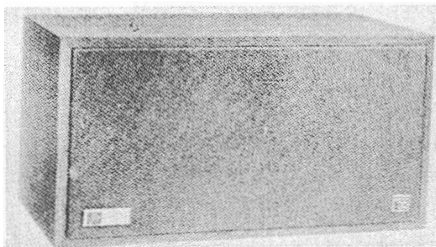

Fisher XP-55

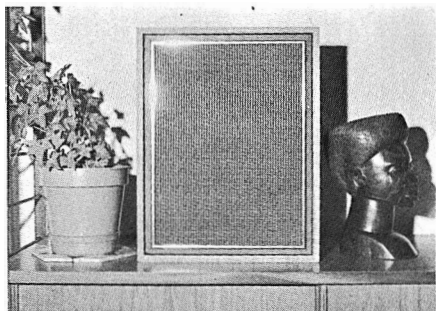

Francis Countdown

EMG HANDMADE GRAMOPHONES LTD., 26 Soho Square, London, W.1. Tel: 01-7344311.

DL/12T. Custom-built enclosure with unit. Floor-standing. Size: 36×20×16 in. tapering to 10 in. Finish in choice of modern veneers. Full technical details and price on request.



FANE ACOUSTICS LTD., Hick Lane, Batley, Yorks. Tel: Batley 2114. Cables: Fane, Batley.

Ionofane 601. High frequency ionophone with horn. FR: 3 KHz-30 KHz ±1dB. Crossover frequency recommended 3.5 KHz. HC: 20W music. Impedance: 15 ohms resistive. Psn: 200-240V 50 Hz or 110-220V 50-60 Hz. Weight: 6½ lb. Price: £29 8s.

Ionofane 604. Full-range speaker system comprising Ionofane 601 high-frequency unit and 12 in. bass unit with 17,000 gauss magnet. HC 20W. FR: 30 Hz-30 KHz. Finish: natural teak. Size: 31×17×12 in. Price: £51 9s.



FERGUSON. British Radio Corporation Ltd., 284 Southbury Road, Enfield, Middlesex. Tel: 01-366 1155.

★**204SS.** Shelf-mounting enclosure with 6½ in. high compliance bass driver and 3½ in. high frequency pressure unit. LC crossover, 3 KHz. FR: 30 Hz-15 KHz. 7W. vci: 8 ohms. Cabinet: extra thick particle board veneered in teak. Size: 8½ in. wide, 16¾ in. high, 7½ in. deep. Designed to match Ferguson Unit Audio system. Supplied with 11 ft cable and DIN plug. Price: £11 14s. 1d. (plus £2 9s. 11d. PT).

★**3402B.** Infinite baffle enclosure. 10×6 in. bass driver and 3⅝ in. treble unit. LC crossover, 3 KHz. FR: 70 Hz-17 KHz. 6W capacity. vci: 8 ohms. Teak veneer. Size: 26×10×9 in. Price: £16 0s. 7d. (plus £3 8s. 5d. PT).

★**3407.** Infinite baffle enclosure. 6½ in. bass driver and 3½ in. treble unit. LC crossover, 3 KHz. FR: 90 Hz-20 KHz. 6W capacity. Impedance: 8 ohms. Teak veneer. Size: 14½×9⅜×7¼ in. Price: £11 14s. 11d. (plus £2 9s. 11d. PT).



FISHER RADIO CORPORATION, Long Island City 1. New York, U.S.A. Distributors:

Getz Bros. and Co. Inc., 2 Harewood Place, London, W1R 0DD. Tel: 01-499 6901.

★**XP-55B.** Speaker enclosure. Free piston system. 8 in. bass driver, 3 in. tweeter. HC 30W. FR: 37 Hz-20 KHz. Size: 10×20×7½ in. Can be used horizontally or vertically. Weight: 18 lb. Finish: walnut. Price: £464s.

XP-66. Speaker enclosure. Free piston system. 12 in. bass driver, 6 in. mid-range unit, 2½ in. tweeter. HC 60W. FR: 30 Hz-19 KHz. Can be used horizontally or vertically. Weight: 40 lb. Size: 14×24½×12 in. Finish: walnut. Price: £58 16s.

XP-7. Speaker enclosure. Free piston system. 12 in. bass driver, two 5 in. units and 1½ in. tweeter. Mid-range drivers are housed in a separate, sealed compartment. HC 60W. FR: 30 Hz-20 KHz. Weight: 45 lb. Finish: oiled walnut. Size: 14×24½×12 in. Price: £63.

XP-9B. Speaker enclosure. Free piston system. 12 in. bass driver, 6 in. lower mid-range, 5 in. upper mid-range and 1½ in. soft dome treble speaker. Each speaker in the system is isolated. HC 60W. FR: 28 Hz-22 KHz. There is a three-position treble balance control at the rear. Weight: 60 lb. Size: 14×24½×12 in. Price: £95 11s.

XP-15B. Speaker enclosure has a 15 in. bass speaker with a unique half-roll surround and a 12 lb magnet structure with 2½ in. dia. voice coil. 8 in. mid-range speaker and 1½ in. hemispherical treble speaker. HC 60W. FR: 28 Hz-20 KHz. Calibrated three-step level control. Weight: 80 lb. Size: 27×27×14¾ in. Price: £159 12s.

XP-18. Speaker enclosure has an 18 in. bass woofer with a 2 in. voice coil operating in a 12½ lb magnet structure. 8 in. lower mid-range and 5¼ in. free-piston speakers with two matched 2 in. treble speakers with 150 deg sound distribution. HC 60W. FR: 30 Hz-22 KHz. Three level controls at rear of cabinet. Weight: 105 lb. Cabinet size: 30½×29½×16½ in. Price: £197 9s.



J. J. FRANCIS (WOOD GREEN) LTD., 123 Alexandra Road, Hornsey, London, N.8. Tel: 01-888 1662.

★**Countdown.** Infinite baffle speaker enclosure. Two units: 3⅝ in. tweeter and 6½ in. long-throw low frequency. Crossover: 1 KHz half section. FR: 50 Hz-20 KHz. HC 10W RMS. vci: 4-15

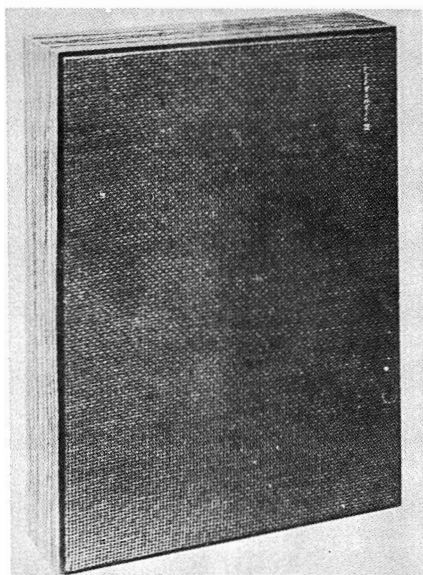

Goodmans Eleganza II

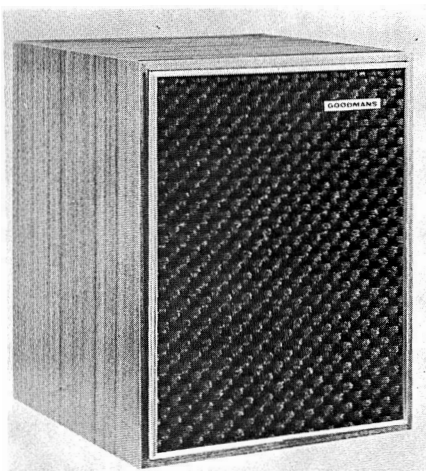

Goodmans Mambo

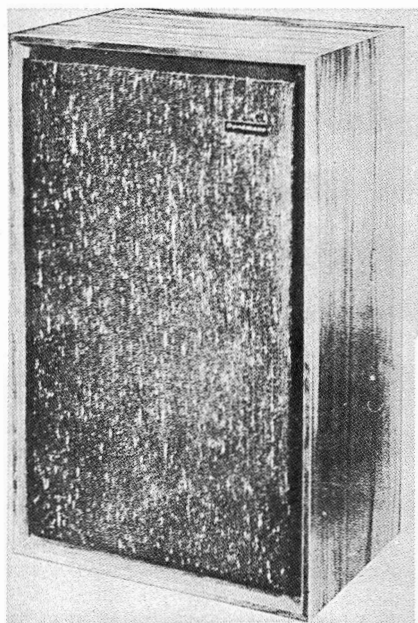

Goodmans Magnum-K

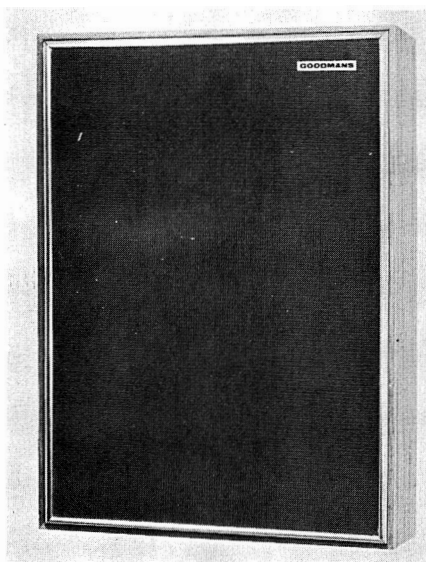

Goodmans Marimba

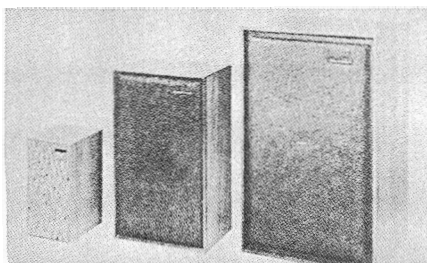

Goodmans Maxim, Mezzo and Magnum

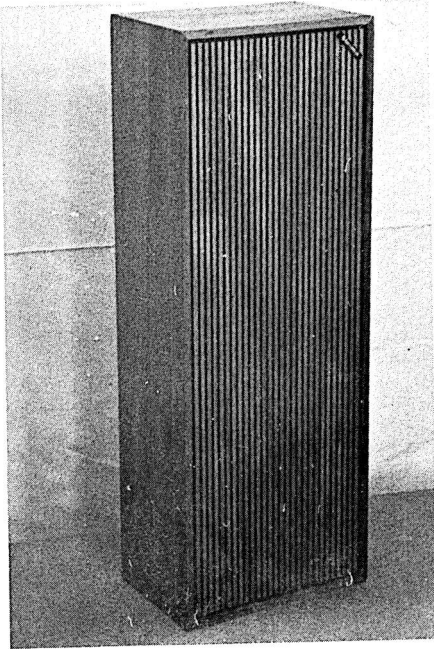

Grosvenor Ste-ma 275

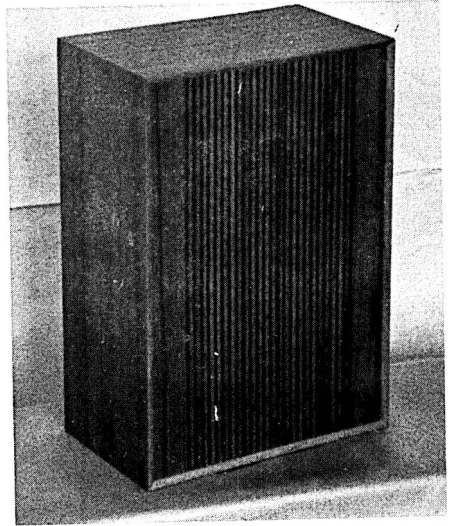

Grosvenor Fonoprodukter TK-7

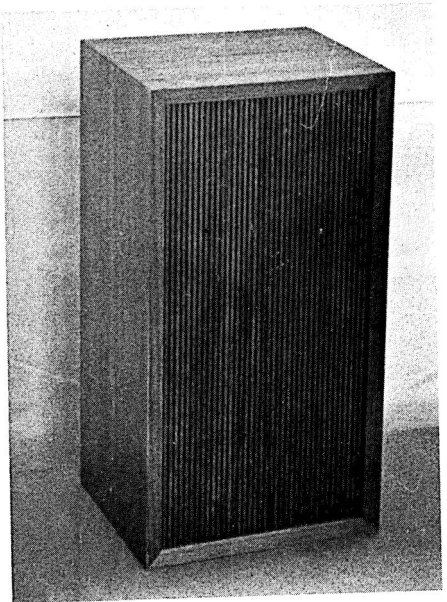
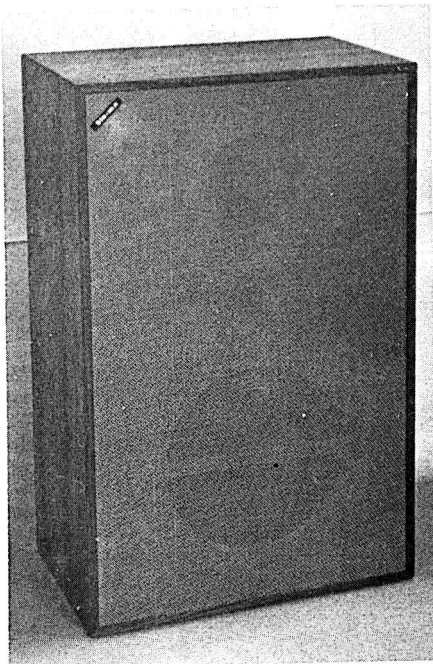

Grosvenor Skand-Elektro SE16

Grosvenor Ste-ma 300

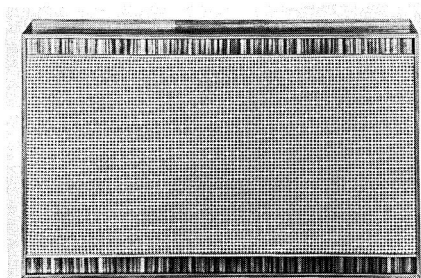

Grundig Box 730

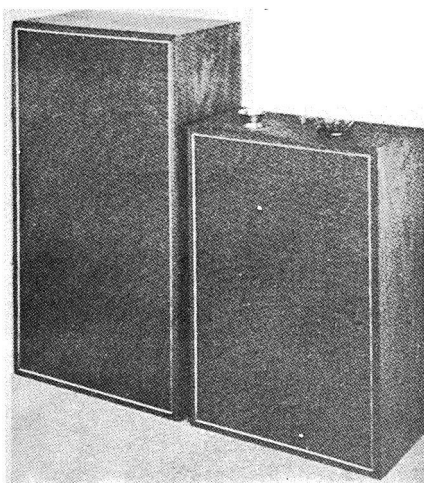

Helme enclosures

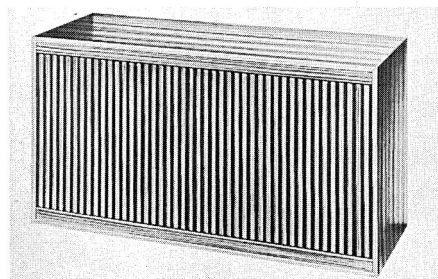

Grundig Box 740

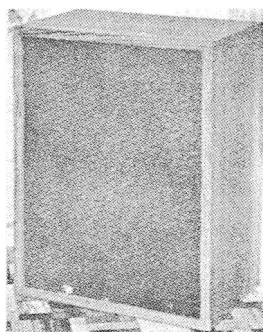

Howland-West Narvik

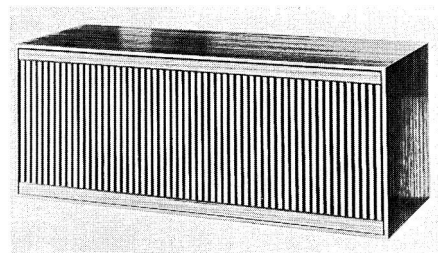

Grundig Box 525

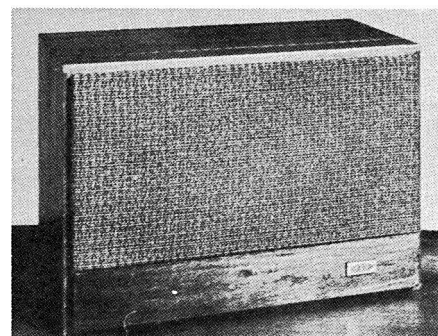

KEF Cresta

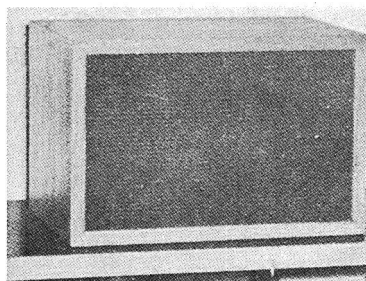

Howland-West Bergen

ohms. Dimensions: 14×10×6 in. Weight: 7 lb 6 oz. Finish: solid teak wood. Internal damping with Dr. Bailey's long fibre wool. Price: £12 (including tax).



GOODMANS LOUDSPEAKERS LTD., Axiom Works, Wembley, Middlesex, England. Tel: 01-902 1200. Cables: Goodaxiom, Wembley.

★**Eleganzia II.** Acoustically sealed enclosure, exceptionally slim. Forward facing. Two units, 12 in. bass unit especially designed for this enclosure, employing Goodmans 'Suprfoam' diaphragm, and one back-loaded mid-range and HF unit. Crossover unit 900 Hz. FR: 35 Hz-15 KHz. HC 15 watts. vci: 15/16 ohms. Size: 27×20×6½ in. Weight: 42 lb. Price: £30.

★**Maxim.** Infinite baffle. Forward facing. Incorporates two units specially designed for this box. Crossover included. FR: 45 Hz-20 KHz. HC 12W. vci: 8-16 ohms. Size: 10½×5½×7¼ in. Weight: approx 7 lb. Price: £16 7s. (plus £4 0s. 9d. PT).

★**Mezzo II.** Infinite baffle containing two units, 12 in. bass unit with inductance/capacitance crossover at 2 KHz. Sealed back 4 in. treble unit. FR: 40 Hz-20 KHz. HC 15W. vci: 8 ohms. Bookshelf speaker enclosure. Finish: teak or walnut to order. Size: 12×19½×9 in. Price: £30 18s.

★**Magnum-K.** Infinite baffle containing three units, 12 in. bass speaker, mid-range direct radiator, back-loaded direct HF radiator. Built-in multiple section crossover, 1.5 KHz and 6 KHz. FR: 30 Hz-20 KHz. HC 25W. Air-cushion suspension to bass unit. Two attenuators allow sound tailoring to room acoustics. Classic styling in teak or walnut. vci: 4-8 ohms. Price: £40 2s.

★**Mambo.** Infinite baffle containing two special units, 5 in. and 2 in., with crossover at 4,500 Hz. FR: 45 Hz-20 KHz. HC 15W RMS. vci: 8 ohms. Cabinet finish is teak or walnut. Size: 10¾×8¾×8 in. deep. Price: £17 18s. (plus £4 8s. 6d. PT), sold in pairs.

★**Marimba.** Infinite baffle containing two units, 6½ in. and 3½ in., with crossover at 4,500 Hz. FR: 45 Hz-20 KHz. HC 15W RMS. vci: 8 ohms. Slim cabinet can be wall mounted, brackets are included. Finished in walnut. Size: 13×19×5½ in. Price: £19 5s. (plus £4 15s. 1d. PT), sold in pairs.

★**3005.** Speaker enclosure. Speaker: 5 in. twin cone. HC 15W. vci: 4 ohms. FR: 30 Hz-20 KHz ±3dB. Cabinet finish: teak. Dimensions: 7×11¾×7 in. Price per pair: £25 (including £29s. 6d. PT each).



GROSVENOR ELECTRONICS LTD., 25 Roman Road, London, E.2. Tel: 01-980 1936.

★**STE-MA Type 275.** Infinite baffle speaker enclosure with 8 in., 5 in. and 2½ in. units. FR: 40 Hz-18 KHz. HC 12W RMS. vci: 8 ohms. Dimensions: 25¼×9½×6½ in. Finish: oiled teak. Made in Denmark. Price: £33 12s.

★**STE-MA. Type 300.** Infinite baffle speaker enclosure with 10 in., 5 in. and 2½ in. units. FR: 30 Hz-20 KHz. HC 18W RMS. vci: 8 ohms. Dimensions: 25¼×15½×10 in. Weight: 26 lb. Finish: oiled teak. Made in Denmark. Price: £22 1s.

STE-MA Type 500. Infinite baffle speaker enclosure with 8 in., 5 in. and 2½ in. units. FR: 30 Hz-18 KHz. HC 18W. vci: 8 ohms. Dimensions: 21×12×10 in. Weight: 23 lb. Finish: oiled teak. Made in Denmark. Price: £28 7s.

★**Fonoprodukter-TK-7.** Infinite baffle speaker enclosure with 6×4 in. special high flux twin cone speaker. FR: 60 Hz-18 KHz. HC 5W. vci: 8 ohms. Dimensions: 11¼×7½×4½ in. Weight: 5 1b. Finish: oiled teak. Made in Norway. Price: £8 8s. 9d. (plus £2 0s. 3d. PT).

★**Skand-Elektro. SE.16.** Infinite baffle speaker enclosure with 6½ in. and 3 in. units. FR: 55 Hz-20 KHz. HC 8W. vci: 8 ohms. Dimensions: 19¼×9½×8½ in. Weight: 12¼ lb. Finish: oiled teak or rosewood. Made in Norway. Price: £13 2s. 6d. (plus £3 1s. 6d. PT).



GRUNDIG (GREAT BRITAIN) LTD., 15 Great Orchard Street, London, W.1. Tel: 01-935 4898.

Box 300. Two-unit enclosure. Two mid-range units. HC 20W max. FR: 50 Hz-12.5 KHz. vci: 5 ohms. Oiled teak. Size: 18×8¼×9 in. Price: £31 4s. 5d. (including PT).

★**Box 525.** Four-unit enclosure. 2 mid/bass units, two tweeters. HC 20W max. FR: 40 Hz-20 KHz. vci: 5 ohms. Oiled teak. Size: 23×9½×9¼ in. Price: £64 3s. 2d. (including PT).

★ **Box 730.** Six-unit enclosure. 2 mid/bass units, four tweeters. HC 50W max. FR: 40 Hz-20 KHz. vci: 5 ohms. Oiled teak. Size: $24\frac{1}{2} \times 15\frac{3}{4} \times 5\frac{1}{2}$ in. Price: £66 14s. 1d. (including PT).

★ **Box 740.** Six-unit enclosure. 2 mid/bass units, four tweeters. HC 50W max. FR: 40 Hz-20 KHz. vci: 5 ohms. Oiled teak. Size: $26 \times 14\frac{1}{2} \times 10$ in. Price: £83 6s. 1d. (including PT).

Box 412. Three-unit enclosure. 1 bass unit, 1 mid-range, 1 tweeter. HC 40W max. FR: 40 Hz-20 KHz. Impedance 5 ohms. Oiled teak. Size: $15\frac{1}{2} \times 9\frac{1}{2} \times 9\frac{1}{4}$ in. Price: £40 15s. 3d. (including PT).

★

HACKER. Hacker Radio Ltd., Norreys Drive, Cox Green, Maidenhead, Berks. Tel: Maidenhead 22261.

LS.1000/15. Triple speaker system in critically air-loaded enclosure, employing one Goodmans 8 in. piston-type unit and two Goodman's 3 in. high-note units. vci: 15 ohms. Teak veneered. Dimensions: $20\frac{1}{4} \times 13\frac{3}{4} \times 11\frac{1}{4}$ in. Price: £24 (including PT).

LS.1000/8. 8 ohm version of LS.1000/15 for use in larger rooms. HC: 15W. Dimensions: $20\frac{1}{4} \times 13\frac{3}{4} \times 11\frac{1}{4}$ in. Price: £24 (including PT).

ST.1000. Stand for either speaker. Price: £2 18s. (including PT).

★

HEATHKIT. See Constructional Kits section.

★

HELME. P. F. and A. R. Helme, Summerbridge, Harrogate, Yorks. Tel: Darley 279.

New range of easy-to-assemble speaker enclosures for the home constructor. Each kit comprises fully finished and polished outer shell (veneered natural teak), set of terminals, wire, uncut front baffle and black vynair covering. All nuts, bolts and screws are included, also BAF wadding to fill cabinet.

Mini. Size: $12 \times 8 \times 7$ in. Volume: 7 litres (425 cu. in.). Price: £6 2s. 6d.

Mistral. Size: $14 \times 9 \times 7$ in. Volume: 10 litres (610 cu. in.). Price: £6 17s. 6d.

Bookshelf. Size: $18 \times 10 \times 9$ in. Volume: 16 litres (980 cu. in.). Price: £8 5s.

Large Bookshelf. Size: $20 \times 11 \times 9$ in. Volume: 20 litres (1,220 cu. in.). Price: £10 5s.

Super Bookshelf. Size: $21 \times 11 \times 10$ in. Volume: 25 litres (1,500 cu. in.). Price: £11 17s. 6d.

★ **Slimline.** Size: $29 \times 21 \times 9$ in. Volume: 62 litres (3,700 cu. in.). Price: £18.

★ **Major.** Size: $31 \times 21\frac{1}{2} \times 12$ in. Volume: 100 litres (6,100 cu. in.). Price: £20 15s.

All enclosures are of infinite baffle type. Speaker drive units are not specified but internal volume will provide guide in conjunction with manufacturers' literature.

★

THOMAS HEINITZ, 35 Moscow Road, Queensway, London, W.2. Tel: 01-229 2077.

C.Q. Junior. Controlled Q reflex enclosure. Special Goodmans or Peerless 10×6 in. units. FR: 45 Hz-15 KHz, depending on unit. Finishes: Teak, walnut, mahogany, all-white (others to order at no extra charge). Size: $16\frac{1}{2} \times 9\frac{1}{2} \times 9\frac{1}{4}$ in. Weight: 7 lb. Price: £9 16s. 7d.

★

HMV. British Radio Corporation Ltd., 284 Southbury Road, Enfield, Middlesex. Tel: 01-366 1155.

2406. Infinite baffle enclosure with 12 in. bass unit and 4 in. mid-range/tweeter. vci: 4 ohms. HC: 30W. FR: 40 Hz-18 KHz. Crossover network at 1.5 KHz. Dimensions: $22 \times 12\frac{3}{8} \times 10$ in. Finish: walnut veneer. Price: £30 10s.

★

HOWLAND-WEST LTD., 2 Park End, South Hill Park, London, N.W.3. Tel: 01-794 6666.

★ **Narvik.** Infinite baffle enclosure with speakers. 12 in. bass driver, mid-range unit and tweeter. Crossover network included. FR: 35 Hz-22 KHz. HC 25W. Size: $23\frac{1}{2} \times 17\frac{3}{4} \times 12$ in. Weight: $32\frac{1}{2}$ lb. Finish: teak. Price: £29 15s.

★ **Bergen.** Infinite baffle enclosure with speakers. $6\frac{1}{2}$ in. high compliance bass driver and tweeter. FR: 50 Hz-22 KHz. HC 12W. Size: $13\frac{3}{4} \times 9 \times 8\frac{3}{8}$ in. Weight: $10\frac{1}{4}$ lb. Finish: teak. Price: £13 10s. (plus £3 5s. 10d. PT).

JORDAN-WATTS. Distributors: Boosey and Hawkes (Sales) Ltd., Sonorous Works, Deansbrook Road, Edgware, Middlesex. Tel: 01-952 7711.

★ **Jumbo.** Infinite baffle. Power handling 12W. Forward facing. Shelf or wall mounting. Incorporates one Jordan-Watts modular unit. FR: 80 Hz-20 KHz. Size: $16\frac{1}{2} \times 8 \times 3\frac{1}{2}$ in. Weight: 13 lb. Finish: teak. Price: £18 10s.

★ **Janet.** Infinite baffle. One full-range Jordan-Watts module. FR: 70 Hz-20 KHz. HC 12W RMS. Compact shelf-mounting full range speaker system. Finish: teak with green Vynair. Size: $12 \times 8 \times 6\frac{1}{2}$ in. Weight: 13 lb. Price: £18 10s.

★ **Juno.** Reflex enclosure. Power handling 12W. Forward facing. Incorporates one Jordan-Watts modular unit. FR: 40 Hz-20 KHz. Size: $24\frac{1}{2} \times 12\frac{1}{2} \times 6\frac{1}{2}$ in. Weight: 27 lb. Price: £25 10s.

★ **Juliet.** Reflex cabinet. One full-range Jordan-Watts module. FR: 40 Hz-20 KHz. HC 12W RMS. Compact shelf-mounting full range speaker system. Finish: teak with green Vynair. Size: $16 \times 10 \times 9$ in. Weight: 28 lb. Price: £25 10s.

★ **Gemini.** Reflex enclosure. Power handling 25W. Forward facing. Incorporates two Jordan-Watts modular units. FR: 40 Hz-20 KHz. Size: $30 \times 13\frac{1}{2} \times 7\frac{1}{2}$ in. Weight: 50 lb. Price: £39 15s.

★ **Jupiter.** Reflex enclosure. Power handling 25W. Forward facing. Incorporates two Jordan-Watts modular units. FR: 20 Hz-20 KHz. Size: $34 \times 5 \times 10\frac{1}{2}$ in. Weight: 70 lb. Prices: £54 10s.

★

KEF ELECTRONICS LTD., Tovil, Maidstone, Kent. Tel: Maidstone 57258. Cables: KEF, Maidstone.

★ **Celeste Mk II.** Totally enclosed. Forward facing. Two drive units; 13×9 in. and $1\frac{1}{2}$ in. tweeter. Crossover 1 KHz. Size: $18 \times 10\frac{3}{4} \times 6\frac{3}{4}$ in. Weight: 21 lb. Price: £29.

★ **Portable Celeste.** Totally enclosed. Forward facing. Two drive units; 13×9 in., $1\frac{1}{2}$ in. tweeter. Crossover 1 KHz. Size: $20 \times 12\frac{1}{2} \times 7\frac{1}{2}$ in. Weight: 26 lb. Price: £34.

Concord. Totally enclosed. Forward facing. Two units; B139 13×9 in., T15 $1\frac{1}{2}$ in. tweeter. Crossover 1 KHz half-section. FR: 30 Hz-

20 KHz. Size: $24 \times 15 \times 9\frac{7}{8}$ in. Weight: 37 lb. Price: £43 10s.

★ **Cresta.** Totally enclosed. Forward facing. Two units; B110 bass driver, T27 HF unit. Crossover 4 KHz. FR: 50 Hz-30 KHz. HC 15W. Impedance 4-8 ohms. Terminal connections. System resonance 59 Hz. Size: $13 \times 9 \times 7$ in. Weight: 14 lb. Shelf-mounting. Finish: walnut or teak veneer with woven brown grille. Price: £18 (plus £4 3s. 7d. PT).

Concerto. Three-speaker system using the bass unit of the Concord with the medium and treble units of the Cresta. vci: 8 ohms. HC 25W RMS. FR 30 Hz-30 KHz. Crossover frequencies: 300 Hz and 4 KHz. Dimensions: $28 \times 17 \times 12$ in. Weight: 50 lb. Finish: walnut or teak veneer. Price: £53 10s.

★

KELETRON. K. & K. Electronics Ltd., 25 Roman Road, London, E.2. Tel: 01-980 1936.

High Fidelity 78. Infinite baffle speaker enclosure designed for housing all types of 8×5 in., 7×4 in. and 6×4 in. speakers. Sub-baffle board is supplied for 7×4 in. or 6×4 in. speaker. Finish: teak. Size: $10\frac{5}{8} \times 6\frac{1}{8} \times 4\frac{5}{8}$ in. Price: £4 7s. 6d. (including PT).

High Fidelity 65. Infinite baffle speaker enclosure for housing all types of circular or square frame $6\frac{1}{2}$ in. speakers and a 3 in. tweeter. Finish: teak. Size: $12\frac{1}{2} \times 7\frac{3}{4} \times 6\frac{1}{8}$ in. Price: £4 19s. 6d. (including PT).

8. Speaker enclosure for housing all types of 8 in. speakers and a 3 in. tweeter. Size: $17\frac{1}{4} \times 10 \times 7\frac{1}{4}$ in. Price: £6 5s. (including PT).

138. Speaker enclosure for housing all types of E.M.I. 13×8 in. speakers. Size: $17\frac{1}{4} \times 10 \times 7\frac{1}{4}$ in. Price: £6 5s.

1012. Speaker enclosure designed for housing a 12 in. or 10 in. speaker and a 4 in. tweeter. Sub-baffle board is supplied for the 10 in. speaker. Size: $21 \times 15 \times 7\frac{1}{4}$ in. Price: £9 5s. (including PT).

High Fidelity 28-E. Infinite baffle speaker enclosure designed for Eagle speaker kit 2-8. Size: $12\frac{1}{2} \times 7\frac{3}{4} \times 6\frac{1}{8}$ in. Price: £4 19s. 6d.

High Fidelity 315-E. Infinite baffle speaker enclosure. Size: $17\frac{1}{4} \times 10 \times 7\frac{1}{4}$ in. Price: £6 5s.

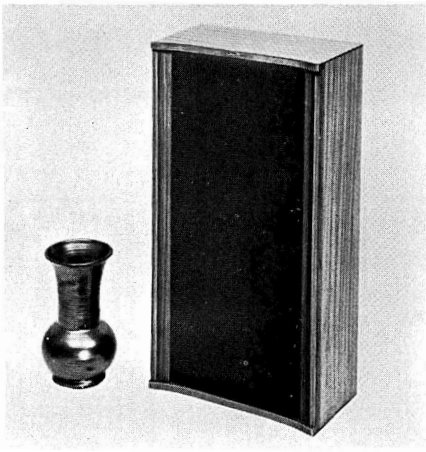

Jordan-Watts Juno

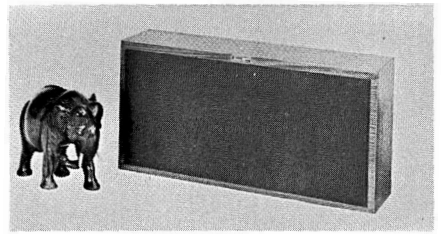

Jordan-Watts Jumbo

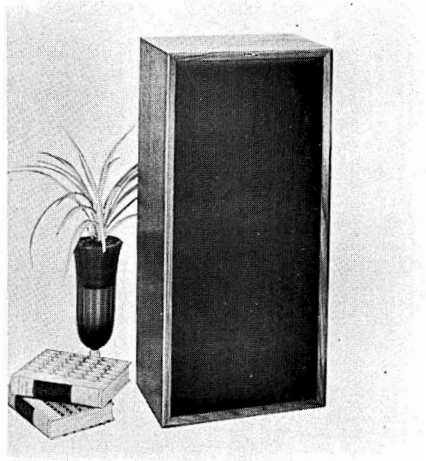

Jordan-Watts Gemini

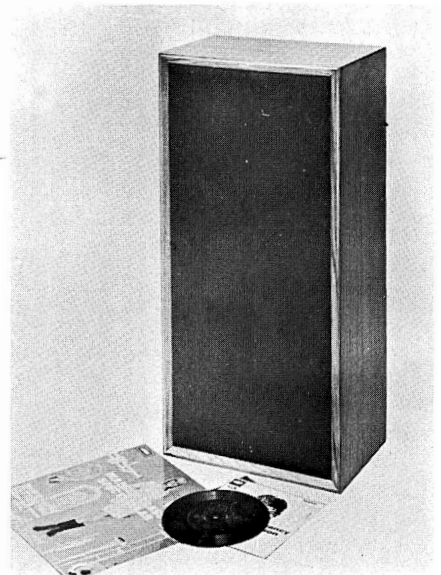

Jordan-Watts Jupiter

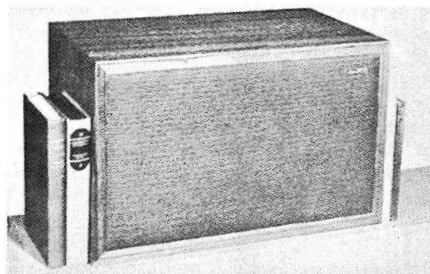

Jordan-Watts Juliet

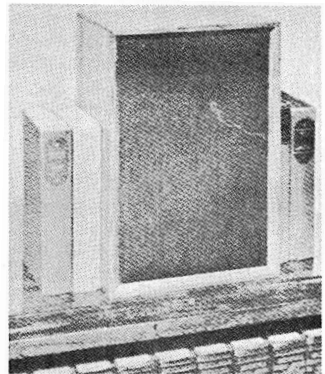

Jordan-Watts Janet

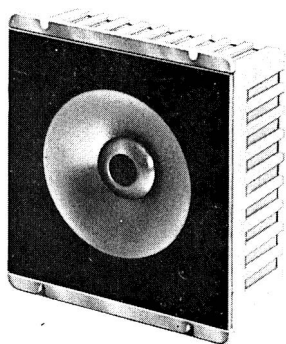

Jordan-Watts module

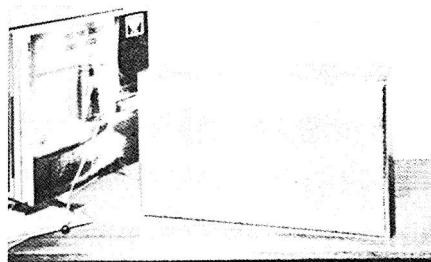

KEF Celeste

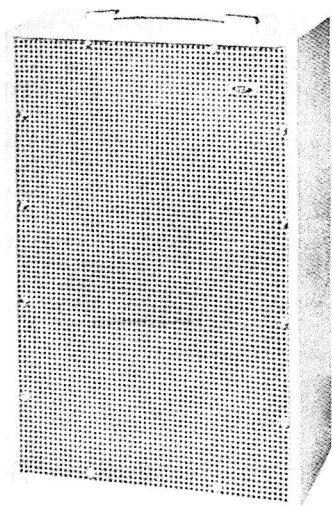

KEF Portable Celeste

High Fidelity 325-E. Infinite baffle speaker enclosure for housing Eagle speaker KIT 3-25. Size: $21 \times 15 \times 7\frac{1}{4}$ in. Price: £9 5s.

KN654/3. Three-way speaker system using $6\frac{1}{2}$ in. bass unit with a $2\frac{1}{4}$ in. parasitic tweeter built into the centre of the bass unit, and a separate 4 in. treble unit with LC crossover unit. vci: 4-8 ohms or 15-16 ohms. HC 5W RMS. FR: 75 Hz-18 KHz. Finish: polished teak. Size: $12\frac{1}{2} \times 7\frac{3}{4} \times 6\frac{1}{4}$ in. Weight: $6\frac{1}{2}$ lb. Price: £9 10s. (including PT).

KN824/3. Three-way speaker system using specially designed 8 in. bass unit with a $3\frac{1}{2}$ in. parasitic tweeter built into the centre of the bass unit and a separate 4 in. treble unit and LC crossover network. vci: 4-8 ohms or 15-16 ohms. HC 7W RMS. FR: 55 Hz-18 KHz. Finish: polished teak. Size: $17\frac{1}{4} \times 10 \times 7\frac{1}{4}$ in. Weight: 11 lb. Price: £11 10s. (including PT).

KN124/3. Three-way speaker system using a specially designed 12 in. bass unit with a $3\frac{1}{2}$ in. parasitic tweeter built into the centre of the bass unit and a separate 4 in. treble unit and LC crossover network. vci: 4-8 ohms or 15-16 ohms. HC 20W RMS. FR: 35 Hz-17 KHz. Finish: polished teak. Size: $21 \times 15 \times 7\frac{1}{2}$ in. Weight: 20 lb. Price: £19 19s. (including PT).

All enclosures supplied with necessary screws, nuts, acoustic padding and terminal connections.



KINGSTEREO. Distributors: Lionel Murray Ltd., 7 West Halkin Street, Belgrave Square, London. S.W.1. Tel: 01-235 6424-5-6.

Teak cabinet speaker enclosures. Price: £9 19s. 6d. (including PT).



KIRKMAN (CRAWLEY) LTD., 40 The Broadway, Crawley, Sussex. Tel: Crawley 26670.

★**Home Concert Hall Mk 2.** Isothermal tapered reflex enclosure with speakers and crossover. Two Richard Allan CR5 bass units and STC 4001E tweeter. Two $\frac{1}{4}$ -section crossovers at 3 KHz and 4 KHz. FR: 28 Hz -6 dB; 20 KHz -3 dB. HC 20W music. Omni-directional throughout frequency range in horizontal plane. Inside and outside of enclosure employed to maintain non-resonant closely controlled acoustic load. Finish: teak with bronze grille. Size: $31 \times 18 \times 8\frac{1}{2}$ in. Weight: 44 lb. Price: £52.

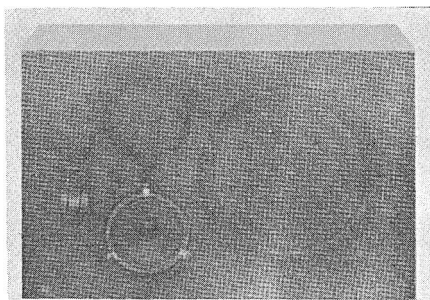

Klein and Hummel OY

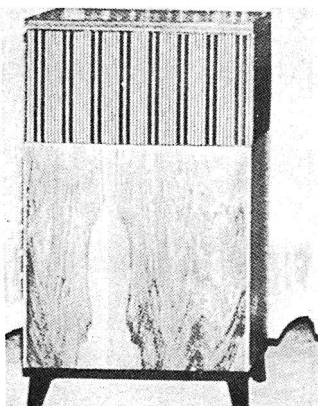

Kirkman Home concert Hall

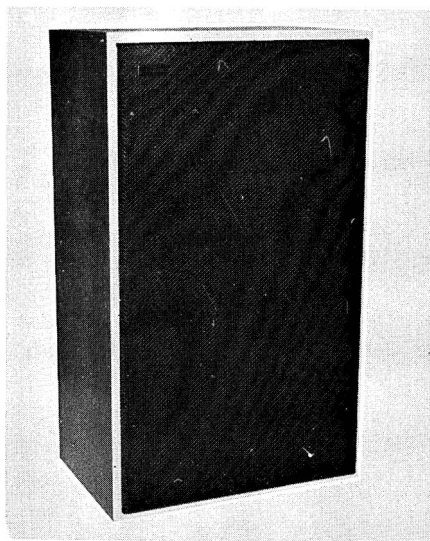

Leak Sandwich

KLEIN & HUMMEL. Sole U.K. agents: F. W. O. Banch Ltd., Holbrook House, Cockfosters, Barnet, Herts. Tel: 01-440 3277.

★ **K. & H. OY.** Studio monitor speaker enclosure comprising two separate built-in 30W solid state bass and treble amplifiers and 4-unit drive system. Input: 0.775V and 1.55V at 4.7K to 500 Hz dividing network filter. Speakers: 9 in. bass unit, two 5 in. mid-lift units and a 'top' horn. FR: 30 Hz-20 KHz. Complete equalisation controls for room and position matching. Dimensions: 19×12×9 in. Weight: 45 lb. Finish: grey formica or walnut. Psn: mains. Price on application.



KLINGER CONTROLS LTD., 10 Friar Street, Carter Lane, London, E.C.4. Tel: 01-236 1811.

S24. Sealed enclosure with 5 in. bass drive unit and tweeter, with $\frac{1}{4}$ -section crossover. HC: 10W, 15 ohms. Dimensions: 13×7×8 in. Price: teak finish £13 13s.; rosewood finish £15 15s.

S32. Sealed enclosure with 8×5 in. drive unit. HC: 5W, 15 ohms. Dimensions: 13×7×8 in. Teak finish. Price: £8 18s. 6d.

S40. Sealed enclosure employing 8×5 in. drive unit and tweeter, with $\frac{1}{4}$ -section crossover. FR: 60 Hz-18 KHz. System resonance 120 Hz. HC: 10W, 15 ohms. Dimensions: 13×7×8 in. Teak finish. Price: £10 10s.

S50. Sealed enclosure employing 8 in. drive unit and tweeter, with $\frac{1}{4}$ -section crossover. FR: 55 Hz-18 KHz. System resonance 80 Hz. HC 15W, 15 ohms. Dimensions: 18½×13×7 in. Teak finish. Price: £22 1s.



KORTING. Europa Electronics Ltd., Howard Place, Shelton, Stoke-on-Trent ST1 4NW. Tel: Stoke-on-Trent 29316.

LSB 15, Type 30 851. Special speaker box. 5 in. base medium sound system, 12,000 gauss; and 4 in. tweeter system, 9,000 gauss. HC 15W approx, music power. FR: 45 Hz-18 KHz. vci: 4.5 ohms. Natural walnut colour, satin finish. Dimensions: 7×11½×9½ in. Supplied with 16 ft patch cord with flat-pin plug. Price: 15 gns (including £2 17s. 9d. PT).

LSB25, Type 29 860. Infinite baffle with bass and treble units. Speakers: 8 in. bass unit, 5×3 in. tweeter. FR: 40 Hz-16 KHz. HC 15W music

power. vci: 4.5 ohms. Size: 22×12×5 in. Finish: satin finish natural walnut. Supplied with 10 ft lead and plug. Price: 25 gns (including £4 16s. 4d. tax).

LSB 45, Type 30 865. Infinite baffle with bass and treble units. Speakers: 9½ in. bass unit, 7×5 in. mid- and upper-frequency unit. FR: 30 Hz-20 KHz. HC 25W music power. vci: 4.5 ohms. Size: 25×13×7 in. Finish: satin finish natural walnut. Supplied with 10 ft lead and plug. Price: 34 gns (including £6 11s. tax).

★

LAFAYETTE. U.K. distributors: Barnet Factors Ltd., 4 Lisle Street, London, W.C.2. Tel: 01-437 2723.

Lafayette CR.25. Reflex speaker enclosure with 8 in. bass unit and 2½ in. tweeter. Crossover: 8 KHz LC. FR: 55 Hz-19.5 KHz. HC 12.5W. vci: 8 ohms. Dimensions: 12×7×10 in. Finish: oiled walnut. Price: £9 (plus £2 8s. 2d. PT).

Lafayette CR.50. Reflex speaker enclosure with 8 in. bass unit and 4 in. tweeter. Crossover: 3 KHz LC. FR: 35 Hz-18 KHz. HC 10W. vci: 8 ohms. Dimensions: 19×8⅝×10¾ in. Finish: oiled walnut. Specially tuned bass reflex enclosure with tube-type ducted port. Price: £11 18s. 3d. (plus £3 1s. 9d. PT).

Lafayette CR.150. Reflex speaker enclosure with 10 in. bass unit and 3½ in. tweeter. LC crossover 2 KHz. FR: 20 Hz-20 KHz. HC 20W RMS. vci: 8 ohms. Dimensions: 11×19×9 in. Weight: 17 lb. Finish: oiled walnut with beige grille fabric. Acoustic suspension design with high frequency brilliance control. Price: £18 18s. (plus £5 2s. PT).

Minuette II. Reflex enclosure with 7×5 in. bass unit and 2½ in. tweeter. High frequency level control. Crossover: 8 KHz LC. FR: 80 Hz-19.5 KHz. HC 5W. vci: 8 ohms. Dimensions: 17⅞×6×9⅞ in. Finish: oiled walnut. Price: £7 10s. (plus £1 19s. 1d. PT).

★

H. J. LEAK & CO. LTD., 57-59 Brunel Road, East Acton, London, W.3. Tel: 01-749 1641. Cables: Sinusoidal. Ealux, London.

★**Sandwich.** Forward facing. Two units, bass 11 in., treble 3 in. Half-section crossover filter. Cabinet can be placed in vertical or horizontal position. The unique sandwich construction diaphragm behaves as a rigid piston, thus

eliminating break-up distortion and resulting in a remarkably smooth frequency response. Impedance 15 ohms. Crossover 900 Hz. Six-element filter. Finish: Walnut, sapele mahogany or teak. Other finishes to order at slightly higher cost. Size: 26×15×12 in. Weight: 49.5 lb. Price: £43 10s.

★**Mini-sandwich.** Forward facing. Two units, bass 12 in. elliptical, treble 3 in. Half-section crossover filter. Cabinet can be placed in vertical or horizontal position. Sandwich construction diaphragm behaves as a rigid piston, thus eliminating break-up distortion and providing a smooth frequency response. Performance indistinguishable from standard Sandwich except for the lowest octave. Size: 18½×11×7 in. Weight: 22 lb. Price: £29 15s.

★

LL ELECTRONIC SALES LTD., 5 Shakespeare Road, London, N.3. Tel: 01-346 3332.

Model LL 15E. Infinite baffle speaker enclosure. One 13×8 in. unit and one 3½ in. tweeter. LC crossover. HC 10W RMS. vci: 15 ohms. Size: 23×12×8 in. Weight: 10 lb. Finished in teak. Price: £19 19s.

★

L. N. B. AUDIO LTD., 25 Cambridge Street, Loughborough, Leics. Tel: Loughborough 61229.

★**Para-Tran 6.** Infinite baffle bookshelf enclosure using 6½ in. bass unit and tweeter via crossover. FR: 50 Hz-17 KHz. HC 10W RMS. Impedance: 8 ohms. Cabinet size: 15½×11×8 in. Weight: 15 lb. Price: £17 6s. 8d. (including PT).

Para-Lab 6. Labyrinth loaded two-way system using 6½ in. bass unit and tweeter via crossover. FR: 40 Hz-17 KHz. HC 12.5W RMS. vci: 8 ohms. Cabinet size: 23½×10×10 in. Weight: 22 lb. Price: £24 13s. 8d. (including PT).

Para-Lab Super. Similar to Para-Lab 6 but using higher flux bass unit and studio quality tweeter. Price: £29 12s. 6d. (including PT).

★

LOCKWOOD & CO. (WOODWORKERS) LTD., 63 Lowlands Road, Harrow, Middx. Tel: 01-422 3704.

Mini-slim. Reflex, forward facing. 12 in. units.

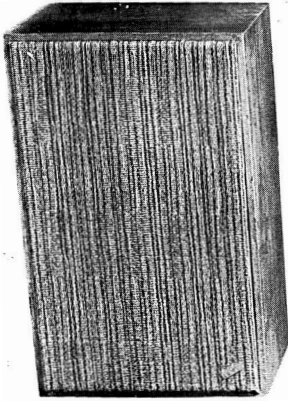

Leak Mini-Sandwich

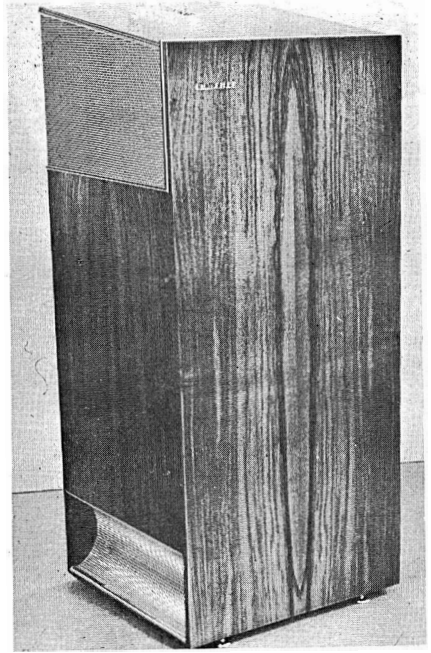

Lowther Acousta Twin

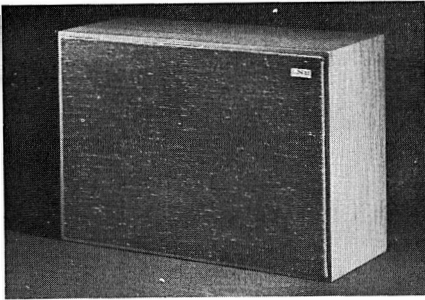

LNB Audio Para-Tran 6

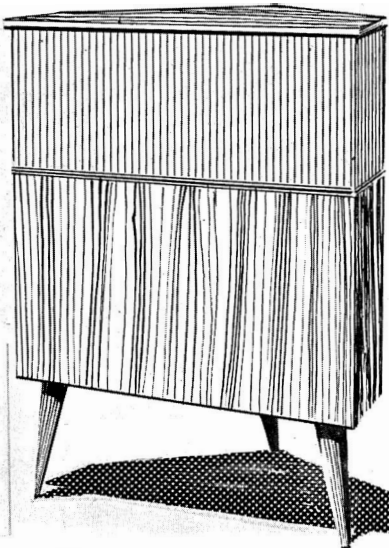

Lowther TPI

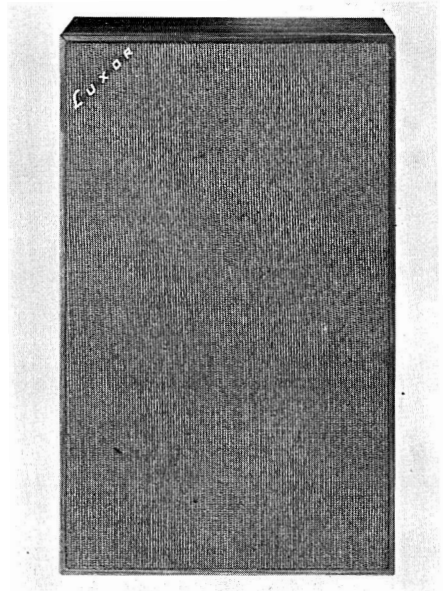

Luxor SH102

Rec Tannoy 12 in. dual concentric. Tannoy III LZ dual concentric. Size: $27\frac{1}{2} \times 19 \times 9\frac{1}{8}$ in. Price (with specified units): £51 15s., £43 10s.

Minor Slim. Reflex, forward facing. 12 or 15 in. units. Rec Tannoy 12 or 15 in. dual concentric, and units listed for Mini-slim. Size: $33\frac{1}{8} \times 20 \times 11\frac{1}{4}$ in. Price (with specified units): £62 10s., £55 15s., £48 10s.

Major Slim. Reflex, forward facing. 12 or 15 in. units. Rec Tannoy 12 in. and 15 in. dual concentric. Size: $38 \times 24 \times 11\frac{1}{4}$ in. Price: £61 15s., £68 10s.

LEI/AS Mk III and LEI/WAS. Studio quality monitoring speakers. Full details and prices on request.



LOWTHER MANUFACTURING CO., Lowther House, St Mark's Road, Bromley, Kent, England. Tel: 01-460 5225. Cables: Lowther, Bromley.

★**Corner Reproducer TPI.** Folded bass horn/direct HF horn type. One specially designed 6 in. pressure unit PM3. Acoustical crossover. FR: 40 Hz-22 KHz. Size: $47 \times 32 \times 31$ in. from corner. Weight: 70 lb. Price of Standard Model A and Model D: £127 15s.; Model B £151 10s.

Acousta Cabinet. Models FH/V, FH/H. Folded horn type, forward facing, with rear folded horn. Vertical on runners, or horizontal on 12 in. legs. Designed for use with single 6 in. or 8 in. unit. Rec Lowther PM6. FR: 40 Hz-18 KHz. Size: $32 \times 18\frac{1}{2} \times 14\frac{1}{2}$ in. Weight: 60 lb. Price without unit: £25 (plus £2 4s. 6d. PT).

Mini Acousta. Model FH/V (vertical) and FH/H (horizontal). Folded horn type. Forward facing with rear folded horn. Veneered all round. Designed for use with one 6-8 in. unit. Rec Lowther PM6 or PM7. FR: 40 Hz-20 KHz. Size: $27 \times 15 \times 13$ in. Price without unit: £27 5s. (plus £2 8s. 6d. PT).

Audiovector. Compound horn. Upward facing mid- and high-frequency horn with rear folded horn. Designed for use with single 6 in. unit. Acoustic crossover. FR: 40 Hz-22 KHz. Rec PM2, PM2 Mk II or PM4. Size: $26\frac{1}{2} \times 19 \times 34$ in. Weight: 75 lb. Price: £68 (without unit).

★**Panoramic Twin Acousta.** Dual folded horn. Side facing and rear folded horn system for mono and stereo reproduction. Designed for use with two PM6, PM7 or PM2 Mk III 6 in. drive

units. Acoustic crossover. FR: 40 Hz-18 KHz. Size: $40 \times 16\frac{1}{2} \times 18$ in. Price without units: £51 (plus £4 10s. 10d. PT).

Dual Position Acousta. Folded horn. Rear-facing into corner or along wall at 45 degrees. Bass outlets coupling into corner of room or along wall. Designed for use with single 6 in. high flux unit. Rec Lowther PM6 or PM7. FR: 40 Hz-18 KHz. Size: $32 \times 9\frac{1}{2} \times 18$ in. Price without unit: £27 5s. (plus £2 8s. 6d. PT).

L.I.B. Acousta. Lowther Ideal Baffle is a special enclosure in the Lowther range of folded rear and compound horn designs. It has closed back with anti-phase slave membrane to overcome resonance. Membrane is coupled to drive unit by compliance and matched via a short labyrinth. Effect is that drive unit frequency response, say 30 Hz-20 KHz, such as PM6, becomes 25 Hz-20 KHz. Veneered teak, walnut or sapele finish. Grille cloth: ripple grey. Dimensions: $19 \times 14 \times 7\frac{1}{2}$ in. Price: £15 (plus £1 9s. 5d. PT).



LUXOR. Distributors: Luxitone Ltd., 84 Bolsover Street, London, W.1. Tel: 01-636 2901.

★**SH102.** Incorporates one 10 in. bass unit, two 2 in. tweeters. FR: 35 Hz-18 KHz. HC: 20W. vci: 4 ohms. Dimensions: $12 \times 21 \times 10$ in. Weight: 19 lb. Finish: teak and rosewood.

★**KH820.** Incorporates one 8 in. bass unit, two 2 in. tweeters. FR: 40 Hz-18 KHz. HC: 20W. vci: 4 ohms. Dimensions: $10 \times 16 \times 8\frac{1}{2}$ in. Weight: 14 lb. Finish: teak and rosewood.

★**KH520.** Incorporates one 5 in. bass unit and one $2\frac{1}{2}$ in. tweeter. FR: 45 Hz-18 KHz. HC: 15W. vci: 4 ohms. Dimensions: $10 \times 7\frac{1}{2} \times 8\frac{1}{2}$ in. Weight: 7 lb. Finish: teak and rosewood.

SH46. Incorporates one 6×4 in. full-range unit. FR: 130 Hz-10 KHz. HC: 5W. vci: 4 ohms. Dimensions: $9 \times 4 \times 8$ in. Weight: 5 lb. Finish: teak and rosewood.



MEDLEY MUSICAL LTD., 4 Felltram Way, Charlton, London, S.E.7. Tel: 01-858 3426.

Musette. Speaker enclosure with 8 in. high flux bass unit and 3-9 in. tweeter. HC 10W. vci: 3 or 15 ohms. FR: 50 Hz-17 KHz. Crossover: 5-5 KHz. Cabinet size: $30 \times 10 \times 7\frac{1}{2}$ in. Price: £19 4s. 10d.

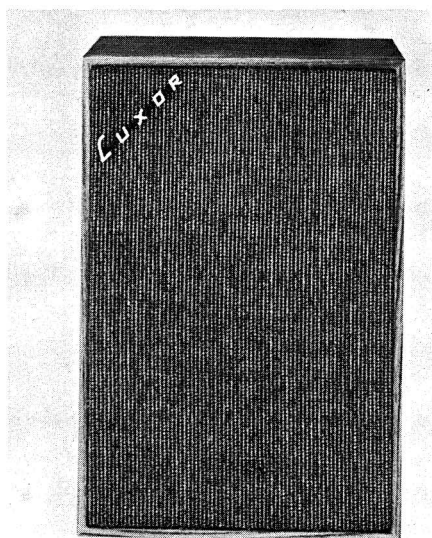

Luxor KH520

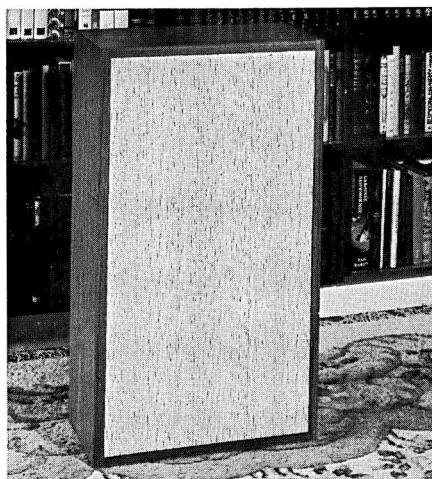

MMG Emperor 101, 102

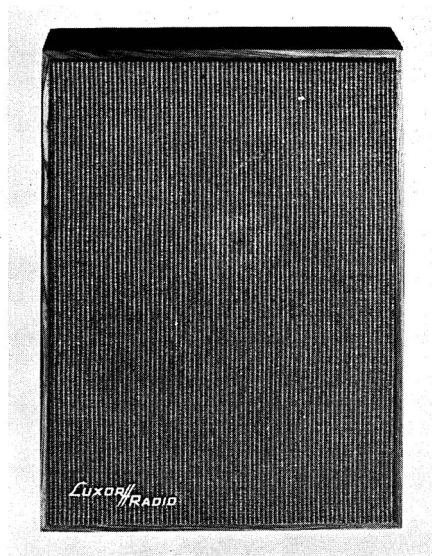

Luxor KH820

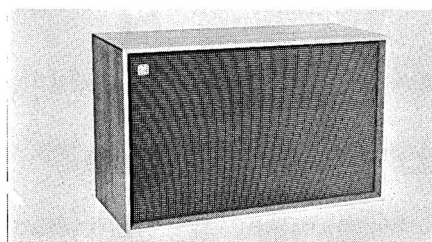

Mordaunt-Short MS200

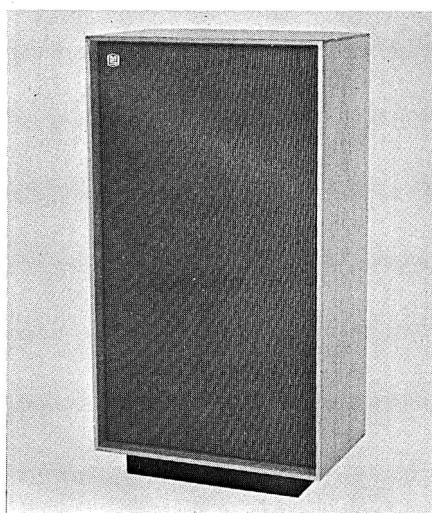

Mordaunt-Short MS400

Mini Musette Mk II. Speaker enclosure with 8×13 in. bass unit and two tweeters, front mounting. HC 10W. vci: 8 or 15 ohms. FR: 60 Hz-15 KHz. Dimensions: 17×10×7½ in. Price: £11.

BLS. Speaker enclosure with 8×13 in. bass unit and 3½ in. tweeter. Crossover 4 KHz. HC 10W. Impedance: 8 or 15 ohms. FR: 50 Hz-17 KHz. Dimensions: 19×14×8 in. Price: £17.

Maxi. Speaker enclosure with 8×13 in. bass unit and two tweeters, front mounting. HC 10W. vci: 8 or 15 ohms. FR: 60 Hz-15 KHz. Dimensions: 16×11½×7 in. Price: £12.



MMG ASSOCIATES, 8 Watford Heath Farm, Oxhey, Watford, Herts, WD1 4ER. Tel: Watford 21754.

★ **Emperor 101.** Infinite baffle type enclosure. 13×8 in. elliptical driver with coaxially mounted high frequency unit. Crossover: 5 KHz choke-capacitor network. FR: 50 Hz-16 KHz. HC 20W. vci: 8 ohms. Adjustable high frequency balance. Finish: teak effect in Melamine plastic, with other finishes to order. Size: 31×17×9 in. Weight: 39½ lb. Price: £29.

★ **Emperor 102.** As Emperor 101 but vci is 16 ohms. Price: £29.



MORDAUNT-SHORT LTD., 12 Hollywood Road, London, S.W.10. Tel: 01-352 9898 and 9818.

MS 100. Infinite baffle cabinet with 8 in. flat piston bass unit, 4 in. mid-range unit and 3 in. tweeter. Crossover: 800 Hz and 5 KHz printed circuit network. FR: 45 Hz-15 KHz. HC 25W. vci: 8 ohms. Dimensions: 18×11×9 in. Weight: 31 lb approx. Finish: teak or walnut veneers, including rear of cabinet. Price: £36 15s.

★ **MS 200.** Infinite baffle enclosure with 8 in. flat piston bass unit, 4 in. mid-range unit and HF 1300 HF unit. Crossover: 800 Hz and 5 KHz printed circuit network. FR: 40 Hz-15 KHz. HC 25W. vci: 8 ohms. Dimensions: 21×13×9 in. Weight: 32 lb approx. Finish: teak or walnut veneer, including rear of cabinet. Price: £42.

MS 300. Infinite baffle enclosure with one 12 in. bass unit, an HF 1300 unit and an STC HF pressure unit. Crossover: 2.250 Hz and 11 KHz

printed circuit network. FR: 40 Hz-25 KHz. HC 25W. vci: 8 ohms. Dimensions: 24×15×9 in. Weight: 331b approx. Finish: teak or walnut veneer, including rear of cabinet. Matched with MS400 for stereo, one floor-standing and one bookshelf. Price: £47 5s.

★ **MS 400.** Infinite baffle enclosure with one 12 in. bass unit, one HF1300 and one STC HF pressure unit. Crossover: 2.250 Hz and 11 KHz printed circuit network. FR: 35 Hz-25 KHz. HC 25W. vci: 8 ohms. Dimensions: 27×15×9 in. on 1¾ in. plinth. Weight: 36 lb. approx. Finish: teak or walnut veneers, including rear of cabinet. Price: £52 10s.

MS 500. Infinite baffle enclosure with 12 in. bass unit and Decca-Kelly 30W ribbon unit. Crossover: 2,500 Hz, variable slope multi-stage network. FR: 30 Hz-25 KHz. HC 30W. vci: 80 ohms. Dimensions: 30×15×12 in. on 1¾ in. plinth. Weight: 41 lb. approx. Finish: teak or walnut veneers, including rear of cabinet. Price: £57 15s.

MS 600. Infinite baffle speaker enclosure with 12 in. bass unit and Decca-Kelly 30W ribbon complete with acoustic lens. Crossover: 2,500 Hz variable slope multi-stage network. FR: 30 Hz-25 KHz. HC 30W. vci: 8 ohms. Dimensions: 30×15×12 in. on 1¾ in. plinth. Weight: 42 lb approx. Finish: teak or walnut veneers including rear of cabinet. Price: £57 15s.

MS 700. Infinite baffle enclosure with 12 in. bass unit, 4 in. mid-range unit and Decca-Kelly 30W ribbon. Crossover: 800 Hz and 4.500 Hz multi-stage network. FR: 25 Hz-25 KHz. HC 30W. vci: 8 ohms. Dimensions: 33×17×12 in. on 1¾ in. plinth. Weight: 52 lb approx. Finish: teak or walnut veneers including rear of cabinet. Price: £73 10s.



NICHOLS ACOUSTIC. See Derwent.



PEAK SOUND (Harrow) Ltd., 32 St. Judes Road, Englefield Green, Egham, Surrey. Tel: Egham 5316.

Baxandall Enclosure. Designed for 9×5 in. speaker and special equalizer network. FR: 60 Hz-16 KHz. flat 100 Hz-10 KHz. HC 10W. vci: 15 ohms. Afrormosia. Size: 18×12×9½ in. Price on application.

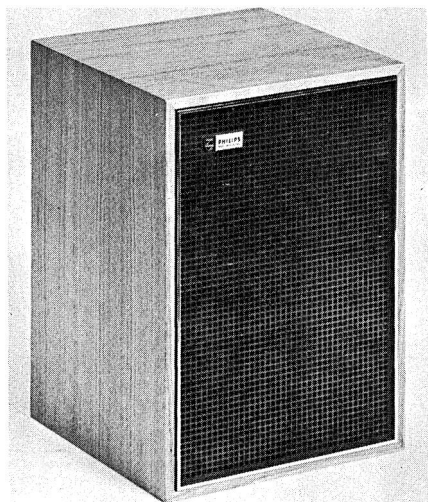

Philips RH481

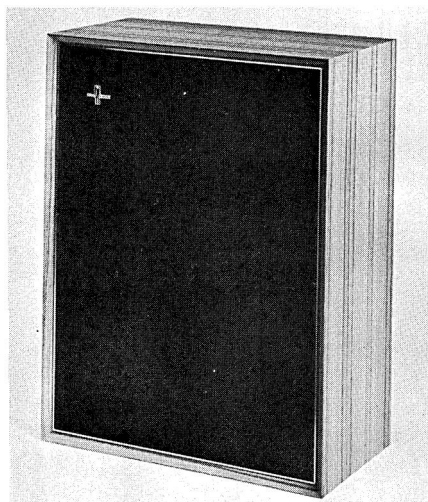

Philips RH497

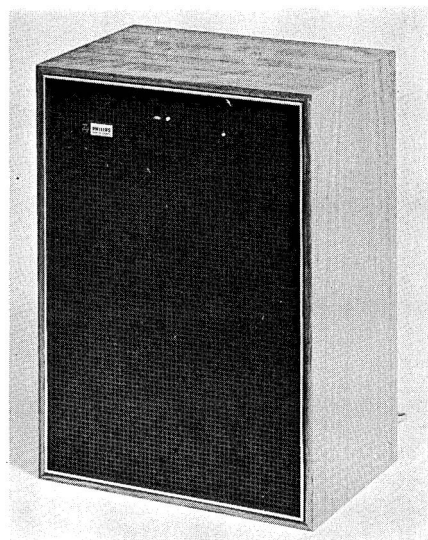

Philips RH482

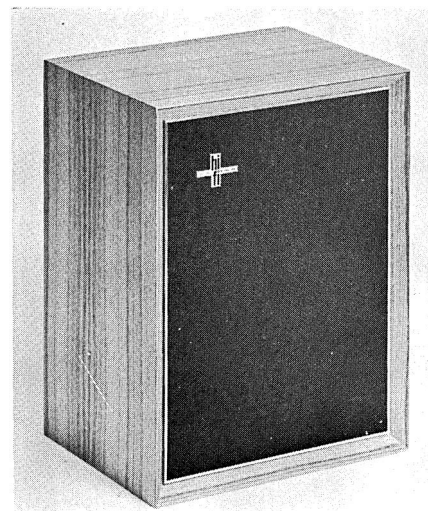

Philips RH491

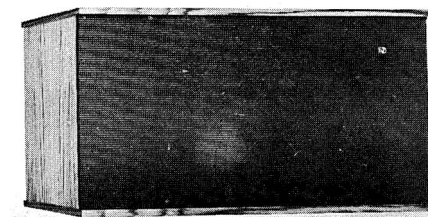

Philips GL.561

PEERLESS. See Brimham.



PHILIPS ELECTRICAL LTD., Century House, Shaftesbury Avenue, London, W.C.2. Tel: 01-437 7777.

★**RH481.** Infinite baffle enclosure with 5 in. dual cone unit. FR: 60 Hz-16 KHz. HC 6W. vci: 8 ohms. Dimensions: $10\frac{3}{4} \times 7\frac{1}{4} \times 7\frac{3}{8}$ in. Teak veneered cabinet. Price: £8 16s. 5d. (plus £2 3s. 7d. PT).

★**RH482.** Infinite baffle enclosure with 7 in. dual cone unit. FR: 60 Hz-18 KHz. HC 10W. vci: 8 ohms. Dimensions: $13\frac{7}{8} \times 9\frac{7}{8} \times 7\frac{3}{8}$ in. Teak veneered cabinet. Price: £14 8s. 8d. (plus £3 11s. 4d. PT).

★**RH491.** Infinite baffle enclosure with 7 in. woofer and 1 in. tweeter. Crossover: 1,600 Hz $\frac{1}{2}$ -section. FR: 55 Hz-20 KHz. HC 20W. vci: 8 ohms. Dimensions: $11\frac{7}{8} \times 9\frac{1}{8} \times 7\frac{1}{4}$ in. Teak veneered cabinet. Price: £17 12s. 10d. (plus £4 7s. 2d. PT).

★**RH497.** Infinite baffle enclosure with 10 in. woofer, 5 in. mid-range and 1 in. tweeter. Crossover: 600 Hz and 4 KHz $\frac{1}{2}$ -section. FR: 40 Hz-20 KHz. vci: 8 ohms. Teak veneered cabinet. Countour switch to adjust top response. Price: £39 5s. 10d. (plus £9 14s. 2d. PT).

★**GL561/70.** Reflex speaker enclosure with 8 in. dual cone unit. FR: 70 Hz-17 KHz. HC 15W. vci: 4-8 ohms. Dimensions: $23\frac{3}{8} \times 11\frac{1}{8} \times 8\frac{3}{8}$ in. Teak veneered cabinet. Price: £21 12s. 7d. (plus £5 6s. 11d. PT).



PIONEER. Distributors: Shriro (UK) Ltd., 8 Bush Lane, London, E.C.4. Tel: 01-626 4711.

CS-52T. Compact 2-way bass reflex enclosure. $6\frac{1}{2}$ in. bass/mid-range unit and $2\frac{1}{2}$ in. tweeter. vci: 4 ohms. FR: 45 Hz-20 KHz. Sensitivity: 93 dB. HC 15W RMS. Finish: walnut. Size: $13\frac{3}{8} \times 8\frac{1}{2} \times 8\frac{3}{8}$ in. Cable and wall brackets provided. Price: £25 16s. 10d. (including £5 11s. 6d. PT).

CS-53. Two-speaker bass reflex enclosure. Shelf or floor. 12 in. bass/mid-range, $3\frac{1}{2}$ in. tweeter. vci: 8 ohms. FR: 45 Hz-20 KHz. Sensitivity: 100 dB. HC 40W (music). Finish: oiled

walnut. Size: $22\frac{1}{2} \times 16\frac{1}{2} \times 11\frac{1}{8}$ in. Cable and felt feet provided. Screw terminal and jack connections. Price: £35 11s. 1d.

CS-77. Three-way bass reflex enclosure. 12 in. bass, 5 in. mid-range, horn tweeter. Fibre glass lined cabinet. FR: 35 Hz-25 KHz. Cross-over frequencies: 800 Hz, 6 KHz. vci: 8 ohms. HC 50W (music). Sensitivity: 102 dB. Finish: lattice grille, oiled walnut sides. Size: $14\frac{5}{8} \times 25\frac{1}{4} \times 12\frac{1}{4}$ in. Weight: 48 lb. Connections: screw or jack. Cable and felt feet provided. Price: £52 7s. 1d.



P. W. B. AUDIO LTD., 33 Call Lane, Leeds 1, Yorks. Tel: Leeds 28559.

Heritage Bookshelf. Infinite baffle enclosure. KEF bass unit. Special Celestion HF1300 tweeter. Crossover frequency: 2 KHz. FR: 45 Hz-18 KHz. HC 30W. vci: 10 ohms. Size: $21 \times 12 \times 8$ in. Finish: teak, walnut, mansonia and others. Price: £27 10s.



QUAD. Acoustical Manufacturing Co. Ltd., St Peter's Road, Huntingdon, Hunts. Tel: Huntingdon 2561/2. Cables: Acoustical.

★**Quad Electrostatic.** Full range doublet covering 45 Hz-18 KHz. Attenuation outside band asymptotic to 18 dB/8ve. Total integrated radiation at max output equivalent to 95 phons in rooms of up to 5,000 cu ft with average reverberation. Dispersion approx 70 deg horizontal; 15 deg vertical. Imp 30-15 ohms, 40 Hz to 8 KHz, falling above 8 KHz. Designed for use with standard Quad 303 Amplifier. Suitable for AC supplies 100-120 or 200-250V 50-60 Hz. Free-standing unit requires no enclosure or cabinet. Weight: 35 lb. Price: £66 complete.



RADFORD. Radford Electronics Ltd., Ashton Vale Estate, Ashton Vale Road, Bristol, 3. Tel: Bristol 662301.

Bookshelf. Infinite baffle enclosure with units. 13×9 in. bass driver 3 in. mid- and high-frequency unit. Crossover 2 KHz. FR 55 Hz-14 KHz. HC 30W. Impedance: 8-16 ohms. 1 in. thick solid wood cabinet lagged with sheeps wool. Size: $21 \times 12 \times 8$ in. Weight: 37 lb. Price: £32 10s.

Beaumonde. Infinite baffle enclosure with

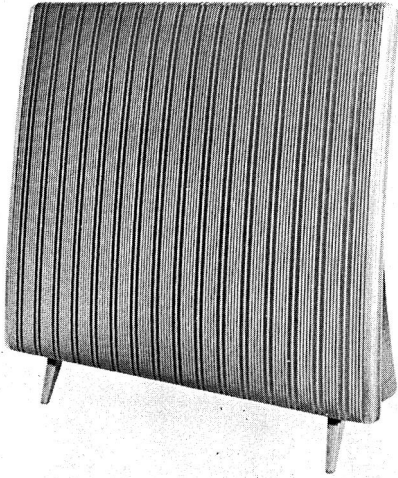

Quad Electrostatic

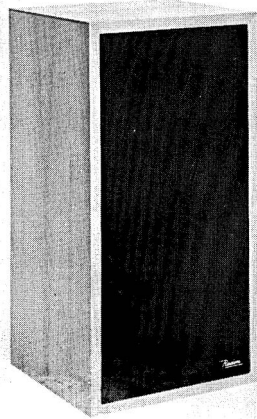

Radon Opal

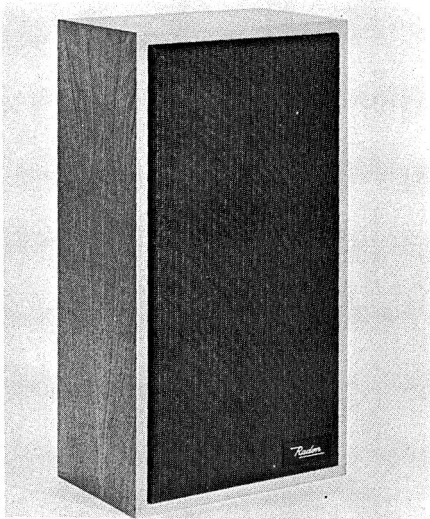

Radon Amethyst

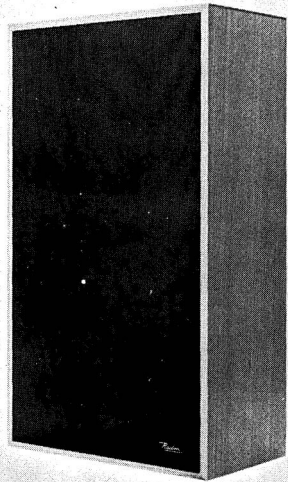

Radon Sapphire

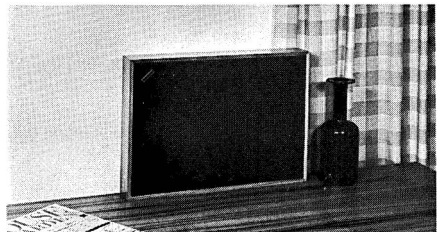

Rogers Wafer System

units. 13 × 9 in. bass driver, 3 in. mid- and high-frequency unit. Crossover 2 KHz. FR 50 Hz-14 KHz. HC 35W. Impedance: 8-12 ohms. 1 in. thick solid wood cabinet lagged with sheeps wool. Afrormosia finish. Size: 22 × 13 × 11½ in. Weight: 50 lb. Price: £39 10s.

Monitor. Infinite baffle enclosure with units. 13 × 9 in. bass driver, 3 in. mid-range unit, 1½ in. driver. Crossover: 500 Hz and 4.2 KHz. FR: 45 Hz-15 KHz. HC 40W. Impedance: 8-12 ohms. 1 in. solid wood cabinet lagged with sheeps wool. Afrormosia finish. Size: 25¼ × 15 × 11½ in. Weight: 50 lb. Price: £57 10s.

Studio. Four-speaker enclosure complete with units and crossovers. 13 × 9 in. bass driver, 3 in. mid-range unit, 1½ in. high-frequency unit, ¾ in. tweeter. Crossover: 500 Hz, 4.2 KHz, 10 KHz. HC 50W. Impedance: 8-12 ohms. 1 in. solid wood cabinet with sheeps wool lagging. Afrormosia finish. Size: 40 × 20 × 17 in. Weight: 112 lb. Price: £97 10s.

Auditorium. Infinite baffle enclosure with units. 13 × 9 in. bass driver, 3 in. mid-range unit, 1½ in. HF unit, ¾ in. tweeter. Crossover: 500 Hz, 4.2 KHz, 10 KHz FR 35 Hz-25 KHz. HC 40W. Impedance: 8-12 ohms. 1 in. solid wood cabinet lagged with sheeps wool. Size: 30 × 16 × 14 in. Weight: 90 lb. Afrormosia finish. Size: 30 × 16 × 14 in. Price: £75.



RADON INDUSTRIAL ELECTRONICS CO. LTD., Brooklands Trading Estate, Orme Road, Worthing, Sussex. Tel: Worthing 34904.

Jewel range of four speakers in hand-built teak enclosures. Finished in satin lacquers and charcoal-coloured fronts. Brass key plates for wall mounting. Impedances: 8 or 15 ohms.

★ **Amethyst SC/1.** Infinite baffle. HC 10W maximum. FR: 60 Hz-17 KHz ±6 dB. System comprises 6½ in. woofer with ceramic magnet of 10,000 gauss and 1 in. voice coil; and 4 in. tweeter with crossover. Size: 19 × 10 × 6 in. £11 5s. (plus £2 12s. 11d. PT).

Emerald SC/2. Infinite baffle. HC 15W maximum. FR: 50 Hz-10 KHz ±5 dB. 10 × 6 in. woofer with aluminium centre cone and high compliance PVC suspension; tweeter and crossover. Price: £16 10s. (plus £3 18s. 3d. PT).

★ **Opal SC/3.** Infinite baffle. HC 15W maximum. FR: 20 Hz-20 KHz ±8 dB. Speakers:

13 × 8 in. woofer using ceramic magnet of 11,000 gauss, high compliance PVC surround, aluminium centre cone; tweeter with 10,000 gauss ceramic magnet, driven from crossover network at 5 KHz. Dimensions: 23 × 12 × 11 in. Price: £18 15s.

★ **Sapphire SC/4.** Enclosure with 12 in. woofer using ceramic magnet of 15,500 lines and 1¼ in. speech coil. Four × 4 in. tweeter assembly on heavy die-cast alloy frame for non-directional sound. HC 25W maximum. FR: 20 Hz-18 KHz ±2 dB. Vabinet size: 30 × 16 × 9 in. Price: £36.



RECORD HOUSING, Brook Road, London, N.22. Tel: 01-888 7487.

Folded Horn Enclosure. Forward facing free-standing. Designed for single 8 in. unit. Rec Richard Allan CG8 or Wharfedale Super 8. Size: 27½ × 16¼ × 10 in. Finish: walnut, mahogany or teak. Price (cabinet only): £12 19s.



RECTAVOX COMPANY, Central Buildings, Wallsend, Northumberland. Tel: Wallsend 624845.

Omni 8. Specially shaped reflex enclosure providing unique versatility of positioning. Designed for 8 in. drive unit with provision for tweeter. Frequency range dependent on drive unit employed. Finish: Teak, walnut or mahogany laminated plastic veneers with satin chrome brass frame. Size: 24½ in. maximum dimension. Price: (enclosure only) £12. May be converted to Omni Mk II by adding tweeter and changing driver unit.

★ **Omni Mk II.** Reflex enclosure with special shape giving low resonant frequency and unique versatility of positioning. Units: K.E.F. B139 foil-stressed expanded polystyrene diaphragm bass and mid-range driver, K.E.F. T15 hemispherical dome tweeter. Crossover five-element ½-section 1 KHz. FR: 30 Hz-20 KHz ±3 dB. vci: 15 ohms. HC 15W. Finish: Teak, walnut or mahogany laminated plastic wood grain veneers, Tygan fret material, satin-chrome brass frame. Size: 24½ in. maximum dimension, fret front 18¾ × 11½ in. Weight: 40 lb. Price: £30 19s. 6d. units; (enclosure only £18).

Comprehensive information available on matching to transistor amplifiers.

★ **Ambi.** Similar performance to the Omni but

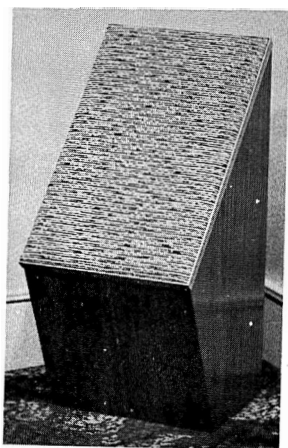

Rectavox Omni Mk II



Sansui SP30: SP50: SP100: SP200: SP300

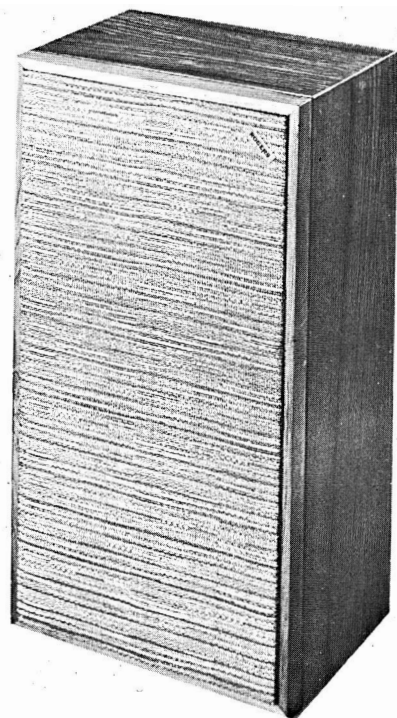

Rogers Ravensbourne "Compact"

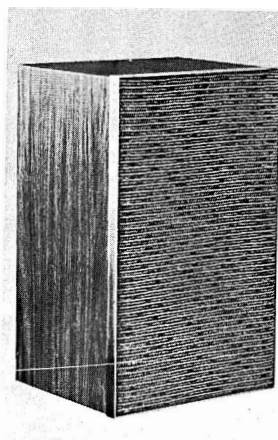

Rectavox Ambi enclosure

in a compact enclosure of more orthodox rectangular shape. Size: $18\frac{3}{8} \times 11\frac{5}{8} \times 9\frac{3}{4}$ in. Weight: 35 lb. Price (with units): £29 8s.; (enclosure only): £10 10s.

Comprehensive information available on request regarding matching to transistor amplifiers.

Wall brackets. Special wall fixing devices for Omni Mk II and Ambi. Price (set of four): 15s.

Matching transformer. Type AA2 20W. FR: 25 Hz-20 KHz. zero dB down at 25 Hz. Price: £3 3s.

Bass corrector C60. Neutralises excessive corner gain and flattens impedance curve. Price: £3 10s.

The Rectavox accessories listed above are designed specifically for use with Omni and Ambi speakers.



ROGERS DEVELOPMENTS (ELECTRONICS) LTD., 4/14 Barmeston Road, Catford, London, S.E.6. Tel: 01-698 7424/4340. Cables: Rodevco, London, S.E.6.

Wafer speaker system. Infinite baffle. 5 in. unit plus tweeter. FR: 40 Hz-16 KHz. HC 12W. vci: 15 ohms. Solid afrormosia frame with black fret material. Size: $13\frac{1}{8} \times 16\frac{5}{8} \times 2\frac{1}{2}$ in. Price: £16 (plus £4 0s. 1d. PT).

★ Ravensbourne Compact. Infinite baffle enclosure with units. 8 in. high-flux bass driver, $3\frac{3}{4}$ in. HF1300 tweeter. Crossover 2.5 KHz. FR: 50 Hz-14 KHz. HC 10-15W RMS. Finish: teak veneer. Size: $22 \times 11\frac{1}{2} \times 8\frac{5}{8}$ in. Price: £25 (plus £6 5s. 1d. PT).



SANSUI. Sole UK importer: Brush Clevite Co. Ltd., Thornhill, Southampton, SO9 1QX. Tel: Southampton 45166.

★ Sansui SP30. Pipe-duct bass reflex enclosure with $6\frac{1}{2}$ in. cone type woofer and 2 in. horn tweeter. HC 20W. vci: 8 ohms. FR: 50 Hz-20 KHz. Crossover: 7 KHz. Dimensions: $16\frac{11}{16} \times 10\frac{11}{16} \times 7\frac{7}{8}$ in. Weight: 9.9 lb. Price: £25 5s. 1d. (plus £6 3s. 6d. PT).

★ Sansui SP50. Horn type enclosure with units. 8 in. bass driver, 2 in. horn tweeter. Crossover 7 KHz. FR: 50 Hz-20 KHz. HC 25W. Imped-

ance 8 ohms. Dimensions: $12\frac{3}{4} \times 9\frac{3}{4} \times 19\frac{3}{4}$ in. Weight: 19.8 lb. Finish: American walnut, hand carved grille. Price: £35 3s. 7d. (plus £8 11s. 11d. PT).

★ Sansui SP100. Reflex enclosure with three units. 10 in. bass driver, 5 in. mid-range unit, 2 in. horn tweeter. Crossover: 1.5 KHz and 5 KHz. FR: 45 Hz-20 KHz. vci: 8 ohms. HC 25W RMS. Three-position level control. Finish: American walnut. Size: $14\frac{1}{8} \times 11\frac{7}{8} \times 24\frac{1}{2}$ in. Weight: $34\frac{1}{2}$ lb. Price: £44 2s. (plus £10 15s. 7d. PT).

★ Sansui SP200. Reflex enclosure with five units. 12 in. bass driver, two 5 in. mid-range units, two 2 in. horn tweeters. Crossover: 1.5 KHz and 5 KHz. FR: 35 Hz-20 KHz. vci: 8 ohms. HC 40W RMS. Three-position level control. Finish: American walnut. Size: $15\frac{1}{8} \times 12\frac{1}{2} \times 25\frac{3}{4}$ in. Weight: $40\frac{1}{2}$ lb. Price: £63.

★ Sansui SP300. Reflex enclosure with four units. 12 in. bass driver, 5 in. mid-range unit, two 2 in. horn tweeters. Crossover: 1.5 KHz and 6 KHz. FR: 30 Hz-20 KHz. vci: 8 ohms. Special pipe ducted bass reflex design. HC 50W RMS. Finish: American walnut. Size: $18 \times 27\frac{1}{2} \times 16\frac{1}{2}$ in. Weight: $78\frac{1}{2}$ lb. Price: £97 10s.



SANYO (Marubeni) UK Ltd., Greycaines Estate, Bushey Mill Lane, Watford, Herts. Tel: Watford 25354.

SX-7. Two-unit system, 10 in. and horn type tweeter. vci: 8 ohms. HC 25W. 45 Hz-20 KHz. Size: $13\frac{1}{2} \times 11\frac{1}{4} \times 23\frac{3}{16}$ in. Price: £38 5s. (plus £9 PT).

SX-6. Four-unit system. 12 in. woofer, $6\frac{3}{4}$ in. squawker, 2 horn-type tweeters. vci: 8 ohms. 30W. 30 Hz-20 KHz. Size: $17\frac{3}{16} \times 11\frac{5}{8} \times 28\frac{3}{4}$ in. Price: £55.



SINCLAIR RADIONICS LTD., 22 Newmarket Road, Cambridge. Tel: Cambridge 52996.

Q14. Compact sealed pressure chamber. FR 60 Hz-16 KHz. HC 14W. Impedance 15 ohms. Price: £6 19s. 6d.

★ System 2000. Compact speaker enclosure of contemporary design. FR 100 Hz-15 KHz. HC 10W RMS. Impedance 8 ohms at 1 KHz. Finish: solid aluminium. Size: $10\frac{1}{2} \times 8\frac{1}{2} \times 8\frac{1}{2}$ in. Price: £12 12s.

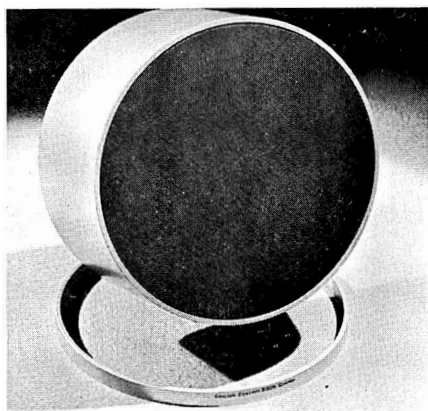

Sinclair System 2000

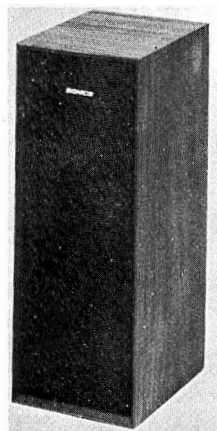

Sonics AS303

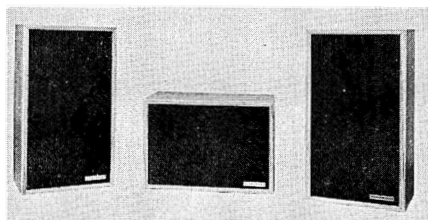

Soundtracks SCS10, SCS5, SCS10E

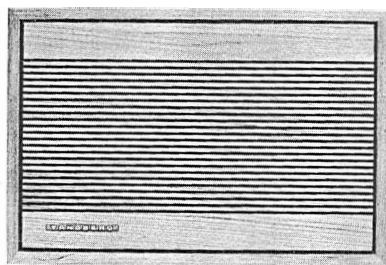

Tandberg System 12

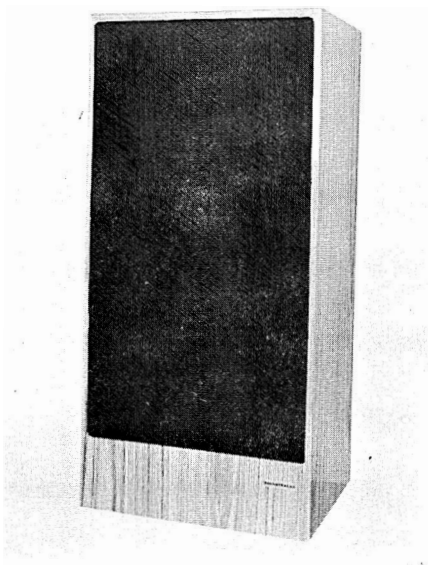

Soundtracks SCS20

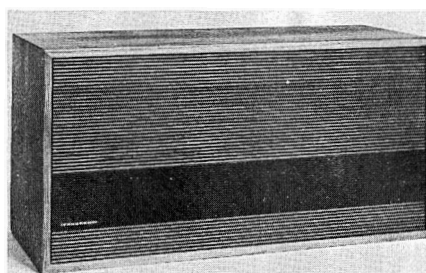

Tandberg System 15

SONICS CORPORATION. U.K. distributor: B. H. Morris & Co. (Radio) Ltd., 84-88 Nelson Street, Tower Hamlets, London, E.1. Tel: 01-790 4824.

AS-57. Bookshelf speaker system with 7 × 5 in. unit. HC 10W (music power). vci: 8 ohms. FR: 70 Hz-18 KHz. Finish: walnut. Dimensions: 15 $\frac{3}{8}$ × 5 $\frac{7}{8}$ × 8 $\frac{1}{4}$ in. Weight: 5.06 lb. Price: £15 per pair.

★ **AS-303.** Bookshelf enclosure with three units: 12 in. extra low resonance woofer with a long travel voice coil; 6 $\frac{1}{2}$ in. sealed back mid-range unit; and exponential horn-type super tweeter. HC 30W (music power). vci: 8 ohms. FR: 35 Hz-20 KHz. Finish: walnut, hand-rubbed oil finish. Dimensions: 25 × 14 $\frac{3}{4}$ × 11 $\frac{7}{8}$ in. Weight: 26.4 lb. Price: £31 10s. each.

AS-330. Five-speaker system in reflex enclosure with precision tuned pipe ducted port design. Speakers: 12 in. high compliance, long throw voice coil woofer; two 6 $\frac{1}{2}$ in. acoustically isolated mid-ranges; and two horn-type HF tweeters. Crossover network: 3-way 12 dB/oct. LC type network. 600 Hz and 5 KHz. HC 40W (music). vci: 8 ohms. FR: 30 Hz-20 KHz. Rear-mounted push-button tone control. Finish: walnut, hand-rubbed oil finish. Size: 26 × 15 $\frac{3}{8}$ × 11 $\frac{5}{8}$ in. Weight: 37.4 lb. Price: £59 10s. each.

AS-440. Pipe ducted $\frac{3}{4}$ in. hardwood reflex enclosure with glasswool acoustic insulation with six speakers in 4-way system. Speakers: 16 in. low resonance woofer; two 6 $\frac{1}{2}$ in. high efficiency sealed back mid-range units; two 3 $\frac{1}{2}$ in. cone type low treble units; and horn-type super high treble unit. Crossover network: 4-way 12 dB/oct. LC type network. 600 Hz, 3.5 KHz and 10 KHz. HC 60W (music). vci: 8 ohms. FR: 25 Hz-20 KHz. Finish: walnut hand-rubbed oil finish. Dimensions: 28 × 18 $\frac{1}{8}$ × 13 in. Weight: 48.4 lb. Price: £72 each.

★

SOUNDMASTER LTD., Brook Road, Wood Green, London, N.22. Tel: 01-888 7487.

Largo. Horn cabinet with Clestion D8/8806 8 in. bass and T1330 3 in. treble unit. Crossover: feed capacitor to tweeter. FR: 25 Hz-15 KHz. HC 15W RMS. vci: 8 ohms. Dimensions: 27 $\frac{1}{2}$ × 16 $\frac{1}{4}$ × 10 $\frac{1}{2}$ in. Weight: 24 lb. Finish: teak. Price: £28 10s.

★

SOUNDTRACKS LTD., Decibel House, Charl-

woods Road, East Grinstead, Sussex. Tel: East Grinstead 21332.

★ **SCS5.** Infinite baffle cabinet with 8 × 5 in. speaker. FR: 90 Hz-14 KHz. HC 5W RMS. vci: 4-8 ohms. Dimensions: 7 × 5 $\frac{1}{2}$ × 12 in. Weight: 4 lb. Finish: teak, charcoal grey baffle covering. Price: £6 16s. (plus £1 12s. PT).

★ **SCS10.** Infinite baffle cabinet with 8 × 5 in. speaker. FR: 70 Hz-14 KHz. HC 10W. vci: 4-8 ohms. Dimensions: 8 $\frac{1}{2}$ × 6 × 15 in. Weight: 6 lb. Finish: teak veneer, charcoal grey baffle covering. Price: £8 10s. (plus £2 PT).

★ **SCS10E.** Infinite baffle cabinet with 8 × 5 in. speaker and one tweeter. Crossover: coaxially mounted tweeter 6 KHz. FR: 70 Hz-17 KHz. HC 10W. vci: 4-8 ohms. Dimensions: 8 $\frac{1}{2}$ × 6 × 15 in. Weight: 6 $\frac{1}{2}$ lb. Finish: teak veneer, charcoal grey baffle covering. Price: £11 1s. (plus £2 12s. PT).

SCS15. Infinite baffle cabinet with one 13 × 8 in. speaker and one tweeter. Crossover: 14A614A 5 KHz. FR: 40 Hz-18 KHz. HC 15W RMS. Impedance: 4-8 ohms. Dimensions: 12 $\frac{1}{2}$ × 6 $\frac{1}{2}$ × 23 in. Weight: 13 lb. Finish: teak veneer, charcoal grey baffle covering. Price: £18 18s.

★ **SCS20.** Infinite baffle cabinet with one 13 × 8 in., one 10 × 6 in., and two tweeters. Crossover: XO4500/4 1.200 Hz and 6 KHz. FR: 20 Hz-20 KHz. HC 20W RMS. vci: 4-8 ohms. Dimensions: 12 $\frac{1}{2}$ × 6 $\frac{1}{2}$ × 23 in. Weight: 33 lb. Price: £46 4s.

★

STENTORIAN. Whiteley Electrical Co. Ltd., Victoria Street, Mansfield, Notts. Tel: Mansfield 24763-5. Cables: Whitebon, Mansfield.

C3. Junior Console. Bass reflex for corner position. 1 or 2 drive units. Rec HF816 or HF1012 with T10 tweeter, if required. Crossover 3 KHz. FR: (HF816) 50 Hz-14 KHz; (HF1012 and T10) 30 Hz-14 KHz. Size: 33 × 22 $\frac{1}{2}$ × 18 $\frac{1}{2}$ in. Price without units: £16 1s. 7d. (plus £1 11s. 11d. PT).

C2. Senior Corner Console. Bass reflex for corner position. 10 in. or 12 in. drive unit with tweeter, if required. Crossover 3 KHz. FR: (HF1012 and T10) 30 Hz-14 KHz; (HF1214 and T12) 25 Hz-17 KHz. Size: 35 × 30 × 19 in. Price without units: £19 18s. 5d. (plus £1 19s. 7d. PT).

Model C4. Corner Console. Similar design to Model C2 but suitable for smaller room. De-

signed for Stentorian HF810 or HF812. Size: 26×17×7½ in. Price without unit: £8 14s. 9d. (plus 17s. 4d. PT).

C14. Thoresby Bass Reflex Corner Console. Designed to utilise acoustic properties of walls. Takes 8 in. or 10 in. units with provision for tweeter. Size: 31×19⅜×17 in. Choice of mahogany (C14) or walnut (C14A) finish. Price: (mahogany) £16 12s. 3d. (plus £1 13s. PT); (walnut) £16 19s. 2d. (plus £1 13s. 8d. PT). Cabinet only without speaker units.

C15. Thoresby Bass Reflex Console. Designed for 8 in. or 10 in. units with provision for tweeter. Size: 31×19⅜×18 in. Choice of mahogany (C15) or walnut (C15A) finish. Prices: (mahogany) £17 19s. 11d. (plus £1 15s. 9d. PT); (walnut) £18 10s. 8d. (plus £1 16s. 10d. PT). Cabinet only without speaker units.

C16 Thoresby Equipment Console. Upright style equipment cabinet with lift-up lid. Takes most makes of gram unit or tape deck, amplifier, control unit and tuner. Available in mahogany or walnut. Supplied packed flat and easily assembled in a few minutes with a screwdriver only. Size: 19⅜×18×31 in. Price: (mahogany) £20 19s. 6d. (plus £2 1s. 8d. PT); (walnut) £21 13s. 5d. (plus £2 3s. PT).

For speaker enclosures with units see entry under Whiteley.



TANDBERG. Distributors: Farnell-Tandberg Ltd., Hereford House, North Court, Vicar Lane, Leeds. 2. Tel: Leeds 39834.

System 7. Enclosure with units. Bass driver 10×6 in., tweeter 2 in. vci: 3 ohms. HC: 8W. FR: 60 Hz-16 KHz. Dimensions: 20½×10×10½ in. Finish: Siamese teak or rosewood. Price: teak, £21 13s. 2d. (plus £5 6s. 10d. PT); rosewood, £23 5s. (plus £5 15s. PT).

System 10. Enclosure with units. 6½ in. bass driver, 2 in. tweeter. vci: 4 ohms. HC: 8W. FR: 60 Hz-16 KHz. Dimensions: 7½×9⅞×9⅞ in. Finish: teak. Price: £14 8s. 8d. (plus £3 11s. 4d. PT).

System 11. Enclosure with units. 6½ in. bass driver, 2 in. tweeter. vci: 4 ohms. HC: 8W. FR: 60 Hz-16 KHz. Dimensions: 12⅝×6×8½ in. Finish: Siamese teak or rosewood. Price: teak, £14 8s. 8d. (plus £3 11s. 4d. PT); rosewood, £16 4s. 6d. (plus £4 0s. 6d. PT).

★**System 12.** Enclosure with units. 6½ in. bass

driver, 2 in. tweeter. vci: 4 ohms. HC: 8W. FR: 50 Hz-16 KHz. Dimensions: 17¼×7½×8½ in. Finish: Siamese teak or rosewood. Price: teak, £16 4s. 6d. (plus £4 0s. 6d. PT); rosewood, £17 17s. 8d. (plus £4 8s. 4d. PT).

System 13. Enclosure with units. 10×6 in. bass driver, 2 in. tweeter. vci: 3 ohms. HC: 8W. FR: 60 Hz-16 KHz. Dimensions: 25½×9⅜×8⅜ in. Finish: Siamese teak or rosewood. Price: teak, £22 9s. (plus £5 11s. PT); rosewood, £24 13s. 3d. (plus £6 1s. 9d. PT).

★**System 15.** Enclosure with 12 in. woofer, 5 in. mid-range unit and 2.5 in. tweeter. vci: 4 ohms. HC: 30W. FR: 35 Hz-16 KHz. Dimensions: 13⅜×11×27½ in. Finish: teak or rosewood. Price: teak, £42; rosewood, £44 10s.

System 16. Extension speaker enclosure, suitable for kitchen, etc. Dimensions: 5×16⅞×4⅞ in. Finish: pearl grey, lacquered. Price: £7 10s. (including PT).



TANNOY. Tannoy Products Ltd., West Norwood, London, S.E.27. Tel: 01-670 1131. Cables: Tannoy, London.

★**Audio Metric.** Infinite baffle. Forward facing. One 12 in. bass and mid-range unit, single suspension small diaphragm presence unit. HC 15W RMS. FR: 40 Hz-16 KHz. Size: 32½×17×7 in. Price: £27 10s.

★**III.LZ Mk II.** Infinite baffle forward facing. Monitor Gold III.LZ dual concentric unit with crossover network. FR: 30 Hz-20 KHz. Size: 14×10⅜×23¼ in. Price: £41.

★**Lancaster.** Reflex (single port) forward facing. Free-standing. One Monitor Gold 12 in. with crossover network. Size: 33½×21½×12½ in. (including 2 in. plinth). Price: £54.

Lancaster. Reflex (single port) forward facing. Corner placing. One Monitor Gold 12 in. with crossover network. Size: 33×25×16⅜ in. (including 2 in. plinth). Price: £54.

Lancaster. Aperiodic free-standing enclosure. One Monitor Gold 15 in. with crossover network. Size: 33½×21½×12½ in. (including 2 in. plinth). Price: £60.

Lancaster. Aperiodic corner-standing enclosure. One Monitor Gold 15 in. unit with cross-

over. Size: $33 \times 25 \times 16\frac{3}{4}$ in. (including 2 in. plinth). Price: £60.

Rectangular York. Reflex (single port) enclosure. Forward facing. Complete with Monitor Gold 15 in. dual concentric unit with crossover. Crossover 1 KHz. FR: 23 Hz-20 KHz. Size: $15 \times 23\frac{1}{2} \times 42$ in. Price: £77 10s.

York. Reflex enclosure. Forward facing unit. Dual throated ports. Corner placing. One Monitor Gold 15 in. dual concentric unit with crossover. FR: 35 Hz-20 KHz. Size: $45\frac{1}{2} \times 32 \times 22\frac{1}{2}$ in. Price: £77 10s.

Rectangular GRF. Single folded horn. Forward facing with front exits. Complete with one Monitor Gold 15 in. dual concentric unit. Crossover 1 KHz. FR: 23 Hz-20 KHz. Size: $17\frac{1}{4} \times 23\frac{1}{2} \times 42$ in. Price: £107 10s.

Corner GRF. Folded horn. Rear loaded horn, forward facing unit. Corner placing. One Monitor Gold 15 in. dual concentric unit. FR: 20 Hz-20 KHz. Size: $48 \times 38 \times 29$ in. Price: £124 10s.

Guy R. Fountain Autograph. Folded horn. Front and rear horn loaded unit. Corner placing. One Monitor Gold 15 in. unit with crossover. FR: 20 Hz-20 KHz. Size: $58\frac{1}{2} \times 43 \times 26\frac{1}{2}$ in. Price: £167 10s.

Tannoy speakers are available in various finishes including teak, mahogany and walnut. Also special finishes quoted on request.



TAYLOR BOOTH & HOLDER, 35 South Street, Eastbourne, Sussex. Tel: Eastbourne 31755.

B.T.T.1 and B.T.T.2. Multiple braced enclosure, incorporating three drive units: one 14×9 in. bass driver and two $1\frac{1}{2}$ in. high flux pressure units with phase correction plates. Type of loading: infinite baffle. Crossover frequency: 3 KHz. Axial frequency response: (Anechoic conditions) 50 Hz-14.5 KHz ± 5 dB. Overall response: 30 Hz-15 KHz. Polar response: 30 deg off axis. 10 KHz response within 2 dB of response at 100 Hz. System resonance: 50 Hz. Cubic capacity: approx 4 cu ft. vci: 8 ohms. HC 20W RMS. Dimensions: $30 \times 20 \times 16\frac{1}{4}$ in. Weight: 72 lb. Finish: both styles in afrormosia, Australian walnut, mahogany, rosewood. Other finishes to order. Difference between models is in cabinet styling. Price on application.

TELEFUNKEN. Distributors: AEG (Great Britain) Ltd., Lonsdale Chambers, 27 Chancery Lane, London, W.C.2. Tel: 01-242 9944.

RB40/41. System comprising two units: $5\frac{1}{8}$ in. bass driver and 5×3 in. mid/treble unit. vci: 4 ohms. HC: 15W. FR: 50 Hz-20 KHz. Finish: walnut. Dimensions: $9\frac{3}{4} \times 6\frac{3}{4} \times 6\frac{3}{8}$ in. Price: £12 15s. (plus £3 PT).

WB60/61. Enclosure comprising two units: $5\frac{1}{8}$ in. bass driver and 5×3 in. mid/treble unit. HC: 15W. FR: 45 Hz-18 KHz. Finish: teak. Dimensions: $18\frac{1}{2} \times 6\frac{1}{2} \times 10$ in. Price: £18 5s. 6d. (plus £4 6s. PT).

RB70H. Enclosure comprising two units: 8 in. bass driver and 7×5 in. mid/treble. vci: 4 ohms. HC: 25W. FR: 40 Hz-18 KHz. Finish: teak. Dimensions: $21 \times 10\frac{1}{4} \times 9\frac{1}{4}$ in. Price: £25 1s. 6d. (plus £5 18s. PT).

L250 Hi-Fi. Enclosure comprising three units: 8 in. bass driver and two 5×3 in. mid/treble units. vci: 4 ohms. HC: 35W. FR: 35 Hz-20 KHz. Finish: walnut. Dimensions: $18 \times 7\frac{1}{8} \times 12\frac{3}{4}$ in. Price: £32 17s. 4d. (plus £7 14s. 9d. PT).



TOSHIBA. Distributor: Hanimex (U.K.) Ltd., 15-24 Great Dover Street, London, S.E.1. Tel: 01-407 8161.

SS15. Infinite baffle speaker comprising two units: 8 in. free edge bass driver and 3 in. cone tweeter, with crossover network at 5 KHz. FR: 60 Hz-20 KHz. HC: 16W at 8 ohms. Soft/normal tone selector. Dimensions: $7\frac{5}{8} \times 17\frac{1}{2} \times 7\frac{5}{8}$ in. Weight: 19.8 lb. Walnut finish. Supplied with $16\frac{1}{2}$ ft. of cable and wall suspension bracket. Price: £28 1s. (plus £5 19s. PT).

SS25. Reflex enclosure comprising three units: 8 in. free edge bass driver, $3\frac{1}{4}$ in. horn tweeter and 8 in. passive speaker with crossover network at 5 KHz. FR: 50 Hz-20 KHz. HC: 25W at 8 ohms. Tone selector switch. Supplied with 16 ft. of cable. Price: £33 2s. (plus £7 2s. PT).

SS41. Infinite baffle speaker comprising three units: 12 in. bass driver, mid-frequency horn and tweeter horn, with crossover networks at 700 Hz and 5 KHz. Mid and upper frequency levels adjustable ± 3 dB. FR: 25 Hz-20 KHz. HC: 40W at 8 ohms. Dimensions: $16\frac{3}{4} \times 28\frac{1}{4} \times$

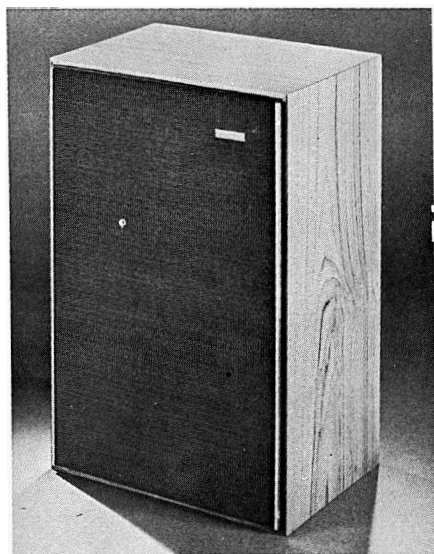

Truvox LS300

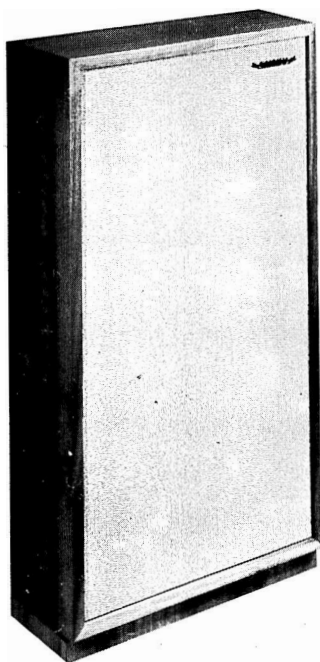

Tannoy Audiometric

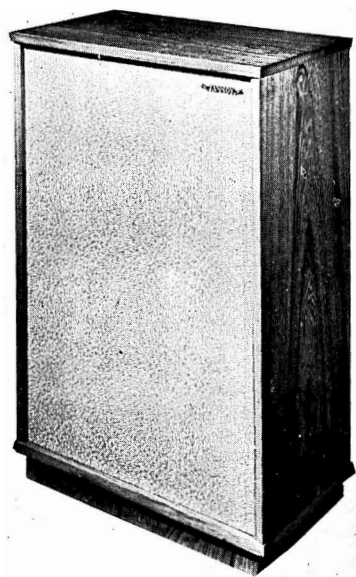

Tannoy Lancaster 12 or 15

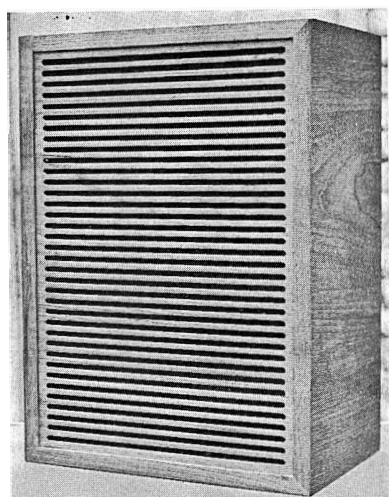

Tripletone Concerto

SPEAKERS

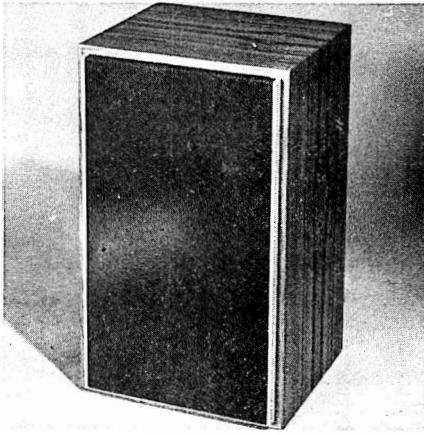

Truvox LS200

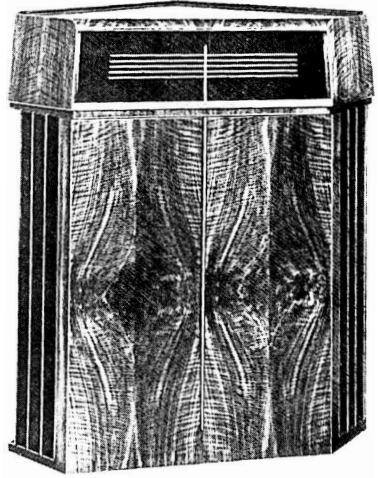

Vitavox Klipschorn

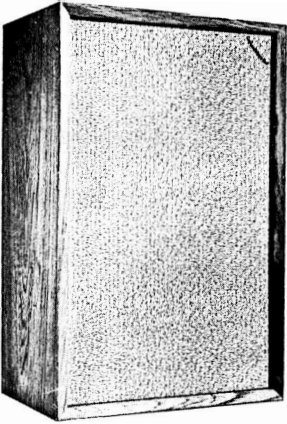

Tannoy Monitor III LZ

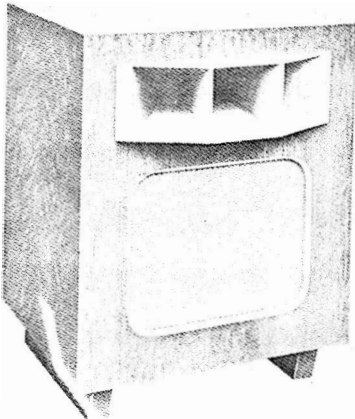

Vitavox Bitone 3200

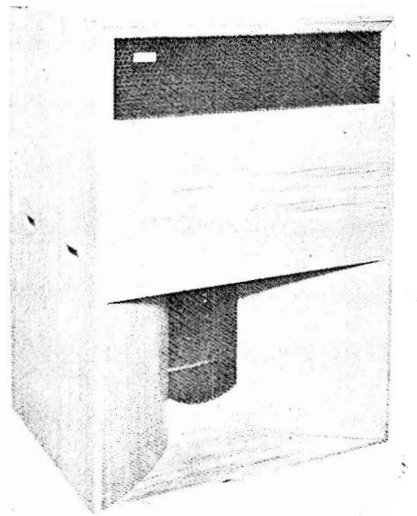

Vitavox Bi-tone Major

15¼ in. Weight: 50.7 lb. Walnut finish. Price: £102 (plus £21 14s. PT).



TRIPLETONE MANUFACTURING CO. LTD., 241a The Broadway, Wimbledon, S.W.19. Tel: 01-542 1189.

★ **Concerto.** Bass reflex enclosure employing twin-cone full range 8 in. unit. FR: 40 Hz-17 KHz. HC 10W RMS. vci: 15 ohms. (2-3 ohms to order). Size: 19½ × 13¼ × 9 in. Weight: 19 lb. Finish: teak. Horizontal or vertical mounting. Price: £11 5s. (plus £2 15s. PT).



TRUVOX. Truvox Ltd., Hythe, Southampton. Tel: Hythe 3265.

★ **LS200.** Infinite baffle enclosure with two units and crossover. 5 in. high compliance bass driver. 1½ in. tweeter. FR: 35 Hz-15 KHz. HC 12W RMS. vci: 15 ohms. Crossover: half-section, four-element LC network. Crossover frequency: 3.5 KHz. Size: 17 × 8 × 5¾ in. Weight: 12 lb. Finish: teak. Can be mounted vertically or horizontally. Price: £22 7s. 3d. (including PT).

★ **LS300.** Infinite baffle enclosure with two units: LF unit 13 × 9 in.; HF unit 1½ in. Crossover: 1.500 Hz. half-section 4-element LC network. FR: 45-20 KHz. HC 20W. vci: 8 ohms. Dimensions: 22 × 14 × 10½ in. Weight: 35.5 lb. Finish: teak cabinet, cloth front panel. Price: £46.



VITAVOX LTD., Westmoreland Road, London, N.W.9. Tel: 01-205 8671. Cables: Vitavox, London, N.W.9.

★ **Klipschorn.** Double channel horn system. Folded LF horn with AK152 drive unit. Forward-facing HF horn with S2 pressure unit. Filter network incorporated. Crossover 500 Hz. FR: 30 Hz-15 KHz. High translational efficiency. Size: 51 × 30 × 27 in. Weight: 210 lb. with drive units. Price: on application.

★ **Bitone Series 3200.** Double channel sound system comprising three-cell horn (distribution 60° wide × 20° high) with 12 in. LF driver in vented enclosure. Filter network 1 KHz crossover attenuation 12 dB per octave. HF balance control 0-8 dB attenuation. HC 20W FR: 50 Hz-15 KHz. Size: 24 × 20 × 19 in. Weight: 70 lb. Price: on application.

Bitone Series 6200. Similar specification to 3200 but with six-cell horn giving distribution

60° wide × 40° high. Size: 29 × 20 × 20 in. Weight: 78 lb. Price: on application.

★ **Bitone Major.** Double channel sound system comprising HF dispersive horn and S.2 HF pressure unit (distribution 90° wide × 20° high) with 15 in. LF driver in special reflex enclosure. Filter network 500 KHz. Crossover attenuation 12 dB/octave. HF balance control 0-8 dB attenuation. HC 30W. FR: 35 Hz-16 KHz. Size: 42 × 30 × 24 in. Weight: 168 lb. Price: on application.



WHITELEY. Whiteley Electrical Radio Co. Ltd., Victoria Street, Mansfield, Nottinghamshire. Tel: 24762-5. Cables: Whitebon, Mansfield.

LC93. Infinite baffle enclosure with unit. One 9 in. HF912-67 speaker unit. FR 60 Hz-20 KHz. HC 10W RMS. Impedance 15 ohms. Acoustically loaded cabinet. Speaker has graded melamine cone with silicon rubber-over-cambic suspension. Size: 19 × 12½ × 8½ in. Weight: 20 lb. Finish: teak or rosewood. Price: (teak) £13 6s. 1d. (plus £3 5s. 9d. PT); (rosewood) £14 6s. 8d. (plus £3 10s. 10d. PT).

LC94. Labyrinth enclosure with unit. One 9 in. HF912/67 speaker unit. FR 45 Hz-20 KHz. HC 10W RMS. Impedance 15 ohms. Acoustic labyrinth with acoustic resistance incorporated in pipe. Special 9 in. speaker as fitted in LC93. Size: 29½ × 23¾ × 6½ in. Weight: 39 lb. Finish: oiled teak or rosewood. Price: (teak) £20 9s. 6d. (plus £5 1s. 2d. PT); (rosewood) £21 16s. 3d. (plus £5 7s. 9d. PT).

LC95. Reflex enclosure with units. One 12 in. HF1214-67 bass driver. one 8 in. T812-67 mid- and upper-frequency speaker. Crossover: ¼ section L/C 1 KHz. FR 27 Hz-20 KHz. HC 15W RMS. Impedance 15 ohms. Acoustically loaded bass reflex cabinet. 12 in. unit melamine treated paper cone with cambic surround. 8 in. unit melamine treated paper ribbed cone and surround. Size: 31½ × 20¾ × 13½ in. Weight: 62 lb. Finish: oiled teak or rosewood. Price: (teak) £46 6s. 3d. (plus £9 13s. 6d. PT); (rosewood) £48 5s. 3d. (plus £10 1s. 8d. PT).

For speaker cabinets without units see entry under Stentorian.



WHARFEDALE. Rank Wharfedale Ltd., Bradford Road, Idle, Bradford, Yorks. Tel: Bradford 612552.

SPEAKERS

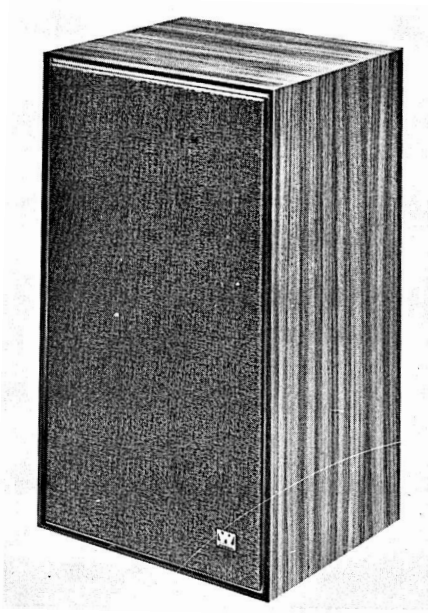

Wharfedale Dovedale III

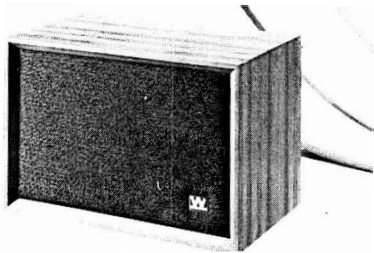

Wharfedale Denton

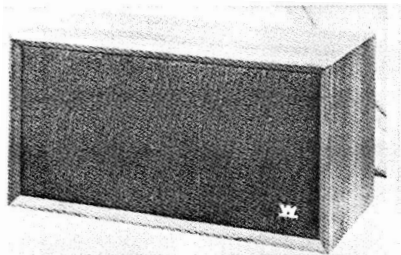

Wharfedale Super Linton

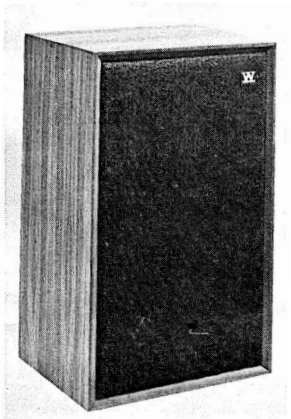

Wharfedale Melton

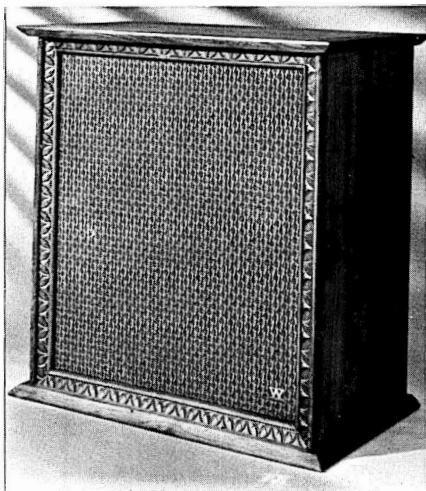

Wharfedale Rosedale

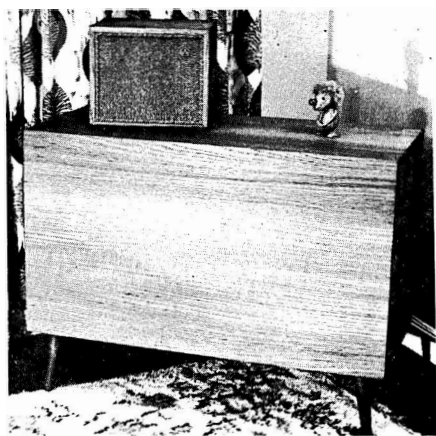

Woollett Frensham and electrostatic

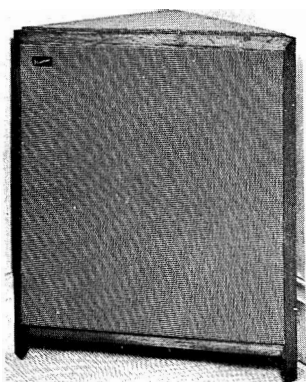

Worden Panosona—three versions

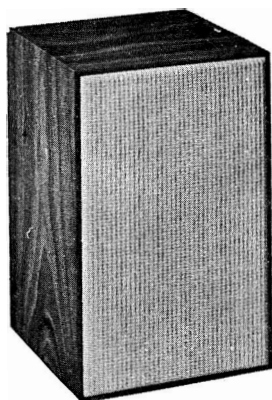

Wye Electronics 500

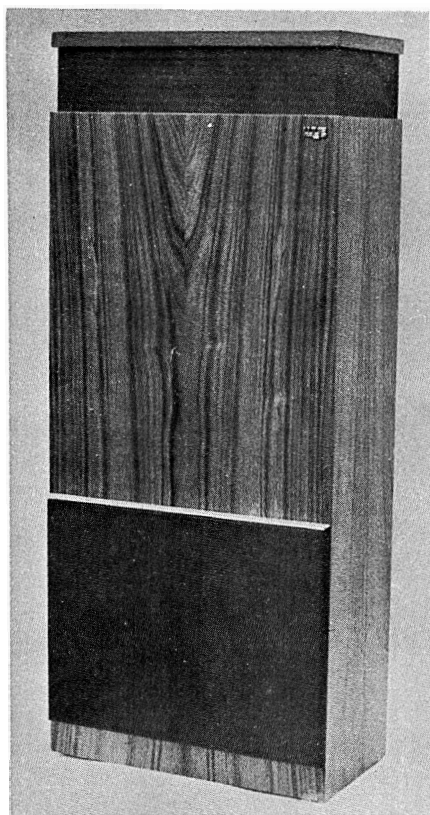
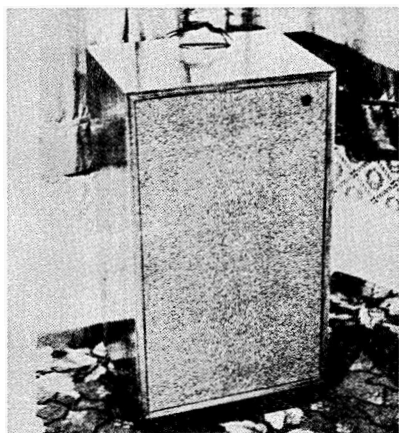

Wye Electronics 1300 column

Woollett Kelsey

Airedale. Omni-directional three-speaker system, incorporating 15 in. bass driver, 8 in. mid-range radiator, 3 in. treble unit. Acoustic resistance loading. Crossover: 400 Hz and 3 KHz. FR: 20 Hz-20 KHz. Mid-range and treble attenuator controls at rear. vci: 15 ohms. Size: 39×27×14 in. Weight: 91 lb. HC 20W RMS. Finish: oiled teak or polished walnut or oiled teak. Price: £69 10s.

★ **Denton.** Two-unit enclosure, 8 in. bass driver, 3 in. tweeter. Crossover: 1.75 KHz. FR: 65 Hz-17 KHz. vci: 4-8 ohms. HC 15W RMS. Finish: oiled teak or polished walnut. Size: 9 $\frac{3}{4}$ ×14×8 $\frac{3}{4}$ in. Price: £13 10s. 1 $\frac{1}{2}$ d. (plus £3 5s. 10 $\frac{1}{2}$ d. PT).

★ **Dovedale III.** Infinite baffle enclosure with 1 in. tweeter, 5 in. mid-range and 12 in. bass speakers. Crossover: 450 Hz and 3 KHz. FR: 40 Hz-20 KHz. HC 35W RMS. vci: 4-8 ohms. Dimensions: 24×14×12 in. Finish: teak or walnut. Electro-mechanical crossover system. Price: £39 10s.

★ **Melton.** Infinite baffle enclosure with 3 in. tweeter and 12 in. bass speakers. Crossover: 1.750 Hz. FR: 45 Hz-17 KHz. HC 25W RMS. vci: 4-8 ohms. Dimensions: 21×13×10 $\frac{1}{4}$ in. Finish: teak or walnut. Price: £29 10s.

★ **Rosedale.** Infinite baffle enclosure with 1 in. tweeter, 5 in. mid-range and 15 in. bass speakers. Crossover: 450 Hz and 3 KHz. FR: 35 Hz-20 KHz. HC 45W RMS. vci: 4-8 ohms. Dimensions: 24×23×13 $\frac{1}{2}$ in. Finish: teak or walnut. Period style cabinet. Price: £55.

★ **Super Linton.** Two-unit enclosure, 8 in. bass driver, 3 in. tweeter. Crossover: 1.75 KHz. FR: 40 Hz-17 KHz. vci: 4-8 ohms. HC 15W RMS. Finish: oiled teak or polished walnut. Size: 19×10×10 in. Price: £16 17s. 8d. (plus £4 2s. 4d. PT).

★

L. G. WOOLLETT & COMPANY LTD., 21 Anerley Station Road, London, S.E.20. Tel: 01-778 9003.

Claremont. Electrostatic mid-range and HF system. Constant charge push-pull electrostatic unit. Crossover 1.5 KHz. -6 dB/octave. FR: 1.5 KHz-20 KHz. HC 15W RMS. Impedance: 16 ohms. Cabinet contains mains polarising unit, crossover, phase corrector for transistor amplifiers, depolarising circuit, pre-set treble attenuator (12 dB range). Mains 200-250V (100-125V to order). Finish: Veneered wood, with

Vynair. Size: 11 $\frac{1}{2}$ ×8 $\frac{3}{4}$ ×8 $\frac{3}{4}$ in. Weight: 4 lb. 12 oz. Price: £227s. 5d.

★ **Kelsey Bass.** Infinite baffle frontal-loaded enclosure intended for use as a bass speaker. Small/large room middle switching. Unit 12 in. foam surround. FR: 20 Hz-5 KHz. HC 20W. vci: 16 ohms. Finish: veneered wood. Size: 33 $\frac{3}{4}$ ×18×14 in. Weight: 52 lb. Price: £44.

Kelsey Full Range. Infinite baffle. Two units; constant charge push-pull electrostatic unit and 12 in. foam surround bass driver. Small/large room middle switching. Crossover $\frac{1}{4}$ -section 1.5 KHz. FR: 20 Hz-20 KHz HC 20W RMS. Impedance 16 ohms. Phase corrected for transistor amplifiers. Mains: 200-250V AC (100-125V AC to order). Finish: veneered wood with brown flecked Vynair. Size: 33 $\frac{3}{4}$ ×18×14 in. Weight: 56 lb. Price: £58 7s. 5d.

★ **Frensham Bass.** Similar specification to Kelsey Bass but in horizontal cabinet on 6 in. legs. Small/large room middle switching. Cabinet size: 31×14 $\frac{3}{4}$ ×16 in. Price: £44.

Leven. Similar specification to Claremont but in rectangular cabinet 10×8 $\frac{1}{2}$ ×8 $\frac{1}{2}$ in. Price: £21 5s.

★

WORDEN AUDIO DEVELOPMENTS LTD., 54 Chepstow Road, London, W.2. Tel: 01-229 4996.

★ **Panosona Reproducer.** Double horn with diffusing chamber. Corner reproducer, designed for near plane-wave distribution from single speaker unit. Available in three versions: (Model A) Size: 54 in. high, 24 in. wide, 14 $\frac{1}{2}$ in. to corner. FR: (with Lowther PM6 or PM7) 20 Hz to over 18 KHz. (Model B) Size: 48 in. high, 21 $\frac{1}{2}$ in. wide, 12 $\frac{1}{2}$ in. to corner. FR: (with Richard Allan CG8T) 30 Hz-17 KHz; (Model C) Size: 27 in. high, 24 in. wide, 13 in. to corner. FR: (with Richard Allan CG8T) 30 Hz-17 KHz. Prices: Model A (speaker enclosure only) £46; Model B (enclosure only) £36; Model C (enclosure only) £28. Lowther PM6 £20 10s.; PM6 Mk 1 £23 10s.; PM7 £31; Richard Allan CG8T £6 12s. 5d. All prices including PT where applicable.

Panosona Bookshelf Speaker. Designed in accordance with the principles of the Panosona Corner Reproducers. Size: 16×9×9 $\frac{1}{2}$ in. Recommended drive units: Richard Allan CG8T £6 18s. 2s. tax paid). Finish: light, medium or dark mahogany, teak, walnut or oak. Contrast-

ing Tygan or Vynair front covering. Price: (enclosure only) £14 including U.K. purchase tax.



WYE ELECTRONICS LTD., Queen Street North, Chesterfield, Derbyshire. Tel: Chesterfield 51116.

★**Stereo 500.** Compact two-unit enclosure. 6½ in. high flux bass driver. 3⅜ in. tweeter. Rear mounted socket and 9 ft connecting lead. Finish: rosewood or teak. Size: 13¼ × 8½ × 8½ in. Price: £23 3s. 6d. (plus £4 11s. 9d. PT).

Stereo 138. Two-unit enclosure. 13 × 8 in. bass with aluminium centre cone and 3⅜ in. HF tweeter. FR: 25 Hz-18 KHz. HC 10W RMS. vci: 4 ohms. Crossover: 5 KHz. Size: 19¾ × 12 × 8½ in. Price: £18 18s.

★**1300 Hi-Fi.** Two-unit column enclosure speaker with 12 in. bass unit and HF1300 3 in. tweeter. FR: 25 Hz-15 KHz. vci: 4, 8, 16 ohms. Crossover: 3 KHz. Size: 36 × 15 × 7½ in. Price: £37 16s.

YAMAHA. U.K. agents: Actina Ltd., Acoustics Division, 60 St John Street, London, E.C.1. Tel: 01-253 7591.

Yamaha NS10. Open baffle speaker system with 15 × 11 in. bass and 2 in. treble units. FR: 40 Hz-18 KHz. HC 10W RMS. vci: 8 ohms. Dimensions: 20 × 14 × 7 in. Weight: 16 lb. Oiled walnut, teak. Price: £39 10s.

Yamaha NS15. Open baffle speaker system with 15 × 13 in. bass and 2 in. treble units. FR: 40 Hz-18 KHz. HC 15W RMS. vci: 8 ohms. Dimensions: 23½ × 7½ × 16½ in. Weight: 26 lb. Finish: oiled walnut, teak. Price: £65.

Yamaha NS20. Open baffle speaker system with 25 × 18 in. bass, 8 in. mid-range, and 2 in. treble units. FR: 40 Hz-18 KHz. HC 20W. vci: 8 ohms. Dimensions: 34 × 12¼ × 24½ in. Weight: 51 lb. Finish: oiled walnut, teak. Three-position tone control. Price: £95.

Yamaha NS30. Open baffle speaker system with 35 × 25 in. bass, 12 in. mid-range, and 2 in. treble units. FR: 40 Hz-18 KHz. HC 30W. vci: 8 ohms. Dimensions: 40½ × 12½ × 29½ in. Weight: 77 lb. Finish: oiled walnut, teak. Three-position tone control. Price: £130.



**RECORDS
TUNERS
TAPE
RECORDERS**

**JAMES
KERR
& CO. LTD.**

**TURNTABLES
AMPLIFIERS
SPEAKERS**

Welcome customers to their new showroom to see and listen to our Selective Range of Amplifiers, Turntables, Tuners, Tape Recorders and Speakers.

A comprehensive Record Department will meet every requirement.

We cater for all musical tastes and can expertly advise on the best or the best to suit your budget.

Public address and Background music installation a speciality.

98-110, Woodlands Road, Glasgow, C3

Tel: 332 0988

PORTABLE & COVERED CABINETS

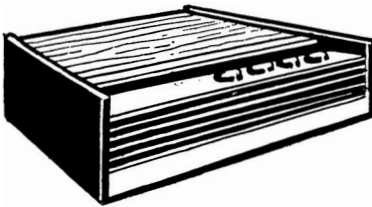

**for AUDIO
RECORD PLAYERS
TAPE RECORDERS
RADIOGRAMS
TELEVISION**

*VENEERED AND POLISHED WORK FOR OTHER
PRODUCTS FOR ELECTRICAL TRADES*

**PRECISION WOOD MACHINED COMPONENTS
MANUFACTURERS, WHOLESALE & EXPORT ONLY**

FIRCASTLE LTD

**4 & 24 ELDON WAY, HOCKLEY TRADING ESTATE
HOCKLEY, ESSEX. Tel: HOCKLEY 2575/6**



SME

MODEL 2000

PLINTH SYSTEM

Designed to house SME precision pick-up arms in combination with leading makes of turntable, the Model 2000 Plinth System combines high-quality workmanship with ease of assembly. The basic unit is finished in selected veneers of teak, straight-grained walnut, or rosewood. A one-piece hinged lid in heavy acrylic is reinforced with a polished stainless steel trim.

Write for details to:

SME LTD · STEYNING · SUSSEX · ENGLAND

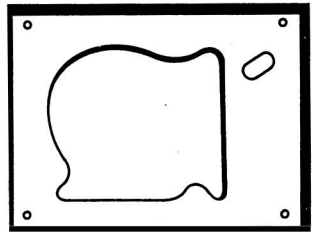

Motor boards in matching veneers are ready cut and drilled for screw-driver assembly with the appropriate pick-up arm and turntable. The range, which will be added to from time to time, includes a blank board which can be cut to special order.

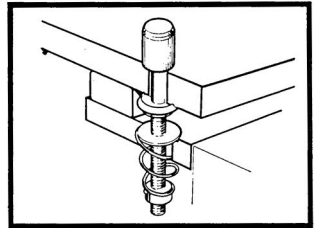

Four-point spring suspension adjustable for height and damping protects the motor board from acoustic feedback and external vibration.

HI-FI CABINETS

BANG & OLUFSEN U.K. DIVISION, Eastbrook Road, Gloucester. Tel: Gloucester 21591.

★ **Trolley 83019**. Pedestal stand with cruciform base and castors. Designed for Beocord tape recorders. Details and price on request.



BARZILAY CO. Distributors: Howland-West Ltd., 2 Park End, South Hill Park, London, N.W.3. Tel: 01-794 6666.

Design 1B. Complete hi-fi cabinet assembly comprising contemporary upright style equipment cabinet and two speaker enclosures. Speakers can be placed at each end of main cabinet to form single unit, or placed separately in the room. Main cabinet has one-piece lift-up lid and three front sliding doors. Accommodation for all types of equipment plus record and tape storage. Size: 81 in. wide, 18¾ in. deep, 28¾ in. high. Finish: American walnut. Price: £189 10s 10d. (plus £17 6s. 7d. PT).

Design 2B. Complete hi-fi cabinet incorporating reflex enclosures for 12 in. or 15 in. units at each end. Lift-up lid to centre portion giving access to accommodation for tuner, amplifier, control unit and record deck or tape deck. Front sliding doors conceal storage space for records and tapes. Distinctive grille to speaker enclosures. Size: 102 in. wide, 18½ in. deep, 28¾ in. high. Finish: American walnut. Price: £133 (plus £12 3s. 2d. PT).

★ **Design 5**. Contemporary hifi cabinet available with matching speaker enclosures, the whole plinth mounted. Supplied ready built or in kit form. Front-opening sliding tambour panelled doors. Accommodation for all equipment and speaker units up to 15 in. Size: 96 in. wide, 18 in. deep, 29 in. high. Speaker cabinets 24 in. wide, main cabinet 48 in. wide. Finish: American walnut. Price: £180 10s. (plus £16 10s. 1d. PT).

K.89. Contemporary low-line hi-fi cabinet for stereo equipment or record storage. Sliding front tambour doors. Accommodation for all units or records. Designed to permit stacking of one unit on top of another. Size: 72 in. wide, 18 in. deep, 17½ in. high. Finish: American walnut. Price: £82 (plus £7 4s. 9d. PT).

CENTRE OF SOUND. V. J. Monk Ltd., 140/141 Plumstead Road, London, S.E.18. Tel: 01-854 2369.

★ **Lowline Major**. Designed to take the majority of modern equipment. Can be custom built to suit customer's requirements. Standard size: 41×17×8 in. (plus legs and Perspex lid). Finish: teak of mahogany. Price: £14 14s.



A. DAVIES & CO., 56 Wellesley Road, London, N.W.5. Tel: 01-485 5775.

★ **Cabinets** for most makes of speakers made to order.



DYNATRON RADIO LTD., St. Peter's Road, Maidenhead, Berks. Tel: Maidenhead 23331.

RSU1. Record storage/equipment console cabinet with side rails on top which will accommodate models HFC10, HFC11, HFC12, TRV20, P61 or P100. The inside has a shelf which could provide storage for the company's TRV20, 45 r.p.m. records, tape spools, or other accessories. Sectioned vertical record space for 150 LPs. Full-length lockable doors and mounted on castors. Finish: teak. Size: 23×20¼×16¼ in. Price: £20 10s.



EATON AUDIO FITMENTS, Leopold Street, Long Eaton, Nottingham, NG10 4QF. Tel: Long Eaton 2662/2818.

Speaker, amplifier, tuner and record cabinets made to customers' requirements. Submit full details for quotation. See also Speaker Enclosure Section.



A. R. FRANKLIN (Audio Engineer), 4 Birch House, Penge, London, S.E.20.

★ **Custom built cabinets**. Period Queen Anne design or will design to customer's sketches. Prices on application.

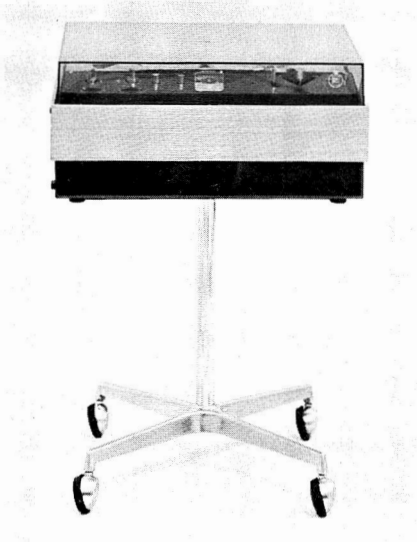

Bang and Olufsen trolley

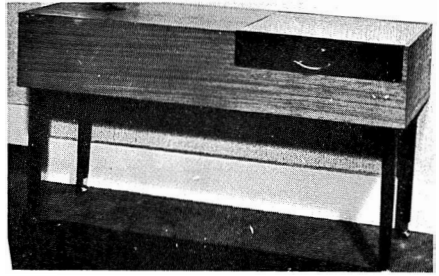

Monk Equipment cabinet

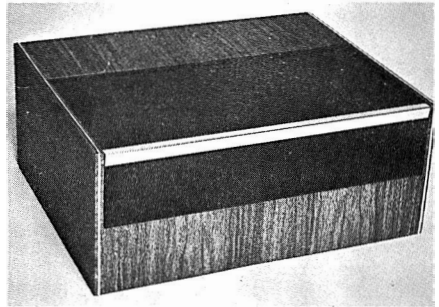

Franklin transcription box

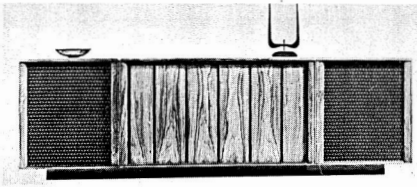

Barzilay Design 5

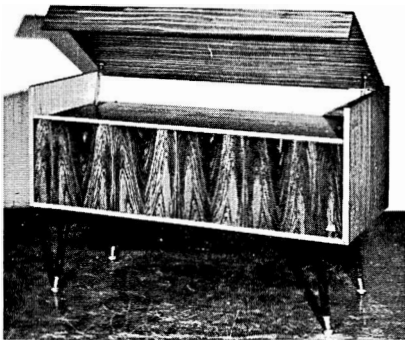

A. Davies contemporary horizontal



Hampstead High Fidelity



Franklin Queen Anne-style chest



Holder Pearce free-standing assembly

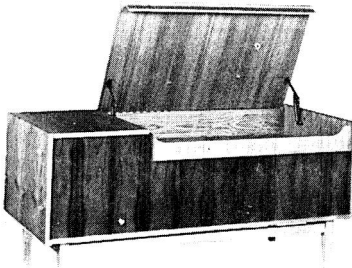

Howland-West Tromso II

HAMPSTEAD HIGH FIDELITY, 91 Heath Street, Hampstead, London, N.W.3. Tel: 01-435-6377 and 0999.

★ **Hampstead.** Low upright cabinet with lift-up lid for gram unit and tape deck. Split lid available at small extra charge. Pull-out front hopper for tuner and control unit or integrated amplifier. Will accommodate gram unit, tape deck, tuner, control unit and amplifier. Takes any pre-amplifier or integrated amplifier not exceeding 14 in. in depth. Available with tape section made into well to hold complete recorder up to 9 in. in height. Will accommodate Ferrograph and Revox with professional size spools. Size (standard model): 40 × 26 × 21 in. Prices: walnut or teak £50; rosewood £60.

Special cabinets and fittings made to order. Designs and drawings prepared for complete room or house hi-fi schemes.



HOLDER PEARCE LTD., 66 Grove Road, Eastbourne, Sussex. Tel: Eastbourne 26565.

★ Built-in or free-standing equipment cabinets designed and built to meet customers' exact requirements. Lift-up or drop-down lids, accommodation to suit any equipment, all standard finishes and also special finishes to blend with furnishing. Details and prices on application.



HOWLAND-WEST LTD., 2 Park End, South Hill Park, London, N.W.3. Tel: 01-794 6666.

★ **Malmo II.** Horizontal cabinet in teak or walnut. Takes all combinations of equipment. Lift-up lid and front opening doors. Overall size: 36 in. wide, 22 in. deep, 26 in. high (inc. 9 in. legs). Motor board 34 $\frac{3}{4}$ × 20 in. Front panel 35 × 8 $\frac{1}{4}$ in. Front panel is recessed 2 in. Magnetic door catches. Motor board adjustable to maximum clearance of 6 in. above. Price (both finishes): £30 (plus £2 14s. 10d. PT).

★ **Tromso II.** Lowline cabinet in teak, walnut or teak with rosewood front panel. Takes gram unit or tape deck, tuner and amplifier. Two lift-up lids. Overall size: 48 × 20 × 14 in. less plinth. Price (teak or walnut): £35 (plus £3 4s. PT); (teak/rosewood): £36 (plus £3 5s. 10d. PT).

★ **Viking Standard.** Lowline shelf-mounting equipment cabinet. Sliding perspex lid to record

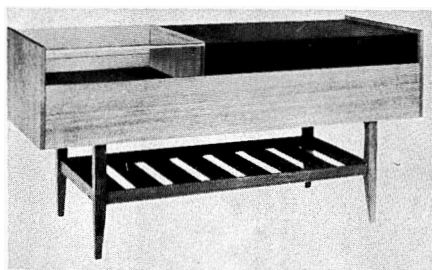

Howland-West Viking Major

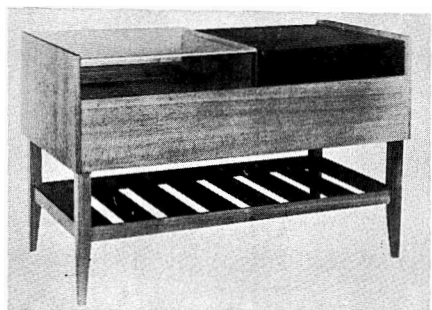

Howland-West Viking Standard

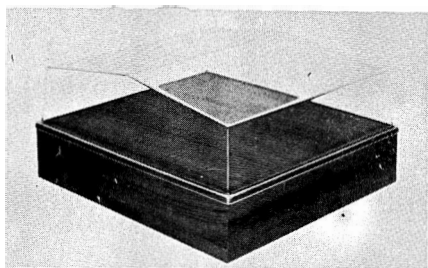

Howland-West HW8

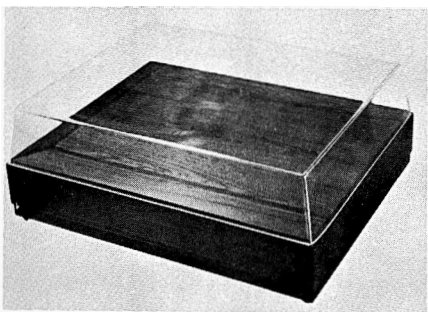

Howland-West HW12



Howland-West Malmo II



Imhofs HFU/18 Jacobean



Imhofs HFU/12 Regency

or tape deck compartment. Accommodation for amplifier, control unit, record unit or tape deck. Size: 39 in. wide, 19¼ in. deep, 12 in. high (14 in. plinth optional extra). Amplifier compartment: 18½ × 16¾ × 10½ in. Motor board: 18 × 19 in. Control panel: 17½ × 6 in. Finish: teak and matt black. Price: £23 10s. (plus £2 3s. PT); plinth £7 (plus 12s. 10d. PT).

★ **Viking Major.** Lowline shelf- or plinth-mounting equipment cabinet. Sliding perspex lid to record or tape deck compartment. Accommodation for amplifier, control unit, tuner, record unit or tape deck. Size: 51 in. wide, 19¼ in. deep, 12 in. high (14 in. plinth optional extra). Amplifier compartment: 30½ × 16¾ × 10½ in. Motor board: 18 × 19 in. Control panel: 29½ in. wide, 6 in. high. Finish: teak and matt black. Price: £27 (plus £2 9s. 4d. PT); plinth £7 (plus 12s. 10d. PT).

Clearview H.W.1. Cabinet in teak, walnut or rosewood. Takes gram unit or tape deck. Lift-off perspex lid. Overall size: 18½ × 16½ × 8½ in. Clearance above board 3¾ in., below board 4½ in. Price: £9 15s. (plus 17s. 9d. PT).

Extra high top HW1-EH. Special version of H.W.1 provides 6 in. clearance above motor board. Additional cost: 16s 5d.

Clearview H.W.7. Shelf- or table-mounting gram unit cabinet. Perspex lid. Motor board cut for Garrard SP25. AT60 etc. Size: 15¾ in. wide, 14½ in. deep, 7½ in. high at edges rising to 8¼ in. at the centre. Finish: teak. Price: £6 16s. 8d. (plus £1 13s. 4d. PT).

Clearview H.W.7/4. As H.W.7. but motor board cut out for Garrard AP75, SL75 and SL95. Price: £6 16s. 8d. (plus £1 13s. 4d. PT).

★ **Clearview H.W.8.** Similar to H.W.7 but with uncut motor board. Height available above motor board 3¼-4¼ in.; depth below top of motor board 3 in. Price: £7 15s. 9d. (plus 14s. 3d. PT).

★ **Clearview H.W.12.** Cabinet in teak. Takes gram unit or tape deck. Lift-off perspex lid. Overall size 23½ × 19 × 8½ in. Clearance above board 3¾ in., below board 4½ in. Price: £12 15s. (plus £1 3s. 3d. PT).

Clearview H. W. 13. Similar to H.W.1, but dimensions 18 × 18½ × 8½ in. Price: £10 10s. (plus 19s. 2d. PT).



IMHOFS. 112-116 New Oxford Street, London.

W.C.1. Tel: 01-636 7878. Cables: Imcase, London. W.C.1.

Type 10. Trolley equipment cabinet. A larger version of the trolley L cabinet. A third compartment has been added to accommodate a tape recorder or to provide storage space for records. Three separate lids, each with a stay, give access to the compartments. Size: 54¼ in. wide, 21 in. deep, 24 in. high (including 3 in. castors). Motor boards: left 17 in. wide, centre 18¾ in. wide, right 16 in. wide, all 19 in. deep. Finish: light or dark sapele mahogany, two-tone mahogany or walnut. Teak of Jacobean styling at slight extra cost. Price: £41 7s. (plus PT).

★ **HFU/18 Mk II.** Compact upright style cabinet with lift-up lid and two front opening doors concealing control panel. Designed to house the average small hi-fi system. Ideal unit for modern homes. Size: 24 in. wide, 19 in. deep, 28 in. high (including 6 in. legs). Motor board 21¾ in. wide, 17 in. deep. Control panel 21¾ in. wide, 14 in. high. Finish: mahogany, teak or walnut. Price: £18 17s. (plus PT).

IMIII/AT6. Designed to house the Garrard AT6 motor. Finish: walnut or mahogany. Lift-up lid. Size: 17 × 9½ × 15½ in. Price: £8 18s. (plus PT).

IMIIIB. Similar to above but measuring 19 × 8 × 18¼ in. Price: £8 18s. (plus PT).

HFU/12. Modern sideboard style equipment cabinet with accommodation for tape deck, transcription motor, amplifier, tuner and over 250 records. Centre sliding section conceals instrument panel and two other panels give access to storage space. Centre portion of top surface hinges up to provide access to turntable or tape deck. Size: 60 in. wide, 22 in. deep, 30 in. high (including 6 in. base). Two 19 × 19 in. motor boards. Control panel 19 in. wide, 15½ in. high. Left-hand compartment 19 in. wide, 19 in. deep, 11 in. high. Right-hand compartment 19 in. wide, 19 in. deep, 18 in. high. Finish: teak, walnut, sapele. Price: £53 19s. 2d. (plus PT).

★ **HFU/12 Regency.** Similar to HFU/12 but in Regency styling. Size: 61 in. wide, 24 in. deep, 30 in. high (including 6 in. legs). Price: £74 14s. 10d. (plus PT).

HFU/16M. Two compartment cabinet with drawer for tape recorder. Either side will accommodate any transcription motor (or auto-changer) and is large enough for the SME3012 arm. Finish: Teak and rosewood; two-tone

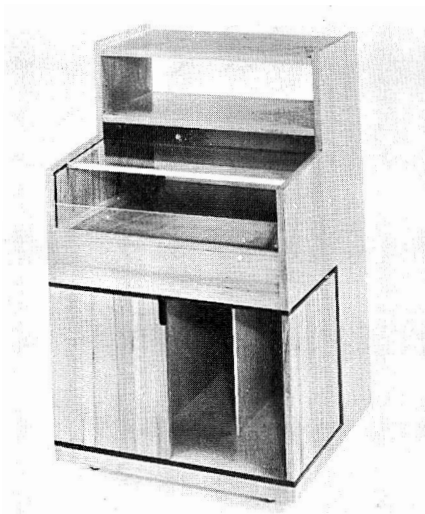

Imhofs HFU/22



Imhofs Type 10 trolley

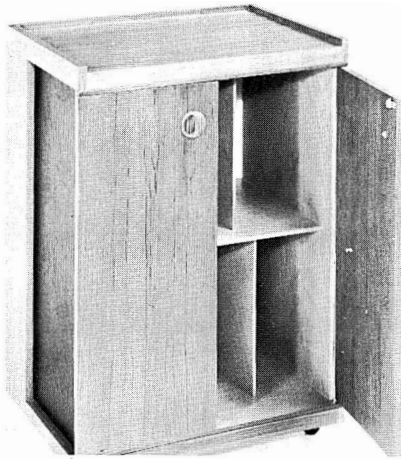

Imhofs HFU/22RS

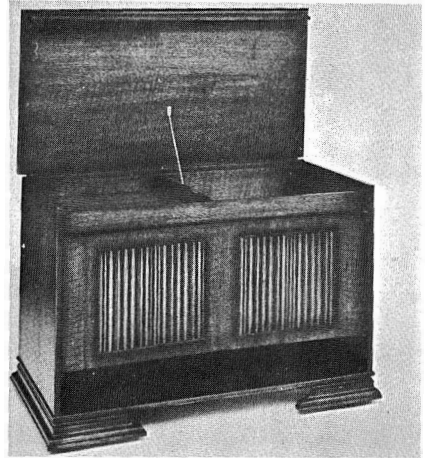

Imhofs Trolley L (Jacobean)



Imhofs Imflex Mini-trolley



Largs Olympic

sapele mahogany; walnut. Single lift-up lid at top. Right-hand side has drop-down panel with withdrawable deck. Size: $41\frac{1}{4} \times 22 \times 28$ in. (including $7\frac{1}{2}$ in. legs). Compartments all 19 in. wide. 20 in. deep. Height above tape recorder deck is 12 in. Price: £38 8s. 5d. (plus PT).

HFU/16M Jacobean. Similar to HFU/16M but in Jacobean styling. Size: 42 in. wide. $22\frac{1}{2}$ in. deep. 27 in. high (including legs). Price: £41 5s. (plus PT).

Type L. Trolley cabinet with two compartments. Easy-running finger-tip movement. Finish: Light or dark sapele mahogany, two-tone mahogany, walnut, teak. Two lift-up lids. Size: $35\frac{3}{4} \times 18 \times 24$ in. (including castors). Compartments $17\frac{1}{2}$ in. and $15\frac{1}{2}$ in. wide, both 16 in. deep. Price: £31 11s. 4d. (plus PT).

★**Type L Jacobean.** Similar to Type L but in Jacobean style. Size: $36\frac{1}{2}$ in. wide. 19 in. deep. 24 in. high (including 3 in. concealed castors). Internal sizes as trolley L. Price: £33 14s. 11d. (plus PT).

★**HFU22.** Console cabinet for the smaller home in upright contemporary styling. Perspex front to the motor compartment automatically drops as the clear perspex lid is pushed back. Two shelves provided for amplifier and tuner. In addition to motor compartment there is storage space for approx. 150 records. Dimensions: $35 \times 21 \times 19$ in. (inc. $1\frac{1}{4}$ in. castors). Height above motor board: $5\frac{1}{4}$ in. Lower shelf height: $5\frac{1}{4}$ in. Finish: teak, sapele mahogany, walnut. Doors fold back flush when open. Designed to match HFU22 RS record storage cabinet. Price: £30 13s. 6d. (plus £2 1s. 3d. PT).

★**HFU22/RS.** Upright record storage cabinet in contemporary styling. Hinged front doors fold back flush when open. Holds approx. 300 records. Dimensions: $31\frac{3}{4} \times 22 \times 16\frac{1}{2}$ in. (inc. $1\frac{1}{4}$ in. castors). Finish: teak, sapele mahogany, walnut. Matches HFU/22 cabinet. Price: £19 13s. (plus £1 9s. 6d. PT).

★**Imflex Mini Trolley.** Trolley control cabinet in contemporary styling. Lift-up perspex lid. Designed to accept transistorised amplifier and tuner, also motor and turntable. Dimensions: $20 \times 32 \times 15\frac{1}{2}$ in. (inc. 2 in. castors). Motor board: $16\frac{3}{8} \times 14\frac{1}{8}$ in. Equipment board: $14\frac{1}{8} \times 14\frac{1}{8}$ in. Finish: teak, sapele mahogany, walnut, rosewood. Designed to enable the equipment module to be removed from the cabinet to allow ease of fitting and servicing equipment. Incorporates magazine/record storage shell. Price: £33 12s. 10d. (plus £2 5s. 4d. PT).

LARGS OF HOLBORN, 76-77 High Holborn, London. W.C.1. Tel: 01-242 2626 (PBX).

★**Olympic.** Upright cabinet with pull-out control panel in oiled teak, satin mahogany, walnut. Takes gram unit, tape deck, tuner and amplifiers. Lift-up lid with tensioned lid stay. Fitted with Shepherd castors. Overall size: $40 \times 22 \times 29$ in. Particularly suitable for Quad. Leak and Ferrograph equipment. Price: £55.

Small Olympic. Similar in style and appearance to Olympic but slightly smaller. Size: $37\frac{1}{2}$ in. long. 18 in. deep. 26 in. high (plus 3 in. castors). Finish: oiled teak, satin mahogany/walnut. Price: £48.

★**Quartette.** Lowline cabinet in oiled teak or mahogany/walnut satin. Two lift-up lids with tension stays. Takes gram unit, tape deck, tuner, control unit and records. Size: 66 in. long. 18 in. deep. 26 in. high. Price: £65.

Large Quartette. Similar in style and appearance to Quartette but especially suitable for larger equipment, i.e. Ferrograph, SME, etc. Size: 70 in. long. 26 in. high. 22 in. deep. Price: £70.

★**Classic.** Traditional style upright equipment cabinet with top lid for gram or tape unit and two front opening doors giving access to front panel with record storage below. Overall size: 26 in. wide. $19\frac{1}{4}$ in. deep. 39 in. high including plinth. Motor board $23\frac{1}{2}$ in. wide. $16\frac{1}{2}$ in. deep. 4 in. below lid. Control panel 23 in. wide. $9\frac{1}{2}$ in. high. Finish: Walnut, sapele or mahogany veneer. Price: £48.

★**Gresham.** Reproduction style cabinet in walnut or mahogany. Two front-opening doors with record storage. Lift-up lid. Space for tuner, control unit and turntable. Size: 40 in. long. $20\frac{1}{2}$ in. deep. $33\frac{3}{4}$ in. high including legs. Price: £85.

★**Hepplewhite A.** Reproduction chest of drawers in curled mahogany or walnut. Lift-up lid with two stays. Dummy drawers. Will accommodate tuner, control unit and turntable. Size: 38 in. long. $20\frac{1}{2}$ in. deep. $31\frac{1}{2}$ in. high including legs. Price: £115.

★**Caithness.** Modern lowline cabinet made in three sections: main equipment cabinet, record and tape storage cabinet, plinth. Main cabinet will accommodate tuner, control unit, turntable and tape deck. Two lift-up lids. Storage cabinet has fixed top and being slightly lower than main cabinet provides ideal setting for ornament or

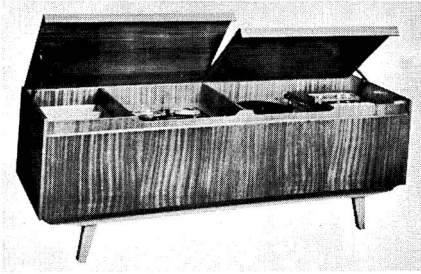

Largs Quartette



Largs Hepplewhite

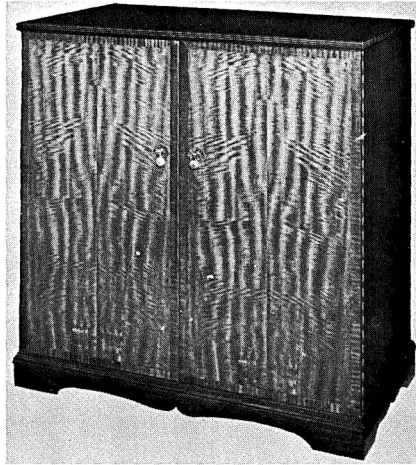

Largs Classic



Largs Caithness



Largs Gresham



Largs Sutherland



Largs Stirling

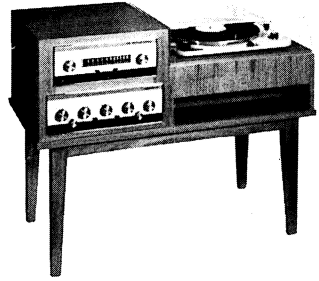

Largs Argyll

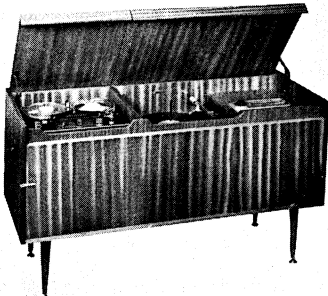

Largs Trio

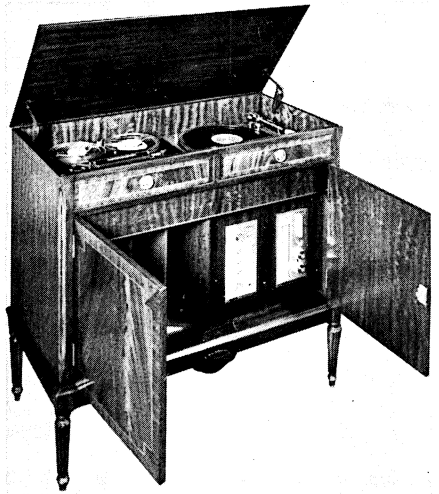

Largs Clarendon

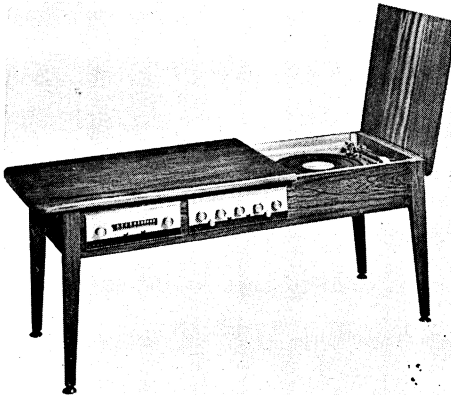

Largs Lanark

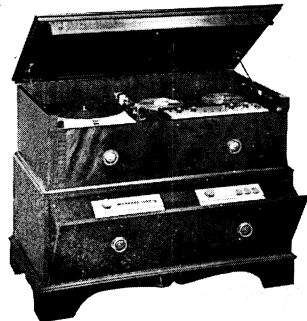

Largs Beaumont

flowers. Size: 78 in. long, 22 in. deep, 26 in. high including 9 in. plinth. Price: £95.

★**Sutherland.** Designed to take large amount of big equipment together with comprehensive record library. Lift-up lid with two stays covers space for turntable and tape deck, drop-down front conceals panel for tuner and control unit. Two front-opening doors at bottom give access to record storage. Size: 40 in. long, 21½ in. deep, 35 in. high. Finish: oiled teak or satin mahogany/walnut. Price: £75.

★**Stirling.** Compact-looking modern cabinet with room for tuner, control unit, turntable and smaller types of tape unit, also space for record storage. Lift-up lid with two stays and sliding doors at front. Size: 40 in. long, 20 in. deep, 27 in. high including 3 in. castors. Finish: oiled teak or satin mahogany/walnut. Price: £59.

★**Trio.** Two lift-up lids cover three compartments, the third compartment being fitted for tape deck or record storage whilst first two accommodate turntable, tuner and control unit. Modern clean style cabinet finished in oiled teak, or satin mahogany/walnut. Size: 48 in. long, 18 in. deep, 26 in. high including 9 in. legs. Price: £46.

★**Large Trio.** Similar in style and appearance to Trio but designed for larger equipment, i.e. Ferrograph, SME, etc. Size: 54 in. long, 22 in. deep, 26 in. high including 9 in. legs. Price: £51.

★**Lanark.** Coffee table with lift-up lid concealing compartment for record unit. Accommodation for transistor tuner and amplifier. Specially designed for Leak equipment. Size: 54 in. long, 19¾ in. deep, 22¾ in. high. Price: £40.

★**Argyll.** Miniature cabinet designed for transistor equipment. Right-hand section will accept all but the largest turntables. Removable transparent plastic dust cover. Left-hand section accommodates tuner and integrated amplifier. Open storage space for records. Size: 33½ in. long, 16¾ in. deep, 11½ in. high plus 14 in. legs. Price: £39 10s.

★**Clarendon.** Elegant reproduction cabinet with accommodation for record unit, tape deck, tuner, amplifier and record storage. Single lift-up lid. Two front-opening doors. Size (overall): 38 in. wide, 36¾ in. high (including 9½ in. legs), 19 in. deep. Motor and tape deck board: 36½ in. wide, 16 in. deep, 4 in. clearance below lid. Control panel: 17 in. wide, 15 in. high. Record storage: 18 in. wide, 15 in. high. Price: £98.

★**Beaumont.** Traditional style with the same facilities as the Olympic. Overall dimensions: 31 × 40 × 21¼ in. Motor board: 36 × 18¾ in., drop 4 in. Control panel: 37¼ × 5 in., drop 1¾ in. Price: £130.

★**Beaumont storage cabinet.** Overall measurements: 31 × 23½ × 17 in. Storage compartments: 13¼ in. high × 19½ in. long, 9 in. high × 21 in. long. Price: £45.

The high-fidelity equipment cabinets listed and illustrated represent only a small selection of Largs' tailor-made products. Largs operates its own cabinet factory and invites enquiries for cabinets to customers' own specifications.

Prices quoted include delivery within 20 miles of High Holborn.



MEDLEY MUSICAL LTD., 4 Feltram Way, Charlton, London. S.E.7. Tel: 01-858 3426.

Plinths. Teak/walnut plinths to house BSR and Garrard Turntables (Transcription or Auto-changer). Dust Covers also available. Size: 14¼ × 12½ × 3½ in. Price: £3 3s. (plus 14s. 8d. PT).

Larger teak/walnut plinths for AP75 and GL75 series. Size: 16 × 13¾ × 3½ in. Price: £4 6s. 3d. (plus 19s. 10d. PT).



PEAK SOUND (Harrow) Ltd., 32 St Judes Road, Englefield Green, Egham, Surrey. Tel: Egham 5316.

Delphi. Lowline cabinet on castors. Counter-balanced lid, two doors. Space for transcription turntable, tape deck, amplifier, tuner, and approx. 250 records. Size: 20 × 24 × 54 in. Price: approx. £80 (varies with finish).



P.W.B. AUDIO LTD., 33 Call Lane, Leeds 1, Yorkshire. Tel: Leeds 28559.

Model A1. Lowline style with single lift-up lid. Takes gram unit, tuner and amplifier. Finish: Teak, walnut, mahogany or oak. Matching or black legs. Rosewood drop on front of lid optional extra. Size: 36 × 16½ × 27 in. Motor board 17½ × 15 in. deep. Amplifier section 17½ × 15 in. deep. Price: £25.

★**Model A2.** Lowline style with twin lift-up lids,

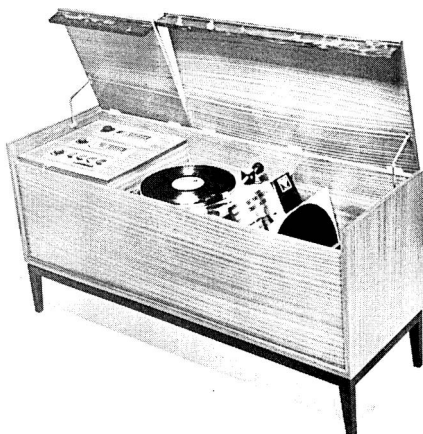

PWB model A2

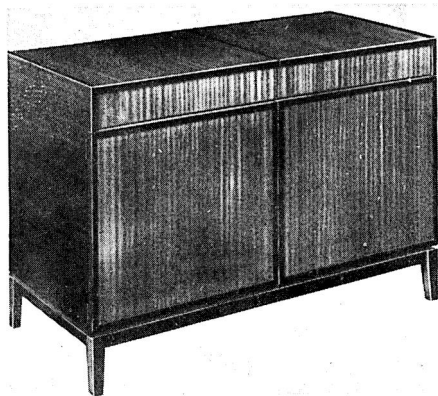

Record Housing Schubert

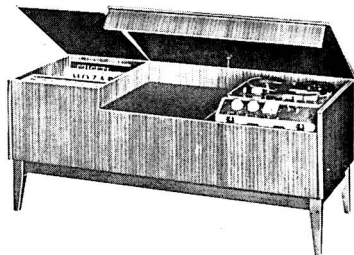

Record Housing Lowflex

smaller left-hand lid over amplifier and tuner section, larger right-hand lid over gram unit and record storage section. Finish: Teak, walnut, mahogany, oak. Matching or black legs. Rosewood drop on front of lids optional extra. Takes

gram unit, tuner, amplifier, and has provision for record storage. Record storage section lifts out to permit tape deck to be fitted. Size: 52 x 16 x 27 in. Internal sections dimensioned as required. Price: £35.



RECORD HOUSING, Brook Road, Wood Green, London, N.22. Tel: 01-888 7487.

★ **Longfellow**. Lowline cabinet in teak. Takes gram unit, tape deck, tuner, amplifier. Record storage (150). One central lift-up lid plus two drop flaps. Overall size: 76½ x 21 x 14 in. (plus 9 in. for legs). Will take complete tape-recorder and largest players, transcription or autochange. Price: £55 13s.

★ **Lowflex**. Lowline cabinet in teak. Takes gram unit, tape deck, tuner, amplifier, etc. Lift-up lids, one with pneumatic stay. Overall size: 59 x 21 x 14 in. (plus 9 in. for legs). Record storage on left. Partition removable if not required. Price: £39 18s.

★ **Schubert**. Upright cabinet in walnut, mahogany or teak. Takes gram unit, tape deck or complete recorder, tuner, amplifier and record storage. Lift-up lids, fold-back doors, right-hand compartment for storage. Overall size: 42 x 21 x 25 in. (plus 6 in. for legs). Price (walnut, mahogany or teak): £47 5s.

Scan Equipment Cabinet. For use as shelf unit or with optional legs. One lift-up lid. Accommodation for gram unit (or tape deck), tuner and amplifier. Size: 19½ in. wide, 16½ in. deep, 15 in. high. Finish: teak, walnut or mahogany. Price: (without legs) £10 15s.; (with legs) £11 16s.

Lowline Two. Lowline equipment cabinet. Single lift-up lid controlled by pneumatic stay. Accommodation for (1): gram unit, tuner, amplifier and records, or (2): complete tape recorder, gram unit, tuner, amplifier. Space for complete Ferrograph recorder or turntable unit with SME 12 in. arm. Size: 42 in. wide, 21 in. deep, 15 in. high (plus 6 in. legs). Finish: teak, walnut. Price: £29 8s.

Britten. Upright style equipment cabinet with record storage. One lift-up lid. Accommodation for gram unit (or tape deck), tuner and amplifier plus 150 records. Size: 20 in. wide, 19½ in. deep, 36 in. high. Finish: teak, walnut or mahogany. Price: £28 7s.

Playview. Shell unit to accommodate gram

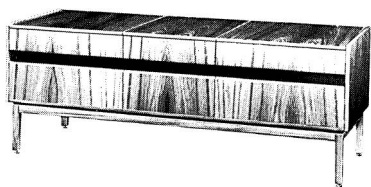

Record Housing Andante

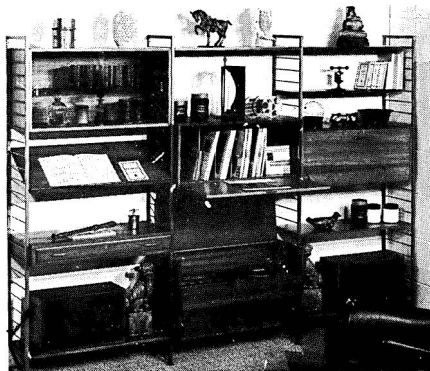

Staples Ladderax Hi-Fi

turntable. Patented hinge or lift-off lid. Size: 19 in. wide, 19 in. deep, 8 in. high. Price: £9 9s.

★ **Andante.** Long lowline equipment cabinet comprising three sections. Lift-up lids to right- and left-hand sections, drop front to centre section. Accommodation for turntable and pick-up, including 12 in. SME arm; largest tape recorders, e.g. Ferrograph or Revox with 10 in. spools; tuner, amplifier and control unit. Size: 63 in. wide, 21 in. deep, 14 in. high (plus 11 in. legs). Finish: teak. Adjustable glides to legs provide firm level standing even on irregular floors. Price: £44 2s.

Cantelina. Lowline cabinet, teak leg frame fitted with black and chrome castors. One lid and one drop-down flap. Accommodation for turntable, amplifier and tuner. Dimensions: $22\frac{1}{2} \times 50\frac{1}{4} \times 17$ in.; turntable section 18 in. wide $\times 15\frac{3}{4}$ in. deep; amplifier section $28\frac{1}{4} \times 7\frac{1}{4} \times 14\frac{1}{2}$ in. Finish: teak. Price: £25 16s. 5d. (plus £2 10s. 7d. PT).



SME Ltd., Steyning, Sussex. BN4 3LN. Tel: Steyning 2228.

★ **Model 2000.** Plinth system with one motorboard ready cut for SME pickup arm and turntable. The one-piece acrylic lid has a stainless steel reinforcing trim. Counter-spring hinges retain the lid open when required. Dimensions: $9 \times 24 \times 20$ in. Prices: teak or walnut, £25 6s. 3d. (plus £6 3s. 9d. PT); rosewood £26 16s. 3d. (plus £6 11s. PT).

All parts of Model 2000 are available separately. These comprise the base, motorboard, acrylic lid, spring mounts (set of four), and left- or right-hand hinge (see constructional kits section).



STAPLES & CO. LTD., Staples Corner, Junction Edgware Road and North Circular Road, London, N.W.2. Tel: 01-452 1144/7.

★ **Ladderax.** Unit system hi-fi cabinet designed to fit Staples Ladderax assembly. Lift-up main lid giving access to space for tuner, control unit and record or tape deck. Front panel removable to facilitate installation. Will accept most modern equipment. Size: 35 in. wide, 17 in. deep, $18\frac{3}{4}$ in. high. Motorboard: $33\frac{3}{4} \times 16 \times \frac{1}{2}$ in., height above $5\frac{3}{4}$ in. Finish: teak veneered only. Full details of other matching units on request. Prices from about £38.



STENTORIAN, Whiteley Electrical Radio Co. Ltd., Victoria Street, Mansfield, Nottinghamshire: Tel: Mansfield 24763/5. Cables: Whitebon, Mansfield.

C16 Thoresby Equipment Console. Upright style equipment cabinet with lift-up lid. Takes most makes of gram unit or tape deck, amplifier, control unit and tuner. Available in mahogany or walnut. Supplied packed flat and easily assembled in a few minutes with a screwdriver only. Size: $19\frac{3}{8} \times 18 \times 31$ in. Price: (mahogany) £20 19s. 6d. (plus £2 1s. 8d. PT); (walnut) £21 13s. 5d. (plus £2 3s. PT).



TYSONS, 41 Russell Street, Leamington Spa. Tel: Leamington Spa 24935.

Tysonic Dower Chest. Lowline style in oak. Suitable for gram unit, tape deck, tuner, amplifier. Lift-up lid. Generally 36 in. to 48 in. long. Prices: £35 to £50.

Equipment installed in antique or reproduction furniture to customers' requirements. Dower chests a speciality.

Why get up to your eyes in statistics - when it's really up to your ears!



Here are the facts: Wharfedale high fidelity speakers bring pure clear sound within the reach of everyone.

Listen to them. Compare them.

Wharfedale design engineers and craftsmen have combined to build speakers that offer better value pound for pound than comparable systems.

You'll hear there's good reason why more hi-fi fans buy Wharfedale than any other make of speaker.



Rank Wharfedale Ltd



don't buy that telly till you've bought this!

Entertainment is rife in our leisure society, and nowhere is it more in evidence than in the enormous range of appliances serving it.

With hundreds of models of radios, televisions, gramophones, tape recorders and the like in the shops these days, the wise consumer knows he should do plenty of shopping around before he chooses the one that best suits his taste and budget. For him, the Radio Year Book is the most comprehensive and timely buying guide available. Users of the Radio Year Book are likely to get exactly what they want. It's got everything from floor-model colour TVs to transistor car radios—over 1,000 entries in all, over half of them illustrated. All entries include the latest retail prices. If you can't find it in the shops, call manufacturers and suppliers from the long list of addresses and phone numbers. When the purchasing is done, enjoy articles of lasting interest on television and VHF radio in the features pages of this useful annual.

RADIO YEAR BOOK 1969/70

Available from booksellers everywhere or direct from the publisher (15s + 2s postage and packing).

IPC Electrical-Electronic Press Ltd.

Dorset House, Stamford Street
London S.E.1.

Belling-Lee Concord will give you a fourth dimension in sound

(well almost)

Nominal flat response from 40mHz to 860mHz including all band II making it ideal for stereo reception, gain 12dB nominal. This means the strength of the signal from the existing aerial will be amplified by FOUR times.

EASILY AND QUICKLY INSTALLED
NO ADJUSTMENT REQUIRED
FULLY TRANSISTORED
DEVELOPED BY BELLING-LEE



L1893
New VHF/UHF
flush mounting diplexer



L1480
Single coaxial
flush mounting outlet



L735A
Coaxial socket for termination
of aerial downleads for FM installation



BELLING-LEE TELEVISION EQUIPMENT

Belling and Lee Ltd., Television Equipment Division, Gt. Cambridge Rd., Enfield, Middx.
Telephone: 01-363 5393 Telex: 263265 Cables: 'Radiobel' Enfield.

Looking for great FM reception?

Then look UP!

Right up to the aerial. Because that's where quality begins.

The excellence of FM reception (and it *can* be very, very good indeed) depends on a high signal to noise ratio. This is achieved only when the limiter is driven hard with as large an input signal as possible.

But even a first-class limiter plus a strong signal can only do so much and no more. Another key factor is the *directivity* of the receiving aerial which is vital in eliminating 'noise' and selecting the desired signal.

Antiference is Britain's most knowledgeable manufacturer of aerials. You can choose from a wide and sophisticated range of Antiference Aerials. For short, medium or long-range reception. For indoor, loft or outdoor placement. Each one is superbly engineered.

Even Antiference Aerials – which are quite literally the best you can buy – are inexpensive. And yet they can make a dramatic improvement to the sound performance of all the rest of the costly radio equipment you use.

For great FM and STEREO reception. Look UP, to Antiference Aerials.

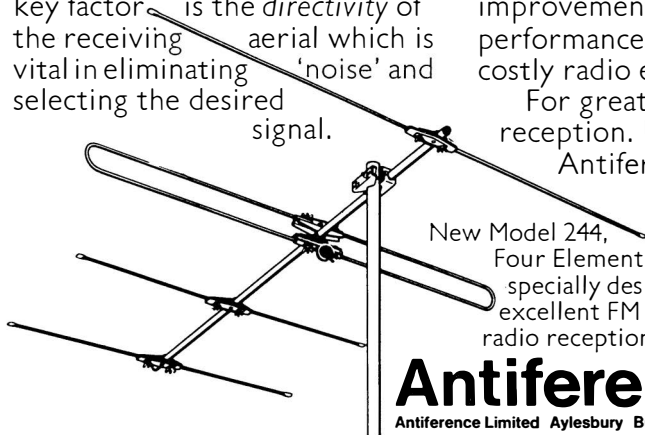

New Model 244,
Four Element Band II aerial
specially designed for
excellent FM and STEREO
radio reception.

Antiference

Antiference Limited Aylesbury Bucks Tel: 2511



DIRECTORY OF FM/VHF AERIALS

AERIALITELTD., Hargreaves Works, Congleton, Cheshire. Tel: Congleton 3892.

Aerpole 900/MU. Band II outdoor dipole with stand-off arm and universal bracket to fit up to 2 in. diameter masts. Price: £1 14s. 6d.

Aeratch 901/XU. Band II wide-spaced H array with attachment to fit masts up to 2 in. diameter. Price: £2 3s.

Aerfringe 902/XU. Band II three-element array comprising director, folded dipole and director. Bracket for mast attachment up to 2 in. diameter. Price: £3 2s.

FM adaptors 616. Comprises two add-on units for clamping to existing Band I dipole with $\frac{1}{2}$ in. diameter vertical elements. Price: 13s. 6d.



ANTIFERRENCE LTD., Bicester Road, Aylesbury, Bucks. Tel: Aylesbury 2511.

Loft 233. Band II three-element loft aerial with folded dipole. Universal mounting clamp with stand-off arm. Fully adjustable for angle and direction. Price: £2 1s.

214. Band II single dipole (array only) with one-hole fitting for 1 in. dia masts. Price: £1 4s. 9d.

214/1A. Band II single dipole array with 7 in. stand-off arm and universal 'grip-on' clamp to fit masts up to 2 in. diameter. Price: £1 13s. 6d.

214/2B. Band II wall mounting single dipole

array. 15 × 1 in. stand-off arm and universal fitting bracket. Price: £1 17s. 6d.

214/9C. Band II chimney mounting single dipole array. 3 ft × 1 in. swan-neck arm and single lashing. Price: £3 0s. 9d.

224. Band II dipole and reflector array with universal clamp to fit masts up to 2 in. diameter. Price: £2 4s.

224/9M. Band II dipole and reflector array with 5 ft × 1 in. cranked mast and single chimney lashing. Price: £4 6s.

234. Band II three-element array comprising folded dipole, director and reflector with universal clamp for masts up to 2 in. diameter. Price: £3 2s. 6d.

234/9M. Band II three-element array with 5 ft × 1 in. cranked mast and single lashing. Price: £5 4s. 6d.

★ **244.** Band II four-element array with universal clamp for masts up to 2 in. dia (recommended by makers for stereo). Price: £3 10s.

Addex-FM. Adaptor stubs for adding to vertical Band I, III or Band I/III arrays with $\frac{3}{8}$ in. or $\frac{1}{2}$ in. diameter elements. Price: 11s. 6d. pair.



BEN NEVIS AERIALS, Belmont Works, Belmont Site, Lewis Street, Stranraer, Scotland. Tel: Stranraer 2677/8.

Ben Nevis V1. Band II single dipole with stand-off arm and universal mast clamp for 1-2 in. masts. Price: £1 8s. 6d.

Ben Nevis V2. Band II dipole and reflector with boom and stand-off arm and universal mast clamp. Price: £2.

Ben Nevis V3. Band II three-element array comprising director, folded dipole and reflector, with stand-off arm and universal mast clamp. Price: £2 18s.

Ben Nevis V4. Band II four-element array comprising two directors, folded dipole and reflector, with stand-off arm and universal mast clamp. Price: £3 10s.

Regal RV1. Similar to V1 but aerial array

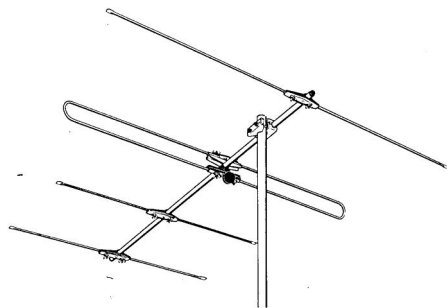

Antiferrence 244

plastic-coated by Plastalux process and fitted anti-vibration insulators. Ideal for exposed locations or where subject to corrosion. Price: £2 14s.

Regal RV2. Similar to V2 but array plastic-coated and fitted anti-vibration insulators. Price: £4 10s.

Regal RV3. Similar to V3 but array plastic-coated and fitted anti-vibration insulators. Price: £6 16s. 6d.

Regal RV4. Similar to V4 but array plastic-coated and fitted anti-vibration insulators. Price: £8 6s. 6d.

V.H.F. aerials custom-built to individual customer's specification.



J. BEAM ENGINEERING LTD., Rothers-
thorpe Crescent, Northampton. Tel: Northamp-
ton 62147.

FMG.1. Band II dipole with 7 in. stand-off aluminium arm with universal grip to fit any mast up to 2 in. diameter. $\frac{3}{8}$ in. aluminium elements with heavily plated universal clamp. Price: £1 15s.

FM2. Band II dipole with reflector. 1 in. diameter aluminium boom. heavily plated universal clamp to fit any mast up to 2 in. diameter. $\frac{3}{8}$ in. aluminium elements. Rustproof precision-cast fittings and waterproof junction box. Price: £2 6s.

FM3. Band II dipole. reflector and director for loft mounting. Price: £2 8s.

FM4.S. Band II folded dipole. two directors and folded reflector. Specially designed for stereo radio which calls for a larger signal input to overcome the drop in signal-to-noise ratio due to the multiplex stereo system. Each array is peaked on local stereo frequency. High front-to-back ratio and clean polar diagram. 1 in. diameter aluminium crossbar. $\frac{1}{2}$ in. diameter elements. Waterproof junction box. Die-cast element clamps with aluminium securing bolts. Heavily plated universal clamp for masts 1 in.-2 in. diameter. For extreme range two FM4.S can be stacked one above the other (6 or 7 ft apart) and connected together by PM/3 phasing and matching harness. Price: FM4.S aerial array £4 7s.. PM/3 harness £1 10s.

FM6.S. Band II broad-band long-range six-

element aerial covering 88-98 MHz. Array comprises dipole. reflector and four directors. Careful design of director chain provides clean polar diagram. For stacked arrays two FM6.S aerials can be connected together by PM/3 harness. Price: FM6.S aerial array £6. PM/3 harness £1 10s.



K.V.A. ELECTRONICS, 40 Monarch Parade, London Road, Mitcham, Surrey. Tel: 01-648 4884.

FML. Band II loft dipole. Two-screw fixing bracket. rotatable base. arms of dipole adjustable to V for optimum results or to clear obstructions. Price: 15s.

FM.SD/W. Band II wall-mounting single dipole with fixing bracket. stand-off arm and provision for swivelling aerial for optimum results. Price: £1 10s.

FML/H. Band II loft-type H aerial comprising dipole. reflector. mounting boom and stand-off arm. Fixing bracket permits aerial to be orientated for best results. Price: £1 12s. 6d.

FML/Y3. Band II three-element loft array comprising director. folded dipole and reflector with stand-off arm and fixing bracket. Particularly suitable in areas where signal strength is poor or where 'ghosting' causes distortion. Price: £2 15s.

FML/Y4. Similar to FML/Y3 but with two directors. Price: £3 2s. 6d.

FM/HC. Band II horizontally polarised outside H aerial comprising dipole. reflector. boom. cranked arm mast and chimney lashing equipment. Price: £3 10s.



LABGEAR LTD., Cromwell Road, Cambridge. Tel: Cambridge 47301.

Labgear 202. Band II dipole with single reflector. Price: £1 14s.

Labgear 203. Band II three-element array comprising director. folded dipole and reflector. Price: £2 17s. 6d.

Labgear 205/W. Band II dipole with cranked arm and wall bracket. Price: 18s.

Labgear 205/L. Band II dipole for loft mount-
ing. Price: 14s.

Labgear 202/Z2. Band II dipole with single reflector. Supplied complete with cranked arm and lashing. Price: £3 7s.

Alloy masts from 6 ft \times 1½ in. to 16 ft \times 2 in.. cranked arms and single and double chimney lashings.



MAXVIEW AERIALS LTD., Maxview Works. Setch. Kings Lynn. Norfolk. Tel: Watlington (Norfolk) 376.

Maxview D/DW. Band II wall-mounting dipole with stand-off arm and adjustable swivel fitting. Price: £1 12s. 8d.

Maxview D/DM. Band II dipole array with bracket for mast fitting. Price: £1 7s. 6d.

Maxview D/HM. Band II array comprising dipole and reflector on boom. Bracket for mast mounting. Price: £1 18s. 6d.

Maxview D/S3. Band II three-element array comprising director, dipole and reflector. Bracket for mast mounting. Price: £2 5s. 6d.

★**Maxview D/FD3.** Band II three-element array comprising director, folded dipole and reflector. Bracket for mast mounting. Price: £2 14s.

Maxview D/STB. Band II Twig stub add-on

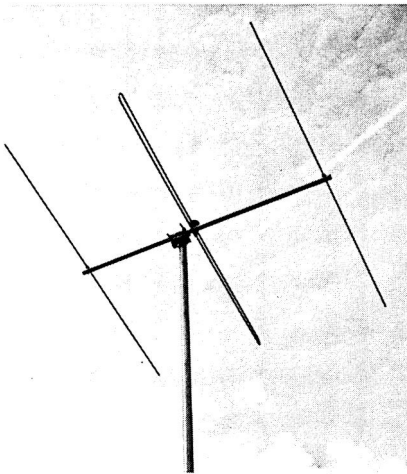

Maxview D/FD3

units for TV aerials to boost Band II reception. Price: 11s.

TELECRAFT LTD., Quadrant Works, Wortley Road. Croydon. Surrey. Tel: 01-684 1191/3.

FM1. Band II single dipole with stand-off arm and wall mounting swivel bracket. Price: approx £1 2s. 6d.

FM2. Band II array comprising dipole and reflector with universal mast-head fixing bracket. Price: approx £1 10s.

FM2-MB. Similar to FM2 but supplied with mast and chimney bracket. Price: approx £2 5s.

FM3. Band II yagi array comprising dipole, reflector and director. Price: approx £2 2s.



TELEFIELD MANUFACTURING CO. LTD., 2 Tucker Street. Bristol 2. Tel: Bristol 28339.

D2/FM. Band II outdoor single dipole with stand-off arm for wall, eaves or fascia mounting. Price: £1 3s. 9d.

D2.U. Band II outdoor single dipole with universal clamp for mast attachment. Price: £1 6s.

S2. Band II stub adaptors for attaching to existing Band I or Band III aerial. Price: 9s.

H2/FM. Band II dipole and reflector array. Price: £1 15s.

3FD2/FM. Band II three-element array comprising director, folded dipole and reflector. Complete with clamp for mast attachment. Price: £2 10s.

4FD2/FM. Band II four-element array comprising two directors, folded dipole and reflector. Complete with mast fixing clamp. Price: £3 2s. 6d.



VISTA GAIN. Vista Gain Sales Co., St Marylebow House, 54 Bow Lane. London. E.C.4. Tel: 01-248 3376 and 1878.

K.2. Band II indoor dipole. Heavily-plated three-step telescopic dipole adjustable for optimum results. Capacity coupled elements for complete safety. Heavy base. Supplied with three yards low-loss coaxial cable. Price: £2 9s. 6d.

You can better radiogra

You know better than we do what you want in a home entertainment system.

So we'll sell you the bits and let you build your own.

You start with the Bush Amplifier Unit, plug it in to a couple of tailored speakers, then add the matched record deck.

Now you've got a superb stereo system punching out a fantastic 32 watts of sound.



The stereo speakers come in matched pairs. You can choose between wall or floor mounting. The speakers plug into the amplifier.

This is the record deck. A beautiful piece of equipment with automatic changing and an ultra light record arm. You plug it into the amplifier.

build a m than we can.

Next you can add the powerful radio tuner to pick up AM, LW and VHF stations and hear them in a way you've never heard before. Then when you've saved up a bit extra you can add more speakers from the Bush range.

The only electronic knowledge you need is how to plug the components together.

The only tools you need are your own hands.



This is the amplifier and tuner combined. You don't have to be rich to afford them together.

This is the radio tuner. Like all the Bush equipment it is finished in dark, tropical olive veneer and brushed aluminium trim. This unit pulls in all radio stations and plugs into the amplifier.

This is the stereo amplifier. It receives the signal from the record player or the radio tuner and blows it up with hi-fi precision. You plug the speakers into the amplifier and the sound blasts out.

Bush

For people who've forgotten just how good music can be

Bush a product of the Rank Organization



Great craftsmen in hi-fidelity sound
have been brought together
to give you a masterpiece...

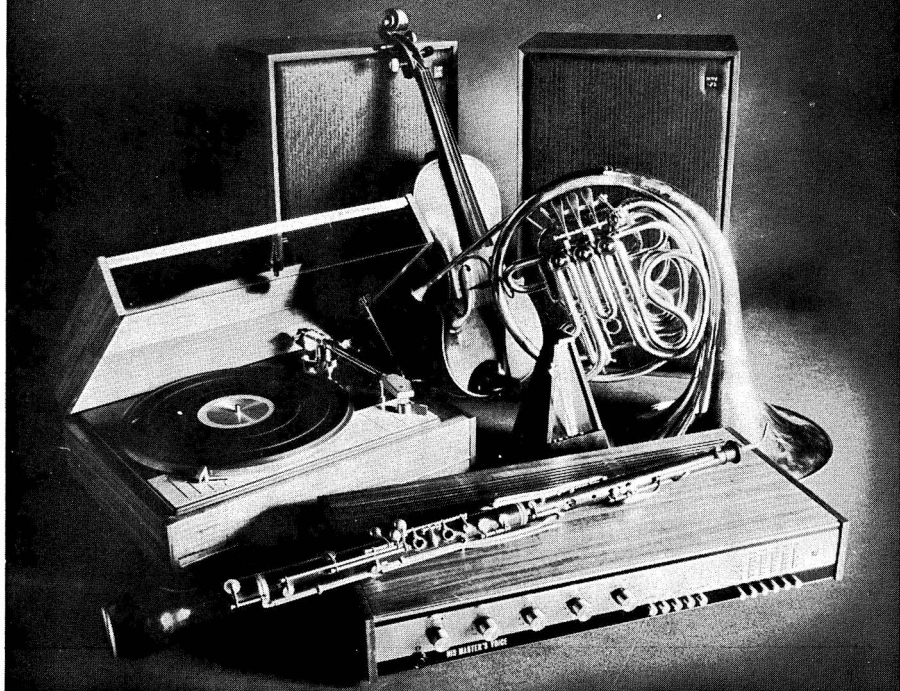

the new HMV 'High Fidelity' stereo system

Once you've heard this hi-fi system, nothing less will be good enough.

For this is stereo for perfectionists.

The speakers are by Goodmans: to give you a frequency range and transient response you'd find hard to better however hard you looked.

The transcription unit is by Goldring and Lenco of Switzerland. Which means you have one of the most advanced precision-made turntables in the world.

All this, together with the HMV amplifier, combine to give you a purity and depth of tone that is incredible.

The elegant cabinet design matches the technical performance.

Come round to your HMV Dealer and

have a look (and a listen). If that doesn't convince you, nothing will.

To all perfectionists. If you'd like to know more about this new hi-fi stereo system — and the features that have helped to make it what it is — write today for our superb full colour brochure.

HMV

 put quality first

Registered Trade Marks of the Gramophone Co. Ltd.

British Radio Corporation is a Member of the Thorn Group

British Radio Corporation Ltd., 284 Southbury Road, Enfield, Middlesex

Highly versatile performance

Model DC-434E

Solid state stereo
tuner-amplifier-turntable unit



This fully-facilitated compact has been designed to provide a three-in-one system giving a sophisticated and highly versatile audio performance.

The tuner-amplifier's solid state circuitry employs 31 transistors and 16 diodes, with a maximum output of 16 Watts per channel. The tuner gives excellent reception on AM and FM, and is multiplex fitted.

Frequency range AM 566-185M FM 87.5-110 Mc.

Frequency response (c/s) 30-18,000 \pm 1 dB.

The precision engineered turntable section, using a moving magnetic cartridge, incorporates an inside force cancellor, which, by a side-thrust compensation technique, keeps the tonearm tracking right through centre of disc groove picking up both channels of stereo records with equal sensitivity. Each speaker contains a 20 cm. double-cone high-compliance speaker for medium and low sound range and one 8 cm. tweeter for high frequencies. Speakers optional extra.

The DC-434E is part of a large and comprehensive range of audio-hi-fi equipment, all of which can be made available through the Sanyo dealer in your area.

This dealer has been selected for first-class before-and-after sales service.

Full specifications for the DC-434E are contained in a fully-illustrated colour leaflet which is



available on request from
Sanyo Marubeni (U.K.) Ltd.,
Bushey Mill Lane, Watford, Herts.
Telephone : 92 25355

People the world over agree there's something about a Sanyo

KLINGER

HIGH QUALITY STEREO SYSTEMS

Brilliant new low cost systems with superb performance — Ready to plug in and play



MODEL KC40 with Garrard 2025 TC. Lightweight arm and pick-up. All silicon high fidelity solid state amplifiers. Two Speaker systems: Bass units and Tweeters.

MODEL KC41 with Garrard SP25/II and Goldring magnetic pick-up. All silicon high fidelity solid state amplifiers. Two loud-speaker systems: Free-cone bass units and Tweeters.

"PHANTOM 505"

SLIM LINE SYSTEM with fold-away changer ideal for shelf or wall mounting. Garrard 3000 with lightweight arm and pickup. Solid state all silicon high fidelity amplifiers. Twin cone speaker systems.



**KLINGER OFFER A WIDE CHOICE OF ELEGANTLY STYLED
AND BEAUTIFULLY FINISHED STEREO PLAYER UNITS,
LOUDSPEAKERS, TUNERS AND AMPLIFIERS**

For full details of the KLINGER range write to:—

KLINGER CONTROLS LIMITED

FRIAR STREET, CARTER LANE, LONDON, E.C.4.

PLAY FAIR

Record Accessories. Stylus Timers, Stylus Cleaners, Antistatic Cleaning Pads, Antistatic Fluid, Discodas.

MICRO-DIAMOND

Replacement Styli. Most comprehensive range, best quality, reliable service, keen prices; also MICRO-DIAMOND retipping service.

WALTON

M.I. Pickup cartridges.

DRY-SPLICE

Tape Accessory and MINIFLUX Tapeheads.

Manufacturers and Distributors:

LENNARD DEVELOPMENTS LTD

497 GREEN LANES,

LONDON, N.13

Tel: (01)-886 3723/4

THE WORDEN

Pansona
Regd. Trade Mark

REPRODUCERS

FOR THE MOST REALISTIC RESULTS POSSIBLE. LEAFLETSON REQUEST
Demonstrations daily at:-

- **H. C. HARRIDGE LTD.**
8, Moore Street, London, W.1.
01-437 7108
- **THE MUSIC ROOM**
56, Crystal Palace Park Rd., Sydenham,
London, S.E. 26. 01-778 8120
- **3D SOUNDS**
45, Arlington Square, All Saints Ave.,
Margate, Kent. Thanet 41212

and
**WORDEN AUDIO
DEVELOPMENTS Ltd.**

54, Chepstow Road, London, W.2.
Telephone: 01-229 4996

Quality First

with

FILM INDUSTRIES

Ribbon microphones

*From a Review of the Model MBA.
"... The Film Industries MBA
ribbon microphone has a most
attractive appearance coupled with
a performance which, in many
respects, can stand comparison
with the best designs at three or
four times its price."*

FILM INDUSTRIES LTD.

Station Avenue,
Kew Gardens, Surrey
TELEPHONE: RIC 8078



Type MBA
Microphone

We match more pockets



You may be a millionaire. But then again, you may not. Which highlights the basic problem of choosing a stereo system. It has to match your pocket. Which in turn, highlights an enormous advantage of Philips Audio Plan. We match more pockets than anybody else.

You can choose any of a dozen or more Audio Plan systems – including amplifiers, tuner-amplifiers, radio tuners, record-decks, tape and cassette recorders and, of course, loudspeaker enclosures. And you can add to your system piece by piece. All beautifully matched in styling and electronics.

Ask for a demonstration.

PHILIPS



Philips Electrical Ltd., Century House, Shaftesbury Avenue, London W.C.2.

Still the best buy in budget Hi-Fi!

DULCI

HIGH FIDELITY AUDIO EQUIPMENT



**PD3
STEREO
PLAYING DECK**

14 $\frac{5}{8}$ " \times 15 $\frac{3}{8}$ " \times 7"

Suggested retail price £23 each

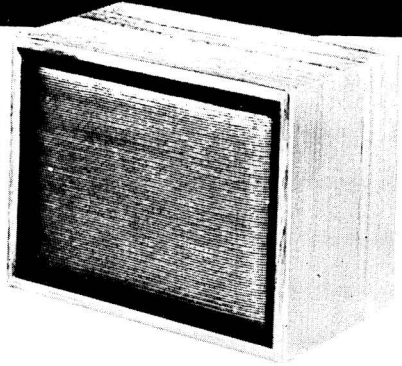

AS3 LOUDSPEAKER

12" \times 9" \times 6" 8 ohms - 6 watts

Suggested retail price £9 each

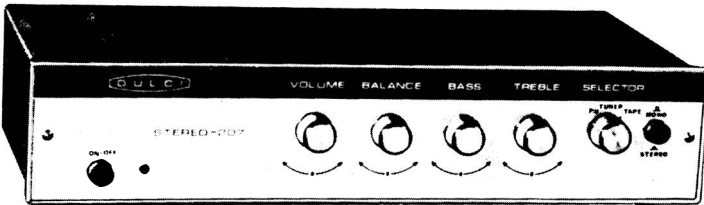

207 STEREO AMPLIFIER

For crystal and ceramic inputs
Suggested retail price £25

FMT7S STEREO F.M. TUNER

Audio output 200 mV

Suggested retail price £31

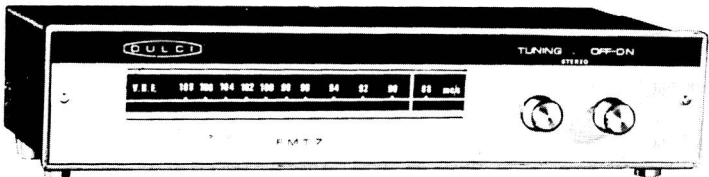

Lee Products (G.B.) Limited.

10-18 Clifton Street, London, EC2 01-247 6711



Bang & Olufsen – for those who consider design and quality before price.

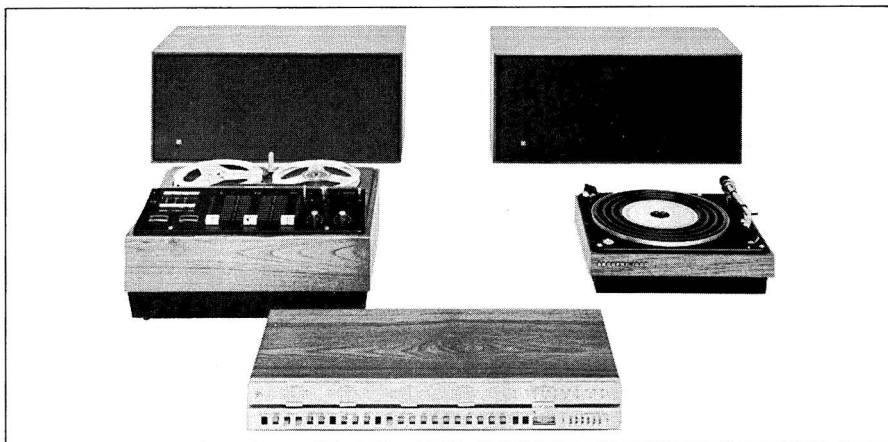

The Beomaster 3000 – a brilliant new stereo FM tuner/amplifier from Bang & Olufsen

Now you can listen to your favourite sounds naturally – piece by piece – through one of the world's most perfectly engineered audio units. As the centre of your audio system, Bang and Olufsen introduce the Beomaster 3000, a highly sophisticated high-fidelity stereo amplifier and FM tuner. Check the new Beomaster 3000 out with your nearest Bang and Olufsen dealer. Don't be a little surprised if you're that bit late for your next appointment. You will have been enjoying the best in audio – world perfect by Bang and Olufsen.

The Bang and Olufsen system shown here consists of the following units:

Beomaster 3000 A combined stereo amplifier and FM tuner, Output 2 x 30 watts RMS – 2 x 60 music-watts. 6 pre-set FM programme controls. Connecting sockets for high and low impedance PU cartridges, a tape-recorder, headphones, and two pairs of loudspeakers.

Beogram 1000 A semi-transcription turntable unit featuring the world famous STL/15 Pick-up arm and SP7 Cartridge. (Speeds 78, 45, 33 $\frac{1}{3}$ r.p.m.).

Beocord 1800 Designed for use with a high fidelity amplifier. Such as the Beomaster 3000 and available in twin or 4 track versions. The twin track model has an additional 4 track stereo head for playback of pre-recorded 4 track tapes.

Beovox 3000 Pressure chamber loudspeaker, roll surround base unit and new dome type high frequency unit. Maximum power handling capacity 40 watts RMS, 60 watts music power; impedance 4 ohms.

As we want people who choose B & O to receive really good advice, every effort has been made to appoint dealers of the best obtainable standards and this policy may have necessarily limited the number in your town or city. So write today for a list and for further information about Beosystems to:—

Bang & Olufsen U.K. Limited, Eastbrook Road, Gloucester. Telephone: 0452 21591.
London Showrooms: 70/71 Welbeck Street, London, W.1. Telephone: 01-486 2144.

COMPLETE-SYSTEM HI-FI

This section of the book gives a selection of 'complete-system hi-fi' with technical details. As many of the units are available also as separate items more comprehensive specifications will be found under the appropriate headings.

The list is not necessarily fully comprehensive and other makers who offer equipment which meets the requirements are invited to submit details for inclusion in future editions.

The minimum requirements qualifying a system for mention in this section are:—

1. Sound quality of hi-fi standard.
2. Fully stereophonic record reproduction and/or tape playback.
3. FM or AM/FM radio tuner.
4. Record turntable or tape deck (or both).
5. Matched units (electronically and aesthetically).
6. Marketed as a complete system by one manufacturer.
7. Ready for use by purchaser without fitting parts or wiring up (apart from plugging in mains supply and connecting speakers).
8. Speakers in separate acoustic enclosures. Make and type of speakers can be optional but must be recommended.

ARENA. Distributed by: Highgate Acoustics Ltd., 184-188 Great Portland Street, London, W.1. Tel: 01-636 2901.

Arena Audio Plan I. Comprises F211 tuner, SP25 Mk II with ceramic cartridge, F210 stereo amplifier, two HT14 or HT17 speakers. Price: £124 19s. (including PT); Multiplex stereo decoder £7 7s. extra.

Arena Audio Plan Ia. As for Plan I but with magnetic cartridge. Price: £131 5s. (including PT).

Arena Audio Plan II. GF1225 stereo player with amplifier, F211 tuner, two HT14 or HT17 speakers. Price: £141 15s. (including PT); multiplex stereo decoder £7 7s. extra.

Arena Audio Plan III. T2400 tuner/amplifier, SL75 with magnetic cartridge, two HT20 speakers. Price: £204 15s. (including PT); multiplex stereo decoder £7 7s. extra.

Arena Audio Plan IIIa. As for Plan III but with HT18 speakers in place of HT20. Price: £220 10s.

Arena Audio Plan IV. T2500F tuner/amplifier, SL75 with magnetic cartridge and two HT20 speakers. Price: £215 5s. (including PT); multiplex stereo decoder £7 7s. extra.

Arena Audio Plan IVa. As for Plan IV but with HT18 speakers in place of HT20. Price: £231 (including PT).

Arena Audio Plan V. T1500F tuner/amplifier, SP25 Mk II deck with magnetic cartridge, two HT7 loudspeakers. Price: £136 10s. (including PT). Multiplex decoder £7 7s. extra.

Arena Audio Plan Va. As for plan V, but with HT10 loudspeakers in place of HT7. Price: £143 17s. (including PT).

Arena Audio Plan VI. T9000 tuner/amplifier with multiplex decoder, PE2020 deck with Pickering V15-AME1 cartridge and two HT25 loudspeakers. Price: £681 9s. (including PT).

Arena Audio Plan VIa. As for Audio Plan VI, but with HT26 loudspeakers. Price: £523 19s. (including PT).



BRAUN. Fi-Cord Ltd., Charlwoods Road, East Grinstead, Sussex. Tel: East Grinstead 21351.

Audio 250. Comprises PS410 turntable unit, tuner and amplifier. Fully transistorised. Output: 15W RMS per channel. FR 30 Hz-30 kHz. Distortion: below 0.5% at 12W output. Tuner: FM, FM-stereo, SW, MW and LW. Stereo beacon. Internal ferrite aerial, pushbutton selected. Record player with fine speed control. Cueing device. Shure M75-6 cartridge. Base in white or charcoal lacquer with wrinkle finish. Plexiglass lid. Cover plates aluminium colour. Size: 6½ × 25½ × 11 in. Price: £259 13s. 4d.

Recommended speakers. L450, L40, L300, L700 (4 ohms).

★

BUSH. Rank Bush Murphy, Power Road, Chiswick, London, W.4. Tel: 01-994 6491.

A746/A747/and loudspeakers. Complete audio system. Range: 88-108MHz, 187-570m. 1070-1900m. Tuning: variable. AFC and multiplex decoder. Tuning meter, illuminated scale and stereo beacon. FM sensitivity: 5µV, aerial impedance: 75 ohms. Output: 2.2V max AM, 1.5V max FM. Psn: AC mains. Dimensions: $16 \times 9\frac{3}{16} \times 4\frac{3}{8}$ in. Price: £27 13s. 7d. (plus £6 10s. 3d. PT). Power amplifier output: 11W RMS per channel. 4-15 ohms. HD: < 0.5% at 11W. FR: 40Hz-20KHz±3dB. Dimensions: $16 \times 9\frac{3}{16} \times 4\frac{3}{8}$ in. Price: £31 11s.

A763. Infinite baffle enclosure for above system. Twin $6\frac{1}{2}$ in. units. Dimensions: $32 \times 9 \times 5$ in. Price: £31 0s. 2d. per pair (inc PT).

A764. Infinite baffle enclosure for above system. Dimensions: $13\frac{7}{8} \times 9\frac{3}{4} \times 8\frac{5}{8}$ in. Price: £34 4s. 4d. per pair (inc PT).

A765. Infinite baffle enclosure for above system. Dimensions: $21 \times 13 \times 9\frac{3}{4}$ in. Price: £60 18s. per pair (inc PT).

★

CROWN. Crown Radio Co. Ltd., 137-149 Goswell Road, London, E.C.1. Tel: 01-253 1971/2.

★**SHC-55, CSP-7.** Complete solid state stereo radio/disc/tape system. Range: 87-108 MHz, 525-1.605 KHz. Power output: 15W RMS per channel into 8 ohm speakers provided. Record player and cassette tape recorder sections incorporated. Dimensions: $7\frac{7}{8} \times 25\frac{3}{16} \times 16\frac{1}{4}$ in. Weight: 29 lb. Dimensions of each loudspeaker enclosure: $13\frac{3}{16} \times 9\frac{1}{16} \times 10\frac{1}{2}$ in. Weight: 10 lb. Prices: with Garrard 2025 auto changer £150 7s. 7d. (plus £37 3s. PT); with Garrard SP25 and Pickering cartridge £155 1s. 9d. (plus £38 6s. 3d. PT); with SP25 and Shure cartridge £157 17s. 4d. (plus £38 19s. 11d. PT).

SHC-51, FM-500, CSP-7. Solid state stereo radio/tape system. Range: 87-108 MHz, 525-1.605 KHz. Power output: 15W RMS per channel into 8 ohm speakers provided. Cassette tape recorder section integrated with power amplifier. Dimensions: amplifier $4\frac{15}{16} \times 15\frac{3}{16} \times$

$10\frac{1}{2}$ in.; tuner $4\frac{15}{16} \times 15\frac{3}{16} \times 10\frac{1}{2}$ in.; each speaker enclosure $13\frac{3}{16} \times 9\frac{1}{16} \times 10\frac{1}{2}$ in. Weight: amplifier and tape unit $14\frac{3}{4}$ lb; tuner $8\frac{1}{2}$ lb; each speaker enclosure 10 lb. Prices: SCH-51 amplifier and tape unit £81 9s. 3d. (plus £20 2s. 4d. PT); FM-500 tuner £42 8s. 11d. (plus £10 9s. 8d. PT); CSP-7 speaker enclosure (each) £15 8s. 9d. (plus £3 16s. 2d. PT).

★

DYNATRON RADIO LTD. St. Peter's Road, Maidenhead, Berks. Tel: Maidenhead 23331.

HFC11. Tuner/amplifier/record player. Wavebands: 87-108 MHz, 185-570 m, 1,100-2,000 m. Multiplex decoder with stereo beacon indicator lamp. FM sensitivity: 2µV 16 dB, 6µV 30 dB, 12µV 40 dB, quieting (S/N). AM sensitivity: 10µV for 20 dB S/N average MW band; 15 µV for 20 dB S/N average band. Separate R.F. and I.F. channels for AM/FM. AFC: AGC action +70 dB for 6 dB change in audio. HC 8-5W per channel RMS. H and N: better than -65 dB. FR: 30 Hz-20 KHz -3 dB. Inputs: tape, 30 mV for 10W at 1 KHz; magnetic pickup, 4.5 mV for 10W at 1 KHz; ceramic pickup, 60 mV for 10W at 1 KHz. Sockets: 3-15 ohms external loudspeakers, tape recorder, external VHF and AM aerials. Shuttered main socket for tape recorder, etc. Controls: rotary tuning, function selector, wavebands, balance, volume, treble (± 10 dB at 10 KHz relative to 1 KHz), bass (± 10 dB at 100 Hz relative to 1 KHz); slide switches for AFC, loudness filter, S filter. Record turntable: Garrard 2025 TC autochanger, with Sonotone 9 TAHC ceramic cartridge and diamond stylus. Dimensions: $9\frac{7}{8} \times 19 \times 16\frac{1}{4}$ in. Price: £94 10s.

HFC11M. Tuner/amplifier/record player with similar specification to model HFC11, but HC 10W per channel RMS. Record turntable: Garrard SP25 Mk II single player. Price: £97 10s.

HFC12. Tuner/amplifier/record player with similar specification to HFC11M model, but uses a Goldring Lenco GL 75 deck with magnetic cartridge. Dimensions: $8\frac{3}{4} \times 19 \times 16\frac{1}{4}$ in. Price: £124 10s.

HFC13. Tuner/amplifier/record player with a similar specification to model HFC12, but with Garrard 3500 autochanger, ceramic cartridge, diamond stylus, micro weight adjustment and lift lever. Dimensions: $26\frac{3}{4} \times 31\frac{1}{2} \times 20\frac{1}{2}$ in. Price: £139 15s.

HFC14 tuner/amplifier/record player with a

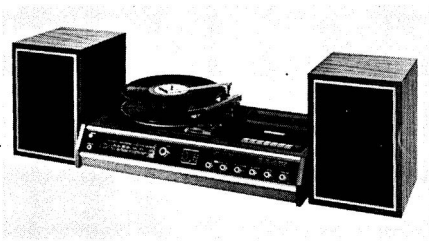

Crown SHC-55

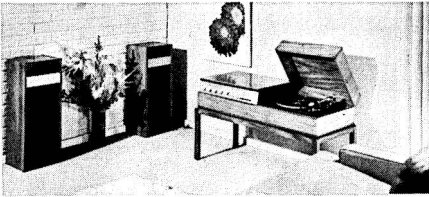

Ferguson Unit Audio

similar specification to the previous model in a different cabinet styling. Size $32\frac{1}{2} \times 32\frac{7}{8} \times 16\frac{1}{4}$ in. Price: £175.



FERGUSON. British Radio Corporation Ltd., 284 Southbury Road, Enfield, Middlesex. Tel: 01-366 1155.

★ **FERGUSON UNIT AUDIO.** System offers choice of FM or AM/FM tuner/amplifier, record unit and/or tape unit, bookshelf or floor-standing speaker enclosures. All units in teak.

Tuner/amplifier 206STA. FM/VHF tuner with five preset tuning buttons. Incorporates stereo decoder and stereo indicator. 27 transistors and 12 diodes. Output 6W per channel at 8 ohms. FR: 30 Hz-20 KHz (6 dB) HD <2%. Price: £44 19s. 7d. (plus £9 12s. 5d. PT).

Tuner/amplifier 205STA. AM/FM tuner amplifier covering VHF, LW, MW and SW. Incorporates stereo decoder and stereo indicator. 26 transistors and 16 diodes. Output: 4W, 8 ohms per channel. FR: 30 Hz-20 KHz (6 dB). HD < 5%. Price: £48 18s. (plus £10 9s. PT).

Playing deck 202RP. Shelf-mounting cabinet with Perspex lid and incorporating Garrard SP25 deck and Sonotone 9TA ceramic cartridge. Diamond LP and sapphire 78 styli. Price: £25 14s. 11d. (plus £5 10s. 1d. PT).

Tape unit 3216. $\frac{1}{4}$ -track recorder in matching furniture style cabinet. Speeds: $7\frac{1}{2}$, $3\frac{3}{4}$, $1\frac{7}{8}$ i/s. Max spool 7 in. Piano key operation. Pause. Meter indicator. Auto-stop. Input mixing. Price: £53 10s. 3d. (plus £12 11s. 9d. PT).

Speaker 204SS. Compact shelf-mounting enclosure. $6\frac{1}{2}$ in. bass driver and $3\frac{1}{2}$ in. tweeter. FR: 30 Hz-15 KHz. Crossover: 3 KHz. Size: $16\frac{3}{4} \times 7\frac{1}{2} \times 8\frac{1}{2}$ in. Can be used horizontally or vertically. Price: £11 14s. 1d. (plus £2 9s. 11d. PT).

Price of complete system. From £112 5s. to £177 5s. approximately.

Unit Audio 3400. Comprises tuner/amplifier and playing desk in coffee table style cabinet. FM 87.5-108 MHz. Stereo decoder and beacon. Preset tuning. Garrard SP25 Mk II deck. Inputs for PU, radio, tape. Transistors. Output: 6W RMS, 8 ohms per channel. FR: 30 Hz-20 KHz (6 dB). Mains 200-250V AC. Size: $36\frac{1}{4} \times 14\frac{3}{4} \times 7\frac{1}{2}$ in. (21 in. high on stand). Price: £72 1s. (plus £16 19s. PT).

Unit Audio 3405. Record player with Garrard SP25 motor unit and Sonotone 9TA cartridge. 6W transistorised stereo amplifier. FR: 30 Hz-20 KHz ± 3 dB. Distortion at stated output: < 2%. Output impedance: 8 ohms. Controls: on/off, bass, treble, volume, stereo/mono. Recommended speakers: Ferguson 3402B or 3407. Teak veneer. Size: $16\frac{1}{2} \times 14\frac{1}{2} \times 7\frac{1}{4}$ in. Price: £42 19s. 9d. (plus £10 2s. 3d. PT).



GOODMANS. Goodmans Loudspeakers Ltd., Axiom Works, Wembley, Middlesex. Tel: 01-902 1200.

Audio Suite. System comprises AM/FM stereo tuner, record unit, stereo integrated amplifier and choice of three Goodmans speakers.

Stereomax tuner. All-silicon transistor AM/FM tuner covering VHF and MW. Separate tuning systems for AM and FM. Stereo decoder available. AFC switchable and operative on both bands. 20 transistors and 21 diodes. Tuning meter. Quiet tuning. Automatic stereo indicator. Price: £65 5s. (plus £17 5s. 5d. PT).

Maxamp 30 amplifier. All-silicon transistor stereo amplifier. Output: 15W RMS per channel. HD <0.3% at 15W. FR: 20 Hz-20 KHz $\pm \frac{1}{2}$ dB. Output impedance: 4-8-15 ohms. Price: £54.

Record unit MT1000. Teak or walnut cabinet

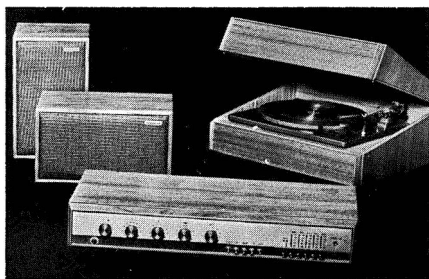

Goodmans Music Suite

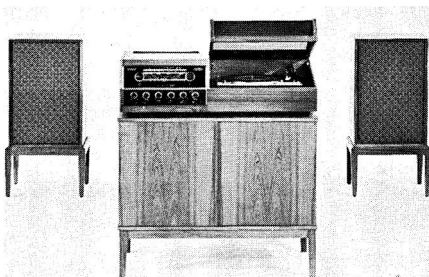

Hacker system

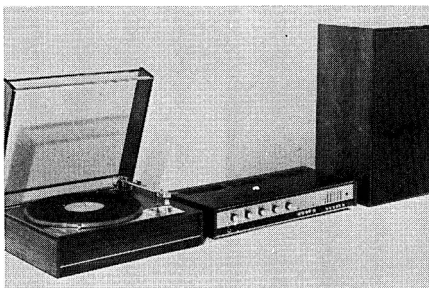

HMV hi-fi system

with lift-up lid incorporating inspection window. Thorens TD150A two-speed turntable and Shure M75-MB cartridge. Pickup lowering device. Mono and stereo diamond stylus. FR: 20 Hz-20 KHz. Price: £58 6s. 6d. (plus £15 8s. 9d. PT).

Recommended speakers. Goodmans Maxim, Mezzo II, Magnum K, Mambo or Marimba.

Price of complete system. From £240 17s. 4d. to £282 6s. 2d.

★ **Music Suite.** System comprises FM stereo tuner/amplifier, record player unit and speakers in matching teak cabinets.

3000. Solid state stereo tuner/amplifier. Range: 87.5-108 MHz. Semiconductors: 33 transistors, 15 diodes, one zener diode, four power rectifier diodes, two vari-cap diodes. Five pre-tunable push buttons. Switchable AFC. Multiplex decoder fitted. Automatic stereo indicator. Price: £77 14s. 7d. (including £16 5s. 4d. PT).

3025. Record player on plinth. 4-speed single play unit with cue and pause control. Automatic trip and return. Price: £37 14s. 9d. (including £7 18s. PT).

3005. Speaker enclosure with 5 in. full range, twin cone unit. Impedance: 4 ohms. Size: 7 × 11 $\frac{3}{8}$ × 7 in. Price: £25 pair (including £2 9s. 6d. PT each).



HACKER. Hacker Radio Ltd., Norreys Drive, Cox Green, Maidenhead, Berks. Tel: Maidenhead 22261.

GAR. 1000 SRD. AM/FM tuner, integrated stereo amplifier and Garrard AP75 record player. Ranges: 87.5-101 MHz; 185-575 m; 1,070-2,040 m. Sensitivity: on FM, better than 1 μ V for 10 dB S/N with full limiting at 5 μ V; 2 μ V at 200 m, 6 μ V at 500 m; 6 μ V at 1,500 m for 10 dB S/N. Stereo decoder, with separation better than 30 dB, 100 Hz-10 KHz on transmission. Inputs: ceramic PU, 0.022 μ F, 5 mV, S/N better than -60 dB; magnetic, 47K, 3 mV, S/N better than -50 dB; radio, 80K, 22 mV, S/N better than -60 dB; aux, 250K, 7 mV, S/N better than -60 dB. FR: 20 Hz-20 KHz \pm 2 dB. Output: 10W class A into 15 ohms; 15W class AB into 8 ohms; 20W class AB into 4 ohms. Psn: 200/245 V, 68VA. Price, without speaker: £175 (including PT). For loud speakers see 'Speaker Enclosure' section. Teak table 40 in. long by 16 in. high by 16 in. wide. Price: £14 14s (including PT).

GAR.1000. As model GAR.1000 SRD, but without stereo decoder. Price: £162 (including PT).

GAR.1001 SRD. As model GAR.1000 SRD but with single waveband (VHF) only. Price: £160 (including PT).

GAR.1001. As model GAR.1000 but with single waveband (VHF) only. Price: £147 (including PT).



HALCYON. Eurovox Ltd., The Power House,

Headstone Lane, Harrow, Middlesex. Tel: 01-428 1021/4.

Stereoplan 260. System comprises shelf-mounting tuner-amplifier with built-in auto-changer and two matching miniature bass reflex speakers. **Radio.** FM/VHF 87.5-101 MHz, LW 1,180-2,050 m, MW 186-571 m. Switchable AFC on FM. Internal ferrite rod for AM, sockets for external VHF aerial. **Amplifier.** Output: 4W per channel. Wide range treble and bass controls. Balance control plus push-button function selectors. **Gram unit.** Garrard 2025TC four-speed autochanger with cue and pause control. Lightweight tubular arm with Acos GP104 cartridge. **Speakers.** Miniature bass reflex type incorporating high flux 8×5 in. units, 12 ohms impedance. **Complete unit.** Woodgrain finish with transparent plastic lid. 15 transistor and 5 diode circuit. Mains: 220-240V 50 Hz. Price: (with speakers) £72 10s. (including PT).



HEATHKIT. Manufactured by Daystrom Ltd., Bristol Road, Gloucester. Tel: Gloucester 29451.

★ **AD-27 Compact.** System comprises shelf-mounting tuner-amplifier with built-in record deck. Designed for use with any of the Heathkit or similar high quality enclosures. **Radio.** FM/VHF covering 88-108 MHz. Aerial input: 300 ohms balanced and 75 ohms coaxial. Sensitivity: 5 μV IHF standard. IF: 10.7 MHz. AFC. HD 1% or less. Stereo decoder included. **Amplifier.** Output: 10W per channel RMS (15W per channel IHF standard). H and N: PU -47 dB, aux -60 dB. FR 15 Hz-50 KHz ±1 dB, 7 Hz-90 KHz ±3 dB. PU input equalised to RIAA. Bass control: -16 dB to +15 dB at 20 Hz. Treble control: -13 to +15 dB at 20 KHz. **Gram unit.** BSR automatic MA70 fitted with Shure M44/MB cartridge. 0.7 thou diamond stylus. Pw 1½-3 gm. FR 20 Hz-20 KHz. Separation: 25 dB at 1 KHz. **Complete unit.** Mains: 105-125V or 210-250V 50-60 Hz. Size: 21¾ in. wide, 7¾ in. high, 14¾ in. deep. Weight: 29 lb. Finish: teak or walnut. Price: (in kit form only) £82. **Recommended speakers:** Cotswold (all versions), Berkeley, Avon or SSU.



HMV. British Radio Corporation Ltd., 284 Southbury Road, Enfield, Middlesex. Tel: 01-366 1155.

★ **2404, 2405, 2406.** Hi-Fi stereo system. Tuner: 87.5-108.3 MHz, 5 preset channels, AFC, multi-



Heathkit AD-27 Compact



LL Electronics Novagram system



LL Electronics 4000 stereo

plex decoder. 15W per channel amplifier. FR: 30 Hz-20 KHz ± 2 dB at 4W. HD: $< 1\%$. Output impedance: 4-15 ohms. Record deck: Goldring/Lenco variable speed (30-86 rpm, 15-18 rpm). 9 lb turntable, pulley drive. Goldring/Lenco pickup with Goldring 800E magnetic cartridge. Wood and Perspex lid. Infinite baffle with 12 in. bass unit and 4 in. mid. and treble unit (Goodmans). LC: 1,500 Hz crossover. Price: £164 10s.

★

LAFAYETTE. U.K. distributors: Barnet Factors Ltd., 4 Lisle Street, London, W.C.2. Tel: 01-437 2723.

Lafayette LR-20. Solid state AM/FM stereo tuner/amplifier with speaker systems. Range: 88-108 MHz, 540-1,600 KHz. Overall sensitivity 7 μ V. Tuner stereo separation: 30 dB at 400 Hz. External aerial: 300 ohms. Built-in ferrite rod aerial for AM. Automatic FM stereo switching with indicator bulb. Controls include function selector for AM, FM, FM AFC, phono-aux; volume/balance, tone, mode switch (stereo-mono); tuning, main on/off, and loudness compensator switch. Stereo headphone jack. Power output: 6W per channel, music power, at 8 ohms. Psn: 220-240V AC. Dimensions: $4\frac{1}{4} \times 15 \times 10\frac{1}{4}$ in. Finish: oiled walnut. Matching speaker enclosures each contain $6\frac{1}{2}$ in. unit. Speaker size: $9\frac{3}{4} \times 7\frac{1}{2} \times 5\frac{1}{4}$ in. Price: £50 2s. 9d. (plus £13 15s. 9d. PT).

★

LL ELECTRONIC SALES LTD., 5 Shakespeare Road, London, N.3. Tel: 01-346 3332.

★**LL4000.** Solid state stereo system. Tuner range: 88-108 MHz. Variable tuning with automatic AFC and fitted multiplex decoder. Controls: tuning, volume on/off, balance, selector for radio, disc or tape; bass, mode mono/stereo, stereo beacon, treble, meter tuning. Power output: 15W per channel RMS. FR: 20 Hz-20 KHz. Output impedance: 8-15 ohms. Distortion: less than 0.5 dB. Motor unit: LL4000 and LL4000-FM, Garrard 3500 with Sonotone 9TAHC pickup cartridge; LL4000M and LL4000MFM, Garrard SP25 with Pickering V-15/AC-2 pickup cartridge. Main unit dimensions: $21 \times 16\frac{1}{2} \times 11\frac{1}{4}$ in. Bookshelf speakers contain $6\frac{1}{2}$ in. heavy-duty unit and $3\frac{1}{2}$ in. tweeter with LC crossover. Finish: oiled teak, with perspex and teak lid. Prices: centre unit only—LL4000 £55 2s. (plus £12 19s. 3d. PT), LL4000M £60 11s. 8d. (plus £14 5s. 1d. PT), LL4000FM £84 3s. 10d. (plus £19 16s. 2d. PT); LL4000MFM £89 13s. 4d.

(plus £21 1s. 11d. PT); LL bookshelf speaker £9 10s. 3d. (plus £2 4s. 10d. PT) each; LL15E speaker £19 19s. each.

★**Novagram.** Solid state stereo system. Tuner range: 88-108 MHz and 125-550 m. Variable tuning with automatic AFC. Controls: tuning, volume on/off, selector for radio, disc, tape, bass, mode mono-stereo, treble, balance, wave-change. Power output: 5W per channel RMS. FR: 40 Hz-16 KHz. Output impedance: 8-15 ohms. Motor unit: Garrard 2025TC with Sonotone 9TAHC pickup cartridge. Overall dimensions: $14 \times 13 \times 3\frac{1}{2}$ in. Speakers contain 6×4 in. unit. Cabinet size: $16 \times 6 \times 8$ in. Cabinets finished in oiled teak, complete with perspex lid. Price complete: £67 3s. (plus £15 16s. PT).

★

MUSICRAFT AUDIO PRODUCTS LTD., 63 High Street, Hounslow, Middlesex. Tel: 01-570 4640.

Musicraft 10.10. All transistor. Waveband: 88-108 MHz. Variable tuning. Controls: tuning, bass, treble, volume, balance, selector and on/off. Output: 10W per channel. FR: 40 Hz-18 KHz. Record unit: Garrard SP25. Pickup cartridge: Shure M3D with diamond stylus. Size: 27 in. wide, $17\frac{3}{4}$ in. deep, $24\frac{3}{4}$ in. high. Finish: oiled teak.

Recommended speakers. Musicraft 10.10 bass reflex system with Jordan Watts drive unit.

Price: Complete system as described in foregoing paragraphs £177 9s.; less tuner £155 6s.; less tuner and speaker £94 10s.

★

PHILIPS. Philips Electrical Ltd., Century House, Shaftesbury Avenue, London, W.C.2. Tel: 01-437 7777.

★**Audio Plan.** This plan offers a wide choice of combinations comprising two tuners, three tuner/amplifiers (including one with built-in cassette tape player), four record turntable decks, and five speaker enclosures.

RH690. Three-waveband tuner: 87.5-104 MHz, 187-577 m and 1,154-2,000 m, with variable tuning and ratio FM det. Sensitivity: 7 μ V (VHF) for 26 dB quieting; 500 μ V (AM). Aerial 300 ohm balanced and ferrite rod (switchable). Decoder with ind. lamp. AFC. Output: 250 mV, 10K. Psn: 110, 127, 220, 240V AC. Dimensions: $13\frac{1}{8} \times 2\frac{3}{8} \times 8\frac{1}{2}$ in. Price: £31 5s. 6d. (plus £7 14s. 6d. PT).

RH691. Four-waveband tuner: 87.5-104 MHz, 187-571 m, 750-2,000 m, 16.2-50.8 m. Variable tuning with duplex flywheel control and tuning indicator meter. Ratio FM det. Sensitivity: $7\mu\text{V}$ (VHF) for 26 dB quieting; $90\mu\text{V}$ (AM). Aerial 300 ohm balanced and switchable ferrite rod. Decoder with ind. lamp. Switchable AFC. Outputs: 1.4V (FM), 600 mV (AM), 10K. Psn: 110, 127, 220, 240V AC. Dimensions: $14\frac{1}{8}\times 3\frac{7}{8}\times 10\frac{3}{8}$ in. Price: £66 11s. 2d. (plus £16 8s. 10d. PT).

RH580. Integrated amplifier. $2\times 6\text{W}$ output into 8 ohms. HD: 1.5% at $2\times 5\text{W}$. FR: 50 Hz-20 KHz -3 dB. NL: -55 dB at 6W overall. Inputs: 3 mV (magnetic PU) or 100 mV (others) for 6W at 1 KHz. Sensitivity: PU 3 mV, 47K (magnetic); 100 mV 60K (crystal); 100 mV, 140K (tuner); 100 mV 140K (tape). Controls: volume (bass compensated); bass (± 3 dB at 65 Hz); treble (+11 dB to -10 dB at 10 KHz); balance. Output transistors: $2\times \text{AD161/162}$. Psn: 110, 127, 220, 240V AC. Dimensions: $13\frac{1}{8}\times 2\frac{7}{8}\times 8\frac{1}{2}$ in. Price: £26.

RH590. Integrated stereo amplifier. $2\times 10\text{W}$ into 8 ohms. HD: <1% at 10W. FR: 25 Hz-15 KHz -3 dB for 10W. NL: 80 dB below 10W. Provision for 4 ohm load at reduced power. Output transistors: $4\times \text{AD149}$. Inputs: PU (magnetic) 3 mV, 47K; crystal 100 mV 100K; tape 100 mV 100K; tuner 100 mV 100K, all at -80 dB overall for 10W. Controls: volume (bass compensated); bass (+16 to -14 dB at 50 Hz); treble (± 14 dB at 10 KHz); balance; rumble (12 dB/octave, -3 dB at 100 Hz); scratch (-3 dB at 6 KHz). Psn: 110, 127, 220, 240V AC. Dimensions: $14\frac{1}{8}\times 3\frac{7}{8}\times 10$ in. Price: £49.

RH591. Integrated amplifier. $2\times 20\text{W}$ into 8 ohms. (Provision for 4 ohms at reduced power). HD: <0.2% at 15W. FR: 20 Hz-50 KHz -3 dB for 20W. S/N: 80 dB below 20W. Output transistors 2×2 BDY20. Inputs: PU (magnetic) 3 mV, 50K; tape 100 mV 500K; tuner 100 mV 500K; aux (or crystal PU) 100 mV 500K. Controls: volume, loudness (2 position); bass (± 16 dB at 50 Hz); treble (+14 dB to

-16 dB at 10 KHz); rumble (12 dB/octave -3 dB at 80 Hz); scratch (two positions: 12 dB/octave -3 dB at 10 KHz, and -3 dB at 5 KHz); presence (switchable, +3 dB at 3 KHz). Psn: 110, 127, 220, 240V AC. Dimensions: $16\frac{1}{2}\times 3\frac{7}{8}\times 10\frac{3}{8}$ in. Price: £73.

RH781. Integrated tuner/amplifier with five wavebands: 87.5-104 MHz, 30.6-50.4 m, 185-214 m, 213-580 m, 800-2,000 m. Tuning: variable (AM), preset (FM). Ratio FM det and tuning meter. Sensitivity: $7\mu\text{V}$ for 26 dB quieting (VHF), $70\mu\text{V}$ (AM). Aerial: 300 ohm balanced (VHF). Decoder with ind. lamp. AFC. Inputs: crystal PU 150 mV 300K; tape 70 mV 200K; both at -47 dB noise level. Controls: volume (loudness); bass (+15 to -5 dB at 80 Hz); treble (+9 to -14 dB at 12 KHz); balance. Output: 4.8 ohms; transistors $2\times \text{AD161/162}$; $2\times 6.5\text{W}$ into 4 ohms. HD: 2% at $2\times 4.5\text{W}$. FR: 50 Hz-20 KHz -3 dB for 6.5W at 10% distortion. NL: 47 dB below 6.5W. Dimensions: $20\frac{1}{4}\times 4\frac{3}{8}\times 8\frac{7}{8}$ in. Price: £60 2s. 5d. (plus £14 17s. 1d. PT).

RH790. Integrated tuner/amplifier with four wavebands: 87.5-104 MHz, 16.7-50.4 m, 187-571 m, 1,154-2,000 m. Variable tuning (AM and FM) and preset (FM). ('Touch tuning' electronically switched presets on FM with varicap tuner unit). Ratio FM det and tuning meter. Sensitivity: $100\mu\text{V}$ (AM); $8\mu\text{V}$ (FM) with 26 dB quieting. Aerial: 300 ohm balanced. Decoder with indicator lamp. Switchable AFC. Inputs: PU (magnetic) 4 mV 50K; (crystal) 70 mV 150K; tape 100 mV 120K. Controls: volume; bass (+16 to -14 dB at 50 Hz); treble (± 14 dB at 10 KHz); scratch (-12 dB/octave, -3 dB at 4 KHz, switchable); switchable low-level bass compensation (+12 dB max at 50 Hz). Output: transistors 2×2 BDY20; $2\times 20\text{W}$ into 8 ohms (provision for 4 ohms at reduced power); HD: <0.2% at 15W. FR: 20 Hz-50 KHz -3 dB at 20W. NL: 80 dB below 20W. Psn: 110, 127, 220, 240V AC. Dimensions: $20\frac{3}{8}\times 4\frac{3}{8}\times 10\frac{3}{8}$ in. Price: £100 4s. 9d. (plus £24 15s. 3d. PT).

RH881. Integrated tuner/amplifier with built-in decoder. Compact tape cassette. Five wavebands: 87-104 MHz, 30.6-50.4 m, 185-214 m, 213-580 m, 800-2,000 m. Variable tuning (AM), preset (FM). Ratio FM det. Decoder with ind. lamp. Sensitivity: $70\mu\text{V}$ (AM), $7\mu\text{V}$ (VHF) for 26 dB quieting. 300 ohm balanced aerial. Inputs: crystal PU 150 mV 300K; tape 70 mV 200K. NL: -47 dB. Controls: volume (loudness: +12 dB at 80 Hz; +6 dB at 12 KHz); bass (+15 dB to -5 dB at 80 Hz); treble (+9 dB to -14 dB at 12 KHz); balance. Output: $2\times$

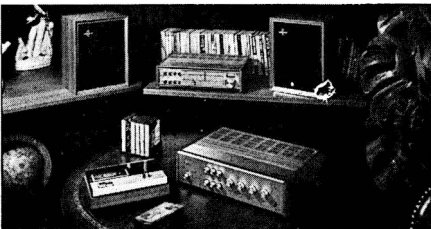

Philips Audio Plan

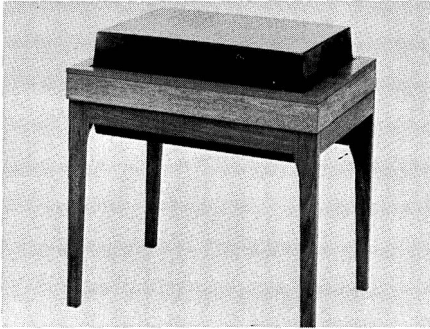

Radon Arundel Stand



Radon AP200 Arundel



Sanyo DC-534E



Sanyo DC-434E

AD161/162 transistors; $2 \times 6.5W$ into 4 ohms (provision for 4-8 ohms). HD: 2% at 4.5W. FR: 50 Hz-20 KHz -3 dB for 6.5W at 10% distortion. NL: 47 dB below 6.5W. Psn: 240V AC. Price: £79 7s. 9d. (plus £19 12s. 3d. PT).

GA146. Record deck with 4-speed auto-changer, arm, GP200 PU head, plinth and lid, incorporating viscous damped cueing device for manual operation. W and F: better than -35 dB (DIN 'A'). 10¼ in. pulley driven steel turntable with diecast rim; 6W asynchronous motor. Price: £24 0s. 8d. (plus £5 18s. 10d. PT).

GA202. Transcription 3-speed record deck with arm, PU, plinth (teak veneered) and lid, with transistorised electronic control of DC motor which maintains speed over nominal mains variations. Long-term drift <0.2%. Fine control $\pm 2\%$. W and F: <0.15% (DIN). Light beam autostop. Viscous damped cueing device. Rumble: <-60 dB (DIN 'B'). 11¼ in. steel 2½ lb turntable. Price: £51 6s. 5d. (plus £12 13s. 7d. PT).

GA217. Two-speed single record player with arm, head, plinth and lid. 33¼, 45 rpm. W and F <0.2%. Rumble: below -55 dB (DIN). 10¼ in. steel turntable, belt driven. 1.7W synchronous motor. Arm fitted with GP200 pickup, stylus pressure adjustment and side-thrust compensation. Price: £25 13s. 9d. (plus £6 7s. PT).

GA228. Single play 4-speed record deck with arm, GP200 head, plinth and lid. Push-button operation. 9W asynchronous motor with 7⅞ in. steel turntable. W and F: <0.2% (DIN). Rumble: -3 dB (DIN 'A'). Price: £16 0s. 4d. (plus £3 19s. 2d. PT).

GL561/70. Reflex speaker enclosure. Power handling cap: 15W RMS. FR: 70 Hz-17 KHz. Drive unit: 8 in. cone. vci: 4-8 ohms. Size: $23\frac{5}{8} \times 11\frac{7}{8} \times 8\frac{5}{8}$ in. Price: £21 12s. 7d. (plus £5 6s. 11d. PT).

RH497. Infinite baffle enclosure. FR: 40 Hz-20 KHz. HC: 40W RMS. Drive units: 10 in. woofer; 5 in. mid-range; 1 in. tweeter. vci: 8 ohms. Size: $21\frac{1}{4} \times 16\frac{1}{4} \times 8\frac{7}{8}$ in. Price: £39 5s. 10d. (plus £9 14s. 2d. PT).

RH491. Infinite baffle enclosure. FR: 55 Hz-20 KHz. HC: 20W RMS. Drive units: 7 in. woofer and 1 in. tweeter. Crossover: ½-section at 1.600 Hz. vci: 8 ohms. Size: $11\frac{7}{8} \times 9\frac{9}{8} \times 7\frac{1}{4}$ in. Price: £17 12s. 10d. (plus £4 7s. 2d. PT).

RH481. Infinite baffle enclosure. FR: 60 Hz-

16 KHz. Drive unit: 5 in. dual cone. HC: 6W RMS. vci: 8 ohms. Size: $10\frac{3}{4} \times 7\frac{1}{4} \times 7\frac{3}{8}$ in. Teak veneer. Price: £8 16s. 5d. (plus £2 3s. 7d. PT).

RH482. Infinite baffle enclosure. FR: 60 Hz-18 KHz. HC: 10W RMS. Drive unit: 7 in. dual cone. vci: 8 ohms. Size: $13\frac{3}{8} \times 9\frac{3}{8} \times 7\frac{3}{8}$ in. Price: £14 8s. 8d. (plus £3 11s. 4d. PT).



RADON INDUSTRIAL ELECTRONICS CO. LTD., Brooklands Trading Estate, Orme Road, Worthing, Sussex. Tel: Worthing 34904.

★**AP200, Arundel.** Solid state stereo system. Range: 87-106 MHz. Sensitivity: 3 μ V, 15 μ V for quieting. Aerial: 75 ohms coaxial. AFC. Multiplex decoder. Power output: 10W per channel RMS, 8-15 ohms. HD 0.1%. FR: 20 Hz-18 KHz \pm 3 dB. Tone controls: bass \pm 20 dB; treble \pm 15 dB. Psn: 220-240V. Tape input: 0.5V. Cartridge: stereo magnetic with diamond stylus. Sensitivity 4 mV for 10W. Dimensions: $8\frac{1}{2} \times 22 \times 16$ in. Finish: teak veneer with satin finish, teak lid with inset plexiglass cover. Prices: Garrard SP25 (heavy turntable) £72 9s. (plus £15 15s. PT); Garrard M60/Mk II autochanger £76 18s. (plus £16 11s. PT); Garrard SL65 autochanger £80 5s. (plus £17 10s. PT); floor stand £6 6s.



ROTEL. U.K. distributors: Pullin Photographic (Rank Aldis Ltd.), P.O. Box 70, Great West Road, Brentford, Middx. Tel: 01-568 9222.

FAX-88. Solid state compact AM/FM stereo tuner/amplifier. Range: 88-108 MHz, 535-1.605 KHz. Sensitivity: FM 2.5 μ V; AM 15 μ V. Signal to noise ratio: 67 dB. Stereo separation: 35 dB. Output power: 10W per channel music power into 4 ohms. HD 0.3%. FR: 25 Hz-15 KHz \pm 1.5 dB. Input sensitivity: magnetic pickup, 2 mV; crystal pickup, 160 mV. H and N: pickup, -60 dB; aux, -75 dB. Speaker systems contain 5 in. unit in sealed, damped enclosures. Impedance: 8 ohms. HC 20W. Price: £92 (including PT).



SANYO. Sanyo Marubeni, Sanyo House, Bushey Mill Lane, Watford, Herts. Tel: Watford 25354/6.

★**DC-434E.** System comprises shelf-mounting AM/FM tuner-amplifier with built-in two-speed record deck. Miniature shelf-mounting speakers optional extras. **Radio.** FM/VHF and medium wavebands. AFC. Stereo decoder with automatic beacon. **Amplifier.** 16W per channel music power. HD 0.1% at rated output. Controls include wide range bass and treble, noise and rumble filters. **Gram unit.** Two speed (33 $\frac{1}{3}$ and 45 rpm). Moving magnet cartridge. Diamond stylus. Adjustable playing weight (3 gm recommended). Bias compensator fitted. Automatic lift-off at end of record. **Complete unit.** Circuit includes 31 transistors (some silicon) and 16 diodes. Outlet sockets for stereo tape recorder and headphones. Woodgrain finish cabinet with clear plastic lift-up lid. Brushed aluminium vertical front panel accessible when lid closed. Price: (excluding speakers) £172 10s. (including PT). **Recommended speakers.** Sanyo SX-X. Each enclosure contains 8 in. high compliance bass driver and 3 in. tweeter with crossover.

★**DC-534E.** System comprises shelf-mounting AM/FM tuner-amplifier with built-in two-speed record deck. Miniature shelf-mounting speakers optional extras. **Radio.** FM/VHF 87.5-110 MHz, 185-566 m. Sensitivity: VHF 3 μ V, MW 300 μ V. IF: VHF 10.7 MHz, MW 470 KHz. Stereo decoder with automatic beacon. **Amplifier.** Output 12W per channel music power. Controls include wide range bass and treble, noise and rumble filters. FR: 20 Hz-20 KHz \pm 1 dB. Stereo separation -25 dB at 1 KHz. **Gram unit.** Two speeds (33 $\frac{1}{3}$ and 45 rpm). 12 in. turntable. Balanced tubular arm with anti-skating device. Pw 3 gm. Moving magnet cartridge. Automatic lowering and lifting device. **Complete unit.** Circuit employs 27 transistors and 14 diodes. Mains: 100, 117, 130, 200, 220 and 240V 50-60 Hz. Consumption: 48W (no signal). Size: $24\frac{1}{2} \times 15\frac{3}{8} \times 10$ in. Weight: 31 $\frac{3}{4}$ lb. Sockets for external aerials, tape play and record, tape head and external speakers. Wood grain finish cabinet with clear plastic lift-up lid. Price: (excluding speakers) £132 10s. **Recommended speakers.** Sanyo SX-X. Each enclosure contains 8 in. high compliance bass driver and 3 in. tweeter with crossover.



SOUNDMASTER LTD., Brook Road, Wood Green, London, N.22. Tel: 01-888 7487.

2000. Solid state stereo tuner/amplifier with record player. Waveband: 88-108 MHz. Variable tuning. Multiplex decoder fitted. Controls: function selection, mode switch, bass, treble,

balance, volume on/off. HC 15W per channel. FR: 20 Hz-20 KHz. Output impedance: 8 ohms. Distortion at stated output: less than 0.5%. Motor unit: Garrard AP75. Pickup cartridge: Pickering U15-AC2. Overall dimensions: $8\frac{1}{2} \times 15\frac{1}{2} \times 22\frac{1}{2}$ in. Speakers: each $16 \times 10 \times 9$ in., compact infinite baffle, with 15W input using Celestion D8-888 (bass) and T1330 (treble). Finish: teak with tinted perspex lid and aluminium trim. Price: £130 (plus £13 13s. 7d. PT).



TOSHIBA. Distributor: Hanimex (U.K.) Ltd., 15-24 Great Dover Street, London, S.E.1. Tel: 01-407 8161.

SM500. Solid state stereo system. Ranges: 88-108 MHz; MW 187-566 m; SW 1.6-4 MHz, 4-10 MHz. Tuning: variable. AFC: switched. Multiplex decoder fitted. Power output: 12W RMS. HD 1%. FR: 20 Hz-30 KHz. Controls: volume, balance, treble, bass, loudness, HF filter, LF filter, AFC, selector, on/off. Output impedance: 8 ohms. Cartridge: Toshiba magnetic. Dimensions: $21\frac{1}{4} \times 16\frac{3}{4} \times 9\frac{1}{4}$ in. Psn: 220/240V. Pair of speakers each with 8 in. roll edge bass unit and $3\frac{1}{4}$ in. horn. vci: 8 ohms. Dimensions: $17\frac{1}{2} \times 11 \times 7\frac{1}{4}$ in. Cabinets finished in rubbed walnut. Price: £155 2s. (plus £33 2s. PT).



TRUVOX LTD., Hythe, Southampton, Hants. Tel: Hythe 3265.

Series 200. System comprises FM mono or integrated circuit stereo tuner, stereo amplifier, stereo tape unit, two loudspeakers, tape recorder. Price from £300 complete (including PT).



VAN DER MOLEN LTD., 1 Mildmay Road, Romford, Essex. Tel: Romford 41904.

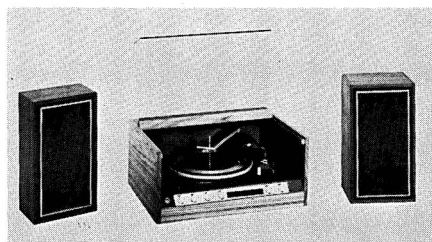

WyndSOR 1600ST

SRG72. Tuner/stereo amplifier/record deck. Separate speakers. Ranges: VHF 88-108 MHz, MW 185-570 m. Controls: Volume on/off, bass, treble, balance, tuning, gram select, MW select, VHF select, AFC. Output 4W per channel RMS, 8 ohms. FR: 50 Hz-18 KHz. Distortion at rated output: 5%. Motor unit Garrard SP25 Mk II. Cartridge: Acos GP93/1. Teak veneer cabinet. Size: $18 \times 16\frac{3}{4} \times 9$ in. Price: £75 17s. (plus £13 8s. PT).



WYNDSOR. WyndSOR Recording Co. Ltd., 2 Bellevue Road, London, N.11. Tel: 01-368 2226.

★**1600ST.** Tuner/amplifier/record player. Wavebands: 87.5-101.5 MHz, 560-185 m, 2.025-1.120 m. Power output: 4W RMS at 8 ohm per channel. FR: 60 Hz-15 KHz ± 3 dB. Controls: tuning, volume, balance, bass, treble, selector. Record turntable: Garrard 2025TC auto-changer, with ACOS GP93 cartridge with diamond stylus. Speaker units: 9×5 in. bass unit with tweeter dome. Dimensions: amplifier $7\frac{3}{4} \times 18\frac{1}{2} \times 13\frac{3}{8}$ in., speaker enclosure $13 \times 7\frac{1}{4} \times 5$ in. Finish: all units in solid teak. Price: complete system £61 4s. (plus £14 8s. PT).

1600SPT. Tuner/amplifier/record player. Details as for 1600ST. Record turntable: Garrard SP25 mark II. Price: complete system £65 9s. (plus £15 8s. PT).



YAMAHA. U.K. agents: Actina Ltd., Acoustics Division, 60 St John Street, London, E.C.1. Tel: 01-253 7591.

Yamaha MA50A. Solid state stereo system. Tuner ranges: 88-108 MHz and 187-565 m. Variable tuning with indicator meter. Multiplex decoder fitted. AFC. Power output: 15W per channel RMS. HD: less than 0.5%. FR: 20 Hz-30 KHz ± 2 dB. Output impedance: 8 ohms. Transcription turntable unit with arm and magnetic cartridge has $33\frac{1}{3}$ and 45 rpm speeds. W and F: less than 0.1%. Turntable: 12 in. aluminium die cast. Belt drive. Motor: 4-pole synchronous. Pickup arm: static balance. Unit also includes provision for the replay of 8-track stereo cartridges. Cabinet dimensions: $10 \times 28 \times 17$ in. Price: £199 17s. 6d.

HACKER

high fidelity units



supreme integrated audio radio high fidelity with distortionless Class A audio amplifier operation

SERIES GAR1000 . . . designed to be judged and proudly owned as the finest all-British high fidelity equipment available today

**Twin radio tuner AM/FM stereo audio amplifiers
high quality turntable and pick-up
In a single compact teak cabinet**

35 transistors and 15 diodes — plug-in modular unit construction — completely separate medium, long and VHF tuners—automatic frequency correction for simple, accurate, noiseless VHF tuning — stereo radio decoder with indicator light — interstation muting and local station markers — large illuminated tuning scale ● Audio amplifiers with distortionless Class A operation of 10 watts RMS per channel with 15 ohm speakers; Class AB operation of 15 watts per channel with 8 ohm speakers — Garrard AP75 playing deck with Goldring 800H magnetic pick-up and diamond stylus ● Front panel controls include : Tuning — Aerial direction (AM) — Volume — Stereo balance — Treble — Bass — Function — Low note filter — High note filter — Mono/Stereo

Fully detailed descriptive literature and name of your nearest appointed dealer
— 'always the best in town' — available on request.

HACKER RADIO LIMITED

independent and proudly British

NORREYS DRIVE
COX GREEN
MAIDENHEAD
BERKS
Tel: Maidenhead 22261

HI-FI HEADPHONES

AKAI. U.K. distributors: Pullin Photographic (Rank Organization), P.O. Box 70, Great West Road, Brentford, Middx. Tel: 01-568 9222.

★ **Akai ASE9S.** Stereo headphones. Lightweight, suitable for most tape recorders. Price: £6 10s.

★

AKG. Distributors: Politechna (London) Ltd., 182-184 Campden Hill Road, Kensington, London. W.8. Tel: 01-727 0711/3 and 5008.

★ **K20.** Dynamic stereo headphones. FR: 30 Hz-20 KHz. Impedance: 75 ohms \pm 20% per channel over entire range, or 600 ohms \pm 20%. Distortion: < 1% at max output. Weight: 7½ oz. Ear cushions removable for washing. Price: £6 5s.

★ **K60.** Dynamic stereo headphones. FR: 16 Hz-20 KHz. Impedance: 75 ohms \pm 20% per channel over entire range, or 600 ohms \pm 20%. Distortion: < 1% max output. Weight: 7 oz. Ear cushions removable for washing. Price: £13 10s.

★

AMPLIVOX LTD., Beresford Avenue, Wembley, Middlesex. Tel: 01-902 8991. Cables: Amplivox, Wembley.

Astralite. High quality moving coil headphones. FR: 50 Hz-15 KHz. Impedance 200 ohms. Wired for mono or stereo. Price on application.

★ **Astralite JL26.** Lightweight moving coil headphones. FR: 20 Hz-20 KHz. Sensitivity: 0.5 mW produces comfortable listening level. Power input: 700 mW for 2% total distortion (3W momentary overload). Impedance: 200 ohms per earphone, may be connected in series, parallel or wired independently for stereo. Contoured earshells with detachable foam cushions. Fully adjustable headband. Special version with boom mic (JL266). Price on application.

★

BRAUN AG. Fi-Cord Ltd., Charlwoods Road, East Grinstead, Sussex. Tel: East Grinstead 21351.

KH1000 stereo headphones. Sensitivity: 110 dB (re. 0.0002 μ bar) at 1 mW. Distortion: less than 0.3% at 120 phons. FR: 16 Hz-20 KHz. Impedance: 400 ohms. HC 400 mW. Price: £21 18s. 7d.

★

DUODE LTD., Westfield Mills, Broad Lane, Leeds, 13. Tel: Pudsey 77536.

Stax SR3. Electrostatic stereo headphones of professional quality complete with matching unit. FR: 25 Hz to over 25 KHz. Impedance: 8 ohms. Price: £29 10s.

★

EAGLE PRODUCTS. Distributors: B. Adler & Sons (Radio) Ltd., Coptic Street, London, W.C.1. Tel: 01-636 9606/7. Cables: Reldab, London.

★ **S.E.1.** Professional Stereo Headphones. FR: 25 Hz-14 KHz. 3 in. dynamic speakers. Isolated right and left channels. 'Flexifoam' seals. Dual Impedance 15 ohms. Price: £4 19s. 9d.

S.E.21. Professional two-way stereo headphones. FR: 25 Hz-18 KHz. Each headphone contains 2½ in. LF unit and ¾ in. treble unit. Level controls and built-in attenuator to protect ears. Impedance 16 ohms. Stereo cable and plug. Adjustable headband. Foam rubber earpads. Price: £9 18s. 5d.

★ **HMA.209.** Moving coil headphones with lightweight microphone on boom. Headphones: 16 ohms; FR: 20 Hz-14 KHz; max input 200 mW. Microphone: moving coil; 200 ohms; FR: 200 Hz-8 KHz. Sensitivity: -75 dB. Separate cords with jack plugs for phones and mic. Price: £9 18s. 5d.

S.E.5 Budget stereo headphones. FR: 30 Hz-15 KHz. Lightweight single headband. Impedance: 8 ohms. Price: £2 19s. 6d.

S.E.28. Studio stereo headphones. FR: 20 Hz-20 KHz. Dome chambers. Separate LF and tweeter units. Impedance: 8 ohms. Adjustable attenuators. Price: £11 0s. 6d.

S.E.30. Studio stereo/mono headphones. FR: 30 Hz-16 KHz. Built-in stereo/mono switch.



Akai ASE-9S



Amplivox Astralite JL26



A.K.G. K20



Eagle SEI stereo headphone



A.K.G. K60



Eagle HMA209



I.T.T. Components 65/1B

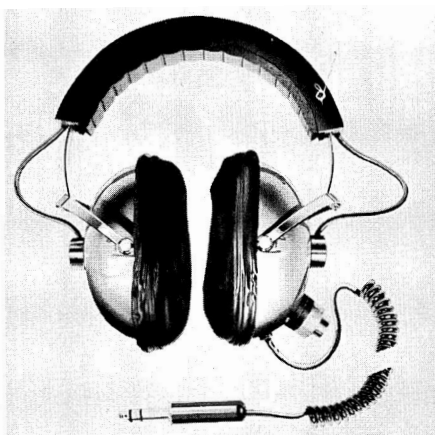

Koss Pro-4A



Koss SP3X-C



Koss ESP-6



Koss 727

Impedance: 8 ohms. Leather ear cushions. Price: £7 7s.



FOSTER. Distributors: E. R. Factors Ltd., 378 Harrow Road, Paddington, London, W.9. Tel: 01-286 9530.

RDF-204. Stereo stethoscope headphones. Impedance: 8 ohms. Grey/white cushioned plastic ear pieces. Price: £2 5s.



GRUNDIG (GREAT BRITAIN) LTD., Newlands Park, London, S.E.26. Tel: 01-778 2211.

211. High quality stereo headphones. Fitted with J21 plugs for connection to Grundig tape recorders. FR: 30 Hz-20 KHz. Distortion factor 1% at 1 mW, 3% at 90 mW. Impedance 400 ohms per system. Supplied with 5½ ft cable. Price: £11 11s.

220. High quality stereo headphones. Fitted with 5½ ft of cable and J21 plugs. FR: 16 Hz-20 KHz. Distortion factor less than 0.3% at intensities of 120 phon. Fluid-filled ear covers. Padded headband. Impedance 400 ohms per system. Price: £19 19s.



ITT-STC. Standard Telephones & Cables Ltd., Electro-Mechanical Product Division, West Road, Harlow, Essex. Tel: Harlow 26811.

★**65/1B.** Broadcast quality headset. FR: 30 Hz-15 KHz. Impedance: 300 ohms. Foam rubber earpads. Supplied complete with 54 in. tinsel cable. Price: £7 7s.



KIRKMAN (CRAWLEY) LTD., 40 The Broadway, Crawley, Sussex. Tel: 0293 26670.

Stereo headphone unit. Supplied in chassis form for mounting on panel or shelf (teak case will be available later). Signal from each channel is delayed and fed to opposite channel to simulate natural stereo. Three-position switch: loudspeakers, headphones, attenuated headphones. Jack sockets for two pairs of phones. Impedance to amplifier 8 ohms resistive. Suitable for headphones 8-600 ohms. Size: 3½ × 1½ × 8 in. Price: to be announced.

KOSS. Distributors: Tape Music Distributors Ltd., 11 Redvers Road, London, N.21. Tel: 01-888 0152.

★**SP3X.** Stereo headphones. Response 10 Hz-15 KHz. Impedance 4-16 ohms. Moving coil. Sponge foam earpads. Distortion less than 1% at maximum audio output. 8 ft 4-way lead. Weight: 15 oz. Supplied with adaptor plate to facilitate use with mono and stereo systems. Colour: dark brown with beige ear and head cushions. Price: £11 15s.

★**PRO-4.** Professional quality stereo headphones. Response 30 Hz-20 KHz. Impedance 4-50 ohms. Moving coil. Fluid-filled ear cushions. Boom mic attachment. Distortion less than 1% at maximum audio output. 8 ft 4-way lead. Weight: 19 oz. Ear cushions removable for washing. Colour: grey-green cups with green ear cushions. Price: £23.

T-5. Remote control listening station. The T-5 box can be placed in the most convenient spot and separate gain controls for each channel enable balance and volume to be set precisely at the listening position. Switch to cut off speakers and jacks for stereophones. Size: 5⅞ × 3⅞ × 2⅞ in. Weight: 14 oz. Price: £4 10s.

★**KO-727.** Sensitive stereo headphones. Will accept up to 60W (music) per channel. Suitable for 4, 8 or 16 ohms output. Removable foam-filled ear cushions. Eight-foot coiled cord for added convenience. Distortion <1% at maximum output. Fully adjustable earpieces. Price: £16 10s.

T-1. Matching unit comprising neat moulded case containing matching transformers for monitoring 600-10,000 ohm outputs. Jacks for two sets of Koss stereophones. Price: £4 10s.

EC-20. Extension cord fitted with stereo jack-plug and socket. Adds 20 ft to the length of normal stereophone lead. Price: £3.

★**ESP-6.** Professional electrostatic headphones. Claimed to be a new concept, incorporating self-energised diaphragms and eliminating the moving cone driver element. Impedance: 4-16 ohms. FR: 27 Hz-19 KHz ±5 dB; 35 Hz-10 KHz ±2½ dB. Complete with fitted portable carrying case and individually measured response curve. Price: £45.

★**K-6.** Stereophones. Impedance: 4 ohms. FR: 10 Hz-15 KHz. Sensitivity: 1V at 400 Hz. Maximum input: 10W per channel. Distortion: less



Koss K-6



Nikko HW45T



Nikko HW35



Nikko HW45V

than 1%. Foam filled vinyl ear cushions. Weight: 15 oz. Price: £12 10s.



LAFAYETTE. U.K. distributors: Barnet Factors Ltd., 4 Lisle Street, London, W.C.2. Tel: 01-437 2723.

Lafayette F-767. Stereo headphones. FR:

30Hz-15 KHz. Sensitivity: 1-2 mW. Impedance: 8 ohms. Air cushioned headband. Soft foam rubber ear cushions. Two 2½ in. transducers. Price: £4 17s. 6d.



M.A.C. ELECTRONIC COMPANY, Villacousta, Portsmouth Road, Ripley, Surrey. Tel: Ripley 3377.

AAU-TV. Provides a ready means of connecting various items of Hi-Fi equipment to a Television Receiver with complete safety. Built-in Isolating Transformer, tapped 3-8-15 ohms, for matching external speaker. Switchable output attenuator for matching input of amplifier or tape recorder. Switching circuit enables the TV speaker to be switched on or off as required. Unit housed in a solid teak case. Prices on request.

★ **AAU-2.** Audio adaptor unit with three-way switch and socket for headphones. Screw connections for two main speakers and two extension speakers. Satin chrome fascia. Switch gives: main speakers only, extension speakers and phones, main and extension speakers. Colour coded four-way connecting cable. Easy-mounting as for AAU-1. Prices on request.

★

NIKKO. Nikko Electric Mfg. Co. Ltd., Distributors: Howland-West Ltd., 2 Park End, South Hill Park, London, N.W.3. Tel: 01-794 6666 and 6033.

★ **HW3S.** Stereo headphones. Single speaker. Impedance: 8 ohms. FR: 20 Hz-18 KHz. Max. input: 0.3W. Price: £4 15s.

★ **HW4ST.** Stereo headphones. Twin speaker, 1½ in. tweeter and 3½ in. woofer coaxially mounted. Fitted with individual tweeter controls on each earpiece. Impedance: 8 ohms. FR: 20 Hz-20 KHz. Max. input: 0.25W. Price: £8 15s.

★ **HW4SV.** Stereo headphones. Single speaker fitted with individual volume controls on each earpiece. Impedance: 8 ohms. FR: 20 Hz-19 KHz. Max. input: 0.3W. Price: £7 10s.

★

PHILIPS ELECTRICAL LTD., Century House, Shaftesbury Avenue, London, W.C.2. Tel: 01-437 7777. Cables: Phillamps, London.

EL3775/85. Mono headphones. FR: 300-3,000 Hz. Sensitivity: 30 mV at 1 KHz. Impedance: 1,000 ohms. Price: £3 12s. 6d.

EL3775/38. Stereo version of EL3775/85. Price: £5 15s.

LBB9900. Stereo hi-fi headphones. Impedance: 600 ohms. Padded earpieces.

PIONEER. Distributors: Shriro (UK) Ltd., 8 Bush Lane, London, E.C.4. Tel: 01-626 4711.

SE-30. Moving coil stereo headphones. Matching impedance 4-16 ohms. FR: 20 Hz-20 KHz. HC 0.5W per earpiece. Acoustically designed casing to improve bass response. Soft circumaural earpads. Easily cleaned. Adjustable headband. Wired for stereo with 8 ft. cable. Weight: 13½ oz. Price: £14 14s.

SE-2P. Moving coil stereo headphones. Matching impedance: 4-16 ohms. FR: 24 Hz-16 KHz. HC 0.5W per channel. Adjustable earpieces of soft padding. Removable soft headband (zip) for cleaning. 6 ft 4 in. cord with jack plug. Price: £6 1s. 4d.

JB21. Junction box to enable stereo amplifiers without headphone jack to be used with any stereo headphones using standard plug. Switch provides: headphones only; speakers only; headphones and speakers. (Correct loading applied to amplifier in 'phones position.) Price: £1 12s.

JB22. Junction cord. Two jack sockets terminating in jack plug. Enables two sets of stereo headphones to be connected to stereo amplifier or JB21. Price: £1 2s. 3d.

★

SANSUI: Distributors: Brush Clevite Co. Ltd., Thornhill, Southampton, SO9 1QX. Tel: Southampton 45166.

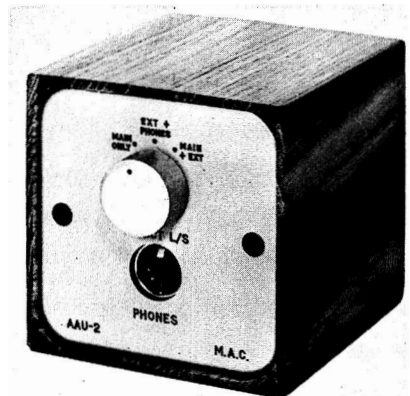

M.A.C. AAU- Hi-Fi unit

SS2. High-quality stereo headphones. Moving coil. Impedance: 8 ohms. Max. power input: 500 mW. FR: 20 Hz-18 KHz. Distortion: -1% at 1 mW input. Price: £7 14s. 6d.

★

SENNHEISER ELECTRONICS. Distributors: Audio Engineering Ltd., 33 Endell Street, London, W.C.2. Tel: 01-836 0033.

★**HD.110.** Stereo headphones wired for mono and stereo. Robust design. Removable washable ear cushions. Easily replaceable cable. FR: 20 Hz-20 KHz. Impedance: 200 ohms $\pm 15\%$ per earpiece. Output: 1 mW per capsule produces 98 dB (16 μ bar) at 1 KHz. Maximum output: 120 dB (200 μ bar) for 1% distortion. Weight: 9 oz. Price: £26.

HD.414. Stereo headphones. Wired for mono or stereo. Lightweight robust design. Removable washable sponge ear pads. FR: 20 Hz-20 KHz. Impedance: 2,000 ohm per capsule. Weight: 7½ oz. Price: £11 15s.

★

SHARPE INSTRUMENTS. Distributor: Carston Electronics Ltd., 71 Oakley Road, Chinnor, Oxon. Tel: Kingston Blount 8561.

HA-9. Stereo. FR: 15 Hz-20 KHz. Impedance 8 ohms/side. Max. input 2 W. Max. output 130 dB s.p.l. Distortion < 1%. Attenuation of ambient noise 40 dB at 1 KHz. Price: £13.

HA-10A. Stereo. Deluxe liquid-filled ear cushions. FR: 15 Hz-20 KHz. Impedance: 8 ohms/side. Max. input 2W. Max. output 130 dB

s.p.l. Distortion < 1%. Attenuation of ambient noise 40 dB. Sensitivity 115 dB ref. 0.0002 dyne cm² at 0.5V input. Price: £20 10s.

HA-10 Mk II. Stereo. Deluxe liquid-filled ear cushions. FR: 15 Hz-30 KHz. Impedance: 8 ohms/side. Max. input 2W. Distortion 0.86% at 1 KHz. Attenuation of ambient noise 40 dB. Sensitivity 115 dB ref. 0.002 dyne cm² at .5V input. Suitable for broadcast and recording studios. Price: £23 5s.

HA-660. Stereo. Fuse protected. For research and other uses requiring truest possible reproduction. FR: 15 Hz-35 KHz. Impedance: 8 ohms/side. Max. output 110 dB s.p.l. Attenuation of ambient noise 40 dB. Sensitivity 4.3V RMS input for rated output. Price: £31.

★

SHURE ELECTRONICS LTD., 84 Blackfriars Road, London, S.E.1. Tel: 01-928 6361.

Jensen HS2 headset. High quality headset. Fully adjustable. Wired for stereo or mono. Full details on request. Price: £15.

★

TELETON ELECTRO (U.K.) CO. LTD., Telton House, Robjohns Road, Widford, Chelmsford, Essex. Tel: 0245 62442.

SH301. Stereo headphones. HC: 500 mW. Impedance: 2 x 8 ohms. FR: 20 Hz-21 KHz. Type: Dynamic. Weight: 13½ oz. Complete with flex and stereo jack plug. Price: £4 6s. 3d.

★

TTC. Distributors: E. R. Factors Ltd., 378 Harrow Road, Paddington, London, W.9. Tel: 01-286 9530.

G-1111. Dynamic stereo headphones. FR: 25 Hz-15 KHz. Adjustable ear pads and headband. Impedance: 8 ohms. Max. input 0.5W. Finish: mid-grey plastic with black trim. Price: £3 19s. 6d.

★

UHER. Distributors: Bosch Ltd., Rhodes Way, Radlett Road, Watford, Herts, WD2 4LB. Tel: Watford 44233.

W671. Stereo magnetic headphones. Price: £9 10s.



Sennheiser HD.110

FRANCIS OF STREATHAM

*invite all
Hi-Fi and Recorder
enthusiasts to their
South London Showrooms*

**LARGE AND UP-TO-DATE STOCKS BY LEADING
MANUFACTURERS AS ADVERTISED BY US IN
HI-FI NEWS, TAPE RECORDER,
THE GRAMOPHONE, HI-FI SOUND, TAPE
RECORDING MAGAZINE, etc.**

- | | |
|--------------|--------------|
| ★ AKAI | ★ QUAD |
| ★ AKG | ★ RESLO |
| ★ AMPEX | ★ REVOX |
| ★ ARENA | ★ ROGERS |
| ★ ARMSTRONG | ★ SENNHUSER |
| ★ B & O | ★ SHURE |
| ★ BRENNELL | ★ SME |
| ★ DUAL | ★ SONY |
| ★ FERROGRAPH | ★ STELLA |
| ★ GARRARD | ★ TANDBERG |
| ★ GRAMPIAN | ★ TELEFUNKEN |
| ★ GRUNDIG | ★ THORENS |
| ★ LEAK | ★ UHER |
| ★ Lenco | ★ VORTEXION |
| ★ PHILIPS | ★ WHARFEDALE |

**NO CHARGES FOR
CREDIT FACILITIES**

★

**LARGEST SELECTION
OF LATEST MODELS**

★

TAPES ● ACCESSORIES

*Personal attention
to all enquiries
without obligation*

WRITE ★ CALL ★ 'PHONE

Please mention Hi-Fi Year Book when writing

FRANCIS OF STREATHAM

169-173, STREATHAM HIGH ROAD, LONDON, S.W.16

Between Streatham Station and St. Leonard's Church

Phone: 01-769 0466

Free Car Park, Prentis Road, Nearby

(Please note this is our only address)

TAPE RECORDER — HI - FI CENTRE (SHEEN) LTD.

INVITE ALL NEWCOMERS—AMATEURS AND ENTHUSIASTS—
TO VISIT OUR LONDON SHOWROOMS AT EAST SHEEN,

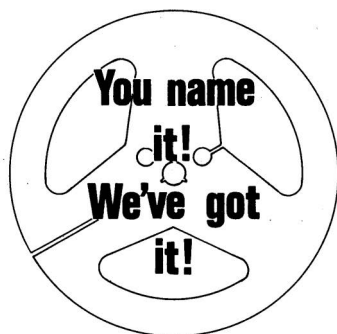

Closed all day Wednesday

Plenty of parking space in Station Car Park

Always a large range of equipment, as shown in this Year Book, etc.

You name it—we've got it

Our business has grown because we care about our customers

and their recommendations

Nothing too large, nothing too small

Our aim is to satisfy and cater for all

All repairs carried out in our own workshop

(No connection with any other centre)

TAPE RECORDER 3 AND 4 STATION PARADE,
HI - FI CENTRE SHEEN LANE, EAST SHEEN,
(SHEEN) LTD. LONDON, S.W.14
Opposite Mortlake Station (S.R.)

DIRECTORY OF HI-FI DEALERS

IMPORTANT NOTE: The following list is of shops where stocks of equipment are kept, and where facilities for demonstration exist. It is not necessarily a complete list, and we invite new dealers to submit details for future publications.

LONDON AREA

AUDIO HOUSE LTD, 5 Ashbourne Parade, Temple Fortune, N.W.11. (near Henley's Corner)

R. BARDEN LTD, 21 Dalston Lane, E.8

BERKELEY ACOUSTICS, 31 Crawford Street, W.1

BERRY'S RADIO LTD, 25 High Holborn, W.C.1

BOWMAN BROS. LTD, Camden High Street, N.W.1

CHELSEA RECORD CENTRE, 203 King's Road, S.W.3

CUSTOM HIGH FIDELITY, 371 Green Lanes, Palmers Green, N.13

DAVENSET RADIO, 2 Burnt Ash Parade, Lee Green, S.E.12

DAVIS & KAYS LTD, 115 Kingsway, London, W.C.2; 5 Turnpike Parade, London, N.15; 857 High Road, Finchley, London, N.12; 4 High Street, Walthamstow, London, E.17; 169 Fore Street, Edmonton, N.18; 61 Seven Sisters Road, N.7

H. NORMAN DAVIS LTD, 91 The Broadway, Mill Hill, N.W.7

DAYSTROM LTD, 233 Tottenham Court Road, W.1

DYNAMIC STORES (SOUND) LTD, 118 Edgware Road, W.2

G. A. ELECTRIC, 81 Portland Road, S. Norwood

J. J. FRANCIS (WOOD GREEN) LTD, 123 Alexandra Road, Hornsey, N.8

FRANCIS OF STREATHAM, 169-173 Streatham High Road, S.W.16

C. C. GOODWIN (SALES) LTD, 7 The Broadway, Wood Green, N.22

GRAHAMS ELECTRICAL LTD, 14 Exmouth Market, E.C.1; 88 Pentonville Road, N.1

HAMPSTEAD HIGH FIDELITY, 91 Heath Street, Hampstead, N.W.3

HAMPTONS OF KENSINGTON, 7 Kensington High Street, W.8

HAVEN HI-FI (EALING) LTD, 196-8 South Ealing Road, W.5

THOMAS HEINITZ, 35 Moscow Road, W.2

HENRY'S RADIO LTD, 303 Edgware Road, W.2

HERALDIC STUDIOS LTD, 114 Broadway, Wimbledon, S.W.19

HERMLYN HI-FI LTD, 230 High Street, Eltham, S.E.9

ALFRED IMHOF, 112-116 New Oxford Street, W.C.1

LARGS OF HOLBORN, 76-77 High Holborn, W.C.1

LASKY'S RADIO, 207 Edgware Road, W.2; 152-153 Fleet Street, E.C.4; 33 Tottenham Court Road, W.1

LEE ELECTRONICS, 400 Edgware Road, W.2

LEWIS RADIO, 100 Chaseside, Southgate, N.14

MAC'S CAMERA SHOPS LTD, 250-252 Kings Street, Hammer-smith, W.6

MASSEYS CENTRE OF SOUND, 121-123 High Road, W.4

MODERN ELECTRONICS LTD, 120 Shaftesbury Avenue, W.1

V. J. MONK LTD, 140-141 Plumstead Road, S.E.18

NATIONAL RADIO SERVICE & TELEVISION CO., 82 St. John's Wood High Street, N.W.8

NEWBURY RADIO (FOREST GATE) LTD, 272 and 305 Romford Road, Forest Gate, E.7

NORTHERN RADIO SERVICES, 16 Kings College Road, N.W.3

NUSOUND, 93 Mortimer Street, W.1; 242-244 Pentonville Road, N.1; 228 Bishopsgate, E.C.2; 36 Lewisham High Street, S.E.13; 2 Maryland Station, E.15; 205 High Street North, E.6; 82 High Holborn, W.C.1

THE PARKFIELD STUDIO, 20 Parkfield Road, New Cross, S.E.14

THE RECORDER CO., 188 West End Lane, West Hampstead, N.W.6

RECORD HUNTER LTD, 27-29 York Road, Waterloo, S.E.1

RECORD RETAILERS LTD, Music Man Record Centre, 487a Oxford Street, W.1

R. E. W. EARLSFIELD, 266 Upper Tooting Road, S.W.17

R. E. W. EARLSFIELD, 146 Charing Cross Road, W.1

R. S. C. (MANCHESTER) LTD, 238 Edgware Road, W.2

R. T. M. (RADIO & TELEVISION) SERVICE LTD, 387b Mare Street, E.8

SANDS HUNTER, 45 Hare Street, Woolwich, S.E.18

SHEEN TAPE RECORDER CENTRE, 3 and 4 Station Parade, Sheen Lane, S.W.14

G. W. SMITH & CO (RADIO) LTD, 311 Edgware Road, W.2; 3 Lisle Street, W.C.2; 34 Lisle Street, W.C.2

H. L. SMITH & CO LTD, 287-289 Edgware Road, W.2

SOUND ELECTRIC CONSULTANTS, 19a Harpenden Road, Wanstead Park, E.12

SOUND INCORPORATED LTD, 126 Broadway, S.W.19

STERN-CLYNE LTD, 9 Camberwell Church Street, S.E.5; 309 Edgware Road, W.2; 109 Fleet Street, E.C.4; 18 and 23 Tottenham Court Road, W.1

STUDIO 99, 57 Fairfax Road, Swiss Cottage, N.W.6

STUDIO TAPES LTD, 199 Hoe Street, E.17

TAPE RECORDER HI-FI CENTRE (SHEEN) LTD, 3 & 4 Station Parade, Sheen Lane, Sheen, S.W.14

TELERADIO, 189 Edgware Road, W.2

TELESONIC LTD, 92 Tottenham Court Road, W.1

TELETAPE LTD, 33 and 59a Edgware Road, W.2; 84-88 Shaftesbury Avenue, W.1

TEL-LEE-RADIO, 220 The Broadway, Wimbledon, S.W.19

T.M.B. (ELECTRONICS) LTD, 115 and 130 Tanners Hill, S.E.8

UNITED TECHNICAL SUPPLIES LTD, 29 Tottenham Court Road, W.1

WALLACE AMPLIFIERS LTD, 4 Soho Street, W.1

WESTMINSTER PHOTOGRAPHIC LTD, Becket House, 83 Cheapside, E.C.2

BALDOCK

K. M. V. CRUMP LTD, Baldock

BARNET

WYNDSOR TV, St Albans Road

BARNESLEY

G.B. STUDIO, Pitt Street

BATH (SOMERSET)

C. MILSOM & SON, North Gate

BEDFORD

CARLOW RADIO LTD, 6 St. Loyes Street

BEXLEY HEATH

HI-FI CENTRE, BROADWAY RADIO, 228 Broadway

BIRMINGHAM

NORMAN H. FIELD ELECTRONICS, 266X Broad Street, 1

GRIFFIN RADIO LTD, 94 Bristol Street, 5

C.H. (HI-FIDELITY) LTD, 167-169 Bromsgrove Street, 5

RACKHAMS LTD, Corporation Street, 2

REEVES SOUND SERVICE LTD, Audio and Photographic Centre, 31 Smallbrook Ringway, 5

R.S.C. (MANCHESTER) LTD, 30-31 Great Western Arcade

COLIN G. TURNER, 39 York Road, King's Heath, 14

KEN WHITTLE LTD, 788 Stratford Road, Sparkhill, 11

R.E.W.

BRITAINS LARGEST HI-FI
AND TAPE RECORDER
SPECIALISTS. UNBEATABLE
OFFERS FOR NEARLY
EVERY MAKE.

offer you-

THE WORLDS LEADING SOUND EQUIPMENT. HEAR IT FOR YOURSELF

All the latest sound reproduction equipment is as near as your post box. You can order by mail from the friendly and experienced REW Mail Order Service. Everything we sell is available on the easiest and friendliest budget terms. *Interest free over 12 months!* If you're exchanging, you can't do better than REW. Our allowances on reputable modern equipment will delight you.

FREE DEMONSTRATIONS

If you want to hear before you buy, call in at either of our showrooms. The staff are experts in sound equipment and will assist and guide you in your choice. *No matter what your budget* you'll get better value at REW. Our bulk buying arrangements with manufacturers means we can offer you the best equipment way below list price.

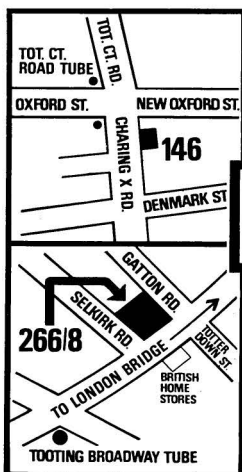

R.E.W. AUDIO VISUAL CO

266-8 UPPER TOOTING ROAD,
LONDON, S.W.17 TEL: 01-872 4471/2 or
146, CHARING CROSS ROAD,
LONDON, W.C.2 TEL: 01-836 3365

- * FAST MAIL ORDER SERVICE
- * GENEROUS PART EXCHANGE
- * PERSONAL EXPORT SERVICE

Equipment can be despatched immediately, free of U.K. Purchase Tax

Call, Phone or Write for details

BISHOP AUCKLAND (DURHAM)

McKENNA & BROWN (PHOTOGRAPHIC) LTD, 134 Newgate Street

BLACKBURN (LANCS)

HOLDINGS AUDIO CENTRE, 39-41 Mincing Lane, Darwen Street

BLACKPOOL

F. BENFELL LTD, 17 Cheapside
THE TAPE RECORDER CENTRE (BLACKPOOL)—C. BRADDOCK LTD, 266 Waterloo Road

BOGNOR REGIS

TANSLEY & COOKE LTD, Television House, Sandymount Avenue; 3-4 Odeon Buildings; 46 Aldwich Road

BOLTON (LANCS)

HARKER & HOWARTH (MUSIC) LTD, 7 The Arcade, Bradshawgate
STEREO ELECTRICS LTD, 150 Higher Bridge Street
R. W. PROFFITT LTD, 71-77 Newport Street

BOURNEMOUTH

NATIONAL RADIO SUPPLIES, 70-72 Holdenhurst Road

BRADFORD

ERRICK'S, 4 Thornton Road, 1
CHRISTOPHER PRATT & SONS LTD, 33 North Parade, 1
R.S.C. (MANCHESTER) LTD, 54-56 Morley Street, 7
VALLANCES, Arndale House, Market Street

BRIGHTON

LANES (RADIO) LTD, 11 Gardner Street

BRISTOL

BRISTOL & WEST RECORDING SERVICE LTD, 6 Park Row
HUSBANDS OF BRISTOL, 8 St. Augustine's Parade, 1
HOUSE OF SOUND LTD, 5 Marsh Street, 1
R.S.C. (MANCHESTER) LTD, 14 Lower Castle Street
SOUND SELECTION, 361/3 Gloucester Road, Bristol 7
STERNE-CLYNE LTD, 28 Merchant Street

BROMLEY (KENT)

JACK HAMILTON, 26 Letchworth Drive
IVOR F. HOWELL, 97 High Street
SOUND SYSTEMS, 218 High Street
WESTMINSTER PHOTOGRAPHIC & HI-FI, 12-14 High Street

BURNLEY

PROFFITTS, Bethesda Street

BURY (LANCS)

J. SMITH & SON (THE ROCK) LTD, 184 The Rock

CAMBRIDGE

ADAM & DELLAR LTD, 61 Regent Street
H. GEE, 94a Mill Road
REECE OF CAMBRIDGE, 1 and 2 Peas Hill
UNIVERSITY AUDIO, 1 and 2 Peas Hill
UNIVERSITY RECORDING COMPANY, 38 Gold Street

CANTERBURY

HI-FI CENTRE, 26 St. Dunstan's Street

CARLISLE

MISONS, Citadel Row

CARDIFF

CITY RADIO (CARDIFF) LTD, Oxford House, 8 Hills Street, Hayes
J. GOUGH & CO LTD, 148-154 North Road

CHATHAM

WOODS & PORTER LTD, 349 High Street

CHELTENHAM

MODERN RADIO (CHELTENHAM) LTD, 40-42 St. James Street
RAY ELECTRICAL (CHELTENHAM) LTD, 287 High Street
UNIVERSITY AUDIO, 87 Winchcombe Street

CHESTER

LLOYD & WYLIE, 42 Bridge Street
PETERS HI-FI AUDIO, 24 St. Michaels Square, Shopping Precinct

CHICHESTER

STORRY'S, 83 North Street

COVENTRY

COVENTRY & DISTRICT CO-OPERATIVE SOCIETY LTD, Central Premises, Corporation Street
COVENTRY TAPE RECORDER SERVICE, 33 King William Street
ELECTRONIC SERVICES, 33 City Arcade
R.E.S. (COVENTRY) LTD, 13 City Arcade; 128 Far Gosford Street

CRAWLEY (SUSSEX)

KIRKMAN, 40 The Broadway

CREWE

CHARLESWORTH'S OF CREWE LTD, 14 Hightown

CROYDON

SPALDING ELECTRICAL LTD, 352-354 Lower Addiscombe Road
STERN-CLYNE LTD, 12 Suffolk House, George Street

DARLINGTON

R.S.C. (MANCHESTER) LTD, 13 Post House Wynd

DARTFORD

WOODS & PORTER LTD, 23 West Hill

DARTMOUTH

PROCTOR RADIO, 24 Foss Street

DERBY

BUCKLAND'S OF DERBY, 41-49 London Road
R.S.C. (MANCHESTER) LTD, 26 Osmaston Road

DONCASTER

FIELD'S RADIO LTD, 52 Hallgate

DORCHESTER

SUTTONS, Hardy Arcade

DORKING (SURREY)

THE HIGH FIDELITY CENTRE, 61 West Street

DUNDEE

LARG & SONS (DUNDEE) LTD, 16-24 Whitehall Street

EASTBOURNE

CENTRAL RADIO (EASTBOURNE) LTD, 15 Langley Road
HOLDER-PEARCE LTD, 66 Grove Road

EDINBURGH

AUDIO AIDS, 58 Ratcliffe Terrace
HI-FI CORNER, 1 Haddington Place, 7
J. I. MITCHELL (CAMERAS) LTD, Haymarket Corner, Edinburgh
R.S.C. (MANCHESTER) LTD, 133 Leith Street

EPPING

CHEW & OSBORNE LTD, 148 High Street

EXETER

JIM GAPPER (IN ASSOCIATION WITH) ALFRED HEXT,
18 Clinton Avenue, off Monks Road

FARNHAM (SURREY)

LLOYD & KEYWORTH LTD, The Record Shop, 26-27
Downing Street

FOLKESTONE

GUILDHALL TAPE RECORDERS, 33 Guildhall Street

GILLINGHAM

BURNS RADIO LTD, 96 Woodlands Road

GLASGOW

J. D. CUTHBERTSON & CO, 21 Cambridge Street, C.2
ECOSSE RECORD LIBRARY, 262 Woodlands Road
McCORMACKS MUSIC LTD, 33 Bath Street, C.2
KERR, McCOSH & CO LTD, 435 Sauchiehall Street, C.2
M. & M. ELECTRONICS LTD, 91 N. Hanover Street, C.1
R.S.C. (MANCHESTER) LTD, 326 Argyle Street
G. H. STEELE LTD, 141 St. Georges Road, C.3

GOODMAYES (ESSEX)

UNIQUE RADIO, 6 The Facade, High Road

GRAVESEND

BENNETT & BROWN, 2 Milton Road

GRIMSBY

JOHN ANGLIN, 385 Cleethorpe Road
LINCOLNSHIRE INSTRUMENT CO, Hi-Fi House, 69-73
Cartergate

GUILDFORD

MERROW SOUND LTD, 229 Epsom Road, Merrow
PORTER'S RADIO SUPPLIES, 15 Chapel Street

HADLEIGH (ESSEX)

CROISSETTE RADIO LTD, The Hi-Fi Room, 212 London Road

HALESOWEN

MARLISON ELECTRONICS, 176 Hagley Road

HALIFAX

TAPERECORDER CENTRE (HALIFAX), 30 King Cross Street

HAMPTON HILL (MIDDLESEX)

MELFORD RADIO SERVICE, 58 Windmill Road

NORTH HARROW (MIDDLESEX)

CITY ELECTRONICS LTD, Broadwalk, Pinner Road

HASSOCKS

TANSLEY & COOKE LTD, 11 Keymer Road

HAYES (MIDDLESEX)

ROWLEYS ELECTRICAL LTD, 10-11 Broadway Parade

HAYWARDS HEATH

TANSLEY & COOKE LTD, 26 South Road

HEMEL HEMPSTEAD

TEE VEE SERVICES, 129-131 Marlowes

HENLEY ON THAMES

G. O. MOORHEN, 190 Reading Road

COVENTRY RADIO LTD.

ESTABLISHED 45 YEARS (1925)

See and hear the best and latest in Hi-Fi equipment at our
Luton Showrooms and demonstration room

Send for information on your requirements

189/191 Dunstable Road, Luton

Telephone: LUTON 28201

TRUVOX — QUAD — REVOX — LEAK — GOODMAN'S

R
O
I
A
R
M
S
T
R
O
N

**FOR ALL YOUR HI-FI REQUIREMENTS
FROM A PLUG TO A SPEAKER**

ROMFORD SOUND & VISION SERVICES LTD.

78A, BRENTWOOD ROAD, ROMFORD, ESSEX

ROMFORD 41644

CASH OR TERMS - SALES & SERVICE

GARRARD — THORENS — S.M.E. — BRYAN — KORTING

A
N
S
U
I
G
R
U
N
D
I



HI-FI AT 20% DISCOUNT

We supply *everything* for the HI-FI enthusiast—amplifiers, tuners, loudspeakers, cabinets, turntables, pickups, cartridges, tape recorders and so on.

Our associated Hi-Fi Company has been in this field since 1925—and we ourselves were established in 1960 as one of Britain's first Mail Order Discount Agencies.

Since then, we have become known for prompt *personal* service—all enquiries and orders are dealt with on the same day as received—and *immaculate after-sales attention* which is vital when buying at discount.

Only new *unused* branded equipment with manufacturers' guarantees. No Membership charges. Hire purchase if required. Send for free brochure (including full range of domestic appliances) to—

THE DISCOUNT BUYING AGENCY
Balcombe, Sussex Tel: Balcombe 295

F. CAVE

★ CASH DISCOUNTS ★ TERMS
★ MAIL ORDER SERVICE

TAPE RECORDER AND HI-FI EQUIPMENT SPECIALIST

AMPLIFIERS & T/AMPLIFIERS
TELETON KENNETH J. ELWIN, ARMSTRONG, LUX, PHILIPS, ROGERS, SANSUI, LEAK, QUAD, WIEN, EAGLE, ETC.

CARTRIDGES
SHURE, CONNOISSEUR, DECCA, AUDIO-TECHNICA, GOLDRING, ETC.

SPEAKERS
DECCA, JORDAN WATTS, LEAK, TANNOY, TANDBERG, CELESTION, GOODMAN, K.E.F. LOWTHER, QUAD, WHARFEDALE, ELAC, BOWER-WILKINS, RADON, ETC.

TURNTABLES
CONNOISSEUR, TRANSCRIPTOR, GOLDRING, THORENS, GARRARD, DUAL, SANSUI, ETC.

TAPE RECORDERS
AKAI, TRUVOX, PHILIPS, REVOX, NATIONAL, AIWA, ETC.

SEND 2/6 P.O. FOR CATALOGUE OR
S.A.E. FOR LIST

F. CAVE

5 BRIDGE STREET, RICHMOND
Telephone: 01-948 1441 (Up to 8pm)

SOUND SUPPLIES

(Loughton) CO. LTD.
01-508 2715

HI-FI SHOWROOM
Brooklyn Parade,
309, High Road,
Loughton, Essex.

SPARES & REPAIRS
12, Smarts Lane,
Loughton, Essex.

STUART BARKER invites you to
His HI-FI CENTRE at

5, The Facade, High Road,
Goodmayes, Essex

UNIQUE RADIO LTD.

01-590 8277
Sound Specialist in Hi-Fi or PA.
M.A.P.A.E.

WALES
Leading Hi-Fi Specialists Est. 1930

J. GOUGH & CO LTD, CARDIFF

Designers of the "Gough Loudspeaker Cabinet"
Stockists of Quad, Leak, Armstrong, B & O, Record Housing, etc., etc.

★ Demonstration rooms available ★

148-154 NORTH ROAD Telephone 28473

CHESTER ● Est. 40 years

TAPE RECORDER AND HI-FI SPECIALISTS

Agents for: Ferrograph, Tandberg, Truvox, Grundig, Philips, Hacker, Armstrong, Leak, Quad, Goodmans, B & O, Wharfedale, Radford, Sony, Bryan, Sanyo, Thorens, S.M.E., Wharfedale, Rogers, Eddystone, Shure.

LLOYD & WYLIE

42 BRIDGE ST., CHESTER Tel: 26704

HI-FI DEALERS

AUDIO & VIDEO CONSULTANTS

John Peters

HEAR THE BEST

HI-FI EQUIPMENT

SEE OUR RANGE OF PORTABLE RADIOS

EQUIPMENT BY
LEADING MAKERS
... SONY, B & O,
SANYO, LEAK, QUAD,
DECCA, SHARPES,
ARMSTRONG,
NATIONAL,
FERROGRAPH, ETC.

SONY VIDEO AGENTS

MOST GENEROUS PART EXCHANGE &
HIRE PURCHASE FACILITIES AVAILABLE
OUTSIDE DEMONSTRATIONS
ARRANGED WITH PLEASURE . . .

ALBION
PLACE
LEEDS 1

TEL. 30257

VIDEO AND HI-FI STUDIO

Hire or Buy Listen to the Best

- ★ Cameras
- ★ Monitors
- ★ Video Tape Recorders
- ★ Ampex
- ★ Ikegami
- ★ G.E.C.
- ★ Loewe Opta
- ★ Bryan
- ★ Truvox
- ★ Leak
- ★ Goodmans
- ★ Goldring
- ★ Thorens
- ★ Eagle, ETC.

FULL SERVICE OFFERED

Holiday Bros. (A.V.) Ltd.
61b Shaw Heath, Stockport

AUDIO CENTRE STOCKPORT

58/62 LOWER HILLGATE · 061-480-4872

COMPREHENSIVE STOCKS OF
RADIO, TAPE AND DISC EQUIPMENT

Advisory Service and Satisfaction assured

FULL AFTER SALES SERVICE
EVENING DEMONSTRATIONS ARRANGED

BLACKPOOL Tel. Blackpool 28756

**BENFELL
OF BLACKPOOL**

F. BENFELL LIMITED
17 Cheapside (Off Abingdon Street)

University **AUDIO**

Specialists in HI-FI equipment

CAMBRIDGE

1 & 2, Peas Hill. Tel: Cambridge 54237

CHELTENHAM

24, Winchcombe Street. Tel: Cheltenham 53228

SOUTHAMPTON

12, Bargate Street. Tel: Southampton 28547

HARKER & HOWARTH (Music) Ltd. of **BOLTON**

For all leading makes of
Hi-Fi Equipment

Goodwin St., Folds Rd., Bolton
and 28 & 32, Churchgate, Bolton
Tel: 26623/4

LEICESTERSHIRE



**audio
sound**

for sound advice

38 Waterloo Street Leicester
Telephone 26319

mccormack's (MUSIC) LTD

SCOTLAND'S PREMIER HI-FI STOCKISTS

WIDE RANGE OF—
**TUNERS - AMPLIFIERS
SPEAKERS-TAPE DECKS
& RECORDERS**

SERVICE WORKSHOP ON THE PREMISES

mccormack's
(MUSIC) LTD

29-33 BATH STREET,
GLASGOW C.2.
Phone: 041-332 8958

HIGH WYCOMBE

HUGHES PHOTOGRAPHIC, 7 High Street
M. W. KEEN LTD, Pauls Row

HITCHIN (HERTS)

RECORD SHOP, 30-31 Hermitage Road

HORSHAM (SUSSEX)

JOHN CAINE LTD, Shelley House, Bishopric
TANSLEY & COOKE, 37 West Street

HOUNSLOW (MIDDLESEX)

MUSICRAFT HI-FI CENTRE, 63 High Street

HUDDERSFIELD

RADIO CRAFT (HUDDERSFIELD) LTD, 38 King Street
J. WOOD & SONS LTD, 67 New Street

HULL

A. BROWN & SONS LTD, 24-28 George Street
R.S.C. (MANCHESTER) LTD, 51 Savile Street

IPSWICH

HI-FI CENTRE (IPSWICH) LTD, 37 Elm Street
R.C.S., 61 Fore Street

ILFORD (ESSEX)

ILFORD AUDIO CENTRE, 335 Green Lane

ILKLEY

ALLEN & WALKER, Sedburgh Buildings and 4 Cowpasture
Road

KEIGHLEY (YORKS)

J. S. RAMSBOTTOM & CO LTD, Cook Lane

KENTON (MIDDLESEX)

GREENE & COOPER LTD, 211 Kenton Road

KESWICK

E. C. WILSON, 70 Main Street

KIDDERMINSTER (WORCS)

F. W. LONG, 14 Mill Street

KINGS LYNN

ARTHUR B. GRIEF, 47 Railway Road

KINGSTON UPON THAMES

EXPERT GRAMOPHONES (SERVICES) LTD, 30 Vincent Road
SURBITON PARK RADIO LTD, 48-50 Surbiton Road

LEAMINGTON SPA

REGENCY ELECTRONICS LTD, 29 Regent Street
TYSONS SOUND ENGINEERS, 41 Russell Street

LEATHERHEAD (SURREY)

MAURICE RICHARDS LTD, Radio House, The Crescent

LEEDS

ELECTRONIC SERVICE (LEEDS) LTD, 59 Street Lane
JOHN PETERS AUDIO CENTRE (Northern High Fidelity Ltd),
Lands Lane, Albion Place
P.W.B. AUDIO LTD, 33 Call Lane, 1
R.S.C. (MANCHESTER) LTD, 5-7 County (Mecca) Arcade,
Briggate, 1
VALLANCES, Headrow House, 1; New Market Street, 1

LEICESTER

AUDIO SOUND, 38 Waterloo Street
DALTON & SONS LTD, 76 Granby Street
HI-FI RECORD BAR, 9-13 Applegate Street
HI-FI STEREO LTD, Forester's Building, St. Nicholas Street
LEICESTER CO-OPERATIVE SOCIETY LTD, High Street
R.S.C. (MANCHESTER) LTD, 32 High Street

LITTLEHAMPTON

TANSLEY & COOKE LTD, 61 High Street

LIVERPOOL

BEAVER RADIO OF WHITECHAPEL
LAMBDA RECORD CO, 70 Liverpool Road, 23
R.S.C. (MANCHESTER) LTD, 73 Dale Street, 2

LOSSIEMOUTH (MORAYSHIRE)

JOHN MUNRO, Library House

LOUGHBOROUGH (LEICS)

RADIO MAINTENANCE (LEICS) LTD, Wards End

LOUGHTON (ESSEX)

SOUND SUPPLIES (LOUGHTON) CO LTD, Smart's Lane

LUTON (BEDS)

COVENTRY RADIO, 189-191 Dunstable Road
D. P. HOBBS LTD, 11 King Street

MACCLESFIELD

HI-FI House, 123 Chestergate

MAIDSTONE

HIGH FIDELITY (MAIDSTONE) LTD, 57 King Street

MANCHESTER

AVGARDE GALLERY LTD, Brazenose Street, 2
GODLEYS, 2-10 Shudehill, 4
LANCASHIRE HI-FI LTD, 8 Deansgate, 3
LLOYD PATON & CO, Ralli Buildings, Stanley Street, 3
MATHERS PHOTOGRAPHICS LTD, 35 John Dalton Street, 2
RARE RECORDS LTD, 5-7 Barton Square, off St. Ann's
Square, 2
R.S.C. (MANCHESTER) LTD, 60a-60b Oldham Street
STERNE-CLYNE LTD, 10 Withy Grove, 4
XLENT ELECTRICS LTD, 537-539 Wilbraham Road, Chorlton-
cum-Hardy

MIDDLESBROUGH (YORKS)

McKENNA & BROWN (PHOTOGRAPHIC) LTD, 122 Lin-
thorpe Road
R.S.C. (MANCHESTER) LTD, 106 Newport Road
SPARKSOUND LTD, 41 Borough Road

NELSON

DON'S HI-FI CENTRE, 92 Manchester Road

NEW BARNET (HERTS)

AUDIO SERVICES, 82 East Barnet Road

NEWCASTLE UPON TYNE

FENHAM RADIO, 158 New Bridge Street, 1
HAYMARKET RADIO, 11a Percy Street
HI-FI CENTRE, 11a Percy Street
J. G. WINDOWS LTD, 1-7 Central Arcade, 1

NEW MALDEN

UNILET PRODUCTS LTD, Compton House (studio entrance
by 37 Malden Road)

NORTHAMPTON

CRYERS. RADIO AND SOUND EQUIPMENT LTD, 220-224
Wellingborough Road
THE RECORDERIE LTD, 3 Rowland Place, Green Lane

NORWICH

YAXLEY'S ELECTRONICS, 99-101 St. Giles Street

NOTTINGHAM

PETER ANSON ELECTRONICS, 165 Arkwright Street
SYD BOOTH, 11 Queen Street
NOTTINGHAM HI-FI CENTRE, 156 Alfreton Road
NOTTINGHAM TAPE RECORDERS LTD, Burton Street
THE AUDIO CENTRE, Photo Centre Building, 28-30 Pelham
Street

Reigate & District

A HIFI

All leading Hi-Fi equipment stocked.
 Demonstration showroom above the camera
 shop at **Alan Laurenson & Co.,**
9, Bell Street, Reigate.

Ring **Reigate 46494** for a home demonstration

*The Specialists in
 High Fidelity Sound*

H. D. KIRK
Stereolectrics
ESTABLISHED 1958

*Where
 Service
 Matters*

203
 St. Georges Rd. Phone 23093
BOLTON BOLTON

FARNHAM

SURREY

- ★ Stockists of all good Hi-Fi apparatus.
- ★ Comparative demonstrations.
- ★ We offer a real after sales service.
- ★ Easiest of terms.
- ★ No parking problems.

Lloyd & Keyworth Ltd.

THE RECORD SHOP

26-27 DOWNING STREET,
 FARNHAM, SURREY
 Telephone: **Farnham 5534**

SURREY AND HAMPSHIRE'S HI-FI SPECIALISTS

DAYTRONICS

OF TEDDINGTON

119A, HIGH STREET

STEREO COMPONENT SYSTEMS
 SPECIALISING IN

SONY - ARENA - DUAL

TEL: 01-977 1324

HENLEY-ON-THAMES AND READING DISTRICT

G. O. MOORHEN

HIGH FIDELITY SPECIALIST

190 READING ROAD, HENLEY. Tel. 4163

Appointed Agent for

Tandberg - Fisher - Revox - Radford
 Bang & Olufsen - Sony

Armstrong, Ferrograph, Leak, Quad,
 Rogers, Goodman, K.E.F., Wharfedale, etc.

Cabinets and complete installations to order

FREE

1969
 CATALOGUE
 140 Pages
 SEND TODAY



- Recording Tapes
- Tape-Recorders
- Hi-Fi Equipment
- FM, AM and AM Radios
- Record Players
- Microphones
- Headphones
- Amps. and Tuners
- Turntables
- Cartridges
- Loudspeakers
- Plugs and Leads
- Accessories

**FANTASTIC
 DISCOUNT
 PRICES**

K. J. ENTERPRISES (Dept. HY)

(HEAD OFFICE & MAIL-ORDER DIVISION)
 33 BRIDLE PATH, WATFORD, HERTS.

Telephone: WATFORD (92) 22338 (3 lines)

HI-FI DEALERS

go SCANDINAVIAN hi-fi . . .

Main Bang & Olufsen Specialists . . . Also: Dynatron, Arena, Tandberg, Sony, Quad, Leak, Rogers, Radford, Philips, Goodmans, Armstrong, Fisher, Scott, Sanyo, Pioneer, Trio, Akia, Sansui, Wharfedale, Ferrograph, Dual, Bryan, Nordmende, Eddystone, Braun, Telefunken, Grundig, Shure, Pickering, Garrard, Thorens, Goldring, S.M.E., National, Eagle, Teleton, Etc.

the hi-fi & tape recorder lounge

● Expert Staff ● Home Demos ● Advice Service
● Comparator Demos ● Part Exchange ● After Sales Service ● Ask to see New Scandinavian Room ● Evening Demos.

**Green Lane, Wilmslow,
Cheshire, SK9 1LR**

For personal attention, ring Wilmslow 24766 and ask for Mr. Bird. Or write for free folders and special Hi-Fi Year Book introductory voucher. All Goods sent post free.

Closed Wednesday except by Appointment.

HOLDINGS



MINCING LANE / DARWEN STREET
BLACKBURN TEL: 59595
7 MILES FROM M6 - CLOSED THURS

ST. HELENS HAROLD STOTT LTD. 18, WESTFIELD ST.

Comparator Demonstrations
Fullest Technical Advice
and Service available

ALL LEADING AGENCIES

Including: B & O, B & W, Sony,
Bryan, Leak, Quad, Revox,
Tanberg, Richard Allan, Goodmans
and many others

Tel: St. Helens 26791

ELECTRONIC SERVICES

33 City Arcade
Coventry CV1 3HX

Your central Hi-Fi supplier

Phone Coventry 24632

Coventry Tape Recorder Service *High Fidelity*

QUALITY AUDIO EQUIPMENT
FOR THE CONNOISSEUR

PART EXCHANGES

SERVICE & OVERHAULS
WITH 90 DAY GUARANTEE

33 King William Street,
Coventry CV1 5JD
Tel.: Coventry 29668

3 Regent Grove,
Leamington Spa,
Warwickshire
Tel.: 29265/6

NORMAN H. FIELD

Audio Specialists

Vehicle & General House,
Hurst Street,
Birmingham, 5
Tel: 021-622 2324

High Fidelity Stereo Demonstrations Daily.

GRIFFIN RADIO LTD

(the high fidelity people)

Fully comprehensive stocks and
advisory service for

**Stereophonic High Fidelity,
Radio, Tape and Disc equipment.**

94 BRISTOL STREET BIRMINGHAM 5

Tel: 021-692 1359 For Servicing 021-643 0867

GLASGOW

*Scotland's Leading Tape Recorder, Video and Hi-Fi
Specialists*

G. H. STEELE LTD.

*Hear true Hi-Fi sound on our 22 speaker comparator
system. 14 Hi-Fi combinations ready for demonstration.*
SONY VIDEO CENTRE

Agents for: Armstrong, Leak, Fisher, Rogers, Quad,
B & O, Goldring, Garrard, Thorens, Connoisseur,
Goodmans, Wharfedale, Kef, Celestion, Decca,
Truvox, Philips, Sony, Arena, Revox, Tandberg,
Brennell, Ferrograph, Akai, Uher, Grundig.

CREDIT TERMS—PART EXCHANGES
Repairs and Servicing. Tel. Douglas 7124

141 St Georges Road, Glasgow C3

MILSOMS

FOR

Arena, Armstrong, B and W, Ferrograph, Garrard, Goldring, Leak, Quad, Radford, Record Housing, Rogers, Sansui, Shure, SME, Thorens, Wharfedale, etc.

NORTHGATE BATH TEL: 5675

AUDIO AIDS

58 RATCLIFFE TERRACE
667-2877 EDINBURGH 9 667-2877

SPECIALISTS IN HI-FI EQUIPMENT AND TAPE RECORDERS | **CUSTOM BUILT HI-FI EQUIPMENT RECORDING STUDIO FACILITIES**

High Fidelity Specialists



Hamilton Electronics (Southampton) Ltd.
35 London Road, Southampton. Phone 28622 3Lines

HIGH WYCOMBE, BUCKS.

M. W. KEEN LTD.

Specialising in Bang & Olufsen, Quad, Leak, Rogers, Trio, Goodmans, Wharfedale, etc.

PAULS ROW Phone: 25691
Comfortable demonstration rooms

PROCTOR RADIO

24 FOSS ST., DARTMOUTH
TEL. 2432

- For all leading makes of Hi-Fi Equipment.
- Records—Tape—Cabinets—Accessories etc.
- Demonstration Room available by appointment.
- Home Demonstrations and installation up to 50 mile radius.
- All service carried out in our own workshops.
- Appointed Grundig service station.
- Personal attention by Mr. C. S. Proctor.

DUAL-LEAK-GRUNDIG-TELEFUNKEN

THE SOUTH WEST

Tom Molland Ltd.

Invite you to visit their well-equipped Demonstration Theatre and compare all the leading makes of Hi-Fi and Tape Equipment at

110 CORNWALL STREET, PLYMOUTH
Telephone 69285

Immediate delivery to ALL Areas

LONDON, N. HOME & EXPORT HI-FI MAIL ORDER SPECIALISTS

See our monthly advertisement in "Gramophone" and "Hi-Fi News" for comprehensive list of all the latest equipment or visit our show-rooms.

Goods despatched by return
Carriage Free (U.K.) Cash or Terms

C. C. GOODWIN (Sales) Ltd.
7, The Broadway, Wood Green, N.22
Tel: 01-888 0077/8

MANCHESTER (SOUTH)

STEREO EQUIPMENT:
RECORDS, TAPE

Lancs. Hi-Fidelity Ltd

Tel: 224 3051

**248 WILMSLOW ROAD,
MANCHESTER 14**

Opposite Portland Hotel . Easy Parking

ORPINGTON

HERMLYN HI-FI, 64 High Street

OXFORD

HORN'S, 6 South Parade
WESTWOOD'S OF OXFORD, 46 George Street

PAIGNTON

PAUL PINCH LTD, Foales Corner

PERTH

GEORGE D. BROWN, 61 Kinnoull Street

PETERBOROUGH

AUDIO CENTRE LTD, 126 Bridge Street
CAMPKINS RECORD SHOP, 15 Long Causeway

PLYMOUTH

TOM MOLLAND LTD, 102 Cornwall Street
ALBERT E. FORD, 84 Cornwall Street
PETER RUSSELL'S HOT RECORD STORE, 24 Market Avenue

PORTSMOUTH

EXPRESS RADIO, 163 and 173 Lake Road

PRESTON (LANCS)

ELECTRA CENTRE, 8 Victoria Buildings, Fishergate

PURLEY

SHEPPARD SOUND EQUIPMENT LTD, 3/4 Royal Oak Centre,
Brighton Road

RADLETT (HERTS)

SHEPPARD SOUND EQUIPMENT, Watling Street

READING

DODD ELECTRIC LTD, 35 Field Road
EDWARDS TELECOLOUR LTD, 495/9 Oxford Road

REDCAR (YORKS)

McKENNA & BROWN (PHOTOGRAPHIC) LTD, 135 High
Street

REDDITCH

SPENCER'S (BROMSGROVE) LTD, 26 Red Lion Street

REIGATE

ALAN LAURENSEN & CO, 9 Bell Street

RICHMOND

F. CAVE, 27 Hill Street

RIPLEY (SURREY)

MOBILE AUDIO CONSULTANTS, Villacousta, Portsmouth
Road

ROMFORD (ESSEX)

NEWBURY RADIO (FOREST GATE) LTD, 120 North Street
ROMFORD SOUND AND VISION SERVICES, 78 Brentwood
Road

RHYL (N. WALES)

THE VAC SHOP, Water Street

SALE (CHESHIRE)

HI FI STEREO, 47 Washway Road

SALFORD

LLOYD PATON & CO LTD, Ralli Buildings, Stanley Street

SALISBURY

SUTTONS, 50 Blue Boar Row
SUTTONS, 3 Endless Street

SETTLE (YORKSHIRE)

J. W. GARNETT, Market Place. Also at 8 Market Street,
Kirby-Lonsdale, via Carnforth

SHEFFIELD

AUDIO CENTRE, 56 West Street, 1
HI-FI SERVICING, 496 Glossop Road, 10
PHILIP CANN LTD, Chapel Walk, Fargate 1
R.S.C. (MANCHESTER) LTD, 13 Exchange Street
SHEFFIELD HIGH FIDELITY, 10 West Street, 1
SHEFFIELD SOUND CENTRE, 101a Ecclesall Road, 11
SOUND CENTRE, 496 Glossop Road, 10

SHREWSBURY

AVON HI-FI LIMITED, 13 Wyle Cop

SLEAFORD

JAMES HUGHES, 10 Westgate

SOUTHALL (MIDDLESEX)

MUSICRAFT HI-FI CENTRE, 20-22 High Street

SOUTHAMPTON

AUDIO CITY LTD, 117 East Street
P. A. BAKER, 111 Above Bar
HAMILTON ELECTRONICS, 35 London Road
LEECH & HAING LTD, 57-61 London Road
J. F. SUTTON, 421 Shirley Road
UNIVERSITY AUDIO OF SOUTHAMPTON, 12 Bargate Street

SOUTHPORT

WAYFARERS RADIO LTD, 18-20 Burton Arcade, Lord Street

SOUTHSEA

TANSLY & COOKE LTD, 161 Albert Road

SOUTHWICK (SUSSEX)

TANSLY & COOKE LTD, 14 Southwick Square

STAFFORD

TOM REEKIE, 10 Bridge Street

STANMORE

THE RECORDERIE, 10 Buckingham Parade

STOCKPORT (CHESHIRE)

FAIRBOTHAM & CO LTD, 58-62 Lower Hillgate
HOLIDAY BROTHERS (AUDIO & VIDEO) LTD, 61b Shaw
Heath

STOKE ON TRENT

HIGH FIDELITY SOUND EQUIPMENT, 116 Birches Head
Road, Hanley
THE HI-FI CENTRE, 31 Pall Mall, Hanley

STOURBRIDGE

E. J. BENTON LTD, 144 High Street

ST. ALBANS

BOLD & BURROWS LTD, Verulam Road

ST. HELENS

HAROLD STOTT LTD, 18 Westfield Street

SUNDERLAND

RED RADIO SHOP & STEREO SOUND STUDIO, 31 Crowtree
Road, and 3 Maritime Terrace

TAUNTON

GRAYS OF TAUNTON, 1 St. James Street

TEDDINGTON (MIDDLESEX)

DAYTRONICS LTD, 119a High Street

Equipment selected from the World's finest
in stock.

VISIT OUR STUDIO

Home demonstrations arranged.

CREDIT SALE — CASH SETTLEMENTS

LLOYD PATON & CO. LTD.

**RALLI BUILDINGS, STANLEY STREET,
OFF BRIDGE STREET, MANCHESTER M3 5HF**

Tele. 061-834 0563/4510

Evenings 061-748 9506 Manchester area
after 7.30 pm 061-247 2584 Cheshire area.
26 63508 Bolton area.

Tom Reekie



high fidelity specialist

**TOM REEKIE 10 BRIDGE STREET
Tel. 51234 STAFFORD**

LONDON AREA *Established 1910*

**H. L. SMITH
& CO. LTD.**

*Comprehensive stock of equipment
by all leading makers.*

**287-9 EDGWARE ROAD
LONDON W.2 Tel: 01-723 5891**

**WALTHAMSTOW
LONDON E.17**

STUDIO TAPES LTD.

**199 Hoe St. We are on the bridge
Nr. Hoe St. Station.
Sales: COP 7277 Service: COP 7278**

Sound Systems

**Your Tape and Hi-Fi
Specialists**

**218 HIGH ST. BROMLEY, KENT
01-460 4000**

**PETER ANSON
ELECTRONICS**

*Wide range of equipment demonstrated under ideal
conditions. Agents for: B & O, Radford, Thorens,
Armstrong, Shure, Goodmans, Sony, Roberts,
Hacker, K-L-H, Tandberg, Arena, Leak, Grundig,
Quad, Revox, Reslo, Ferrograph, Truvox, Akai,
Lowther.*

EXPERT REPAIRS AND SERVICING

**Telephone: 89374
165 ARKWRIGHT STREET,
NOTTINGHAM**

RUSSELLS

NEWPORT

I.O.W.

AGENTS for: Ampex, B & O, Brenell,
Ferrograph, Grundig, Sony, Truvox,
Philips, Leak, Quad, etc. Sony Video
Tape Recorder Centre. Records and Pre-
Recorded Tapes.

**NEWPORT 3864
40 UPPER ST. JAMES' STREET**

AVGARDE Gallery Ltd.

34 Brazennose Street, Manchester 2

RECORDS AND FINE SOUND EQUIPMENT

ADC - B & W - Celestion - Connoisseur -
Decca - EMI - Empire - Garrard - Goldring
- Goodmans - KEF - Leak - Lowther -
Ortofon - Quad - Radford - Revox - Rogers
- Shure - SME - Tandberg - Thorens -
Wharfedale.

High Class Service & Repairs

HI-FI DEALERS

HORNS

SIX SOUTH PARADE

Telephone OXFORD 55360

STOKE-ON-TRENT, STAFFS.

See and Hear the Best in
the Latest Equipment at

The HI-FI CENTRE

31, PALL MALL, HANLEY
(Opp. Theatre Royal) Phone: 25194

The Most Up-to-Date and
Best Demonstration Studio
In the Area.

TEESSIDE & DURHAM

See, Hear, and Choose your equipment from the
North's finest Hi-Fidelity and Tape Centres.

Specialised agencies include:—Tandberg - Ferro-
graph - Revox - Bang & Olufsen - Philips - Dual -
Sansui - Trio - B & W etc.

Shop and Home Demonstrations always with
pleasure.

Easy credit terms and part exchange (Photographic
and Audio).

MCKENNA & BROWN LTD.

122 Linthorpe Road, Middlesbrough. Tel: 48345

135 High Street, Redcar. Tel: 3829

11 Bondgate, Darlington. Tel: 2266

134 Newgate Street, Bishop Auckland. Tel: 2266

HI-FI STEREO

47 WASHWAY ROAD, SALE,
CHESHIRE

(Tel: 061-973 5577) (opposite Sale Locarno)

Stockists for all good Hi-Fi units

Probably the best selection of gramophone records in
Cheshire. Specialists in building complete systems
into matching cabinets. All finishes available.

Free Hi-Fi brochure sent on request to residents
within 30-mile radius of Sale.



BLACK KNIGHT SERVICES

Ashton-u-Lyne, Lancs.

STD: 061-330 2836 or 3991 (evenings)
HI-FI & PUBLIC ADDRESS SPECIALISTS

'RUMBLECURE' Patentees.

(Write or phone for advice leaflets)
Also: ASHTON HI-FI-AUDIO WORK

Also:
ASHTON HI-FI-AUDIO WORKSHOPS
(Please telephone in first instance)

G.A.

81 Portland Road
South Norwood
01-654 3200

ELECTRIC

Hi-Fi and Public Address Equipment
Rogers and other leading makes

ILFORD AUDIO CENTRE

*Daily Hi-Fi demonstrations in our
comparator operated listening studio
Evening demonstrations by
appointment*

Agents for:

Bang & Olufsen - Radford - Armstrong
Quad - Leak - Sanyo - Trio - Klinger, etc.

Credit Facilities - After Sales Service

335 GREEN LANE, SEVEN KINGS, ILFORD, ESSEX
Telephone: 01-599 1826

— No Parking restrictions —

TRURO

EDMUND FORD, 9 Pydar Street

TUNBRIDGE WELLS

GOULDEN & CURRY LTD, 59, 61 and 66 High Street
STUDIO 4, 15 Ritz Buildings, Church Road

WATFORD

DAVIS & KAYS, 22 Woodlands Parade
E.M.E. (WATFORD) LTD, 188 Queens Road
RADIOLUX LTD, 36 Woodlands Parade, High Street

WEMBLEY

DAVIS & KAYS, 3 Wembley Hill Road, The Triangle

WESTHOUGHTON (LANCS)

MAXTONE HIGH FIDELITY, 31 Lee Bank

WEYBRIDGE

WEYBRIDGE AUDIO, 32 Baker Street

WIGAN

H. PLUMB & SON, Dicconson Street

WILMSLOW

HI-FI AND TAPE RECORDER LOUNGE, Green Lane

WINDSOR

AUDIOCRAFT LTD, 89-90 High Street, Eton

WOKING

E. H. MAXWELL & SONS LTD, 87 Walton Road; Guildford
Road; Chertsey Road



BBC VHF SOUND BROADCASTING STATIONS



EXISTING STATIONS:-	MAIN RELAY	●
LOW-POWER RELAY		▲
STATIONS PLANNED OR UNDER CONSTRUCTION		△
AREA COVERED		▨

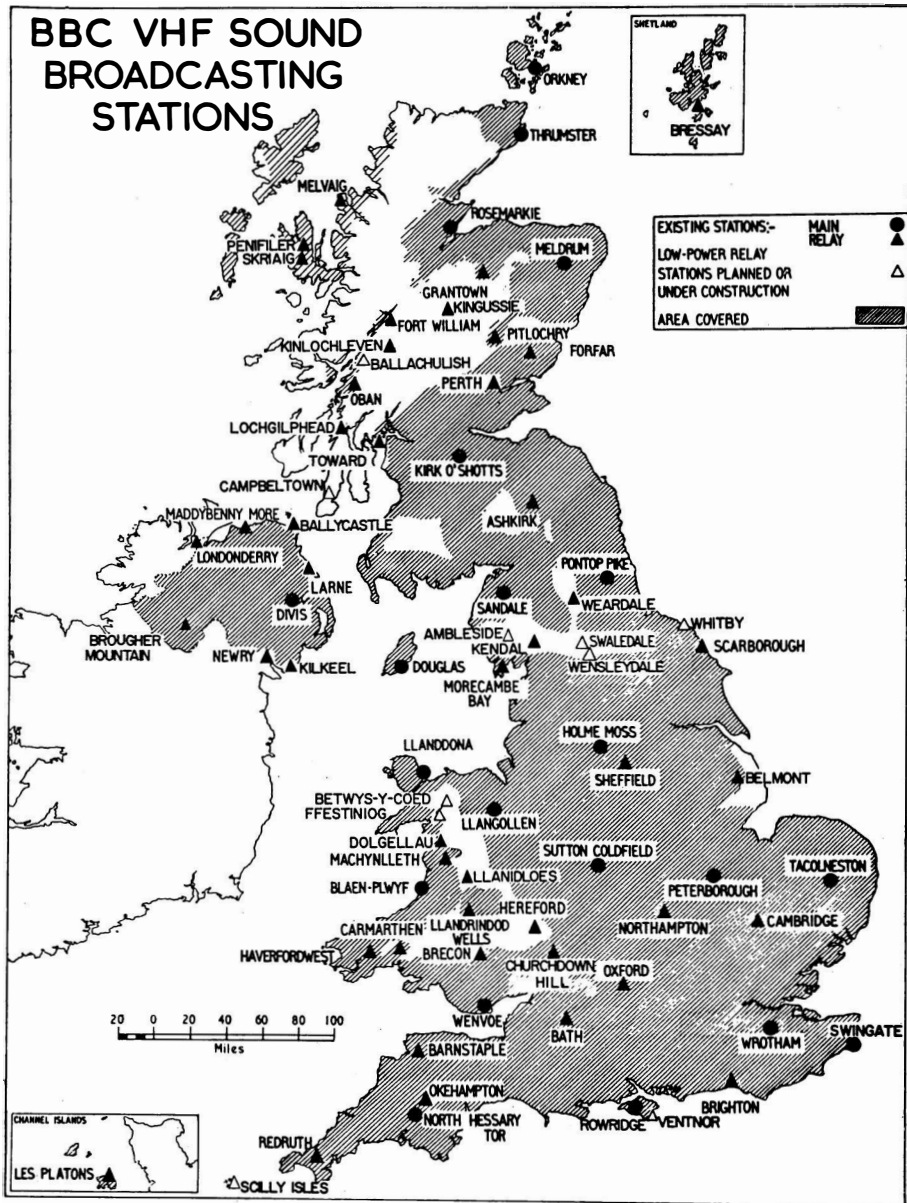

ADVERTISERS' INDEX

	Page
Acoustical Mfg. Co. Ltd.	Dust Jacket
Adler B. & Sons (Radio) Ltd.	154
Agfa-Gevaert Ltd.	237
Akai (Pullin Photographic Ltd.)	144, 145
A.K.G. (Politechnica London Ltd.)	261
Antiference Ltd.	382
Armstrong Audio Ltd.	140
Audio Technica (Shriro Ltd.)	148
Bang & Olufsen U.K. Ltd.	394
Belling & Lee Ltd.	381
Black Knight Services Ltd.	99
British Radio Corporation—H.M.V.	388
Brenell Engineering Ltd.	186
Brush Clevite Co. Ltd.	259
B.S.R. Ltd.	101
F.W.O. Bauch Ltd.	262
Bush Radio	386, 387
Carston Electronics Ltd.	260
Cecil Watts Ltd	238
Celestion Ltd.	290 & 293
Colton & Co. (Lapidaries) Ltd.	48
Davis & Kays Ltd.	288
Decca Ltd.	76
E.M.G. Handmade Gramophones Ltd.	103
Film Industries Ltd.	391
Fircastle Ltd.	365
Francis of Streatham	413
Garrard Engineering & Mfg. Co. Ltd.	88
Goldring Mfg. Co. Ltd.	50, 51
Goodmans Industries Ltd.	318
Grampian Reproducers Ltd.	141
Grosvenor Electronics Ltd.	292
Grundig (Great Britain) Ltd.	188
Hacker Radio Ltd.	405
Heathkit (Daystrom Ltd.)	120
Henry's Radio Ltd.	139
Hi Fi Dealers' Directory	418, 419, 420, 421, 423, 424, 425, 427, 428
Imhof (Retail) Ltd.	102
K. & K. Electronics Ltd.	289
Kerr, James & Co. Ltd.	365
Klinger Controls Ltd.	390
Largs of Holborn	185
Lasky's Radio	119
H. J. Leak & Co. Ltd.	142, 143
Lee Products(GB)Ltd.	393
Lennard Developments	391
Lind Air Optronics Ltd.	74
Lowther Manufacturing Co.	190

3M's Company Ltd.	240
Mastertape (Magnetic) Ltd.	239
Metrosound Sales Ltd.	49
Modern Electrics Ltd.	75
B. H. Morris & Co. (Radio) Ltd.	191
Peak Sound (Harrow) Ltd.	146
Philips Electrical Ltd.	392
Pioneer (Swisstone)	149
Radio Year Book	380
The Rectavox Company	313
R.E.W. (Earlsfield) Ltd.	417
Richard Allan Ltd.	291
Rogers Developments (Electronics)	104
Sanyo	389
Shure Electronics Ltd.	53
S.M.E. Ltd.	54 & 366
Sony (UK) Ltd.	87
A. R. Sugden & Co. Ltd.	52
Tannoy Products Ltd.	294
Tape Recorder, Hi Fi Centre (Sheen) Ltd.	414
Telefunken (A.E.G. Great Britain Ltd.)	122
Tripletone Manufacturing Co. Ltd.	121
Uher (Bosch Ltd.)	187
United Mercantile Co. Ltd.	150
United Technical Supplies Ltd.	236
Videorama Ltd.	147
Vortexion Ltd.	151
Welbrook Engineering Electronics Ltd.	152
Wharfedale (Rank Wharfedale Ltd.)	379
Whiteley Electrical Radio Co. Ltd.	153
Worden Audio Developments Ltd.	391