

1956

# HI-FI YEAR BOOK



10'6

PICKUPS • AMPLIFIERS • MOTORS  
TUNERS • SPEAKERS • TAPE RECORDERS

# Hi-Fi Year Book

————— 1956 Edition —————

*Editor* - - MILES HENSLOW



*Published by :*

MILES HENSLOW PUBLICATIONS LIMITED,  
99 MORTIMER STREET - - LONDON, W.1



## FOREWORD

THIS Hi-Fi Year Book (1956 Edition) has been arranged, in sections, to cover the whole subject of High-Fidelity sound reproduction in its logical sequence, beginning with a history and ending with a peep into the future. Between these two extremes, are the chapters dealing with the various items of equipment, arranged in their order of appearance, from pickup to speaker, etc.

In each chapter, available equipment has been presented alphabetically, in directory form with relevant technical data. Where apparatus is illustrated, the picture page numbers are given. To increase the usefulness of this book, all advertisements are grouped in one section and indexed on page 136, and should be referred to for additional data. Prices in the editorial section are shown without Purchase Tax. While every effort has been made to ensure accuracy, no responsibility can be accepted for discrepancies.

As this is the first edition of Hi-Fi Year Book, and is therefore an experiment in layout and arrangement, any criticisms and suggestions for the enlargement and improvement of future editions will be very welcome.

MILES HENSLOW

### Hi-Fi GUARANTEE

THE purpose of this Year Book is to take the subject of Hi-Fi to pieces, and to explain it in the most simple and understandable terms, and at the same time to provide as complete a survey as possible of all the best equipment available today on the British Market. Readers may accept, as a guarantee of quality, that no mention is made in this book of any piece of equipment that is not of really good standard, and that no advertisement is accepted from any manufacturer of components or instruments whose products are not up to the standard of "Hi-Fi", as it is understood and accepted in its true meaning, by the Trade as a whole, by the acknowledged experts of the day, and by the editorial and publishing office of Hi-Fi Year Book.

It is, of course, important to add that no implication of unworthiness is intended towards any manufacturers whose products may have escaped mention, or whose advertisements do not appear in these pages. The above guarantee is a positive one—not a negative one, and we can only repeat that those products which *are* mentioned, or advertised, may be bought with full confidence.

# CONTRIBUTORS

TO

# HI-FI YEAR BOOK

---

**P. D. Collings-Wells, B.Sc. (Eng.)**

Chief of Research, Goodmans Industries Ltd.

**G. F. Dutton, Ph.D., D.I.C., A.M.I.E.E.**

Head of Advance Development Group, Record Division of E.M.I. Ltd.

**Stanley Kelly**

Designer of Acos Hi-G series of pickups and RLS speaker

**James Moir, M.I.E.E.**

Electronics Division of the B.T.H. Company Ltd.

**C. W. Morle, M.B.E.**

Construction Group B.S.R.A.

**George Tillett**

Designer of Armstrong A-10 Amplifier and F.M.56 Tuner

**Cecil E. Watts**

Past-President of the British Sound Recording Association.

Designer of the original B.B.C. disc recording equipment

**Ralph L. West, B.Sc.**

Lecturer in Telecommunications, Northern Polytechnic, London, N.

Designer of the Decca Corner Speaker

# INDEX

	PAGE
FOREWORD ... ..	3
LIST OF CONTRIBUTORS ... ..	4
HISTORY OF THE PHONOGRAPH ... ..	6
GROOVES AND STYLI ... ..	9
MAKING A RECORD ... ..	14
ACOUSTICS (Introduction) ... ..	17
ACOUSTICS (Chapter 2) ... ..	21
WHAT IS HI-FI ? ... ..	27
HI-FI REQUIREMENTS ... ..	29
STYLI ... ..	37
PICKUPS ... ..	41
PICKUPS (Manufacturers' Directory) ... ..	54
MOTOR UNITS ... ..	55
MOTOR UNITS (Manufacturers' Directory) ... ..	58
AMPLIFIERS AND CONTROL UNITS (Introduction) ... ..	59
AMPLIFIERS (Chapter 2) ... ..	67
AMPLIFIERS (Manufacturers' Directory) ... ..	76
B.B.C. V.H.F. SERVICE AREAS (Map) ... ..	80
B.B.C. F.M. STATIONS AND FREQUENCIES ... ..	81
RADIO TUNERS ... ..	81
F.M. TUNERS ... ..	83
RADIO TUNERS (Manufacturers' Directory) ... ..	88
SPEAKERS AND ENCLOSURES ... ..	91
SPEAKERS (Manufacturers' Directory) ... ..	105
MAGNETIC RECORDING ... ..	111
TAPE RECORDERS (Manufacturers' Directory) ... ..	119
STEREOPHONIC SOUND ... ..	121
HOME CONSTRUCTION ... ..	125
HOW TO SOLDER ... ..	132
COMPONENTS (Manufacturers' Directory) ... ..	133
THE FUTURE ... ..	134
LIST OF ADVERTISERS AND DEALERS ... ..	136
ADVERTISERS' ANNOUNCEMENTS ... ..	137

# THE PHONOGRAPH

A SHORT PICTORIAL HISTORY

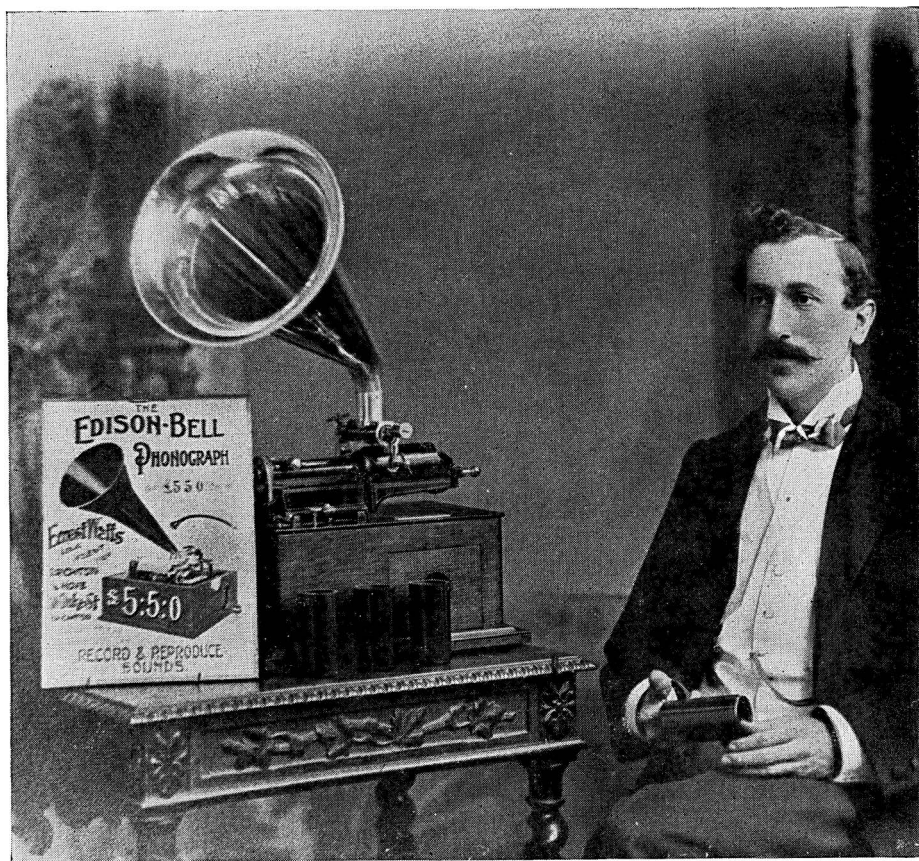

★ 1902—This Edison Bell super machine “recorded and reproduced” sound—and all this for £5 5s. Od., with purchase tax still half a century in the future. The demonstrator is Ernest Watts, father of Cecil E. Watts, whose own study and experience of sound recording extends back to early days, and whose photomicrographic research (see pages 9 to 13) is world famous.

AS Cecil Watts remarks in the next chapter, the history of the gramophone and recording has been written fully and often. This survey is therefore confined to brief comment and “landmark” pictures. It might well be sub-headed “where we came in”; for with our modern tape machines we can now record and reproduce sound in the home, as did the proud owners of the Edison Bell model pictured above. We have been through the list of styli, and we have returned home to the sapphire. We are even likely to see a return to Edison’s Hill-and-Dale

recording principle, used in conjunction with lateral recording for stereophonic sound on disc.

The sixty years or so that have passed, since Emile Berliner’s disc player appeared, have seen tremendous progress in every branch of sound recording and reproduction. The pictures on pages 7 and 8 take us only to 1907. The equipment listed and pictured in the remainder of this book tell the rest of the story to date, and yet, as we go to Press, we hear of great new developments that will add more pages to the “phonograph’s” history.

**1888**—*Emil Berliner's invention, which he called the gramophone. It was hand-driven and played 5-in. discs. The photo on page 10 shows a section of the early sound track and stylus.*

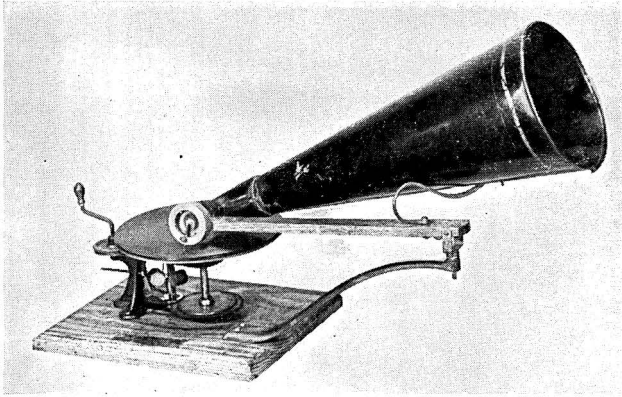
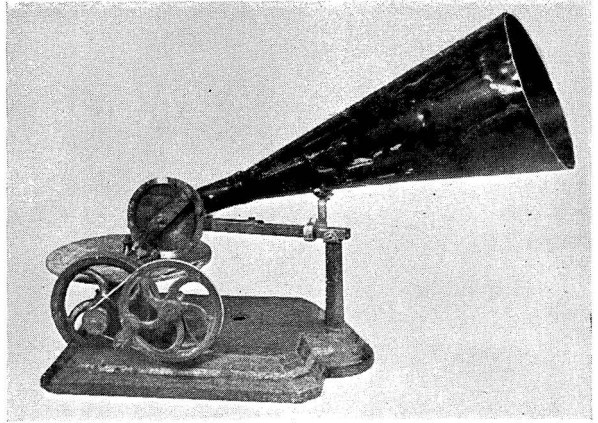

**1897**—*Made by the Gramophone and Typewriter Co.—this model was hand driven, and had ball governors turned by a fibre wheel. If turned too fast, an elastic band slipped, so controlling tonal pitch.*

**1897** — *The famous H.M.V. "trade-mark" model was made (and painted with the dog by Francis Barraud two years later). It was driven by a clockwork motor, and fitted with a turntable brake.*





**1900**—A cylinder-type phonograph, the Columbia Graphophone. “Sound magnified and accentuated 16 times in volume” was the makers’ claim. It won the Paris Grand Prix award.

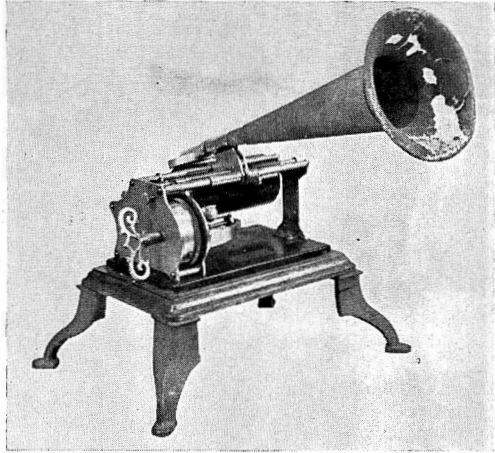

**1905** — The Edison “Gem” phonograph. This neat, spring-driven portable played Edison cylinders of the Hill-and-Dale type, and used a sapphire stylus. See the photo on page 10.

**1907** — The H.M.V. Gramophone. Its “Exhibition” sound-box with mica diaphragm, “Goose-neck” taper arm, and independent suspension of sound box, were among the new features. It played a 12-in. disc at a single winding.



# A SHORT HISTORY of GROOVES & STYLI

By Cecil Watts

THE history of the Gramophone is by now so well known that there seems little useful purpose in further repetition. To the student of High Fidelity reproduction, however, a study of the evolution of the groove in the gramophone record is essential ; and a thorough knowledge of the facts that led to present day practice will provide a basis for the better understanding of likely future developments.

All too little information on this subject is available in a form that can be easily understood by the newcomer, and the various needles or styli that have been advised from time to time must still cause considerable confusion, even to the experienced Gramophile.

The accompanying illustrations probably speak louder than words. They are all to the same magnification, although the apparent mass of stylus can be misleading : if the full length of this were included it would require a page 5 ft. long.

## Early Thoughts

To start at the beginning (which will take us back nearly 100 years), Mr. Leon Scott in 1859 demonstrated to the Royal Association a device which recorded the vibrations of sound. He had devised a mechanism consisting of a revolving cylinder, coated with lamp black ; and by traversing the surface of this with a stylus (a hog's bristle) attached to a diaphragm stretched over the narrow end of a funnel, he produced a visible trace of sounds made into the funnel, in the form of a lateral wavy line.

This was no doubt the first conversion of sound into a physical shape ; but it was left to Thomas A. Edison, 18 years later, to use this principle with a cylinder covered with tinfoil, but with at least one other big difference—the vibrations on his cylinder were indented vertically, producing a trace of varying depth ; and being formed in a

harder material they could be retraced with a reproducing stylus, and thus reconverted into sound.

In the next few years other experimenters improved on this. By 1886 a patent had been granted to Messrs. Bell & Tainter, covering the use of wax for this purpose ; and it was in this form that the public were first able to buy the Edison Bell talking machine, as it was then called.

The machine had a clockwork motor and used wax cylinders which played for about 2 minutes. Its frequency response was probably not much more than an octave, around 1,000 cycles. The reproducing stylus was a sapphire or ruby, formed into a ball point (Fig. 1).

## Lateral Recording

It is perhaps significant that the earliest reproducers used a non-abrasive material for the record and a permanent type of stylus.

A few years previous to this, another experimenter, Emile Berliner was convinced that the "Hill and Dale" method used by Edison did not exactly respond to the sudden accelerations of loud sounds, and he reasoned that the lateral wavy line of Leon Scott, in the form of a groove, would control the stylus tip movement in both directions.

He devised a machine using a flat disc instead of a cylinder. The use of wax had already been covered by patents, but he was eventually able to produce a trace on a disc of zinc smeared with tallow which, by immersion in acid, etched a groove of even depth into the zinc, with the sound vibrations registered as a lateral wavy line.

By covering this surface with graphite it was possible to electroplate a skin over this to form a negative, which could be pressed into a softer material to produce unlimited copies of the original.

By 1897 the gramophone as we now know it was available to us, and records pressed

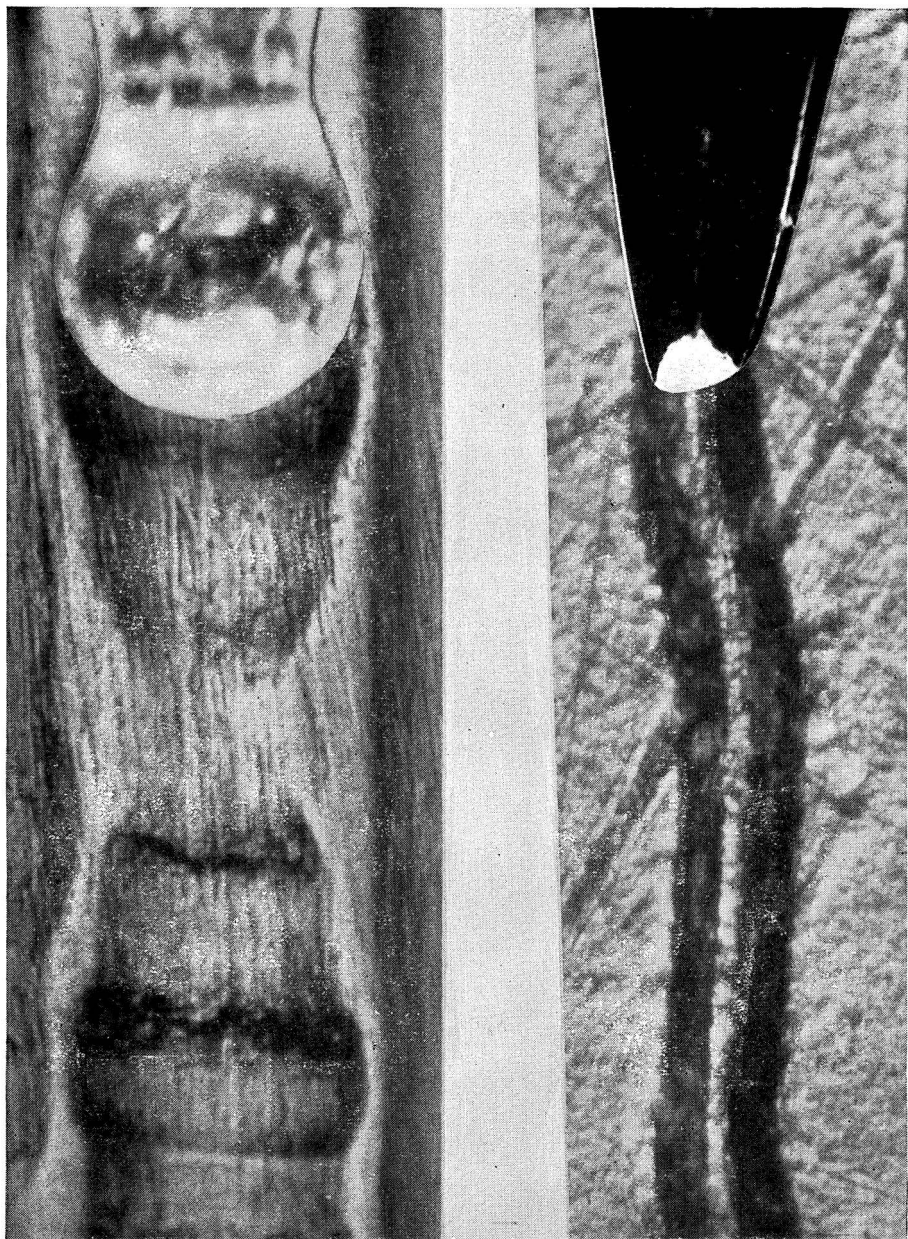

*Fig. 1. This photomicrograph is of an early Edison Bell recording of the Hill-and-Dale type and it shows very clearly the indentation of the sound track at the bottom of the groove. At the top of the photo is the reproducing stylus tip enlarged to scale.*

*Fig. 2. Here we see an example of one of the first lateral grooves. It is an early Berliner pressing from an etched zinc master. Again, at the head of the photo, is the reproducing stylus enlarged to scale. The stylus (a steel needle) has been turned to show the wear.*

in a hard thermoplastic material—mainly composed of slate dust and carbon black, bound together with shellac—were in common use. Fig. 2 illustrates a section of the groove from one dated 1899. The stylus has been turned to show the tip of the steel needle, worn to fit the groove.

It was no doubt obvious from the start that this new form of record would require a different form of stylus. The abrasive and rough nature of the groove, together with its varying shape, due to the uncertainty of the etching process, indicated the use of a needle which would grind itself to fit the groove in the first few rotations of the record. A tapered steel needle was found to be suitable, and continued to be popular for many years.

### Exit the Cylinder

The enormous advantage of the disc over the cylinder soon resulted in the latter becoming obsolete, except for office dictation machines where copies were not normally required; so from this point we need only concern ourselves with the further development of the disc record.

The speed of rotation of the disc was calculated to allow the size of the stylus tip to trace accurately the wave form of the highest frequencies recorded. The frequency response of these early machines was possibly two octaves, 500 to 2,000 cycles, and a speed of 81 r.p.m., later reduced to 78 r.p.m., became standard.

The standard diameter of records in 1900 was 5 in., and this was gradually increased to 8 in., then to 10 in. and 12 in. after the manufacturers had pooled their patents to their common advantage.

### Standardization

Developments and improvements in both machines and records followed rapidly until 1914. Records were standardized with a "U" shaped groove, 10 in. and 12 in. in diameter, playing for 3 and 4 minutes respectively, and they had a life of between 30 and 40 playings (see Fig. 3). Here again it will be seen that the stylus has been turned to show the wear. The steel needles used varied only in thickness, the thickest giving a loud tone, and the thinnest and most flexible a soft tone. They were only used for one playing and then thrown away.

The rapid wear of the groove, however, caused a great deal of concern during these years to all those who valued their collections of records. Apart from the cost (some celebrity records cost over £1 even in those days), the increasing scratch became distress-

ing and every effort was made to reduce this apparently inevitable wear. Fibre and thorn needles were introduced in an effort to extend the life of the record and it is certain that they accomplished their purpose, although at some sacrifice in the reproduction of the higher frequencies.

Due to the use of wax for the original recording, the groove improved in shape and polish; more sensitive diaphragms permitted higher recorded velocities; and by 1925 the acoustic method of recording and reproduction had reached its limit of development. The frequency range was now approximately 160 to 2,000 cycles, and except for the gradual improvements in materials and manufacture this form of groove remained stabilized until the introduction of electrical recording in 1925.

The dynamics of this new technique made possible the recording of accelerations too violent for the existing reproducers, which sometimes destroyed the new records in a single playing; so improved sound boxes were designed for acoustic machines, and eventually pickups and electrical reproducers became available to cover the new requirements.

### Up to 5,000 C.P.S.

The frequency range of electrical reproducers quickly widened to include from 80 to 5,000 cycles (nearly 6 octaves), and even acoustic machines were designed on matched impedance principles.

*Mass* and *compliance* had become the major problem, which was energetically tackled; and by the end of World War II it was possible to record practically the entire audible range of frequencies from below 30 to over 15,000 cycles. Fig. 4 shows the remarkably clean groove of Decca's *ffrr* technique, and a sapphire stylus. The rapid development of this period soon exposed the fact that recording had out-distanced reproduction.

### Electrical Reproduction

The use of electrical reproduction for high fidelity purposes soon became universal, and pickups were quickly designed with smaller and smaller masses and improved compliance. Downward pressure of the stylus on the groove wall was measured in grammes instead of ounces.

The abrasive content of the disc material, too, was reduced to provide quieter surfaces, and the end of the era of steel needles came in sight. The groove became a true 90 degree "V" shape and sapphire styli began to appear again after being dormant for nearly

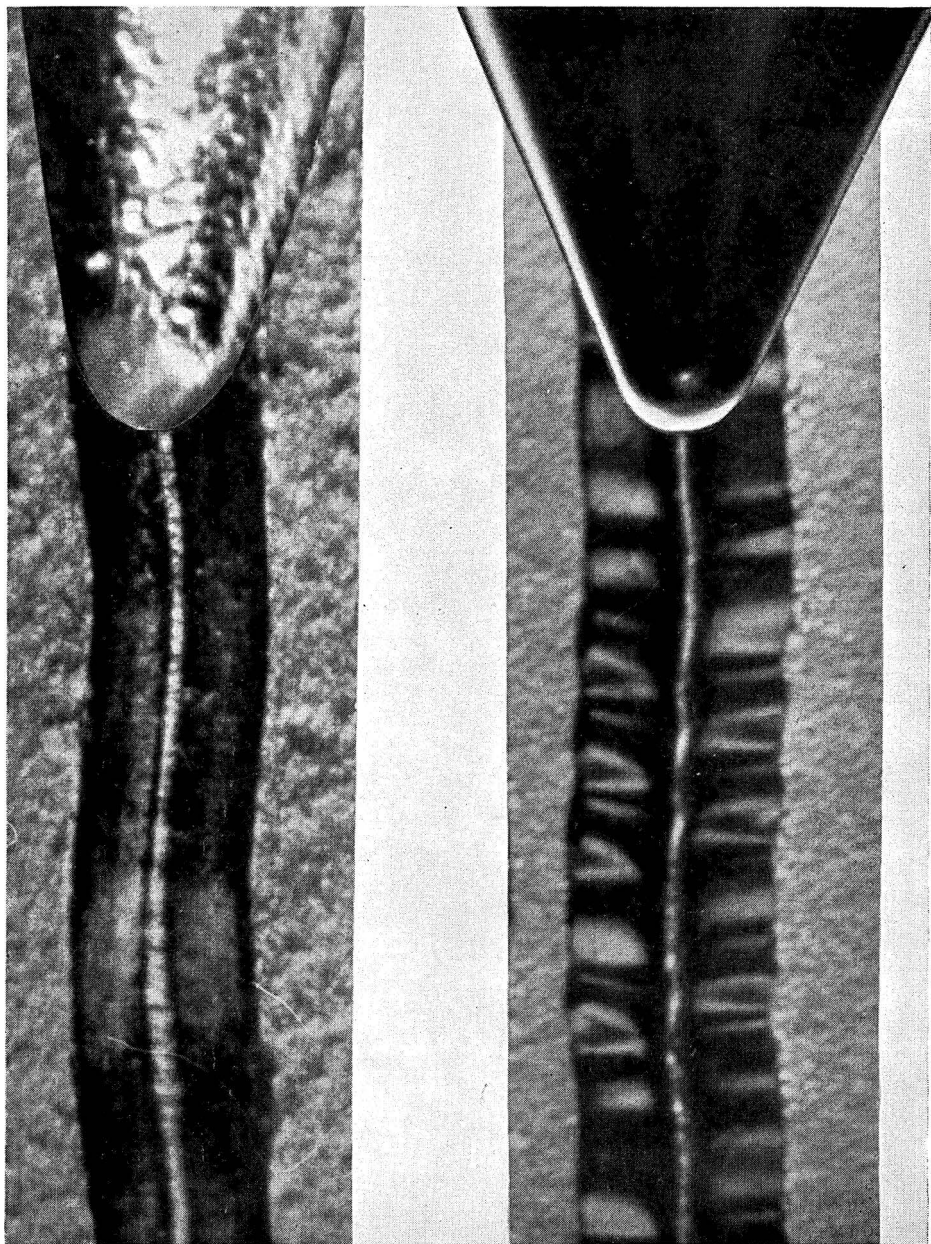

*Fig. 3. This illustration shows the groove of an early shellac pressing (1905), made from a wax master. As before, the stylus point has been turned so as to show the worn surface. The stylus is a steel needle. Comparison between this, and the next figure, shows the tremendous progress being made.*

*Fig. 4. This picture of a Decca f f r r standard (78 r.p.m.) pressing, together with a sapphire playing stylus enlarged to scale, shows clearly the advent of the higher frequencies to disc recordings. These can be seen as ripples, cut into the walls of the groove by the recording stylus.*

## THE GROOVE TODAY

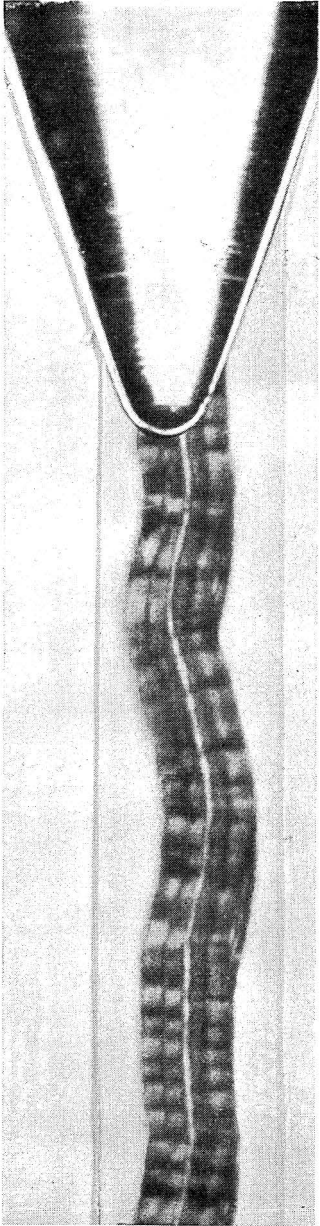

Fig. 5. Finally, we come to the present day, and the microgroove. This groove section, and its playing stylus, are enlarged to the same scale as all the others. The groove width is .003 in. and the stylus tip radius is .001 in. Compare it with the stylus of Fig. 1.

50 years. The dimensions of these styli were naturally very much reduced. Their accurately ground and polished tips permitted the adequate tracing of the full frequency range. Another great step forward came at about 1950, when the development of plastics provided an improved material for disc making; this had no abrasive filler.

### Enter the L.P.

It was now found possible to reduce the groove size to approximately half, and to reduce the speed of the turntable to  $33\frac{1}{3}$  r.p.m.—and still to maintain the full frequency range of recording, with the added advantage of much reduced surface noise. This also made possible a much longer playing time of up to 25 minutes per side, and it is this record which, during the following years, was developed to the long playing microgroove record of the present day. The groove size for this type of record is normally .003 in. wide and .0015 in. deep using a stylus tip of .001 in. radius (Fig. 5). Providing that dust and abrasive matter is prevented from remaining in the groove these records have a useful life of more than 100 playings with a stylus life to suit.

### Back to Hill-and-Dale ?

An intermediate speed of 45 r.p.m. is also used for records of shorter duration, using the same groove and stylus sizes. One can predict even smaller groove sizes, with slower linear speeds, as the development of the pickup progresses—and even a combined “Hill and Dale” and lateral groove for 2 channel or stereophonic reproduction. There are already signs that these are on the way.

One thing however is certain; to employ equipment even a few years old on a modern record, may well result in wiping out most of the beauty of the recorded sound, so the moral is obvious—*Don't play new records on old equipment.*

### THE PHOTOMICROGRAPHS

The unique illustrations (Figs. 1-5) on these pages are photomicrographs specially taken for this book by the author, Cecil Watts. They are all to the same magnification ( $\times 200$ ), and in each case the playing stylus has been superimposed at the top of the groove section, enlarged to scale, and turned through 90 degrees in order to show the wear at the area of contact. We are indebted to the Gramophone Exchange for providing the Edison cylinder for photographing.

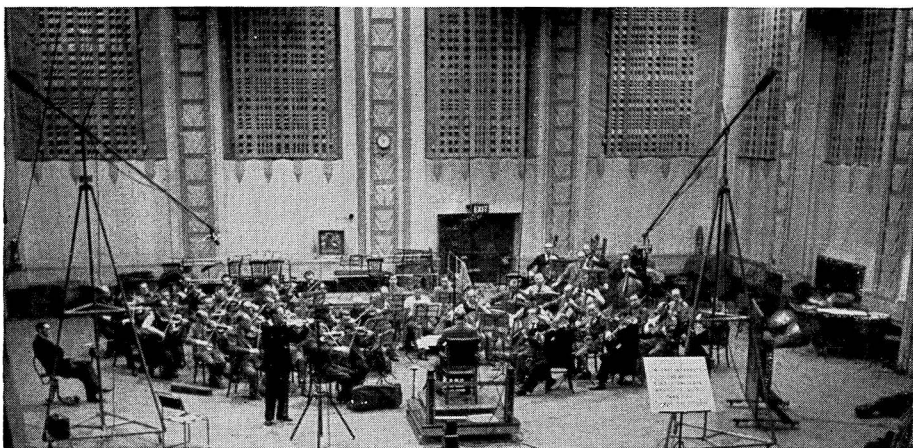

1. (above) Shows the recording of a symphonic work. Output from the microphone is fed via amplifiers to tape recorders. Many "takes" are made of quite short sections of the music.

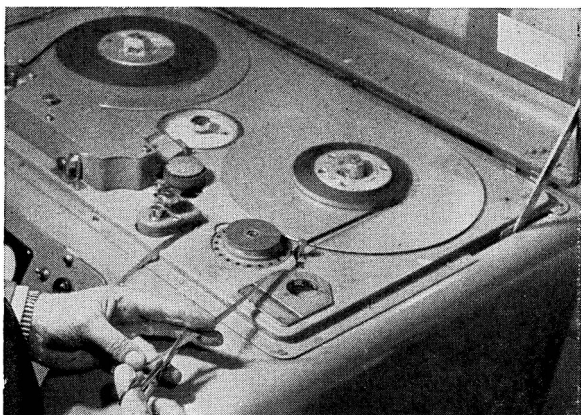

2. (left) Editing comes next. The best "takes" are selected and skilfully joined. Then with the musical score, and a pair of non-magnetic scissors, the editor prepares the final master tape from which discs will be made.

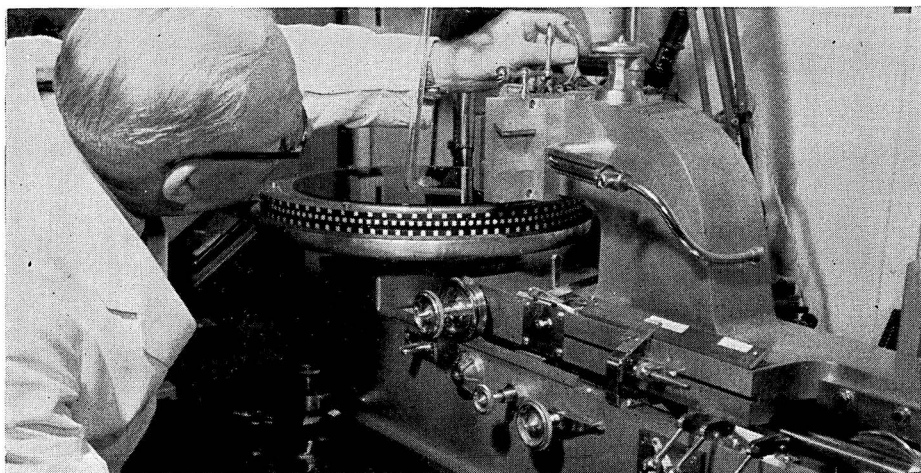

3. A lacquer disc is now cut from the tape recording.

# HOW A RECORD IS MADE

★ These ten pictures show the key operations in the making of a gramophone record, beginning with a recording session in the E.M.I. studio at St. Johns Wood, London.

The other shots were taken at the H.M.V. factory at Hayes, Middlesex.

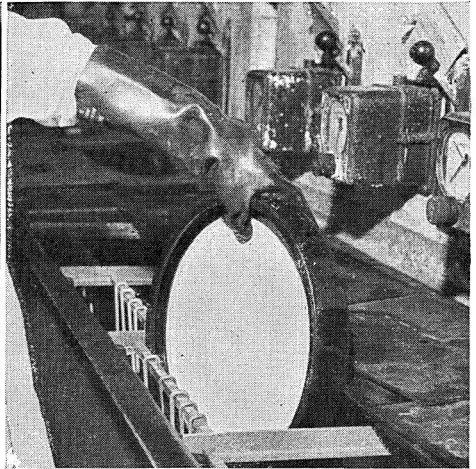
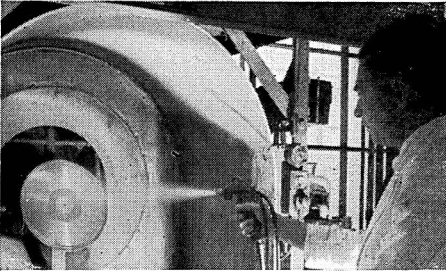

*A sprayed lacquer disc goes into the plating bath.*

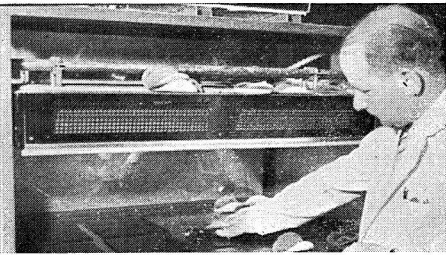

*The lacquer disc is sprayed (top left) with a silver solution, to make it electrically conductive. It is then immersed in a plating bath (top right) and a metal shell is "grown" on to its surface. This shell is the "Master." It is a **negative**, with ridges in place of grooves. To obtain copies, a second shell is grown from it, called the "Mother" (a positive with grooves) : and from the "Mother" are grown further numbers of negatives, the "Stampers." At bottom, a "Mother" is being stripped away from the "Master."*

[CONTINUED OVER





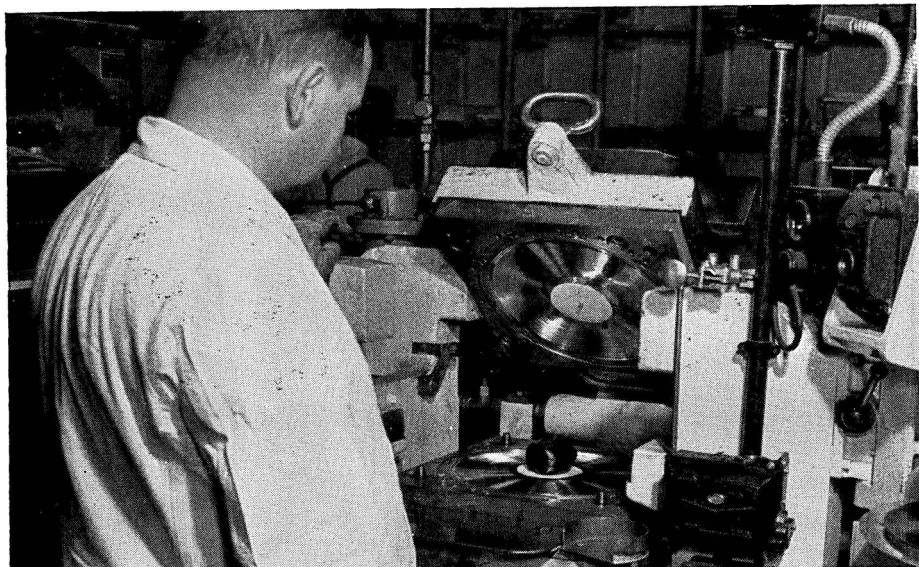

The plastic material, from which the 1-p.s and 45s are made, is a compound of vinyl co-polymers and other ingredients. After being thoroughly mixed, the material is rolled into a finely constituted, pliable "blanket." This is then re-rolled in a large conveyor machine (centre photo, page 15), so that it emerges at the thickness required, and automatically scored into "biscuits" which contain the exact amount of material for a 7-in., 10-in. or 12-in. disc. To prepare the biscuits for the presses, they are pre-heated in electric ovens, and then rolled into a suitable shape (lower photo, page 15).

Meanwhile, the presses are prepared, with a Stamper for each side of the disc to be made. The labels are placed in position, one against each Stamper, and a lump of pre-heated biscuit is placed at the centre of the lower Stamper (top photo). The press is closed, and heat is applied. Then, after a short interval, the press is opened, and the finished disc can be lifted out. The final photo shows a newly pressed 7-in. E.P. After trimming and inspection it will be slipped into its sleeve and despatched for sale.

# ACOUSTICS

By Stanley Kelly

(Introduction)

**S**OUND, by definition, is sensed by pressure vibrations acting on the drum of the ear. It results in a complex and intricate mechanical action through the ear mechanism which stimulates our mental perception. The transmission of sound from its source to the hearer occurs by means of longitudinal vibrations of the medium in which it is transmitted. Under normal circumstances, this medium is air, and we loosely refer to the transmission as "sound waves." What we hear are the disturbances (or sound waves) of the air immediately adjacent to the ear drum. We do not hear the source itself, this is because of the well-known physical fact that a thing or action can only occur at any one point in space at a particular time, and our appreciation of this is purely subjective. (Which poses the "\$64 question": "Does the sound of an explosion exist if no-one is within audible range to hear it?") From this, it follows that we need a *material elastic body* to transmit sound, and thus there can be *no* sound transmission in a vacuum. This is perhaps fortunate, otherwise the terrific explosions on the sun, seen by us as sunspots, might play havoc with our nerves. We are fortunate to find, in this increasingly noisier world, that the truly great forces of nature—electric fields, gravitation, cosmic rays, and so on—are silent.

## The Velocity of Sound

The velocity of sound is approximately 1,100 ft. per second in air under normal atmospheric conditions. Light waves travel about 186,000 miles per second, which is nearly a million times as fast; but these are of an entirely different type of wave motion, at present postulated as "non-material transverse vibrations in the ether."

We may therefore assume that waves are necessary for hearing, but they must be within a certain frequency range. Some sound waves vibrate too slowly for us to

hear them, although under certain circumstances we can perceive them by feeling. Others are too rapid, but we can detect them by specially designed instruments. The audible range is approximately 20 c.p.s. to 20,000 c.p.s.—in other words, a ratio of about 1,000 to 1.

It is difficult to form a mental picture of longitudinal vibrations, but ripples produced on the surface of a pond when a stone is thrown into it give a good analogy of sound waves. In place of the crests and troughs which we see on the pond, we have compressions and rarefactions of the air, caused by the microscopic movement of the air particles backwards and forwards in the direction of propagation.

## Goods Train Analogy

Another analogy is the goods train shunting backwards and forwards in the sidings: although the mean point of the goods train is stationary, the energy is transmitted from truck to truck in a series of bumps and pulls along the whole line—i.e., compressions and rarefactions of the sound wave travel outwards from the source, although the mean position of any individual air particle is stationary.

Energy is dissipated in the form of friction, and over a distance gradually disappears. The frequency of the "pushes" and "pulls" however, remains unchanged.

We can thus see that sound transmission depends on the transfer of energy by sound waves, which normally spread out in every direction, steadily expending their energy by heating the air and the obstacles in their path. The energy of the wave is derived from the source of sound. When the power supplied to the source ceases, the vibrations will rapidly diminish to zero and the sound waves will no longer be produced. The strength or intensity of these waves will depend on the efficiency of the coupling

between the sound producing mechanism and the sound wave.

Modern loudspeakers are a good example of this principle. The driving mechanism is usually a moving coil with a very small area. It does not therefore displace very much air, and so it cannot produce loud results by itself. But immediately we affix a piston, in the form of a diaphragm with a relatively large area to the coil, we make a much greater volume of air vibrate at the same velocity. By correct design, we can thus provide an optimum load which will suitably match the power available, thus resulting in efficient reproduction.

Other attributes of sound waves are *reflection, diffraction, interference*, and—most important of all—*resonance*. Resonance shows itself when the frequency of the sound wave is identical with the natural frequency of the object disturbed; its practical result is to augment considerably the loudness at that particular frequency, and it operates by virtue of its efficiency in loading and radiation.

### Resonance

For example, we have all at some time or other placed a sea shell to our ear to listen to the "sound of the sea"—the explanation is not far to seek. The air particles are always vibrating in random motion, and this can be shown to consist of frequencies of all values, some sub-audible, some in the audio range, and some supra-audible. The shell, by virtue of its dimensions, selects one or more of these frequencies by resonance, and greatly magnifies its effect on the ear. This effect was investigated by the German physicist Helmholtz, during the last century, and the Helmholtz resonator (or modifications of it) is used extensively in modern acoustics. The so-called vented enclosure, or reflex cabinet, is nothing more than an application of the Helmholtz resonator and the sea shell.

Without the effect of resonance, musical instruments as we know them today would be virtually impossible. Most wind instruments depend on the facts that an open-ended pipe will resonate at a particular frequency, primarily determined by its length, and that the longer the pipe the lower will be the frequency.

In the case of an organ, wind is blown on to a sharp lip at the base of the pipe and eddy currents or vortices are set up. These in turn excite the mass of air inside the tube, which oscillates most strongly at its resonant

frequency, which is selected by the geometrical configuration of the tube itself.

In the case of reed instruments, the reed is vibrated back and forth by the air supply, so that puffs of air are alternatively forced up the tube and into the free space; and again, by virtue of the resonance of the tube, an approximately pure single note is radiated.

In the case of stringed instruments, the volume of air displaced by the strings alone is extremely small, and the action is not very efficient. By mechanically connecting the strings on to the sounding board, the effective area is considerably increased. In this case, the strings are resonant, and determine the pitch of the note, and the body of the instrument is used as a sound radiator. Naturally, the body has one or more resonant frequencies of its own, but it is usually forced to vibrate at some frequency different from its natural frequency, and we get what are termed "forced vibrations." These "forced vibrations" usually tend to die away very rapidly, and although they do not materially alter the pitch of the note, they control to a large extent the quality or timbre of it. It is interesting to note that considerably more energy must be exerted by the artist in forcing the bow across the strings when they are efficiently coupled to the radiator than the strings alone, and anyone who has bowed a violin (low loading) and a double bass (high loading) will appreciate this fact.

### Harmonic Vibrations

Up to the present, we have considered sound vibrations as comprising one note only, which is usually termed simple harmonic motion. In actual life, the reverse is true. Most sounds around us are very complex. That is to say, they are made up of a number of waves of different frequencies existing simultaneously. Of course, any particular particle of air at any given instant can only be moving at one velocity, and in one given direction.

About 100 years ago, a mathematician by name of Fourier, proved that any complex wave can be broken down into a series of simple harmonic vibrations (or sine waves, as they are named by the technical) and that there would be a specific and definite mathematical relationship between each of the component waves forming the whole. In the case of musical instruments and voices, these complex waves consist of a fundamental note and a number of overtones.

These overtones usually bear a harmonic

relationship to the fundamental note. For instance, middle A on the piano is usually 440 c.p.s., but if the wave form from the piano is analysed, it will be found that in addition to 440, there will be 880, 1,340, 1,760 and other multiples of 440 c.p.s. present. It is these harmonics, and their relationship and amplitude to the fundamental and to each other, that determine the tone colouration of an instrument. They depend on the physical properties of that particular instrument, and they originate in natural resonance. In the case of percussion instruments, the overtones are generally inharmonic upper partials of a transient nature and defy any simple mathematical analysis.

The foregoing discussion has been devoted to sound waves of a relatively sustained nature, comprising one or more discreet frequencies, and it is this fact which distinguishes music, whether instrumental or vocal, from noise, which by definition is a completely random mixture of sound waves of all frequencies. (This does not, of course, refer to the efforts of some modern musicians and composers !)

#### Pitch and Loudness

We perceive the sounds around us by virtue of two attributes, *pitch* and *loudness*. The higher the frequency of a note, the higher does the pitch appear to be to the ear. And the greater the intensity of power in the wave, the louder does it sound. We measure frequency in cycles per second (c.p.s.), and power intensity in microwatts per square centimetre.

In order to appreciate intelligently any phenomenon, we must discuss it quantitatively. How do we express pitch and loudness? Let us take pitch first. If we strike lower C, middle C, and upper C in turn on a piano, we will note that there is a definite subjective relationship between them. The actual frequencies of the three notes should be 128, 256, and 512 c.p.s., but if we listen carefully, we will note that there is apparently the same difference in pitch between lower C and middle C as there is between middle C and upper C. In other words, the brain only appreciates the ratios of frequency, and not the absolute difference in cycles per second. We measure the pitch in terms of octaves, which is the ratio of exactly twice (or half) of one frequency to its partner.

In present day music, the octave is divided into 12 equal steps and these semitones (as they are termed for convenience) are divided

into 100 smaller steps, known as cents. A cent is approximately the smallest difference in pitch that a trained musician can distinguish. Because the octave is a frequency ratio of 2, the semitone is a frequency ratio of the 12th root of 2, which is a ratio of 1.06.

#### The "Tempered" Scale

In the case of the piano and other keyboard instruments, it is not possible to obtain a perfect diatonic scale, and the scale is accordingly "tempered" in order to mitigate the inharmonious effect of the inevitable inaccuracies of tuning. When this revolutionary idea was first brought up, some 300 years ago, there were earnest discussions among the musicians, who generally of one accord damned the idea and postulated that music was going to perdition. J. S. Bach fortunately proved them completely wrong with his "48 Preludes and Fugues for the Well-Tempered Clavier," showing that it was possible to modulate from one key to another without causing too much distress to any but the most obdurate longbeards. Although, even today, some violinists claim that the piano should never be allowed to play in concert with them because of small differences in tuning.

As with pitch, so we have similar difficulties in our perception of loudness with respect to power intensity. If we have three sounds of the same pitch, with power intensities of 0.1, 1, and 10 microwatts per sq. cm., the 10 microwatt sound will be sensed to be just as much louder than the 1 microwatt sound as the 1 microwatt sound is to the 0.1 microwatt sound. This power intensity ratio of 10 to 1 is used as a standard reference throughout the communications field, and it has been given the name of "Bell" in honour of Alexander Graham Bell, the inventor of the telephone.

#### Bells and Decibels

In practice we always refer to a Bell as 10 decibels (i.e., ten 1/10th of a Bell and written "10 db"). This is because the Bell is too large a ratio to be conveniently handled. The decibel, mathematically expressed, is a power ratio of approximately 1.25 to 1. We can therefore say that there is a difference of 1 db in power of two sounds, when one contains approximately 25 per cent. more power than the other.

To summarise, pitch is the subjective interpretation by the brain of frequency, as is loudness to that of power intensity. The two are somewhat inter-related, but that need not concern us at this stage.

# AUDIO FREQUENCIES

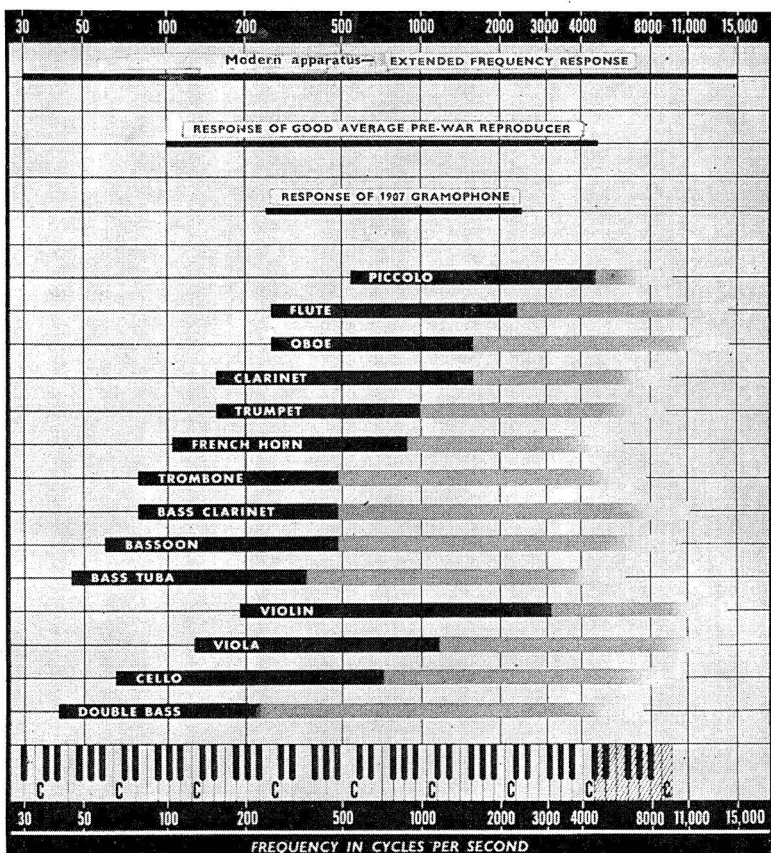

★ This chart shows the audio ranges of various instruments, with harmonics shaded—and shows the need for good equipment.

TABLE 1

Tonic Sol-fa .. .. .	Doh	Re	Mi	Fa	Sol	La	Ti	Doh
Vibration Nos. .. .. .	24	27	30	32	35	40	45	48
Interval between adjacent Notes ..	$\frac{9}{8}$	$\frac{10}{9}$	$\frac{16}{15}$	$\frac{9}{8}$	$\frac{10}{9}$	$\frac{9}{8}$	$\frac{16}{15}$	
Interval from Key Note .. .. .	$\frac{9}{8}$	$\frac{5}{4}$	$\frac{4}{3}$	$\frac{3}{2}$	$\frac{5}{3}$	$\frac{15}{8}$		2
Philosophical Scale .. .. .	256	288	320	341.33	384	426.66	48	512
Helmholtz Scale, Key C .. .. .	C	D	E	F	G	A	B	C <sup>1</sup>

TABLE 2

Note .. .. .	C	D	E	F	G	A	B	C <sup>1</sup>	D <sup>1</sup>
Diatonic .. .. .	256	288	320	341.3	384	426.6	480	512	576
Interval .. .. .	1.125	1.11	1.067	1.125	1.11	1.125	1.067	1.125	
Equal Temperament .. .. .	256	287.4	322.5	341.7	383.6	430.6	483	512	575
Interval .. .. .	1.12	1.12	1.06	1.12	1.12	1.12	1.06	1.12	

# ACOUSTICS

## Chapter 2

WESTERN music is built round a system of eight notes, commonly called the *diatonic* scale. The eight basic notes are doh, re, mi, fa, sol, la, ti, doh. The ratio between two notes is termed an interval, which between adjacent notes of an "untempered" scale is either  $9/8$ ,  $10/9$ , or  $16/15$ . The first two are termed major and minor tones respectively, and the smallest,  $16/15$ , is a semitone. Table 1 gives these ratios (page 20). Four semitones are also fitted between the main tones to give a total of twelve semitones for the octave. This augmented scale is normally called a *chromatic* scale. Among other scales is the *minor diatonic*, obtained by reducing the major interval in the major diatonic scale by a semitone. The diatonic scale is probably the most sophisticated in use. Primitive people use simpler systems. One such is the *pentatonic*, or five note scale, which in key C consists of C D E G A, C octave (notes F and B are omitted). Most primitive people use this scale and its intervals are approximately the same as bagpipes, although according to the Scots there is a major distinction.

### The Musical Scales

When the Greek civilisation was young, scales were in common use, and it is presumed that they arose principally by chance, followed by intuition, and at a much later date by reasoning. Pythagoras was the first known philosopher to introduce any scientific computation into the building of these scales, and pointed out that chords, which sounded harmonious, always comprised notes of which the frequencies were in a simple ratio. The most satisfying chord is that of octaves (ratio  $2/1$ ); the next occurs in a major fifth (ratio  $3/2$ ). In most mixed choirs, the males sing an octave lower, although "Sweet Adeline" is usually sung in fifths—this apparently being due to the natural tendency of uninhibited males to sing in this interval. It is also true of primitive races.

Musical instruments may be classified under three headings: percussion, wind and strings. Although percussion instruments

produce essentially transient sounds, some of them are tuned (kettle-drum, triangle, etc.) whilst others just make a loud noise at the appropriate moment (cymbals, big drum, clappers, etc.). Wind instruments, with the exception of the organ, are blown mainly by expired air. They consist of reed instruments (clarinets, saxophones, etc.); simple tubes in which the sound is produced by blowing across the opening (flute, piccolo, etc.); and the remainder, principally brass, in which the vibrations are produced by the lips (bugle, cornet, trombone, etc.).

### Cornet, Clarinet and Big Trombone

The strings produce sound by being hammered (pianoforte), plucked (harp), and bowed (violins). Of the whole gamut of instruments of the orchestra, only one type of wind instrument (the trombone), and of all the strings only the violin family, can give an unlimited number of notes within their respective ranges. With the other instruments the number of notes is fixed—in the case of keyboard instruments, by the number of keys; and in the case of blown instruments, by the resonant length of tube contained in it—this length being controlled either by pistons (cornet, French horn, etc.), or by covering holes in the side of the tube (clarinet, and so forth).

### Musical Intervals

In the true mathematical scale, modulation from one key to another implies that the interval in the new scale will always be enharmonic. Unfortunately, with the basic octave of twelve semitones tuned in diatonic fashion, it is not possible to modulate from one key to another. In point of fact, in the case of a piano some fifty keys per octave would be necessary if the intervals were to be maintained exactly. Entirely apart from the fact that the pianist is only blessed with ten digits, a piano possessing 362 keys is clearly an impractical engineering proposition. This difficulty is removed (in part) by a practical compromise; that is, the intervals between adjacent semitones are arranged to be equal,

the scale is then said to be "tempered," and musicians usually refer to this as the scale of "equal temperament." Table 2 (page 20) shows frequencies and intervals in the scale of C for diatonic and equal temperament notations.

Theoretically, this difference is important ; but, practically, we seem to get along very well for all its academic disadvantages. This is especially so when during the course of an evening's hard work, due solely to the heating of the atmosphere, the pitch of the wind instruments rises by anything from one to three cents. Whilst the philosophical pitch A is 426.7 c.p.s., musicians have standardised it at 440 c.p.s. ; although during the latter part of the 19th century the London Philharmonic actually raised the pitch of A to 467 c.p.s., which of course must have rendered life very difficult for the purists blessed with absolute pitch.

### A Little Mathematics

In order that progress in any art or science may take place, it is necessary that precise quantitative information be accumulated, stored, and made available to all interested parties ; and the simplest and most precise manner in which this can be effected is by means of mathematical equations. These equations are, however, not necessarily fundamental truths, but the recorded observations of experimenters who believe them to be factual. Where they are confirmed by other disinterested parties over a period of time, they become accepted as fundamental truths.

In the preceding article, we mentioned that sound is produced by alternate rarefactions and compressions of air, and that it is transmitted through the medium in straight lines with a finite velocity, "v" :

$$v = \sqrt{\frac{E}{\rho}}$$

where E is the elasticity, i.e., the ratio of the change in pressure to the corresponding change of volume per unit volume, and  $\rho$  is the density and = 0.00121 gms. per c.c. at 20 deg. C. and 760 mm. mercury atmospheric pressure. Under these conditions, the velocity of sound is 34,300 cm. per sec., and it will be seen that this expression does not contain frequency. We can therefore infer that all frequencies are transmitted at the same velocity.

Because of the economic importance of electrical engineering, a tremendous amount of effort has been expended in developing powerful mathematical tools for solving the many problems, and by a system of

"dynamical analogues" it is possible to apply electrical concepts to both mechanical and acoustical engineering, and it is usual in the case of acoustics to use the following equivalents :

- (1) *Pressure* (dynes/cm.<sup>2</sup>) = *Electro Motive Force* (volts).
- (2) *Volume Current* (c.c./sec.) = *Current* (amps).
- (3) *Acoustical Impedance* (gms./cm.<sup>2</sup>) = *Electrical Impedance* (ohms).

These fundamental parameters can be expanded to cover all quantities and conditions.

It is customary when designing acoustic circuits to use the concept of *impedance*, and it can be shown that the specific acoustic impedance Z of a medium =  $\rho c$ . This is a real quantity for plane progressive waves, and is not true for standing plane waves or spherical waves (these two latter conditions will not be covered in this Article). Under normal atmospheric conditions, the standard characteristic impedance of air is usually taken at 41.5 acoustic ohms (gms./cm.<sup>2</sup>).

### Intensity

*Intensity* :—The most commonly used standard of intensity is that of 1,000 c.p.s. pure tone, adjusted to be barely audible to normal human ears. It corresponds to 10<sup>-16</sup> watts per cm.<sup>2</sup>, and also to an R.M.S. amplitude of 0.000204 dynes per cm.<sup>2</sup>. This base is the generally accepted one for calibrating audiometers, noise-meters, etc. Table 3 (page 24) shows some common noises based on this reference level. For scientific work, the usual intensity standard is that corresponding to an R.M.S. pressure of 1 dyne per cm.<sup>2</sup>

### Loudness

*Loudness* :—The loudness of a sound is basically dependent upon the intensity ; but because loudness is purely subjective, it thus follows that a sound of a given intensity will not appear to be equally loud to different observers. Various arbitrary scales have been suggested, but the one in common use is based on equal ratios. Unfortunately, the ear is not equally sensitive to sounds of different frequency, and the loudness of the received note depends also upon its pitch. The true loudness scale must be so constructed that when the units are doubled the sensation will be doubled, and that their relationship will always be linear. The ear is most sensitive in the 3,000 c.p.s. to 4,000 c.p.s. frequency band, and its sensitivity decreases above and below these frequencies.

It has been experimentally determined that, for equal loudness at various frequencies, the intensity of these frequencies will vary, and the system of "equal loudness contours" has been evolved. Fig. 1 shows the response

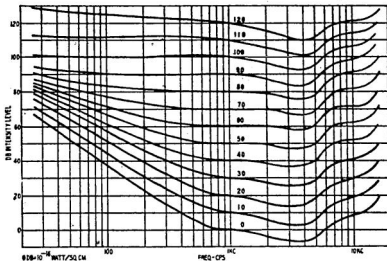

FIG. 1

of a normal ear. It will be noticed that the intensity level is given in decibels.

(For the scientifically minded, the decibel scale is based on the intensity level. It is actually ten times the logarithm of the sound's intensity, to the reference intensity of 10-16 watts/cm<sup>2</sup>—which is the approximate minimum sound detectable by normal human beings. It can also be expressed in terms of pressure. In this case the actual level, expressed in decibels, is twenty times the logarithm of the ratio of the sound pressure to the reference pressure of 0.0002 dynes per square centimetre. For scientific work, the reference is one millionth of normal atmospheric pressure, and is actually one dyne per square centimetre.)

### Pitch

*Pitch* :—Pitch is the subjective quality of sound which determines its position in a musical scale. Frequency is defined as the number of cycles per second of a given wave. Because the apparent pitch of a given tone is a function of the intensity of that tone, pitch is specified as the frequency of a pure tone at any given sound pressure which, to the average hearer, occupies the same position in a musical scale. There is a variation in frequency of notes of constant pitch, thus it will be seen that pitch and frequency are *not* the same thing.

### Resonance

*Resonance* :—Resonance will occur in any system where there is coupled mass and stiffness, and the amplitude of the resonance will be determined by the losses in the circuit. The basic acoustic resonator was investigated by Helmholtz, and usually bears

his name. It consists of an enclosed cavity in which the electrical analogue of the contained air exhibits the characteristics of a capacitance. This is usually termed the "acoustic compliance," and is defined as the volume displacement that is produced by the application of unit pressure.

(Those of us who recall sixth form physics will remember the formula for acoustic compliance. Briefly, it is the ratio of the velocity of sound in air, times its density. Also, the inductance of an acoustic element is the ratio of its effective mass to the square of the cross-sectional area of the duct : it is analogous to electrical inductance.)

Resonance will occur when the acoustic reactance is equal to zero. This is only true where there are no losses in the circuit ; in physical resonators the losses are sufficiently small, and the above expression gives the resonant frequency within the limits of experimental error.

If the resonator is excited by means of a piston fixed in its wall, the impedance presented to the piston will be a function of frequency, rising to a maximum at resonance; and this effect is made use of in vented enclosures to reduce distortion and increase the low frequency response of loudspeakers. Figs. 2 and 3 are the physical results of this formula when applied to the vented enclosure. Generally, the constants known are the resonant frequency of the speaker, the piston diameter (the actual projected cone diameter where it cuts the anulus), and the proposed volume of the cabinet. Usually it is wise to make the area of the port equal to the piston area for optimum loading.

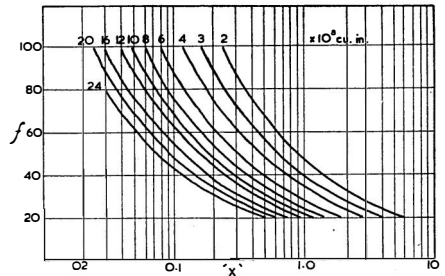

FIG. 2

As an illustration, let us take an actual case. A 12 in. loudspeaker, resonant frequency 45 c.p.s., effective cone diameter 10 in., effective cone area 78.5 in.<sup>2</sup>, volume



of cabinet 6 cu. ft. Enter chart, Fig. 2, at 45 c.p.s. until it crosses a curve at 6 cu. ft. (10,600 cu. in.); project downwards to determine value of  $X = 0.18$ . The line  $X = .18$  in Fig. 3 relates the length to the area of the port for all combinations to resonate the volume to 45 c.p.s. For area of port = 78.5 in.<sup>2</sup>, length is seen to be = 6 in.

The foregoing has assumed that the maximum dimension of the resonator is considerably less than one wavelength. Where the dimensions of the enclosure are comparable to a wavelength, the above simple terms will not hold, and it must be treated as a complex resonator having numerous allowed modes of vibration. If it is rectangular, the normal modes will be perpendicular to each other, corresponding to length, width and breadth. They will occur at frequencies at which the particular room dimension is a multiple of half wavelengths.

Cross resonances in loudspeaker cabinets would only become troublesome above a few

hundred c.p.s. and are damped out by means of felt fixed to the cabinet walls, but in the case of normal listening rooms, complex resonances will be found at frequencies below 200 c.p.s. For a room 16 ft. × 12 ft. × 8 ft., the following resonant frequencies will be found for the first three modes of vibration :-

c.p.s.	c.p.s.	c.p.s.	c.p.s.
35	77	96	112
46	83	98	115
57	90	102	120
69	92	107	125

These resonant modes are very important in that they can considerably colour the reproduction from a supposedly flat loudspeaker. Their effect on reproduced sound will be controlled by the absorption coefficient of the walls of the chamber, and as this coefficient decreases from 0.99, their effect becomes increasingly evident.

In a room with infinitely hard walls, and perfect reflecting surfaces, the decay of the sound wave will be due only to the viscosity

**TABLE 3**

VARIOUS NOISES AND ORCHESTRAL EFFECTS	R.M.S. SOUND	SOUND	POWER
	PRESSURE IN Dynes per sq. cm.	INTENSITIES Microwatts per sq. cm.	LEVEL Decibels
Threshold ... ..	0.000204	10-10	0
	0.000363	3.165 × 10-10	5
	0.000645	10-9	10
	0.001146	3.165 × 10-9	15
Whisper 4 ft. from source ...	0.000204	10-8	20
	0.00363	3.165 × 10-8	25
Soft Violin 12 ft. from source	0.00645	10-7	30
	0.01146	3.165 × 10-7	35
	0.0204	10-6	40
	0.036	3.165 × 10-6	45
Bell F4 160 ft. from source	0.0645	10-5	50
Ordinary conversation 3 ft. from source ... ..	0.1146	3.165 × 10-5	55
	0.204	10-4	60
	0.363	3.165 × 10-4	65
Bell F2 160 ft. from source ...	0.645	10-3	70
	1.146	3.165 × 10-3	75
Full Orchestra			
Bell F4 6 ft. from source ...	2.04	10-2	80
	3.63	3.165 × 10-2	85
	6.45	10-1	90
	11.46	0.3165	95
	20.4	1.0	100
Bell F2 6 ft. from source			
	36.3	3.165	105
Thunder ... ..	64.5	10.0	110
Hammer 2 ft. from source ...	114.6	31.65	115
	204	100.00	120
	363	316.5	125
Threshold of Pain ... ..	645	1000.0	130

of the air, and the reverberation time (that is the time for the incident sound to die away completely) will be an indefinitely long time. The reverberation time of a room is of extreme importance, both for the studio where the sound originates, and for the listening room where it is reproduced.

In the case of our mediaeval churches with relatively lossless (acoustical) construction, the reverberation time was considerable and it is a sobering thought that in order to get reasonable articulation efficiency, the delivery of the sermon and of the singing had to be correspondingly slow, and it may be that the reactionary attitude of the mediaeval church to the development of music was conditioned by this fact. It was not until the quantitative measurements by Sabine, in the last decade of the 19th century, that the superstitious awe of the laymen (and sad to say of the engineer) concerning the fundamentals of architectural acoustics were superseded by a firm foundation of scientific knowledge.

Sabine's definition of reverberation time was, the time in seconds required for an initial sound to die away to zero. In practice, this was a volume range of 60 db.

This formula was arrived at experimentally, and is  $T = \frac{0.05V}{a}$ . The only information

required being the volume, V, and the total absorption, a.

The best description of "total absorption" is an open window, and all absorption coefficients are given in ratios to this concept. It is rather shattering that, acoustically at

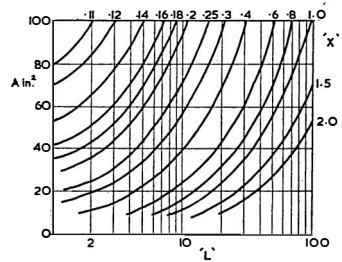
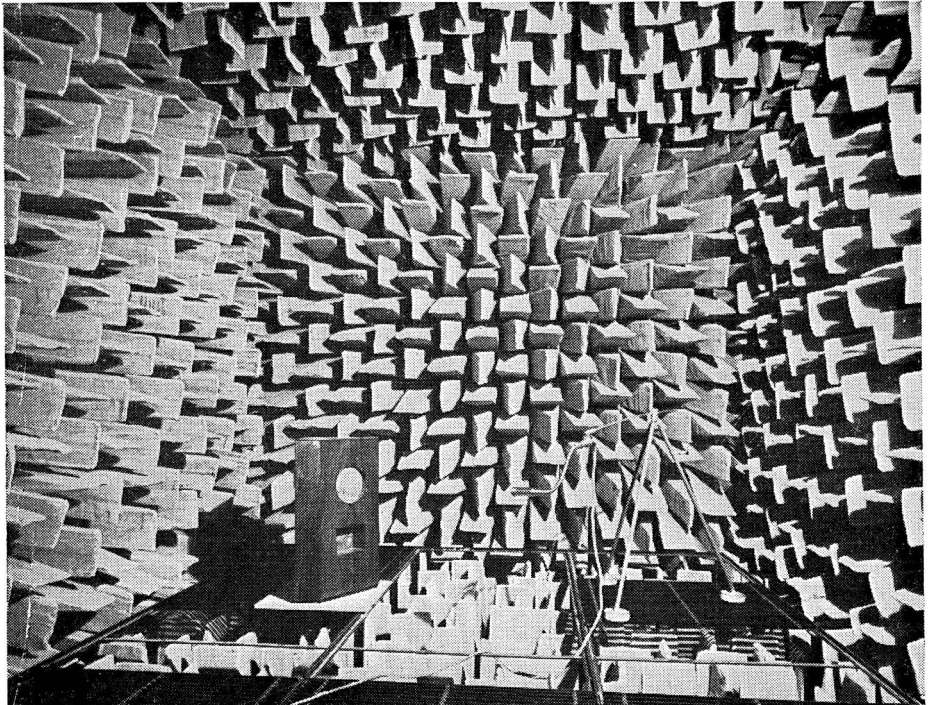

FIG. 3

least, a human being is only equal to 4.5 sq. ft. of empty space. There is a definite relationship between the volume of a room



★ The absolute opposite to the hard-walled rooms and reverberating mediaeval churches mentioned above by Stanley Kelly, is this anechoic room of uncanny silence described overleaf.

and its ideal reverberation time for optimum listening conditions ; for the concert hall, 1.5 to 2 seconds seems about right, although it is controlled by the hall dimensions. Additionally, there is an optimum ratio between the number of instruments in the orchestra and the total absorption of the room. On average, each instrument produces energy at a rate equal to 200 units (square feet of open window or equivalent) of absorption. If the hall does not provide sufficient absorption, the resultant sound will be overpowering ; and if the absorption (sometimes called damping) is too great the

music will be thin and weak. This also applies to the room where music is reproduced, and the brilliance or otherwise of a recording can be controlled by the amount and disposition of the damping materials (rugs, furniture, drapes, etc.) in the room.

Thus, we see that acoustics, the Cinderella of the sciences, is a major factor in the concept and realisation of " Hi-Fi " and the increased enjoyment which can be obtained from even modest equipment when used under the optimum listening conditions will more than repay the time spent obtaining them.

## THE GOODMANS ANECHOIC ROOM

By P. D. Collings-Wells

THE object of anechoic rooms is to stimulate free space conditions, making possible absolute acoustic measurements whose accuracy is such that results obtained can be used not only for research and development, but also as a basis of discussion on technical points with national and commercial laboratories throughout the world.

When the anechoic room was being designed, it was considered essential to prevent structurally borne vibrations from disturbing the sensitive measurements planned ; and so the " room within a room " construction was resorted to. The complete room, with external masonry, was suspended on rubber, this forming the only contact with the remainder of the building. The effectiveness of this treatment can be gauged by the fact that although all the rail traffic to London's Euston station, as well as the local electric service, passes within 100 feet of the room, and vibrates the whole building, the vibration that reaches the interior of the room is negligible, and only just detectable.

The room occupies 4,500 cubic feet, and all its internal surfaces have a lining of bonded glass fibre to a thickness of three feet. In order to provide efficient breakup of all surfaces, the glass fibre is made into wedges, each wedge having a base area of 64 square inches. The picture on page 25 shows the style of construction. A light steel grating, or " cat-walk," is provided a few inches above the tips of the wedges lining the floor to enable apparatus to be positioned. The grating can then be removed to leave a minimum number of reflecting surfaces. The door of the room is unusual in its method of operation. It is extremely heavy, and physically is of the same construction and lining as the walls. This makes it very bulky,

and it would occupy a large amount of space when open if it were hinged in the conventional manner. Accordingly, it was arranged for the door to move in the manner of a portcullis ; and electro-hydraulic apparatus was installed to raise the door into a tower on the roof of the building ; this and the lowering operation being controlled by two " lift " button switches.

The effectiveness of the room from the acoustic viewpoint has been proved by measurements showing the very close adherence to the inverse square law of sound intensity reduction with increasing distance from the source, under free field conditions. Effects produced within the room are recorded on a high speed level recorder. This will indicate on a moving chart any changes of sound pressure which occur at the measuring position, and can faithfully record changes in pressure which may be as rapid as 1,000 decibels per second. This recorder can be mechanically linked to a beat frequency oscillator, thereby providing a direct frequency scale as the x-axis. The oscillator in turn can be coupled to a mechanism which will interrupt the wave train being fed to a loudspeaker under test ; the interruptions can be made at any desired rate, and since the frequency of the signal is continuously varying, a complete set of decay curves can be obtained, spaced only a few cycles apart throughout the whole audio range. By this means it is possible to detect not only poor acoustical damping and stray resonances in loudspeaker baffles and enclosures, but also similar features in loudspeakers themselves. Diaphragm behaviour at high frequencies is often so complex that this method provides the only means of locating certain undesirable modes of vibration.

# WHAT IS Hi-Fi?

HI-FI is the accepted abbreviation for the term High Fidelity; and High Fidelity is the term adopted by a wide and growing public to sum up high quality sound reproduction. It is at once a goal for the enthusiast, a tag for the manufacturer of sound equipment, and a trap for the unwary. The enthusiast knows that, however he experiments, he will still die without having achieved Complete Fidelity. The manufacturer of good equipment, who knows that his products are as good as his skill and modern knowledge can make them, is well entitled to advertise them as "Hi-Fi"; but he often shrinks from doing so, because the term is so much abused by others who hang the Hi-Fi label upon equipment which has no right to that classification. And it is this factor which provides the trap for the newcomer, who may often be tempted to buy in good faith, when a little experience would have made him look further afield.

## A Guide to Value

*The only broad guide that one can give to the uninformed buyer is this. Do not expect to get "Hi-Fi" results from equipment that cannot, by reason of its cheapness, possibly be built up of components good enough to provide the results desired.*

Perhaps some manufacturer will one day register and use the name "Potiphar" for his amplifier or speaker; but even then, in terms of sound recording and reproduction, "High Fidelity" will always be as slightly elastic as that legendary lady's girdle, for it is as technically impossible to achieve a completely accurate reproduction of a remotely recorded sound picture as it is to qualify the meaning of the word Fidelity.

Fidelity means faithfulness. A bank manager would not employ a clerk with a reference endorsed "Hi-Ho." He would demand, simply, "Honesty," and nothing less. Nevertheless, "Hi-Fi" is a good tag for its subject, because it has acquired (if used carefully) the exact meaning that is intended, and only one example is needed to explain it.

Twenty years ago, for haphazard instance, pick-ups, amplifiers and speakers were made

for the reproduction of sound, as recorded on gramophone records. This equipment, assembled and used by a small band of enthusiasts, was nicknamed "Hi-Fi," and the sounds that it reproduced represented a reasonably good copy of the sound recorded on the discs of the day. But those discs, good as they seemed then, had not captured nearly as much of the original as the discs of 1956 will hold. And the equipment of that day, adequate as it then was for the job, is well out of date today. The "degree of Fidelity" has altered. Recording engineers have improved the pattern, and makers of reproducing equipment have taken full advantage of it. But, by the same token, the recorded sound of 1966, and the reproducers of that era, should undoubtedly provide a greater "degree of Fidelity"—a "Higher-Fi"—for listeners than that which we accept as top-grade today. So we must think of "Hi-Fi" as a tag to denote *the best possible*.

## Hi-Fi and Higher-Fi

This leads immediately to another important qualification which demands explanation, for it confuses almost every newcomer to the field; and there must be no dodging the issue where price is concerned. Readers of this book, in common with everyone who has studied the various advertisements of equipment manufacturers, are bound to wonder why, for instance, an amplifier costing £42, and described as "Hi-Fi" can be all that much better than another amplifier costing £24 and described in the same terms. And why, for further example, a pick-up costing £5 should come into the "Hi-Fi" category when another maker demands £20 for what he insists is "Hi-Fi," and the best!

The simplest way of answering the question—until a study of this book has given readers a much broader understanding of the whole affair—is to repeat the phrase used a couple of paragraphs back, "*the best possible*," and to add on to it the qualification, "*for the money available*." And one must, in all sincerity, add the further rider, "*to satisfy the needs of the purchaser*."

Coming a bit closer to the point at issue, there are thousands of people who, having

never appreciated good quality sound, will be entranced by the quality of a £60—£80 set of equipment, and who will hear so much that they did not know it was possible to hear that, to them, *at that stage*, the £60—£80 outlay is sufficient. Even if pressed to listen to something better, they could not take in the difference. But later, having become acclimatised to what was once “good,” they are ready to listen for extra sound.

Therefore, look at the term “Hi-Fi” in a sensible, everyday setting, as an ambition rather than as a hurdle of fixed height that must be jumped. All other factors dismissed, the occupier of a room measuring 12 by 8 feet might endure agonies of frustration if he installed a £200 reproducer in it; for not only would a £100 have given him all the quality and value that the space needed, but he could neither appreciate the extra that he had paid for, nor spare the floor space that it demanded.

#### Choose in Advance

Look upon the selection of apparatus to be found in this Year Book as a collection of high quality units. *Any group of these units, chosen according to the space and money available, as a correctly integrated system, will provide a quality of sound reproduction that is well within the meaning of the term “Hi-Fi.”*

Be satisfied, too, that with a set of “Hi-Fi” equipment, properly used, it is possible to hear, from a record or a radio transmission or a spool of magnetic tape, a reproduction of the original sound in the studio so nearly a faithful copy of the original that average human ears will not mind the difference—if they notice it.

That, then, is “Hi-Fi” in broad terms. It cannot be obtained unless minimum standards are insisted upon, and paid for. Beyond those standards, according to the degree of enthusiasm available, and the amount of money to be spent, there is a lot of fun to be found, by going in search of higher and higher degrees of Fi.

#### FOR FURTHER READING

★ Strongly recommended for additional reading on the subject of High Fidelity are three books by G. A. Briggs: “Sound Reproduction,” “Loudspeakers” (The Why and How of good reproduction), and, just published, “High Fidelity”, the why and how for amateurs.

★ For up-to-date reviews and articles the two monthly periodicals “Record News” and “Hi-Fi News” cover the whole field of classical l.p.s and equipment.

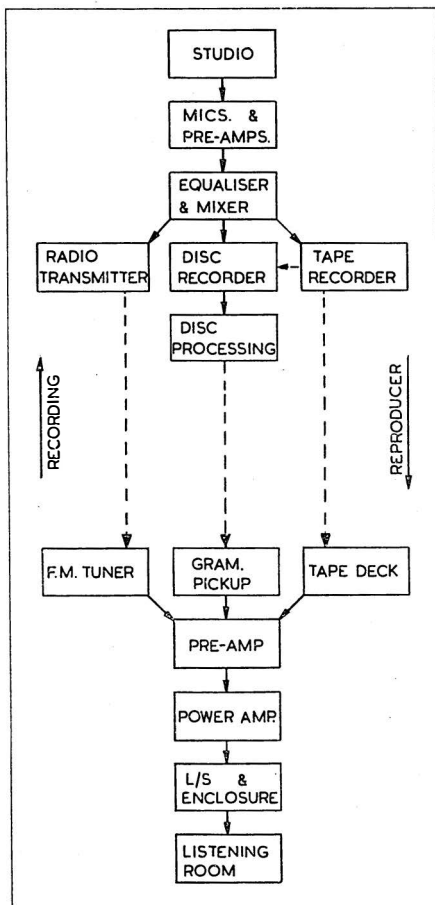

The diagram above shows the complete set-up of all the factors involved in the high fidelity chain, from studio to listening room. With the exception of broadcast transmitters, with their equalising and mixing equipment, which are outside the scope of this book, the links in the above chain are all discussed in their appropriate chapters and sections. By way of summary, the whole chain is dealt with, link by link, in the following chapter, “Requirements of Hi-Fi.” Readers with a mind for technical information will find certain formulae and diagrams in the sections on Acoustics, Styli, and Pickups. Readers who wish to dodge these issues will find that the sections can be read without reference to them. The story is complete, either way!

# Hi-Fi REQUIREMENTS

By Stanley Kelly

WE cannot do better here than briefly run through the chain of events, from the original creation of the sound in the studio, to its re-creation in the listener's home. The whole gamut of physical science is involved : namely acoustics, mechanics, electricity and magnetism ; and it is only by their correct integration that we can hope even to approximate the original sound. Before we get too enthusiastic, let us state categorically that, within the dictionary meaning of fidelity, we are asking an impossibly high standard for home reproduction ; but it is possible, with the latest equipment correctly used, to create an illusion which will satisfy everyone except the hypercritical pedant.

## The Sound in the Studio

The original sound may be created (in the case of a soloist or small chamber orchestra) in a tiny studio, 15 × 20 ft. ; or again, for symphonic works, in the vastness of the Royal Albert Hall ; and the "character" of the acoustics of the studio will impress itself on the recording. Varying microphone techniques are used in order to bring pre-eminence to a particular instrument—especially in mood music, where as many as ten microphones may be used for a single recording. In such cases, particular units are faded in at the psychological moment by the recording engineer to obtain the exact interpretation desired by the artist (Fig. 1, page 30). Thus, the absolute limit of each excursion into high fidelity is determined once and for all in the recording studio, by the acoustics of the room, and the skill of the recording engineer. And let it be said here and now that, in the hands of the best exponents of the art, this degree of excellence leaves nothing to be desired.

The acoustics of the studio are so arranged that the amount of reflected sound (and thus the reverberation) are optimum for the class of music being performed ; but where special effects are required, extra rooms

known as "echo" rooms may be pressed into service to give the required degree of "ambience" to the performance. The microphones and associated amplifiers are usually equalised to give a faithful response from 30 c.p.s. to 18,000 c.p.s., and in some cases, 20,000 c.p.s. The total distortion generated by them is considerably less than a 10th of 1 per cent.

Nowadays, the majority of recordings are initially made on tape, and the precision and workmanship of the modern professional tape recorder must be seen to be believed, with the result that the master tape has a corrected frequency response of 30 to 15,000 c.p.s.  $\pm$  1 db, including microphone, pre-amplifiers, and a total distortion of about 0.2 per cent. This response is a basic response, and where recordings are made outside the strictly controlled studio, both the bass and treble levels may be modified to suit the conditions of the concert hall where the recording is taking place. In all cases, however, these modifications to the basic response curves are made subjectively by listening through a high fidelity monitoring loudspeaker, and the recording is not made until the engineer and artist are satisfied that optimum results are being obtained.

## Discs from Tapes

The gramophone disc "masters" are then produced from the tape. The modifications of the basic "straight line" frequency response are applied to the disc recording amplifier at this stage, to give the correct "recording characteristic." After the various processes, the ubiquitous record is pressed ; and it is surprising but true that, when played back with suitable apparatus, the best of modern records are flat within  $\pm$  2 db from 30 to 15,000 c.p.s., and the total distortion introduced by all causes, throughout the whole recording and reproducing chain, is less than 1 per cent. *This should be compared with an average domestic radio receiver, in*

which the frequency range is rarely greater than 100 c.p.s. to 6,000 c.p.s.,  $\pm 10$  db, with distortions running anything up to 15 or 20 per cent.

At this stage, it can be said that, in the majority of cases, any distortion introduced is in the reproducing system rather than in

the recording. This happy state of affairs, however, does not hold 100 per cent., and occasionally records are released to the public which cannot be adequately reproduced on modern equipment. Fortunately, the reviewers of the reputable gramophone magazines don't hesitate to indicate these

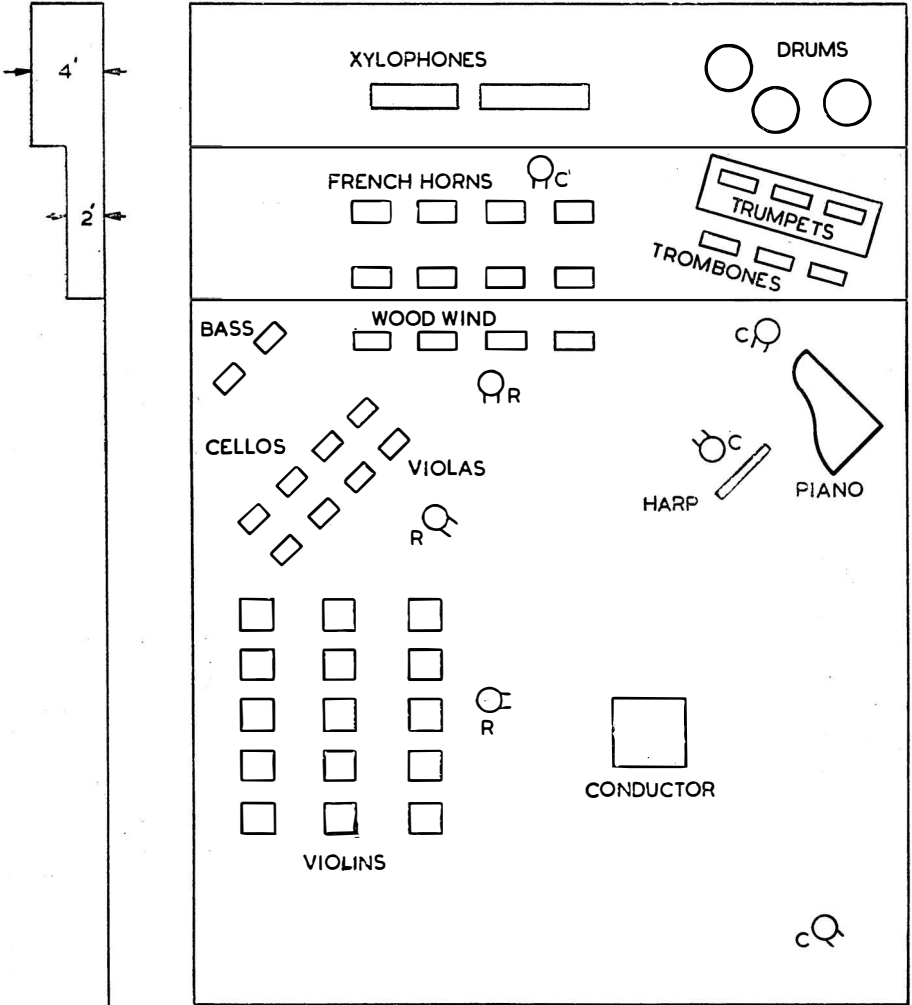

⊙ MICROPHONE. R-RIBBON. C-CARDIOID

FIG. I. RECORDING STUDIO LAYOUT

bad records, and the potential buyer is counselled to take their critiques seriously.

In the case of radio transmission, the general standard of FM is at least as good and sometimes better than the best gramophone records. The B.B.C. have been rightly cautious in their claims for frequency response and fidelity, especially when outside broadcasts over long telephone land lines are made ; but in the case of the Wrotham station, when transmitting live performances from the London studios, or the Royal Festival Hall, a frequency band in excess of 30 to 15,000 c.p.s., with an incredibly low distortion content, is usually obtained. All of which puts the onus fairly and squarely on the reproducing equipment for 95 per cent. of the time.

### Reproducing Equipment

The basic equipment for high fidelity reproduction consists of gramophone turntable and pickup ; FM tuner ; tape recorder ; pre-amplifier, with tone correcting circuits ; power amplifier ; loudspeaker and its enclosure ; and last, but by no means the least important, a comfortable room, correctly proportioned acoustically, in which the proud owner may suitably house the equipment and listen at his ease.

The gramophone turntable should preferably be 3-speed, and without automatic stop, *it should most certainly not be a record changer*. The turntable proper should be heavy and well balanced, and "wow" and "rumble" should be at a minimum. Several excellent examples commonly termed "transcription" units are available on the home market, and are discussed in their appropriate section.

Sufficient power must be available to ensure that there is not the slightest sign of speed variation on heavily recorded passages. For the musical purist, who is sensitive to absolute pitch, the units with the variable speed control offer a definite advantage : in these days of over-loaded power stations, the drive motor may frequently run somewhat slow, and the reproduced pitch may be anything up to 25 cents flat. Additionally, even the master tapes and discs are not always exactly on speed.

### Pickups

The pickup is probably the most important single item of equipment, because on its excellence depends the whole of one's enjoyment, and also to a large extent the life of the record. One cannot advise too strongly : *save pennies on the amplifier, use only a two-speaker instead of a three-speaker*

*system, but whatever else you save on, buy the best possible pickup ; and for L.P.s if at all possible, invest in a diamond stylus*. The majority of the modern gramophile's woes can usually be traced to one or other of various pickup faults.

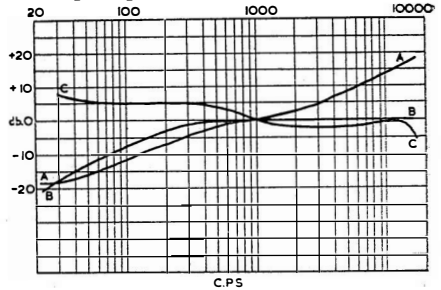

Fig. 2.—The above curves are : A-A, 78 r.p.m. constant velocity, magnetic pickup. B-B, 33 $\frac{1}{3}$  microgroove, magnetic pickup. C-C, both 78 and 33 $\frac{1}{3}$ , crystal pickup

The various types of pickups—magnetic, crystal, etc.—each have their own different virtues, and it can usually be said that for simple equipment the crystal cartridge (which has its own equalising networks built into the cartridge) will be most satisfactory. For the listener requiring the ultimate, where cost is of secondary consideration, the moving coil pickup is pre-eminent (Fig. 2). In fairness, however, the difference between the best examples of the various pickup designs is little more than a hair's breadth. There is one point which is important : crystal pickups are generally more sensitive to motor rumble and acoustic feedback than magnetic types, and this point must be borne in mind when deciding on the motor and the possibility of mechanico-acoustic feedback in the final installation.

### Tape Recorders

The principal advantage of the tape recorder as far as the amateur is concerned, is the relative ease with which recordings can be made from either live, pickup, or recorded, or broadcast material. It is not normally possible to damage the tape due to over-modulation, as is the case with direct disc recording, and provided a recorded tape is not subjected to a strong magnetic field, the life of the recording is, to all intents and purposes, indefinite.

Magnetic tape recording, however, has its own special idiosyncrasies and difficulties. Because the stored energy content of the tape is extremely low compared with a gramophone disc, the induced voltage into the playback head is likewise low ; further-



more, the output is proportional to frequency to some limiting value, and it then decreases rapidly according to an entirely different law (Fig. 3). We are thus faced with a rather difficult equalising problem, and because the induced voltage is very low at low frequencies, special care must be taken to ensure adequate magnetic shielding of the playback head. The high frequency response is primarily a function of the linear tape speed and the effective gap width of the recording and playback heads. Most modern heads are precision ground and polished to extremely close limits and have a physical gap width of approximately  $1/10,000$ ".

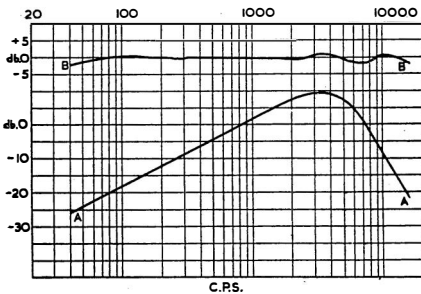

Fig. 3—The two tape recording playback curves above are: A-A, unequalised, and B-B, equalised

The magnetic oxide coating of the film is extremely abrasive, and the wear of the pole faces of the heads is not inconsiderable, therefore deterioration of performance with time must be expected. It is probable that the life of the average head is not much greater than 1,500 hours, and in some cases is considerably less.

In order to preserve a good signal to noise ratio, RF erasure is invariably used on modern tape decks; and in order to improve the linearity, RF bias is used during a recording. This RF current must be of extreme purity, and failure of otherwise excellent designs to meet the highest standards of reproduction have been traced to inability to appreciate this simple fact.

Where possible, separate equalising systems should be used for both recording and playback, in order that the most efficient use of the tape characteristics may be obtained, although in cheaper systems this is not economically possible. As before mentioned, the output voltage of the playback head is very small, and in order to obtain the maximum signal to noise ratio the pre-amplifier must be carefully designed with special attention to hum, microphony, and

noise. Some manufacturers have solved this insidious problem by using a small battery-fed transistor amplifier, mounted immediately adjacent to the playback head, the output signal is thus raised to a level which can be easily handled without fear of hum and other troubles.

### Tape Mechanisms

The mechanical problems of the tape drive mechanism are roughly parallel with the disc drive. Freedom from "wow," "hunting," and "rumble" are just as important, and the solution just as difficult. There are additional difficulties to be overcome. Efficient automatic braking must be used to prevent yards of tape spilling over the drawing-room floor when the machine is switched off; and the tensioning of the take-up and feed spools must be maintained at optimum within fine limits, if constancy of speed is to be obtained. There is still considerable discussion as to whether one, two, or three motors provide the best results; but it is a fundamental truism that, in the long run, the simplest and best engineered mechanism, irrespective of the *modus vivendi*, usually gives the best results.

The final problem, and one which will probably prove the most difficult of solution when mass produced "pre-recorded" tapes\* are used, or where the same head is used for half-track operation, is the initial adjustment and maintenance of the "verticality" of the gap. The ultimate high frequency response can be seriously affected if the plane of the recorded magnetic wave is not exactly parallel to the gap. When the effective gap width is half a wavelength, complete cancellation takes place, and there is theoretically zero recording on the tape. At a  $7\frac{1}{2}$ " per second tape speed, this will usually be about 15 Kc/s. With a standard head, an error of one degree of verticality will reduce this high frequency point to 13 Kc/s. Five degrees will reduce it to 9 Kc/s. In other words, all the high frequency equalising which has been applied will cease to be effective, and the level of the high frequency signal will be considerably attenuated (Fig. 4).

### Fool-proof Switching

Another requirement is completely fool-proof switching. It should not be possible to apply the erase current on playback or re-wind, and all controls should be so

\* The writer is at a loss to understand the precise meaning of "pre-recorded." He feels that if it is "pre-recorded," it means a blank tape, but the manufacturers of these "pre-recorded" tapes, in their wisdom, have decreed that it means a recorded tape.

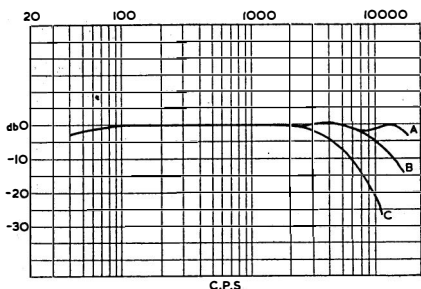

FIG. 4—Tape equalised response with : A, gap vertical ; B, gap 1 deg. from vertical ; C, gap 5 deg. from vertical

interlocked that the non-technical user cannot fail to obtain correct results. One little refinement sadly lacking in most tape recorders is an accurate "elapsed time" indicator. Nothing is more infuriating than having to reverse back and forth in order to find an elusive phrase which could be found instantly if it were known that it occurred at, say, 7 minutes 43 seconds from the start.

### F.M. Tuners

Unless one lives in the shadow of a broadcasting station, the medium wave broadcast band, with its whistles, monkey chatter, and other venial forms of interference completely mitigate against its use for serious high fidelity reproduction. Fortunately, V.H.F., Frequency Modulation transmission has gone far towards solving these problems. It is a truism that we get nothing for nothing in this life, and the price for interference-free, high-fidelity reproduction is a considerable increase in precision, both of components and workmanship. The difficulties of oscillator drift are multiplied by 100, and small mechanical details, such as the tuning drive and scale, become major feats of engineering. Unless automatic tuning (a very desirable feature) is properly engineered, an accurate tuning indicator is essential, because unlike amplitude modulation systems of transmission, one cannot rely on the volume level as an indicator for exact tuning with FM transmission. It is essential for the receiver to possess adequate sensitivity, and that the limiter be fully effective.

The de-modulator can take two forms, either ratio detector or Foster-Seely ; both have their merits and disadvantages, but the writer is inclined to favour the Foster-Seely as being the more linear of the two, although the initial adjustment and complexities of the circuit are somewhat greater. It is essential that the de-emphasising circuits are correctly

adjusted, and it is regretted that a number of otherwise excellent tuners fail in this respect. Nothing is more irritating than having to apply an arbitrary amount of "top cut" in order to obtain a reasonable high frequency reproduction.

In the London area, and probably within a 25 mile radius of the other FM transmitters, almost any arbitrary length of wire used as an aerial will produce some kind of result ; but a good, correctly designed and fitted outside aerial should be regarded as a "must." This is especially important for listeners who reside near roads carrying a fair amount of vehicular traffic.

### Extra Power Supplies

Most modern amplifiers today have provision for feeding the tuner from their power supply, and the circuitry is so arranged that the selector switch on the pre-amplifier automatically connects the power to the tuner when switched to the appropriate position. It is best if the heaters of the H.F. tuner valves can be alight all the time, the power switching being on the H.T. line only.

The purpose of the pre-amplifier is to increase the level of the pickup or microphone and modify the frequency characteristic, so that a linear output is fed to the power amplifier. Because of the multiplicity of recording characteristics, it is difficult to obtain 100 per cent. equalisation for all of them. This, however, is seldom necessary, and in general perfectly satisfactory results, are obtained with switched equalising circuits for : (a) 78 *British* ; (b) *Ortho.* (78 *American*) ; (c) *Decca L.P.* ; (d) *H.M.V. L.P.* This is especially so when the reproducer is used with crystal pickups, in which approximate equalisation is obtained automatically in the cartridge.

### Controls

Pre-set adjustment for level of pickup, tape, and radio inputs are an advantage on a pre-amplifier, because it is very annoying to switch from, say, pickup to radio, and to be greeted with an ear shattering din, some 20 or 30 db higher than the previous programme. Whilst bass and treble "boost" and "cut" controls are considered a "must," their range need not be any greater than  $\pm 10$  db. If one or other has to be continuously kept at one end of its spectrum there is something wrong with either the equalising network, pickup, or loudspeaker.

A steep cutting lowpass filter variable from, say, 5 to 15 Kc/s., is a very useful addition, especially if the slope can also be

varied. It is particularly helpful when playing old-type recordings, reducing needle scratch to a reasonable amount without cutting the top too much, as would be the case where normal treble tone control would be applied. On some L.P. records it is especially useful for getting rid of a certain amount of "featheriness" where too much pre-emphasis has been used in the recording.

### Amplifiers

In terms of performance, the modern power amplifier is probably the most nearly perfect link in the whole chain of reproduction equipment. Most amplifiers today claim a total harmonic distortion of less than 0.1 per cent. This is usually specified at an arbitrary output (the nominal maximum) and at a frequency of 400 c.p.s. It is to be regretted that all manufacturers do not state the harmonic distortion at the rated output at 30 c.p.s. and 10,000 c.p.s. in addition to the mid-band frequency, because it is just as important that low distortion figures are obtained at the extremes of the band in addition to the middle, and this is usually the reverse of the case. Low intermodulation content is becoming increasingly important with the growing use of wide band reproducers, and 1956/7 may well see this problem tackled by using dual or, in the ultimate, three channel amplifiers, each of which only handles a portion of the audio spectrum.

as it enables strict comparison to be made under identical test conditions ; but under working conditions, the loudspeaker presents anything but a resistive load, and the amplifier should be checked for stability with the output terminals open-circuited, short-circuited, with an inductive and a capacitive load, respectively. Suggested figures for the inductance are 1 millihenry and 10 millihenrys ; and the capacitive load, 0.25 mf and 2 mf. If the amplifier is unstable under any of these conditions, it should be rejected because it means that the safety margin of the feedback circuit is insufficient.

### Feedback Effects

The other effect of negative feedback is to worsen considerably the overload characteristics. It will be seen that in the case of two triodes without feedback the overload characteristic is a gentle curve in which the distortion does not rise very rapidly at any point. As increasing amounts of negative feedback are applied, the initial distortion is reduced progressively, but it is seen that a "knee" develops in the curve, which becomes sharper and sharper. A very small overload may then cause harmonic distortion of 20 or 30 per cent. (Fig. 5). This distressing phenomenon can be aggravated if the feedback is reduced under these circumstances, or eliminated due to blocking of one of the stages. If this happens, incipient RF oscillation generally results, causing "tizziness" of reproduction at high levels. Therefore, in the absence of an "overload versus distortion" curve, the amplifier should be tested with an oscilloscope when driven hard, to check that the output wave is clipped equally on each crest, with no sign of fuzz.

### Earthing Essential

It goes without saying that the amplifier should be adequately fused, and that it must always be earthed.

Despite a public prejudice, electrolytic condensers are now proving completely satisfactory under service conditions in the United Kingdom, although they may fail under certain tropical conditions. One last point, if the output transformer is of the multi-ratio type, and feedback is taken from the secondary—check and make sure that it is set for the correct loudspeaker impedance and that the correct value of feedback resistance is in circuit.

Hum and acoustic feedback should be checked at all positions of tone controls with the gain control set to maximum ; or where

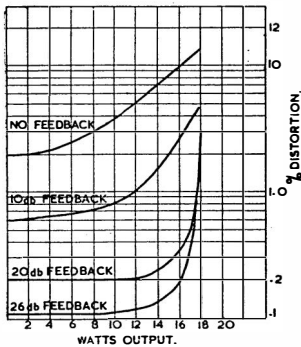

FIG. 5.—Feedback, output, and distortion

The increasing use of negative feedback as a means of reducing distortion and hum, and increasing the frequency response of the amplifier, brings with it its own particular train of trouble. Beware the amplifier which is only conditionally stable. All test figures on amplifiers are stated in terms of a non-reactive load. This is quite right and proper,

pre-set gain controls have not been fitted, at the point which gives maximum undistorted output from the amplifier with normal programme material. Should hum be excessive, or should any acoustic feedback be apparent, these faults must be cleared before reasonable reproduction can be expected. The easiest way to check for acoustic feedback is to place the pickup on the record with the motor stopped. There should be no trace of feedback. Motor rumble can be checked at the same time by placing the stylus on a small piece of wood placed on the motor board with the motor running. This should be checked at all three speeds of the motor. If the rumble is excessive, or if it builds up into a howl, this should be investigated, and eliminated.

### Speakers

To date, the weakest link in the chain is the loudspeaker system, although new wide-range electrostatic loudspeakers have scored a heavy victory in removing this stigma. With conventional moving coil radiators in reflex cabinet or acoustic labyrinths, it is difficult to obtain a wide response with any semblance of smoothness, and the majority of loudspeakers today will not reproduce (under average listening conditions) a spectrum of 30 c.p.s. to 15,000 c.p.s. with a fidelity of better than  $\pm 10$  db over this range.

It is instructive to place a microphone, connected to an oscilloscope, in front of a loudspeaker and to sweep the audio frequency band with a variable frequency oscillator. At the low frequency end, incorrect loading, due to the resonant frequencies of the enclosure and loudspeaker not being matched, results in high amplitude peaks, "one note bass," and increased distortion. It is extremely difficult to obtain a 30 c.p.s. note free from frequency doubling, and in a lot of cases if pure 30 c.p.s. tone is applied to the speaker, what one hears is not 30 c.p.s. but usually 60 c.p.s. and 90 c.p.s. in varying proportions, and the ear mechanism supplies the fundamental tone. With organ pipes this may be all right, but it results in muddy bass from the loudspeaker.

### Cross Resonances

Insufficient damping of the enclosure results in cross resonances in the 200 to 800 c.p.s. region, giving a peculiar "boxy" tone to some speakers. Extended high frequency response is usually obtained in single cone speakers by a number of artifices, most of which rely on cross coupled reson-

ances with which it is impossible to get a smooth response.

By far the best high frequency radiators are either horn-loaded ribbons or electrostatic units. In each case, the diaphragm moves as a rigid piston, with the whole of its area in phase, and with constant velocity, because the driving force is applied equally at all points of the surface. The best way to check whether the speaker is reproducing faithfully, or whether it is adding too much of its own character, is either to apply "white" noise and listen to the tone of the reproduced noise, or alternatively to apply a high frequency signal in the 13 to 15 Kc/s. region. If there is any appreciable cone "breakup," this will show as colouration of the single high frequency tone, generally in the 5 to 8 Kc/s. region. This is dealt with at length in the article on loudspeakers.

Finally, in multi-unit speaker systems, it is most important that the balance between the various units is correct. If the high frequency unit is more sensitive than the bass, the input to it should be attenuated, instead of applying treble cut via the pre-amplifier. The reverse is true where the bass speaker is more sensitive.

### Speaker Positioning

The position of the speaker in the listening room is most important, and the speaker placed in a corner is usually the most satisfactory. Principally, because the incident wave does not strike any wall perpendicularly, reflections and standing waves due to them are less liable to occur; also, the efficiency of the speaker system is increased. It should be noted that the positioning of some speakers is an extremely critical factor, and a difference in spacing of a few inches from the wall can make all the difference between clean, sharp bass reproduction and muddy indescribable noise.

Most high frequency speakers have a tendency to beam, and this point should be checked. Normally, an included angle of 45 deg. beam width at 10 Kc/s. will be satisfactory for a speaker placed in the corner of a room. If it is placed mid-wall, the minimum of 100 deg. should be aimed at: this is an almost impossible achievement, with one or two notable exceptions.

The listening room acoustics are one of the most important, but probably the most neglected of all the facets of high fidelity reproduction—principally (but unfortunately) because rooms have been fundamentally designed to be lived in, and because listening

to recorded sound has come as a very secondary afterthought.

The reverberation time of the average room is generally slightly greater than optimum, and it is worth while experimenting by placing the speaker system facing the curtains if they are normally drawn when listening. A heavy carpet and underfelt, while improving the reverberation characteristics, can reduce the "liveness" of the reproduction considerably, and it is a good plan either to have the speaker placed directly on the floorboards or lino, or with its own reflecting board on the floor rather than directly on to the carpet.

It has been established that a 75-piece symphony orchestra produces approximately 60 or 70 watts of peak acoustic power for approximately 1 per cent. of its playing time, of which the frequency bands containing the maximum peak powers are 250 to 500 c.p.s. and 8,000 to 11,000 c.p.s. It has been contended that, in order to reproduce this orchestra with realism, a like amount of acoustic power is required; so with loud-speaker efficiency averaging 10 per cent., power amplifiers with a rating of 750 watts should therefore be required. For the domestic listener, this makes complete nonsense. It is interesting to note that, seated in a favourable position in a good auditorium (say the Royal Festival Hall), the average pressure actually affecting the ear of the listener is of the order of 0.5 dynes/cm<sup>2</sup> (which is equivalent to average conversation) although the peak power on a fff crescendo is about 150 to 200 dynes/cm<sup>2</sup>.

#### Efficiency and Distortion

What we require is a reproducer which, under average domestic conditions, will reproduce this sound intensity. The volume of an average room can be taken as about 1,000 to 1,500 cu. ft. and (with the average damping due to drapes, etc., giving a reverberation time of 0.5 to 1 second) it requires an average power of about 10 milliwatts for quiet music, and of approximately 100 times that amount to handle the loud passages. Average speaker efficiency is between 5 and 10 per cent. Although some manufacturers claim considerably greater efficiency, it is safe to say that the *majority* of speakers used on *domestic* reproducers have an efficiency of less than 10 per cent. The loudspeaker therefore requires a maximum power of 10 to 20 watts peak input to reproduce our orchestra at its correct level.

Unfortunately, we have omitted distortion, and the majority of speakers generate

considerable amounts of harmonic distortion of the lower register, especially around the lower resonant frequencies, and a fair amount of intermodulation distortion in the upper regions. Even untutored ears are sensitive to harmonic and intermodulation distortion and the natural result is for the listener to reduce the volume.

When *all* forms of distortion are reduced to negligible proportions, say of the order of 2 to 3 per cent. (these distortions include those existing in the recording medium, which is rarely less than 1 per cent.; in the pickup or other transducer; in the amplifier; and in the loudspeaker) surprisingly high intensities of reproduced sound can be tolerated, without any distressing effect on the ears. It seems to be one of nature's immutable laws that the louder the sound the greater is the distortion being generated.

#### Summary

To summarise: for domestic listening, we require an absolute minimum of 7 watts and a maximum of 20 watts undistorted output from the amplifier. We require a frequency response sensibly flat from 30 to 20,000 c.p.s., and a total distortion content of the whole frequency band at maximum output of less than 0.5 per cent. The loudspeaker should have a bass resonance below 60 c.p.s., and preferably below 50 c.p.s.; the upper end should be smooth and flat, preferably to at least 15 Kc/s. The pickup's lower frequency resonance should be below 30 c.p.s. and preferably below 20 c.p.s. The upper resonance should be at least 15 Kc/s., and preferably 18 to 20 Kc/s. Diamond stylus for L.P. should be mandatory. Distortion values for loudspeaker and pickup are difficult to generalise upon, but total distortion at all signal levels and under all circumstances of the complete system should be less than 10 per cent. (although few speakers currently available meet this requirement). The pickup and test record should not, *under any circumstance*, generate more than 2 per cent. of the total distortion.

#### Buy After Planning

Finally, a high fidelity system is a series of integrated units, and the strength is only that of the weakest link. It is foolish to pay 150 guineas for a loudspeaker to work with a £13 8s. 4d. amplifier, and vice versa. If the system is to be built piecemeal, it should be planned beforehand and, if possible, the complete, intended system listened to. The various units can then be purchased as and when circumstances permit.

# STYLI

By Stanley Kelly

THE old tag that "the strength of a chain is only that of the weakest link" is just as true of high fidelity reproduction as of battleships, bridges, and big buildings. The ubiquitous stylus, since its fall from grace when steel needles replaced the early sapphire styli of the Edison cylinder machines, can rightly claim to have been this weakest link; and it is only during the past ten years that the sapphire stylus has again come into its own. Steel needles can be dismissed without further to do by anyone seriously interested in high fidelity reproduction. Entirely apart from excessive mass, and the fact that the "point" is rapidly worn to a chisel shape, thus preventing it following the original record undulation of the higher frequencies, it is probably the most effective mechanism yet invented for the systematic destruction of gramophone records.

## Record Protection

Because of the defects of the steel needle, the only known method of preserving some semblance of the pristine elegance of the gramophone record was the use of thorn or fibre needles. Before the advent of science in the design of gramophone pickups, which has resulted in the modern ultra lightweight unit, this type of stylus was the only protection that could be afforded to the record.

In the first few years after the war, when serious attempts were made to reduce the playing weight of gramophone pickups, the improvement of an average playing weight of 4 oz. (110 gms.) to 25 gms. made possible the use of jewelled styli. Despite various makers' claims, sapphire styli should not be used with pickups requiring a playing weight greater than 25 gms. Even then there is considerable risk of damage to the stylus, as force beyond its elastic limit can be applied, entirely apart from a very high rate of wear. Until about 1950, the manufacture of sapphire styli was carried out by lapidaries, using the traditional gem stone methods of

fabrication, and this resulted in high production cost. Pressure was therefore brought to bear upon the engineers who attempted to produce substitutes, usually a form of tungsten carbide. These were never really satisfactory and fortunately for all concerned, soon died a natural death.

## Sapphires

In the end, sapphire in its various forms stood alone as the only stylus material which could seriously be considered for high fidelity pickups. Improvements in the design of pickups has now resulted in units with a frequency response in excess of present day requirements, and in which the playing weight is as small as 3 gms. This, in its turn, has considerably increased the effective life of the styli, but because of the extended frequency response, a rigorous standard of polish is required in order that surface noise shall be reduced to the absolute minimum.

Because the high frequency resonance is in part controlled by the radius of the stylus, production limits on styli dimensions have had to be considerably tightened in recent years. In view of the extremely stringent requirements specified by the pickup manufacturer for his styli, it is a wonder that they can be produced in any quantity for even a king's ransom—indeed, they are currently produced for a very modest sum at a rate exceeding 12,000,000 per year in this country alone.

## Diamonds

The ultimate requirement for a stylus is that it shall be infinitely hard. The hardest substance known to man is diamond, and because it can take an extremely high polish it is being pressed more and more into service; and it cannot be emphasised too strongly that, whenever possible, a diamond stylus should be used. It goes without saying, of course, that the product must meet at least the same standard of perfection as

required for a sapphire stylus, *and it should only be purchased from a thoroughly reliable and tested source.*

### **Styli Production**

Apart from the chemical composition, modern sapphire or ruby styli have very little in common with gem stones of the same name. Although a few styli are still produced from natural gems, these are in the minority ; not because of the difference in price of the raw material, but because the synthetic product can be obtained in uniform sizes, thus rendering processing considerably easier. Sapphire, whether natural or synthetic, is pure aluminium oxide ( $Al_2O_3$ ). Ruby is basically the same material with an extra oxide impurity.

The process of making synthetic sapphire is simple, and the method commonly used today was developed by a Frenchman, Francois Verneuil. It consists of a tiny furnace heated with an oxy-hydrogen flame in which powdered  $Al_2O_3$  is fed through the flame and deposited on a small ceramic stud. After a while, a small blob is formed, and by correct integration of rate of flow, temperature, and withdrawal of the pedestal from the centre of the furnace, the sapphire aggregate is produced in the form of a boule. Boules generally are some two or three inches long, with a maximum diameter of approximately one inch. There is considerable strain set up during the growing, because of the temperature inequalities through the section, and if the tip at the end of the boule (sometimes referred to as a seed) is given a sharp tap, the boule will split neatly into two pieces.

### **Half-Boules and Rondels**

The half-boule is then sawn into thin sections, the thickness of each section being slightly greater than the diameter of the ultimate stylus rondel, and because of their shape they are termed half-moons. The half-moons are then sawn into strips of square section, and the strips again sawn into lengths very slightly greater than the ultimate stylus. These strips are fed into a centreless grinding machine which produces a little cylinder of sapphire.

Up to this stage, the production can be made largely automatic, and apart from the maintenance of the machines, and the generally unavailing requirements of keeping diamond grinding powder out of bearings and other essential pieces of mechanism, no great technological difficulties are encountered ; nor can the process be termed an art,

The final production of the cone and the highly polished spherical tip is another matter ; in most cases this operation is performed by hand on a lapidary's wheel, in the same traditional manner that gem stones have been produced from time immemorial. Obviously, small local modifications are introduced by different firms in the trade because of their individual manufacturing requirements, but basically the method of production is an art rather than science.

### **Automation**

Numerous attempts have been made to render these processes entirely automatic, and now appear to be bearing fruit. Two completely automatic machines are used, one of which takes the rondel from a hopper and grinds the cone shaped end. It produces coned rondels at a rate of approximately 20,000 per week. The coned rondels are then placed in a special form of tumbling machine, together with a grinding powder and other attritive materials. Many thousand of these tiny points are placed in the tumbling machine simultaneously and, as they tumble, the cone tips are gradually radiused into a spherical form. After a pre-determined period of time this process is complete and, as can be shown by statistical mechanics, the pointed end must have assumed a perfectly spherical shape, the radius of the sapphire point being governed by its mass.

Production of diamond styli is a very different matter, and although a lot of money has been, and still is being, spent on research into automation, the chances of this dream becoming a fact are at present slim. There is no parallel in quantity production of diamond in a manner analogous to synthetic sapphire. With most forming systems (other than forging) the final form is obtained by rubbing the subject with a harder material ; in the case of sapphire, diamond powder is used ; and because diamond is many times harder than sapphire, it is an extremely effective material ; with diamond points, however, the process is slow in the extreme, just because it is so hard.

"Artificial" diamonds have been produced in small quantities by various investigators, and are today being manufactured to a very limited extent in the U.S.A. They are very small, and unfortunately the production cost is considerably greater than the natural stone. Diamond styli are produced from selected "chips" of approximately the correct size, which are then bruted and finally polished to shape. This is largely a

FIG. 1. *Sapphires*

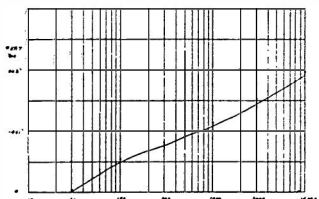

FIG. 2. *Diamonds*

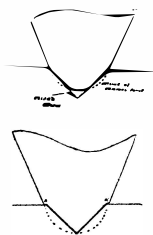
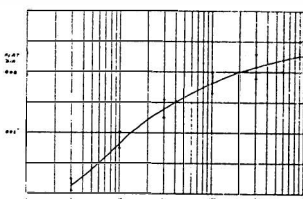

FIG. 3

Figs. 1 and 2 show the comparative useful, or "safe," lives of sapphires and diamonds. Fig. 1 concerns sapphires. The vertical lines represent hours of playing—the first group, a line per hour; the second group, a line for each 10 hours; the third group, a line for each 100 hours. The horizontal lines represent the size of "flat" that is worn by playing. Fig. 2 concerns diamonds, with the first group of verticals a line for each 10 hours; second

group a line for each 100; third group a line for each 1,000 hours. The horizontals represent the same "flats" as for sapphires. The second horizontal (a 1 thou. in. flat) occurs at 15 hours for sapphires, and 750 hours for diamonds. Fig. 3 (top) shows this to be tolerable, and (bottom) a flat of  $1\frac{1}{2}$  thou. in.—havoc to discs—which occurs at 40 hours with sapphires and 2,500 hours with diamonds (third horizontal).

hand process, and a really well finished diamond point may account for anything up to 20 hours' work on the part of the operator; and with overheads and taxation being what they are, it is easy to see that the high price asked for diamond styli is justified.

The question often asked is: "are artificial sapphires as good as natural ones?" In the case of gem stones the answer is no, if only because of the scarcity of the natural stone. The expert can always tell synthetic sapphire of boule form at a glance, because the natural stone is generally a nearly perfect, rectilinear crystal; and the boule, by virtue of its method of growing, is always of curved section; therefore the striations are always of spherical form. Growing oriented sapphire from correctly cut natural sapphire seed is sometimes used, and rods up to several feet long, one-tenth of an inch in diameter, are in quantity production for specific purposes.

Whether natural stone is better than synthetic for stylus use is an open question. The natural stone has undoubtedly snob value, but wear tests indicate that its life is no greater than the synthetic product. The hardness of the sapphire crystal, however, is not constant in all directions, and there is therefore a statistical probability that some styli (even from the same boule or the same natural stone) will have a greater life than others.

During the playing of one 12 in. L.P. record, a stylus travels nearly half a mile, and exerts a pressure on the walls of the record groove of approximately 7,000 lbs./sq. in.; and it is at the same time subject to accelerations of anything up to 3,000 times gravity.

It is difficult to visualise these forces, but it is known that the instantaneous temperature of the stylus point can reach several hundred degrees C. for short (1 microsecond) periods of time. It is little wonder therefore that very minute particles of dust, which inevitably become embedded in the surface of the soft vinylite record, should offer considerable abrasive action to the stylus. The vinylite itself, although quite soft, has a self-lubricating property, due to the "plasticiser" entering into its composition, and some recent

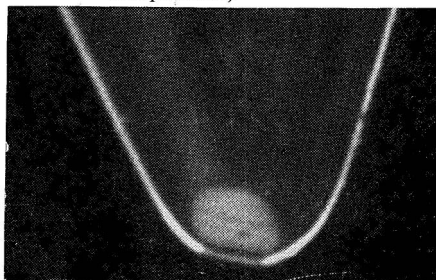

FIG. 4 shows the flat on a sapphire after 60 l.p. playings.

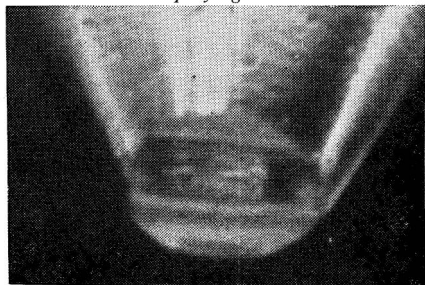

FIG. 5 shows a sapphire after "permanent" use



experiments on a stylus and record played under sterile conditions gave an increase in life of both units by about  $\times 4$  over normal domestic conditions.

Actual tests on styli wear, using a high quality pickup at a playing weight of 7 gms., are shown overleaf (Figs. 1 and 2). The curve on each graph shows the mean life expectancy before a "flat" of a given size develops, and the vertical lines give the standard deviation of the flat size of all the styli, tested at that particular time. The increased life due to the use of diamond styli is self evident, and it becomes a matter of simple arithmetic to decide whether the extra money required for investing in a diamond is justified. Fig. 3 shows what happens to the stylus on larger values of "flat" size. Photomicrographs of actual styli, taken by Cecil Watts, are reproduced here. Fig. 4 shows the wear after an indeterminate playing time, probably 100 hours or so, whilst Fig. 5 was the result of playing 60 mixed L.P. records. Fig. 6 shows a section of groove after having been used with such a point, and it is evident that the stylus is already unable to trace accurately any frequency higher than 2 Kc/s. or 3 Kc/s.,

The record no doubt still has a useful life, for any but high fidelity reproduction, and further wear of the old stylus will be less rapid, due to the larger area now in contact with the groove. Had the stylus been a good diamond, in one of the highest quality

pickups, with probably a 3 gm. downward pressure, and the records kept free of dust, it is doubtful if any wear could yet be measured.

This wide difference makes any hard and fast rule impossible. In fact, in the first instance, the records have now been permanently damaged, and one is inclined to say that replacing the stylus can hardly improve things, except of course when a new record is introduced. As the worn stylus cannot trace the higher frequencies, the only noticeable difference from the rest will be that it has less surface noise. It will quickly deteriorate to the condition of the rest of the collection and the makers will be judged on the general low standard.

Here, then, is the reason for most of the conflicting evidence and opinions of experts and users alike.

The improvements made during the past two or three years in both record and stylus finish, make it possible to use new records, in conjunction with the best modern apparatus, with a confidence that allows for many hundreds of playings of choice records without apparent depreciation.

On the other hand, the more that records are played with a partly worn stylus, or even with one which has lost its initial polish, the more rapid will be the wear, with a consequent general loss of quality and rapid increase of extraneous noise.

It cannot be emphasised strongly enough that the ultimate life of the records, and hence one's enjoyment of them, is dependent solely upon the condition of the reproducing point. For high fidelity reproduction, only sapphire (or ruby) or diamond should be used. 78 r.p.m. records which have been played with a steel needle should on no account be played with a jewel stylus, otherwise irreparable damage to the stylus (which in its turn will be passed on to subsequent records) will result.

*There is no such thing as a "permanent stylus" and it is suggested in all seriousness that sapphire styli should be replaced at the very outside after 25 hours of playing on L.P. records.*

In the case of diamond, the diamond should be inspected for wear after 1,000 hours, and every 200 hours or so afterwards. These are, in the writer's opinion, top limits for styli life; and in view of the high cost of present-day discs it may well be cheaper in the long run to replace the styli more frequently, in order to ensure as far as possible that one's precious records are not damaged by worn styli.

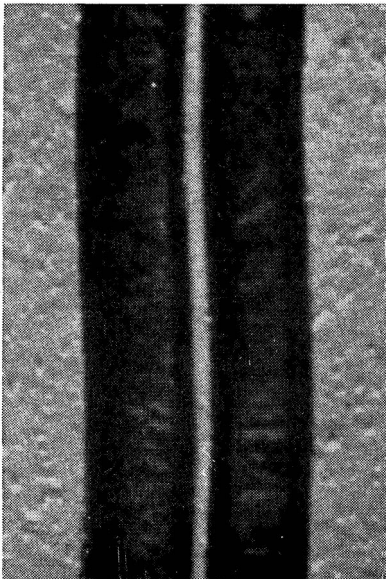

FIG. 6 An l.p. groove after use with a well-worn stylus.

# PICKUPS

By Stanley Kelly

**M**ORE effort (and sweat and blood and tears) has probably been expended in the evolution of gramophone pickups than with any other component used in sound reproduction. Whether all this effort can be justified is debatable, but there can be no question that the best examples of modern pickup practice are beyond reproach, and they will stand comparison for fidelity of reproduction, consistency, and all the other desirable attributes, with the rest of the high fidelity reproducing chain. This has not always been so, and only a few years ago serious discussion took place as to whether loudspeakers or pickups were the worst offenders. Today, with one notable exception in the loudspeaker art, pickups are much nearer their ultimate goal than loudspeakers.

## Points to Consider

Before the purchase of a pickup is undertaken, some thought must be given, not only to the ultimate requirements of the unit, but more particularly to the ancillary equipment with which it will be used. The input circuit of the pre-amplifier can modify considerably the response of the pickup, and for this reason the two units should be considered together. If the pickup is a magnetic type, of low impedance, an output voltage of a fraction of a millivolt only may be expected; and either a transformer or a high gain pre-amplifier must be used with it. Again, if a crystal pickup is used, the input impedance of the amplifier must be high (with an absolute minimum of 0.5 megohm, and preferably 1 to 2 megohms) unless an extra equalising circuit is fitted between the pickup and the amplifier to present the correct terminal conditions to the pickup.

Most modern crystal pickups have a "corrected" response, in order to equalise approximately the recording characteristics of the gramophone record. Some manufacturers feed a crystal pickup into a relatively low value of resistance (usually between 20,000 and 100,000 ohms) to obtain a "constant velocity" response from

it. Whilst this will give an approximate overall velocity response, its use is to be deprecated, because the Rochelle Salt crystal element normally used in these pickups shows a very bad capacity temperature coefficient, in which the capacity may vary by as much as 3:1 over the normal range of room temperatures found in this country. The time constant of the pickup and amplifier input resistance, and hence the exact equalising, will be a function of temperature and so will vary from day to day. Additionally, because of the impedance characteristic of the pickup, considerably more harmonic distortion can be generated than when it is fed into a high load impedance—say, greater than 0.5 megohms. It is far better to equalise the pickup, by placing a small capacity in series and using a normal 0.5 or 1 megohm grid leak, proportioning the capacity to resistance to give a correct turnover point.

## Pickup and Arm

The ultimate response of the pickup is very closely related to the constants of the tone arm, and the two must always be considered together for a particular installation. With the exception of the variable reluctance type of pickup, where the two styli are mechanically completely isolated, "turnover" type cart-ridges are generally to be deprecated. This is because the reaction of the free stylus always has an adverse effect on the overall performance. In some cases, this is mitigated by using a lossy mechanical coupling between the stylus and the crystal but, as is usual with all compromises, something has to suffer. In this case it is usually effective stylus mass and extended high frequency response.

Present day pickups can be divided into two main classes: (a) "constant velocity," i.e., pickups in which their output voltage is an exact reproduction of the velocity of the impressed trace of the gramophone record; and (b) "corrected pickups," in which an attempt has been made by the designer and

manufacturer to build in corrections for the recording characteristic of the record.

### Magnetic Cartridges

Type (a) includes all current types of magnetic cartridges. These include light-weight moving iron, variable reluctance, and moving coil pickups; whilst type (b) is confined exclusively to particular types of crystal pickups. Each type has its advantages. In the case of type (a), if the recording characteristic is known, it is possible to compensate exactly this characteristic in the pre-amplifier; and most high fidelity amplifiers today have a switch marked "78 American," "78 British," "L.P.," "Ortho," etc., which controls equalising networks in the amplifier.

If the pickup is truly a constant velocity type, and if the recording engineer has faithfully observed his Company's published recording characteristic, a straight line frequency response should be obtained. Of necessity, all recording characteristics are varied somewhat to meet the acoustic requirements of the recording studio; additionally, slight imperfections in the cartridge and amplifier compensating network, due to component tolerances, mitigate against this much desired end.

### Crystal Cartridges

In the case of type (b) pickups, the response of the cartridge is modified from constant velocity to some other law in an attempt to compensate the recording characteristic, and thus to obviate the necessity for equalising networks in the amplifier. This is usually obtained by decreasing the treble response and increasing the bass response. At the best, it can only be an approximation, principally because of the difference in recording characteristics of the various companies, and also because in complex electro-mechanical circuits it is not possible, under mass production conditions, to control these variables sufficiently closely to equalise exactly.

Let us now examine the general mechanics of the pickups. Class (a): classical theory indicates that a voltage will be generated whenever there is relative movement of a magnetic field and an electrical conductor, and that this voltage will be directly proportional to the rate of change of the flux linkages. Our ideal pickup should therefore consist of a virtually massless system (thus requiring no dissipation of energy in moving it), in which the velocity of the conductor (or armature, as the case may be) would move in exact sympathy with the undulations

of the record groove. The voltage so generated would then be an exact reproduction with the aforementioned intelligence.

We are all familiar with the tuning fork which, when suitably struck, emits a musical note. The pitch or frequency of this note is determined by two things only: the effective mass, and the effective stiffness of the tuning fork. We have an exact parallel in the case of a gramophone pickup, in which two major resonances occur, each of these resonances being determined by a mass and a stiffness. At the high frequency end, the resonance (sometimes referred to as the needle resonance) is principally governed by the effective mass of the stylus system, and the "stiffness" of the contact between the stylus point and the record groove wall. This frequency should be as high as possible, preferably in excess of 20 Kc/s.; and because the stiffness of the record material is substantially constant, the only practical way to increase the value of the high frequency resonance is to reduce the effective mass of the stylus. This means smaller moving parts, fewer flux linkages, and reduced output.

### L.F. Resonance

The other resonance occurs at a low frequency: with the best pickups, below 20 c.p.s.; with average pickups, between 20 and 27 c.p.s.; and with the not-so-good pickups, above 30 c.p.s. This resonance is caused by the effective lateral mass of the pickup and tone arm, and the stiffness of the armature restoring force; for various practical reasons, the lateral mass should be about 30 gms.; thus in order to bring the resonant frequency as low as possible, the restoring force must be weak. In the case of moving iron or variable reluctance pickups, the restoring force is necessary to return the armature to a central position in opposition to the magnetic field. Therefore, a low resonant frequency is usually indicative of a reduced field and again, reduced output. All of which goes to show that, at the present stage of the art, wide frequency response usually means low output.

In the case of moving coil pickups this is not necessarily true; but because of the large gap used in present day systems, a relatively inefficient magnetic structure is obtained, again resulting in low output. It is worth noting that, whilst with armature type or variable reluctance pickups there is a very definite and distinct relationship between the stiffness of the armature restoring force (governed by the magnetic field strength) and the output of the pickup, this relationship

does not hold for moving coil pickups ; and it is theoretically possible, and will some day be a practical proposition, for a moving coil pickup to give an output of several volts, which is more than comparable to the highest output of crystal pickups today.

To summarise, magnetic pickups give a substantially uniform output versus velocity characteristic over the major portion of the frequency spectrum, with the addition of two resonances : one at the sub-audible end, preferably below 20 c.p.s., and the other at the supra-audible end, preferably above 20 Kc/s.

### Crystal Pickup Correction

Type (b) pickups : unlike magnetic pickups, the voltage developed by a crystal pickup is proportional to the force to which the crystal is subjected, and not directly to the velocity of the stylus. Simple mathematics will show that for a sinusoidal motion of the stylus, if the crystal is suspended in a viscous medium exhibiting a purely frictional (resistive) characteristic, the force applied to the crystal will be proportional to the velocity of the stylus. If, however, the crystal is clamped by a purely elastic medium, the force applied to the crystal will be proportional to the amplitude of the stylus movement, and for constant velocity recordings will be inversely proportional to frequency. By correctly proportioning the values of elasticity and viscosity of the crystal mounting supports to the crystal parameters, it is possible to approximate the inverse of the recording characteristic.

### Effects of Mass and Stiffness

Unfortunately, it is not possible to separate all the various elements completely, and the effect of the crystal mass and stiffness and other components modifies the above simple assumptions ; thus the response of the cartridge varies more or less from the ideal, according to how close an approximation the designer can effect ; and, incidentally, according to how well the manufacturer can maintain the tolerances of his various component parts and assemblies.

The high and low frequency resonances mentioned for the magnetic cartridge occur in exactly the same manner, and for the same general reasons, with the crystal cartridge, although they are usually slightly less predominant because of the mechanical losses deliberately introduced into the circuit for other reasons. It is probable that the deviations from the desired response of the

best crystal cartridges are no greater than the rest of the reproducing chain.

Certain types of distortion are inevitable in record production because of the geometry of the system. These basic distortions are considerably aggravated by resonances in the pickup, more particularly if they occur in the 30 to 45 c.p.s. and 7,000 to 11,000 c.p.s. regions. Should resonances occur in these bands, in which the amplitude is greater than a few db's, the intermodulation distortion can be distressing, and it is these resonances, particularly the high frequency one, which give rise to much of the "coloured" needle scratch, tizziness, and violins with tin bellies, which have been considered the prerequisites of high fidelity reproduction in the immediate past. Resonances are a nuisance, and at the present stage of the art they are inevitable, but their effect can be minimised by being placed outside the recorded spectrum. The wider apart the resonances, generally, the better the pickup and the lower the output. Whilst the published response curve of the gramophone pickup is a good guide to its performance, it is by no means gospel.

### Stylus Radius

Its response is also controlled by the material of the record and the radius of the stylus. Some ten years ago, the writer found a very easy way of getting rid of a troublesome resonance at 9 Kc/s., by increasing the radius of the stylus from 0.002 in. to 0.0025 in. (this was stream recording, of course, using shellac discs at 78 r.p.m.). This simple expedient moved the resonance out of harm's way by altering the compliance between the stylus point and the record to a more equitable value ; in the case of L.P. records, a variation in high frequency resonance of several Kc/s. (in one instance, from 14 Kc/s. to 16.5 Kc/s.) could be obtained by judiciously choosing the radius of the stylus on either the bottom or top limit of the production specification.

### L.P. Records

Most British records are produced in accordance with British Standard Specification No. 1928. This, among other requirements, specifies the design centres and limits for groove profile, and dimensions for the reproducing stylus. These are :

*Groove width* 0.002 in. to 0.003 in.

*Stylus radius* 0.001 in.  $\pm$  0.0002 in.

The limits are extremely important when one considers high modulation levels and maximum playing times. With the bottom limit of 0.002 in. for groove width and a top limit of 0.0012 in. for stylus radius, pinch effect

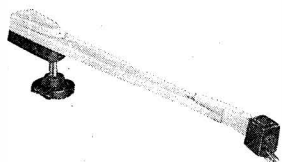

*Acos GP 20 arm with head*

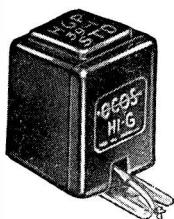

*Acos HGP 39 crystal head*

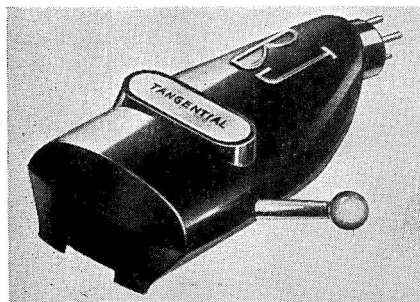

*B.J. pickup shell for various cartridges*



*Connoisseur MK 2 lightweight head*

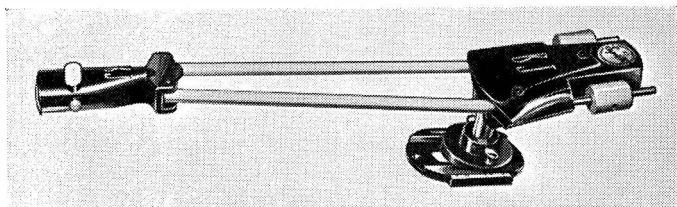

*B.J. "Super 90" pickup arm (16. in.)*

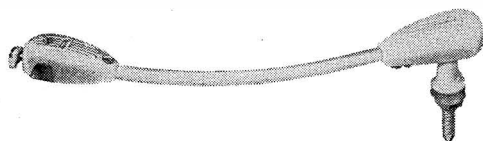

*Collaro transcription pickup arm and head*

limits maximum modulation at the high frequencies. The foregoing facts have been stated because the intelligent design of reproducers is very intimately connected with the physical constants of the disc.

Most British recordings are produced on a variable pitch system, in order to obtain maximum playing time for a given maximum recording level. The maximum amplitude at the low frequency end is approximately 0.01 cm., and the maximum velocity at the high frequency end can be 45 cm./sec.

The record behaves essentially as a constant velocity generator with a compliance across the output terminals. This is equivalent to a constant current generator in parallel with a capacitance, and it is this compliance, together with the effective mass of the stylus tip, which is generally responsible for the high frequency exhibited by most pickups. The value of this compliance is about  $1.5 \times 10^{-8}$  cm./dyne for shellac 78 r.p.m. records, and  $2.5 \times 10^{-8}$  cm./dyne for Vinyl L.P. records.

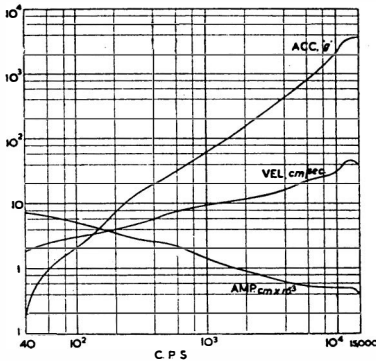

FIG. 1.

Fig. 1 shows the recording characteristics of a British long-playing disc, as taken from Decca LXT 2695, and then equated for maximum possible recording levels. The high frequency pre-emphasis on present British records is considerably less than on the American product. This is extremely important, in view of the maximum acceleration at high frequencies to which the stylus tip can be subjected. Non-tracking at these high frequencies can result in a very insidious form of distortion which, in the writer's opinion, is one reason why the high frequency distortion of some L.P. pressings is so bad.

In modern symphonic music, the peak power is radiated in approximately two main frequency bands: the low frequency band covering up to 500 c.p.s., and the high frequency band 8 Kc/s. to 11 Kc/s.; and

from a total peak power of approximately 60 acoustic watts, the bass drum radiates about 24 watts in the low frequency region, and the cymbals radiate 10 watts in the 8 Kc/s. to 11 Kc/s. region. The total power above 11 Kc/s. decreases very rapidly, and for practical design purposes 10 Kc/s. can usually be taken as the upper frequency limit for maximum modulation. This maximum velocity is approximately 32 cm./sec. and corresponds to an acceleration of about 2,000 g. When it is realised that the effective mass of the stylus tip is increased by 2,000 times at this frequency, the necessity for very low effective mass referred to the stylus tip becomes apparent.

At the low frequency end of the scale, the displacement is the controlling factor, and the maximum value is approximately 0.008 to 0.01 cm. The value of this displacement, together with the vertical stylus force, determines the minimum working compliance of the reproducer system.

#### Pinch Effect

As is well known, pinch effect becomes increasingly serious at high frequencies, especially when the recorded velocity is high, and the linear velocity of the groove past the stylus tip is small; i.e., towards the centre of the disc. This pinch effect results in a vertical velocity being imparted to the stylus point at twice the lateral frequency. Fleming gives the vertical velocity of the stylus point as approximately twice the product of the stylus radius and the frequency, multiplied by the square of the ratio of the vibrational velocity (signal level) to the linear groove velocity. This latter component is the actual speed of the groove past the stylus point.

It will be apparent that this vertical velocity is directly proportional to frequency, and varies as the square of the ratio of the vibrational velocity to the linear velocity. In practice, this means that the pinch effect will become serious towards the centre of the disc, especially with high modulation levels of the high frequencies.

The groove velocity has been assumed at 42 cm./sec. for a diameter of 12 cm. at  $33\frac{1}{3}$  r.p.m. These are the practical commercial limits for high frequency velocity and inner groove diameter on English L.P. recordings of good quality.

Fig. 2 shows the relationship between vertical and horizontal velocities for an L.P. record cut in accordance with the characteristics of Fig. 1. Thus, at 10 Kc/s., the lateral and vertical velocities are approximately the same, and at higher frequencies

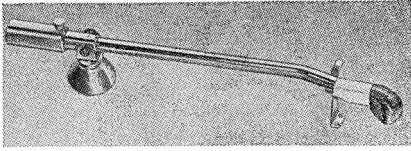

*Decca pickup arm Type 13024 with  
magnetic head*

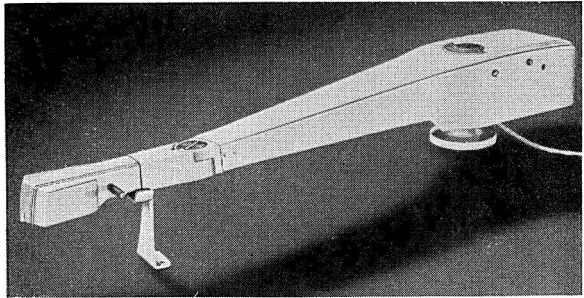

*E.M.I. transcription  
pickup Type 17a, with  
head*

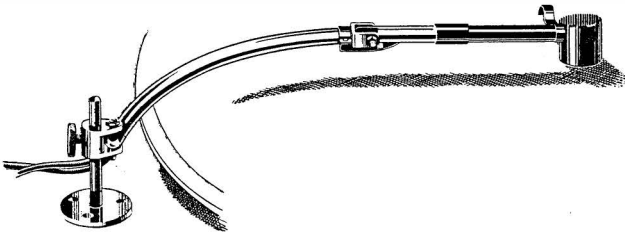

*Expert hand-made arm and head*



*Expert playing desk, fitted with two arms*

the vertical velocity could actually exceed the lateral velocity. This ratio is credible when it is remembered that the radius of the stylus tip is considerably greater than the wavelength of a 14 Kc/s. trace at these low groove velocities.

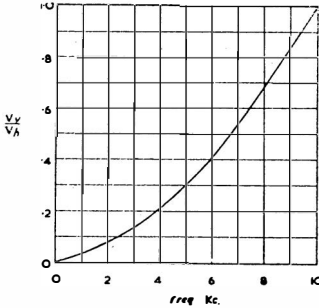

FIG. 2.

The result of the pinch effect is threefold. If the mass and area of the moving system in the vertical direction are large, as in the case of pickups with low vertical compliance, the whole pickup head will tend to vibrate vertically, and the disc will tend to vibrate in a horizontal plane, because the two masses are coupled by a 45 deg. plane. Thus considerable radiation of acoustic energy will take place at double the lateral modulation frequency; it is this second harmonic radiation that gives rise to the distressing needle chatter heard on some pickups.

The second effect is more important. That is, increased record and stylus wear (due to the high mechanical impedance at the stylus tip in a vertical direction) when subjected to these high accelerations. Finally, some pickups have an appreciable vertical response, and the result of this pinch effect will be to convert the pickup into a very effective generator of second harmonic distortion.

Tracing distortion also rears its ugly head. This is a function of the geometry of the record design, and results in high levels of intermodulation distortion if high amplitudes are recorded on the inside grooves of the record. (This is usually the case on the final crescendo that terminates most symphonic works.) It can amount to anything up to 20 per cent.

### Basic Pickup Design

The record groove walls normally have an included angle of 90 deg. and the stylus tip is spherical in shape. The lateral undulations of the groove will result in relative lateral motion of the stylus (providing the downward vertical force is greater than the lateral force). It can be shown that the maximum

lateral force exerted on the stylus is equal to the maximum displacement, divided by the compliance of the stylus system. If the vertical force due to the weight of the pickup head is less than the horizontal force, due to the relative motion of the record groove, the stylus will tend to ride up one or other of the walls of the groove. The minimum weight required to keep the stylus in the groove will be equal to the maximum displacement in cms. divided by 981 times the stylus compliance.

Fig. 3 shows the ratio of stylus force against mechanical impedance, assuming the levels shown in Fig. 1. For any other maximum velocity, a different curve would obviously be required. The successful tracing of any record is controlled by three, and only three, factors. The impedance of the stylus tip, the recorded velocity, and the vertical "stylus force" or "playing weight."

If we take the simplest mechanical system used in any pickup (comprising a rigid armature with a stylus at one end, a restoring means, and a bearing) it will behave as a

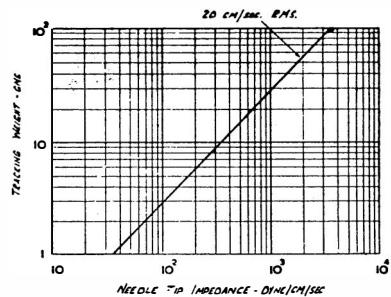
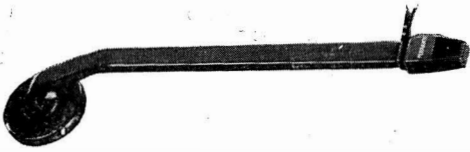

FIG. 3.

simple series resonant circuit, in which the effective mass of the stylus will resonate with the stiffness (reciprocal of compliance) of the restoring medium. We can obviously choose any values we wish, but the final playing weight of the pickup will be determined by the compliance and displacement at the low frequency end, and the mass and acceleration at the highest frequencies. Failure to appreciate these two simple facts has caused more headaches and disappointments for pickup designers (to say nothing of the unfortunate purchasers of their products) than all the other factors put together. They are most important parameters, and determine precisely the final performance of the pickup.

For a playing weight of 10 gm., this will give a value of  $10^{-6}$  cm./dyne. In practice, this value must be increased by at least





*Ferranti ribbon pickup  
with arm*

*Goldring arm with  
"500" cartridge head*

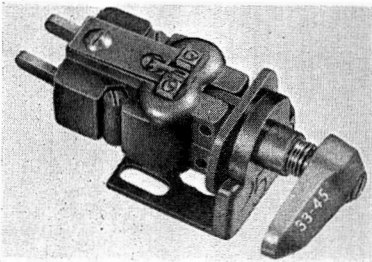
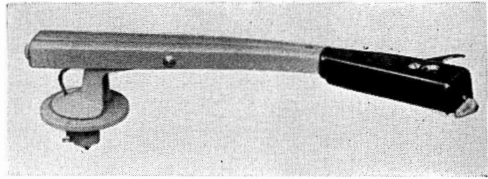

*Goldring variable reluctance cartridge  
Type "500"*

*Goldring "Jubilee"  
micro-balanced trans-  
cription pickup arm*

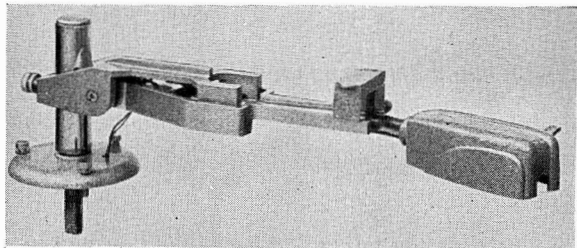

times (w<sub>0</sub>) in order to allow a factor of safety, and it is also assumed that the effective lateral mass of the pickup and tone arm will resonate with this compliance at a frequency lower than the lowest recorded frequency. Should the low frequency resonance occur in the recorded band, the stylus tip impedance will rise at the resonant frequency. This will require an increase in playing weight by the same ratio to keep the stylus in contact with the groove walls.

The maximum effective mass of the armature (referred to the stylus point) which can be used under a given set of conditions, is the ratio of playing weight to the stylus acceleration. Taking the maximum acceleration as 2,000 g., the practical maximum dynamic armature mass at the stylus point is 5 milligrams for a playing weight of 10 grams. Unfortunately, not many pickups meet this requirement. Taking these two values of mass and compliance, and applying the usual formula for series resonance, gives a frequency at which the impedance is minimum. It has been experimentally determined that this resonance should not be greater than about 1 Kc/s. in order that the maximum mechanical impedance shall be approximately equal at both ends of the frequency spectrum.

#### Mechanical Impedance

Mechanical impedance is defined as the ratio of force / velocity : therefore, knowing our maximum recorded velocity, and the usable stylus force determined by the playing weight, we can specify the maximum mechanical impedance of the system for adequate groove tracing. This, for L.P. records at 10 gm., is approximately 300 mechanical ohms.

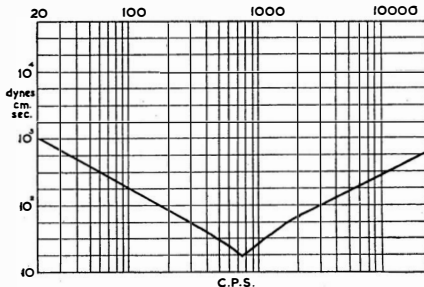

FIG. 4. Basic Pickup analogue

Fig. 4 shows a low compliance, low mass system, of a typical pickup. The low mass is satisfactory for high frequency tracing, and

the unit will be satisfactory at frequencies down to 30 c.p.s., because the stiffness of the restoring force is reasonably small. It is seen that the resonant frequency is approximately 750 c.p.s., which is well below the maximum.

In the above example we have assumed an ideal system, with infinite tone arm mass and zero record compliance. In practice we find the record behaves as a constant current generator in parallel with a compliance ; the value of this compliance on Vinyl records is about  $2.5 \times 10^{-8}$  cm./dyne, and this will resonate with the effective stylus mass at some high frequency, giving rise to the so-called stylus resonance. At the resonant frequency, the mechanical impedance of the system will rise by a ratio determined by the Q of the system, which is usually of the order of 4 to 10. Should this resonant frequency occur below 10 Kc/s., tracing difficulties will usually be experienced due to the high stylus tip impedance in this frequency band,

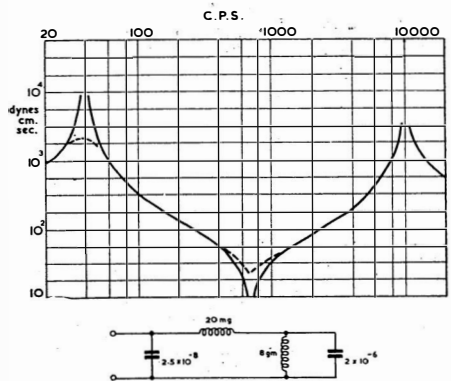
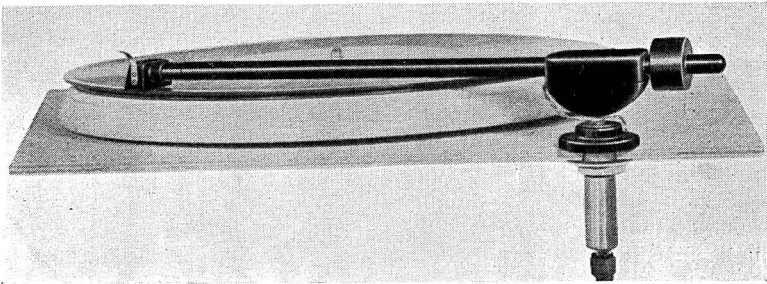

FIG. 5. Experimental System

together with colouration of scratch and accentuation of response at that frequency ; and if it is desired to move the resonance outside this band, the only solution is to reduce the armature mass. There is nothing that the pickup designer can do about the record compliance !

Until now, we have dealt only with the armature mass, and have taken the mass of the rest of the system on trust. The effective lateral mass of the tone arm and pickup head may be anywhere between 10 and 60 gm., and this mass will resonate with the armature compliance at some low frequency ; it is the aim of the pickup designer to put this as low as possible, preferably outside the recorded range.

Fig. 5 shows the mechanical impedance of an experimental system. It will be seen that



*Leak Dynamic pickup and arm*

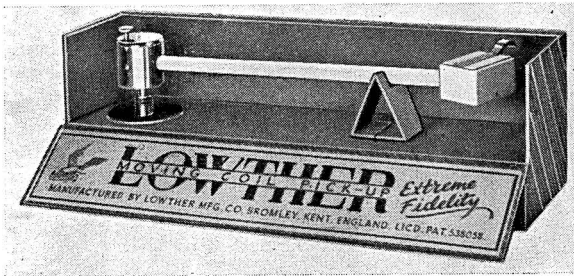

*Lowther moving coil pickup and arm*

*Ortofon pickup head on B.J. arm*

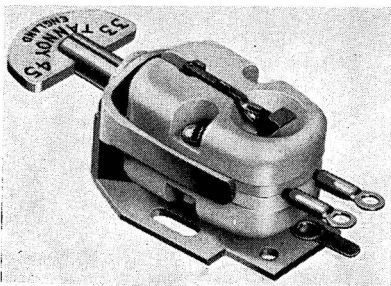
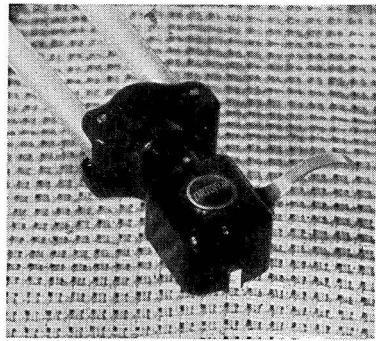

*Tannoy variable reluctance cartridge*

the low frequency has been put at 40 c.p.s. This is much too high for modern reproducers, and should normally be at 20 c.p.s. If the effective mass of the tone arm is increased from 8 gm. to 32 gm., the resonance will come at the right frequency, i.e., 20 c.p.s., and it is standard practice nowadays to make the effective mass of the pickup system between 30 gm. and 40 gm. We must, however, be careful that the resonant frequency is not very close to  $22\frac{1}{2}$  c.p.s., which is the rumble frequency of most of the domestic turntables. This rumble frequency

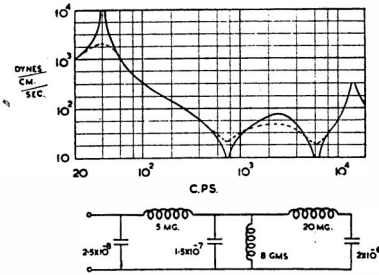

FIG. 6.

consists of a  $22\frac{1}{2}$  c.p.s. vertical elliptical motion, rotating about its vertical axis at an indeterminate speed, and with appreciable lateral content; the low frequency Q of the pickup is usually 2 to 5 (and sometimes up to 25), and with a healthy loudspeaker bass response, the rumble can be extremely annoying.

By the judicious application of some form of damping to the tone arm back bearing, the effective Q, and hence the mechanical impedance, at the resonant frequency can be considerably reduced. At the high frequency end, the effective armature mass will resonate with the record compliance, and if adequate damping is not applied, the rise in stylus tip impedance can quite easily be times 8 or 10. In Fig. 5, this is shown at 10 Kc/s. and if it is desired to increase the frequency of this resonance, the effective mass at the stylus tip must be reduced. Referring to the circuit schematic, the mechanical input from the record is at the left, the record compliance is shown as a capacity across the input. The series inductance is the armature mass, the parallel inductance is the total tone arm and pickup mass, and the capacity across it is the armature restoring means.

A pickup design, in accordance with the above philosophy, will suffer from one major defect: if the armature mass (either

magnetic or crystal) is reduced to sufficiently small proportions to put the upper resonance outside the recorded band, the sensitivity of the pickup will suffer; and in the case of magnetic units, possible distortion due to saturation of the armature may occur if an attempt is made to restore the sensitivity by increasing the magnetic flux.

One compromise is to decouple the main moving system (armature or moving coil or crystal) from the stylus tip by means of a cantilever. Fig. 6 shows the effect of this. Here, two extra resonances are introduced, a parallel resonance at 2,500 c.p.s., and a series resonance at 6 Kc/s. The stylus tip resonance has now been pushed to approximately 15 Kc/s., and the overall effect is to reduce considerably the impedance in the high frequency region. It should be noted that the 15 Kc/s. resonance is the stylus mass resonating with the record and cantilever arm compliances in series; that at 2,500 c.p.s. is the armature mass resonating with the cantilever arm and restoring means compliances in series; and the 700 c.p.s. resonance is the armature mass resonating with the restoring means compliance; and, finally, the 40 c.p.s. resonance is the tone arm mass resonating with all the compliances in parallel.

The benefits derived from a cantilever stylus are not confined to the reduction of lateral stylus tip impedance at the high frequencies. The total effective mass of the cantilever proper is usually very much smaller

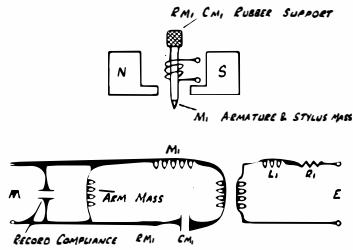

FIG. 7.

than the armature system. Additionally, the vertical compliance can be increased to a value which will efficiently decouple the rest of the system from the vertical undulations due to pinch effect. The design of the cantilever, however, must be a judicious compromise between low mass and high compliance (low effective mass usually necessitates a short cantilever and high compliance requires the reverse); if the length is excessive the unit will behave as a low pass filter.

### Practical Pickups

The normal magnetic pickup is shown in Fig. 7, in which the armature is suspended at the remote end. This is used with a sapphire type stylus, and it is possible to produce pickups in which the effective stylus mass is less than 5 milligrams, and the compliance greater than  $2 \times 10^{-6}$  cm./dyne. This results in very good tracing capabilities, but the price paid is a general low overall efficiency. The pickup suffers from the disadvantage of inherently low vertical compliance, with the result that needle talk is excessive. A later development of this basic type is the "variable reluctance" unit. This uses a cantilever stylus, and the stylus itself is used as an armature. In some cases, the whole of the stylus arm is magnetic; in others, a tiny piece of very efficient magnetic material is carried immediately adjacent to the stylus tip. Variable reluctance cartridges are characterised by the extremely low stylus mass (because there are no extra appendages), and because of the low magnetic efficiency the compliance can be considerable. It is probable that this construction represents the ultimate for wide range and low distortion in the design of magnetic moving iron pickups, but unfortunately the electrical output is usually very low.

The first practical solution to wide range reproduction with low mechanical impedance was achieved by Mr. Voigt, with his long narrow moving coil; and the majority of moving coil pickups designed and manufactured today are based on the precepts laid

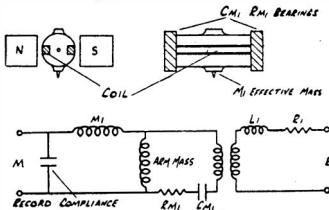

FIG. 8.

down by this pioneer of high fidelity. Fig. 8 shows a typical example. The coil is one with a lightweight plastic former, cylindrical in shape; it has rubber tube bearings and is supported in a uniform magnetic field. Rotation of the former results in voltage being generated which is proportional to the field, the number of turns and the velocity.

It is possible to reduce the effective mass to about 5 to 7 milligrams for normal construction, and in the case of ribbon type units to about half this value. The efficiency of both units is low and unless precautions are taken, in the case of the ribbon unit, to have a completely balanced electrical system, the induced hum, especially in the connecting leads, can be serious. Because the coil and former are essentially non-magnetic there is no tendency for the armature to stick to either of the pole pieces, and the bearings which are also used as restoring means can be made highly compliant. There is a limit, however; if they are made too compliant, the armature will be deflected off-centre by the playing weight, and will

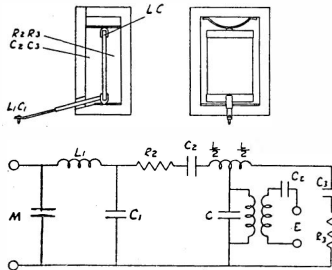

FIG. 9.

tend to roll on the top of the bearing. The plinth on top of the armature is used as a dynamic balancing medium; otherwise, at high frequencies, the centre of gravity of the armature will move progressively from the geometrical centre, resulting in the effective mass of the armature increasing with frequency.

### Moving Coils

Taking present day reproducers, the best moving coil units probably represent the epitome of high fidelity design, with the exception of needle talk, which is high, because the relatively large area of the armature is rigidly connected to the stylus tip, and is a very efficient radiator of sound energy at high frequencies. A recent continental pickup has been produced, using a vertical coil with a cantilever type stylus connected to it. This results in a very considerable reduction in needle talk without losing any of the advantages of the moving coil system.

Finally, there is the cantilever type crystal unit shown in Fig. 9. The crystal is very freely suspended, so that there is appreciable

motion along its length. It is restrained at the remote end by material which has a high compliance but a very small resistance, and the cavity is filled with a highly viscous gel. By this means, the correct ratio of resistance/reactance can be achieved easily in production. It has the added advantage that the crystal is hermetically sealed against moisture, and that the damping is applied over the whole crystal, rather than to one place only. The compliance is of the order of  $3.5$  to  $5 \times 10^{-6}$ , resulting in a low frequency resonance of about 15 c.p.s. with a normal tone arm. The effective mass in the high frequency region is about 5 mg., resulting in the resonance being about 15 Kc/s., but because of the high damping factor applied; it is more nearly correct to say that the system is aperiodic.

In the foregoing examples the equivalent circuit has been shown in a simplified version, in that it only deals with the lateral components. As we have indicated, there is additionally a vertical component, which in certain circumstances can affect the response of the pickup; and there is also a torsional component. The vertical compliance will resonate with the effective vertical mass of the tone arm in an exactly analogous manner to the lateral condition; and with some spring loaded tone arms a highly efficient oscillatory circuit results, sometimes with Q's as high as 25. If this should occur, either near the rumble frequency or in the lower recording range, trouble can be expected, due to either increased motor rumble or groove

jumping on heavily modulated passages, even though the cartridge itself is beyond suspicion. In the case of the torsional compliance, the torsional moment of inertia of the arm is usually quite low, and results in wiggles in the response somewhere between 200 and 600 c.p.s.

As is well known, if a straight arm is used a considerable tracking error can exist; and so a tentative international standard has been promulgated for pickup arms in domestic reproducers, with centres of 7 in. from pickup arm pedestal to turntable centre, 0.6 in. overhang and an offset angle of 26 deg. Using these values, the maximum error occurs on the outside of the disc, and is less than 3 deg., resulting in a maximum distortion due to this cause of approximately 0.2 per cent.

Considerable artist's licence has been exercised in the design of tone arms. Some are good, some are not so good; and in a number of cases, strict technical efficiency has been subjugated in the interests of decor. It is usually considered best engineering practice to make any product as simple as possible; and in the case of tone arms, multiplicity of bearings, unless made with extreme accuracy, must be deprecated. For these reasons, and in order that the various moments of inertia may be equalised, the writer prefers a single point suspension with a counter-balanced weight.

The selection of the correct type of pickup is as important as that of the amplifier and loudspeaker, and pennies should never be saved in attempting to buy a cut-price article.

## DIRECTORY OF PICKUPS AND ARMS

**Burne-Jones**, Magnum House, London, S.E.1. (*Photo page 44.*)

B.J. "Tangential" pickup arm. Price £2 4s. 11d. (+ P.T.).

B.J. "Super 90 tangential" pickup arm. Prices: 12 in. size, £11 11s.; 16 in. size, £12 15s. (both + P.T.).

B.J. pickup head crystal. For spec.: see Acos H.G.P. Price £1 12s. 6d. (+ P.T.).

B.J. pickup shell for holding cartridges. Price 17s. 3d. (+ P.T.).

**Collaro Ltd.**, Ripple Works, By-pass Road, Barking, Essex, England. (*Photo page 44.*)

"Studio Transcription" arm, complete with "Studio P" cartridge. Turnover type for l.p. and 78 r.p.m. Price £3 17s. 6d. (+ P.T. in U.K.).

"Studio P" crystal cartridge. Output voltage, 50 mV from l.p. Frequency response 50 to 12,000 c.p.s. Downward pressure 7.5 grams. Load impedance,  $\frac{1}{2}$  Megohm. Price with 2 sapphire styli, £2 6s. (+ P.T.).

**A. R. Sugden & Co., Ltd.**, Well Green Lane, Brighouse, Yorkshire, England. (*Photo page 44.*)

Connoisseur Mk 2 moving coil. Output voltage, 15 mV from l.p. Frequency response 20 to 20,000 c.p.s. ( $\pm 2$  db). Downward pressure, 4 grams. Load impedance 400 ohms. Price with diamond £6 12s.; with sapphire £3 10s. (both + P.T. in U.K.).

Connoisseur Mk. 2 pickup arm, complete with one head (l.p. or 78). Price with diamond £8 15s.; with sapphire £5 13s. (both + P.T. in U.K.).

**Cosmocord Ltd.**, Enfield, Middlesex, England. (Photo page 44.)

**Acos.** Crystal cartridge head, Type HGP—39. Output voltage  $\frac{1}{2}$  v from l.p. Frequency response, 40 to 13,000 c.p.s. Downward pressure 8 grams. Load impedance, 1 Megohm. Prices : with sapphire stylus, £3 12s. ; with diamond stylus, £5 10s. (+ P.T. in U.K.).

**Acos pickup arm.** Type GPO 20 Hi-g, complete with HGP—39 head (l.p. or 78 r.p.m.) with sapphire stylus. Price £2 12s. (+ P.T. in U.K.).

**Decca Ltd.**, 1-3 Brixton Road, London, S.W.9. (Photo page 46.)

Pickup arm, type 13024, to take 3-p.m. plug-in heads. Price on application.

**E.M.I. Ltd.**, International Dept., Hayes, Middx., England. (Photo page 46.)

Unipivot transcription arm and pickup, model 17a. Moving coil. Output voltage, 50 mV from l.p. (at transformer secondary). Frequency response, 30-14,000 c.p.s. Downward pressure, 8 grams. Load impedance, 1 ohm. Arm plays discs up to 17 in. dia. Price on application.

**Expert Gramophones Ltd.**, Ingerthorpe, Great North Road, London. (Photo page 46.)

Hand-made pickup arm, with hard steel pointed pivots for vertical and horizontal movements. Adjustable for tracking, height, and stylus pressure with moving coil pickup head. Output voltage (at transformer sec.) 60 mV from l.p. Frequency response, 40 to 20,000 c.p.s. ( $\pm 1$  db). Downward pressure, 3 grams. Load impedance, 10 ohms. Price, with diamond stylus, £11 5s. (+ P.T. in U.K.).

**Ferranti.** Distributed by Acoustical Manufacturing Co., Ltd., Huntingdon, Hunts, England. (Photo page 48.)

Ribbon type pickup, complete with arm. Output voltage (at transformer secondary), 1 mV from l.p. Frequency response, uniform up to at least 20,000 c.p.s. Downward pressure, 5 grams. Load impedance 100,000 ohms. Price with diamond stylus £15 5s. Transformer, £4 (both + P.T. in U.K.).

**Goldring Manufacturing Co.**, 486/488 High Road, Leytonstone, London, E.11. (Photo page 48.)

Pickup cartridge, type 500. Variable

reluctance. Output voltage, 10 mV from l.p. Frequency response, 30 to 20,000 c.p.s. Downward pressure, 4 grams. Load impedance 50,000 ohms. Price, with 2 sapphire styli, £2 10s. ; with 1 sapphire and 1 diamond for l.p., £6 (both + P.T. in U.K.).

Pickup arm, complete with Type 500 cartridge fitted 2 sapphires, £5 ; 1 sapphire and 1 diamond, £8 10s. (+ P.T. in U.K.).

Jubilee micro-balanced transcription arm. Adjustable height. Stylus pressure shown on scale (2-12 grams) and adjustable. Head takes all standard cartridges. Type TR 1 for 10 in. and 11 in. discs ; TR 2 for discs up to 16 in. Price on application.

**H. J. Leak & Co., Ltd.**, Brunel Road, Westway Factory Estate, London, W.3. (Photo page 50.)

Dynamic pickup. Moving coil. Output voltage, 11 mV from l.p. (at transformer secondary). Frequency response, 40-20,000 c.p.s. ( $\pm 1$  db). Downward pressure 2 to 3 grams for l.p. Load impedance (coil 6 ohms). Prices : (Arm) £2 15s. ; Head with diamond stylus, £5 15s. (+ P.T. in U.K.).

**Lowther Manufacturing Co.**, Lowther House, St. Marks Road, Bromley, Kent, England.

Moving coil pickup. Output voltage, 5 mV from l.p. Frequency response, 20-20,000 c.p.s. ( $\pm 1$  db). Downward pressure, 5 grams. Prices : with diamond, £12 10s. ; with sapphire, £5 10s. (+ P.T.).

**Ortofon.** Fonofilm Industri A/S Copenhagen. Distributed in the U.K. by Rimington Van Wyck Ltd., 42 Cranbourn Street, London, W.C.2. (Photo page 50.)

Moving coil pickups. Types A, AB, B, C, with downward pressure of 7, 6, 5, and 3 grams respectively. Output voltage (at pickup), 0.15 mV from l.p. Coil impedance 1.5 ohms. Load impedance 10,000 ohms. Frequency response, 20 to 25,000 c.p.s. (within 1 db). Price, with sapphire stylus and including transformer, £17 17s. (Tax included)

**Tannoy Products Ltd.**, West Norwood, London, S.E.17. (Photo page 50.)

Variluctance pickup cartridge. Output voltage 20 mV from l.p. Frequency response, to 16,000 c.p.s. ( $\pm 2$  db). Downward pressure 6 grams. Load impedance 50,000 ohms. Price, with l.p. diamond and 78 r.p.m. sapphire, £9 10s. (+ P.T. in U.K.).

# MOTOR UNITS

By Stanley S. Kelly

**S**TRANGE as it may seem, the gramophone motor (or turntable, as it is generally termed today) is the one essential piece of equipment in which the specification has not materially altered during the whole history of recorded music. Until the advent of electrical recording, the major cost of any reproducer was expended on the driving mechanism. Most of us can remember the early Thorens, and Garrard 3 and 4 spring motors, with their cleverly contrived governors. Then, as now, the main engineering ingenuity was directed to producing a wow and rumble free drive. Rumble was not quite so important then as it is today, principally because the acoustic reproducer did not, in fact, reproduce very much below 300 c.p.s.. The advent of electrical recording and reproducing equipment, with unlimited amplification and a frequency response extending down to 30 c.p.s. even 30 years ago, resulted in rumble becoming a major factor. Rumble and wow are probably the most important evils still attendant upon gramophone turntables, and their complete elimination is still taxing some of the best brains in the industry.

## Requirements

High fidelity reproduction demands low frequency response to approximately 30 c.p.s., and modern records are engraved with extremely high modulation factors down to this frequency. In order that there shall be no variation in speed on these heavy passages, it is essential that (a) the prime mover (electrical motor) shall be of sufficient power ; and (b) that the inertia of the turntable shall be adequate to store enough energy to smooth out any cyclic variations in the motor speed. Which in turn leads to a large, heavy turntable and an efficient motor.

In the early days, motor consumptions of 60 watts were quite common, but latest models now consume about 15 watts, some using a little more power and some a little less, depending principally upon the transmission losses of the speed reduction system.

This speed reduction is usually accomplished through friction drive wheels. It is very rare, except in professional equipment, to find cut gears used, because the degree of precision required to give a rumble-free drive would probably add £20 or £30 to the cost of the motor.

## The Drive

Friction drive requires that at least one of the wheels shall be flexible, and this is achieved by coating a roller or disc with a rubber compound. Rubber, whether natural or synthetic, possesses a rather undesirable quality (which in part is due to its flexibility) namely, cold flow. That is, if the rubber covered disc or roller is pressed against any other object for a period of time, the shape becomes distorted and, in technical parlance, a "flat" develops. It is therefore essential, where this system is used on gramophone turntables, that the idler wheel (as this piece of equipment is usually called) shall automatically disengage from the driving shaft and the driven member, which is usually the turntable itself. Otherwise, after a period of use, the flats on the idler will make it a very efficient generator of rumble.

The motor itself produces two main types of vibrations. The first is due to mechanical unbalance of the rotor ; and with the majority, but not all, of present-day motors this unbalance causes a  $22\frac{1}{2}$  c.p.s. vibration to be transmitted via the bearings and shaft to the rest of the assembly. The other vibration is 100 c.p.s., due to the laminations moving, and strictly speaking it should not be apparent on the type of motor used for high fidelity reproduction.

It is theoretically possible to eliminate the  $22\frac{1}{2}$  c.p.s. vibration by correctly balancing the rotor ; but even with the most modern balancing equipment some slight unbalance usually persists, and with the best type of units this vibration is "decoupled" from the rest of the unit by flexibly mounting the motor. Inertia of the flywheel, and the compliance of the idler, should form an effective low pass filter, and thus prevent





*Garrard "301." transcription unit. 3-speed and variable.*



*Connoisseur transcription unit. 3-speed and variable*

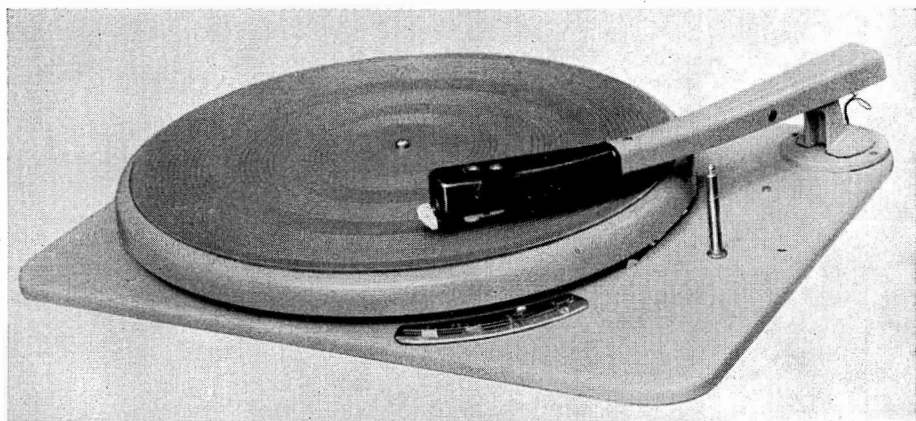

*Lenco transcription unit. 4-speed and variable*



*Collaro "2010" transcription unit. 3-speed*

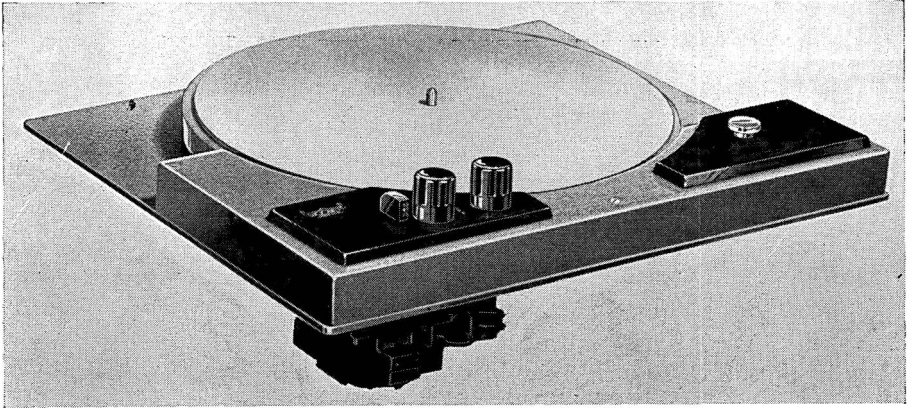

*Woollett transcription unit. 3-speed*

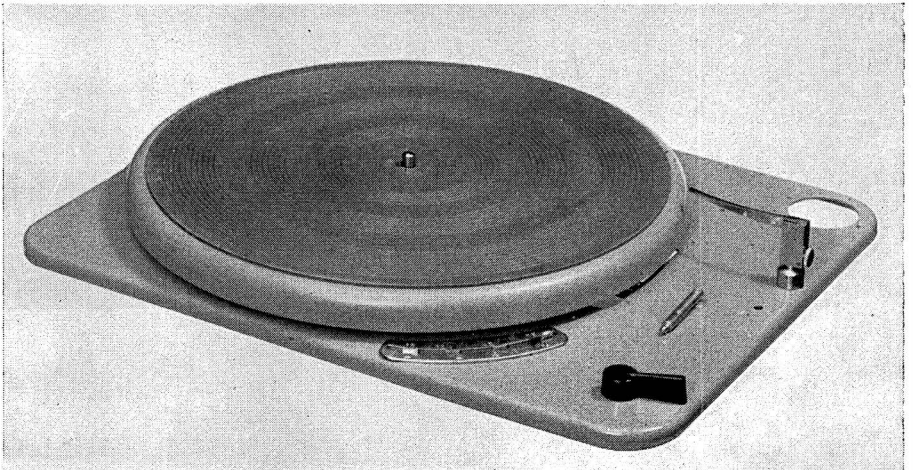

*Lenco unit with pickup "lift and lower" device*

direct transmission of the  $22\frac{1}{2}$  c.p.s. rumble to the turntable face.

The analysis of the  $22\frac{1}{2}$  c.p.s. frequency is difficult. The mounting plate tends to vibrate with a circular horizontal motion, whilst the turntable itself modulates this  $22\frac{1}{2}$  c.p.s. with its own rotational frequency. Additionally, it is possible for more than one mode of unbalance to exist in the rotor ; this results in an addition to the horizontal component of a smaller vertical one, and it is this vertical vibration which can prove extremely troublesome with some types of crystal pickups which are sensitive to vertical vibration—particularly if their low frequency resonance is about  $22\frac{1}{2}$  c.p.s.

Modern long-playing records, especially those of  $33\frac{1}{3}$  r.p.m., place the most stringent requirements upon wow and rumble ; and units which achieve a satisfactory performance on 78 r.p.m. often fall down completely at the lower speed. This is aggravated by the fact that the driving pulley for  $33\frac{1}{3}$  r.p.m. speed is rather less than half the diameter of the 78 r.p.m. speed and small variations in eccentricity, etc., become increasingly important. Tests for wow and rumble should

therefore be made at  $33\frac{1}{3}$  r.p.m.

Constancy of speed is of extreme importance but, sad to say, it is seldom achieved absolutely ; not because of deficiencies in the motor design, but because of the wide day-to-day variation in both voltage and frequency obtained from most of the Electricity Supply's undertakings. Where the listener is blessed (or cursed) with the sense of absolute pitch, some control over motor speed is an added advantage, and two British units at least possess this desirable feature.

The turntable should preferably be non-magnetic, otherwise the leakage flux from even the best of modern magnetic pickups will cause an additional force to be created, which will increase the playing weight.

The best gramophone turntables have been christened "transcription units." Those produced in this country are characterised by an extremely massive turntable and a solidly constructed base plate. Elaborate precautions are taken to prevent rumble and wow, and it is essential that the maker's mounting instructions be rigidly adhered to. *Never, never* fit the turntable and pickup in the same cabinet as the speaker.

## DIRECTORY OF MOTOR UNITS

**Important Note :** No mention is made of record-changers in the following directory. The list is confined to motor units of transcription quality only. The products listed below can be recommended, and conform to the requirements necessary for high quality sound reproduction. The three speeds refer to 78, 45, and  $33\frac{1}{3}$  r.p.m. unless otherwise detailed.

\* \* \*

**Collaro Limited**, Ripple Works, By-Pass Road, Barking, Essex, England. (*Photo page 57.*)

*Transcription Unit, Model 2010.* Three speeds. Complete with pickup arm and "Studio P" head with turnover cartridge. Plays discs up to 16 in. diameter. Price £13 16s. 6d. (+ P.T. in U.K.).

\* \* \*

**Goldring Manufacturing Co. (Great Britain) Ltd.**, 486/488 High Road, Leytonstone, London, E.11. (*Photos pages 56/57.*)

*Lenco Transcription Unit, Type GL 50/4.* Four speeds at pre-selected points for 78, 45,  $33\frac{1}{3}$  and  $16\frac{2}{3}$  r.p.m. positions. Speed continuously variable from 29 to 86 r.p.m. Complete with pickup arm and Goldring "500"

cartridge. Price £15 15s. (+ P.T. in U.K.).

*Lenco Transcription Unit, Type GL 56.* As above, but with mechanical pickup "lift and lower" device. Price £16 16s. (+ P.T. in U.K.).

*Lenco Transcription Motor Type GL 55.* As Type GL 56, but without pickup arm and head. Price £12 12s. (+ P.T. in U.K.).

\* \* \*

**Woollett Sound and Wireless Equipment**, Wells Park Road, London, S.E.26. (*Photo page 57.*)

*Transcription Motor Unit.* Three speeds. Price £15 2s. 6d. (+ P.T. in U.K.).

\* \* \*

**Garrard Engineering & Manufacturing Co., Ltd.**, Swindon, Wiltshire, England. (*Photo page 56.*)

*Model 301 Transcription Motor.* Three speeds. Variable speed adjustment. Price £19 (+ P.T. in U.K.).

\* \* \*

**A. R. Sugden & Co. (Engineers) Ltd.**, Well Green Lane, Brighouse, Yorkshire, England. (*Photo page 56.*)

*Connoisseur Transcription Motor.* Three speeds. With variable speed adjustment. Price £20 (+ P.T. in U.K.).

# AMPLIFIERS and CONTROL UNITS

## An Introduction

IN its simplest form, an amplifier could consist of (and did in the very early days) an H.T. battery, a valve, and another battery (L.T.) to heat the valve's filament. By connecting the output of the gramophone's pickup to the input of this simple one-valve circuit, and by connecting the speaker to the output, it would be possible to gain enough amplification to make the weak voltages from the pickup yield a fair, audible sound from the speaker. However, two important factors would be necessary to ensure that such an elementary set-up worked sufficiently well to provide any results at all. First, the electrical impedance of the pickup would have to be very nearly equal to the electrical resistance of the circuit to which it was connected, otherwise there would be such a serious loss of electrical energy, that very little of the pickup's output would be available for amplification; in practice this means as high as possible, because the input impedance of modern valves is extremely high. Second, the electrical impedance of the speaker would also have to be very nearly equal to the electrical impedance of the part of the circuit to which it, in turn, was connected. Or, as before, much of the amplified "signal" from the valve would be wasted in electrical losses, and would not reach the speaker to drive it properly.

### Mismatching and Distortion

This matter of ensuring that the electrical resistances of any two components are equal is known as "matching." Although the most noticeable effect of a mismatch, in the elementary amplifier suggested above, would be an almost inaudible output, *the most serious effect of it would be the creation of distortion.* This is easily explained. If the power of the same simple amplifier were to be increased, the sound from the speaker would become louder, as the losses through the mismatched circuits were overcome by sheer increase of energy; but only those sound frequencies

that found the mismatch least troublesome would come through in strength; and those that found the unequal struggle too much for them would come through in a weakened condition—or, as the electrician describes it, "attenuated."

If all types of pickup had exactly the same impedance, and if all speakers were of a standard impedance too, it would be possible for all manufacturers to make amplifiers without any thought for the components that were to be used with them. But the very reverse is the case. Some pickups (notably crystal pickups) have a very high impedance, and others (moving coil types, for instance) are intentionally made with a very low impedance. Therefore it is essential for an amplifier to embody some form of adjustable matching device, so that the purchaser can use it with any type of pickup that he fancies.

### Speaker Matching

At "the other end" of the amplifier—the *output* end—the position is less complicated, because today nearly all speakers are made with the same low electrical impedance (15 ohms). But there *are* some high impedance speakers about, and there are also some of even lower impedance; so to be on the safe side some manufacturers embody a speaker matching device on their amplifiers as well. This is one of the "refinements" that cost money.

Speakers are now made with low impedance windings, for technical reasons, as described on other pages, for those who want to go into things more thoroughly. The very nature of valves is such that they are of extremely high internal resistance. Therefore, since the speaker has to be connected to the output of a valve (or pair of valves), the amplifier *must* embody some sort of device for levelling out this difference in the two resistances—or "impedances." For very many reasons the best device for the job in this case is a transformer (there are some

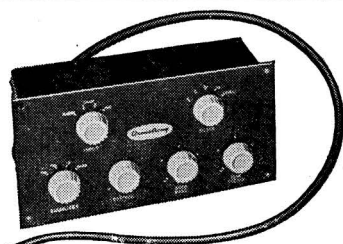
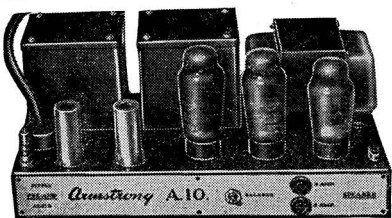

*Armstrong A 10 Control Unit and Amplifier, 10/12 watts. Price £29 10s.*

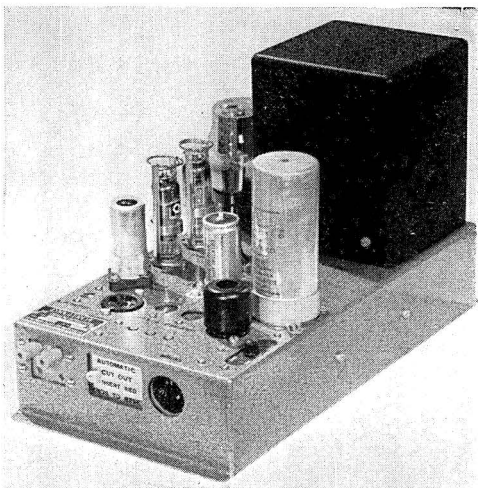
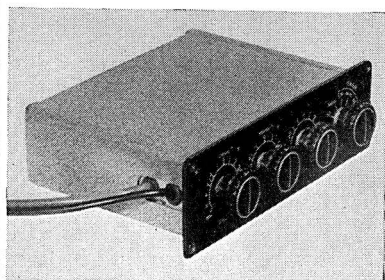

*Dynatron Control Unit (T.C.10) and Amplifier (L.F.10), 12 watts. Price £37 17s. 6d.*

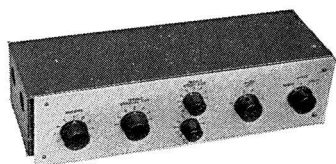
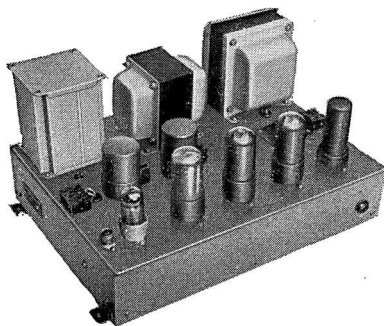
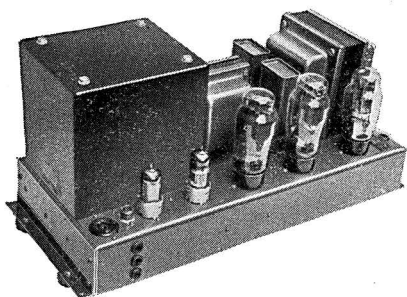

*Expert Control Unit, £17, and above (left) Master Amplifier £35, (right) Standard Amplifier £23*

first-class American and Dutch amplifiers which do not use transformers). A transformer does just what its name implies. It transforms any combination of voltage and current to any other desired combination. In the case of an output transformer, the transformation required is: high voltage and low current into low voltage and greater current. The transformation is effected by the simple expedient of "coupling"—or winding closely together—two coils of wire of different numbers of turns. To reduce an A.C. voltage from 100 volts to 10 volts, one would wind ten times the number of turns of wire on the first coil as on the second. The reduction would then be 10 to 1. And, since electrical power (measured in watts) is simply *voltage* × *current*, when one is increased the other decreases, and the power stays the same (ignoring losses for convenience of explanation!).

### Output Transformers

As is described in the chapter on speakers, strength of *current* is what is wanted in the speaker, rather than strength of voltage; and so, naturally, the lower the resistance (impedance) of the circuit, the greater the current will flow for any given voltage. Thus it will be seen that all this fits very conveniently into the scheme of things. Because of the H.T. voltage at the valve, and *the high resistance of the valve*, there is a low current. And so the first (or "primary") winding of the output transformer needs a lot of turns of fine wire, which very usefully means a very high resistance to match the valve to which it is connected. But the 2nd (or "secondary") winding of the transformer has to match the very low resistance (impedance) of the speaker, so only a very few turns of comparatively thick wire are needed, and the result is a big "step-down" in voltage, with a corresponding "step-up" in current—which is just what is wanted.

This fairly long description of the principles of the output transformer is intentional, because the "O.P.T.", as it is called in Hi-Fi jargon, is the most important part of the whole amplifier. It is so important that, for *perfect* Hi-Fi sound reproduction, the rest of an amplifier should, in theory, be designed around it. In practice there has to be compromise, because the cost of *the ideal* O.P.T. would be prohibitive; and there is not one designer of Hi-Fi amplifiers who would not admit (if he took you quietly into a corner and whispered the truth) that he would love to have been able to put a little

bit more into the O.P.T. ! As it is, the O.P.T. is, or should be, the most expensive component in the amplifier. Upon its design depends the major percentage of the total distortion of the amplifier, the degree of control the amplifier has over the speaker it drives—and, therefore, the final determination of the quality of the whole Hi-Fi equipment. "The better the O.P.T. the Higher the Fi."

This is intentionally a sweeping statement, so consider the difficulties that face the O.P.T.'s designer. From the chapter on sound frequencies (page 17) it will be seen that musical notes vary in frequency from 30 c.p.s. to 29,000 c.p.c. Now these audible frequencies are in the form of electrical frequencies when they pass through the amplifier's circuits: in other words they are alternating voltages which cause alternating current (on the same basis as household A.C.) to flow; and any electrical component which embodies a coil, or winding, in its make-up has a tendency to favour some frequencies of A.C. more than others. Indeed, a coil can be so wound as to offer an almost impossible barrier of resistance to some frequencies, while allowing others to pass at full strength.

In the case of the coils of an O.P.T. it is theoretically desirable that there shall be no loss at any frequency—from the very lowest, to the very highest. Of course this is an unattainable ideal in practice. Such a transformer would be about twice as big as the biggest found today on any standard amplifier; and it would cost about four or five times as much as the most expensive now produced.

### The Importance of the O.P.T.

If all the foregoing does no more than offer one sure guide as to what not to buy, it will have more than served its purpose., i.e., if you are after Hi-Fi you will most certainly not find it in an amplifier with a small O.P.T., for this is a sure indication that money has been saved on the most important component; and however good the remainder of the assembly may be, a poor O.P.T. will ruin the lot. Even a low-power amplifier should have a fairly large O.P.T., and the greater the output power that is quoted, the larger must the O.P.T. be in order to handle the larger currents involved. It is possible that some amplifiers will use a new transformer development—using grain oriented strip material wound into "C" cores, instead of the conventional type lamination. This results in smaller size and somewhat increased efficiency, but at increased cost. This type of transformer is extremely useful for portable

*E.M.G. Control Unit DCU1 and  
Amplifier D.R.24, 12 watts. Price  
complete £45*

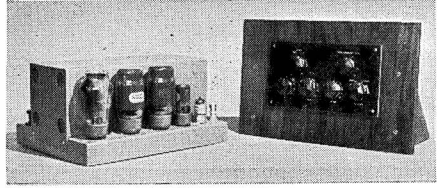

*G.E.C. Control Unit (BCS 2415) and  
Amplifier (BCS 2416), 25 watts.  
Price complete £63.*

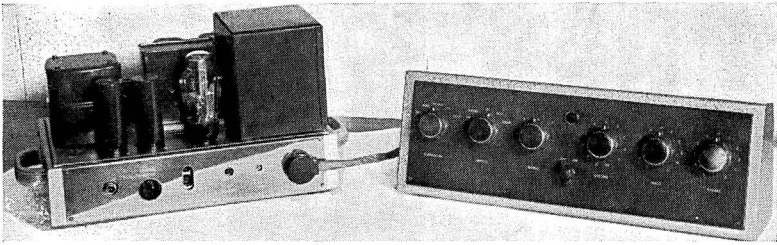

*H.M.V. Control Unit and Amplifier (3050E), 18 watts. Price not announced at  
time of publication*

*Leak. "Point One" Control  
Unit. Price £10 10s.; and  
T.L.10 Amplifier, 10 watts.  
Price £17 17s.*

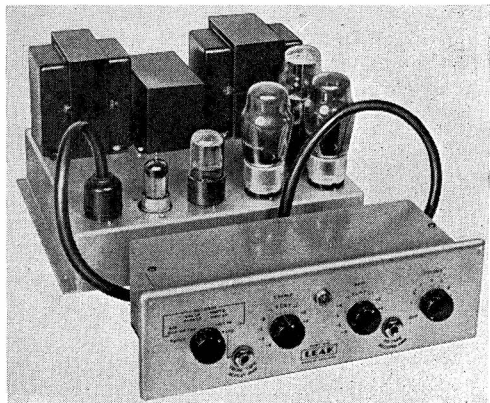

equipment or where space and weight are at a premium.

So far, then, we have three essentials of an amplifier: (1) A device for matching pickups. (2) A device for matching speakers. (3) An O.P.T. We come next to what should, logically, be point number one—the basic power supply.

### The Power Supply

The first component here is another transformer, which accepts the household mains A.C. supply. It must step this voltage *down* to (usually) 6.3 volts through one coil, for heating the valves; and it must step it *up* to provide a higher voltage for the valves' high tension supply. Next, since the valves' high tension supply must be of the D.C. type, the stepped-up voltage has to be rectified; and this is done by a rectifier valve or metal rectifier. And again, since it is essential that no trace of mains hum shall creep into the amplifying circuits, a very efficient "smoothing" assembly is required. Finally, because many users of amplifiers will want to run radio tuners from this power source, the transformer, the rectifier valve, and the smoothing assembly have to be of sufficiently generous design to provide a surplus of power in case it is needed. Most amplifiers are now fitted with such an "extra power outlet" in the form of a multi-way socket.

The rest of the amplifier is, in most makes, of fairly standard electrical design, although the various circuits chosen by different manufacturers have their own peculiarities. Needless to say, however, the quality of the components used in the assembly can vary considerably, and their cost will affect the final price of the unit.

### The Valve Line-up

The typical Hi-Fi amplifier has five valves in its make-up, one for rectifying the H.T. supply and four for the "amplifier proper."

The first valve is a voltage amplifier and is used (a) to give sufficient amplification to drive the next stage of the amplifier, and (b) to make up the loss of overall amplification due to the application of negative feedback. This is followed by valve No. 2, usually a double triode. This valve is used to provide equal and opposite voltages for driving the valves 3 and 4, which are the "output" valves, and in the majority of amplifiers these are "matched" as a pair with identical electrical characters, operate together in what is known as a "push-pull"

output stage. That is to say, while one of them is amplifying the "negative" bump of an electrical vibration, the other is amplifying the "positive" bump; and in the next instant their jobs are reversed. One "pushes" while the other "pulls." The output of one is connected to one end of the O.P.T.'s primary winding, and the output of the second is connected to the other end. The centre-point of the primary winding, or coil, is connected to the neutral point between the two valves. Thus the current flowing through the O.P.T.'s primary is always equal in both directions.

### Power Ratings

An amplifier is always given a "power rating." That is the maximum output at which it works most happily. It is also the output at which it gives minimum distortion to the music it is amplifying. For example, in the specification of an amplifier, one might see 10 watts, distortion .25 per cent.; 12 watts, distortion 1.0 per cent. Peak power 15 watts. This means, in homely terms, that the total distortion of the output would be only one quarter of one hundredth part of the output, with the volume control set to feed the speaker with 10 watts of power (a *lot* of sound, incidentally!); but that if the volume were turned up to give only 2 more watts of output, the distortion of the whole would increase by times four. The final figure means that, even with the amplifier giving full output, there is still a reserve to be called on when needed by the music. In other words, if a sudden crescendo of sound came from the record, the amplifier could provide the power (up to a further 3 watts) to handle the "peak" without serious overloading distortion becoming noticeable.

The distortion figures quoted as examples above represent a good average. Smaller percentages show a more exacting design. And these things, again, are what one pays for.

### The Pre-amplifier

The amplifier, discussed in the above section, could be used by itself, with a pickup connected to its input point, and with a speaker plugged into its output socket. The noise would, however, be deafening, unless a volume control were fitted between pickup and amplifier, because it would otherwise deliver its full volume as soon as it were switched on. The quality of the music would be up to the best Hi-Fi standards, provided that the "recording characteristic" of the record being played were perfectly



*Leak. "Vari-Slope" 2  
Control Unit. Price  
£16 16s.; and T.L./12  
Amplifier, 12 watts. Price  
£28 7s.*

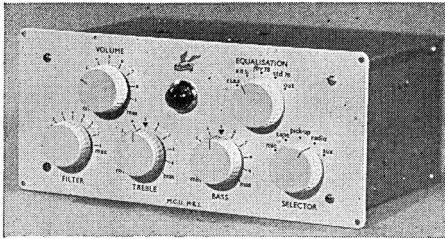
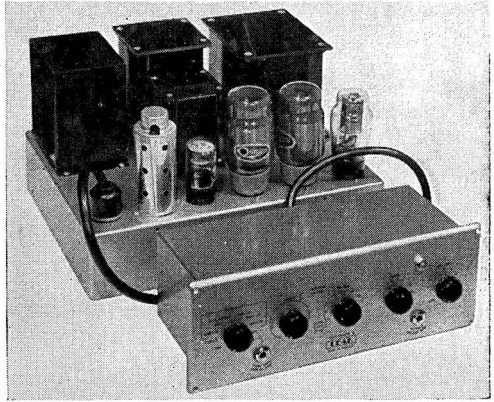

*Lowther. Master Control  
Unit, Mk.1. Price £20.  
Master Control Unit  
Mk.2. Price £24*

*Lowther. "Linear 10"  
Amplifier, 10 watts. Price  
£25*

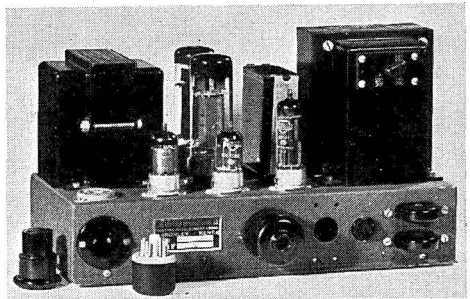

*Lowther. TP10 Amplifier  
(in future to be known as  
"Linear 16"), 16 watts.  
Price £40*

sued to the amplifier, and provided that the pickup were perfectly matched to the amplifier. In other words, the amplifier *could* be used as it stood ; but the chances are a thousand-to-one against the results being a sparkling success, even discounting the views of the neighbours in the two or three adjoining streets. This is because most British-made amplifiers are supplied in two separate units—*Main amplifier* and *pre-amplifier*—and they are usually bought and used together.

The pre-amplifier is often called the *control unit*, and this is probably the better name for it, because although every such unit embodies *all* the controls which govern the main amplifier, and although most of these units are themselves miniature amplifiers, *some of them do not pre-amplify : they merely control.*

The idea behind the pre-amplifier is very simple. Outputs from some pickups are very weak—far too weak to enable the main amplifier to build them up sufficiently to drive a speaker at the required volume. So it is necessary to boost them up considerably, by means of an extra valve ; and the most sensible place to do the boosting is at the shortest possible distance from the pickup, before any loss of energy can occur, either in unnecessarily long wires, or in complicated electrical circuits. Therefore, since the amplifier is to have a control unit to govern its behaviour, there is a ready-made home for the extra pre-amplifying valve. Hence the more usual name for the control unit—*pre-amplifier*.

#### **The Control Unit**

The pre-amplifier or control unit—call it what you will—does a large number of jobs. It is, in fact, a necessity. But in answer to the obvious question, “then why not make it a part of the main amplifier?”, there are two good reasons. The first is that the main amplifier is a bulky, heavy unit, which can be far more conveniently stowed away out of sight : the second is that not everyone wants the control unit, because amplifiers have other uses, besides that of record reproduction ; and one pre-amplifier can also be used to control more than one amplifier. So the matter of economy is important. Some of the smaller amplifiers do, in fact, include the pre-amplifier and controls in the one unit.

Taking the points of the “pre-amp” in their logical order (1) *pre-amplification* has already been discussed.

(2) *Selection of inputs.* An amplifier that is to be used in the home will probably be

used with (a) a gramophone pickup for records ; (b) a radio tuner ; quite possibly (c) a microphone for announcements at small parties or dances, and (d) a tape recorder. Now most of these accessories have different impedances, and therefore require to be separately matched to the amplifier ; and it is also convenient to have them all plugged into the control unit, so that one or the other can be switched into immediate use, rather than have to un-plug one and plug-in another. Therefore nearly all “pre-amps” have sockets, or screw terminals, to take plugs or wires from “radio tuner,” “microphone,” and “pickup,” and an increasing number of makers are now incorporating sockets for “tape” units. These sockets or connection points are connected, inside the “pre-amp” case, to a matching arrangement to suit the component, and all of them are connected to the *selector switch*, which is clearly marked : “Radio”—“Mic”—“Tape,” and then either “L.P.”—“78,” or “L.P.”—“AES”—“FFRR78”—“STD 78,” or something similar. An explanation of these latter initials is given in the article which follows but, briefly, they indicate selector switch positions at which the pre-amplifier's circuits are properly selected to match the type of record being played to the amplifier.

#### **Tone Controls**

(3) *Tone and volume controls* :—In order to “cut” or to “boost” either bass or treble ends of the frequency range to be amplified, separate controls are provided. Also, in order to govern the volume of the output that the speaker will deliver, the level of the input to the main amplifier must be regulated ; and this is done by the volume control.

(4) *Filters* :—Finally, to control the degree of “cut” that is desirable, most pre-amplifiers embody a filter system. This is sometimes in two parts (i) a switched filter, which “cuts” top at, say, 5, 7, 9 and 10 Kc/s., with an extra switched position to allow the full un-cut frequency range to pass through, and (ii) a “variable slope” filter, which determines the abruptness or gradual “tailing-off” of the cut, beyond the limit set by the switch referred to.

#### **Hi-Fi DEALERS**

Readers will be interested to know of their nearest Hi-Fi Dealers. A list of these will be found on page 136 together with an

**ADVERTISERS' INDEX**

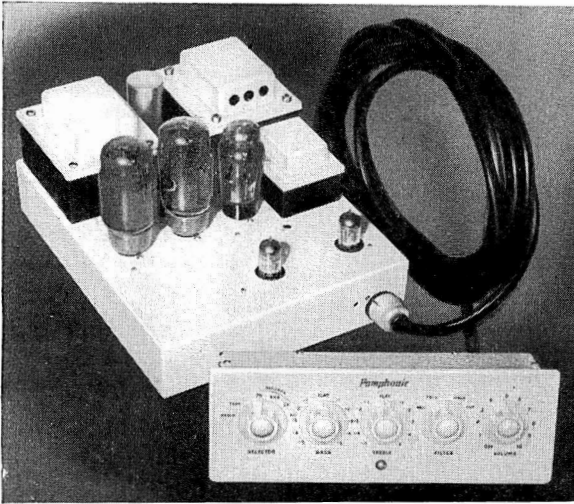

*Pamphonic. Control Unit (1002a). Price £12 12s. ; and Amplifier (1002), 25 watts. Price £29 8s.*

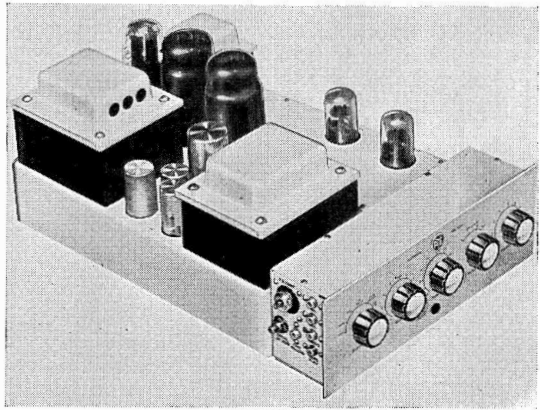

*Pye. Control Unit (H.F. 25a). Price £12 12s. ; and Amplifier (H.F.25), 25 watts. Price £29 8s.*

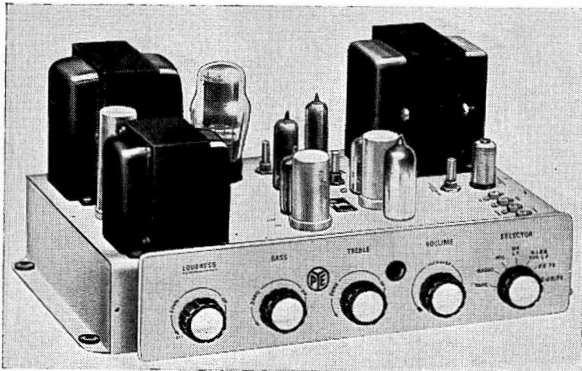

*Pye. Amplifier type H.F. 5/8, 5 watts. Price £26 5s.*

# AMPLIFIERS

By George Tillet

THE simplest definition of High-Fidelity is natural reproduction, that is reproduction faithful to the original. We have all heard systems, alleged to be "High-Fidelity" by their fond owners, which produce spectacular results by exaggerating the bass or treble—or possibly both.

As Gilbert Briggs points out<sup>1</sup>, "if you notice the bass in the reproduction, or if the extreme 'top' is prominent, then there is something wrong because you do not notice bass and treble emphasis at a concert."

The heart of a High-Fidelity system is the amplifier, the basic requirements of which can be stated as follows :

(1) Low harmonic and intermodulation distortion. (2) Linear frequency response. (3) Good transient response. (4) Adequate power output. (5) Low output resistance. (6) Low hum and noise level. (7) Efficient tone controls and filter system. (8) Reasonably versatile equalising facilities and pickup matching.

## Harmonic and Intermodulation Distortion

In a perfect amplifier, which in spite of advertisers' claims does not exist, the relationship between the input voltage and the output voltage is linear as shown by the line OA in Fig. 1. In other words, a pure sine wave applied to the input terminals would produce a pure sine wave at the output. In practice, however, due to the inherent curvature of valve characteristics, transformer deficiencies, etc., the relationship between the input voltage and the output voltage is non-linear, as represented by the curve OB. Consequently the application of a pure sine wave of, say, 50 cycles would result in a distorted output consisting of 50 cycles fundamental, plus a second harmonic of 100 cycles, a third harmonic of 150, a fourth at 200 and so on.

This harmonic distortion is bad enough

but worse is to come. If a weaker note of 1,000 cycles is also applied to the amplifier, then because the 50 cycle note is being amplified in a non-linear fashion, it follows that the 1,000 cycle note mixed with it will be distorted by it, and will produce a whole series of sum-and-difference frequencies (i.e., 1,050, 950, 1,100, 900, 850, 1,150 and so on). This intermodulation distortion, as it is called, is much more serious than harmonic distortion, for the spurious sum-and-difference frequencies are not harmoniously related to the original tones, and they are nearly always unpleasant to the ear.

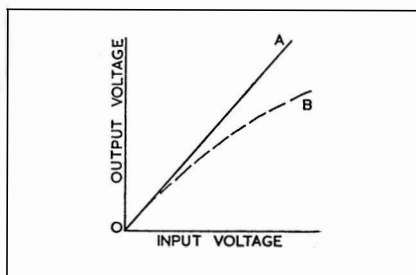
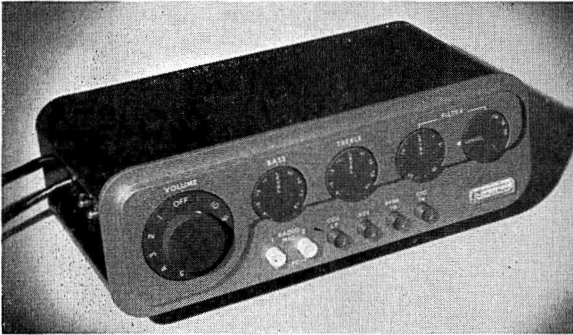

FIG. 1

All musical instruments depend on the production of harmonics for the creation of their characteristic tone or timbre ; that is why a note played on a flute sounds different from the same note played on a clarinet. An amplifier that merely distorted the harmonics might succeed in making a piano sound different from the original, but it would not necessarily sound unpleasant—it might even sound better than the original ! Fig. 2 shows the harmonic relationships of two pianos—one a grand, and the other a small upright. Notice the higher content of fundamental in the grand piano, this is heard by the ear as better tone quality.

It is generally agreed that the presence of higher order harmonics, such as the 5th, 7th and 9th which are not harmoniously related

1.—*Record News*, Feb., 1956, p. 591 (quoting a remark by Peter Walker).



*Quad. Control Unit (Q.C.2). Price £19 10s., including pickup adaptor plug. Extra pickup adaptors, each 12s. 6d.*

*Quad. Control Unit, showing remarkably fine layout and wiring. Input sockets are at centre, and pickup adaptor socket is at left.*

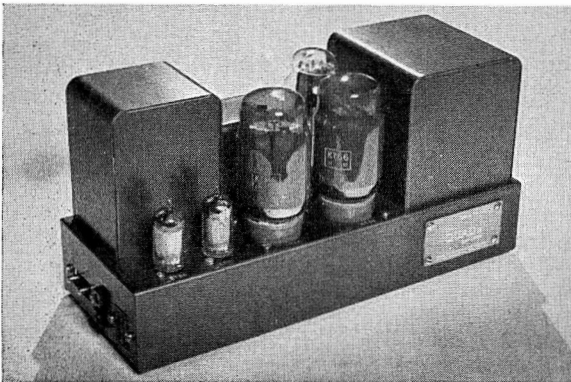
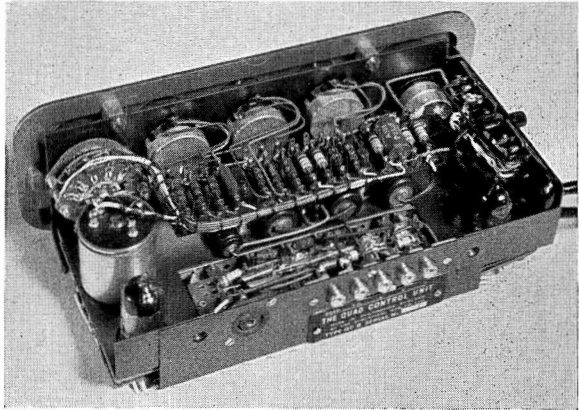

*Quad 2. Main Amplifier, 15 watts. Price £22 10s. Control unit and Amplifier complete £42*

to the fundamental, are objectionable, even in small percentages. The method used for testing an amplifier for harmonic distortion is to apply a sine wave to the input terminals, and to connect the output of the amplifier to a wave analyser or distortion factor meter. This removes the fundamental, leaving the harmonics generated by the amplifier. These can then be measured and expressed as a percentage. Since the higher order harmonics are progressively more unpleasant, some authorities<sup>2</sup> advocate the "weighting"

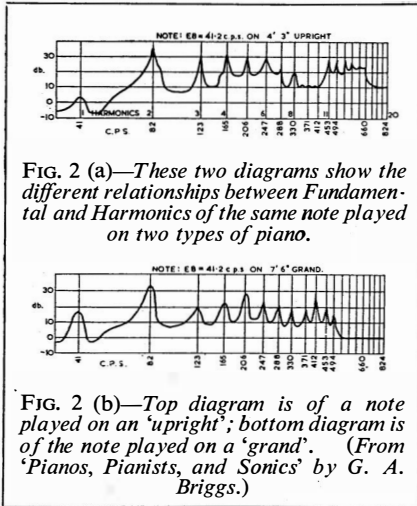

FIG. 2 (a)—These two diagrams show the different relationships between Fundamental and Harmonics of the same note played on two types of piano.

FIG. 2 (b)—Top diagram is of a note played on an 'upright'; bottom diagram is of the note played on a 'grand'. (From 'Pianos, Pianists, and Sonics' by G. A. Briggs.)

of the figures accordingly; but as it is difficult to assess their relative unpleasantness, this method is not popular.

### Intermodulation Distortion

Intermodulation distortion is measured by introducing into the amplifier a composite signal, composed of a high frequency and a low frequency—usually 40 and 10,000 cycles, or 70 and 7,000 cycles, in the proportion of 4 to 1. The output of the amplifier is connected to a wave analyser or distortion factor meter as before. The low frequency signal is removed and the modulation of the high frequency signal can be measured and expressed as a percentage. A good amplifier should have a total harmonic percentage at full output of below 0.2 per cent. and an

- 2.—D. Shorter, "The Influence of Higher Order Harmonics," *Electronic Eng.*, April, 1950.
- 3.—Le Bel, "Psycho-acoustical aspects of listener preference tests," *Audio, Eng.*, Aug., 1947.
- 4.—D. T. N. Williamson, *Wireless World*, April, 1947.

intermodulation distortion of below 2 per cent. Before leaving the subject of distortion it should be noted that the permissible distortion in a wide range High-Fidelity system is to a certain extent dependent on the frequency range, thus a filter should be fitted to reduce the range when distortion is present in the programme material.<sup>3</sup>

### Linear Frequency Response

This should be substantially flat from 20 to at least 20,000 cycles, and although the human ear cannot hear frequencies beyond 15 or 20,000 cycles, nevertheless if the internal bandwidth of an amplifier does not extend up to at least 40,000 cycles (that is up to 10 times the frequency of the highest fundamental musical note) transient response will suffer, and the amplifier will lack "attack." At the bass end it is important that the power response be maintained down to 20 cycles. If it is not, a filter should be fitted to prevent these low frequencies from reaching the amplifier, their effect would be to cause distortion even though the notes themselves might not be audible.<sup>4</sup>

Frequency response should always be stated with a reference figure, it is useless (or misleading) to state that a certain amplifier has a response extending from 20 to 20,000 cycles, if the response is 10 or 20 db down at each end of the scale. The usual reference figure is 1,000 cycles, and a good amplifier would have a response of  $\pm 1$ db from 20 to 20,000 cycles ref. 1,000 cycles.

### Good Transient Response

A wide frequency response, as indicated above, is not the only factor affecting reproduction of transients, which are sounds of short duration, such as made by cymbals,

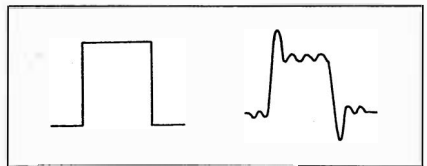
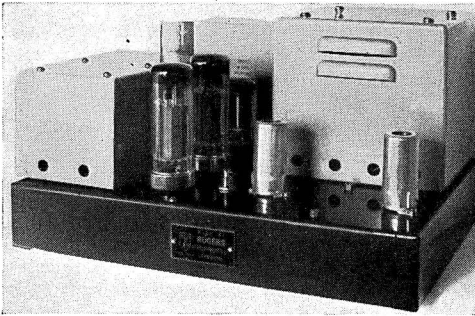
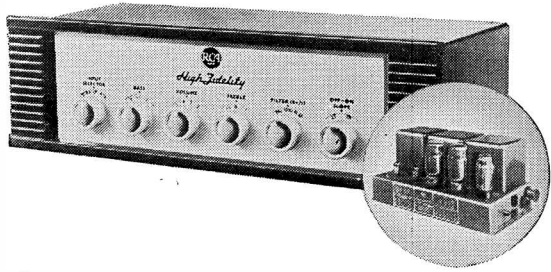

FIG. 3—(left) is of a square wave input to an amplifier, and (right) the affected output.

piano or other percussive instruments. It is equally important that the amplifier is free from peaks and supersonic oscillations which will cause "Ringing." With amplifiers using large amounts of negative feedback it is vital that the high frequency response is controlled and that correct damping is applied. Testing is usually done by applying a square wave to the amplifier, the output of which is connected to an oscilloscope. Fig. 3

*R.C.A. Control Unit and Amplifier, 12 watts. Price complete £48*



*Rogers R.D. Senior Amplifier, 15/20 watts. Price £28*

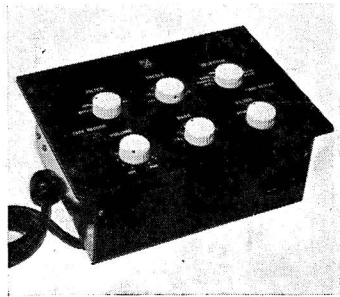

*Rogers R.D. Senior Control Unit. Price £14*



*Rogers R.D. Junior Control Unit and Amplifier, 8/10 watts. Price complete £26*

shows the effect of transient “ringing” on a square wave of 10,000 cycles, produced by incorrect damping in the negative feedback loop (see also page 34). Transient response can also adversely be affected by phase changes, caused by the use of some types of tone control, or high or low pass filters having a steep cut or “roll-off.”<sup>5</sup>

#### Adequate Power Output

Ample power must be available in order to handle peak transient power without distortion. Assuming a speaker system of average efficiency (5 per cent.) the normal power used under domestic conditions would be of the order of 250 to 350 milliwatts ; but to handle peak transient power with an adequate factor of safety, an amplifier rated at 10 watts must be used. If the listener is fortunate enough to have a large room (and tolerant neighbours), or an inefficient speaker system, then it would be advisable to specify a larger reserve of power—say 20 to 25 watts. The power response of an amplifier is not necessarily identical with the frequency response. Some amplifiers optimistically rated as “10 watt” have no difficulty in giving the stated output at 1,000 cycles, but at 50 cycles it is quite another story. One

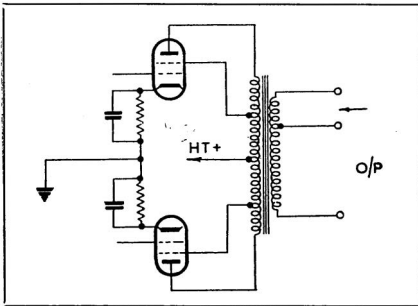

FIG. 4—An ultra-linear output stage.

such amplifier, which uses a small output transformer, was tested recently and found to deliver a maximum output of 5 watts at 40 cycles ! The moral is, when buying an amplifier make sure that the output transformer is a large one with plenty of iron—unless the core material is made of grain oriented strip or “C” core. These special materials enable the transformer to be of half the size of conventional types, but they

5.—Langford-Smith, *Radio Designers Handbook*, chapter 15.

6.—*Wireless World*, Sept., 1952, p. 360.

7.—*Audio Engineering*, Nov., 1951, p. 15.

8.—*Electronics*, March, 1952, p. 131.

are not widely used yet on account of their expense.

Many amplifiers including the Armstrong, RCA, Pye and Pamphonic use the “Ultra Linear” output circuit. This is a modified form of the normal push-pull output stage in which the screen grids are connected toappings on the output transformer which

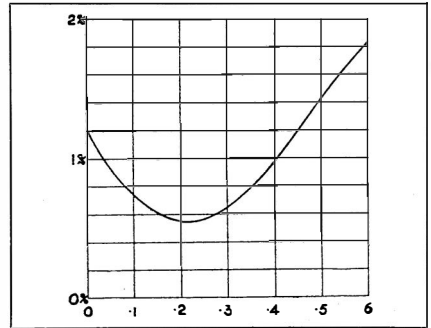

FIG. 5—Ratio of common winding to total winding. Diagram showing reduction of Harmonic distortion obtained by choice of optimum tapping point for triode. (Main feedback loop disconnected.)

results in a mode of operation intermediate between triodes and tetodes (see Fig. 4). This “distributed lead” circuit, as it is also termed has the following advantages :

- (a) Less overall feedback required for a given result, thus giving a better margin of stability.
- (b) Greater efficiency—36 per cent. against 27 per cent. for triodes.<sup>6</sup>
- (c) Reduction of harmonic distortion (see Fig. 5).<sup>7</sup>
- (d) Much lower peak variations in current which is inherent with triode output stages. This can cause serious distortion at peak outputs if the power supply does not have an effectively low impedance at audio frequencies.<sup>8</sup>

A variation of this circuit is used by the “Quad 2” amplifier. In this case the common portion of the winding is inserted in the cathodes resulting in the voltage appearing across that portion being effectively applied to the grids as negative feedback.

#### Low Output Resistance

Although the nominal output impedance of an amplifier may be specified as 15 ohms, the actual impedance as “seen” by the speaker may be very much less—perhaps only half an ohm. The damping factor can be defined as the relationship between the speaker impedance and the source impedance. A high damping factor means that the speaker “sees” a very low resistance, and this resistance acts as a brake on the speaker.



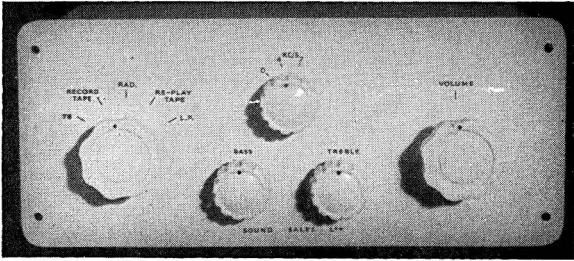

*Sound Sales. A-Z Junior Control Unit, and Amplifier, 10 watts. Price complete £22 10s.*

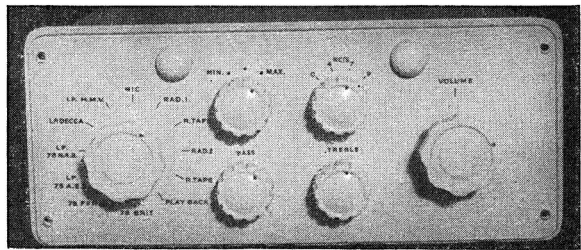
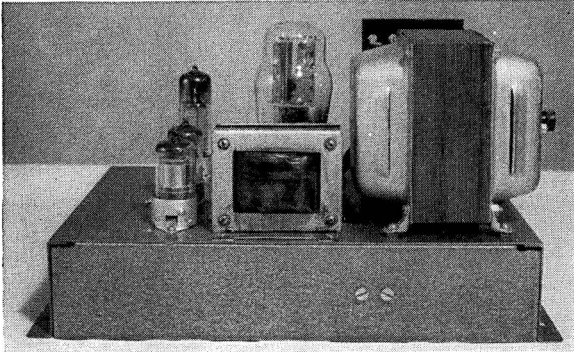

*Sound Sales. A-Z Senior Control Unit, and Amplifier, 20 watts. Price complete £40*

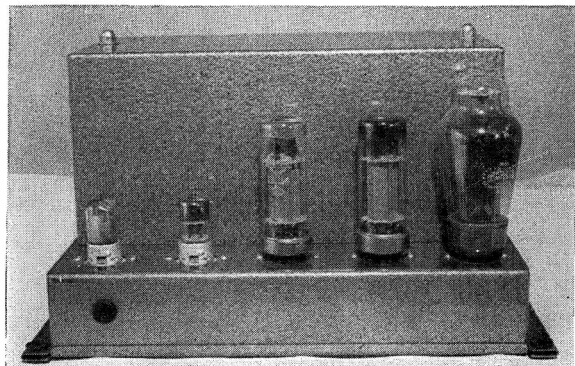

As soon as the audio drive ceases, the cone of the speaker is rapidly brought to rest, instead of tending to vibrate at its natural resonant frequency.

Some amplifiers are fitted with a variable damping control, and its use is based on the theory that there is a certain critical damping factor for every speaker system. By varying the proportions of negative and positive feedback in the amplifier, any damping factor can be obtained, although the normal practice is to cover from about 30 to infinity—which means the output resistance becomes zero. In other words, a complete short circuit.<sup>9</sup> There is no doubt that, when used with an indifferent speaker system, variable damping does effect an improvement, but the surprising thing is that when it is used with a good speaker system it is very difficult to detect any difference in results, even if the control is turned from one extreme to the other. However, this is easier to understand when it is realised that a good system, having a well damped enclosure, will reflect very little effective resonance into the electrical circuit—certainly too small for a critical damping point to be determined.

#### Hum and Noise Level

Sometimes these figures are given separately and sometimes a combined figure is quoted. Hum consists mainly of a mixture of 50 cycles and 100 cycles, and it can be due to insufficient smoothing in the power supply to the valves, pick up from the valve heater supply—either inside the valve itself, or in the associated wiring, radiations from the mains transformer, etc. Internal valve noise is responsible for most of the hiss heard on a very high gain amplifier, although carbon resistors and electrolytic condensers contribute a share. In high grade amplifiers it is customary to use special “low-noise” resistors where applicable, and the advent of such special valves as the Mullard E.F.86 and the G.E.C. Z729 have enabled the noise factor to be reduced to negligible proportions.

Figures are usually quoted as being relative to the full output of the amplifier, and a level of—90 db cannot be heard, even quite close to the speaker, and a level of—80 can be considered very satisfactory. It should be mentioned in passing that, since high frequency noise is a periodic (i.e., not confined to any particular frequency) its effect will be emphasised if the amplifier or

speaker system has a peak, or peaks. At the other end of the scale it is obvious that the better the low frequency response of the speaker, the more it will show up hum.

#### Efficient Tone Controls and Filter System

All modern High-Fidelity amplifiers have both bass and treble controls, and these usually permit both boost and cut, thus enabling the listener to compensate to a certain extent for studio or recording deficiencies, and for room acoustics, etc. Furthermore, owing to the non-linearity of the human ear, bass boost and (to a lesser extent) treble boost is required when listening at low volume levels.

Fig. 1 on page 23 shows the Fletcher-Munson equal-loudness curves, which demonstrate the relative intensities needed at various frequencies to produce sounds of the same *apparent* loudness. It is immediately apparent that much higher intensities are needed for low frequencies at lower loudness levels. It is possible to partially compensate for this automatically, by using special twin or tapped volume controls (sometimes known as loudness controls), and these are fairly popular in the U.S.A. In this country, however, opinion favours the use of the normal tone controls for compensation since they are more flexible and efficient in dealing with so many variable factors.

For average use, a boost and cut of 12 db at 50 cycles and 10,000 cycles is more than adequate. Two types of tone are commonly used—one a passive network of condensers and resistors, and the other the Baxandall,<sup>10</sup> which makes use of selective negative feedback. The first has the effect of rotating the response about a central “hinge”—normally 1,000 cycles, whereas the Baxandall control operates somewhat differently, as the boost and cut is initially confined to each end of the spectrum. This has the advantage that the extreme low frequencies can be boosted appreciably without affecting the response in the region of 300-500 cycles. A further advantage of this type of control is the fact that, as it utilises feedback, the distortion introduced is greatly minimised.

#### Filters

In order to avoid distortion produced by imperfect radio transmissions, or on gramophone records, due to processing defects or wear, it is often necessary to restrict the upper frequency response by means of a filter. Four switched positions giving nominal “Roll-offs” between 5 and 12 Kc/s. are normally sufficient. The first position at

9.—Crowhurst, *Radio Electronics*, Nov., 1955 ; also *Audio*, Sept., 1955.

10.—“Negative feedback control,” P. J. Baxandall, *Wireless World*, Oct., 1948.

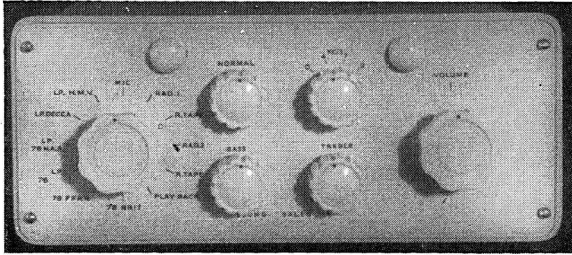

*Sound Sales. Tri-Channel Control Unit, and the two Amplifiers, giving three channels. The control unit regulates the inputs to all three channels, which in turn drive their own speaker units (bass, centre, and treble). The speaker is illustrated on page 92, and is included in the all-in price of £115.*

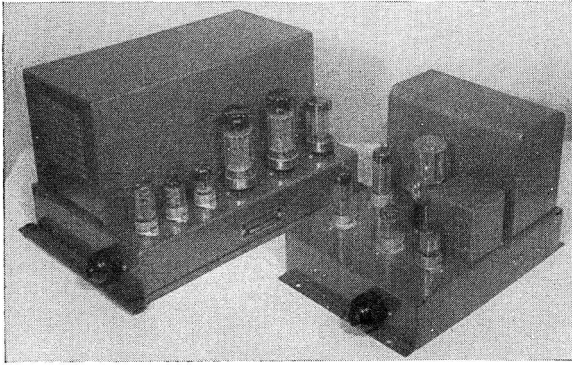

*Tannoy. Control Unit "De Luxe" model. Price £31. (Amplifier, not shown, 20 watts, £32)*

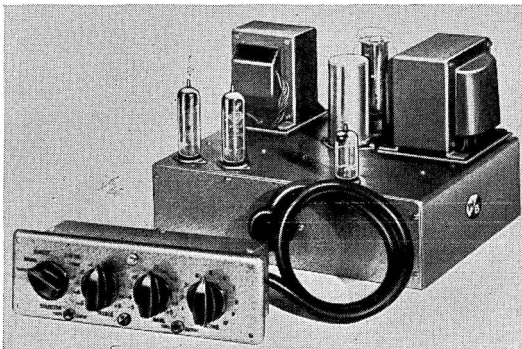
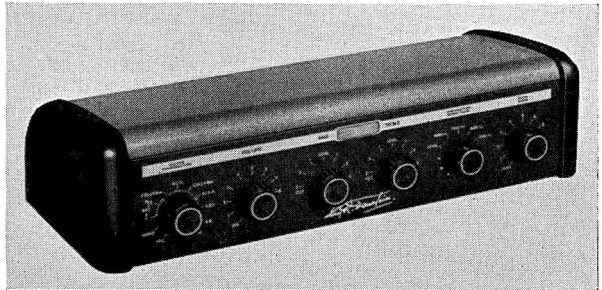

*Whiteley Electrical. W.B.12 Control Unit and Amplifier, 12 watts. Price £25*

5 Kc/s. is particularly useful for coping with early 78 r.p.m. recordings.

A worthwhile refinement is the inclusion of a variable slope control, permitting the actual rate of attenuation to be varied from a gentle slope to a steep cut, and this device is incorporated in the *Quad 2, Leak Varislope, RCA, Tannoy, Lowther, Rogers, and Sound Sales* amplifiers. At the low frequency end of the scale it is necessary to attenuate the response below 20 to 30 cycles to avoid "rumble" produced by gramophone motors.

With the advent of the standard RIAA recording curve, the provision of a large selection of equalising curves is not so important and it is now considered sufficient to provide 3 or 4 positions only.

Various methods are used to obtain pickup matching, i.e., to provide the correct input impedance (and attenuation if necessary) for a wide variety of pickups. The Armstrong and the RCA have two input positions: one for magnetic pickup and one for crystal; the Armstrong has two switched positions, which is a useful device for comparison purposes, or when two pickups are used. The Rogers and Leak, have variable input attenuators, whilst the Quad 2, the Pye, and the Pamphonic, use plug-in matching units.

#### Negative Feedback

All modern amplifiers make extensive use of negative feedback, in fact it would be impossible to achieve anything like the foregoing specifications without its use. Basically, negative feedback means that a portion of the output of an amplifier is fed back into the input—but in opposite phase, thus cancelling much of the inherent distortion. The amount of feedback in decibels is the ratio of the original voltage to the corrected voltage; thus the number of db feedback also refers to the reduction in amplifier gain. For example, suppose a 10 watt amplifier gives full output with a signal input of .1 volt, then the application of 26 db of feedback means that the amplifier gain will have been reduced by 26 db, which is equivalent to 20 times. This means that 20 times the original signal of .1 volt (i.e., 2 volts) will now be required to produce the same 10 watts. Assuming that the amplifier is correctly designed then the distortion will also be reduced by a factor of 20.

Naturally, the gain of the amplifier would have to be increased in order to compensate for the loss caused by feedback, but this presents no serious problem; it is indeed a small price to pay for such a reduction in distortion. H. J. Leak, who revolutionised performance standards of high fidelity

amplifiers in 1945, with the famous "Point One" amplifier, said at that time that negative feedback can be considered as a tool in the hands of audio designers. Indeed it is, for besides drastically reducing harmonic and intermodulation distortion, it can also perform the following functions:—

- (a) Improve the frequency response.
- (b) Reduce the output resistance of an amplifier, hence increasing the damping factor of the output stage which without feedback would be between 1 and 4, depending whether triodes or tetrodes were used. This factor is increased proportionately to the amount of feedback used.
- (c) Reduce noise originating in the stage or stages within the feedback loop.

It must not be thought however that this "tool" is in effect a magic wand, it will not magically transform a poor amplifier into a good one. In this connection, it is not generally realised that the application of feedback to an amplifier having a high distortion factor will merely exchange a high proportion of lower order harmonics, such as the second and third, for a smaller proportion of higher order harmonics, which in practice may be just as unpleasant. This effect is due to the feedback voltage (containing a high proportion of 2nd and 3rd harmonic) in its turn generating its own harmonics (4th and 9th, etc.). This, in my opinion, is why two amplifiers having similar specifications sound quite different in a side-by-side comparison test.

Great care must be taken to ensure that the feedback remains negative at all frequencies. If phase shifting takes place sufficiently it may become positive, and so cause oscillation either inside or outside the audio band. In practice, the most likely cause of phase shifting is the output transformer; and in order to reduce leakage reactance, multi-sectionalised windings are commonly used. Many early amplifiers, incorporating a large amount of feedback, had a narrow margin of stability, and, to quote Briggs, "using them was like putting a racehorse between the shafts of a corporation dust cart; every time a bit of dust blows in its face it is liable to snort and rear, and it may do damage to the equipment."

Many American amplifiers, and at least one British one (the Armstrong) increase the stability factor by using a separate feedback winding thus isolating the amplifier from the possible effects of long speaker leads or cross-over units.

11.—G. Briggs, *Sound Reproduction*, p. 201.

# DIRECTORY OF CONTROL UNITS AND AMPLIFIERS

**Important Note :** In accordance with editorial policy, as laid down in our guarantee on page 3, only these products which measure up to good high fidelity standards are listed below. It may therefore be taken as read that the minimum basic requirements are well covered in the makers' specifications of the following pre-amplifiers and amplifiers. For example, a substantially flat frequency response from 20 to 20,000 cycles per second ; a total distortion of less than 0.5 per cent. at the rated output ; a hum and noise level

of at least -75 dbs. In some cases, of course, these figures are well exceeded ; but readers who require exact details are advised to write direct for makers' technical specifications. Unless otherwise stated, all equipment listed is supplied to operate from A.C. mains at 250 volts, 50 cycles per second, and all pre-amplifiers draw their power supplies from the main amplifiers which they control. In the following directory notes, the term "Control Unit" is used to cover pre-amplifiers and/or control units.

**Armstrong.** A 10 control unit and amplifier. (*Photo page 60.*)

*Control Unit.* Inputs, radio ; pickups, high and low impedance ; mic. Controls, selector switch for above ; equaliser, with 4 record positions ; volume ; treble, with cut and boost ; bass, with cut and boost ; filter, with five switched positions for "cancel" 5, 7, and 9 K/cs., with "trough" position at 9 K/cs. Power outlet for tuner.

*Amplifier.* Power output, 10-12 watts. Sensitivity, 250 mV for 10 watts. Output valves, EL 37, or 6L6. Ultra linear. Output impedances, 2-4, and 11-16 ohms. Prices : control unit £9 15s. ; amplifier £19 15s. ; complete £29 10s. Armstrong Wireless and Television Co. Ltd., Warlters Road, Holloway, London, N.7.

\* \* \*

**Dynatron.** Control unit TC 10, and amplifier LF 10. (*Photo page 60.*)

*Control Unit.* Inputs, high and low gain pickups ; radio tuner ; tape recorder. Controls ; selector for the above, plus 3 record equalising positions ; bass, with boost and cut ; treble, with boost and cut ; volume.

*Amplifier.* Power output, 12 watts. Sensitivity, 0.75 volt r.m.s. for 12 watts output. Output impedances 15, and 7.5 or 3.75 ohms. Prices : control unit £12 17s. 6d. ; amplifier £25 ; complete £37 17s. 6d. Dynatron Radio Ltd., Castle Hill, Maidenhead, Berks.

\* \* \*

**E.M.G.** Control unit DCU1, and amplifier DR24. (*Photo page 62.*)

*Control Unit.* Inputs, radio ; pickup ; mic. Controls, selector switch for the above, and 2 record equalising positions ; treble, with boost and cut ; bass, with boost and cut ; volume ; on/off ; filter, switching in and variable from 4,000 to 8,500 c.p.s.

*Amplifier.* Power output, 12 watts. Sensitivity, 0.5 volt for 12 watts output valves,

KT 66. Output impedances, 15 ohms. Prices : control unit £18 ; amplifier £27.

\* \* \*

**E.M.G.** Amplifier DR28, with controls on panel. Power output, 4 watts. Sensitivity, 30 mV for 4 watts. Inputs, radio ; pickup. Controls, selector for above, with 2 record equalising positions ; treble ; bass ; volume ; output impedances, 15 ohms. Price £21. E.M.G. Handmade Gramophones Ltd., 6 Newman Street, London, W.7.

\* \* \*

**Expert.** Control unit and "Master" amplifier. (*Photo page 60.*)

*Control Unit.* Inputs, pickup ; tape ; radio. Controls, selector switch for the above ; bass with zero to 6 (switch positions) ; bass, cutting from switched "zero," and boosting on each of other 5 ; treble, with zero to 6 (switch positions) ; treble with slope for switched positions ; volume.

*Amplifier.* Power output, 15 watts. Sensitivity, 200 mV for 15 watts. Output valves, EL 37. Triode output. Output impedance, 15 ohms. Prices : control unit £17 ; amplifier £35.

\* \* \*

**Expert.** "Standard" amplifier. Power output, 8 watts. (*Photo page 60.*) Sensitivity, 250 mV for 8 watts. Output valves, 6V6 as tetrodes. Output impedance, 15 ohms. Price £23. Expert Gramophones Ltd., Ingerthorpe, Great North Road, London, N.2.

\* \* \*

**G.E.C.** Control unit & amplifier BCS 2417/18.

*Control Unit.* Inputs, pickup ; tape ; radio. Controls, selector switch for the above, with 4 record equalising positions ; treble, with variable boost and cut ; bass, with variable boost and cut ; "Presence" ; volume. Power outlet for supplying tuner.

*Amplifier.* Power output, 12 watts. Sensitivity, 20 mV for 12 watts. Output

valves, N709 pentodes. Ultra linear. Output impedances, 15 ohms, or for 1, 2, or 3 3/5-ohm speakers. Price on application.

\* \* \*

**G.E.C.** Control unit BCS 2415, and amplifier BCS 2416. (Photo page 62.)

*Control Unit.* Inputs, mic.; radio; pickup. Controls, selector switch for above, with 3 record equalising positions; volume; treble selector, with boost and cut in 7 steps; bass selector, with boost and cut in 7 steps, and with cut-off filters at 9, 7, and 5 K/cs.; treble rate cut, variable with boost and cut; presence control, continuously variable. Power supply for tuner.

*Amplifier.* Power output, 25 watts. Sensitivity, 103 mV for 25 watts. Output valves, KT 66. Output impedances, 15 ohms. Price, complete with interconnecting cables, etc. £63. The General Electric Co. Ltd., Magnet House, Kingsway, London, W.C.2.

\* \* \*

**H.M.V.** Control unit and amplifier. (Photo page 62). Model 3050 (for Model 3052).

*Control Unit.* Inputs, F.M.; A.M. radio; T.V.; aux.; pickup. Controls, selector switch for the above; equaliser switch, 5 positions; on/off; treble, with cut and boost; bass, with cut and boost; volume; filter, with cut at 5, 9, 13 and 20 Kc/s. Power supply outlet for tuners.

*Amplifier* (housed in 3052 speaker unit) Power output, 18 watts max. Sensitivity, 2.0 volts for 10 watts output. Output valves, KT 66. Price to be announced. The Gramophone Co. Ltd., Hayes, Middlesex, England.

\* \* \*

**Leak.** "Point One" control unit and TL/10 amplifier. (Photo page 62.)

*Control Unit.* Inputs, pickup; tape, by jacks, for "record" and "Playback"; radio; with attenuator control. Controls, selector switch for the above, with 4 record equalising positions; volume; treble, with boost and cut; bass with boost and cut. Power supply outlet for tuner.

*Amplifier.* Power output, 10 watts. Sensitivity, 125 mV for 10 watts. Output valves, KT 61. Ultra linear. Output impedances, 4, 8 and 16 ohms. Prices: "Point One" control unit £10 10s.; amplifier £17 17s. H. J. Leak and Co. Ltd., Brunel Road, London, W.3.

\* \* \*

**Leak,** "Vari-Slope" 2 control unit, and TL/12 amplifier. (Photo page 64.)

*Control Unit.* Inputs, pickup; radio; tape (jacks for "record and playback"); mic.; auxiliary. Controls, selector switch

for the above, with 6 record equalising positions (10 positions in all); volume, with on/off; treble, with boost and cut; bass, with boost and cut; filter slope control, from 9, 7, 5 and 3 Kc/s.

*Amplifier.* Power output, 12 watts. Sensitivity, 148 mV for 12 watts. Output valves, KT 66. Output impedances, 2, 8, 16 and 32 ohms. Prices: "Vari-Slope" 2 control unit £16 16s.; TL/12 amplifier £28 7s.

\* \* \*

**Leak:** TL/25a amplifier.

Output, 25 watts. Sensitivity, 148 mV for 25 watts. Output valves, KT 66. Output impedances, 2, 8, 16 and 32 ohms. Price £34 7s.

*Note:* Both Leak control units ("Point One" and "Vari-Slope" 2) can be used with all three amplifiers listed above.

\* \* \*

**Lowther.** Master control unit Mk. 1 and amplifier TP.10\*. (Photo page 64.)

*Control Unit.* Inputs, tape; radio; auxiliary; mic. (tape outlet independent of volume control); pickup. Controls, selector switch for the above; record equalising switch with 5 positions; volume, with on/off; treble, with boost and cut; bass, with boost and cut.

*Amplifier.* Power output, 16 watts. Sensitivity, 1 volt for 16 watts. Power outlet for tuner. Output valves, EL.34 "Lowther linear." Output impedances, 0.95, 3.8, 8.5 and 16 ohms. Prices: Control unit £20; amplifier £40; complete £60.

\*The TP.10 will in future be known as the Lowther "Linear 16."

\* \* \*

**Lowther.** "Linear 10" amplifier. Power output, 10 watts. Sensitivity, 0.75 volt for 10 watts. Output valves, EL.34 "Lowther linear." Output impedances, 3.5 and 16 ohms. Power for tuner. Price £25.

\* \* \*

**Lowther.** Master control unit Mk. 2. This is similar in all detail to the Mk.1 unit described above, but possesses the extra facility of "tape playback" direct from the tape head. Price £24. *Note:* Either control unit can be used with either amplifier. Lowther Manufacturing Co., Lowther House, St. Marks Road, Bromley, Kent, England

\* \* \*

**Pamphonic.** Control unit 1002a and amplifier 1002. (Photo page 66.)

*Control Unit.* Inputs, mic.; magnetic pickup; radio/tape. Controls, selector switch for above, with 3 record equalising

positions ; treble, with cut and boost ; bass, with cut and boost ; filter, switched to cut at 4, 7 and 12 Kc/s. ; volume, with on/off. Power outlet for supplying tuner.

*Amplifier.* Power output, 25 watts. Sensitivity, 0.35 volt for 15 watts. Output valves, KT 66. Output impedances, 3.75, 6.6, 15 or 60 ohms. Prices : Control unit £12 12s. ; amplifier £29 8s. ; complete £42.

\* \* \*

**Pamphonic.** Amplifier type 1003. Controls and amplifier in one unit.

Inputs, mic. ; radio ; tape ; pickup. Controls, selector for the above, with 3 record equalising positions ; treble, with boost and cut ; bass, with boost and cut ; volume ; power outlet for tuner ; power output, 10 watts ; output valves, 6AQ5 ; output impedances, 3.5 and 15 ohms. Price £28 7s. Pamphonic Reproducers Ltd., 17 Stratton Street, London, W.1.

\* \* \*

**Pye.** Amplifier HF 5/8. Controls and amplifier in one unit. (*Photo page 66.*)

Inputs, pickup ; tape ; mic. ; radio. Controls, selector for the above, with 4 record equalising positions ; treble, with boost and cut ; bass, with boost and cut ; volume ; loudness compensator. Power output, 5 watts. Sensitivity for 5 watts, tape and radio, 100 mV ; mic., 4 mV ; pickup, 20, 20, 18, 22 mV respectively for the four positions, at 1 Kc/s. Output valves, 6AQ12 or EL90. Output impedances, 15 and 4 ohms. Price £26 5s.

\* \* \*

**Pye.** Control unit H.F. 25a, and amplifier H.F. 25. (*Photo page 66.*)

*Control Unit.* Inputs, radio (with attenuator control) ; pickup (with 5 matching plugs available) ; mic. ; tape "in" ; tape "out". Controls, selector for above, with 4 record equalising positions ; treble, with cut and boost ; bass, with cut and boost ; volume, with on/off ; filter, switched for cancel, 4, 7, and 12 Kc/s. cut. There is no power outlet for supplying extra units.

*Amplifier.* Power output, 25 watts. Sensitivity, 0.5 volt for 25 watts. Output valves, KT 66. Ultra linear. Output impedances, 3.75, 6.6, 15, and 60 ohms. Prices : control unit £12 12s. ; amplifier £29 8s. ; complete £42. Pye Ltd., Cambridge, England.

\* \* \*

**Quad 2.** Control unit and amplifier. (*Photo page 68.*)

*Control Unit.* Inputs, radio ; radio/mic. ; pickup. Controls, push-button selection for above, and for record equalisation ; volume,

with on/off ; bass, with boost and cut ; treble, with boost and cut ; filter, switched for "cancel," 5, 7, and 10 Kc/s. ; variable slope filter, 2 power outlets for tuners. Pickup matching by interchangeable plugs.

*Amplifier.* Power output, 15 watts. Sensitivity, 1.4 volts for 15 watts. Output valves, KT 66. Ultra linear. Output impedances, 7 and 15 ohms. Prices : control unit £19 10s. ; amplifier £22 10s. ; complete £42. Acoustical Manufacturing Co., Huntingdon, Hunts, England.

\* \* \*

**R.C.A.** Control unit and amplifier. (*Photo page 70.*)

*Control Unit.* Inputs, magnetic pickup ; crystal pickup ; radio/tape ; mic. Controls, selector switch for the above, with mixing facility for mic. with radio and tape ; treble, with boost and cut ; bass, with boost and cut ; volume ; filter, switched for level, 5, 7, and 10 Kc/s. ; variable filter slope, with on/off. Power outlet for supplying tuner..

*Amplifier.* Power output, rated 12 watts. Sensitivity, 1.2 volts for 12 watts. Output valves, KT 66. Improved Ultra linear. Output impedances, 4, 7, and 15 ohms. Price complete £48. R.C.A. Photophone Ltd., Lincoln Way, Windmill Road, Sunbury-on-Thames, Middlesex.

\* \* \*

**Rogers.** R.D. senior control unit, and R.D. senior amplifier. (*Photo page 70.*)

*Control Unit.* Inputs, radio ; mic. ; pickup. Controls, selector switch for the above, with 6 record equalising positions ; treble, with 3 cut, 2 boost, and level positions ; bass, with 2 cut, 3 boost, and level positions ; volume ; switched high-pass filter, operating at 25 and 60 c.p.s. ; switched low-pass filter, operating at 5, 9, and 20 Kc/s. Power outlets for radio tuners. (A modified control unit is now being manufactured, to replace this.)

*Amplifier.* Power output, 15/20 watts. Sensitivity, 1 volt for 15 watts. Output impedances, .95, 3.8, 8.5, and 15.2 ohms. Output valves Mullard EL 34. Ultra linear. Prices : control unit £14 ; amplifier £28.

\* \* \*

**Rogers.** R.D. junior. Control unit and R.D. junior amplifier. (*Photo page 70.*)

*Control Unit.* Inputs, radio ; radio ; tape (jacks for "record" and "replay") ; pickup. Controls, selector switch for the above, with 4 record equalising positions ; treble, with variable boost and cut ; bass, with switched boost and cut ; volume ; filter, variable from 4.5 to 8.5 Kc/s. cut. Power outlet for tuner.

**Amplifier.** Power output, 8-10 watts. Sensitivity, 0.75 volt for 8 watts. Output valves, EL 84. Ultra linear. Output impedances, 2-3, 6-8, 12-16 ohms, by matching plugs available. Price £26 complete with control unit. Rogers Developments (Electronics) Ltd., Rodevco House, 116, Blackheath Road, London, S.E.10.

**Sound Sales.** A-Z senior, control unit and amplifier. (Photo page 72.)

**Control Unit.** Inputs, radio ; radio ; tape record ; tape record ; tape playback ; mic. ; pickup. Controls, selector switch for the above, with 6 record equalising positions (12 positions in all) ; treble, with boost and cut ; bass, with boost and cut ; volume ; 3-position pickup matching ; rumble filter ; H.F. filter, with " off," 4, 7, and 9 Kc/s. cut positions. Power outlet for tuner supply.

**Amplifier.** Power output, 20 watts. Sensitivity, 5 mV for 20 watts. Output valves, EL 34. Ultra linear. Output impedance, 3, 6, 15, 30 ohms. Price £40.

**Sound Sales.** A-Z junior Mk. 2, control unit and amplifier. (Photo page 72.)

**Control Unit.** Inputs, pickup ; radio ; tape record ; tape playback. Controls, selector switch for the above, with 2 record equalising positions ; volume ; treble, with boost and cut ; bass, with boost and cut ; filter, with " out " position and cut at 4 and 7 Kc/s. Power outlet for tuner supply.

**Amplifier.** Power output, 10 watts. Sensitivity, 1 volt for 10 watts output. Output valves, EL 84. Ultra linear. Output impedance, 3, 6, 15, 30 ohms. Price £22 10s.

**Sound Sales.** Tri-channel control unit and amplifiers. (Photo page 74.)

**Control Unit.** Inputs, radio ; radio ; tape record ; tape record ; tape playback ; mic. ; pickup. Controls, selector switch for above, with 6 record equalising positions (12 positions in all) ; volume ; treble, with boost and cut ; bass, with boost and cut ; " Normal," with boost and cut ; filter, cutting at 4, 7, and 9 Kc/s. This control unit, controls the three separate amplifiers (for bass, middle and treble frequency bands, respectively). Having adjusted " bass," " normal " and " treble " controls, the " volume " control varies all three channels, as adjusted. The three main amplifiers then feed a multi-speaker unit (Photo page 92).

**Main Amplifiers.** Power outputs (bass channel) 22 watts ; (treble channel) 1.5 watts and (centre channel) 10 watts. Output

valves of above amplifiers : 2 EL 37's in push pull ; 1 ECL 80 triode pentode ; 2 KT 61 tetrodes, respectively. Ultra linear. Price complete and including tri-channel speaker £115. Sound Sales Ltd., West Street, Farnham, Surrey, England.

**Tannoy.** Control units and amplifier. (Photo page 74.)

**Control Unit** (" De Luxe "). Inputs, mic. ; radio ; pickup ; tape. Controls, selector for above, with 8 record equalising positions ; treble, with stepped cut and boost ; bass, with stepped boost and cut ; filter, switched for " level " and cut at 4, 5, 7, and 9 Kc/s. ; filter slope ; volume.

**Alternative Control Unit** (" Standard ") now available. Inputs, mic. ; radio ; tape ; pickup. Controls, selector switch for the above, with 3 record equalising positions ; volume with on/off ; treble, with cut and boost ; bass, with cut and boost ; filter, switched for level, and 4, 6, 8, 9 and 10 Kc/s.

**Amplifier.** Power output, 20 watts. Sensitivity, 0.4 volt and 20 watts. Output valves, KT 66. Ultra linear. Output impedances, normal 16 ohms, but adjustable 1 to 64 ohms. Prices : control units (" De Luxe ") £31 ; (Standard) £16 10s. ; amplifier £32. Tannoy Products Ltd., West Norwood, London, S.E.27.

**Thermionic Products.** Control unit TP 100 CU and Amplifier TP 100.

**Control Unit.** Inputs, radio/tape ; mic. ; pickup. Controls, selector switch for above, with 4 record equalising positions ; volume ; treble with variable boost and cut ; bass with variable boost and cut ; filter switch with " cancel," and cut at 5 and 7 Kc/s.

**Amplifier.** Power output 10 watts. Sensitivity, 1.2 volts for 10 watts. Output valves N709. Ultra linear. Output impedances, 15 or 1.5 ohms. Thermionic Products Ltd., Hythe, Southampton, England

**Whiteley.** W.B.12 control unit and amplifier. (Photo page 74.)

**Control Unit.** Inputs, pickup ; tape ; radio. Controls, selector switch for the above, with 3 record equalising positions ; treble, with cut and boost ; bass, with cut and boost ; volume. Power outlet for tuner.

**Amplifier.** Power output, 12 watts. Sensitivity, 50 mV for 10 watts. Output valves, EL 84. Output impedances, 3-4, and 15 ohms. Price complete £25. Whiteley Electrical Radio Co. Ltd., Mansfield, Notts, England.



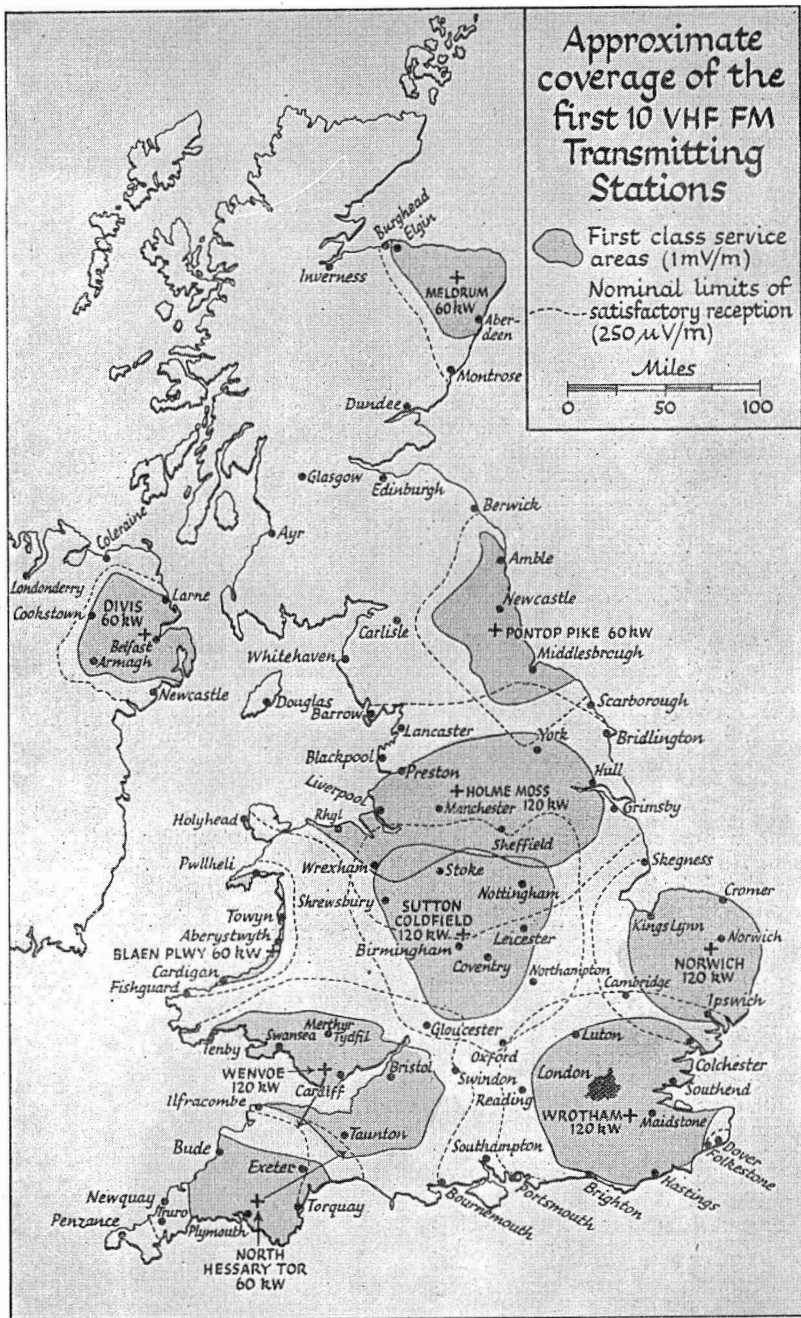

★ This map, published by courtesy of the B.B.C., shows the sites of the first 10 F.M. transmitters. Listeners in the shaded areas should enjoy first-class reception (field strength 1 mV/m). Dotted lines enclose areas in which good reception can normally be expected (field strength 250 μV/m), but efficient aerials may well extend these limits

# RADIO TUNERS

## INTRODUCTION

**M**OST sets of High Fidelity equipment are purchased, in the first place, for the reproduction of music from disc. Lately, however, with the advent of the high quality broadcast transmissions by the B.B.C. on V.H.F., more and more people are extending the scope of their equipment so as to take advantage of it. Those who have yet to hear a V.H.F. transmission by the F.M. system have a pleasant experience in store ; and it is probably no extravagant statement to say that most owners of Hi-Fi equipment will ultimately invest in the necessary "tuner" unit.

F.M. radio transmissions differ considerably from the normal A.M. broadcasts on the long, medium and short wave-bands. Readers who wish to know more about the technicalities of F.M. will find a very good outline of the subject in the following article by George Tillet. Suffice it to say here that an ordinary radio receiver will not receive F.M. broadcasts, and that an F.M. receiver is correspondingly "deaf" to everyday A.M. transmissions.

In time, when the present B.B.C. scheme is completed, approximately 83 per cent. of the population of the United Kingdom will be able to receive the three programmes via F.M. In the meantime, however, there may be many owners of Hi-Fi equipment who wish to use their apparatus for handling everyday radio broadcasts to best advantage, both from Home and overseas stations. And it must be remembered, too, that F.M. receivers

will *not* provide a full range of programmes from Europe and the rest of the world.

For the listener who never strays beyond the "Home," "Light" and "Third" programmes of the B.B.C., an F.M. receiver will suffice ; but the more adventurous listener will always need an A.M. receiver to take him further afield.

Radio *tuners*, as distinct from radio *receivers*, are units designed to work in conjunction with other apparatus. The owner of a set of Hi-Fi equipment already possesses a speaker unit and an amplifier ; and if he has chosen his amplifier with an ear to the future, its power pack will not only be designed to carry the load of at least one, and probably two extra units, but it will also possess a 4-pin socket (or two of them) into which he can plug the unit when he buys it. A radio *receiver* consists, basically, of a power pack, a system of tuning circuits, an amplifier, and a speaker. Since a chain of Hi-Fi equipment embodies all these ingredients, with the exception of the system of tuning circuits, only the "tuner" is needed ; and hence the title of this comparatively modern component.

"Tuners" can be bought for the reception of A.M. broadcasts only, on the Long, Medium, and Short bands. They are also available for the reception of F.M. transmissions only. And they are also made to cover both types of transmission.

### DIRECTORY OF B.B.C. F.M. STATIONS AND FREQUENCIES

STATION	Light	Third	Home	STATION	Light	Third	Home
	<i>Frequencies in Mc/s.</i>				<i>Frequencies in Mc/s.</i>		
Wrotham ...	89.1	91.3	93.5	Sutton Coldfield ...	88.3	90.5	92.7
Pontop Pike ...	88.5	90.7	92.9	Norwich ...	89.7	91.9	94.1
Divis ...	90.1	92.3	94.5	Blaen Plwy ...	88.7	90.9	93.1
Meldrum ...	88.7	90.9	93.1	Holme Moss ...	89.3	91.5	93.7
North Hessary Tor	88.1	90.3	92.5	Wenvoe ...	89.9	92.1	94.3

Only three connections are normally necessary, when adding a radio tuner to a Hi-Fi set-up. First, the aerial is plugged into the tuner, by means of co-axial cable and plug (as with television) ; next, the tuner is plugged into the pre-amplifier, or control unit, so that it can draw its power supply ; and, finally, a short co-axial lead from the tuner is plugged into the pre-amplifier, in order to feed the broadcast signal (converted to audio frequency by the tuner) into the Hi-Fi amplifying and reproducing system. The tuner often has one control only—the tuning knob, though some are fitted with an on/off switch. The volume, treble, and bass controls of a radio receiver are of course unnecessary, because they are available on the pre-amplifier.

Stated briefly, the two great advantages of F.M. broadcasts over A.M. are (a) far greater

band-width, which enables the complete audio range to be handled and reproduced with a high degree of fidelity, and (b) almost non-existent background.

On occasion, when "live" broadcasts are made by the B.B.C., and when no land-line losses and restrictions between studio and transmitter have impaired the original signal, the quality of the sound that can be reproduced through good equipment is considerably superior to that which can be expected from the very best L.P. disc. And on such occasions, the Hi-Fi enthusiast, who is also fortunate enough to possess a tape recorder of really high quality, can make recordings of a very high order indeed.

The subject of tape recorders is dealt with elsewhere in this book, and the "layout" of the whole equipment is shown schematically on page 28.

*Armstrong F.M. Tuner  
Type F.M. 56. Price  
£15 15s. 2d. (plus P.T.)*

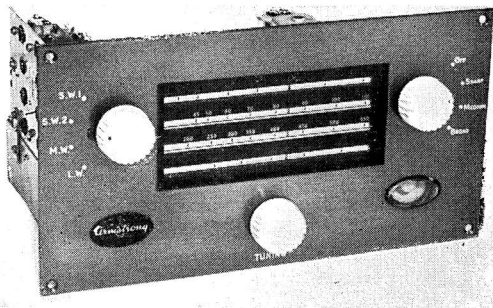
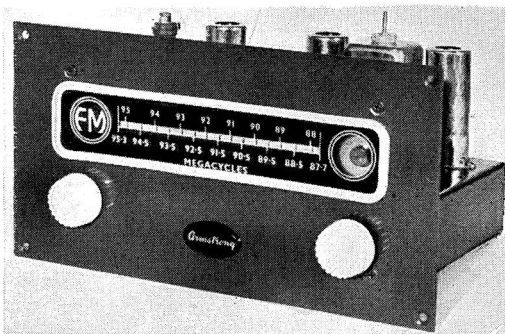

*Armstrong A.M. Tuner  
Type A.M. 44. Price  
£14 3s. 6d. (plus P.T.)*

*Chapman F.M. Tuner  
Type F.M.81 Mk. 2  
Price £15 15s. (plus P.T.)*

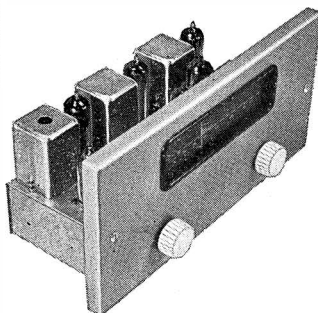

# F. M. TUNERS

By George Tillet

MANY things in the field of electronics seem to have been invented somewhat prematurely—prime examples being the moving coil speaker and the magnetic tape recorder, both of which were invented as long ago as 1898 (or thereabouts). F.M., or to give it its full name, *Frequency Modulation*, is another example. As far back as 1921 its use was suggested by Captain Round<sup>1</sup> for providing an alternative method of radio transmission having a better signal-to-noise ratio than that attained with other systems. Nevertheless, it was not until 1936, when Major Armstrong demonstrated a successful system in America, that it began to be widely adopted—and then only in that country. In spite of its use in television there, a few years ago there was a marked decline in the popularity of F.M.; but more recently the interest in high-fidelity reproduction has resulted in a revival.

## The Advantages of V.H.F.

In Europe, F.M. is the standard form of transmission for television sound, and in Germany alone there are now more than 100 F.M. broadcast stations. Here, in Britain, the B.B.C. has inaugurated a scheme for 10 stations, each radiating three programmes; and when this scheme is completed at the end of 1956 it will provide a coverage for more than 75 per cent. of the population. The principal advantages of F.M. as applied to these new B.B.C. stations are as follows: (a) Freedom from whistles and interference from other stations; (b) better quality reproduction, resulting from wider bandwidth. (c) F.M. not only has an inherently better signal-to-noise ratio, but because most electrical interference is impulsive in character it can be considerably reduced by a "limiter" which removes peaks exceeding the steady carrier voltage.

Because of the number of stations operating in the medium wave-band it is rarely possible to use a receiver having a wider bandwidth than about 7 Kc/s. without experiencing annoying whistles, and other interference, from stations operating on adjacent channels;

thus the reproduction becomes a travesty of the real thing, for we know that a bandwidth of at least 15 Kc/s. is desirable.

The new B.B.C. stations operate on the V.H.F. short wave-band (V.H.F. standing for Very High Frequencies). This V.H.F. band, which in this country covers 88 to 100 megacycles (that is 3 to approximately  $3\frac{1}{2}$  metres), is not subject to the same limitations; even supposing a channel as wide as 200 Kc/s., there is room for several hundred stations. Furthermore, due to their comparatively short range, it is possible for several stations to share the same channel without mutual interference.

The normal frequency range transmitted on medium waves rarely exceeds 10,000 c.p.s. but direct transmissions from the V.H.F. stations extend up to at least 15,000 c.p.s. The use of land lines unfortunately often restricts the frequency range, but even so the quality of reproduction (aided as it is by a silent background) is far superior to that obtainable from the medium wave stations.

## F.M. versus A.M.

The fundamental difference of F.M. from the conventional type of transmission known as A.M. (short for Amplitude Modulation) is the fact that the carrier wave of an A.M. station varies in intensity, in proportion to the modulation, while the modulation of an F.M. station actually swings the carrier backwards and forwards from its nominal frequency. *The number of times per second that the carrier swings about its nominal position determines the frequency, and the extent of the swing determines the loudness of the signal.*

The principal differences in the circuit of an F.M. tuner lie in the detector circuit, which must be able to convert a frequency swing, or variation, into a variation in amplitude at an audio rate. Until 1947, the main type of detector used was the "Foster-Seeley," a phase detector named after its American inventors. A circuit of this detector, or "discriminator" as it is called, is shown in Fig. 1. Both primary and

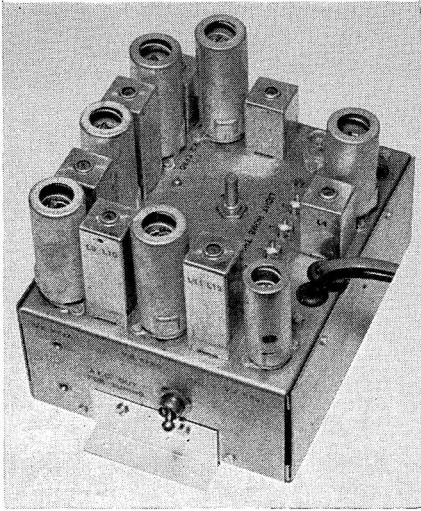

*(left) Dynatron F.M. Tuner  
Type F.M.1. Price £18 (plus P.T.)*



*(above) Jason F.M. Tuner  
Price £11 19s. 3d. (plus P.T.)*

*(Right) Chapman A.M. Tuner  
Type S.6.B.S. Price £33 (plus P.T.)*

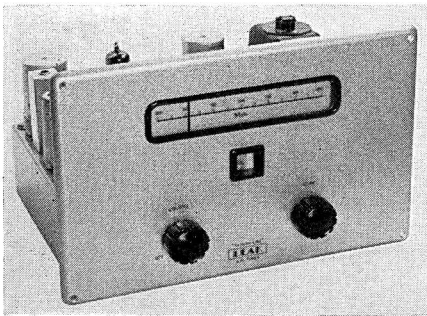
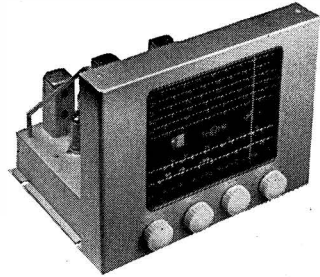

*(left) Leak F.M. Tuner  
Price £25 (plus P.T.)*

*Lowther F.M. Tuner Mk. 2  
Price £22 (plus P.T.)*

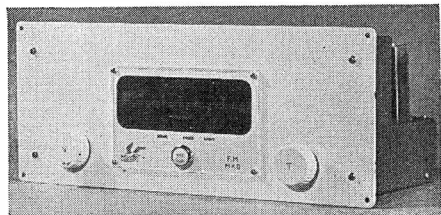

secondary circuits of the transformer T1 are tuned to the I.F. frequency (usually 10.7 megs., or 10.7 million cycles per second). Since the secondary winding is accurately centre-tapped, equal voltages (but of opposite phase) are applied to each diode anode D1

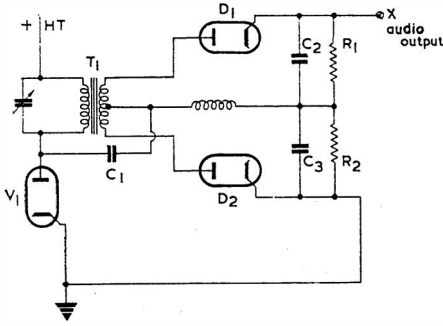

FIG. 1—Foster-Seeley Phase Discriminator Circuit

and D2. The carrier voltage from V1 is also applied, via the condenser C1, to the centre tap, and thus equally to the two diodes.

While the carrier is undeviated and constant at 10.7 megs., it follows that as the input to the diodes is equal, therefore equal and opposing voltages will appear at their output across R1 and R2, thus the resulting output is zero. If the carrier frequency is then changed (that is to say, modulated) the state of balance in the circuit is also changed. The voltage applied to the diodes then depends on the relationship between the induced voltage from the transformer windings and the voltage applied via the condenser C1. This voltage changes in either direction, depending upon whether the carrier frequency is above or below resonance. As a result one half of the detector load R1 becomes more positive, and the other half R2 becomes more negative. The total voltage, varying with the modulation from the broadcasting station, is thus added together across R1 and R2, and the audio output is taken from the point marked X.

### The Ratio Detector

A somewhat similar form of discriminator, called the "ratio detector," is also widely used, especially in domestic receivers both in this country and Germany. Fig. 2 shows the basic circuit. Like the Foster-Seeley phase detector, the ratio detector also uses an additional coupling to the centre tap of

the transformer secondary. This coupling is inductive and is taken via the coil L1. Furthermore, the two diodes are connected in opposite directions, and their resulting outputs oppose each other instead of helping each other as in the previous case. The actual load circuit consists of a resistance, shunted by a high capacity condenser C1. When the carrier frequency changes, the balance of the circuit is also changed; the change produces varying currents from the diodes, with the out-of-balance current appearing at C2. Since the amount of audio output depends on the ratio of the diode currents, this explains the name "ratio detector." Because of the large size of the reservoir C1, pulses of electrical interference are swamped; thus the ratio detector has a better signal-to-noise factor than the Foster-Seeley.

### Improved Balance

A further improvement can be effected by dividing the load resistor into two sections, taking the earth point to the junction. If this tapping point is made variable, it is possible to obtain a high degree of balance, and thus to compensate to some extent for variations in coils, valves or especially germanium diodes if used. Unfortunately, the degree of balance of a ratio detector is more dependent on the amount of input than

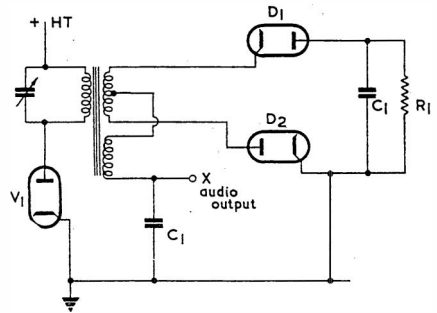
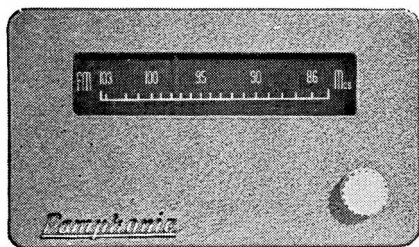

FIG. 2—Ratio Discriminator Circuit

a Foster-Seeley detector and this, coupled with the slightly better linearity possible, has resulted in extensive use of the latter type in tuners intended for high-fidelity use.

The audio modulation of an F.M. station is pre-emphasised: that is to say, high audio frequencies are "lifted," and appropriate steps have to be taken to correct for this in the receiver. This is called de-emphasis and,



*Pamphonic F.M. Tuner  
Price £12 12s. (plus P.T.)*

*Pye F.M./A.M. Tuner  
Type H.F.T. III  
Price £21 19s. 8d. (plus P.T.)*

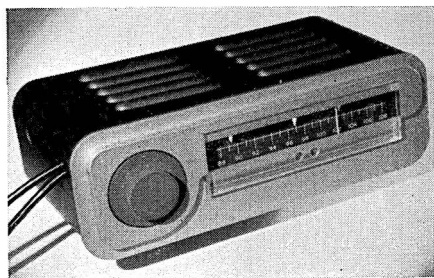
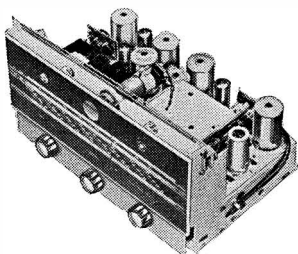

*Quad F.M. Tuner  
Price £21 (plus P.T.)*

*Quad F.M. Tuner with case  
removed to show layout*

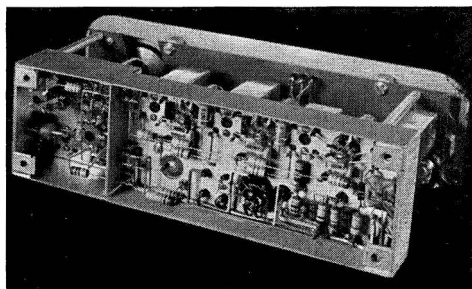

in the process, noise is also de-emphasised with the signal. The correction network (consisting of condensers and resistors having the correct time constant) is usually inserted immediately following the audio output from the discriminator. Pre-emphasis can also be applied to A.M. transmission<sup>2</sup> but the improvement in signal-to-noise is not so great.

In order to eliminate noise, which is in effect amplitude variations superimposed on the incoming signal, all tuners using phase detectors, and some using ratio detectors, have a "limiter" stage. This is usually the function of the final I.F. valve, which is so biased that it is not affected by amplitude variations of the carrier; consequently peaks of noise are removed. It is easy to see that tuning an F.M. receiver must be extremely accurate, for any mistuning will result in an unbalance of the detector circuit, causing considerable distortion; and much ingenuity has gone into the design of suitable tuning indicators.

#### Tuning Indicators

The simplest form of indicator—the "magic eye"—is inevitably something of a compromise, because the wide bandwidth used (at least 200 Kc/s.) means that the correct centre point is indeterminate. However, an exception must be made in the case of the "Leak" tuner, which uses a conventional magic eye indicator in conjunction with two metal rectifiers fed from A.C. to give an accurate reference voltage. The Lowther tuner incorporates a press-button switch which injects a small A.C. voltage into the I.F. circuit, and any mistuning results in a hum being heard: this hum is then tuned to zero. Probably the most ingenious idea is that used in the "Quad" tuner. This involves the use of two neon lamps in conjunction with a double triode valve, one neon being connected in each anode circuit. The valve, which is cathode connected, is coupled to the output of the discriminator in such a way that correct balance is indicated by both neons lighting, and the *direction* of mis-tune is indicated by the appropriate neon diminishing in brightness or being extinguished altogether.

Frequency "drift" is also a problem on these very high frequencies, but with careful design and with the use of special temperature compensated condensers in the oscillator circuit, this can be reduced to negligible proportions. Several tuners, including the Lowther, Rogers and Dynatron, incorporate

automatic frequency control. This is achieved by utilising the discriminator voltage to bias a reactance valve which, in turn, is coupled to the oscillator valve, thus altering the frequency and so "pulling" the receiver into tune. Actually, the phase discriminator was invented by Foster and Seeley for the purpose of automatic frequency control, and was in fact used by a number of British domestic radio receivers, including the "Murphy," many years ago.

#### Tuning Arrangements

The majority of tuners use permeability tuning, as, for example, Quad, Armstrong, T.S.L. and Pye; but condenser tuning is used by a number of other makers, including Jason, Chapman and Pamphonic. An unconventional system is used in the new "Leak" tuner. This is a "Trough Line" inductor, which is claimed to provide an unusually high degree of stability. Switch type tuners—i.e., tuners having no tuning facilities other than three stations selected by a switch—are becoming more popular and are made by Dynatron, Chapman and Pye—the latter using three crystals to control the frequencies selected. In the higher-price class are a number of combined tuners, that is to say, tuners that cover the medium and long wave-bands in addition to the V.H.F. band. Among these are the Chapman, the Pye, and Eddystone—the latter having three switched positions covering spot frequencies on the medium and long wave bands.

When buying a tuner, if it is not self powered, make sure that the amplifier with which it will be used can provide adequate power. Some amplifiers have *no* provision for auxiliary power supplies. Many firms, such as Sound Sales, and Pamphonic, can provide a power supply unit if desired.

The choice of aerials will mainly depend on the distance from the broadcasting station; within an area of 10 to 20 miles, a simple flexible dipole will probably suffice. The total length of the elements should be 5 feet, with a quarter-inch spacing in the middle; and if possible it should be installed in the loft. At greater distances from the transmitter an outside aerial is recommended, and listeners in "fringe" areas will need a "H" or multi-element type. These outside aerials can conveniently be mounted on the same mast as the television aerial, and in fact combined aerials of this type are available.

1 "Radio, Review," Vol. 2, p. 220 (1921).

2 "Frequency Modulation," K. Sturley, p. 12.



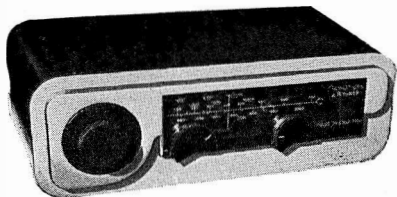

*Quad A.M. Tuner*  
Price £21 (plus P.T.)

*Sound Sales F.M. Tuner*  
Mk.2. Price £15  
(plus P.T.)

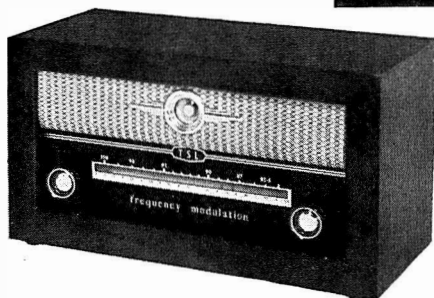
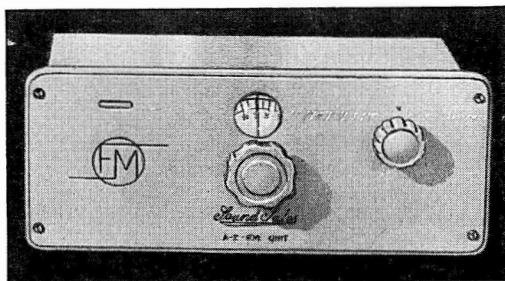

*T.S.L. "Empress" F.M. Adaptor*  
Price £12 14s. 3d. (plus P.T.)

## DIRECTORY OF RADIO TUNERS

**Important Note :** The tuners listed below all conform to the minimum standards acceptable for high quality sound reproduction. The specifications are abridged by the following assumptions : that, unless otherwise stated (i) tuning is variable ; (ii) output voltages are 100 mV or over, and adequate for feeding the amplifiers noted in this book, and (iii) output impedances ensure suitable matching to them. P/N denotes power supplies needed. S/P denotes self-powered.

\* \* \*

**Armstrong Wireless & Television Co. Ltd.,** Warlters Road, Holloway, London, N.7. (Photos page 82.)

*F.M. Tuner type FM56.* Range 88-95 Mc/s. Ratio det. P/N 250v at 30 mA ; 6.3v at 2 amps. Magic eye. Price £15 15s. 2d. (+ P.T.).

*A.M. Tuner type AM44.* Range 15-50 ; 49-120 ; 190-550 ; 900-2,000 metres. P/N 250/320v at 20 mA ; 6.3v at 1.4 amps. Price £14 3s. 6d. (+ P.T.).

\* \* \*

**Acoustical Manufacturing Co.,** Huntingdon, Hunts, England. (Photos pages 86/88.)

*F.M. Tuner.* Range 87.5-108 Mc/s. Foster-Seely. P/N 330v at 27 mA ; 6.3v at 1.85 amps. Price £21 (+ P.T.).

*A.M. Tuner.* Range 190-550 ; 800-2,000 metres. Var. select. P/N 330v at 20 mA ; 6.3v at 1.2 amps. Price £21 (+ P.T.).

\* \* \*

**C. T. Chapman (Reproducers) Ltd.,** Riley Works, Riley Street, London, S.W.10. (Photos pages 82/84.)

*F.M. Tuner FM81 Mk. 2.* Range 87.5-100 Mc/s. Ratio det. P/N 250v at 40 mA ; 6.3v

at 2 amps. Magic eye. Output 40 mV. Price £15 15s. (+ P.T.).

*A.M. Tuner S4.* Range 16-50 ; 195-550 ; 800-2,000 metres. Var. select. P/N 250v at 20 mA ; 6.3v at 1 amp. Price £12 (+ P.T.).

*A.M. Tuner S5.* Range and other details as for S4. Price £16 (+ P.T.).

*A.M. Tuner S6.* Range as S4. P/N 250v at 30/40 mA ; 6.3v at 1½ amps. Price £22 10s. (+ P.T.).

*A.M. Tuner S6BS.* Six bandspread ranges: 13, 16, 19, 25, 31, and 41 metres ; also 15-43 ; 43-140 ; 175-570 metres. Var. select. P/N as for S6. Price £33 (+ P.T.).

*AM/FM Tuner, Type S5FM.* Range (FM) 87-100 Mc/s. ; (AM) as on tuner S5. Ratio det. P/N 200/250v at 40/50 mA ; 6.3v at 2½ amps. Price £24 7s. 6d. (+ P.T.).

\* \* \*

**Dynatron Radio Ltd.,** The Firs, Castle Hill, Maidenhead, Berks, England. (*Photo page 84.*)

*A.M./F.M. Tuner T10.* Range (F.M.) 88-100 Mc/s. ; (A.M.) 13-48 ; 48-160 ; 185-575 ; 800-2,000 metres. Var. select. Price £43 15s. (+ P.T.).

*F.M. Tuner FM1.* Range 88-95 Mc/s. Switched pre-tuned spots for 3 B.B.C. progs. A.F.C. P/N 220v at 20 mA ; 6.3v at 2.5 amps. Price £18 (+ P.T.).

\* \* \*

**Stratton & Co. Ltd.** Birmingham 31, England.

*"Eddystone" 820 F.M. Tuner,* with 3 switched pre-set spot frequencies for A.M., 2 in medium, and 1 in long wave-band. F.M. range 87.5- 100 Mc/s. Foster-Seely. Magic eye. S/P. Price £28 10s. (+ P.T.).

\* \* \*

**Jason Motor and Electronic Co.,** 328 Cricklewood Lane, London, N.W.2. (*Photo page 84.*)

*F.M. Tuner.* Range 88-100 Mc/s. Ratio det. P/N 220v at 25 mA ; 6.3v at 1.5 amps. Price £11 19s. 3d. (+ P.T.).

*A.M./F.M. Tuner.* Range (F.M.) 88-100 Mc/s ; (A.M.) 195-560 metres. Ratio det. A.F.C. S/P. Price £20 12s. 6d. (+ P.T.).

**H. J. Leak & Co. Ltd.,** 57 Brunel Road, London, W.3. (*Photo page 84.*)

*F.M. Tuner.* Range 88-100 Mc/s. Foster-Seely. Magic eye. S/P. Price £25 (+ P.T.).

\* \* \*

**Lowther Manufacturing Co.,** St. Marks Lane, Bromley, Kent, England. (*Photo page 84.*)

*F.M. Tuner Mk. 2.* Range 85-100 Mc/s. Foster-Seely. A.F.C. Audio tuning indic. P/N 250v at 30/35 mA ; 6.3v at 2 amps. Price £22 (+ P.T.).

\* \* \*

**Pamphonic Reproducers Ltd.,** 17 Stratton Street, London, W.1. (*Photo page 86.*)

*F.M. Tuner.* Range 86-103 Mc/s. Ratio det. Magic eye. P/N 250v D.C. at 30 mA ; 6.3v at 1.5 amps. Price £12 12s. (+ P.T.).

\* \* \*

**Pye Ltd.,** Cambridge, England. (*Photo page 86.*)

*F.M./A.M. Tuner HFT 111.* Range (F.M.) 87-100 Mc/s. ; (A.M.) 183-564 ; 956-1,910 metres. Phase discrim. Magic eye. S/P. Prices : £25 10s. 8d., or chassis, £21 19s. 8d. (+ P.T.).

\* \* \*

**Rogers Developments (Electronics) Ltd.,** 116 Blackheath Road, London, S.E.10.

*F.M. Tuner.* Provisional details : Foster-Seely. A.F.C. Price £17 10s. (+ P.T.).

\* \* \*

**Sound Sales Ltd.,** West Street, Farnham, Surrey, England. (*Photo page 88.*)

*F.M. Tuner Mk. 2.* Range 86-100 Mc/s. Foster-Seely. Calibrated tuning. Magic eye. P/N 230/250v at 30/40 mA ; 6.3v at 1.5 amps. Price £15 (+ P.T.).

*A.M. Tuner Mk. 2.* Range 190-570 ; 800-2,000 metres. P/N 230v at 15 mA ; 6.3v at 1.5 amps. Magic eye. Price £12 15s. (+ P.T.).

\* \* \*

**Technical Suppliers Ltd.,** 63 Goldhawk Road, London, W.12. (*Photo page 88.*)

*"Empress" F.M. Tuner.* Range 85-101 Mc/s. Foster-Seely. S/P. Magic eye. Price £12 14s. 3d. (+ P.T.).

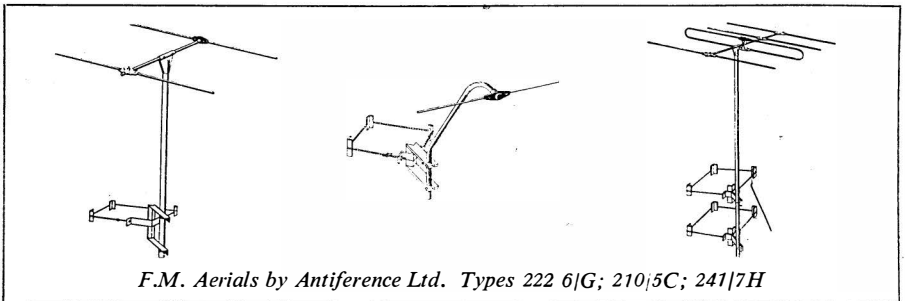

*F.M. Aerials by Antiference Ltd. Types 222 6/G ; 210 5/C ; 241 7/H*

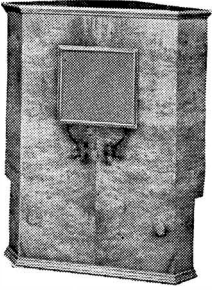

*B.K. Partners, type M.V.C.*



*B.K. Partners, type W.R.L.12*

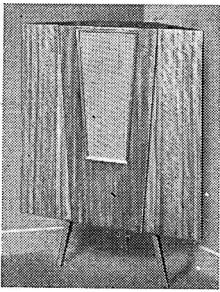

*B.K. Partners, type H.C.10*

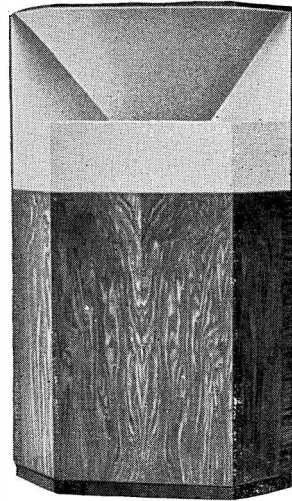

*(above) Expert "Master Speaker"*

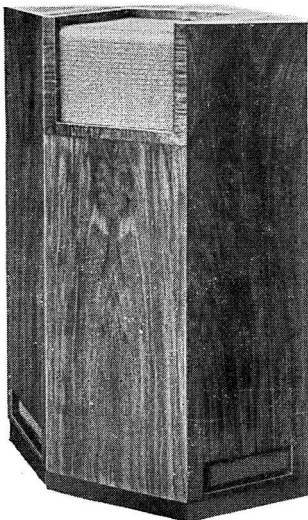

*(left) Expert "All Range"*

# SPEAKERS AND ENCLOSURES

By Ralph West

VERY wisely, my parents forbade me to touch "wireless" until I had finished my matriculation. By then Rice & Kellogs' paper was 2 years old and the moving coil speaker was known, spoken of with awe, but not yet seen in the shops. I graduated via "phones in a basin" (quite literally!), a pleated paper cone driven from a mutilated earpiece, to a 2 ft. square linen diaphragm driven from a balanced armature movement, exchanged in the local store for our old portable (only just) gramophone! I shall never forget the thrill of having on loan for two nights an 8 in. Rola energised moving coil speaker. It ran my wet H.T. down, and I had to lug all 120v of it a mile to recharge it in my grandmother's pantry; but it was well worth it!

By the time I had saved, swapped, begged, and passed another birthday, permanent magnet models were obtainable and my dream came true.

## What Progress?

How far have we progressed since then? With the ordinary commercial speaker, I'd say not at all, except that a few ounces of magnet material do the job that took several pounds in those days. With the better class of speaker for more serious use—yes a long way, and we're still progressing. Since this last war there has been a tremendous upsurge of interest, and increase of knowledge of the subject we call high fidelity. It is partly due to pent-up ideas that were conceived during the war; partly due to our more even distribution of wealth, which has enabled more people to indulge their interests; and partly due to our increasing total of knowledge. A further impetus has been given by the fact that the whole art has now reached a stage where most music-lovers and musicians can enjoy listening to our efforts without being acutely conscious of the technical shortcomings thereof.

How far have we got? Bluntly, not far enough; there is yet no cause for complacency. A very simple experiment has made this abundantly clear to me. About five years ago, I had the privilege of testing every make of loudspeaker available in this country. Using a white noise source—to those not familiar with the term, it sounds like rain on a lawn at low level, and at high level like Niagara Falls—it was switched in turn from speaker to speaker and they all sounded different. Only one could have been right! Today they are still all different, so I suggest, as I did then, that none of them is quite perfect. Personally, I hope we never do reach perfection, there is such a lot of fun (and headaches, too) striving for something better.

## Perfection Unlikely

Actually we never shall reach perfection. Think of neckties. We have not yet reached perfection there, as there are to be had all sorts of shapes, sizes, materials, colours, patterns and prices. They all do their allotted job, and most of us manage to find one we like best. Well, the loudspeaker has, I think, reached something like that degree of development—we shall never all agree which is the best loudspeaker.

There are today, in this country, a large number of enthusiastic manufacturers of high-class driving units and enclosures that produce really "nice noises," and their enthusiasm has advanced the science and the art considerably. The last few years have given us many speaker units with a wider frequency response—that is, improved high note response and lower cone resonances—that enable us to produce low frequencies more easily, and with less distortion. Coupled with this there has been a general smoothing of the response; at least a reduction in the more violent resonances in the range 2,000 c.p.s. to 6,000 c.p.s. (These were some of



*Expert "Acoustic Column"*

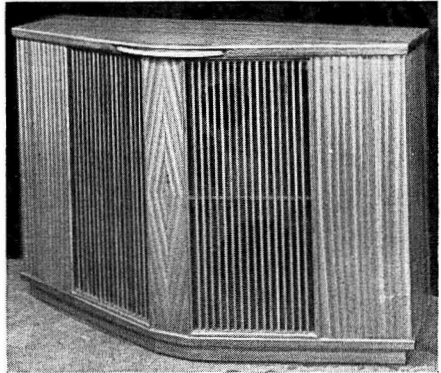

*H.M.V. Model 3052  
which houses the main amplifier*

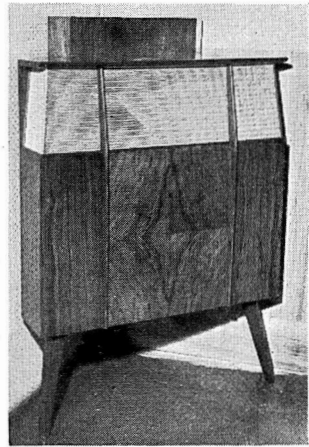

*(above) Lowther T.P.I.*

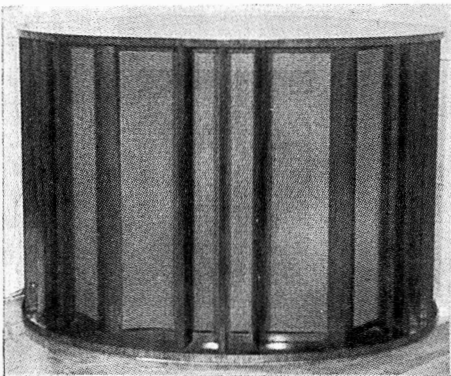

*(left) Sound Sales Tri-Channel  
Reproducers*

the things that tortured the musician and music-lovers a few years ago, when they exasperated us by preferring acoustic gramophones to our proudest efforts !)

Given a reasonable amount of money, we can produce a response curve virtually flat over the whole audible range ; but that is not enough. Tiny resonances, not shown up by most testing methods yet devised, are often audible to the keen ear, especially to the experienced ear. When we are told that, "it doesn't sound quite right," or "I don't like it," by a musician, it is up to us engineers to find just what is wrong ; there most certainly is something wrong.

### Mathematical Approach

This brings us back to the white noise test, and the word "colouration." It involves not only the cone, but sundry pockets of air in and around the cone, the speech coil, the cabinet ; the flexible surround to the cone, the flexible leads to the speech coil ; the cabinet itself, etc. Much of this is being dealt with by accumulated experience. Latterly there is welcome evidence of a more widespread quantitative mathematical solution to some of the problems. This is welcome, because it increases the likelihood of being able to reproduce, at any future time, speaker systems of identical performance. It also enables us to design so as to produce a desired performance quickly, and with a minimum of trial-and-error. The days of trial-and-error as the main method of development are largely over—it takes too long for one thing ; but the ear is still the final arbiter in all our efforts.

### The Listening Room

One last word about frequency characteristics. All our efforts may be brought to nought by the acoustics of the listening room. The total amount, and the position, of soft furnishings will materially alter the high note response, and distribution, whilst standing waves (and the especially bad ones, eigentones) will alter the low frequency response. The shape and size of the room, the position of the speaker, and the position of the listener, all add up. Raleigh pointed this out around 1880 ; how he must chuckle now ! Mind, this does not mean that it is not worth our while trying to produce an even response. It does mean, though, that an inferior speaker in lucky surroundings can be almost perfect, whereas an excellent design may be very disappointing in certain locations. Trial and error here is probably

quicker than calculation, as not only are the calculations rather long, but the low note response and low note damping of many speakers varies with position in the room. Unfortunately, the corner, which is generally the best position as regards acoustic loading (hence response and damping comment), is the best position to evoke room resonances or eigentones. This is why many speakers have, surprisingly, real harmonic-free output, above threshold, at 30-35 c.p.s. !

### Styles of Loudspeaker Reproduction

What do we expect of our loudspeaker ? Surely this—if we closed our eyes, then we should be unable to say whether we were listening to the real thing or not. How near can we expect to get to it ? Some years ago P. G. A. H. Voigt suggested this as an attainable ideal. The loudspeaker is like a hole in the wall, separating the listener from the concert hall. On this basis, the larger the hole the better ; and his own domestic corner horn, which appeared in 1936, was designed around that concept. The horn mouth was about 18 in.  $\times$  24 in., and the results created quite a stir for many years ; many are still in use and are by no means out of date yet. The driving unit was a nominal 8 in., which is still a popular size today. Reflection of sound from a large, specially-shaped surface produced the "large hole." Quite a number of modern speakers are on similar lines, and have a reflecting surface built-in ; one even closely resembles the Voigt by its general shape. Others point the speaker at the wall, ceiling, or corner, so that the sound reflected back into the room comes from an area considerably greater than that of the cone itself. By moving the speaker farther back from the wall, or farther out of the corner, the "hole" becomes very large indeed.

### Reverberation

The material ideally suited to this type of presentation is generally that emanating from a large studio, probably with a large audience too. The signal produced contains the sounds coming from the actual instruments themselves, plus sundry reflected sounds from the studio or auditorium walls, etc., plus audience and other noises.

The sum total of the reflected sounds is known as reverberation ; and reverberation, plus the other extras, is sometimes known as ambient sound. Sitting in such an auditorium, the listener receives sound from a variety of directions. The orchestra itself

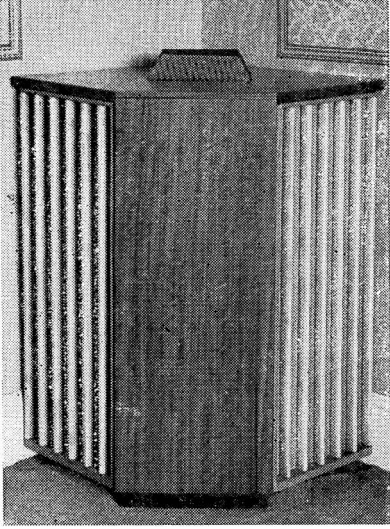

*Rogers Corner Horn (with side louvres)*

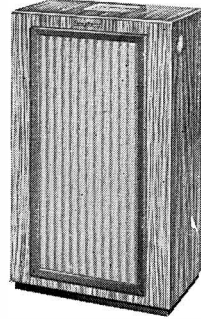

*Pamphonic "Victor Senior"*

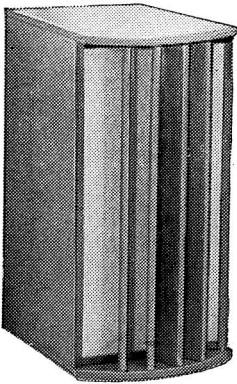

*(above) Sound Sales "Phase Inverter" Speaker*

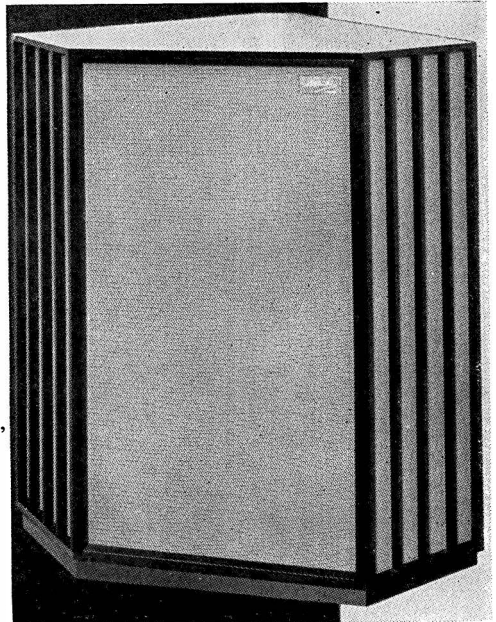

*(right) Tannoy "G.R.F."*

subtends a considerable angle at the listener's neck ; add to that reflections from the walls, panels behind it and either side of it, sometimes above it also, and an even larger angle is involved. This shows very clearly why a "large hole" is needed, and why the use of reflection from walls and corners is so successful.

A completely different approach was demonstrated more recently by Cecil Watts. He produced a number of very fine (disc) recordings of solo voice, solo instrument, and small ensemble, with the microphone placed very close to the source of sound. The recorded sound then contained the item itself and virtually no ambients. Reflected sounds did reach the microphone, but were at such a low level compared with the direct sound that they were inaudible. These recordings were then played back from a specially designed speaker, placed in the room where the instrument or vocalist would have stood if performing there. The speaker was designed to radiate equally in all directions over a very wide frequency range. A 15 in. and a 12 in. unit, in two sand-filled reflex cabinets built back to back, provided the bass ; and two 8 in. units mounted vertically, and carrying conical reflectors, handled the higher frequencies. It was affectionately known as "Watts' Folly" !

### Speakers and Material

With these conditions the listening room provides its own ambients, and it is a perfectly natural situation. In the former case, the room ambients add on to those already in the reproduced signal, but are generally small compared with those from the studio or auditorium. Note also that these basic speaker types are intended to handle quite different material, both of which are available in radio and record form, more probably in record form. Orchestras, bands, organs, and choirs suit the Voigt type speaker, whereas solo items and the spoken voice (in a small studio) suit the Watts type.

A large orchestral item is not very satisfying heard on the second type. Though the distribution of sound is excellent, the apparent size of the source (and it is judged more by the high frequency part of it) is too small. With the first type, and a solo vocal item, the soloist is somewhere behind the speaker cabinet ; or just beyond the wall or corner—a little indefinite and not so satisfying as when heard on the second type. A word of warning here—the second type of speaker should have its high note output between

3 ft. 6 in. and 5 ft. above floor level—otherwise the soloist may seem to be kneeling down. The effect does not matter quite so much with the Voigt type (though he has actually satisfied that requirement). Here, if the source of sound is low down, the listener is merely in the first row of the circle—again a perfectly natural situation. Logically, we should have two different speakers, or a convertible one on wheels ! Most of us settle for a compromise, biased in the direction we like best.

### Radiation and Distribution of Sound (low frequencies)

If the source of sound has dimensions less than about one wavelength, energy is radiated more or less in all directions. This holds for all bass notes and all bass speakers, and for most speakers up to about 400 c.p.s. At this end of the scale, then, no effort need be made to improve distribution of sound. Whenever the listener sits in his room, the low notes will reach him ; though standing waves will boost some frequencies

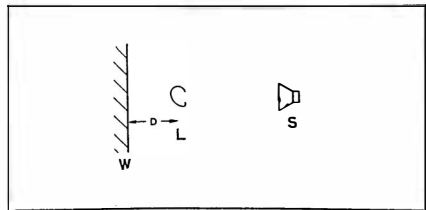

FIG. 1

and reduce others. Fig. 1. The Listener L shown hears two signals ; one from the loudspeaker S, and one reflected back from the wall W behind him. This latter has travelled an extra distance  $2D$  and therefore arrives a little later. If it is half a cycle later, it will practically cancel the direct signal reaching the listener at that moment, as it is now out of step or of opposite phase. If he were twice the distance away, or listening to a note one octave higher, it would be noticeably louder than normal, as the two signals would augment each other.

### Cancellation Condition

For the condition of cancellation,  $D$  equals  $\frac{1}{4}$  of a wavelength. Moral, don't sit 5 ft. 7 in. from the wall when listening to an organ recital in the key of G ! Sitting close to the wall or close to a corner gives the small boost for all frequencies. Most readers will already have noticed that the corner of the



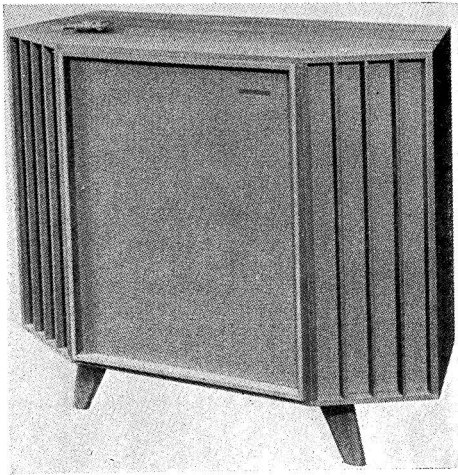

*Tannoy "Landsdown"*

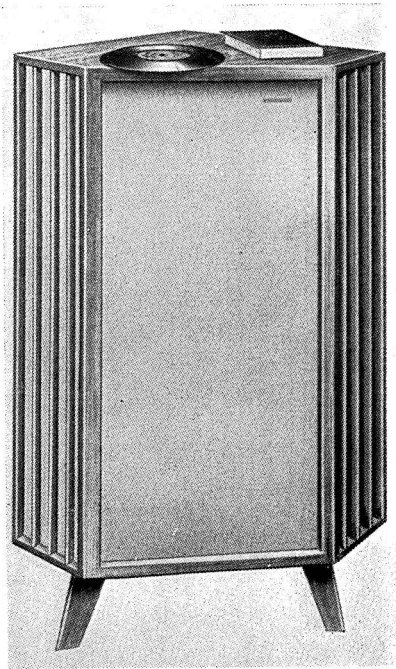

*Tannoy "York"*

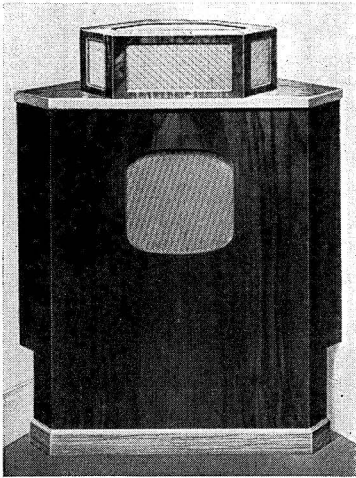

*(above) Wharfedale 3-speaker enclosure*

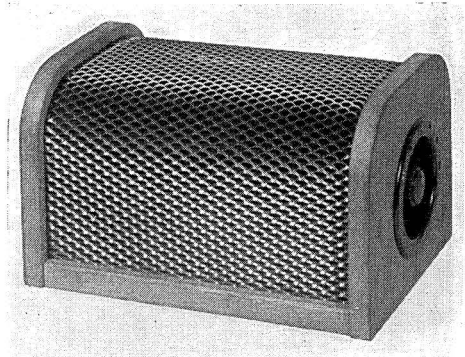

*(right) Wharfedale omni-directional, Super 3, with volume control*

room remote from the loudspeaker flutters the bass response. Fig. 2 shows the general

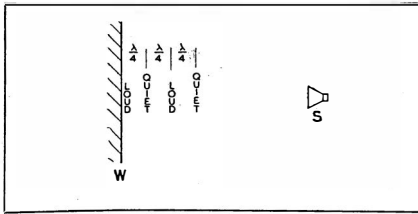

FIG. 2—Loud=High Sound Pressure=Pressure Antinode.

standing wave phenomenon that exists for each and every sound of duration more than a tenth of a second or so. It is even more complex when reflections from the walls, the ceiling and the floor are considered as well. The pattern changes from moment to moment with most music, and is of course different for every note in a musical chord.

### Eigentones

Fig. 3—eigentones occur when this pattern fits the room exactly (it must terminate at a wall or corner in a high sound pressure region). The loudspeaker will only excite those that have an "antinode" coinciding with its position. The strongest ones will occur between rigid, smooth, parallel, surfaces, but between corners the very lowest

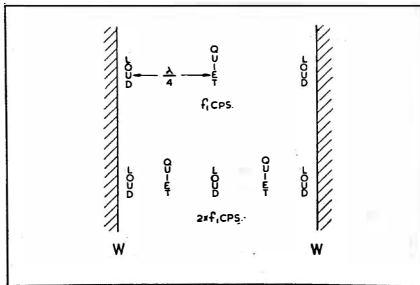

FIG. 3

ones can be observed, as already mentioned. This also explains the superior acoustics of rooms or buildings with an irregular shape—unfortunately not often found in small houses or flats.

As we have seen, the low frequency sound energy tends to travel away from the speaker in all directions. As the speaker normally stands on the floor, this restricts its spread to a hemisphere, and when placed in a corner it can only spread into  $\frac{1}{8}$  of a sphere. This

concentration is very welcome, as it is never easy to produce low frequency energy with speakers and cabinets of sizes that are acceptable in the home.

### High Notes

At the high frequency end of the scale, the dimensions of the sound radiation can easily be several wavelengths. At 4,000 c.p.s., roughly the top note of the piano, a wavelength is about 3 in. Under these conditions all flat devices, and more so hollow ones, will tend to concentrate the sound into a beam.

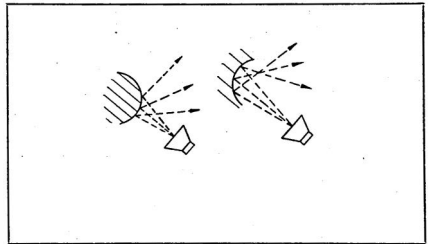
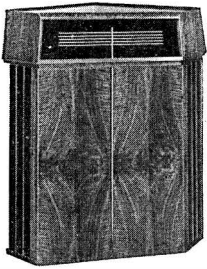

FIG. 4

The higher the frequency, the narrower the beam, and the more objectionable it is when projected straight across the room at ear level. No wonder domestic radio sets are fitted with such drastic "tone controls"!

The cheapest way out of this dilemma is to project the high note beam across the room at knee level, or a little higher, and far too often this easy way out is utilised. A somewhat better way is to project the beam above the listeners' heads. This gives a better top response, since the upper half of a room usually has less absorption than the lower half, and random reflection distributes it fairly evenly all over the room. The overall result is not very satisfactory, since it tends to produce a confusion of sound from all directions, instead of predominantly from one general direction. Best of all is the use of a properly designed reflecting system, or the walls, etc., as previously described. Both a concave and a convex surface can spread the high note beam, but the behaviour shown in Fig. 4 only holds when the dimensions of the reflectors are at least several wavelengths. Thus a reflector, say 12 in.  $\times$  12 in., any shape, will have virtually no effect below about 1,000 c.p.s., and very little normal reflection below 4,000 c.p.s. when it is only then 4 wavelengths wide. Likewise a 2 in. diameter sphere placed on the axis of a speaker only starts to have any noticeable effect above 12 Kc/s.! This does show why



*Klipschorn Speaker*

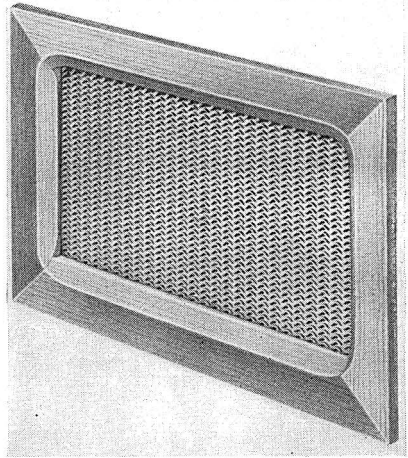

*Goodmans Acoustical Resistance Unit*

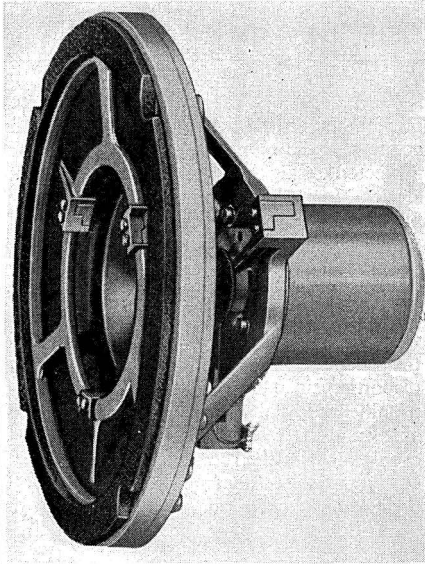

*(above) Goodmans Axiom 80*

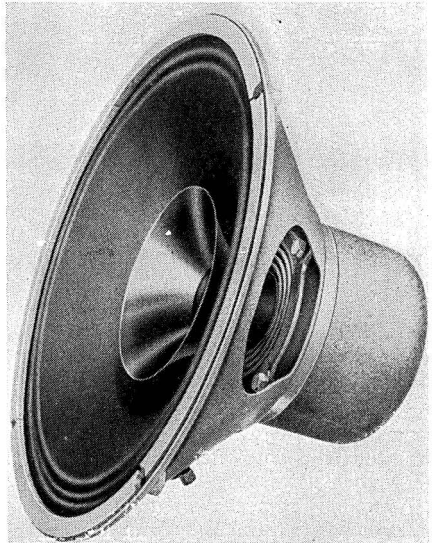

*(right) Goodmans Axiom 150 Mk. 2*

walls, etc., can be so effective when used intelligently.

There are two speaker designs that automatically produce a spreading high note output. One has a convex surface, a shape that can now be easily realised in practice—the electrostatic speaker. The other has dimensions less than a wavelength; that's all! A very small tweeter comes into this latter category; so does a vertical ribbon (though careful horn design is needed, otherwise it may beam the high notes). Chapman and Trier, of Kolster Brandes,

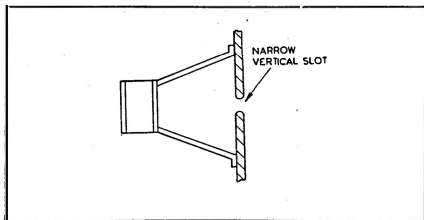

FIG. 5

patented a very simple device to achieve this same condition—the Slot (Fig. 5).

The Slot itself becomes the source of sound, and since it is very narrow, it gives wide distribution in the horizontal plane. In the vertical plane, the high note beam is as narrow as ever, but that does not matter. It has two drawbacks from the high fidelity point of view. These are, (a) actual high note loss (as well as an apparent loss due to the better distribution), and (b) the entrapped pocket of air does resonate. With 8 in. units and slots about  $\frac{3}{4}$  in.-1 in. wide, running the full vertical height of the unit, quite useful results are possible. Apropos of this phenomenon, two points come to mind. Firstly, when using two speakers in the same plane they should be placed one above the other, and not side by side. The latter widens the source and narrows the beam horizontally. (They can be placed side by side, inclined at an angle to each other). Secondly, the elliptical speaker gives the wider spread when placed with its long axis vertical, but do cover it to save constant explanations!

What are the main design requirements? For high notes they are mainly lightness of moving parts. An aluminium speech coil instead of a copper one helps. Reduction in size gives reduction in weight, but this leads to reduced power handling, and provides one of the strong arguments in favour of the

multi-speaker system with properly designed crossovers. Taken to the limit, the ribbon and electrostatic must score heavily. That has been amply demonstrated on many occasions. The ribbon is often looked upon as being too fragile, since very thin aluminium leaf is used. If its efficiency is high, then less energy is turned to heat (and more into sound) and the likelihood of burning it out is considerably reduced.

The use of twin cones driven from the same speech coil, patented originally by Voigt, helps considerably. When producing a low note, the speech coil, the small cone and the large cone, all move as one; and the extra mass of the small cone has negligible effect. At high frequencies, only the speech coil and the small cone move, the large cone being made flexible enough for this to happen. The total moving mass at high frequencies is thus considerably reduced. One last factor contributing to high note response is the field strength—or, more accurately, the degree of saturation of the pole tips. The coil has resistance and inductance too, helped by its ferrous surroundings. Put very simply, the centre pole is its core. Thus at high frequencies the total impedance of the speech coil rises, less current flows, and less energy is taken from the amplifier to be turned into sound. If the field strength is high enough, the iron centre pole and the outer pole tips may be saturated. In that case the inductance of the

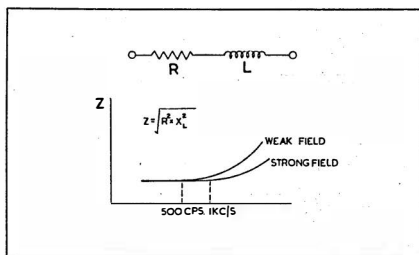
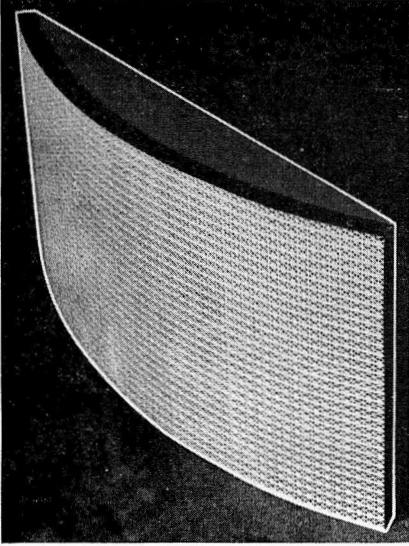

FIG. 6

coil is much lower, as the iron has no effect on its inductance. The rise of impedance is less, and the output will be maintained to a higher frequency.

Fig. 6—if the driving unit is very small indeed, like a ribbon or a so-called pressure unit, then, in the interests of efficiency and power handling, a small horn will be needed. The electrostatic is not likely to need this help.

For low notes, the speaker is of secondary importance provided that certain things are:



*Leak Electrostatic Unit*

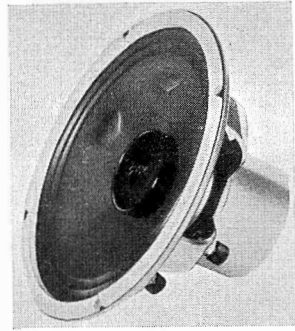

*G.E.C. Metal cone unit*

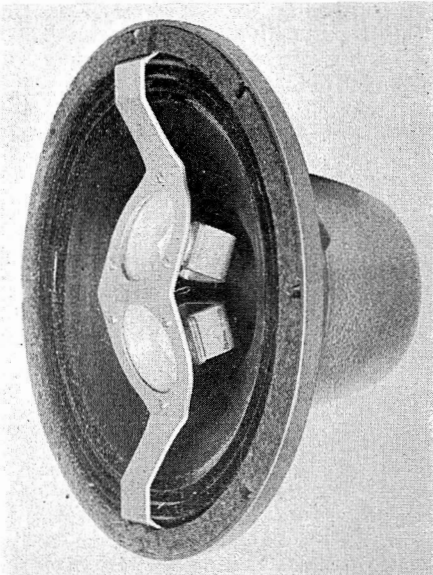

*(above) Lorenz L.P.H. 312/2 triple-unit*

*(right) Plessey 15-in. dual concentric unit*

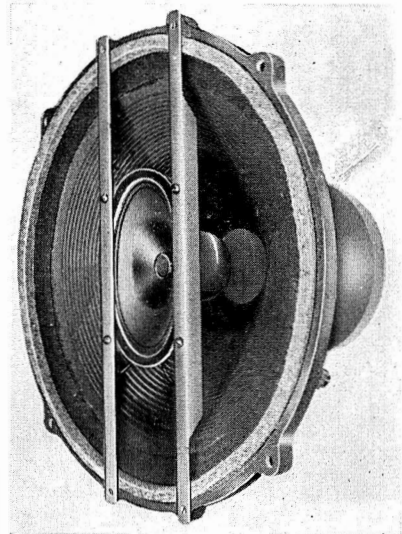

done. For instance, it is possible to produce lots of fairly pure sound at 40 c.p.s. with a really cheap 8 in. unit having a cone resonance of, say, 150 c.p.s. ! The response would definitely not be flat from 40 c.p.s. upwards unless a very large horn was used—so large, in fact, that it would be quite unthinkable for domestic use. From a

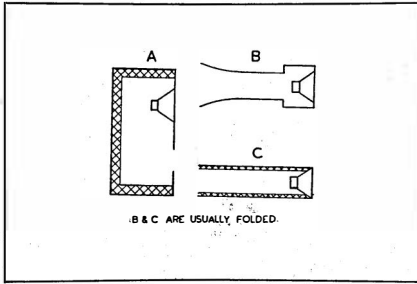

FIG. 7

practical point of view we must reduce the overall size, and often simplify the structure for purely financial reasons. Three main methods are in current use ; the reflex, the horn and the labyrinth.

Fig. 7—the reflex is really a Helmholtz resonator, and isolates the front and back radiations of the cone, so preventing cancellation down to quite a low frequency, and absorbing most of the rear energy. At very low frequencies some emerges from the port and augments that from the cone ; and at the air column resonance the cone is practically stationary and only the port produces sound.

The horn also isolates back and front of the cone, but aims at giving useful output over a much wider range than does the reflex port. In practice its performance at the very low frequencies is somewhat similar to the reflex, as its shape and size has to be a compromise, and it resonates (gently) just above cut-off. If cunningly done however, the resonance, or resonances, are almost impossible to detect.

The labyrinth aims at absorbing all the rear cone radiation. It fails, of course, at the very low frequencies, due to inevitable space limitations ; and it behaves much like the horn and reflex at the very lowest frequencies.

All three give very similar overall results, and I doubt whether one could decide by ear which one was being listened to. The horn generally has the highest efficiency, as it

aims to use the rear radiation rather than to absorb it.

Voigt tackled the problem from a different viewpoint, using a quarter wave (closed) pipe instead of a Helmholtz resonator (the reflex) to isolate front and back radiations and to provide cone loading. Unfortunately this will also resonate at times 3 and possibly at times 5 the fundamental frequency. To overcome this, he placed the cone  $\frac{1}{3}$  of the way from the closed end. To effect damping, he tapered the pipe instead of lining it, thus turning more energy into sound, instead of into heat in the lining. Its impedance curve and overall performance is very similar to the others, but it does tend to be more efficient at the very lowest frequencies for a given volume. The similarity between Figs. 7b and 8d should be noticed.

### Acoustic Damping

Acoustic damping occurs either by driving the air through small holes, or by allowing the air to move a flexible partition, so that its fibres rub together. In each case, the acoustic energy is turned into heat. The flexible partition is generally avoided, as it may buzz or rattle at certain frequencies (the Royal Festival Hall uses this method for low note absorption). The first process only

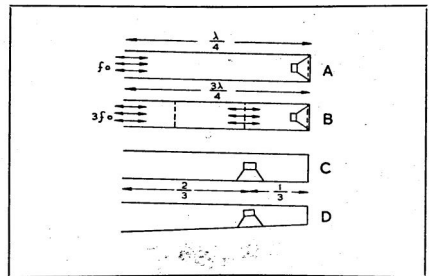
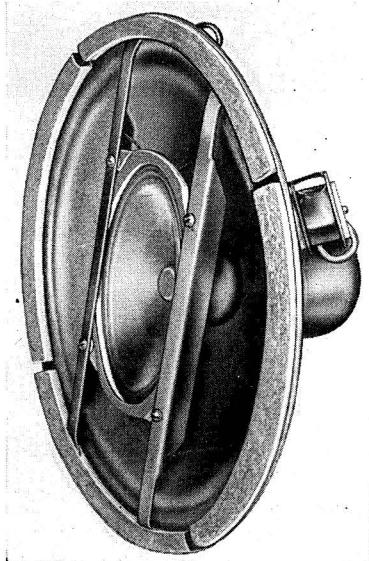
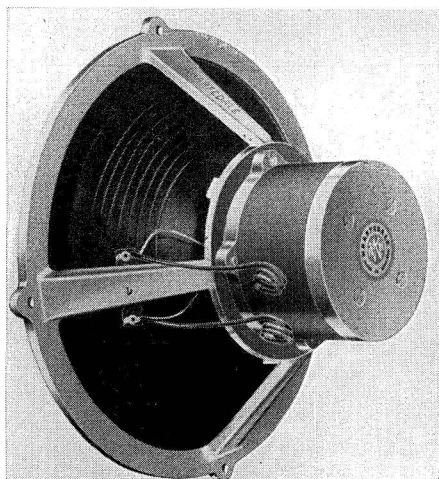

FIG. 8

works if the air really is driven through. Putting the absorbing material on the cabinet walls (Fig. 9) is the least efficient way known! At, and very close to, the wall the air is stationary, and only at a quarter of a wavelength away is there much movement (standing waves again !); thus a felt 1 in. thick will work beautifully above 3,000 c.p.s., but not below ! It may, of course, stop the panel buzzing. Hanging the absorbing material in midstream (Fig. 10) is far more efficient, and far less is needed, and it really does do something below a few thousand c.p.s.



*Plessey 12-in. dual concentric unit*



*Wharfedale Super 12/CS/AL unit*

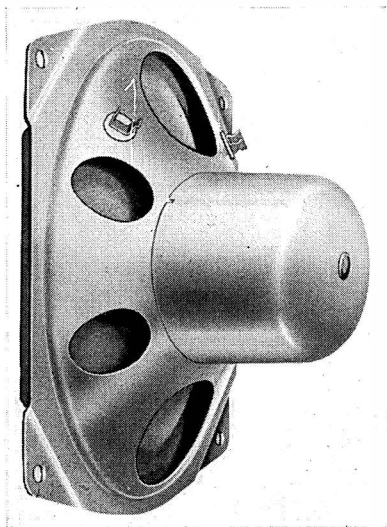

*Plessey H.F. Tweeter*

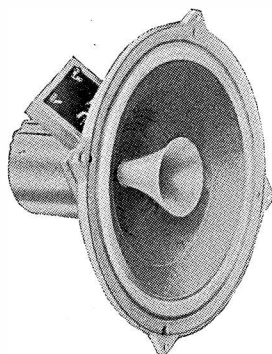

*W.B. 12-in. concentric duplex*

The acoustic resistance devices just making their commercial debut work on this principle.

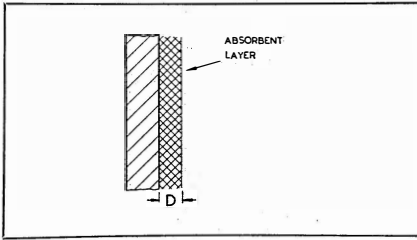

FIG. 9—Very little absorption occurs below the frequency  $f = \frac{13,000 \text{ c.p.s.}}{4 \times D}$  where  $D =$  thickness in inches.

Being the product of calculation, their action depends on precise design and stability in use. One type uses felt deposited on to a metallic mesh ; another uses narrow saw cuts in a wooden panel. It should be emphasised that such devices are *not* a panacea for all acoustic ills, to be added indiscriminately to existing designs. They cannot add anything, but only absorb or divert unwanted energy, and then only if the correct resistance is used in the right place. The future should produce more speaker assemblies using such elements, as more designers become familiar with the electro-mechanical analogies, and dare to use them !

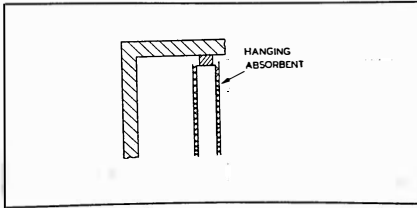

FIG. 10—Hanging absorber has a useful effect at all frequencies.

The ideal acoustic damping is the conversion of all the mechanical energy into sound. As Voigt once pointed out, if the speaker was 100 per cent. efficient, it would have no resonances, need no damping, and automatically have a flat response ! We shall be happy when we can make a speaker 10 per cent. efficient at all frequencies.

#### Cone Break-up and Electrostatic Speakers

The death knell of the moving coil has been sounded, but it may give us many more years of useful service for very cheap and for compact sound sources. The electrostatic is quite old, many of us still have the remains of a Primostatic speaker high

up on a dusty shelf. 1934, I think. The recent re-design, stimulated by F. V. Hunt's book, has now made it a working proposition. Not only have we more and better materials available than we had in 1934, but we have also better quality signals available.

The electrostatic has one very big advantage over our present moving coil designs ; that is, the whole radiating surface moves as one piece, whereas with the moving coil speaker it can only happen at low frequencies. (Fig. 11). When the speech coil moves, it starts the cone moving too, but it takes time before the whole cone has started. The time depends on the diameter and velocity of sound in the

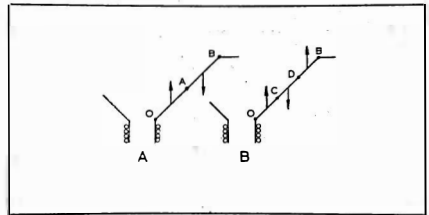

FIG. 11

cone material. At some critical frequency, the inner half of the cone OA in Fig. 11a could be moving in the opposite direction to the outer annulus A B. Now if these areas are similar, and if the cone itself does not absorb so much of the energy that the annulus A B hardly moves, the response curve will show a very marked dip. If the cone is of softer more absorbent material, so that less energy gets through to the A B area, the dip is much less and a little wider. At a higher frequency the sections O C and B D will be in step, and a peak occurs on the curve.

These effects set in below 1 Kc/s. for large speakers ; at about 1-2 Kc/s. for most 8 in. units ; at 4 Kc/s. for 8 in. metal cone types (on account of the higher velocity of sound in aluminium), and above 10 Kc/s. for a very small tweeter cone. Elliptical cones, annular ribs, curved cones, graduated paper thickness, hardened centres, etc., are all aimed at minimising these effects, for that is all they can do ; the effects are always still recognisable.

The ribbon unit shares this big advantage with the electrostatic, though for obvious reasons it cannot enjoy such a large surface area. Thus it is obvious that the days of the moving coil speaker, for high frequencies anyway, are numbered.



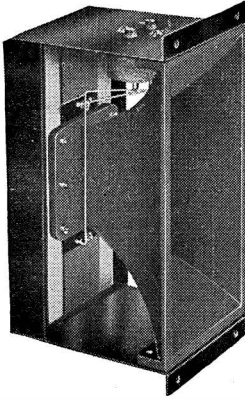

*Kelly R.L.S.I. Ribbon Tweeter*

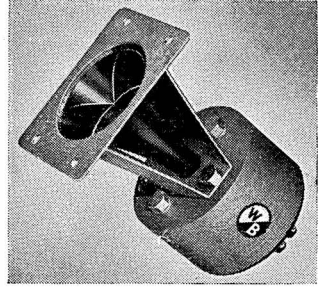

*W.B. Tweeter Unit*

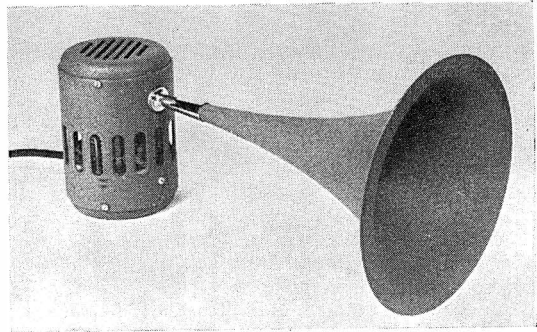

*Plessey Ionophone Tweeter*

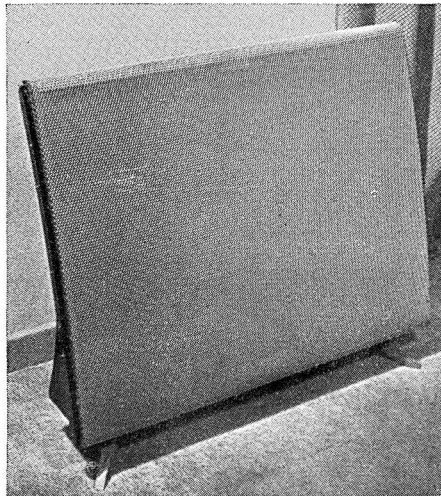

*Quad Full-range Electrostatic Speaker*

# SPEAKERS & ENCLOSURES — Directory

**IMPORTANT NOTE**—Readers will appreciate that, of all Hi-Fi equipment, the range of choice in the speaker field is by far the greatest. Also, because the various enclosures offered for sale use so many combinations of these speakers, the range of choice is considerably extended. The following list may not be complete, but it is reasonably comprehensive, and it takes into account only those units (and enclosures employing those units) which come well within the minimum requirements demanded for good quality reproduction of sound. However, since the individual preferences of different people will finally dictate the types of enclosures, and the combinations of units that are wanted, readers who wish to build up their reproducers will find the following directory a useful guide, used in conjunction with the information given in the preceding article, and that on “Requirements of Hi-Fi.”

## Complete Speakers

**B.K. Partners.** H.C.12. Forward facing 12-in. (Tannoy) unit with rear horn loading. Half section 800 c.p.s. crossover feeds vertically mounted Axiom 80. Horn takes over below 200 c.p.s. and no bass lift needed. Top assembly carries adjustable plane reflector to vary apparent location of source and high note distribution.

L.F. drive unit. Voice coil diam.,  $1\frac{3}{4}$  in., v.c.i., 15 ohms., f.d., 14,000 gauss. Total flux, 158,000 Maxwells. H.F. unit : see Goodmans Axiom 80. Price 75 gns.

**B.K. Partners.** H.C.10. Forward facing 10-in. unit with rear horn loading. Provision for H.F. unit either facing forward to give precise sound location, or upwards and rearwards for corner reflection. Units, Wharfedale bronze 10-in. CS/B and Super 3.

**B.K. Partners.** WRL.12. (*Photo page 90*). Wall reflecting labyrinth using 12-in. unit and 1 or 2 H.F. units, with suitable crossover. The 3rd unit when used would be a 3-in. tweeter or ribbon. Large effective source area. Units, Goodmans Audiom 60. Goodmans Axiom 101. B.K. Partners Ltd., 229 Regent Street, London, W.1.

\* \* \*

**Decca.** Corner speaker. Corner reflection from inclined 8-in. unit with tapered quarter wave bass loading. Large effective source area. Drive unit (as tested), Wharfedale Super 8. Price £29 17s.

The Decca Record Co. Ltd., 1 Brixton Road, London, S.W.9.

**E.M.G.** DCR.60. Corner reflection from inclined 15-in. concentric unit. Rigid cabinet contains sufficient damping to act as infinite baffle. As speaker intended to stand 2 ft. from corner, very wide effective source and uniform high note distribution. Drive unit, Tannoy 15-in. dual concentric. Price £77.

**E.M.G.** DCR.61. Slightly smaller version of DCR60 using 12-in. concentric speaker unit. Drive unit, Tannoy 12-in. dual concentric. Price £65 5s. E.M.G. Hand-made Gramophones Ltd., 6 Newman Street, London, W.1.

\* \* \*

**Expert.** Masterspeaker. (*Photo page 90*). Vertically mounted 15-in. concentric, in large well-damped corner reflex cabinet. Shaped reflector gives even distribution over room (90 deg.). Drive unit, Tannoy 15-in. dual concentric. Price £110.

**Expert.** All Range. (*Photo page 90*). Vertically mounted 12-in. unit in well-damped corner reflex. H.F. unit facing out of corner to give more precise sound location. Drive units, Wharfedale W.12 C/S and Super 5. Price £65.

**Expert.** Acoustic Column. (*Photo page 92*). Vertically mounted 10-in. concentric unit in well-damped elongated reflex. Wide source effect by reflection from walls and ceiling. Shaped reflector available to convert it to precisely located source. Drive unit, W.B. 10-in. concentric duplex. Price £27 16s. 4d. (+ P.T.). Expert Gramophones Ltd., Ingerthorpe, Great North Road, London, N.2.

**H.M.V.** Model 3052. (*Photo page 92*). (Preliminary details). Total of 6 units Bass—3 units on baffle, operating down to 25 c.p.s. Middle—2 shielded cone electrodynamic units on baffle, for response up to 10 Kc/s. Treble—1 narrow ribbon in top front of cabinet for 10 Kc/s. upwards “into supersonic.” Enclosure houses main amplifier. Price not yet announced. E.M.I. Ltd., Hayes, Middlesex, England.

\* \* \*

**Lowther.** Lowther Corner Reproducer. (*Photo page 92*). T.P.1. (P.M. 3 in.). A fully horn-loaded twin-cone 8-in. unit of advanced design. Front of cone drives wide horn at ideal level. Back of cone drives folded bass horn using space under cabinet, bounded by corner of room as final section. The speech coil, tube, and small free-edged H.F. cone effectively horn-loaded by “stabiliser” to prevent ringing. H.F. response exceptional and distribution even over whole 90 deg. by shaped reflector, and absence of usual beam from cone. F.d. 21,000-22,000 gauss. Price £96. Lowther Manufacturing Co., St. Marks Road, Bromley, Kent.

\* \* \*

**Pamphonic Reproducers Ltd.,** 17 Stratton Street, London, W.1. (*Photo page 94*). “Victor” speaker enclosure. Bass unit, 15 in. Flux density 16,000 lines. Power capacity, 15 watts. Treble unit, elliptical, with aluminium voice coil and former. The whole in enclosure with room matching switch. Impedance, 15 ohms. Price £57 15s.

\* \* \*

**Pye Ltd.,** Cambridge, England. “Concerto” speaker enclosure. With dual concentric unit. Bass, 12 in. unit. Flux density, L.F. gap, 10,000 gauss. Treble unit, pressure type. Flux density, H.F. gap, 15,000 gauss. Speech coils fed through crossover network, crossing at 1,700 c.p.s. Power capacity, 15 watts. Price £68 5s.

\* \* \*

**Rogers.** Corner Horn. (*Photo page 94*). Vertically mounted 8-in. unit rear-loaded with folded horn, uses walls as final section. Conical reflector on axis gives 360 deg. H.F. distribution. Sound striking corner increases effective source area. Price, as illustrated and with Axiom 102, £32 5s. 2d. Rogers Developments (Electronics) Co. Ltd., 116 Blackheath Road, London, S.E.10.

**Sound Sales.** “Phase Inverter.” (*Photo page 94*). Incorporates Sound Sales “Dual Suspension 12” unit in “Phase Inverter” cabinet. Drive unit F.d. 10,600 gauss. Gap flux 95,000 Maxwells. V.c.i. 15 ohms. Price complete £16 10s. Unit, £9 13s. 4d.

**Sound Sales.** “Tri-Channel” Speaker. (*Photo page 92*). Incorporates units for bass, middle and treble frequencies, driven by their respective amplifiers. Refer to amplifier section and photo on page 74. Sound Sales Ltd., West Street, Farnham, Surrey, England.

\* \* \*

**Tannoy.** “Autograph.” (*Photo page 94*). Forward facing 15-in. dual concentric, horn-loaded front and rear in cabinet of ample dimensions gives efficiency well above average. Effective source area varies with frequency giving excellent balance between extreme requirements. H.F. source at correct height and distribution even. Price £150 3s.

**Tannoy.** “G.R.F.” Slightly smaller version of “Autograph,” with same unit and very similar performance in all respects. Price £116 10s.

**Tannoy.** “York.” (*Photo page 96*). Forward facing 15-in. concentric, in corner-mounted well-damped reflex. Price £71 8s.

**Tannoy.** “Landsdown.” (*Photo page 96*). Forward facing 12-in. concentric, in wall-mounted damped reflex. Price £68 5s. Tannoy Products Limited, West Norwood, London, S.E.77.

\* \* \*

**Vitavox.** “Klipschorn” Reproducer. Folded corner horn using radiator from front only of 15-in. unit. H.F. from dispersive horn with S2 pressure unit, via 500 c.p.s. crossover. Price (with crossover) £145; without £135. Vitavox Ltd., Westmoreland Road, London, N.W.9.

\* \* \*

**Wharfedale.** 3-speaker system. (*Photo page 96*). Forward facing 15-in. unit in sand-filled panel fitting corner provides large reflex enclosure. Top assembly houses horizontally mounted 8-in. and 3-in. units fed from 800 c.p.s. and 5,000 c.p.s. crossovers and level controls. Reflection from walls and ceiling gives excellent distribution and very wide effective source. Extreme bass very good. Drive units W15/CS. Super 8 C/S, Super 3. Price £73 10s.

**Wharfedale.** Super 3 omni-directional cabinet (*photo page 96*) for Super 3 Tweeter unit. Includes volume control. Price £5 (+ P.T.).

**Wharfedale.** Bronze Reflex cabinet. 10-in. unit in reflex cabinet with internal slotted wood acoustic resistance. Output down to 35 c.p.s. without appreciable harmonic content despite small size. Cabinet can be turned round to obtain wall reflection. Drive unit (as tested) 10-in. Bronze C.S.B. Price without unit £14. Wharfedale Wireless Works Ltd., Idle, Bradford, Yorks.

#### Electrostatic Speakers

**Leak Loudspeaker System.** Forward-facing 15-in. moving coil unit, possessing novel feature (as yet undisclosed), designed to avoid cone break-up and consequent irregularities in frequency response. Convex push/pull electrostatic unit (*photo page 100*) (1,500 c.p.s. crossover) provides excellent H.F. distribution with virtually zero distortion. Rear radiator from electrostatic unit reflects from wall to give wide sound source, whilst direct radiation preserves accurate location of source. Price: L.F. unit £18 18s.; H.F. unit in cabinet, with polarising unit and filter, £18 18s. H.J. Leak and Co. Ltd., 57 Brunell Road, London, W.3.

\* \* \*

**Acoustical Constant Charge Loudspeaker.\*** (*Photo page 104*). Direct radiating full frequency range electrostatic doublet. Moving element  $7 \times 10^{-4}$  grams per square centimetre. Being of constant-charge-per-unit-area type, it is distortionless. Distribution is figure of eight, practically independent of frequency. Designed to operate with standard Quad amplifier or equivalent. No bass lift needed. Price, complete with polarising and matching units, £35—£40. Acoustical Manufacturing Co. Ltd., Huntingdon, Hunts.

\*As this is the first full frequency range speaker of this type to be demonstrated, the following notes will be of interest.

It is a velocity device, as opposed to all previous successful moving coil speakers, which are operated as pressure devices; hence its figure-of-eight or cosine distribution. One advantage of this is that it can only produce one-third of the possible standing waves in a room, i.e., only along its axis. Room colouration is still further reduced, as a much smaller area of wall and ceiling receives sound direct from the loudspeaker. Results are thus less dependent

on speaker and listener positions. Operation with constant-charge-per-unit-area gives zero distortion up to the point of overload, determined by ionisation of the air. The frequency response is perfectly flat, and no resonances can occur within the working range since there are neither cabinets nor pockets in which there can be stored energy. As there is no separate tweeter or woofer, position of source does not vary with frequency, and there is no maximum phase shift in a complex waveform cannot exceed 90 deg., i.e., radiation is completely homogeneous. With decorative protecting grille it is approximately 33 in. by 25 in. by 3 in. with slightly deeper base housing the E.H.T. supply, etc. Mains consumption is approximately 6 watts and sensitivity is within 3 db of normal good loudspeaker systems.

#### Speaker Drive Units

**Acoustical**—see complete loudspeaker section.  
**Duode Sound Reproducers**, 3 Newman Yard, London, W.1.

12 B/C—12 in. with duode drive. Flux density, 13,500 gauss. Voice coil  $1\frac{1}{2}$  in. Impedance 15 ohms (8 ohms optional). Peak input 15 watts. Price £15.

12 C—Same, except flux density 16,500 gauss. Price £20.

\* \* \*

**The General Electric Co. Ltd.**, Kingsway, London, W.C.2. (*Photo page 100*).

*Metal cone speaker* (B.C.S. 1851). 8-in. diameter with damped drive. Flux density, 13,500 gauss. Voice coil 1 in. on aluminium tube. Continuous rating, 6 watts. Impedance, 4 ohms. Price £6 13s. 7d. (+ P.T.).

*Co-axial H.F. "Presence" unit* for the above (fed through 10 Mfd. condenser), impedance 15 ohms. Price on application.

\* \* \*

**Goodmans Industries Limited**, Axiom Works, Wembley, Middlesex. (*Photo page 98*).

*Axiom 80*.  $9\frac{1}{2}$  in. diameter, with twin exponential cones and cantilever suspension. Flux density 17,000 gauss, total flux 62,600 Maxwells. Voice coil 1 in. Peak input  $4\frac{1}{6}$  watts. Impedance 15 ohms. Price £17 10s. (+ P.T.).

*Axiom 102*. 8-in. single hyperbolic cone. Flux density 16,000 gauss. Total flux 63,000 Maxwells. Voice coil 1 in. Impedance 3 ohms and 15 ohms. Peak input 7 watts. Price £7 10s. (+ P.T.).

*Axiom 150 Mk. II*. 12-in. twin curved cone. Flux density 14,000 gauss. Voice

coil  $1\frac{3}{4}$  in. Impedance 15 ohms. Peak input 15 watts. Price £10 15s. 9d.

*Axiom 22 Mk. II.* Similar but high flux, 17,500 gauss. Total flux 195,000 Maxwells. Peak input 20 watts.

\* \* \*

**Thermionic Products** (Kelly Acoustics), Hythe, Southampton. (Photo page 104).

*R.L.S.1.* Horn-loaded H.F. ribbon for use with 3,000 c.p.s. crossover. Impedance 15 ohms or 3 ohms. Price 12 gns.

\* \* \*

**H. J. Leak**—see complete loudspeaker section.

**Lowther**—see complete loudspeaker section.

\* \* \*

**The Plessey Company Ltd.**, Vicarage Lane, Ilford, Essex, England. (Photo pages 100/104).

*15-in. Dual Concentric.* 15-in. bass cone velour surround. H.F. unit 6 in. by 4 in. elliptical. Built-in crossover unit (approximately 2,000 c.p.s.).

*12-in. Dual Concentric.* 12-in. bass cone. H.F. unit 6 in. by 4 in. elliptical. Built-in crossover unit (approximately 2,000 c.p.s.).

*6 in. by 4 in. H.F. Tweeter.* High flux density. Aluminium voice coil.

*Ionophone Type D.15 Tweeter.* Incorporates built-in R.F. oscillator. No moving parts involved. High voltage at R.F. is applied to an electrode in a specially shaped quartz tube. The air in the tube is thus ionised. The resultant ionisation is then modulated by the audio output from the amplifier.

\* \* \*

**Tannoy Products, Limited**, West Norwood, London, S.E.27.

*15-in. Dual-concentric.* 15-in. paper cone, with series gap concentric pressure drive unit using hollow centre pole and paper cone as horn. Voice coils 2 in. L.F. gap 12,000 gauss, H.F. gap 18,000 gauss. Crossover 1,000 c.p.s. Impedance 15 ohms. Power handling 25 watts. Price with crossover £35 12s.

*12-in. Dual concentric.* 12-in. paper cone, with series gap concentric pressure drive unit using hollow centre pole and paper cone as horn. Voice coils 2 in. L.F. gap 10,000 gauss, H.F. gap 15,000 gauss. Crossover 1,700 c.p.s. Impedance 18 ohms. Power handling 15 watts. Price with crossover £29 5s.

\* \* \*

**Whiteley Electrical Radio Co. Ltd.**, Mansfield, Notts. (Photo pages 102/4).

*W.B. Stentorian.* 12-in. concentric-duplex. 12-in. cambric cone with series gap concentric pressure drive, using hollow centre pole and short horn. Voice coils  $1\frac{1}{2}$  in. L.F. gap 14,000 gauss., H.F. gap 17,000 gauss. Crossover 3,000 c.p.s. Impedance 15 ohms. Power handling 15 watts. Price £25.

*10-in. concentric-duplex.* 12-in. cambric cone with series gap concentric pressure drive using hollow centre pole and short horn. L.F. gap 12,000 gauss, H.F. gap 13,000 gauss. Crossover 3,000 c.p.s. Impedance 15 ohms. Power handling 7 watts. Price 10 gns.

*Model H.F. 1012.* 10-in. cambric cone. Flux density 12,000 gauss. Handling capacity 10 watts. Impedance—universal impedance speech coil, 3-7, 5-15 ohms. (7.5 ohms only uses half speech coil). Price £4 17s. 6d.

*T.12 Tweeters.* Pressure type H.F. units with short plastic horns. Flux density 16,000 gauss. Handling capacity 15 watts above 3 Kc/s. Crossover 3 Kc/s. Impedance 15 ohms. Price 12 gns.

*T.10 Tweeters.* Pressure type H.F. unit with short plastic horns. Flux density 14,000 gauss. Handling capacity 5 watts above 2 Kc/s. Crossover 3 Kc/s. Impedance 15 ohms. Price 4 gns.

\* \* \*

**Technical Supplies Ltd.**, Hudson House, 63 Goldhawk Road, London, W.12. (Photo page 100).

*TSL Lorenz L.P.H. 312/2.* A triple-unit speaker, with 2 treble units bridge-mounted across the face of the main bass unit. 12-in. bass unit. 2 $\frac{1}{2}$ -in. treble units. Voice coil diameters, bass  $1\frac{1}{2}$  in., treble  $\frac{1}{2}$  in. flux densities, bass unit 17,500 gauss., treble units 17,500 crossover frequency, 2,000 cycles. Price £14 19s. 6d.

*TSL Lorenz Tweeter Type L.P.H.65.* Suggested cross-over 2,000 c.p.s. V.c.i. 5.5 ohms. Frequency range 1,600—20,000 c.p.s. Voice coil diameter  $\frac{1}{2}$  in. F.D. 17,500 gauss. Price £1 19s. 6d.

\* \* \*

**Vitavox Ltd.**, Westmoreland Road, London, N.W.9.

*Type C.N. 157* dispersive H.F. horn. Wide angle dispersive horn for use with S.2 pressure unit. Voice coil 3 in. Total flux 150,000 Maxwells. Horn cutoff 300 c.p.s. Crossover 1,000 c.p.s. Power handling 10 watts above 200 c.p.s. Impedance 15 ohms. Price (horn and drive) £16 + £35 = £51.

**Wharfedale Wireless Works Ltd.,** Idle, Bradford, Yorks.

*Super 3.* 3-in. paper cone type with aluminium dome speech coil, centre pole 1 in. Flux density 13,000 gauss. Crossover 3,000 c.p.s. Max. input 5/6 watts above 1,000 c.p.s. Impedance 2/3 ohms and 8/10 ohms. Price £5 (+ P.T.).

*Super 8/CS.* 8-in. cloth surround paper cone type, centre pole 1 in. Flux density 13,000 gauss. Max. input 4 watts for use as middle in treble speaker. Impedance 12/15 ohms. Price £5 (+ P.T.).

*10-in. Bronze/CS.B.* 10-in. cloth surround with hardened cone centre., centre pole 1 in. Flux density 10,000 gauss. Max. input 5 watts. Impedance 2/3 ohms and 12/15 ohms. Price £3 19s. 6d. (+ P.T.).

*Super 12 C.S./A.L.* 12-in. cloth surround and aluminium voice coil and hardened cone apex. Centre pole 1 3/4 in. Flux density 17,000 gauss. Impedance 12/15 ohms. Price £17 10s.

*W.15/CS.* 15-in. cloth surround ideal for bass speaker. Centre pole 2 in. Flux density 13,500 gauss. Response range 25-2,000 c.p.s. Impedance 12/15 ohms. Peak input 15 watts. Price £17 10s.

#### Acoustic Resistance Units

**Goodmans Industries Ltd.,** Wembley. (Photo page 98).

172 A.R.U. tested with Axiom 150 Mk. II in correct cabinet. Very little overall colouration, response extraordinarily smooth down to 35/40 c.p.s.

#### Crossovers and Filters

**Wharfedale Wireless Works Ltd.** Also, most speaker manufacturers make crossover circuits for their own products.

It is possible to feed the H.F. unit of a multi-speaker assembly via a condenser, usually 4 M.F.-8 M.F. (for 15 ohm types). This adds the extra top without cutting that from the main speaker. This is satisfactory if the main speaker has a smooth top response (or none at all). It does, however, reduce the total load on the amplifier at high frequencies. For domestic use this is immaterial, since the full power of the amplifier will never be needed, and the distortion it may introduce will be completely undetectable. For balance, the H.F. unit may be operated by filtering a 50 ohms potentiometer between the condenser and the speaker.

Davey variable steep-cutting filter. Useful filter for playing certain old 78 r.p.m. records through modern equipment. The cut is 30 db/octave and can be varied between 4,000 c.p.s. and 8,000 c.p.s. and switch is fitted to cut it completely out of circuit. Intended for use between amplifier and speaker (15 ohms). Price £4 10s.

#### Constructional Details for Enclosures

**G.E.C.** Octagonal reflex cabinet with hanging sound absorption designed primarily for one or two metal cone speaker units. Usable with any 8-in. unit.

**Goodmans Industries Ltd.** Enclosures for one, two and four Axiom 80 units, including a bass horn-loaded type. Enclosures for Axiom 22 and 150. (The above are friction loaded cabinets with A.R.U.) Reflex enclosures for Axiom 101 and 102. Both rectangular and corner fitting types are available.

**W.B.** Reflex cabinets for various models. They also make a "ready to assemble" cabinet.

**Wharfedale.** Rectangular reflex cabinet for 8 in., 10 in. and 12 in. units. Flat sand-filled corner panels for 8 in., 10 in. and 12 in. units. Nine cubic feet sand-filled corner reflex for 15-in. unit. Nine cubic feet brick corner reflex for 15-in. units. Top unit for the 3-speaker system.

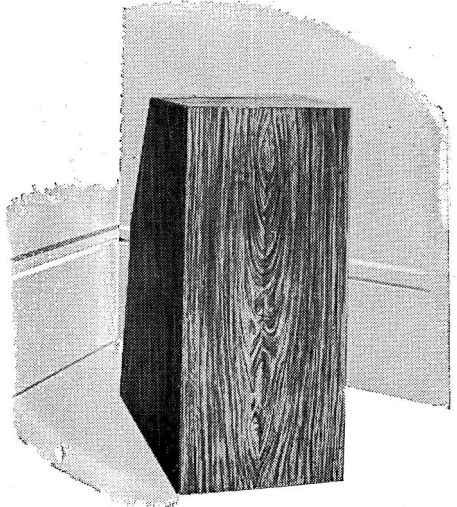

*A corner reflector speaker by E.M.G.*

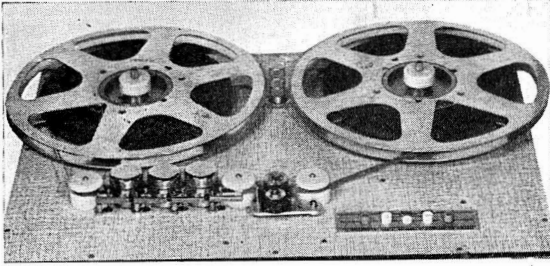

Above : *Bradmatic tape deck. Model 50*

Right : *Two photos of Bradmatic sound heads*

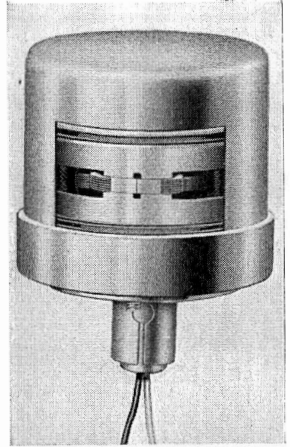
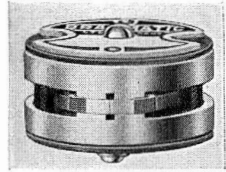

Above : *BTR/2 tape recorder by E.M.I., for studio work. Two speeds.*



Right : *TR/50 tape recorder, also by E.M.I., for professional work. Two speeds*

# MAGNETIC RECORDING

By G. F. Dutton

ONLY a few years after Edison had introduced the mechanical phonograph, Valdemar Poulsen published his invention of the Telephonograph in Copenhagen in 1899. Poulsen described the use of a magnetisable body as a new kind of phonograph record and developed it for use with the telephone for recording messages. In the words of his patent specification :

“ The invention is based on the fact that, when a body made of a magnetisable material is touched at different points and at different times by an electro-magnet included in an electric circuit, which carries electric currents varying in accordance with the vibrations of sound, its parts are subjected to such varied magnetic influences that, conversely by the action of the magnetisable body upon the electro-magnet, the same sounds are subsequently given out in the telephone (or loud-speaker) as those which originally caused the magnetic action upon the magnetisable body.”

## Early Methods

In one form of his invention Poulsen used steel tape or wire, which pressed against the poles of the electro-magnet as it moved from one drum to another. In another form he used a strip or sheet of material, such as paper, covered with a magnetisable metallic dust ; and he further described the use of a disc of magnetisable material over which the electro-magnet might be guided spirally, in a similar fashion to one form of dictation machine now in use in this country. Poulsen also explained that the recording could be wiped off the magnetisable body by passing a steady current through the electro-magnet, so that the tape, wire, or disc, could be used over and over again.

Owing to the rather feeble signals obtainable from these magnetic recordings, further exploitation of the invention had to await the development of the electronic valve amplifier. In 1921, Carlson and Carpenter in America showed that the intensity of the recorded signals could be increased, and

the distortion reduced, by applying a high frequency bias current along with the signal currents. In 1929, Pfeumer in Germany, developed a homogeneous magnetic tape in which iron powder was mixed with an organic binding medium. The Poulsen invention was further developed by Blattner and independently by Stille. The Marconi-Stille steel tape recorder was used for recording broadcast programmes in this country and in Australia. The steel tape was operated at a speed of 50 in./sec. and was wound on 2-ft. diameter spools.

## Plastic Tapes

Just before World War II, the Germans had developed the plastic based tape for use with recording heads operating with the dC bias system. In 1940, Braunmühl and Weber of Berlin re-introduced the high frequency bias system. This system showed great superiority of signal/noise ratio compared with the use of dC bias. This high frequency bias system spread rapidly in Germany and was used by most of their broadcasting stations during the war. During the war the Germans also developed a cellulose/acetate film coated with ferric oxide powder.

Next to be developed was the L type tape, which was a mixture of polyvinyl chloride and ferric oxide. This mixture after being rolled to form a continuous sheet was stretched or tensilised to produce a film 0.0025 in. thick. This film was very stable mechanically but owing to the low proportion of magnetic oxide, 35 per cent., the high frequency response and the sensitivity were low. This homogeneous tape was followed by a tape composed of a strong tensilised P.V.C. base film coated with a dense mixture of oxide with a small amount of binder.

In this country, E.M.I. Limited produced coated cellulose/acetate based tapes early in 1947. They were in quantity production by the end of that year. All these early tapes, including the German-produced, were made with low coercivity magnetic oxide ; and in





*Portable battery-operated tape recorder Type L/2 by E.M.I., as used by the B.B.C. Single speed*

*E.M.I. tape player Type 3031 for replays of half or full-track tape records*

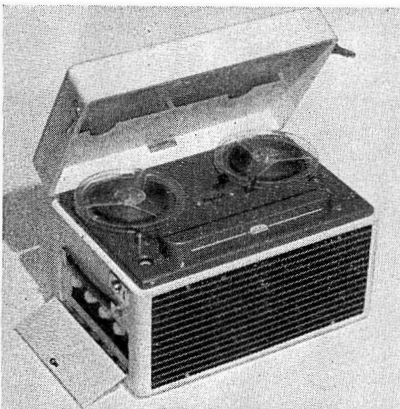

*Simon Sound tape recorder Type SP 2. Two speeds*

order to obtain a reasonable response at 12 Kc/s. the tape had to be operated at a speed of 30 in./sec. These low coercivity tapes were quickly followed by high coercivity tapes, which increased the performance of the tape recorder to such an extent that the tape speed could be reduced from 30 in./sec. to 15 in./sec., and at the same time the frequency range was increased up to 15 Kc/s.

Using modern drive systems and improved magnetic heads, the magnetic steel wire 0.004 in. diameter still finds employment in small portable dictating machines. The steel wire is very economical in storage space but it requires very careful handling. It is not used for high quality recording because of its poor signal/noise ratio and because of the unsteadiness of the wire speed.

#### Standard Speeds

Fortunately the various standardising authorities got to work soon after the war, and established standards for tape speeds and the essential dimensions of the tape and tape spools. A British Standards Institution document 1568 was issued in 1949, and was followed by a revision in 1953. This document set out the dimensions of the tape, which follow closely those adopted by the German plastic tape as follows:

Width ... 0.250 in. + 0 in. — 0.006 in.

Thickness 0.0023 in. maximum

For domestic and commercial recording the nominal tape speeds were standardised at 15 in./sec., 7.5 in./sec., 3.75 in./sec. and 1.875 in./sec.

#### Reproducing Characteristics

An Amendment No. 1, July 1954, was issued, and this deals with the reproducing characteristics for tape speeds of 30 in./sec., 15 in./sec. and 7½ in./sec. It accepts the standards adopted by the Comite Consultatif International des Radiocommunications (C.C.I.R.). After allowing for the replay head losses, the replay amplifier is given a certain pre-emphasis which is the same for a tape speed of 15 in./sec. This pre-emphasis is defined as a response curve which falls with increasing frequency in conformity with the impedance of a series combination of a capacitance and a resistance having a time constant of 35 micro-seconds. For a tape speed of 7½ in./sec., the time constant is 100 micro-seconds.

For broadcasting, the primary speed is 15 in./sec., while 30 in./sec. and 7½ in./sec. are considered to be secondary speeds. In the gramophone industry the primary speed for master tape recording has been 30 in./sec.,

but the technique of tape manufacture and of magnetic head design might develop to such an extent that a tape speed of 15 in./sec. is likely to be the primary speed for this class of work in the near future.

The International Electro-Technical Commission (I.E.C.) is responsible for drawing up international standards in the commercial and domestic tape fields. In September, 1955, this organisation adopted the C.C.I.R. replay characteristic recommendations and introduced more detailed standardisation of spools, track dimensions, etc. This I.E.C. standard has not yet been published. While these international standards are being negotiated, the broadcasting organisations in America are using a slightly different reproducing characteristic to that recommended by C.C.I.R. The American NARTB characteristic for 15 in./sec. and 7½ in./sec. shows a pre-emphasis of 50 micro-seconds at the high frequency end, and 3,180 micro-seconds in the low frequencies. It is hoped that the Americans will fall into line with I.E.C. standards as agreed at the Philadelphia Conference.

#### Improved Materials

No reference is made to standard frequency response tapes in the above mentioned documents. Nevertheless it is normal practice in tape machine testing to use standard frequency tapes which have been made and calibrated with reference to the standard replay chain characteristic. These tapes will be on sale for use in the domestic as well as the professional markets.

The early tapes made on cellulose/acetate base film are liable to twist and curl when subjected to humidity changes. Certain difficulties were also encountered, due to varying amounts of solvent retention in the cast acetate base. The great advantage of this base was its uniformity of thickness. Cellulose films, having a higher acetal value, are more stable in face of humidity changes but are not sufficiently flexible. The tensilised PVC base films are supple and absolutely unaffected by humidity changes. Polyester base films are quite stable against humidity change, are very strong and are extremely uniform in thickness and surface texture. The main drawback at the moment is the high price.

Plastic magnetic tapes can be obtained in two main thicknesses: 0.002 in. and 0.001 in. The latter is usually termed thin base tape and a 7-in. spool will carry 1,800 ft. compared with 1,200 ft. with the thicker base. The

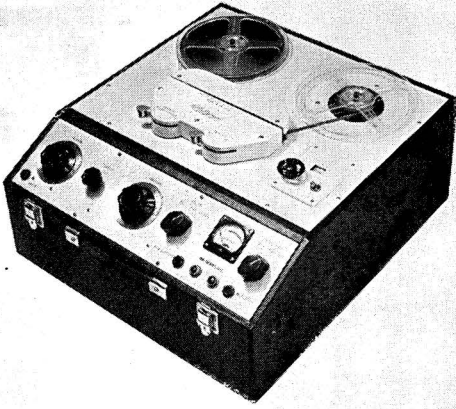

Above : "Reflectograph" Series 100 portable recorder with variable tape speed



Right : Rudman Darlington twin-channel "Reflectograph" recorder for professional use

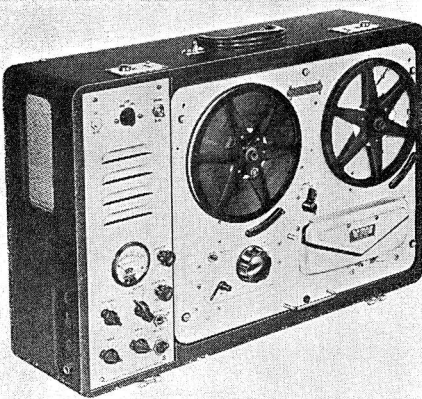

Vortexion, mains-operated portable tape recorder, Wright and Weaire deck  
Two speeds

comparative strength of the film bases is set out below.

In order to obtain a uniform response and a low background noise, the magnetic oxide has to be made extremely pure, uniform in particle size, and must be well dispersed in the binding medium. The surface of the coating must be extremely smooth and the film must be supple and flat, so as to make intimate contact with the pole faces of the record and replay magnetic heads. The high frequency response depends to a large extent on getting a very intimate contact with the head gap. On the other hand, tape which is smooth on both sides does not spool as well as tape which is slightly roughened.

#### Unwanted Printing

Paper base tape has been used from time to time, but it is unsuitable for high quality recording since the grain structure of the paper causes the coating surface to be rough, and thus produces a high modulation noise and prevents good contact between the oxide and the head gap, with a consequent loss of frequency response.

The magnetic properties of the oxide at low induction fields must be carefully controlled so that it is not sensitive to spurious printing of signals from one layer to the next during storage life. With modern high coercivity tapes this print is less than 55 db below the signal after three days' contact. The ratio of the print to the signal depends on the spread of the signal field, the closeness of contact between the magnetic layers and the time interval between removal from contact (i.e., un-winding) and the replay. High temperature during storage tends to increase print, and it is therefore advisable to store tapes in reasonably cool conditions. During recent tests the print difference obtained from thick and from thin base tapes was less than 1 db, but this depended on the type of oxide used. Normally the difference can be considered to be negligible.

The Polyester and P.V.C. film bases readily became electrified when spooling, and a suitable anti-static treatment of the coating has been developed in order to render it non-static. This is now in production.

In this country the production of tape is approximately 750 million feet per year and it is estimated that the production figure in the U.S.A. is about five times this figure.

In the process of magnetic recording the magnetisation of the oxide coating is along the length of the tape and the magnetic field is produced by the fringing field of the air gap in the magnetic head. The performance of the head in the high frequency region will depend not so much on the width of the gap but more on the uniformity and sharpness of the trailing edges of the pole face in the gap. During reproduction the high frequency scanning loss will be appreciable if the width of the gap is comparable with the quarter wave length of the signal on the tape. At a tape speed of  $7\frac{1}{2}$  in./sec. the quarter wave length of a 10 Kc/s. signal is  $0.19 \times 10^{-3}$  in. The air gap length should therefore be less than  $0.15 \times 10^{-3}$  in.

#### Gap Settings

It often happens, due to a roundness of the pole edges at the gap that the effective gap is considerably greater than the apparent gap. Obviously the azimuth adjustment of the record and replay gaps must be set very exactly, and it is best to carry this out with the aid of a standard recording of, say, 8 Kc/s. made on a specially adjusted head. With frequencies of short wave length, such as  $0.2 \times 10^{-3}$  in. on the tape, the contribution of the recorded field from the magnetic particles situated further than, say,  $0.4 \times 10^{-3}$  in. from the gap, is almost negligible and therefore no advantage is to be gained by increasing the thickness of the oxide beyond this. In fact, while the low frequency response will increase with coating thickness the high frequency response will tend to fall.

The dynamic range of magnetic recording is usually defined as the ratio of the level which produces a 2 per cent. total harmonic distortion of a 1 Kc/s. signal on the tape, to the noise level of the background of the tape without signal, but with the correct bias flowing in the record head. The ratio is expressed in db and it is desirable to measure the noise through a 40 phon aural weighting network. It is very important that the bias

	<i>Paper Base</i>	<i>Cellulose</i>	<i>P.V.C.</i>		<i>Mylar</i>
Thickness Base ... ..	0.0015	0.0016	0.0016	0.001 in.	0.001 in.
Coating ... ..	0.0005	0.0005	0.0005	0.0005	0.0005
Tensile Strength ... ..	5.9 lbs.	5.25 lbs.	8 lbs.	5½ lbs.	6½ lbs.
Elongation at Break ... ..	—	20%	54%	52%	120%
Elongation at ½-lb. load ... ..	—	0.22%	0.22%	0.30%	—
Yield Point ... ..	—	4.75 lbs.	4.2 lbs.	2.75 lbs.	4.00 lbs.
Elongation at Yield Point ... ..	—	—	6.0%	4.8%	6.0%

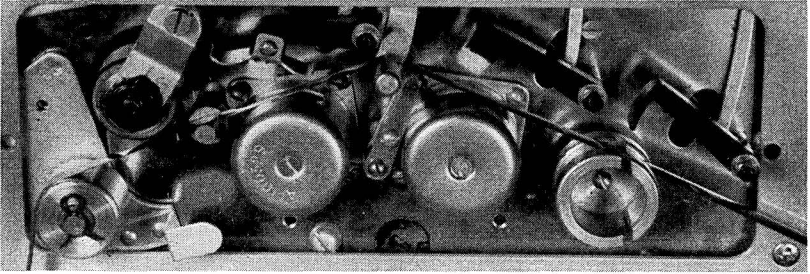

*Close-up view of sound heads and capstan arrangement, as part of standard Wright and Weaire deck used on "Ferrograph," Vortexion and other recorders*

*The "Bib" tape splicer, made by Multicore, which is recommended to all owners of tape recorders*

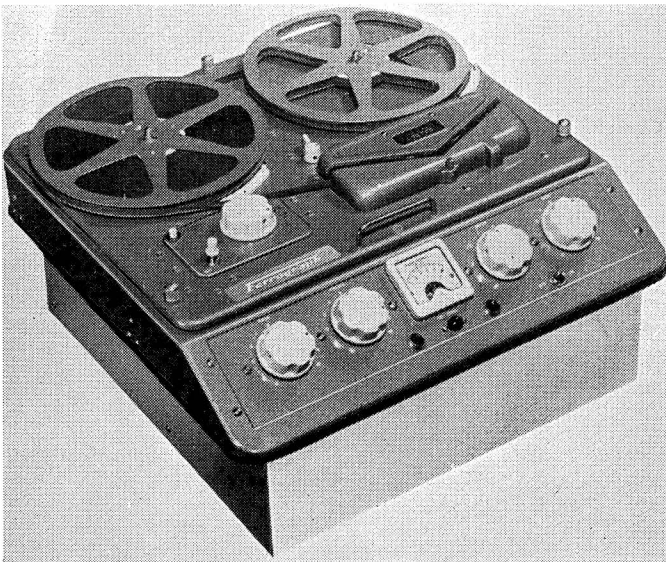
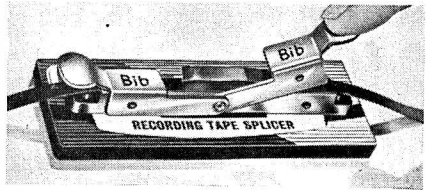

*Ferrograph 66 H tape recorder with Wright and Weaire deck, as above*

current should be free (less than 0.1 per cent.) from the even harmonics, otherwise the effect will be similar to a slight permanent magnetisation of the head. To get the best results the bias is adjusted as follows :

Apply a 1 Kc/s. signal to the record head then increase the bias until the signal on replay (monitor) reaches maximum. Continue to increase the bias curve until the signal falls by 2 db. This amount of bias is termed - 2 db overbias, and it is found to give the most satisfactory dynamic range and low modulation noise. In these conditions the dynamic range with good tapes is better than 65 db. The frequency of the bias current is not important, but it should be well above the maximum recorded signal and should be high enough to subject the magnetic particles to at least ten complete reversal cycles during its passage over the record head gap. A frequency of 80 to 100 Kc/s. is considered adequate for high quality recording. For a given tape and a given head the bias should remain constant but may want slight adjustment as the head wears.

The professional machine will require a great number of facilities, such as accurate tape timing mechanism, accommodation for large size spools, two-speed operation, facilities for routine testing of the electrical circuits, etc. These extra facilities tend to increase the weight of the apparatus and from a private individual's point of view, the weight factor is rather an important one since he may want to transport his mechanism in a private car for recording music festivals, etc.

The quality obtainable for a tape speed of  $7\frac{1}{2}$  in./sec. should be adequate for the most discerning enthusiast, and the relative performance of the professional and good quality semi-professional machines is almost negligible regarding the essential features.

#### Drive Mechanisms

There are a great variety of tape recording and reproducing machines on the market. Fortunately the early standardising of tape spools has allowed a considerable freedom of interchange of tape recordings. Nearly all machines use the pressure roller and capstan method of tape drive. When this system is correctly designed, the wow and flutter can be reduced to a negligible amount. Some machines drive the capstan direct by a flexible coupling from the motor shaft, and for this purpose it is necessary to use a small diameter capstan. Other designers prefer to use large diameter capstans and take the drive through the capstan shaft by a speed step down

belt drive. In this case the quality of the belt must be extremely uniform in order to avoid wow and flutter. The professional tape machines use synchronous hysteresis motors for the tape drive, while excellent results can be obtained with induction motors. To avoid the possibility of spurious tape magnetisation the capstan spindle and the tape guides should be made of non-magnetic stainless steel or hard chromium-plated bronze.

#### Studio Machines

The Studio tape machines are usually supplied with three motors, one synchronous motor to operate the tape drive and two motors to operate the spools. In portable machines economy of weight is attained by making the synchronous tape motor operate the spooling. For this purpose, resort has to be made to slipping felt clutches. If these are well made and correctly lubricated there is very little trouble from judder.

Space does not allow detailed description of the many interesting recording professional machines, but it might be worth while drawing attention to two extremes in tape recorder design which have been carrying out hard work in the professional field of gramophone record making and broadcasting for several years. I refer to the E.M.I. L2 battery operated tape recorder, which is illustrated on page 112. This model, including all batteries, weighs  $14\frac{1}{2}$  lbs. and can be slung from a strap over the shoulder of the operator and carried about during operation. The playing time for the 15 in./sec. model is  $7\frac{1}{2}$  minutes. For the  $7\frac{1}{2}$  in./sec. model 15 minutes, and for the  $3\frac{3}{4}$  in./sec. model 30 minutes. The tape drive is supplied by miniature centrifugal switch governed motor operating at 12 volts from either dry batteries or re-chargeable silver zinc storage batteries. Frequency response for the 15 in./sec. model is up to 10 Kc/s. At the other end of the scale, the E.M.I. BTR/II is a Studio machine weighing about 200 lbs. and fitted with all the accessories and adjustments that are required for a Studio tape machine. This machine is illustrated on page 110.

It is hoped that manufacturers of tape playing equipment will offer unit components for sale so that the purchaser interested in first-class quality reproduction can build up his installation by stages depending on the money available. If he starts in a modest way he should buy a good tape mechanism and he should choose this mechanism with an eye to his ultimate requirements. If the aim is to have a Stereo reproducer then this tape

machine should be capable of Stereo operation as well as single channel, or it should be capable of being easily modified to perform this function by the addition of a special replay head. To spend a lot of money on a single channel tape player when Stereo offers so much for the future, is hardly a wise investment. There is no need to purchase all the Stereo equipment at one time. After having chosen a suitable mechanism the choice of the amplifier and loudspeaker should be made with a view to doubling up on this when the time comes to operate on Stereo. Buy a good amplifier and good loudspeakers of such a size that two can be accommodated in the music room. There need be no fear regarding the single channel tape records. They will still sound good even when compared with the added interest of the Stereo records.

Tape Records (sometimes called pre-recorded tapes) intended to operate at a tape speed of  $7\frac{1}{2}$  in./sec., have been in quantity production for close on two years and a fair repertoire has been formed. The frequency range on these tapes extends uniformly up to 10 Kc/s., and there is an appreciable response well above this. The tape machines to play these records were at first rather expensive but there are signs of simpler and less expensive models being available soon. These tape records are made on a standard  $\frac{1}{4}$ -in. wide tape, but are recorded with two

tracks each 0.110 in. wide and separated by a non-recorded track 0.030 in. wide between them. The first track is recorded from left to right, while the other is recorded in the reverse direction. This arrangement allows the tape to be played in either direction and continuity of playing can be obtained by simply reversing the motor drive and switching the replay amplifier from the head operating from the top track to that on the bottom track. The cleanliness of the reproduction and the uniformity of quality throughout the length of the tape amply rewards the listener for the little extra trouble he is put to in threading up the tapes on the machine, compared with putting a disc on a normal gramophone.

Tape Records are produced by the simple process of copying or re-recording direct from a 15 in./sec. master tape. One master tape can be arranged to serve any number of slaves operating at a tape speed of  $7\frac{1}{2}$  in./sec.

Last year Stereosonic twin-channel tape records were introduced on the market and the repertoire is rapidly growing. These tapes are made to the same track dimensions as the single-channel dual track records mentioned above. It is therefore possible to design a replay machine that will operate either single channel tapes, or, by suitably switching head connections, Stereosonic Tapes.

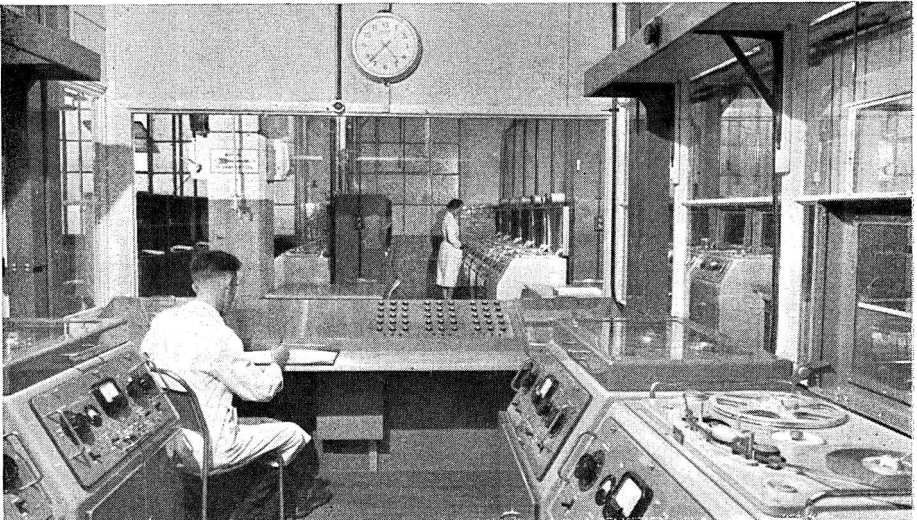

*Illustration shows part of the Tape Record Production Department at the H.M.V. Factories. If production rate demands, the speed of the master and that of the slaves can be doubled without loss of quality.*

# DIRECTORY OF TAPE RECORDERS

**Important note :** These instruments are of the highest quality. Their frequency response is not less than : (15 in. p.s.) 50-15,000 c.p.s.  $\pm 3$  db ; ( $7\frac{1}{2}$  in. p.s.) 60-10,000 c.p.s.  $\pm 3$  db ; ( $3\frac{3}{4}$  in. p.s.) 70-6,000 c.p.s.  $\pm 3$  db unless noted. Readers are invited to write to the makers for full details. Abbreviations used : Prof. (professional use) ; G.P. (general purpose) ; Tr. (No. of tracks) ; Mtrs. (No. of motors) ; Op. (output power). Power is required from A.C. mains 200/250v at 50 c.p.s.

\* \* \*

**Bradmatic Ltd.**, Station Road, Aston, Birmingham 6. (*Photos page 110.*)

*Tape deck 5B.* Speeds  $7\frac{1}{2}$  in. ;  $3\frac{3}{4}$  in. Tr. 2. Fast fwd. and rwd. Mtrs. 3. 6RP heads. 7 in. reels (1,200 ft.). Price £42.

*Tape deck 5CS.* The same, but  $9\frac{3}{8}$  in. reels (2,250 ft.). Price £45 10s.

*Tape deck 5D.* The same, but  $10\frac{1}{2}$  in. reels (2,400 ft.). Price £50.

*D2 Portable recorder.* With 5B deck as above. Price £117.

*Stereophonic reproducer.* Available shortly. Speed  $7\frac{1}{2}$  in. Response 30-15,000 c.p.s.

*Sound heads.* 5RP (record/play) £3 5s. ; 6RP (super fid. record/play) £3 15s. ; 5R (record) and 5E (erase) £3 5s. ; Stereophonic (record/play) £14 10s.

\* \* \*

**British Ferrograph Recorder Co. Ltd.**, 131 Sloane Street, London, S.W.1. (*Photo page 115.*)

*Ferrograph 66H.* GP. Speeds 15 in. ;  $7\frac{1}{2}$  in. Tr. 2. Fast fwd. and rwd. Mtrs. 3. Op.  $2\frac{1}{2}$  watts. Price £92 8s.

*Ferrograph 66N.* GP. The same, but speeds  $7\frac{1}{2}$  in. ;  $3\frac{3}{4}$  in. Price £88 4s.

\* \* \*

**Collaro Ltd.**, Ripple Works, By-Pass Road, Barkington, Essex, England. (*Photo page 120.*)

*Tape transcriptor.* Preliminary details. Speeds 15 in. ;  $7\frac{1}{2}$  in. ;  $3\frac{3}{4}$  in. Tr. 2. Fitted 4 heads for record/replay either track without removing spools. Mtrs. 2. Price £20

\* \* \*

**E.M.I. Sales & Service Ltd.**, Hayes, Middx., England. (*Photos pages 110/12.*)

*BTR/2a Tape recorder.* Prof. Speeds 15 in. ;  $7\frac{1}{2}$  in. Tr. 2. Fast fwd. and rwd. Mtrs. 3.

*BTR/2b Tape recorder.* As above, with speeds 30 in. ; 15 in.

*TR/50a Tape recorder.* Prof. Speeds 15 in. ;  $7\frac{1}{2}$  in. (responses to 12,000 and 8,000  $\pm 3$  db). Tr. 2. Fast fwd. and rwd. Mtrs. 1.

*TR/50b Tape recorder.* As above, with speeds  $7\frac{1}{2}$  in. ;  $3\frac{3}{4}$  in. (responses to 8,000 and 4,000  $\pm 3$  db).

*L/2 Tape recorder.* Lightweight battery driven portable. Single speed (15 in., or  $7\frac{1}{2}$  in., or  $3\frac{3}{4}$  in.). Responses to 10, 7, or 3 Kc/s.  $\pm 3$  db. All above, prices on application.

*H.M.V. Types 3031 ; 3032 Tape players.* GP. Speeds  $7\frac{1}{2}$  in. Tr. 2. Fast fwd. and rwd. Mtrs. 1.

*H.M.V. Stereosonic reproducer.* GP. Speed  $7\frac{1}{2}$  in. Mtrs. 1. Incl. 2 amplifiers (Op. 10 watts each) and 2 speakers (each 2 units). Prices for both above on application.

\* \* \*

**M.S.S. Recording Co. Ltd.**, Poyle Close, Colnbrook, Bucks, England.

*PMR/2XS Portable recorder.* Prof. Speeds 15 in. ;  $7\frac{1}{2}$  in. Tr. 2.

*LAR/P/2 PA unit* for above, incl. spkr. Op. 10 watts.

*PMR/1CX recorder.* Speeds  $7\frac{1}{2}$  in. ;  $3\frac{3}{4}$  in. Tr. 2. Spkr.

*PMR/3 Portable recorder.* GP. Speeds  $7\frac{1}{2}$  in. ;  $3\frac{3}{4}$  in. Tr. 2. Fast fwd. and rwd. Op. 3 watts.

*PMR/3DE recorder.* GP. Speeds  $7\frac{1}{2}$  in. ;  $3\frac{3}{4}$  in. Tr. 2. Mtrs. 3. Op. 5 watts.

*Tape deck, Type D.* Speeds  $7\frac{1}{2}$  in. ;  $3\frac{3}{4}$  in. Prices of all above on application.

\* \* \*

**Rudman Darlington (Electronics) Ltd.**, Wednesfield, Staffs, England. (*Photos page 114.*)

*Reflectograph RR, Series 100.* Portable recorder. Transistorised playback amplifier. Speed, variable from  $3\frac{3}{4}$  in. to  $8\frac{1}{2}$  in. Tr. 2. Mtrs. 3. Price £105.

*Reflectograph.* Twin Channel Recorder for professional work. Price on application.

*Tape deck T.D.M.* Speed, variable as above. Tr. 2. Fast fwd. and rwd. Mtrs. 3. Price on application.

\* \* \*

**Simon Sound Service Ltd.**, 46-50 George Street, London, W.1. (*Photo page 112.*)

*S.P.2 Portable recorder.* GP. Speeds  $7\frac{1}{2}$  in. ;  $3\frac{3}{4}$  in. Fast fwd. and rwd. Mtrs. 3. Op. 10 watts. Price £78 15s.

\* \* \*

**Specto Ltd.**, Vale Road, Windsor, Berks, England.

*Stereophonic reproducer.* GP. Var. speed. Fast fwd. and rwd. 2 pre-amps and amplifiers. Op. 15 watts.



*Specto tape players, Types 120 and 122.*  
Var. speed. Tr. 2. Fast fwd. and rwd.  
Mtrs. 3. Op. 15 watts. Prices on application.

\* \* \*

**Vortexion Ltd., 257-263 The Broadway, Wimbledon, London, S.W.19.** (Photo page 114.)

*Vortexion Portable recorder* (Wearite deck).  
Speeds  $7\frac{1}{2}$  in. ;  $3\frac{3}{4}$  in. Tr. 2. Fast fwd. and  
rwd. Mtrs. 3. Prices (2a deck) £84 ;

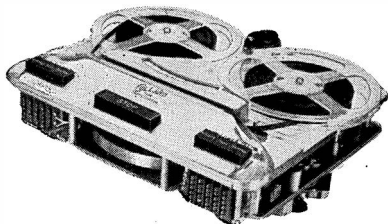

*Collaro "Tape Transcription" deck, with push-button controls and three speeds.*

(B2 deck, with extra head for monitoring while recording, etc.) £99.

*Power supply unit.* For driving the above from 12v car battery. Price £18.

\* \* \*

**Wright & Weaire Ltd., 138 Sloane Street, London, S.W.1.**

*Wearite tape deck, Series 2.* Speeds  $7\frac{1}{2}$  in. ;  $3\frac{3}{4}$  in. Tr. 2. Fast fwd. and rwd. Mtrs. 3. Price on application.

## RECORDING TAPE

**E.M.I. Sales & Service Ltd., Hayes, Middx.**

*"Emitape."* Various grades, on standard spools of all sizes.

\* \* \*

**Minnesota Mining & Manufacturing Corporation Ltd., Arden Road, Adderley Park, Birmingham 8.**

*"Scotch Boy" tape.* Various grades, on standard spools of all sizes.

# HOW TO EDIT TAPES

THE serious user of a tape recorder will need to edit tapes, both for reasons of economy and for the artistic presentation of the recordings he has made. By cutting out unwanted sections of tape, and subsequently joining them together, considerable economies can be effected in the cost of recording tape. Precision joints made with a device similar to the "Bib" Recording Tape Splicer (marketed by Multicore Solders Limited) make certain that the tape so jointed will pass smoothly through the heads of the recorder without jamming.

## Silent Joints

Precision made joints also mean that music or speech subsequently recorded over them will not be affected by clicks, or other unwanted noise, which would otherwise be heard if faulty or joints with gaps were made. Most tape recorders are now of the dual track type. By adopting the following procedure owners can not only save tape costs, but also gain a good deal of extra amusement :—

When recording programmes which may require editing, a tape should be selected which has either nothing or an unwanted programme on the other track. An example of such a recording might be a broadcast programme of operatic arias with a spoken commentary before each item. If it is decided that the commentary might be irksome and that it would occupy valuable tape, the commentary can be cut out and

the unwanted lengths of tape can then be joined together. As the joints are so soundly made this tape can be used for other recordings. The second track of the operatic arias tape can also be used, for recording another programme that will not require editing.

Some makes of recorders, including the "Ferroglyph," are now supplied as standard with the decks ready drilled for mounting the "Bib" Splicer. A razor cutter, which is accommodated in a slot in the base of the splicer is also supplied with the "Bib" model.

## Tape Economy

The user of this ingenious accessory can edit tapes in much the same way as ciné film enthusiasts edit their films, with the added advantage that, unlike pieces of edited film which are subsequently wasted, every length of recording tape so cut out from the main tape can be joined and used again.

The method of using a recording tape splicer similar to that shown on page 116 is simple and precise. The two clamps lock the two ends of tape in position over a diagonal slot. A cut with a razor blade is then made, and after the surplus recording tape on the left-hand side has been removed, a short length of cellulose tape is applied across the two ends of the tape. The cellulose tape is then trimmed lengthwise in the slots provided and the clamps are lifted and the joined tape is ready for use.

# STEREOPHONIC SOUND

By J. Moir

NATURE has provided man with two ears in order that he can recognise and appreciate the direction from which sounds approach him, a facility that is entirely lost if a single channel sound reproducer system is interposed between the sound source and the listener. Experience has shown that if this advantage is sacrificed, music loses clarity, an orchestra loses size and its most satisfying crescendo tends to become a confused mass of sound in which the contribution of the individual instruments is almost completely lost. A monaural system necessarily converts the movement of actors about a large stage into movement up and down a tunnel with the microphone at its mouth.

A binaural reproducer system retains most of these advantages by using two headphones, connected back to two microphones through two entirely separate amplifier chains. Headphones have obvious disadvantages from the user's point of view, but all the advantages can be retained by a stereophonic system using two, three, five or even more loudspeakers, each fed through its own amplifier from its own microphone.

## Early Experiments

The advantages of a binaural system were demonstrated as early as 1881, when two-channel reproduction of music from the stage of the Paris opera house was demonstrated, using headphones; but the whole equipment was so much in advance of its time, that it was probably only looked upon as an interesting experiment. In the years between 1881 and 1928 the thermionic valve transformed the art, and microphones and loudspeakers, though still rather second rate by current standards, were immensely superior to those available in 1881. In 1929 the Columbia Gramophone Co., now part of E.M.I., started work on the problem, and in 1931 A. D. Blumlein filed patent number 394,325, the discussion in the patent showing

an advanced understanding of the basic principles of the stereophonic art.

The necessity of having two separate channels is a major disadvantage, particularly when gramophone discs are the intermediate link between orchestra and listener; but Blumlein showed his usual touch of genius in producing a single groove record, having two separate signals recorded as lateral and vertical modulation of the same groove. At the time this neat idea appeared much more interesting as a method of recording two separate tunes, on one side of a disc, but the idea was never commercialised for either purpose.

## Work by Bell Laboratories

Other laboratories were also interested in stereophony, and in 1934, Bell Labs. presented a very comprehensive series of papers to the American Institute of Electrical Engineers in a symposium on Auditory Perspective. The six papers covered every phase of the subject, from "Basic Requirements" to "Loudspeakers and Microphones," and they remain mandatory reading for every engineer interested in stereophony. For the accompanying demonstration, Bell Laboratories reproduced, stereophonically, the whole of a symphony concert, transmitting it by telephone line from Philadelphia to Washington and reproducing it in the Constitution Hall, a huge building with a volume of nearly 1,000,000 cubic feet and capable of seating 4,000 people.

In his earlier work, Blumlein used only two channels; but the experimental work that preceded the Washington demonstrations conclusively proved that three channels gave a considerable improvement in illusion. Previously it had become fashionable to judge the quality of a reproducer system by the frequency range it covered, but the advent of multi-channel stereophonic systems rather shattered this idea, for it was found

that the public preferred a stereophonic system with a frequency band width of only 3,500 c/s. to a single channel system having a band width of 15 Kc/s.

Fired by the success of Bell Laboratories experiments, the author made his first experiments in 1934, using a two channel system to reproduce a brass band rehearsal. This showed great promise, but the necessity of using two channels appeared to be an overwhelming objection to the commercial production of stereophonic sound films; a clear case of over-rating the magnitude of the obstacles to be surmounted.

### Fantasia

The excellent results obtained by Bell Laboratories were not, however, lost on the engineers of some of the sound film recording companies, for in 1938-9 Walt Disney released "Fantasia," a film that relied on the excellence of its stereophonic sound system for its appeal. This was an undoubted technical success, but its commercial success was restricted by the Second World War. The film was shown outside America, but only with a single photographic sound track. The stereophonic version, shown in America, employed multiple photographic tracks and, as room for these could not be found on the standard sound film, all the tracks were recorded on a second film, run through a separate sound head electrically interlocked with the picture projectors.

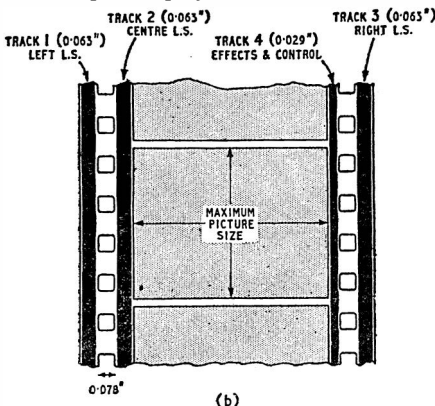

FIG. 1. CinemaScope system of stereophonic sound on film

All development work was suspended during the war, but the development of television, particularly in America, necessitated some sharpening of the wits, and the sound film engineers returned to stereophonic sound. The German development of magnetic sound recording during the war

showed the way to obtain better quality sound on narrower tracks, so the Twentieth Century Fox engineers took the courageous step of introducing wide pictures, complete with a three channel stereophonic sound system using four sound tracks on a picture film of the standard width. The location of the sound tracks is shown in Fig. 1, the fourth and narrow track being used for the



FIG. 2

Four separate pickups are spaced in this head to correspond with the sound tracks in Fig. 1 sound effects reproduced through small speakers placed round the walls of the theatre.

The early stereophonic sound films were very successful commercially, and this led many film companies to re-record films they had already in stock with single photographic tracks. The "stereophonic recordings" were produced from the existing photographic track by manual switching and fading, but this procedure has few of the advantages of true stereophonic recording and it has only served to discredit stereophony.

The commercial necessity of having the four-track reproducer sound head as an item that could be added to existing machines in the theatres resulted in "bolt on" units similar to that shown in Fig. 2, but it is interesting to note that the total wow and flutter distortion reaches a low limit which is not surpassed by any of the commercial tape recorders for public use.

### Stereophonic Discs

The disc recording engineers were not idle meanwhile, and Cook, in America, released stereophonic recordings for public use. Blumlein's original idea of simultaneous lateral and vertical modulation of a single groove was discarded, two tracks being obtained by using half the platter surface for each track, though the playing time per side is reduced to half the normal by this pro-

cedure. Two pickup heads are required, the two heads being mounted together in a single arm in order to obtain the necessary accuracy of time coincidence of the two tracks—an essential feature if true stereophonic results are to be obtained.

Other American recording companies followed Cook into the stereophonic recording market. Opinions on the performance of these stereophonic discs vary all the way from the uninhibited enthusiasm of some American critics to plain dissatisfaction by some other listeners; but it is not quite clear whether the dissatisfaction is due to the recording process or to the listener's own equipment.

Discs of the normal type clearly present considerable fundamental difficulties in getting adequate playing time, or more than two tracks; in fact, many engineers have thought that disc recording of stereophonic sound should not be attempted, and that all stereophonic recordings should be released on  $\frac{1}{2}$ -in. magnetic tape. Magnetic recordings offer a better quality of sound, even on 100 mil. tracks, and the adoption of tracks of this width allows two stereophonic tracks to be recorded side by side on  $\frac{1}{4}$ -in. tape, without introducing difficulties due to time difference between tracks.

#### **“Stereosonic” Tapes**

E.M.I. have pioneered in this country by introducing stereophonic recordings for public use under their trade name of “Stereosonic.” Columbia have followed suit, so there are now about a dozen tapes available to the public. Though all the available tapes have not been sampled, the performance of those that have been heard is of a high standard, and certainly heralds a new age in domestic sound reproduction.

The channel separation given by the use of two tracks must be continued through to the loudspeaker system, and the E.M.I. Stereosonic reproducer system (Fig. aa) consists of two separate loudspeaker enclosures of impressive size, one containing the tape deck and the amplifier system, while the second contains a speaker assembly and power amplifier. For optimum results it is suggested that the two speaker assemblies be mounted in the two corners of the room, slightly toed inwards to give adequate coverage of the room. Uniform angular distribution of sound over the frequency range is clearly necessary, for ideally the response of the two speaker systems should be the same at all points in the room if the stereophonic effects are to be adequately reproduced. To ensure uniform distribution from the speaker units

themselves, a  $13\frac{1}{2}$ -in. elliptical cone speaker unit is used to reproduce the frequency range up to 6 Kc/s., with a ribbon unit handling the frequency components from 6 Kc/s. up to the limit of audibility.

An interesting feature of the amplifier system is the inclusion of a “balance” control that adjusts the relative output from the two speaker systems, and thus serves to centralise the position of the sound image between the two speakers.

#### **Microphone Placing**

Microphone placement during the original recording presents many problems to the recording engineers, and in this respect E.M.I. practice presents some interesting features. Two microphones must be used for a two-channel system. These would normally be mounted in front of the orchestra, and out towards the edge of the area occupied by the orchestra. E.M.I. have adopted another approach, mounting two microphones of the ribbon directional type mutually at right angles, one above the other in the same mount—an arrangement that greatly simplifies microphone positioning during a recording session. As the two units are roughly coincident in space, the contribution of the effects of time-difference to the total stereophonic illusion is minimised, but the loudness-difference effects are magnified.

Philips have adopted a similar approach, mounting two high quality capacitor type microphones in a block of wood about the same size as the human head, a technique that emphasises the frequency characteristic difference effects. Philips Research Laboratory have been active pioneers in the stereophonic reproducer art, and their stereophonic tape recordings have reached a very high standard; however, they are not yet available to the general public. The loudspeaker system favoured by Philips presents a novel approach, in so far as they use a single low frequency speaker dealing with the low frequency components below 500 c/s. from both channels. They claim that this is a justifiable economy, for the components below 500 c/s. carry little stereophonic information.

#### **Stereophony in Cinemas**

While the economics of the situation probably limit the use of more than two channels in a domestic system, sound film engineers are slowly moving towards systems of greater complexity, and with a greater number of channels. The engineers responsible for “Cinerama” use a five-channel system, a solution adopted by Twentieth

Century Fox engineers when introducing an improved sound reproducer system to match their new 55 mm. film system, intended for use in key theatres in the major cities.

Two-channel systems have some inherent limitations which, though of no great account in domestic surroundings, are of vital importance in a large hall, or when the sound is used as part of a film presentation. A two-channel system reproduces an actor following a straight path across the recording stage, as a character following a concave path across the screen. This "concavity effect" is minimised by an increase in the number of channels, for this reduces the distance between loudspeakers. "Concavity" is also a function of the microphone type and positioning, but this becomes much less critical with a multi-channel system.

use two receivers for a stereophonic reception.

Woodyard has demonstrated that left and right channel signals may be simultaneously carried by a single channel, AM being used for the signals from one microphone, while FM is used for the signal from the other microphones.

### Single Channel Systems

Single-channel systems can now be designed to have any frequency bandwidth and distortion levels thought desirable, but the ends of the frequency range make only a small contribution to the overall quality when this is judged subjectively. Further improvement must come from the adoption of stereophonic transmission, for this produces a quality improvement that far outweighs the improvement to be gained by extending the frequency

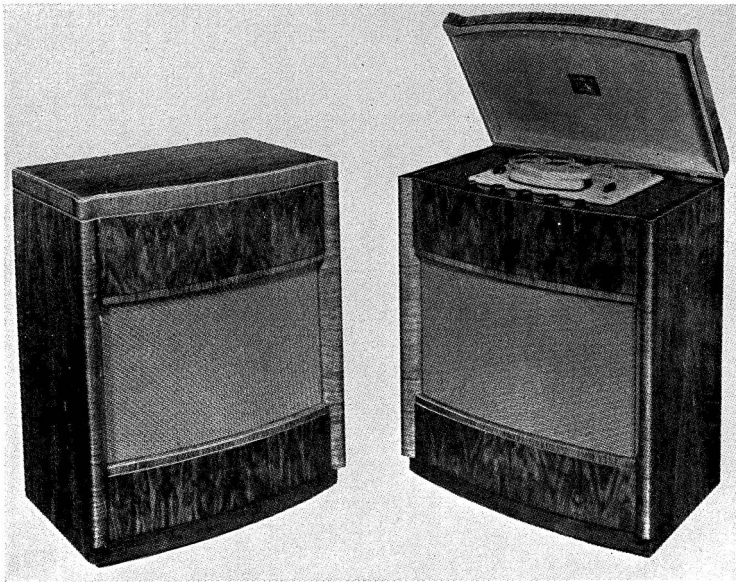

FIG. 3 *H.M.V. Model 3034 Stereosonic reproducing equipment, for sound from tape in the home*

The difficulty of finding sufficient frequency bandwidth to allow even two channels for a stereophonic transmission by radio, limits its application in the radio field. Some American stations, having both an AM and FM licence, run both transmitters to provide a stereophonic transmission. This idea has some merits, for if the same programme is going out to both groups of listeners, it is a relatively simple matter to use two spaced microphones to give separate inputs to the two transmitters, without any sacrifice in quality to those listeners who do not wish to

range. A stereophonic transmission has a live and vital quality that is entirely missing from a single-channel transmission—a symphony orchestra filling the whole of the space *between* the speakers with sound of a quality and clarity that is unmatched by a monaural reproducer of any frequency range.

---

\*My thanks are due to Messrs. Chapman and Hall for permission to reproduce parts of the chapter on Stereophonic Sound from my book *High Quality Sound Reproduction* to be published shortly.

# HOME CONSTRUCTION

By C. W. Morle

**H**IGH FIDELITY sound reproducing apparatus can appeal to different people in different ways. For some, it is only a means to an end, and the apparatus has no virtue except to achieve the ultimate object, the enjoyment of music. A second group of enthusiasts also finds pleasure in being able to listen in this way to the music they like, at a time and place of their own choosing; but in addition they learn that to make the apparatus is also an instructive and pleasant pastime, which adds to the final enjoyment.

Lastly, there is the group of purists interested exclusively in the apparatus itself, listening only for its imperfections; who, in the small hours, reel to their beds dizzy with decibels, their grey hairs tinged with the soot of their midnight lamps; for whom each extra cycle is a battlefield bringing victory or defeat. However, as such as these have rarely been known to listen to actual music, we are not concerned with them here.

## **"I Made it Myself"**

Anyone who has built a piece of apparatus, and made it work satisfactorily, will at least be familiar with its circuit and will be able to repair it more easily should a fault develop later; but since the early days of radio a great many people have wanted to make apparatus just for the pleasure of making it and being able to say "I made it myself." When broadcasting started, it was often easier and cheaper to make receivers than to buy them. With the novelty of being able to listen at all, none was in the mood to criticise the quality of the results, and home construction was very general. As commercial techniques of design and manufacture improved greatly, and eventually outstripped those of the majority of constructors, more and more people turned to the superior commercial article, with its performance that could not easily be emulated by the home constructor. Recently there has been a great revival of interest in home construction, and now there

is available a wide range of apparatus capable of very good results, and specifically designed for home construction. High quality amplifiers, pre-amplifiers, tape recorders and reproducers, and radio tuners, can be made by constructors who have only the most modest technical knowledge or tools, with every hope of success.

At the same time, while successful results can be obtained, a word of warning is necessary. Reputable designers of apparatus for home construction go to considerable trouble when preparing instruction manuals to ensure that their original prototype apparatus works properly; and in addition they make sure that the results obtained in the laboratory can be repeated by the home constructor if the parts specified are used as described in their instruction manual. Those last few words are important. The constructor may find that he has some components which seem to be near enough the same as those specified in the manual. There is a great temptation to use these components, rather than buy new ones. Such components can be used, of course, but at the risk of results which fall short of those hoped for, and the compilers of the instruction manual can scarcely be expected to deal amiably with queries about such modified apparatus.

## **Old Parts for Experiments**

All this is not to say that circuits are not capable of modification or improvement, or that experimenting should not be undertaken. Experiments are a splendid way of learning, but they are best carried out with the remains of an unwanted radio receiver, when the effects of bright flashes or the smell of burning insulation can be regarded with more equanimity than with a new and expensive kit of parts.

Before starting home construction therefore, it is as well to consider whether or not "first time" results are wanted. If so, it is as well to choose a good manual and to follow the instructions closely. If not, the



*New output pentode EL34 by Mullard. Ideal for audio work*

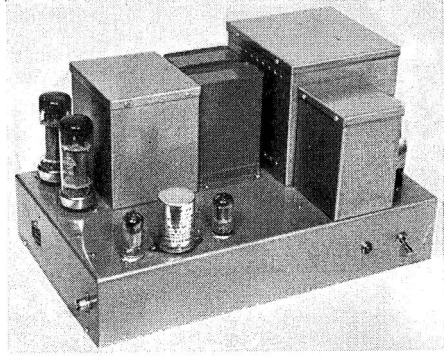

*20 watt amplifier built from the Mullard circuit*

*Mullard 5/10 amplifier built to plan from circuit*

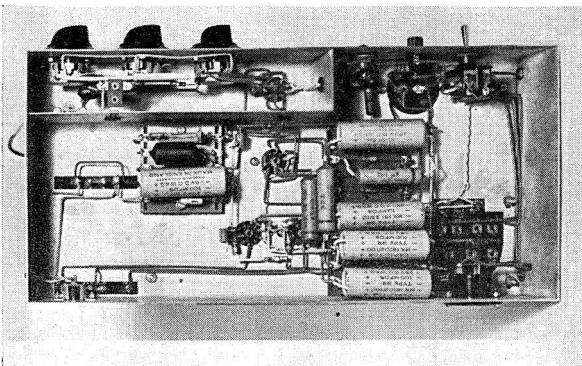
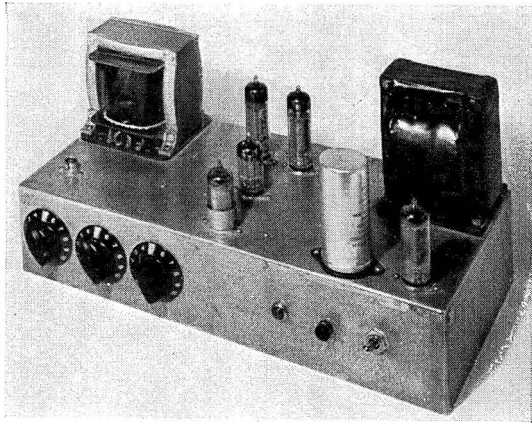

*Under chassis view of the Mullard 5/10*

extent of any departure must depend upon the constructor's skill and knowledge, and his facilities for detecting and correcting any faults which may occur.

### Types of Construction

As mentioned above, successful home construction is possible with only the very simplest knowledge, and it is proposed to deal briefly with the various types of construction, grouping these types in order according to the degree of knowledge and skill required.

*Group I* :—In this group is the so-called printed circuit. In this construction a thin board of insulating material has deposited on it a network of conductors formed of copper foil, and which take the place of the connecting wires used in a conventional construction. The board has holes in it, through which the terminal wires of capacitors, resistors and so on can be passed, and these wires then soldered to the foil strips; valve holders and other components can be connected up in a similar way. Construction is restricted to inserting components in the right holes, and soldering their terminal wires. This gives to the amateur the great advantage of the printed circuit technique: the avoidance of wrong connections. It is scarcely to be recommended that the home constructor realises the full advantage of the technique and makes all the soldered joints simultaneously by dipping the board in a solder bath, but even when the joints are made one at a time by hand this method is the most reliable, and it is also probably the quickest way of building an amplifier. No technical knowledge is required, and one needs only the ability to make a simple soldered joint. At present, printed circuits (made by T.C.C.) are available for the Mullard 510 and Osram 912 amplifiers.

*Group II* :—In this group are constructions in which traditional wiring is adopted, using a metal chassis. The detailed chassis layout is given, and a suitable chassis, ready for assembly, is available. Usually it is possible to buy a complete kit, including the chassis, all components, nuts and bolts and connecting wire, and the necessary instructions. The wiring of the components is given in detail. The constructor need have little technical knowledge, though he should preferably be able to read a circuit diagram. He must be able to use a soldering iron with moderate skill.

*Group III* :—This group is similar to Group II in the type of construction

employed, but rather less detailed layout and wiring instructions are given. The constructor must be able to read a circuit diagram and he must have a little more technical knowledge.

*Group IV* :—The type of construction in this group is confined to the person of experience and skill sufficient to translate a circuit diagram from a magazine into a practical form, to wire it from the diagram without further instruction, to test it and, if necessary, make any alterations to make it work satisfactorily. Those who fall into this category can also design their own circuits, with correct component values for a specified performance.

### Tools and Equipment

No construction can be attempted without at least a few tools. When buying tools, it is no extravagance to buy good ones. Nothing is more exasperating than a screw-driver with a blade tip which bends or chips, or wire cutters which fail to cut because their cutting edges have become indented with use. For *Group I* construction mentioned above, the minimum list of tools is: (a) Soldering iron and solder; (b) 2 screw-drivers; (c) Pliers; (d) Wire cutters.

There is a lot to be said for the old-fashioned soldering iron, heated by gas or a spirit lamp; it is cheap and can be heated quickly, and it can be made sufficiently hot to avoid "dry" joints. However, for home use, the electrically-heated type is more widely used. It is more convenient to use, and it does not overheat and burn if left standing for a time. Whatever type is chosen, the bit should be small, especially if the apparatus to be wired up includes modern miniature components, so that it can be used in a confined space; but if it is very small it may be difficult to solder a joint where a number of wires meet. The Solon Instrument Iron is a good compromise, as is the Adcola. Miniature irons include the Oryx and Litesold.

### Choice of Tools

Flux-cored solder is universally used for electronic work, 60/40 tin-lead being suitable. Some solders, for example Multicore, can be obtained in a variety of thicknesses, about 16 or 18 S.W.G. being convenient.

The wire cutters should be of the side-cutting type, about 4 in. long. The best cutters are expensive but a less expensive pair can be made to give long service if they are



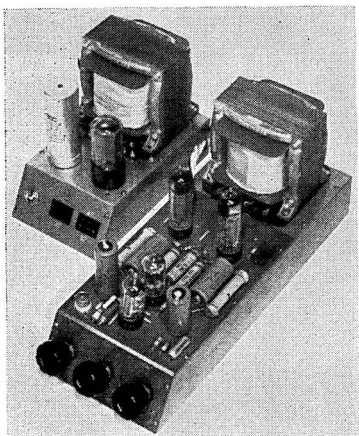

*Mullard 5/10 and  
separate power unit  
built with T.C.C.  
printed circuit*

*Left, Mullard 5/10  
built with "normal"  
components, and  
(right) compare  
with T.C.C. printed  
circuit form of  
construction*

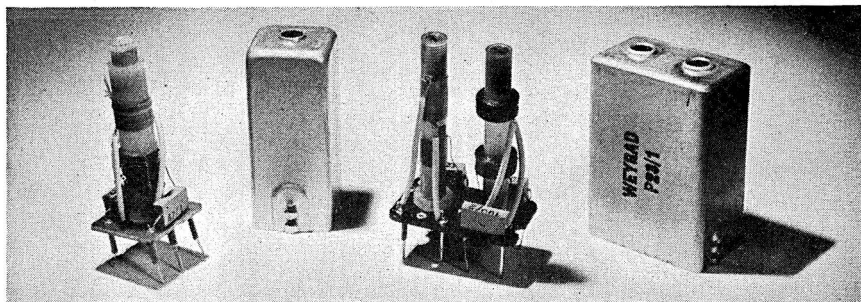
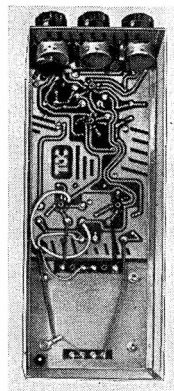
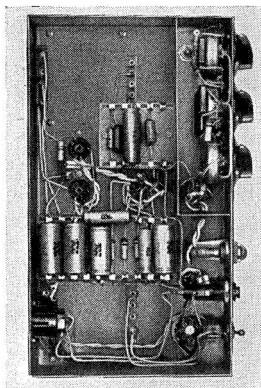

*"Weyrad" coils and cans specially suited for the home construction of radio tuners*

used only on the softer materials, and not used on steel or hard brass.

A screw-driver for general use should have about a  $\frac{1}{4}$ -in. blade, and a smaller one with about a  $\frac{1}{8}$ -in. blade is needed for the fixing screws of control knobs.

The pliers should be flat-jawed and about 6 in. long; and even if they have wire cutting edges it is still desirable to have wire cutters, since pliers cannot be used to cut in inaccessible corners.

As additional tools, a pair of long thin "snipe-nosed" pliers is extremely useful, and a cheap but most effective tool is a *Bib* wire stripper.

### Cutting Large Holes

To this short list of necessary tools there can be added many others, especially if it is intended to buy an undrilled chassis and to make the necessary holes for the components oneself. In this case a hand drill and a small selection of drills, including 2, 4 and 6 B.A. clearance sizes are essential. Some components have  $\frac{3}{8}$ -in. mounting holes, and as most hand drills will not take a drill larger than  $\frac{1}{2}$  in., a special drill must be used, or a  $\frac{1}{2}$ -in. hole can be opened out with a file. Larger holes can be made by cutting a ring of small holes, finishing off with a file; but for these holes chassis punches of the Q-Max type are immensely more convenient. If the chassis themselves are to be made from sheet metal, a variety of metal working tools will be also required.

### Test Gear

So far, no mention has been made of any electrical test gear, and so long as construction is confined to the *Group I* and *II* types, it is quite possible that the need for a measuring instrument may not arise. All the same, a good multi-range meter, capable of measuring voltage and current, preferably both alternating and direct, and resistance, is an invaluable help, not only in the installation and servicing or repair of sound equipment, but also of many kinds of electrical apparatus. AVO, British Physical Laboratories, Pullin and Taylor all make instruments of this kind.

The testing and assessment of performance of sound equipment is a fascinating study in itself. To examine the performance of an amplifier with an audio oscillator and oscilloscope is not likely to be a possibility except for a favoured few, but it is a most revealing method of finding out whether the amplifier can really be called high-fidelity.

In passing, modern commercial audio oscillators of the Wien bridge type have a performance and price which before the war would have been considered almost unattainable. The "Advance" and "Taylor" instruments in this field, both modestly priced, have remarkable stability and purity of output.

Such instruments are beyond the means of all but a few amateurs, and in the space of this brief survey it is not possible to give them more than passing mention. Nevertheless, high quality apparatus cannot be developed without them.

A special case arises with radio "tuners," either for broadcast band reception or for receiving the very high frequency (V.H.F.) frequency-modulation (F.M.) transmissions. These tuners have to be correctly aligned for proper results, and this is best done with test gear; but a local radio service agent, or the suppliers of a kit of parts, will usually undertake the task for a matter of a few shillings.

### Types of Apparatus

The individual parts of high fidelity equipment have their own peculiar points in design, and some of the more important ones are mentioned below.

*The Power Amplifier*:—In a power amplifier there is one component which is of such outstanding importance that it probably is not exaggeration to say that the amplifier is designed around it. This is the output transformer. Without exception, high fidelity amplifiers make use of negative feedback, in which a voltage from the output of the amplifier is fed back to the input. By this device it is possible to decrease the distortion produced, in proportion to the degree of feedback used, until a point is reached where the effect is reversed, and where quality deteriorates rapidly. It happens that the properties of a transformer which permit a large degree of feedback can be obtained only with careful and expensive design.

### Transformers

It follows that the highest performance of power amplifiers can be obtained only when a good transformer is used in a carefully designed circuit. If any attempt is to be made to experiment with substitute components in a high fidelity amplifier design, a substitute transformer is the unit most likely to give trouble. Some amplifiers permit alternative transformers; in such cases the transformer suppliers—for example, Parmeko, Partridge, Woden, Whiteley and so on—will specify their products as suitable, and will give

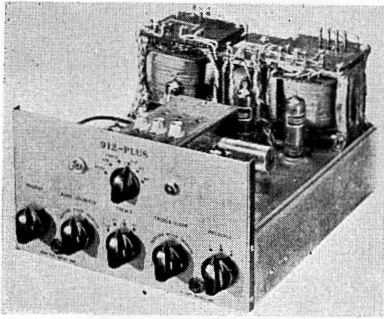

*G.E.C. constructional version of the Osram "912 plus" amplifier circuit*

*Another home constructor's version of the Osram "912 plus" amplifier*

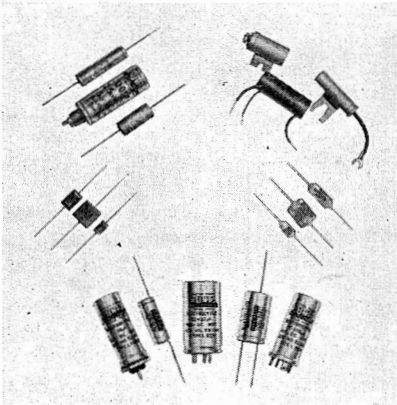
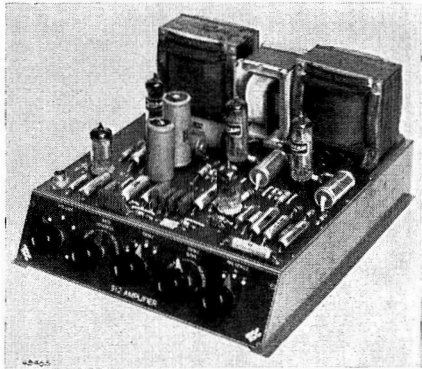

*Hunts capacitors, illustrated here, are particularly recommended for home construction work where close tolerances are needed*

*A neat assembly of tuning and tuned circuit components by "Weyrad"*

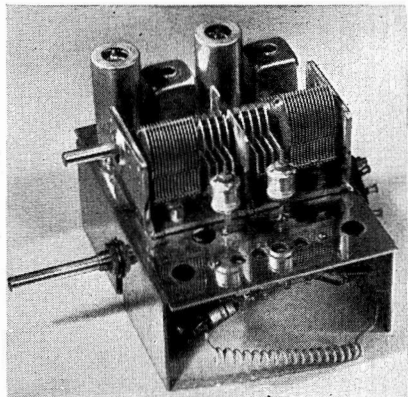

technical data about them to substantiate it.

Mention has already been made of the inadvisability of using "equivalent" valves; and in a push-pull amplifier (as nearly all high fidelity amplifiers are) it is desirable that the valves should be roughly matched as to anode currents in normal working conditions.

Two other important components in a power amplifier are the coupling condensers to the output valves. They should be of very high insulation resistance; otherwise the output valves may be permanently damaged, since any leakage will cause excessive anode current.

Because of their compactness and cheapness compared with paper types, electrolytic capacitors are widely used in power amplifiers for smoothing and for by-passing. Anyone who has had the experience of an electrolytic smoothing capacitor exploding inside an apparatus, due to excessive leakage current, or of the mysterious results obtained when a by-pass capacitor becomes defective, needs no reminder of the advantage of using capacitors of reputed makes—for instance, B.E.C., Dubilier, Hunt, T.C.C.—and, above all, of avoiding old stock. Electrolytic capacitors do not have an indefinite shelf-life, and if they have been left unused for a long time they need to be brought into service with care.

★

*Pre-amplifiers* :—A pre-amplifier can be taken to mean that part of an amplifying system, either separate or combined with the power amplifier, which has bass, treble and allied controls; it is characterised by a propensity for producing hum. In pre-amplifiers intended for small input voltages, such as those from microphones or some of the very high quality magnetic and moving coil pickups, connections and layout of components have a marked effect on the production of hum within the pre-amplifier.

This applies particularly to the input to the first valve, and this again is a point where the instruction manual should be followed closely. It should be noted here that hum can be introduced by failing to "earth" the metal parts of gramophone motor and pickup, and also by earthing them casually at too many points.

★

*Tape Recorders* :—If hum in pre-amplifiers is a difficulty, hum in tape recorders is a major problem. High fidelity reproduction demands a completely inaudible hum and noise level at the loudspeaker, and one of the

advantages of magnetic tape recording is the inherently lower noise level that this medium permits. Owing to the very small voltage that is obtained from the tape, however, technical skill of a high order is required in order to realise fully these potentialities of tape records.

The very small voltage obtained from tape means also that great amplification is required, and this in turn brings with it the dangers of actual or incipient instability and distortion. It is a very searching test for a tape recorder (and one which some commercial recorders do not pass with distinction) to switch it to "Reproduce" and, without a tape in position, to turn up the volume control to a point corresponding roughly to full output and listen for hum, noise or instability. The tape recorder which produces only a faint hiss under these conditions can be considered to be very good.

The best designed commercial tape recorders usually have to be adjusted individually to reduce residual hum to a minimum. Similar results can be obtained by a home constructor, but great care and patience are necessary.

★

*Tuners* :—There are broadcast band tuners and F.M. tuners, and both kinds can be made at home successfully. F.M. tuners are the more difficult to design and build successfully in the first place, but because of this difficulty much more detailed layouts and wiring instructions are usually given. At V.H.F. the "dress," or arrangement, of wiring is important; for example, two close wires may provide, by the capacitance between them, an unwanted path for the currents involved, giving rise to oscillations or instability. Despite this, many such tuners have been made successfully at home from the variety of excellent kits available.

### Conclusion

In conclusion, home construction might be summed up by saying that it is an instructive, and to those who like using their hands, an intriguing pastime. All the same, good results with electronic apparatus in general can be obtained only with a certain quota of experience and know-how and constructional skill; there is a chance of an occasional lucky shot just as there is with most things, but the odds are very much against it.

So, before starting constructing, the would-be constructor should ask: Do I want to amuse myself and have lots of fun, or do I want the best results quickly? If the

latter, have I the time and the skill to get those results by experiment, or shall I stick to the book and get my quota of ability from others ?

Whatever he does, the home constructor will find that he automatically becomes a member of a circle of enthusiasts who are always ready to help each other, and to whom increasing time is being devoted in the technical Press and in the technical Societies and Associations.

## HOW TO SOLDER

THE claim that "no soldering is necessary," which occasionally appears in amplifier manufacturers' advertisements, seems to indicate that some Audio enthusiasts think that soldering is a difficult process. However, if a few simple principles are understood, and if the necessary relatively inexpensive equipment is available, any Audio enthusiast should be able to tackle simple soldering jobs without any trepidation.

*Equipment* :—It is necessary to possess a suitable soldering iron, preferably electric, and some good quality cored solder with a non-corrosive flux. *It cannot be stressed too strongly that acid or fluid fluxes must on no account be used or subsequent corrosion will occur and the joints will become faulty.*

A good, reliable solder is "Ersin Multi-core" which is available at most electrical shops and high fidelity dealers. For wiring conventional chassis, and for soldering screened leads, use 60/40 alloy, which is available in 18 S.W.G. 2s. 6d. and 5s. cartons. The outside of the cartons is colour coded red. This solder wire contains 5 cores of non-corrosive flux and is also available in a special 2s. 6d. carton of very fine diameter (22 S.W.G.) for the soldering of printed circuits. Whilst this printed circuit solder can be used for conventional wire-to-tag joints, it is preferable not to use the thicker 18 S.W.G. solder for printed circuit wiring.

Whilst on this subject, it is well to mention that only a small soldering iron should be used for making joints on printed circuits, and to note that such joints should be made as quickly as possible in order to prevent the copper laminate coming away from the base.

Other tools that will be required are a pair of round nose pliers and a "Bib" Wire Stripper and Cutter.

### Apply Iron and Solder Together

The golden rule, which must be observed when undertaking soldering jobs on electronic

equipment, is to ensure that the solder wire is applied to the heated components at the same time as the soldering tool is applied. The reason for this rule is that the flux is contained in the solder wire, and it is essential that the flux be applied to the components that are to be jointed, in order to remove the surface oxides and to prevent them forming during the soldering operation. Probably 90 per cent. of the trouble experienced in soldering jobs is due to the fact that the solder is applied to the iron, and that the tool is then applied to the components. Consequently, the flux is just wasted.

Some of the Audio enthusiast's soldering jobs will be the soldering of wires to pins of plugs, and the soldering of screened leads to plugs. Many of these jobs can often be undertaken more easily by fixing the iron in a vice than by holding the tool in the hands. By this means the wires and plugs can be applied to the solder bit with one hand, and the solder wire with the other. When wires are to be connected to tags, it is a good plan to follow the professional practice of passing the wire through the hole in the tag, thus making a mechanical joint before the solder joint is effected.

### Cleanliness Essential

Always remember that another golden rule of soldering is cleanliness. Whilst modern non-corrosive fluxes will remove surface oxides, it is not intended that they

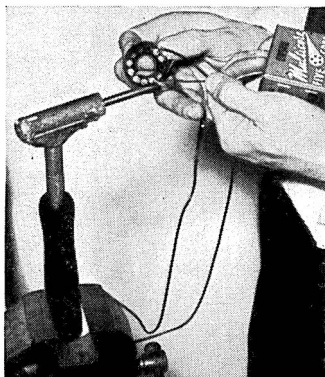

*A vice helps, and provides the "third hand" that soldering often demands*

should remove dirt. Consequently, if old wires are being soldered, or if joints are being made to tags of components which have been in use for a long time, it may be necessary first to remove dirt by cleaning with a file, glasspaper or even a pen-knife.

If the solder does not run very easily, and if you know that the solder wire is of good quality, you have a sure indication that you are applying insufficient heat. This may be due to the soldering tool having an insufficient bit temperature. Generally, this deficiency will be the result of one of two reasons. Either the heating element in the soldering iron is worn out, or the whole design of the iron is too small for the job which is being undertaken. For example, for jointing wires to tags in many of the small amplifiers, which are now marketed for Audio enthusiasts, the soldering iron of small physical size is an advantage. On the other hand, this type of soldering iron is quite unsuitable for soldering a wire to the ground tag of a large metal chassis.

Whilst it is possible to get unsatisfactory joints because too much heat is applied, many more faulty joints are made by applying too little heat. Even when undertaking soldering jobs in which low melting point insulation material is used, it is invariably

advantageous to apply a lot of heat for a short time, rather than a little heat for a long time. When soldering screened cables to plugs, some initial difficulty may sometimes be experienced, due to the low melting point insulation between the wire and the screening being melted—thus causing a “short” between the inner wire or wires and the screening. If, however, the soldering job is undertaken quickly, with an iron of sufficient bit temperature, this trouble should be avoided. In some circumstances, it is advantageous to use a thermal shunt to conduct the excessive heat away quickly. A simple form of thermal shunt would be a pair of pliers.

There is considerable fascination in undertaking a good soldering job and after a short while the Audio enthusiast will find that soldered joints can be made more quickly than by any other method. Furthermore, equipment assembled in this way gives a professional appearance to a high fidelity installation.

---

## DIRECTORY OF COMPONENT MAKERS

### Condensers

**Sydney S. Bird and Sons Ltd.**, Cambridge  
Arterial Road, Enfield, Middx.

Mica dielectric and air dielectric trimmers.

**A. H. Hunt (Capacitors) Ltd.**

Electrolytics, foil and paper, metalised paper, and ceramics. Special attention to requirements of home constructors.

**Telegraph Condenser Co. Ltd.**, Wales Farm  
Road, London, W.3.

All types of capacitors. Printed circuits.

### Resistors

**Erie Resistor Ltd.**, Carlisle Road, Hendon,  
London, N.W.9.

Carbon and wire-wound resistors.

**Erg Industrial Corporation Ltd.**, 10 Portman  
Square, London, W.1.

Carbon and wire-wound resistors.

### Potentiometers

**Colvern Ltd.**, Mawneys Road, Romford,  
Essex.

Sealed wire-wound potentiometers and variable resistors.

### Coils

**Weymouth Radio Manufacturing Co. Ltd.**,  
16 Crescent Street, Weymouth, Dorset.

R.F. coils, I.F. transformers, chokes and tuned coils, discriminator transformers, etc.

### Transformers

**Partridge Transformers Ltd.**, Roebuck Road,  
Tolworth, Surrey.

All types of audio transformers, C-cored transformers, etc.

**Woden Transformer Co. Ltd.**, Moxley Road,  
Bilston, Staffs.

Chokes, relays and transformers, C-cored, etc.

### Transistors

**Standard Telephones and Cables Ltd.**, Brimar  
Valve Works, Footscray, Kent.

Transistors, germanium rectifiers, quartz crystals, valves, etc.

### Circuits

**Mullard Ltd.** (Valve Division), Century  
House, Shaftesbury Avenue, London,  
W.C.2.

Booklets of Mullard 5-10 and 20-watt amplifiers, and F.M. tuner on request, price 3/6.

**G.E.C. Ltd.**, Magnet House, Kingsway,  
London, W.C.2.

Osram “912 Plus” amplifier booklet, on request, price 4/-.

### Test Gear

**The Automatic Coil Winder Co. Ltd.**, 92-96  
Vauxhall Bridge Road, London, S.W.1.

**British Physical Laboratories**, Houseboat  
Works, Radlett, Herts.

**Taylor Electrical Instruments Ltd.**, Montrose  
Avenue, Slough, Bucks.

**Advance Components Ltd.**, Marlowe Road,  
Walthamstow, London, E.17.

# THE FUTURE

IT would be fascinating, here, to look ahead and to forecast the development of Hi-Fi reproduction and equipment, ten or twenty years hence ; but in a book of this nature, which is essentially a catalogue of facts, one should not stray into the realms of prophecy. Within limits, however, one can look ahead, because it is surely permissible to take the known possibilities of today, and to show how they could be brought into use in the homes of tomorrow. In other words, where there are already facts to work upon, and where there are actual materials to work with, there is nothing to stop the enthusiast from taking them into his workshop and making something of them. And what the enthusiast can do, so may the experimenters in the laboratories of various factories be doing at this very time.

## Stereophonic Discs ?

One of the most interesting developments we must consider is the stereophonic L.P. disc. Twin sound tracks are already available on tape, as marketed by E.M.I., and in the United States of America there are discs on sale with dual sound tracks. The first of these to appear was the Cook disc, with the second track beginning about half-way across the record. An extension of the pick-up arm carries a second pick-up, and the two heads, with their styli, follow their respective sound tracks. The disadvantages of this arrangement are obvious ; and not the least of them is the halved playing time of the disc.

A second development, which has been worked upon in the laboratories, involves the use of two different types of sound track in one groove : (1) the normal, lateral recording in which the cutter leaves the sound pattern on the walls of the groove-it cuts, and (2) the original Edison idea, or "Hill-and Dale" sound track, which is cut in the bottom of the groove. One stylus, responding to vertical movement, is used to transcribe the Hill-and-Dale recording, while another stylus, responding laterally, deciphers the lateral track. Both styli can be mounted in a single head, one slightly behind the other ; or it is even possible to arrange one stylus in such a way that it will respond to both lateral

and vertical movements, in order to pick up the outputs from both tracks.

Still another possibility, which is engaging the minds of technicians, is that of recording the two tracks on the "carrier" principle, in much the same way as a pair of telephone wires can be used to carry two conversations. In this case, the stylus would collect the complete pattern of both recordings, and the amplifier circuits would separate the two halves of the pattern, amplifying and passing them on to the two speakers. Whichever system is used, however, is immaterial from the point of view of the listener, who will soon be able to buy stereophonic discs of one kind or another !

That leads directly into the possibilities of the *Longer-Playing Disc*, which is already on sale in America in 7-in. form, and on the continent of Europe in 16-in. form. The playing speed of these discs is half that of the normal L.P. (16½ r.p.m.). The American 7-in. version plays for a maximum of 45 minutes per side (music) and 60 minutes per side (speech). The larger, Continental disc, which has been developed for the recording of talking books, for the blind, and for educational purposes, has a maximum playing time (speech) of something like two hours. How, and in what form they will appear in Great Britain is a matter for speculation ; but come they will, and before long.

## Stereophony via Radio ?

Stereophonic sound via radio has also been tried out in the U.S.A., where broadcasting IS NOT a State monopoly, and where independently-owned transmitters can be used with greater freedom as a consequence. By radiating the same programme from two transmitters—each radiation resulting from a different microphone source—the listener is provided with the two halves of a stereophonic programme if he cares to take advantage of the fact ; and he can combine them, via two receivers and two speakers, to give himself stereophonic reception in the home.

There would be nothing to prevent the B.B.C. from embarking upon such a system of stereophonic broadcasts over here, but for the fact that public money is involved,

and that costly experiments for the comparative few would not, presumably, be tolerated at present, with so many other important things demanded by the majority. If the B.B.C. were faced with competition, it would probably have to do many things. As it is, there is no need, while the monopolistic umbrella protects it! Now that programmes are radiated in four different frequency bands (L.W., M.W., V.H.F. and television V.H.F.), it would be quite possible to use two, or even more, microphone sources from the same programme on occasion. Perhaps these words will be repeated, and heard in those Very High Places where things are decided.

Next, there is the very exciting possibility of recording complete television programmes on tape (or on some similar medium). This has already been done in the laboratory. There are, of course, some very big problems to be overcome before such a system could be made a commercial proposition, because of the very high frequencies involved with the vision channel. In order to obtain really good definition of detail in a *sound* recording, music should not be recorded at a tape speed of less than 15 in. per second. To obtain comparatively good definition in a vision recording, the tape speed (using present methods) might have to be something like 500 inches per second!

There are ways and means of reducing this figure from absurdity to near-realism, however, and time will undoubtedly yield a practical method. For instance, just as the B.B.C. uses the "interlacing" method of scanning for T.V., so could two tracks on a tape be used to take half the recording; and four narrower tracks would again halve the necessary tape speed, and so on. Again, improved qualities of tape should make it possible to run at still lower speeds; and these and other factors could be combined to make the satisfactory recording of vision a practical proposition in the not too far distant future.

Such developments as the above—longer-playing L.P.s; stereophonic broadcasts; twin-track discs; recorded T.V.—are only the more spectacular highlights of what we may reasonably expect to have with us in the years ahead. We must not lose sight of the more earthly developments that are on the way—smaller equipment, using the transistor in place of the thermionic valve—more realistic reproduction from our speaker systems—improvements in the quality of discs themselves, and so on. While the scientists are busy jumping the hurdles, we shall be well advised to learn how to run—having used *all* the available aids at our disposal to help us to walk *perfectly*!

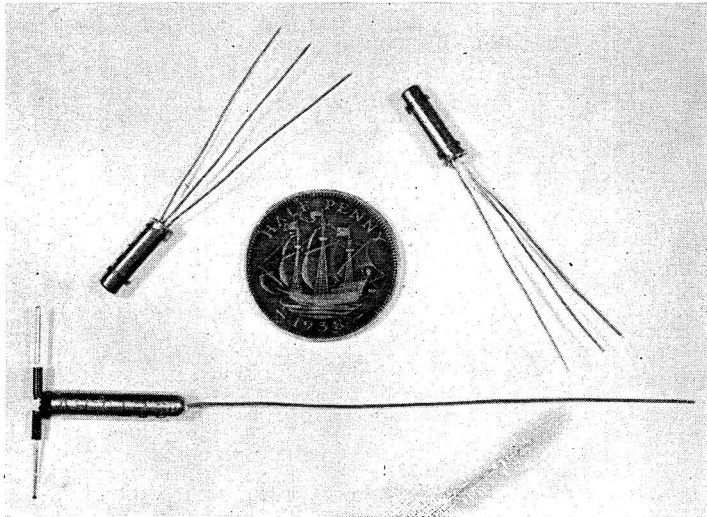

★ These transistors, made by the S.T.C. Brimar factory, show how the equipment of the future may shrink in size.



# DIRECTORY OF HI-FI DEALERS

**IMPORTANT NOTE :** The following list is of shops where stocks of equipment are known to be kept, and where facilities for demonstrations exist. It is not necessarily a complete list, and we invite new dealers to submit details for future publication.

## LONDON AREA

**BERRYS (SHORT WAVES) LTD.,** 25 High Holborn, W.C.1  
**B.K. PARTNERS LTD.,** 229 Regent Street, W.1  
**CITY SALE & EXCHANGE LTD.,** 93 Fleet Street, E.C.4  
**CLASSIC ELECTRICAL CO. LTD.,** 352-364 Lower Addiscombe Road, Croydon, Surrey  
**GRAMOPHONE EXCHANGE,** 121-123 Shaftesbury Avenue, W.C.2  
**H. C. HARRIDGE,** 8 Moor Street, Cambridge Circus, W.1  
**HARRODS LTD.,** Knightsbridge, S.W.1  
**HOLLEY'S RADIO,** 285 Camberwell Road, S.E.5  
**ALFRED IMHOF,** 112 New Oxford Street, W.1  
**MODERN ELECTRICS LTD.,** 164 Charing Cross Road, W.C.2  
**MUSICRAFT,** 20-22 High Street, Southall, Middlesex  
**PETER JONES,** Sloane Square, S.W.1  
**QUALITY MART,** 8 Dartmouth Park Avenue, N.W.5  
**SELFRIDGES LTD.,** Oxford Street, W.1  
**TELE-RADIO (1943) LTD.,** 189 Edgware Road, W.2  
**WEBBS RADIO,** 14 Soho Street, W.1

## BATH

**C. MILSOM & SON,** North Gate, Bath, Somerset

## BOURNEMOUTH (HANTS)

**RONALDSON,** 205 Seabourne Road, Southbourne, Bournemouth

## BIRMINGHAM

**JEWKS & CO.,** 293 Broad Street

## BRIGHTON (SUSSEX)

**LANES,** 11 Gardner Street

## BRISTOL (SOMERSET)

**BRISTOL & WEST RECORDING SERVICES LTD.,** 6 Park Row

## CAMBRIDGE

**K.P. CAMERA SHOP,** 12a Kings Parade  
**G. P. REECE,** 1-2 Peas Hill  
**UNIVERSITY RECORDINGS,** 16 Burleigh Place

## LEICESTER

**G. W. COWLING LTD.,** 26 Belvoir Street  
**DALTON & SONS LTD.,** 76 Granby Street

## LIVERPOOL

**BEAVER AUDIO LTD.,** 60-62 Whitechapel

## MANCHESTER

**LANCASTER HI-FIDELITY CO.,** 144 Oxford Road

## OXFORD

**L. WESTWOOD,** 46 George Street

## READING (BERKS)

**BARNES & AVIS,** 35 London Street  
**HICKIE & HICKIE,** 153 Friar Street

## SALISBURY (WILTS)

**J. F. SUTTON,** 89 Crane Street

## SOUTHPORT (LANCS)

**ALDRIDGES (MUSIC) LTD.,** 14-16 Houghton Street

## STOKE-ON-TRENT (STAFFS)

**HIGH FIDELITY SOUND EQUIPMENT,** 116 Birches Head Road, Hanley

## TUNBRIDGE WELLS (KENT)

**GOULDEN & CURRY,** 59-61 High Street  
**PERCY POWELL LTD.,** 54 High Street

## WALSALL (STAFFS)

**H. TAYLOR & SON,** Bridge Street

## WOLVERHAMPTON (STAFFS)

**PODMORE LTD.,** 19 Merridale Road

## WORCESTER

**JOHNSONS,** 46 Friar Street

## WORTHING (SUSSEX)

**BARNES & SPICER,** 4 Connaught Buildings, Chapel Road

## ALPHABETICAL LIST OF ADVERTISERS

	Page		Page
ACOUSTICAL MANUFACTURING CO. ...	137	JASON ELECTRONIC CO. ...	165
ANTIFERRENCE LTD. ...	138	LANCASTER HI-FIDELITY ...	159
ARMSTRONG WIRELESS & TELEVISION CO. ...	139	H. J. LEAK & CO. LTD. ...	160
B.K. PARTNERS LTD. ...	150	LOWTHER MANUFACTURING CO. ...	162
BRADMATIC LTD. ...	141	MULTICORE SOLDERS ...	175
BURNE-JONES CO. ...	174	MUSICRAFT ...	178
C. T. CHAPMAN ...	143	PAMPHONIC REPRODUCERS ...	156
CLASSIC ELECTRICAL ...	179	PYE LTD. ...	158
COSMOCORD LTD. ...	145	QUALITY MART ...	148/9
CONNOISSEUR ...	171	R.C.A. PHOTOPHONE LTD. ...	164
COLLARO LTD. ...	163	RIMINGTON VAN WYCK ...	173
E.M.I. LTD. ...	166	ROGERS DEVELOPMENTS LTD. ...	170
EXPERT GRAMOPHONES ...	140	SIMON SOUND SERVICE ...	147
GARRARD ENGINEERING & MANUFACTURING CO. LTD. ...	151	SOUND SALES LTD. ...	172
GOLDRING MANUFACTURING CO. LTD. ...	152/3	A. L. STAMFORD ...	144
GOODMANS INDUSTRIES LTD. ...	154	THERMIONIC PRODUCTS ...	176
GRAMOPHONE EXCHANGE ...	155	TECHNICAL SUPPLIERS LTD. ...	142
H.C. HARRIDGE ...	161	VITAVOX LTD. ...	168
HIS MASTER'S VOICE ...	167	VORTEXION LTD. ...	177
A. H. HUNT ...	157	WEBBS RADIO ...	146
		WHARFEDALE WIRELESS LTD. ...	169
		WHITELEY ELECTRICAL RADIO CO. LTD. ...	180

For the **CLOSEST** approach  
to the **ORIGINAL** sound

**QUAD II  
MAIN  
AMPLIFIER**

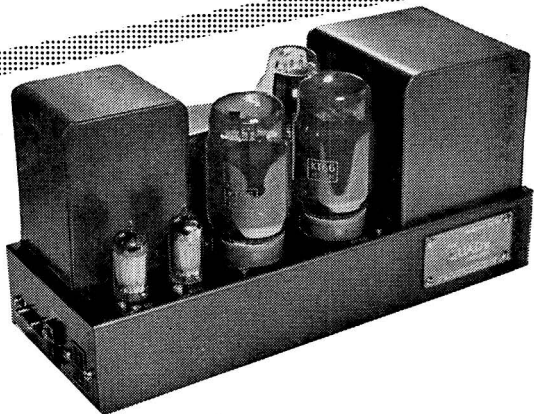

**QUAD II  
CONTROL  
UNIT**

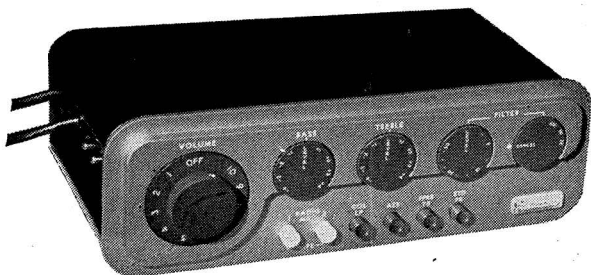

**ACOUSTICAL  
FM  
TUNER**

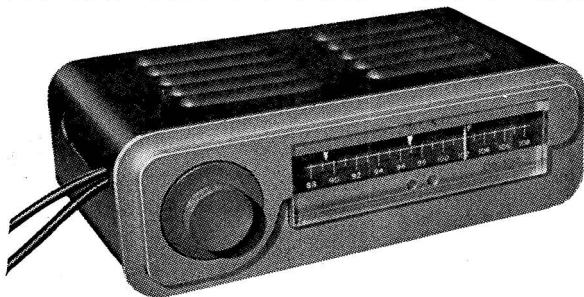

**ACOUSTICAL**  
MANUFACTURING CO. LTD.  
HUNTINGDON · HUNTS · TEL. 1361



Literature giving full details and  
specifications sent on request.

# ANTIFERRENCE

# VHF/FM AERIALS

All Antiferrence aerials are fully covered and protected by patents or patents pending.

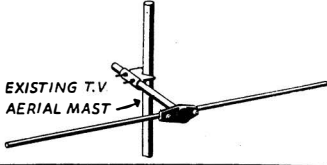
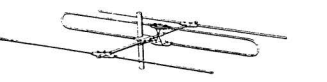
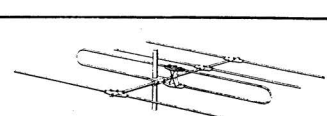
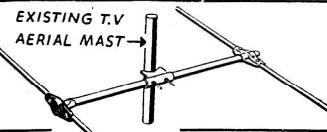
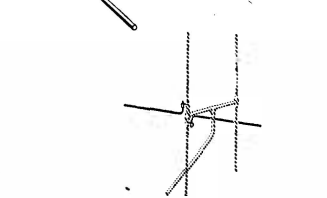
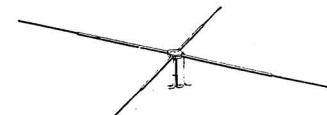
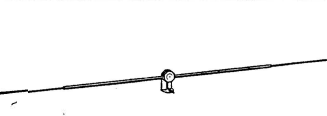
 <p>EXISTING T.V. AERIAL MAST</p>	<b>210/1A</b> <b>26/6</b>	Single Dipole with swanneck mast and lashing equipment for CHIMNEY MOUNTING <b>210/5C . 47/6</b> Single Dipole with cranked mast and UNIVERSAL BRACKET for SURFACE MOUNTING <b>210/2D . 35/-</b>
	<b>230</b> <b>75/-</b>	3-element array with 10 ft. x 1 1/2 in. diameter mast and Heavy Duty SINGLE lashing equipment for CHIMNEY MOUNTING <b>231/6G . 150/-</b>
	<b>240</b> <b>85/-</b>	4-element array with 12 ft. x 2 in. diameter mast and Heavy Duty DOUBLE lashing equipment for CHIMNEY MOUNTING <b>241/7H . 200/-</b>
 <p>EXISTING T.V. AERIAL MAST</p>	<b>220</b> <b>40/-</b>	Dipole and Reflector with 6 ft. mast and lashing equipment for CHIMNEY MOUNTING <b>221/4E . 75/-</b> Dipole and Reflector with 10 ft. x 1 1/2 in. diameter mast and Heavy Duty SINGLE lashing equipment for CHIMNEY MOUNTING <b>222/6G . 115/-</b>
	<b>'ADDEX'</b> <b>FM</b> <b>12/6</b>	This "ADDEX" FM ADAPTOR KIT can be used on all VERTICALLY POLARISED DIPOLE or "H" Type BAND 1 T.V. AERIALS having 1/2 in. or 3/8 in. diameter rods. It is suitable ONLY for COMBINED TV/FM Receivers having a SINGLE AERIAL INPUT SOCKET. No additional lead-in cable is required and no alteration to the existing aerial cable connections is necessary
	<b>U4H</b> <b>FM</b> <b>22/-</b>	A 4 Rod Telescopic Aerial for LOFT MOUNTING. Tuneable for peak performance
	<b>U2W</b> <b>FM</b> <b>15/-</b>	A 2 Rod Telescopic Aerial in a CREAM PLASTIC FINISH, complete with 15 ft. cream co-axial cable for ROOM MOUNTING. Tuneable for peak performance <b>U2RC/FM . 21/-</b> As U2RC/FM, but less co-axial cable <b>U2R/FM . 15/-</b>

All Antiferrence VHF/FM aerials are factory assembled and aligned as a complete aerial, tuned for peak performance. The complete arrays are packed in one carton—instantly ready for mounting.

# ANTIFERRENCE LIMITED

AYLESBURY, BUCKS  
Telephone : Aylesbury 1467/8/9

# Armstrongs have triplets . . .

by which they mean that they are making three completely matched units incorporating all the latest developments and of a sufficiently high standard to form the basis of the most ambitious high fidelity system. The front panels match completely, being of high quality brass finished in Florentine Bronze. (Dimensions  $9\frac{3}{4}$  ins x  $5\frac{1}{4}$  ins).

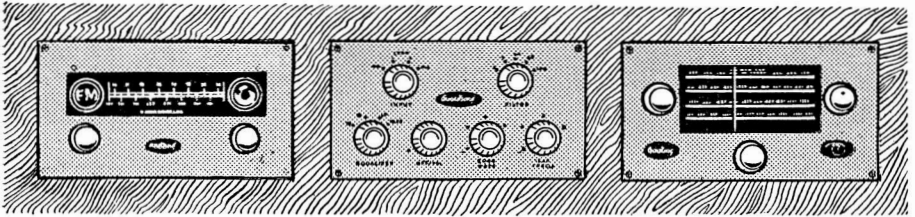

## FM 56 VHF TUNER

Permeability Tuning.  
Freedom from drift.  
Automatic Limiting.  
Magic Eye Tuning.  
AF attenuator.  
3-position HT supply socket.

£22 - 1 - 0

## A.10 AMPLIFIER & CONTROL UNIT

OUTPUT: 10-12 watts ultralinear.  
DISTORTION: 0.1% total harmonic @ 8 watts.  
RESPONSE: within 1 db 15-30,000 cps.

### CONTROLS

1. Inputs: GRAM (2), RADIO, MIC/TAPE.
2. Equaliser, 4-position.
3. Filter, 6 positions with Rumble filter and "Presence."
- 4 & 5: Bass and Treble ( $\pm 15$  db).

Complete £29 - 10 - 0

## AM 44 AM TUNER

4 wavebands—2 Short, Medium and Long.  
Variable Selectivity.  
Infinite Impedance Detector.  
Magic Eye Tuning.  
Cathode Follower output.

£19 - 17 - 0

Demonstrations of these and other models in our range at your local High Fidelity Specialists, or at our Showrooms in Holloway.

Full descriptive literature will be sent on request

**ARMSTRONG WIRELESS & TELEVISION CO. LTD.**  
WARLTERS ROAD, LONDON, N.7



# EXPERT

MAKERS OF HIGH QUALITY  
REPRODUCING EQUIPMENT  
FOR OVER THIRTY YEARS

---

---

*Write for details of*

## HIGH FIDELITY

- ★ PICKUPS
- ★ TAPE RECORDERS
- ★ PLAYING DESKS
- ★ CONTROL UNITS
- ★ AMPLIFIERS
- ★ FM & AM TUNERS
- ★ SPEAKERS & ENCLOSURES

## EXPORT

*During the past thirty years we have built Models for export to every corner of the world, for places where reliability is even more important than reproduction, and have built up a name and reputation among Overseas music lovers that is unsurpassed. No matter how hot, how damp, or how cold the climatic conditions may be, your Expert will "stand up to it," our hundreds of Overseas testimonials are ample proof of this.*

*You can order an Expert with confidence, confidence in the individual attention you will receive from its makers, confidence in the craftsmanship and quality of materials put into it, and above all—confidence in its performance.*

EXPERT GRAMOPHONES LIMITED  
INGERTHORPE · GREAT NORTH ROAD · LONDON · N.2

TEL.: MOUNTVIEW 6875

# Where Quality Counts— Your Choice is

High class tape recording equipment.

All desks fitted with three motors, two tape speeds, servo braking and push-button control. Twin track heads.

Tape Desks available:

Model 5b (to take 7 in. reels) . . .	£42 0 0
Model 5c (to take 9½ in. reels) . . .	£47 10 0
Model 5d (to take 10½ in. reels) . . .	£50 0 0

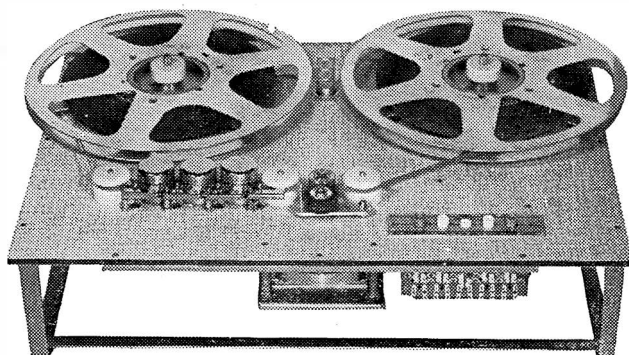

Model 5 D Tape Desk

Magnetic Sound Heads available:

Type 6RP (Super fidelity) . . . . .	£3 15 0
Type 5RP (Record/Play) . . . . .	£3 5 0
Type 5E (Erase) . . . . .	£3 5 0
Type 5R (Record) . . . . .	£3 5 0

Mumetal Screening Cans for the above heads, 8/6 each.  
Amplifiers, microphones and etc. Magnetic Tape and reels,  
Scotch Boy, Emitape always in stock.

Send for Lists:

## BRADMATIC LTD.

STATION ROAD, WITTON LANE, BIRMINGHAM, 6  
TELEPHONE: EAST 2881-2 TELEGRAMS: BRADMATIC, BIRMINGHAM

# EXPAND AND

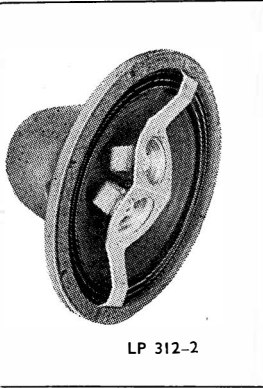

LP 312-2

**LABORATORY BALANCED.** The TSL LORENZ LP312-2 is a main bass 12 in. diaial speaker combined with two LPH65 electro-magnetic high frequency TREBLE units permanently mounted coaxially across the front of the main bass speaker at such an angle to give full spherical binaural response. All are laboratory balanced and matched for perfect tone with a frequency range of 20 cycles to 22,500 cycles essentially level output. To ensure level frequency response the voice coils of the two treble speakers are fed through a specially designed crossover net-work which balances the frequency response of the three speakers as a combined unit.

## SPECIFICATION LP312-2

	Bass	Treble
Impedance	15 ohms	
Frequency range	20-22,500 c/s	
Power rating	25 w	
Peak power rating	40 w	
Diameter	12½ in.	2½ in.
Depth	7⅞ in.	2 in.
Baffle opening	10⅞ in.	

Speech coil dia.	1.5 in.	Treble ½ in.
Fundamental resonance	20 c/s	1,600 c/s
Flux density	17,500 gauss	17,500 gauss
Intermodulation products	Under 0.5%	
Crossover freq.	2,000 c/s	
Finish:	Grey and blue vitreous anti-corrosion stove enamel.	
	Retail Price <b>£14 19s. 6d.</b>	
	(Not subject to Purchase Tax)	

# IMPROVE ANY

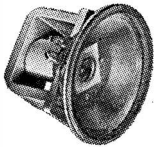

LPH 65

The TSL LORENZ LPH65 is the basic treble speaker used in the TSL LORENZ Sound System. Round in shape to ensure smooth melodious sound the plastic cone is fully tropicalised. Special features are the super high flux density magnet of 17,500 gauss and non-perforated back plate.

## SPECIFICATION LPH65

TSL LORENZ High Frequency cone-horn type treble unit.	
Impedance	5.5 ohms
Frequency range with suitable high pass filter condenser	2,000-22,500 c/s
Power rating as a single unit	3 w
Peak power rating as a single unit	5 w

Diameter	... ..	2½ in.
Depth	... ..	2 in.
Baffle opening	... ..	2½ in.

Price **£1 19s. 6d.**  
(inc. Purchase Tax)

# SOUND SYSTEM

## SUPER HIGH FIDELITY THIS YEAR

**LET YOUR EARS BE THE JUDGE . . .** crisp, clear, natural reproduction without colouration with TSL LORENZ speaker units. Ten years ahead in engineering and design this speaker unit will enable you to design and build up a sound system in your own home which will truly add the miracle of LIFE to the magic of music . . .

**IMPROVE YOUR OWN H.F. SOUNDSYSTEM.** For those devotees of high fidelity who possess bass speakers fitting one or more LPH65 treble units will greatly extend your range of super fidelity reproduction. They are, without a doubt, the most sensitive and efficient treble reproducers research has revealed to date. The non-perforated back plate ensures that the LPH65 can be used with any other speakers irrespective of make or type without interaction taking place.



Details of Bass-Reflex enclosures for the TSL LORENZ LP312-2 may be obtained from

Get the best possible results from your TSL LORENZ SOUND SYSTEM . . . feed in the output from the

## TSL EMPRESS FM/VHF ADAPTOR !

**NO INTERFERENCE.** Convert your present radio or radiogram to FM/VHF and receive under perfect conditions—free from static, heterodyne whistles and electrical interference.

**THE "EMPRESS"** with magic eye tuning is self powered and has 6 valves and 10 tuned circuits for maximum sensitivity. The output is fixed to match into any amplifier, radio set or radiogram. Price complete **£12 14s. 3d.** plus **£4 18s. 3d.** P. Tax

**TECHNICAL SUPPLIERS LTD.,** Exclusive distributors throughout Great Britain and the Commonwealth  
HUDSON HOUSE, 63 GOLDHAWK ROAD, LONDON, W.12. Tel. : SHEpherds Bush 2581/4794

# TUNERS

**F.M.** VHF TUNER completely stable drift free tuning complete with volume control, tuning indicator A.V.C. etc. Sensitivity better than  $4\mu\text{v}$  for 20 db quieting.

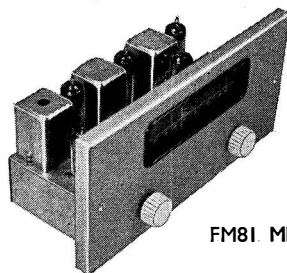

FM81 MK II

**A.M.** 9 Band all wave tuner, 13m-570m Band spread. Variable selectivity, Tuning indicator, Logging scale. Delayed Amplified A.V.C. Sensitivity  $2\mu\text{v}$  for 250 m/v output.

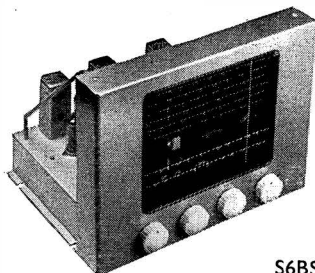

S6BS

**FM/AM** World Wide AM 12.5m-550m PLUS completely stable drift free VHF F.M. Tuning indicator. Sensitivity AM better than  $10\mu\text{v}$  for 250 m/v. F.M. better than  $8\mu\text{v}$  for 20 db quieting.

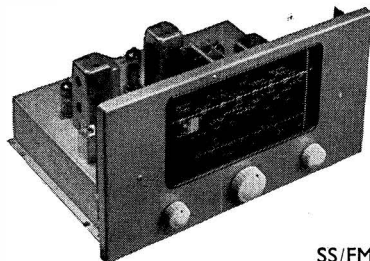

SS/FM

*Manufactured and Guaranteed by:—*

**C. T. CHAPMAN (REPRODUCERS) LTD.**

**RILEY WORKS, RILEY STREET, CHELSEA, S.W.10**

*Telephone Flaxman 4577/8*



# CABINETS by STAMFORD

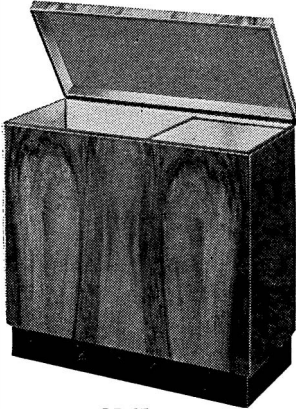

GP 17

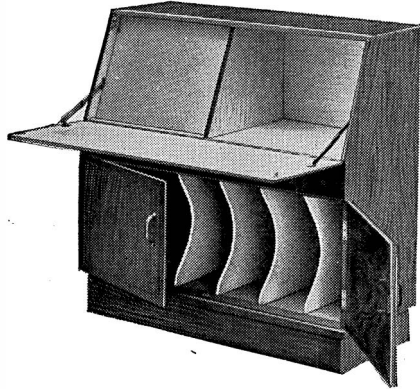

GP 21

Included in our range are numerous General Purpose Cabinets in widths of 17", 30" and 33", which can be modified to special requirements, and apertures cut to templates. Prices of those shown above are GP 17, £10/10/- or 33/- deposit and 9 monthly payments of 21/2; GP 21, £16/18/6 or 51/- deposit and 9 monthly payments of 34/4.

Cabinets are supplied in oak, walnut and mahogany, selected veneers, finished in shade required. Delivery 12/6 in England and Wales. (Scotland and N. Ireland 25/-). Money Refund Guarantee.

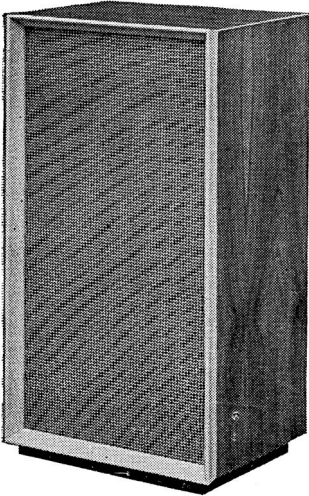

S 4

We specialise in Speaker Enclosures, corner and rectangular, embodying Messrs. Goodmans Acoustic Resistance Unit and so reducing the size of the cabinets by a third.

The price of S4 design is £14/7/6 or 45/- deposit and 9 monthly payments of 29/-. Also supplied complete with the Axiom 150 Mark II and Acoustic Resistance Unit. Price £27/18/6. or £4/4/- deposit and 9 monthly payments of 56/10.



THE MARLOW

Record Cabinets are supplied by the INCH, FOOT or YARD. Illustrated is The Marlow, 2 ft. wide. Price £11/15/- or 36/- deposit and 9 monthly payments 23/9. Purchase Tax 8/5.

Write for our New Catalogue. From years of specialised production we have designed 34 cabinets, styled to suit all tastes, of reliable construction and pleasing appearance. Prices range from £5/10/0—£30.

**A. L. STAMFORD (Dept. P13)**  
20 COLLEGE PARADE, SALUSBURY ROAD, LONDON, N.W.6

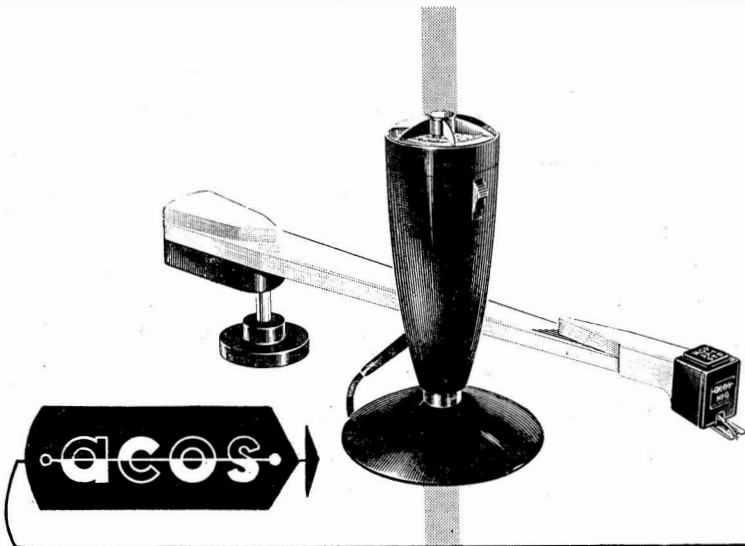

## CRYSTAL PICK-UPS and MICROPHONES

### CRYSTAL MICROPHONES

ACOS microphones and microphone inserts are widely used in disc and tape recording, P.A. systems, amateur and professional broadcasting, acoustic measurement and industrial noise measurement. There are hand, desk, stand and lapel models and retail prices for complete microphones range from £1.5.0 to £12.12.0.

### CRYSTAL PICK-UPS

#### REPLACEMENT HEADS & CARTRIDGES

ACOS Hi-g pick-ups, either with turnover heads or with easily interchangeable heads, to suit standard or long playing records, represent a major ACOS contribution to high fidelity reproduction of both types of record, as witness the number of manufacturers who have standardised on ACOS pick-ups or cartridges. Replacement plug-in type heads are available for modernising existing equipment. Typical retail prices are £2.10.0 (plus P.T.) for the GP 20 Hi-g Pick-up with HGP 39-1 Head; £1.12.6 (plus P.T.) for most of the Replacement Heads.

*.... always well ahead*

COSMOCORD LIMITED • ENFIELD • MIDDLESEX • Tel: ENField 4022

From Tottenham Court Rd.  
Tube go westward along  
Oxford St., and Soho St. is  
first on left.

**WEBB'S**  
*Radio*

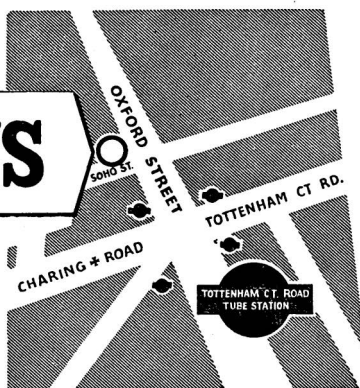

# Instant Comparison

*In our demonstration room you  
may hear and compare all that is  
best in high fidelity reproduction*

## of any combination of Amplifier, Speaker, Pickup and Radio

### AMPLIFIERS by

ACOUSTICAL  
ROGERS  
ARMSTRONG  
R.C.A.

### SPEAKERS by

GOODMANS  
VITAVOX  
TANNOY  
WHARFEDALE  
BARKER

### F.M. and A.M. RADIO UNITS by

ACOUSTICAL  
EDDYSTONE  
ARMSTRONG  
CHAPMAN  
JASON

### PICKUPS and MOTORS by

COLLARO  
TANNOY  
GARRARD  
CONNOISSEUR  
FERRANTI  
LEAK

*Speciality Repairs are another Webb's activity.  
Our Service Department will renovate and  
modernise any good quality sound reproducing  
apparatus*

**WEBB'S** *Radio*

14 SOHO STREET, OXFORD STREET, W.1

Telephone Gerrard 2089

Open 9.00 to 5.30 (7.00 Thursdays) and 9.00 to 1.00 Saturdays

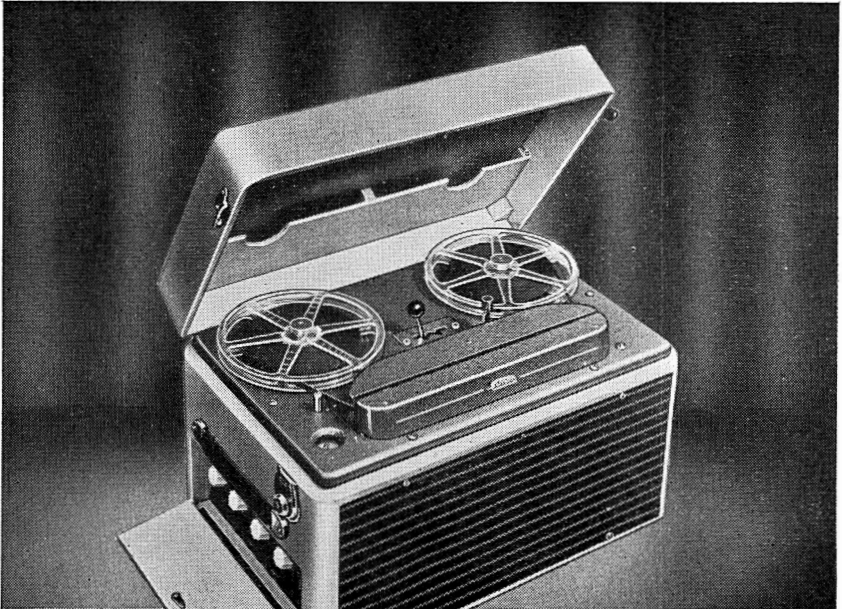

The Simon Model SP/2 Tape Recorder

## Designed for real fidelity...

... and what is more, designed by engineers who have been in on the "art and mystery" of tape recording from the word go.

The Simon is one of the very few machines which can offer a frequency response of 50-12,000 c.p.s. plus or minus 3 db at  $7\frac{1}{2}$  i.p.s. Its appearance is a delight - above and below the deck. Its performance is superb. An instrument of precision and versatility - a switch converts it from Tape Recorder to 10-watt Amplifier or Record Reproducer.

### 'AFFAIRS OF TAPE'

Ask for a copy of this free 8-page Booklet. It gives the inside story of the SP/2.

### Tape too!

Simon 'Library' Tape is supplied on a new easy-thread spool, and in a clever new pack for long safe storage. Its specially prepared PVC base ensures intimate contact with recording heads.

Highly sensitive - response to 15,000 c.p.s. to give highest performance with negligible background noise.

Simon  
**Library**  
Tape

7-inch plastic spools,  
(1,200 ft.)



## Simon is *Sound* recording

SIMON SOUND SERVICE LTD., 46/50 GEORGE STREET, PORTMAN SQ. LONDON, W.1.,  
Telephone: WELbeck 2371 (5 lines)

Northern Depot:

J. D. MORRISON & CO. LTD., WAKEFIELD HOUSE, 11/13 NEW WAKEFIELD STREET,  
MANCHESTER, 1. Telephone: Central 2959

# COMPREHENDING

**WHAT DO YOU KNOW?** Little or much about this new craft, you should judge it well to deal with **QUALITY MART**. Let us tell you why—though many readers will know already.

**COMPREHENSIVE STOCKS**, of course, though many offer equally wide selection to outward appearance. Additionally we have those accessories that make the complete service together with circuit familiarity and spares for every leading maker's equipment.

—for example, all colours of panels and knobs for Rogers amplifiers, all p.u. matching units for the Quad II, sapphire and diamond styli in great variety, F.M. aerials, tapes for all recorders, etc.—glance through the details on the opposite page or, better, send for our new catalogue.

**TECHNICAL COMPREHENSION** too makes it so much better to deal with **QUALITY MART**. A sales staff that has trained engineering experience of all that we sell and a shrewd appraisal of that which is new.

**IN SHORT** : Be your knowledge, your needs or your means large or small you will do well to deal with us ; if we can't supply your wants your case will be unusual, but in any instance your enquiry will be met with courtesy, efficiency and—**COMPREHENSION**.

---

## QUALITY MART RECORD SERVICE

This is one of the largest departments dealing with despatch of many thousands of records annually to home and overseas customers. A large stock is carried, every record guaranteed factory-fresh, inspected for visible flaws, cleaned and all LP's and 45's contained within full size Gardisk polythene bags to ensure unblemished copies reach the customer wherever he may be. Regular customers receive monthly complete record lists of all labels. Full details on request.

---

**PROVINCIAL** postal customers are given the fullest assistance in choice of equipment as also those **OVERSEAS** (or proceeding overseas) who additionally enjoy tax-free purchase facilities. Careful packing of equipment and records ensures safe transit to all parts.

---

**QUALITY MART Showrooms are only 20 mins. from Charing Cross  
Bus 27, 134, 137 or Underground to Tufnell Park, thence 4 mins. walk**

---

# HIGH FIDELITY

ON

RADIO

OR

RECORDS

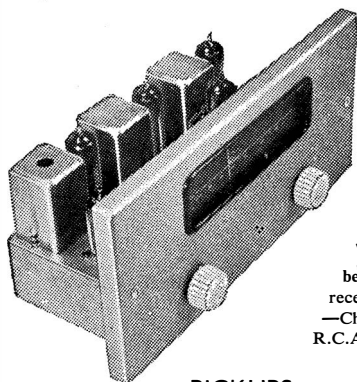

*Chapman  
VHF/FM Tuner  
FM81, Mk. II*



*B.J. "Super 90"  
Pickup Arm*

**VHF/FM RADIO** gives vastly better quality. Units and complete receivers by Acoustical — Champion — Chapman — Jason — Pamphonic — R.C.A. — Starr

*Garrard 301  
Turntable Unit*

## PICKUPS

by Acos — B.J. — B.S.R. — Collaro — Connoisseur — Decca — Garrard — Goldring — Leak — Ortofon — Tannoy — Sapphire and Diamond Styli.

**TURNTABLES** non-auto, transcription, changers, by B.J. — B.S.R. — Collaro — Connoisseur — Garrard — Woollett.

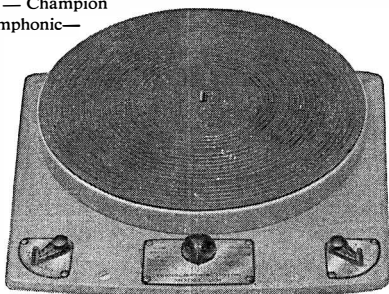

*R.C.A. "New Orthophonic"  
High Fidelity Control Unit  
and Power Amplifier (inset)*

## CABINETS

to modern and traditional design in stock and to order, speaker cabinets to makers' specifications. Also by W.B.

**FULL EQUIPMENT CATALOGUE HF6** — including details of credit terms — 6d. p.p. post free; Overseas air-mailed 3/6.

## AMPLIFIERS

in great variety by Acoustical — Leak — Pamphonic — R.C.A. — Rogers — Starr — W.B.

## LOUDSPEAKERS

as units and in cabinets by Goodmans — Kelly — Lorenz — Pamphonic — Tannoy — Wharfedale — W.B. Stentorian — Vitavox.

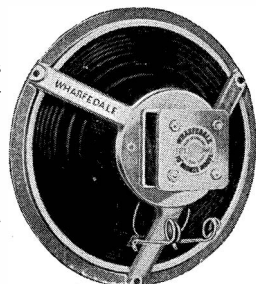

*Wharfedale 10 in.  
Bronze CSB Unit*

# QUALITY MART

(STARR AUDIO, LTD.)

**TAPE RECORDERS**, tapes, accessories, including Collaro Tape Transcriber, Starr Tape Recorder Amplifier. Gramophone and Radio accessories, including the Dust Bug record cleaner, Record Cabinets, Cases and Indices, F.M. aerials, crossover units, popular technical books, etc., etc.

8 DARTMOUTH PARK AVENUE, LONDON, N.W.5.

GULiver 1131

# BK

## Custom-Built

## REPRODUCERS

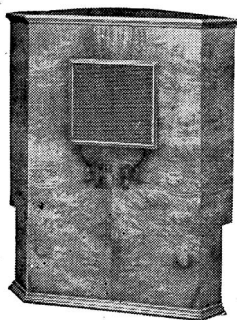

Type MVC

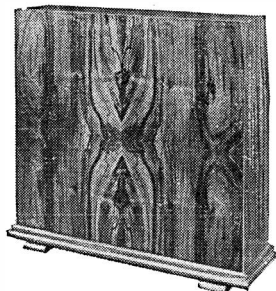

Type HRL 8.

We are exhibiting on Stand No. 10 at the B.S.R.A. Exhibition (Waldorf Hotel, May 26 & 27). Demonstrations will be given in Room 206.



Type HC 12

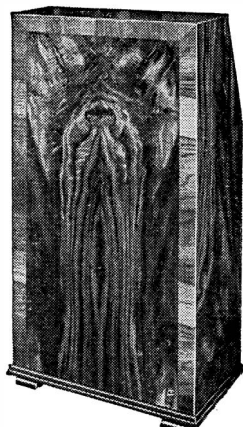

Type WRL 12

We specialise in equipment designed to meet the exacting requirements of the export market. Enquiries are invited.

### Demonstrations

Daily 10.30 a.m. — 5.30 p.m.  
Saturday 10.30 a.m.—12.30 p.m.

*In addition* to a wide range of separate loudspeaker enclosures and complete assemblies, B.K. supply and recommend equipment by:—

ACOUSTICAL	ARMSTRONG
CHAPMAN	COLLARO
DYNATRON	GARRARD
GOODMANS	GOODSELL
LEAK	ORTOFON
R.C.A.	ROGERS
TANNOY	WHARFEDALE

## B-K Partners Ltd

229 Regent Street London, W.1  
(Entrance Hanover St.)  
Telephone REGent 7363

# Garrard

AUDIO PERFECTION

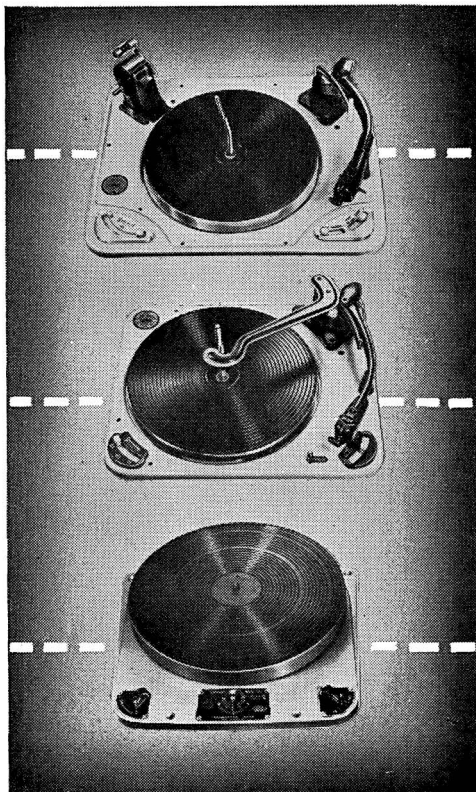

## MODELS TA AND T

These two units occupy very little cabinet space. They differ in that the Model TA has a die-cast aluminium pickup arm to take a range of plug-in pickups, while the Model T is equipped with a one piece Bakelite arm and turn-over pickup. Both are supplied with a centre hole adaptor for playing large hole 45 r.p.m. records. Both possess a fully automatic stop, and stylus pressure is readily adjustable. Finished in cream and brown enamel.

*Garrard supply a complete range of pick-up heads and record playing accessories.*

## MODELS RC.88 AND RC.98

The RC.88 will automatically play any number of records up to eight using the well-proved sloping type of record spindle and adjustable platform. The RC.98 is similar in design but has the additional features of an electrical speed control and switch click suppressor.

## MODELS RC.120 AND 121

These Garrard three-speed automatic record changers are designed to meet the demand for small compact units. Both of these maintain the Garrard reputation for quality and reliability.

## MODEL 301

With this motor we have reached a hitherto unattainable high standard in the manufacture of High Fidelity gramophone components. Wow and flutter have been reduced to minimum levels, and very fine degrees of control on all three speeds have been made possible. The motor possesses the excellent finish always associated with Garrard products. A turntable stroboscopically marked on its rim for 33 $\frac{1}{3}$ , 45 and 78 r.p.m is available at extra cost. State if for 50 or 60 cycles.



THE GARRARD ENGINEERING AND MANUFACTURING CO LTD  
Swindon • Wilts • England

*IMPORTANT NOTE—The Auto-changers in this advertisement are not advertised for Hi-Fidelity reproduction.*



# PRECISION *High Fidelity* 4 SPEED TRANSCRIPTION UNIT

WITH VARIABLE SPEED ADJUSTMENT



## MAIN FEATURES

- Speed **continuously variable** from 29 r.p.m. to 86 r.p.m. Pre-set adjustable "click-in" positions for 78, 45, 33 $\frac{1}{2}$  and 16 r.p.m. Playing old celebrity discs requiring speeds above 78 r.p.m. Tuning record pitch to musical instruments. Correcting for mains frequency variations.
- Accurately balanced heavy precision made turntable eliminates Wow and Flutter.
- Unique VERTICAL EDGE-DRIVE PULLEY principle eliminates Rumble.
- Less than 1% change in speed for up to 13% change in Line Voltage.
- Large resilient 4-pole constant velocity motor.
- Model G.L.50/4 and G.L.56 fitted with weight adjustable precision Pick-up-Arm with plug-in shell, incorporating the **Superb Goldring Variable Reluctance Cartridge No. 500.**



GL50/4

TYPE GL50/4 Low loading velocity operated Automatic Stop Price **£15.15.0** P.T. **£6.2.10**

TYPE GL55. Without Pickup. FITTED WITH BAND LOCATION DEVICE

Price **£12.12.0** P.T. **£4.18.4**



GL55

TYPE GL56. Complete with Pickup. FITTED WITH BAND LOCATION DEVICE

Price **£16.16.0** P.T. **£6.11.0**

DIAMOND STYLUS EXTRA

Price **£3.15.0** P.T. **£1.9.3**

Write for technical reports to—

**THE GOLDRING MANUFACTURING CO. (GT. BRITAIN) LTD.**

486/488, HIGH ROAD, LEYTONSTONE, LONDON, E.11.

LEYtonstone 8343-4-5

**GOLDRING PRODUCTS** \*  
*Leading in  
the HI-FI field*

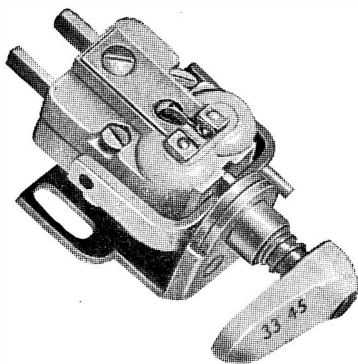

**CARTRIDGE N° 500**  
*acclaimed the world over as  
one of the best!*

THE GOLDRING RANGE INCLUDES THE FOLLOWING  
HI-FI EQUIPMENT :

- ★ **GOLDRING PRE-AMPLIFIER FOR USE WITH  
No. 500 CARTRIDGE**
- ★ **GOLDRING JUBILEE MICRO BALANCED  
TRANSCRIPTION ARMS**

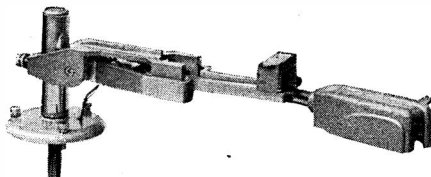

- ★ **GOLDRING SUPER QUALITY** Diamond and Sapphire  
Styli for GOLDRING CARTRIDGES and Replacements for  
other well-known Pick-Ups.
- ★ **GOLDRING ANTI-STATIC CLEANING PADS**  
Specially developed for removing dust from L.P. Records.

---

*Write for descriptive leaflets to:—*

**THE GOLDRING MANUFACTURING CO. (GREAT BRITAIN) LTD.**

486 & 488 HIGH ROAD, LEYTONSTONE, LONDON, E.11.

Telephone : LEYtonstone 8343-4-5

---

# Axiom

... the word that  
stands for  
**HIGH FIDELITY**

Unlocking the vitality and freshness of recorded music, Goodmans AXIOM loudspeakers exploit to the full the thrilling possibilities of real high fidelity. Crisp and clear in the treble... stirring in the bass... they confer a rare and real sense of "presence" and fidelity.

Make the most of every opportunity to hear these loudspeakers - they are a revelation and a delight.

- *Right: top to bottom, Axiom 102, Axiom 22 Mk II, Axiom 150 Mk II, Axiom 80.*

The "close-to-perfect" combination - Axiom speaker PLUS Axiom Enclosure PLUS Acoustical Resistance Unit (shown right). The A.R.U. enables better acoustical performance than ever before to be obtained in a cabinet only two-thirds the volume of the reflex cabinet for the same speaker.

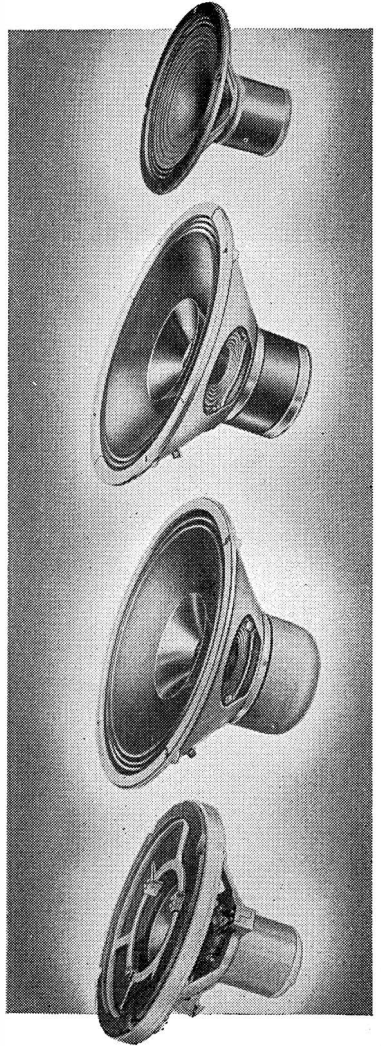
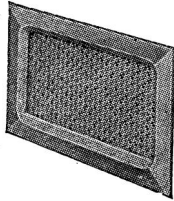

**Goodmans**

Write now for full details of Axiom Loudspeakers, Enclosures, and the Axiom Acoustical Resistance Unit.

GOODMANS INDUSTRIES, LTD., AXIOM WORKS, WEMBLEY, MIDDLESEX.  
Telephone: WEMbley 1200.



# NEW RECORDS

## Keep your Record Collection up to date AT ASTRA HOUSE

where every worth-while L.P. record of good music is kept in stock, there is also a staff of capable assistants all of them eager concert and opera fans, who can and do give really knowledgeable advice on what particular recording or performance is best worthy of your attention.

This service is available to Post Customers as well as to Personal Callers. New L.P. records are Post and Packing free.

### EXCHANGE

At the same time we can relieve you of any unwanted L.P.s or 78 r.p.m.s you no longer wish to keep, in part-payment for the records you do want. Records handed in for allowance must be in perfect condition—damaged or worn records can only be treated as scrap.

### RECORD STORAGE

We are now able to offer record storage boxes for L.P.s large enough to take all makes of L.P. records in their jackets. These boxes are made up in attractive book form in three colours, red, green and black, and will hold approximately twelve records each.

#### *Prices:*

12-in. size : 12s. 6d. 10-in. size : 8s. 6d. 7-in. size : 6s. 6d.

### SLIGHTLY USED RECORDS

For the L.P. enthusiast with a limited purse our second-hand L.P. record department offers wonderful opportunities. 3,000 perfect records in stock, which may be selected by number or title and if desired, tried over in our audition rooms.

Similarly our second-hand 78 department offers wonderful bargains to the enthusiast who cannot afford L.P. or still prefers 78s. 5,000 12-in. records, Symphonies, Concertos, Operas, Chamber Music at from 2s. 6d. to 5s. 0d. per record to browse through.

For the collector of Golden Age records there are, in what has become known as 'Dead Man's Corner', some 2,000 Vocal records by famous artists of the past, at attractive prices.

*Please note we do not issue lists of used records.*

We hold a complete stock of Pre-recorded Tapes including the Stereoscopic Recordings. We also stock B.A.S.F. LP magnetic Tape : 1,200 ft.—£2.0.0. 1,700 ft.—£2.15.0.

# THE GRAMOPHONE EXCHANGE

*Midway between the Palace and Saville Theatres*

**Astra House**

**121-123 Shaftesbury Avenue, London WC 2**

Temple Bar 3007

# Pamphonic

for outstanding  
equipment in the  
field of High Fidelity

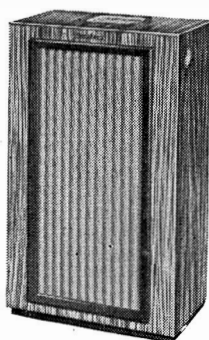
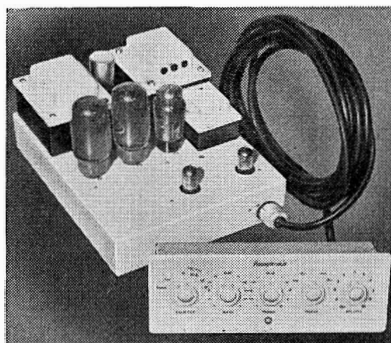

## 'VICTOR' LOUDSPEAKER

A 15-in. dia. permanent magnet Bass unit and special mounting of the Treble unit, eliminates beaming and gives wide angle diffusion. Room matching switch incorporated. 44½ in. high, 24½ in. wide, 18¼ in. deep, finish in either African Mahogany or Walnut Veneer with Old Gold metal grille. 15 watts.

10 watts Junior model also available.

## AMPLIFIER 1002

Consisting of a main amplifier and pre-amplifier control unit, 1002A, with inputs for Radio, Tape, Microphone and Gram. This is a superb combination, capable of 25 watts continuous output. Six selector positions and separate Bass, Treble and Volume controls. Harmonic distortion—Approx. 0.05% at 15 watts 1 Kc/s. Frequency response 1 c/s. to over 100,000 c/s. Mains input—100 to 150 volts and 200 to 250 volts AC 50/60 c/s.

## AMPLIFIER 1003

Designed to give high fidelity reproduction from a suitable Gram., Radio Tuner, Microphone or Tape source. Selector switch for six correction networks. Bass, Treble and Volume controls. Edge-lit panel.

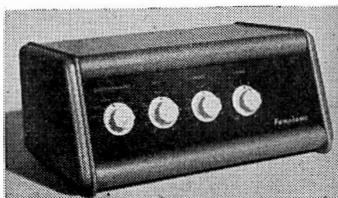

The output of the amplifier is brought to the back, where there is a 3½ ohm and a 15 ohm loudspeaker connection. Power output 8-10 watts.

★ Remember this slogan

# Pamphonic

for sound - NATURALLY!

Write for illustrated leaflets of these and other equipment

**PAMPHONIC REPRODUCERS LTD**

17 Stratton Street, London, W.1.

Phone GROsvenor 1926



# Home Constructors

## MAKE A SOUND JOB OF IT WITH . . .

# HUNTS CAPACITORS

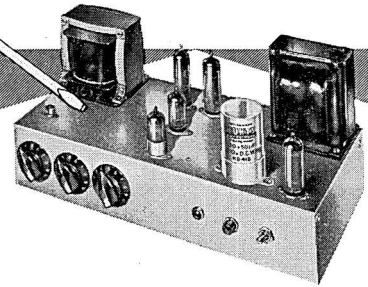

### APPROVED CAPACITOR KIT FOR THE OSRAM 912 HI-FI Amplifier

Ref.	Capacitance	Volts D.C. Wkg.	List No.	List Price s. d.
C 1	0.005 $\mu$ F	1000	B 402	2 0
C 2	25 $\mu$ F	25	JD 52T	2 6
C 3	0.1 $\mu$ F	350	B 406	2 3
C 4	0.05 $\mu$ F	500	B 405	2 3
C 5	8 + 16 $\mu$ F	450	JE 56I	7 6
C 6	470pF $\pm$ 5%	350	L 433	1 6
C 7	1000pF $\pm$ 5%	350	L 435	1 9
C 8	2000pF $\pm$ 5%	350	L 435	2 4 1/2
C 9	0.02 $\mu$ F	750	B 404	2 1 1/2
C 10	22pF $\pm$ 5%	350	L 430	1 6
C 11	220pF $\pm$ 5%	350	L 433	1 6
C 12	470pF $\pm$ 5%	350	L 433	1 6
C 13	25 $\mu$ F	25	JD 52T	2 6
C 14	0.1 $\mu$ F	150	B 500	2 0
C 15	2 $\mu$ F	150	B 504	5 6
C 16	0.01 $\mu$ F	350	B 810	1 6
C 17	0.05 $\mu$ F	500	B 405	2 3
C 18	0.05 $\mu$ F	500	B 405	2 3
C 19	50 $\mu$ F	25	JD 53T	2 9
C 20	50 $\mu$ F	25	JD 53T	2 9
C 21	0.001 $\mu$ F	600	B 847	1 3
C 22	0.001 $\mu$ F	600	B 847	1 3
C 23	8 + 16 $\mu$ F	450	JE 56I	7 6

2 Horizontal Mounting clips H I  
 Special price for complete kit **£2.15.0**

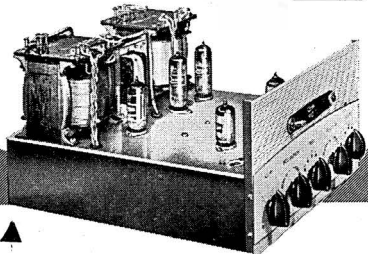

### APPROVED CAPACITOR KIT FOR PASSIVE INPUT UNIT — 11/10 1/2 d.

**A. H. HUNT (Capacitors) LTD.**  
**WANDSWORTH, LONDON, S.W.18**

Telephone: **BAT**tersea 1083/7

And in Canada: **HUNT CAPACITORS (Canada) LTD. AJAX ONTARIO**

### APPROVED CAPACITOR KIT FOR THE MULLARD 5 VALVE 10 watt circuit

Ref.	Capacitance	Volts D.C. Wkg.	List No.	List Price s. d.
C1/2	50 + 50 $\mu$ F	350	KB 418	12 6
C 3	8 $\mu$ F	450	JF 553TS	3 6
C 4	8 $\mu$ F	450	JF 553TS	3 6
C 5	100 $\mu$ F	12	JF 28T	3 9
C 6	0.02 $\mu$ F	600	A 61	1 1 1/2
C 7	0.1 $\mu$ F	600	A 65	1 6
C 8	0.1 $\mu$ F	600	A 65	1 6
C 9	0.1 $\mu$ F	600	A 65	1 6
C 10	100 $\mu$ F	25	JF 54T	3 9
C 11	100 $\mu$ F	25	JF 54T	3 9
C 12	180pF $\pm$ 5%	350	L 431	1 6
C 13	0.001 $\mu$ F $\pm$ 5%	600	B 822	1 3
C 14	33pF $\pm$ 10%	350	L 430	1 4 1/2
C 15	680pF $\pm$ 10%	350	L 435	1 7 1/2
C 16	270pF $\pm$ 10%	350	L 433	1 4 1/2
C 17	3300pF $\pm$ 10%	350	L 435	3 6

Mounting clip for C 1/2  
 Special price for complete kit **£2. 5. 0**

\* The capacitance at this stage is determined by the impedance of the Loud Speaker.  
 3.75 ohms requires 180pF  $\pm$  5%  
 7 ohms requires 120pF  $\pm$  5%  
 15 ohms requires 82pF  $\pm$  5% } 1/6 each





# *Music in the modern home*

Pye High Fidelity systems herald a new era of good listening and good living. Designed to fit pleasingly into the modern home, these technically perfect units bring you music of every kind — broadcast or recorded — with all the living beauty of the original sound, exactly adjusted to suit your requirements. For full details of Pye High Fidelity systems, see your Pye Dealer or write to the High Fidelity Division, Pye Ltd., Cambridge.

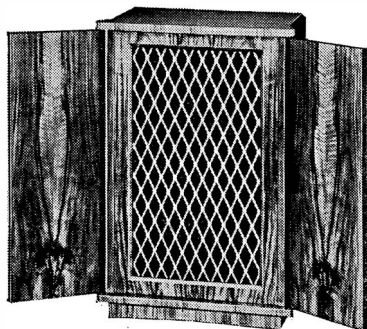
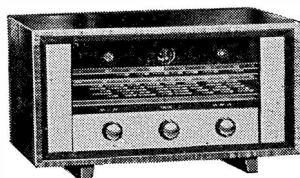
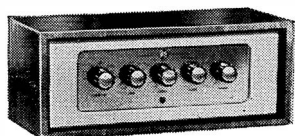

*The units shown are:  
(right) the Concerto  
Dual-Concentric  
Loudspeaker,  
(centre) the FM/AM  
Radio Tuner, and  
(top) the HF25A/W  
Tone Control Unit.*

## **HIGH FIDELITY SYSTEMS**

*— the New Sound in Home Entertainment*

P Y E L I M I T E D O F C A M B R I D G E

# IF YOU LIVE IN THE NORTH L.H.F. of MANCHESTER

Telephone—ARDwick 5762—Telegrams

have the largest and most comprehensive range of  
**QUALITY AUDIO EQUIPMENT** in the provinces.

Direct comparison facilities for the hearing of various makes of Amplifiers and Loudspeakers, and large stocks are held on the premises.

The "L.H.F." organisation is under the control of H. Higham, who has been a student and enthusiast of Sound reproduction for 20 years.

Amongst the well-known makes of equipment stocked and demonstrated, are the following :

## AMPLIFIERS

R.C.A.  
Acoustical  
Goodsell  
Leak  
Armstrong  
Pamphonic  
Rogers  
Pye  
Sound Sales

## SPEAKERS

Wharfedale  
Goodmans  
Pamphonic  
Barker  
Kelly  
Stentorian  
Sound Sales  
Adams  
G.E.C.  
Tannoy

## MOTORS

Garrard  
Connoisseur  
Collaro  
and others

## PICKUPS

Connoisseur  
Ortofon  
Leak  
Tannoy  
Lowther  
etc., etc.

## TUNER UNITS (FM and AM)

Pye  
Acoustical  
Goodsell  
Chapman  
Armstrong

## RADIOGRAM CHASSIS

Armstrong 105  
Empress

## TAPE RECORDERS

Ferroglyph  
Simon  
Wyndson

## TAPE DECKS

Truvox  
Weavite  
Collaro\*  
(\*when available)

*CABINETS stocked and made to order.*

**HIRE PURCHASE AND CREDIT FACILITIES arranged with pleasure.**

Well equipped SERVICE DEPT. for the Maintenance,  
Repair and Overhauling of all types of Audio equipment.

*Direct Delivery Service to all parts of the North.*

**The North's Sound Reproduction Specialists,  
144, OXFORD ROAD, MANCHESTER 13**

*Bus Routes : 41 or 42 (Stop opposite Roxy Cinema). If coming by Car drive towards the University.*



**LANCASTER HI-FIDELITY CO.  
L.H.F.**





# TRADITION

## IN A YOUNG INDUSTRY

The oldest high fidelity amplifiers in the world are of LEAK manufacture. In 1945 as the result of war-time research in our laboratory we were able to offer, to an astonished world of audio engineers, amplifiers with a distortion content as low as 0.1 per cent. A survey of engineering literature will confirm that we were the first manufacturers in the world to design and market amplifiers with such a small distortion content, and the magnitude of this advance can be gauged when it is remembered that the then accepted standard for laboratory amplifiers was 2 per cent. distortion. Our figure of 0.1 per cent. was received with incredulity, but it was subsequently confirmed by the National Physical Laboratory and this criterion is still an accepted world-wide standard.

With this clear lead on low-distortion amplifiers we were able to build up an export market much greater than the domestic one, and the increased volume of manufacture resulted in lower prices, which, in turn, brought real high fidelity amplifiers within the reach of the music-lover at home.

We have devoted 21 years entirely to the development and manufacture of audio products and we are proud of our position as the leaders in this field. We are also proud of the fact that the "Point One" amplifiers supplied to our first customers are still giving them results which, even now, cannot be surpassed. Our research and development departments are ever active, our pre-amplifiers have been redesigned for use with the latest input devices, and we have made great progress in the war on prices. From long experience, by the employment of new techniques and by extreme attention to design details during development work on the pre-production models, we enable our labour force to achieve a high output per man-hour. The labour costs thus saved offset the increased costs incurred for high-grade materials, components and finishes, and this together with quantity production (made possible only by a world-wide market) explains how quality products may be sold at reasonable prices.

To our old customers we give our thanks for their support and recommendation—the basis on which our Company has grown. Those who are seeking to obtain the highest quality of gramophone and radio reproduction would be wise to hear and inspect LEAK products which, with their tradition of excellence, represent the best that can be obtained; used by the B.B.C. and overseas broadcasting companies and recording studios throughout the world.

# LEAK

HIGH FIDELITY  
EQUIPMENT

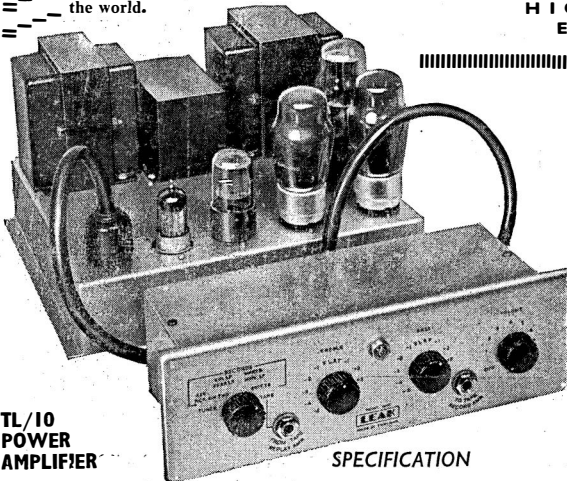

The products we manufacture are:—

Amplifiers  
Dynamic (Moving Coil) Pickups  
F.M. Tuner Units

and later in 1956 a loudspeaker system  
incorporating a balanced push-pull  
electrostatic treble loudspeaker unit

illustrated on left is the

**LEAK TL/10 AMPLIFIER**

AND "POINT ONE"

**PRE-AMPLIFIER 27 gns. complete**

### TL/10 POWER AMPLIFIER

### SPECIFICATION

### "POINT ONE" PRE-AMPLIFIER

Maximum power output : 10 watts.  
Frequency Response :  $\pm 1$  db 20 c/s to 20,000 c/s.  
Harmonic Distortion : 0.1%, 1,000 c/s, 7.5 watts  
output.  
Feedback Magnitude : 26 db, main loop.  
Damping Factor : 25  
Hum : —80 db referred to 10 watts.  
Loudspeaker Impedances : 16 ohms, 8 ohms, and  
4 ohms.

### ELECTROSTATIC LOUSPEAKERS

Reprints of "The Gramophone" article (May, 1955), by  
H. J. LEAK, summarising his work and findings on  
Electrostatic and Dynamic Loudspeakers, are available  
on request free of charge.

**H. J. LEAK & CO. LTD., BRUNEL ROAD, WESTWAY FACTORY ESTATE, ACTON, W.3**

Telephone : SHEpherds Bush 1173/4/5

Telegrams : Sinusoidal Ealux London Cables : Sinusoidal London

### ★ Pickup

The pre-amplifier will operate from any pickup generally available in the world. A continuously variable input attenuator at the rear of the pre-amplifier permits the instantaneous use of crystal, moving-iron and moving-coil pickups.

### ★ Distortion

Of the order of 0.1%.

### ★ Treble

Continuously variable, +9 db to —15 db at 10,000 c/s.

### ★ Bass

Continuously variable +12 db to —13 db at 40 c/s.

★ Write for leaflet H.F. ★

# OUR SPECIAL HIGH-FIDELITY RECORD REPRODUCER

built around

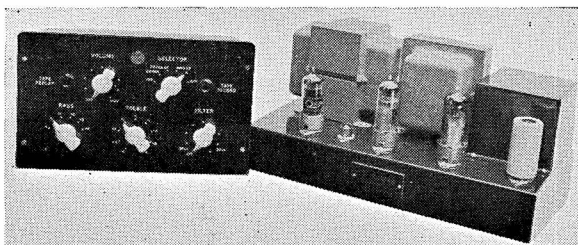

*THE ROGERS RD JUNIOR AMPLIFIER*

CONSOLE CABINET—CORNER REFLECTOR CABINET  
ROGERS RD JUNIOR AMPLIFIER AND CONTROL UNIT  
COLLARO 2010 TRANSCRIPTION UNIT  
WHARFEDALE 10 in. CSB SPEAKER

Assembled, Fixed and Delivered Anywhere  
2 YEARS' GUARANTEE

**£76 . or**

SIX MONTHLY PAYMENTS OF £13

Photos and Details of other Equipment on Request

*Official Stockists for Quad, Pamphonic,  
Rogers, and other High Fidelity Equipment*

## H. C. HARRIDGE

8 MOOR ST., CAMBRIDGE CIRCUS, W.1.

Hours of Business :

Monday, Tuesday, Wednesday	..	..	..	..	..	..	..	..	10 a.m. to 5.30 p.m.
Friday	..	..	..	..	..	..	..	..	10 a.m. to 7.00 p.m.
Saturday	..	..	..	..	..	..	..	..	10 a.m. to 5.00 p.m.
Thursday	..	..	..	..	..	..	..	..	Closed all Day

# - towards perfection -

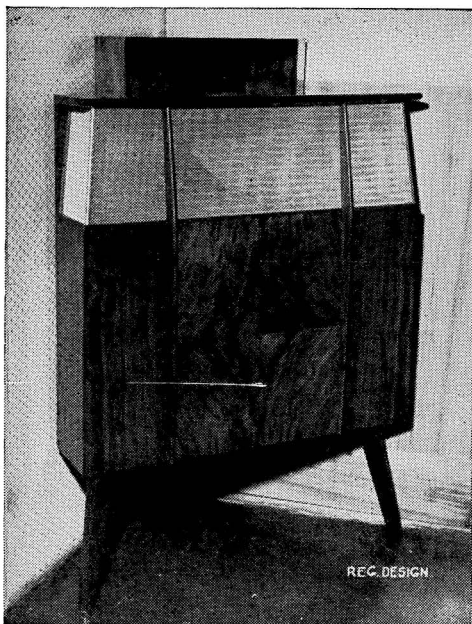

**Type T.P.1 £96**  
as illustrated. Finished in walnut or oak (ex works).

## ACCLAIMED . . . BRITAIN'S FINEST AUDIO REPRODUCER

- ★ Built as a musical instrument, sounds like a musical instrument.
- ★ This amazing development is yet another Lowther contribution to the art of electro-acoustic reproduction.
- ★ The most efficient reproducer of audio frequencies in the world with single driver unit/compound horn housing.
- ★ Now in use by Television, Broadcasting and Recording studios throughout the world as a standard monitor.

For details of this and other Lowther products please write to :

**THE LOWTHER MANUFACTURING COMPANY - LOWTHER HOUSE  
ST. MARK'S ROAD - BROMLEY - KENT - ENGLAND**

Telephone : RAVensbourne 5225

THE WORLD TURNS TO  **COLLARO**  
QUALITY PRODUCTS

## THE NEW COLLARO TAPE TRANSCRIPTOR

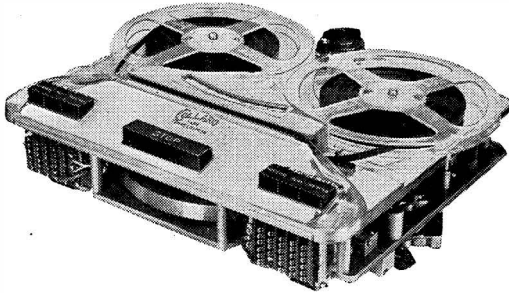

This new High-Fidelity Tape Deck has been designed on Transcription quality principles for live recording, recording from F.M. Broadcasts, etc., and reproducing pre-recorded tapes. A twin-track model fitted with four heads, it runs at speeds of  $3\frac{1}{2}$ ,  $7\frac{1}{2}$  and 15 inches per second. It has low wattage input motors, and the tape tensioning is automatic.

The operation and the braking are mechanical and performed without the aid of rubber belts or solenoids. The 3-speed mechanism effects the final drive through the periphery of a heavyweight flywheel and is instantaneously reversible. The drive pulleys retract automatically when the machine is switched off.

### **3-SPEED GRAMOPHONE TRANSCRIPTION UNIT (MODEL 2010)**

Entirely new type 3-speed mechanism ensures absolutely uniform speed, with reproduction free from frequency modulation. A very heavy turntable is fitted with a ground and lapped spindle running onto a ball which takes the entire thrust of the turntable, and results in correct speed with no detectable "wow" or "rumble." Any type of "Studio" turnover crystal cartridge can be fitted. Model 2010 can also be supplied without pickup.

**COLLARO LTD., Ripple Works, By-Pass Road, Barking, Essex.**

Telephone : Rippleway 5533-Telex 8748

Telegrams : Korllaro-Telex-Barking

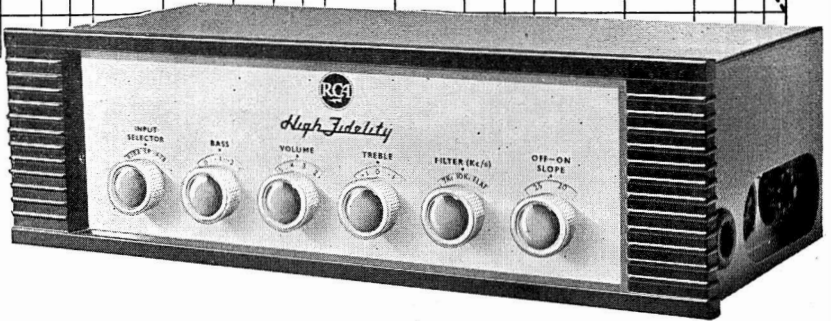
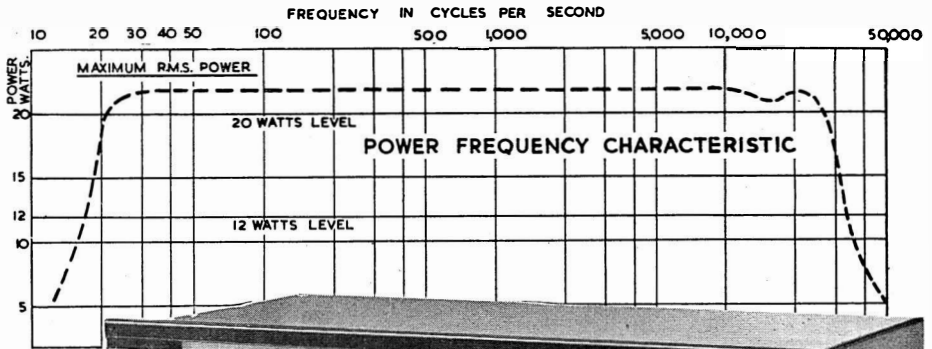

## *New Orthophonic High Fidelity*

The RCA amplifier embodies features entirely new to audio engineering and is the result of 25 years intense specialisation in professional sound engineering.

- Main amplifier output, 12 watts nominal rating. Peaks in excess of 20 watts with power maintained over frequency range 25/20,000 c.p.s.
- Frequency response, within 0.2 db 20/25,000 c.p.s. Within 0.5 db 10/60,000 c.p.s.
- R.I.A.A. 11.5 m.v. input for rated output 500 c/s turnover. 12 db roll off at 10 K/cs, 3 db flattening at 50 c/s.
- Mixing facilities for microphone input with Radio/Tape.
- Twin ganged control with accurate volume gradation.

*The RCA New Orthophonic High Fidelity equipment comprising pre-amplifier control unit (above) and main amplifier (right) £48.0.0*

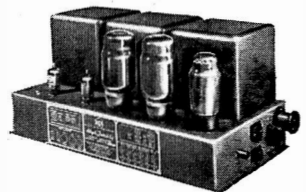

RCA PHOTOPHONE LTD., LINCOLN WAY, WINDMILL ROAD, SUNBURY-ON-THAMES, MIDDLESEX  
(An associate Company of Radio Corporation of America.)

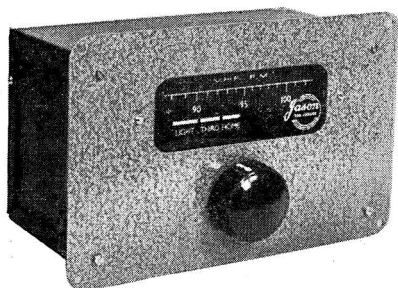

OUR F.M. TUNER IS REASONABLY PRICED AT £16 12s. 7d. (INCLUDING TAX), AND MAY BE USED WITH ANY AMPLIFIER. A SEPARATE POWER SUPPLY IS NORMALLY NOT REQUIRED, SINCE THE H.T. CURRENT CONSUMPTION IS ONLY 25 mA AT 220 VOLTS.

## JASON—SPECIALISTS IN F.M.

THE JASON MOTOR & ELECTRONIC CO.  
328, CRICKLEWOOD LANE,  
LONDON, N.W.2

Telephone: SPE 7050

OUR MEDIUM-WAVE AND F.M. TUNER HAS F.M. AUTOMATIC FREQUENCY CONTROL, MAKING THIS THE IDEAL TUNER FOR USE WITH A TAPE RECORDER. THE UNIT IS SELF POWERED, MINIMISING THE INTER-CONNECTIONS. THE PERFORMANCE IS NOT IN ANY WAY DEGRADED BY COMBINING THE TWO BANDS. THE 'FRONT ENDS' ARE QUITE SEPARATE, AND THE F.M. HAS A LOW NOISE 'CASCODE' INPUT.

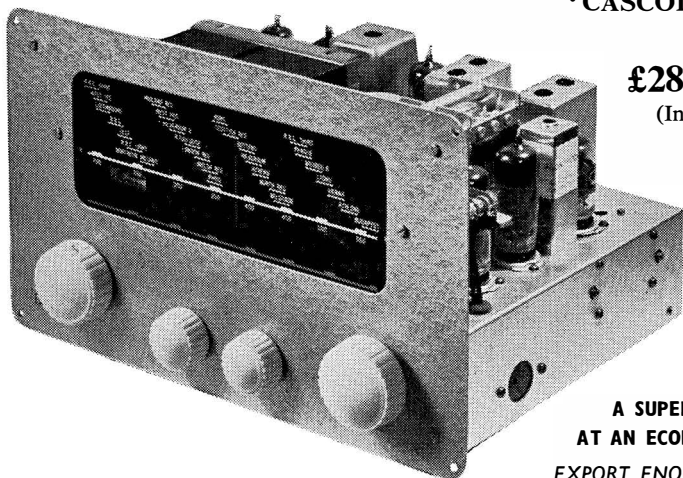

PRICE  
£28 13s. 6d.  
(Including Tax)

COMING  
SHORTLY

A SUPERIOR AMPLIFIER  
AT AN ECONOMICAL PRICE.  
EXPORT ENQUIRES INVITED.

<sup>66</sup>STEREOSOMIC<sup>99</sup>

# ***TAPE RECORDINGS***

---

the amazing  
achievement of recording sound in  
depth and breadth

---



AVAILABLE ONLY ON  
***"HIS MASTER'S VOICE"***

AND ***COLUMBIA***

RECORDINGS



*Details from your record dealer  
or direct from E.M.I. LIMITED*

(RECORD DIVISION) • 8-11 GT. CASTLE STREET • LONDON • W.1.

# “HIS MASTER’S VOICE” ‘stereosonic’ sound!

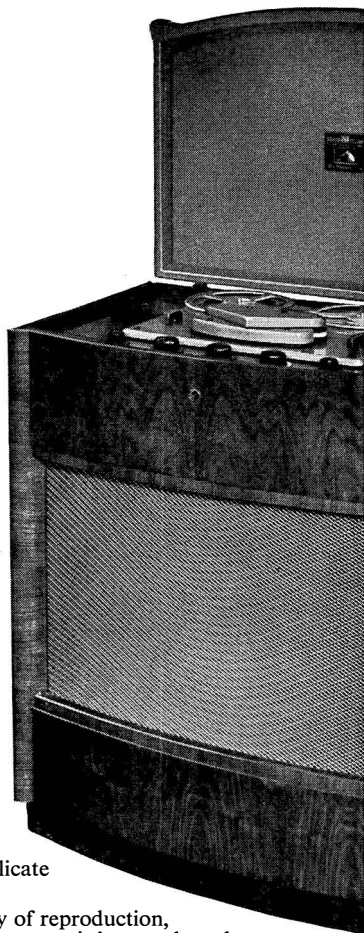
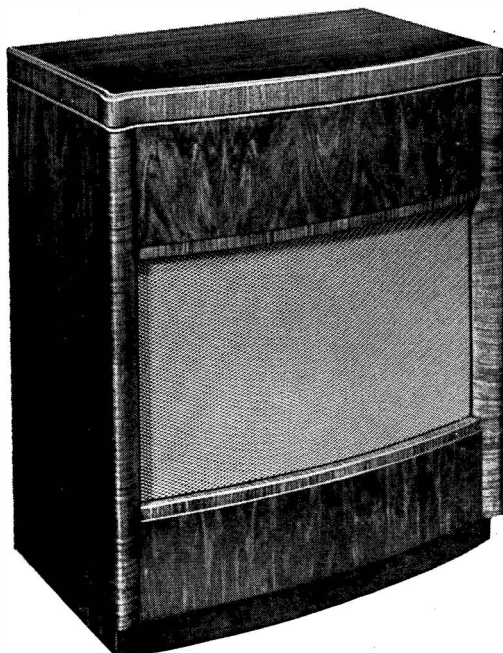

**MODEL 3034**—Specially designed for reproducing the remarkable ‘Stereosonic’ Tape Records with all the outstanding qualities of breadth, perspective and direction, which make ‘Stereosonic’ sound the only true re-creation of the dimensional atmosphere of the original performance.

The two finely figured walnut veneer cabinets are identical in external appearance. One contains the tape deck, the two pre-amplifiers, one power amplifier, and one loudspeaker system; the other houses a duplicate power amplifier and loudspeaker system.

This superb equipment gives the highest possible quality of reproduction, not only from “His Master’s Voice” and Columbia ‘Stereosonic’ tapes, but also from the normal (single channel) tape records.

*Write for full technical details of these High Fidelity tape models*

**MODEL 3031**

Table model tape player for single-channel tape records, or other tapes recorded at  $7\frac{1}{2}$ "/sec., full or half-track. For use with existing radios, radiograms or amplifier-loudspeaker combinations.

Price 48 GNS. (P.T. exempt)

**MODEL 3032**

Console model similar to Model 3031 but with ample storage space for tapes and discs.

Price 69 GNS. (P.T. exempt)

**MODEL 3033**

A self-contained reproducer for single-channel tape records, or other  $7\frac{1}{2}$ "/sec. tapes. Incorporates high fidelity amplifier and dual-speaker system.

Price 155 GNS. (P.T. exempt)

**MODEL 3034**

As illustrated and described above.

Price 275 GNS. (P.T. exempt)



## “HIS MASTER’S VOICE”

THE GRAMOPHONE COMPANY LTD. - HAYES - MIDDLESEX





# VITAVOX

## loudspeakers and microphones

Type B.50 Dynamic Microphones are available without switch or with "press-to-talk" switches. Nominal frequency response is 60-8000 c.p.s. Standard finish is Bronze Hammetone.

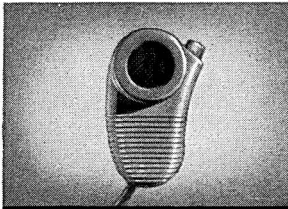

Type B.51 is a Piezo Crystal Microphone with a choice of four different "press-to-talk" switching arrangements or without switch.

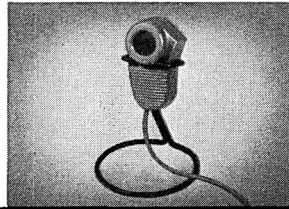

Type B.52 Microphone incorporating matching transformer in place of switch and connects direct to grid or medium impedance lines.

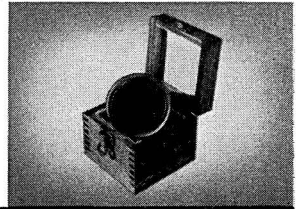

Type "A" Dynamic Microphones have for some time, been the favourite instrument for high grade sound reinforcement.

The GP.1 Pressure Unit is of minimum size and weight consistent with a high standard of performance and reliability.

A wide range of horns includes Multicell, Car Mounting and Circular Exponential types designed to give maximum efficiency.

Type K12/10 and K12/20 cone type moving coil loudspeakers incorporate the latest high efficiency magnet systems. P.H.C. 10 and 20 W.

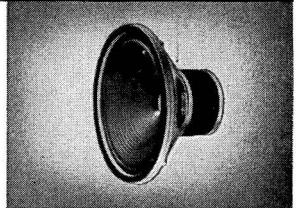
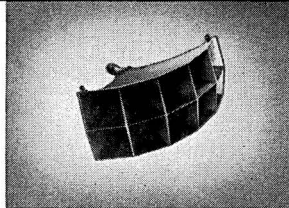
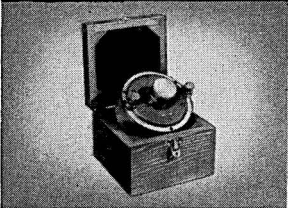

*Fullest information on these  
and other Vitavox products  
gladly sent on request.*

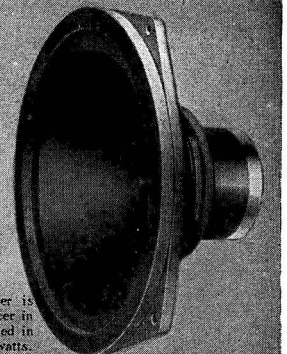

VITAVOX LIMITED  
Westmoreland Road, London, N. W. 9.,  
England. Telephone: COLindale 8671.

The K15/40 moving coil loudspeaker is usually employed as a L.F. reproducer in dual channel systems of the type used in cinemas. Power handling capacity 40 watts.

OMNI-DIRECTIONAL

# 3-Speaker System

W15C/S SUPER 8/CS SUPER 3

*Treble Units Facing Upwards ; Crossover Frequencies 800 and 5,000 c/s.*

The bass speaker is the W.15/CS with a fundamental resonance below 30C/S ; the middle speaker is the Super 8/CS ; and the third speaker is the new Super 3 with response well maintained to 20,000 C/S. The crossover unit is a  $\frac{1}{2}$  section type, with crossover frequencies of 800 and 5,000 C/S. A volume Control is fitted to the middle and top speakers which also face upwards to avoid undue directional effects.

This Speaker System has been used in highly successful Lecture Demonstrations at the Royal Festival Hall and at the Carnegie Hall, New York.

## PRICES (TAX FREE)

W.15/CS sand-filled Enclosure ..	£47	0	0
Treble Assembly .. ..	£18	0	0
HS/CR3 Crossover with V.C.'s ..	£8	10	0
	£73	10	0

*2 Sand-filled Back Panels (40 in. x 24 in.) to complete the enclosure, where a suitable corner is not available, can be supplied at £12 per pair.*

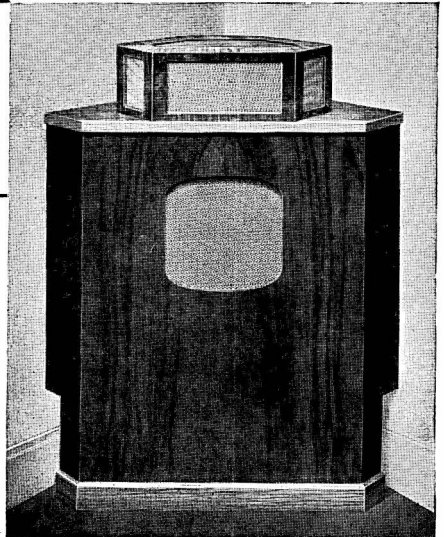

# Wharfedale

WIRELESS WORKS LTD.

BRADFORD ROAD · IDLE · BRADFORD · YORKS

Phone: Idle 1235/6 (2 lines).

Grams: Wharfedel, Idle, Bradford.

# RD JUNIOR

AMPLIFIER AND CONTROL UNIT



Most popular in a range of equipment designed expressly for domestic high fidelity systems, the RD JUNIOR Amplifier and Control Unit meet the requirements of the average installation. Push-pull EL84s—8-10 watts output. **£26** complete.

## RD JUNIOR

VHF FM UNIT

A 7-valve receiver of advanced design, the RD JUNIOR F.M. unit employs the very latest techniques and has one of the most ambitious specifications so far offered in this country. We are confident that it will prove a worthy counterpart to the RD JUNIOR Amplifier, with which it has primarily been designed to work.

Price **£17.10.0** (P.T. **£7.7.0**)

## RD JUNIOR

CORNER HORN

Primarily intended to house the exceptional Goodmans Axiom 102 speaker, the Junior Corner Horn combines excellent bass response with virtually perfect treble diffusion to provide a standard of performance far superior to that suggested by its modest price. Compact in size it is the ideal reproducer for domestic use and the perfect companion for the RD JUNIOR Amplifier. Basic price less speaker and side panels, **£18.17.6**

## RD SENIOR

MAIN AMPLIFIER

Providing a standard of reproduction limited only by the equipment with which it is used the RD SENIOR is suitable for the most ambitious domestic installation and is the obvious choice for music societies, schools, etc. Push-pull EL34s 15-20 watts output. Price **£28** complete.

All units share an unusually high standard of construction and wiring which together with the use of high grade conservatively rated components combine to provide absolute reliability, a factor reflected in the TWO YEAR GUARANTEE covering all our products.

Illustrated literature dealing with all units, and in particular a 12-page Booklet dealing solely with the RD JUNIOR Amplifier and Control Unit, is available post free on request. Trade and Export enquiries invited.

## RD SENIOR

MK. III CONTROL UNIT

An entirely new design intended to work with either the Junior or Senior main amplifier, used in place of the Junior Control Unit, it affords greater flexibility of control and increased sensitivity. Price **£14** complete

**ROGERS DEVELOPMENTS (ELECTRONICS) LTD.**

"Rodevco House," 116, Blackheath Road, Greenwich, London, S.E.10

Telegrams: RODEVCO GREEN LONDON

Telephone: TIDeway 1723

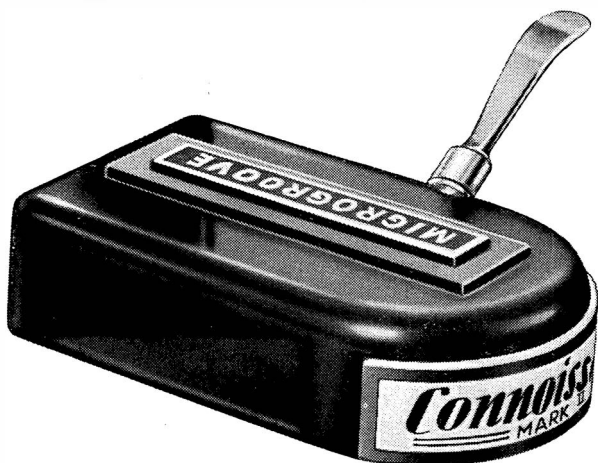

# *Connoisseur*

## **Sound Products**

manufactured by A. R. Sugden & Co. (Engineers), Ltd.  
36, Well Green Lane, Brighouse, Yorkshire.

Range of products manufactured for use in High Fidelity home installations, Recording and Broadcast Studios.

- 12 in. Transcription Turntables.
- 16 in. Transcription Turntables.
- Disc Recorder and associated equipment.
- Playback and recording amplifiers.
- Magnetic light-weight pickups and arms.

Illustrated is the Connoisseur Super Light-Weight Pickup Mark II, which gives a frequency range  $\pm 2$  db from 20 c/s to 20 Kc/s. at  $33\frac{1}{3}$  r.p.m. The voltage output is 15 mV from I.p. discs.

# Experts' Choice

"TRI-CHANNEL" — The 3C of REPRODUCTION  
A unique system for those who desire the world's best.

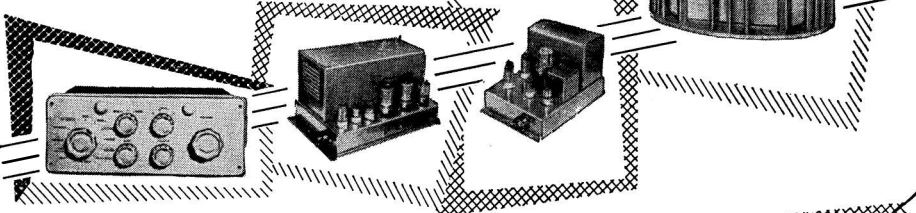

◀ THE NEW SENIOR "A-Z" 20W  
WIDE RANGE AMPLIFIER  
THE ACE OF MEDIUM-  
POWERED AMPLIFIERS ▶

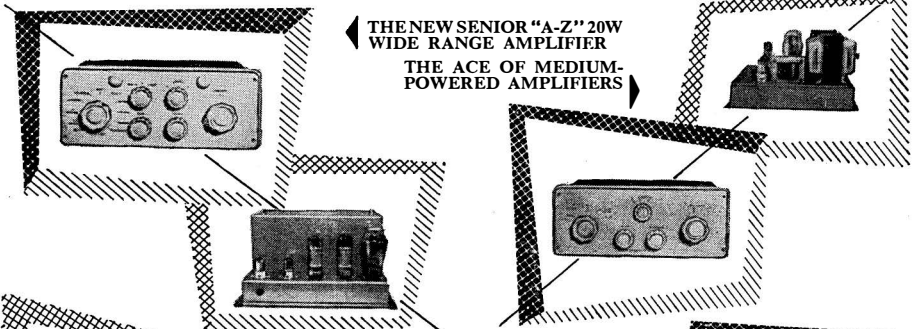

THE NEW LOOK F.M. UNIT and the  
NEW LOOK "A-Z" RADIO UNIT ▶

THE FAMOUS PHASE INVERTER with  
optional H.F. Attachment.

The above is a glimpse of a world famous range of  
"hi-fi" equipments based on twenty-five years'  
experience plus enthusiasm.

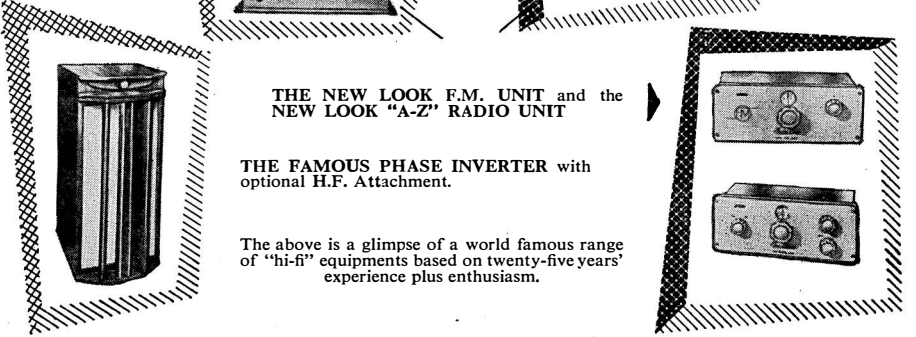

## SOUND SALES LIMITED

*Works and Acoustic Laboratories*

**WEST STREET, FARNHAM, SURREY, ENGLAND**

Tel. Farnham 6461/2/3

Grams. "Sounsense, Farnham"

**NEW YORK · MALAYA · HONG KONG · SOUTH AFRICA · NEW ZEALAND · ITALY**

## COMBINED FORGES—ffrr and the ORTOFON PICK-UP

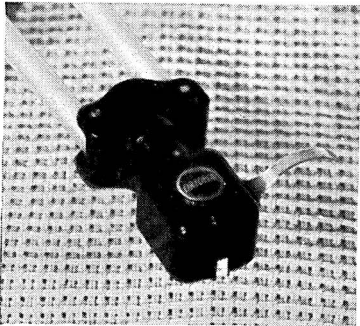

**DECCA** made a tremendous forward stride in the Science and Art of disc-recording when they introduced in 1945 frr (full frequency range recording).

They reached another landmark when in 1950 they allied this system to their Long Playing records. We marvel at Decca's achievements in this specific field. Let me state that there is no prejudice in my judgment—the proof is “on record.”

Such wonderful recording is worthy of a wonderful Pick-up. Imagine the tremendous advantage to be gained by incorporating the Ortofon Pick-up with your Reproducer. The Ortofon is the only

Pick-up available in which the unrivalled moving-coil principle has been married to that of the cantilever stylus. It is available in this country principally in two types—namely, “C” and “AB,” in their different price categories. We specialise in the type “C.” This is the more expensive, and the finest Pick-up that money can buy. Write for Brochure. Price : Type “C,” with transformer and including Purchase Tax, £19 4s. Fred Smith.

**RIMINGTON VAN WYCK**

*42 Cranbourn Street London WC2 GERrard 1171*

Take two

letters ...

*. . . typed on different machines. Both may be perfect, yet they will not look the same. You may prefer one, but you cannot say that the other is bad.*

Now take two different combinations of high fidelity equipment, of equal technical merit. Connoisseurs will say with conviction that one is better than the other, but the choice will vary. Why? Because it is always a matter of taste.

We at Classic recognise this divergence of opinion. With a natural desire to please everyone, we stock all the high quality equipment available, and our showroom is equipped to give comparative demonstrations. But we go further than that. We carry out these demonstrations for our own information, so that we can give the fullest possible advice to customers who cannot call, and we back it with a very efficient export despatch department. In this way we have established a specialised Hi-Fi service that is second to none, not only supplying the needs of music lovers at home, but satisfying the demands of an ever-increasing number of enthusiasts in many countries throughout the world.

Our catalogue of high fidelity-record reproducing and tape recording equipment will gladly be sent free on request

# CLASSIC

**ELECTRICAL COMPANY LIMITED**

*THE QUALITY SPECIALISTS IN HI-FI AND TAPE RECORDING EQUIPMENT*

352-364 Lower Addiscombe Road, Croydon, Surrey, England.

Telephone : ADDiscombe 6061



# RECORDING TAPE SPLICER

**“Everyone who uses a tape recorder will need this little tool. It is indispensable.”**

WROTE P. WILSON, TECHNICAL CORRESPONDENT OF “THE GRAMOPHONE”

The Bib Tape Splicer enables tape to be jointed easily and tapes to be edited to the accuracy of a syllable. The splicer will pay for itself in a short time because all spare lengths of tape can be quickly jointed and used for recording, without the joints being heard. Use the Bib—a professional type splicer—and *enjoy* editing your tapes. Send a stamped addressed envelope to the address shown below for a helpful leaflet on tape editing. The Bib Splicer is supplied complete

with razor cutter and mounted on flock covered panel. It may be conveniently mounted on the decks of most tape recorders. All Ferrograph Recorders are now supplied with holes already drilled to take Bib Splicers.

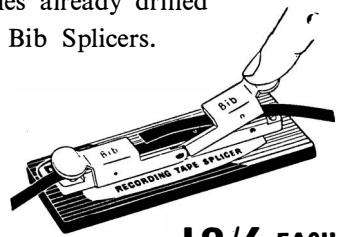

**18/6 EACH**

## BIB WIRE STRIPPER & CUTTER

This three-in-one tool strips insulation without nicking the wire, cuts wires cleanly and splits plastic extruded twin flex. The Bib Wire Stripper and Cutter saves hours of time and irritation, particularly when a number of connections have to be made in the assembly of units of a high fidelity installation.

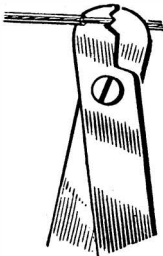

3/6 each

## ERSIN MULTICORE SOLDER 5 CORES NON-CORROSIVE FLUX

Home Constructor's Pack contains either 19 ft. of 18 s.w.g. 60/40 alloy—for soldering screened leads and wire to tag joints of amplifiers, pickups, etc.—or 40 ft. of 22 s.w.g. 60/40 alloy—for the soldering of printed circuits.

2/6 each

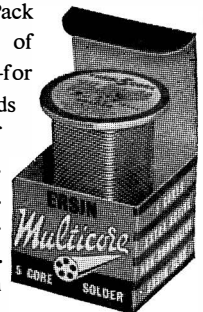

## MULTICORE SOLDERS LTD.

MULTICORE WORKS, DEPT. H.F.I., HEMEL HEMPSTEAD, HERTS. (BOXMOOR 3636)



***We invite you...***

to write for full details of these two outstanding products in our range of Sound Reproducing Equipment



*The Sign for Sound*

# 1

**THE THERMIONIC  
10 WATT AMPLIFIER  
AND CONTROL UNIT**

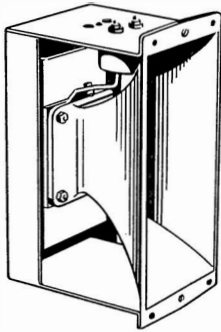
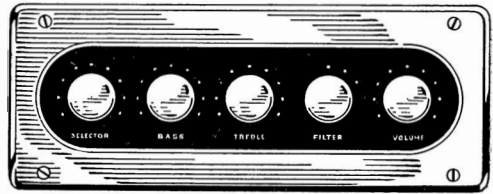

# 2

**THE RLS/I  
RIBBON TWEETER, BEING  
DEMONSTRATED IN FOUR  
DIFFERENT LOUDSPEAKER  
SYSTEMS**

*Two other established products—*



**DIPLOMAT  
DICTATING  
MACHINE**

**MULTI-  
CHANNEL  
AIRPORT  
RECORDER**

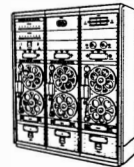

**THERMIONIC PRODUCTS LIMITED  
HYTHE · SOUTHAMPTON · ENGLAND**

Telephone: Hythe (Southampton) 3265/9

Cables: Technico, Hythe, Southampton

# VORTEXION

## HIGH QUALITY TAPE RECORDER

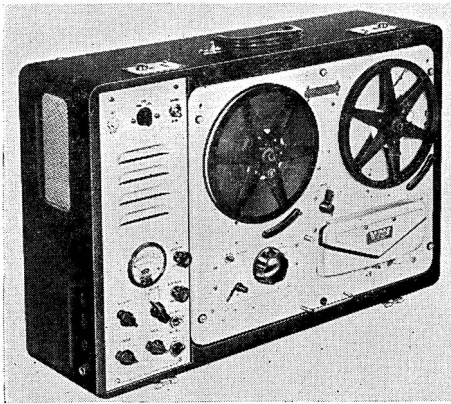

- ★ The total hum and noise at  $7\frac{1}{2}$  inches per second 50-12,000 c.p.s. unweighted is better than 50 dbs.
  - ★ The meter fitted for reading signal level will also read bias voltage to enable a level response to be obtained under all circumstances. A control is provided for bias adjustment to compensate low mains or ageing valves.
  - ★ A lower bias lifts the treble response and increases distortion. A high bias attenuates the treble and reduces distortion. The normal setting is inscribed for each instrument.
- ★ The distortion of the recording amplifier under recording conditions is too low to be accurately measured and is negligible.
  - ★ A heavy mu-metal shielded microphone transformer is built in for 15-30 ohms balanced and screened line, and requires only 7 micro-volts approximately to fully load. This is equivalent to 20 ft. from a ribbon microphone and the cable may be extended 440 yds. without appreciable loss.
  - ★ The 0.5 megohm input is fully loaded by 18 millivolts and is suitable for crystal P.U.'s, microphone or radio inputs.
  - ★ A power plug is provided for a radio feeder unit, etc. Variable bass and treble controls are fitted for control of the play back signal.
  - ★ The power output is 3.5 watts heavily damped by negative feedback and an oval internal speaker is built in for monitoring purposes.
  - ★ The play back amplifier may be used as a microphone or gramophone amplifier separately or whilst recording is being made.
  - ★ The unit may be left running on record or play back, even with 1,750 ft. reels, with the lid closed.

**PRICE, complete with WEARITE TAPE DECK, £84 0 0**

**Power Supply Unit** to work from 12-volt Battery with an output of 230 volts, 120 watts, 50 cycles within 1 per cent. Suppressed for use with Tape Recorder. **PRICE £18 0 0**

---

---

## VORTEXION LTD.

**257-263, THE BROADWAY, WIMBLEDON, LONDON, S.W.19**

Telephone: LIB. 2814 and 6242-3

Telegrams: "Vortexion, Wimble, London."

# *HI-FI at your fingertips . . .*

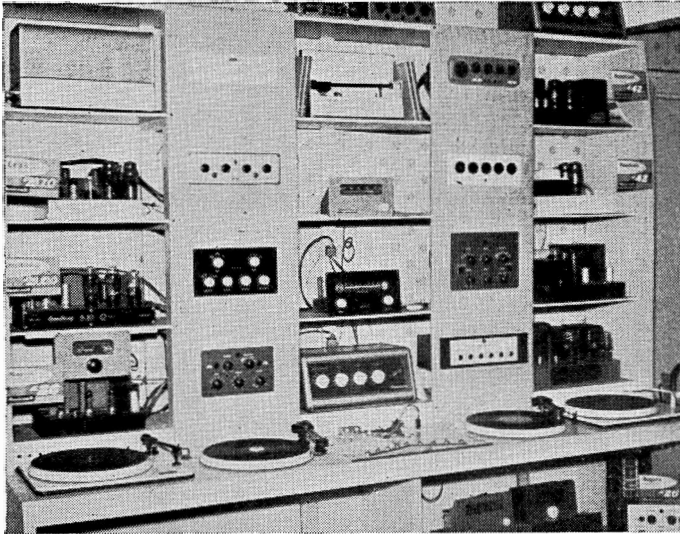

At Musicraft we have selected the **best** loudspeakers, amplifiers, pickups etc., **in their price range** and installed them with an overall control panel. You can listen to any amplifier playing with any loudspeaker or other unit of Hi-Fi equipment - with an eye on your needs and budget - merely at the turn of a switch.

## *EQUIPMENT ON DEMONSTRATION INCLUDES:*

### **SPEAKERS BY**

PAMPHONIC  
TANNOY  
WHARFEDALE  
GOODMANS

### **PICKUPS BY**

LEAK · TANNOY  
DECCA · COLLARO  
B.J.

### **AMPLIFIERS BY**

TANNOY · LEAK  
PAMPHONIC  
ROGERS · E.A.R.  
ARMSTRONG  
etc., etc.

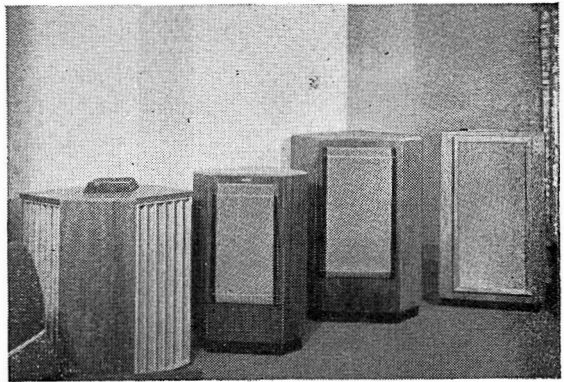

We also have in our showroom a large selection of enclosure and loudspeaker cabinets of our own make as well as other reputable manufacturers. Classical or contemporary - we can suit your taste and pocket.

# ***Musicraft***

20/22 High Street · Southall · Middlesex  
Tel: SOUThall 2838

Opp. Town Hall: Buses 83, 105, 120, 607. Western Region trains

# BJ

T  
A  
N  
G  
E  
N  
T  
I  
A  
L

## The Most Famous Name In Pick-up Arms

### *The "Super 90"*

Complete versatility and adaptability make this the most advanced arm in the world. Friction-free tangential tracking goes with finger-touch pedestal adjustments and counter balances. An effortless optimum is achieved with any choice of head or cartridge.

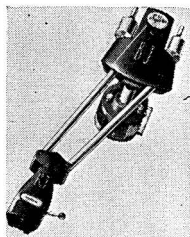

### *BJ Standard Arm*

By overcoming tracking error BJ sets a new standard in high fidelity reproduction. Its addition to any gramophone immediately reveals the advantages of reduced distortion and longer record life.

### *The Plug-in Shell*

Designed to adapt all popular cartridges to the BJ arms, the shell's attractive lines and versatility are combined with finger lift control. Cartridges include Tannoy, Goldring, Collaro, Acos and most American types.

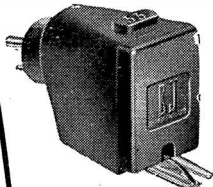

### *The BJ C12 Head*

The advantages of high sensitivity and cantilever stylus action are united in a head of extremely low mass. The total weight is only 11 grammes.

### *Counterweight Unit*

The addition of this weight unit to the standard arm permits speed and accuracy in weight compensation. The total point pressure range is 4 grammes.

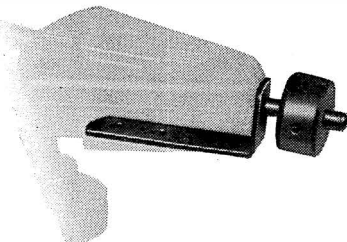

ASK YOUR LOCAL DEALER FOR FULL DETAILS

**BURNE JONES • LONDON • ENGLAND**

# The STENTORIAN Range of High Fidelity Equipment

The New W.B.12  
High Fidelity  
Amplifier  
Price £25

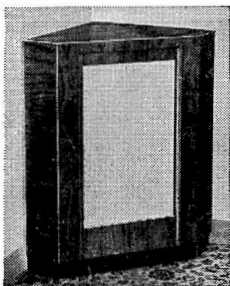
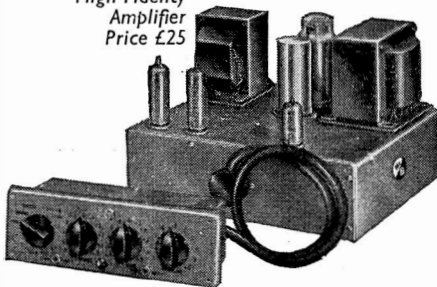

Ready to assemble  
Cabinets from £5.10.0  
Bass Reflex Corner  
Console. Price £11.11.0



Tweeter Units  
£4.4.0 &  
£12.12.0

Stentorian  
12" Concentric  
Duplex Loudspeaker  
£25; 10" Unit £10.19.6.

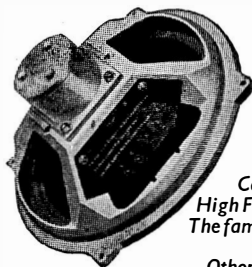
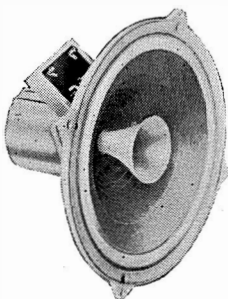

Stentorian  
Cambric Cone  
High Fidelity Units  
The famous HF1012  
at £4.19.9  
Others from 47/6



Radio and T.V.  
Trolley Tables  
70/-, 98/- &  
105/-



T.V. & Record Cabinets  
£9.14.3 & £10.4.9

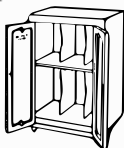

High Fidelity enthusiasts who have proved for themselves the quality of our products will forgive us if we repeat—for the benefit of those others who have yet to follow suit—that the Stentorian range has demonstrated that true High Fidelity is obtainable at very realistic cost.

The results of 30 years' experience in sound reproduction are embodied in all W.B. lines—in speakers, cabinets and in the amazing W.B.12 Amplifier. The success of our efforts is evidenced by the letters which arrive daily from all parts of the world.

Descriptive leaflets sent on request, or ask your usual dealer to demonstrate.



WHITELEY ELECTRICAL RADIO CO. LTD • MANSFIELD • NOTTS

# THE 3 LEADING SPECIALISED PUBLICATIONS

PLANNED TO COVER THE WHOLE FIELD OF  
SOUND RECORDING AND REPRODUCTION

## RECORD NEWS

for the "classics"

● In *Record News* all the new releases are catalogued each month. All discs are reviewed by a panel of 25 specialists. Full details are given of artists, prices, playing times, release dates, and U.S.A. equivalent numbers. This complete survey is only to be found in *Record News*. Specimen copy on request.

## POP RECORDS

for popular and jazz

● In *Pop Records* are reviews of all types of music and recordings beyond the scope of *Record News*. Here again the reviewers are specialists in their subjects—Jazz, Strict Tempo, Show music, Latin-American, and popular music. *Pop Records* is profusely illustrated. Specimen copy on request.

## HI-FI NEWS

for equipment and tape

● In *Hi-Fi News* will be found a complete month-by-month survey of everything that is new in the Audio field. Reviews of all new apparatus, photographs and diagrams, will make *Hi-Fi News* the most informative paper of its kind. Specimen on request.

BY THE SAME EDITORIAL OFFICE  
AS 'HI-FI YEAR BOOK'

99 MORTIMER STREET, LONDON, W.1

## record news



Monthly . . . . . 1s. 6d.

## pop records

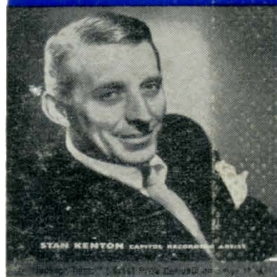

Monthly . . . . . 1s. 6d.

## hi-fi news

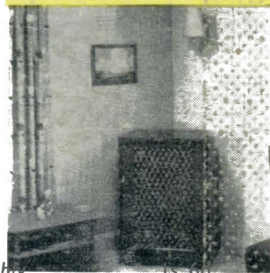

Monthly . . . . . 1s. 6d.