

HI-FI WORLD

MAY 2022

UK £5.00

www.hi-fiworld.co.uk

FREE READER CLASSIFIED ADS IN THIS ISSUE!



MONOPULSE MODEL S A
active loudspeakers **EXCLUSIVE!**



DIAD C 399 **EXCLUSIVE!**
hybrid digital dac amplifier



Audio M17
digital audio player **EXCLUSIVE!**

EXCLUSIVE!

TEAC UD-701N

network player/dac

COMPETITION



**WIN A BLUE AURA BLUE 1
RECEIVER WORTH £399!
(UK ONLY)**



- PURE EVOKE PLAY SMART RADIO** **EXCLUSIVE!**
- PRO-JECT CD BOX S3 CD PLAYER** **EXCLUSIVE!**
- Q ACOUSTICS M20 HD ACTIVE SPEAKERS**
- MUSICAL FIDELITY LX2 LPS PHONO STAGE**

MAY 2022



9 770961 766215



**SIX PAGES OF LETTERS - THE BEST WINS A PAIR OF
ACOUSTIC ENERGYS NEW AE100² LOUDSPEAKERS! (UK ONLY)**

Winning performance



CHORDTM
COMPANY



Audiophile quality at a realistic price

The multi-award-winning Chord Company cables feature the latest high-performance shielding and our unique ARAY technology, first introduced on our flagship products and now benefitting all ranges.

A wide variety of analogue and digital interconnects are available alongside high-performance speaker, tone arm, mains power and HDMI cables. We also supply stand feet, contact cleaner and the acclaimed English Electric 8Switch and 16Switch.

Proudly designed in England since 1985 by a dedicated team of music, cinema and game lovers. Used and recommended worldwide by a host of professionals, including record producers, studio engineers, musicians and hi-fi manufacturers.

Ask your nearest Chord Company retailer for a demonstration/loan - including the new Chord Company PowerHAUS mains blocks.

Find out more: www.chord.co.uk



World Radio History

Grand Prix

welcome

EDITOR

Noel Keywood
e-mail: editorial@hi-fiworld.co.uk

DESIGN EDITOR

Faiza Chunara
tel: +44 (0)7399 361 785
e-mail: adproduction@hi-fiworld.co.uk

PRODUCTION EDITOR

David Noble
tel: +44 (0) 207 286 1270
e-mail: classifieds@hi-fiworld.co.uk

SALES MANAGER

Louise Palfrey
mob: +44 (0) 7917 047 548
e-mail: louise@hi-fiworld.co.uk

ADVERTISING EXECUTIVE

Rose Williams
mob: +44 (0) 7956 885 189
e-mail: rose@hi-fiworld.co.uk

PUBLISHER

Noel Keywood
e-mail: publisher@hi-fiworld.co.uk

FREE READERS CLASSIFIEDS

tel: +44 (0) 207 286 1270
e-mail: classifieds@hi-fiworld.co.uk

SUBSCRIPTIONS

tel: +44 (0) 1442 820 580
fax: +44 (0) 1442 827 912
e-mail: hi-fiworld@webscribe.co.uk

PHOTOGRAPHY

David Noble
tel: +44 (0) 207 286 1270

WRITERS

Paul Rigby, Martin Pipe, John Pickford.



Difficult to explain why a premium digital-to-analogue convertor should measure badly, especially from top Japanese manufacturer Teac. They don't clearly state what is different about the UD-701N, only listing technicalities such as optional one-bit or multi-bit operation. This doesn't say a lot, even to a digital engineer. Instead you are expected to listen and make up your own

mind – not always so easy. Our Rohde&Schwarz UPV audio analyser however showed very clearly what this convertor was doing and how it differed from the norm – as set by ESS and their dominance of the world-wide market. You can find out on p10 about Teac's complex, specialised network DAC, including how it sounds unlike all else.

Pushing technology very hard on another front comes NAD, with their C 399 Class D amplifier. In the same way Teac's UD-701N is bafflingly complex, so is advanced Class D, but again measurement showed the C 399 overcomes all Class D weaknesses in terms of load sensitivity, delivering perfect results into a real loudspeaker. Add in so much more – including loudspeaker tuning – and this amplifier is a tour-de-force that is worth knowing about. You can find out about it on p40.

Teac (Japan) and NAD (Canada) are not alone in trying to move technology forward. FiiO (China) adopt a similar approach with their new M17 digital audio player. This is a machine that shoehorn's top quality parts into a just-portable package, for headphone quality that is beyond reproach. It can also be used to drive a hi-fi system. Find out more about all this on p66.

Many people would rather not struggle with apps, wi-fi and the need for a home network. For them the CD soldiers on and we keep a close eye on developments. That's why we're pleased to bring you a simple approach by Pro-Ject with their CD Box S3. You can read more on p19.

Our May 2022 issue features high fidelity in futuristic form. It can be technically challenging, but the payback is great sound quality. I hope you enjoy reading about it.

Noel Keywood
Editor



hi-fi world

Audio Web Publishing
Office 052
464 Edgware Road
London
W2 1AH
www.hi-fiworld.co.uk

verdicts

●●●●● OUTSTANDING
●●●● EXCELLENT
●●● GOOD
●●●● MEDIOCRE
● POOR
£ VALUE

testing (see www.hi-fiworld.co.uk for full explanations of all our tests)

To ensure the upmost accuracy in our product reviews, *Hi-Fi World* has extremely comprehensive in-house test facilities, and our test equipment - from big names like Rohde & Schwarz and Hewlett Packard - is amongst the most advanced in the world.

Loudspeakers are measured using a calibrated Bruel & Kjaer microphone feeding a Clio-based computer

analyser, using pulsed and gated sinewaves, in a large room to eliminate the room's influence. Pickup arm vibration is measured with a Bruel & Kjaer accelerometer.

No other UK hi-fi magazine has in-house testing, and none has access to such advanced tests across all types of equipment. That's why you can depend on *Hi-Fi World* reviews.



ELECTRONIC MAGAZINE

Go to our website www.hi-fiworld.co.uk to buy an electronic version of this magazine, individual issues, back issues or a subscription.

Distributed by Select Publisher Services Ltd. P.O. Box 6337, Boumemouth, BH1 9EH UK Tel +44 (0) 1202 586848

Printed by Precision Colour Printing Halesfield 1, Stirchley, Telford TF7 4QQ, United Kingdom Tel: +44 (0) 1952 585585

Our Agents in Malaysia Millennium Hi-Fi & AV Simon Chang Showroom & office, 500-1-3 First Floor Wisma Indah (Shen Court), Jalan Tun Razak 50400 Kuala Lumpur, Malaysia

Tel: 603 9283 8171 Fax: 603 9281 3762 e-mail: info@millennium-audio.com

All unsolicited submissions and goods are at the owner's risk. We accept no responsibility for such submissions, nor do we undertake to return them.

No material may be reproduced from this magazine without the publisher's written permission. © Audio Web Publishing Ltd

contents



LOUDSPEAKERS

Q ACOUSTICS M20 HD ACTIVE SPEAKERS 32

A small, affordable active loudspeaker that offers hi-res quality. Noel Keywood takes a close look.

MONOPULSE MODEL S A ACTIVE LOUDSPEAKERS 58

A large, complex, 'net connected loudspeaker with massive ability at low (direct) price. Reviewed by Noel Keywood.



DIGITAL

TEAC UD-701N NETWORK PLAYER/DAC 10

Specialist Network player/DAC/preamp from Teac, aimed at aficionados. Digital sound with bite. Noel Keywood listens closely.

PRO-JECT CD BOX S3 CD PLAYER 19

Martin Pipe checks out a budget CD player from Pro-Ject.

FiiO M17 DIGITAL AUDIO PLAYER 66

Portable digital players don't usually come like this. Noel Keywood explains why.

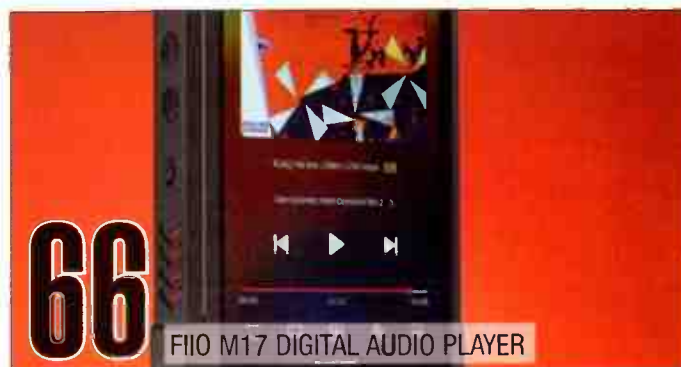

MAY 2022

VOLUME 32 : NO. 3

AMPLIFICATION

40 NAD C 399 HYBRID DIGITAL DAC AMPLIFIER

A digital amplifier of massive ability and distinctive sound. Noel Keywood listens.

OLDE WORLDE

46 GRAMDECK

Martin Pipe looks at a tape recorder that was driven by a record player. Extraordinary.

VINYL

70 NEWS

All the latest and greatest vinyl releases for you, from the pen of Paul Rigby.

72 MUSICAL FIDELITY LX2 LPS

A small budget MM/MC phono stage for vinyl enthusiasts. John Pickford checks it out.

77 AUDIOPHILE BOOKS

Changing genres – three books reviewed by Paul Rigby: The Britpop Bible, Marillion and Kathy Valentine's memoir.

82 CLASSIC CUTS

Andy Bey, Experience and judgement, reviewed by Paul Rigby.



58 MONOPULSE MODEL S A ACTIVE LOUDSPEAKERS

REGULARS

7 NEWS

Words from the world...

25 COMPETITION

Your chance to win a Blue Aura 1 receiver worth £399.

38 SUBSCRIPTIONS

Ensure your copy every month and save money too!

26 MAIL

Six pages of your views, wonderful as always...

64 AUDIOPHILE VINYL

Paul Rigby rounds up the latest audiophile vinyl releases

51,53,55,57 OPINION

The team get to grips with matters music, hi-fi and life!

78 DIAL-A-DEALER

A comprehensive guide to UK hi-fi retailers.

79 CLASSIFIEDS

Second-hand bargains.

80 NEXT MONTH

What we hope to bring you in the next sizzling issue...

81 ADVERTISERS' INDEX

82 CLASSIC CUTS

Andy Bey, Experience and judgement, reviewed by Paul Rigby.



BLADE

Now with Metamaterial
Absorption Technology



A sound statement. An icon that engages every sense.

BLADE

A bold and striking presence, BLADE pushes the boundaries of what is possible with sound. The world's first Single Apparent Source loudspeaker now with Metamaterial Absorption Technology

Authorized Retailers



Listen and believe



World Radio History

email:news@hi-fiworld.co.uk

news



BLADE RUNNERS

The latest speakers to exploit KEF's proprietary 'Metamaterial Absorption Technology' (MAT) are the striking-looking Blade One and Two Meta floorstanders (£30,000 and £22,500 respectively), as well as no fewer than five 'Reference Meta' models (ranging in price from £4,750 to £17,500).

MAT takes the form of a disc with a complex maze-like structure, which was developed in conjunction with acoustic engineers in Hong Kong. Mounted in the cabinet behind a drive unit, MAT reduces distortion by efficiently-absorbing unwanted sound. Building on this are the unusually-shaped cabinets of the Blades, which "eliminate sound-blurring standing waves". The cabinets of the more conservatively-styled Reference models – two three-way floorstanding speakers, a three-way standmount speaker, and two three-way centre speakers – were designed using finite-element analysis, with constrained-layer damping to turn any remaining unwanted vibration into heat.

All models feature the latest 'Single Apparent Source' revision of the Uni-Q driver array, which KEF describes as its "signature sound's building block". Extending the bass response of the Blades are two side-mounted pairs of low-frequency drivers, mounted back-to-back in separate chambers; those of the Reference range are front-facing.

Further details: bit.ly/3HqnlhN (Blade One/Two Meta); bit.ly/33TTJkn (Reference Meta); bit.ly/3C33bP5 (– paper)



MARANTZ GOES WITH THE STREAM

Clearly derived from 2020's 'master-tuned' Model 30 is the Marantz Model 40n integrated amplifier. At £2,199, the Model 40n is £700 cheaper – and has an inbuilt HEOS streaming client thrown into the bargain. It's compatible with services like Spotify Connect, Amazon Music, Tidal and TuneIn radio. With a wireless or wired network connection, it will also access 'local' content; hi-res audio (up to 24/192 PCM, or 5.6 MHz DSD) is supported. Bluetooth is onboard too, and voice control is another possibility.

As an amplifier the 40n isn't quite as powerful as the 30, with a pair of 70W (8Ω) Class A/B output stages, but the firm's iconic Hyper-Dynamic Amplifier Modules (HDAMs) still feature. You also get a MM phono stage, three analogue inputs, coaxial/

optical digital connectivity and a HDMI ARC port for decent sound from TV. Marantz is keen to point out the simplicity of its proposition; just add speakers, for "satisfying" streaming without "stacks of complicated equipment".

Further details: bit.ly/3hnsuSA

AUDIO TECHNICA GO THE DISTANCE

A "market-leading" 15-hour battery life – with its feed-forward active noise cancellation mode engaged – is the key feature of Audio Technica's ATH-CKS50TW "true wireless" earbuds. Battery life increases to 20 hours without noise cancellation.

The buds are supplied in a USB-C charging case that extends "on the go" use to an impressive 50 hours. Inside each "easy-to-wear" bud, designed to fit the ear comfortably without falling out, is a 9mm 20Ω dynamic driver for "deep, powerful bass".

Other features include IPX4 water resistance, customisable buttons, certification for Sony's 360 Reality Audio 'immersive music experience', multipoint Bluetooth 5.2 support with fast pairing, 'hear-through' for location awareness and low latency to keep gamers and video-viewers happy. Yours for £149.99, complete with USB cables and a set of eartips.

Further details: bit.ly/36M9POE



MANI ON A MISSION

Schiit has announced a revised version of Mani phono stage, which is named after the moon personified in Norse mythology. The full-metal jacketed \$149 Mani 2, which can be configured for MM and MC cartridges, is modestly described by its maker as "simply the highest-performance affordable phono preamp, period".

Internally, the key circuitry of the all-American Mani 2 is a low-noise Texas Instruments op-amp (the OPA1612) and passive RIAA network built from 2% precision film capacitors and 0.1% thin-film resistors. The power supply, fed by an external wall-wart power unit, is dual-rail thereby enabling the audio circuitry to be DC-coupled. Thanks to four steps of gain (35/45/50/60dB) and comprehensive loading (38/47/200/47k Ω resistive, 47/100/150/200pF capacitive), the Mani 2 can - according to Schiit - accommodate "virtually any cartridge". These settings are configured via DIP switches on the base, as is a defeatable passive LF filter (6 or 12dB/octave) for dealing with record warps and other subsonic problems.

Further details: bit.ly/3HnBp0L



RED, WHITE AND BRUNEL BLUE

Unashamedly-patriotic hi-fi manufacturer English Acoustics - whose automotive-grade paint-jobs include Brunel Blue and Dartmoor Bronze - has announced an updated version of its dual-mono Stereo 21c valve power amplifier. Specifying 6X50s pentodes in its ultra-linear output stage, an output of 25W per channel with distortion of less than 0.1% is claimed. Within the steel chassis, which is end-capped with CNC-machined billets, is circuitry built with "watchmaking-grade attention to detail" from high-grade components - paper-in-oil and silver mica capacitors, for example.

The output transformers are, like those of the 21c, designed in-house and made locally. Although rear-panel balanced XLR inputs are provided in addition to the 21c's unbalanced phonos, the "Made in Britain-certified" 41c lacks its smaller brother's unusual accumulated running-time meter. A Stereo 41c will set you back between £7,500 and £8,250, depending on finish and warranty.

Further details: bit.ly/3hif4Cz



(ALMOST) FREE...FOR ALL

QED is one of the 'grand-daddies' of audiophile cabling, helping to establish an entire industry back in the 1970s. It made its name with an affordable yet purpose-designed 79-strand speaker cable that spawned numerous imitators. Although there are QED cables to compete with the esoteric giants, the Hertfordshire-based firm has returned to its roots.

The recently-introduced and keenly-priced 'Connect' range is extensive, covering RF leads and computer interfacing as well as more traditional audiophile fare like interconnects and speaker cables. Common to all are a satin black finish and biodegradable packaging. QED makes use of 99.99% oxygen-free copper conductors, HDFE dielectrics, ultra-flexible PVC jackets and moulded-on connectors with gold-plated contacts.

Among the offerings are stereo phono-to-phono interconnects (0.75m, £9.95; 1.5m, £10.95; 3m, £12.95), a headphone extension with 3.5mm connectors (1.5m, £9.95; 3m length, £11.95), speaker cable (6m for £24.95) and 1.5m of TOSlink (optical) for a mere tenner.

Further details: bit.ly/3Lr2p2v



POWER GAMES

New from Russ Andrews is a £1,699 'Signature' version of its eight-way PowerBlock mains distribution unit. As with previous versions, the 'Process Q' treated Signature is a lifetime-guaranteed triangular device with pairs of 13A double-sockets on its two upper sides.

These Signature SuperSockets are claimed to be "the finest-sounding that Russ has auditioned". Unswitched, they feature "rhodium-plated phosphor-bronze contacts". On one side of the fire-resistant ABS-encased 327x133x135mm unit is a heavy-duty 16A IEC mains inlet, together with an earth terminal for 'RF Router' grounding devices; on the other is a 16A IEC mains outlet for 'daisy-chaining' another block.

Russ Andrews tells us there's a "MegaClamp" to protect equipment from lightning and mains spikes" and that heavy-gauge copper TCX Kimber Kable is used for all internal wiring. On which subject, no IEC mains cable is supplied. Naturally, Russ Andrews recommends its own Kimber types (£219 upwards).

Further details: bit.ly/3M4lqtW (Russ Andrews)





ITALIAN JOB

Latest entrant into the somewhat crowded 'streaming speaker' market is this admittedly-gorgeous £1,599 Omnia, from Vicenza-based Sonus faber. Within that distinctively-styled cabinet, with its authentic wood surface, is a seven-speaker audio system backed by 490W of amplification and Sonus faber's Crescendo 3D DSP technology.

This, we're told, harnesses two side-mounted 1.75in. wide-range speakers for a "greater sense of dimensionality and immersivity". The other drivers are two 0.75in neodymium-magnet silk-dome tweeters, a pair of 3in. midrange drivers and a downward-firing 6.5in. long-throw woofer with an aluminium cone. In addition to Wi-Fi and Ethernet, for services like SpotifyConnect and TIDAL, are aptX Bluetooth, HDMI ARC for better TV sound and an analogue input that can be toggled between MM phono and unequalised line-level.

Sources are selected via the supplied remote or the unit's touch-sensitive 'Senso' control system, which confirms your choice by changing colour. Other features include Roon Readiness, in-built Chromecast and walnut or graphite finishes.

Further details: bit.ly/3tcb8N

HUMMING A TUNE

Clearly intending to snatch sales from the likes of Chord and iFi is the Colibri from EarMen, whose compact Tradutto home DAC we reviewed recently. With dimensions of 77x35x14mm, the £289 Colibri 'headphone DAC' is even tinier than the Tradutto. Sharing its name with a genus of hummingbird, the diminutive device is intended for use with smartphones and computers.

Conventional digital inputs are conspicuous by their absence, the Colibri instead being equipped with two USB-C ports – one for charging (for up to five hours of continuous use) and the other for data. Based around the ESS ES9281 PRO DAC, the European-made Colibri has a balanced internal architecture. To take full advantage of this, there's a balanced 4.4mm output (up to 280mV per channel, into 32Ω) as well as a 'standard' 3.5mm socket for unbalanced phones (up to 75mV per channel, into 32Ω).

Other features include a CNC-milled casing, hi-res support (DSD64/128 via DoP, up to 32/384 PCM), MQA compatibility, gold-plated circuit board and side-mounted volume control buttons.

Further details: bit.ly/3t5sxYA (Earmen site); bit.ly/3tclK7V (UK distributor SCV)



BACK TO BLACK...DISCS

We tend to think of Roberts as a supplier of posh wireless sets to the landed gentry, but it does other stuff too. Consider its RT200 two-speed direct-drive turntable, which boasts a carbon-fibre tonearm pre-fitted with an Audio-Technica AT-95E MM cartridge.

The wooden-bodied RT200 features a switchable preamp, and a USB port that allows users to digitise their records with computers. It will (briefly!) be joined by an Amy Winehouse-themed limited edition. Engraved with its unique number in the collection (only 50 will be built) the RT200 X Amy Edition features an exclusive turntable mat and reproductions of the singer's signature and iconic heart-shaped doodles.

The Amy Winehouse Foundation, a charity set up by her family to build the self-esteem and resilience of young people, will receive a(n unspecified) percentage of the collaboration's proceeds. We trust it's a generous percentage; at £450, the RT200 X Amy sells for £150 more than the 'cooking' RT200.

Further details: bit.ly/35D4vw8



Bit Master

Multi-bit or 1 Bit? Noel Keywood chooses with Teac's impressive new UD-701N digital DAC and streamer.

Here's a DAC quite unlike all else. That's because Teac have built it around their own custom circuitry and high grade audio com-

ponents. No ESS or AKM chips inside this one; quite the reverse: it goes off in another direction, stepping back to basic multi-bit digital conversion. Priced at £3300 this flagship product will catch the

attention of purists worldwide who claim that good 'ol multibit sounds better.

What's going on at digital level inside this almost-disconcerting device is complex and the



product's topology is not clearly explained. But I have a good idea, confirmed by its behaviour under measurement. Suffice it to say at this introductory point, the UD-701N offers users two basic processing options: multi-bit or 1 bit (as they are labelled), as well as three optional Delta-Sigma sampling frequencies and three Delta-Sigma filter options. This will leave most people baffled I suspect. Oh, and I forgot to mention it has Upsampling too! Point being it's a DAC for digital aficionados to tweak and tune for the sound they prefer.

There's more to this machine than just its unusual digital conversion technology however.

Unlike most DACs it is also a streamer and the way Teac go about all this is unlike most others. Internet connection is by Ethernet cable only (no wi-fi) and streaming is app driven. However, Teac's app is a streaming player, not a control app; it cannot be used to select filters for example – the remote control/front panel controls are needed for this.

Whilst there's no CD player mechanism there are front and rear USB Flash drive (mass storage) sockets able to read ripped CD files, or hi-res all the way up to 32/384 PCM, or (quad-speed) DSD256. The rear socket can be used as permanent storage, the front for casual plug-

in. Teac's HR Streamer app will read the music on these drives; no front panel display is available, making the app essential and 'net connection necessary. Playing from Flash storage I find easy and convenient, the short, direct link between storage and DAC giving best sound quality. This is an assured way to play DSD – no DSD over DoP malarkey – and I even got a 384kHz sample rate (test) file to play, just as Teac claim. This is a bit academic of course, but at least it's possible.

There are four selectable S/PDIF digital inputs, two optical and two electrical. The opticals work up to 24/192 I found (unlike some). Then there is USB for



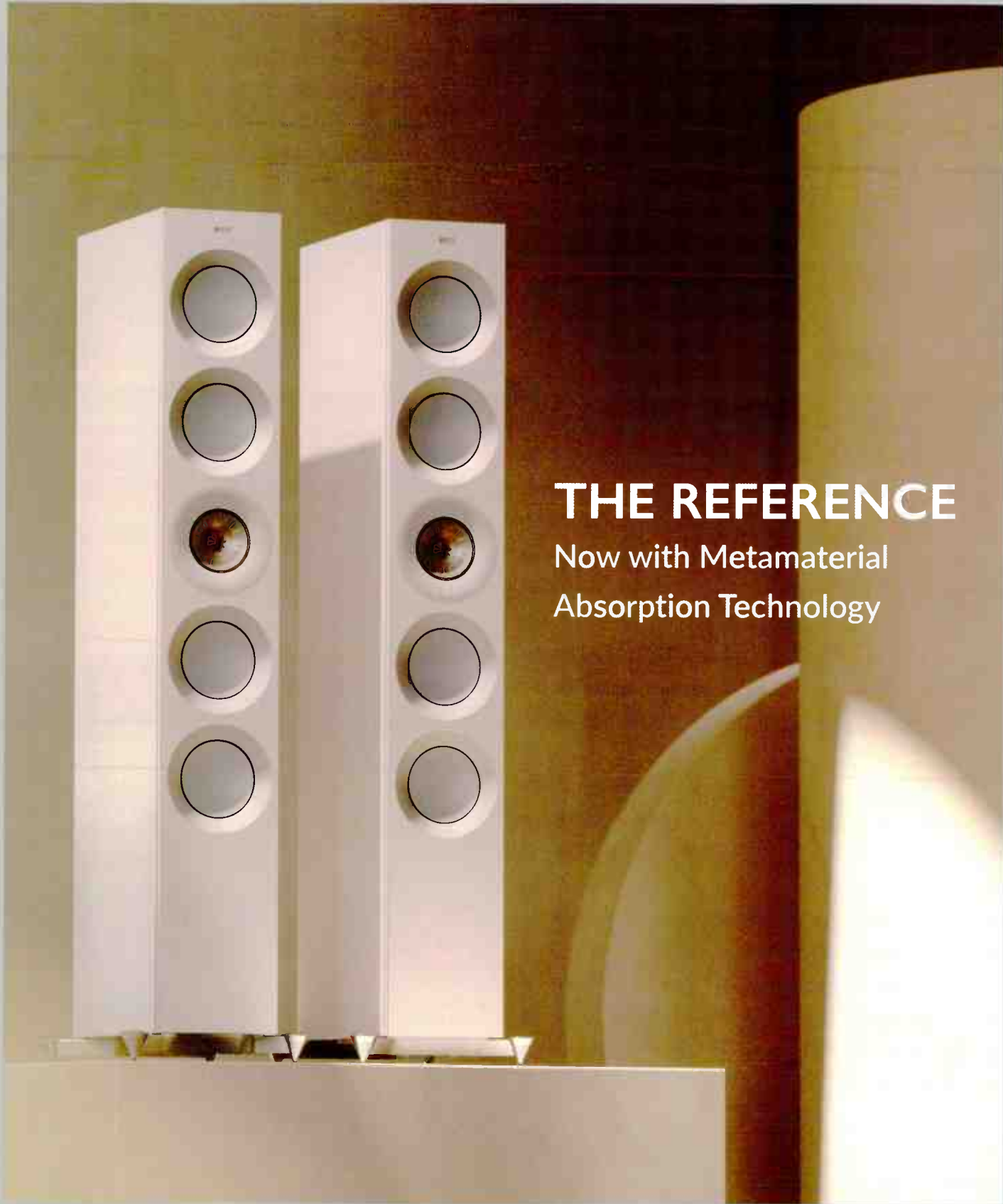

THE REFERENCE

Now with Metamaterial Absorption Technology



Detail Remastered. An icon redefined for tomorrow.

THE REFERENCE

The essential for any audiophile. Handcrafted by the masters who set the standard for audio quality, THE REFERENCE has been the benchmark for loudspeakers and sound reproduction. THE REFERENCE is an embodiment of KEF's philosophy and the relentless pursuit of perfection. Now with Metamaterial Absorption Technology.

Authorised Retailers



Listen and believe





A complex interior dominated by four toroidal mains transformers, each one feeding a separate linear power supply. The vastly complex circuit board houses Teac's own custom digital convertor chips, that make this DAC very different to all others.

computer connection and this will as usual accept DSD via DoP, plus all hi-res.

I was surprised to see my Mac recognised the Teac as an Airplay output and Audirvana+ confirmed its presence and Airplay's CD-only quality, push-playing music to it. The PC (Windows 10) saw it as (Flash drive) storage on the network and would play from it; the app saw the PC's music library and would play from it too. Teac say it will also address a NAS drive and of course it sees music servers like Tidal, Qobuz etc.

I can't say I enjoyed using Teac's app: it has an intrusive and unnecessary play-list screen, plus cramped control icons and oversized artwork placeholders that appear as large grey blocks when no artwork exists.

There's Bluetooth 4.1 (old), so music can be sent from any Bluetooth equipped device – commonly mobile 'phone, tablet or portable player. Pairing is a two-part process of source selection then a button-press to initiate, something that caught me out initially. Various compression schemes are fitted including Sony

LDAC and Qualcomm aptX HD, plus Apple's AAC and standard SBC. However, there's no LE2 for later iPhones running Bluetooth 5.1 and this slightly lacklustered my hi-res files from an iPhone 11X Pro with Onkyo HF player (hi-res. version).

So much for getting music in digitally. It also has an analogue Line input that could, for example, accept a phono stage and when Line is selected there is very high gain available to the RCA phono socket/XLR socket analogue outputs that feed an amplifier. There is no Bluetooth transmit function: output is strictly by wire.

Although not unusually large, measuring 444mm wide, 334mm deep and 111mm high, the UD-701N is very heavy, weighing 11.8kgs. That's because there are no fewer than four toroidal mains transformers inside, one each for Left and Right digital and analogue stages. These are linear supplies of course, not switched-modes.

SOUND QUALITY

I connected the Teac to our Primaluna EVO 300 Hybrid amplifier (valve/transistor),

driving Martin Logan ESL-X hybrid electrostatic loudspeakers (electrostatic with bass bin),



A music library app screen with grey placeholders where no artwork exists. Small control icons at top.

Every note. Every word.
Every detail.

LS50 Wireless II

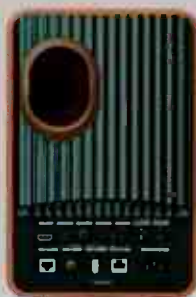

LS50 Wireless II - The Ultimate Wireless HiFi

When you first listen to the new LS50 Wireless II, close your eyes. You'll find it hard to believe that a sound so pure is coming from such compact wireless speakers. That's because our unique Metamaterial Absorption Technology (MAT™) eliminates the high-frequency distortion inside the speaker. So keep your eyes closed and keep listening; there's a whole world of streamed music to enjoy.

AirPlay2, Spotify, Tidal, Qobuz, Internet radio, HDMI, and more.



World Radio History

Listen and believe





Analogue outputs and inputs at left and centre. Between them and at top, the RJ45 ethernet socket for internet connection with, alongside, a USB mass storage socket to accommodate Flash memory music file storage.

connected via Chord Company Signature Reference screened loudspeaker cables. For the most part I relied upon playing from Flash drive, but an Oppo BDP-205D player was used as a CD transport as well, connected by QED Quartz optical digital cable.

Having been there and suffered that in the 1980s I knew what to expect in terms of basic presentation from this player. No surprise to hear a very upfront sound that I could describe as “bright” – but that would not be saying much. There was a sense of clear openness in the basic presentation, with singers and instruments projected forward in challenging fashion. A fast, zippy presentation with vivid bass that brought in a sense of muscularity and dynamism that was exciting. Can't help feeling Teac's power supplies contributed here, as much as digital conversion technology.

The sound was quite different to the current norm – as epitomised by ESS DACs that have all but taken over. ESS offer listeners silky smooth sound free from offence – and with fine insight and superb stage depth. With this player Teac bring the stage forward, make it vividly insightful but drop any pretence of warmth or depth. No palliative to tame dodgy digital, but a more direct delivery that was both challenging and exciting. Think of ESS as a warm cosy bedroom, join Teac for a brisk run in the park – in January. Both have their merits, whilst being complete opposites.

Where stage depth was truncated, stage area was expanded. I heard large, full height images between the electrostatic panels, strong and stark at left and right. Diana Krall's Narrow Daylight (24/96) usually comes

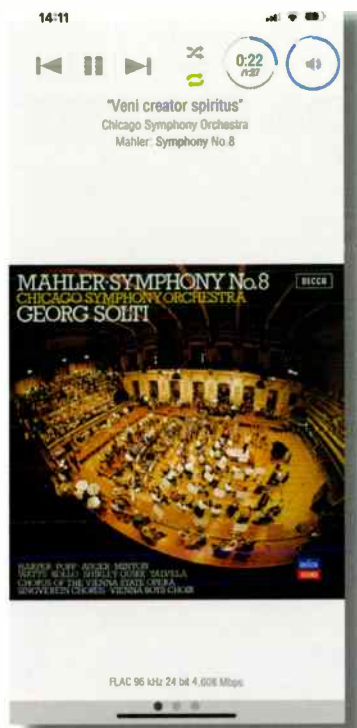

The main app play screen – simple and clear with artwork and file data.

across as dark and smoky; the Teac threw windows open, let in daylight and imposed stark clarity. No smoky stuff here. Cymbal strikes had power and substance, images took on a sense of solidity and weight. The bass line strode along firmly. I sat entranced, but also querulous. And here things get a little complicated.

I was running the UD-701N in raw state, meaning Upconversion off, Delta-Sigma sample rate at its lowest (x128) giving highest (out-of-band) noise, and the DSD filter set to Off so as not to curb this noise. This left me to switch between two basic operational states: multi-bit and 1 bit. First surprise was that 1 bit sounded coarser than multi-bit: Since

conversion to 1 bit is associated with improved sound this seemed surprising. I felt there was slight hacksaw edge. I liked multi-bit: it was fast yet more amenable.

Time to twiddle. Setting Delta-Sigma sample rate (Fs) to its highest value (x256) for lowest noise, and selecting the FIR1 DSD filter softened out the sound, much as expected, but most obvious was subtle degradation of the otherwise chiselled sound stage. There was also less edge to transients, and a little less laceration in the sound. However, even with every ‘improvement’ strategy selected the UD-701N still came over as more forward, open and fast than the current crop. A nearest equivalent would be Chord Electronics DACs, in outline at least.

However, when running raw this DAC gives entirely different (worse) measured results to most and, together with its multiple linear power supplies, has speed and punch like few others. Funny combo / unusual sound.

Quite what effect these many options had subjectively I found to be music dependent. For meaty Rock some may prefer to run it raw with 1 Bit, although I shied away from the



A relatively simple and dedicated remote control unit that is central to usage, since the app does not mirror its functions.



Hi-Fi World
"OUTSTANDING - amongst the best!" August 2019

Hi-Fi Choice

Hi-Fi World
"Best Valve Amplifier"

NEW Stereo 40 MK IV £2699

New Upgraded Model. Now With Headphone Socket

Hi-Fi World
"Well Made Lucid Sounding"

2021 PRODUCT OF THE YEAR AWARD

designed by *David Shaw*

Bluetooth
Option Available

LA4 MK III £1799

Versatile line stage pre-amplifier to match valve or solid state power amplifiers.

Innovative Designs From Icon Audio

Hi-Fi World
"OUTSTANDING - amongst the best!" March 2019

60 + 60 Watts Triode
115 + 115 Watts UL
Tung Sol KT150/170
£4699

MB90 MK II Monoblock Power Amplifiers many features

Hi-Fi World
"OUTSTANDING - amongst the best!" March 2019

See our full range of Loudspeakers Amplifiers Pre-amplifiers Phono stages at: iconaudio.com

Stereo 300 MK II £4399

Sublime Sound From Vintage 300B Triodes

Bluetooth
Option Available

Hi-Fi World

Stereo 25 MK II from £1599

Simplified ST40 30W UL, HQ Headphone Socket

Hi-Fi World
"Best Valve Amplifier"

Hi-Fi World

Stereo 30se £2699

Single Ended Pure Class A, 28W UL, 18w Triode

Hi-Fi World

Hi-Fi World
"HIGHLY RECOMMENDED"

PS1 MK II MM/MC £1749

Our fantastic value pure valve phono stage. MC and MM

Hi-Fi Choice
RECOMMENDED

Hi-Fi World

PS3 MK II MC/MM £2999

Pure Valve Phono Pre-amplification At Its Best!

Hi-Fi World

Bluetooth
Option Available

Hi-Fi World

HP8 MK II £999

Smooth non-fatiguing Triode Sound, Match 8-600 Ohms

Hi-Fi World
"HIGHLY RECOMMENDED"

Hi-Fi World

NEW ST 60 MK IV £4199

Outstanding Performance 80w UL, 50w Triode

Buy direct from us or through one of our carefully chosen dealers or distributors:

<p>Audio Affair Birmingham, B9 4AA Tel: 0121 224 7351 Web: www.audioaffair.co.uk</p>	<p>SMC Custom Installations Shrewsbury SY1 3TJ Tel: 01743 234945 Web: smccustominstall.co.uk</p>	<p>Shropshire Hi Fi Westbury SY5 9QP Tel: 01743 232317 Email: shropshirehifi1@gmail.com</p>	<p>Analogue Seduction Whittlesey Peterborough Tel: 01733 350878 Web: www.analogueseduction.net</p>
<p>Audio Gold Crouch End, London Tel: 0208 341 9007 Web: www.audiogold.co.uk</p>	<p>Wilkinsons Hi Fi Nelson, Lancashire Tel: 01282 612901 Web: www.wilkinsons.tv</p>	<p>Canada: Audioarcan Barrie, Ontario, Canada Tel: +1 249 880 5040 Web: www.audioarcan.com</p>	<p>Australia: Decibel Hi Fi Coopers Plains QLD 4108 Tel: 0486 022 877 Web: www.decibelhifi.com.au</p>
<p>Germany: TCG Handels GmbH Nordhorn 45831, Germany Tel: +49 (0) 5921 78849.27 Web: www.tcg-gmbh.de</p>	<p>USA: Music Direct Chicago IL 60660 USA Tel: +1 800 449 8333 Web: www.musicdirect.com</p>	<p>Spain: Union Musical Casa Werner Barcelona 08010, Spain Tel: +34 933 021 792 Web: www.werner-musica.com</p>	<p>WANTED! HIGH QUALITY DEALERS IN MOST AREAS/COUNTRIES</p>

Thinking of buying valve amplification?
You are welcome to contact us regarding compatibility or other questions. We are small & friendly and helpful!
With many years experience of valves in Hi Fi

B GRADE & EX-DEMO BARGAINS!
Technically perfect Fully Guaranteed. Audition in our Leicester showroom. Most models available. See our website, email or ring for availability. Subject to availability*. Prices vary.

edginess. Dramatic certainly, but also uncouth. With classical, running like this pushed choral sections of the Chicago Symphony orchestra forwards but they had sore throats in Mahler's Symphony No8 (24/96). Selecting Multibit cured the throat problem and also put in better delineation between singers and instruments. There was a tad more stage depth too, but still not ESS style. The Teac pushes everything forward – part of its drama – and in doing so comes across as clearer and more explicit than most else. Generally I found its drama better suited to visceral Rock – but I did rather like the big, solid sound of Benjamin Grosvenor's piano when playing Chopin's Nocturne No5, Op15, No2 (24/96).

With Nils Lofgren's Keith Don't Go (CD), which has strong

treble from close miked guitar strings, there was a slight loss of bite to transients, as measurement predicted, due to high-treble roll down. However, the performance was so dramatic, particularly in its broad, open sound staging and rock hard imagery that this hardly seemed to matter.

With another test track I know well, Safri Duo's Samb Adagio, the powerful synth beat pounded out with relentless strength, again confirming the Teac's extraordinary bass quality.

With DSD it was best to use 1 Bit at top sample rate (x512) for best smoothness and depth, FIR 1 filter adding to this, whilst slightly reducing openness of sound staging. Results with DSD were superb, as you might hope from a DAC that has obviously been honed to work well with

it. Also be aware I use very high resolution electrostatic panels that are phase coherent to hear all this; with conventional loudspeakers the sound staging properties may be less obvious, but I feel sure this DAC's basic character will be rendered clearly.

CONCLUSION

Teac's UD-701N is a sonically distinctive and enormously capable streaming DAC. Without a doubt Teac have engineered it superbly, the four big linear power supplies being responsible for its tight, powerful bass that betters all other DACs. Its dramatic sound sets it apart. It does not measure well and is far from the current norm, technically. All the same, well worth hearing if you want digital with drama. In this regard it is easily the best.

MEASURED PERFORMANCE

This is a very unusual and highly specialised "drive it yourself" DAC with numerous tune options that affect measured performance. Firstly there is a multi-bit DAC with tunable Delta-Sigma input modulator. Set to 'PCM Delta Sigma – Multi-bit' meaning pure multi-bit (no prior D-S modulation) distortion was expectedly high – around 0.4% (-60dB, 24 bit) as our analysis shows. Choosing 'PCM Delta Sigma – 1 bit' brought in prior D-S modulation, improving linearity to 0.18% but with added noise. To lessen this noise it was necessary to set Delta Sigma Fs (sampling frequency) to x512 to push the noise up-band and DSD filter to its most effective FIR1 setting.

In spite of all this the final best distortion result of 0.18% (shown here) is ten times higher than the 0.02% of current DAC chips. With CD (16bit) distortion rose to around 0.35% at -60dB, not much above the 0.25% figure from today's best chips (set by quantisation noise), so no disaster with CD.

At full level, pure multi-bit operation delivered 0.02% distortion against 0.002% with Delta-Sigma 1bit prior modulation – but peak level values, whilst commonly quoted, are inconsequential to sound quality.

To summarise, with hi-res distortion was x10 higher at best, with CD it was fractionally (x1.5) higher.

Because of the presence of multi-bit distortion or 1bit noise, EIAJ Dynamic Range with hi-res (24bit) measured

around 103dB, much the same as CD.

I can't be too specific about any final result because Sampling Frequency, Delta-Sigma rate and Noise Filter values all wandered slightly, possibly due to temperature variations at component/junction level, and perhaps lack of corrective feedback.

With filters off frequency response rolled off slowly above 39kHz with 192kHz sample rate PCM. Selecting Brick Wall filter this extended to 82kHz. With CD, output rolled down above 10kHz, as shown – sufficient to produce slight warmth but better damped transients. Slow, well damped filters give a clean sound and are popular, so no issue here from a purist perspective.

Output levels were high at 9V from XLR/headphones balanced, 5V from RCA and headphone 6.3mm unbalanced. All these outputs were achieved from a full scale digital input (0dB FS) so there is enough gain in the system. There was x15 (23dB) gain from Line-in to Line-out at max volume; the Teac can drive any power amplifier.

Working from Ethernet and using Teac HR Streamer app control on an iPhone, the UD-701N retrieved the music library on a USB flash (mass storage) drive plugged into the front panel playing test files that showed results here were identical to S/PDIF and USB connection. And as Teac claim a 384kHz PCM test file played perfectly.

The UD-701N did not measure well in terms of digital-to-analogue

conversion but it discards ultimate performance figures for a purist approach that can only be judged by subjective sound quality. NK

DIGITAL

Frequency response	4Hz-39kHz
Distortion (-60dB, 24bit)	0.18%
Dynamic range (EIAJ)	103dB
Output (RCA / XLR)	5V / 9V
Gain	x15 (23dB)

FREQUENCY RESPONSE CD

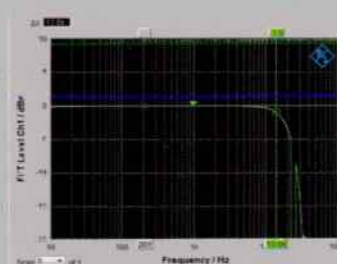

DISTORTION

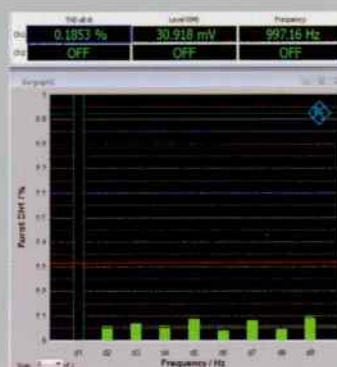

TEAC UD-701N
£3300



OUTSTANDING - amongst the best.

VALUE - keenly priced.

VERDICT

Big, bold sound that's punchy and challenging. Not cuddly or warm.

FOR

- bold sound
- build and finish
- multiple sources

AGAINST

- old Bluetooth 4.1
- limited stage depth
- poor user guidance

TEAC
eu.teac-audio.com

HI-FI WORLD

ON THE APP STORE

The screenshot shows the App Store page for the Hi-Fi World app. At the top, there's a navigation bar with 'App Store', 'Entertainment', and 'audio web publishing ltd'. The app icon is a globe with 'HI-FI WORLD' text. Below the icon, it says 'Hi-Fi World (4+)' and 'audio web publishing ltd'. There are tabs for 'Details', 'Ratings and Reviews', and 'Related'. A 'Screenshots' section shows three preview images: a magazine cover for May 2012 featuring a TEAC UD-701N DAC, a 'contents' page with various articles and prices, and a 'MAY 2012' issue page. A 'Description' section states: 'Hi-Fi World brings you the best in hi-fi...from around the world! - We listen and measure products in depth, at our London offices. - Expert opinion from a team of renowned writers, musicians and engineers. - International standard measurements using Rohde & Schwarz test equipment...'. An 'Information' section lists: Developer: audio web publishing ltd; Category: Entertainment; Updated: 7 Dec, 2014; Version: 1.0; Size: 9 MB; Rating: Rated 4+; Family Sharing: Yes; Compatibility: Requires iOS 5.0 or later. Compatible with iPhone, iPad, and iPod touch; Languages: English.

**DOWNLOAD OUR APP ON APPLE AND ANDROID
DOWNLOAD FROM iTUNES OR GOOGLE PLAY
iPad, iPhone, iPod, Tablets OUT NOW!**

Living in a Box

Martin Pipe listens to his compact discs on a compact player.

Back in the mists of time, when 'digital' was a thing, CD players were expensive and aspirational items. As a result those ostentatious front panels were loaded with buttons, alongside fluorescent displays that were flashy in all senses of the word. While your peers remained locked in the analogue age with their scratchy vinyl and poor pressings, you were in the exalted position of being able to play the relatively-limited choice of CDs then available...and wanted the world to know it! At this point of audio history, once-treasured LP collections started being consigned to skips or bootsales because listeners had been convinced to buy their music all over again. It wasn't the first time this has happened - and it won't be the last.

Nowadays, CDs are themselves being unceremoniously 'skipped' - not quite the 40th birthday present

the format had in mind. The mass-market prefers to stream music (most of which is CD quality, albeit worsened with lossy compression) 'on-demand', while audiophiles have fallen back in love with analogue playback.

We might be at a situation where the listener who discarded the original vinyl after buying the CD version is now opting for the remastered LP (as remastering is a digital process nowadays, why not just buy the music in that form?). Those with more sense than money realised that there is plenty of music on CD, the throwaways and charity-shop bargains enabling a pretty good music collection to be assembled for next to nothing. And - if done properly - CD can actually sound pretty good. Many of the criticisms could be levelled at early software of lousy quality. Perhaps unfairly, they stuck.

Judging by the discarded CDs I encounter on a near-daily basis,

it would seem that the general public is indeed ashamed of those CDs - which, like those similarly-unfashionable DVDs, take up a lot of space in homes that are getting smaller. It is somewhat ironic that Pro-Ject, which enticed cash-challenged audiophiles to 'go analogue in the third millennium' with its budget turntables, is now urging us to reconsider the much-maligned silver disc. Clearly a champion of the underdog, the Austrian hi-fi firm has however been making CD players as small and unobtrusive as possible. A (compact) case in point is the £349 CD Box S3. The first of a new Pro-Ject product line, it occupies the same volume as a handful of jewel boxes.

The neat and uncluttered aluminium fascia presented to the world by the S3 is as far removed from those early Japanese players as it's possible to get! Helping to achieve its diminutive stature is





On the threshold of a disc...the CD Box S3's mechanism is slot-loading. It will accept CD-R and CD-RW media, as well as those of the more familiar silver variety.

its transport, which accepts discs via a slot rather than a tray. I've had trouble in the past with these internally-complex slot-loading drive mechanisms, which are traditionally associated with in-car audio systems. They don't handle oddly-shaped or sized discs, but are fine with the standard 5in. type. The drive inside the S3 proved to be reliable, and behaved perfectly no matter how I treated it. Most, but by no means all, of my torture discs - CDs that are scuffed and scratched - loaded and played acceptably.

In addition to commercial mass-produced CDs, I found that the S3 would play self-recorded CD-Rs and CD-RWs. Unlike some budget CD players, though, the S3 won't accept CD-ROMs containing MP3 files. Indeed, features are rather sparse. The cheap and plasticky tactile-bubble remote enables you to directly access as well as skip between tracks. You can also arrange for the current track or entire disc to repeat-play if desired, and there's a pause function (duplicated, like track skip, by front-panel buttons). The volume controls will only be of any use if your amplifier is a Pro-Ject model. I was impressed by the readability of the 1.5in. LCD screen, which is white-on-black by default but can be 'inverted' if need be. It's

alphanumeric capable; what a pity, then, that CD-Text info cannot be displayed.

The S3 feeds audio into a hi-fi system via analogue phonos or - if used as a transport - coaxial S/PDIF. A peek inside reveals that most of the basic CD player electronics forms part of the bought-in mechanism, which is built around a LC78616PE 'jungle chip'. This sends timing and recovered digital

audio data - said to be "1:1 bit-accurate" - to a Pro-ject board that contains two Burr-Brown chips - a DIT4096 S/PDIF interface, and a PCM5102A DAC from which the analogue outputs are derived using a collection of surface-mounted components. Power is derived from the supplied 9V d.c. wall-wart, rather than internally-fitted circuitry, raising the possibility of upgrades and unusual energy alternatives. It's all neat, well-

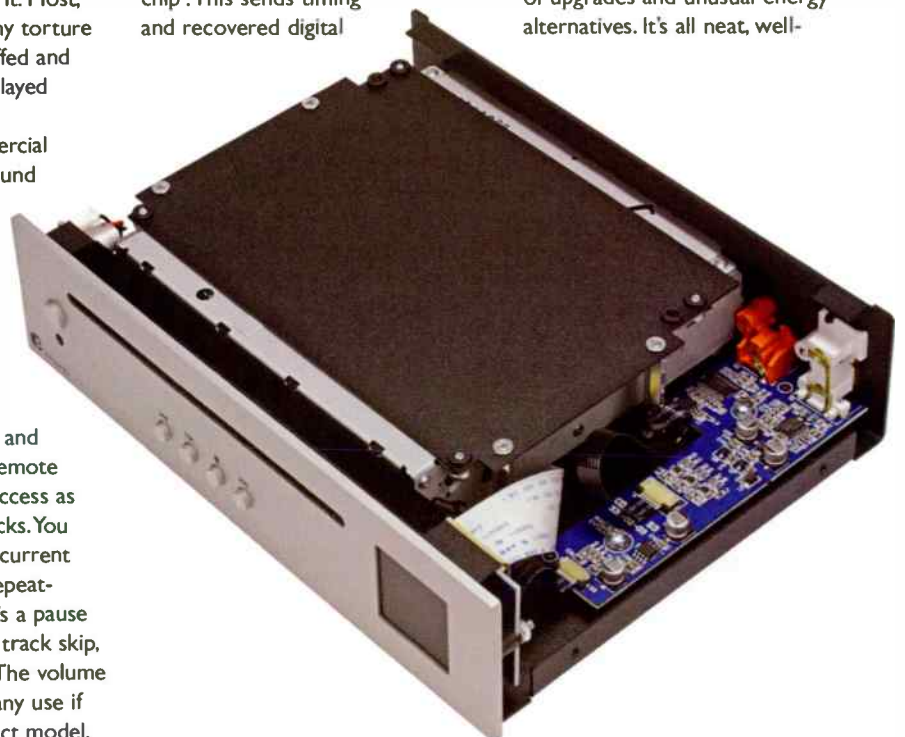

Most of the electronics live under the bought-in mechanism, which sends recovered digital audio data to the small board on the right. This contains two Burr-Brown chips.

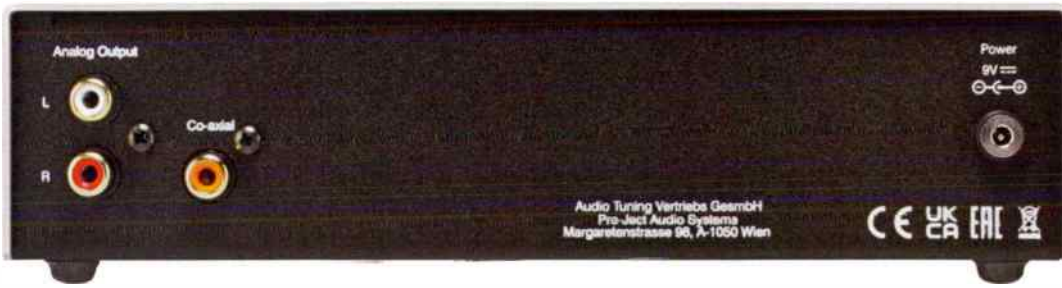

Its coaxial digital output and reliance on an external power supply give the CD Box S3 upgrade potential.

constructed and seems built to last a long time.

SOUND QUALITY

Coupled to a Cambridge Edge NQ/W combo and Quadral Aurum Wotan VIII speakers, I found the S3 to be detailed and communicative. I was impressed by how much percussive information could be retrieved from, for example, the 2009 eponymous debut album by Them Crooked Vultures - the

"Miles Davis's heavenly Kind of Blue (1997 SBM release) retained its impact, and was rendered with appropriate clarity and tonal colour"

although the stereo image was very good given the S3's modest price. Used as a transport with the Edge NQ's DAC, it was felt that the presentation was perceptibly more open. Even so, the S3 performs well for what is to all intents and purposes a budget player.

gimmick-free and refreshingly easy-to-use CD Box S3 proves there's life in the old format yet. For what is a budget model by audiophile standards, it turns in a creditable performance. As it is, the S3 should serve more affordable systems well. Its digital output provides an upgrade path, enabling it to be used as a no nonsense transport with better DACs. The slot-loading drive performed impeccably and the S3's neat and unobtrusive form factor should win it friends too.



This cheap and plasticky remote was our only real disappointment. Replace it with a decent 'universal' when you can!

CONCLUSION

The public may be falling out of love with the CD - indeed, more than half of the discs featured here were rescued from the recycler - but the

supergroup featuring members of the Foo Fighters, Led Zeppelin and Queens of the Stone Age. Searing Zeppelin-esque guitar sounds were also done justice. Moving to something completely different - Chicane's Behind the Sun - I found that the bass lacked impact, as revealed by tracks like the Enya-sampling Saltwater.

The heartbeat intro of Pink Floyd's Dark Side of the Moon also drew me to the same conclusion, while at the same time more happily proving that the S3 copes fine with gapless CDs. Miles Davis's heavenly Kind of Blue (1997 SBM release) retained its impact, and was rendered with appropriate clarity and tonal colour. With complex orchestral fare - including Sir Colin Davis conducting the LSO for a performance of Holst's Planet Suite - I noted that the music could sound a little congested at times,

MEASURED PERFORMANCE

The CD Box S3 gave normal 2V output at maximum digital level (0dB FS) with an expected distortion value of 0.005%. As level descended however distortion rose quite rapidly below -50dB FS, measuring 0.9% at -60dB where around 0.25% is expected. Since this level was duplicated at the digital output as well, our digital analyser showed, the player's digital side appeared to be adding noise of some sort; it was not a problem within the DAC. Measured EIAJ Dynamic Range was degraded to 97dB where around 100dB is common from CD - not a large shortfall, NK

DIGITAL	
Frequency response	4Hz-21kHz
Distortion (-60dB, 16bit)	0.9%
Dynamic range (EIAJ)	97dB
Output	2V

FREQUENCY RESPONSE

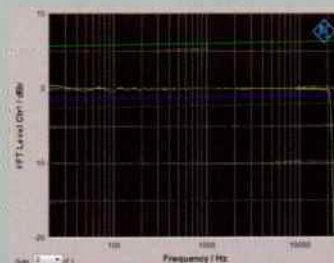

DISTORTION

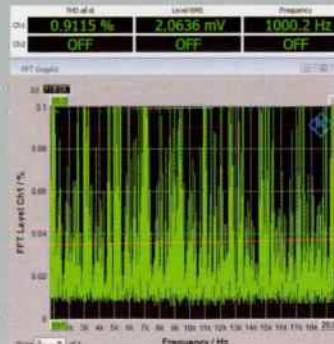

PRO-JECT CD BOX S3 £349



EXCELLENT - extremely capable.

VALUE - keenly priced.

VERDICT

It's difficult not to like this little player, which will give many a chance to rediscover their CDs - instead of throwing them away!

FOR

- neat design that's very easy to use
- clarity and detail under most circumstances
- upgrade path

AGAINST

- lack of bass impact
- can sound a little muddled at times
- remote has a cheap and plasticky feel

Henley Audio
+44 (0)1235 511166
www.henleyaudio.co.uk

Pure And Simple

A portable smart radio offering DAB, FM, internet radio and Spotify. John Pickford tunes in.

The opening gambit in the Product Details section of Pure's blurb reads as follows: "Entertainment information and the best the internet has to offer

in terms of audio sources packed into a versatile music system that can't (just) be placed in a single room". Could they have thought up a clumsier and more confusing

description for a portable smart radio? I found myself laughing out loud on more than one occasion at the flowery - and often baffling - hyperbole.

Measuring 12.1cm x 22.1cm x





The flip up screen reveals buttons to access the various menus, such as the source select menu shown here. It folds away to preserve the elegant look of the system.

14.9cm (HWD) and weighing 2.1kg, the Evoke is conventionally sized and Pure assures us it provides 'easily placed sound for any home without the need for much measuring and pondering.' Hmm.

All jesting aside, the Evoke Play is a smart radio in more ways than one. It's stylishly smart with an uncluttered front baffle, looking traditional without being obviously retro in design. It would look equally at home in a minimalist living room, or on a shelf full of ornaments and paraphernalia. Our review sample came in Coffee Black, which looks gorgeous, while Cotton White is offered as an alternative. The cloth grille is made from eco-certified and recycled wool so no two models are visually identical, and I can confirm Pure's claim that the cloth is 'virtually



The System settings menu offers various sub-menus. Select the Equaliser menu to adjust treble and bass.

odourless'.

On the top panel is a rotary control/push button that serves as both a volume control and power switch, beneath which are buttons to store and access station presets. Adjacent to these controls is a flip-up screen that can be folded away when not in use to preserve the sleek profile of the unit. More buttons for selecting sources and accessing the various menus (to set the alarm clock for example) are situated here.

Radio wise, the Evoke offers a multitude of DAB stations as well as FM, while Bluetooth and Spotify connect allows for streaming music from the internet. Accessing the various functions is simple and intuitive so I was listening to BBC 6 Music in a matter of seconds. I suspected accessing my Spotify library would be a little more involved, however having selected the service from the source menu, the Evoke system's brilliant setup wizard (which also sets the correct date and time on initial power-up) found my network immediately. I glanced at the manual to see what I might have to do next, but by the time I looked back at the screen I was being

invited to continue listening to the last album I'd played from Spotify. I was impressed.

Producing generous sound from what Pure calls a 'versatile sound miracle' is a 90mm woofer flanked by two 20mm tweeters, powered by a 40W amplifier. Despite the twin tweeters being just a few centimetres apart, the Evoke produces a decent stereo image if it's placed directly in front of the listener with the drivers at head height. Wherever it is placed, sound quality is extremely good with a well-balanced tone from top to bottom; there's nothing boom box like about this system's classy sonic character.

Midrange clarity is first rate and the system is free from that loudness curve voicing small



A downwards firing port aids bass response while the ChargePAK battery offers 12 hours of wireless play.

systems often have, which produces a hollow 'boom and tizz' sound. Speech is presented naturally and music is similarly produced without obvious artifice. Bass and treble can be adjusted to taste and, thankfully, the system is too refined to employ those nasty factory-set EQ curves designed for use with particular genres of music.

Anyone looking for a portable DAB/FM radio that also offers internet access to services such as Spotify will be impressed with the quality of sound and ease of use offered here, I feel.

As a self-contained radio and music streaming system – there's no auxiliary input for external sources, nor output to a hi-fi – the Pure Evoke Play is an extremely smart choice.

PURE EVOKE PLAY
£199



OUTSTANDING - amongst the best.

VALUE - keenly priced.

VERDICT

Superb sound and ease of use from a stylish portable radio and streaming system.

FOR

- exceptional clarity of sound
- DAB, FM and internet radio
- spotify connect
- intuitive to use
- stylish appearance

AGAINST

- no aux in or out

www.pure.com



website: www.jordanacoustics.co.uk

tel 01202 911 886 email ask@jordanacoustics.co.uk



TURNTABLE READY
PHONO STAGE BUILT IN



SONUS FABER OMNIA

Streaming System

£1,599

With Omnia, Sonus faber adds to its collection a contemporary and powerful all-in-one active system. The system embraces innovative acoustic technologies with wood elements customary of Sonus faber, fitting seamlessly within any home environment. Sonus faber's Natural Sound enhances life at home with loved ones.

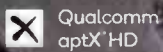

Visit www.jordanacoustics.co.uk to find out more.

WIN

**A BLUE AURA'S
OUTSTANDING BLUE 1
RECEIVER WORTH £399
IN THIS MONTH'S GREAT
GIVEAWAY!**

www.blueaura.co.uk



Here's your chance to win Blue Aura's superb Blue 1 receiver, reviewed in the March 2022 issue. Read the review excerpt below and answer the questions.

"The amplifier for example delivers a firm 77W, measuring superbly (see Measured Performance). No sign of crossover distortion nor anything like it, something budget amps suffer from.

Although the presence of VHF/FM radio suggests Blue Aura have targeted oldies looking for

something that will magically revive the Home Service, that's not so. Moving forwards in time from analogue radio brings us to Digital Audio Broadcasting, that wonder of the modern age that never quite made it, in spite of the European Broadcasting Union's best efforts. All the same, for those far from Wrotham, Holme Moss, North Hessary Tor and such wind swept hills there may be a short range DAB transmitter close by that does the job, in which case the Blue 1 is able to receive its signals in DAB or DAB+ form.

Another step forward in time

brings us to Bluetooth (v5), also a radio transmission system and available in Blue 1.

Leaving air waves behind, the Blue 1 has plenty of other digital inputs. Receivers of the past did not come with record players (let's not talk radiograms) but this one gets a disc spinner – a slot loading CD player. There are also optical and electrical S/PDIF inputs, plus a front panel mounted USB drive socket that will read a Flash (memory) drive (in Sony parlance, a Memory Stick)".

For a chance to win this great prize, just answer the four easy questions at right. Send your entries on a postcard only, by 10th May 2022 to:

**May 2022 Competition,
Hi-Fi World magazine,
Office 052
464 Edgware Road
London W2 1AH**

RULES AND CONDITIONS OF ENTRY

- ONLY ONE ENTRY PER HOUSEHOLD
- MULTIPLE ENTRIES WILL BE AUTOMATICALLY DISQUALIFIED
- PURCHASE OF THE MAGAZINE IS NOT A PRE-CONDITION OF ENTRY
- NO CORRESPONDENCE WILL BE ENTERED INTO
- THE EDITOR'S DECISION IS FINAL
- NO EMPLOYEES OF AUDIO WEB PUBLISHING LIMITED, OR OF ANY COMPANIES ASSOCIATED WITH THE PRODUCTION OR DISTRIBUTION OF THE PRIZES, MAY ENTER

QUESTIONS

[1] Power output?

- [a] 10W
- [b] 66W
- [c] 77W
- [d] 770W

[2] What was missing?

- [a] bells
- [b] whistles
- [c] wheels
- [d] crossover distortion

[3] disc spinner is -

- [a] wind-up gramophone
- [b] CD player
- [c] Blue-ray player
- [d] LP player

[4] What may be "close by" -

- [a] train station
- [b] DAB transmitter
- [c] Radio Moscow
- [d] Voice of America

**ENTRIES WILL BE ACCEPTED ON A POSTCARD ONLY
PLEASE ENSURE YOU PUT YOUR TELEPHONE NUMBER &
POSTAL ADDRESS ON YOUR ENTRY OTHERWISE THE ENTRY WILL NOT BE ACCEPTED**

**FEBRUARY 2022 WINNERS:
ZEN CAN HEADPHONE AMPLIFIER: Mr. David Dineage of Walsall
ZEN PHONO PHONO STAGE: Mr. Robert Leitch of Glasgow**

Mail

LETTER OF THE MONTH PRIZE

Visit our website at:
www.hi-fiworld.co.uk or send your
emails to letters@hi-fiworld.co.uk.

Letter of the month wins a pair of
Acoustic Energy NEW AE100²
bookshelf speakers

Answers by: NK - Noel Keywood; PR - Paul Rigby;
MP - Martin Pipe; JP - John Pickford.



ACOUSTIC ENERGY AE100² BOOKSHELF SPEAKER

<https://www.acoustic-energy.co.uk/>

[subject to availability - Satin Black, Satin White and Walnut vinyl veneer]

A PAIR OF ACOUSTIC ENERGY AE100² LOUDSPEAKERS are on their way to DAVID GREY, Letter of the Month winner in our April 2022 issue.

Letter of the Month

BEARING BENEFITS

Since I last wrote about the upgrade path on my Garrard 401 and commented on the LVA power supply I've been able to invest more. The Rega RB300 arm with Moth counterweights and rewire was replaced with an Origin Live Illustrious. The Ortofon 2M Black bought when first reviewed in 2007 has been replaced with a 2M Black LVB. As I replaced arm and cartridge together I can't separate their affects but certainly the realistic sound that comes when Viv Stanshall introduces Tubular Bells is sublime.

The Christmas wish list inspired me to replace my SDS mat with a Funk Achromat. The Achromat made a good sound stage better and helped individual instruments stand out.

Finally, after waiting a few weeks I received the SMD Acoustics 401 Brass Oil Bearing & Spindle Upgrade I'd been waiting for. All of the changes were to my ears improvements but the new bearing is really icing on the cake, it brings the



An evocative shot of a Garrard 401 turntable, with packing. Find one in original condition like this and your future is assured!



Ortofon 2M Black LVB, a top MM cartridge with boron cantilever for a fast sound.

whole sound stage into better focus and the timbre of instruments is improved. So thanks to the continued efforts of folk such as Shaun Daniels, Arthur Khoubesserian and Mark Baker my interest and enjoyment of vinyl continues.

To give a little context to my



SMD Acoustics 401 Brass Oil Bearing & Spindle Upgrade

£790.00

SELECT SPINDLE OPTION

Standard spindle 0

QUANTITY

1 2

ADD TO CART

Product Code: SMD-401 Brass Bearing

David Bond bought this new high precision bearing assembly from experts Peak Hi-Fi, for his 401 turntable. Not cheap!

the rest of the system and the hum is still there. Frequency sounds at about twice mains hum. There was no hum from the speakers hence I'm certain it's not an earth loop. I'm also using good quality mains leads cut as short as possible between wall & box.

input waveform flat top or hum. I have tried connecting a large 1:1 transformer between wall & pre-amp. This does change the waveform on the oscilloscope: it rounds the top of the sine wave but seems to introduce a harmonic giving a second peak at the -3dB half-power point.

My system is all valve and the other boxes are all marked 240V input. There is a gentle hum from each box but nothing too intrusive I just assumed that it was normal to always have hum from valve kit, although now I'm not too sure.

I just wonder if the high mains voltage and flat-top waveform could be the cause of my problems.

As always your advice & guidance would be much appreciated.

Best regards,
Ted Martin

Hi Ted. Like you we see high mains voltage and a clipped (flat top) waveform from our local St John's Wood power station in North London. I presume they clip the



Origin Live Illustrious tone arm replaced a Rega RB300, says David Bond.

musical tastes, my answer to the Counterpoint introductory question is that my first record purchase was a Quick One by the Who.

Best wishes

David Bond

The paperwork states that the pre-amp is wired for 230V input "...being the UK standard..." I've removed the cover to check the taps on the primary and they are clearly wired for 230V input.

I've checked my mains supply, using two difference meters, and at a number of mains sockets around my house, and it measures between 248V and 252V at all times of the day and night (even checked at 2:30am).

I then used an oscilloscope to view the input voltage waveform. The sine wave has a very distinct flat top instead of a curve.

I'm a little unsure quite what to do: I did wonder about moving the primary taps to the 240V setting although this would be a tricky soldering job as the location is difficult to get at.

Alternatively I wondered about buying a mains-regenerator to provide "... a perfect sine wave supply at 230V..." But these are quite expensive.

I do use an Isotek Aquarius Evo mains conditioner between the wall socket and the system. But this has no effect on the voltage or

CURING HUM

Can you explain the significance of mains voltage and if it might cause a transformer to hum please?

I've recently bought a new valve DAC which has a large square transformer and a valve regulated power supply. But there is a loud hum which seems to be coming from the transformer. Although it's not always easy to localise the source of the hum.

I've plugged the DAC in at several mains outlets without it connected to

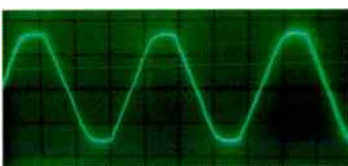

"The sine wave has a very distinct flat top instead of a curve" says Ted Martin about his mains. Just like ours, shown here.

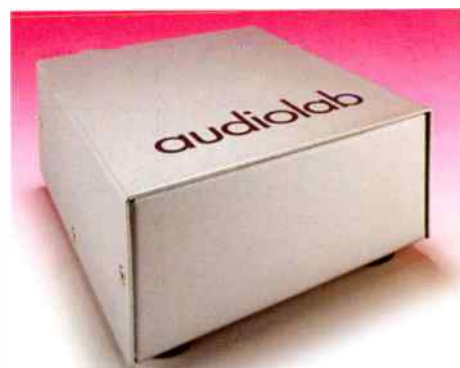

Audiolab's DC Block removes d.c. from the mains, lessening noise in transformers.

waveform in some sort of voltage regulator.

Sounds like the EI core ("large square transformer") in your valve DAC is buzzing as result of the dirty waveform, as they can do. I put the handle of a large



A mains regenerator, like the Power Inspired AG1500S pictured here, is a sure way of feeding clean mains to the hi-fi. At 1.5kW this is too much for Ted, but lower power versions (circa £350) were available.

screwdriver against my ear and blade on the transformer to check for buzz, acting as a stethoscope.

As you find, most mains transformers are little affected, but it does depend on the core size and current being drawn, plus other funnies such as the effectiveness of impregnation and core lamination material.

A trick we used in World Audio Design valve amplifiers was to raise the mains transformer above the (steel) chassis by using brass spacers (nuts). This reduces the magnetic field in the chassis and also lessens transmitted vibration: it might just quieten your DAC sufficiently. Our transformers did not buzz, because big EIs, when run conservatively, are quiet.

Another possible cure is an Audiolab DC Block (£99) because if the waveform is asymmetric there will be a d.c. component and this will induce noise. The Audiolab (Sept 21 issue) eliminates this. If you are fed from a small local transformer (in the street) then this will eliminate d.c., and may make the Audiolab ineffective.

A mains regenerator like the Power Inspired AG1500S (Sept 18 issue) is a certain solution, although a lower power version delivering 500W would probably be sufficient for your purposes. Best to contact them about "double conversion" supplies since the website was unclear about what is currently available. **NK**

CROSSOVER

I realised recently that I have now owned my Monitor Audio BR5 loudspeakers for twelve years, and must have enjoyed hundreds of hours listening to them.

I'm still happy with them, and seem to remember that quite soon after they came out they brought out BR6's which were the same but had been 'revoiced'. It made me think about crossovers and internal components. That's the one item that can't be upgraded, yet is vital to the final sound of the loudspeakers.

So I wondered why manufacturers don't make the crossover a separate unit (a small box?) which could be plugged into the rear of the cabinet between the loudspeakers. It seems they miss a trick here, as they could sell different voicings according to listeners' preference of music, budget, and willingness to upgrade, perhaps to components with tighter tolerances or higher specs.

Best wishes,

Melvyn Dover.



Monitor Audio BR6. A re-voiced version of my BR5, says Melvyn Dover.

Hi Melvyn. Very true. I run a pair of KLS9 loudspeakers with external crossovers. Currently they are housed in black ABS cases that sit on the floor, just behind the cabinet. The main reason for doing this was to eliminate the influence of vibration. It's a very simple but effective mod. And indeed as you suggest this idea can be extended to upgraded versions with better components, alternative voicing, adjustability and what have you, available as upgrades. As standard, the crossover could be attached to cabinet rear, giving conventional form. It could be simply unhooked and placed on floor as an initial upgrade: only a longer lead would be needed between cabinet drive unit outputs and crossover case. The variations and improvements thereafter are endless. As you say, manufacturers "miss a trick here".

NK

WHICH CARTRIDGE NEXT

I have (belatedly) read the letters pages of the March issue of Hi-Fi World, in particular the Letter of the Month titled Which Cartridge Next. I was, recently, in a similar situation to the author. I had, for many years, used a variety of moving coil cartridges, latterly a couple of Denon DL-304s. When the last of those showed serious signs of wear, I substituted an old, but still viable, Roksan Corus Black, as a stopgap, while I pondered a suitable replacement.

Not liking the price of moving coil cartridges that I thought would be most suitable, I took a punt on a new Goldring 1042 stylus, which fits nicely into the body of my Corus Black. A Gyger S stylus for under £200 can't be bad. I am delighted to say that my purchase did not disappoint and works well in my OriginLive Silver II arm on a Garrard 401. Tracking is very secure and the sound stage open and detailed, with a very quiet background. Surface noise rarely intrudes. I am steadily working my way through my vinyl collection and loving every minute.

I recall that, in times past, Noel Keywood used a Goldring 1042 as his standard cartridge, mounted, if I remember correctly, in an SME IV (or V) arm on a Garrard 401. I was, therefore, rather surprised that Noel, in his reply to the author, did not include this cartridge in his list of recommendations. An old design it may be but it still performs very well



Goldring 1042. "Tracking is very secure and the sound stage open and detailed, with a very quiet background" says Paul Topping.

and offers excellent value for money.

I was also interested in the review of Chord's Mojo 2. I have been a Mojo user for 5 years, as a DAC for portable players and, also, in my main system. The sound quality has remained superb. I can see that the 2 offers some improvements that are very useful, such as the isolated mains and tone controls, but the review would appear to infer that the sound quality is very similar to its predecessor. I do not feel the need to upgrade.

Kind regards

**Paul Topping
Lancashire**

Hi Paul. Yes, the dear old Goldring 1042 was a lovely listen, very smooth and detailed – a sophisticated sound that was easy on the ear. I did later find a 1012GX had more 'get up and go' however and over the years more advanced designs have come along that I feel offer greater insight, notably Ortofon's 2M Black and Black LVB cartridges, as well Audio Technica's VM750SH that I rather favour. Its tapered cantilever is a step up, as is its finely polished and mounted Shibata stylus. The result is so good as to challenge many moving coils in terms of clarity, speed and insight. **NK**

REVIEWS

I have been reading hi-fi magazines since 1978, so I have a little experience about the evolution of journalism through the years. I read French magazines of course, La Revue Du Son certainly with Jean Hiraga, and also US and English magazines.

Let's say it plainly: reviews are generally less and less informative about the product, less technical details and less pictures of the item, but more shocking the tone

of the review looks more and more like marketing literature. And this phenomenon increased with the arrival of streamers and low cost turntables.

I know the period is though for the industry and advertisement campaign of a certain brand are always welcome and nobody wants to lose the money it brings.

Now, and that's the point of my letter, I appreciate the independence of Hi-Fi World, the reviews are always balanced and honest, when an item doesn't fill the bill the review is clear about it. I think about Moonriver 404 for example with a pack of IC in the power output.

So if some magazines are not short of good words for a product be aware that HFW is an honest magazine on which we can rely, even if it is always better to listen to it by yourself before purchase.

**Remi Balestie
France.**

MISTRACKING AND WEAR

In the Measured Performance part of your review of the Luxman LMC-5 (March '22), you mentioned it being "a good tracker". OK, so torture tracks (25cms/sec) that few cartridges manage are a good indicator of tracking ability, but when the cartridge fails to track such a groove does it damage the vinyl?

Yes, a tracking weight of 2g or so is light, but considering the small contact area between record and stylus, plus the acceleration the stylus experiences, does this, over time,



Luxman LMC-5. "You mentioned it being a good tracker" says John Malcolm.

distort (or even damage) the purity of the cut groove?

In other words, how much abuse can a test disc take before it becomes unreliable, even misleading? Also, are test discs made of extra hard wearing vinyl, or just have extra

weight (say a 200g-plus disc)? Finally, does this have any relevance to the playing life of a normal LP?

This sort of thing is interesting to me, but I suspect it can get technical pretty quickly, so I'm asking an expert for an In English explanation please.

Yours sincerely

John Malcolm

Hi John. Yes, mistracking damages discs but they do also have a plastic limit that allows the deformed groove to recover if not



Clearaudio Trackability Test Record (£60) – comprehensive analysis of tracking ability at 315Hz. Long test tone sequences help preserve groove quality.

pushed past that limit. Meaning mistracking does not guarantee groove damage – but I think we all have LPs (mainly from the past) where the buzz of mistracking can be heard, often on female vocals where there's strong high frequency energy.

Back to test LPs. They are lightly used and when a cartridge mistracks the test ceases. For as long as high performance cartridges under review are able to traverse the tracks cleanly then they show there is no permanent damage. We also use a new Clearaudio Tracking Test LP as a double-check of our CBS STR-170 test discs.

I'm not aware any of these test discs use special vinyl and none are 200gm either, but they are precision cut on the best lathes, and subsequently checked for accuracy. **NK**

EGGS & BASKETS

Martin Pipe's item in the January edition reminded me of the experience I had a while ago. If I had relied solely on listening to the radio online, I wouldn't have been able to listen to quality radio for about a



A vhf/fm tuner like the gorgeous Pioneer TX-9500 II shown here (1976) assures top quality VHF/FM radio reception, for when someone "reverses a van into the Virgin Media cabinet" and the internet went down, says Mike Bickley.

week! This was because someone had reversed a van into the Virgin Media cabinet further down the road, and it took about a week before it was fixed. If there was ever a reason to never switch off FM, my experience would be it! The powers that be shouldn't get hung up solely on the merits of sound quality on-line: for me reliability plays a big part!

Now I know listening to the radio via an FM tuner isn't Martin's preferable way of listening, but if I didn't have an FM tuner at the time I would have lost radio altogether, so never put all your eggs in one basket.

Same with television. For our viewing needs, Freeview is good enough. However a number of neighbours use cable for viewing, then complain about the loss in service, having put all their eggs in one basket and ditched free to air via an aerial. Progress isn't always the way forward! Regards

Mike Bickley.

Hi Mike. Yes, I recently had a similar experience. My B.T. phone/internet went down, which was odd because all my neighbours were OK, allowing me to piggy-back using BTWi-fi. Turned out to be a fault at the exchange I was told, affecting my line only. This, by the way, is in NW London (Paddington) where high-speed lines were laid only months ago. We're in the Dark Ages here.

The situation has been even worse in local office buildings we use/have used, where when internet disappears the landlords blame the local telecom provider and they blame the landlord's internal distribution network – so nothing gets fixed! It might be better if internet was broadcast by low power transmitters atop lamp posts for better coverage. And resistant to vans. **NK**

TANNOY EXPERIENCE

John Pickford's reaction upon hearing the Tannoy HPD 385 Dual Concentric Arden loudspeakers for the first time is quite normal. I bought my HPD 315 DCs in around 1975 after hearing them at the Olympia Audio Fair in the 1970s. They are in Tannoy's Chatsworth enclosures.

I was using a pair of Wharfedale Dovedale loudspeakers and – like John – it came as a revelation upon hearing the Tannoys. I am still using them today and they still impress. Under Tannoy's guidance, they have been modified. In fact if you can trawl back through my emails to HFW you will see the modifications that have been made; they were all worth doing, although some modifications won't apply to the Ardens. The disintegration of the roll surround is typical of a pro thrashed pair; under domestic conditions it may not happen.

Regards

Mike Bickley.

HEARING WINDFELD

I read with a smile Wayne Allen's piece on Rega MM cheap cartridge in the March issue. Reminds me of my youth days and a Pioneer PL12 D turntable, trying out cheap cartridges back in the '70s.

However, at the other extreme I have just fitted an Ortofon Windfeld T1 MC to my Michell Orbe and SME V tone arm. I have been looking out for one since reading Noel's review back last year. This cartridge now retails a shade under £4k !!. Picked mine up off the usual auction web site for a 3rd of new price.

I have to say this cartridge has

opened my system up tremendously. The detail now being extracted from an LP is breathtaking. Bass is deeper and fuller, with the midrange being lifted – and as for the treble it's very clear.

Also, have you heard of a chemical substance called Triton X. When added to a record cleaning solution it works wonders, really digging out the grunge in the groove.

Thanks once again for an excellent monthly read.

All the best,

Nigel Sach.

Hi Nigel. Phew, that is some saving. It is indeed a lovely MC cartridge, with Replican stylus on boron rod cantilever, for a fast, detailed sound.

Never heard of Triton X and hope it is efficacious without being



Tannoy Arden, with massive 15in Dual-Concentric HPD 385 drive unit.

damaging. Ortofon point out that cleaning chemicals (alcohol, lighter fluid etc) can attack adhesives used to bond styli, and I recall it being said that they can also damage vinyl. Makes me nervous about using or even recommending unknown fluids. **NK**

GET WARM

Earlier this year you kindly published my query about a Quad VA -1 amp. Amazingly my letter won me a pair of KEF speakers! Thank you very



"I wonder if an Audionote Oto would work with my Tannoy Devons?" asks Mike Farrow.

much. They are sounding very nice in my bedroom/study system. I did try them in place of my Tannoys in my main system and was surprised how good they sounded, although obviously lacking a bit of the scale and drive of the Tannoys.

Anyway, although you recommended a couple of replacement transistor amps I was still looking to try a valve amp. Never owned one, but want to try one! I was able to try out a Prima Luna Evo 300 integrated amp from my local hi-fi dealer. I really wanted to like it but it was not to be. Sure, the mid range had far more detail than my aged Quad amps, but the overall

too old such as a Leak. I wonder if something like an Audionote Oto would work with my Tannoy Devons? Audionote are reasonably local to me, so I could presumably get them to service a second-hand Oto. I would be interested in your thoughts.

Mike Farrow

are very popular in the Far East.

If you want to go for valve sound big-time then you need to hear 300Bs, the world's most famous triode. I use 'em at home: think big, open and spacious, also very easy going and totally natural. There's nothing quite like a 300B but they are expensive, starting at £100 each. And you need four.

Look closely at Icon Audio's Stereo 300 MkII (£3999) I would suggest – it has a gorgeous sound. If you want to go further, then consider their Stereo 845 (£7500). These triodes have more slam than the 300B but with their graphite anodes a darker sound too. In your dreams perhaps! Mine too.

Or there is Icon Audio's simple and pure Stereo 30SE single-ended that I favour. I use it as a "blameless" amplifier for review work since it produces no crossover distortion and imposes no character because of its circuit simplicity. It isn't really blameless



Icon Audio's Stereo 300 MkII amplifier may well suit Mike Farrow, who wants a valve amp that does not sound like a transistor amp.

Hi Mike. I am sure the Oto will sound lovely, but it is rated at 10W in push-pull or single-ended form, using EL84 pentodes (known for a sweet sound). Not quite certain they're going to go very loud; Tannoy owners usually want more.

PrimaLuna use EL34s that are known to have a light insightful sound that I suppose you could say is a tad lacking in character. They have never been my first choice but

of course, being too laid back for some.

Conversely, valve amps – especially with KT88s – can be very fast and punchy, but I assume you don't favour this approach. Audio Research and McIntosh excel here.

I hope this helps. It does seem you need to audition a few to try and sort out what sort of sound from valves you are happy with.

NK

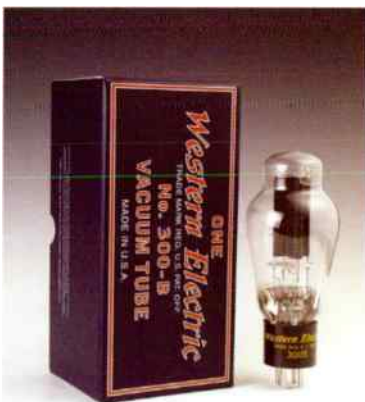

The 300B triode, introduced 1938 for audio work. Pure, low distortion sound unlike anything else.

sound was sterile and not engaging. Sadly it went back to the dealer. I've since been advised (not by the dealer) that the stock valves produce this sort of sound.

I still want to try a valve amp, but not one that sounds like a transistor amp. I don't fancy anything

Wireless Matters

A small wireless loudspeaker from Q Acoustics, the M20 HD, is a budget bargain. Or is it? Noel Keywood looks closely.

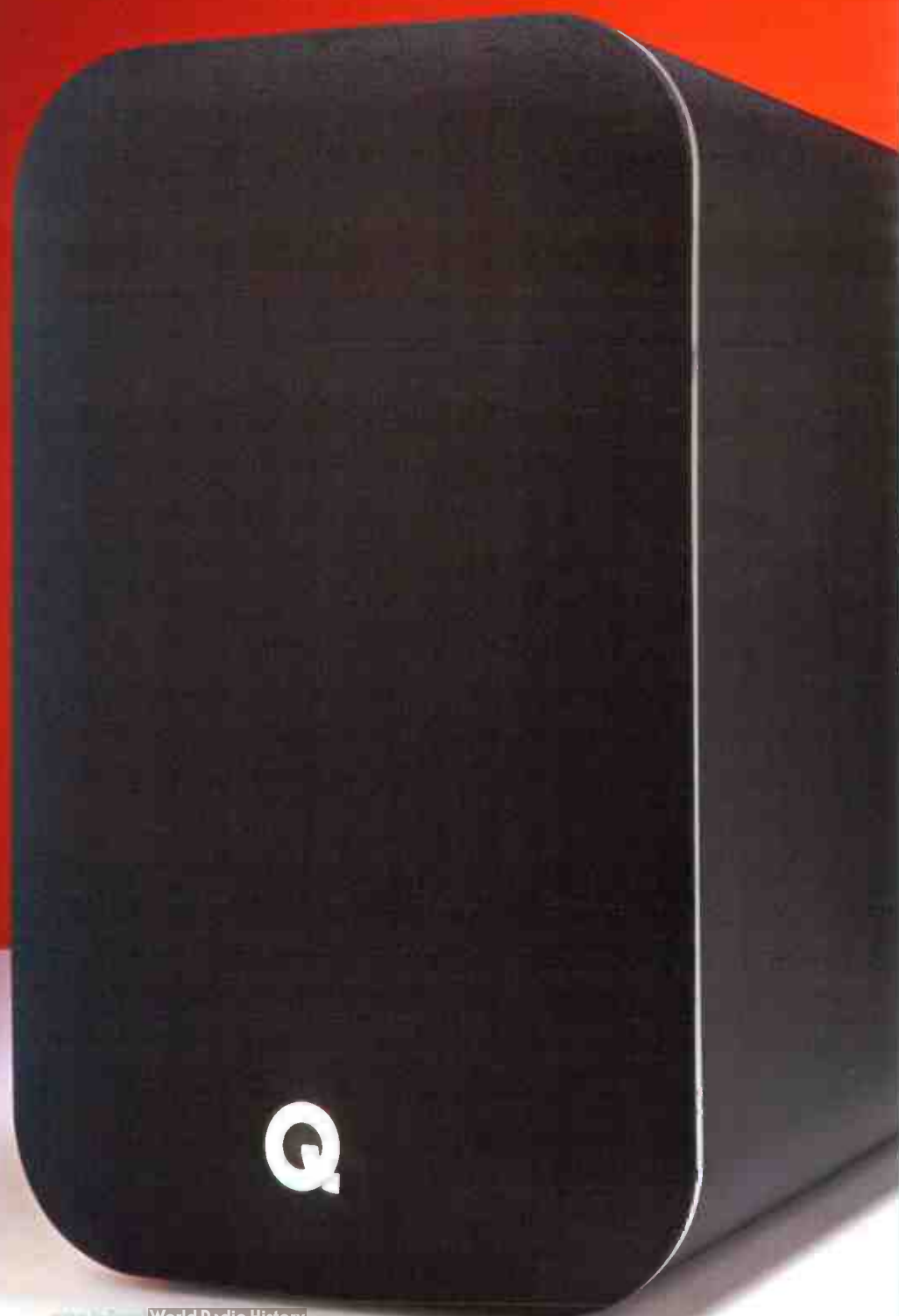

Small, powered smart 'speakers are becoming increasingly popular – and they have a lot to offer. With amplifiers on-board and internet connection, cost can be north of £1000. Q Acoustics offer their entry level M20 HD Wireless system for just £399 – an astonishingly low price. What are the drawbacks you might wonder? Here's a close look.

Well, there's no internet for starters, so you don't have wi-fi to eliminate wires and this has drawn complaint that Q Acoustics description of the M20 HD as Wireless is misleading, as it has plenty of 'em! Hmm...

Well, it does but we haven't yet managed to eliminate mains power to an active loudspeaker and whilst

it would be possible to Bluetooth-link the two loudspeakers instead of using a simple wire link as Q Acoustics do, this would then mean two active loudspeakers and another mains cable. Seemingly making this criticism unrealistic.

The "wireless" description is close enough to a useful reality when the source is a Bluetooth connected source (transmitter) like a computer or mobile phone, that can play music files or commercial music services like Spotify, Tidal etc. This is a simple, direct way of using wireless connection little different to wi-fi and app control, a common alternative, except that it demands use of a remote control in place of app control – something many prefer, including me. Apps become

dated then updated; lose an old app and you may not be able to replace it.

Both my Mac and iPhone saw and connected to the 'speakers quickly and without difficulty, allowing me to play their music libraries, including hi-res and DSD. But of course you only get CD quality via Bluetooth, although those with an Android phone sporting aptX HD will manage better as the 'speakers are so equipped.

The subject of wires gets a little more tricky once that 'HD' suffix comes into play. If you want to get High Definition through these little speakers then it needs either a USB connection to a computer or an S/PDIF digital



Jamo®

CONCERT 9 SERIES



BRING THE CONCERT HOME

PREMIUM CONCERT SPEAKER SERIES

Our Concert 9 speaker series perfectly melds premium acoustic performance with a modern, luxurious design to create gorgeous furniture whose exceptional acoustics are surpassed only by their beauty. High quality wood grain finishes, full length woven tweed grilles, satin painted MDF baffles, all new sleeker chrome logos, satin aluminium trim rings, centre plugs and stabilizer feet make the Concert 9 series II aesthetically elegant, while providing a true audiophile experience.



C93 II
December 2019



C95 II
May 2019



TURNING HEADS

FEATURE PACKED 3 SPEED HI-FI TURNTABLE

TURN 3 is a precision-engineered semi automatic belt-drive record player with a heavy MDF construction and clever anti-vibration feet, which ensure a stable platform for the turntable. The sleek gloss black plinth houses a low-noise DC motor that keeps un-wanted noise and resonance to a minimum.



Jan 2017

FIND OUT MORE AT

Henleyaudio.co.uk

link through optical or electrical cable. With these up to 24/192 is possible I found. So for hi-res wires are indeed needed, but that's hardly unusual and to be expected at this low price. The only oddity here was USB brought up three selection options (headphone/speaker/SPDIF) on both Mac and PC, of which only SPDIF worked – and it isn't an S/PDIF connection! Up to 24/192 PCM played, but not DSD unless converted to PCM.

All of which I hope explains the basic functionality of this little system. To get into physical basics, one loudspeaker carries all the electronics and therefore needs mains connection for power, the other is passive, connected by a 396cm (13ft) slim two core cable. With an 80cm drop to ground this makes for 236cm (8ft) maximum spacing. Each cabinet is a conventional two-way with bass/midrange unit and tweeter. A 32W per channel (claimed) amplifier sits in the active cabinet and Q Acoustics have fitted a left/right switch so it can be put either side, closest to a mains outlet – to minimise wire! The only visible wire then

is that between the loudspeakers, linking them, if Bluetooth sources are used. Not bad at the price.

The cabinets are solidly made and well finished, weighing 5.5/5.1kgs and measuring 279mm high, 170mm high and 296mm deep. Inside lie 22mm tweeter with a very smooth response our measurements showed, plus a 125mm (5in) bass/midrange unit. A small three-way toggle switch on the rear panel can be set for conventional flat output (free field), wall positioning or corner positioning, the last two reducing bass progressively to lessen room boom.

A remote control unit selects inputs, controls volume, has a mute and a power on/off. The active speaker has auto power-down so must be woken up by the remote. There is no master power-off switch; it sits in stand-



Top touch controls, illuminated, on the active loudspeaker for power and volume. The high standard of finish can be seen here.

by. Full power off is at the mains socket only. Small touch-controls sit atop the active cabinet so the system can be driven manually if the remote loses battery power or goes missing down the settee.

It was a very easy system to



An active loudspeaker (left) carries a stereo power amplifier, with an output through 4mm sockets to the passive partner (right), via a cable terminated with 4mm banana plugs. The active speaker carries a USB B input for computer connection, as well as optical and electrical inputs, plus analogue inputs through RCA phono sockets. At right a three-position toggle switch selects Wall, Corner or Free Field placement, adjusting bass response to suit. The amplifier's electrical response measured flat at Wall.

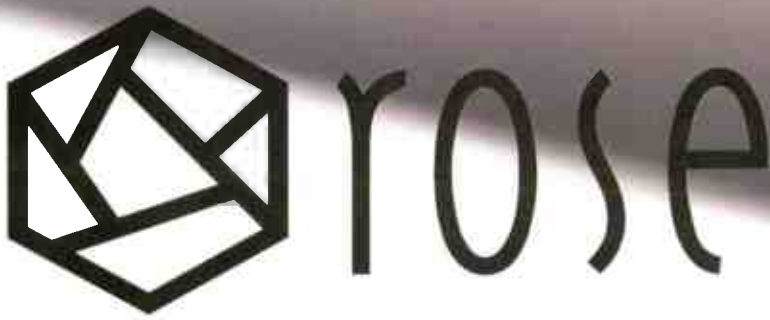

The impression of sound with eyes and ears

ON DEMO
NOW

-  MQA
-  roon
-  TIDAL
-  qobuz
-  Spotify
-  4K
UHDTV
-  HDMI
-  DSD Direct Stream Digital



RS201E

Professional Hi-Fi Media Player



AUGUST 2021



JULY 2021



Distributed by Henley Audio

T: +44 (0) 1235 511 166 | E: sales@henleyaudio.co.uk | W: www.henleyaudio.co.uk | f: HenleyAudioUK | y: HenleyAudio

set up and use I found. However, where Bluetooth connection and operation was fast and assured, initial USB connection was erratic: it took many attempts to get the speakers recognised by my Mac and PC computers and a MacBook Pro laptop was particularly reticent about recognition. Once running however, USB was stable. Also, USB 2.0 connected more assuredly than USB 3.0 (blue socket), a not uncommon situation.

SOUND QUALITY

For the most part I drove the MD20 HDs from my iPhone 11X Pro using Bluetooth, music supplied by an Onkyo HF player app, but also used a USB connected Mac (Mojave) acting as a desktop source, running Audirvana+ hi-res player.

The internal amplifier doesn't have a lot of bass kick but it did a satisfactory job with bass lines.

For me, what stood out sonically was a slight sharpness from the tweeter, or perhaps it was the amplifier driving the tweeter. When I checked this (see Measured Performance) it turned out to be the amplifier. The Eagles 'Somebody' – a track that is compressed to make it sound



A neat little remote control, foam bungs for the ports and a loudspeaker connecting cable with tinned bare wire ends.

"This system does a lot at a very low price in an attractive package. This I admired"

What soon became apparent was the automatic volume limiter: these 'speakers play loud, but no louder! Don't expect to rock the joint. Turn up volume and it will only go so far: there's a clever limiter in there that avoids overload distortion (and overheating).

loud – easily gets tinselly and did so here; I dialled in some equalisation in my Onkyo HF player app (it has an eleven band equaliser) slightly rolling down treble and this did the trick. Overall the sound was good, if not startlingly good shall I say, because of treble rise in the mediocre Class D amplifier

used. This is doubtless down to budget constraints.

CONCLUSION

This system does a lot at a very low price in an attractive package. This I admired. I was expecting a classic Q Acoustics sound balance (smooth) but instead heard a peculiarly sharp sound. If this sort of brightness appeals, as it can do to some, then the M20 HDs do a decent job at the price. With a better amplifier inside I would have been much happier though. A comprehensive package at a super-low price, with limitations.

MEASURED PERFORMANCE

Our frequency response analysis of the M20 HD shows broadly flat output from 60Hz up to 20kHz, in line with expectations from Q Acoustics who consistently engineer for an accurate balance. There is a slight dip at the 2.5kHz crossover point between bass/mid and tweeter, slightly softening the midrange, but also lessening digital harshness. A near field analysis showed very smooth output from the tweeter, suggesting it will sound smooth and free from harshness.

The response shown is 'free field' on the rear three-way switch where bass is strongest; 'wall' and 'corner' switch positions reduce bass to lessen boom in these locations. The port (red trace) is tuned to 50Hz, adding a little to low frequency output. The analogue Line inputs need just 150mV to produce 90dB at one metre so can be driven by a headphone output.

The amplifier has an output limiter to prevent overload, maximum output being 12V. This equates to 36W into 4 Ohms, distortion hovering around 0.1%. With Bluetooth dynamic range measured 98dB – about CD quality. There was however a need to use a 10kHz LP filter to get this result as Class D noise rises steeply above 10kHz.

Via digital optical in (S/PDIF) and USB, frequency response peaks at 40kHz before rolling down sharply to the 96kHz upper limit of a 192kHz sample rate input, our analysis shows. The Analogue input has a brick wall filter at 24kHz from an input ADC.

This is a complex digital amplifier, likely with power fold down to prevent overheating – common on Class D chips.

The loudspeaker has a basically accurate tonal balance but the Class D drive amplifier has limited power, a treble peak and noise above 10kHz. **NK**

FREQUENCY RESPONSE



FREQUENCY RESPONSE amp

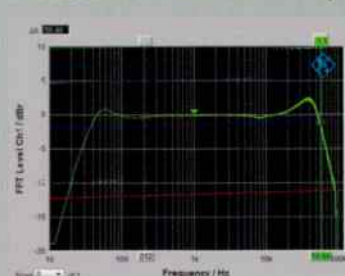

Q ACOUSTICS M20 HD £399

GOOD - worth auditioning

VALUE - keenly priced

VERDICT

A lovely package let down by a weak digital amplifier. OK at the price.

FOR

- functionality
- appearance & finish
- neat remote control

AGAINST

- limpid bass
- sharp treble
- USB I.D. confusion

Q Acoustics
+44 (0) 1279 501111
www.qacoustics.co.uk

PUT A SPRING IN YOUR STEP

VISIT OUR WEBSITE: www.hi-fiworld.co.uk

**A SUBSCRIPTION TO HI-FI WORLD
MAKES THE PERFECT GIFT FOR
YOUR NEAREST AND DEAREST.**

SAVE

...up to

20%

Subscribe today and you will get a special discounted rate giving a **saving of 10% to 20%** off the cover price. That's an amazing £4.50 - £4.00 per issue including postage.



So don't delay, take out a subscription today!

FOR BACK ISSUES ENQUIRIES PLEASE CALL

01442 820580

OVERSEAS SUBSCRIPTIONS IF YOU LIVE OUTSIDE THE UK,
PLEASE CALL FOR OUR LATEST PRICES

+44 (0) 1442 820580

SO WHAT ARE YOU WAITING FOR? CALL NOW!!!

SUBSCRIPTION HOTLINE 01442 820 580

Lines open Mon-Fri 9.00-5.00 or (weekend answering service available)

FOR OUR
ON-LINE MAGAZINE
GO TO WWW.HI-FIWORLD.CO.UK

email:
hifiworld@webscribe.co.uk

WITH THIS GREAT OFFER

WHY SUBSCRIBE TO HI-FI WORLD?

- 12 issues a year delivered straight to your door.
- Be first to grab a bargain in our "Free Reader Classified Ads" section.
- Run by dedicated hi-fi engineers and enthusiasts.
- Hi-Fi World has become famous for its informative reviews and radical kit designs.
- PLUS!** Subscribe by Direct Debit and receive a 20% discount on a yearly subscription (UK only).

6 monthly Direct Debit:
Pay 27.00 every 6 months saving 10% off the yearly subscription rate of £60.00

Annual Direct Debit:
Pay £48.00 every 12 months saving 20% off the yearly subscription rate of £60.00

Annual payment by debit/credit card:
Pay £54.00 saving 10% off the yearly subscription rate of £60.00

Instruction to your Bank or Building Society to pay by Direct Debit



Please fill in this form and send to:

Originator's Identification Number

4	2	7	0	4	9
---	---	---	---	---	---

Name and full Postal Address of your Bank/Building Society
 To: The Manager Bank/Building Society
 Address
 Postcode

Name(s) of Account Holder(s)

Branch Sort Code

Bank/Building Society Account Number

Reference
 HF

Instruction to your Bank or Building Society
 Please pay Webscribe Ltd Direct Debits from the account in this Instruction subject to the safeguards assured by the Direct Debit Guarantee. I understand that this instruction may remain with Webscribe Ltd and, if so, details will be passed electronically to my Bank/Building Society.

Signature(s)
 Date

Bank and Building Societies may not accept Direct Debits Instructions for some types of accounts
The guarantee should be detached and retained by the Payer

The Direct Debit Guarantee



- This Guarantee is offered by all banks and building societies that accept instructions to pay Direct Debits
- If there are any changes to the amount, date or frequency of your Direct Debit Webscribe Ltd will notify you 10 working days in advance of your account being debited or as otherwise agreed. If you request Webscribe Ltd to collect a payment, confirmation of the amount and date will be given to you at the time of the request
- If an error is made in the payment of your Direct Debit by Webscribe Ltd or your bank or building society you are entitled to a full and immediate refund of the amount paid from your bank or building society
- If you receive a refund you are not entitled to, you must pay it back when Webscribe Ltd asks you to
- You can cancel a Direct Debit at any time by simply contacting your bank or building society. Written confirmation may be required. Please also notify us.

TERMS & CONDITIONS: You will receive 12 issues per year. Minimum subscription term is 12 months. Prices include P&P and are correct at the time of going to press. All prices are quoted in sterling. Offer available for UK subscribers, only. For enquiries relating to overseas pricing call + 44 (0) 1442 820 580.

Your Details

Title _____ Forename _____

Surname _____

Address _____

Post Code _____

Daytime Tel: _____

Email: _____

Please debit my VISA MASTER MAESTRO AMEX (SWITCH)

Security No: (last three digits printed on the signature strip)

Valid from Date: ____/____/____ Expiry Date: ____/____/____

Switch card issue No:

Cardholder Signature: _____

Outside UK:-
EUROPE Airmail £60.00
OVERSEAS Airmail £80.00



Send this form to:

Hi-Fi World, Subscriptions Department Unit 4 College Road, Business Park, College Road North, Aston Clinton HP22 5EZ



Super Stream

NAD's new C 399 amplifier brings high quality Class D into an affordable price bracket. Noel Keywood explains.

The C 399 amplifier recently released by NAD trickles down from their Master Series which, in a nutshell, means it totes latest Class D technologies at lower price – £1800. For this you get a 180W amplifier and a whole bundle of interesting technology. Our review amplifier was fitted with an MDC2 BlueOS-D module, bring-

ing retail price up £2100.

I suspect a lot of readers will be interested in the D suffix of this module since it denotes Dirac loudspeaker tuning and indeed, in the box was a small measuring microphone of the sort you get on A/V receivers. The idea of tuning a loudspeaker to match a room I know is popular, but is a subject in itself that I'll get to later.

Curious was that this add-in board also carries internet connection to enable streaming, plus it houses a Bluetooth transmitter – a melange of ability. The C 399 comes with BT aerial on its chassis that I believe is a Bluetooth receiver, the MDC2 BlueOS-D adding ability to transmit to Bluetooth headphones, loudspeakers and such like. Looks like other NAD modules



are not compatible with the C 399 because it has a new two-way comms protocol, MDC2 succeeding MDC. Complicated – and I haven't got to the main amplifier yet!

Although the C 399 comes in NAD's spartan livery that harks back to the early NAD2020 if my memory serves me correctly, it is far, far away from its classic amplifier topology. Inside there is an advanced Class D 'analogue switching amplifier', commonly known as a digital amplifier. These things don't have a good reputation but Hypex (Netherlands) got it right some time ago and NAD acknowledge that here. As a result the C 399 doesn't produce oodles of distortion, nor change frequency response with load, nor is it upset by reactance of a real speaker load, measurement showed.

Feeding this power amplifier is an ESS ES9028 super high quality DAC and there may even be 'digital' feedback, these things being in the toolbox of Class D design. The power supply is an in-house designed switch-mode that they say is robust and well regulated; it has

an auto-standby mode that can be disabled.

At heart the C 399 is digital, meaning it has a digital signal processor (that I updated) where the audio can be manipulated but, unusually, this does not include the tone controls, since they work in Bypass mode. What is bypassed? An ADC that converts analogue inputs to digital. This may send a shiver down the spine of some, but although NAD stay pointedly silent about it (except on p18 of the User Manual), performance measured out as equivalent to good 16bit, having 103dB dynamic range and 23kHz bandwidth. Just be aware that input overload is 2V unless Bypass is used, always an issue with ADCs.

Analogue inputs comprise Aux 1 & 2, plus a phono stage, all through phono sockets – no balanced XLRs. Phono has gain set for MM (and 47k input load) but there is gain adjustment of up to +5dB – enough to accommodate MC cartridges too.

Naturally, there are plenty of digital inputs, but no USB computer connection. The optical or electrical S/PDIF digital inputs are primary,

feeding the ESS DAC to give a massive 121dB dynamic range via the Class D output amplifier. Making the C 399 a fine choice for digital sources. However, it is DSD free as it were, as there's no USB input to accept DoP, nor a card slot for direct file injection; perhaps a future MDC2 board will offer one or both.

It's technically possible to stream DSD from a PC but although my Windows 10 PC saw the C 399 on the network, the BluOS app did not see its music library, for which it would need UPnP. So no-go here.

My Mac (macOS Mojave) saw it as an Airplay connected replay device, allowing Audirvana+ to push-play all file types including DSD, but only at CD quality, Airplay's audio format.

The MDC2 BlueOS-D board offers network connection (ethernet or wi-fi), allowing use of the BluOS control app. (iOS or Android) to oversee streaming and Bluetooth. To enable Dirac another app. must be downloaded, so you can see life gets a little complicated – and I haven't mentioned the remote control with its dedicated function pages!

The BluOS app saw the C 399 as a Bluetooth device or as a Bluetooth controlled loudspeaker, the latter removing volume control duplication and allowing the BluOS player full control and display of album artwork – even DSD from my Mac (although it was in truth CD quality PCM).

Onkyo HF player on an iPhone 11X Pro played hi-res files via Bluetooth and it worked well, but again CD quality unless you have an Android phone with aptX HD. The list of loaded music service apps is long, which is a convenience. All the major names are there: Spotify, Amazon, Qobuz, Tidal etc. There's internet radio of course. So although operationally awkward the app is functionally rich, except there's no ability to access music on a PC as I have already mentioned.

Exciting to get Dirac room correction I thought, but the data integration needs some improvement. The User manual says nothing about it, nor the module data sheet, other than there is a (free) license for Dirac Live in basic form, with an option to upgrade (paid-for). No teasers about what it has to offer.

What's on offer is Dirac Live LE, a truncated version of the full programme. It works from 20Hz to 500Hz, correcting bass and lower midrange room variations imposed upon loudspeaker response. And – don't tell anyone – that's all you need. The big issue is bass boom and

suckout, and Dirac claims to correct this, although I would suggest it is best to use the term "ameliorate" in such tuning schemes. No info on how to initiate and set up this system was provided, so time for YouTube where I found "set up Dirac Live room correction on NAD with Smartphone app" since the app is different from much else.

I went through this lengthy process many times because Dirac

had a strong affect on image solidity and position until mic positions were spot on with mic pointing direct at loudspeaker. Then I could switch Dirac correction on and off at the amplifier, using the remote control, without image shifting. For the most part our Martin Logan ESL-X electrostatics imaged more firmly without correction, but when I got tuning right there was little in it.

Accepting suggested correction audibly reduced bass so I dialled in a few dBs progressive bass lift, simulating room gain but without peaks/dips, and this was an arguable improvement. Since correction can be manually tuned Dirac is best thought of as a tuning system where you get the sound you want, with flattened peaks and dips, rather than any simple way of achieving notional perfection. After much experimental tuning and manual tweaking I think most people would feel it beneficial. The mic lead is 17ft (540cm) long and plugs into the MDC2 board via a small adaptor.

The amplifier is surprisingly heavy, weighing 11.2kgs, with dimensions of 435mm wide, 390mm deep and 120mm high. At left on the front panel is a scroll dial that can be used to dig through a number of logic layers, including a Settings under Settings layer, such duplication being confusing. Once learnt however, there's access to

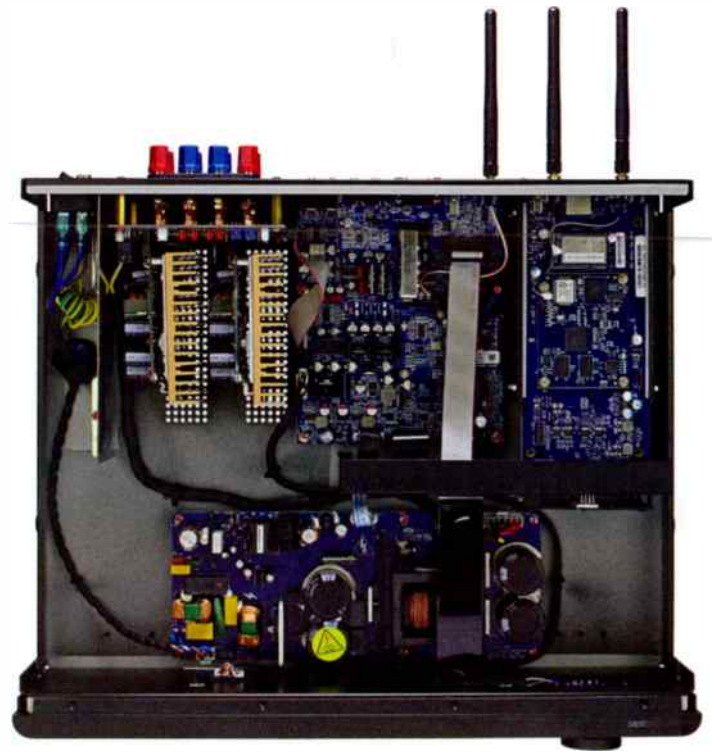

This internal shot from above shows mains input at extreme left, feeding switch-mode power supply nestling behind the front panel. Behind the loudspeaker sockets are heatsinks and at right the MDC2 slide-in circuit board carrying Bluetooth (transmit) and wi-fi aerials.



NAD's MDC2 BlueOS-D plug-in board with gold plated sockets for Bluetooth (transmit) and wi-fi aerials, both supplied. The board slides in on white plastic rails and is secured with two screws. Two boards can be accommodated. Easy to fit if care is taken to engage board with side rails.

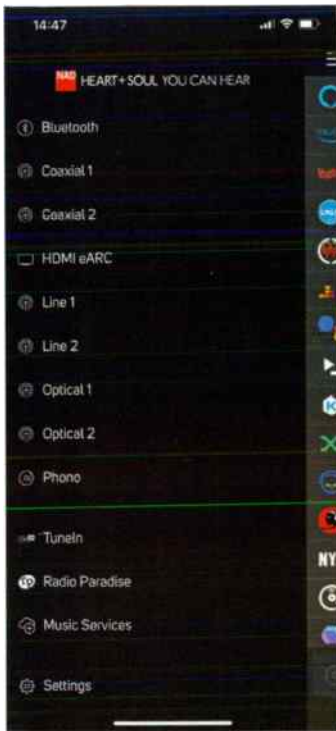

A wide range of selectable inputs on the app screen.

tone controls, balance control, gain settings on each input and much, much more. Loudspeakers can be turned off for headphone listening. See picture captions for more on the buttons and sockets.

SOUND QUALITY

An Oppo BDP-205D silver disc player was connected to the NAD via QED Quartz glass optical cable, to play CD. For hi-res I sent in digital files from a battery driven Astell&Kern AK120 portable player over a short optical cable, again avoiding ground noise. Loudspeakers were Martin Logan ESL-X hybrid electrostatics connected by Chord Company Signature Reference screened cables.

Sound quality was much as expected from NAD and ESS in



NAD's MDC2 BlueOS-D board that comes as an optional user upgrade. It carries Bluetooth transmit and wi-fi aeriels connected to gold plated sockets at right. At centre an RJ45 ethernet socket and at top a Dirac loudspeaker tuning USB input. The board is massively complex, full of hi-tech chips.

combination, since both go for a smooth to warm balance – and that's what I heard in full fat form from the word go, as over-arching character. My vivid test track laced with high treble, Nils Lofgren's Keith Don't Go, was completely tamed, to a degree that surprised me. His tortured guitar strings became an easy listen, there was a good feeling of depth to this live recording and I could hear right into what was going on.

As the tracks rolled by, what became apparent was a creamy smooth mid-band with tremendous insight: a very subtle sound that gently revealed all in wondrously easy fashion. No screaming treble, no false emphasis... heaven forbid, no. Think of a sound with suave civility. I was drawn into possibly the best insight and revelation of digital tracks I have ever heard, as if something magic was going on, but there were some peculiar and ambiguous properties. Amber Rubarth's Storms Across the Oceans (24/96) was warmer and more sumptuous than I've ever heard, but also with a level of insight that I have also never heard.

Fleetwood Mac's Second Hand News punched out with bright balance, followed by Dreams that was a complete contrast: well balanced, and with powerful deep bass. Dreams I use as a classic Rock



The Dirac loudspeaker tuning kit that comes with MDC2 BlueOS-D board. It comprises a small circular microphone with long lead and 3.5mm jack plug that connects into an adaptor board that feeds a dedicated USB A socket.

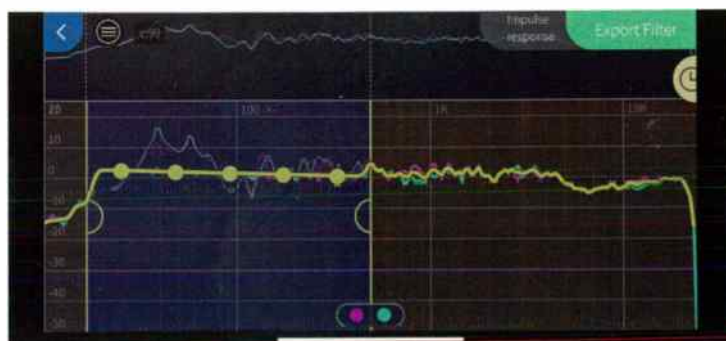

A Dirac tune screen showing suggested response below 500Hz (left), user adjustable by moving (yellow) frequency markers up or down. The broad blue peak at left is 'room gain'.

track – play this properly or die! – and the C 399 played it superbly, no need for undertakers.

I was hearing big differences between digital files, sometimes rude insight. But for the most part a deeply relaxing full bodied rendition that suited Classical as well as Rock. Orchestral sections were unusually well separated with the Minnesota Orchestra playing Korsakov's Snow Maiden (24/96), similarly voices were stable and focussed with Oculi Omnium (24/96). With both Classical and Rock the C 399 had

v40s



Shadow Edition

Enjoy the warm, clear sound of valve amplification from all your audio devices with the v40s from Blue Aura.

blueaura.co.uk

v40s
Blackline





At left two MDC2 card slots, one with BluOS-D card equipped wi-fi and Bluetooth transmit aerials. Top centre are control ports and, below, analogue and digital inputs, including HDMI with ARC for TV, preamp output and Phono input.

exceptional imaging and see-through clarity, it also has big, fleshed out bass that gave a fine sense of scale: a lovely listen.

What's not to like? The sound is big'n'easy, a bit valve amp like. Some may want more openness and verve: both approaches have their merits.

CONCLUSION

NAD's C 399 was far from easy

to set up and understand, partly because it is more convoluted in behaviour than products with dedicated control apps, partly because there was no User info for the MDC2 BluOS-D module. And zilch on Dirac loudspeaker tuning.

In terms of sound quality however, what I heard was quite special: it had me riveted with superb imaging and stage depth in particular,

but there was also a deep insight few else achieve. Part of this is due to close internal coupling of a superb ESS DAC to NAD's undoubtedly excellent Class D amplifier. The two are a magic combo.

If you want a smooth, svelte presentation that offers deep revelation and will never offend, try and audition this very unusual amplifier. A top listen.

MEASURED PERFORMANCE

The NAD C 399 amplifier produced 210 Watts into 8 Ohms, increasing to 342 Watts into 4 Ohms, making it a 250W amplifier into 6 Ohms (the impedance of current loudspeakers). Massively powerful then, comfortably within NAD's spec of 180 Watts – and it ran cool.

Output impedance was very low at 0.03Ω giving a damping factor of 266, imposing strong electrical damping of loudspeakers. The amplifier likely has two feedback loops to control output Z as it is an issue with Class D switching amplifiers, but not here measurement shows. The C 399 response varied less than a traditional Class A/B with Zobel output network and was unaffected by loudspeaker inductance.

Because this is a 'digital' amplifier at heart, analogue inputs (Aux, Phono) run through an (unspecified) ADC that limits frequency response to 23kHz by a brick-wall filter, measurement shows. However, there is a Bypass function that extends response to 48kHz and tone controls still remain functional.

With a digital 192kHz sample rate S/PDIF input via Opt 1 the response limit rose to 48kHz (-1dB) before a slow roll down to the 96kHz upper theoretical limit, our analysis shows. Conversion to analogue (or PDM) ahead of the Class D power amplifier is by an ESS ES9028 DAC and it had an impressive 121dB Dynamic Range. As mentioned there was no change between 8 and 4 Ohm loads

Distortion levels with a 24bit digital

input were impressively low, measuring less than 0.01%, irrespective of level and frequency, often sinking to 0.001%. With 2mH series inductance as presented by a real loudspeaker, distortion changed little, to around 0.1% where some digital amplifiers rise to percents.

Distortion via the input ADC was small – around 0.04%. With a measured dynamic range value of 103dB (CD quality) via the Aux 1 input it contributes little distortion or noise. It does however have a strict 2V input limit.

The Phono input measured flat from 15Hz to 20kHz; warp filtering cancels out-of-phase warp signals. Sensitivity was 3.5mV in and overload a satisfactory 32mV Noise was very low at -80dB. Gain can be varied to accommodate MC cartridges (+5dB max); tone controls are operative and the ADC can be bypassed.

With Bluetooth, frequency response extended to 18kHz but dynamic range was 101dB – CD quality – from a Bluetooth 5.1 iPhone 11X Pro that lacks aptX-HD. So aptX-HD equipped phones should manage better but an iPhone can also manage better with later Bluetooth 5.1 LE receivers using the LC3 codec.

The C 399 is massively powerful and has superb digital dynamic range. **NK**

Power (8Ω)	210W
Frequency response	4Hz-48kHz
Distortion (10kHz, 1W, 4Ω)	0.01%
Noise (IEC A)	-98dB
Sensitivity	200mV

PHONO	
Frequency response	15Hz-20kHz
Distortion (-60dB, 24bit)	0.12%
Sensitivity	3.5mV
Overload	32mV

DIGITAL	
Frequency response	4Hz-48kHz
Distortion (-60dB, 24bit)	0.02%
Dynamic range (EIAJ)	121dB

FREQUENCY RESPONSE

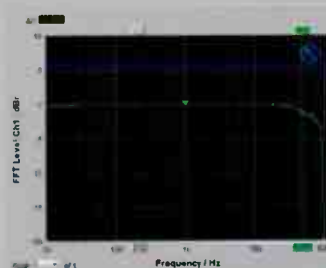

DISTORTION

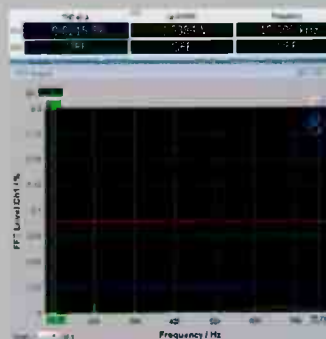

**NAD C 399 AMP
£2100**



OUTSTANDING - amongst the best.

VERDICT

Operationally complex but with superbly smooth and insightful sound.

FOR

- sleekly smooth sound
- big bass
- wonderful digital insight

AGAINST

- clunky app
- no DSD replay
- lacks verve

NAD Electronics
www.nadelectronics.com

On the record



Martin Pipe remembers the Gramdeck, an unusual device that transforms a record player into a tape recorder!

In the early 1960s – around fifteen years after it was used to record and disseminate Nazi propaganda – quarter-inch reel-to-reel tape recording was fast becoming a desirable consumer product. Junior's first gurgles could be captured for posterity, while budding musicians saw its practice potential. 'Tape letters' gave correspondence an audio dimension and hobbyist recording clubs up and down the country began to exploit the medium's creative potential on a collaborative basis. Sound tracks, usually with less-than-ideal synchronisation, could be added to home-movie films. Record companies started releasing music on 'tape records' as an alternative to the LP, and well-heeled hi-fi enthusiasts enjoyed pre-recorded music in stereo for the very first time through such means.

In the Netherlands, birthplace

of tape-recording giant Philips, 6.4% of households boasted a tape recorder. Within five years, this number had doubled. It was a similar story here; by 1965, you could find a tape recorder in nearly 13% of UK homes.

Tape recorders weren't alas particularly cheap. At the beginning of 1959, the least-unaffordable tape recorder was probably the Sound Belle – a compact and attractively-designed single-speed (9.5cm/s) half-track machine with a 7x4in elliptical

amplifier. Tape reels – no wider than 4.25in – were set into upper casework recesses, and its -3dB frequency response maxed out at a whopping 8.5kHz. To get you going, the British-made Sound Belle was

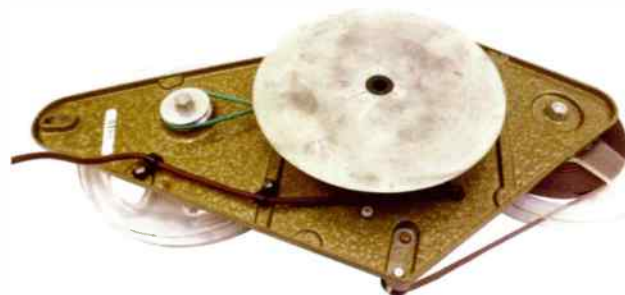

On the underside of the deck is an aluminium 'drive plate' that rests on the turntable mat, and the coiled-steel drive belt that couples it to the take-up spool.

supplied with a crystal microphone, tape and take-up spool. It sold for £27 – nearly £650 of today's

money, in other words.

By the end of that year, a much more affordable alternative – £13.12s, the equivalent of just over £300 today – was available. Despite its considerably-lower price, this new entrant had a more attractive spec than the aforementioned Belle...and, for that matter, pricier models too. It offered multiple recording speeds and could accommodate 5.75in. spools.

The machine in question was the 'world patent pending' Gramdeck, that achieved its goals through highly-unusual means. Indeed, it must surely rank as one of the oddest audio-related contraptions to be offered to the Great British Public (and, for that matter, the Dutch...who could buy a Gramdeck for 285 guilders). This is because the Gramdeck, as its name suggests, was the first (and, to my knowledge, only!) piece of equipment designed to turn a gramophone or record player into a tape deck. It's not a tape recorder in the conventional sense, as it has no power amplifier or speaker of

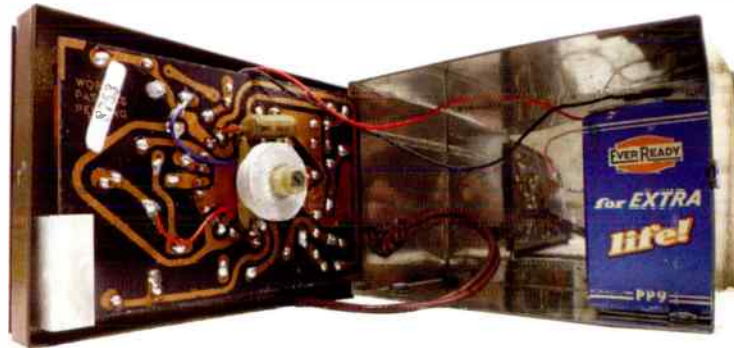

The Gramdeck control unit built its transistorised electronics onto a circuit board. Shown is the original Ever Ready PP9 battery. This one is dead but, even after more than 50 years, hasn't 'leaked'!

components, which were neatly-packaged in separate boxes. This was the 'presentation' of consumer electronics, long before it became the present era's marketing-driven waste!

The first is the 'tape table' that fits over the central spindle of the host turntable and is held steady by a cone-shaped pillar assembly that's screwed into the record player's plinth. It's thus easy to

pulling the tape through its unusual path and onto the takeup spool. The latter is driven, via a coiled-steel drive belt, from a pulley on the shaft of the drive plate.

Obviously, the tape speed depends on the record player. Tutching cleverly designed the Gramdeck so that the tape moves at 7.5ips – then the most popular 'serious' speed – when the turntable revolves at 78



When the record player's turntable is revolving, a lever brings this small rubber pinch roller into contact with the capstan shaft to pull the tape through its unusual path.

its own. The logic of the designer, one 'A. Tutching' was impeccable. At the time, there were far more record players in circulation than tape recorders. Why not use their motive power to turn tapes instead of records? Tutching convinced the firm that installed radar equipment in Viscount and Britannia aircraft to make the Gramdeck...and the scene was set for a very unusual tape recorder.

The Gramdeck has two main

remove the Gramdeck, so that the record player can revert back to its original purpose.

Underneath the Gramdeck's bronze-finished chassis is a flat circular 'drive plate' that rests on the turntable mat. It's coupled to a machined aluminium cylinder, on the top side of the chassis, that acts as a capstan. When the turntable is revolving, a lever brings a small rubber pinch roller into contact with the capstan – thereby

New! A TRULY REMARKABLE BRITISH INVENTION!
Gramdeck
GRAMPHONE TAPE RECORDER

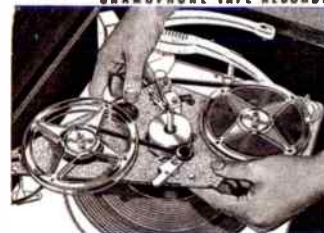

Turns any gramophone into a superb TAPE-RECORDER!

£13.12s. —and back into a record-player in a moment

EASY TERMS
★ Uses standard tape
★ Play at 7 1/2" per sec.
★ or three other speeds
★ Records direct from radio or microphone
★ Brass and food resistant

MADE BY THE FIRM THAT MAKES RADAR EQUIPMENT FOR VISCOUNTS AND BRITANNIAS!

Free!
PRaise FROM THE PRESS
"Real hi-fi results... reproduction smooth." —Radio & TV Review
"Radio Review" — "Provides the same recording and playback quality as many high priced tape recorders."
"Radio Review" — "Gives better than most other cheap gramophone tape recorders in the £10-£20 price range."
"American Review" — "Better than many so-called hi-fi recorders."
—London Cine World

FREE BOOK—POST NOW!

I would like to know how to turn my gramophone into a Super-class tape-recorder... please send me the Gramdeck Book—FREE and without obligation. (Write if you prefer not to cut paper.)
NAME.....
ADDRESS.....

Gramdeck
GRAMPHONE TAPE RECORDER
(Dept. TA/81), 29, WRIGHT'S LANE, LONDON, W.1.

An early (1959) ad for the revolutionary Gramdeck. The unit was to undergo changes in appearance during its production run.

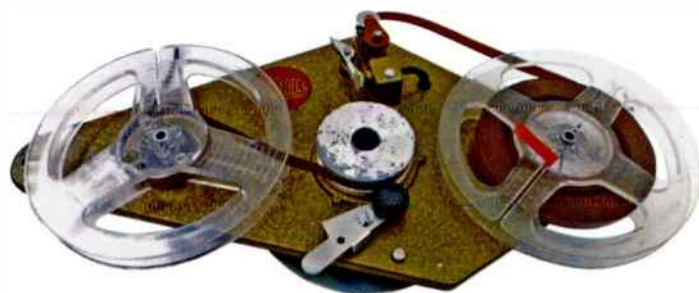

Coupled to Gramdeck's flat circular 'drive plate', which rests on the mat of the turntable beneath, is an aluminium cylinder that acts as a capstan. It has been machined to a diameter that corresponds to a tape speed of 7.5ips when the turntable revolves at 78rpm.

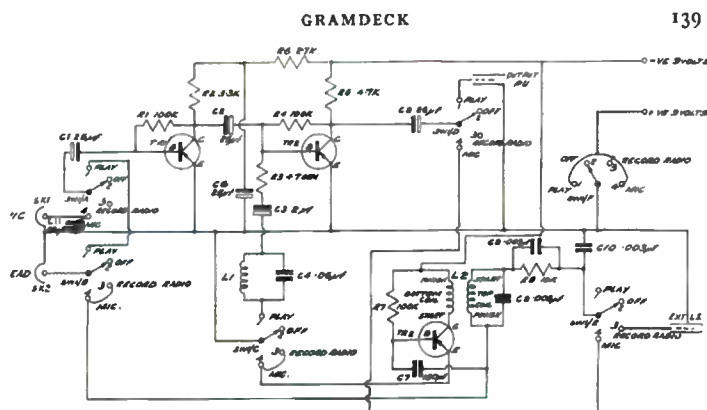

CIRCUIT DIAGRAM—GRAMDECK PRE-AMPLIFIER (Mk. II)

Three germanium transistors - two for the amplifier, the third for a bias oscillator - are used in the Gramdeck's simple but effective electronics. A radio set, with 'gram' input, was used as an amplifier/speaker.

rpm (he also presumed that obsolete gramophones and 1930s radiograms would enjoy new leases of life with the Gramdeck).

Unfortunately, his design means that other 'standard' turntable speeds result in non-standard tape speeds – 4.3ips (45rpm), 3.2ips (33.3rpm) and 1.6ips (16rpm). Turntables with a 'varispeed' function could however compensate for this, thereby enabling 'correct' tape speeds of 3.75ips and 1.875ips to be attained.

The tape path is itself unorthodox. There's no erase head, a much-cheaper permanent magnet being used instead. Recording and playback operations require the tape to be 'faced up' differently, the former enabling the magnet to be 'passed'. I can imagine owners accidentally ruining treasured recordings or expensive tape records by absent-mindedly choosing the wrong path! In both cases, the head – a shielded half-track type (enabling two mono recordings of equal length, one on

each side of the tape) is specified. Another lever engages a pressure-pad, to keep the tape in contact with the head.

To rewind the tape, the Gramdeck designer specified a handle that fitted onto the supply reel. Change the tape path by disengaging the pinch roller, though, and you could rewind (albeit more slowly) without manual intervention. No purpose-designed fast-forward facility was provided. Very unusual, so it's perhaps just as well that Gramdeck offered a 'free installation service' to perplexed customers.

The second core part of the Gramdeck proposition was the electronics – described as the 'pre-amplifier control unit'. At a time when most tape recorders were built around valves, the control unit was transistorised. On a printed circuit board (another then-modern technique) are a mere three of these XB102 germanium PNP devices, which are powered by an internally-fitted 9V battery. Gramdeck claimed that "600 hours" of use were possible from one such PP9, which in 1959 could be replaced for a mere 3s. 8d.

It follows that with a battery-powered record player or 'wind-up' gramophone, the Gramdeck could be pressed into service as a portable tape recorder. Two transistors were used for the amplifier, while the third formed a bias oscillator. A switch moved the control unit between playback, or recording from either 'radio' (higher-level line input) or microphone (supplied). The switch's fourth position removed power



The shielded record/playback head, a half-track type that enables recordings to be made on either side of the tape. There's no erase head, a much-cheaper permanent magnet (visible above) being threaded into the tape path during recording.

this is the **GRAMDECK**



... NEW ... ORIGINAL ... VERSATILE ... LOW PRICED
IT CONVERTS ANY RADIOGRAM INTO A
TAPE RECORDER!

SOME TECHNICAL DETAILS

- Output at peak recording level 4 mV rms.
- Impedance from CCRS tape 2.1 ohm from 1 KHz to 10 KHz, falling 3 dB per octave below 1 KHz (Hand checked with 6002 meter)
- Wear and Plester (from tape table only) better than 0.15% rms., measuring all components from 8-100 c/s. With conventional turntables, better than 0.5%. With conventional gramophones or turntables, better than 0.7%.
- Output voltage from CCRS tape, or average programme level, 0.25 volts rms.
- Noise: Better than 3 dB rms.
- Dimensions: Playing EMI or CCRS tape up to 3.48 from 60 to 18,000 c/s. Record/Replay, the same as above.

The second unit, Control Unit, contains a dry battery with a useful life in excess of 600 hours, enabling recordings to be made from microphones, or radios, and phylaxids to be made through radio or radiogram via pickup input—or directly to the Hi-Fi pre-amplifier and amplifier. A selector switch controls these facilities.

Please write for full details of this revolutionary device, to the manufacturers:

STEVENAGE TOOLS AND SWITCHES LIMITED
WALKER ROAD · STEVENAGE · HERTFORDSHIRE · ENGLAND

A later Gramdeck ad extols the unusual tape attachment's virtues as a 'truly remarkable' British invention. We can't argue with that!

from the control unit altogether.

On the front-panel of the control unit are two TV aerial-type Belling-Lee sockets. One accepts the trailing coaxial lead from the Gramdeck tape deck, while a microphone plugs into the other. As the Gramdeck has no speaker of its own, reproduction had to be through an external audio system. With this in mind, another 'captive cable' connects the preamp to the 'pick-up' socket of a radio set (other amps and speakers could of course be used). Another lead enables the control unit to be fed from the radio's 'extension



The second key part of the Gramdeck proposition is this transistorised 'preamplifier control unit'. Gramdeck claimed that a single PP9 battery could power it for up to 600 hours of use.

loudspeaker' socket, so that broadcast programmes can be recorded. No recording level control or 'magic eye' was offered, and so the user had to experiment with the radio's volume control in order to determine the optimum recording level. Too hissy, and it's too low; too congested or distorted, and it's too high. Another disadvantage is that the Gramdeck doesn't provide equalisation for

different tape speeds, the system presumably being optimised for 7.5ips. The tone controls of your radio or amp could however be used to compensate.

At 7.5ips, Gramdeck claimed a frequency response of 60Hz-10kHz within 3dB – in performance terms, this was in line with the era's tape recorders. I found recordings to be rather 'hissy', which is down to those ancient transistors as well as the permanent-magnet erase system.

Wow and flutter is dependent on the performance of the record player used it with. With a vintage

Decca wind-up gramophone (which will offer four minutes or so of continuous recording before the handle needs 'reanking'), pitch instability is obvious. Switching to a Goldring-Lenco GL75 turntable, with its massive idler-driven platter, I found that matters are noticeably better. On the whole, though, Mr. Tutching's clever arrangement worked very well given the limitations of late-1950s technology, and for a couple of years the Gramdeck helped to bring tape recording within reach of more people.

Serious tape enthusiasts liked them too, as they made cheap 'second decks' for dubbing and so on.

The Gramdeck was advertised constantly in the specialist press throughout 1960, but seems to have disappeared completely the following year. The industry was moving fast; easier-to-use purpose-designed tape recorders were becoming cheaper, thereby



The ingenious Gramdeck, the first (and only?) piece of equipment designed to turn a gramophone or record player into a tape deck, must surely rank as one of the oddest audio-related contraptions to be offered for sale!

nudging this most unusual of audio products into history. Many Gramdecks were however sold, and they regularly surface on eBay. Prices tend to be in the region of £20 per 'set', but complete examples are seldom encountered. The pillar tends to be missing, as it was left attached to the 'host' record player, and you'll usually be greeted by a circular 'hole' in the deck box instead of a mike. Nowadays, a technological curiosity then, but a fascinating one all the same.

Klipsch
HERITAGE
LOUDSPEAKERS

Sonically
SUPERIOR

INTRODUCING THE

Forte
IV



DESIGNED & ASSEMBLED
IN THE
USA
CRAFTED WITH PRIDE IN
HOPE, ARKANSAS

FLOORSTANDING LOUDSPEAKERS

Horn Loaded Loudspeakers | 15" Passive Radiator | New High Fidelity Network | 99dB Sensitivity

Since its inception in 1985, the Forte has been a standout speaker. The new Forte IV is a three-way horn-loaded speaker design featuring updated cosmetics and the latest advancements in acoustic engineering for premium performance.

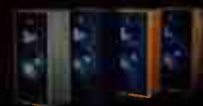

Available in 4 bookmatched finishes

H
HENLEY
AUDIO

Distributed by Henley Audio

T: +44 (0) 1235 511 166 | E: sales@henleyaudio.co.uk | W: www.henleyaudio.co.uk | [f](#): HenleyAudioUK | [y](#): HenleyAudio

World Radio History

"much hi-res PCM looks like old 16bit originally destined for CD"



Noel Keywood

Last month I talked about a popular YouTube video entitled *The Truth About Vinyl* that amusingly placed pickup cartridge in the counter-weight. Imaginative. But the point of this video was to explain that vinyl could not sound better than CD – and belief that it did was based on “personal preference”, not objective truth.

It's a naive yet common view. But why is it common: why do so many people believe digital is perfect and that dodgy old technologies like LP cannot by their very nature be better?

What we see and feel with LP is a rickety old vinyl disc from the 1950s, often warped. Then there's the surface noise when needle hits groove, ticks and pops, wear... the list goes on. CD is conspicuously way ahead: flat, smaller, shiny, read by a laser. And 1980s digital. How on earth could the former be better than the latter?

The problem here is we are looking at the discs, not the music on them – the two are very different. With CD, analogue must be converted to digital and back again and it's in this conversion process music gets mangled. That's its historic weakness.

At no time back in the 1980s, when CD was released, do I recall any mention of this issue. Analogue-to-digital convertors (ADCs), used in studios to convert music to digital, were shrouded in mystery. Little more was known about digital-to-analogue convertors (DACs) needed in consumer CD players. Back then digital technology was the province of a few big companies like Philips and Sony – and what they revealed about it was both limited and manicured.

For example, distortion was quoted at full level, just as it always

had been with analogue, and the figure was impressively low, around 0.001%. By contrast LP was in the 5%-10% range, so no contest.

Not so. This was peak level, the worst condition for LP but the best condition for CD. Down at ordinary music levels, distortion on LP was far lower and from CD far higher. Did Philips know? They must have, but it was for the world to find out.

When I received early CD players for review, I became suspicious by coarse midrange and graunchy treble. Compared to my Pioneer PLC-590 DD turntable with SME3009 arm and Stanton 681EEE cartridge CD wasn't obviously better, it seemed to have problems. But what were they? We had all been told that this shiny new digital system was “perfect”.

In 1983 I bought an advanced Hewlett Packard HP3561A spectrum analyser able to measure what was going on. Philips would not sell their professional test CDs to me, which is why I suspect they knew about the problems these discs would reveal. But I got hold of one in any case, plus an array of Japanese test CDs from Technics, Denon and the like – and they all came up with the same result. At normal music levels distortion from CD was higher than that from LP, and at low levels it was appalling. In one player the analyser flashed up 110% – there was more distortion than signal! I remember listening to classical where massed violins shimmered in a sea of distortion – a gruesome experience.

The world has moved on of course. Today large electronics companies like Texas Instruments are major players, introducing high quality audio ADCs around 2003 onward (e.g. PCM1804) whilst only recently (Nov 2020) has ESS released its ES9822Pro 32bit ADC that they claim is clearly the world's best. High

quality audio ADCs started appearing in the 2000s, suggesting earlier digital recordings were of mediocre quality.

Hi-fi buffs may know about Philips early TDA1541 (1985) resistive ladder DAC chips, responsible for severe replay distortion levels I have quoted. Less well known is what levels of noise and distortion ADCs were producing back then. Since this is a more difficult technology than that of the DAC we can assume an order of magnitude more, so around 10% distortion at -60dB. Add conversion distortions together (ADC+DAC) and large values appear, well north of 10%. That's what we hear from early digital recordings. Far from perfect I'd suggest.

Digital files are tenacious: they hang around, lurking on hard drives around the world. Wanna re-issue old classics from the 1980s/90s? Just dig out those old digital files, re-package and sell them. I have quite a lot of this stuff and it always sounds bad in exactly the same way: dimensionally flat, coarse and unengaging.

It gets worse. Old CD files can be up-converted to hi-res. I analysed fifty hi-res tracks recently and forty eight had brick wall filtering at 21kHz, suggesting they were lifts from CD (could be 24/48s but I doubt it). Is this why hi-res often doesn't sound convincingly better? Much 'hi-res' PCM looks like old 16bit originally destined for CD.

So we are diddled by digital. Which is all a bit different to the view that digital is perfect and always will be.

Does modern digital fulfil the promise of perfection? 24bit gets close enough and DSD closer – but whether what we hear will ever match the promise I somehow doubt. Something always gets in the way, like MP3 – and now streaming! ●

Sonus faber
ARTISAN OF SOUND

McIntosh
LEGENDARY PERFORMANCE™

IsoTek
The power to perform

Handmade in Italy
Bassocontinuo
FINE AUDIO RACKS



Experience these prestigious and award-winning brands at your nearest specialist dealer:

www.finesounds.uk/dealers

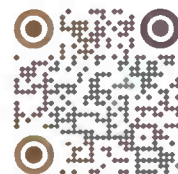

fs **finesounds**
UNITED KINGDOM

Distributors of the finest high-fidelity audio components

t. 01592 744 710 | www.finesounds.uk | info@finesounds.uk

Fine Sounds UK is a McIntosh Group Company

World Radio History

"I can grab the subtle musical cues often missed when listening via loudspeakers"



Martin Pipe

Hi-fi was once a rich man's plaything. Over the years, falling prices have brought the hobby to those on more modest incomes.

Adjusting for decades of inflation, an excellent single-source playback system can now be acquired for the same money that would have bought the cheapest (i.e. non hi-fi) tape recorder back in 1960. We have taken such trends for granted – as we have the increased affordability (and wider choice) of other goods and services, alongside general living standards that continued to improve. Food prices have, in real terms, fallen over time to the point where they are no longer a significant contribution to household budgets. Also heading downwards was the cost of energy – the electricity that powers your hi-fi equipment, as well as the gas that heats your listening room.

However, this situation has changed, and over the past months prices have instead been moving in the opposite direction. According to the Energy Saving Trust, demand for gas increased as countries began to recover from the pandemic and prices rose as a result. Renewable energy sources like wind and solar were less productive during the winter months, and cold weather forced more people to turn their heating up. Adding to this perfect storm is the invasion of Ukraine by Russia, a significant player in the energy market. Russia's unprovoked act of aggression has ramped up the price of petrol and diesel.

In the UK, gas and electricity consumers were protected by a price cap. Many energy companies could not absorb the rising wholesale prices of fuel, and went bust. The customers of no fewer

than 29 such firms were, according to the Citizens Advice Bureau, transferred to new suppliers. By the time you're reading these words, said price cap will have been raised. Its effects will also be significant. Shell Energy, for example, is hiking up the price of 1kWh of electricity from 20.871p to 29.239p. At the same time, its gas rates will jump from 4.055p to 7.344p per kWh. These are, on average, about double those charged as recently as a year ago. Meanwhile, British Gas has told its capped-tariff customers that from April 1st, when the cap rises, they will pay as much as 30p per kWh for electricity. Furthermore its daily standing charges will be as high as 51p for electricity, and 37p for gas.

Rising energy costs are forcing consumers and businesses into making difficult decisions, as well as contributing to an inflation spike. Just as we had assumed that energy, food and indeed consumer goods would continue to get cheaper there seems no end to the energy crisis in sight.

So what can we do? From a technology perspective I'd say that LED light-bulbs, if you're not using them, are definitely worthwhile. They've improved considerably in recent years. The ones now sold in supermarkets are affordable, reliable, offer decent illumination and are considerably less-wasteful of energy than traditional incandescent or even halogen bulbs.

Closer to home, valves (lovely though they are!) aren't efficient compared to, say, Class-D semiconductor circuitry. However a modest stereo valve amp consumes around 150W and won't impact your electricity bill to any significant degree, if used for a

couple of hours in the evening (and probably won't at all, if you have a solar PV installation and listen during daylight hours!). And during the winter at least, warmth goes into the room.

Far more wasteful was the advice – alas still heeded by some – to leave their hi-fi systems switched on all the time. Not only doing so will add pounds to your bill, but such nonsense – a by-product of the vanishing 'cheap energy' era – can actually cause premature failure of equipment (especially if, like most gear, it contains electrolytic capacitors). The EU now requires stand-by systems to consume no more than 1W from the mains and increasingly hi-fi products are being fitted with auto-standby circuitry, so when silent for a period (sometimes adjustable) will go into sleep mode, much as computers have done for many years now.

Another possibility is (don't laugh!) resorting to headphones. The amplifiers that drive cans measure their output in milliwatts rather than watts. They require smaller power supplies, and are hence easier on your bill. A decent circumaural pair is comfortable to wear and isolates music from ambient noise. I can grab the subtle musical cues and details that are often missed when listening via loudspeakers.

That said, loudspeakers and 'phones are a different experience; both have their pros and cons. Frequently associated with headphones is a 'hole in the head' effect. To get around this, some headphone amplifiers – among them Chord and iFi – offer a 'cross-feed' function that blends channels to give a more loudspeaker-like presentation and this can work very well I find. ●



SOUNDECK

Especially for vinyl lovers... THE NEW DESIGN Sounddeck PM Platter Mat

"All we can say is WOW. It is a very favourable improvement"

J K

"It's hard to put into words the dramatic improvement the PM brings to my SL-1200"

Frank T

"My view? Genius thinking outside of the box. Physics at work for much improved record playback"

Walter D

email sales@soundeck.co.uk to request information, receive a link to videos & reviews or discuss special sizes/products



Available in 295mm 292mm or 285mm
Material SDS 4mm aluminium laminate

Price £90 inc VAT
online shop & info www.soundeck.co.uk



E Series



S Series



M Series

AIRaudio
UK Distributor for Hana Cartridges

INFORMATION AND UK DEALER LIST
www.hana-cartridges.co.uk

TELEPHONE
01491 629 629

"Youngsters don't carry that baggage, they just hear two great 70s rock bands doing their thing"

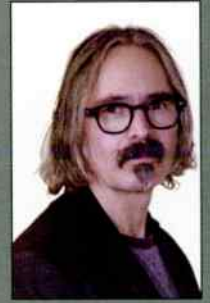

John Pickford

I'd rather Jack than Fleetwood Mac", sang The Reynolds Girls on their 1989 top ten hit I'd Rather Jack. How times have changed. At the time of writing, Fleetwood Mac's greatest hits compilation '50 Years – Don't Stop' has a top 10 placing in the UK albums chart, having been in the charts for over three years.

'Rumours', the band's most enduringly popular LP originally released in 1977, is currently enjoying its 928th consecutive week in the UK album charts, having sold 34,593 new vinyl copies in 2021, while in the US it sold 6000 copies on vinyl during the last week of January 2022, making it the No.1 album on the vinyl chart.

Despite the millions of copies floating about, my friends who own second-hand record shops tell me they struggle to buy-in enough copies to meet demand. One shop – the wonderful Wanted Records in Bristol – even has a bespoke wooden sign in the window with a lift and shift sliding bar to indicate whether Rumours is in or out of stock.

It's not old geezers buying the record though, I am told. It's mainly teenagers and twenty somethings – predominantly female – who can't get enough of the album's glossy soft rock.

The resurgence of vinyl has inspired a generation of younger listeners to seek out classic albums from vinyl's 1970s heyday and Rumours is seemingly a must have in any discerning Gen Z's record collection. Several of today's pop stars have cited Fleetwood Mac, and in particular Stevie Nicks, as an influence, including Miley Cyrus,

who has collaborated with Nicks, and Harry Styles, who enjoys a high profile friendship with the singer.

Speaking to The Guardian for an article about the Rumours phenomenon, 15 year old Jane Wagel explained her interest in the album was stoked by Styles' endorsement. "I know that Harry likes Fleetwood Mac, and I trust him because he likes David Bowie" she said. "I'm definitely a punk person, a rock person. I wouldn't expect myself to be that into Fleetwood Mac. But it's kind of its own thing. It's really beautiful, and it has its own personality; all the songs are different, but cohesive".

I find it interesting that someone who thinks of themselves as a punk rocker would embrace an album such as Rumours – that certainly wouldn't have happened in the year of its release, when punk was threatening to consign the likes of Fleetwood Mac, Pink Floyd and all the prog rock acts to the history books. Generation X people like me felt the aftershocks of punk at full force and professing a liking for Jethro Tull or Genesis was a no-no.

Today's young music fans have no such prejudice, it seems, so bands such as ELO – once terminally uncool despite huge sales – are now hip. I always secretly liked Mr. Blue Sky back then, but I would never have admitted it; it wasn't allowed among the crowd I mixed with. REM were in, ELO were out.

As a teenager in the post-punk 1980s, certain musical viewpoints were a given. Led Zeppelin were cool but Status Quo were naff, for example. Youngsters nowadays don't carry that baggage, they just hear two great 70s rock bands doing their thing. But I remember reading

back then how in 1971 it would have been inconceivable for a serious Led Zep fan to like a teeny bop act such as T Rex, yet to me, in 1985, Marc Bolan was every bit as cool as Page, Plant and co.

Even Phil Collins, always an easy target for self-styled music tastemakers of yore, is making an impression on today's youth. There's a wonderful video that appeared on YouTube a couple of years ago, showing the reaction of a couple of teenage hip-hop dudes hearing In The Air Tonight for the first time. Their appreciation of the vocal performance is apparent from the get go, however when Phil's trademark gated tom-tom fill kicks in their reaction is priceless. "Woah! I've never seen somebody drop a beat 3 minutes into a song. That's good, man. That's unique".

What a contrast then, to a couple of chaps I know. One is a massive Oasis fan and as such, hates Blur with a passion to this day. He's been fighting the Battle of Britpop since 1995. Perhaps that's not so surprising as there was never any love lost between members of those bands back then.

More surprisingly perhaps, especially considering his encyclopaedic knowledge of pop history, is my septuagenarian friend who still feels it necessary to sneer at The Beatles because he's a die-hard Rolling Stones fanatic. He knows the two bands were great friends throughout the 60s, but he nailed his colours to the mast in 1964 and there's no going back now.

Sandi Thom was quite prescient when she sang "I wish I was a punk rocker with flowers in my hair" in 2006. There's little room for tribalism in today's musical melting pot. ●



All Action

With internet connection, an app and active drive, the Monopulse S A has it all.

Noel Keywood explains.

Here's an ingenious loudspeaker at a great price – £1590 for our version – one that's hand-built to order in the UK. A major reason for the price is that it's available direct only, a 50% deposit being required upon placing the order. Then Monopulse can provide their active Model S A in a variety of cloth colours and base veneers. What surprised me most though was that this is a streaming loudspeaker – yes, it has an app!

Bigger surprise – it was a good one. Unlike mconnect, 8player and so many other apps that I regularly wrestle with. Next surprise, it comes from China – not a place known for clarity of visual design or logical functionality. Making what could have been quite a difficult experience relatively easy. Monopulse are not responsible for this 4Stream app: it's allied to an Arylic S10 streaming module they attach to the rear of the powered loudspeaker.

That's just a quick resume of the Monopulse Model S A (A for active) floorstanding loudspeaker. One loudspeaker is powered from the mains, carrying a Fosi TB10A TPA3116 mini stereo 35W power amplifier (see Measured Performance) with bass and treble tone controls. One channel of this amplifier drives the active speaker, the other drives a passive (unpowered) partner via a supplied cable, terminated in 4mm banana plugs. This is a relatively common way of doing things, the benefit being only one 'speaker needs connection to the mains for power and there's no duplication between 'speakers.

Central to operation is the remote/app controlled

Arylic S10 module that has broad ability. It connects into the home (local) network via wi-fi or wired Ethernet connection. There are multiple inputs: Aux (analogue), Bluetooth 5 (2016) that has a high data rate, USB Flash drive (mass storage memory), and an RJ45 Ethernet socket. The module has an Aux input and there is a direct Aux input too, so a conventional analogue preamplifier can be used, connected through phono socket terminated cables (unbalanced).

Insert a Flash drive at rear and you can read its music library from the app, with the one drawback that DSD goes unrecognised. Up to 24/192 PCM is seen and played however, including FLAC files. This module delivers an analogue output into the amplifier from digital inputs, so has an (unspecified) DAC on-board. What it lacks is a USB input for connection to a computer or S/PDIF digital inputs.

My PC (Windows 10) music library was seen as Home Music Share, allowing me to pull-play from it, including hi-res but not DSD. The Mac (Mojave) saw it as an Airplay device allowing me to push-play from the computer, but Airplay is CD quality only. The app grabbed all this easily and quickly, presenting it over just three 'home' screens (one a redundant Settings screen with no settings). It also has a comprehensive list of commercial music servers (Spotify, Qobuz, Amazon etc, internet radio stations, opening these speakers to a wide array of music sources.

The way Monopulse pack in the small amplifier, a master power

switch, input and output sockets I found initially confusing, but it all worked reasonably well, except that the 4mm loudspeaker output terminals are obstructed by any Flash drive in use and/or an RJ45 Ethernet plug, both of which I used. The remote has a power-off button but this is for the input module alone. There's a master switch for power to the amplifier and module, but it is on the floor, and there's also an amplifier power switch! All this is a bit awkward.

The amplifier's tone controls – difficult to get at – are best thought of as pre-sets, because there are also tone controls in the app, so things can be tweaked whilst listening. With tone controls on the amplifier set to 12 o'clock the tonal balance was bass light/treble strong measurement



It's all a bit cramped at rear, where the Arylic streaming module sits just above a modified connection panel whose top 4mm sockets lie beneath Ethernet cable and Flash drive. The loudspeaker cable is not shown plugged in here. There are Aux in phono sockets too.

PASS

Introducing the XP-12 & XP-17



Enjoy the Experience

Pass Laboratories, Auburn, CA 95602 | 530.878.5350 | passlabs.com

Distributed by Select Audio | Tel 01900 601954 | www.selectaudio.co.uk

selectaudio[®]
exquisite audio products

World Radio History

+4dB up at 16kHz. I found the best balance at 1 o'clock on the bass control (slight bass lift) and 10 o'clock or thereabouts on the treble control (slight treble cut). Then the Model S A sounded nicely balanced, fast in its treble and clear, whilst not overly sharp, even with treble-heavy content like Nils Lofgren's Keith Don't Go that has strong harmonics up to 20kHz. I heard intense detail aided by the peak, plus super-sharp images on the sound stage: it was all quite dramatic.



The supplied black loudspeaker cable that interconnects the loudspeakers.

With classic Rock like Fleetwood Mac's Dreams (24/96 FLAC) there was plenty of punch from kick drum, that was tight and well controlled. This brought a good sense of scale to the track and Stevie Nicks chimed out clear at centre stage. Putting plenty more classic Rock through the system it all came out well: there was always obvious yet fast treble, intense high frequency detail and good sense of clarity, if with some slight sense of being box bound at



The active loudspeaker at left needs mains connection. The passive loudspeaker at right is unpowered, connected by a loudspeaker cable.



4Stream app music library list.

and listening showed, but this was corrected by a quick twiddle to achieve reasonable accuracy. These controls in practice enable adjustment for personal preference of course. Measurement showed that for best accuracy bass needs to be lifted slightly and treble turned down.

The loudspeaker itself is a two-way with Kevlar cone 160mm (6.5in) bass/midrange that is port loaded, crossing over to a 28mm silk dome tweeter. The port fires out through the base of the cabinet so cannot be seen. The grille cloth is a cabinet wrap that cannot be removed.

SOUND QUALITY

With treble and bass set flat on the amplifier tone controls the tweeter dominated, bringing a sharp edge to the sound – as expected because the tweeter is



The small Fosi Audio Class D 35W stereo amplifier with uncalibrated bass, treble and volume controls, plus toggle power switch. Below is a main power switch and underneath that a mains power input.

HI-FI WORLD

ON THE APP STORE

The screenshot shows the App Store page for the Hi-Fi World app. At the top, there's a navigation bar with 'App Store', 'Entertainment', and 'audio web publishing ltd'. The app icon is a globe with 'HI-FI WORLD' text. Below it, the app is titled 'Hi-Fi World' by 'audio web publishing ltd'. There are tabs for 'Details', 'Ratings and Reviews', and 'Related'. A 'Screenshots' section shows three preview images: the magazine cover for May 2012 featuring a TEAC UD-701N network player, a 'contents' page with various audio equipment images, and a 'MAY 2022' issue page. On the left, there's a 'Get' button, 'Offers In-App Purchases' section, and a 'TOP IN-APP PURCHASES' list. At the bottom, there's a 'Description' section with a brief overview and a list of features, and an 'Information' section with technical details like developer, category, version, and compatibility.

App Store > Entertainment > audio web publishing ltd

Hi-Fi World

audio web publishing ltd >

Details Ratings and Reviews Related

Screenshots

VINYL NEWS AND REVIEWS SECTION SEE PAGE 70
HI-FI WORLD
MAY 2022 UK £3.99
THE READER CLASSIFIED ADS IN THIS ISSUE
TEAC UD-701N network player/dac
COMPETITION
MAY 2022

contents

MAY 2022
AMPLIFICATION
4. ANAL C/D AND HYBRID DIGITAL DAC AMPLIFIERS
SPEAKERS
BLUES AND JAZZ
GRANDER
RECORDS
CLASSIFIED ADS
MAY 2022

TOP IN-APP PURCHASES

This app is designed for both iPhone and iPad

Rating: 4+

1. Hi-Fi World Dec 2015	£3.99
2. Hi-Fi World Subscription	£8.99
3. Hi-Fi World August 2015	£3.99
4. Hi-Fi World September 2015	£3.99
5. Hi-Fi World June 2015	£3.99
6. Hi-Fi World May 2015	£3.99
7. Hi-Fi World December 2015	£3.99
8. Hi-Fi World February 2015	£3.99
9. Hi-Fi World November 2015	£3.99
10. Hi-Fi World December 2014	£3.99

LINKS

Privacy Policy

© 2014 Hi-Fi World

Description

Hi-Fi World brings you the best in hi-fi... from around the world!

- We listen and measure products in depth, at our London offices.
- Expert opinion from a team of renowned writers, musicians and engineers.
- International standard measurements using Rohde & Schwarz test equipment.

Information

Developer: audio web publishing ltd
Category: Entertainment
Updated: 7 Dec 2014
Version: 1.0
Size: 9 MB
Rating: Rated 4+
Family Sharing: Yes
Compatibility: Requires iOS 5.0 or later. Compatible with iPhone, iPad, and iPod touch.
Languages: English

**DOWNLOAD OUR APP ON APPLE AND ANDROID
DOWNLOAD FROM iTUNES OR GOOGLE PLAY**

iPad, iPhone, iPod, Tablets OUT NOW!



The underside of the Arylic S10 carries a variety of input sockets, including RJ45 for Ethernet and USB for Flash memory storage. At right analogue output and power input, plus Bluetooth aerial cable.

high-ish volume. I say “-ish” here as I did not push the amplifier too hard, to avoid overload.

Swapping from ‘WiFi’ to ‘BT’ I got a slightly firmer and smoother delivery, due I suspect to the Arylic’s Bluetooth 5 status, and I also got to play DSD files, pumped out as PCM, instead of a rush of white noise over WiFi. To explain,

the iPhone 11X Pro has Bluetooth 5.1 and an Onkyo HF player (hi-res version) that delivers 24bit resolution and converts DSD to PCM. This all came together nicely to provide fine sound quality. Sending DSD raw over wi-fi just produced noise. Playing from a USB Flash drive also gave excellent results.

With classical there was some limitation to stage depth but still a vivacious and detailed sound that was convincing and engaging. With

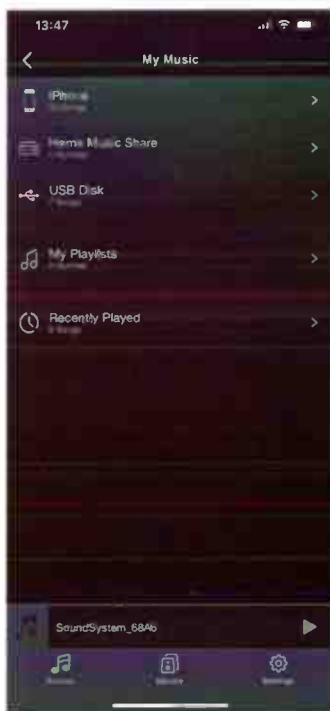

4Stream app source list.

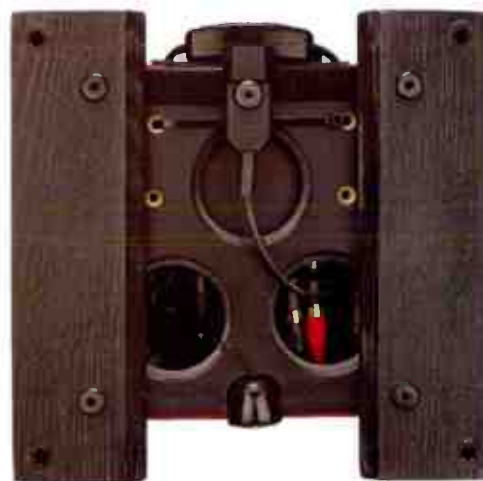

From beneath a chamber carrying connections can be seen, plus front remote control sensor. Spikes can be fitted. There is a port hidden inside too.

Bach’s Concerto for Harpsichord, Flute and Violin instrumental timbre was broad and instrument definition crisp, only stage depth was limited.

CONCLUSION

The Monopulse Model SA was an impressive package all-round. It’s adjustable for good tonal accuracy, has tight bass, clear midrange and crisp treble. There isn’t a mass of power but it was sufficient to go loud. It’s a bit fiddly to set up but after that worked consistently well, giving excellent sound quality from a wide array of sources. As a total package, great value at a low price. I even liked the app!

MEASURED PERFORMANCE

The Monopulse SA has a broad and reasonably even output around the 0dB datum our third-octave pink noise analysis shows. Notable features are deep bass extension – full output being maintained down to a very low 30Hz – and a strong, sharp treble peak around 16kHz. There is also a crossover suckout at 2kHz, sufficient to subjectively soften the midband, reducing “fierceness”. The downward firing port is tuned to 30Hz to augment deep bass (red trace).

This analysis was made with the bass and treble controls set to give best measured result. With the small knobs set to the 12 o’clock position treble output was around +2dB up and bass around -1dB down – not accurate.

Our published result shows what is the best possible, but bass and treble can be raised or lowered by substantial amount to suit any preference. Pair

matching between active and passive loudspeaker was good, within 1dB.

The small Fosi MB10A amplifier is built around a Texas Instruments TPA3116D Class D power amplifier chip that is rated as 50W per channel into 4 Ohms on its data sheet; we measured 16V into 4 Ohms – 64 Watts. It was 16V into 8 Ohms too (32W); Monopulse rate it at 35W. Distortion was low at 0.1%. It has full protection against shorts and overheating, as well as line voltage changes from the PSU. Input is analogue Texas note. Frequency response measured Class D peak free to 100kHz – impressive.

Supplying an analogue input to the amplifier is an Arylic S10 streaming module that has wi-fi, Bluetooth, and analogue inputs, plus USB Flash memory card socket.

This is a complex package that measures well at the price. NK

FREQUENCY RESPONSE

Green - driver output
Red - port output

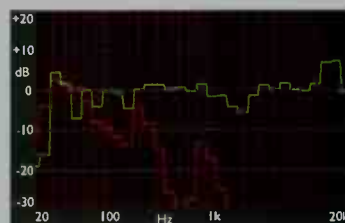

FREQUENCY RESPONSE amp

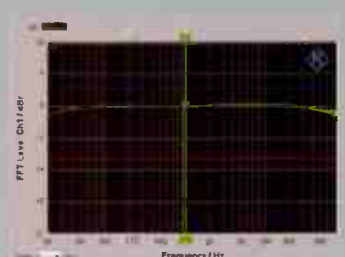

MONOPULSE SA LOUDSPEAKER
£1590



OUTSTANDING - amongst the best at the price.

VALUE - keenly priced.

VERDICT
A complex ‘wireless’ loudspeaker that does a good job all round.

FOR
- adjustable sound balance
- clear and crisp delivery
- multiple hi-res sources
- app and remote control

AGAINST
- mediocre finish
- limited power
- slightly boxy

MonoPulse
+44 (0)7785 558238
www.monopulse.co.uk

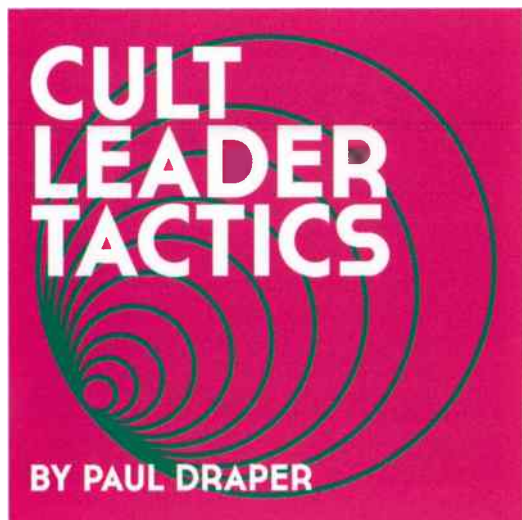

PAUL DRAPER

Cult Leader Tactics
kscope

Now yes, this is a vinyl column but, to be fair to Draper, the label and the fans, I must also make mention of the rather lovely 10"-sized CD book edition that features the album, live performances from 2019, demos and out-takes and more – over three discs plus a DVD, including surround sound files and 24bit/48kHz hi-res files.

So then, Draper. Who is he? Well many of you will better know the man as the lead singer of the band, Mansun, who were responsible for one of my favourite '90s album releases, 'Attack of the Grey Lantern' (1996) which some labelled as Britpop but most certainly was not. That album transcended the genre. Mansun broke up after Draper was diagnosed with cancer. By the time he was ready to work again the band, in 2003, had drifted apart.

Draper buckled down to

work as a song-writer and producer for other artists and then let slip to his fan base that he was building a body of solo work on the side and a dialogue arose from that, you might say.

Now kscope has provided Draper with a platform and here we are. This is an album that looks without (the world's political situation) and within (his own issues). There's plenty of solid work here, tightly woven, efficiently produced. It doesn't grab me in the same way that '...Grey Lantern' did but I do like what Draper is doing here and it's certainly great to see him back in the saddle.

Mastering is excellent. Vocals are pushed way back into 3D space, adding structure to the soundstage. Presentation is neutral and balanced.

This is a fine collection and I look forward to bigger and better, next time around.

AUDIOPHILE

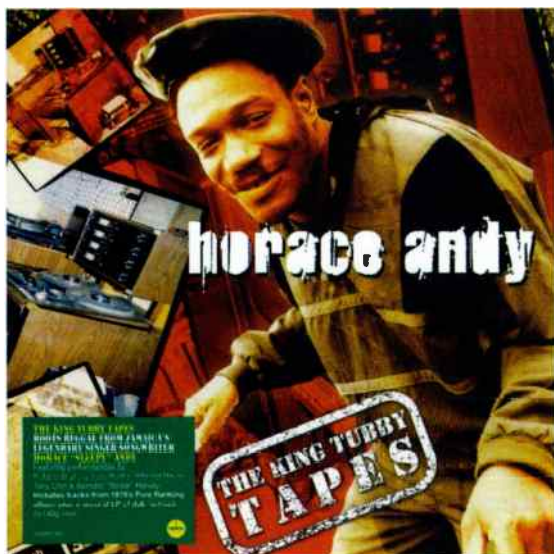

HORACE ANDY

The King Tubby Tapes
Demon

Horace Andy had an iconic voice in Jamaican reggae with his light, soul-inflected delivery. His voice was easy on the ear, giving him relatively broad appeal. It was also an important ingredient in his seventies output which was mighty indeed, producing hits by the bucket load, while his more recent work saw him appear within trip hop classics like Massive Attack's debut LP, 'Blue Lines'.

This collection includes artists such as Robbie Shakespeare, Carlton "Santa" Davis, Tony Chin and Bernard "Touter" Harvey.

In mastering terms, Demon has had to struggle a little with a restated dynamic reach which has cause pinched treble response and rolled off mids.

Nevertheless, the label has done a sterling job. The soundstage is admirably wide. There is a wealth of information on offer here while bass is suitably forward

and hefty, even though - at times - it can feel that it's being pushed too far. I have the feeling that effect occurring at source though.

Despite the slightly limited detail the basic midband region is packed with information while there is still air around this area so the information in this part of the frequency spectrum still has space to wander.

We last saw this compilation initially spread over two CDs, in 2002 on Jet Star which was, in itself, largely the album 'Pure Ranking' (1979) with added tracks. Alongside that was a vinyl version released by Charm, also in 2002, losing two tracks, 'Modern Dub' and 'Modern Babylon'. What Demon has done here is to replicate that Charm release. Even so, I'm still happy that Demon went to the effort of giving us two instead of a, for example, 'new' heavily edited single disc here to save cash.

This is the great man's debut album, as many self-titled albums tend to be, unleashed upon the world in 1970 and spanning a restrained twenty nine minutes of change. Cooder knew when to stop. Many musicians could use a similar lesson in self editing.

At this point Ry Cooder was around twenty-two years of age but he'd already hung around The Rolling Stones, Taj Mahal, Captain Beefheart and other luminaries. When you pick up that sort of experience then your confidence as a musician can only increase, especially if you have creative ideas of your own.

And Cooder had lots of those, as this album shows. You've got blues here, some folk, there's rock and even pop vibes. Then add arrangements and musicianship from Van Dyke Parks, backing by the likes of Roy Estrada and backing by Gloria Jones and more and you have a

fine pot of stew to draw from.

And let's not forget the songs. Covers from John Estes ('Goin' to Brownsville'), Blind Willie Johnson ('Dark is the Night') and Woody Guthrie ('Do Re Mi') mix with more contemporary fare (Randy Newman's 'Old Kentucky Home') and Cooder's own contribution ('Available Space'), this is an album that's full of charm and sophistication, in terms of delivery and musical skill.

The original mastering on this one is right up in your face. The volume is relatively high so you might find yourself backing off a tad in gain terms. There's plenty of detail on offer, especially from the Cooder guitar, which roams across a very wide soundstage.

Sure, Cooder's vocal abilities don't do some of the blues songs true justice but his guitar work makes up for a lot of that and he has lots of heart – so you end up cheering him on.

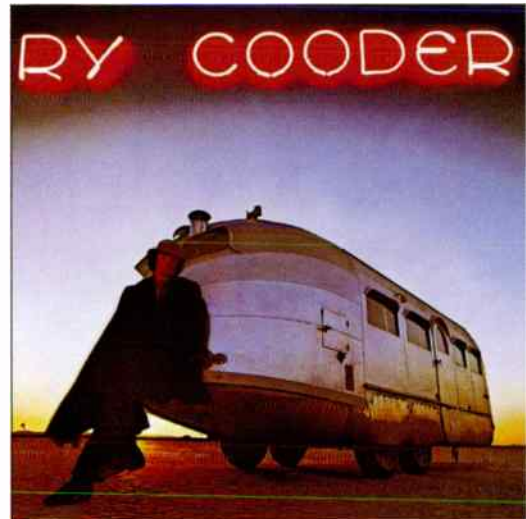

RY COODER

Ry Cooder
Warner Bros

AUDIOPHILE

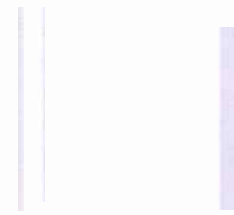

I don't cover too many hits packages in this column but I thought I'd make an exception with this release because it appeared in and amongst the band's first flush of success. In this case, it was released in 1985 and packed in twelve tracks that showed their impact on the times and how they had carved an area in the musical space when faced with competition from the likes of The Smiths, New Order and Depeche Mode.

Let's take nothing away from the band as a unit because most groups experience success because of the band as a collective but, of course, special mention has to be given to the remarkable vocal abilities from lead singer, Ian McCulloch who managed to lift his voice to almost cinematic levels in terms of pure creative drama. There were moments when he

would instill a cup full of awe into the Bunnymen canon with his shifting octaves. Meanwhile Will Sergeant's sparkling guitar work lifted the songs towards symphonic highs at times.

This is a neat collection of songs because it spans 1980 to 1985 and, because it appeared on the shelf in 1985, it also draws a line of sorts. It's a statement. A conclusion to a burst of creativity, if you will.

As for the mastering on this one? There is a real 3D affect around the stereo image that is beautifully transparent in terms of allowing detail from the rear of the mix to find its ways to the ear. There is a slight – and I mean slight – note of compression around the upper mids but it never gets in the way. The album track 'Bring on the Dancing Horses', featured on the Pretty in Pink (1986) sound track, is included as a bonus.



ECHO & THE BUNNYMEN

Songs to Learn & Sing
Warner

Size Matters

A portable digital player bigger than most others. Noel Keywood wrestles with FiiO's new M17.

Long ago I recall the emergence of “transportable” computers. These were an attempt to shrink down full size desktop computers to something that could be moved – or lugged shall

I say. “Transportable” is the word that popped up in my head when I saw the new FiiO M17 (£1499.99) portable digital player. All the many FiiOs I’ve reviewed were small – so what happened here?

By FiiO’s standards the M17

is big, lumberjack big – as in you’d need lumberjack pockets to cope. The leg pockets of my cargo trousers swallowed it, in place of the resident iPhone, and with a weight of 610gms it’s best placed low to avoid falling over! The screen area is little less than an iPhone – big. And bright – no problems with visibility here. It’s much like a large mobile phone except at 30mm about x4 thicker. Having a machined alloy case however, no problem with solidity and strength.

So why? As FiiO state, it is to get closer to the sound of a full sized hi-fi system from a portable player. There are many portables available today with top spec chips and when I review them my reference is an Audiolab M-DAC+, with ESS ES9018 DAC chip driven by a linear mains power supply. The portables always fail to match bass power and control – tunefulness – of the Audiolab. Batteries cannot match connection to a power station! Cue FiiO’s use of a large 9200mAh battery plus massive 470mF super-capacitor to handle peaks. Additionally, there’s a 12V alternative power supply to bolster the internal supply, ideally when allied to a docking unit, something I’ll come to later.

The battery feeds not one but two ES9038Pro digital-to-analogue converter (DAC) chips from ESS of California. This chip gives highest performance with all eight outputs strapped together – but then it becomes a mono chip. So one must be used in each channel. The penalty is not only cost – two of the world’s most expensive DAC chips needed – but power consumption. That’s why the big case gets warm and the docking station has a cooling fan! Battery life is quoted as 9hrs on one charge and there are fast-charge options.

Downstream from the FSS DAC lie two THX AAA 7888+ line driver

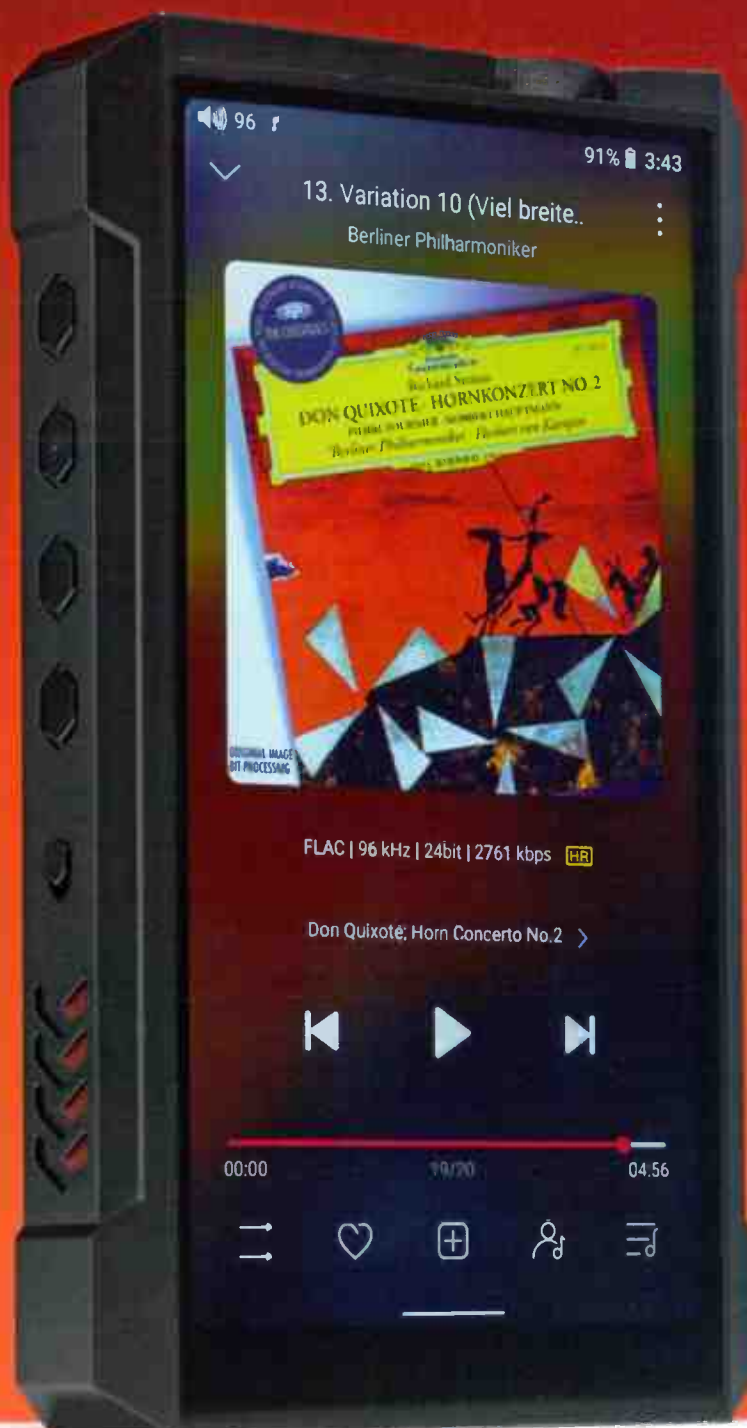

chips that they say are optimised for high power delivery to headphones. On this player they feed a selection of four headphone sockets. There are 1/4in (6.3mm) and 3.5mm stereo output jacks (unbalanced), plus 2.5mm and 4.4mm balanced output jacks, the latter being most useful. They can be set for headphone use (PO) or as Line Out (LO), where volume is fixed at max.

The player has an Android based operating system run on a Qualcomm Snapdragon 660 processor, with 64GB internal storage for music files, plus a microSD card slot that can read cards up to 2TB. So plenty of storage, even for DSD files. There is wi-fi for internet connection and this must be used for Airplay to work, allow updating, Google Chrome web browser and other apps.

FiiO unusually split usage into 'operating modes': Android with apps, Music Player, USB DAC,

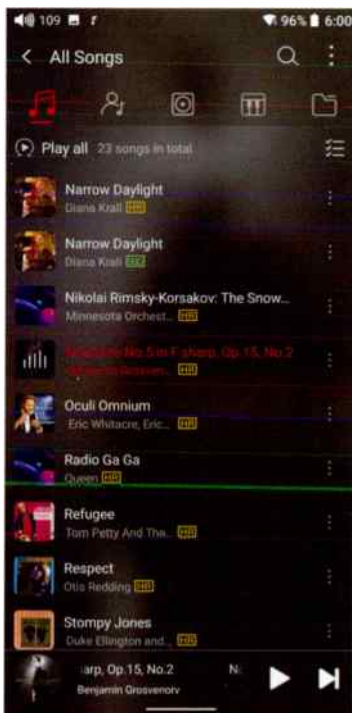

M17 screen. A nicely proportioned and colourful music library screen, with clear format legends – DSD, Hi-Res etc.

Bluetooth receive, S/PDIF receive and Airplay. It's a bit of a faff to move around them – so many screens – but I guess that in use most people will get used to access by a swiped drop-down screen. Music apps can be downloaded of course, from Spotify, Apple, Amazon,



At top a big rotary volume control and four headphone sockets, all different. At side a power button and volume up/down.

Qobuz and such like.

Initial funnies I encountered were a clock set to time in Shenzhen, China that didn't update when 'net connected, and stony silence from a USB C – USB C link (USB3) to my Mac. I sat there puzzled: this thing should work, it usually does. But not here. With FiiO's supplied USB C - USB A crossover cable however, the little green man of the Android loader popped up, enabling music file transfer.

Android interfaces more slickly with a PC where the player was seen as an attached device. The M17 saw the PC as a network attached Media Server and was able to read its music files through Windows Media Player. The Mac was seen too, an alternative to Airplay.

Bluetooth 5 receive (Rx) is provided to accept incoming from a portable phone, with a whole slew of codecs to suit various phones including aptX-HD (Android) and LDAC (Sony). With my iPhone 11XPro (BT 5.1) it flagged up AAC (Advanced Audio Codec) but this incorporates a new codec called LC3 (Low Complexity Communications Codec) that Bluetooth say "supports 24 and 32bit depths" at up to 48kHz sample rate. With the M17 a massive 119dB Dynamic Range was measured, an amazing result, putting Bluetooth firmly into hi-res league here – far ahead of its current reputation as a mediocre medium.

There is Bluetooth transmit (Tx) as well, to send music out to headphones and loudspeakers. Just bear in mind that BT headphones use tiny batteries driving tiny amplifiers with weedy bass, sacrificing sound quality for convenience. Also, sending digital out means it will be processed by an external DAC, not the ES9038Pros

in the player – a waste of their ability. Buy a player like this for its analogue output quality I'd suggest, into headphones or the hi-fi, ideally by balanced connection.

On the base is a large co-axial (RCA phono socket) in/out for S/PDIF digital connection. This could, for example, accept the digital output from a CD player, placed nearby.

Bringing me onto use as a hi-fi system sitting on a stand, or the DK3 multi-function dock as it is called. Rather than charging and/or working from 5V USB power a separate power supply delivering

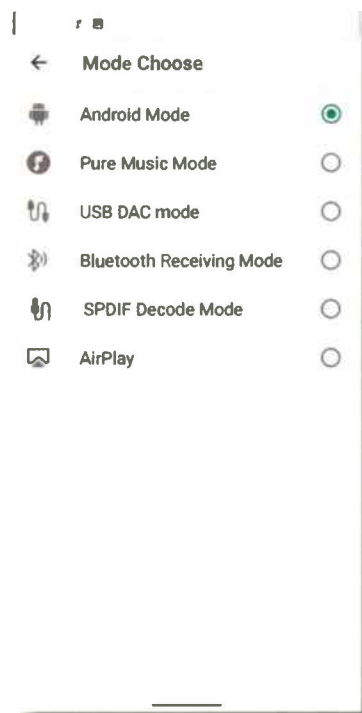

M17 screen. The six basic modes of operation can be found in a swipe down menu.

12V 3A is provided that, FiiO say, increases the internal power line voltage by 35%, for even better results. There's a special 'Over-ear



On the base a coaxial 12V d.c. power input (left) a USB C for computer connection and USB C for power, plus S/PDIF in/out.

headphone mode' to take advantage of this that I don't understand the logic of, since this allows 9V to be sent into headphones where 4V is plenty enough. Perhaps there are some super-inefficient magnetic planar or electrostatic 'phones that need it. The DK3 needs an additional 5V USB supply to drive the fan, but the player did not get past warm when I used it.

was no volume control on the 'phone's app – or not one I could find – when working in this mode. It saw the player's music library, allowing me to select and play songs, but no more. I also downloaded a FiiO control app to my phone but the M17 was not in its compatibility list and it did not work, so no way to select different filters or such like. With Bluetooth you get remote

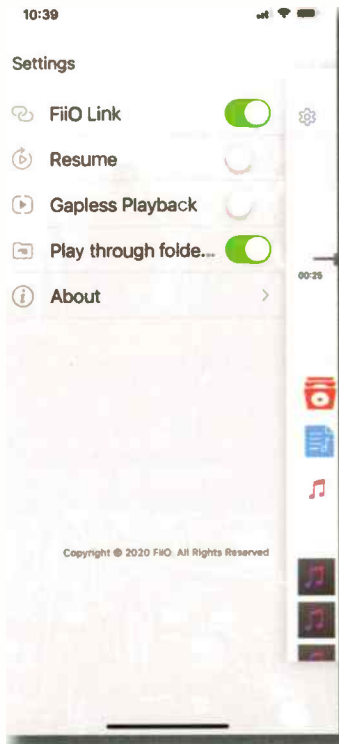

Mobile 'phone player app. screen. Activate FiiO Link in Settings (needs IP address) and the 'phone becomes a remote music player.

In a situation where the M17 is connected to the hi-fi through a headphone output it needs remote (app) control. This is possible by downloading their player app to the phone and establishing a wi-fi link through an IP address. But this seems a work in progress as there



Mobile 'phone player app. screen. The Play screen lacks volume control when working by FiiO link. Peculiar.

play and volume control of course, if not access to the player's own music library.

This is not an especially easy player to use. In some modes (e.g. Bluetooth) the swipe-down screen is unavailable, another Exit route must be taken. I did like the home

screen background of circuit boards, much nicer than the psychedelic screens of some players. There are pics of ESS chips, no valves unfortunately, but you can load your own pics so this is possible. Start time is a little lengthy at 27 seconds. The player screen is populated with – to me irrelevant – Recently Played, Most Played and Recently Added lists that remain even when the music library (on microSD card) has been removed, so they have to be manually erased by Reset Database. Messy. As music players go FiiO's needs tidying up. Good to see was a VU level meter that showed music level and clear legends in the track lists showing quality (Hi-Res, DSD, etc).

SOUND QUALITY

For the most part I played from a library of music on a microSD card. This is the most direct method and allows me to use a lot of DSD without having to load it all to internal memory. I also used Bluetooth, music on the phone being handled by an Onkyo HF player, paid-for hi-res version that sends 24bit, as well as DSD.

FiiO's player made its point straight away with Mick Fleetwood's kick drum at the start of The Chain (24/96) played out of the 'phone over Bluetooth. It was not just solid and powerful, but textured too in a way that I have not heard before, using Oppo PM1 planar magnetic 'phones. And this was running from battery, not the external power supply (which added a tad more low bass). Bass heavy tracks like Daft Punk's Giorgio by Moroder (24/88.2) were fluid, clear and powerful, the closing synth run in this track making its point by drilling through my head.

Moving on to Cry Me A River (24/96) by Diana Krall made plain that this player has top ESS DACs – big, mellow and deep sound stage, making this laconic track a great listen. The lady's vocals had fine dynamic contrast, she sounded big bodied (in voice that is!) and the sound stage was a warm room surrounding her. Similarly, Johanneke Zomer fairly soared singing Lascia chi'io Pianga (DSD), ethereally clear and powerful on crescendos. Even the strings came over as full bodied.

Another feature was sturdy left and right images when volume was turned up and cross faded drums (Go Your Own Way) were



M17 screen. The Play screen carries technical data as well as cover art.

hammering out (Mick Fleetwood again): the M17 delivered this one with speed and slam, plus rock steady imaging. A big sound, heavy Rock, music with cojones. The M17 captured its zeitgeist. And I must get back to English!

But the point is battery powered players start to collapse

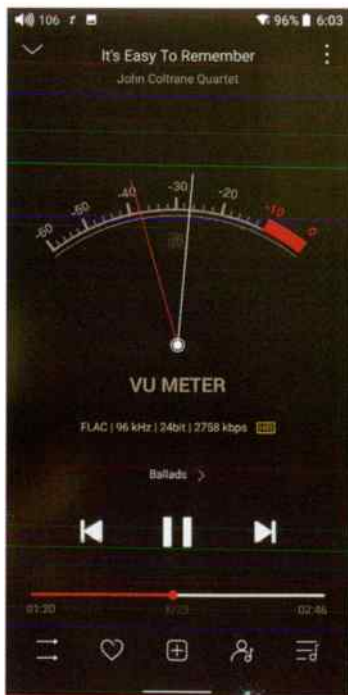

M17 screen. Tap on cover artwork and up comes a VU meter showing music level (peak and average).

back to mono at low frequencies when pushed hard, the sound stage subjectively narrows and becomes laterally vague. FiiO have conquered this problem well here, the result being a wide, stable stage even with panned kick drum.

CONCLUSION

FiiO's M17 sort-of-portable player has huge ability, that's for sure. Its big internal power supply and twin ESS9038Pro DACs deliver a thunderous low end, capacious sound staging and easy demeanour – no graunch from dodgy digital. OK, you need cargo trousers for it, but then you do get a sound that's like a home system, or likely better.

Not the easiest or most elegant player in software terms, it takes acclimatisation and much User Manual reading – but the manual is good in that it does explain how to invoke a function in simple manner. An easy read.

Although a shock to see initially, I quickly got used to the bulk. In fact, my iPhone started to feel flimsy after using the M17 – and its big,



The DK3 stand, with 5V USB powered fan. There's no clamp for the player, it just rests on the shelf.

bright iPhone quality screen helps. Bit like buying a big vehicle after a small one: the step up can be persuasive.

So big, bulky, challenging to use in its complexity, but with a sound that reflects its physicality. It won me over.

MEASURED PERFORMANCE

Frequency response (192kHz sample rate) measured flat to 89kHz with the fast filters – that varied little amongst themselves. The Slow filter reduced this little, to 74kHz. There are seven filters, all of which I have seen before and likely those provided as options by ESS in their ES9038Pro chip. Custom design filters are possible with these chips but FiiO

have not gone down this route. With CD (44.1kHz sample rate) the situation was much the same, cutoff frequency varying from 19kHz up to 21kHz – small differences. Slow filters give best time-domain impulse response, and the least sharp, best damped sound.

Distortion levels at -60dB with a 24bit digital input were impressively low, measuring 0.017%, irrespective of level and frequency, sinking to 0.0002% at full scale (0dB FS).

EIAJ Dynamic Range measured a high 123dB – and 119dB from Bluetooth – an exceptional result.

Output from the 4.4mm balanced Pentaconn socket was 4V maximum and from the 3.5mm unbalanced socket 2V. With the 12V supply connected and Over Ear Headphone mode selected output measured a massive 9V from the balanced outputs and half this unbalanced – more than enough for headphones where around 1V is extremely loud.

The M17 – turned in superb measured result all round. Only the filters could have been more useful. **NK**

FREQUENCY RESPONSE

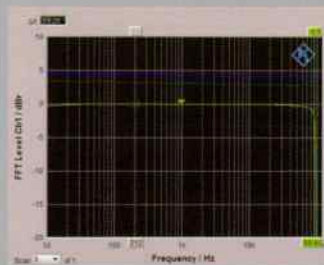

DISTORTION

Test at	Level (dB)	Frequency	
Ch1	0.0177 %	4.0240 mV	997.00 Hz
Ch2	OFF	OFF	OFF

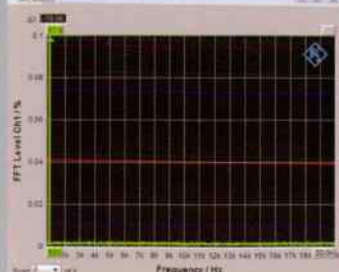

DIGITAL

Frequency response	4Hz-89kHz
Distortion (-60dB, 24bit)	0.017%
Dynamic range (EIAJ)	123dB
Output (bal)	9V max

FIIO M17 £1499.99



OUTSTANDING - amongst the best.

VERDICT

Powerful, smooth sound and masses of ability, if weighty and complex.

FOR

- sound quality
- range of ability
- build and finish

AGAINST

- complex set-up options
- limited remote control
- graphically overloaded software player

Advanced MP3 Players
+44 (0) 343 289 6880
www.advancedmp3players.co.uk

vinyl section

contents

MAY 2022

www.hi-fiworld.co.uk

MUSICAL FIDELITY LX2 LPS 72

A small MM/MC phono stage for vinyl enthusiasts. John Pickford checks it out.

AUDIOPHILE BOOKS 77

Changing genres – three books reviewed by Paul Rigby: The Britpop Bible, Marillion and Kathy Valentine's memoir.

CLASSIC CUTS 82

Andy Bey, Experience and Judgement, reviewed by Paul Rigby.

BEAR FAMILY DUO

'Left Behind' is thirteen-track 10" compilation from Germany's Bear Family (www.bear-family.com) including a 34-track CD and sixteen-page booklet from Felsted (a subsidiary of the London label). There's an excellent range of rockers here from the late fifties and early sixties.

Jonny Burnette's '...and the Rock'n Roll Trio' can only be ordered from the company website. This 500 copy, blue vinyl, limited-edition 10" release arrives with a postcard and a reproduction of a very rare South African pressing from 1956.



news

BILLY COBHAM

From Germany's Speakers Corner (www.speakerscornerrecords.com) comes 'Total Eclipse', from the ex-Miles Davis and the Mahavishnu Orchestra fusion drummer, Billy Cobham. And fusion is what we have here that both inspires and wows.



JAMIROQUAI

'Travelling Without Moving' (Sony) took acid jazz and pop to a fine point and then unleashed the result, producing a one-group phenomenon, incredibly hook-laden songs, a sprightly delivery and irritatingly large and squishy hats.



JERRY & THE PELICAN SYSTEM

The Polish jazz group has a new six-tracker called 'Sariani' (Yeyeh Holland). Mixing ambience and electronica with jazz, this fusion outing offers a fascinating blend of the avant with the melodic.



O'CONNELL & LOVE

Alabama 3's lead singer (i.e. Larry Love/Rob Spragg) is here with O'Connell on 'Will You Be There?' ([Mountmellick](http://Mountmellick.com); oconnellandlove.tumblr.com), a rootsie/folkie-tinged singer-songwriter outing with enough grit to keep things interesting. And grit, after all, is the stuff that makes pearls.



WEDDING PRESENT

'24 Songs' presents two songs per month, every month, occupying the flip side of a 7". So that's twelve 7" singles across a

full year. The first two are out now with the first including guest, Louise Wener (Sleeper). Check out linktr.ee/24 songs for subscription details.



SUN RA

'Lanquidity' ([Strut](http://Strut.com); <https://strut.k7store.com>) was originally released in 1978 on Philly Jazz and was recorded at Bob Bank's Blank Tapes after the Arkestra had appeared on Saturday Night Live. This jam-based, fusion outing offers slow-paced funk and low-key psychedelia. It's an interesting departure.



BONOBO

'Fragments' (*Ninja Tune; ninjatune.net/home*) features 12 tracks, supported by Jamila Woods, Joji, Kadhja Bonet, Jordan Rakei, O'Flynn and Miguel Atwood-Ferguson, resulting in a multi-textural, multi-flavoured sonic hamper of electro-soul, jazzified synth rhythms, old fashioned 90s-era 'trance' and chart-tastic R&B vibes. Phew!

**THE FISHHEADS**

'Songs from the Fishheads' is a 2-track, 45rpm 7" single featuring covers of The Monkees' 'Pleasant Valley Sunday' and Chet Powers' peacenik ditty, 'Let's Get Together'. Beautifully retro and packed full of flower chains, this release oozes sunshine and the howl of innocence.

**TRENTMØLLER**

From Trentemøller comes the new album, 'Memoria' (In My Room) a dark wave/shoegaze, atmospheric outing from this Danish artist with Lise Fritze on vocals. The vocal outings are excellent, the instrumentals are even better.

**LIS WESSBERG**

...and her trombone has created 'Yellow Map' (April; aprilrecords. bandcamp.com/merch) offers Danish-flavoured, 4-piece jazz. Her press talks about "cool jazz" and "cinematic" and I agree. There's a calming, considered delivery from Wessberg that is immensely appealing. Yet there's also complexity and rumination if your ears care to dig a little.

**PHONO48**

I don't normally feature 12" singles but this 3-track disc offered a suitably hifi-esque name so I couldn't resist. Soul cut 'So Pure', created by photographer Dean Chalkley was created from scratch and recorded in 48 hours by six musicians who'd never worked together before. This is deep-groove soul with jazzy edges that winks at classic times gone by.

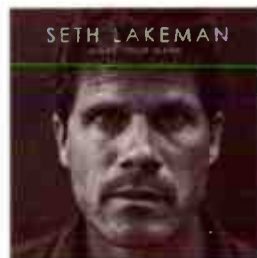
**SETH LAKEMAN**

Folkie, Lakeman is back with fourteen songs on 'Make Your Mark' (*Honour Oak; sethlakeman. tmstor.es*). Lakeman is not afraid to bathe in trad folk waters but he's also happy to stretch his alt.folk and mainstream tendons which is why he has a broad-based audience. Canny chap.

**RODNEY CROMWELL**

Cromwell's 'Memory Box' (*Happy Robots; www.happyrobots.co.uk*) provides electro-primitivism combined with a low-key, restrained vocal delivery and some delicious melodies that are both simple yet direct.

**SOUL REVIVERS**

Nick Manasseh and David Hill's Soul Revivers offer 'On the Grov' (*Acid Jazz; soulrevivers.bandcamp.com*), music that stemmed from a 2017 crime film project 'Yardie'. This is West London reggae of a cool, thoughtful and restrained kind. This is an album that stops, takes a deep breath, looks around and reports its findings.

JOHN MCLAUGHLIN

On 'The Montreux Years' (BMG), the legendary guitarist showcases his Montreux performances on this double album ranging from 1978 to 2016 and featuring different line ups such as The Mahavishnu Orchestra, The Heart Of Things band, The Free Spirits and The 4th Dimension. Beautifully presented.

**THE MADNESS**

After Madness broke up in 1986, four former band members created The Madness' self-titled album (Union Square) which was...different. Not Madness, certainly. Something else. They sounded lost, they tried too hard, over produced and formulaic in pop terms. And yet, for fans it's an essential part of the story. Part of the evolution. It should be heard.



eleanor mcevoy love must be tough

LIMITED SPECIAL EDITION OF LOVE MUST BE TOUGH AVAILABLE AS SACD (PLAYABLE ON ALL CD PLAYERS).
THE ORIGINAL LP IS AVAILABLE FROM DIVERSE VINYL.

eleanor mcevoy

love must be tough

limited special edition

2 extra tracks

*Mother's Little Helper • Love Must Be Tough
 Old New Borrowed and Blue • Lullback Woman
 If You Want Me To Stay • Hell Out Deller Days
 The Night May Still Be Young, But I Am Not
 Hands Off Him • Shame On The Moon
 Easy in Love • He Never Spoke Spanish To Me
 I Know The Drive (When She Used To Back 'n Roll)*

eleanormcevoy.com

A homage to Americana, further tales of love and passion gained, lost and fought over, including songs written by Eleanor McEvoy with Johnny Rivers, Rodney Crowell, Brad Parker and Dave Rotheray.

Featuring tracks originally recorded by Terry Allen, Priscilla Bowman, Rodney Crowell, Nick Lowe, The Rolling Stones, Sly Stone & The Texas Tornados, with two extra tracks—The Fratellis 'Whistle For The Choir' & 'Please Heart, You're Killing Me'.

.....

"Eleanor is the most real-sounding woman you'll ever hear on disc. The album is a great mix of originals and well-chosen covers that she makes entirely her own." — Classic American

"This is a superb blend of covers & originals. Like a female Van Morrison, she swings from the Stones to Dave Edmunds and from country to jazz, the most booze-sodden balladry since the Pogues. McEvoy sounds like the sort of woman who might greet you with a bottle of red one night and a rolling pin the next". — Truck & Driver ★★★★★ *Album of the Month*

"This is a band album, rich with brass and Hammond organ, and we're back in the Sixties again in some smokey nightclub... Love Must Be Tough may have been around for a while but it still may be the best thing you'll hear this year." —Dai Jeffries *RnR, May 2021*

Enjoy the Music.com

HIGH-END SHOWS | NEWS | REVIEWS

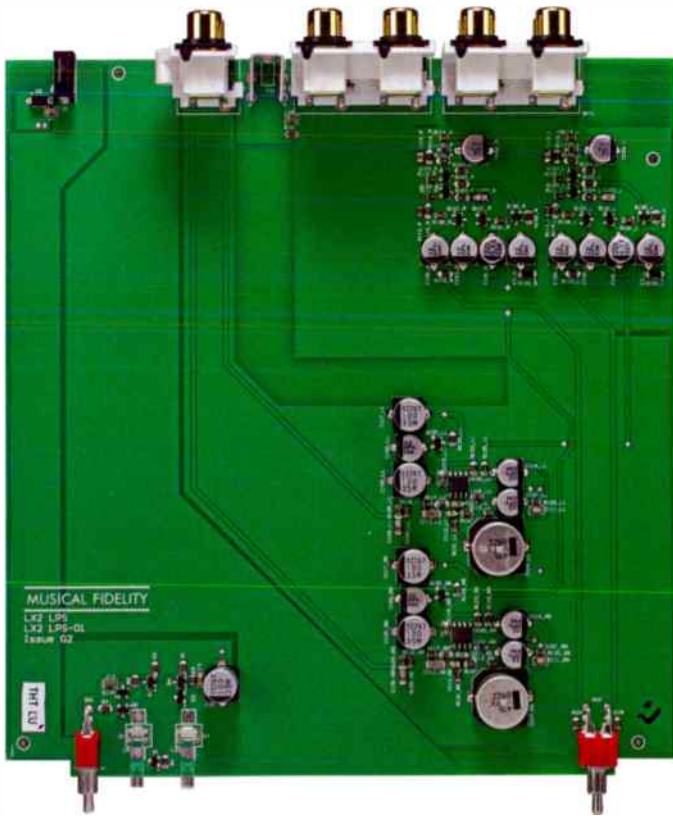

A look under the hood reveals neatly constructed electronics, including NE5532 Op amps and some large capacitors, in amongst the robotically mounted surface-mount devices (SMDs).

Don't try this at home though as there are no user serviceable parts inside and opening the unit invalidates the guarantee.

spend £500 plus to discover the delights of moving coil.

Arctic Monkeys' Tranquillity Base & Casino (Domino Recording Company 2018) is a lush sounding record, quite different from the up-tempo indie-rock of their early recordings and its sweeping soundscapes played to the LX2-LPS strengths brilliantly. While the inherent character of the phono stage remained unchanged, the sound became more lively and open, so much so I had to remind myself I was listening to a moving coil cartridge and phono stage combination costing less than many believe is the starting point for good MC replay.

With such excellent results achieved with the LX2-LPS in my office system, I unplugged my reference Icon Audio PSI, replacing it with this new phono stage. With my Benz Micro/ Michell TechnoArm equipped Thorens TD124 plugged directly

into the MC input and outputting through a passive preamp to my Leak TL12 plus monoblocks driving Tannoy Berkeleys, I was impressed with how well the inexpensive MF phono stage held its own in such rarefied company.

I won't pretend the solid-state LX2-LPS is the equal of the valve PSI, however, if we subscribe to the theory that a system is only as good as the weakest link in the chain, the affordable phono stage held strong. The valve stage offers a liquid smoothness and spacious, holographic soundstage the solid-state unit can't compete with, yet it was still an enjoyable listen, with well-controlled bass, clean midrange and glossy treble. This dedicated phono amplifier offers exceptional sound quality for the money – don't let the bargain price put you off.



Hi-fi hobbyists can make their own loading plugs to customise the phono stage to suit their cartridges.

MEASURED PERFORMANCE

Both MM and MC inputs measured flat across the audio band, our analysis shows. There is no warp filter so full gain is available down to 10Hz.

Gain values were conventional at x117 (41dB) with MM and x1167 with MC (61dB).

The output swing of this unit was very low at 2.3V, where most are 8-10V, imposing very low input overload values of 20mV for MM and 2mV for MC. Ideally, 30mV and 3mV are more appropriate, values high output cartridges can reach with commercial discs. Our review sample came with a standard wall wart supply rated at 12V, but the d.c. input is rated at 12-24V so it appears the optional uprated EPS supply is needed for better figures here.

Noise levels were low, measuring -83dB with MM and -80dB with MC – the latter being very low for MC.

The LX2 LPS was accurately equalised and low in noise but its overload ceiling is also low. The optional EPS power supply would likely improve this by delivering a high voltage. **NK**

Frequency response 8Hz-20kHz
Distortion (-60dB, 24bit) 0.1%
Gain (MM / MC) x117 / x1167
Overload (MM / MC) 20 / 2mV in (2.3V out)

FREQUENCY RESPONSE

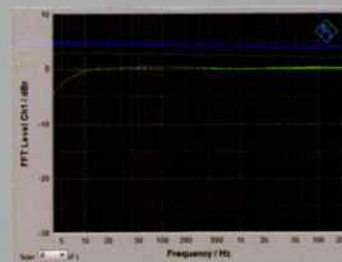

DISTORTION

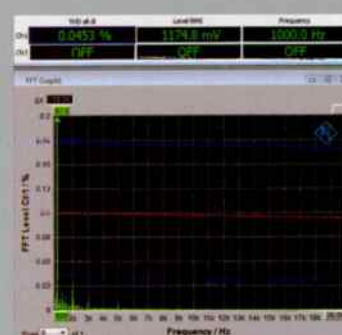

MUSICAL FIDELITY LX2-LPS £199



OUTSTANDING - amongst the best.

VALUE - keenly priced.

VERDICT

High quality, flexible phono amplification at low cost.

FOR

- clean, accurate sound
- compatible with all cartridges
- loading adjustment catered for
- upgradable power supply

AGAINST

- no mono switch

Henley Audio
+44 (0)1235 511166
www.henleyaudio.co.uk

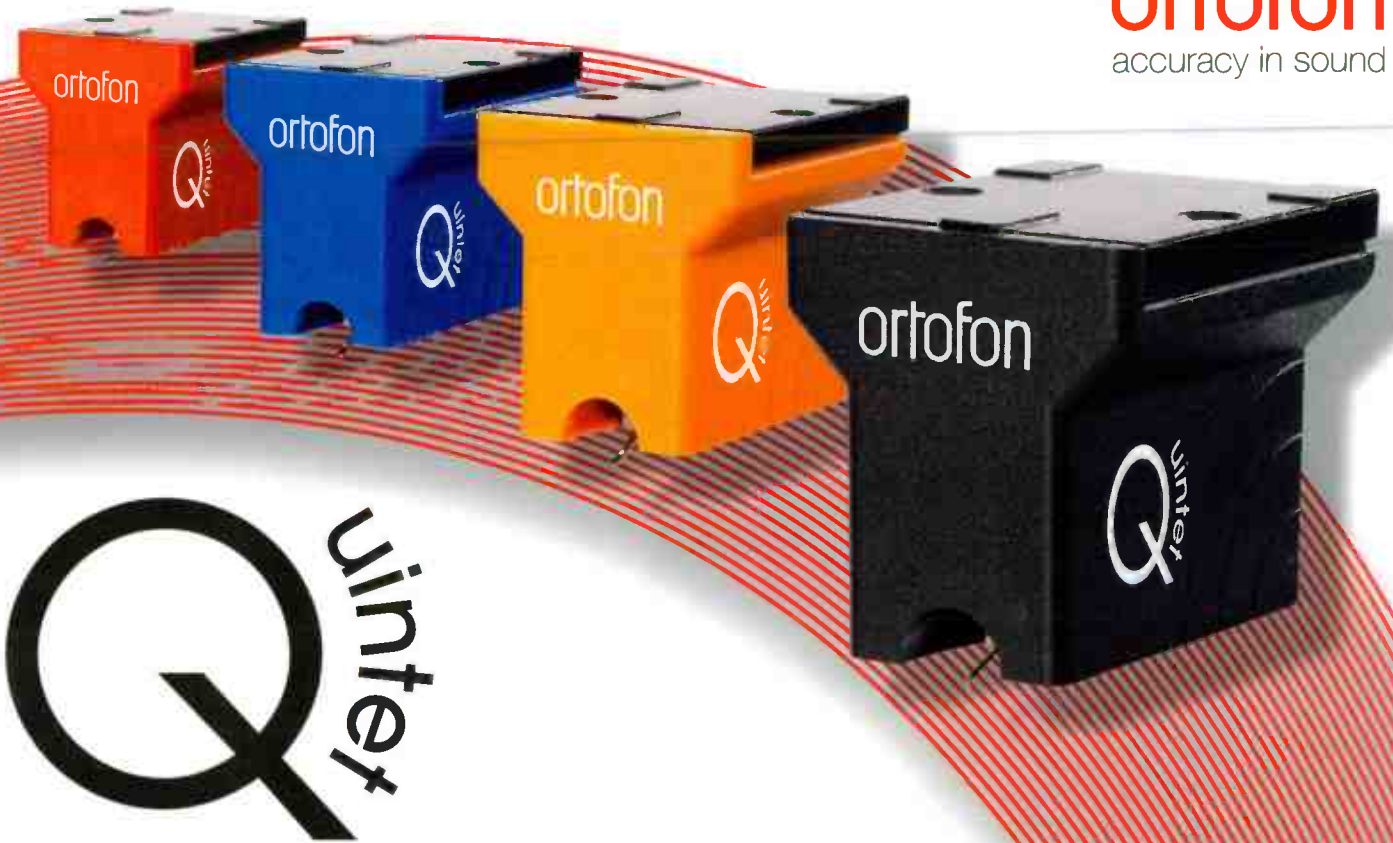

MODERN CLASSICS

Since 1948 Ortofon have introduced nearly 100 different moving coil pick-up cartridges to the hi-fi market. This proud heritage shines brightly in our Quintet Series.

All Quintet cartridges use the same ABS thermoplastic bodies and neodymium magnets, but each model in the range has its own sonic expression that reflects its status. From the well-rounded **Quintet Red**, through the smooth **Quintet Blue** and spacious yet dynamic **Quintet Bronze**, up to the pure audio excellence of the **Quintet Black S**; this series offers something for every discerning listener at a very attractive price. The Quintet Series also includes a true-mono cartridge, for accurate reproduction of older mono recordings.

Quintet cartridge design

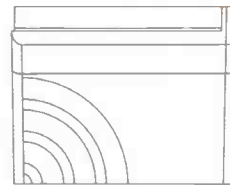
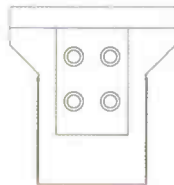
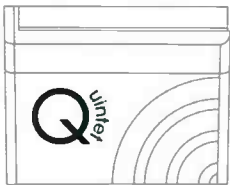

Quintet Black S
May 2014



Quintet Blue
December 2014



Quintet Black S
July 2017



Quintet Blue
July 2019

Quick Shift

We're shifting genres in this issue from a Britpop 'bible' to the Go-Go's Kathy Valentine and Marillion's Mark Kelly.

THE BRITPOP BIBLE

When you hear that there's a book on the way to you for review from My Joynson, you hide behind the sofa because you know that it will be a tome about the size of a house. That's just about right for this new work of immensity that focuses on that particularly British take on rock. This one features sixteen pages of colour including a host of record sleeves that will trigger a swathe of nostalgic reminiscence. "I haven't thought about Kenickie in ages!" thought I as well as Louise Wener and her so-called 'Sleeper Blokes'. Ah Memories.

The book itself is packed with information on bands, albums, singles and a ton of information related to all.

Let's take a random example. Let's look at Hefner and see how they're treated. We're told who was in the group and what role they took, an album discography, catalogue number, date of release, notes relating to those are listed beneath. There's plenty of hardcore fan information here such as promo releases, session information and more. Then you get an EP listing, lots of notes on those, singles information and a long essay on the band's in-depth career history. They appeared as guest on this album and unreleased tracks can be found on that disc. That kind of thing. All within closely spaced type.

The book is exhaustive. And quite brilliant. Joynson has done it again. This is an essential book if you're into the genre, any Britpop band or music in general. Buy it.

KATHY VALENTINE

As Valentine, bass player in the girl band, The Go-Go's, said herself, there were not that many ladies in bands during the late seventies and eighties. Valentine's childhood exposure to Suzi Quatro provided inspiration though.

Her childhood lacked stability

as her parents divorced, Valentine became a 'latchkey' kid, she drank, she smoked cigarettes, then pot, then came the drugs. Stumbling into sex provided a doubtful reputation amongst her peers which created self-image problems then an abortion followed that. She was still a child. And we're not even past page thirty five yet!

The music proved her salvation though: The Sex Pistols, The Ramones, The Runaways and then The Go-Go's themselves and how it was being a woman in rock, back then. 'Tough' is the word.

There's a smattering of celeb culture in this book. Times with John Belushi, The Police, Rod Stewart and many more. This is a fast paced and action-packed account. Exhausting but in a good way.

MARK KELLY

Keyboard player for the Neo-prog band, Marillion, Kelly gives us his autobiography from childhood, family and friends. From tales of bullies at school to bullies in the workplace, his political and social views and more but it's his work with Marillion that holds the attention.

We travel through the creative process, the parties and the tensions. The inter-personal relationships are the most fascinating of all of course, especially when the band's ex-lead singer Fish was involved.

I found the later discussion of how a band survives on its own in partnership with its own fan base interesting indeed. Marillion were one of the pioneers of what would later be termed crowd funding. Their early forays into this new mechanic are an interesting read and it's a tale of how the fans can infuse their heroes and can give them the energy to carry on. There's nothing like feeling loved. Even prog bands need it. A highly enjoyable book.

Title: **The Britpop Bible**
 Authors: **Vernon Joynson**
 Publisher: **Borderline**
 Price: **£55**
 Pages: **724**

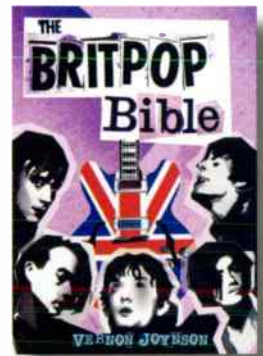

Title: **All I Ever Wanted - A Rock'n'Roll Memoir**
 Authors: **Kathy Valentine**
 Publisher: **Jawbone**
 Price: **£14.95**
 Pages: **272**

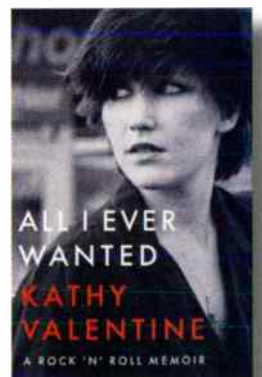

Title: **Marillion - Misadventures & Marathons**
 Authors: **Mark Kelly**
 Publisher: **Kingmaker**
 Price: **£24.99**
 Pages: **258**

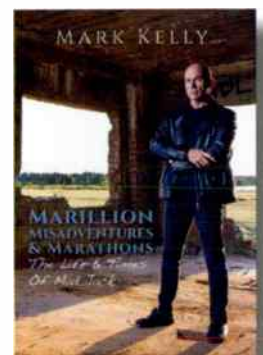

Dial A Dealer Directory

directory of Hi-Fi Dealers throughout the UK and Ireland.



Inspire Hi-Fi
 www.inspirehifi.co.uk
 +44 (0)1246 268887

2 CHANNEL AUDIO SPECIALISTS

Including our own bespoke award winning turntables and a comprehensive range of turntable upgrades.

While you wait servicing and upgrades available.

Linn Sondek LP12 upgrades and servicing. Demo's by appointment.

ROKSAN, ORTOFON, SLMKO, PROJECT, MUSICAL FIDELITY, KLIPSON, UNISON RESEARCH, KUZMA, YAMAHA, MONITOR AUDIO, AUDIO TECHNICA, ORIGIN LIVE, AUDIO ORGANIK HI-FI RACKS, STAX HI-FI RACKS, LEHMANN, OPEN, CUSTOM DESIGN



MonoPulse

The reality of a stage

9 High Street, Hampton Wick,
 Kingston upon Thames, Surrey KT1 4DA
Open: Tuesday - Saturday 10am - 6pm
0208 943 3530

Infidelity
 MUSIC & CINEMA SYSTEMS

NAIM, LINN, REGA, ARCAM, B&W 800 SERIES, PMC, FOCAL, DYNVECTOR, KUDOS, VELODYNE, STAX, LYRA, QPPO, TANGERINE AUDIO, TELLURIUM Q.

SEE AND HEAR THE VERY BEST

CEDIA MEMBER clarity

iBasso Audio DX220



5.0 inch 1080P Sharp Full Screen/Dual ES9028PRO/On Cell Touch Panel/Octa Core CPU/Android 8.1 OS/MQA/XMOS USB-DAC/Femtosecond Oscillators/Quick Charge/Replaceable AMP Card

Available to order from AMP3.
 Hi-Fi World readers, 5% off the DX220 using voucher code
 HIFIDX220 at amp3.co.uk

DESIGNED & HANDMADE IN SCOTLAND

Equator



Our high-precision Achromatic RCA and Z plugs are designed to have minimal impact on the signal – with virtually nothing added, nothing taken away – resulting in improved sound quality.

Now standard on Element, Equator, Hyper & our new Ailsa cables.

Equator
 Achromatic
 Speaker
 Z

ACHROMATIC

LOW - MASS
 NON - MAGNETIC
 COLD - WELD
 CONNECTOR

ATLAS
 the performance connection
 atlascables.com

free reader Classifieds

TERMS AND CONDITIONS: Only one advert per reader. No Trade adverts. This section is strictly for readers selling secondhand hi-fi equipment only. Maximum length per advert is 30 words. Adverts over 30 words will not be accepted. Telephone numbers and E-mail addresses are treated as one word. Model numbers are treated as one word i.e. Quad 303 = two words. Email your advert to; classifieds@hi-fiworld.co.uk or fill in the form on page 81 and post it to Hi-Fi World Free Readers Ads, Office 052, 464 Edgware Road, London W2 1AH. Sorry, we cannot accept adverts over the telephone. The Publisher reserves the right to judge submissions.

QUAD ESL 988 speakers. Black. Downsizing forces sale. Superb condition. F.S.H., original packaging. £1000. Collection or could deliver for a small charge. Tel: 01827 284 023 or 07855 579 797

BEOGRAM 5500 record deck, mint, £495. Musical Fidelity E100 amplifier, E50 CD, E60 tuner, mint, £500. Roksan Attesa CD player, top loader, £500. Hi-Fi Year Book 1974, £25. 01708 457 691

BENCHMARK LA4 Reference line preamplifier in black with remote control. As new, warranty, genuine reason for sale. £1600 ono. Tel: 07778 500901

CLASSIC VINTAGE Heavyweights. Restored in very good condition. Yamaha CR-2020, Marantz 2226 & Marantz 2229 AM/FM stereo receivers. Asking £85, £60 & £60 or offer for whole collection! Lots of open-reel tape and top decks, ask for a list as no internet here. Tel: Brian 01773 831 830 after 3pm or voice-mail.

VPI CLASSIC 30th Anniversary turntable, JMW 10.5 arm & Dynavector DV20-XL cartridge, unused from new. Asking £2650. Dem/collect mid Derbyshire. Tel: Brian 01773 831 830 after 3pm or voice-mail.

LEAK TROUGHLINE Three One Thing Audio MPX3 all Mullard valves, excellent, £350 + carriage. Tel: 07598 670 008 (Lowestoft)

PRIMARE i30 amp (black), £750, Primare CD31 CD player (black), £750. Boxed, with remotes. Tel: Bill 02084 649 055 (Bromley)

TECHNICS TONEARM from Technics SL1200G. New unused, £495. Linn Kairn preamp with remote, manual, power cable, boxed £375. Linn Klout power amp, manual and power cable, boxed, excellent. £549. Tel 02392 453 382 (Hants)

WILSON DUETTE II & stands. Obsidian Black. All accessories, instructions etc. Condition as new. Nursed from new, hence price of £11.5k (RRP £26k). Can demonstrate. Tel. 07704 145 987 (am only) or Email: norbertstefan@yahoo.co.uk (Bedfordshire)

LONDON DECCA Gold cartridge. 3 pin version. Bought 1992. About 10 hours used. Untouched since. As new mint. Box. Inspection welcome. Olympus OM2N with one frame motor winder. Mint. Please call 07505 057 414. (London/Camden/Hampstead)

MUSICAL FIDELITY X-A1 Series integrated amplifier with external Musical Fidelity power supply. Mint condition. Box. Demo welcome. £375 ono. Please call 07505 057 414. (London/Hampstead/Camden)

NAIM NAIT 1 (Red LED) Totally original. Sounds superb. In good condition. £390. Ring for details. 07410 408 954.

CUSTOM BUILT moving coil step up. Sowter transformers in mu-meral screens. Externally switchable ratios & loadings. Full spec available on request. £499 + p&p. Call Mike on 01527 873 766.

NICE CONDITION original NAD 3020 amplifier. Great sound. £100. JVC 4VN 990 quad amp. Great condition, (not tested). £350. Call Anwar 07410 408 954.

BENZ MICRO MC Glider L2 Cartridge. New September 2018 little used. Excellent condition. Photos available £775.00 ono. Tel: Nigel 07913 121 771 or Email: ngsach57@gmail.com

TRIO KR 8050, £650. Pioneer CTF 700, £150. Technics CT550 tuner, £30. Akai CSF 11 cassette, £40. All good condition. Collect Stoke. Tel: Alan 01782 334 357

WANTED: Top quality Hi-Fi separates and complete systems, Naim, Linn, Cyrus, PMC, Audio Research etc, fast, friendly response and willing to travel/pay cash. Please call me on 0781 5892458 or Email me at pogsonp@aol.com

2 NAKAMICHI CR-7 Tape Deck £2600 (or £1300 for one deck) Both near mint and used regularly. One deck, light in tape well not working. I believe both to be gear drive. One recently serviced by Peter Dolman and the other a few years back by B & W England Tel 07983 864 126

TRANSCRIPTORS RECORD Sweep and stylus brush, will split, £190. Audio Technica AT637 stylus cleaner, boxed, unused, £100. Technics EPC 205 Mk3 cartridge, integrated headshell, boxed, never used, £300. Tel: 01708 457 691

PROJECT XPERIENCE Classic olive wood turntable. New lid. Gold Note cartridge. Carbon fibre arm. Boxed. Manual. £795. Tisbury Domino phono amp, boxed, barely used, £130. Tel: 01772 780 976 (Lancs)

DENON PMA 2500 NE amplifier. Boxed as new. £1500. Tel: 07908 431 807

PICK UP THE JUNE 2022 ISSUE OF HI-FI WORLD ON SALE
APRIL 29TH 2022, OR SUBSCRIBE AND GET IT DELIVERED
TO YOUR DOOR: SEE PAGE 38

NEXT MONTH JUNE 2022 ISSUE

KLIPSCH HERESY IV SPEAKERS

Pictured alongside a valve amplifier and old motorcycle in advertisements, Klipsch are trying to say something about their Heresy IV. Equipped with a big 12in bass unit, plus efficient Tractrix horns, Klipsch specify a massive 99dB sound pressure from 1W. Just like 'speakers of old. Moving back to old values for an exciting sound? Don't miss reading our review of this loudspeaker in the next great issue.



ADVERTISERS INDEX

Absolute Sounds OBC
 Air Audio 56
 Atlas Cables 78
 Blue Aura 44
 EnjoyTheMusic.com 74
 Fine Sounds 54
 Henley Audio 34,36,50,52,76
 iBasso Audio 78
 Icon Audio 14
 Infidelity 78
 Inspire Hi-Fi 78
 Jordan Acoustics 24
 KEF 6,12,14
 Monopulse 78
 SCV IBC
 Select Audio 60
 Soundeck 56
 The Chord Company IFC

FREE READER CLASSIFIED ADS ORDER FORM

STOP PRESS

TERMS AND CONDITIONS: Only one advert per reader. Maximum length per advert is 30 words, Adverts over 30 words will not be accepted. No Trade Adverts. This section is strictly for readers selling secondhand hi-fi equipment only. Telephone numbers and E-mail addresses are treated as one word. Model numbers are treated as one word i.e. Quad 303 = two words. Sorry, we cannot accept adverts over the telephone. The Publisher reserves the right to judge submissions.

You can email your advert to us at: classifieds@hi-fiworld.co.uk or write or type your advertisement copy in block capitals with one word per box and post it to us at:

Hi-Fi World Free Readers Ads,
 Office 052
 464 Edgware Road
 London
 W2 1AH

We cannot accept adverts over the telephone

WE WILL ACCEPT PHOTOCOPIES OF THIS FORM

1	2
3	4
5	6
7	8
9	10
11	12
13	14
15	16
17	18
19	20
21	22
23	24
25	26
27	28
29	30

Name: _____
 Address: _____

 Post Code: _____
 Daytime Tel: _____

FREE READER CLASSIFIED ADVERT COPY DEADLINE FOR JUNE 2022 ISSUE 12TH APRIL 2022

ANDY BEY

EXPERIENCE AND JUDGEMENT SPEAKERS CORNER

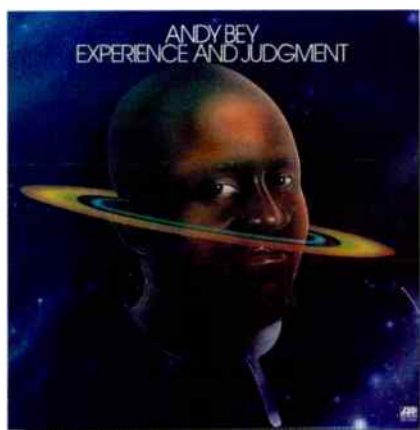

"it means that Bey has total control of his voice and material in hand"

The shame of it is that a lot of people reading this will declare "Andy who?". And I don't blame them, at all. Too much good music and too many great performers somehow disappear under the radar. So consider this one a sort of wake up call.

So, to properly cover this album, let's address that question. Who is Andy Bey? Bey was born in New Jersey in the USA in 1939 and quickly found that he had a voice. It was a voice that would develop quickly and would be recognised by many. Bey had a strong and wide-ranging voice. His delivery can range from jazz vocal to blues to full-throated soul. Sometimes within the same song.

Bey recorded his first album when he was seventeen, 'Mama's Little Boy's Got the Blues'. He even founded a sibling group with his two sisters as Andy & the Bey Sisters, recording three albums and touring Europe.

Big names recognised Bey's talent pretty quickly. People like Hank Mobley and Max Roach performed with him. With Gary Bartz he produced highly political works directed at the USA's handling of the Vietnam conflict. The man was not afraid to speak up.

In fact, the man is a thinker and a bit of a music and life-based philosopher. "I think I'm a more spiritual person. You can be religious and not be spiritual. You can be spiritual and not be religious at all. It's not about a judgmental thing; everybody's at a different level. And I find that, with myself, it's dealing with everyday challenges. That to me is more important than dealing with anything else. If you can't handle the things around you, if you don't know how to adjust to your surroundings and understanding what happiness is not...when you understand what happiness is not, then you arrive at what happiness is".

As the seventies progressed, Bey teamed up with Horace Silver and performed on some of Silver's religious-toned LPs of the early seventies.

It was around this time that this album popped up. 'Experience and Judgement' was released in 1974 on the Atlantic label. I don't know if the Silver influence had anything to

do with it and the sense of spirituality has already been mentioned here but, on this LP, there is a real spiritual feeling to this jazz funk album. I say jazz funk but you'd be forgiven for calling this release hard-core soul. Depends how you look at it, really.

Bey uses his voice to maximum impact on this twelve-track release, half of which were written by Bey himself. He can lift his delivery up to alto from a smooth baritone. Although maybe Bey would disagree. As he told The New York Times. "I can sing like a tenor at full power, like UHNUHNUHnuhnuh (cue a bellow from the chest, starting high and descending) but I'm really not a tenor. Range doesn't determine what you are; it's the colour of your voice. And the colour of my voice is very dark, very deep. I'm a bass-baritone".

It's Bey's organisation that is most impressive. His work resembles the skill of a top footballer. That is, no matter how crowded the work, how high the emotion, how busy the task involved, he will always find space to work and room to manoeuvre – appearing that he has more time to think than he really has. It's an impressive illusion because it means that Bey has total control of his voice and material in hand.

Some might think that Bey's powerful voice was too much for the majority of jazz material. Well here, with this soul underpinning, it might have found its home. His baritone combining with life advice and comments on Tune Up and You Should Have Seen The Way that focuses on yoga, meditation and healthy eating. A self-help performance on black wax, you might say.

Over the past twenty years, this album has seen a couple of reissues: back in 2005 from Atlantic itself and Be With Records in 2016. I have to say that I didn't get a chance to hear those issues but I can recommend this one from the highly respected audiophile label, Germany's Speakers Corner.

Created from original master tapes, this vinyl edition is an analogue production throughout the chain while the rather nice pressing has been produced by Germany's own Pallas. One of the best pressing plants in the world. **PR**



TRIANGLE

MANUFACTURE ELECTROACOUSTIQUE



40th
ANNIVERSARY

Two iconic models reinvented in a Limited Edition

 MADE IN
FRANCE

Distributed exclusively in the UK & Ireland by **SCV Distribution**
For your nearest dealer call 03301 222500 | www.scvdistribution.co.uk
World Radio History

ENOUGH SAID

"Setting a new standard for tube amplification."

Jed Dergay - *TONEAudio*

EVO 400 Tube Preamplifier & EVO 400 Tube Poweramplifier

"Tube Magic."

Vadi Forrester - *The Absolute Sound*

EVO 100 Tube Digital Analogue Converter

"It is in combination that the PrimaLuna Evo 300 duo shine. This isn't magic synergy or tweaking the response of one to suit the other."

Alan Sircom - *HiFi Plus*

EVO 300 Tube Preamplifier & EVO 300 Tube Poweramplifier

"The PrimaLuna EVO 400 Integrated surpasses its predecessor, the DiaLogue Premium HP Integrated, thereby inheriting the throne of the best integrated tube amplifier in the world"

Max Robinson - *Music Emotion Magazine*

EVO 400 Tube Integrated Amplifier



 **absolute sounds ltd.**

International Distributors & Consultants of Specialised Hi-End Audio & Video Systems

58 Durham Road, London, SW20 0TW

T: +44 (0)20 89 71 39 09

absolutesounds.com info@absolutesounds.com

 **PrimaLuna®**

For Your Nearest Dealer Please Visit

The **Absolute Sounds** Website