

# HI-FI WORLD

MARCH 2017

UK £4.50

www.hi-fiworld.co.uk

**FREE READER CLASSIFIED ADS IN THIS ISSUE!**



**NEAT IOTA ALPHA** EXCLUSIVE!  
loudspeaker



**LUXMAN EQ-500** EXCLUSIVE!  
phonostage



**BLUE AURA**  
v40/ps40 LE system EXCLUSIVE!

**ROHDE & SCHWARZ**  
MEASUREMENT



## QUAD VA-ONE amplifier EXCLUSIVE!



- AUDIO RESEARCH ARC DAC9 EXCLUSIVE!
- YAMAHA R-N402D RECEIVER EXCLUSIVE!
- COWON PLENUE S PORTABLE PLAYER EXCLUSIVE!
- AUDIO VECTOR QR3 LOUDSPEAKERS

### COMPETITION



WIN A **CYBUS ONE**  
INTEGRATED AMPLIFIER  
WORTH £699!  
(UK ONLY)

MARCH 2017



9 177096 1766208

**7 PAGES OF LETTERS - THE BEST WINS A PAIR OF  
QUADRAL RHODIUM 200 LOUDSPEAKERS! (UK ONLY)**



**HI-FI WORLD**



*"If you have a good system and want to give it a boost these may just be the most cost-effective way to do that"*

Chord Shawline Range  
Hi-Fi World October 2016



*"The Shawlines are really top-class interconnects... Give them an audition and hear for yourself"*

OUR VERDICT



Chord Shawline Analogue  
Hi-Fi Choice July 2016

THE CHORD COMPANY  
**Shawline**  
ANALOGUE  
THE CHORD COMPANY  
**Shawline**  
ANALOGUE

## Connect with us

Designed and hand built in England by music lovers since 1985. Enjoyed by music lovers all over the world.

The Chord Company Ltd, Millsway Centre,  
Amesbury SP4 7RX, UK

To get more information and find your nearest retailer, please call us on:  
+44 (0)1980 625700 or visit:

[www.chord.co.uk](http://www.chord.co.uk)



THE  
**CHORD**<sup>TM</sup>  
COMPANY

## EDITOR

Noel Keywood  
e-mail: [editorial@hi-fiworld.co.uk](mailto:editorial@hi-fiworld.co.uk)

## DESIGN EDITOR

Faiza Chunara  
tel: +44 (0) 20 8206 6018  
e-mail: [adproduction@hi-fiworld.co.uk](mailto:adproduction@hi-fiworld.co.uk)

## PRODUCTION EDITOR

David Noble  
tel: +44 (0) 20 8206 6019  
e-mail: [classifieds@hi-fiworld.co.uk](mailto:classifieds@hi-fiworld.co.uk)

## SALES MANAGER

Louise Palfrey  
mob: +44 (0) 7917 047 548  
e-mail: [louise@hi-fiworld.co.uk](mailto:louise@hi-fiworld.co.uk)

## ADVERTISING EXECUTIVE

Joanna Holmes  
mob: +44 (0) 7958 602347  
e-mail: [joanna@hi-fiworld.co.uk](mailto:joanna@hi-fiworld.co.uk)

## PUBLISHER

Noel Keywood  
e-mail: [publisher@hi-fiworld.co.uk](mailto:publisher@hi-fiworld.co.uk)

## FREE READERS CLASSIFIEDS

tel: +44 (0) 20 8 206 6019  
e-mail: [classifieds@hi-fiworld.co.uk](mailto:classifieds@hi-fiworld.co.uk)

## SUBSCRIPTIONS

tel: +44 (0) 1442 820 580  
fax: +44 (0) 1442 827 912  
e-mail: [hifiworld@webscribe.co.uk](mailto:hifiworld@webscribe.co.uk)

## PHOTOGRAPHY

David Noble  
tel: +44 (0) 20 8206 6019

## WRITERS

Paul Rigby, Jon Myles, Martin Pipe.



**O**ur March issue wasn't planned to be heavy in valves and vinyl. We aim to offer a broad cross section of content so there's something for everyone, from budget to esoteric, from deep digital like streamers to simple valve amps anyone can afford – never forgetting vinyl of course, in steady ascendancy against all the odds.

But ever more intriguing products and ideas find their way into our offices, most undercover, as it were. A good example is Quad's VA-One, reviewed by Martin Pipe in this issue (p11). It's a

thoroughly modern idea, a mini-amp designed to drive both loudspeakers and headphones, small enough to sit on a shelf or desk and not take over. Equipped with Bluetooth and a USB input, as well as trad. digital optical and electrical S/PDIF digital inputs, it'll work with phones, computers and portable players. Fifteen Watts per channel will deliver high volume into any loudspeaker – more than most listeners and neighbours can stand. Yet it uses valves. Inexpensive ones known for their sweet sound: EL86s. If you are intrigued by the idea of listening to a modern valve amplifier, here's a great starting point.

The great debate about LP sound quality rumbles on: this is something we can all relate to easily. Yes, they are meant to sound good but – er – often do not. It's frustrating for everyone and the reasons seem to be random and mysterious, hidden away in the vicissitudes of production. Our readers letters this month raise many issues and provide some warnings (p28), as well guidance on where to go for a good sound, in this case Sony Legacy. Many modern LPs are derived from digital copy masters, not always of good quality.

Digital moves ahead so rapidly that what was state of the art yesterday is dust today. Interesting then that Direct Stream Digital (DSD) is slowly gaining cred. as easier on the ear than Pulse Code Modulation (PCM) and perhaps in future we'll see better LP sound as a result from DSD masters.

Mobile Fidelity meanwhile have put into practice a better, if more expensive way to produce an LP, as Paul Rigby's fascinating interview with them (p89) explains. Take one popular classic album like Carlos Santana's Abraxas, produce it by this new method, charge \$100 and what do you have – a sell out. Curses! When I read the piece I thought "I'll pay money to hear that", but no chance. Everyone else has beaten me to it. Just goes to show where vinyl is going at this very minute: it's almost an overheated bubble market. But a fascinating one all the same.

And finally, as if all this wasn't crazy enough, Martin Pipe digs deep into a technological corner – that of RIAA equalisation – and comes up with some intriguing facts. The free computer editing program Audacity has the ability to digitally apply RIAA and inverse RIAA correction. See his column on p73. There seems to be no end to the unholy alliance of valves, vinyl and digital.

**Noel Keywood**  
**Editor**

## testing (see [www.hi-fiworld.co.uk](http://www.hi-fiworld.co.uk) for full explanations of all our tests)

To ensure the upmost accuracy in our product reviews, *Hi-Fi World* has extremely comprehensive in-house test facilities, and our test equipment - from big names like Rohde & Schwarz and Hewlett Packard - is amongst the most advanced in the world.

Loudspeakers are measured using a calibrated Bruel & Kjaer microphone feeding a Clio-based computer

analyser, using pulsed and gated sinewaves, in a large room to eliminate the room's influence. Pickup arm vibration is measured with a Bruel & Kjaer accelerometer.

No other UK hi-fi magazine has in-house testing, and none has access to such advanced tests across all types of equipment. That's why you can depend on *Hi-Fi World* reviews.

## hi-fi world

Audio Web Publishing  
Studio 204,  
Buspace Studio,  
Conlan Street,  
London W10 5AP  
[www.hi-fiworld.co.uk](http://www.hi-fiworld.co.uk)

## verdicts

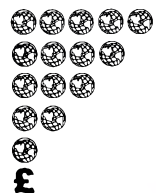

**OUTSTANDING** amongst the best  
**EXCELLENT** extremely capable  
**GOOD** worth auditioning  
**MEDIOCRE** unremarkable  
**POOR** flawed  
**VALUE** keenly priced

## ELECTRONIC MAGAZINE

Go to our website [www.hi-fiworld.co.uk](http://www.hi-fiworld.co.uk) to buy an electronic version of this magazine, individual issues, back issues or a subscription.



Distributed by Comag Specialist, Tavistock Road, West Drayton, Tavistock Works, UB7 7QX Tel +44 (0) 1895 433662

Printed by Precision Colour Printing Halesfield 1, Stirchley, Telford TF7 4QQ, United Kingdom Tel: +44 (0) 1952 585585

Our Agents in Malaysia Millennium Hi-Fi & AV Simon Chang Showroom & office, 500-1-3 First Floor Wisma Indah (Shen Court), Jalan Tun Razak 50400 Kuala Lumpur, Malaysia  
Tel: 603 9283 8171 Fax: 603 9281 3762 e-mail: [info@millennium-audio.com](mailto:info@millennium-audio.com)

All unsolicited submissions and goods are at the owner's risk. We accept no responsibility for such submissions, nor do we undertake to return them.  
No material may be reproduced from this magazine without the publisher's written permission. © Audio Web Publishing Ltd

# contents



19

YAMAHA R-N402D RECEIVER

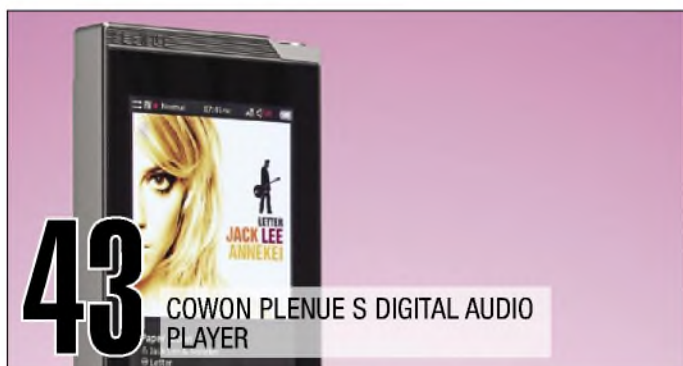

43

COWON PLENUE S DIGITAL AUDIO PLAYER

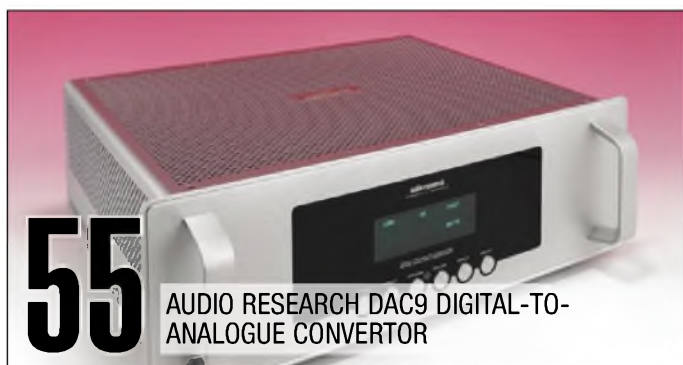

55

AUDIO RESEARCH DAC9 DIGITAL-TO-ANALOGUE CONVERTOR



84

LUXMAN EQ-500 PHONOSTAGE

## LOUDSPEAKERS

### NEAT IOTA ALPHA LOUDSPEAKERS 15

A small floorstanding loudspeaker that sounds much larger than it looks. Jon Myles is bowled over by the Neat Iota Alpha.

### AUDIOVECTOR LOUDSPEAKERS 63

Danish loudspeaker brand Audiovector debuts a new entry-level model. Jon Myles takes a listen.

## DIGITAL

### COWON PLENUE S 43

Cowon's new Plenue S digital audio player has the likes of Astell&Kern's top models in its sights. Noel Keywood finds out if it measures up.

### AUDIO RESEARCH ARC DAC9 55

A valve-based DAC from high-end legend Audio Research charms Jon Myles.

## AMPLIFICATION

### QUAD VA-ONE AMPLIFIER 11

Martin Pipe discovers Quad's latest compact valve amplifier offers superb value.

### YAMAHA R-N402D RECEIVER 19

Yamaha's latest network receiver is put through its paces by Martin Pipe.

### BLUE AURA v40/ps40 LIMITED EDITION 39

A compact valve amplifier and matching ribbon-equipped bookshelf loudspeakers make a potent combination, says Jon Myles.



11

QUAD VA-ONE AMPLIFIER

# MARCH 2017

VOLUME 27 : NO. 1

## CABLES

### 23 BLACK RHODIUM TEMPEST

Derby-based Black Rhodium's new loudspeaker cable brings the best out of high-end systems, says Jon Myles.

## FEATURE

### 48 HI-FI WORLD AT BRISTOL 2017

Come and meet the Hi-Fi World team and read about our latest subscription offer!

## SOUNDBITES

### 35 TRINITY HYPERION HEADPHONES/OED USB CABLE

A £35 set of in-ear headphones for everyday use plus an excellent value USB cable to improve your listening.

## OLDE WORLDE

### 51 RADIOGRAM PART II

Martin Pipe continues his look back at how radio advances helped usher in the world of hi-fi as we know it today.

## VINYL

### 82 NEWS

All the latest and greatest vinyl releases for you, from the pen of Paul Rigby.

### 84 LUXMAN EQ-500 PHONOSTAGE

Noel Keywood gets under the skin of one of the most advanced phonostages on the market today.

### 89 MOBILE FIDELITY

Paul Rigby explains all about Mobile Fidelity's innovative One Step remastering/pressing process.



NEAT IOTA ALPHA LOUDSPEAKERS

## REGULARS

### 7 NEWS

Words from the world...

### 27 COMPETITION

Your chance to win a Cryus One amplifier worth £699.

### 28 MAIL

Seven pages of your views, wonderful as always...

### 36 SUBSCRIPTIONS

Ensure your copy every month and save money too!

### 60 AUDIOPHILE VINYL

Paul Rigby rounds up the latest audiophile vinyl releases.

### 67,69,71,73 OPINION

The team get to grips with matters music, hi-fi and life!

### 76 WORLD CLASSICS

Brilliant designs that have stood the test of time...

### 94 DIAL-A-DEALER

A comprehensive guide to UK hi-fi retailers.

### 95 CLASSIFIEDS

The latest batch of second-hand bargains.

### 96 NEXT MONTH

What we hope to bring you in the next sizzling issue...

### 97 ADVERTISERS' INDEX

### 98 CLASSIC CUTS

Paul Rigby on Thomas Dolby's The Golden Age Of Wireless.



# HI-FI WORLD



NOW AVAILABLE  
ON THE APP STORE

App Store > Entertainment > audio web publishing ltd

**Hi-Fi World**   
audio web publishing ltd >

Details Ratings and Reviews Related

Screenshots iPhone iPad



Offers In-App Purchases  
This app is designed for both iPhone and iPad

Rating: 4+

**TOP IN-APP PURCHASES**

1.	Hi-Fi World Dec 2015	£3.99
2.	Hi-Fi World Subscription	£8.99
3.	Hi-Fi World August 2015	£3.99
4.	Hi-Fi World September 2015	£3.99
5.	Hi-Fi World June 2015	£3.99
6.	Hi-Fi World May 2015	£3.99
7.	Hi-Fi World December 2015	£3.99
8.	Hi-Fi World February 2015	£3.99
9.	Hi-Fi World November 2015	£3.99
10.	Hi-Fi World December 2014	£3.99

**LINKS**

Privacy Policy

© 2014 Hi-Fi World

**Description**

Hi-Fi World brings you the best in hi-fi...from around the world!

- We listen and measure products in depth, at our London offices.
- Expert opinion from a team of renowned writers, musicians and engineers.
- International standard measurements using Rohde & Schwarz test equipment...

**Information**

Developer	audio web publishing ltd
Category	Entertainment
Updated	7 Dec. 2014
Version	1.0
Size	9 MB
Rating	Rated 4+
Family Sharing	Yes
Compatibility	Requires iOS 5.0 or later. Compatible with iPhone, iPad, and iPod touch.
Languages	English

**DOWNLOAD OUR APP ON APPLE AND ANDROID  
DOWNLOAD FROM iTUNES OR GOOGLE PLAY  
iPad, iPhone, iPod, Tablets OUT NOW!**

email:news@hi-fiworld.co.uk

# news

## NEW MARANTZ FLAGSHIP RANGE

Marantz has launched what it describes as its most advanced hi-fi combination to date. The Premium 10 series comprises the SA-10 SACD/CD player/DAC and PM-10 amplifier.

The SA-10 replaces the SA-7, the previous Marantz reference disc player, and as well as CD and SACD playback also includes a high-resolution digital-to-analogue conversion stage.

Two dedicated master clocks are used to ensure all digital signals are upsampled directly to DSD 256 – or four times the SACD standard – without any need for sample rate conversion, and there's a choice of two filter settings to allow the listener to shape the sound.

Partnering it is the PM-10 amplifier which is completely balanced throughout its signal path and uses a dual-mono construction with differential amplification delivering 200 Watts per channel into 8 Ohms. Also incorporated is an all-discrete phono stage catering for both MM and MC cartridges.

The layout is fully balanced, from the input section all the way through to the final power amplifier section and has two sets of balanced inputs and also conventional unbalanced line-level inputs – the signal from these inputs being converted to balanced working before being passed through the amplifier. This ensures optimal signal purity and rejection of interference.

The preamp uses the famous Marantz Hyper-Dynamic Amplifier Modules (or HDAMs), which are tiny amplifiers in miniature, built from discrete components for the best possible sound quality rather than using the 'chip-amps' found in rival designs.

For more information visit [www.marantz.co.uk](http://www.marantz.co.uk)



## MONITOR AUDIO LAUNCHES HIGH PERFORMANCE 'INVISIBLE' SPEAKER

Monitor Audio has introduced the IV140, a loudspeaker designed to deliver exceptional performance in concealed in-wall and in-ceiling applications.

At just 95mm deep, (83.5mm fitting depth), the IV140 will fit into all conventional 4" stud bays within walls, leaving enough room for cabling, or within ceilings. Once skimmed with plaster, the speaker can be finished with paint, light wallpaper or fabric to ensure that it remains invisible in use.

Monitor Audio's IV140 features a large low-frequency exciter for punchy, high power bass along with two high frequency exciters which are bonded to a flat, soft polymer membrane surface to produce sound vibration.

The design effectively limits low frequency below 75Hz which can be a major asset, especially when the IV140 is deployed in home cinemas with an additional subwoofer.

Monitor Audio's IV140 is protected against overload by automatic re-setting circuit breakers. These will attenuate output for a specific time period to allow the system to cool until normal operation can safely resume.

For more information call +44 (0)1268 740580 or contact [info@monitoraudio.co.uk](mailto:info@monitoraudio.co.uk)



## NOVAFIDELITY X50

The X50 is the latest in the NovaFidelity X-Series range. This is a pure digital music server with database, CD ripper and network streamer. It runs from a Dual Core ARM Cortex A9 processor running at 1GHz. In terms of storage it is RAID supported for up to 12TB with high speed internal data processing for backup, copy and the rest. In terms of supported file formats, the X50 can handle 24bit/192kHz WAV, FLAC files as well as DSD64, DSD128, DSD256 via DSD to I2S hardware conversion.

A customised remote control app is available for iOS and Android while the unit itself offers a 178mm TFT LCD (1024x600 pixels) screen. The X50 also includes a DAB+/FM Tuner, CD ripping capability with CD metadata and album cover art and an Airplay function for iOS devices. Music services supported include: Tidal, Deezer, Qobuz, Airable and Spotify Connect.

The typical price is from £1,995 for an X50 with 2TB of storage.

To read more, click [www.novafidelity.co.uk](http://www.novafidelity.co.uk) or call +44 (0)1892 320479





## VERSUS AUDIO MP CLOCK EDITION MUSIC PLAYER

Versus Audio MP Clock Edition is a Music Player built inside an aluminium chassis. Large heat sinks guarantee passive cooling for the motherboard and power supply.

The digital signal is fed to an external DAC or USB converter through USB, utilising a SOTM tX-USBexp output board with a separate linear power supply.

The motherboard by DFI uses an Atom 3800 processor and supports 64bit operating systems. Moreover, the player uses an input filter by Furutech and all wiring in the power supply is provided by Oyaide. Price is TBA.

To learn more go to [www.versusaudio.eu](http://www.versusaudio.eu).

## IODATA FIDATA HFA1 NETWORK AUDIO SERVER

The HFA1, utilising Twonky Server 7, incorporates two 850EVO SSDs from Samsung. These drives utilise the manufacturer's 3D V-NAND flash memory to minimise voltage fluctuations and increase the part's lifespan.

The HFA1's circuit board incorporates low-ESR electrolytic capacitors that includes audio-grade components. A valve crystal oscillator with low phase-noise characteristics is also added to limit clock jitter. Support for DSD files as well as WAV and FLAC is featured.

Spanning 350 x 350 x 64mm, the unit weighs in at 6kg and is price around £6,400.

To learn more, [click www.iodata.jp](http://click www.iodata.jp).



## HECO ELEMENTA

The Elementa loudspeaker range comprises a floorstanding model (700) a standmount (300) a centre channel (Center 30) and an active subwoofer (3830A). Elementa makes use of a 28mm silk compound dome with ferrofluid damping, a double magnet and an aluminium face plate are included.

The woofer and mid driver use woven, long fibre, paper diaphragms mounted in long throw surrounds.

Machined from MDF and featuring extensive bracing, they also have rounded edges to minimise unwanted diffraction effects.

Tweeter level is adjustable between Flat and +2dB to allow optimal set up in AV systems. Prices range from £379.985 to £1899.95.

For further details call +44 (0)1822 612449 or [click www.puresound.info](http://click www.puresound.info).



## NOBLE AUDIO LOW COST ITEM

Noble Audio has launched the Noble X exclusively on Massdrop (the community-driven commerce site). A special limited-edition in-ear monitor, the Noble X features the same build materials and metalwork as Noble's other models but with a basket-weave texture and midnight blue finish.

Each unit features two proprietary balanced armature drivers: one for midrange/treble and the other for bass.

The promotion is limited to 2,000 units (three per customer) and is available to both US and international consumers.

Accessories include two pairs of single-flange silicone ear tips, two pairs of Noble foam ear tips, one pair of double-flange silicone ear tips, a cleaning tool and carrying case.

Price is \$249 - or around £200.

To learn more go to [www.nobleaudio.com](http://www.nobleaudio.com).

## METAXAS & SINS IKARUS AMPLIFIER

This distinctive amplifier features a sculptured massive CNC machined aluminium case and milspec double-sided oxygen-free copper PC board.

In addition, it uses a complete dual mono approach in power supplies with separate individual high-speed rectifier diodes with almost 40,000uF of filtering supplies.

A Grayhill rotary switch and ALPS Blue Velvet potentiometer are the only components the signal encounters on its way to the amplifier circuits. Offering 50W it is priced at \$30,000.

Click [www.metaxas.ccm](http://www.metaxas.ccm) for more information.



## MUSAIC MPL STREAMING

British Audio start-up Mosaic has launched its third wireless audio product – the MPL streaming player

The MPL can connect to any device with an analogue line-level input and can also be used with any product having an S/PDIF or Toslink digital input. Via the Mosaic app, the MPL allows playback of the music on phones and tablets and in stored DLNA/UPnP music collections. Price is £250.

For further information [click www.mosaic.com](http://click www.mosaic.com).





## DUAL RETURNS TO THE UK

Leading German turntable company Dual has relaunched in the UK. Once the largest manufacturer of turntables in Europe, the brand enjoyed an esteemed history for class-leading products through the 1960s, 70s and 80s. For 2017 the brand is back in the UK with an initial offering of three new well-featured budget models.

Prices range from the entry-level, fully automatic MTR-15 at £124.99 to the budget audiophile MTR-75 with enhanced chassis, belt drive, USB output and Audio Technica cartridge at £249.99. The £229.99 MTR-25 is a direct-drive model with variable speed control, styled as a traditional prosumer DJ deck.

The MTR-75 will lead Dual's UK relaunch for audiophiles on budget, bringing much of the brands upmarket CS-series experience to this affordable deck. With a sleek satin-black finished chassis on large vibration damping feet, the MTR-75 is belt driven to an aluminium platter via a DC servo motor with selectable speed. It's built-in RIAA phono stage has been developed to get the best from a wide range of Moving Magnet cartridges.

The MTR-75's straight aluminium tonearm has a damped lift mechanism and comes pre-fitted with an Audio Technica MM cartridge standard. The MTR-75 retails at £249.99 with the MTR-40 costing £229.99 and the entry-level MTR-15 at £124.99.

Watch out for a full review in next months issue.



## ACOUSTIC PREFERENCE'S GRACIOSO 2.0 LE

Each speaker features 184 wooden blocks with criss-cross grain to lower resonance. The blocks are cut and each segment is hand-positioned and then brushed with four layers of natural wax.

A dispersed 'down fire' bass reflex system is used for easier room placement, while a bass reflex tube is placed on the bottom of the cabinet to conduct air via a proprietary diffuser.

A point-to-point crossover system plus Mundorf electronics are used within plus solid silver internal wires for LE models. In terms of drivers, mid-bass drivers are sourced from Morel to raise their sensitivity over 90dB.

For upper frequency range, the company has chosen Scanspeak tweeters, made as matched pairs. Crossovers are additionally dampened with proprietary layers of rubber on the down side. Each crossover component is bolted and glued to the base and point-to-point wired, which is then bolted to the cabinet. Finally, aluminium bi-wiring terminals are provided for single or bi-wire speaker connection with high grade rhodium connectors. Each unit weighs in at 27kg. Price is around £9,800.

To learn more, click [www.acoustic-preference.com](http://www.acoustic-preference.com).

## AURIS AUDIO FORTE 150

Utilising two KT150 and a pair of 6SN7 valves (with bias adjustment included) plus an output transformer on a double C-core, this 100WV, push-pull, power amplifier uses Mundorf capacitors and WBT silver connectors as well as silver wiring for the signal path.

Finally, balanced input with Lundahl transformers can be installed on request. Spanning 510 x 350 x 340mm and weighing in at 27.5kg, the price is around £13,500.

To learn more log-on to [www.aurisaudio.rs](http://www.aurisaudio.rs).



## XTZ SPIRIT SERIES OF SPEAKERS

Swedish hi-fi outfit XTZ is to release a new series of speakers. The series will contain a floorstanding speaker (Spirit 11, €850), two centre speakers (Spirit 8, €345 and Spirit 6, €285) and one wall speaker (Spirit 2, €390). A 12" Subwoofer, the Spirit SUB 12 (#520) will complete the Spirit series. All speakers are painted in a multilayer paint and equipped with attached cover grills.

The tweeter of the Spirit series is a 25mm silk dome. The cooling is provided by a low viscosity ferro fluid and a high power alloy voice coil made of aluminium and copper. The waveguide helps to balance the dispersion.

The mid/bass driver originates from the XTZ laboratory and is customised to fit the Spirit speakers. Its membrane consists of acrylonitrile butadiene styrene (ABS) and a long fibre pulp mixture in a sandwich construction to increase stiffness. A specially developed and strong magnet system is used.

To learn more visit [www.xtzsound.eu](http://www.xtzsound.eu)



# SME

## MODEL 15

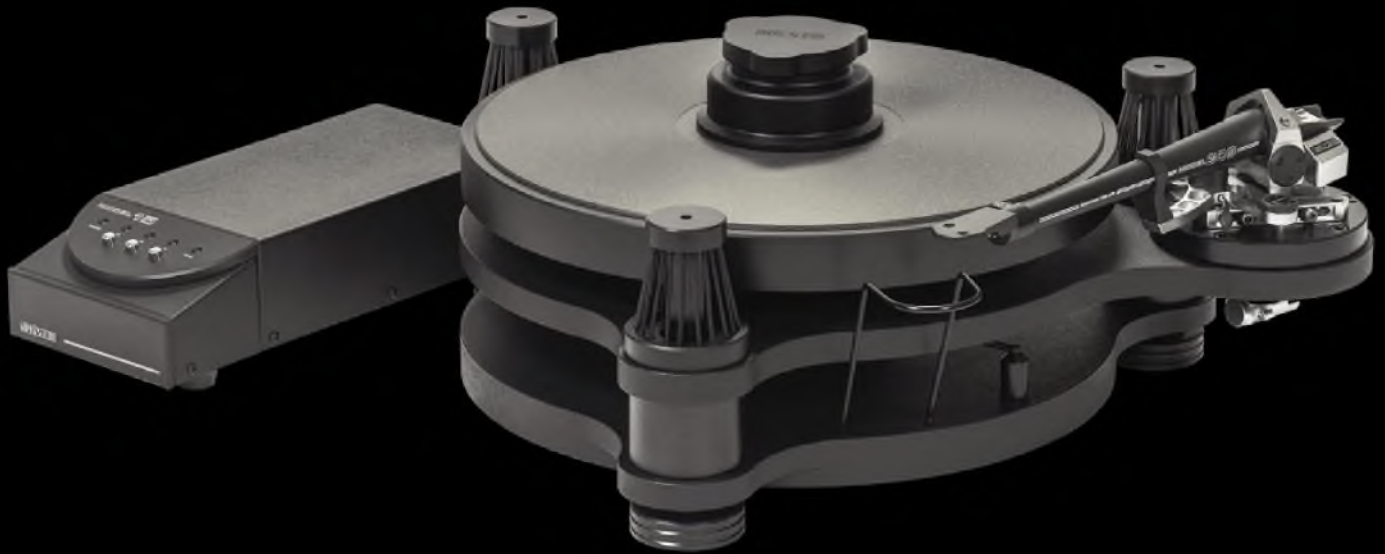

## Experience a New Dimension in Sound

The Model 15 could be described as "the ultimate in recovery vehicles", allowing the cartridge to retrieve the last nth of recorded material whether digital or analogue, from the vinyl disc and thus approaches the ultimate in perfection.

Receiving its inspiration from the superb Model 10 precision turntable the Model 15 seeks to emulate the excellence of our Models 20/3 & 30/2 turntable whilst retaining the more compact footprint preferred by many of our enthusiasts.

The Model 15 has been designed with the same attention to detail combined with simplicity of operation that has come to be expected from all SME products. Its superb performance together with laid back styling make it a glamorous addition to your sound system that will astound and amaze listeners for many years to come.

### **SME Limited**

Mill Road  
Steyning  
West Sussex  
BN44 3GY

**T** +44(0) 1903 814321  
**F** +44(0) 1903 814269  
**E** [enquiries@sme-audio.com](mailto:enquiries@sme-audio.com)  
[www.sme-audio.com](http://www.sme-audio.com)

*Audio  
Lounge*  
LONDON

### **Call for a demo**

#### **Audio Lounge**

138 Wigmore Street  
London W1U 3SG  
020 7487 4080  
[www.audiolounge.co.uk](http://www.audiolounge.co.uk)

# Musical tube journey

**Martin Pipe falls in love with Quad's VA-One – a modestly-specced valve amp that's a joy to listen to.**

**B**ack in the 1960s, when hi-fi was a pursuit new to many, you'd see plans in the various DIY electronics magazines for stereo amplifiers of low power output – well by today's standards. Although transistors were starting to make their presence felt back then,

the valve still held sway – power transistors suitable for hi-fi use were, at that time, rare and expensive. Why did you need them when a pair of small, cheap EL84 pentodes could, operating in push-pull, drive your speakers with a useful ten to fifteen watts?

Admittedly these amps were a far

cry from the big Leaks and Radfords, and the Quad II monoblocks with their distinctive KT66 beam tetrodes, but such exciting and era-defining beasts were for the better-off.

Over fifty years on, we have the VA-One from Quad. Deceptively heavy and finished in 'Lancaster Grey', the VA-One's appearance is defined





**The valve complement, two pairs of EL84s operating in push-pull at rear, and ECC83 plus ECC82 double-triodes acting as preamp/phase splitters.**

by a large volume control and the front-mounted cage that protects its seven valves. Its stylistic origins in the FA-One headphone amplifier, reviewed so enthusiastically by this magazine a couple of years back, is plain to see. The shared 'industrial-austere' appearance harks back to the '22' control unit its lucky owner would partner with the aforementioned '11s' and, more often than not, a pair of ESL57 electrostatic speakers.

Instead of the 6SN7s that the FA-One relies on for headphone

muscle, the VA-One employs - as with those designs of yesteryear - pairs of EL84s, working together to power your speakers via output transformers that must surely account for much of the unit's 11kg weight. The 15 watts (into 6 ohms) available from each of the robust speaker terminals - headphones, out of interest, are also catered for - doesn't sound like much but it can go a long way. Further back in the audio chain are ECC82 twin-triode driver/phase-splitters and an ECC83 buffer through which the source signal begins its thermionic journey through the VA-One.

Which brings me to inputs. And in this regard the VA-One departs from the classics of the past, thanks to a half-century of technological progress. Sure, there's a gold-plated line input (Aux) for an external phono stage, tape machine or tuner. But there's also a 24/192 DAC on board, which can be fed from a multiplicity of sources. In addition to optical and coaxial inputs for conventional digital sources are a USB port for computers and - courtesy of an aerial that screws into the rear panel - apt-X Bluetooth radio for dredging audio files from smart devices. Windows PCs need a USB driver - Macs don't.

Inputs can be selected from the front panel, or the neat little handset that Quad supplies. The VA-One's volume control that, more than anything, evokes Quad's heritage, is motorised and can thus also be operated from the remote; there

are mute and 'standby' functions too, as well as a mains isolation switch round the back. You have to wait 20 seconds for the filaments to warm up - during which the input LEDs flash in sequence - before the volume control returns to its zero position and the last-used audio source is selected. Then the fun can begin!

**SOUND QUALITY**

As well as sources including a FiiO X3 personal hi-res player (connected digitally) and a USB-interfaced Windows PC, I tried the VA-One with a number of speakers - ranging from tiny KEF LM1s to floor-standing Quadral Aurum Wotan VIIIIs. The VA-One worked happily with all of them. In fact, I was continually amazed at what a 'big' sound it could develop. And by that I mean a sense of scale; there's no artificiality or a tendency to emphasise one part of the audible spectrum over another.

Take for example the Stranglers' timeless debut *Rattus Norvegicus* - the album that launched a thousand bass-players! JJ Burnel's bass was allowed to growl with a satisfying depth on Peaches, but it didn't intrude on the other players. And in *Princess of the Streets*, Hugh Cornwell's bluesy guitar seared with emotional intensity yet did not dominate proceedings. What I heard was clean, natural and oh so musical!

The atmospheric motorik groove that underlies Full Stop, from Radiohead's *A Moon Shaped Pool* (24-bit FLAC), flowed from the speakers with brooding intensity and rhythmic zeal. And when the guitars and bass dropped in, it wasn't

to the detriment of the existing soundscape. This may be a dense mix, but everything was identifiable within the image - and tonally in the right proportion. The guitars and drumming of the comparatively-simpler (well, initially!) Identikit track that follows were presented in filigree detail, while I could almost feel the presence of singer Thom Yorke. Everything was given due



**All the connections you need are here - note the use of high-quality socketry for analogue in and speakers. Digital sources can be connected via optical, coaxial or USB; the vertical aerial, meanwhile, is associated with a receiver that will stream audio from Bluetooth devices.**





**The busy internal construction of the VA-One. With most of the electronics on a single circuit board, volume production is eased - and costs reduced. I kept the VA-One running continuously for listening periods of 12 hours, with no ill-effect. Note the big Alps Blue motorised volume control at top left – a quality item.**

space, with no hint of overcrowding.

Switching to symphonic music didn't faze the VA-One either. The dynamic swings of Liszt's Faust suite (Hungarian State Symphony Orchestra/Francesco D'Avalos, FLAC CD rip) were accommodated. The third movement's crescendos, with their furious percussive crashes, were free of strain – and furthermore the accompanying triangles retained their clarity. Once again, the VA-One's neutral tonal balance, resolution and ability to convey a believable stereo image made for an involving listen.

And although the VA-One is not optimised for 'canned music' in the same way as the PA-One is, headphone listening was nevertheless a worthwhile experience too, certainly with the Oppo PM3s at my disposal. Steve Reich's Music for a Large Ensemble (FLAC CD rip) poured through my ears, creating an almost three-dimensional expanse of rhythm and tonal colour. The urgency of the piece was conveyed vividly, as were the various instrumental textures.

Finally, we have Bluetooth. The upper percussion of White Mountain (from Genesis' Trespass, FLAC CD rip) sounded a little splashy to my ears, while there's a slight hardness to Peter Gabriel's voice; for some reason (possibly local interference) the odd drop-out spoilt proceedings. Bluetooth may introduce lossy compression into the proceedings, but despite this I got more musical satisfaction from my Oppo PM3s via the VA-One than I did listening

'directly' to the Samsung phone's headphone output!

**CONCLUSION**

Quad is to be congratulated for the VA-One, that punches way above its weight. Regardless of the music I threw at it, this little amplifier delivered the goods with pin-sharp clarity. It makes listening a compelling and enjoyable experience – which is just as things should be.

Its ability to handle analogue as well as various types of digital sources, in addition to the inclusion of a worthwhile headphone output and practical remote control, means it's versatile too!

A fine little machine then, built and finished to Quad's high standards, allowing EL84s today to deliver even better sound than they did yesterday.

**MEASURED PERFORMANCE**

The Quad VA-One amplifier delivers 15 Watts – enough power to drive any reasonably sensitive (88dB/Watt) floor standing loudspeaker very loud, and less sensitive small speakers (84dB/Watt) reasonably loud. Distortion from Aux to loudspeaker was a 0.06%, mainly second harmonic, so the VA-One is a low distortion amplifier.

The headphone output runs from loudspeaker output so it too delivers 11 Volts and the same frequency response and distortion result.

Frequency response (Aux input)

**FREQUENCY RESPONSE**

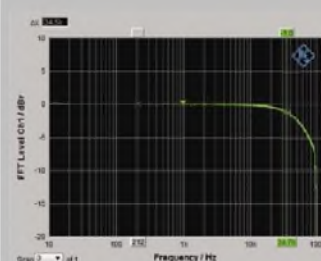

**DISTORTION (digital -60dB)**

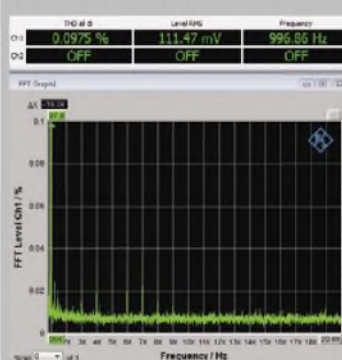

measured a wide 3Hz-42kHz and via the digital inputs (USB and S/PDIF) to 34kHz with a 192kHz sample rate signal, with a slow roll off to the upper theoretical limit of 96kHz (-8dB). So the digital section complements hi-resolution digital well. The optical input receiver accepts 192kHz sample rate, so an Astell&Kern player with 24/192 optical output will work with the VA-One.

Via the digital inputs dynamic range measured a respectable 111dB, well above CD (102dB) if not up with midrange solid state DACs at 115dB, due to their lower noise floor. Thermal noise from valves compromises this figure in all valve equipment. Distortion with hi-res digital (24bit) was low at 0.1% and 0.22% from CD (16bit). There were no limitations via USB either.

The VA-One measured well all round as a low power but sweet valve amplifier with digital section and headphone drive.

**NK**  
**Power** 15watts

**Analogue (Aux in)**  
**Frequency response** 3Hz-42kHz  
**Separation** 96dB  
**Noise** -98dB  
**Distortion** 0.13%

**Digital (24/192)**  
**Frequency response** 4Hz-34Hz  
**Separation** 97dB  
**Noise** -109dB  
**Distortion** 0.1%  
**Dynamic range** 111dB

**QUAD VA-ONE**  
**£1300**



**OUTSTANDING - amongst the best.**

**VALUE - keenly priced.**

**VERDICT**

Supremely musical, sensibly featured and visually-distinctive.

**FOR**

- clean, balanced, fast and, above all, musical.
- inputs cover all current possibilities.
- excellent headphone output.

**AGAINST**

- industrial looks might not appeal to some.
- no DSD-over-PCM support or LED confirmation of USB mode.
- occasional Bluetooth drop-out (with Samsung Galaxy S4 Mini).

Quad  
+44 (0)1480 447700  
www.quad-hifi.co.uk

# EVERYTHING WILL BECOME CLEAR

**WHAT HI-FI?**

Stars of CES|2016 ★

MONITOR AUDIO PLATINUM II

EXPERIENCE THE REVEALING  
CHEMISTRY OF A PURER PLATINUM



DISCOVER THE PLATINUM II ALCHEMY AT ONE OF THE FOLLOWING STOCKISTS:

**A FANTHORPE LTD**  
Hull, 01482 223 096  
[www.fanthorpes.co.uk](http://www.fanthorpes.co.uk)

**AUDIOVISUAL ONLINE**  
Bacup, 01706 878 444  
[www.audiovisualonline.co.uk](http://www.audiovisualonline.co.uk)

**NINTRONICS LTD**  
Welwyn Garden City, 01707 320788  
[www.nintronics.co.uk](http://www.nintronics.co.uk)

**P & A AUDIOVISUAL**  
Crosby, 01519 247 287  
[www.paaudiovisual.co.uk](http://www.paaudiovisual.co.uk)

**PETER TYSON**  
Carlisle, 01228 546 756  
[www.peter Tyson.co.uk](http://www.peter Tyson.co.uk)

**PHILLIP DOOLEY**  
Macclesfield, 01625 264 666  
[www.dooleys-hifi.co.uk](http://www.dooleys-hifi.co.uk)

**SEVENOAKS SOUND & VISION**  
Southampton, 02380 337 770  
[www.sevenoakssoundandvision.co.uk](http://www.sevenoakssoundandvision.co.uk)

**SMC CUSTOM INSTALLATIONS**  
Shrewsbury, 01743 234 945  
[www.smccustominstalls.co.uk](http://www.smccustominstalls.co.uk)

**SOUTHPORT HI-FI**  
Southport, 01704 536 901  
[www.paaudiovisual.co.uk](http://www.paaudiovisual.co.uk)

**VICKERS HI-FI**  
York, 01904 691 600  
[www.vickershifi.com](http://www.vickershifi.com)

**PLATINUM II**  
[monitoraudio.com](http://monitoraudio.com)

**MONITOR AUDIO**®



# Small Is Beautiful

**Neat Acoustics new Iota Alpha loudspeaker may be the smallest floorstander you have ever seen – but its sound is big and beautiful, says Jon Myles.**

It's fair to say that North East of England-based loudspeaker manufacturer Neat Acoustics is a company that likes to go about things in its own way.

Not ones to slavishly follow fashion, the Durham outfit doesn't bring out a succession of models at the drop of a hat like some rivals, in the hope of garnering headlines and the eyes and ears of potential buyers. Instead it takes things a little slower – only introducing products when convinced they add something to the existing range.

So when it does announce a new loudspeaker you tend to sit up and take notice. So it was when the Iota appeared some four years ago. Undoubtedly unusual, the Iotas were

designed to be used on their sides, standing just 13cm tall, 20cm wide and 16.5cm deep and featuring a planar ribbon tweeter.

Its dimensions made it an ideal desktop 'speaker – but the sound was so good it was easily the equal of some standmounts twice its size. No wonder it quickly became a best-seller.

Little surprise then, that Neat has looked to build on that success with a bigger brother to the Iota – but they've done it in their own unique style.

So what we have is the Neat Iota Alpha – a floorstander but probably the smallest example of that breed you'll ever come across, as it stands just 48cm tall on its spikes. Add in a width of 20cm and a depth of just 16cm and the word diminutive

immediately springs to mind.

Small as the cabinet is, it's firmly constructed and nicely finished. The internal arrangement consists of two chambers, the upper containing the same 10cm mid-bass and 50mm EMIT planar magnetic tweeter of the original Iota, while the larger, lower portion houses a 13.4cm downward-firing woofer (making the use of the spikes essential) in a rear-firing ported chamber.

The top portion of the Alphas is angled backwards at the front to direct sound from the mid/bass unit and tweeter towards the listener's head height while the rear contains a single pair of binding posts. The loudspeakers are also

***Downward firing bass unit and large spikes to maintain clearance.***





Pro-ject  
AUDIO SYSTEMS

# *The Classic*



August 2016



Best Turntable 2016-2017

## *An Instant Classic*

The Classic was released to celebrate Pro-ject Audio Systems' 25th Anniversary. This retro-inspired turntable has been designed from the ground-up to combine timeless aesthetics with modern technology and audiophile sound performance.

The striking frame design is available in three wood finishes, and provides clever decoupling between the acoustically treated aluminium platter and the motor.

The new motor is powered by a built-in generator, for a consistent performance, and drives a sub-platter that sits atop a precision-engineered main bearing.

The all-new 9" Classic Tonearm is made of aluminium and carbon fibre, for unrivalled rigidity while retaining a low mass. The arm benefits from a new bearing system for completely free movement and is supplied as standard with an Ortofon 2M Silver cartridge.

**Available Now for £799.00 (UK SRP)**



Distributed by Henley Designs Ltd.

T: +44 (0)1235 511 166 | E: sales@henleydesigns.co.uk | W: www.henleydesigns.co.uk



handed - so you can choose to have the tweeters on the outside or inside depending on taste (more of which later).

Neat quotes the impedance of the Alphas as 4 Ohms – so an amplifier of decent power is needed to drive them to high levels – see our Measured Performance for detailed information. As the company's products have a long-standing reputation for working well with Naim electronics I partnered them with the potent Supernait 2 amplifier fed by a Naim NDS streamer through a Chord 2Qute DAC with Tellurium Q Silver Diamond 'speaker cables.

## SOUND QUALITY

The Neat Iota Alphas belie their proportions with the size of the sound they produce. It's a little disconcerting at first – your vision goes to the little speaker sitting on the floor below you, yet the music is floating way above the top of the cabinets and anchored firmly in front of your eyes. You quickly forget about their size and instead focus on the sound they are producing.

And that sound is undeniably infectious and fun. Bass response is remarkably deep and firm while soundstage and imaging has pin-point focus.

On The Clash's live 'From Here To Eternity' (24/96) Terry Chimes's machine gun-like rat-a-tat drumming at the start of 'Janie Jones' kicks with real intensity while when Paul Simonon's bass comes in the notes are fast and tuneful with depth and substance to them.

Switching to more spaced-out grooves of Jah Wobble and Bill Laswell's 'Radioaxiom - A Dub Transmission' shows just how well the three drive units integrate together. This CD has some deep, pulsing bass with various electronic effects plus cornet and trumpet lines floating above.

The Iota Alphas picked out these layers precisely, allowing me to hear into the mix – but at the same time melded it together as a coherent whole so there was no disconnect between the bass, mid and treble. Not all downward-firing woofers do this, some sounding a little disconnected and boomy which can rob music of pace.

The Alphas 13.4cm bass unit, by contrast, is extremely pacy so it pushes music along with an assured tempo. The tweeter is also well-judged, having plenty of dynamic range

and a sweet, open quality that never strays into harshness. Joni Mitchell's dulcimer from the classic 'Blue' album was spine-tinglingly realistic with Pete Kleinow's pedal steel guitar having bite without any artificial zinginess.

As mentioned earlier the Alphas are handed loudspeakers – so you can have the tweeters either on the inside or outside. I found with the former there was definitely a sharper image with a very detailed presentation. The latter, however, had a broader, more natural and expansive soundstage with a bit more air around acoustic instruments. I'd advise experimentation in your own room to see which suits you best.

Fortunately this is easy as the Neats are fairly easy-going in terms of placement. I found 30cm from a rear wall with a slight toe-in (10%) worked best. Pushing them back 10cm brought a little extra bass but it remained well-defined without tipping into a boomy sludge.

To be hyper-critical, the Iota Alphas don't have quite the outright scale of some larger floorstanders with commensurately bigger drive

units. They do, however, have a naturalness and toe-tapping vibrancy that simply breaths life into music. It's a quality that makes you return to them time after time and nod your head in appreciation of their talents.

## CONCLUSION

There's no denying that at £1385 the Neat Iota Alphas are up against some tough competition and at that price level you can get a great many loudspeakers that offer a lot more real estate for your money.

But don't let that compact size put you off. These Iotas sound anything but small and – more importantly – are an absolute joy to listen to. If sheer musical communication is the measure of a good loudspeaker then the new Neats have it in spades. Pair them with good amplification and they cannot fail to put a smile on your face.



Single wire terminals and a small reflex port inhabit the rear.

## MEASURED PERFORMANCE

The Iota Alphas come in handed pairs, giving flatest response with their ribbon tweeters on the outside, not inside – the most common arrangement. Our third-octave analysis of pink noise shows that positioned like this, treble is smooth but slightly raised, enough to make treble sound obvious, but not excessively bright.

Ribbon tweeters sound fast, clean and pure; such emphasis is commonly chosen by designers and is subjectively a good compromise.

### FREQUENCY RESPONSE

Green - driver output  
Red - port output



### IMPEDANCE



There's only a small dip at crossover (3kHz) between the small, forward firing six inch bass/midrange unit and the tweeter, so rendition of detail will be good.

The downward firing bass unit in the base of the cabinet reaches down to 55Hz and the small port provides additional output down to 30Hz. So the Iota goes low, but bass power, especially from the small port, will not be great. Acoustic damping is very broad, or red port trace shows, and the impedance trace confirms. The Iota will play a bass tune well, without waffle or overhang. It's low frequency output is smooth too, so notes will be reproduced evenly.

Impedance measured 6 Ohms overall, but across the low frequency spectrum this is a 4 Ohm loudspeaker. In spite of drawing current it was insensitive, as small speakers usually are, delivering a low 83dB sound pressure level at 1m from one nominal Watt (2.8V) of input. Similarly sized stand mounters commonly deliver around 86dB so some power is needed to go loud, at least 60 Watts.

The Iota Alpha is an interesting design with a well honed performance, measurement shows. It is accurate, will have low colouration and well controlled bass, but is insensitive. **NK**

## NEAT IOTA ALPHA £1385



**OUTSTANDING** - amongst the best.

### VERDICT

Small but incredibly potent. These new Neats are a terrific package that bring life to every genre of music.

### FOR

- fast, rich bass.
- detailed treble.
- superb stereo imaging.
- toe-tapping sound.

### AGAINST

- need power.

Neat Acoustics  
+44 (0)1833 631021  
www.neat.co.uk

# Tellurium Q®

10 products of the year and most wanted components in just 2 years by preserving relative phase relationships in a signal



## Introducing our new high performance Digital Streaming Cable

"Tellurium Q have surpassed themselves here. It is often said that all cables colour the sound of a system to some extent, but the Silver Diamonds do it to a lesser extent than any other product I've heard so far."

John Myles. HiFi World

"If you're looking for a major jump in your system's performance, I'd suggest buying a pair of these instead of considering a hardware upgrade. Before you write this advice off to cable delusion, expectation bias, or the recent Mercury retrograde phase, please take note: I have never said this in TONE's 11-year history"

Jeff Dorgay, Tone Audio

"Well, I have just stumbled upon a speaker cable that I'm very tempted to put in a class of its own"

Mono & Stereo



facebook.com/telluriumq

telluriumq.com

+44 (0)1458 251 997



# Digitally yours



**Martin Pipe struggles to find a digital base that Yamaha hasn't covered with its MusicCast R-N402D network receiver.**

It may be the smaller and moderately cheaper brother of the excellent R-N602 reviewed in these pages recently, yet the R-N402D actually has a higher-powered amplifier on board (100W, against the 602D's 80W). The 'D' suffix refers to a feature that was missing on the R-N602 – a tuner capable of receiving DAB services, as well as Band II FM broadcasts. Having said that, the R-N402D leaves out the AM capabilities. Not that these are of any relevance to hi-fi...

Serious radio listeners argue that DAB, or rather the UK's bodged implementation that favours choice over quality and is underpinned by obsolete technology, isn't particularly relevant to hi-fi either. But as I write these words, the Norwegian authorities have just announced a

controversial intention to close down FM and shift all off-air listening to DAB. The UK announced that FM transmitters will only be switched off permanently after more than 50% of listening is digital, which will naturally disappoint the remaining millions of UK residents. This could happen in 2020 or thereabouts.

So it makes sense to invest in a receiver that will continue to receive three years after you purchase it! The R-N402D's tuner is even compatible with the more recent DAB+ variant, which promises better sound quality or even more stations. It's unlikely that we'll see DAB+ in the UK – one of the first DAB adopters – any time soon, as it will render obsolete a considerable number of existing DAB radio sets, and the government will have enough trouble dealing with

angry FM listeners...

But what if the sound of low-bitrate DAB offends your ears? Fear not, as the R-N402D will also tune into the DAB alternative that is Internet radio. It achieves this via an Ethernet or Wi-fi network connection. Most UK broadcasters also stream their services, sometimes using codecs like MP3 and AAC at higher-than-DAB bitrates. All of the BBC nationals now stream at 320kbps AAC, and in my view the Radio 3 one is audibly superior to FM, never mind DAB.

With the R-N402D you have to define your Internet radio stations on a computer or smart device via a 'vTuner' website (free registration, which 'locks' your particular R-N402D to the site via a unique 'vTuner ID' code, is required). As



**The sheer number of remote buttons nods towards the unit's plentiful features. A smartphone equipped with the free MusicCast Controller app is a better bet – especially if you're listening in the dark!**

we noted in our previous review, this arrangement is infinitely-preferable to slogging through enormous lists of stations to find the station you're after. You can search alphabetically, or browse lists by location, genre, language or location. These chosen stations then appear as 'bookmarks' on your R-N402D.

But naturally, there's more to the R-N402D's network prowess – which Yamaha has branded 'MusicCast' - than mere Internet radio. The Spotify, Napster, Juke and Qobuz subscription-music services are covered, and the unit will also stream music from AirPlay and DLNA servers, Bluetooth devices and front-panel USB memory keys, iPods and iPhones, as well as storage media containing files. All music codecs are supported - MP3, AAC, WAV, ALAC, AIFF, FLAC and well as one-bit DSD (up to 5.6MHz).

If you take the lossless route, you'll appreciate that 24-bit resolution is supported, up to 192kHz sample rate. As many as 40 of your favourite tracks – or alternatives like podcasts and radio stations – can be stored as 'presets'. Great, I suppose, if you can't live without a specific piece of music! A peek inside the receiver reveals that Yamaha has plumped for the same TI/Burr-Brown DSD1791 DAC that underpinned the R-N602. This

natively-supports DSD64, as well as hi-res PCM. The DAC can also be fed by two external sources, like CD players and TVs, via optical and coaxial inputs.

The analogue side? Unfortunately, Yamaha hasn't been as generous here as it was with the R-N602. Yes, you get the FM tuner (with 40 presets and RDS). But although four line inputs – alongside one output, which alas lacks tape-loop functionality – are provided, Yamaha has stopped short of including a phono input for vinyl fans. Evidently, this unit is being pitched squarely at digital converts.

And while there are tone controls, they are not the R-N602's good old-fashioned analogue types with pots, complete with the 'Yamaha special' that is a 'loudness' knob. No, what you get here are 'up' and 'down' buttons for treble and bass. Disappointingly, a 'pure direct' function is conspicuous by its absence and although there's a headphone socket and indepen-

Rogers GS5 floor-standing speakers, music on USB and an external aerial. The R-N402D has a comprehensive source built-in, meaning that you need little else – certainly as far as digital playback goes. I stuck mostly with digital, using Yamaha's excellent MusicCast app to surf through tracks and radio stations with the minimum of hassle.

To be honest, the R-N402D initially sounded a little edgy at low listening levels – I found such character particularly-noticeable with headphones (Oppo PM3s). But after a couple of weeks listening, things improved.

My experience is that the R-N402D likes to be played loud, especially with rock and dance. Then it rewards with an energetic performance, albeit one that lacks the absolute finesse of more expensive audiophile-class gear.

Much of that is probably down to signal-processing circuitry that can't be disengaged; I found that the

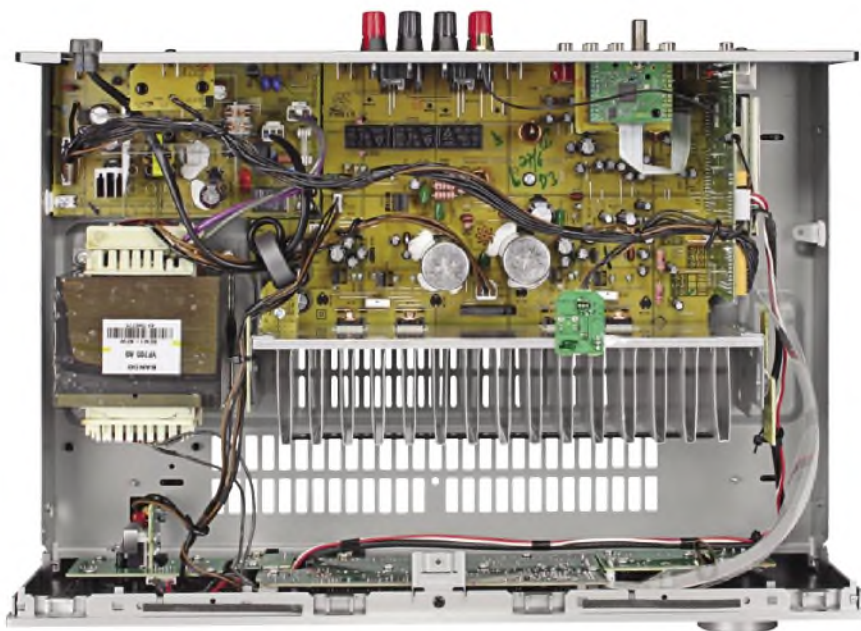

**Surprisingly little inside, much of the space being occupied by the mains transformer and heatsinks for the power amplifier's output transistors. The main circuit is populated mostly by amplifier and power supply circuitry, most of the 'clever stuff' being undertaken by DAB-tuner and digital-audio 'sub boards'.**

dently-switchable provision for two speakers, there's no subwoofer output of the sort fitted to Onkyo's competing TX-8150.

### SOUND QUALITY

Most of my listening took place with the equipment I partnered with the R-N602. Among them were a Panasonic DVD player, a network with storage, a Samsung smartphone,

R-N602's 'pure direct' mode could make a significant improvement. That said, even as it stands I couldn't fault the enjoyment factor and overall tonal balance it delivers.

It also pushes above its weight in some key areas. The bass drum that sets the pace of Back in Judy's Jungle (Brian Eno's Taking Tiger Mountain by Strategy, 2004 remaster, FLAC CD rip) was taut and plunged satisfyingly

deep, yet stayed clear of overhang. Such control demonstrates how well that power is being harnessed.

Also occupying this end of the audio spectrum was the track's bass guitar, which remained clean and easy to follow – as were the other musical elements. The upper ranges of the drum kit were endowed with 'snap', while the keyboards and guitars waltzed along nicely.

Confusion and blending only became apparent when I auditioned more complex works – notably a couple of golden-era Genesis remasters.

Bluetooth, although a good practical feature, can introduce congestion of its own on account of the lossy compression that it adds to the reproduction chain. Yet hi-def music emerged with honour. The artwork of Piltch, Davis and Friends' 1996 album *Take One* features glowing tubes, suggesting that the associated music is of audiophile quality (recorded live on analogue tape, then transferred to DSD64). Played here on a USB stick I got a real sense of intimacy from this spontaneous acoustic-jazz outing, the instruments were well-defined not only in terms of their textural subtleties but also in their placement within the stereo image.

The R-N402D's FM tuner performed very well with BBC Radios 3 and 4, and its lineage is evident. Sensitivity is fine, meaning that the pauses between movements during the live concerts carried by Radio 3 were free of obtrusive noise; all I could hear was audience hubbub, punctuated by the odd cough. And when the music resumed the space, poise and evenness of response noted with the R-N602's tuner proved to be largely intact too.

The DAB section also fared well. Imaging and upper response were a tad better than FM, but some of the finer musical detailing had taken a back seat. Thankfully, the dreaded 'digital burbles' were not troublesome!

It's a pity that Radio 3's HD stream cannot for now be intercepted by the R-N402D. It's listed in vTuner, but after adding it to my station shortcuts the receiver rejected it outright. You have to make do with the 128kbps MP3 stream, which in audio terms is on a rough par with the DAB offering. The vast majority of BBC and UK commercial stations are also available in this form, and a trawl through the tens of thousands of



**Connections for two pairs of speakers, plus four line-level inputs (one with output), are offered; no provision for subwoofer or turntable here. Optical and coaxial inputs (no USB) for conventional digital sources are accompanied by Ethernet and a Wi-fi aerial for the others. FM and DAB radio are both served by the same aerial input socket.**

stations operating internationally can be rewarding in terms of variety – if not quality hi-fi listening. In the latter respect, it trounces the short-wave listening that would have been your only option not so long ago

**CONCLUSION**

Although it misses out on some of the recently-reviewed R-N602's analogue niceties – an integrated phono stage, for example - the R-N402D represents a fantastic taster

for the many flavours of digital listening; in this regard, it's hard to think of any non-physical medium that Yamaha has left out.

Better still, the brilliant MusicCast app makes them all easy to drive. The R-N402D has plenty of power on tap too, rarely running out of puff. And although it does facilitate an emotional musical connection, one wonders how much more could have been achieved with a 'pure direct' function.

**MEASURED PERFORMANCE**

The R-N402D is powerful for its size, producing 144 Watts into 8 Ohms and 210 Watts into 4 Ohms. Distortion levels within the amplifier were low, 0.1% or less according to frequency, but it suffers classic crossover, likely being a cool running Class B, so may not sound svelte. Input sensitivity was low at 610mV and frequency response wide,

reaching 90kHz.

Both electrical and optical digital inputs worked up to 192kHz sample rate, frequency response (shown here) falling away quite early above 20kHz, to the upper limit of 96kHz with 192kHz sample rate digital (PCM). Dynamic range, a crucial value, measured a low 103dB with hi-res (24/96) digital, no better than CD – poor by current standards, where 115dB or so is common. Distortion was also high at 0.1%, mainly from second harmonic and a high noise floor.

The R-N402D is powerful, but it isn't too refined in many areas, especially in amplifier crossover distortion and digital dynamic range. A good set of results overall at the price, but unexceptional.

**NK**

**FREQUENCY RESPONSE**

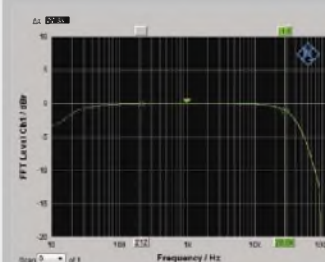

**DISTORTION**

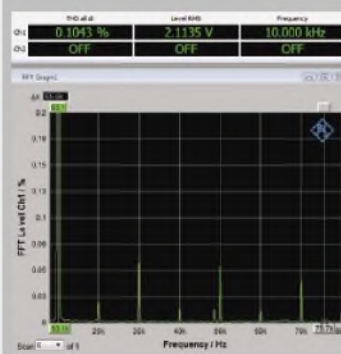

<b>Power</b>	<b>144watts</b>
<b>CD/tuner/aux.</b>	
<b>Frequency response</b>	<b>9Hz-90kHz</b>
<b>Separation</b>	<b>96dB</b>
<b>Noise</b>	<b>-95dB</b>
<b>Distortion</b>	<b>0.02%</b>
<b>Sensitivity</b>	<b>610mV</b>
<b>Digital (24/192)</b>	
<b>Frequency response</b>	<b>7Hz-28kHz</b>
<b>Separation</b>	<b>97dB</b>
<b>Noise</b>	<b>-100dB</b>
<b>Distortion</b>	<b>0.1%</b>
<b>Dynamic range</b>	<b>103dB</b>

**YAMAHA R-N602 £350**



**EXCELLENT - extremely capable.**

**VALUE - keenly priced.**

**VERDICT**  
Worthy of consideration if your budget is more limited than your digital horizons.

**FOR**  
- punchy and engaging.  
- numerous digital music choices, from DAB to DLNA.  
- MusicCast app sets standards for ease of use.

**AGAINST**  
- loses some subtleties.  
- line output unaccompanied by a tape loop.  
- no phono stage or 'direct' function.

Yamaha  
+44 (0)844 811 1116  
<http://uk.yamaha.com>

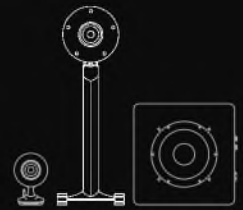

TD712zMK2

Forget what you know about speakers. **Just listen.**

'The ECLIPSE TD712ZMK2s singularly excel at making music magic; enthralling, gripping, compelling.'

David Price, HiFi World

Visit a specialist audio retailer to hear it for yourself.



'A holographic sonic image from a whole different vantage point.'

Robb Report, June 2015



July 2011



WHAT HI-FI?  
SOUND AND VISION  
WHATHIFI.COM



September 2009



HiVi Grand Prize 2009



# The Tempest

**No, not the Shakespeare play but a new loudspeaker cable from respected company Black Rhodium. Jon Myles plugs it in and listens.**

**L**ike most cable manufacturers Black Rhodium has a range of products to suit most budgets. The Derby-based company's portfolio stretches from the likes of the award-winning Twist at £5 per metre to the exotic Thunder at approaching £5000 for a 3 metre pair.

All have one thing in common - they are designed by owner Graham Nalty who founded the company back in 2002 and has decades of experience in the hi-fi industry.

One of the latest cables to emanate from his workshop is the strikingly-named Tempest DCT ++ - a development of Black Rhodium's Twist, Twirl and Samba lines but with some important design additions. Costing £2400 for a 3 metre pair, it sits at the upper end of the Black Rhodium catalogue and utilises silver-plated copper cores for the signal.

As with all Black Rhodium cables special attention has been paid to eliminating radio frequency and electro-magnetic interference. This is done by twisting the conductors together along their length, as well as applying filtering directly to the wires.

In addition, two of Graham Nalty's proprietary GN Legacy VS-

4 vibration stabilisers are fitted to each positive and negative cable to dampen micro-dynamic interference travelling through the conductors.

One other key element is the use of deep cryogenic treatment (the DCT in the name) to give a more uniform molecular structure - while Black Rhodium also applies its proprietary Crystal Sound Process which it says refocuses the outermost skin of the conductor to aid conduction properties. Rhodium-plated straight line connectors are also fitted - Graham believing the material brings a livelier and more exciting presentation to music than alternative metals.

## SOUND QUALITY

All cables have a certain sonic signature - but at this price you want as little as possible so the character of the amplifier and 'speakers shines through.

And that's what the Tempest does. Connected between a Naim Supernait 2 and a pair of Neat Iota Alpha loudspeakers they sounded fast and full-bodied - revealing the bass heft of the Naim and the pacy nature of the Neats.

With David Bowie's 'Blackstar' the soundstage on 'Tis Pity She Was A Whore' opened up with a potent

punch to the kick drum. Donny McCaslin's free-form saxophone was biting crisp without sounding harsh.

The low-end isn't over-pronounced but it sounds natural, with energy some 'speaker cables do not convey. On Ian Dury's 'Hit Me With Your Rhythm Stick' it was clear just how complex Norman Watt-Roy's 16-notes-to-the-bar bassline is.

There was a natural, organic flow to the music, so while there was plenty of detail the overall presentation never sounded clinical. On big orchestral works it was easy to place the various musicians in the soundstage, while on crescendoes power flooded through.

Of course, that means the Tempest cables won't mask any inherent deficiencies in your system - but at this price it's likely to be paired with decent ancillaries so that shouldn't prove a problem.

What it will do, though, is allow you to get the best out of your amplifier/loudspeaker combination.

## CONCLUSION

Designer Graham Nalty's years of experience shine through in this latest cable from Black Rhodium. It is uncoloured and open in its presentation, with a pacy feel that doesn't stint in the detail department.

**BLACK RHODIUM  
TEMPEST £2400  
PER 3 METRE PAIR**



**OUTSTANDING - amongst  
the best.**

### VERDICT

An excellent cable with depth, realism and detail. Brings out the best in good-quality components.

### FOR

- good bass
- speedy presentation
- openness
- quality construction

### AGAINST

- nothing

Black Rhodium  
+44 (0) 1332 342233  
www.blackrhodium.co.uk



**Jordan  
Acoustics**

01202 911 886  
bournemouth store

01592 744 779  
glenrothes store

web site: [www.jordanacoustics.co.uk](http://www.jordanacoustics.co.uk)

follow us  



**Looking to upgrade  
to the NEW Marantz  
10 Series?**

Call us for special trade-in  
deals on your existing Hi-Fi  
equipment\*\*

\*\*subject to terms & conditions



FROM KEN ISHIWATA

# Introducing the NEW 10 Series Reference from the UK's most successful Marantz Legendary retailer - Jordan Acoustics

Bringing together everything Marantz engineers have learned, designed and developed over more than 70 years, the Premium 10 series is a ground-breaking combination of established audio practice and innovative thinking, meticulously built and designed to deliver superb performance and sets new standards. Above all, it remains true to the maxim that has guided Marantz for many years, and which is summed up in one very simple statement:

**Because music matters.**



## SA-10

SUPER AUDIO CD PLAYER

**£5,999**

(black or champagne finish)

**Finance Example\***

Initial 20% deposit of  
£1,199.80, then £159.97  
per month for 30 months



## PM-10

INTEGRATED AMPLIFIER

**£6,999**

(black or champagne finish)

**Finance Example\***

Initial 20% deposit of  
£1,399.80, then £186.64  
per month for 30 months

\*Other finance terms available.

\*Finance is subject to status & conditions.

\*Further information upon request.



**Stereo 845pp**  
 "King of Triodes" ST845pp 50wpch £6,495 Worlds first 845 PP integrated amplifier



**Stereo 60 MKIIIm** hi-fi+  
 ST60 IIm with KT150 valves 80wpch, 50w Triode Outstanding performance £3,299



**Stereo 40 MKIIIm**  
 ST40 IIm True "Hi End" Amplifier, Triode 25w, UL 45w many features from £1,899



**Stereo 25 MKII**  
 Simplified ST40 30wpch UL, HQ Headphone socket, "Easy Bias" From £1,099 (EL34)



**Stereo 30se**  
 Stereo 30se KT150 Valves Pure Class A 18w Triode, 26w UL £1,999



**PS1 MKII MM/MC**  
 Our extraordinarily good pure valve phono stage only £1,099 MM or £1299 MC/MM



**PS3 MKII MC/MM Phono Preamp**  
 100% Pure Valve Pure valve Phono Preamplifier £2,499



**HP8 MKII** Only £749  
 Pure Triode With Output Transformers matching 8-600 Ohms



New 15" Horn speaker now on demonstration

See our range of speakers specially designed for valve amplifiers

Icon Audio have a valve amplifier to suit all purposes. From 15 watts per channel to 80w integrated or 16w to 250w mono blocks. Immerse yourself in our warm easy listening detailed sound. David Shaw has been making innovative highly regarded amplifiers for 15 years which are all leaders in their class, some like the unique ST845 or HP8 have no equal, and others like the ST60 and ST40 are "outstanding" in performance and value for money. All our amplifiers are handmade, "point to point" with our own hand wound transformers in our own factory and finished in Leicester. Built to last and be easily serviced.

Various upgrades are available including capacitors and valves. As a UK company we offer rapid economical service on all our products both old and new. Come for a listen at our Leicester showroom or order from one of our appointed dealers. For more information see our website, ring or email us, or ask for our latest brochure printed on real paper!

Buy direct from us or through one of dealers or worldwide distributors  
 UK only prices including 20% VAT and mainland delivery. Some models show upgraded valves. E&OE



# WIN A CYRUS ONE INTEGRATED AMPLIFIER WORTH £699 IN THIS MONTH'S GREAT GIVEAWAY!

**H**ere's your chance to win the Cyrus One integrated amplifier we reviewed last month. Read the review excerpt below and answer the questions.

"The Cyrus One features a Class D power amplifier delivering a claimed 100 Watts per channel into 6 Ohms. Then there's aptX Bluetooth for streaming music from a 'phone, tablet or computer; a Class A/B headphone output plus a moving-magnet (MM) phono stage. The only thing lacking is

a DAC which may or may not be an issue for potential buyers.

Design-wise it retains the classic Cyrus shoebox size at 85mm x 220mm x 390mm (H/W/D) but the look is rather different. Instead of the small knobs, buttons and display screen found on most Cyrus amplifiers the glossy fascia sports two black, large diameter knobs for input selection and volume, surrounded by bright white LED lights.

As well as Bluetooth and an MM phono stage input for a turntable, there are also four line-level inputs, including an A/V by-pass, a pre-out

facility, plus two pairs of 'speaker binding posts to facilitate bi-wiring.

A credit card sized remote gives access to all controls from the luxury of your armchair – and while it is small, it is well laid-out and clear. Alternatively, there's a free app available for iOS and Android devices to do the job.

The Cyrus certainly has good reserves of power and that comes through when you fire it up. It has a big, bold sound with plenty of punch to it."

For a chance to win this great prize, just answer the four easy questions at right. Send your entries on a postcard only, by 14th March 2017 to:

**March 2017 Competition,  
Hi-Fi World magazine,  
Studio 204,  
Buspace Studio,  
Conlan Street,  
Notting Hill,  
London W10 5AP**

## RULES AND CONDITIONS OF ENTRY

- ONLY ONE ENTRY PER HOUSEHOLD
- MULTIPLE ENTRIES WILL BE AUTOMATICALLY DISQUALIFIED
- PURCHASE OF THE MAGAZINE IS NOT A PRE-CONDITION OF ENTRY
- NO CORRESPONDENCE WILL BE ENTERED INTO
- THE EDITOR'S DECISION IS FINAL
- NO EMPLOYEES OF AUDIO WEB PUBLISHING LIMITED, OR OF ANY COMPANIES ASSOCIATED WITH THE PRODUCTION OR DISTRIBUTION OF THE PRIZES, MAY ENTER

## QUESTIONS

**[1] What Class is the power amplifier?**

- [a] Upper Class
- [b] Class A
- [c] Class of 2016
- [d] Class D

**[2] What does the phono stage match?**

- [a] crystal cartridges
- [b] MM cartridges
- [c] microphones
- [d] accelerometers

**[3] Are its lights –**

- [a] white LED
- [b] fluorescent
- [c] halogen
- [d] UV

**[4] The free app runs on –**

- [a] petrol
- [b] methanol
- [c] iOS & Android
- [d] steam

**entries will be accepted on a postcard only**

**DECEMBER 2016 WINNER: TANNOY ECLIPSE 3 LOUDSPEAKERS  
Mr. Paul Chambers of Peterborough**

# Mail



**Visit our website at [www.hi-fiworld.co.uk](http://www.hi-fiworld.co.uk) or send your emails to [letters@hi-fiworld.co.uk](mailto:letters@hi-fiworld.co.uk). Letter of the month wins a pair of Quadral's Rhodium 200 loudspeakers.**

**QUADRAL RHODIUM 200**

Answers by: NK - Noel Keywood; JM - Jon Myles; PR - Paul Rigby; MP - Martin Pipe.

[www.quadral.com/en/loudspeaker/rhodium-200](http://www.quadral.com/en/loudspeaker/rhodium-200)

**For more advice see Letters from earlier issues at [www.hi-fiworld.co.uk/letters](http://www.hi-fiworld.co.uk/letters)**

**A QUADRAL BREEZE ONE portable powered loudspeaker is on it's way to MARK DOUGLAS, Letter of the Month winner in our February 2017 issue.**

## Letter of the Month

### GOLDEN AGE

Claudio Marinelli raised the subject of reissue LP quality, and given the often exorbitant prices charged for these, he is right to do so. I would suggest that sometimes the poor quality has more to do with the remastering than the pressing/EQ or ADC issues.

The Pink Floyd LP used as an example of a poor product exactly replicates my feelings towards the CD issue of the same album. Indeed, I purchased a 'Best Of' CD from the same remastered suite in the hope that the 'Wish You Were Here' CD was a one off. It wasn't. The last remastering of the Floyd catalogue was, in my opinion, very poor. Like Claudio, I am able to make direct comparisons with earlier issues.

Notwithstanding the above, it is perhaps easier to find re-issue LPs that sound good. In some cases very good and in a few cases, as you noted in a review of the Beatles Mono reissues, better than the originals.

Let's hear it then for Sony Legacy. I have read that all the Sony LPs are mastered from a digital source. If so then I have no complaints. The Bob Dylan Bootleg Series, The Band Box Set and Simon and Garfunkel's Complete Box set were, I believe, all Sony legacy

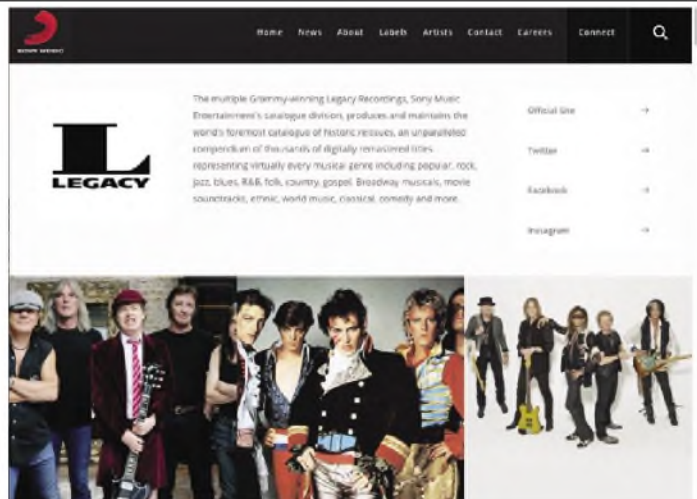

**"Let's hear it then for Sony Legacy" says Andy Andrews.  
"Sony Legacy products are all very good".**

products and are all very good.

Likewise, I have never been disappointed with Mobile Fidelity or Analogue Productions reissues. The 'new' Abbey Road remasters are also very good. Re-issues of this quality must have a high production cost and are usually of limited runs. The high purchase price therefore is sometimes justified.

In comparison with the heyday of LPs we live in a golden age. In the late sixties, early seventies, there was more bad product around than there

is now. Flimsy sleeves, poor pressings (I still have a few – CS&N first album anyone?) and vinyl that stayed just the right side of the trade descriptions act! The only thing that is not improving is my bank balance.

Kind Regards  
**Andy Andrews**

Thanks Andy. That's how I see it: I have some amazing new vinyl, worth every penny of the asking price, but am now also picking up some

disappointing re-pressings at around £15 or so that sound like rush jobs to me. I would rather pay more than this for a decent re-master onto new stampers and modern, quiet 180gm vinyl, or better 200gm flat with no lip because it sits on the platter mat better. But see the next letter for more experiences. **NK**

### DIGITALLY THIN LIZZY

It was interesting reading Noel Keywood's comments in response to a reader's letter on newly manufactured LPs. Included in his response was something I've noticed – that many musicians have an animus towards hi-fi. To me, as a music lover and musician, this seems incomprehensible as I want to enjoy my music as best as I can – and hi-fi is the obvious way to achieve it. I can't understand the dichotomy as a creator of music, why would you want to neuter the experience of listening to it?

Going onto the main discussion in Noel's response about how re-issue LPs are mixed from reference to studio monitors at loud volume goes some way to inform my experience with them.

As the original LP of Thin Lizzy's 1973 album 'Vagabonds of the Western World' was hard to get hold of and ones that come up fairly costly, I was interested in the reissue of it as an LP. I asked the re-issuing company how it was mastered, thinking it would be sourced from CD etc. and they said it had been 'cut from the original analogue tapes'. However, on buying it, I found it 'flat' and un-dynamic to my ears, rather like the CD version I had of it. To satisfy my curiosity I managed to get a copy of the original LP and it had life (!) dynamic and was musical, even though it was a well-used copy. It brought back memories of when I had the original LP in 1980.



**Thin Lizzy's 'Vagabonds of the Western World' LP.**

On reflection I thought it would be highly unlikely that the original master tapes would have survived from Decca – and even if they did would not be in a condition to produce a master from them as it was in 1973 – even if 'baking' them was done to restore functionality.

A clue to this was in another Thin Lizzy reissue I bought, this time their 1976 'Jailbreak' LP. The inner sleeve had a repro. of the original master tape box where it was mastered. Scribbled in were the various dates when the tape was baked.

When I first got the record I thought it sounded OK, bright, loud and too prominent drums. As before, I got a reasonable copy of the original LP and compared it with the reissue. At first I felt the original seemed muted in comparison but over time I played the reissue against the original and began to notice how harsh the reissue sounded, hardly any dynamics between soft/loud and basically my same experience of listening to CD versions of old records.

Then on looking closer at the repro of the tape box I noticed a small yellow sticker was added saying that it had been transferred to MO (magneto optical) disc sampled at 96 kHz/24 bit. I was listening to a record manufactured from a digitised version of the original.

I tried not to be too partisan to the original in my tests (as with some things it is obvious the original is best) but it wouldn't have really mattered if the re-issues were 'better' only that what I was listening to was as musical and enjoyable as I remembered the original was. As I said my reasons for buying the re-issues was scarcity and cost as a good copy of the original 'Vagabonds' is around £80 and I thought a nice new record would sound the same as an original if pressed from original master tapes and maybe I'd get a better pressing as it was pressed on 180g vinyl. However, now I'm not keen to buy any more re-issue LPs if possible.

Perhaps I'm lucky I don't like much new music as the LP versions brought out by new artists now will invariably have been recorded digitally – I guess that could be yet further discussion.

Thanks,  
**Tony Bilny**  
**Yorkshire**

Hi Tony – yes, turning analogue to digital is another very big



**Thin Lizzy's 'Jailbreak' LP.**

discussion. What a shame so much music has been mangled by it so far. Even though 96kHz/24 on MO sounds good, much depends upon ADC quality and this has often been poor; I hate to think of what you could really be listening to.

Sony are still quietly promoting the use of DSD however, as a mastering and storage medium, and I believe editing can now be carried out in DSD too. DXD (high rate PCM) also sounds decent enough to me, if not quite as neutral as DSD. Then there is renewed interest in high speed pro open-reel tape recorders (no ADC – woo hoo!) about which everyone seems to agree: they are the doggies. **NK**

### TIME FOR DSD

Is 2017 the year for audiophiles to transfer their vinyl to DSD? I look forward to reading your sound quality 'take' on this in *Hi-Fi World*. See this url for more: <http://blog.nativesdsd.com/recording-music-analog-tape-lps-dsd>.

I am still looking for a server/player a la Melco N1A, Innuos Zen Mini or Zenith, or Cocktail Audio Pro X 100. I hope you will consider a comparative test. The half size Zen Mini would sit nicely by the half size Audiolab M-DAC+



**Professional open reel tape recorders are becoming sought after items. Will analogue recording revive?**

but how does sound quality compare to more expensive player/servers, especially streaming DSD?

My news is that I celebrate a significant birthday early this year and I already have the present from my wonderful wife - a PrimaLuna Dialogue Premium HP with EL34 valves. Yes, I have joined the audiophile cognoscenti.

What can I say that Hi-Fi World has not said before? Valves are just hi-fi nirvana. Even though Jon Myles only awarded four globes, and you all seem to prefer Icon Audio, I chose, as a tube 'novice', the PrimaLuna for the protection circuits. Anyway, Jon did later choose the same amp for his recommended valve based system. And there is the KT150 valve upgrade to look forward to, but I am not in any hurry yet.

Best wishes,

**Mike Tartaglia-Kershaw**

Thanks for the link Mike. Yes, that is very interesting and if you've heard DSD - I listen to it regularly on digital Audio players in for review - you soon become aware it is smoother and more liquid in progress, shall I say, than PCM of any resolution. I believe I am right in saying that DSD is difficult to edit, without conversion to PCM, and this has always been a limitation to its use.

Just about all DAC chips have DSD conversion on-board nowadays, but manufacturers commonly choose not to implement it because it adds complexity and cost to a product. Looks like all this is slowly changing though.

Valves done properly are superb. I wish you a Happy Birthday in Nirvana! **NK**

### DOWNLOADS

Jon Myles seems to be a little hungover after the Christmas/New Year period. In his editorial column about trends in music sales he refers to downloads as becoming the more popular method. According to the latest stats digital downloads are in decline with streaming in the ascendent. Jon, in his review of the Eclipse sub, refers to Lester Young's solo on the Mingus Ah Um album. Not in this universe or any other as far I am aware! Great mag by the way. Have bought every issue since day one.

**Richard Burton**

Hi Richard. You are correct - streaming is in the ascendency according to latest figures, as I discuss in my column this month. Downloads do, however, still represent a



**The PrimaLuna Dialogue Premium HP valve amplifier, a birthday present for Mike Tartaglia-Kershaw. "Valves are just hi-fi nirvana" Mike says.**

significant market and many people have a large stock of them on their computers or network attached storage devices.

As to the Lester Young reference: mea culpa. I was referencing the saxophone solos on Mingus's 'Goodbye Pork Pie Hat' from Mingus Ah Um - which is, of course, a tribute to Lester Young. JM

### OVERWHELMED

My wife and I have been audiophiles for many years although we have not invested in any very serious equipment until now. In a nutshell we would like to get a basic music set up which we see as: a network music playing device,



**The Mingus Ah Um album.**

DAC, amps and floorstanders. We have been reading all the well-established Hi-Fi magazines including your own for a number of months, but still feel overwhelmed at the choice available.

Adding to that, although our local high-end store has been very pleasant and helpful with discussions, they suggest that we choose two sets of speakers based on reviews, they will then choose the other aforementioned components for us to set up a demo

and then we will be able to compare them and make a choice.

Aside from the obvious bias that could be introduced by an unscrupulous or inexperienced vendor, does it really come down to a choice of two or should we be insisting on a comparison of 5 systems, 10 even?

In terms of budget, we would like to spend less than £15,000 on the entire system. Our room is around 11 by 16 and our music choices are very varied from electronic to classical. If you are able to offer any advice on the above both in terms of how to go about choosing equipment and any specific recommendations on good choices to go for, that would be much appreciated.

(As a side note we currently have various devices playing into a Denon PMA-700AE driving a pair of KEF Cresta 10 stand mounts.)

Regards,

**Paul,  
London**

Hi Paul. Your letter alarmed me! From where you are today there is no great need to spend £15k to upgrade, especially in 11ft x 16ft room; put big, expensive speakers in that and you will over-drive it.

Talking about loudspeakers, which is where I would start, you mention no names. So I will suggest straight away you listen to the Quadral Chromium Style 8 - our loudspeaker of 2016 - which is a floorstander with ribbon tweeter costing £1800. It will suit your room, it is smooth, accurate and sophisticated, it has pure ribbon treble and it is dynamic and exciting.

From here then listen to other loudspeakers, using the Chromium Style 8 as a quality benchmark.



**Quadral's Chromium Style 8 loudspeaker – our pick of 2016 and a benchmark product that must be heard.**

Monitor Audio PL200 II, B&W 804 come to mind or, since you are in London, take a trip to KJ W1 (Marylebone) where you can hear Martin Logan hybrid electrostatics. The new and affordable EM-X will suit your room. Just be aware these are analytical reviewer's loudspeakers and don't flatter bright transistor amplifiers or poor recordings.

Loudspeakers are a matter of personal taste; most reputable makes are well designed, built and fundamentally accurate, but they sound different all the same. Just chose what you like, after reasonably long, relaxed demo using music of your choice; do not let someone else blast demo tracks at you.

I have a London room just like yours and know that you can over-drive the main modes, causing room boom, if you install a loudspeaker with big bass output – meaning two bass drivers or more. If you can get a home demo to guard against this, all the better.

After settling the loudspeaker issue you can then move on to partnering equipment. A streamer and amplifier suggests you look at Naim's large and effective range. About which Jon Myles can say more.

**NK**

Hi Paul, you are right in saying that the choice of equipment can be bewildering if you are looking to build a system from scratch. The good news, though, is that with a budget of up to £15,000 you and your wife will be able to assemble a very good set-up indeed.

Where to start? I'd go along with your dealer's advice to a certain extent in starting off with the loudspeakers first as these undoubtedly have the biggest impact on the sound - but I'd recommend listening to at least four or five different models to start with. Try to narrow down exactly what you are looking for in terms of sonic signature; are you looking for absolute detail and accuracy, deep bass, exceptional imaging or, perhaps, extended high frequencies?

Different 'speakers can and do excel in different areas and what suits one person may disappoint someone else. Read through our reviews to get an idea of which 'speakers may suit your own tastes.

Once you've narrowed down your choice let the dealer assemble their suggested systems for a thorough audition - using your own selection of music. Always remember, your own ears will let you know if you like what you're hearing. **JM**

### **RUNNING LOW**

Hi there. Wondering if anyone there can offer some much needed advice regards my system. This is my system: B&W Nautilus 804, Pathos Logos, Arcam CD192, Arcam D33, Chord anthem tuned array digital, Atlas Mavros XLR from DAC to amp, Atlas Hyper bi-wire speaker cable. All of my listening is done at low volumes, but after extended listening the sound becomes brighter (which I dislike) and lacking in bass weight and extension.

We've been told that the speakers are on the bright side, which would explain why I've always preferred a weighty and fuller sounding amp. So I'm thinking, perhaps these speakers are not conducive to quieter volume, relaxed listening? I have considered a pair of

B&W CM9 2s. Would these give me the bass at lower volumes or just be a sidestep? Maximum budget of £3,000, also happy to go second-hand. I'd love some input from people who aren't trying to sell me something. Thanks in advance.  
Lisa Jackson

Hi Lisa. I'd broadly agree with the view that, for your purposes, the B&W loudspeakers are best replaced. You do not state room size, but since you use low levels, power isn't an issue and your Pathos Logos amplifier has plenty in any case.

Look to audition wall standing loudspeakers that excite the room best at low frequencies and here I'd suggest ribbon tweeter designs like the new Quadral Aurum Galan 9, Monitor Audio PL100 II, Quad Z-1. Ribbon tweeters give airy treble and have always been my preference; they will best complement the quality of your other system components.

Be aware that at low levels the ear becomes less sensitive to bass and treble, making for a subjectively weak sound. Loudness controls aim to combat this. They are rare on high-end products but it is a route you may need to go down – Japanese big-name amplifiers (Sony, Yamaha etc) commonly have loudness controls.

You really do need a home demo that takes into account your room acoustics, with loudspeakers placed on stands placed close to a rear wall; if bass is too obvious (unlikely) they



**The Quad Z-1 stand mounted loudspeaker with ribbon tweeter. Suitable for low listening and a complement to Lisa Jackson's hi-fi.**

can be moved forward a few feet. What you hear in a dealer demo will only represent what you hear at home if the demo room is of similar dimensions and construction (e.g. brick walls) to your home. I hope this helps. **NK**

### YAMAHA NS-1000M

Many years ago as a callow youth I wandered up and down Tottenham Court Road lusting after various bits of exotic hi fi. I wasn't really interested in the orthodoxy of the time – the British is best with no knobs and a turntable that bounced like a trampoline weren't appealing to me. So my objects of desire were Denon turntables, big class A Japanese amps and Yamaha NS-1000M speakers. Unfortunately funds were short so my ideal system was beyond my means.

Since then I've had various systems; some were great and some were disasters but within those systems I've had a few of the items I wanted all those years ago. I had a beautiful

The rest of my system is: Technics SL150 with an Origin Live upgraded Rega RB250 (I've got a Technics SL1210 that I'll be switching the arm to when I get the time), a Marantz PM-15 S1 amp, a Marantz SA-15 S1 super audio CD player and a Yamaha CT810 FM tuner. I've also got a MacBook pro with a Dragonfly DAC with a few downloads and CD copies on it that I use for convenience.

The question is – where do I go from here? The speakers are staying after all the years of lust and so are the CD player and the tuner (one of the best I've heard and let's hope FM goes on a for many years). I'm happy with the turntable as well but the 1210, when I get round to putting the arm on, will probably be an improvement.

I think though there could be a better matched amp even though the Marantz is good. Looking on the internet there's everything recommended as a match for the 1000Ms including Naim, Croft, Audiolab, Icon, original Exposures, etc., etc. which isn't a lot of help, so any

I'm gradually getting through. He's an enthusiast and always good to chat to about all things hi fi.

Regards,

**Geoff Fielding.**

Hi Geoff. The big 12in bass unit of the legendary Yamaha NS-1000Ms is best controlled by an amplifier like a Naim; I'd suggest a Supernait 2 as you don't want high volume. Naims are smooth and punchy, but note that the sealed NS-1000M enclosure is overdamped and does not go especially low; the NS-100Ms were studio monitors designed to work against a rear wall. That's why you often see them perched incongruously on stands in hi-fi systems, for close to rear wall positioning.

You may well like to clean/upgrade the 1970s input spring clip terminals (often replaced by 4mm sockets in real life) and connectors to the crossover and bass unit too, according to whether you want to renovate or restore these speakers. You get a better second-hand price with restoration but better sound with renovation.

The beryllium dome midrange especially gives this loudspeaker a presence most trad hi-fi speakers lack. But note that midrange domes, beloved in studio monitors, are not especially smooth; they are projective. Have fun! **NK**



**A lovely looking pair of restored and tweaked Yamaha NS-1000M loudspeakers from Japanese supplier Kenrick Sound (<http://kenricksound.com>). Note the big beryllium dome midrange units.**

Denon turntable and a great big beast of a Sansui one as well and both were exceptional, I had a Marantz pm94 that melted from the inside with the heat it generated but sounded great whilst it worked and a Sansui that's now become collectable. I didn't manage to get hold of a pair of Yamaha NS-1000Ms though. That was until a couple of weeks ago when I found a pair for a reasonable price in decent condition. Most of the ones I've looked at in the past were a bit ropey – holes where brackets were fitted for studio mounting and generally a bit knocked about but the ones I've bought have just been used domestically.

recommendations would be appreciated. I'd like a bit more warmth without losing detail and speed, so would the Icon Audio 30SE fit the bill? Or should I go for a solid-state Class A amp? I don't need a lot of power as my listening room is fairly small.

As a postscript, it was my Marantz amp that Dave Tutt wrote about in the letters page of the November issue of your mag even though it says it's an "S2", it was my "S1". It went down on one channel and he sorted it out. He's also done work on speakers and various other bits of hi-fi for me as I have a house full of not quite working kit that

Hi Geoff, the Yamaha NS-1000Ms are fascinating loudspeakers that still retain a loyal following to this day. The use of a 12-inch bass driver in a sealed box coupled with beryllium mid and tweeter units sets it apart from almost anything else in the market nowadays.

They can, though, be brutally revealing of partnering equipment and demand quality amplification. I'd recommend trying them with the Icon Audio ST30se as it will give you a rich, warm bass without sacrificing any detail or resolution. I've also heard them sounding good partnered with Naim amplification so the Supernait 2 would be a viable alternative. This would certainly make the most of the bass qualities of the NS-1000Ms with a little more punch than your current Marantz (good as it is).

Try them both and see which you prefer. **JM**

### DISCUSS

*It is a universally accepted fact that all good things come in threes. So here are*





**Drive Yamaha NS-1000Ms with a Naim Supernait 2. It has smooth midrange and treble – and powerful bass.**

my three universally aligned discussion points.

One. On the subject of power outputs and volume controls. Even if one accepted the argument that it is a good thing to have surplus power on tap for the clean reproduction of peaks, this still does not get around the unwieldy volume controls fitted by most manufacturers. On my little amplifier (NAD C350 which I still like for its inherent speed and control) the volume control rarely ventures further than seven or eight o'clock on the control. This makes the fine control of perceived level very difficult. I am sure that many others find themselves in this position. Wouldn't it be better to use a digital control with a wide array of settings which could be engineered to provide the most resolution where it is needed, i.e. at the lower range of the control. I doubt that this would be materially more expensive to implement than a good quality analogue contact wiper type of control. Furthermore, it would obviate the tendency for wear and tear and channel imbalance found in conventional controls.

Two. I share Noel's fascination with DAPS and the often absurdly good audio reproduction that may be wrung from the little blighters. However, the point about fussy presentation and illogical controls to be found in many is well made. An exception, I have found, are the devices marketed by the Chinese company xDuo. My beautifully constructed, Linux based xDuo X3 is minimalistic in design, while allowing for anything sensible that you might want to do with it. Its controls are logically implemented for one hand operation, even in the dark. With its CS4398 DAC its sounds fine and it may accept two 128gb cards, enough storage for most, and also has a good line out. You can source an X3 for around £75, surely an outstanding bargain. But there is now a new model, the X10 which sports the AK4490 DAC, as found in certain

high-end models including A&K, together with the Muses 8920 amplifier chip. It retains all the good features of the X3, including a different, but logical, control surface and looks great. All this for around £130! Of course, FiiO provide good value with their various models, but it seems that xDuo can even run rings around them. Perhaps a review of the X3 or X10, or both, would be well received within the pages of HFW?

Three. Is it my imagination or has the quality of (BBC) DAB increased slightly over the last few months? As I am unable to grab a workable FM signal in my location, I resorted to DAB early on and, like many others, was disappointed with the perceived quality and the BBC's allocation of bandwidth in favour of a plethora of daft fringe interest stations instead of focusing upon quality for the main stations. However, sound quality on Radio 3 seems to have become somewhat more acceptable. What's going on? Have the BBC tweaked the coding algorithms? I am using the relatively inexpensive, but beautifully made, Onkyo T4030 tuner and, on good quality live transmissions, I sometimes forget that I am listening to a DAB broadcast. Now, if the BBC would only embrace DAB+ and bring us, at least on the main channels, some increased bandwidth, this would be wonderful. Are there any BBC engineers reading this who would like to comment? Or perhaps HFW has some insider information?

So, there they are. My three discussion marbles for you to roll

around while contemplating the meaning of life and the workings of the universe. By the way, HFW remains tops among the audio rags.

**Mark Douglas,  
Berkhamsted**

Lots of interesting points there Mark – thanks. Martin Pipe is our BBC 3 expert who has long, in-depth conversations with them. So over to him on the subject of DAB quality.

The issue of digital volume controls is an interesting one that currently concerns me, as I have to choose one for an all-discrete, fully balanced, transistor phono stage I designed over Christmas 2015 and have never quite completed. The issue is finding a suitable four-channel, balanced volume control. What a weird business this is!

What it showed me is there are no end of pure digital controls, and solid-state integrated-circuit based controls, all of which have limitations. You can get 'em, but do you want 'em?

The best designs are switched resistor networks, but these are expensive and get complicated. They do exist however and give the sort of low-level resolution you are looking for. As you note there is a lot wrong with running a wiper over a track, even if it does work in practice, especially when the track is long, as in an Alps Blue.

Once upon a time volume pots were big and had good mechanical resolution at low settings; your NAD pot is likely small and you will forever pay for what you didn't pay for!

Thank you for the xDuo recommendation. We will certainly seek out the players you mention. DAPs are indeed fascinating little blighters! **NK**



**The new xDuo X10 – a fabulous specification and just £130, Mark Douglas tells us.**

It's interesting that you can get a good DAB signal, while the FM coverage in your area is poor. This should hold you well in the future, as the close-down of the FM service could start as early as 2020 when, it is estimated, that 50% of all listening is digital (what about the other 50%?). All BBC music services with the exception of Radio 3 have bitrates of 128kbps. Radio 3 goes out at 160kbps, except when live concerts are being carried and the bitrate is raised to 192kbps.

The AAC codec supported by DAB+ is efficient - in other words it can offer better sound quality at the same bitrate or allow more stations to be squeezed into the same space. Later arrivals to digital radio broadcasting adopted DAB+ from the outset. It remains to be seen if the BBC switches to the newer system any time soon; it would be embarrassing to the authorities if older DAB radios (which don't support DAB+) were to be made redundant before FM shutdown! Listening with the DAB tuners built into the Onkyo and Yamaha receivers I have reviewed recently, I was pleasantly surprised with the results from Radio 4 (admittedly mostly speech) as well as Radio 3's lunchtime and evening concerts.

Masking of detail and background 'burbling' are much less evident than I recall, as you say. I use a multi-element DAB aerial aimed at the local transmitter. In any case, I find that stations reliant on pop music, BBC and commercial alike, aren't so easy to listen to via DAB for any length of time; fatigue soon sets in. The government has made high-speed national broadband a key priority and this makes online streaming a practical alternative to DAB. All of the national BBC services, not just Radio 3, are available as 320kbps AAC streams, as well as 128kbps MP3. And the sound quality can be superb, especially with live music. Indeed, I prefer to listen to Radio 3 in this form; it's the closest to a FM replacement I've heard so far. Not all digital radio tuners are alas compatible. If sheer variety of stations is important to you, then internet radio trounces DAB any day of the week! **MP**

### PRO-JECT CLASSIC REVIEW

Greetings and I'd like to point out a few matters concerning the recent review of this turntable. Whilst I have no axe to grind regarding NK's assessment

of its strengths and weaknesses might I mention that there are a couple of points worth mentioning which might be of benefit to would-be purchasers.

Firstly, this turntable was originally released at the £799 price point, more sensible in my opinion and the reason I bought one! There is a magnetic 'catch' which secured the arm but, admittedly, it's not the same as a simpler and more secure mechanical device.

Personally speaking, I found it a doddle to set up but the instructions were not the clearest read as you mention. It's an affordable turntable and provided me with an easy solution

Quad Vena and a pair of PMC Twenty 21s. I appreciate the honest review, but a bit of tweaking will improve it no end.

**Simon Gregory,  
Skipton**

Very interesting Simon - and I'm glad you are happy with the Pro-Ject. After reviewing the Audio Technica and Re-loop turntables, both of which - almost certainly - are sourced from Hanpin of Taiwan, I felt they offered much easier set-up, slicker operation and very good sound, at a lower price than the Pro-Ject.

There's no intrinsic benefit in



**The Pro-Ject Classic turntable reviewed in our February 2017 issue. "A bit of tweaking will improve it no end" says Simon Gregory.**

but I have tweaked things considerably to make it perform better. It sits on an Audio Suspension wall shelf, I'd say this is the best solution and it does fit their standard model.

Ditch that Ortofon cartridge, it is a bit crude and far too bright and forward. I went for a Hana EH and that works a real treat (via a Pro-Ject Tube Box DS - gain set at 50dB which seems to work best). Mind you, the Hana has had a price increase of £60 since I bought mine...

Replace the felt mat with a Wooden Bull leather/cork one, as suggested as a Christmas buy in your January issue. It's a good fit, looks nice and seems more stable. Indeed, there are some aspects of the turntable which show cost-cutting, but it works a treat now through a

fiddly set-up, even if these days the internet seems to think otherwise. And all your efforts can be thrown out if obscure but important issues such as cartridge alignment in the headshell is wrong; box-shape cartridges with flat sides (Nagaoka) best resolve this issue. But how many of these are there?

As you say the budget Ortofon Silver cartridge isn't attractive in its sound, although doubtless after a few hundred hours it may well start to soften out - if you can stand it that long! Not the vinyl sound most people expect either, when coming into the field.

The Hannas are good, as you say, or a Goldring 1012GX would suit. Both are much more analogue like.

**NK**



### TRINITY HYPERION IN-EAR MONITORS £35

In-ear 'phones costing between £30 and £40 are a hotly-contested sector of the market. It's around this price you start to get a sound that is a clear improvement on the free earphones packed in with most mobile 'phones or portable players, while the cost isn't so prohibitive to fear subjecting them to the stress and strain of use.

Entering this sector is the new £35 Hyperion from UK company Trinity. First impressions were positive – they feature aluminium housings and 7mm Neodymium titanium diaphragm

drivers with a sturdy 1.2 metre multi-braid woven cable.

Packed into the box are no less than seven different eartips to ensure you can get a tight seal, plus a hard carrying case and an L-plug adaptor if you'd prefer to use them that way. They are also extremely light at a mere 13 grams, meaning they feel very comfortable even over extended listening periods.

Soundwise they are also subtly different to many models at this price in having a fairly even balance. The treble is a little forward but not excessively so while – thankfully – the

bass hasn't been artificially pumped up so what you get is an open, atmospheric sound with plenty of air and detail.

Even on dense material instruments were easy to follow and there is a spaciousness to the presentation, giving large orchestral works such as 'Mahler's Number 1' a sense of scale.

They have sufficient resolution to reveal file quality; you'll know when you are playing compressed MP3s but also hear the difference when turning to 16bit/44.1kHz and above. That's not something all sub-£40 in-ear 'phones can lay claim to.

Their even balance also means they have a good sense of timing. Fast-paced tracks like The Libertines' 'Heart Of The Matter' were driven along with plenty of energy – without sacrificing detail.

If you are looking for an inexpensive pair of in-ears for daily use then these are worth auditioning.

**JM**

[[www.trinity-audio-engineering.myshopify.com](http://www.trinity-audio-engineering.myshopify.com)]

# SOUNDBITES



### QED REFERENCE USB A/MICRO B CABLE £69.95

No matter what people say, not all USB cables are built the same. Just as with Toslink optical connectors, some cheaper cables can seriously affect the signal flow – or in some cases fail to pass higher bit rates at all between components.

That's why I'm a firm fan of QED's Reference Optical Quartz Toslink solution - which uses 210 separate boro-silicate glass fibres

in its construction to ensure it can pass signals of up to 24bit/192kHz between components with low jitter.

For those looking to connect a computer or storage device to a high-quality DAC via USB, QED also manufacture the Reference USB A to Micro B lead priced at £69.95 for a 0.3 metre length (other lengths are available). Sturdily constructed,

it uses a twisted pair of oxygen free copper conductors bound in an aluminium wrap. There's also an internal floating ferrite jacket which QED says significantly reduces jitter and timing errors.

The USB connector plugs are gold-plated and sheathed in chunky rubber surrounds to provide long life, especially if the cable is being repeatedly pulled in and out.

Replacing the stock cable

between a MacBook Air and a Chord Mojo DAC/headphone amplifier, the QED certainly proves its worth.

High frequencies, especially, displayed noticeably more sparkle with cymbals, gaining an extra shimmer.

The Mojo doesn't lack transparency but via the Reference I could hear extra little details. Sinead O'Connor's intakes of breath on her 'Sean-Nós Nua' collection of Irish ballads became more noticeable, adding to the haunting atmosphere.

The cable didn't add anything but brought a clearer focus and improved sense of timing. The effect was most vivid on high-definition tracks and consistent across all genres of music.

If you are sceptical whether better digital cables can make a difference I'd recommend trying the QED to hear just what an improvement it can bring. **JM**

[[www.qed.co.uk](http://www.qed.co.uk)]

# A PERFECT NEW YEAR

VISIT OUR WEBSITE: [www.hi-fiworld.co.uk](http://www.hi-fiworld.co.uk)

**A SUBSCRIPTION TO HI-FI WORLD  
MAKES THE PERFECT GIFT FOR  
YOUR NEAREST AND DEAREST.**

**SAVE**

...up to

**26%**



Subscribe today and you will get a special discounted rate giving a **saving of 15% to 26%** off the cover price. That's an amazing **£3.83 - £3.33** per issue including postage.



***So don't delay, take out a subscription today!***

FOR BACK ISSUES ENQUIRIES PLEASE CALL

**01442 820580**

OVERSEAS SUBSCRIPTIONS IF YOU LIVE OUTSIDE THE UK,  
PLEASE CALL FOR OUR LATEST PRICES

**+44 (0) 1442 820580**

**SO WHAT ARE YOU WAITING FOR? CALL NOW!!!**

**SUBSCRIPTION HOTLINE 01442 820 580**

Lines open Mon-Fri 9.00-5.00 or (weekend answering service available)

FOR OUR  
ON-LINE MAGAZINE  
GO TO [WWW.HI-FIWORLD.CO.UK](http://WWW.HI-FIWORLD.CO.UK)

email:  
[hifiworld@webscribe.co.uk](mailto:hifiworld@webscribe.co.uk)





**Inspire Hi-Fi**

Our popular, comprehensive and award winning package refines the Linn Sondek LP12 sound. Creating more detail, separation, dynamics and soundstage.



Vivid LP12 Upgrade



Roksan Xerxes Upgrade



New Vivid DC Carbon



Rega Upgrade

**We also offer comprehensive, award winning Upgrade Packages for Rega, Thorens, Technics, Roksan Xerxes and more.**

Plus. A range of our own UK manufactured, award winning turntables. Direct to you at less cost.

Contact us for all your turntable and hi-fi requirements **01246 268887**

Unit 1 / Westwick Park / Broombank Road / Chesterfield S41 9QJ / E: robert@inspirehifi.co.uk

[www.inspirehifi.co.uk](http://www.inspirehifi.co.uk)  

# Singing The Blues



**Blue Aura pairs its v40 amplifier with a new set of classy loudspeakers in a limited edition package. Jon Myles listens with pleasure.**

**B**lue Aura's Blackline v40 integrated amplifier impressed us greatly last year (Hi-Fi World July 2016 issue). Here was a compact valve/transistor design offering a claimed 30 Watts per channel output and featuring an in-built DAC, aptX Bluetooth connectivity plus USB and analogue RCA inputs. As well as two gently glowing 12AU7/ECC82 tubes at the front it also featured a 6e2 magic-eye indicator valve to show volume level.

More importantly it also sounded exceptionally sweet with a dynamic, punchy presentation allied to a lush

midband. Just the sort of thing to introduce people to the joys of vacuum tubes.

No surprise, then, that it proved a huge success - with Blue Aura soon discovering that dealers were pairing it with loudspeakers costing £600 and above so good was its performance.

It's that fact that explains this new limited edition package from the Cambridgeshire-based company. They've taken the original v40, given it a cosmetic makeover, and paired it with a set of new speakers named ps40 LE engineered to bring the best out of the classy little amplifier.

Both amp and 'speakers are available separately priced at £549 and £499 respectively but are ideally meant to be sold as a package which costs a wallet-friendly £999.

The v40 LE is technically similar to the original but gains a high-gloss walnut fascia that matches the finish on the loudspeakers. You get the same valve complement, behind sitting two small transformers for the signal and power circuits.

Rotary controls handle volume and source selection, replicated on a credit card-sized remote control unit. Rear inputs consist of a single set of unbalanced RCAs, a micro-USB for

# plato

## THE CLASS A HOT BOX



Everything you  
need for home  
entertainment in  
one convenient  
place...

## THAT RUNS COOLER

### What does the PLATO system do?

- ✓ Automated vinyl recording
- ✓ Android & iOS control application
- ✓ High-Res audio & video output
- ✓ Large storage & backup system
- ✓ Simple & reliable streaming capability
- ✓ Powerful amplification

**FIND YOUR LOCAL DEALER AT:**

[www.convert-av.com](http://www.convert-av.com)

CONVERT



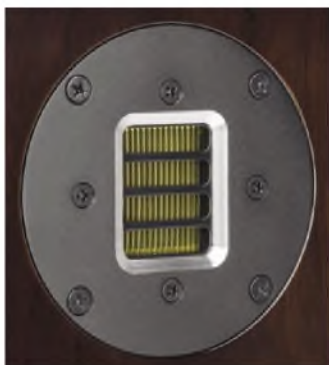

**The new ps40 LE loudspeaker uses a Heil-type Air Motion Transformer for its high-frequency driver which brings added air and atmosphere.**

connection to a computer, a 3.5mm mini-jack analogue input, and a socket for attaching the included Bluetooth antenna.

There's also a subwoofer output and the 'speaker connections accept both spades and banana plugs.

As for the loudspeakers, they are ostensibly a development of Blue Aura's existing ps40 standmount but are so heavily revised as to constitute a new model.

The cabinet is larger at 253mm x 145mm x 205mm (H/W/D) while the drive units are completely new – a 4.5" hemp-integrated mid/bass driver allied to a Heil-type Air Motion Transformer for the high frequencies.

A single pair of 'speaker binding posts sit on the rear, below a small reflex port for added bass response.

Fit and finish is exemplary for the price, the gloss walnut finish and gold logo plate beneath the main driver giving them a decidedly upmarket look. Paired with the v40 LE amplifier you'd be given for thinking this package was selling for at least 50 per cent more than its asking price on looks alone.

## SOUND QUALITY

I already knew the qualities of the Blue Aura amplifier from previous experience but combining it with the ps40 LE 'speakers served to accentuate those abilities.

Their Air Motion Transformer tweeter is clear and insightful with plenty of high-frequency information. The cymbal work on John Coltrane's 'Interstellar Space' possessed finesse and detail without any trace of harshness. The improvised saxophone lines also floated free of the cabinets with a good sense of scale and height.

Down below the mid/bass driver

has a firm, punchy low-end for its size and a speedy presentation that matches well with the extended highs of the tweeter.

Obviously they don't produce earth-shaking bass but there's never a feeling you are missing out on any essential musical information. Indeed, the thundering tympani parts on 'Widow's Peak' by Bat For Lashes came across with surprising force – encouraging me to push the volume up a few notches.

That done the sound swelled to easily fill Hi-Fi World's large listening room. The v40 LE may not be the most powerful of amplifiers but it is essentially refined and has enough grip to push the ps40s sufficiently loud without the sound collapsing in on itself.

Replacing the standmounts with a pair of similarly-priced Yamaha NS-F330 floorstanders (see review forthcoming issue) showed just how well matched the Blue Aura combination is. The Yamahas did bring some extra bass depth but lacked the refined, detailed mids and treble of the ps40 LEs.

Streaming Bluetooth via an iPhone 7 Plus proved easy with pairing taking place in seconds. The internal DAC is limited to 16bit/48kHz which isn't a problem via this mode of replay and the sound was again full and vibrant

with a healthy amount of detail and good rhythmic drive. Undoubtedly, it's a handy feature to have.

Taken individually the v40 LE and ps40 LEs are impressive performers at their price with a good range of features. Put together, though, they are undoubtedly more than the sum of their parts, possessing a natural synergy that elevates their abilities to something rather special.



**A 6e2 magic eye indicator valve sits at the front of the v40 LE amplifier to give a visual indication of volume level. A real eye-catching feature.**

## CONCLUSION

This is one impressive little system for just £999. The valve section of the v40 LE amplifier doesn't just look good but also brings a lovely, rich, organic flavour to the sound while the ps40 LE loudspeakers are as musically coherent as any you'll find at this price. It's a package that comes highly recommended.

### BLUE AURA V40 LE/PS40

For a chance to win this limited edition Blue Aura package see our Bristol Show preview on page 48.

## MEASURED PERFORMANCE

The Blue Aura ps40 LE loudspeakers have a very smooth response characteristic, especially from the ribbon tweeter.

Our third-octave pink noise analysis was taken 30 degrees off axis; on-axis treble rose by a greater degree. This characteristic, taken in conjunction with an over-damped bass response where bass falls away below 200Hz, means the speakers have been designed for wall standing, not toed-in toward listeners but firing straight down the room. The small port adds to bass around 50Hz, our red trace shows.

Sensitivity was surprisingly high too, at 87.5dB from one nominal Watt (2.8V) of input, even with a 6 Ohm dcr bass unit. The only small issue is an internal box modal resonance making itself known through the port and through forward output around 1kHz, that may well be heard as a small amount of box colour. The ps40 LE 'speakers will sound very smooth and highly detailed all the same.

The Blue Aura V40 amplifier produced 10 Watts into 8 Ohms and 15 Watts into 4 Ohms, from what is a solid-state amplifier fronted by preamp valves. Distortion levels were well under control, measuring 0.1% in the midband and around 0.2% at high frequencies.

The amplifier remains a fascinating and innovative design, whilst the ps40 LE loudspeakers are superbly engineered little wall standers with a folded ribbon tweeter of outstanding performance. They will shade many larger and more expensive alternatives., measurement shows. **NK**

### FREQUENCY RESPONSE

**Green - driver output**  
**Red - port output**



### BLUE AURA v40 /ps40 LE £999



**OUTSTANDING - amongst the best.**

**VALUE - keenly priced.**

### VERDICT

A talented valve/transistor hybrid amplifier with a pair of sonically assured loudspeakers at a bargain price. Luxurious looks with a sound to match.

### FOR

- rich, warm sound
- valve input stage
- Bluetooth
- refined 'speakers with good bass and extended treble
- quality looks
- price

### AGAINST

- nothing at the price

Blue Aura  
+44 (0)1480 477738  
www.blueaura.co.uk

Connect your home to a deeper music experience

mu-so



Channelling forty years of audio engineering, we present Mu-so. A range of compact, yet commanding wireless music systems, that will unleash you music wherever it's stored, in breathtaking quality. Advanced connectivity includes AirPlay, Bluetooth®, Spotify Connect®, TIDAL, iRadio and multiroom streaming.

naimaudio.com



Go Deeper

Experience at John Lewis, selected Apple stores and our network of specialist audio retailers.



AirPlay is a trademark of Apple Inc.

# S for Super

Cowon's new Plenue S Digital Audio Player aims to take on the likes of Astell&Kern in the high-end sector of the market. Noel Keywood puts it through its paces.

**T**he Digital Audio Player (DAP) market has uniquely become a technological battleground fought on the quality of chips used and performance specs. I'll say right here that Cowon do a good job with all this in the Plenue S; measurement showed its fundamental performance is pretty damn impressive.

This is a mid-sized player,

weighing in at 204gms on our scales – heavy for a shirt pocket but no strain for a trouser pocket, and an easy fit too, measuring 65mm wide, 119mm high and 18mm deep. The case is machined alloy and very sturdy, as you might hope at the price. It uses an ARM Cortex A9 microprocessor running Linux – no Android Jellybean here. In conjunction with a large, high resolution (480x800) AMOLED

touch screen

the Plenue S is fast and responsive; start time was just 10 seconds where around 30 seconds is common.

On board it has 128GB of memory and a single microSD card slot will accept 200GB of memory. It plays most digital formats, including WAV, FLAC, AIFF and ALAC, as well as quad DSD native (i.e. not converted to PCM) and even DXD to 384kHz by downsampling.

There's one 3.5mm stereo headphone jack with integral optical digital output, like Astell&Kern players, allowing the Plenue S to be connected to an external DAC so it can be used as a digital source for a hi-fi system, which is the way I use my Astell&Kern AK120 most of the time. All you need to do this is a digital (S/PDIF) optical cable, with an adaptor that goes into the 3.5mm headphone jack of the player. Maplin and hi-fi dealers stock both. Note, however, that many hi-fi DACs fall silent when fed 192kHz PCM through an optical cable due to data rate limited optical receivers.

The Plenue S can itself be used as an external DAC, via its microUSB connector, allowing it to provide high-quality headphone listening from a computer; it worked fine on my Mac.

And finally we come to the player's balanced analogue audio output, something that is problematic in portables. Cowon use a four-pole 3.5mm socket on the Plenue S and although it is not marked with a headphone symbol it passes through the volume control, so can be used for balanced headphones, even though Cowon don't state this. Balanced connection offers a slightly crisper, purer sound, although not to any great degree I find, but getting twin screened cable into a tiny 3.5mm four pole plug is almost impossible, so custom made cable is essential.

Pins on the base of the player allow it to be stood on an external





## Purist natural sound

See us in room 213 at the 30<sup>th</sup> Sound & Vision Show in Bristol - Feb 24<sup>th</sup> to 26<sup>th</sup> 2017

  
malvern audio research

ARTISAN HI-FIDELITY EQUIPMENT



+44 (0)7831 197019 / +44 (0)7875 527116 [malvernaudioresearch.co.uk](http://malvernaudioresearch.co.uk)

MingDa / Dynasty / Audio Detail / Pre Audio / Albedo / hORNS / Gigawatt / Lampizator / Soundbox

cradle for both charging and balanced audio line output to XLR sockets that can feed a hi-fi. It is better to connect digitally, though, to avoid battery driven analogue stages in the player that flatten dynamics.

The Plenu S user interface is relatively simple and easy to use as high end players go. It has a good range of facilities, including Fast and Slow filter settings, a wide range of equalisations and BBE sound enhancement. The sound level meters were a tad weird in behaviour: they have been

more prominence, so I could easily hear into Freddie Mercury at the microphone with this track. Intelligibility went up then, whilst low-end punch and definition fell back a tad. This is usually the case with battery-powered players but that the Plenu S doesn't break the mould at its asking price is a disappointment.

Using my Philips Fidelio X1 headphones and Oppo PM1s with an Audiolab M-DAC optically connected to the Plenu S showed it lacked the front-to-back stage depth of the Audiolab, and its sustenance of dynamic contrasts – but then most DAPs do when

run against a top flight mains powered DAC. Large classical works like the Berliner Philharmoniker playing 'Don Quixote, Horn Concerto No 2, Richard Strauss' (24/96) fared very well, the orchestra sitting on an expansive soundstage where string sections were well delineated and sounded smooth, horns blared centre stage and slow strikes against a kettle drum were easy to pick out.



The gentle top end of this player did not especially suit my slightly warm Oppo PM1 planar magnetic headphones, and I missed not being able to crank volume up and down freely with a rotary volume control of the kind found on many players; fumbling for the 'up' sector of the small volume rocker wasn't especially easy.

**The top face has headphone (3-pole) and balanced (4-pole) line 3.5mm outputs. The headphone incorporates an optical digital (S/PDIF) output.**

**Note the small volume control up/down rocker.**



**The bottom face has a microUSB socket and contacts for a cradle (extra).**

made to artificially flicker at a high rate, even with a steady signal – odd. And their scales are a-about-t, with peak marked as 10 (it should be 0) and 0 being around -60dB, measurement showed.

With music files loaded from a Mac, desktop files (preceded by an underscore) were hidden so this player is Mac friendly where many are not – populating the music file list with unplayable Mac desktops.

**SOUND QUALITY**

After a few tracks with programmed synths, characterised by 'perfect' timing, such as Queen's 'Radio Ga Ga' (24/96) it became clear that this player is a low jitter design with clean and concise treble and a rigidly correct sense of pace, a property that isn't foremost subjectively but does help towards a crisp sense of time progression.

This apart the Plenu S was smooth and mellow in its midband tone, quite lush with Diana Krall singing 'Narrow Daylight' (24/96), the prominent bass line well reproduced in power and pace. Notes were fleshed out and reasonably free of the bloom that commonly affects battery driven devices.

However, with the aforementioned 'Radio Ga Ga', after a pre-run through the Audiolab M-DAC the low frequency end lacked convincing contrasts, sounding bogged down, giving the midrange

**CONCLUSION**

The Plenu S has a wide range of useful facilities and there were no technological hurdles to cross in using it; even plugs and leads for the 4-pole, 3.5mm balanced headphone socket are available.

It has a superb screen and a very fast turn on time. The only issue is high price: it might measure very well but there was nothing sufficiently outstanding in either sound quality or facilities to warrant such a price, irrespective of the technology within the player.

**MEASURED PERFORMANCE**

Cowon have successfully teased massive dynamic range out of the Burr Brown PCM1792A DAC, no less than 120dB measurement our Rohde&Schwarz UPL analyser showed. As current quality players typically

come in around 115dB, the Plenu S is well ahead in this important parameter. It is less than the 129dB quoted by Burr Brown but this is attributable to the low voltage, battery-powered circuitry of a DAP.

**FREQUENCY RESPONSE**

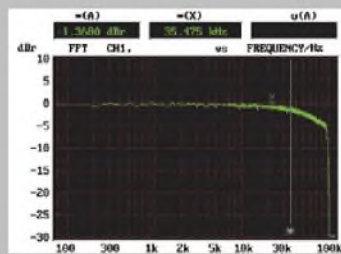

Distortion was low at full output of 0dB, measuring 0.003% (hphone) and 0.0008% (Bal). At -60dB the Plenu S was again ahead of most else, coming in at 0.02% with 24bit PCM, at -60dB. This is as good as the best mains powered hi-fi DACs – impressive. It means both the DAC chip and following buffer and headphone drive amps are all quality, low distortion and noise parts.

Maximum output was a high 3V maximum via Headphone or Balanced headphone, more than enough to drive any headphone, even insensitive magnetic planars (Oppo etc). So the Plenu S measured well in all areas, with more dynamic range than other players.

**DISTORTION**

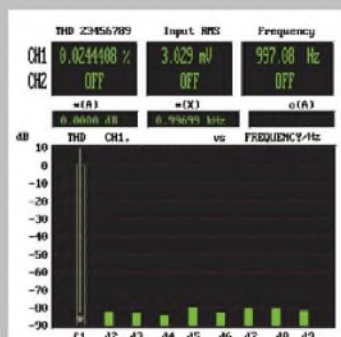

Frequency response	10Hz-35Hz
Separation	94dB
Noise	-118dB
Distortion	0.02%
Dynamic range (24bit)	120dB

**COWON PLENU S (PS) £1,299.00**



**EXCELLENT - extremely capable.**

**VERDICT**

A fine player all round, but very expensive.

**FOR**

- large screen
- superb build
- balanced output

**AGAINST**

- high price
- small volume control
- not outstanding

Advanced MP3 Players  
+44 (0) 343 289 6880  
www.advancedmp3players.co.uk

# Bowers & Wilkins

## Designed for listening

The new CM Series loudspeakers are undoubtedly beautiful, capable of gracing any room with their clean lines and high-quality finishes. But as with all Bowers & Wilkins loudspeakers form must follow function, and thanks to our Decoupled Double Domes and tweeter-on-top technology you won't believe how beautiful your music can sound.

[bowers-wilkins.com](http://bowers-wilkins.com)



Decoupled Double Dome tweeter



# HI-FI WORLD

NOW AVAILABLE  
ON THE APP STORE



App Store > Entertainment > audio web publishing ltd

**Hi-Fi World** 

audio web publishing ltd >

Details Ratings and Reviews Related

Screenshots iPhone iPad



Offers In-App Purchases

This app is designed for both iPhone and iPad

Rating: 4+

**TOP IN-APP PURCHASES**

1. Hi-Fi World Dec 2015	£3.99
2. Hi-Fi World Subscription	£8.99
3. Hi-Fi World August 2015	£3.99
4. Hi-Fi World September 2015	£3.99
5. Hi-Fi World June 2015	£3.99
6. Hi-Fi World May 2015	£3.99
7. Hi-Fi World December 2015	£3.99
8. Hi-Fi World February 2015	£3.99
9. Hi-Fi World November 2015	£3.99
10. Hi-Fi World December 2014	£3.99

**LINKS**

Privacy Policy

© 2014 Hi-Fi World

**Description**

Hi-Fi World brings you the best in hi-fi...from around the world!

- We listen and measure products in depth, at our London offices.
- Expert opinion from a team of renowned writers, musicians and engineers.
- International standard measurements using Rohde & Schwarz test equipment...

**Information**

Developer	audio web publishing ltd
Category	Entertainment
Updated	7 Dec. 2014
Version	1.0
Size	9 MB
Rating	Rated 4+
Family Sharing	Yes
Compatibility	Requires iOS 5.0 or later. Compatible with iPhone, iPad, and iPod touch.
Languages	English

**DOWNLOAD OUR APP ON APPLE AND ANDROID  
DOWNLOAD FROM iTUNES OR GOOGLE PLAY  
iPad, iPhone, iPod, Tablets OUT NOW!**

# See us at BRISTOL!

... the Bristol Sound & Vision Show 2017  
Stand 4A in the Bristol Suite, ground floor.

**T**he UK's biggest and most popular hi-fi show is almost upon us once again. Bristol Sound & Vision takes place between Friday 24th and Sunday 26th February 2017. More than 182 brands will be exhibiting their products at the Marriott City Centre Hotel in Castle Street, from 10am to 5pm each day.

As always Hi-Fi World will be there on Stand 4A in the Bristol Suite so don't forget to pop along to meet the team. Come and see us with your questions, stories and systems – or just for a friendly chat.

This is always a popular and busy show, packed with UK manufacturers – so don't miss it. See you there!

For Show details including ticket prices, click on [www.bristolshow.co.uk](http://www.bristolshow.co.uk). It is held at the Marriott City Centre Hotel, 2 Lower Castle Street, Old Market, Bristol, England BS1 3AD.



## BRISTOL SOUND & VISION SHOW

24TH - 26TH February 2017  
10.00am - 5.00pm everyday

Friday 24th - Sunday 26th February 2017

### Where?

Marriott City Centre Hotel,  
Lower Castle Street,  
Bristol, BS1 3AD

### How much?

Adults		
One Day	(on the Door) £12.50	Online £11 +£1.50 booking fee
Two Days	-	£20 +£1.25 booking fee
Three Days	-	£30.00 +2.00 booking fee
Students/Senior Citizens (over 65)		
One Day	(on the Door) £11	Online £9.50 +£0.95 booking fee
Two Days	-	£17+£1.25 booking fee
Three Days	-	£25.50 +2.00 booking fee

Accompanied Children under 16 FREE



# THIS YEAR ...

**SUBSCRIBE & RECEIVE A  
WS10i WIRELESS STEREO  
LOUDSPEAKER WORTH  
£466.65 OR WS30i  
ACTIVE MONITOR  
LOUDSPEAKERS  
WORTH £199!**



BLUE AURA WS30i

BLUE AURA WS10i

Blue Aura v40/ps40 Limited Edition



## Also...

**A CHANCE TO WIN BLUE  
AURA'S v40 LIMITED EDITION  
SYSTEM WORTH £999!**

Take out a 12-month subscription to Hi-Fi World at the Bristol Show and receive a Blue Aura WS10i wireless stereo loudspeaker or a Blue Aura WS30i active monitor 'speaker.

Also, all subscribers will be entered into a prize draw to win Blue Aura's superb valve-based v40 LE amplifier and loudspeaker limited edition package.

**TERMS & CONDITIONS:** You will receive 12 issues per year. Minimum subscription term is 12 months. Prices include P&P. Offer available to first time subscribers at the Bristol Show 2017 between 24th and 26th of February 2017. One product only per subscription. Your subscription will start with the April 2017 issue.

## Plus...

### Hi-Fi queries?

If there's something you want answered or just fancy a chat then come along and meet the Hi-Fi World team in Room 332 on Sunday February 26th, between 11am and 2pm.

We'll be on hand to meet our readers and answer any questions you might have.





**reloop**®

# TURN3

PREMIUM ANALOGUE HI-FI-TURNTABLE WITH DIGITAL USB-AUDIO INTERFACE

- Pre-installed Ortofon 2M Red cartridge
- Headshell connection provides added flexibility
- High-quality built-in Phono Stage
- USB output for recording your vinyl
- Low-vibration DC motor
- Integrated motor control with large speed selector (33, 45 and 78 RPM)
- Aluminium platter with rubber damping
- Adjustable anti-skating



Distributed by Henley Designs Ltd.

T: +44 (0)1235 511 166 | E: sales@henleydesigns.co.uk | W: www.henleydesigns.co.uk

# Radio evolution

**Martin Pipe discovers 1930s radio construction, some hi-fi familiarities and luxury sets that cost more than houses in his latest look at the evolution of radio.**

Last month, we saw how radio – popularly known as ‘the wireless’ – became such an important part of 1930s life, thanks to the enormous variety of entertainment and information that was yours (certainly in the UK) for the price of a radio licence and some electricity. We also outlined the sorts of receiving set that were available to the typical family, and the beginnings of interest in high-quality music reproduction. From the mid-1930s, the radio that took pride of place on a British sideboard or stand was more often or not a 4-valve (5, if you count the rectifier) ‘superhet’ design capable of tuning into the long and medium-wave AM bands.

If he didn’t want to buy a ready-built Bush, Ekco, Marconiphone or Murphy, the more adventurous or technically-minded radio enthusiast could build his own set from a kit – or plans published, over several months in magazines like *Wireless World* and *Practical Wireless*. This could work out cheaper as the labour cost was now measured in your own spare time. The ‘lists of parts’ were published the previous month, giving

the reader time to acquire them from the local radio shop or a mail-order supplier. When the issue arrived, the relevant article would include details of how to wind the coils, a circuit diagram and a chassis layout marked with measurements so that the metalwork could be folded, stamped and drilled.

Most radios were designed purely with broadcasts in mind but your vistas of entertainment could subsequently be widened through the addition of an off-board 78rpm turntable which plugged into the radio’s rear-mounted ‘P(ick)U(p)’ socket.

Those with a bit more disposable income could however obtain their costly radiogram complete ‘in one go’. Here, the radio chassis and turntable were built by the manufacturer into a large wooden enclosure. The greater cabinet volume could accommodate a larger speaker drive unit helping to ensure an improved bass response.

As far back as the 1930s, there was interest in improving sound quality. Looking through back-issues of *Wireless World* I found articles and on turntable developments, ‘stereophonic’ sound, improving the fidelity of radio reception, optical soundtracks, pick-up resonance, piezoelectric tweeters, amplifier design and tone controls.

In 1932 you could buy an electrostatic speaker – the ‘Primustatic’ – that reached the giddy heights of 15kHz. Not that any contemporary source material could match it! Two years later Paul Voigt launched his Domestic Corner Horn speaker. Even today, its

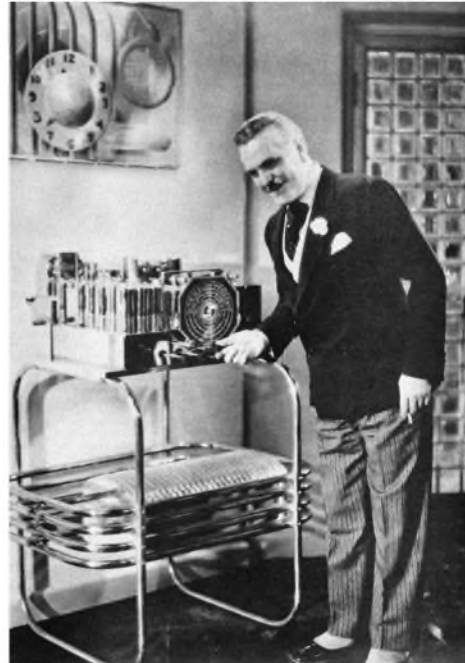

*The 1937-model 30-tube E. H. Scott Philharmonic was visually-striking thanks to its glowing valves and chrome-plated metalwork.*

reproduction can astound.

By the late 1930s, mid-range domestic radios were offering such luxuries as short-wave reception, push-button (i.e. preset) tuning, variable selectivity, advanced forms of ‘automatic volume control’, ‘magic eye’ tuning indicators and push-pull amplification.

Some firms catered exclusively for those to whom money was no object. Keates-Hacker built radiograms to the highest standard, with beautifully-finished cabinets and record changers that could accommodate as many as 20 discs of mixed size.

At the very top of the pile, though, was the American firm E. H. Scott which from its Chicago factory produced some of the most advanced and best-performing receivers of the era. At a time when most radios would have four or five valves, E. H. Scott models would employ more than 20! The 1935 ‘Hi-Fidelity All-Wave Superhet’ chassis was equipped



*E. H. Scott’s 1941-model Philharmonic, the controls of which are seen here, is an early FM-capable set. Note that the band covered is the old 42-50MHz band. Not long after WWII, US FM broadcasting was shifted to Band II (88-108MHz) where it remains today.*

**THE EXCLUSIVE TECHNOLOGY OF OUR VERY BEST HIGH END CABLES  
CAN NOW BE ENJOYED BY A MUCH LARGER AUDIENCE**

**You Need Timing...Very, Very, Very Good Timing**

**Black Rhodium FOXTROT Loudspeaker Cable**

*"Vocals have plenty of detail and all the nuances of expression are very evident. Imaging and timing are both excellent."*

Hi-Fi Choice

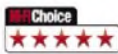

**Read the Hi-Fi Choice review**

Visit [www.blackrhodium.co.uk](http://www.blackrhodium.co.uk) and download the review from the link on the homepage



**EXCLUSIVE FEATURES**

- |                      |   |                            |   |
|----------------------|---|----------------------------|---|
| Stunning Clarity     | ✓ | Extensive Dynamics         | ✓ |
| Sharp Definition     | ✓ | Natural Decays             | ✓ |
| Spacious Ambience    | ✓ | Effortlessly Open          | ✓ |
| Musically Expressive | ✓ | Excellent Timing           | ✓ |
| Wide Imaging         | ✓ | Powerful Deep Bass         | ✓ |
| Very Affordable      | ✓ | <b>Now read the review</b> |   |

Buy Foxtrot at any Black Rhodium dealer or Online [www.blackrhodium.co.uk](http://www.blackrhodium.co.uk)

**Hear Foxtrot at these dealers**

Zouch Audio 01530 414 128 | MCRU 01484 540 561 | Analogue Seduction 01733 350 878  
Doug Brady Hi-Fi 01925 828 009 | HomeSound 01316 621 327 | Audiophillia 01312 219 753  
DoGood Audio 01515 253 845 | Audio T, Swansea 01792 474 608 | Peak HiFi 01225 761 832

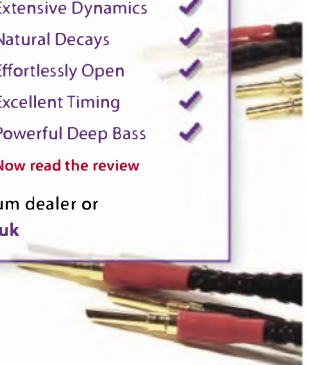





Order by phone on +44 (0)191 259 0700 or Online with Paypal or C/Card



**SOUND DAMPED STEEL**

**Sounddeck PM Platter Mat £90**  
Available in 295mm, 292mm or 285mm sizes to fit most turntables the Sounddeck PM converts vibrational energy into heat and so minimises interference from feedback and rumble - allowing your cartridge to track information in an LP's grooves with greater accuracy bringing enhanced detail across the frequency range.





**Sounddeck DPS Damping Puck £90**  
The 500g SDS damping puck is immaculately machined from two pieces of stainless steel, it's bonded together with a thin layer of sound-absorbing polymer forming a constrained layer. It sits firmly over the top of a turntable's spindle - holding the vinyl securely to the platter to extract a larger soundstage, firmer bass and extra detail. There's also an aluminium version which weighs 152g.

[www.sounddeck.co.uk](http://www.sounddeck.co.uk)



Highly recommended!





**PRISTINE VINYL**  
Serious about Vinyl





**VIVAC RCS**

*"The Vivac Record Cleaning System is one of the best upgrades a vinyl-lover can make."*

**Clean the record, release the sound**

Contact us today or visit our website to find out why.  
[www.pristinevinyl.com](http://www.pristinevinyl.com) t: +44 (0) 1837 871288

**ARMSTRONG**  
**WE ARE VERY HAPPY**  
 because we can still supply our chassis at former prices, in fact in our "Wireless World" friends, however, we must point out that in the near future a slight increase will be inevitable owing to the rise in cost of essential materials. BUT—our accordance with our "Trade-In Policy" only the bare increased expenditure we incur will be added.

We apologise for the delay in delivery of some models, particularly AW125 PP, but we feel sure you will appreciate the most difficult the war has created. Everything possible is being done to give you the prompt service it has always been our pleasure to provide.

When sending your order it will help us greatly if you would allow as much time as possible for delivery.

Send for our Illustrated Art Catalogue which fully describes our full range, including the following:

**MODEL 5510 — 16-V SUPERHET-STRAIGHT ALL-WAVE HIGH-FIDELITY R-G CHASSIS**  
 Incorporating Two Independent Circuits, Superheterodyne and Straight, having R.F. Pre-amplifier and R.C. Coupled Push-Pull Triode Output capable of handling 8 watts.

The chassis of the 5510 is unique. When used as a STRAIGHT receiver two 10" ranges are in operation with A.V.C. Coupled Converter to meet for distortionless detection together with Triode Push-Pull output. A form of auto-tune lock is superior to switch from "Super-het" to "Straight." The Gramophone Amplifier has been specially studied and revised; can be in 12 cps. reproduced with excellent quality.

**MODEL AW38—8-V ALL-WAVE SUPERHET**  
 This radiogram chassis has R.C. Coupled Push-Pull Output capable of handling 8 watts.

The long war Quality Year we have carefully studied the design of our more economically priced models and it's now possible for these requiring 8 cps. quality with economy in set-up their design.

**Matched Push-Pull Speaker for above 1 gm.**

**MODEL AW125PP—12-V 5-BAND ALL-WAVE R-G CHASSIS (12-550 continuous, 1000-2000 m)**  
 with R.F. Pre-Amplifier, 2 I.F. stages with Variable Selectivity, Manual R.F. gain control and 10 watts R.C. coupled Triode P.P. Output.

Readers need no introduction to this most popular model, as frequently reviewed by the Wireless World on Jan. 24th last. **17 cps.**

**7 DAYS' APPROVAL—12 MONTHS' GUARANTEE**  
**ARMSTRONG MANUFACTURING CO.**  
 WARRIERS ROAD, HOLLISWAY, LONDON, N.7  
 (LONDON Office: 25, Abchurch Lane, E.C. 4)

The 10-valve Armstrong SS10 radio chassis was intended for building into your choice of cabinet. Unusually, it could be operated in TRF (tuned radio frequency) or super-set modes.

with 23. It covered key portions of the long, medium and short-wave bands in four ranges spanning 155kHz to 22.6MHz, offered four stages of IF amplification, included a beat-frequency oscillator for recovery of morse-code transmissions and drove separate tweeters and woofers with a 35 Watt output stage.

In 1935 Britain, this chassis sold for £145. To put things into perspective, a teacher then earned £480 annually.

Competing with E. H. Scott on its American home turf were radio giants Zenith and Crosley. Zenith's set, the 25-tube 1000Z 'Stratosphere' console, sold for \$750 in 1935. Its speaker system, which comprised a 12in. woofer and two tweeters, had 50 Watts of amplification at its disposal. Despite the expense, 350 were reputedly sold. In contrast, only a few of the \$1,500 1936-vintage Crosley 'WLW Super-Power' sets, the conception of which was inspired by the Zenith, were built. Named after the high-powered Ohio AM radio station that the Crosley empire also happened to own, this 475lb. monster covered all frequencies from 540kHz to 18MHz.

An interesting mid-1930s American radio development that could have exercised the audio capabilities of the 'super-set' elite was 'Apex'. Its wider-bandwidth AM transmissions were carried on the 25-42MHz VHF band – this was

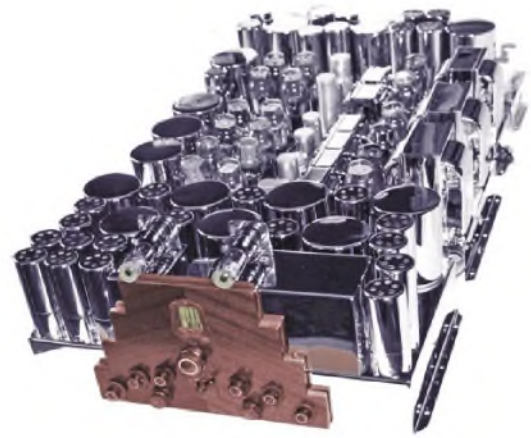

One of the very best E. H. Scott models was the Quaranta, which was built to order in the mid-1930s. It started out in Scott's laboratories as a 23-tube 'all-wave' design but with extra refinements – the number of valves could reach 57!

cutting-edge technology in 1934! – and listeners required a receiver or converter capable of tuning into these 'high-fidelity' stations. Surprisingly, they weren't rare; by 1939, Apex transmissions were available in 22 states. The 'Apex' name came from the VHF transmission aerials, which were erected as high as possible. The UK didn't have Apex, but the audio channel of its 405-line VHF TV system (launched in 1936) was of similar performance potential. It occasionally carried 'sound-only' concerts to the relatively-small numbers of people who owned TVs, or radios with a 'TV sound' band.

But in the US, the days of Apex were numbered – thanks to another recent advance in technology. Immediate pre-war sets, like E. H. Scott's 28-valve 'Phantom Deluxe', offered something very new – reception of FM radio, which was invented by Edwin Armstrong. FM is far more resistant to electrical interference and 'atmospherics' than AM and because channels had a wider bandwidth the frequency response could be significantly extended.

Sales were far from stratospheric, and their FM capabilities were to become obsolete after the war; the 44-50MHz band was reallocated to TV services. In 1945 FM broadcasting moved to VHF Band II, which spanned 88 to 108MHz. The rest of the world, with the exception of the Soviet Union and Japan, also plumped for Band II FM; the BBC began its FM broadcasts in 1955. By this time, the quest for high-fidelity was well under way and becoming an industry in its own right. The days of "wire-edge top register and banjo-like piano" – as one pre-war listener put it – were coming to an end...

**THE "PRIMUSTATIC" LOUD SPEAKER.**

READERS of this journal are already familiar with the principle underlying the operation of the electrostatic loud speaker, but hitherto few opportunities have occurred in this country of obtaining practical experience with reproducers of this type. The fact that the British-made "Primustatic" loud speaker, shown at Olympia last autumn, is now in production, is, therefore, an event of first importance for recognition of the advantages of the electrostatic loud speaker is, in our opinion, long overdue. It is in the reproduction of the higher frequencies that the electrostatic loud speaker shows its superiority over other types. The extremely low inertia of the

very high frequencies, such as the jingling of keys, ringing of bells, etc., are most realistically reproduced, and we have seldom heard the characteristic qualities of string instruments so well rendered. Measurements showed that there was a ready response to frequencies up to at least 15,000 cycles (the highest frequency available from the oscillator used). At the other end of the scale the output was well maintained down to 250 cycles, but fell off rapidly below 150 cycles. The bass response can be improved by experimenting with the matching between the loud speaker and output valve impedances, but the amplitudes which would be required in the bass to balance the excellent accurate output in the upper register could not be obtained without rattling and possible damage to the diaphragm. Nevertheless, the response goes down low enough to give perfectly natural speech, and many people prefer the light and delicate quality which it confers to music. The construction of the "Primustatic" loud speaker is a view to obtaining the benefit of the bass response of a moving coil in conjunction with the exceptionally good performance of the "Primustatic" loud speaker in the reproduction of transients and high harmonics.

It is, however, advisable to work with values in the region of 500 volts, as with lower values there is a tendency to introduce second harmonic distortion at the lower frequencies.

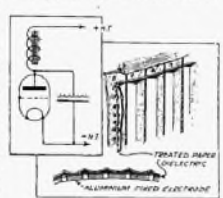

Constructional details and method of connecting the "Primustatic" loud speaker.

frequency, and this must be borne in mind when matching with the output valve. A special Ferraz (tapped output) choke is available for this purpose, and very full information regarding the output resistance and the method of applying the polarising voltage from the H.T. supply to the receiver is contained in the instruction booklet.

The dimensions of the standard model are 2 1/2 in. x 1 1/2 in. x 5 1/2 in., and the convex front was found to give far less distortion of the high frequencies than is usually the case with cone diaphragms. As a result it is sometimes difficult to tell from which direction the sound is emanating—a distinctive effect which is well suited to many types of transmission.

The maker is The Primus Manufacturing Co., Prims House, Willow Street, London, E.C.2.



Front and back views of the "Primustatic" "Standard" model loud speaker.

The design and arrangement of the perforated front plate and the fluted foil electrode have resulted in a degree of sensitivity somewhere between that of the moving coil and moving iron types of loud speaker. This has been obtained with polarising voltages of the order of 150 to 300 volts, which is considerably less than is required for previous electrostatic types.

We think of electrostatic speakers as something new but this 'Primustatic' panel – as featured in the magazine Wireless World – was sold in 1932. However, electrostatic speakers go back even further - a 1930 report on the Berlin radio show makes reference to a German Vogt design.



 **UNISON**  
RESEARCH

## *Unico Series*

*The Unico range of hybrid electronics from Unison Research combine the warmth of valves with the power and the accuracy of solid-state systems. All Unico products are recognised by their thick sand-blasted aluminium fascias and solid, reliable build quality.*

*Unison Research are recognised around the world as a leading manufacturer of high-end audio systems, and the quality shines through in the Unico range. First-class components, solid build and phenomenal sound; all designed and assembled in Italy.*

*[www.unisonresearch.co.uk](http://www.unisonresearch.co.uk)*

# American Beauty



**Iconic US company Audio Research has unveiled a new entry-level DAC with a valve-based analogue stage. Jon Myles loves how it sounds.**

**T**here's no mistaking the look of American high-end manufacturer Audio Research's range of components. Like its sister US company McIntosh (they're both owned by the Italian Fine Sounds Group), Audio Research products have a distinctive design that sets them apart from rivals.

First they boast a workmanlike, purposeful look with a minimum of fripperies in a style that hasn't changed much over almost 50 years of continuous production. Then, they have a bomb-proof build quality which makes you realise why some of the company's original products are still giving sterling service to this day.

And – most strikingly – they're pretty big. This includes the new DAC9 digital-to-analogue converter I am reviewing here. Give it a cursory glance and you'd be forgiven for thinking it was a muscular power amplifier, with its hefty 137mm x 480mm x 348mm (H/W/D) casework, a pair of studio-like grab handles either side and a perforated top plate for ventilation.

In the days of some DACs measuring not much more than a paperback book the size could be seen as overkill – but there are good reasons for it.

For a start, you know immediately it's an Audio Research with all the kudos that entails.

Secondly, it's part of a new entry-level Foundation series products that all share similar dimensions for aesthetic purposes. Along with the DAC9 there's an LS28 pre-amplifier and PH9 phono stage – with a VT80 power amp on its way.

Finally, the analogue output circuit of the DAC employs a pair of valves (or tubes should I say!) – 6H30 triodes which, while not running overly hot, do need room to breathe.

The digital section of the Audio Research uses a quad DAC architecture based on the Burr-Brown PCM1792A chip for both PCM and DSD data. Additionally, all PCM data in the DAC9 utilises an external digital processor with 32-bit precision which is said to provide a much more natural sound.

All DSD data is maintained in its

original form and direct-converted and analogue-filtered within the Burr-Brown PCM1792A DAC, as opposed to the more the common practice of converting DSD to PCM.

There's the standard array of inputs, USB accepting up to 384kHz files as well as DSD, whilst a continuous S/PDIF digital stream can enter through RCA phono sockets, a BNC connector, an AES/EBU balanced XLR socket (192kHz), or Toslink optical (96kHz).

Outputs are on both RCA phono sockets and balanced XLRs.

Selectable digital filters allow the user to choose between slow and fast roll-off, and a 384kHz upsampling option available on all inputs.

The latter functions, as well as on/off, input and mute, can be selected through a row of six push buttons on the fascia that sit below a large, fluorescent display screen. Alternatively a metal-bodied remote gives access to all the controls.

Price? Exactly £7,498 – not an insignificant amount, but when you consider the exemplary build quality – including hand-soldered

**Audio Research DAC9 uses a pair of 6H30 triode valves in its analogue output stage.**





**WHAT HI-FI?**  
SOUND AND VISION



**WHAT HI-FI?**  
AWARDS 2014

**Turntables**

Best turntable £800+  
Clearaudio Concept



**HI-FI WORLD**  
VERDICT 





circuit boards and specially selected parts – plus promised longevity (Audio Research claims it can repair, refurbish or restore almost any product it has ever made), it starts to make sense. The Foundation series may be entry-level but the DAC9 gives little away to some of its more expensive brethren in terms of construction. As for its sonic attributes...

**SOUND QUALITY**

Slotting the DAC9 between a McIntosh MC152 power amplifier and the excellent Bluesound Vault 2 high-resolution music server, it took just a few tracks to realise the DAC9 is an especially refined performer. There's nothing cold or clinical in its performance, rather an unforced, organic presentation with just a hint of warmth to it.

That warmth, though, doesn't come at the expense of instrumental definition. Take BB King and Eric Clapton's steamy 'Three O'Clock Blues' workout (88.2kHz). There was both initial sting and a sense of body to guitar notes – and they echoed into the distance just a little longer than usual; the track dripped with atmosphere.

I put this effect down to the fact that DAC9 is free of digital hash and so instruments have exceptional clarity, with air and space around them.

Moving to the Guarneri String Quartet's rendition of Ravel's 'String Quartet in F Major' (96kHz) the sound of finger on string during the pizzicato section was so lifelike I could almost picture the player in front of me.

Allied to this detail was a degree of muscularity that imbued rock music with controlled power. On Johnny Thunders And The Heartbreakers' 'Get Off The Phone' the drums not only pounded, but had a vibrant bounce to them. Bass was fulsome and rounded, the Acoustic Research having a low-end many DACs struggle to match. This is quite a muddy recording with a production that does the band no favours, but the DAC9 managed to cut through it all to deliver the attack and propulsion the track deserves.

Switching on the upsampling mode also helped clear some of the recording's inherent mush bringing extra sparkle to the guitars.

As for the digital filter options, I preferred the slow setting which seemed to bring a greater sense of

scale; the fast roll-off sharpened things up at the expense of overall organic flow. This, though, will be very much a question of personal taste.

I'd also recommend using the balanced outputs if you can. With the McIntosh amplifier these gave a markedly bolder sound with greater stage depth without sacrificing any of the DAC9's inherent detail.

Whatever the settings and connections, though, the Acoustic Research DAC9 paints an entirely convincing musical picture. It can beguile you via a smooth, authoritative and detailed presentation with sophisticated recordings, but respond with power, guts and driving rhythm when replaying a raucous guitar, bass and drums combination.

If you are looking for a DAC at around this price-point then the Acoustic Research should be at the head of your shortlist.

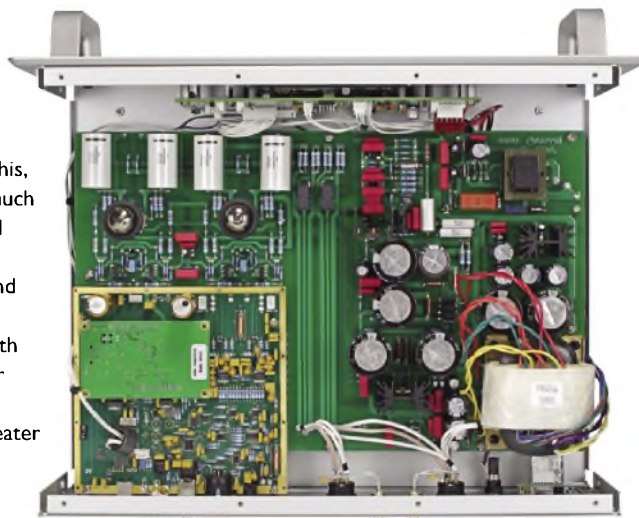

*Internally, construction is to Audio Research's high standards with hand-soldered circuit boards and neat wiring. The circuit itself is built around a Burr-Brown PCM1792A DAC chip.*

**CONCLUSION**

The DAC9 may not boast some of the bells and whistles of some digital-to-analogue converters but what's inside counts and this is where it comes up trumps. The sound is deliciously rich and detailed, with a healthy dose of attack and vigour that never failed to excite me. If you've ever fancied a slice of the Audio Research sound but couldn't quite stretch to the price then this new entry-level component could be for you.

**MEASURED PERFORMANCE**

DAC9 delivers 3.7V from its balanced (XLR socket) output and 1.85V from its unbalanced (phono socket) output, just a tad below standard (4V/2V) and what is becoming common (6V/3V). The point being DAC9 will not seem as loud as competitors; volume will need to be

increased a tad. This is unusual for valve based equipment where high voltage swings and output overload values are easy to achieve and commonly used to make a product 'loud'.

Valves suffer thermal noise that limits distortion and dynamic range figures. DAC9 all the same managed a high 116dB dynamic range from its balanced output, but a low 105dB – little better than CD – from its unbalanced phono socket output, so is best run from its balanced output.

Distortion via XLR was low at 0.2% from CD and 0.03% from hi-res digital (24bit), figures up with the best.

Frequency response was very wide, stretching flat from 4Hz to 90kHz, with a very steep cut-off above this frequency to the 96kHz upper theoretical limit for 192kHz sample rate.

With valves it is difficult to get class leading distortion, noise and dynamic range figures, but DAC9 manages well all round, dynamic range inevitably being below that of the best solid-state units.

NK

Frequency response	4Hz-90kHz
Separation	94dB
Noise	-115dB
Distortion	0.03%
Dynamic range (24bit)	116dB

**FREQUENCY RESPONSE**

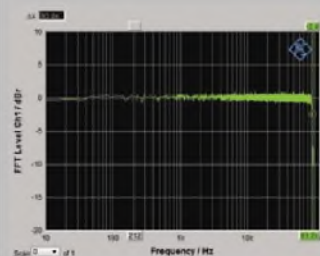

**DISTORTION**

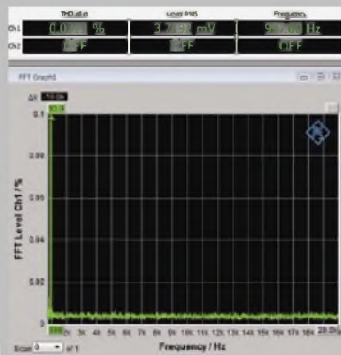

**AUDIO RESEARCH DAC9 £7498**



**OUTSTANDING - amongst the best.**

**VERDICT**

A fluid, organic sounding DAC that breaths life into all forms of music. Allies resolution with superb poise and great punch.

**FOR**

- powerful bass
- authoritative presentation
- rich detail
- build quality

**AGAINST**

- industrial appearance

Absolute Sounds  
+44 (0) 20 8971 3909  
www.absolutesounds.com



SCANSONIC

AUDIO ANALOGUE  
soundpleasure

DECENTAUDIO.CO.UK



TEL: 05602 054669

EMAIL: INFO@DECENTAUDIO.CO.UK

AUDIO ANALOGUE - KRONOS AUDIO - MAGNEPAN - RIVA AUDIO - SCA



*Transfiguration*

**KRONOS**  
TIME FOR MUSIC™



**DECENT AUDIO**  
SOUND DISTRIBUTION

ANSONIC - TRANSFIGURATION - USHER - VAN DEN HUL - VELA AUDIO



OSCAR PETERSON TRIO

Walking The Line  
MPS

**T**here are not too many true stars in music but you can say this about Oscar Peterson and

say it with total confidence: he was one of the greatest piano players who ever lived.

You think of Peterson playing and you see, hear and even feel the agility within his deft and nimble finger work. I much prefer Peterson to his own hero, Art Tatum.

The latter was a supreme technician – quite possibly the best – but I only admire Tatum. His actual music is too practical for me. Too mechanical.

I enjoy, am more uplifted and emotionally moved by Peterson. That's the difference. Some say that his style was a bit too busy but he did it with with a sense of rhythm: that was his magic.

Put Peterson in a large jazz band and he would fit in very nicely but it would be a waste of effort and talent. Peterson

needed to shine from a trio or even backing a vocalist as part of a small group. He had a swing style that could easily bop with the best.

This 1970 recording for Hans Georg Brunner-Schwer's label features George "Jiri" Mraz on bass and Ray Price on drums. In sound terms, I was impressed by the simultaneous impression of the grand epic and the intimate.

The former is printed to the ear by the enormity and majesty of the Peterson piano.

He is lavish in his serving of notation so that the ear is swamped by an energy that is exuberant but his music also swings like crazy.

The intimacy can both be heard by the constant chatter and noises from the participants. They are obviously enjoying themselves and are in the moment while the bass interjects a personal, textural resonance that reminds you of the clarity of this recording.

AUDIOPHILE VINYL



BLACK GRAPE

It's Great When You're Straight...Yeah  
Radioactive

**I** think it was more to do with the fact that Shaun Ryder was still alive and vertical that turned most people's heads when he announced the launch of his new band, Black Grape, after the 1992 dissolution of Happy Mondays. After all, Ryder and drugs had been the best of friends for many years.

The shock was compounded when, would you believe it, the debut album from the band – this very LP – was not only good, it was great. More than that, while the Happy Mondays were generally received with a soft spot for those hands in the air, techno-crazed, dance yer rocks off, scoot down the M25 trying to find the next free rave, unrestrained 'E' times, what Black Grape gave us was not only just as good, it was what the Happy Mondays should have been all the time.

More relaxed. More funky. More nonsense. The grooves were

a whole lot deeper too while Ryder now had fellow rapper Kermit to bounce off. The fact that it blows into all compass directions like an exploding shell but does so without any hint of manufactured design is a triumph of creativity.

The LP hit the charts at No 1 on its release in October 1995, yielding the Top 10 hit singles 'Reverend Black Grape' and 'In The Name of the Father' plus a third Top 20 hit in the form of 'Kelly's Heroes'

The LP has been well served by this reissue which treats the busy and complex arrangements calmly and evenly without any bright upper mids or smearing bass intriguing upon the enjoyment.

The amount of inherent space and air infused into the pressing means that it is relatively easy, on a decent hi-fi system, to hear even subtle and quite delicate secondary percussion without any problems.

“ I grew up on the borderline, I never grew upon one particular culture... Minneapolis is so far behind other major cities in the country, it forces you to create your own sound. There's no point in copying other trends because, by the time they get here, they're out of date”.

Such was the city for Prince, a place where black people formed only 5 per cent of the population. Prince did his best to develop his musical talents, playing music and writing his own songs for a school band.

He was then asked to play guitar on a series of demos by Brooklyn musician Pepé Willie. His first thoughts on seeing Prince? “Boy – he's got a big afro!” Soon after, a group was formed, 94 East, consisting of Pepé and a host of local talent including Prince. Demos were recorded and a deal was eventually signed with Polydor. Which was abruptly cancelled much

to everyone's disappointment: this, despite two (still unreleased) songs being recorded by the label.

When Prince launched into his star-studded career, these early recordings were released as ‘The Minneapolis Genius: 94 East’ in 1986 on the Hot Pink label. This compilation is not a retread of that release. As Pepé Willie said “On ‘Minneapolis Genius’ the original recordings had been updated with additional instrumental parts and remixed. But now we've added eight further songs in their original form with the vocals included and no added overdubs”.

Hence, the standard LP version provides six tracks while a limited edition box set offers 17 tracks over three pieces of vinyl.

The sound is punchy, precise and exhibits a funk-filled impact but I'm impressed with the tonal balance here and the lack of any horrible peak limiting. A welcome historical testament to a glorious career, horribly cut short.



PRINCE

94 East featuring Prince Charly

AUDIOPHILE VINYL

Floyd have been enjoying themselves of late with the announcement of major exhibition in the V&A museum, the release of a humongous box set which promises to be the first of many and the reissue of the band's entire catalogue on vinyl.

This vinyl LP reissue batch I have received is but a small part of that larger campaign and includes ‘Atom Heart Mother’ (1970), ‘The Wall’ (1979) and ‘The Division Bell’ (1994). I chose to look at a decidedly unloved release from 1972, ‘Obscured By Clouds’ – the soundtrack to the Barbet Schroeder film ‘La Vallée’.

The floaty nature of the music did not go down too well with the critics of the time because, they said, that the music had no real aim or direction. The pastoral nature was too grassy, the spacey aspects too full of starlight. Yes, you do get a few songs in the heady

instrumental mix such as ‘Burning Bridges’ and ‘Wot's...uh the Deal’ while ‘Childhood's End’ has a certain ‘Dark Side of the Moon’-to-come flavour. It was all too bitty for most ears. Just a bit messy for the rest. But, hey, I like it. I like it for exactly those reasons. OK, you could call it a time and a place and a reflection of both but it also projects individualism and a sense of experimenting in public, which I'm all for. Why hide in the studio and pretend that your musical direction emerged fully formed like The Beatles did?

In terms of sound quality the mastering is very good indeed, taken from the original master tapes and processed by James Guthrie, Joel Plante and Bernie Grundman. Compression is largely absent. If there is any, it's there in tiny, subtle ways to enhance a frequency here or there but there's nothing obvious or out of place. A welcome release.

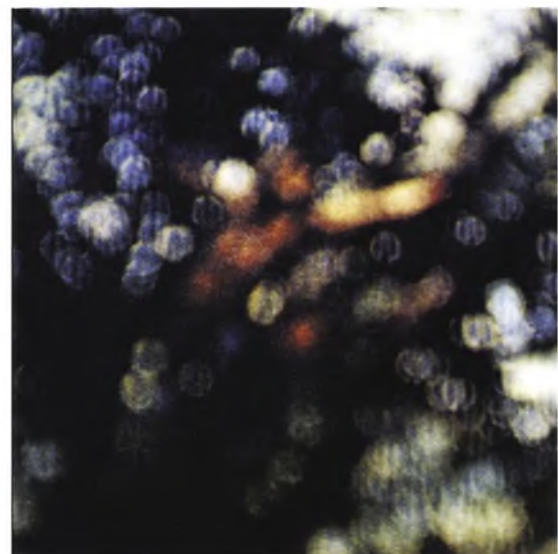

PINK FLOYD

Obscured by Clouds Pink Floyd Records

# e.One

by bel canto

*"It's one of my favorite power amps.  
I can't recommend it highly enough."*

Bel Canto REF600M review  
Sound Stage Hi-Fi, February 2016

*"This is possibly the best of the solid  
state DACs I have listened to at its  
price (and some more)."*

Bel Canto DAC 2.7 Review  
Hi-Fi Today, January 2016



Distributed in the UK and Ireland by:

padood

www.padood.com | info@padood.com  
+44 (0)1223 653199 | 20 Station Road, Cambridge CB1 2JD

# Vector Drive

Danish brand Audiovector's new QR range aims to offer the kind of performance associated with its higher-end models at a much more affordable price. Jon Myles tries out the QR3 floorstander.



**D**enmark is famous for many things; it's the home of Lego and Hamlet, birthplace of Hans Christian Andersen and Metallica drummer Lars Ulrich, has the oldest continuing monarchy in the world and also gave us the Danish pastry.

And then there's hi-fi - most especially loudspeakers. The country has a rich tradition of producing quality transducers - so much so that in the 1960s and 1970s Denmark produced more 'speakers per capita than any other country in the world.

One of its most successful manufacturers is Audiovector which was founded back in 1979 and has built a loyal following across Europe ever since - especially with the likes of its Arrete models.

Now they've been joined by a new entry-level QR range - consisting of a standmount (QR1) and the QR3 floorstander on review here.

It's a well-proportioned bass reflex model measuring 94.2cm x 19cm x 23.2cm (H/W/D) and employing three drive units. These operate in a 2.5-way mode whereby the lower unit handles the bass and crosses over at 400Hz to the mid/bass driver.

These units are a new design from Audiovector which it has dubbed Pure Piston and is constructed from two layers of aluminium cone separated by a fibre filling and foam glue. The company says this combines the inherent rigidity and lightness of aluminium with the resilience of foam to push break-up modes up to a higher frequency and so match better with the tweeter.

30<sup>th</sup>  
ANNIVERSARY

# SOUND & VISION

## THE BRISTOL SHOW

Over 170 brands booked  
with more to come!

24<sup>th</sup> - 26<sup>th</sup> February 2017. 10 a.m. - 5 p.m. every day at the Bristol Marriott City Centre Hotel



SAVE TIME  
& MONEY  
Buy Your  
Tickets  
Online\*

[www.bristolshow.co.uk](http://www.bristolshow.co.uk)

### ADMISSION

#### Adults

£12.50 on the door  
£11 online\*

#### Students & Seniors (over 65)

£11 on the door  
£9.50 online\*

Multiple day tickets  
available online only

Accompanied Children  
Under 16 FREE

\*online booking fee applies

**BRANDS INCLUDE:** Acoustic Energy, Air Audio, Albedo, Alpha Design Labs (ADL), Amphion, Anatech Distribution, Apollo Hi-Fi, Arcam, Armour Home Electronics, Art Vinyl, ar:tone, Astell & Kern, Astin Trew, Atacama Audio, Atlas Cables, Auden Distribution, Audeze, Audio Analogue, Audio Detail, Audio Note, Audio Technica, Audioengine, Audiolab, AudioQuest, Auralic, AV Tech Solutions, Avantgarde Acoustics, Bedini, Blue Horizon, Bluesound, Bowers & Wilkins, Brodmann Acoustics, Bryston, Buffalo Technology, Canton, CH Precision, Chord Company, Chord Electronics, Chord Mojo, Classé, Clearaudio, Clearer Audio, Computers Unlimited, Convert Technologies, Creaktiv, Creek Audio, Custom Design, Cyrus, Dali, Decent Audio, Devialet, Diverse Vinyl, DS Audio, Dynaudio, ELAC, Elipson, Epos, Esoteric, Exposure, Focal, Fostex, Furutech, Gamut, Goldring, Grado, Graham Audio, Harbeth Audio, Hegel, Henley Designs, Hi-Fi Racks, Hi-Fi+, HiFi Critic, hORNS, IAG, Icon Audio, iFi Audio, Innuos, IsoAcoustics, IsoTek, JL Audio, Karma AV, Kate Koeppel, KEF, Keith Monks, Kennerton, Knosti, Kog Audio, Kudos Audio, Larsen, Leema Acoustics, Lehmann, Markaudio-Sota, Mass Fidelity, MCRU, Meico Audio, Meze, Michell Engineering, Ming Da, Mission, Miyajima, Monitor Audio, MSHD Power, Music First Audio, Musical Fidelity, Musical Surroundings, Nagaoka, Naim Audio, Neat Acoustics, Nordost, Novafidelity, NuForce, NuNu Distribution, Onkyo, Opera Loudspeakers, Ophidian Audio, Oracle Audio, Orbitsound, Ortoton, Pioneer, Plato, PMC, Power Wrap, Pre Audio, Pristine Vinyl, Pro-Ject, ProAc, PSB, Puritan Audio Laboratories, Q Acoustics, Q-Up, QED, Quad, quadral, Quadraspire, Questyle, Rega, REL Acoustics, Roksan, Rotel, Ruark Audio, Russell K, Scansonic, SCV Distribution, Select Audio, Sennheiser, Silent Mounts, Sonic Design, Sony, Sota Acoustics, Sound Foundations, Spondor, SSC, Supra Cables, T+A, TAD, Tangent, Teac, Technics, Tellurium Q, The Vinyl Adventure, Timestep, Tonar International, Townshend Audio, Unison Research, van den Hul, Vinyls Best, Vivac, Wavelength Distribution, Wharfedale, What Hi-Fi?, Wilson Benesch and many more...

HI-FI, STREAMING, HOME CINEMA,  
PROJECTORS, VINYL, HEADPHONES  
- THEY ARE ALL AT BRISTOL!

Witness the launch of dozens of new products,  
with many brought directly from the Consumer  
Electronics Show in Las Vegas

- ▶ **NAIM AUDIO** Discover Uniti by Naim, the revolutionary new streaming platform
- ▶ **REGA** launch a new version of their best selling entry level integrated 50wpc stereo amplifier - the Brio

£10,000 OF HI-FI  
TO BE WON IN THE WHAT HI-FI?  
SHOW COMPETITION

- ▶ **BOWERS & WILKINS** demonstrate the 800 Series Diamond in a variety of configurations for the first time in the UK
- ▶ **Q ACOUSTICS** The world's first public demonstration of the Concept 500 loudspeakers
- ▶ **NOVAFIDELITY** The NEW X50 Music Server with database plus much more
- ▶ **OPHIDIAN** The Prophet P1 and P2 high performance loudspeakers will make their debut alongside the award winning M-series

#### GETTING TO THE SHOW

**BY TRAIN:** Temple Meads Station is a short distance from the Marriott.

**BY CAR:** From the M4 take J19 (M32 - Bristol). Follow signs for City Centre and RAC signs to the Show. For those using satellite navigation systems the hotel post code is BS1 3AD. Easy local parking in Cabot Circus car park and Broadmead and Bond Street NCPs.



[www.bristolshow.co.uk](http://www.bristolshow.co.uk)

For the latest news and a  
full list of brands exhibiting  
please visit our website

Organised by

In association with



audio-T

WHAT HI-FI?



This is important as the QR3 is equipped with a gold leaf ribbon Air Motion Tweeter similar to that used in Audiovector's flagship R11 Arrete floorstander. This sits in a fascia plate made from aerospace grade aluminium which has been precision machined, glass blasted and then brushed in two different directions.

Sitting directly in front of the tweeter is a handsome-looking rose gold mesh - but it's not merely for show. The fine grille also acts as a filter to help control sibilants for a cleaner, more focused sound.

Two sets of speaker binding posts sit on the rear to facilitate bi-wiring or bi-amping. The reflex port is of the down-firing variety so the main cabinet sits on four steel columns secured to the plinth to give it room to operate. This, in theory, means the QR3 can be used closer to a back wall than other rear-firing designs.

The 'speakers are available in either high-gloss black or satin white and are priced at £1350.

## SOUND QUALITY

I mainly paired the QR3s with our reference McIntosh MC152 power amplifier, but also used them on the end of a Creek Evolution 100A integrated and also the Blue Aura v40 LE valve amp reviewed elsewhere this issue.

While the latter is relatively low-powered it easily drove the Audiovectors to loud levels - mainly because they are extremely sensitive. They do, though, respond well to some quality Watts, being resolving enough to show the difference between various amplifiers.

With the McIntosh in place the QR3s proved adept at carrying a tune through the midband and bass regions. They are not warm sounding or overly rich in their presentation but admirably clean sounding with a good sense of scale.

Cueing up Led Zeppelin's 'Dazed And Confused' there was a physicality to John Paul Jones's bass guitar - the notes having both depth and resonance. There was also a wide soundstage with images extending beyond the edge of the cabinets and projected well into the room.

This brings a toe-tapping sense of dynamism to any music with sufficient drive. ZZ Top's 'Eliminator' album simply galloped along with a metronomic sense of timing. There's no doubt these 'speakers thrive on anything with an infectious beat.

The top mid/bass unit's high 3kHz crossover means there's good integration with the Air Motion Tweeter - something that can sometimes be a problem with ribbon-type designs.

The tweeter itself is clean and open with an extension range dome units just cannot match. It is rather obviously forward, though. On the plus side this gives a great sense of detail - the QR3s uncovering musical elements that can be masked by other loudspeakers. On Ornette Coleman's 'Free Jazz' Donald Cherry's trumpet was sharper and more clearly defined than I usually hear from my resident Spendor ASR 'speakers.

This plays well with high-resolution music where the extra musical information makes its presence felt. On Anthony Braxton's live 'Pine Top Aerial Music' (24/96) Anne Rhodes' vocal gymnastics have a crystalline quality. That tweeter grille is also doing its job as there isn't a hint of sibilance throughout the whole performance.

However, the downside is poorly recorded tracks or low-quality MP3s can sound a little edgy at times. That said, anyone spending this sort of money on a pair of loudspeakers



*The Audiovector uses a down-firing reflex port - which helps with close to rear wall placement.*

probably won't be listening to a vast amount of MP3s anyway (if they have any sense!).

Stick to good quality material, though, and the Audiovectors will turn in a sterling performance. The fact that they'll work happily with even relatively low-powered amplifiers is also a bonus.

## CONCLUSION

A smooth bass and midband coupled with a dynamic sound make the Audiovector QR3s an engaging listen. The Air Motion Tweeter projects masses of detail but doesn't flatter poor recordings.

## MEASURED PERFORMANCE

Treble output from the tweeter of the QR3 rises strongly from the crossover point at 3kHz, to reach +7dB at 16kHz, the steady lift upward being obvious in our third-octave frequency response analysis. This is enough to make the loudspeaker sound obviously bright in tonal balance, although because the lift is smooth and consistent treble

quality may be acceptable in itself. The QR3 is not tonally accurate however, the lift likely being a deliberate design decision chosen to make the speaker stand out.

Treble lift apart, the QR3 measured flat and smooth across the audio band, suggesting low colouration due to a lack of local mechanical resonances. It reaches down smoothly to 40Hz, the suggestion here being it will play a bass tune evenly and well. Port damping (red trace) is broad our analysis shows and the impedance curve backs this up in the width of the port dip around 40Hz. Again, this points to well controlled bass.

The QR3s proved massively sensitive, delivering 90.5dB sound pressure level (SPL) - very loud - from one nominal Watt of input (2.8V). This is more than most rivals and means that 40 Watt amplifiers will be more than sufficient. However, with a low DCR of 3.3 Ohms and measured impedance of 5.5 Ohms overall, the QR3s draw current, albeit into a substantially resistive load.

The QR3s measure well, ignoring the obvious treble lift that will be audible and unflattering to poor digital, MP3s etc. **NK**

### FREQUENCY RESPONSE

**Green - driver output**  
**Red - port output**

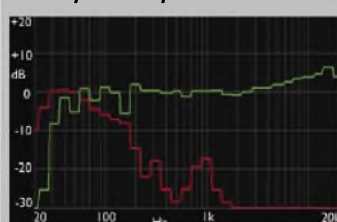

### IMPEDANCE

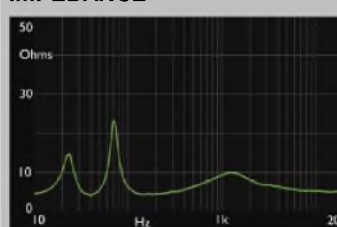

## AUDIOVECTOR QR3

£1350



**EXCELLENT** - extremely capable.

**VALUE** - keenly priced

### VERDICT

A great sense of scale and pinpoint timing - they engage the senses.

### FOR

- smooth midband.
- well-controlled bass.
- extended highs.
- excell with high-res digital.

### AGAINST

- forward treble.

Audiovector  
www.audiovector.com



Do Good Audio are a family run independent Hi-Fi shop based in Liverpool. With one shop in the North of the City and another shop soon to be opened in the South. We have a wide range of quality Hi-Fi to choose from and can offer quality demonstrations in either location.

We believe in service first and foremost and understand that care needs to be taken in building a Hi-Fi system, so we consider all aspects and requirements before advising and demonstrating.

We pride ourselves on our service and believe purchasing a pair of headphones for £40 should be just as enjoyable as purchasing a high end system from us. Whatever you need we are here to help whether it is sales, service, repairs or just some honest advice without the sales pressure! Do Good Audio is a place for music lovers run by music lovers.



Visit us at: Do Good Audio, 489 Rice Lane, Liverpool, L9 8AP  
 [www.DoGoodAudio.co.uk](http://www.DoGoodAudio.co.uk) [info@dogoodaudio.co.uk](mailto:info@dogoodaudio.co.uk) 0151 525 3845

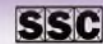
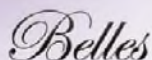
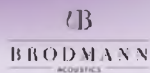

## NORTH WEST AUDIO SHOW 2017

The very best in HiFi and Audio in fabulous surroundings!

**24 - 25th June**  
**Crannage Hall, Cheshire**

**Free parking and Free entry**  
**Live music**

**[www.audioshow.co.uk](http://www.audioshow.co.uk)**

**Great deals on overnight stay\***

\*Quote "Audio" when booking

**MEDIA PARTNER**  
**Hifi Pig**

[www.hifipig.com](http://www.hifipig.com)



# "Well-designed and produced valve amps are an art form"



Noel Keywood

Over Christmas I dug out a long neglected World Audio Design K5881 valve amplifier – a mule used for prototyping work – and set about getting it back into action. Why have a good valve amplifier sitting idle and unappreciated when you have a son who won't stop talking about guitar amplifiers – using valves as the classics did – and asks why "the amp in the junk room" isn't working? Surely Hendrix sounds more authentic through such an amp? Hmmm – good point.

To get the K5881 working I needed some 5881 valves – in a hurry just before Christmas. Living in North West London, Watford Valves are my nearest supplier – a quick run up the M1. On their website I realised that guitar amplifiers feature more prominently than hi-fi amplifiers. There's a market out there, but the music business is more interested in valves than commercial audio and high fidelity it seems. They sound "louder, warmer and can be pushed" I am informed (well, thanks!).

Valves are used in microphone preamps too, because they don't suddenly go into violent overload, producing ripping distortion, when a singer bellows into the mic held against the mouth.

All of which is to say that my most exciting Christmas activity, way beyond setting fire to the Christmas pud, showed me where the thermionic world is currently at. The trad. revival – old recordings, old values – continues apace in the music business, arguably more so than the hi-fi business. Valve based guitar amps in particular are popular, sold on an entirely different proposition to hi-fi valve amps, with ruggedness, 'power' and – these days – an authentic sound, being the selling points.

This is fine by me. Well-designed

and produced valve amps are an art form. I know from doing it – and they are a source of deep musical satisfaction. If there is heart and soul in music, valve amplifiers convey it best. Power they have aplenty, even if the specs say otherwise. Valve amps sound powerful because they deliver dynamic contrasts well, so you get great dynamics even at low volumes. A 20 Watt guitar amplifier is considered loud, and a 50 Watter will fill a stadium, I'm told.

Authentic – well of course. All the greats used 'em; there's nothing more to say.

Rugged? They're rugged in that you can unplug them and plug them and even short their outputs and they'll keep working, where transistors go 'phut'. Transistors need complex circuitry for protection against overload. Valves get away with none. OK, there's a little more to it than this, but that's the broad picture.

Getting K5881 working reminded me yet again what an easy but totally fulfilling musical experience valve amplifiers can be in an everyday home. Once the valves were in it was put into my son's bedroom and hooked up to a pair of Revolver loudspeakers – an Oppo CD/DVD player with remote control of volume acting as a CD source. Sounding powerful and dynamic straight away, it has been glowing ever since, aided also by a Line6 preamp unit and a Stratocaster. I'm aided by ear protectors.

K5881 was designed by traditional pen/paper/calculator method back in 1995. Over Christmas 2016 I spent some peaceful hours putting the design into LTSpice, the free design software from Linear Technology, and all voltages in the computer analysis tallied perfectly with the real thing. After 21 years this amplifier, with brushed chrome chassis, chromed

transformer top caps, an SRPP input stage and plenty of special capacitors, had no trouble in resurrection; it emerged sounding wonderful.

The K5881 was deliberately given a strong industrial mains switch and an all-welded chassis to survive the years, the idea always being that an amplifier you build yourself, you service yourself and potentially it can go on forever. The reality is a bit different: output valves can fail catastrophically, burning out the output transformer primary winding, unless an HT fuse is used – and I saw no fuse in this mule. So fitting fuses is a job to be done, hopefully before next Christmas.

After hearing K5881 deliver the goods, I was more invigorated by Luxman's EQ-500 phono stage that I review in this issue. A look inside showed me it is a true attempt at the best, using discrete components – which you have to do with valves of course, as no-one ever came up with thermionic ICs! It is not based on cheap chips, as most are, often with nasty DIP switches soldered directly to the circuit board.

The Luxman uses miniature, sealed small-signal relays with a very low contact resistance over a life that is quoted as one million operations. Every hi-fi product should use them, but most don't. Why? They are expensive.

And so are transformers, yet Luxman use them everywhere in the EQ-500. Most manufacturers arrange a balanced output through an integrated circuit designed for this purpose but Luxman use transformers here too – almost unheard of. Why? They are expensive (£30 a stereo pair). Chips are cheap – just £1 in this role.

Valves "done properly" offer extraordinary results. And that is why I had a very happy thermionic Christmas. ●

# THE VINYL REVOLUTION



## The EVO and the new EVOke now you have a choice !

The new EVOke has world beating performance and right now we have the unit reviewed in this issue and a brand new one for sale. Performance figures are comparable with the world's most expensive turntables and the ability to fit any arm or cartridge mean you can have the EVOke that you want

The EVO was used by Hi-Fi World to evaluate the Beatles In Mono records and is now used as their reference. The EVO comes fitted with the legendary SME 309 tonearm loved by so many and a cartridge of your choice.

We have worked with direct drive turntables and moving coil cartridges for 35 years. We can supply completely new units with 5 year guarantees, used ones with 5 year guarantees, or we can convert your own.

**Stereo, Mono & 78 rpm** Artisan Noriyuki Miyajima has been making phono cartridges in Japan for more than three decades. Only recently discovered by American and European audiophiles, they have since received rave reviews all over the world and deservedly so.

Every Miyajima cartridge is handcrafted in-house by a dedicated full-time team of six based in Fukuoka. The cartridge bodies are individually precision-milled from rare and exotic hardwoods including ebony, rosewood and African blackwood (mpingo). These dense natural materials lend a vibrant and natural tonality to the sound.

Miyajima - Benz LPS - Denon DL103 - DL-102 mono - Audio Technica AT33 & OC9  
SME Turntables & Tonearms - Oyaide - Furutech - Klipsch - 78rpm - SL1200 Mods

Tax free best prices for World wide mail order by Fed Ex

Sound Hi Fi Dartmouth Devon 01803 833366 [www.SoundHiFi.com](http://www.SoundHiFi.com)

[www.blackrhodium.co.uk](http://www.blackrhodium.co.uk)

**Black Rhodium**

+44 (01332 342233)

THE EXCLUSIVE TECHNOLOGY OF OUR VERY BEST HIGH END CABLES  
CAN NOW BE ENJOYED BY A MUCH LARGER AUDIENCE

## Goodbye to Harshness...Hello Effortlessness

### Black Rhodium FOXTROT Loudspeaker Cable

*"The very affordable Foxtrots certainly deliver a delightfully open and effortless sound from my system."*

Hi-Fi Choice



### Read the Hi-Fi Choice review

Visit [www.blackrhodium.co.uk](http://www.blackrhodium.co.uk) and download the review from the link on the homepage



### EXCLUSIVE FEATURES

Stunning Clarity	✓	Extensive Dynamics	✓
Sharp Definition	✓	Natural Decays	✓
Spacious Ambience	✓	Effortlessly Open	✓
Musically Expressive	✓	Excellent Timing	✓
Wide Imaging	✓	Powerful Deep Bass	✓
Very Affordable	✓	<b>Now read the review</b>	

Buy Foxtrot at any Black Rhodium dealer or online [www.blackrhodium.co.uk](http://www.blackrhodium.co.uk)

### Hear Foxtrot at these dealers

Zouch Audio 01530 414 128 | MCRU 01484 540 561 | Analogue Seduction 01733 350 878  
Doug Brady Hi-Fi 01925 828 009 | HomeSound 01316 621 327 | Audiophilia 01312 219 753  
DoGood Audio 01515 253 845 | Audio T, Swansea 01792 474 608 | Peak HiFi 01226 761 832

# "Blues is a selfish genre. It's an inner wail set to melody"



Paul Rigby

**M**usic is divided into genres and within each genre, there is a rainbow of colours that represents mood. Take rock, for example. You can listen to uplifting symphonic prog rock from Yes that is almost spiritual in its glory for life and then you can turn to the indie rock of The Smiths and be one step away from a drug overdose in a matter of minutes.

I exaggerate, I know – but the essence is there and I could go on, touching on many other colours and shades in the rock rainbow that appeals to all rock fans throughout their lives.

You can hear the same from folk, from jazz, from reggae and classical. There is only one musical genre that purposefully barges into the colour palette and stamps its entire emotional output on a single colour: the blues.

In general, clichéd terms whenever you hear the name of that genre you immediately tune your brain to negativity: sadness, loss, despair and the like.

You actually wonder at times just exactly who the blues is for. Some believe that the entire genre exists not for the audience but for the people who play it. Blues is a selfish genre. It's introspective. It's an inner wail set to melody.

"I been in the blues all my life. I'm still delivering 'cause I got a long memory" said the legendary Muddy Waters.

"A guy will promise you the world and give you nothin' and that's the blues" opined Otis Rush.

"Anybody singing the blues is in a deep pit yelling for help" was the conclusion of Mahalia Jackson.

No-one ever said that he was playing his Bontempi synthesiser on the street corner because "I got a

bad case of greens". No-one ever sang about yellows except Coldplay and no-one ever lived their life by purples unless your name was Prince.

But many people sang about, lived their lives around and suffered under the banner that was the blues. Oddly, though, and more than any other genre with the one exception of jazz, the blues has a strong academic association.

It also allies itself with profundity, earnestness and resolution. There is also a school of thought among nerdy fans that the blues is super serious and lives by a book of rules.

Which all goes to prove why the blues is possibly the least understood musical genre around. It's also why the intensity of the genre and the often single minded nature of the music has created more musical snobs than just about any other genre on the planet.

Even rock icons such as Todd Rundgren was aware of the power of the 'purist'. "My guitar heroes are Eric Clapton and Jeff Beck and people like that – so I've tried to make an album of Robert Johnson covers that, well, while not totally faithful for blues purists, is faithful for people like me that grew up with the '60s and the electric blues-rock versions of Johnson's songs" he said.

More directly, I recently noticed this internet forum comment from a blues fan in the USA – "I live in an area with a lot of Blues Societies and clubs. These guys are all Nazis about blues and how it should be played and what should be used to play it".

For myself, this is a sad state of affairs and, I'm sure, would be frowned upon by the greats within the genre.

Those who claim that the 'real' blues is indeed pure and unsullied by cross-genre contamination have

plenty of evidence to hand, this is true. You only have to look at Ace Records ([www.acerecords.co.uk](http://www.acerecords.co.uk)) Smokey Hogg's 'Deep Ellum Rambler' that documents his country blues sides for the Modern label, and guitar legend Elmore James' superb box set 'The Classic Early Recordings 1951-1956' (which details a host of studio rarities and many alternative studio takes) for supposed confirmation of this.

I would counter, though, that these and others like them, who died early and well before the blues resurgence in the later sixties (Hogg in 1960 and James in 1963) were seen as specialists only because they were never truly introduced to sustained external influence. If they were, I'm sure that both would have introduced other genres into their work.

That purist view is maintained through the likes of John Lee Hooker's 'The Legendary Modern Recordings 1948-1954' but later Hooker appeared with female backing singers, folk blues outings and then there were all of those star-studded guest fests on later LPs.

B.B. King has hard core blues on 'The Best of the Kent Singles 1958-1971' but he would later tackle Nashville country and record with jazz-funk outfit, the Crusaders.

While hard blues can be heard on Slim Harpo's 'The Best of...' he was also renowned for recording country to rock'n'roll.

Less about rules than about people, the blues has been unfairly shackled with a scholastic, restrictive view of the world when, in fact, it's a sort of diary of life.

Yes, an intensely personal and sometimes shocking confessional framed by rhythmic prose. What comes from within is the essence of the blues, not the musical or instrumental frame that it sits within. ●



**K3 CD Di  
AVAILABLE NOW!**  
Enjoy the phenomenal  
K3 CD Player with two  
additional digital inputs.

STYLE.  
PERFORMANCE.  
FUNCTION.



K3 Integrated  
January 2015



K3 Integrated  
February 2015



K3 System  
April 2015

## K3 INTEGRATED AMPLIFIER & CD PLAYERS

Roksan's K3 Series of hi-fi electronics put sound quality first. But more than just sounding great, they're also effortlessly simple to use and come in a design that anyone would be proud to put at the centre of their music system.

The K3 Integrated Amplifier has been built with today's discerning audiophile in mind. Boasting five Line Level inputs, an exceptional Moving Magnet phono stage and superior aptX® Bluetooth technology; it is an ideal hub for all manner of audio sources. There is power and bass drive in abundance, with superb sound staging and engaging detail that is both refined and enjoyable.

The K3 CD Player and the new K3 CD Di are high-quality source components that deliver a rich, almost analogue, sound performance that perfectly matches the Integrated Amplifier's delivery. When you put together a Roksan K3 system, you're guaranteed a package that is truly unrivalled for the price.



Distributed by **Henley Designs Ltd.**

T: +44 (0)1235 511 166 | E: sales@henleydesigns.co.uk | W: www.henleydesigns.co.uk

# “Drake’s ‘One Dance’ was streamed a whopping 119 million times in the UK last year”



Jon Myles

**T**echnology moves at an ever-increasing pace these days. No sooner has one innovation been assimilated into the mainstream consumer space than it is transcended by something new.

And the consumption of music is not immune to this. If you are in any doubt about that, take a look at some of latest figures for UK music sales over the previous 12 months.

It seems that for the first time since Apple’s iTunes ushered digital downloads into the mass market more than a decade ago, their sales have gone into decline – rapidly being overtaken by on-demand streaming services such as those from Spotify, Tidal and now Apple itself.

The shift is highlighted by the success of 2016’s best-selling track ‘One Dance’ by Drake: it racked up 15 weeks at the top of the UK’s singles chart. In total it shifted more than 1.7 million units – of which 505,000 were downloads but a whopping 119 million-plus came from streaming services. And for a real eye-opener, Drake also took the title of most-streamed artists worldwide with an end-of-year figure of some 4.2 billion individual listens.

Indeed the format is becoming so wildly popular that the Official Charts Company has announced it is changing its policy over counting them for the basis of compiling sales figures. Previously a song had to be streamed 100 times for it to be counted as the equivalent of a physical sale. Now that figure is being revised upwards to 150 to lessen the possibility of releases such as ‘One Dance’ dominating the charts almost entirely due to their popularity on the likes of Spotify.

And – despite the occasional

gripes over the royalties paid to artists by the streaming service giants – it seems the major record companies have finally embraced this method of delivering music as a saviour, after years of declining revenue caused by recession, piracy and falling CD sales.

At the end of last year, for example, one of the world’s biggest labels, Warner Music, announced an eight-year high in its revenues of £2.66 billion. Crucially around £823 million of that came from streaming – more than from downloads or physical sales.

Other labels are also reporting similar surges in figures, thanks to the growing popularity of streaming with the market – up by some 60 per cent in the US alone last year. Worldwide digital revenues overtook physical sales of music for the first time in 2016 and that was despite a 16 per cent fall in the number of digital downloads.

Some industry experts estimate download totals could decline by as much as 30 per cent during 2017 as more and more people opt to stream their music as their primary mode of consumption.

While some of the major labels were initially sceptical in regards to the future of streaming, its exponential growth and the revenue streams it now offers means it is a major – and a growing part of their business models.

There is also another element to it which attracts them. Whereas buying a digital download or physical artefact such as a CD or vinyl LP generates a one-off royalty payment for the producer, repeated plays bring no extra revenue.

Streaming is inherently different. Every time a track is listened to it produces a payment to the artist and label. And although that amount

may be small (Spotify pays between \$0.006 and \$0.0084 per stream to rights holders) it adds up to quite a tidy sum if multiplied millions and millions of times around the world. And it will still be paid whether the song is streamed today, next year or a decade from now.

There are advantages to the consumer too. Being a subscriber to both Tidal (because of its sound quality) and Spotify (because of the range of its catalogue) I now have access to more music than I could ever have imagined just a few years ago – and all for a monthly fee of around £20. Indeed, I’m discovering bands and artists I would never have come across before, broadening my musical tastes.

Both these services produce excellent curated playlists to point you in the direction of new music you may like, based on your previous listening. It’s a bit like having a John Peel Show available 24-hours a day, which can only be described as a good thing.

On the other hand, if I ever decide to cancel my subscriptions I’ll lose all this music as, unlike downloads, it’s not physically stored on my computer or NAS drive.

It is also not high-resolution fare (Tidal offers CD quality, Spotify 320kbps) so if you want to listen to your favourites in 24bit/96kHz and above, digital music downloads still remain the only way. This is one reason downloads will probably continue to be the digital file of choice for many music enthusiasts for a good while yet – even if the mainstream market continues to shift towards streaming.

However, as bandwidth increases it might not be long before true high-resolution streaming services start to come on-line – which could hasten the shake-up of the market. ●

# BLACK | BEAUTY



Evocative styling  
Contemporary features

Enjoy the warm, clear sound of valve amplification from all your audio devices with the new v40 from Blue Aura.

[blueaura.co.uk](http://blueaura.co.uk)

v 40  
Blackline





# "If half-speed recording works for CD-4 why not use similar for stereo?"



Martin Pipe

A few issues ago, I described my experiences with the 'half-speed' digitising of Quadraphonic LPs. The technically-sophisticated discrete CD-4 and UD-4 formats relied on cartridges with a 50kHz response and a 'fine-line' stylus tip. Although many modern cartridges have fine-line stylii, few go above 25kHz or so.

If you need a cartridge to play your CD-4 LPs through a compatible decoder (like JVC's 4DD-5) I can recommend the Audio-Technica AT-440MLb. This is an MM design; some MC carts have the necessary frequency response but a step-up device will be necessary.

My original idea was to play CD-4 records on a turntable capable of rotating at 16rpm (I used a Thorens TD125) and equipped with a decent MM cart. Its output went, via a low-noise preamplifier, to a digital recorder capable of capturing 24-bit files at 48kHz. The file header of the resulting recording was 'doctored' so that a compatible music player (a Cambridge CXN) was 'fooled' into playing it at 96kHz. It was playing at twice the sample rate and thus the original speed of the record.

Before playback, I checked the doctored file with an audio-editing program – which confirmed that the CD-4 carrier was present at a usable level. The stereo line-output of the CXN was fed, via attenuators, to the input of the CD-4 demodulator.

Guess what? It worked! So if you have a 24-bit digital recorder and the necessary quad gear but don't want another cartridge here's a method of 'unlocking' your CD-4 records.

There are other advantages. Firstly, record wear is eliminated as you'll thereafter be playing the digital file. Secondly, they should sound better – notably in terms of

transient reproduction.

If half-speed recording works for CD-4 why not use similar for stereo records? Those doctored 96kHz files would make for excellent-quality half-speed transfers, right?

The situation isn't quite as simple. While the CD-4 decoder is expecting a 'straight' signal – i.e. it does all of the equalisation, decoding and other processes needed to reconstitute four channels of discrete audio – your stereo LP capture will sound bright and gutless when played on your hi-fi system.

This is because there is no RIAA correction (de-emphasis), which is necessary to correct the equalisation applied (pre-emphasis) during the mastering phase – thereby restoring a 'flat' response. In basic terms, the deceptively-simple RIAA pre-emphasis curve cuts the bass (so that groove-width can be reduced, increasing packing-density and making long-playing records practical) and boosts the treble. RIAA de-emphasis does the 'inverse'. Bass is boosted, which is why rumble can be problematic. But because higher-frequencies are cut, LPs sound much 'quieter' than previous generations of records.

You could connect your digital player, via an attenuator, to your amp's RIAA stage when auditioning these files. Yes, you'd save on record wear – but it's far from convenient. Far better, surely, to apply RIAA de-emphasis (ideally in software) to these files? The result would then play with the correct tonal balance – just like your downloads, CD rips and other digital files. Funnily enough, the 'free' Audacity audio-editing program has an 'inverse RIAA' equalisation-curve. Although I obtained encouraging results, tweaks were needed to make it sound right.

That was in early 2016. A recent letter from Canadian reader Dr. M.

Jeffrey Rabin reopened the case. What about "the inevitable phase error?", he asked. It turns out that the DSP algorithms that Audacity uses to implement digital filtering are of the FIR (Finite Impulse Response) type. FIR is 'phase-linear', and does not emulate any of the phase-shifts that you get in a multi-pole active-filter of the sort that constitutes the average RIAA phono stage.

No phase shifts? Isn't that a good thing? Not if 'equal-and-opposite' phase shifts were introduced during RIAA pre-emphasis! Phase irregularities can, amongst other things, muddle the stereo and impair the transient response.

However, another type of digital filter – IIR (Infinite Impulse Response) – simulates the 'poles' of its analogue equivalent and the attendant phase shifts.

'Software RIAA', with reference to Audacity, was being discussed on forums back in 2009. Many users asked for IIR to be implemented. However, the 2015 Windows version of Audacity I was using is FIR-based – as, it would appear, is the current version.

There are however alternatives. One relies on a hotch-potch of software, but the specific versions needed are no longer available, and the plugins were hosted on a now-dead file-sharing site. I did however find three commercial products. Adobe Audition uses IIR for its parametric-equaliser, encouraging someone (<http://bit.ly/2jeF6eG>) to prepare a RIAA preset.

Also interesting are Diamond Cut 8 (Windows, <http://bit.ly/2i0mNxG>) and Stereo Sauce (Mac, useful information here: <http://bit.ly/2iTageQ>).

Is this how we might be processing LP in the future? It is an entirely different approach, but my experiments show it works. ●

"...it handles stringed instruments in a way that makes most rivals sound like a bedside radio, but its performance with voices is such that it gets you wondering if Boenicke has also found a way to equip the W8 with lungs..." ~ Ed Selley, HiFi Choice



## Boenicke Audio W8 Loudspeakers

From: £5,526

- Sensitivity: 87 dB / watt / m
- Nom. impedance: 4 ohms
- Rear ambient tweeter
- Available in Walnut, Ash, Cherry & Oak

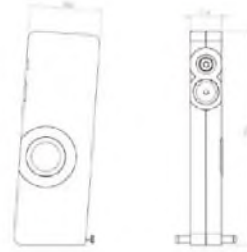

## PUREPOWER+

### PurePower+ Reference Grade AC Regenerator Range

From: £2,995

2000 Model:

-INPUT;

- Nominal Voltage: 230 VAC
- Voltage Range: 100-300 VAC
- Frequency: 50 / 60 Hz Auto-sensing
- Frequency range: 40-70 Hz

OUTPUT;

- Output Voltage: 230 VAC (208/220/230/240 VAC - User selectable)
- Voltage Regulation:  $\pm 1\%$  of nominal
- Output Frequency: 50 or 60 Hz - user selectable
- Frequency Regulation:  $\pm 0.5\%$

"...the sound has not varied by day, time of day, or programming. In other words, the units have cleaned up the electricity to the point where its quality never varies." ~ Bill Gaw, EnjoytheMusic.com



S O t M

Ultimate High Performance Audio

## SOtM sMS-200 Mini Network Player £449



- PCM 32bit/384KHz max, DSDx64, DSDx128, DSDx256
- Ultra Low Jitter Clock and Noise Regulator
- Roon Ready, Shairpoint, DLNA renderer & more

"...the sMS-200 easily takes the top spot in my list of recommended file players and walks away with a well-deserved value award"--Frederic Beudot, 6moons.com



NEW IN

## Wyred 4 Sound mINT Integrated Amplifier £1,499



- Built-in ESS Sabre DAC & high-end headphone amp
- 24/96kHz USB input
- 24/192 Toslink and Coaxial input
- No drivers required



"Here is a most versatile and satisfying performer that I can see as the heart of a fine computer-driven desktop system, or, as I used it, as a small office system with both analog- and computer-derived sources." ~ Wayne Garcia, The Absolute Sound

Generous part exchange available, please contact us for more information.

web: eliteaudiouk.com

e-mail: info@eliteaudiouk.com

tel: 020 3397 1119



We do not sell these products. It is for your information only.

# WORLD CLASSICS

Here is our list of the great and good from audio's glorious past, products that have earned their place in hi-fi history. You'll also see some oddities which aren't classic as such, but are great used buys. The year of introduction is given, alongside the original UK launch price.

## TURNTABLES

**EAT FORTE** 2009 £12,500  
Lavishly finished two box, two motor turntable with gorgeous Ikeda 407 tonearm bundled. Exceptionally stable and unfussy performer with a relaxed but highly enjoyable gait.



**FUNK FIRM VECTOR II** 2009 £860  
Innovative engineering gives a nimble, pacey and musical sound that's one of the best at the price.

**REGA P2** 2008 £300  
Excellent value for money engineering, easy set up and fine sound.

**MCINTOSH MT10** 2008 £8,995  
Big, expensive, controversially styled and glows more than some might consider necessary, but an astonishingly good performer.

**REGA P3-24** 2008 £405  
Seminal affordable audiophile deck with fine bundled tonearm. Tweakable, and really sings with optional £150 outboard power supply.

**ACOUSTIC SOLID ONE** 2007 £4,050  
Huge turntable, both in terms of sheer mass and sonic dynamics. Fit up to three arms and enjoy, just don't damage your back moving it...

**AVID VOLVERE SEQUEL** 2007 £4,600  
Stylish high end vinyl spinner with industrial strength build quality and a sound to match. Sound is edge-of-the-seat stuff.

**MICHELL GYRODEC SE** 2005 £1,115  
Design icon with superlative build. Sound is beautifully smooth, effortless and exceptionally expansive.

**MARANTZ TT-15S1** 2005 £1,299  
Cracking all in one deck/arm/cartridge combination, this must surely be the best sound/plug and play package at this price point.

**MICHELL TECNODEC** 2003 £579  
Superb introduction to Michell turntables - on a budget. Top quality build and elegant design mean it's still the class of the mid-price field.



**MICHELL ORBE** 1995 £2,500  
The top Michell disc spinner remains a superbly capable all rounder with powerful, spacious sound that's delicate and beguiling.

**SME MODEL 10A** 1995 £4,700  
Exquisitely engineered deck and SME V tonearm combo that's an extremely accomplished performer with classical music.

**LINN AXIS** 1987 £253  
Cut-price version of the Sondek with LVX arm. Elegant and decently performing package. Later version with Akito tonearm better.

**TECHNICS SL-P1200** 1987 £800  
CD version of the Technics SL-1200 turntable. Massively built to withstand the rigours of 'pr' use and laden with facilities - a great eighties icon.

**ROKSAN XERXES** 1984 £550  
Super tight and clean sound, with excellent transients. Less musical than the Sondek, but more neutral. Sagging plinth top-plates make them a dubious used buy.

**DUAL CS505** 1982 £75  
Simple high quality engineering and a respectable low mass tonearm made for a brilliant budget buy. Polished, smooth and slightly bland sound.

**MICHELL GYRODEC** 1981 £599  
Thanks to its stunning visuals, this bold design wasn't accorded the respect it deserved. Clean, solid and architectural sound.

**TOWNSHEND ROCK** 1979 £ N/A  
Novel machine has extremely clean and fluid sound. Substantially modified through the years, and capable of superb results even today.

**MARANTZ TT1000** 1978 £ N/A  
Beautiful seventies high end belt drive with sweet and clean sound. Rare in Europe, but big in Japan.



**REGA PLANAR 3** 1978 £79  
Brilliantly simple but clean and musical performer, complete with Acus-derived S-shaped tonearm. 1983 saw the arrival of the RB300, which added detail at the expense of warmth. Superb budget buy.

**SONY PS-B80** 1978 £800  
First outing for Sony's impressive 'Biotracer' electronic tonearm. Built like a tank with a clean and tidy sound, albeit lacking involvement. Scarily complicated and with no spares support - buy with caution!

**TRIO LD-7D** 1978 £600  
The best 'all-in-one' turntable package ever made. Clean, powerful and three-dimensional sound, ultimately limited by the tonearm.

**ADC ACCUTRAC 4000** 1976 £300  
Bonkers 1970s direct drive that uses an infra red beam to allow track selection and programming. More of a visual and operational delight than a sonic stunner.

**PIONEER PLC-590** 1976 £600  
Sturdy and competent motor unit that performs well with a wide range of tonearms. Check very thoroughly before buying due to electronic complexity and use of some now-obsolete ICs.

**PIONEER PL12D** 1973 £36  
When vinyl was the leading source, this bought new standards of noise performance and stability to the class, plus a low friction S-shaped tonearm. Later PL112D was off the pace compared to rivals.



**TECHNICS SP10** 1973 £400  
Seminal Japanese engineering. Sonics depend on plinths, but a well mounted SP10 will give any modern a hard time, especially in respect of bass power and midband accuracy.

**LINN SONDEK LP12** 1973 £86  
For many, the Brit superdeck; constant mods meant that early ones sound warmer and more lyrical than modern versions. Recent 'SE' mods have brought it into the 21st century, albeit at a price.

**ARISTON RD11S** 1972 £94  
Modern evolution of Thorens' original belt drive paradigm. Scotland's original super-deck was warm and musical, albeit soft. Still capable of fine results today.

**GOLDRING LENCO GL75** 1970 £15.65  
Simple, well engineered motor unit with soft, sweet sound and reasonable tonearm. Good spares and servicing support even today.

**GARRARD 301/401** 1953 £19  
Tremendously strong and articulate with only a veiled treble to let it down.



**THORENS TD124** 1959 £ N/A  
The template for virtually every 1970s 'superdeck', this iconic design was the only real competition for Garrard's 301. It was sweeter and more lyrical, yet lighter and less impactful in the bass.

**TO NEARMS**

**REGA RB251** 2009 £136  
Capable way past its price point, the new 3-point mount version of the classic RB250 serves up a taut and detailed sound. A little lean for some tastes, but responds well to rewiring and counter-weight modification.

**HELIUS OMEGA** 2008 £1,595  
Stylish and solid lump of arm with fabulous build quality, that turns in a dynamic and weighty performance.

**AUDIO ORIGAMI PU7** 2007 £1,300  
The classic Syrinx PU3 updated to spectacular effect. Hand made to order, with any mass, length and colour you care for. Fit, finish and sound truly impressive.



**GRAHAM PHANTOM** 2006 £3,160  
Sonically stunning arm with magnificent bass dexterity and soundstaging. Build quality up to SME standards, which is really saying something!

**TRI-PLANAR PRECISION** 2006 £3,600  
Immaculate build, exquisite design and one of the most naturally musical and lucid sounds around.

**MICHELL TECNOARM A** 2003 £442  
Clever reworking of the Rega theme, using blasting, drilling and rewiring!

**SME 309** 1989 £767  
Mid-price SME comes complete with cost-cut aluminium armtube and detachable headshell. Tight, neutral sound with good tonality, but lacks the IV's pace and precision.

**NAIM ARO** 1987 £1,425  
Charismatic unipivot is poor at frequency extremes but sublime in the midband; truly emotive and insightful.

**SME SERIES V** 1987 £2,390  
Vice-like bass with incredible weight, ultra clear midband and treble astound, although some don't like its matter of factness!

**NAIM ARO** 1986 £875  
Truly encearing and charismatic performer - wonderfully engaging mid-band makes up for softened frequency extremes.



**ALPHASON HR100S** 1981 £150  
First class arm, practically up to present-day standards. Buy carefully, though, as there is no service available now. Totally under priced when new, exceptional.

**SME SERIES III** 1979 £113  
Clever variable mass design complete with Titanium Nitride tube tried to be all things to all men, and failed. Charming nonetheless, with a warm and inoffensive sound.

**TECHNICS EPA-501** 1979 £ N/A  
Popular partner for late seventies Technics motor units. Nice build and Titanium Nitride tube can't compensate for middling sound.

**LINN ITTOK LVII** 1978 £253  
Japanese design to Linn specs made for a musical, rhythmic sound with real dynamics. The final LVIII version worth seeking out.

**AUDIO TECHNICA AT 1120** 1978 £75  
Fine finish can't compensate for this ultra low mass arm's limited sonics - a good starter arm if you've only got a few quid to spend.

**HADCOCK GH228** 1976 £46  
Evergreen unipivot with lovely sweet, fluid sound. Excellent service backup.

**ACOS LUSTRE GST-1** 1975 £46  
The archetypal S-shaped seventies arm; good, propulsive and involving sound in its day, but ragged and undynamic now.

**SME 3009** 1959 £18  
Once state of the art, but long since bettered. Musical enough, but weak at frequency extremes and veiled in the midband. Legendary serviceability and stunning build has made it a cult, used prices unjustifiably high.

**PHONO STAGES**

**CREEK OBH-8 SE** 1996 £180  
Punchy, rhythmic character with oodles of detail makes this a great budget audiophile classic. Partner with a Goldring G1042 for an unbeatable budget combination.

**MICHELL ISO** 1988 £ N/A  
This Tom Evans-designed black box started the trend for high performance offboard phono stages. Charismatic, musical and punchy - if lacking in finesse.



**LINN LINNK** 1984 £149  
Naim-designed MC phono stage built to partner the original Naim NAIT - yes, really! Fine sound, although off the pace these days.

**INTEGRATED AMPLIFIERS**

**NAIM NAIT XS** 2009 £1,250  
With much of the sound of the Supernait at half the price, this is powerful, articulate and smooth beyond class expectations.

**MUSICAL FIDELITY PRIMO** 2009 £7,900  
Seriously expensive, but one listen explains why. Wonderfully exuberant sound that can only come from a top quality tube design.

**SUGDEN A21A S2** 2008 £1,469  
Crystalline clarity, dizzying speed and forensic detailing. Power limited so needs sensitive speakers.

**CREEK OBH-22** 2008 £350  
Brilliant value budget passive, with remote control, mute and input switching, plus an easy, a neutral sound.

**CAMBRIDGE 840A V2** 2007 £750  
Version 2 addresses version 1's weaknesses to turn in a mightily accomplished performance, offering power, finesse and detail.

**SUGDEN IA4** 2007 £3,650  
Goodly amount of Class A power, icy clarity and a breathtakingly fast, musical sound make this one of the very best super-integrateds.

**NUFORCE P-9** 2007 £2,200  
Impressive two box preamp with superb resolution and an engaging sound.

**MELODY PURE BLACK 101D** 2007 £3,295  
The clarity and openness of valves plus firm grip and fine detail make this a preamplifier masterpiece.

**AUDIOLAB 8000S** 2006 £400  
In another life, this sold for three times the price, making it a stand-out bargain now. Very clean, powerful and tidy sound.

**MCINTOSH MA6800** 1995 £3735  
Effortlessly sweet, strong and powerful with semi-styling to match.

**DELTEC** 1987 £1900  
Fast, dry and with excellent transients, this first DPA integrated is the real deal for eighties obsessives. Ridiculously punchy 80W per channel from a tiny, half-size box. Radical, cool and more than a little strange.

**EXPOSURE VII/VIII** 1985 £625  
Seminal pre-power, offering most of what Naim amps did with just that little bit extra smoothness. Lean, punchy and musical.



**AUDIOLAB 8000A** 1985 £495  
Smooth integrated with clean MM/MC phono stage and huge feature count. Extremely reliable, too. Post '93 versions a top used buy.

**VTL MINIMAL/50W MONOBLOCK** 1985 £1,300  
Rugged, professional build and finish allied to a lively and punchy sound (albeit with limited power) make them an excellent used buy.

**MUSICAL FIDELITY A1** 1985 £350  
Beguiling Class A integrated with exquisite styling. Questionable reliability.

**MISSION CYRUS 2** 1984 £299  
Classic 1980s minimalism combines arresting styling with clean, open, lively sound. Further upgradeable with PSX power supply.



**NAIM NAIT** 1984 £350  
Superb rhythms and dynamics make it truly musical, but tonally monochromatic. Fine phono stage, very low power.

**CREEK CAS4040** 1983 £150  
More musical than any budget amp before it; CAS4140 loses tone controls, gains grip.

**MYST TMA3** 1983 £300  
Madcap eighties minimalism, but a strong and tight performer all the same.

**ROTEL RA-820BX** 1983 £139  
Lively and clean budget integrated that arguably started the move to minimalism.

**NAD 3020** 1979 £69  
Brilliantly smooth, sweet and punchy at the price and even has a better phono stage than you'd expect. The archetypal budget super-amp.

**ROGERS A75** 1978 £220  
Lots of sensible facilities, a goodly power output and nice sound in one box. The later A75II and A100 versions offered improved sonics and were seriously sweet.

**A&R A60** 1977 £115  
Sweet and musical feature-packed integrated; the Audiolab 8000A remains a classic.



**SUGDEN C51/P51** 1976 £130  
Soft sounding early Sugden combo with a plethora of facilities and filters. A sweet and endearing performer but lacking in power and poor load driving ability.

**SUGDEN A21** 1969 £ N/A  
Class A transistor integrated with an eminently likeable smoothness and musicality. Limited inputs via DIN sockets.

**ROGERS CADET III** 1965 £34  
Sweet sounding valve integrated, uses ECL86 output valves, even has a half useable phono stage, sweet, warm a good introduction to valves

**CHAPMAN 305** 1960 £40  
Smooth pre/power combo with a sweet and open sound. Not quite up to Leak/Quad standards but considerably cheaper secondhand.

## POWER AMPLIFIERS

**ELECTROCOMPANET NEMO** 2009 £4,995 (EACH)

Norwegian power station as cool as a glacier tonally, yet impresses with sheer physicality and fleetness of foot. 600W per channel.

**NUFORCE REFERENCE 9SE V2** 2006 £1,750  
Brilliant value for money monoblocks with massive power and super-clean, three dimensional sound.

**QUAD II-80** 2005 £6,000 PER PAIR

Quad's best ever power amplifier. Dramatic performer with silky but dark tonality, blistering dynamics, serious power and compellingly musical sound.



**QUAD 909** 2001 £900  
Current-dumper has a smooth and expansive character with enough wallop to drive most loads. Not the most musical, but superb value all the same.

**NAIM NAP 500** 2000 £17,950  
Flagship amplifier will drive just about any speaker with ease. Factor in the company's trademark pace, rhythm and timing and it all adds up to one effortlessly musical package.

**MARANTZ MODEL 9** 1997 £8000  
Authentic reproduction monoblocks still more than cut the sonic mustard. Highly expensive and highly sought after.

**MICHELL ALECTO** 1997 £1989  
Crisp, clean and beautifully controlled with gorgeous styling. Partnered with the £1650 Orca this sounds delicious!



**MUSICAL FIDELITY XA200** 1996 £1000  
200W of sweet smooth transistor stomp in a grooved tube! Under-rated oddity.

**PIONEER M-73** 1988 £1,200  
Monster stomp from this seminal Japanese power amplifier, complete with switchable Class A and Class B operation. Clean, open and assured sounding, albeit a tad behind the pace on high speed dance music. Rosewood side cheeks and black brushed aluminium completes the experience.

**KRELL KMA100 II** 1987 £5,750  
Monoblock version of the giant KSA-100 is one of the seminal 80s transistor power amplifiers. Massive wallop allied to clean and open Class A sound makes this one of the best amplifiers of its type.

**RADFORD STA25 RENAISSANCE** 1986 £977  
This reworking of Radford's original late sixties design was possessed of a wonderfully rich, old school valve sound with enough power (25W) and lots of subtlety.

**QUAD 405** 1978 £115  
The first of the current dumpers is a capable design with smooth, effortless power and a decently musical sound. 606 and 707 continue the theme with greater detail and incision.

**HH ELECTRONICS TPA-500 AMPLIFIERS** 1973 £110  
Simple design with easily available components, solid build quality and fine sound make for a surprisingly overlooked bargain

**LECSON AP1** 1973 £ N/A  
Madcap cylindrical styling alluded to its 'tower of power' pretensions, but it wasn't. Poor build, but decently clean sounding when working.

**QUAD 303** 1968 £55  
Bullet proof build, but woolly sound. Off the pace, but endearing nonetheless. Some pipe smoking slipper wearers swear by them!

**LEAK STEREO 20** 1958 £31  
Excellent workaday classic valve amplifier with decent power and drive. Surprisingly modern sounding if rebuilt sympathetically. Irrepressibly musical and fluid.



**LEAK STEREO 60** 1958 £N/A  
Leak's biggest valve power amp offers 35 Watts per channel and more low end welly than the smaller Stereo 20. Despite concerns over reliability rarity value means high price.

**QUAD II** 1952 £22  
The all-time classic valve amplifier, with a deliciously fluid and lyrical voice. In other respects though, it sounds hopelessly dated. Low power and hard to partner properly



**LEAK POINT ONE, TL10, TL12.1, TL12 PLUS** 1949 £28  
Early classics that are getting expensive. Overhauling is de rigueur before use, using original parts if possible. Surprisingly crisp and musical. Deeply impressive in fine fettle.

## PRE AMPLIFIERS

**AUDIOLAB 8000C** 1991 £499  
Tonally grey but fine phono input and great facilities make it an excellent general purpose tool.



**CROFT MICRO** 1986 £150  
Budget valve pre-amp with exceptionally transparent performance.

**CONRAD JOHNSON MOTIV MC-8** 1986 £2,500  
Minimalist FET-based preamplifier is brilliantly neutral and smooth with a spry, light balance in the mould of Sugden. Something of a curio, but worthwhile nonetheless

**AUDIO RESEARCH SP-8** 1982 £1,400  
Beautifully designed and built high end tube pre-amplifier with deliciously sweet and smooth sound. Not the last word in incision or grip.

**LINN LK-1** 1986 £499  
A brave attempt to bring remote controlled user-friendliness to hair-shirt audiophile hi-fi. Didn't quite work, but not bad for under £100.

**NAIM NAC 32.5** 1978 £ N/A  
Classic high end pre. Brilliantly fast and incisive sound that's a joy with vinyl! but a tad forward for digital.

**LECSON AC-1** 1973 £ N/A  
Amazing styling courtesy of Allan Boothroyd can't disguise its rather cloudy sound, but a design classic nonetheless.

**QUAD 33** 1968 £43  
Better than the 22, but Quad's first tranny pre isn't outstanding. Responds well to tweaking/ rebuilding though...



**LEAK POINT ONE STEREO** 1958 £ N/A  
Good for their time, but way off the pace these days. Use of EF85 pentode valve for high gain rules out ultra performance. Not the highest 4!

**QUAD 22** 1958 £25  
The partner to the much vaunted Quad II mono-blocks - cloudy and vague sound means it's for anacrophiles only.

**LOUDSPEAKERS**

**WHARFEDALE DIAMOND 10.3** 2010 £290  
Great small standmounters for audiophiles on a budget; dry punchy sound with impressive sound-staging at the price.



**YAMAHA SOAVO 1.1** 2009 £3,000  
Musical, transparent with impressive dynamics and cohesion. Excellent build and finish.

**USHER BE-10** 2009 £10,500  
Clever high end moving coil design with immense speed and dizzying clarity allied to epic punch. Needs the best ancillaries to fly, though...



**SPENDOR A5** 2009 £1,695  
Multi-talented floorstanders with generous scale and punch and Spendor's classic mid-range detail. Deliver a sound that thoroughly engages whatever you care to play.

**MONITOR AUDIO PL100** 2008 £2,300  
The flagship 'Platinum' series standmounter has a lovely warm and delicate sound with superlative treble.



**MARTIN LOGAN SOURCE** 2008 £1,600  
Brilliant entry level electrostatics, giving a taste of loudspeaker esoterica for the price of most moving coil boxes. Tremendous clarity, evenness and delicacy, although not the world's most powerful sound.

**PMC OB11** 2008 £2,950  
Cleverly updated floorstanders give scale and solidity in slim and well finished package

**ISOPHON GALILEO** 2007 £2,100  
Big standmounters that really grip the music and offer quite startling dynamics and grip.

**ONE THING AUDIO ESL57** 2007 £1,450  
One Thing Audio's modifications keep the good old ESL57 at the very top of the game.

**MOWGAN AUDIO MABON** 2007 £3,995  
Massively capable loudspeakers that offer dynamics, scale and clarity in an elegantly simple package. Wide range of finishes, too.

**B&O BEOLAB 9** 2007 £5,000  
Technically impressive and visually striking loudspeakers with sound quality that more than matches their looks.



**ISOPHON CASSIANO** 2007 £12,900  
Drive units featuring exotic materials allied to superlative build quality result in an immensely capable loudspeaker. Not an easy load to drive, however.

**B&W 686** 2007 £299  
Baby standmounters offer a sophisticated and mature performance that belies both their dimensions and price tag

**QUAD ESL-2905** 2006 £5,995  
The old 989 with all the bugs taken out, this gives a brilliantly neutral and open sound like only a top electrostatic can; still not a natural rock loud-speaker, though

**B&W 801D** 2006 £10,500  
In many respects, the ultimate studio monitor; dazzling clarity and speed with commanding scale and dynamics



**REVOLVER CYGNIS** 2006 £5,999  
Revolver pull out all the stops and show what they can do with this magnificent flagship loudspeaker. A superb monitor that is like a mini B&W 801D in many ways.

**USHER BE-718** 2007 £1,600  
Beryllium tweeters work superbly, allied to a fast and punchy bass driver. The result is subtle, smooth and emotive.

**USHER S-520** 2006 £350  
Astonishingly capable budget standmounters that offer detail and dynamics well beyond their price and dimensions

**ACOUSTIC ENERGY AE1 CLASSIC** 2006 £845  
Brilliantly successful remake of an iconic design; not flawless, but surely one of the most musical loudspeakers ever made



**MISSION X-SPACE** 1999 £499  
The first mass production sub and sat system using NXT panels is a sure-fire future classic - not flawless, but a tantalisingly unboxy sound nevertheless!

**MISSION 752** 1995 £495  
Cracking Henry Azima-designed floorstanders combined HDA drive units and metal dome tweeters with surprisingly warm results. Benign load characteristics makes them great for valves

**TANNOY WESTMINSTER** 1985 £4500  
Folded horn monsters which sound good if you have the space. Not the last word in tautness but can drive large rooms and image like few others



**CELESTION SL6** 1984 £350  
Smallish two way design complete with aluminium dome tweeter and plastic mid-bass unit set the blueprint for nineteen eighties loudspeakers. Very open and clean sounding, albeit course at high frequencies and limp in the bass. Speakers would never be the same again...

**HEYBROOK HB1** 1982 £130  
Peter Comeau designed standmounters with an amazingly lyrical yet decently refined sound. Good enough to partner with very high end ancillaries, yet great with budget kit too. A classic



**QUAD ESL63** 1980 £1200  
An update of the ESL57, with stiffer cabinets. Until the 989, the best of the Quad electrostatics.

**MISSION 770** 1980 £375  
Back in its day, it was an innovative product and one of the first of the polypropylene designs: warm, smooth, clean and powerful sound.

**ACOUSTIC RESEARCH AR18S** 1978 £125  
Yank designed, British built loudspeaker became a budget staple for many rock fans, thanks to the great speed from the paper drivers, although finesse was must definitely not their forte...

**YAMAHA NS1000** 1977 £532  
High tech Beryllium midband and tweeter domes and brutish 12" woofers in massive sealed mirror image cabinets equals stunning transients, speed and wallop allied to superb transparency and ultra low distortion. Partner carefully!



**JR 149** 1977 £120  
Cylindrical speaker was ignored for decades but now back in fashion! Based on classic KEF T27/B110 combo as seen in the BBC LS3/5a. Doesn't play loud, needs a powerful transistor amplifier, but has clarity and imaging.

**KEF R105** 1977 £785  
Three way Bextreme-based floorstander gave a truly wideband listen and massive (500W) power handling. A very neutral, spacious and polite sounding design, but rhythmically well off the pace.

**SPENDOR BC1** 1976 £240  
 Celestion HF1300 tweeter meets bespoke Spendor Bextrene mid-bass unit. The result is a beautifully warm yet focussed sound. A little bass bloom necessitates careful low-stand mounting.



**IMF TLS80** 1976 £550  
 Warm and powerful 1970s behemoth with transmission loading and a mixture of KEF and Celestion drive units. Impressively physical wideband sound but rhythms not a forte.

**HH ELECTRONICS TPA-50D AMPLIFIERS** 1973 £110  
 Simple design with easily available components, solid build quality and fine sound make for a surprisingly overlooked bargain. Not exactly stylish, however.

**BBC LS3/5A** 1972 £88  
 Extremely low colouration design is amazing in some respects – articulation, stage depth, clarity – and useless in others (both frequency extremes). Came in wide variety of guises from various manufacturers building it under licence.

**LEAK SANDWICH** 1961 £39 EACH  
 Warm sounding infinite baffle that, with a reasonably powerful amplifier can sound quite satisfying.

**QUAD ESL57** 1956 £45 EACH  
 Wonderfully open and neutral sound puts box loudspeakers to shame. Properly serviced they give superb midband performance, although frequency extremes less impressive. Ideally, use in stacked pairs or with subwoofers and supertweeters.

## SYSTEMS

**MERIDIAN SOOLOOS 2.1** 2010 £6,990  
 Crisp styling, bright, colourful touchscreen, plus excellent search facilities. This is one hard disk music system with a difference. Best partnered to Meridian active loudspeakers.



**NAIM UNIQUTE** 2010 £995  
 Great little half width one-box system with truly impressive sound allied to a wealth of source options.

**ARCAM SOLO MINI** 2008 £650  
 Half the size and two-thirds the price of a full-sized Solo, the Mini gives very little away in terms of performance to its bigger brother.

**MERIDIAN F80** 2007 £1,500  
 Fantastically built and versatile DVD/CD/DAB/FM/AM unit, designed in conjunction with Ferrari. Ignore nay-sayers who sneer that it isn't a 'proper' hi-fi product. Just listen.

**SHANLING MC-30** 2007 £650  
 Quite possibly the cutest all-in-one around with fine performance from the CD player, tuner and MP3 player input. Very low power, though.



**AURA NOTE PREMIER** 2007 £1,500  
 Lovely shiny CD/tuner/amplifier with fine sound quality and dynamic abilities.



**MARANTZ 'LEGEND'** 2007 £22,000  
 The combination of SA-7S1 disc player, SC-7S2 preamp and MA-9S2 monoblocks delivers jaw-dropping performance.

**ARCAM SOLO NEO** 2006 £1,100  
 Excellent all-in-one system, with a warm, smooth and balanced sound to match the features and style.

**PEACHTREE AUDIO IDECCO** £1,000  
 Excellent sounding iPod dock, impressive DAC and fine amplifier section make this an excellent one box style system.



## TUNERS

**ARCAM FMJ T32** 2009 £600  
 Excellent hybrid FM/DAB+ tuner with a smooth, engaging sound. Factor in its fine build and it's a super value package.



**MAGNUM DYNALAB MD-100T** 2006 £1,895  
 One of the best ways to hear FM that we know; superbly open and musical sound in a quirky but characterful package.

**MYRYAD MXT4000** 2005 £1,000  
 Sumptuous sound and top-notch build quality make for a tempting AM/FM package. Warm and richly detailed on good-quality music broadcasts.

**NAIM NAT03** 1993 £595  
 The warm, atmospheric sound is further proof of Naim's proficiency with tuners.

**CREEK CAS3140** 1985 £199  
 Excellent detail, separation and dynamics - brilliantly musical at the price. T40 continued the theme...

**QUAD FM4** 1983 £240  
 Supreme ergonomics allied to a pleasingly lyrical sound with plenty of sweetness and detail made this one of the best tuners around upon its launch.



**NAD 4040** 1979 £79  
 Tremendously smooth and natural sound allied to low prices and good availability make this budget analogue esoterica.

**MARANTZ ST-8** 1978 £353  
 Marantz's finest radio moment. Warm, organic sound plus an oscilloscope for checking the signal strength and multipath.

**YAMAHA CT7000** 1977 £444  
 Combines sleek ergonomics, high sensitivity and an explicit, detailed sound.

**SONY ST-5950** 1977 £222  
 One of the first Dolby FM-equipped tuners, a format that came to nought. Still, it was Sony's most expensive tuner to date, and boasted good sound quality with brilliant ergonomics.



**ROGERS T75** 1977 £125  
 Superb mid-price British audiophile design, complete with understated black fascia. Smooth and sweet with fine dimensionality.

**SANSUI TU-9900** 1976 £300  
 A flagship Japanese tuner. It boasts superlative RF performance and an extremely smooth and fluid sound.



**TECHNICS ST-8080** 1976 £180  
 Superb FM stage makes for a clean and smooth listen.

**REVOX B760** 1975 £520  
 The Revox offers superlative measured performance although the sound isn't quite as staggering as the numbers. Fine nonetheless, and surely the most durable tuner here?

**SEQUERRA MODEL 1** 1973 £1300  
 Possibly the ultimate FM tuner. Massive in terms of technology, size and features dedicated to extracting every ounce of performance from radio, including impressive multi-purpose oscilloscope display.

**LEAK TROUGHLINE** 1956 £25  
 Series I an interesting ornament but limited to 88-100MHz only. II and III are arguably the best-sounding tuners ever. Adaptation for stereo easy via phono multiplex socket. Deliciously fluid with true dimensionality.



## HEADPHONE AMPLIFIERS

**GRAHAM SLEE NOVO** 2009 £255

Dynamic headphone amplifier with a great sense of timing. Crisp, clear treble and warm midrange gives an involving sound.



**MUSICAL FIDELITY X-CAN V8** 2008 £350

Open and explicitly detailed sound plus serious bass wallop. A great partner for most mid-to-high end headphones.

## CD PLAYER/RECORDERS

**MUSICAL FIDELITY TRIVISTA** 2002 £4000

When playing SACDs, the sweetest, most lucid and lyrical digital disc spinner we've heard. Old school stereo, pure DSD design. CD sound is up in the £1000 class, too! Future classic.

**MARANTZ SA-1** 2000 £5,000

The greatest argument for SACD. This sublime Ken Ishiwata design is utterly musically convincing with both CD and SACD, beating most audiophile CD spinners hands down.



**SONY MDS-JE555ES** 2000 £900

The best sounding MD deck ever, thanks to awesome build and heroic ATRAC-DSP Type R coding.

**PIONEER PDR-555RW** 1999 £480

For a moment, this was the CD recorder to have. Clean and detailed.

**MARANTZ DR-17** 1999 £1100

Probably the best sounding CD recorder made; built like a brick with a true audiophile sound and HDCD compatibility.



**CAMBRIDGE AUDIO CD4SE** 1998 £200

A touch soft in the treble and tonally light, but outstanding in every other respect.

**SONY TCD-8 DATMAN** 1996 £599

Super clean sound makes this an amazing portable, but fragile.

**LINN KARIK III** 1995 £1775

The final Karik was a gem. Superb transport gives a brilliantly tight, grippy dynamic sound, albeit tonally dry.

**NAIM CDS** 1990 £ N/A

Classic Philips 16x4 chipset with serious attention to power supplies equals grin-inducing sonics.

**MARANTZ CD73** 1983 £700

A riot of gold brushed aluminium and LEDs, this distinctive machine squeezed every last ounce from its 14x4 DAC - super musical.



**MERIDIAN 207** 1988 £995

Beautifully-built two-box with pre-amp stage. Very musical although not as refined as modern Bitstream gear. No digital output.

**SONY CDP-R1/DAS-R1** 1987 £3,000

Sony's first two boxer was right first time. Tonally lean, but probably the most detailed and architectural sounding machine of the eighties.

**CAMBRIDGE AUDIO CD1** 1986 £1500

Inspired Stan Curtis redesign of Philips CD104, complete with switchable digital filter. Lean but tight and musical performer.



**MERIDIAN MCD** 1984 £600

The first British 'audiophile' machine was a sweeter, more detailed Philips CD100 14x4 never sounded so good, until the MCD Pro arrived a year later.

**SONY CDP-701ES** 1984 £890

Sony's first bespoke audiophile machine used a 16x2 DAC to provide a clinically incisive sound; supreme build quality allied to the pure unadulterated luxury of a paperbook-sized remote control.

**YAMAHA CD-X1** 1983 £340

Nicely built 16x2 machine with a very sharp and detailed sound; sometimes too much so. Excellent ergonomics, unlike almost every other rival of the time.

**SONY CDP-101** 1982 £800

The first Japanese CD spinner was powerful and involving. Brilliant transport more than compensated for 16x2 DAC, and you even got remote control!



## ANALOGUE RECORDERS

**AIWA XD-009** 1989 £600

Aiwa's Nak beater didn't, but it wasn't half bad nonetheless. Massive spec even included a 16x4 DAC!

**NAKAMICHI CR-7E** 1987 £800

The very best sounding Nakamichi ever - but lacks the visual drama of a Dragon.



**SONY WM-D6C** 1985 £290

Single capstan transport on a par with a Swiss watch, single rec/replay head better than most Naks. Result: sublime.

**PIONEER CTF-950** 1978 £400

Not up to modern standards sonically, but a great symbol of the cassette deck art nonetheless.

**YAMAHA TC-800GL** 1977 £179

Early classic with ski-slope styling. Middling sonics by modern standards, but cool nonetheless!

**SONY TC-377** 1972 £N/A

A competitor to the Akai 4000D open reel machine, the Sony offered better sound quality and is still no slouch by modern standards.

**REVOX A77** 1968 £145

The first domestic open reel that the pros used at home. Superbly made, but sonically off the pace these days.

## COMPACT DISC TRANSPORTS

**ESOTERIC P0** 1997 £8,000

The best CD drive bar none. Brilliantly incisive, ridiculously over engineered.

**TEAC VRDS-T1** 1994 £600

Warm and expansive sound made this a mid price hit. Well built, with a slick mech.

**KENWOOD 9010** 1986 £600

The first discrete Jap transport was beautifully done and responds well to re-clocking.

## DACS

**DCS ELGAR** 1997 £8500

Extremely open and natural performer, albeit extremely pricey - superb.

**DPA LITTLE BIT 3** 1996 £299

Rich, clean, rhythmic and punchy sound transforms budget CD players.

**CAMBRIDGE AUDIO DAC MAGIC** 1995 £99

Good value upgrade for budget CD players with extensive facilities and detailed sonics.

**PINK TRIANGLE DACAPD** 1993 £ N/A

Exquisite, the warmest and most lyrical 16bit digital audio we have ever heard.

**QED DIGIT** 1991 £90

Budget bitstream performer with tweaks aplenty. Positron PSU upgrade makes it smooth, but now past it.

## CABLES

**MISSING LINK CRYO REFERENCE 2008**  
£495/0.5M

High end' interconnects, with deliciously smooth, open and subtle sound without a hint of edge.

**TECHLINK WIRES XS** 2007 £20

Highly accomplished interconnects at an absurdly low price. Stunning value for money.

**VDH ULTIMATE THE FIRST** 2004 £250

Carbon interconnects that help you forget the electronics and concentrate on the music. Miraculous transparency. Tight and tuneful bass mixed with air and space.



**WIREWORLD OASIS 5** 2003 £99/M

Excellent mid-price design with a very neutral, silky and self-effacing sound. Superb value for money.

**TCI CONSTRICTOR 13A-6 BLOCK** 2003 £120

Top quality 'affordable' mains outlet block, with fine build and good sonics. Well worth the extra over standard high street specials, which sound coarse and two-dimensional by comparison.

# vinyl section

## contents

MARCH 2017

[www.hi-fiworld.co.uk](http://www.hi-fiworld.co.uk)

### LUXMAN EQ-500 84

Noel Keywood gets to grips with Luxman's new and lavishly-featured valve-based phono stage.

### MOBILE FIDELITY 89

Paul Rigby talks to Mobile Fidelity about its innovative One Step mastering/pressing process.

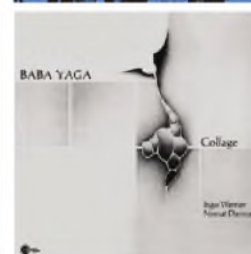

# news

DAVE BRUBECK QUARTET  
TIME OUT  
STEREO + MONO



## JAZZ CLASSICS

Featuring newly remastered, one-time pressing 180gm releases, this new Jazz Classics batch ([www.discovery-records.com](http://www.discovery-records.com)) includes Dave Brubeck's classic 'Time Out', an exploration in time signatures. Deservedly one of the most popular jazz albums of all time. This edition includes both stereo and mono versions.

From 1959, Cannonball Adderley recorded 'Them Dirty Blues' with his brother, cornetist Nat Adderley. This is soul-jazz that is full of spirit and sparkle with a post-bop technicality.

Finally, Miles Davis-era John Coltrane's 'Settin' The Pace', a relaxed, easy-going outing that pushes boundaries but retains a thoughtful rhythm.

Also look out for guitarist Wes Montgomery's 'The Montgomery Brothers' from 1958 plus Dizzy Gillespie Octet's 'The Greatest Trumpet of Them All' (1957), a surprisingly repressed and even self-consciously restrained outing.

## WAH WAH

Two pairs from this superb Spanish label ([www.wah-wahsupersonic.com](http://www.wah-wahsupersonic.com)). Sweet Marie was a melodic, harmony-drenched Hollywood group who travelled to Hawaii after the national success of 'I', which featured the hit 'Remember Mary'. Sequel 'Stuck in Paradise', a blues-laden rock outing, is well worth grabbing as hard rock of a different stripe.

The second pairing comes from Baba Yaga, a kraut-fusion band formed by Ingo Werner (ex-My Solid Ground) and Nemat Darman (Iranian percussionist, multi-instrumentalist). 'Collage' (1974) is mixed Eastern improv and spaced out experimentations while 'Featuring Ingo Werner' (1974) offers an art rock, Cressida-like approach that smells very British prog-like in tone.

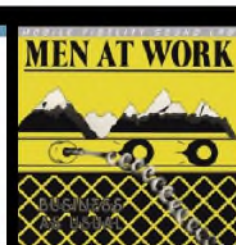

## MOBILE FIDELITY

Three from this US-based audiophile outfit ([www.mofi.com](http://www.mofi.com)) including Hall & Oates's 'Rock 'n Soul, Pt. I: Greatest Hits' (1983) spanning a host of hits including 'Kiss on My List', 'Private Eyes' and 'I Can't Go for That (No Can Do)'.

Love's 'Forever Changes' (1967) was almost ignored upon initial release but has now been recognised as a masterpiece, an evocative album.

Finally, Men At Work's 'Business as Usual' features 'Who Can It Be Now?' and 'Down Under', combining pop/rock hooks with a quirky new wave production.



## MUSIC ON VINYL

Keeping up its relentless pace and variety, Music On Vinyl ([www.musiconvinyl.com](http://www.musiconvinyl.com)) launches into this issue with jazz rock outfit Colosseum's 'Valentyne Suite' (1969) which is more a blues cum prog LP. Doesn't quite live up to its reputation but still worthy of a listen as is folkies Pentangle's incredible 1968 spacious and dynamic debut 'The Pentangle'. It hits the ground running and stars John Rembourn and Bert Jansch on guitars.

From the ladies is Carla Thomas' debut 'Gee Whiz' (1968), a poppy outing built around the title track single. Not Stax-like at all...or Thomas-like, for that matter.

Also out is Sarah McLachlan's star-making 'Fumbling Towards Ecstasy' – her 1993, plainly spoken and candid masterpiece that broke ground for future female singer-songwriters.

Also look out for the rather ham-fisted 2004 album from Cypress Hill 'Till Death Us Do Part'; The Bad Plus's new release 'It's Hard', offering innovative pop covers in a jazz setting; Mobb Deep's accessible, rather approachable 'Infamy' (2001) that introduced the group to a wider audience and, finally, Delinquent Habits' 'Here Come The Horns' (1998) a Latino hip-hop group combining English and Spanish lyrics.

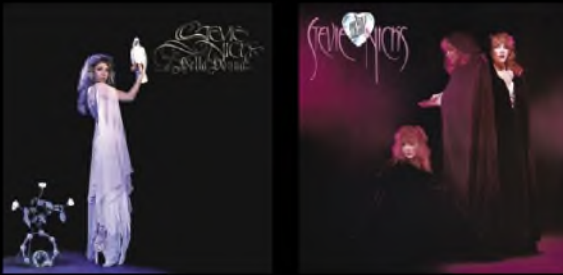

## STEVIE NICKS

Two Rhino reissues from Stevie Nicks. Her debut 'Bella Donna' (1981) features hits such as 'Leather and Lace' (featuring Don Henley) and her duet with Tom Petty, 'Stop Draggin' My Heart Around'. Engaging and relatively understated. 'The Wild Heart' (1983) retained the formula but did it well meaning that both LPs sound as if they've fallen out of the same sleeve.

## MOZART

'Symphonies No.25, No.35 "Haffner" and No.39' from Wiener Philharmoniker via Riccardo Muti has been remastered as a numbered limited edition from the original masters via Georg Burdisek, pressed via Germany's respected Pallas plant and released via those very nice turntable people at Pro-ject ([www.henleydesigns.co.uk](http://www.henleydesigns.co.uk)).



## ...AND FINALLY

Cliff Richard's back via Sony with 'Just...Fabulous Rock'n'Roll', his 101st album, including a duet with Elvis Presley (really) on 'Blue Suede Shoes'. It also features Peter Frampton.



Chip Wickham's 'La Sombra' (*Lovemonk*; <http://lovemonk.net/tag/chip-wickham/>) is a jazz-groove cross-over in the same vein as early Yusef Lateef. Don't call it jazz, call it music.



A double album, Simple Mind's 'Acoustic' (*Caroline*; [www.simpleminds.com](http://www.simpleminds.com)) is just that, low-key versions of energetic originals. Features three bonus tracks.

Baltic Fleet's self-titled LP on clear vinyl (*Blow Up* [www.blowup.co.uk](http://www.blowup.co.uk)) centres around Paul Fleming (keyboards with Echo & The Bunnymen for five years) and offers light, happy chappy, poppy synths. The friendly face of electronica.



From Marianne Dissard, a dramatic, sincere and terribly meaningful French lyricism via 'The Cat Not Me' ([www.vacilando68.org](http://www.vacilando68.org)) in which Dissard views this pop thing with an almost smirking patience.

Donna Summer fans look out for 'The Ultimate Collection' (Crimson) featuring two LPs of hits including the 3:56 version of MacArthur Park (these things matter to fans) and a 7" remix of 'I Don't Want to Get Hurt'.



Finally, Animotion is back (remember 1984's hit single, 'Obsession?'). 'Raise Your Expectations' (*Invisible Hands*; [www.invisiblehands.co.uk](http://www.invisiblehands.co.uk)) is pop-friendly, chart-friendly, radio-friendly, dance-floor friendly. No thinking required.

# Luscious Lux

**Luxman's new valve-based EQ-500 phono stage is a purist design aimed at bringing the best out of your vinyl. Noel Keywood explains all.**

**T**he Luxman EQ-500 phono stage I am reviewing here costs £4495 and, looking inside, I almost fell backward in disbelief: it is one of the most complex and purist designs I recall seeing, brimming full of parts, as our internal shot shows.

Luxman say it is “a vacuum tube design for all stages” and looking inside I could see this is the case. It is a veritable work of art internally, extremely complicated and purist in its design approach.

The EQ-500 is big and heavy: it weighs 12.5kg when unpacked. A lot of this lies in the sheet steel cover and chassis. Thick mild steel provides good electromagnetic screening to prevent hum but Luxman have additionally used a screened internal chamber for the valve amplifying stages, with a cover of copper-plated steel. Copper plating lessens magnetically induced eddy currents and that, it has been plausibly claimed, improves the sound by not inducing

magnetic hysteresis distortions back into the circuitry.

Measuring 397mm deep, the unit needs a shelf at least 16in deep – and make that 18in when a rear protruding XLR connector is used. That's more than most turntables need. With a width of 440mm (17in) it will fit a 19in rack and the low height of 92mm means it occupies little vertical space. Having an internal mains power supply, itself well-screened, it will be usable below most turntables without inducing hum into a sensitive pick-up cartridge just above. This was the case when placed in a rack directly below our turntable (details later); our system was hum free.

The small illuminated meters give reassurance that the unit is not being overloaded due to the use of incorrect settings, overload being marked as a red sector at the top end of the scale. A meter sensitivity lever switch that can be flipped upward to High to enable music dynamics to be better seen.

Luxman offer front panel rotary selector buttons that provide a wide range of input options that must be manually selected to suit the turntable used. For MM cartridges input impedance is 47k nominal as usual, with 30k and 100k minimum and maximum (rarely needed) options. Input capacitance can set from 0pF to 300pF to tweak treble a little, the high value often being a good choice at taking the sting out of high treble whilst boosting midrange presence.

Then there are Moving Coil (MC) cartridge options: MC High (output) and MC Low. High output types have more coil turns and need a higher load, commonly 400 Ohms and this is the value quoted on the website, whilst the handbook says 40 Ohms – unusually low (see Measured Performance for more on this).

The MC Low option is set very low, to 2.5 Ohms quoted (website and handbook), where 100 Ohms is usual and 10 Ohms an absolute minimum. This is so unusual I had to



measure it to be sure there wasn't an error. It is however, technically justifiable in that for best power transfer through a transformer the load must match the generator, this giving the best signal to noise ratio, since MC cartridges typically have 1-2 Ohm generators. Luxman have used permalloy input transformers on both MC High and Low – four in all – to get optimum performance on both inputs.

Anyway, the final outcome is a massively low noise (hiss) floor, 6dB or lower than any other phono stage; with volume right up there is no hiss. The EQ-500 is then the go-to preamp if you intend to use a really esoteric, low output MC cartridge. It has massive dynamic range. However, I cannot understand why, with input transformers, Luxman did not provide balanced inputs as an option.

There is also a Phase Invert switch that some insist offers obvious improvement with 'out of phase' LPs, a Mono/Stereo selector that will reduce noise when playing mono LPs with a stereo cartridge, plus Low Cut and High Cut filters. The Low Cut is a warp filter to eliminate loudspeaker cone flap when playing warped records and the High Cut drastically cuts treble to suppress surface noise, ticks and pops. There is also an Articulation demagnetiser.

The rear panel carries balanced XLR socketed outputs, fed from expensive output transformers – not cheap chips. There are two pairs of phono socket outputs too.

All three inputs are via phono sockets, with gold-plated earth terminals. Three turntables can be permanently connected and switched between.

A valve-rectified power supply, using an EZ81 and a choke, is fitted. Amplifying valves are four ECC83 and two ECC82 double triodes.

The EQ-500 is superbly finished in classic 1970s Japanese style but is built to much higher standards of component quality – both possible and expected today. Switch on was accompanied by a firm click of the push button power switch and a mute circuit keeps switch-on silent through the hi-fi.

## SOUND QUALITY

As I use valve phono stages out of choice, some distinctive properties of the EQ-500 made themselves obvious. It has a relatively dry and specific sound tonally, rather than being warm or lush. Violins in 'Mozart's Symphony No35' stood forward on the soundstage. There was a rich sense of detail within the strings, with instruments well separated from each other. The performance was expansive, stretching in a wide and densely-filled arc between the XStat panels of our Martin Logan ESL-X hybrid electrostatic loudspeakers. The Luxman doesn't have quite the sense

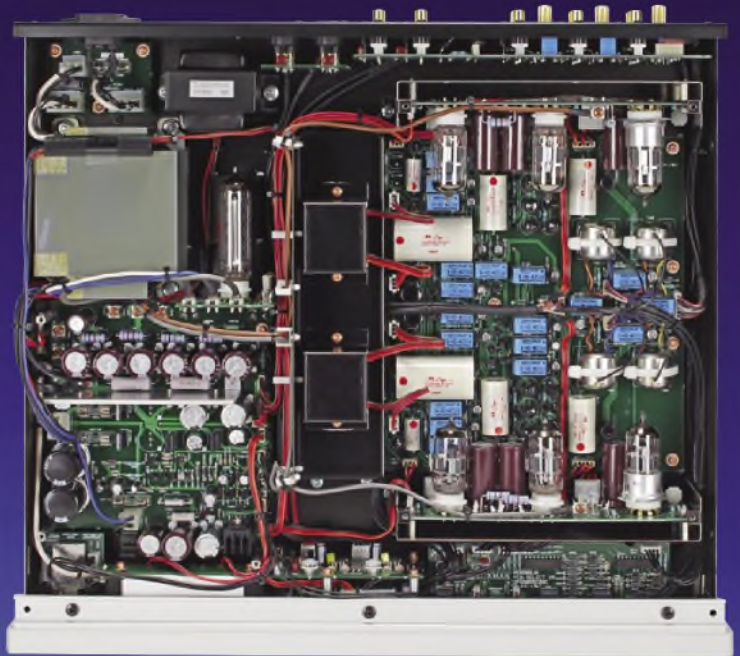

*Inside an internal screened compartment sits double triode amplifying valves, lying horizontally for a low profile. At centre right are four small permalloy input transformers, for MC High and MC Low.*

of depth of our Icon Audio PS3, exchanging that for a more intense sense of analysis.

The sense of tautness and control within the sound affected how this pre-amp played bass with the introductory notes in Kate Bush's 'King of the Mountain' from Aerial (180gm) being placed perfectly in pitch and power: I could clearly hear how the scale was being covered. The EQ-500 plays bass tight and clean and made more sense of our new-purchase Fleetwood Mac 'Rumours' LP that sounds like it was recorded

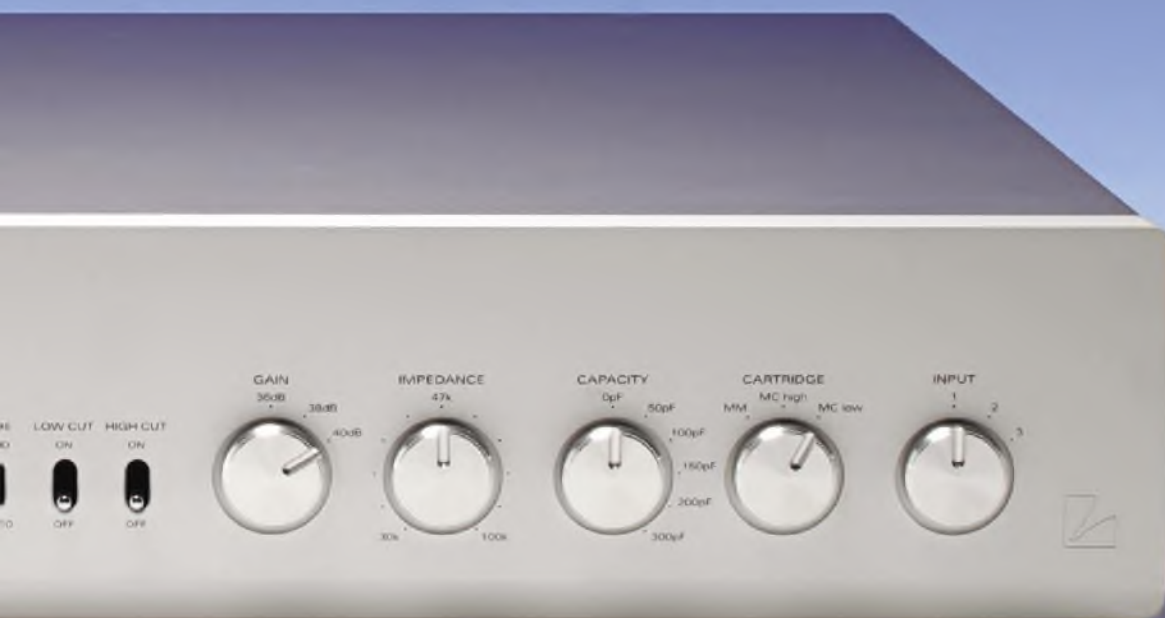



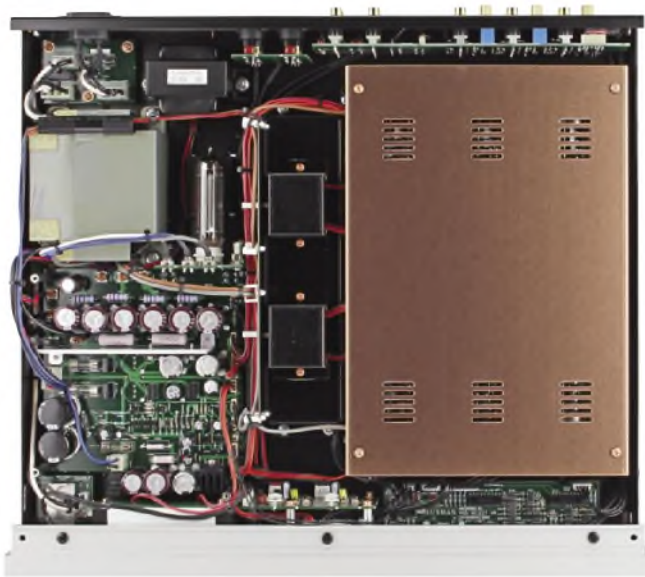

**Inside the EQ-500 lie screened mains transformers top left and the EZ81 rectifier. At centre are the square black output transformers and at right lies a copper plated steel screening case housing the valve amplifiers.**

in a cardboard shoe box (where our hi-res digital files from the master tapes do not). The dry sound of the Luxman dispersed some of the cardboard character and kept a tight grip on both Mick Fleetwood's drumming and John McVie's bass.

Amy Winehouses's 'Back to

Black' made clear just how revealing the Luxman is, putting an intense spotlight onto her vocals.

Spinning Otis Redding on 'Otis Blue', accompanying musicians Booker T and the M.G.s with The Mar-Keys playing live behind him at the Stax Studios in Memphis, 1965,

were all set out right in front of me, the Luxman mining every fine nuance and detail within the various tracks – fabulous. I felt like I was there.

With our Timestep Evo modified Technics SL-1210 turntable and SME309 arm carrying an Ortofon A-95 MC pick-up cartridge, I found the EQ-500 had barely enough gain to drive our McIntosh MC152 or Icon Audio Stereo 30SE power amps loud: it needs a preamp with gain. Lack of a volume control prevents it from running power amps direct, although I settled on our Icon Audio Stereo 30SE with volume control because it is a great match to the Martin Logan ESL-X electrostatics

**CONCLUSION**

Luxman's EQ-500 is a wonderfully pure phonostage in concept and design. It delivers fabulous sound and can lay claim to having a measured dynamic range above all else.

There is insight, analysis and control just about no other phono stage can match along with classic valve smoothness, time domain liquidity and good stage depth. A go-to product if you have a quality MC cartridge and want to be amazed/thrilled by LP.

**MEASURED PERFORMANCE**

Target gain for an MC phono stage is x1000 or 60dB, very low output designs needing 70dB. At maximum gain (MC Low, 40dB) the EQ-500 delivered x2700 (69dB), so it suits very low output MCs. Overload occurred at 13V out (1% thd), which translates back to 5mV in. The balanced XLR output delivered identical gain.

Maximum gain with MC High was x920 (59dB), overload occurring at 13V out / 15mV in – a good result.

There was a problem with input impedances. MM was correct at 47k, but MC High is quoted as 400 Ohms (about right) but measured 70 Ohms. This is lower than the common value of 100 Ohms, and far from spec.

Luxman quote MC Low as having a very low input impedance of 2.5 Ohms, but this measured 7 Ohms. The lowest advisable input impedance for MC is around 10 Ohms, but 7 Ohms is acceptable. MC High is fine for most MC cartridges, the MC Low input being for super low output types.

A direct consequence of using such a low input impedance with transformers is ultra-low noise and this the EQ-500 had, equivalent input noise (A wtd.)

being 0.04µV – 6dB quieter than the quietest MC preamps available. So in spite of using valves, which are noisier than transistors, the input transformers have been proportioned to make this the quietest MC preamp on the market.

The meters, set to Low (sensitivity) indicate maximum (0dB) at 1mV, 2mV and 9mV input with MC Low, MC High and MM respectively – conservatively low values well below overload.

RIAA equalisation was accurate, giving flat frequency response across the audio band with MC and MM, although gain was running out with MC so there is a slow roll off below 50Hz. Switching in the Low Cut filter rolls down output strongly below 50Hz, producing -14dB attenuation at 6Hz where warps are strongest – a good result. The High Cut filter rolls down treble fast above 3kHz and will produce a warm sound, but certainly lessen surface noise, ticks and pops etc.

The EQ-500 offers exceptional results. With ultra low noise input transformers, all-valve amplification and balanced line output transformers it is a highly specialised design that has been well executed. **NK**

Frequency response	20Hz-20kHz
Separation	86dB
Noise (e.i.n.)	0.04µV
Distortion	0.05%
Gain (max)	x2700 (69dB)

**FREQUENCY RESPONSE**

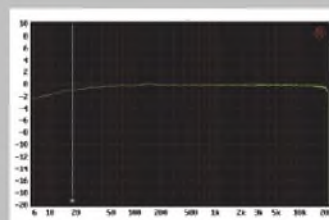

**DISTORTION**

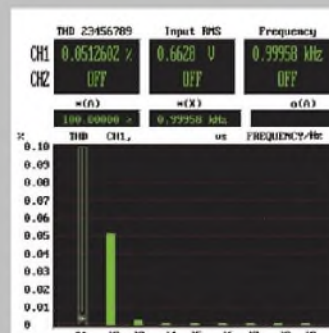

**LUXMAN'S EQ-500**  
£4,495



**OUTSTANDING - amongst the best.**

**VERDICT**

A wonderful valve phono stage in its sound: taut, insightful and pure. Beautifully made too.

**FOR**

- analytical sound
- build and finish
- meters
- ultra low noise

**AGAINST**

- no balanced input
- no output level control
- needs a preamp
- big and heavy

IAG  
+44 (0)1480 447700  
www.quad-hifi.co.uk

## Annual Clearance

	Retail	Clearance
Bel Canto REF500M power amplifier (pair)	£3,998	<b>£2,199</b>
Bel Canto REF1000M Mk2 power amplifier (pair)	£7,000	<b>£2,499</b>
Bryston 28B SST2 1000W power amplifier (pair)	£19,000	<b>£7,599</b>
Burson Audio Timekeeper	£1,950	<b>£1,199</b>
Burson Audio Conductor SL9018	£1,199	<b>£999</b>
Chord Chordette Maxx amplifier	£989	<b>£799</b>
Chord Sarum speaker cable (3.5m pair)	£3,850	<b>£2,999</b>
Clearaudio Performance DC turntable	£2,495	<b>£1,999</b>
Cyrus 82 DAC QX (Quartz Silver)	£1,970	<b>£1,549</b>
Cyrus SmartPower	£599	<b>£349</b>
Denon AVP-A1HD processor	£5,799	<b>£1,499</b>
Denon DVD-A1UD universal player	£4,500	<b>£1,199</b>
Devialet 200	£5,490	<b>£4,399</b>
Devialet 250 Companion	£7,990	<b>£5,499</b>
Devialet 400	£9,890	<b>£6,999</b>
Dynaudio Focus 220	£2,500	<b>£799</b>
Focal Diablo Utopia + stands (White Carrara)	£9,898	<b>£6,499</b>
Focal Scala Utopia V2 (Black Lacquer)	£21,399	<b>£12,749</b>
Grace M903 headphone amplifier	£2,150	<b>£1,599</b>
KEF Reference 1 (Gloss Rosewood)	£5,000	<b>£4,249</b>
KEF Reference 3 (Walnut)	£7,500	<b>£6,399</b>
KEF Reference 5 (Gloss Black)	£10,500	<b>£8,899</b>
KEF R500 (Walnut)	£1,500	<b>£1,149</b>
KEF R700 (Rosewood)	£2,000	<b>£1,549</b>
Lavry AD122-96 MKIII (analogue to digital converter)	£5,360	<b>£3,199</b>
Lavry 3000S (sample rate/bit depth converter)	£4,248	<b>£2,099</b>
Linn Akurate 212 (Rosenut)	£4,380	<b>£3,299</b>
Linn Akurate 4200 (Silver)	£5,270	<b>£3,849</b>
Linn LP12 Akurate (Walnut, no cartridge)	£5,270	<b>£4,449</b>
Linn Majik 4100 (Black)	£2,410	<b>£1,899</b>
Mark Levinson No32 Reference preamp	£15,000	<b>£7,499</b>
Moon 180 MiND streamer	£799	<b>£499</b>
Moon 380D MiND DAC streamer	£4,500	<b>£2,999</b>
Musical Fidelity E20 and E30	£900	<b>£649</b>
Pass Labs XP-25 phono stage	£12,000	<b>£6,499</b>
Plinius SA-Reference power amplifier	£17,000	<b>£13,599</b>
PMC Fact 12 (Tiger Ebony)	£12,995	<b>£9,749</b>
Proac D20R (Cherry)	£4,750	<b>£3,749</b>
PS Audio P5 mains regenerator	£3,500	<b>£2,199</b>
Quad PA One headphone amplifier	£1,200	<b>£999</b>
Raidho D1 + stands (Walnut Burl)	£15,125	<b>£10,599</b>
Sennheiser HD800 headphones	£1,099	<b>£799</b>
Sennheiser IE800 headphones	£599	<b>£499</b>
Sim2 HT5000 projector	£42,500	<b>£7,499</b>
Sonus Faber Olympica II (Graphite)	£5,398	<b>£5,049</b>
Sonus Faber Olympica III (Walnut)	£8,998	<b>£6,799</b>
Sonus Faber Venere 1.5 + stands (Gloss Black)	£1,298	<b>£999</b>
Spendor A5R (Walnut)	£1,995	<b>£1,399</b>
Torus RM16 power conditioner	£7,900	<b>£1,999</b>
Vitus RCD-101 (Black)	£9,700	<b>£7,249</b>
Vitus RI-100 (Black)	£9,900	<b>£6,999</b>
YG Acoustics Carmel (Silver)	£20,000	<b>£14,999</b>

Welcome to Criterion Audio's annual clearance, where we have great prices on ex-demo and customer trade-in stock from the last year. You can help us make space for the amazing new models and brands we are bringing in.

info@critterionaudio.com | 01223 233730  
www.critterionaudio.com



TO ADVERTISE HERE  
PLEASE CALL JOANNA HOLMES ON  
+44 (0) 7958 602347  
OR EMAIL:  
joanna@hi-fiworld.co.uk



# One Step Beyond

Looking to push the vinyl mastering/pressing envelope, Paul Rigby talks to John Wood and Shawn Britton of Mobile Fidelity about its innovative One Step vinyl process.



“Instead of utilising the industry-standard three-step lacquer process, Mobile Fidelity Sound Lab’s new UltraDisc One-Step (UDIS) uses only one step, bypassing two processes of generational loss”.

So said the company. Hence, the UDIS stamper, called a convert, produces the actual records. None of this ‘father’, ‘mother’ routine that you normally see, the world over, when vinyl is made on a day-to-day basis from negative and positive copies before the final vinyl is created for commercial sale (see the accompanying graphic).

“We compared the test pressing One Step recordings with the standard pressings,” explained Senior

Mastering Engineer Shawn Britton. “We heard a better signal to noise ratio and the surface noise was lower. To use audiophile reviewer terms [lots of sarcasm here] ‘the blacks are blacker!’ Meaning it’s fricken’ quieter, you know?!”

The first release using the system is Santana’s ‘Abraxas’. It starts out with the track ‘Singing Winds, Crying Beasts’ with cymbal washes and then, what Stan Ricker (the late, great mastering engineer and pioneer of half-speed mastering) used to call “‘Twinkly s\*\*t.” Which was a great term to use at hi-fi shows, by the way. For those wind chimes, you hear greater detail. You hear more of those low-level details. Reverb tails carry out better, there’s a more pliable sound stage. It’s pretty impressive. I thought that it might be



**Shawn Britton, Mobile Fidelity’s Chief Mastering Engineer.**

# Audio Venue

bespoke audio visual consultants

The World's finest audio visual equipment



Auralic Aries



Bowers & Wilkins  
800 D3



Naim Uniti Atom



Proac K6



Classe Audio Sigma 2200i



PMC Twenty5.24

Trade ins and interest  
free credit available

27 Bond Street  
Ealing  
London W5 5AS  
T 020 8567 8703  
E w5@audiovenue.com

36 Queen Street  
Maidenhead  
Berkshire SL6 1HZ  
T 01628 633 995  
E info@audiovenue.com

[audiovenue.com](http://audiovenue.com)

**BRANDS INCLUDE** Anthem, Arcam, Audeze, Audio Research, Audiophile Base, Audioquest, Astell & Kern, Dagastino, Inc, Bowers & Wilkins, Chord, Classe Audio, Control 4, Devialet, Esoteric, Hana, JL Audio, Kaleidescape, KEF, Koetsu, Krell, Luxman, Mark Levinson, Martin Logan, Michell Engineering, Musical Fidelity, Naim Audio, OPPO, PMC, Primaluna, Proac, Project, PS audio, Rotel, Ruark Audio, Sennheiser, SME, SONOS, Sonus Faber, Spectral Furniture, Quadraspire, Wilson Audio, Yamaha, and many more...

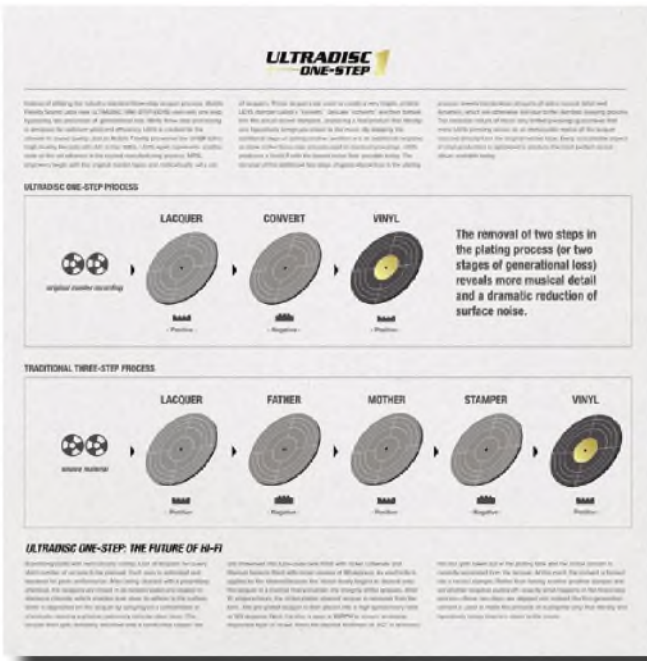

**The Ultradisc One Stop process compared to the standard pressing process.**

a high frequency thing but we now think that the bass is more solid too”.

Why does the One Step system sound so good? Well the clue is in that first paragraph. “I would think from a physical point of view that, when you electro-plate something and then peel it apart, as in the case of a lacquer and the convert, then metallise that – which would make it a father at that point – and then peel that apart, there’s bound to be some slight distortions introduced in those processes” said Britton. “If you think about the groove walls, these things are 2mil deep, smaller than a human hair. The grooves, therefore, are so small that groove wall deformation is entirely possible.”

Hence, if you remove the extra

steps currently utilised in the vinyl record creation process – and these processes are very physical – then there is less chance of even tiny groove deformations occurring and thus more chance for the music to really sing.

“In LP mastering, one of the concerns that you always have is that low level details are going to be lost in the surface noise, so what some people (i.e. mastering engineers) do, in very quiet passages, is goose up the level a little bit to get it out of the surface noise, but you don’t have to do that now, with One Step” said Britton. “That’s something that we like to stay away from here, we want the full dynamic range of the music as it is off the master tapes.



**The One Step process certainly allows us to lower the levels, said Britton.**

Adjusting any levels would only be for the greater good of the album. For example, to equalise the volume over different tracks so that you are not adjusting the volume control track by track, so it doesn’t jar. That’s dependent on the mixing too”.

The One Step process, which also runs at 45rpm to further enhance sound quality, might produce superb sonics but it is hardly a common process. As Executive Vice-President of Mo-Fi John Wood explained.

“No-one has tried this process commercially before, it’s too



**John Wood, Executive Vice President at Mobile Fidelity**

expensive. I know of no-one else who has done it before in the same way that we are doing it. There might have been a few small experiments out there. I know that Stereophile magazine tried to do it, for example, but they abandoned the project because it was too expensive. We can do it because we are charging \$100 per product”.

So why now for Mobile Fidelity? Why launch into this process at this time? “Well, we actually started developing the system three years ago. Tim de Paravacini built our cutting lathe electronics for the Neumann lathe and the tape machine electronic enhancements to our Studer reel-to-reel tape deck. He mentioned it to us. We are always asking Tim, ‘What can we do better? Can we tweak the tape machine more? What can we do to the lathe? Let’s try something.’ So Tim mentioned this One Step process to us, which hasn’t really been used in the past because the yields are

# Enjoy the Music.com<sup>®</sup>

Enjoy the Music.com is the Internet's leading information site for high fidelity audio equipment and consumer electronics since 1995. Being affiliated with many prominent publications plus offering its own *Review Magazine* and over 200 show reports online, *Enjoy the Music.com* is official media partners with AXPONA, Los Angeles Audio Show, and RMAF plus Internet partners with *The Absolute Sound*, *Australian Hi-Fi*, *CANADA HiFi*, *hi-fi+*, *Hi-Fi World*, *HIFICRITIC*, *HiFi Media*, *Sound Practices* and *VALVE* magazine.

LAAS  
LOS ANGELES AUDIO SHOW

ROCKY MOUNTAIN  
INTERNATIONAL  
AUDIO FEST

AXPONA  
AUDIO EXPO NORTH AMERICA



Billy Vee  
SOUND • SYSTEMS

London Linn & naim Specialist

CALL SALES: (020) 8318 5755 or 8852 1321 - 248 Lee High Road, London, SE13 5PL  
Web: - [www.billyvee.co.uk](http://www.billyvee.co.uk) email: [sales@billyvee.co.uk](mailto:sales@billyvee.co.uk) Full delivery and installation services.



Full Naim Uniti & Classic series available



Full Linn DS range on demonstration

**Trade in your CD Player & claim up to £1000 against a new digital Streaming player - offering you easier access to your music and better sound quality**

Please call in or visit [billyvee.co.uk](http://billyvee.co.uk) for full details of this and other great new performance enhancing promotions



Peak HiFi

DEMONSTRATIONS

Available by appointment 7 days a week

PART  
EXCHANGE  
WELCOME



Audio Desk • Bryston • Classic Turntable Company • Dynavector • Goldring • Jelco • Koetsu • Lehmann Audio • Martin Logan • Oracle Audio • Ortofon  
Peak Turntable Company • PMC • Pro-ject • QED • Quadral • Roksan • Rothwell Audio • SMD Acoustics • SME • Stirling Broadcast • Sugden Audio

[www.peakhifi.co.uk](http://www.peakhifi.co.uk)

Tel: 01226 761832

Mob: 07801 821791

[sales@peakhifi.co.uk](mailto:sales@peakhifi.co.uk)

ridiculously low. We always take heed of what Tim says so we thought, OK, let's do it".

Ah, the "yields". The problem with working with a fragile 'convert' to produce the final records is that Mobile Fidelity was only comfortable in producing 500 records from it while retaining maximum sound quality before wear and tear was due to set in.

But what if you want to produce 2,500 units from the original lacquer (as Mo-Fi has done for the debut release, Santana's 'Abraxas')? It means that five separate converts had to be produced to end at the final figure of 2,500. And that was a reason for the high final price. Despite utilising less generational steps you do end up spending more money on One Step. As John explained "The cutting engineer has to cut five A-sides and five B-sides, there's more stylus replacements during that cutting process, then there's his extra time, then the pressing plant has five processes too and then

there is their time. And so on".

Santana's 'Abraxas' is a classic album but why choose that particular title? Why not do a modern recording to tape?

"Why use that beat-up old record, eh? 'Abraxas' is known as a really well-recorded rock album" said Wood. "Sure, there's audiophile recordings of a triangle that rings out in a church that sounds fantastic but this type of record is what we do best. We wanted to present this sort of compelling stuff with the sound quality to match. 'Abraxas' is a well-known album too which helps. Thus, anything that appears on One Step will be noted for its recording quality. There's a balance between the sound quality and the music, of course. We wanted it to be an experience kind of thing. Each title has to fit. We'll be very selective."

Look out for a full review of the One Step version of the Santana 'Abraxas' LP soon.

## A DOLLAR TOO FAR?

Mobile Fidelity wanted to produce the first pressing of Santana's 'Abraxas' as a statement product for the One Step process, not knowing if there was a real customer demand for it. The company was prepared to 'take a hit', in terms of investment if the records didn't sell, "That was a concern, yes," said Wood "Is there a market for a \$100, 2LP record in a box? The Santana LP was a trial but the response was excellent. What happened? We sold out before we even had stock! There's copies on eBay now, looking for \$200-300. I've seen a low number edition on sale for \$800. And that's just now! The demand was overwhelmingly stronger than we thought it would be."

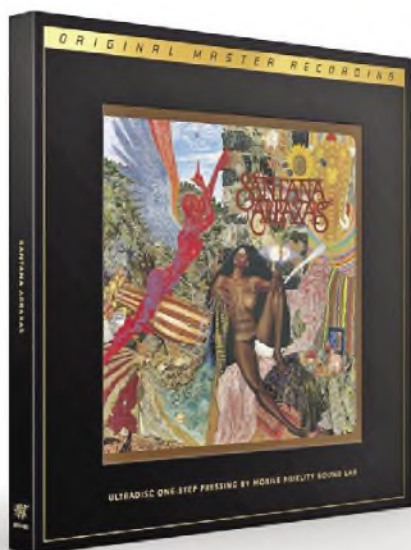

*MoFi*

ELECTRONICS

## MOBILE FIDELITY'S HI-FI HARDWARE



We are familiar with Mobile Fidelity's foray into 'software' and their magnificent vinyl pressings but now the outfit is looking towards entering the hardware market.

The company hasn't approached this market segment in a half-hearted manner either because the new hi-fi products include two turntables, two phono amps, three cartridges and two turntable weights!

The StudioDeck turntable utilises a 19mm Delrin platter with a MoFi/Allen Perkins (founder of Spiral Groove) 10" arm, MDF plinth, an isolated high torque motor, a hardened steel inverted bearing with isolation feet supplied by respected outfit HRS and a dust-cover (removable). Price is \$999.

The UltraDeck is similar but increases the Delrin platter thickness to 33mm with additional arm damping and Cardas tonearm wiring. Price is \$1,799.

Both can be supplied with a StudioTracker (extra \$150) and a UltraTracker (extra \$200) cartridges, respectively. The former is a V-Twin generator based, high-output MM with an elliptical stylus and polymer body (normal selling price is \$199) while the latter includes a nude stylus and well-damped billet aluminium body (normal price is \$499).

Another new cartridge design from MoFi is the MasterTracker (\$699), another high output MM with a micro linear stylus and pure Ohno copper coils that arrives in the same aluminium body type.

The StudioPhono amplifier has been designed by MoFi and Tim de Paravicini, can handle MM/MC signals and features a subsonic filter plus mono mode at \$249 while the Class A UltraPhono is different at \$499 as it offers variable loading, a headphone amplifier and adjustable gain.

The two turntable weights, designed by HRS, feature proprietary vibration isolation technology and come in two weights depending on the mass of your platter. Price will be announced for both soon.

All of the above are now commercially available.



# Dial A Dealer Directory

directory of Hi-Fi Dealers throughout the UK and Ireland.

**The Right Note**  
Music in the home

**BATH**  
Music in the Home

Tel: +44 (0)1225 874728  
Web: www.rightnote.co.uk

**Digital:** Aurender, Bel Canto, CEC, dCS, Gamut, VertexAQ.

**Vinyl:** Aesthetics, Graham, Spiral Groove, Transfiguration.

**Tuners:** Magnum Dynalab.

**Amplifiers:** Aesthetix, Bel Canto, CAT, Gamut, Storm Audio, Vitus, VTL.

**Loudspeakers:** Avalon, Gamut, Kaiser Acoustics (Chiara & Vivace), NEAT, Totem, Velodyne (subs).

**Cables:** Chord Co., DNM, Nordost, Siltech, Tellurium, VertexAQ, Mains Aetheia, Vertex AQ.

**Supports:** Arcici, Black Ravioli, Hi-Fi Racks, LeadingEdge, Stands Unique, Vertex AQ.

**Room acoustics:** LeadingEdge

**sound cinergy**  
specialists in home entertainment

37 high street, Aldridge, WS9 8NL  
Tel: 01922 457926  
www.soundcinergy.co.uk  
email: clive@soundcinergy.co.uk

Black Rhodium, Chord Co, Exposure, Heed, Kudos, Lehmann, Linn, Marantz, Michell, Monitor Audio, Naim, Neat, Nordost, Okki Nokki, Ortofon, Project, Rega, Roksan.

Check our website for ex dem and secondhand bargains. Ample car parking.

Tuesday - Saturday 10.00am - 5.30pm

**Peak HiFi**

For all your Hi-Fi requirements

www.peakhifi.co.uk

Martin Logan • Ortofon • Unison Research  
Oracle Audio • SME • Thorens • Classic Turntable Co  
Project Audio • SMD Acoustics • Dynavector • Jelco  
Koetsu • Sugden Audio • Lehmann Audio • PMC

sales@peakhifi.co.uk  
Tel: 01226 761832 Mob: 07801 821791

Available 9am - 9pm 7 Days a Week

TO ADVERTISE HERE  
PLEASE CALL  
JOANNA HOLMES ON  
+44 (0) 7958 602347  
OR EMAIL:  
joanna@hi-fiworld.co.uk



ADVERTISE HERE IN OUR  
NEW DIAL A DEALER  
DIRECTORY!  
PLEASE CALL JOANNA  
HOLMES ON  
+44 (0) 7958 602347  
OR EMAIL:  
joanna@hi-fiworld.co.uk

**IAN HARRISON HI-FI SALE!**  
HI-FI AT DISCOUNT PRICES. FREE NATIONWIDE DELIVERY  
Email: ian.harrison@mercian.myzen.co.uk

**SPEND £2000 OR MORE ON ANY TURNTABLE, TONEARM OR TURNTABLE AND ARM AND GET A £500 CARTRIDGE FREE!**

**SPECIAL OFFERS!! SALE! UP TO 40% OFF!!**  
VAN DEN HUL MC10 SPECIAL £875, VAN DEN HUL MC1 SPECIAL £1000, ZYX R100 £600, DENON DL103 £140, DENON DL103R £215, AUDIO TECHNICA AT-ART9 £725

<p><b>TONEARMS</b> AMG CARTRIDGE MAN GRAHAM HELIUS MICHELL MOERCH MOTH ORTOFON PRO-JECT REED REGA ROKSAN SME*</p> <p><b>HEADPHONE AMPS</b> CREEK FIDELITY AUDIO GRAHAM SLEE LEHMANN PRO-JECT SUGDEN</p> <p><b>AMPLIFIERS</b> CREEK EAR/YOSHINO ICON AUDIO SUGDEN TOM EVANS</p> <p><b>ACCESSORIES</b> DIGITAL STYLUS GAUGES, RECORD CLEANING MACHINES, CLEANERS, AUDIO CASSETTES</p>	<p><b>CARTRIDGES</b> AIR TIGHT AUDIO TECHNICA BENZ MICRO CARTRIDGE MAN DECCA LONDON DENON GOLDRING KOETSU ORTOFON SOUND SMITH TECHDAS VAN DEN HUL ZYX</p> <p><b>SPEAKERS</b> ACAPPELLA CABASSE EPOS HARBETH Q. ACOUSTICS</p> <p><b>CD PLAYERS</b> CREEK EAR/YOSHINO ICON AUDIO SUGDEN</p>	<p><b>PHONOSTAGES</b> EAR YOSHINO GRAHAM SLEE ICON AUDIO LEHMANN MUSICAL SURROUNDINGS PARASOUND PRO-JECT PURE SOUND ROTHWELL TOM EVANS TRICHORD WHEST AUDIO</p> <p><b>CABLES</b> BLACK RHODIUM IXOS KUBALA-SOSNA PEERLESS PRO-JECT QED SUPRA TRANSPARENT WIREWORLD</p> <p><b>RECORD CLEANING</b> PROJECT MOTH</p>	<p><b>TURNTABLES</b> AMAZON AUDIO AUDIO TECHNICA INSPIRE MICHELL MUSIC HALL PRO-JECT SRM TECH THORENS</p> <p><b>HIFI FURNITURE</b> ALPHASON ATACAMA CUSTOM DESIGN HI FI RACKS MUNARI MUSIC TOOLS NORSTONE QUADRASPHIRE SOUNDSTYLE TRACK AUDIO</p> <p><b>HEADPHONES</b> AUDIO TECHNICA BEYER ERGO GRADO PSB SENNHEISER</p>
---	---	---	---

\* PHONE FOR TERMS. PLEASE PHONE TO CONFIRM PRICE & AVAILABILITY PRIOR TO ORDERING. ALL GOODS ARE BRAND NEW & BOXED WITH FULL U.K. GUARANTEES. NO EX. DEM OR EX DISPLAY GOODS. NO GREY IMPORTS. GOODS ARE NOT SUPPLIED ON APPROVAL. SORRY, NO GENERAL CATALOGUES. PLEASE PHONE OR WRITE FOR SPECIFIC REVIEWS, BROCHURES OR PRICES. SUPPLIER OF HIFI PRODUCTS & ACCESSORIES SINCE 1986 MAIL ORDER ONLY FROM: IAN HARRISON, 7 MILL HILL, REPTON, DERBY, DE65 6GQ. TEL: 01283 702875. 9am - 9pm INCLUDING SUNDAYS.

**criterion audio**



Criterion Audio is a premium hi-fi dealer in Cambridge. From vinyl and valves to the latest in streaming and headphones, we can help you find the perfect audio system to suit your budget and needs. Call us on 01223 233730 to arrange a demo.

Criterion House, Oakington Road, Cambridge CB3 0QH  
www.criterionaudio.com info@criterionaudio.com

# free reader Classifieds

**TERMS AND CONDITIONS:** Only one advert per reader. No Trade adverts. This section is strictly for readers selling secondhand hi-fi equipment only. Maximum length per advert is 30 words, Adverts over 30 words will not be accepted. Telephone numbers and E-mail addresses are treated as one word. Model numbers are treated as one word i.e. Quad 303 = two words. Email your advert to; [classifieds@hi-fiworld.co.uk](mailto:classifieds@hi-fiworld.co.uk) or fill in the form on page 97 and post it to Hi-Fi World Free Readers Ads, Studio 204, Buspace Studio, Conlan Street, Notting Hill, London W10 5AP. Sorry, we cannot accept adverts over the telephone. The Publisher reserves the right to judge submissions.

**MUSICAL FIDELITY KW** phonostage, purchased new, £1200. Pioneer DLV909 Laser DVD player, boxed, £250 ono. Technics SL150 Mk1 DD turntable, SME 3009 S2 detachable M75ED, £450 ono. Collect, courier. Tel: 01708 457 691

**TANNOYS** 15 inch Gold, new front suspension and cross-overs recapped, £840. Tannoys 12 inch Red fixed crossovers, 16ohm. More damping factor: £2200. Quad RIAA preamps, £25 each. Tel: John 020 8669 4816 (South London)

**CYRUS 8 XPD QX** (DAC amp) Excellent sounding unit, boxed, £725 ovno. Thorens TD321 (mint) Linn arm, original user, paperwork, £475. Tel: 07973 42 62 91 (Birmingham)

**KEF R100 speakers**, £300. Tel: Mr Rolls 01442 874 749 (Berkhamsted)

**NORDOST BLUE Heaven** speaker cables. 2 x 5m lengths. Nordost Z. banana connectors. In excellent condition. Original type. Price new £550. Sale price £225 ono. Tel: George 01646 693 986 or Email: [scottpiggies.pigsty@btinternet.com](mailto:scottpiggies.pigsty@btinternet.com) (West Wales)

**ARCAM A28** integrated amplifier. Recent overhaul by Arcam. Boxed with instruction book. Offers. Buyer collects North Bucks. Tel: 01908 645 353

**UNISON RESEARCH Unico** Hy-brid integrated amplifier, £650. Audion Silver Night single ended 300B with Border Patrol Mk1 power supply, £650. Tel: 020 7263 5702 after 7pm. 07505 057414 anytime

**QUAD POWER amp 405 MkII** plus 303 preamp with original boxes and manuals. The pair, including cables, £200. Tel: 01332 232 892 (Derby)

**PAIR ROGERS LS7 speakers.** One owner. Professionally checked. Woodwork good. Acoustic wadding available. Quite heavy. £250. Buyer collects, Cotswolds. Tel: 01451 830 579

**CELESTION A2** floor standing 2 1/2-way speakers. Elegant cherrywood finish. Legendary sound quality plus 8ohm - 91dB efficiency and superb bass. Later 3-bar tweeter. £300 ono. Tel: 07775 886 720 or Email: [frankhyland@hotmail.co.uk](mailto:frankhyland@hotmail.co.uk)

**ROKSAN K2/BT** integrated amplifier. Roksan K2-CD player, £375 each. Not used. Project Classic turntable, Eucalyptus finish, £475, new, unused. Rotel RCD-12 CD player, unused, £300. Tel: 020 7386 9177 (London)

I HAVE over 40 original drivers from Bowers & Wilkins (including DM604), Mission, PMC and Dynaudio. Please Email: [fatlizzy@gmail.com](mailto:fatlizzy@gmail.com) for full list.

**AUDIOLAB 8200CDQ** pre-amp/CD player £549. Also pair of Audiolab 8200MB mono amplifiers 250w/ch £1,100. Units in silver and immaculate condition with original boxes, manuals etc. Tel: 023 8073 8935 or Email: [golf3385@hotmail.co.uk](mailto:golf3385@hotmail.co.uk)

**CHORD ELECTRONICS QBD76** Digital to Analogue Converter Black Excellent Condition Bluetooth/ USB/ 2 X coax 2 X Balanced AES 2 X optical RRP £3600 Sell £2100 Telephone 01243 528010 West Sussex

**PIONEER AX10AIS** home theatre amplifier. Pair Kef Reference 201 with stands and 202c centre Plus pair Kef Q4 surround speakers and Rel Strata5 subwoofer. £1500. Tel 01689830798

**FOR SALE:** ProAc Response D1B Loudspeakers serial No. 000203 Mahogany. Excellent sound and condition, includes spikes, cones, manual and boxes £1150 Tel 01865 739342 or email [peterstroudley060@gmail.com](mailto:peterstroudley060@gmail.com) (Oxford area)

**WHITE MARBLE** bespoke speaker stands. Built by a monumental mason 470mm high 355mm deep 270mm wide. 27.4 Kg. Offers. Pictures available. 01159 877 567, 07783 327 689, [spinkray.rs@gmail.com](mailto:spinkray.rs@gmail.com)

**LEAD AUDIO** Northern Fidelity 32bit-384KHz DAC and headphone amplifier, immaculate condition, used only a few times, great Hi Fi World review, £300, Serious offers considered. Email: [davidprior@email.com](mailto:davidprior@email.com).

**WORLD CLASSICS.** Exposure V1/V111 pre and power amps. VGC. Also available Exposure V1 power supply. In need of repair: £500 ono. Tel: 01924 456856 (West Yorkshire). Email: [loughe@tiscali.co.uk](mailto:loughe@tiscali.co.uk)

**MUSICAL FIDELITY M61** integrated amplifier in silver, mint condition, less than 50 hours use with all packaging, happy to demonstrate, pictures on request, £1050. Tel: 01902 884694 Email: [jukey39@yahoo.co.uk](mailto:jukey39@yahoo.co.uk)

**FOR SALE,** Music First Audio Classic copper pre-amp. Mark 2 transformers, 2x stereo XLR outputs, in excellent condition with box £1100 ono. Music First Audio copper classic, serviced and in excellent condition with box. £850 ono. Whest Two phono stage, in excellent condition and boxed, £375. Email: [stephen-holme@blueyonder.co.uk](mailto:stephen-holme@blueyonder.co.uk) or Text or call 07742758182.

**VAN DEN Hul** The Wind mark 2 speaker cable for sale, 2 metre, (4 lengths, R and L) £85. Nordost SPM balanced interconnect, 1m, boxed as new, mint cond outstanding sound £375. Please Email [booning4@hotmail.com](mailto:booning4@hotmail.com)

**NEAT MOTIVE 1** Floor stander loudspeakers Cherrywood veneer excellent speakers, excellent sound can dem. £600 ovno. London 07957384795. Evan.

**AUDION SILVER Night** 300B Monoblocks, older type with no volume pot, 18wpc, original boxes Ideally pick up from Glasgow, or delivery extra by RMSD £750 [kjholland@hotmail.co.uk](mailto:kjholland@hotmail.co.uk) 01415508436

**MUSICAL FIDELITY A5** CD Player (£450) and A5 Preamp (£500). Also Tag McLaren PA10R pre-amplifier (£400) All excellent condition, boxed, instruction manual. Text 07802448931 (Manchester)

**HI-FI MAGAZINES** Excess 1000, many different titles back to 1970's. I am looking to sell in bulk. Ring for full titles and offers. Tel: 01708 457 691

**AVI DUO** speakers brand new build in original cabinets with extra special crossovers. Any dem: must be heard! Text your e mail for photos £600 07793749178 London

**GARRARD 401,** Rega RB300, Goldring 1042 with plinth/cover, great sound and condition, £1499 ono. Power supply for Class A amps, for amps of around 15-20W, £300 ono. Call 0207 499 8729

**AUDIO INNOVATIONS P2** phonostage. Also wired as a preamp. Hi-spec all valve plus step-up transformers. Little use. £475 ono. Tel: 01527 579 938 for more info

# NEXT MONTH APRIL 2017 ISSUE

## WHARFEDALE DIAMOND ACTIVE SE ES LOUDSPEAKERS

Next month we will be looking at Wharfedale's latest Diamond Active loudspeakers. With on-board 100 Watt power amplifiers and wireless communication, you can say goodbye to cables, notwithstanding a bit of mains power of course, and goodbye to the power amplifier. Point your Bluetooth phone or portable digital player at them and – hey presto - high fidelity sound. We'll be using measurement and listening tests to see just how good that sound is, in the next issue. Don't miss it: this is where loudspeakers are going.



Also, we hope to bring you –  
DUAL MTR75 TURNTABLE  
PEIGA CLASSIC 3.0 STANDMOUNTS  
OPUS #2 PORTABLE PLAYER  
SCHIIT SAGA PRE AMP S  
BENCHMARK MEDIA DAC3  
ROKSAN BLAK AMPLIFIER  
...and much more.

This is a selection of what we hope to bring you, not a complete list. We regret that due to a wide range of issues, we cannot guarantee that all products listed above will appear.

PICK UP THE APRIL 2017 ISSUE OF HI-FI WORLD ON SALE FEBRUARY 28TH 2017,  
OR SUBSCRIBE AND GET IT DELIVERED TO YOUR DOOR: SEE PAGE 36



**ADVERTISERS INDEX**

2nd Hand Hi-Fi 86  
 Absolute Sounds OBC  
 Audio T 64  
 Audio Venue 90  
 B&W 46  
 Billy Vee 92  
 Black Rhodium 52,68  
 Blue Aura 72  
 Convert AV 40  
 Criterion Audio 88,94  
 Decent Audio 58,59  
 Eclipse 22  
 Elite Distribution 74,75  
 Enjoy The Music.com 92  
 Henley Designs 16,50,54,70  
 Ian Harrison 94  
 Icon Audio 26  
 Inspire Hi-Fi 38  
 Jordan Acoustics 24,25  
 Mingda 44  
 Monitor Audio 14  
 NAD IBC  
 Naim 42  
 Nu Nu Distribution 66  
 Padood 62  
 Peak Hi-Fi 92,94  
 Pristine Vinyl 52  
 SME 10  
 Sound Cinergy 94  
 Sound Damped Steel 52  
 Sound Hi-Fi 68  
 Sounds Fowndation 56  
 Tellurium Q 18  
 The Chord Company IFC  
 The Right Note 94

# FREE READER CLASSIFIED ADS ORDER FORM

**STOP PRESS**

**TERMS AND CONDITIONS:** Only one advert per reader. Maximum length per advert is 30 words, Adverts over 30 words will not be accepted. No Trade Adverts. This section is strictly for readers selling secondhand hi-fi equipment only. Telephone numbers and E-mail addresses are treated as one word. Model numbers are treated as one word i.e. Quad 303 = two words. Sorry, we cannot accept adverts over the telephone. The Publisher reserves the right to judge submissions.

You can email your advert to us at: [classifieds@hi-fiworld.co.uk](mailto:classifieds@hi-fiworld.co.uk) or write or type your advertisement copy in block capitals with one word per box and post it to us at:

Hi-Fi World Free Readers Ads,  
 Studio 204,  
 Buspace Studio,  
 Conlan Street,  
 London W10 5AP

**We cannot accept adverts over the telephone**

1	2
3	4
5	6
7	8
9	10
11	12
13	14
15	16
17	18
19	20
21	22
23	24
25	26
27	28
29	30

Name: \_\_\_\_\_  
 Address: \_\_\_\_\_  
 \_\_\_\_\_  
 Post Code: \_\_\_\_\_  
 Daytime Tel: \_\_\_\_\_

**FREE READER CLASSIFIED ADVERTS COPY DEADLINES**  
 APRIL 2017 - 6TH FEBRUARY  
 MAY 2017 - 9TH MARCH

# THOMAS DOLBY

## THE GOLDEN AGE OF WIRELESS VENICE IN PERIL

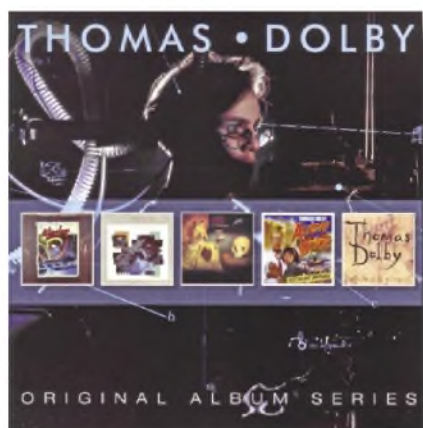

"What made the album one of quality was its broad writing skills"

**D**o you remember Dr Magnus Pyke? He was all over TV when I was in my early teens. Pyke was a British scientist who had a successful career in nutrition as a branch of biochemistry and was later

slotted into a media role because he – firstly – ideally fitted the role of the eccentric/mad scientist with his alarming habit of waving his arms around when he talked, but also brought a populist flavour of science to the TV public – and was much loved for it.

He also became a pop star. Well, of sorts. The reason was that he featured in the song 'She Blinded Me With Science' which became a hit single that arose from this unfairly neglected and supremely crafted piece of electro-pop.

Apart from the Pyke appeal, Dolby's attraction, for youngsters like myself, was his use of synthesisers, mechanical beasts that were still very much novelty factors in any song at the time. Dolby swathed his music in it and so was immediately allied to other 'electro' and electronic favourites of the time, including early generational Human League and Jean-Michel Jarre to krautrock influences like Kraftwerk and Tangerine Dream. Dolby also had heaps of street cred. with his quirky, slightly Victorian dress edge blending with his John Lennon glasses, giving him a distinctive image.

What made the album one of quality, though, was its broad writing skills. Unlike many releases from those who serve the charts with a hit single, this album didn't simply repeat that formula in slightly tweaked clone formats. 'Wireless' instead produced an imaginative swathe of synth pop replete with associated talents that gave the album a certain kudos.

Take the single itself, that featured Kevin Armstrong (who worked with Iggy Pop and Bowie) on guitar, Matthew Seligman (ex-Soft Boys) on bass, famous 'star' producer Robert "Mutt" Lange on backing vocals and co-production with Tim Friese-Greene (Hawkwind, Talk Talk et al). And then there was XTC's Andy Partridge on harmonica, Mute Records boss Daniel Miller on keyboards and even punk legend Lene Lovich adding vocals of her own.

Dolby never offered annoying electronica,

it was never twee or overly cute, but he did position his work in a slightly more upbeat mode and was lighter and more optimistic than some of his contemporaries such as Gary Numan. That said, Dolby did delve into darker subjects.

"A lot of my songs speak to the uncertainty that surrounds technology" he said. "Even a romantic song like 'Airwaves' is a post-apocalyptic love story, really, set in this very unstable, dangerous time when technology has failed us. Looking for sounds, I was drawn toward things that were evocative and atmospheric, that drew on the bright and the dark side of technology".

Another, rather darker, track includes one of my favourite songs from the album, the B-side to the 'Science' hit single that struck a chord with many - 'One Of Our Submarines'. As he described to The Electricity Club ([www.electricity-club.co.uk](http://www.electricity-club.co.uk)), the song had a personal connection. "Lyrically, the inspiration for it was my uncle Stephen who served in a submarine in the Second World War and drowned in it. It was all a bit pointless because they weren't actually engaged in a battle, they were doing manoeuvres at the time so that's a bit of a tragedy. I grew up with this photo of him by the stairs in his naval outfit. My lovely dad, being a professor, certainly wasn't an action man so I always looked up to my uncle as being the action man of the family".

"I thought about it as I grew up; you get older and your Boys Own illusion and the whole British Empire, Army, Navy, etc, you get a little bit more subversive and start to turn against it. So that was the background to the song. His death became a metaphor for the fall of the British Empire really".

This album can now be purchased as a very reasonably priced CD as part of Warner's low-cost compilation boxes series dubbed the 'Original Album Series'.

The Thomas Dolby Box set includes a host of additional album releases, notably: 'The Flat Earth' (1984), 'Music From the Film 'Gothic' (1987), 'Aliens Ate My Buick' (1988) and 'Astronauts & Heretics' (1992). Other recent releases in the 'Original Album Series' includes collections from Iron Butterfly, Mike Oldfield, Ronnie Hawkins and Dr Feelgood. **PR**



# BLUESOUND IS THE SOUND OF VINTAGE SESSIONS IN HIGH RES.



**BLUESOUND IS THE PREMIUM WIRELESS HIGH RESOLUTION MULTI-ROOM HIFI SYSTEM**  
EXPERIENCE MQA® AND BLUESOUND AT THE 30TH ANNUAL BRISTOL HI-FI SHOW, FEBRUARY 24 - 26, IN SUITE 310

[BLUESOUND.COM](http://BLUESOUND.COM)

# *d*IGITAL *C*AN *S*ING

First launched in 2012, the dCS Vivaldi CD/SACD Transport, Upsampler, Master Clock and matching DAC represent the very best digital audio components that this legendary company can make. Already supreme in its field, it is Absolute Sounds' unequivocal belief that the dCS Vivaldi system has been elevated to new heights thanks to its Version 2.0 upgrades.

Joining the four-box Vivaldi is the revised Rossini system, which comprises a Rossini

Player – either as a standalone DAC or including a high-performance CD transport – and the Rossini Master Clock. The company also makes the Debussy DAC, specifically designed for computer audio use.

The numbers are in. Four dCS Vivaldi components, making up the dCS “Stack”, plus the Version 2.0 upgrades really do equal new maths. Your nearest Absolute Sounds or dCS retailer will help you discover just how good digital audio can be ... no kidding!



 **absolute sounds** ltd.

International Distributors & Consultants of Specialised Hi-End Audio & Video Systems

58 Durham Road, London, SW20 0TW T: +44 (0)20 89 71 39 09

W: [www.absolutesounds.com](http://www.absolutesounds.com) E: [info@absolutesounds.com](mailto:info@absolutesounds.com)

For Your Nearest Dealer Please Visit The [Absolute Sounds](http://www.absolutesounds.com) Website

*dCS*  
ONLY THE MUSIC