

HI-FI WORLD

JULY 2012

UK £4.10

www.hi-fiworld.co.uk

FREE READER CLASSIFIED ADS IN THIS ISSUE!



DOACOUSTICS 2050i+ loudspeakers



EXCLUSIVE!
ORTOFON XPRESSION cartridge



SUPERTEST
twelve loudspeaker cables

ROHDE & SCHWARZ MEASUREMENT



EXCLUSIVE!

MING DA MC805-A amplifier



- ARCAM drDOCK
- HEED OBLISK Si AMPLIFIER
- GRACE M903 HEADPHONE AMPLIFIER **EXCLUSIVE!**
- DOACOUSTICS MODEL 201 LOUDSPEAKERS **EXCLUSIVE!**
- PARADIGM SHIFT A2 ACTIVE LOUDSPEAKERS

COMPETITION



WIN A SANSUI WMH-700L SYSTEM WORTH £500! (UK ONLY)

JULY 2012

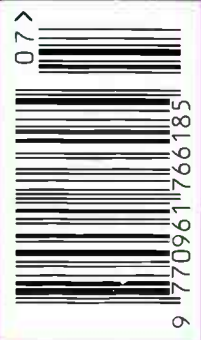

7 PAGES OF LETTERS - THE BEST WINS A PAIR OF KEF Q100 LOUDSPEAKERS! (UK ONLY)



FURUTECH

PLUGS, ZEN AND SOUND



WWW.FURUTECH.COM

sound foundations
www.soundfoundations.co.uk

+44(0)1276-501-392
info@soundfoundations.co.uk

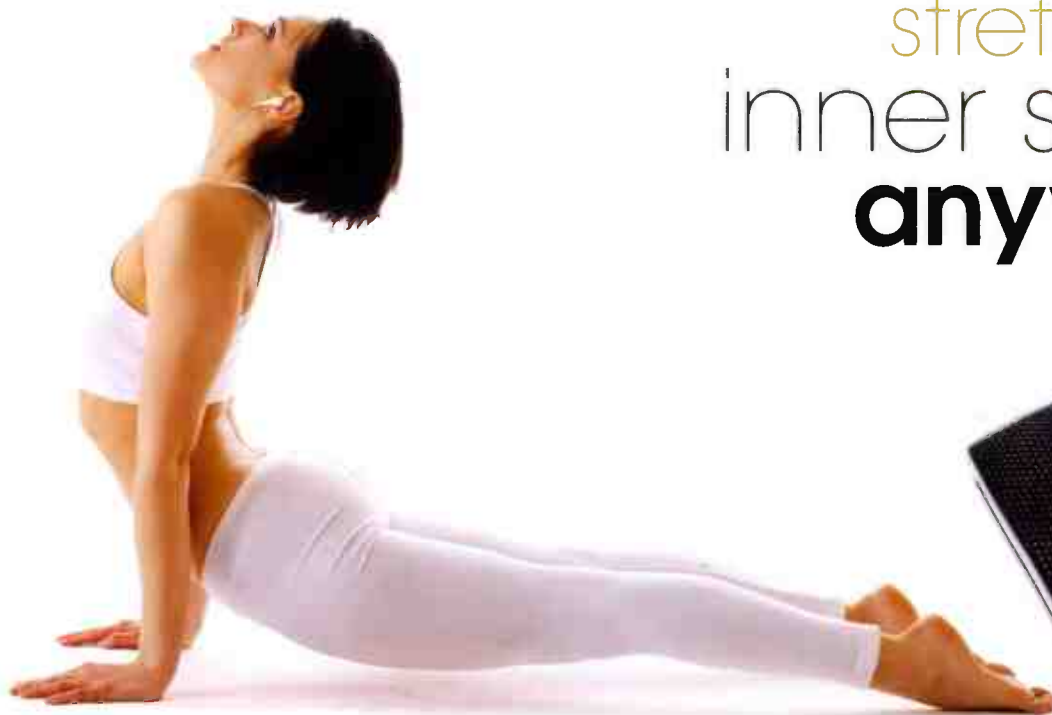

stretch your
inner sound,
anywhere.



ADL CRUISE : a pocket-size amp with attitude :

ADL
ALPHA DESIGN LABS

by FURUTECH Tokyo • Japan
service@adl-av.com

sound foundations
www.soundfoundations.co.uk

+44(0)1276-501-392
info@soundfoundations.co.uk

World Radio History

60

XTZ CD100 MkII CD player.



12

Ming Da MC805-A Single Ended amplifier.

58

Paradigm Shift A2 active 'speaker.



27

DoAcoustics Model 201 loudspeaker.

92

Ortofon Xpression cartridge.



47

Grace M903 headphone amplifier.

LOUDSPEAKERS

DOACOUSTICS MODEL 201 27
Noel Keywood on the curious case of a Kensai lookalike.

Q ACOUSTICS 2050I 44
Noel Keywood reviews a popular budget floorstander.

PARADIGM SHIFT A2 58
Adam Smith enjoys an inexpensive active loudspeaker from Canada.

DIGITAL

XTZ CDI00 MKII 60
Paul Rigby listens to a quality budget CD player.

GRACE M903 HEADPHONE AMP 47
An advanced headphone amplifier reviewed by Paul Rigby.

ISOTEK SOLUS EVO 3 81
Tony Bolton gets power obsessed.

ARCAM DR DOCK 43
Paul Rigby listens reviews an advanced iPod dock.

AMPLIFICATION

MING DA MC805-A 12
Noel Keywood auditions a Single Ended valve amplifier.

LOUDSPEAKER CABLES GROUP TEST 15
Paul Rigby assesses a group of loudspeaker cables.

HEED OBELISK SI AMP/X2 PSU 38
A specialised amplifier gets Paul Rigby's ear.

FEATURES

MUNICH SHOW REPORT 70
Noel Keywood and Adam Smith visit the High End Show, Munich.

OLDE WORLDE 78
Haden Boardman remembers a Heathkit valve amplifier

GADGETS 119
Paul Rigby looks at collection of fascinating hi-fi gadgets

VINYL SECTION

NEWS 90
Paul Rigby has all the latest and greatest vinyl releases for you

**ORTOFON MC XPRESSION
CARTRIDGE 92**
Adam Smith listens to a cartridge that is a headshell too!

ANALOGUE INNOVATION SOLE LP12 95
Tony Bolton checks out another Linn LP 12 turntable upgrade.

MASTERING LP 98
Paul Rigby on how LPs are mastered.

STYLUS GAUGE ROUND UP 103
Tony Bolton and Noel Keywood look at what is available.



7 NEWS

Words from the front...

25 COMPETITION

Your chance to win a Sansui WMH-700L system.

30 MAIL

Seven pages of your views; no small amount of controversy here...

51 WORLD STANDARDS

Brand new, updated guide to the latest and greatest hi-fi hardware on sale.

64 WORLD CLASSICS

Brilliant designs that have stood the test of time...

74 SUBSCRIPTIONS

Ensure your copy every month and save money too!

76 AUDIOPHILE VINYL

Paul Rigby rounds up the latest audiophile vinyl releases

83, 85, 87, 89 OPINION

The team get to grips with matters music, hi-fi and life!

114 DIAL-A-DEALER

A comprehensive guide to UK hi-fi retailers

116 CLASSIFIEDS

Three pages of second-hand bargains

120 NEXT MONTH

What we hope to bring you in the next sizzling issue...

121 ADVERTISERS' INDEX

122 CLASSIC CUTS

Paul Rigby listens to Ike Turner Studio Productions.



a worthy partner



email:news@hi-fiworld.co.uk

news

SONUS SOUNDS

Named after Verdi's opera and handcrafted by Sonus Faber in Vicenza, Italy, the Aida is a tall speaker: 6ft tall, in fact, sporting a lyre-shaped cabinet and wooden cheeks. Available in violin red, walnut or limited-edition white, the speakers include the company's own Z.V.T. (Zero Vibration Transmission) system that decouples them from the floor, along with a Bow Spring suspension system, in order to remove sonically damaging resonances.

Packed with drive units, seven in all, the Aida features a 29mm tweeter, 180mm midrange driver and a pair of 220mm bass drivers firing forwards from the front. An additional 320mm bass driver is mounted in the base of the cabinet and vents between the angled bottom panel and the aluminium base plate. In addition, a further 29mm tweeter and 120mm midrange driver fires backwards, from the rear of the cabinet. The output of these rear-firing drivers is adjustable, to suit the listening space.

It's the rear-firing drivers that provide the patented 'Sound Field Shaper' which is said to optimise the distribution of the speakers sound output. The idea being to create a true 3D sound image.

Sit down for this next bit. The Sonus Faber Aida is available to order now, priced at £79,000 per pair. Nurse – the smelling salts! Click on www.absolutesounds.com, or call the company on 020 8971 3909 if you wish to discuss payment methodology.



HEAD PHONEBOX

MF Audio has announced the forthcoming release of its Phone Box headphone amplifier.

Now, that unused output of the MF Audio Classic, Baby Reference or Reference preamplifier can be turned into a dedicated headphone amplifier. Inside the box is a solid state, custom designed headphone amplifier circuit, powered by an external 12V DC power supply. Spanning 50 x 110 x 140mm, the inputs to the Phone Box can be either XLR balanced or RCA unbalanced. The Phone Box is priced at £276.

Click on mfaudio.co.uk/phonebox.htm or call on 01424 858260 for more information.

CARBON NEW DATED

Pro-Ject's Debut Carbon turntable improves over the original Debut model with the inclusion of an 8.6" one-piece carbon fibre tonearm. This gives the Debut Carbon its name, a notable addition for such a low-priced turntable. The arm is fitted with an Ortofon 2M Red cartridge. The supplied counterweight is also of a new design, utilising Sorbothane to further reduce any vibrations.

Sorbothane is also part of the improved motor decoupling. The motor isolation now involves a combination of the traditional O-Ring suspension with the added presence of two isolation feet made of the substance. A rounded belt has also been included, a larger, heavier platter, enhanced connection options and all-new power supply.

Finally, the Debut Carbon will be the first Pro-Ject turntable supplied with a new external DC power supply.

Presented in gloss black, a variety of other colour finishes will soon be available, as well as a version with the convenient addition of a phono stage and USB A/D converter built into the underside of the plinth, for an additional cost. Price is £300.





NEW AVs FROM YAMAHA

Yamaha has announced a new series of AV amplifiers under the snappily monickered RXV-73 banner.

They feature 4k2k hi-def video pass through on all models, plus 4k2k upscaling from the RC-V673 model upwards. Another high priority feature is a new ECO mode that promises to lower the power consumption of the unit by over twenty percent.

In terms of sound quality, the company has addressed the sometimes thorny problem of how to integrate the front presence speakers by

including a Virtual Presence Speaker technology on the 673 and 773 models to provide a 3D effect.

With CinemaDSP and SCENE features (to store your favourite AV settings), the new series includes support for DNLA and Apple's Airplay.

Prices include £250 for the RX-V373, £340 for the RX-V473, the RX-V573 is £440 while the RX-V673 is £500 with the top-of-the-range RC-V773 fetching £650. Click on www.uk.yamaha.com or phone 0844 811 1116



192kHz DAC from Chord

Squeezing in under £1,000 (£990, to be exact), the QuteHD is a high-performance DAC featuring a bespoke circuit design. It can handle sample rates from 44.1kHz to 192kHz (and up to 384kHz on SPDIF), along with a 192kHz-compatible USB input. Along with standard PCM files, the QuteHD can also process DSD data using the latest DSD-over-USB support.

The custom-designed FPGA (Field Programmable Gate Array) incorporates: SPDIF decoding; Isochronous USB timing and Digital PLL; WTA interpolation filtering; DSD over USB support and finally, the Pulse Array DAC and an asynchronous USB, isolating the digital clocks from the computer.

The QuteHD has been constructed from a one-piece aluminium chassis. A top-mounted 'porthole' changes colour with differing incoming sample frequencies. Weighing just 400g and spanning 160x70x40mm, you can find out more by clicking on www.chordelectronics.co.uk or phoning 01622 721444.



P3 FOR BOWERS & WILKINS

New from B&W and built for mobile use, the lightweight, foldable, P3 headphones include specially designed ear pad fabric for improved acoustics and comfort. Built from aluminium and durable rubber, the P3 can be stored in its own compact hard-shell carry case. Reportedly, B&W has designed the P3's speaker diaphragms to feature driver terminals that have been positioned to ensure uniform airflow, resulting in more linear movement and less distortion.

Included in the design are ultra-linear neodymium magnets and memory foam cushions on the ear pads. Price is £169.99. Call 01903 221 500 or click on www.bowers-wilkins.com for more information.



HALF IN-EAR

The new Cresyn C510E headphones, say the company, sound a little like vented speakers. Most in-ear headphones are sealed at the rear and like all closed-back designs they can suffer from internal reflections that colour the sound. The C510E's dual-chamber, strategically damped, semi-open back construction has been designed to extend the bass response but with the added intention of minimising internal reflections.

More than that, however, the C510Es are half in-ear. Why? Because some people find the completely in-ear option uncomfortable. The Cresyn solution is intended to reduce fatigue.

These aluminium housed phones feature soft silicon ear tips (in four different sizes), together with a pair of Comply T-400 memory foam tips. You also get a protective carrying pouch. Price is £30.

Click on www.ihheadphones.co.uk for more information.





RUARK DO CHARITY

UK music charity, Nordoff Robbins, whose work revolves around working with vulnerable children and adults through music, has collaborated with Ruark Audio to produce a new, limited edition, version of its R1 Mk.II radio. Finished in an orange high gloss lacquer which reflects the charity's corporate colour - fifteen pounds from the sale of each model will be donated to the charity while the owner of each radio will receive a lapel badge and certificate.

Click on www.ruarkaudio.com for more information or ring 01702 601410



NAIM ENHANCEMENTS

Naim fans will be happy to hear that its hard disk player/servers have now been fitted with greater hard disk capacity: a 2TB hard drive, in fact. SSD drive capacity has not been changed. The 2TB drive now also includes a folder called Downloads, to be used as a storage for downloads or rips. In addition, the server software has now been upgraded to Version 1.6C which fixes a few bugs. Also, Naim's n-Serve app has been updated to Version 2.3 providing enhanced levels of music management including metadata editing and an online look-up of the AMG database and web search for album art using Google, Yahoo or Bing.

Click on www.naimaudio.com or ring 01722 426 600 for more information

TANNOY TENS

Tannoy's new Definition DC10A features a single point source Alnico Dual Concentric driver matched to Tannoy's latest birch-ply cabinet design. Taking sonic cues from the Tannoy Prestige series, it is powered by Alcomax 3 Alnico motors, a long term driver magnet material.

The Alnico-powered 10 DC driver of the DC10A uses the latest iteration of Tannoy's aluminium alloy tweeter with PepperPot WaveGuide while the mid and low frequencies are handled by a multi-fibre cone, allied to an Alcomax 3 Alnico magnet that sits on the outside of the voice coils.

The sculptured cabinet forms a complex parabolic curve to minimise acoustic resonances and internal reflections. Deep Cryogenic Treatment (DCT) of the entire crossover assembly and low loss laminated core inductors and polypropylene capacitors that are acoustically damped using a DMT compound, results in reduced internal stresses in the microstructure of the crossover components, joints and conductors.

The speaker uses a unique fifth speaker terminal to electrically ground the driver chassis to reduce potential RF interference in the audio system.

Spanning 1135 x 345 x 438mm and weighing in at 42.7kg, the DC10A will cost £12,000

Click on www.tannoy.com or ring 01236 420199 for more information.



BLUE AURA V30 DOCK

An iPod dock with a tweak, this dock is resplendent with valves. It comprises a 30W amplifier with two audio processing valves, along with a volume indicator valve. Shielded, two-way bass reflex stereo loudspeakers are covered in black faux-leather. Even the amplifier features leather-covered side cheeks. Price: £279.00

Click on www.blueaura.co.uk or ring 01480 477738 for more information



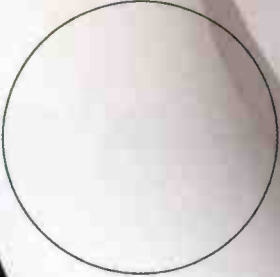

Storm Turntable

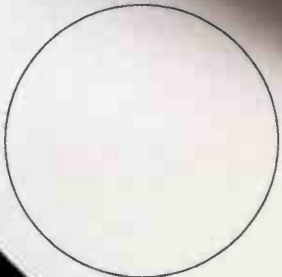

“ ...a highly capable deck that sits comfortably and against stiff competition - excellent value for money. ”

Acoustic Signature Storm Turntable
Awarded 5 stars - Hi-Fi World Review

VERDICT ●●●●●

Advanced technology combined with micro-precision engineering from Germany underpins the quality and value of these superb turntables.

Owning an Acoustic-Signature turntable could be your best long term investment in the supreme medium for music reproduction – prices from £1,632 to over £20,000.

Distributed in the UK by:



Tel +44 (0)1491 629629 | info@airaudio.co.uk | www.airaudio.co.uk

DEALER ENQUIRIES VERY WELCOME

manufacturers web ~~Site Review~~ www.acoustic-signature.com

MUNICH PEEK

Appearing at the recent Munich High End 2012 show was the Audio Research Reference 750, the company's new flagship monoblock power amplifier. Along with the Reference 5SE line-stage preamplifier, Reference Phono 2SE phono preamp and forthcoming Reference DAC. Meanwhile, the founder of Krell, Dan D'Agostino, launched a second product under his own name: the Momentum Stereo power amplifier while Krell itself showed a host of new hardware, including the S-550i integrated amp and Phantom III preamp. Devialet was eager to chat about the Devialet AIR, the company's proprietary Wi-Fi streaming technology, equipping the D-Premier. EAT (Euro Audio Team), revealed its latest turntable, the E-Flat, complete with a light, rigid carbon-fibre tonearm.

On the Magico stand, a new family of high-end speakers appeared. The Q7 is Magico's forthcoming reference-class speaker while the S5 introduces coloured paint finishes.

Click on www.absolutesounds.co.uk or call 0208 971 3909



ALBEDO — THE REAL THING

Arriving on these shores via Poland and loaded down with cables, Albedo boast that they do not rebrand or rebadge but create from scratch: from smelting their own silver to the final boxing.

The range includes the Blue (£120/m) series of interconnects. Finished with gold plated, RCA plugs, they feature silver rectangular solid core wires running in parallel.

Flat One (£400/m) is a fully symmetrical design, without a screen. The silver 5N ribbons used work within an air gap to reduce dielectric capacitance to a negligible level.

Geo (£600/m) are high-end cables built with silver rectangular conductors and finished with a graphite outer sleeve. Special low resistance RCA plugs with a thick silver coat arrive as standard.

Stepping up a notch is Monolith (£700/m) featuring wide, yet slim ribbon, thick silver coated RCAs or Rhodium-coated XLR connectors.

Versus (£1,500/m) is built with parallel-layered silver cores, separately isolated into three clusters and protected with silicone isolation and arriving with Rhodium coated plugs.

Albedo's speaker cables, including the Blue (£300 for 3m) model, are finished with high quality silver spades or BFA (beryllium copper) golden coated banana plugs. Blue is made from silver, circular, solid core wires and isolated with Silicone-PVC based blue sleeves.

The AIR I (£600 for 3m) sound balance naturally matches the Flat-One interconnects with which it shares design principles. Design uses silver ribbons in air isolation. Finished with silver spades or gold coated BFA (beryllium copper) bananas.

The Air II (£900 for 3m) sounds sonically similar to the AIR I but is a bit warmer. It uses silver ribbons with antistatic isolation and a parallel pattern with similar connectors.

Monolith (£1,000 for 3m) speaker cables use very thin ribbons secured by an antistatic air insulation enveloped in silver-ish wrap with silver spades or BFA (beryllium copper) golden coated banana plugs.

The Versus (£3,500 for 3m) speaker cable is built with a combination of wide silver ribbons finished with silver or Rhodium coated spades. You can also have Rhodium coated Furutech banana plugs. Each pair is supplied with a unique serial number.

Finally, the Metamorphosis (£7,000 for 3m) is constructed from tens of conductors, blending ribbons and solid core silver of different diameters and different dielectrics. All isolated into silicone wrap and finished with silver spades, Rhodium coated spade or Rhodium-coated Furutech banana plugs.

For more information click on www.gpoint-audio.com or call 01435 865540





Da truth

The Ming Da MC805-A Single-Ended valve amplifier delivers a truthful sound, Noel Keywood finds.

If there's an amplifier that is mythically perfect, it is the Single-Ended, or SE. In real life they are anything but perfect, but most people acknowledge that sound quality wise, they are unbeatable. I wouldn't say an SE shades all else, but they are always delightfully solid sounding, putting more meat on the bone it always seems to me, than your everyday push-pull types. And here to demonstrate and prove the point are a pair of Ming Da MC805-A monoblock Single-Ended power amplifiers. Feeding them in this review was an updated MC 300-PRE preamp, tweaked by the UK importers to

eliminate the problems I experienced with it (see our September 2011 issue).

By definition Single-Ended amplifiers lack crossover distortion, but to be truthful they don't lack distortion, so their notional perfection is just that. The reality is a little different from the rosy picture some paint of the SE, but at the same time I have yet to hear a bad one. In spite of the difficulties of their design most SEs are valve amplifiers. Few transistor Single-Ended amplifiers exist, because audio transistors run burning hot in this role, but in the UK Tellurium Q and Sugden make them. Valve amplifiers need

gapped output transformers able to withstand direct-current passing through them without suffering magnetic saturation (overload). And they need massive cores as well, making valve SE amplifiers very heavy, unless power output is limited. So as you might guess most SEs are low power amplifiers, in order to make them liftable, and they are usually monoblocks too, just to make them physically manageable. And that describes in outline the Ming Da MC805-A monoblock power amplifiers reviewed here. Each one weighs 22kgs, heavy but liftable, and measures 230mm wide, 480mm deep and 240 high, at least with 805s

lacking top caps as fitted to our amplifiers. Power output is quoted as 40 Watts but ours produced way below under test (see MEASURED PERFORMANCE). It sounds little, but in use the meters showed that, as usual, very little power is used in normal daily use and I never got the meters near their red overload zone.

Each amplifier uses a single 805 power triode, two 6SN7 small signal triodes and a Chinese 6P3P (6L6) acting as a driver. Our amps had 'different' valves to those shown on the UK website or on the web generally. This is because there are numerous variants of the 6L6 and 6SN7, both in shape and designation and the UK importers prefer the standard tubular 6SN7 to the 'Onion bulb' variant, that may look good but is microphonic. You will even see 805s with anode top caps being used, but since the cap is probably carrying 800V or so, you will not find such a tube being used in any country with safety laws!

The rear panel carries an 8 Ohm output with a 4 Ohm tap, plus a single phono input socket. Mains power is switched on by a rocker switch lurking on each left side, just behind the front panel. Power amplifier switch-on was fuss free; there was no thrum from the transformers nor any switch on thump. Like most valve amps these run up slowly and smoothly, the big 805s emitting a bright glow from their thoriated tungsten heaters.

Feeding the monoblocks was the aurally impressive MC-300 preamplifier. Ming Da UK have eliminated the bass peak I found under review by changing feedback capacitor values, and cured excessive microphony by fitting non-microphonic 6SN7 valves. The MC300-PRE has balanced inputs and I fed it from the balanced outputs of our Electrocompaniet ECD1 DAC. Outputs are unbalanced phono sockets that feed the power amplifiers.

SOUND QUALITY

The MC805-As were, not unsurprisingly, as sweet and pure in their treble as you could either imagine or hope for. To say they had liquid treble would barely do them justice. It is only when you hear cymbals ringing with such sonorous purity that the justification of amplifiers like this becomes apparent. If valve amplifiers produce treble that is easier and more convincing in its timbral character than transistor amplifiers, then SEs like the MC805-As take the whole



process a step further, with a quality rarely encountered elsewhere. These are amplifiers that charm your ears, not chew them. As you might expect there is no sign of top end brightness or harshness, but at the same time these amplifiers reach 38kHz and there is not the slight sense of warmth that comes from a roll off above 15kHz or so caused by the distributed capacitance in the giant winding stacks of high power output transformers.

A deliciously lucid yet fast midband quality had Renee Fleming singing clearly just in front of the loudspeakers with a tactile presence that only valve amplifiers can manage. The amplifiers also painted up a gloriously wide sound stage on which instruments and singers had a rich and intense presence, even at full left and right. I recognised this as a property of the MC300 preamplifier, a highly specialised design tuned right up to the limit using specialised valves and components. Like all Single-Ended amplifiers the MC805-As gave a big, solid feel to singers and instruments, placing them onto a sound stage that fell away backwards, giving a feeling of great depth.

With low damping factor valve amplifiers like these, bass quality depends much upon the acoustic and magnetic damping in the loudspeaker I have found. I used the MC805-As across a wide variety of loudspeakers, including World Audio Design KLS9s, Sendor S8es, Tannoy DC8Ts and Linn Aktivs. They gave strong, well controlled bass with all these

loudspeakers except the Spondors, which are under-damped and boom with valve amplifiers. Valve amplifiers generally sound fuller bodied than transistor amplifiers, but the MC805-As took this a stage further and could thunder when volume was turned right up.

CONCLUSION

Providing suitable loudspeakers are used there's little can better a Single-Ended amplifier like the Ming-Da MC805-A. It has big, full bodied sound that comes across as lithe but tactile as well. Yet this amplifier is so naturally pure and sweet in its treble it is unmatchable by all else except other valve SEs. The glorious MC-300 preamplifier is a must and it raises the price of the package of course, but less will not do. It contributes strongly to wonderful sound staging, bringing a vibrancy to instruments unmatched elsewhere. This is a great combination of pre and power amplifiers, one that gives the highest sound quality. Obviously, the output transformers need optimising to deliver close to the quoted power. This apart, the Ming Da amplifier combo is recommended, because it gives breathtaking sound quality from an easy to use package that is fuss free, yet convincingly thermionic high-end.

VERDICT ●●●●
 Fabulous Single-Ended sound with no drawbacks, except less power than quoted. Need careful loudspeaker matching.

Ming Da MC805-A £3499/pr
 Ming Da
 +44 (0)1684 293111
 www.mingda.co.uk

- FOR**
- sweet treble
 - broad, intense imaging
 - big bodied sound

- AGAINST**
- small speakers don't suit
 - less power than quoted
 - size / weight

MEASURED PERFORMANCE

The Ming Da MC805-A produced 14 Watts for 1% distortion and 20 Watts for 3%. The quoted output power of 40 Watts was only approached by putting an 8 Ohm load on the 4 Ohm tap, where 36 Watts was achieved for 3% distortion. This indicates the secondary is incorrectly load matched and needs fewer turns.

Overload was slow, as usual with single-ended valve amplifiers having limited feedback. Full output was delivered at 40Hz, distortion measuring 2% at 14 Watts, mostly third harmonic from the transformer.

The meters indicated full output at a 3% distortion level and were accurate enough in showing a realistic overload level for musical peaks. When power is limited meters like this are a good idea I feel.

Distortion levels were low in the midband and comprised second and third harmonic at lower power levels. Higher harmonics appeared as power increased though, and this is usually due to the output transformer core moving into saturation, a big issue with single-ended valve amps and the reason they have massive transformers. High frequency extension was good from these transformers, considering their size: they reached 38kHz -1dB.

Damping factor was inevitably low,

measuring just 3, so a loudspeaker with good acoustic damping is needed, like a Triangle Antal or similar. Sensitivity was normal enough at 0.76V for full output (i.e. 14 Watts). Noise was low at -90dB and hum a low 1.5mV at 100Hz, just audible close to a loudspeaker.

The Ming Da MC805-A needs better output load matching to achieve its quoted power output and achieve its full potential. However, with an 8 Ohm load on the 4 Ohm tap it worked properly and gave a decent set of results. NK

Power	14watts
Frequency response	2.5Hz-38kHz
Noise	-90dB
Distortion	0.23%
Sensitivity	760mV
Damping factor	3.1

DISTORTION



twenty series

Platinum
Twenty Year Warranty

The next generation of beautifully elegant,
handcrafted, British loudspeakers.



"The PMCs captured everything perfectly and had me on the edge of my seat with excitement - always a good sign"

H-FWORLD June'12
●●●●●

"It is a phenomenally musical speaker that makes everything you play as exciting and engaging as it was the first time you heard it if not more so"

"You can't ignore the music, even when the level is low it draws you in and won't let go"

hi fi+ Feb'12

Ask for a demonstration

twenty:24
Diamond Black



PMC[®]
www.pmc-speakers.com

T +44 (0) 870 4441044
sales@promonitor.co.uk





Cable Care

In the market for value-for-money speaker cable? Paul Rigby listens to twelve of the best circa-£100 types...

One of the most contentious areas within all hi-fi is the cable: interconnect or speaker. Manoeuvre any hi-fi fan onto the subject and strong views will pour forth. Some say that cables are nothing but a con, others swear by their favourites, some proclaim that cable sound quality should not vary and talk technical to explain their position, while others spend more money on cables than actual hardware because of the improvement that they hear - or should that be think they hear?

I was once sceptical about the whole issue of cable sound quality differences, but performing A-B tests on this wide range of cables only served to convince me otherwise. Cables make a difference...a big difference. Not just in terms of

changing the 'tone' of the music snaking its way through your hi-fi but also, in more practical and definitive terms, in how they handle 'distortion'. In this way, cables can obviously affect dynamic range, clarity and soundstage of any hi-fi.

This month, we are looking at twelve pairs of speaker cables around the £100 mark - a crucial price point and one that serves as a first serious entry into the cable accessory field.

Battling it out this month is the Audioquest Type 2, Chord Carnival Silver Screen, TALK Cables TALK 3, Russ Andrews Kimber Kable 4PR, Black Rhodium Twist Tellurium Q Blue, Wireworld Luna 16/4, HiDiamond Diamond 1, Clear Audio Copper-line Alpha, TCI Diamondback, Fisual Havana FX and Van Den Hul's The Arctic.

THE CONTENDERS:	PRICE
FISUAL HAVANA FX	£48/3M
AUDIOQUEST TYPE 2	£60/3M
TALK CABLES TALK 3	£64/3M
BLACK RHODIUM TWIST	£71/3M
TELLURIUM Q BLUE	£82.50/3M
CHORD CARNIVAL SILVER SCREEN	£85/3M
RUSS ANDREWS KIMBER KABLE 4PR	£85/3.5M
WIREWORLD LUNA 16/4	£93/3M
TCI DIAMONDBACK	£108/3M
HIDIAMOND DIAMOND 1	£110/3M
CLEAR AUDIO COPPER-LINE ALPHA	£130/3M
VDH THE ARCTIC	£140/3M

TEST SYSTEM:

T+A G10/SME 9/Benz Glider turntable
 Trichord Dino phono amp
 Cambridge 651A integrated amplifier
 XTZ CD-100/11 CD player
 Chord Anthem 2 interconnects
 Hi-Fi Racks Podium shelf
 AE Radiance One speakers
 Atacama HMS 1 stands

FISUAL HAVANA FX £48/3M



VERDICT ●●●●£

Although effective for general cable use, the Fisual Havana FXs are best used for jazz and singer-songwriter output, excelling in the midband and treble regions.

FISUAL HAVANA FX £48/3M

Fisual

☎ +44 (0)1706 878444

www.fisual.co.uk

FOR

- airy presentation
- detailed mids
- delicate treble

AGAINST

- bass light
- tight fitting plugs

The Fisual Havana FX uses oxygen free copper conductors and a dual aluminium foil screen. The conductors are twisted and sit within a dual shield plus a soft PVC jacket. The Havana FX cable is the cheapest entry within this group test so will have the key price advantage on the competition. But does it offer value for money?

SOUND QUALITY

Using the Sugababes' 'Stronger' (such a terrible production – any cable that

tackles this one correctly must be good), the Havanas showed a wealth of air and space surrounding the instruments that gave a free, rather relaxed attitude to the presentation. Bass was quite tight but sat a little lighter on the ear compared to my initial reference Chord Epic Twin cables. Within such a presentation, and at this price point, I was expecting bright upper mids and fizzy treble but there was enough attention to anti-distortion practices to prevent that happening.

Onto vinyl and Sam Cooke's 'Mr.

Soul' and 'I Wish You Love' the Fisual cables continued their open nature of the mids and treble. This aspect had the effect of opening up the upper frequencies, providing brassy cymbals in the treble area and vibrant piano that added an almost playful aspect to the test sequence. To 'pay' for this sparkle the Fisuals had a coolness in the upper frequency range. That said, for the price, the Havanas had great ability to shine a light on midrange-based detail, so providing a smooth sheen to strings and a crispness to the snare drum that the Chord Epic Twins found hard to emulate.

Back to CD and Crippled Black Phoenix's post rock LP, '(Mankind) The Crafty Ape' that mixes the epic with the low key, plus Rock with the Pastoral. The Fisuals lacked the power and the majesty of the Epic Twins. The sheer grandeur imposed by that extra bass support was lacking but, during the more Pastoral synth moment, the Havanas showed a delicacy that spoke of raw emotion while the acoustic guitars were a devastating accurate.

AUDIOQUEST TYPE 2 £60/3M



VERDICT ●●●●

A niche cable that loves rock but is a bit short of subtlety. If you like your music metallic, then this is the cable for you.

AUDIOQUEST TYPE 2 £60/3M

Audioquest

☎ +31 165 54 1404

www.audioquest.com

FOR

- rocking bass
- musicality
- midrange impact

AGAINST

- strident presentation
- niche application

Audioquest's entry level speaker cable tends to be found at hi-fi dealers on large drums, from which the dealer can snip lengths to your requirements. In technical terms, the Type 2 uses four individually insulated LGC copper conductors, although two of those are of a slightly thicker gauge. The four internal conductors are formed in a spiral pattern to enhance the overall aural balance, the signal carrying abilities but also the rejection of harmful distortion.

SOUND QUALITY

The Audioquest showed an

immediate increase in the amount and quality of low bass, compare to the Fisuals, via the Sugababes, and that provided this track with a large degree of heft and solidity, driving the music forward with purpose.

This highly compressed track is susceptible to a nasty shade of brightness, so demands dedicated anti-distortion measures to alleviate it. The Audioquest didn't provide too much of this, however. This 'honesty' did provide a great sense of transparency but the almost clinical aspect of the presentation does warrant careful system matching and source selection.

Upper mid detail was good but couldn't match the more insightful nature of the Fisual Havana FX.

Over to vinyl and the well lit upper mids could still be detected on the warming Sam Cooke LP which gave the Cooke vocal quite an aggressive stance. The original mastering did threaten to add an upper mid bloom which the slightly strident nature of the Audioquests did much to encourage. That said, the attendant strings had power and body while the piano, although lacking the delicacy and fragility of the Fisuals, provided plenty of impact. On 'Willow Weep For Me', the track swung hard with a powerful determination that drove the piano, drums and flute, almost dragging them to a conclusion.

Spinning the Crippled Black Phoenix CD was more like it. The Type 2, in cable terms, was a bit of a power driver, sounding more comfortable with this aggressive rock. Bass roared while guitars pierced. Upper mids were still well lit but the heaving bass alleviated that bias somewhat.

TALK ELECTRONICS TALK 3 £64/3M



The TALK 3 speaker cables offer a spaced pair of 2.5sq mm OFC copper cores which have been insulated with a thin layer of 'TALK Flex'. This is a material created by TALK Electronics itself. The cables are then inserted into a dark green PVC jacket for protection from pulling and scraping during installation.

SOUND QUALITY

It took a few seconds to realise what was going on but, the more the Sugababes track progressed, the more I moved forward into the soundstage. A welcome 3D

view was established in which the percussion and lead synth runs were situated way off into the distance, giving the soundstage an attractive and encompassing depth. This helped to enhance instrumental separation that gave each instrument more independence of movement, providing a complex presentation that involved the ear, drawing it into the mix.

Bass was both heavy and meaty but upper frequencies were a little raised in the upper mid area that highlighted the track's compression, showing little real attention to anti-distortion measures in the design.

Moving to Sam Cooke, the

structured soundstage helped to prevent any noticeable bloom on the Cooke vocal despite an element of upper mid lift that was not as excessive as the Audioquest but was there in minimal form.

On 'Willow Weep For Me', the instrumental separation led to a far more relaxed presentation, each instrument now had room to manoeuvre, giving space to ease into the song without the rush and bluster of the Audioquest. The incisive detail of the Fisuals wasn't quite there but the TALK 3s did provide the best ordered and most transparent take on this vinyl track, thus far.

Over to Crippled Black Phoenix and the drums, while thumping, may not have had the weight and heft of the Audioquest but the introductory guitar was separated from the mix for the first time, giving it a new, more exciting identity and intensity while the acoustic guitar had a precise, detailed, metallic feel. Not as sparkling as the Fisual Havana FX but with a sensibly paced approach. With the guitarist displaying time and patience, he never sounded hurried.

VERDICT ●●●●● £

Ideal for complex works on either digital or vinyl sources, the TALK 3 brings sense to the busiest of mixes.

TALK ELECTRONICS TALK 3 £64/3M

Talk Electronics

+44 (0)8456 123388

www.talkelectronics.com

FOR

- 3D soundstage
- instrumental separation
- transparency

AGAINST

- polite mids

BLACK RHODIUM TWIST £71/3M



The twisted action of the Black Rhodium cables have actually prompted the company to label the cables as 'Twist'. The idea, according to the company, is to prevent the cable acting as a loop aerial for airborne radio frequency interference which can cause audible distortion to the sound quality. With the positive and negative cores connected in opposite directions, the noise floor between the musical notes lowers. The cable is supplied with insulation of twice the thickness of other cables in the Black Rhodium range, again to improve sound quality.

SOUND QUALITY

It took until cable number four but the Twist is the first cable to approach the compressed Sugababes track with a developed and evolved sense of maturity. The obvious anti-distortive design facets applied to the design provided a great sense of relief to the ear. As well as a sense of clarity and focus to the musical presentation as a whole. Yes, the excessive peak limiting on the Sugababes' track could be heard which proved that the Twist retained life and edge but that compression was so focused and balanced in its approach that this track was truly

listenable for the first time.

Another first for the Sam Cooke vinyl was that I could truly hear Cooke's voice free from bloom that surrounded the Audioquest, TALK 3 and even the Fisual. The sweeping strings were at their most romantic here, exceeding even the incisive quality of the Fisual, for the first time. The sense of clarity and instrumental separation was superior even to the TALK 3 while that cable's 3D soundstage was matched by the Twist.

Moving to Crippled Black Phoenix, the brief first track of this album had, to this point, suffered from a slightly unfocused air from all of the previous cables. Now, the clear presentation, lacking in damaging distortion, provided a purer translation. The acoustic guitar was both precise and sparkling with a metallic definition that contrasted well with the ethereal backing vocal. The later, Pink Floyd-like vocal and guitar provided the most characterful presentation thus far, teasing apart the often complex arrangement.

VERDICT ●●●●●

A classy, high quality cable, providing top quality sound reproduction over all formats and sources.

BLACK RHODIUM TWIST

£71/3M

Black Rhodium

+44 (0)1332 342233

www.blackrhodium.co.uk

FOR

- soundstage
- dynamics
- focus

AGAINST

- nothing

TELLURIUM Q BLUE £82.50/3M



VERDICT ●●●●●

A cable based upon an anti-distortive design and it shows via its magnificent sound quality.

TELLURIUM Q BLUE £82.50/3M

TelluriumQ
 ☎ +44 (0)1458 251997
 www.telluriumq.com

FOR

- clarity
- focus
- soundstage
- overall sound quality

AGAINST

- nothing

While the Tellurium Blue speaker cable is the company's entry level speaker cable, what it's made from is a closely guarded secret. As is its design. When asked, the company basically refused to reveal all. So, apart from confirming the blue colour, that's your lot.

SOUND QUALITY

Listening to the Black Rhodium Twist, it seemed hardly possible that any other cable could exceed its performance but the Blue does just that. It seemed that, whatever the

Twist could do, the Blue could do it slightly better starting with that 3D soundstage which had tremendous depth but was coupled with even greater focus that seemed to actually repair the damaging compression on the Sugababes' track. Such was the attention to detail from the Tellurium Q Blue.

The positives just kept on coming. Bass was tight and punchy, treble no longer hurt my ears during vocal climaxes. The midrange was so tightly controlled that no extraneous frequencies caused by peak limiting escaped the mix.

Moving to the Sam Cooke vinyl

which was, via the Blue, at its most expressive, making the likes of the Audioquest offensive in comparison while the Fisual was asked to politely give way when compared directly. The backing orchestra, behind Cooke, eased its way through the track like a gently flowing river, such was the smoothness of the overall delivery. The snare drum held a sense of being tonally 'right' while the strings almost dripped with emotion. Also, for the first time, the subtly placed flute played a more integrated part of the mix rather than sounding out on a limb.

Finally, the Crippled Black Phoenix CD took on an ordered soundstage, everything was where it should be, giving a panoramic view of the soundstage. In fact, the music sounded like it was just that, on stage, via a uniform presentation. Bass was impressive via its large mass while the lower mids, though the electric guitar, were dramatic and forceful. This time, the Pastoral slices, interspersing the heavier prog rock, were found to be more complex.

CHORD CARNIVAL SILVER SCREEN £60/3M



VERDICT ●●●●●

A vinyl-only cable that loves the more precise music output such as jazz, where it can display its inherent, meticulous, nature.

CHORD CARNIVAL SILVER SCREEN £85/3M

Chord Company
 ☎ +44 (0)1980 625700
 www.chord.co.uk

FOR

- thorough presentation
- anti-distortive design
- controlled delivery

AGAINST

- recessed mids
- careful source matching

Like the Audioquest, the Chords have been created so that the wire arrives in a twisted configuration to enhance the sound quality and to minimise distortion.

The wires themselves are presented as fifteen gauge, multi-stranded oxygen free copper (OFC) with polyethylene (zero halogen) shielding. Chord say that the cable is surrounded by PVC to minimise mechanical noise.

SOUND QUALITY

The first thought, when listening to the Chords was just how darned polite they were. There was none of the raucous behaviour advocated

by the Audioquest and certainly none of the 'irresponsible', flighty upper midrange of the Fisuals. The Chords were very well behaved — the sort of cables, in fact, that you could introduce to your mother. For example, bass didn't run too low to be nasty and grinding but had sufficient quantity to keep the track ticking over. Upper frequencies didn't sparkle but supplied enough information to keep you well informed. On the other hand, the nasty stridency of the Sugababes' track was kept in-line with enough anti-distortive measures to prevent too many harsh frequencies hurting your ears.

These attributes worked more efficiently and more effectively with vinyl than they did with CD, with which the Chords proved more compatible. Cooke's vocals had none of the unruly bloom of the Audioquest and, while it also didn't have the detail of the Fisual, it did have an inherent musicality that came to the fore within the analogue medium. An easy going, swing jazz track that was hip but precise, the Chords were a little bit OCD in that they craved order and were scrupulous in how the music was presented with special attention given to the source quality and type.

Moving to the Cripple Black Phoenix CD, the Chord's reserved nature proved difficult for it to truly let its hair down. A slightly recessed midrange and less than expressive bass damaged musicality, reigning in emotion and keeping a lid on the excitement. That said, its anti-distortive design showed immediately in the tight bass performance that allowed space to be revealed around it, giving other dynamics a chance to flourish.

RUSS ANDREWS KIMBER KABLE 4PR £85/3.5M



The Kimber Kables take the increasingly familiar spiral production technique and give it a unique, well, twist. In this case, the core of the Kimber cable is a woven pattern. The reason for the shape is down to creator Ray Kimber who, when he was installing sound systems for discos back in the seventies, found that the 'noise' from the light system was interfering with the speaker cables. Intriguingly, shielding didn't help because electromagnetic noise passed straight through. The woven pattern was favoured, even in favour of the twist method.

SOUND QUALITY

The woven aspect of the Kimber does provide a measure of low distortion output, although not as much as the Black Rhodium Twist or the Tellurium Q Blue. Still, this does help to make the upper mids more palatable on the screeching Sugababes' track, along with the TALK 3 cables, but without the latter's sense of depth within the soundstage. In class terms, the Kimber takes a similar approach to audio as the Chords: not particularly sparkling in terms of mining detail but also not falling foul of some of the aural deficiencies of the Audioquest.

Switching to vinyl and Sam

Cook, despite reintroducing that slightly disturbing vocal bloom in the midrange, formally eradicated by both the Black Rhodium and the Tellurium Q cables, the Kimber presented an inoffensive presentation, although the soundstage was rather shrunken when compared to the likes of the TALK 3 and Fisual. The Kimber did provide an admirable midrange performance with the piano, for example, offering a jaunty, energetic performance, while the reduction in distortion did provide enhanced detail within the drum section.

As for the post rock output of Cripple Black Phoenix, the reduced distortion helped to enhance the aggressive guitar display while the bass drum had more room to manoeuvre. Midrange didn't display tremendous insight and, like the Chord, there was a touch of recessive behaviour in the midrange. Nevertheless, the Kimber provided a controlled, even sensible, performance that would be paired well with a system suffering from an unruly behaviour while bringing a sense of decorum to proceedings.

VERDICT ●●●●

An admirable performer that shows attention to an anti-distortive design. A cable to bring sanity to an unpredictable hi-fi chain.

RUSS ANDREWS KIMBER
KABLE 4PR £85/3.5M
 Russ Andrews
 ☎ +44 (0)1539 797300
 www.russandrews.com

FOR

- calms unruly frequencies
- controlled presentation
- brisk sonics

AGAINST

- recessed mids

WIREWORLD LUNA 16/4 £93/3M



The description of the design of the Luna cable might not be termed 'twist' but it is described as 'double helix' which, to my mind, is as near to 'twist' as dammit.

Using HD Polyethylene to cover four conductors, this thirteen gauge cable is the company's value for money entry into the speaker cable range.

SOUND QUALITY

Although the Luna didn't quite have the clarity and focus displayed by the Black Rhodium or Tellurium Q cables, it did possess intriguing sonic abilities. That bass may not have plumbed the subterranean depths

occupied by the Audioquest but the lower frequencies were very tidy, tight and efficient on the Sugababes' track, 'Stronger'. Within this song, the Luna maintained a grip on the lower frequency performance throughout. While the cable didn't enjoy the extreme 3D effect of the TALK 3, it did provide a broad and deep soundstage, which encouraged an admirable instrumental separation that, in terms of the midrange and treble, did reveal some upper mid lift but only enough to provide an edge, it was never offensive.

Handling the Sam Cooke vinyl, the Luna showed a penchant for analogue playback. Its low distortion

performance gave the Cooke vocal, despite a touch of bloom, an attractively emotive performance while the percussion had a smoothly expressive sound that, tonally, was on the nail. Piano was also full of energy and style.

In general terms, the Luna did tackle distortion but did so in a different way to the Black Rhodium or Tellurium Q cables. Compared to the Twist and the Blue, the smoothing midrange effect was present to an extent with the Luna but you also were faced with the Fisual-like cool midrange and treble.

For the Cripple Black Phoenix post rock, the Luna offered a collection of impressive sonic highs, stuck together, which made the sound output sound a little manufactured but the bottom line, for this track, was impressive, nonetheless. Witness the powerful, heavy duty drum with an imposing electric guitar accompaniment and the crisp approach to mids on this stormy prog-like track with an almost clinical approach to the acoustic guitar.

VERDICT ●●●●£

Dynamically, it demands your attention with a number of showcase sonic highs.

WIREWORLD
LUNA 16/4 £93/3M
 Wireworld
 ☎ +44 (0)20 8991 9200
 www.wireworldcable.co.uk

FOR

- bass grip
- broad soundstage
- tonal interpretation

AGAINST

- partially contrived mids

Vibrations mask your audio enjoyment as they journey through the inner workings of your equipment. Oriton have found an answer to this problem:

BlackBullets

The magic is in the sound.

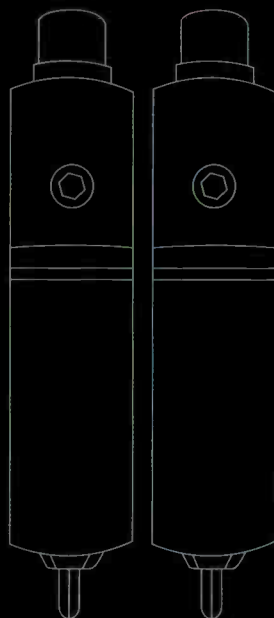

"The Oriton Bullets take all of five seconds to fit and produce a superb return of sound quality. To me, buying a set of Oriton Bullets for your hi-fi chain is a complete no brainer"

Paul Rigby HI-FI World

Unit 2, Pontymister Industrial Estate, Risca NP11 6NP

Telephone: 01633 549 530 | Email: info@oriton.co.uk | Twitter: @OritonAudio
Buy a pair exclusively at: www.oriton.co.uk/blackbullets

Oriton[™]

TCI DIAMONDBACK £108/3M



The TCI Diamondback is a low profile cable, spanning just 2.1 x 15mm. Using 'aerospace grade' silver plated OFC copper conductors and Superthane insulation, the Diamondback is the mono wire version of the company's similar TCI Anaconda speaker cable which is bi-wired.

SOUND QUALITY

The initial impression that I gained after starting the sound review for the Diamondback was that it was quite a dynamic cable. The TCI roared out of the blocks with the Sugababes' track, 'Stronger', producing a meaty

bass that under laid the track, driving it forwards with a strong momentum. The bass was a major feature of the cable because of its relatively characterful make-up. Subtle, low frequency elements within the track were highlighted with some ease, providing new insight into this aspect of the mix.

While midrange performance was generally good, there was an upper midrange lift which, although it was not as pronounced as the Audioquest, was also not as recessed as the Chord or Kimber but neither did it have the smoothness and flow of the Twist or Blue. Hence, it sat somewhere in-between the lot,

producing an admirably balanced sound.

Turning towards the Sam Cooke vinyl, 'Mr. Soul' and, on the track, 'I Wish You Love', the TCI Diamondbacks produced a slight bloom to the Cooke vocal and the upper mids were excited enough to add a slight lift. They also produced quite a forceful suite of sweeping strings. On the next track, 'Willow Weep For Me', the percussion was also enhanced by the slightly raised midrange, providing another 'spot highlight'. This approach didn't give an overly natural sound but could give an overly dull hi-fi chain an injection of life.

Finally, on the post rock Cripple Black Phoenix track, the rising mids did intrude a little on the heavy guitar during the opening track sequence but the dynamic nature of the cables provided an epic tone to the music. During the acoustic guitar sequence, the hard edge did give an 'attack' to the sequence while the David Gilmour-like vocal delivery was finely etched which highlighted his subtle emotional delivery.

VERDICT ●●●●

Big on the bass with a relatively clinical upper frequency range provides music with impact.

TCI DIAMONDBACK £108/3M

TCI Cables

+44 (0)77 1019 6949

www.tcicables.com

FOR

- dynamic presentation
- bass impact
- midrange attack

AGAINST

- upper midrange lift

HIDIAMOND DIAMOND I £110/3M



HiDiamond's entry-level speaker cable, the Diamond I, utilises two conductors and uses an intriguing applied technology called VRC 4 (4 times copper cooked). The bottom line for this process is that the more you 'cook' your copper the purer, theoretically, it should get. The company declares that it cooks its copper twice as much as its competitors.

SOUND QUALITY

On the Sugababes' track, the Diamonds provided a bass that was slightly lighter in heft than the TCI but, on the other hand, a midrange

that was a touch smoother. The Diamond still retained some upper mid lift which added a shine to the vocal delivery so, during strong vocal harmony sequences, it revealed the inherent peak limiting. The midrange was not as harsh as the Audioquest but did have a slightly more strident aspect than the Luna.

Moving to the Sam Cooke vinyl, the upper mid lift added a seasoning of bloom to the Cooke delivery but there was plenty of energy and emotion in this ballad that was backed up by a tinkling piano, illustrating the spot-lit midrange. Despite the relatively lighter bass response, the Diamonds did offer a

secure bass foundation that provided a great sense of musicality.

Although the midrange could have been a little more incisive, there was enough detail on offer to provide a relatively well balanced output. Treble, meanwhile, was highlighted to a degree that provided, if not a fragile delicacy, then at least tonally friendly cymbal effects.

Moving to the lively Cripple Black Phoenix and the Diamond showed its love of dynamic, high energy, music with this energetic prog-like, post rock piece. The portentous, robotic voice, that could be heard at the beginning of the album, was particularly clear while the lighter and quite recessed bass response was masked by the forceful lead electric guitar. The insertion, after the heavy guitar chords, of the mild mannered Mellotron synth sound contrasted well with the following acoustic guitar that successfully integrated the complex midrange elements which, although it could have been better defined, blended well with the rest of the track.

VERDICT ●●●●

A cable that is greater than the sum of its parts with musicality as its strong point.

HIDIAMOND

DIAMOND I £110/3M

HiDiamond

+44 (0)1785 748 446

www.quadralgb-ie.co.uk

FOR

- musicality
- balanced output
- forceful presentation

AGAINST

- recessed bass
- slightly strident upper mids

CLEARER AUDIO COPPER-LINE ALPHA £130/3M

**VERDICT** ●●●●

Rock-centric cables that prefer to let their hair down and boogie, the Clearer Audio Copper-Line Alphas are party cables par excellence.

CLEARER AUDIO COPPER-LINE ALPHA £130/3M

Clear Audio

☎ +44 (0)1792 543981

www.cleareraudio.com

FOR

- controlled bass
- analogue performance
- musicality

AGAINST

- careful system matching
- bright mids

This is Clearer Audio's entry-level speaker cable that dealers will normally supply off the reel. The cable includes a Floating Dielectric System made from PE air-tubes and Teflon insulation, and pure copper connections, in this case the Eichmann Bayonet Plug. You also receive an 'advanced' pre-burning in period to help run in your cables.

SOUND QUALITY

The Clearer marries the two distinct personalities that had, up to this point, yet to be seen together. Namely, a rather bright upper

midrange that tended to emphasise the highly compressed nature of the Sugababes' track resulting in harmonic vocal climaxes that proved less than comfortable to the ear, reminding me of the upper mid performance of the Audioquest, plus the rather restricted low frequency performance that gave a controlled atmosphere to the music and was previously heard via both the Chords and The Kimber.

The upper mid brightness was reduced somewhat when Sam Cooke's vinyl tracks hove into view. This factor was largely because of the venerable wax's naturally warming nature but the upper

midrange lift could still be detected. The strings did tend to screech a little during energetic moments while the flute was a little bloomy when it made its almost random appearances. Within the general presentation, though, the controlling nature of the cable did give a very firm hand to the lower frequencies which is useful for errant hi-fi chains. This jazz-based track proved rather too complex for the Clearer Audio Copper-Lines, the organic work within the mix produced midrange smudging that prevented the required accuracy from emerging. The use of piano, sax and delicate percussion was treated with a certain impatience by the Clearer cables.

When the Clearer grappled with the Cripple Black Phoenix rock track, the reaction from the cable was a lot more positive with this dynamic, high energy track, especially the booming drums and the noisy guitars. The rising mids allowed energy to flow while the controlled bass encouraged texture and variation in the low frequency range.

VAN DEN HUL THE ARCTIC £140/3M

**VERDICT** ●●●●

Tonally correct, impressive bass characteristics and a top vinyl performer, The Arctic should be high up on your demo list.

VAN DEN HUL THE ARCTIC £140/3M

Henley Designs

☎ +44 (0)1235 511 166

www.henleydesigns.co.uk

FOR

- bass
- clarity
- epic mids

AGAINST

- slight mid bloom

The Arctic is made of two conductors of twelve gauge made from very high grade large crystal OFC with a dense pure silver coating. The white outer jacket is made of HULLIFLEX 4. The two conductors have different insulator shapes: one is round and the other has two edges with type printing on the flat surface: useful as a polarity finder.

SOUND QUALITY

The Van Den Huls sit in a group of cables that take the anti-distortive question seriously but don't find a completely successful solution to

the problem. Along with the likes of the Luna and TALK 3, The Arctic cables offer a tight, focused lower frequency response that not only gives a smooth bass output but one that lowers noise to increase bass-oriented clarity, allowing a host of new and interesting low frequency elements to enter the mix. The upper mids do take some of that lower distortion benefit but they don't quite go as far as the Black Rhodium Twist or the Tellurium Q Blue so that the upper frequencies are not quite as smooth or as focused. There is still plenty to admire here, though. The bass response is tight, firm and punchy while the mids offer a broad,

epic quality that speaks of experience and maturity.

The Sam Cooke vinyl retained more of a balanced output, due to the format's analogue warmth. The Cooke vocal has a touch of lift in the midrange but remains both emotive and very enjoyable. While The Arctic's bass gives this ballad a gentle musicality, the anti-distortive design helps clarity within this relatively complex mix. Bloom is minimised while each instrument is kept apart long enough to broaden the soundstage and convey a relatively relaxed presentation.

Utilising a beautifully staged percussion sequence that forces quite a majestic portrait along with a powerful electric guitar chord selection, The Arctic showed its low frequency power to full effect on Cripple Black Phoenix, while the contrasting organic acoustic guitar exhibited enough clarity to give an effectively dynamic response. The Arctic performed well, defining the varied tonal characteristics of each instrument and enhancing the enjoyment of the whole track.



And they say that there's no difference in sound between cables. Fooyey! That cables are used purely to change the tone of the sound and nothing more. Fiddlesticks! This group test revealed genuine, constructive (and destructive) changes in sound quality that could easily be attributed to a major change in hi-fi hardware.

Beginning in reverse order and a range of cables that are angled more towards niche markets. The Audioquest Type 2, Russ Andrews Kimber Kable 4PR, Clear Audio Copper-line Alpha and Chord Carnival Silver Screen all take a specific aspect of hi-fi reproduction and focus upon that. The Audioquest is a brilliant party animal with big, meaty, powerful bass that loves to rock while the Clearer adopts a very similar attitude, bringing the musicality, the overall tone of high energy music, to the fore very successfully. The Chord and Kimber cables are all about order and control and are wonderful cables for those hi-fi chains that need to be reined in. Acting like sheep dogs, the pair are highly recommended to bring a sense of calm to a hi-fi system.

Next, the HiDiamond Diamond I and TCI Diamondback start from a similar position to the Audioquest but add more mature and balanced flavours to provide a better overall sound but with that essential strength in musicality with high impact.

The TALK Cables TALK 3 receive a very respectable sixth place, largely due to its tremendous soundstaging abilities along with its fine, general sonic abilities while the Wireworld Luna 16/4 provides a creditable fifth due to its many sonic highlights. Wireworld are on the right lines with this cable that should be on all demo lists due to its ability to connect with different hi-fi system types.

The Fisual Havana FX deserves a prize all of its own. The cheapest cable here, but fourth place? This is a cable that does so much right and what it cannot do it rightly leaves well alone

rather than disrupting its delicate sonic balance. For the price? A quite remarkable design.

Third place goes to the Van Den Hul's The Arctic, a cable that has obviously been designed by experienced, knowledgeable and practised engineers. It's just frustrating that the cable got so close but fell at

these endeavours means that other cables' performance is patchy at best whereas Black Rhodium and Tellurium not only save time in targeting the problems on a design level (just see how restrained and basic each cable looks compared to the complex and large girthed competitors) but they also save money which means

'the pair achieve great quality sound with cables offering both effectiveness and efficiency'

the last hurdle.

The top two cables in this test might not be the most expensive on show here but they are both ahead of the rest in terms of performance. The fact that they attack, head on, the distortion problem means that the extraneous noise and associated rubbish that hangs onto the sonic output, restricting dynamic response and squeezing the clarity factor, is tackled straight away.

The pair achieve great quality sound with cables offering both effectiveness and efficiency. Both the Black Rhodium Twist and the Tellurium Q Blue don't mess around. Which infers that the other cable manufacturers are almost feeling around in the dark, not quite sure what the problem is, not too sure how to tackle it and, hey, if they stumble upon certain elements that provide a few right answers then that's a welcome bonus. The result of

that you don't have to spend money supporting inefficient research efforts.

The Black Rhodium Twist is a super cable. So simple to look at, beautifully designed and so easy on the ear with a remarkable price. It should be demoted even if you have an expensive hi-fi system. Such is the cable's general superiority. With one exception...

In absolute terms, the Tellurium Q Blue pips the Black Rhodium Twist to the top. The difference in performance is not massive but it is there. The Blue, over the entire frequency range and in all areas, just beats the Twist to the top in every category. It drains even more distortion from music, producing a superior soundstage and instrumental separation, it delivers a devastating degree of clarity, a greater amount of transparency and a class-leading focus that never fails to surprise. The Tellurium Q Blue is a great cable.



exposure
high fidelity audio

1010

tickle your ears with real hi-fi sound

1010

Integrated Amplifier CD Player

please visit www.exposurehifi.com



Exposure Electronics Ltd:
Unit 18, Winston Business Centre
43 Chartwell Road
Lancing Business Park Lancing
BN15 8TU
Tel: +44 1273 423877
Fax: +44 1273 806648

World Radio History



WIN A SANSUI WMH-700L SYSTEM WORTH £500 IN THIS MONTH'S GREAT GIVEAWAY!

Here's your chance to win a Sansui WMH-700L. Read what we said in our review in the June 2012 issue and answer the questions, at left on this page.

"The WMH-700L mini-system is the first of a minor deluge of hi-fi kit of all types and genres. Presented as a two-box system with a separate pair of boxed speakers, the system offers a CD player and an internet receiver, which each span a neat 285x170x70mm in either silver or black, an ideal size for a study, kitchen or bedsit and, with two separate chassis, offering lots of storage options which comparative Japanese systems, present in a single chassis, do not. The CD is unremarkable in terms of controls and sockets but the super slim, 6mm thick CD's

drawer is worthy of note.

Within the receiver is a Frontier Silicon chip handling FM, DAB, DAB+, internet radio and streaming, "Ours is the first piece of hi-fi that incorporates every aspect of the functionality of this module," said Mitchell. "That means that our receiver can be controlled by a freely downloadable iPhone app, it supports FLAC, it streams music and more."

The receiver features a USB port for an external hard disk or storage key and there are two auxiliary ports, one of which is a 3.5mm socket to take a MP3 player and a forthcoming iPod dock. The compact, stand-mounted speakers feature a simple mid/bass driver and a basic tweeter and are connected via bell wire.

Set-up shows just how fully featured the Sansui is and how carefully it has been designed. It's UK origins hold it in good stead too.

Firstly, the Sansui's network player is based upon a text-based, nested menu system accessible via chassis buttons viewed via a small, frontal LED screen. Normally, I find such designs anathema but the Sansui was saved by three factors. Firstly, the nested menu is not too complicated. Secondly, the accompanying manual – essential to talk you through network set-up – has been written by the head of Sansui UK. You cannot beat having an English manual written by a fluent English speaker who obviously knows what he's talking about. Compare this manual with a typical Japanese effort which looks like they're thrown a game of Scrabble into the air and transcribed the result. Thirdly, the included, freely downloadable, Libretto iPhone app, if you have an iPhone that is, can fully control the Sansui, offering a professional, easy to use, touch screen interface."

- end -

For a chance to win this great prize, just answer the following four easy questions. Send your entries on a postcard only, by 31st June 2012 to:

**July 2012 Competition,
Hi-Fi World magazine,
Unit G4, Argo House,
Kilburn Park Road,
London NW6 5LF**

RULES AND CONDITIONS OF ENTRY

- ONLY ONE ENTRY PER HOUSEHOLD
- MULTIPLE ENTRIES WILL BE AUTOMATICALLY DISQUALIFIED
- PURCHASE OF THE MAGAZINE IS NOT A PRE-CONDITION OF ENTRY
- NO CORRESPONDENCE WILL BE ENTERED INTO
- THE EDITOR'S DECISION IS FINAL
- NO EMPLOYEES OF AUDIO PUBLISHING LIMITED, OR OF ANY COMPANIES ASSOCIATED WITH THE PRODUCTION OR DISTRIBUTION OF THE PRIZES, MAY ENTER

QUESTIONS

[1] Is it an ideal size for?

- [a] bathroom
- [b] potting shed
- [c] kitchen
- [d] dog kennel

[2] What chip is inside?

- [a] top chip
- [b] hot chip
- [c] old chip
- [d] Frontier Silicon chip

[3] What is the USB port for?

- [a] ethernet
- [b] storage key
- [c] vhf aerial
- [d] keyboard

[4] The speakers are connected by?

- [a] mains cable
- [b] bell wire
- [c] string
- [d] Blu-tac

July 2012 Competition
Hi-Fi World Magazine
Unit G4,
Argo House
Kilburn Park Rd.
London NW6 5LF

entries will be accepted on a postcard only

**APRIL 2012 CYRUS STREAM X WINNER:
Mr Bell of Cookham, Berkshire**



Denton - living the legacy...

Wharfedale's 80th Anniversary Limited Edition



Britain's most famous loudspeaker brand is 80 years old this year. To celebrate, Wharfedale is reviving one of its most popular models of the past – the Denton.

Introduced in 1967, the Denton exemplified Wharfedale's twin edicts of quality and value, balancing fine craftsmanship, natural sound quality and affordability inside a compact loudspeaker that was bought in its millions right across the globe.

The Denton 80th Anniversary Edition remains true to its illustrious namesake whilst making the most of modern materials and manufacturing techniques to deliver a speaker that is fully equipped for the 21st Century.





Curious case

The curious case of two loudspeakers that look alike is investigated by Noel Keywood, when reviewing the DoAcoustics Model 201.

I looked at the DoAcoustics Model 201 and thought "it's an Audiosmile Kensai": superficially it looks identical. "Or is an Audiosmile Kensai a DoAcoustics 201?" was my next thought. This intriguing question was only of interest because the Kensai is a loudspeaker that everyone likes, irrespective of taste. Could the DoAcoustics, from Italy, be equally appealing? If so it would become an instant star.

But then there is price. The Kensai started out at £1500, rose to £2100 to accommodate overseas dealer margins but has since subsided to its original price. This greatly undercuts the 201 which costs £4695 in the U.K., making it a very expensive stand mounter indeed.

I thought it would be interesting to put my Sherlock Holmes hat on and sit in a pub on Baker Street to

sort through the evidence relating to this curious case of similar loudspeakers. In the event I didn't make it to the pub, but here is the evidence. We first reviewed the Kensai in our June 2009 issue; it arrived at our offices March 09 and had just been released at this date. That's some time ago, attributing

"DoAcoustics have gone for a natural tonal balance is obvious"

design originality to Audiosmile methinks. But it is entirely possible DoAcoustics have never heard of 'em and just opted to use the same SEAS Excel bass/midrange unit with magnesium cone, and a stationary copper phase plug at its centre, through happenstance. Putting its Thiele-Small parameters into a box

calculation CAD package would automatically come up with a box the same size as the Kensai's.

So far then, a man from Mars could conceivably have come up with a loudspeaker like this, assuming he'd spotted SEAS drive units on the Martian internet, fed by some earthling's wireless transmitter

– probably mine. Only the unlikely choice of pairing it with a magnetic planar tweeter suggests Mars-to-Earth contact in this strange case, DoAcoustics being aware of the Kensai's lovely sound and how it was achieved.

Magnetic planar tweeters are less than common at present, so their

SERIES M2-12R

The Model M2-12R precision pick-up arm is an extension of our popular Series M2 range offering optimum cartridge choice with minimal tracking error and harmonic distortion associated with a 12 inch arm.

Providing classic looks and meticulous build quality, this arm offers all the most important features; traditional 'J' shaped tone-arm, detachable S2-R aluminium headshell with azimuth adjustment, two stage tungsten counterbalance system, superb quality ball race bearings and a level of rigidity to suit all types of cartridge.

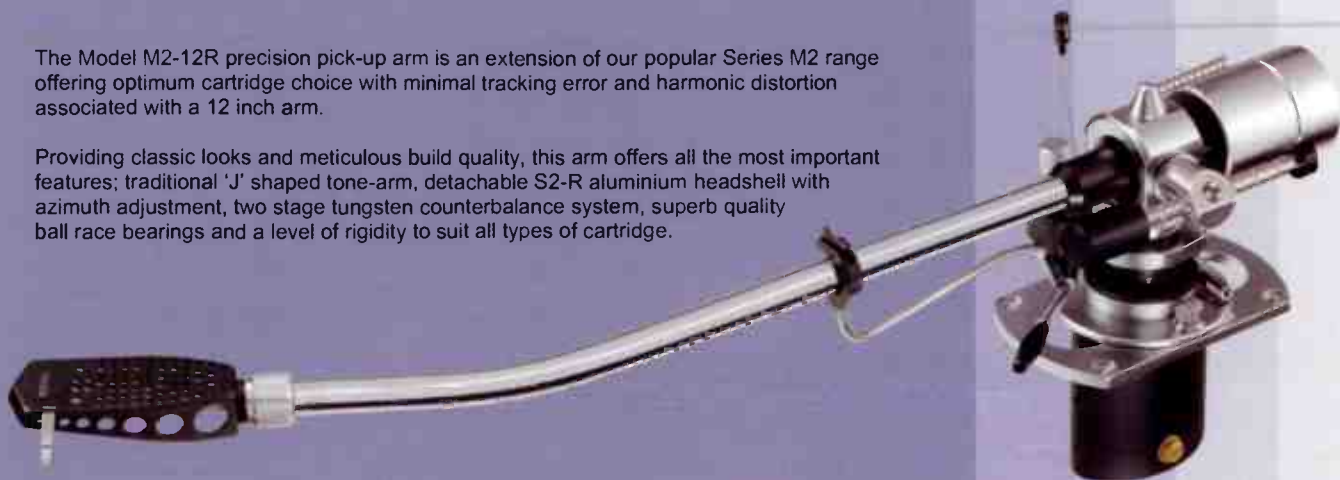

SME

"The best pick-up arm in the world"

SME LIMITED • STEYNING • SUSSEX • BN44 3GY • ENGLAND TEL +44 (0)1903 814321 • FAX +44 (0)1903 814269 • www.sme.ltd.uk • sales@sme.ltd.uk

TWIST

TWIST cuts the cost of enjoying your music at only £3.50 per metre



*"Twist delivers voice and guitars in a fluid and effortless style...
A well thought out cable that delivers a touch of class to budget
systems at a very reasonable price"*

HI-FI CHOICE, June 2012

Why Choose Twist?

- ✓ Ultra Flexibility
- ✓ Low Price
- ✓ Easy To Manage
- ✓ Ideal For Install
- ✓ Great Sound Quality

What Our Customers Say:

"Natural and comfortable to listen to"
Robert Hoyle, Audiovation - Huddersfield. www.audiovation.co.uk

"Punches well above its weight"
Steve, Rayleigh HI-FI - Chelmsford. www.rayleighhifi.com

"Very popular with customers"
Derek Rapkin, H.G. Rapkin - Northampton. www.hgrapkin.co.uk

Read the full reviews and more on our website

Different by Design

We have taken the design of our very best cable, the highly acclaimed Ninja DCT++, and cut out everything that costs.
What we have left is a simple, basic good design that takes you much closer to the musicians

CLAIM YOUR **FREE** 1m SAMPLE FROM US TODAY AND ENJOY THE SMOOTH NATURAL SOUND OF TWIST IN YOUR MUSIC

Black Rhodium

www.blackrhodium.co.uk
sales@blackrhodium.co.uk
+44 (0)1332 342233

use in the 201 would have suggested the Kensai being used for inspiration. These days China produces them (e.g. Hi-Vi) but they remain rare. But although the DoAcoustics 201 tweeter looks like the Audiosmile unit and gives very similar measured results it is in fact a folded ribbon tweeter from Fountek (China) NeoCD3.0 – and not a magnetic planar. So these loudspeakers look much alike but are different under the skin, investigation shows.

All the same, the 201 has been tonally balanced almost identically to the Kensai. Their frequency responses are nearly identical, comparison of their test results shows. They could almost be the same loudspeaker, on the basis of this evidence alone.

However, their impedance curves are totally different. Because the impedance of a loudspeaker says much about it, these two loudspeakers are less alike internally than they appear externally.

And that, Watson, is a the evidence as it stands in this strange case of two loudspeakers that are the same but different – ignoring the price gap of course, which is huge.

What you get with the DoAcoustics 201 is a well built stand mounter. It weighs a heavy 14kgs and measures 350mm high, 200mm wide and 320mm deep, and feels solid. It needs a high stand to put it at ear height. Huge machined aluminium end pieces add a nice touch and the rear panel carries a port and a single pair of input terminals, so bi-wiring is not possible.

SOUND QUALITY

Perhaps everyone should make loudspeakers with the SEAS Excel bass/midrange unit and a planar tweeter because it gives a result that is immediately and deeply attractive. It took no time at all to like the 201s for a beautifully easy sense of clarity and gentle but deep insight. They

come across as sweet and colour free; there is no metallic sheen to provide enhancement from the magnesium cone and the 201 ribbon tweeter was silky smooth.

That DoAcoustics have gone for a natural tonal balance is obvious from the off, but what makes the 201s different is



that they don't sound warm or dull. All our torture albums, like Duffy's 'Rockferry' that has added "graunch" from digital distortion that has been deliberately added, played easily through the 201s, where this track can for example often sound almost unbearable through a loudspeaker with a prominent metal dome tweeter.

Bass came over as a little inflated and plummy even from an Audiolab 8200A amplifier, but it was pleasant all the same, giving the 201s a generous bottom end. Even though we had sound absorbing panels behind each loudspeaker to absorb colouration from the port there was a little boxy boom coming from this source, listening from behind showed, but the 201s differ little from the norm in this area. We positioned them 8in from a wall.

This was one of the best loudspeakers I have heard for reproducing Nigel Kennedy's Stradivarius. The violin at last had seemingly natural body and its own rich signature, whilst its strings were beautifully delineated. Classical music lovers will find the 201s a dream I suspect, arguably preferable to electrostatics in possessing a slightly darker and denser treble quality.

The 201s have plenty of midrange body, bass power and are temporally nimble

too, so they play heavy rock well and delivered Lady Gaga's 'Bad Romance' with an easy rolling power. The box again boomed a little when pounded by the bass synths, but Gaga's vocals were clear and intelligible.

Sitting 12ft distant the mediocre drive unit integration wasn't obvious as I was in what is termed "the far field" getting energy from walls and ceiling, even though acoustically damped. Moving in closer showed that the 201s sound balanced on axis but get a little soft off axis. Generally, far away (24ft) they sound warm because high frequency energy put into the room is low. So the 201s are best heard close up, meaning under 10ft away; they are not big room loudspeakers. Imaging was firm and tidy and strictly between the loudspeakers.

CONCLUSION

In essence the DoAcoustics 201 is a lovely loudspeaker, distinguished by a sound similar to the Audiosmile Kensai, which it resembles. Technically it needs a little tidying up, with better inter-drive unit phase matching and removal of the midrange dip to lessen the sense of warmth. As it stands the 201 still shades most other loudspeakers if you value its accurate presentation, but the Audiosmile Kensai rather spoils its party by costing £3k less.

VERDICT ●●●●

A quality standmounter with a lovely sound, tending to warmth. Too expensive by far, however.

DOACOUSTICS
MODEL 201 £4695
STUDIO5 AVB Limited
 ☎ +44 0843 523 5725

- FOR**
- sweet treble
 - detailed
 - natural tonal balance

- AGAINST**
- high price
 - insensitive
 - some bass boom

MEASURED PERFORMANCE

Our green frequency response trace was the flattest result available from the 201, just above the central axis (phase plug) of the bass/midrange unit. Phase matching between tweeter and bass/mid was not too good, the output dip around 2.5kHz deepening substantially above the bass unit axis. On high stands the 201 will be at ear height and have a good, even tonal balance, albeit with some softness from the recessed midrange. At other heights it will sound warm and likely diffuse. The drivers would benefit from better integration but as they are, the 201 has been balanced to be accurate but easy on the ear, more so than most loudspeakers.

Bass output shelves down below 200Hz, making near-wall mounting best so the rear wall reflects the bass energy. The port works down to 50Hz, our red trace shows, and port output measured +6dB up on forward output from the bass unit, at 80Hz, a common value. This means the port provides quite a lot of extra low output and the 201 will likely have quite fast, bouncy bass, but not subsonics.

As a load the 201 hovers between 3 Ohm - 4 Ohm the impedance trace shows, so it draws current. Worse, in spite of this it is very insensitive, producing just 82dB Sound Pressure

Level from one nominal watt (2.8V) of input. Amplifiers of 100 Watts or so are needed as a result, to go loud.

The DoAcoustics 201 will have an easy sound balance, likely controlled bass of good quality and sensible level and a generally refined but likely mild manner. It needs a lot of power to go loud. NK

FREQUENCY RESPONSE

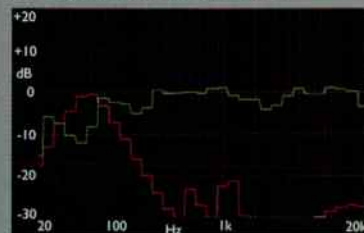

Green - driver output
 Red - port output

IMPEDANCE

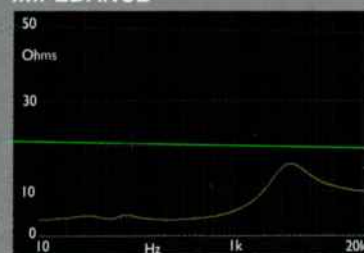

mail



Visit our website at www.hi-fiworld.co.uk or send your emails to letters@hi-fiworld.co.uk. Letter of the month wins a pair of KEF Q100 loudspeakers.

LETTER OF THE MONTH PRIZE



KEF Q100 LOUDSPEAKERS

A pair of KEF Q100 loudspeakers are on their way to STEVE BENNETT, Letter of the Month winner in our June 2012 issue.

Letter of the Month



A Rega RB300 arm on a Sansui SR222 Mk2 belt drive turntable gives "more detail retrieval and more musicality than I ever remembered" says Dennis Slater.

SANSUI SAVED

I wanted to copy some old LPs, via the Creative Audigy sound card fitted to my computer, to the hard disk and from there write to CDs for playing in my main system (Marantz CD63 K1 player, Cyrus One amplifier and Monitor Audio RX6 loudspeakers with Cambridge Audio 500 Series interconnects and QED XT speaker cables).

The problem was I didn't have a turntable. Needing one for this purpose, plus wanting to keep costs down, I headed off to eBay.

To cut a long story short, I ended up with two turntables, both of which had faults on them. One, a Sansui SR222 Mk 2 had wiring and bearing faults (this had been knocked about a

bit, damaging the arm, but was cosmetically good). The second, a Rega Planar 3, had motor speed and hum problems.

The answer was obvious. I set about rewiring the Rega RB300 arm (as an upgrade), which was in good condition, with silver plated copper tonearm wire (non branded) obtained from eBay (I'm not easily deterred) and fitted it to the Sansui deck.

Measurements for spindle to pivot, overhang etc. were obtained from Rega specifications for the arm. I wired the tonearm wires directly to gold plated phono sockets fitted to the plinth so that various interconnects could be tried. The arm board is a Maplin project box lid and I used Blu-Tac between surfaces as damping material. The results can be

seen in the attached photograph. I've since fitted Michell cartridge tags and trimmed the wiring to tidy things up.

I think you'll agree that the combination certainly looks the part, but more importantly and connected to the Cyrus amp. with an Audio Technica AT110E cartridge, the sound is nothing short of a revelation, much better than I expected. I know descriptions are subjective but phrases such as more detail retrieval and more musicality than I ever remembered, spring to mind. Tracking is excellent as well and of course, there's that unmistakable analogue sound.

So, a fruitful and rewarding accidental project. Thanks for looking at the letter/email. I hope you enjoyed reading it as much as I did doing the work.

Regards,
**Dennis Slater
Normanton**

It's always nice to hear about a satisfying home project. There's nothing quite like DIY to get a great result from simple items, fettled to give their best. The Rega RB300 arm can support cartridges better than the basic Audio Technica AT100E however, so you've got plenty of leeway to go further with your vinyl. We usually recommend Goldring 1000 Series cartridges like the 1022GX reviewed recently, or Ortofon 2M series, especially the 2M Black. **NK**

For more advice see Letters from earlier issues at www.hi-fiworld.co.uk/letters

DAC AND DOCK

A recent issue had an article on DACs, some of them upsampling, leading you to comment that better digital sound than CD possible. I don't know if I am asking the right question here, but is there such a beast as an upsampling DAC with iPod dock? I am hoping to use one with an iPod/iPhone and an existing Denon DVD800 (Pioneer A209R amp, Castle Pembroke II speakers).

A final comment about your World Favourites. I understand you can't test everything, but I am surprised headphones are given so little space (unless they are Sennheisers....). Last summer I trialled a number of different ones for my iPhone, and the clear winner to me were the AT 55s. I also bought a low-cost pair of SH for the TV. Are there any portable headphones that work off the dock connector (with some kind of built-in DAC?).

Regards,

Manolis Kroussaniotakis
Cyprus

Hi Manolis. You can extract the digital output of an iPod using a Cambridge Audio iD100 iPod / iPhone dock. This has S/PDIF outputs that can be connected to an upsampling DAC and the Cambridge Audio Stream Magic 6 is just one of



The Cambridge Stream Magic 6 upsamples all digital inputs. It accepts an S/PDIF input from Cambridge Audio's iDock 100, that reads digital from iPod and iPhone.

these, plus a lot more. Alternatively, just type Upsampling DAC into a search engine and take your choice, since all have S/PDIF inputs and will work with the iD100.

Upsampling makes anti-alias filtering easier and more effective. However, it doesn't much improve basic sound quality in my experience, which with 16bit, especially in AAC compressed form as on the iPod, can't really be polished up to convincing hi-fi status, so don't expect too much.

My iPhone 4, does however, give great sound quality from 24/48 PCM music in WAV files, and I often convert high resolution 24/96 PCM music to 24/48 using the XLD file

format conversion program so I can replay them on the move. This is a way to get good sounding music from the iPod and iPhone, especially when connected to an external DAC. The iPhone at least, and likely the iPod, will not play higher sampling rates, but bit depth has more impact on sound quality so this is no big issue subjectively.

So, for good sound quality down-convert 24/96 to 24/48, rather than trying to up-convert the dismal stuff that usually resides on these devices. **NK**

DEATH OF CD?

Are we looking at the end of the Compact Disc? With sales of the physical medium plummeting, has the CD had its day? It's ironic that the format that was invented to kill off vinyl is struggling to keep its head above water while analogue is probably in better health than it's ever been. It's possibly true to say there are more turntable manufacturers out there now than during the format's heyday in the 60s and 70s. Most of them may be quite small and niche but they are producing some incredibly high quality products. Digital streamers, too, are also increasing in number and, in the main, in quality as well.

Where does this leave the

humble Compact Disc? The superior sound quality that was promised when it arrived in the early 80s never really materialised (I still remember Tomorrow's World smearing jam over a disc then getting it to play). A mid to high-end turntable will beat any top disc spinner. With vinyl there is always more depth, more scale and more enjoyment. There is also the nostalgia factor to consider. Some people like to read the sleeve notes without the use of a magnifying glass. They like to go through the ritual of sliding the vinyl out of its sleeve, checking for fingerprints or other marks and carefully placing the stylus into the groove.

Before this starts to sound like a Marks and Spencer food advert, I

don't feel the same thing with CD. In 30 year's time no one is going to say, "Do you remember those little shiny discs you put in a machine and pressed a button to hear the music?" Doesn't have the same ring to it, does it? I think CD will limp on for a few years longer before being consigned to the format history bin, alongside Eight-Track and MiniDisc. Maybe the generation that grew up with it will try and cling on to it like a life jacket floating in the open sea. The generation that had given up on vinyl as old fashioned but can't quite get their head round iPods may talk about how much easier CD is to use and how can you put something on in the car while taking little Tarquin to school.

In fact, there are kids growing up now who know nothing other than downloads and internet streaming. Though for them I issue a word of warning. Technology never stays still, not even for a moment. There will come a day when these youngsters have grown up themselves and they see some kid walking down the street, nodding away to the latest tunes on invisible headphones as the music he's hearing has been downloaded to a chip inserted directly into his brain. Watch this space, it could happen.

Matthew Abbott
Lancaster

It seems that silver discs are going out of fashion, seen as a yesteryear technology. Today we store information in memory. Boxes of cogs and wheels, from CD players to hard drives, are strictly yesterday it seems.

Heavens, I am even hearing that e-mail is yesterday too! Soon, tomorrow will be declared yesterday in an attempt to get ahead. But then that is true too, since the day after tomorrow makes tomorrow yesterday. I don't think we can win this one! **NK**

DIGITAL BLUS

I am still battling my way to get the best sound(s) from digital music. I have written before on my experiences, but things have developed since then and I hope I can contribute some more. I was suffering the ignorance of precisely what SACD and DVD-A recording resolutions were and how best to play them back, when an article in your magazine, by chance, mostly explained it all.

Fair enough: loins girded etc. and move on. Then there are all the various resolutions of digital music that is available for download. I groaned again; quite a few choices there and



Philips launched CD in 1983, showing it off at a press conference in Holland. As technologies go it has had a long lifespan.

the inevitable arguments as to what sounded better. We came out of the CD vs HDCD vs SACD vs DVD-A era. Now we have Ogg, FLAC, AAC etc. and various hi-res files at 24/48, 24/96 and 24/192 resolutions, in stereo or surround mixes.

I have realised I am old school in that I want a physical "thing" for my money. Even buying a cheap MP3 seemed hollow as I didn't feel as if I had anything for my money, so I concentrated on collecting hi-res music on disc. Fortunately for many prog/metal fans, two disc releases with surround mixes on the 2nd disc are quite popular and often in DVD-A format, so I was happy for a while. My trusty Pioneer 656-A gets good use as a result.

Then a possible Nirvana appeared; rock music on Blu-ray!! Prayers answered I thought!! Full fat hi-res music on a disc I can buy; with a picture; and sleeve notes. I duly ordered the remastered Moving Pictures by Rush, one of my all time favourite albums, and the 2nd disc was actually on Blu Ray in 5.1 surround. The re-master on CD was quite good, but I felt the dreaded dynamic compression had been introduced somewhat, but I wasn't that bothered. I had the vinyl version and an early CD release.

So, with some anticipation, I put on the Blu Ray. I never finished one play through. It seems that some albums should be left as stereo. True, the sound was very clear and a delight to listen to, but the surround just seemed to separate the strands of the recording. I was left thinking of those TV shows about classic albums, where an engineer plays a little of a recorded track which

sounded a bit naff, then you heard it mixed in the whole recording and it sounded fabulous! Well, I put it away and thought, that was a 30+ year old album, maybe I should get something newer.

Then Steven Wilson announces that his new studio album is being recorded for a Blu-ray release. Oh joy! An artist I like releasing straight to Blu-ray, only to find that it has either a 24/96 PCM stereo or 5.1 DTS-HD Master Audio soundtrack. So, where are the full fat, uncompressed stereo/surround mixes?

I have been disappointed twice with hi-res on Blu-ray now, but I am not near to giving up. My Rega P3 is still top dog for me and records are wonderful to own. I do like surround music and am sure that I will find some cracking new studio releases eventually either as new, or SACD/DVD-A re-issues or on Blu-ray.

I am just a bit overwhelmed at the variety of digital music files. Surely it dwarfs even the SACD vs DVD-A debate?

Then there is the matter of replay equipment, but that is for another letter. I must say I have felt that you give good advice for us non-techies on how to navigate this mess. Along the way I have picked up some excellent surround discs, despite the above woes.

Yours,

Paul Clewlow

Hi Paul. Surround-sound does give a different sonic perspective to traditional stereo, according to how it is mixed. A lot of what is on Blu-ray is taken from live concerts and you get a view from the audience, the rear loudspeakers just carrying crowd noise and general ambient information. It differs from DVD-A by carrying video, which imposes such a mix, otherwise guitars seen at front would be heard from behind – and that would seem weird!

DVD-A, lacking video, could and sometimes did carry music mixed into the full surround-field, with sound and effects from behind as well as front – and very interesting it was too at times. Blu-ray music-only discs are not so common and even those I have, from 2L for example, commonly have a stereo mix, although others choose to place the listener within an ensemble. It's all a bit ad-hoc really, in terms of where you sit with regard to the musicians. What is certain is that with 24/96 recordings sound quality is, in most cases, appreciably crisper and more detailed than CD.

You ask "where are the full fat, uncompressed stereo/surround mixes?". The DTS-HD Master Audio track is in effect just such a thing and it is what you are after. Although 'compressed' it is losslessly

compressed, so you lose nothing when de-compressed on replay. Lossless compression halves the storage capacity required, although with Blu-ray this isn't so much of an issue unless super high resolution 24/192 audio is used together with HD video.

That's the theory anyway! Looking at www.gracefordrowning.com I see they say the stereo mix is high resolution 24/96 whilst the surround-sound is audio from concerts, resolution being unstated. I suspect much of it will be 24/48 or 24/96 however, but just how good it will sound in the home depends upon how well it was recorded under live conditions. It all gets complex and confusing.

In all, though, I enjoy Blu-ray for its ever expanding catalogue of music. But most people see it as a video disc little better than DVD in quality terms, but a lot more expensive and unnecessarily complicated, which it is. It is another missed opportunity for



Steve Wilson 'Grace for Drowning' Blu-ray. "where are the full fat, uncompressed stereo/surround mixes?" asks Paul Clewlow.

Sony, who basically saw it as a great hardware platform for Sony Pictures, yet seem totally unable to exploit its potential – and the world is moving on. **NK**

SME IN A SPIN

I have decided to invest in an SME 10 and Series V arm after a long audition at Walrus Systems (thanks Les & Pete). So having also decided (definitely) not to make any other changes before I've lived with the new turntable/arm for a while I have immediately assessed the cost and timing of getting my Trichord Dino upgraded to a Mk2 and the Dino + PSU converted to Never Connected spec. even before SME have confirmed a delivery date!

Is there no hope for me though personally, it seems like £424 well spent before I think about a more significant upgrade - or should I save my pennies now (up to £1,500?) to spend on a more comprehensive move up

Letters On-Line!

You can now read our Letters on-line, from the last issue back to March 2010. That's a treasure trove of information and advice to our readers, as well as a fascinating catalogue of reader's systems and views. There's mountains of buying information, all just a click away on your computer or i-Pad. Have fun!

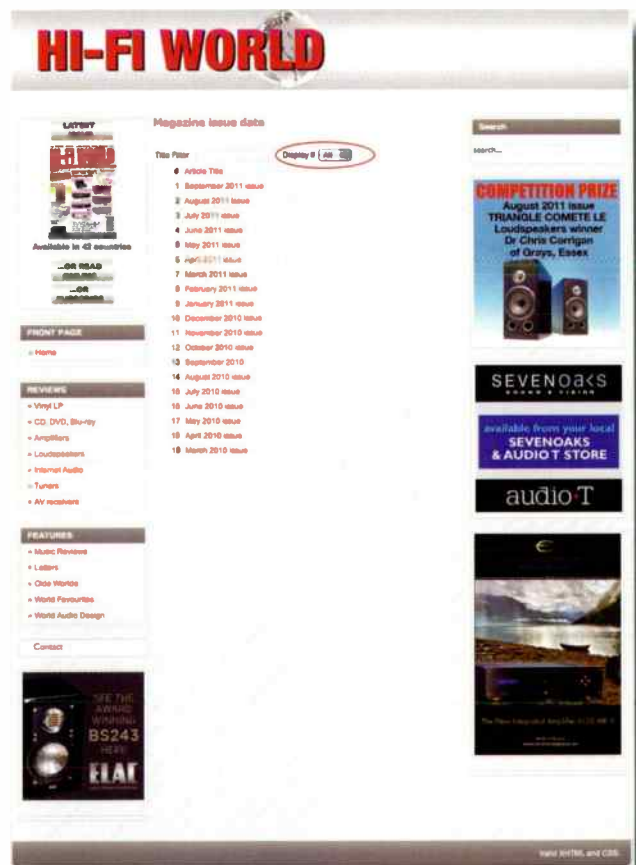

You can reply to Letters using the e-mail link at the top of the page -

World Mail June 2011 Issue

Write to us! E-mail → letters@hi-fiworld.co.uk

Letters are published first in the magazine, then here in our web archive. We cannot guarantee to answer all mail, but we do manage most!

Or comment in the Comment section at the bottom of each page.

Your experts are -
 DP David Price, editor; MK Noel Keywood, publisher; PR Paul Rigby, reviewer; TB Tony Bolton, reviewer; RT Rafael Todes, reviewer (Allied String Quartet); AS Adam Smith, reviewer; DC Dave Cawley, Sound Hi-Fi, World Design, etc.

...or the reply pane at the bottom of the page.
 Replies will go on-line and in the magazine if suitable.

Add your comment

Your name:

Subject:

Comment:

Word verification:

Post Preview

Just go to www.hi-fiworld.co.uk and click on Letters in the left hand menu list, under the FEATURES category. This will take you to the individual months of issue. To see the full list set the 'Display' drop-down list to 'All'.



SME 10 turntable and SME V magnesium tone arm. Fabulous quality, but don't forget the cartridge Graham!

the ladder to complement my current system which I am warned must sound 'bright'. I found the detail, scale and rhythm that the SME 10/V produced absolutely beguiling and the way voices are portrayed, truly impressive.

I listen to a wide range of stuff but increasingly, jazz and classical as well as more contemporary performances. As an illustration, to audition the SMEs I took along my own copies of Mystery Train - Elvis, So - Peter Gabriel, Buena Vista Social Club, Kind of Blue - Miles Davis (who else?) and La Traviata (21 y/o DG edition).

The choice of good quality phono stages seems pretty bewildering to me especially as maybe I should look at something with those funny glowing things as well as the boring boxes of transistors. I'd welcome your thoughts and recommendations as I don't sense

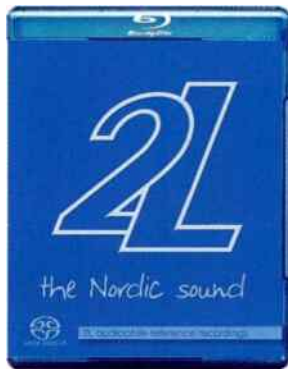

2L of Norway issue plenty of material on Blu-ray recorded at full 24/192 resolution.

it will be that easy to borrow samples to listen to at home before buying.

I have a small study/listening room (3.9m x 2.7m) with a solid floor and my current system comprises Origin Live Ultra (classic) / Origin Live Silver (Mk2) / Dynavec 20x cartridge / Origin Live Advanced power supply and DC 200 motor. Trichord Dino & Dino+ phono stage.

Cyrus DAC XP+ / PSX-R, Cyrus Mono X (x4), and Monitor Audio Studio 20 SE.

Digital sources are a Teac VRDS - T I

transport, Cyrus daD7 (with Trichord I Clock) / PSX-R.

*Kind regards,
Graham Wynde*

Hi Graham. Your new SME10 and SMEV arm are spectacular products and somewhat outshine your humble Dynavec DV-20X moving coil cartridge, a dated budget design, and the Trichord Dino phono stage which although good is not really in the same league.

These days Benz Micro and Van den Hul are setting the pace in moving coil cartridges, closely followed by the slightly more sober Ortofon. A Benz Micro Ace SL or Van den Hul DDT-II will improve the sound usefully at limited cost (under £1000). However, an SMEV arm suits better MCs should you be feeling flush and the sky is the limit. Ortofon's Cadenza Bronze is one of my favourites.

You will hear large and clear differences between transistor and valve phono stages, the latter giving a more spacious and open sound, with less hard treble. Our recommendation in your case would be an Icon Audio PS3, which has a valve regulated power supply. None of these items are overly expensive but they will hone your SME's sound nicely. **NK**

DAC RESOLUTION

Why do most high resolution digital to analogue converters only have an output frequency response up to 20 kHz? This seems to defeat the point of having high sample rates above 44 kHz. Whether the normal human ear could hear the difference is another question.

**Rick Barfoot
Brussels**

These days high resolution DACs, meaning ones that handle 96kHz and 192kHz sample rate digital, vary in where their analogue frequency response actually rolls off. Our measurements show a -1dB point at around 35kHz and a smooth roll

off above that, from a first order filter that imposes little phase shift. Japanese receiver manufacturers are a little more fastidious and more commonly engineer flat response to 60kHz or more, and Naim do this with their DACs too. If you are reading response figures of 20kHz this might relate to performance with a 44.1 or 48kHz sample rate test signal, a limitation of the test equipment. The DAC may well roll off at a high analogue frequency, but the test signal is itself band limited by sample rate. Only recent, expensive test equipment generates 96kHz and 192kHz sample rate digital test signals.

To make it absolutely clear to readers, a DAC that can resolve 96kHz sample rate digital should have an analogue output that reaches up to 48kHz and one that resolves 192kHz sample rate should reach 96kHz in the analogue domain. The analogue response is half the sample rate. In practice manufacturers commonly use low order analogue filters to minimise in-band (i.e. below 20kHz) phase shift, which the ear may well hear. This is why high sample rates were proposed in the first place, not because the ear was thought to be able to reach 48kHz or 96kHz!

However, to take this subject a little further, some people who really know a thing or two about digital, like Rob Watts the original designer of Deltec products, state that 384kHz sample rate or more is necessary. So far, I hear little difference between 96kHz and 192kHz sample rate, but that is as much likely due to current ADC technology as it is to potential audibility.

There is, however, clear benefit in greater bit depth, meaning 24bit is audibly better than 16bit, but whether upcoming 32bit will make a difference we will have to see.

The drawback to ultra high resolution audio is that file sizes and data rates increase proportionally, to a level beyond the capacity of current storage and transmission channels. For the time being at least (i.e. the next decade or so) a move to 24bit resolution at 48kHz or 96kHz sample rate would be just fine, sound quality wise, I believe. We need to hone current technologies to produce good results at this level. This means swinging away from yesterday's crappy compression technologies into something fitter for today's purpose, yet not so inflated as to overload high capacity cable networks for marginal improvements.

And one final thought! All today's music files are two channel stereo.

Surround-sound music files are just over the horizon and coming soon. Whether anyone will want them I doubt. A bit like 3D TV, surround-sound is a crudely awkward and intrusive technology that I suspect most people feel they don't need. But that doesn't mean we are not to hear about it! **NK**

KIWI SPEAKERS

Where I live in New Zealand decent hi-fi gear is very limited and often auditioning in our own home is out of the question. Consequently those of us who live here rely heavily on reviews and the advice of experienced people like yourselves.

I would like to upgrade my 'speakers and would like your opinion on two or three options of floor standing speakers to fit my system. Currently my system comprises a NAD M55 disc spinner, NAD M3 amp, B&W 685 speakers on stands, B&W ASW610 sub (to fill out the very bottom end), Slinkylink speaker cables and Neotec silver interconnect. I listen to all types of music but find myself being more drawn to the jazz and folk genres. I have a 4x7 room but am hoping to move to a new home with a larger listening room.

I have found the 685s a bit harsh at times and listening fatigue can set in after a while. I do like the idea of the Martin Logan Electromotions but I would have to import them so would have to be super confident that they would suit. There is also a possibility to audition some Tannoy DC10s but again I have to be very certain to warrant the supplier getting them in especially. The same situation applies to Monitor Audio and Sonus Faber. My budget would be at its limit at the Tannoy's.

Thanks heaps,

Grant Barraclough
New Zealand

Hi Grant. I guess your 4x7 dimensions are metres and not feet, in which case it is a fair size room that would just about accommodate the 'speakers you list.

Because open panel electrostatics have a totally different sound to box loudspeakers, not everyone likes them. Martin Logans have a box bass unit too, and this doesn't integrate perfectly with the open panel, although I acclimatise to it for the sake of appreciating all the other things Martin Logans do so well. So it is difficult to recommend the Electromotions without audition; they are a step into another world, loudspeaker wise.

The Tannoy DC10s are being updated to DC10As and are easier to recommend. Your room is barely big enough I feel, and you may well

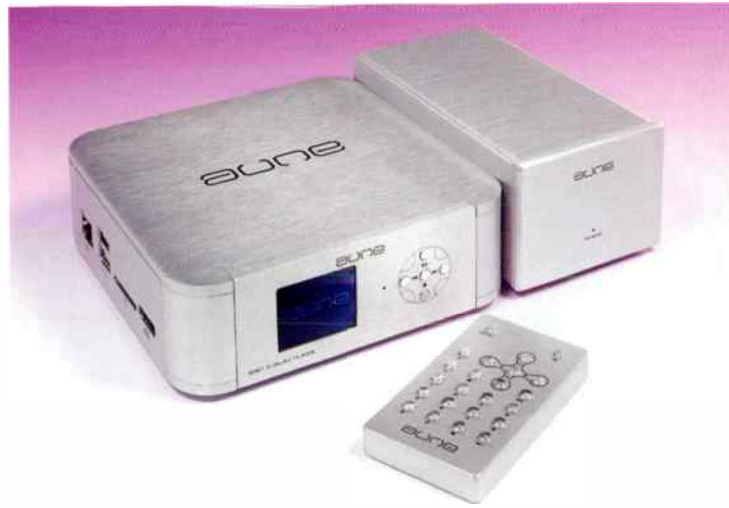

The Aune S1 media player has a DAC that reaches to 100kHz, suitable for 192kHz sample rate digital, our analysis with a Rohde & Schwarz UPV below shows. But analysers able to make this measurement are currently rare.

be better off with DC8Ts or the new Tannoy Precision 6.4s. Tannoy engineer in very smooth treble and you would find them much easier than the B&W 685s. If your dealer can demo Monitor Audios the GX200 is a nice loudspeaker, if with 'obvious' treble from its ribbon tweeter, but it is good quality treble. I hope this helps.

NK

STYLUS LOSSES

Your review of the Goldring G1022 reminded me of something perplexing about cartridge test measurements over the years. Despite its fancy Gyger I stylus, the G1022 suffered 5dB treble loss at 20kHz when tracing inner grooves. However when you previously tested the cheaper G1012 with the less fine Gyger II stylus, this showed only 3dB loss and the Ortofon Vivo Blue, which has a simple elliptical, showed only 4dB loss. Even more bizarrely, when the spherical-tipped Denon DL103 and London Decca Professional were tested, they only lost 3dB at 20kHz on inner grooves. What is going on? In theory high frequency tracing, particularly on inner grooves, should improve as we move from spherical tips to simple ellipticals and then to Gyger II and Gyger I tips – and subjective listening tends to support this view. However frequency response tests have rarely shown any relationship between stylus shape and inner groove high frequency response.

Does anyone have an explanation for this peculiar state of affairs? Is the theoretical advantage of line contact tips being cancelled out by poor alignment, or does their advantage only come into play at higher modulation levels? It is unusual to find such a conflict between theoretical predictions and test results and it would be interesting to know

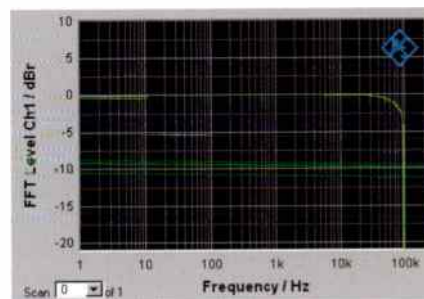

what is going on.

Yours sincerely,

Alasdair Beal
Leeds

Differences of a few dB exist in the test discs, as well as between samples of cartridges, styli geometries and stylus alignment on the cantilever. LP is a very imprecise technology and it isn't realistic to expect digital levels of precision from it under measurement. The inner groove response test looks at the situation in general to check nothing too extreme or unusual is occurring with a cartridge, as well as to see how it has been balanced. **NK**

GOLDRING CARTRIDGES

Re-reading the latest issue of HFW, I came across the letter on page 36 from Gerry Martin and your own reply. A couple of thoughts occurred to me.

First, I think Goldring are wrong in rejecting the request for assistance on the basis of a 1-year warranty having run out. According to the law relating to the Supply of Goods including The Sale and Supply of Goods to Consumers Regulations 2002, Goldring and their distributors/vendors have a responsibility for the quality of this product for a total of 6 years. However, I believe it would be the responsibility of the consumer to prove that the product was faulty at the time of purchase if the fault is established more than 6 months after



Tannoy Precision 6.4 loudspeakers may well suit Grant Barraclough's room in New Zealand.

purchase; the burden of proof lies on the vendor during the first 6 months only.

In this case, assuming a manufacturing fault, it should not be too difficult to prove that this was indeed the case and so successfully be able to reject the goods. There is in fact further case law in the UK that gives more than 6 months to consider rejection of goods in many circumstances.

Secondly, Goldring must realise they are dealing with a manufacturing fault, so they are stupid in turning down Mr Martin's request for help – very bad business sense, if you ask me! The fact that you have written about it and I have noticed proves this pretty neatly I think.

Finally, I think it would be fair if HFW in the future 'refrained' from recommending a product with such poor quality control and customer service. Best wishes,

**Olle Andersson
Dorset**

Thanks for your observations Olle. UK hi-fi companies are often none too generous when it comes to customer disputes, it seems from our postbag. But then we do hear the complaints but rarely the praise (if there is any!), so ours is not strictly an impartial position. But see the next letter.

One faulty product and a disappointing response does not statistically damn all Goldring cartridges and prove they have bad quality control. That is an assumption too far. We've all used plenty of

Goldrings over the years, without problem, and so have readers. To ignore what is a very effective product would be to act against the best interests of our readers. **NK**

LEEMA LOVE

I feel I need to write to you regarding customer satisfaction. Approximately three years ago I purchased a Leema Stream CD player of which I am very impressed – well was.

It suddenly developed a driver error and wouldn't allow the drawer to open. I contacted Leema via their web site and contacted them to see where I stood. They responded within minutes, asking me which day would suit me as they wanted to collect the machine and take a look at it for me. I work away from home a lot and after some messing about, at my end, they collected my machine and kept me posted all the time and said it would be a 7 working day turnaround before I would see the machine.

They resolved the problem but not only that, they also uploaded the latest software for my Stream and upgraded it to the Leema Stream 2 free of charge. Their services were out of this world, and I must say so is my CD player now. Thank you all at Leema.

Phil Dilley

ROOM ISSUES

I love reading the reviews about exotic hi-fi equipment, while drooling over the pictures of tubes glowing away, Mac power meters, Teflon capacitors and such! I particularly like Hi-Fi World for your reviews on analog and valve gear! One day I am going to have a set of the Icon 845 MKII power amps that you use as a reference.

Until recently I forgot about probably the most important component in my stereo only system, the listening room. We recently moved house. In the old house the stereo had been set up in the lounge room which had a lot of weird angles (no parallel walls), thick carpet, openings into other rooms and a lot of overstuffed furniture. The sound was really quite good. The soundstage was as wide as the speakers and as deep as the front wall, with good tonal balance and imaging.

The room that was set aside in the new house for the stereo had nearly perfect dimensions: 3.1m wide x 3.6m long x 2.4m high, but with hard wood floors. The room was to be a dedicated listening room with the speakers (large 3 ways), a DIY air rack to hold the amp and SACD player and my listening chair. I got the system set up, thinking that things would sound very good. It sounded terrible muddy sound, boomy bass, limited soundstage, blurred imaging, overly bright, just about

unlistenable! First thing to go in was a thick wool carpet to cover the floor. A little better, but still not very listenable, and only at very low volumes.

What to do? I had been thinking about room treatments for the new room before we moved in, so I installed some DIY Argent Room Lenses and some DIY Tube Traps. The sound clarified and became extremely listenable! The soundstage goes beyond the speakers to the right and left and the depth is unbelievable (when it is present in the recording). Muddiness is gone. Bass is taut and more powerful. Mids are sweet and pure as are the high frequencies. Imaging is pinpoint. With small jazz groups you would swear they are in the room with you! The sound had blossomed and was beyond what I thought was possible from my system. For far less than the cost of any single electronic item in my stereo I achieved a sound that no upgrade has ever allowed me to hear!

Cheers,
**Peter Gron
Australia**

Hi Peter. You are right that the room is crucial and indeed we have just moved offices to get a room that is great for loudspeaker reviewing. But whilst your new room may have good proportions, it is too small to avoid problems. The carpet will help absorb the floor wave from the loudspeaker, but the low ceiling may need some diffuser panels to eliminate ceiling images; I heard people singing from the ceiling in a demo a few months ago! The room just wasn't right in this respect and our own listening room has ceiling diffusers to ensure we are listening to the loudspeaker and not the ceiling.

Your largest dimension results in a room mode at 48Hz, which is high. It will enhance bass at this frequency, which will suit small stand mounting loudspeakers but not big floorstanders. Small room volumes have a higher Q than large rooms too, so you get bouncer/boomier bass. There are plenty of room mode calculators on the internet by the way. Put room mode calculator into a search engine or go to www.realtraps.com for plenty of info on all this.

I have no experience of Argent Room Lenses, but you would need to use wall hangings acting as an absorber or diffuser panels to lessen flutter echo in your room and bass traps in corners to control bass boom.

The sound stage will move beyond the loudspeakers when left and right wall reflections reflect treble energy to the listening



Sound diffusing panels on the Vicoustic stand at the High End Show in Munich this year. These disperse sound waves, getting rid of phantom images, whilst not causing a dead sound.

position. As with the ceiling, diffuser panels are best used to control this effect. They distribute the energy, rather than absorbing it. You end up with a lively sound, but not one so strong in any frequency band as to interfere with the loudspeakers. Absorbers result in a dead sounding room, albeit a 'quiet' one I have found, Brits can go to www.studio-spares.com and their Acoustics section to find absorber and diffuser panels to clean up common room problems, **NK**

SWEETNESS WITH LIGHT

In the middle seventies I was living in the Victoria Centre in Nottingham. As was my wont, I popped one day into the demonstration room of the local hi-fi dealer, I think that it might have been the first of the Superfi chain. I vividly remember hearing music being played on an admittedly large pair of speakers. There was such a sense of ease and calm to the music: it was all laid out and was "there" rather than "here". I was able to listen to it, rather than it being like a pair of speakers on my shoulders facing into my ears. So many systems seem to pin me to the chair or the wall behind, awful.

Also, I remain quite severely sensitive to aggressive or nasty treble. It can really make my ears wince.

In the last five years or so I have evolved my system as follows; CD player is an Electrocompaniet EMC-1 with matching Electrocompaniet EC1-5 amplifier and Diapason Adamantes speakers on their original equipment Diapason stands. Balanced interconnects were made up by the dealer and Black Rhodium Tango speaker cable. Mains cable is just a bog standard distribution block.

So why am I asking for help? The system isn't terrible but isn't quite where

I want it to be. When I went to the Bristol show I thought that the general style of the presentation of the music by the Audio Note room seemed good, as was the Gamut company.

I'm looking for a sweet open sound which doesn't harden up as the volume increases, an absence of a harsh or strident treble good detail and imaging.

Politicians would have us believe that choice is a good thing. But there is so much choice in hi-fi equipment that without help from someone who has a wide range of experience in the industry it would consume a couple of lifetimes. I am prepared to consider changing any one or indeed several pieces of my equipment from mains block to speakers. I have had a valve amplifier but found in the end that it was difficult to live with the heat. I hope that you might be able to help me.

With best wishes

Martin Dickinson

As lovely as the Adamantes are, they are a small loudspeaker and you cannot expect them to have the big, open relaxed sound of large Audio Note AN-E loudspeakers driven by Audio Note valve amplifiers, or a big pair of El Superiores S7s from Gamut. Visit some dealer showrooms and listen to big loudspeakers, that is assuming you have a room large enough to accommodate them.

If you are using Adamantes because space is limited then a pair of floorstanders balanced for near-wall use, like KEF Classic iQ50s would give a bigger sound. Spendor A3s may well appeal too, if you want a smooth balance and have limited space. Spendor's ep38 polymer cone gives very low coloration and a natural tonal balance plus a sense of warmth that makes for an easy going presentation. **NK**

CLASSICAL QUERY

I look forward to every issue of Hi-Fi World as I regard your publication unsurpassed. My desire is that it remain that way, which is why I feel the need to offer some constructive criticism.

As your learned readers will know, there is equipment that portrays some music styles better than others and a thorough, professional review will reveal those characteristics, which brings me to my point. The article on Inspire's Monarch turntable left me hanging and frustrated. The same goes for the article on Musical Fidelity's V-LPS 11 phono stage. Why? Because not once was there reference to Rock, popular or other styles of music. This is a gross oversight that diminishes the article's credibility. Are we to assume the only potential customers are those with a preference for jazz, classical or chamber music? May I suggest you include an additional perspective from someone more attuned to other musical styles, especially if the original reviewer is not familiar with these.

This will be of huge assistance to those compiling a 'short list'. As such, I feel both reviews are incomplete and were not deserving of a place in your fine publication.

Sincerely,

Michael Ivosevic

I understand your frustration and indeed if we run reviews missing either reference to Rock or Classical music we get complaints from the faction ignored!

The reviewer you allude to is Rafael Todes, who plays violin with the Allegri String Quartet. You can see him at right in www.allegriquartet.org.uk. Rafael is by far the most educated and astute listener I have ever encountered, and that makes him a dynamite reviewer. He has musical experience others cannot hope to match and can hear right into what products are doing. This means his reviews, including that of the Inspire Monarch turntable are piercingly perceptive. This is valuable; it ensures our reviews are accurate, meaningful and useful rather than misleading. That's a lot more than I can say for much of what is published. However, we cannot ignore Rock and I take your point. Obtaining more than one opinion is a good way to tackle this issue. **NK**



Spendor A3 loudspeakers have an ep38 polymer cone for smooth, natural sound.



Take Heed?

Getting the most out of a single design while promoting value for money, Paul Rigby reviews the expandable Heed Obelisk si Mk.II and X2 Add-On PSU

Richard Hay has been around a bit. He worked at Truvox (known for their reel-to-reel tape recorders) and was chief engineer at Radford Audio, "...at the end of the valve days and at the beginning of the semi-conductor days," confirmed Hay.

During the mid-eighties, he designed the Ion Obelisk, but then, "I left the hi-fi industry, in the early days of digital. I felt that people were running headlong into computer-based entertainment and not listening to the music, they were listening to digits and specifications".

With the Obelisk design still resonating, old distribution contacts in Hungary and Germany wanted to continue the amp's lineage. "Back in the mid-2000s, the German distributor asked for a new Obelisk while two of the Hungarians, Alpar and Zsolt Huszti, offered to

manufacture it. An update followed, known as the Obelisk 3X. I gave them quite a lot of input but it was far from a complete product, it was a bit 'garage'-like".

More work has been done to improve the general casework style with further products – eight in all released while a specialist digital engineer has joined the design team.

Here, I will be reviewing the si (Super Integrated) stand-alone, integrated amplifier along with its immediate upgrade, the X2, external power

supply, "When you plug in the power supply, that's a 350VA transformer that feeds the power amp only, monaurally," said Hay. "The power supply that sits within the pre-amp (160VA), powers the pre-amp only at this point."

As an integrated, the amplifier runs 35W into 8 Ohms and 50W

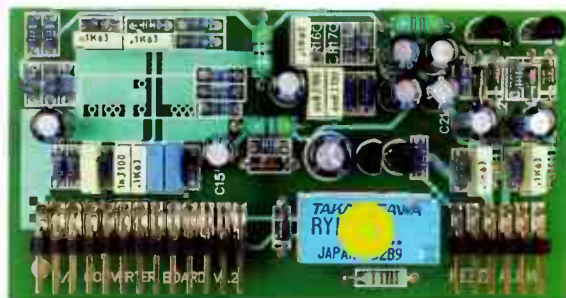

Heed Obelisk Si DAC board turns the Obelisk into a 'digital' amplifier with an S/PDIF input.

in 4 Ohms. With the added external power supply fitted, you rise to 60W into 8 Ohms and 100W into 4 Ohms.

One of the principle features of the Heed amplifier is its ability to utilise plug-in cards to add extra facilities. They include a MM phono card and a DAC option (I took a look at the DAC, for this review). Although Heed recommends that a registered dealer handle the installation, the process is very simple and, if you're used to popping PC cards into your mini tower, then you will find Heed cards a cinch to install. The DAC, for example, required the si case to be removed, the card to be slotted home, two clearly marked jumpers (left and right channels) to be moved to the DAC setting and the case popped back on. The process took me less than five minutes. In the reviewed integrated, there is space for a single card. Heed also produce a specialist pre-amp (the Pre) which can take two cards.

So why do the cards at all? "They are more expensive if boxed separately" said Hay. "A card is a more affordable approach. A phono card is £145 but £300 boxed, the DAC is £265 for a card but £515 as a finished box."

On the outside of the si is an ALPS Blue motorised volume pot while the inputs have six positions. The first is a null position which acts as a mute. The next five are standard inputs, "Input one can be a line input, a DAC (which then feeds a S/PDIF on the rear) or MM phono," said Hay.

On the rear, sits a pair of speaker sockets plus "...a Pre/Line output can be a tape output socket which, internally, you can set up to be a tape outlet or a line outlet (via another jumper link)."

There's also a shorting plug socket for a 'dumb', stubby, plug. When connected, this prevents the integrated amplifier entering mute mode if you are not using the external power supply.

Inside is a large toroidal power supply with a chunky internal heat-sink housed alongside the power and thermal tracking drives. The power amp section is built around it on a board "that also includes the smoothing power supplies that are shared, in the integrated set-up, with the pre and power sections. Everything is done with very short links and no wiring. We hate wire in signal paths" said Hay. "The PCB board has twice the normal copper weight in it with short runs between components which means we take a long time to design the boards."

As for the X2 power supply? It includes, inside, a large toroidal



Heed Obelisk Si internal shows motor powered Alps volume control at (top right), and input selection with a rotary mechanical switch (bottom left).

power supply with a twin-mono power supply. Simplistic but high quality.

SOUND QUALITY

But was the sound of a similarly high quality? During our chat, Hay also talked about his close friendship with Naim and particularly Naim's founder, Julian Vereker, and how the Heed products 'sang from the same songsheet' as a company but that Naim's hardware lacked certain sound elements that his products

Blues', the Heed offered a subtle, well delineated bass and percussion line that was full of detail. This jazz piece provided an admirable midrange performance that had more delicacy than the Naim but there was also a touch of midband recess from the si that had me wishing for a greater, more incisive, performance in this sonic region. The slightly subdued nature prevented me launching into full blown toe tapping.

It was time to add the X2 power supply to provide a level playing field

" an almost epic portrayal of the music and a smooth tonal rendition"

added to the sonic menu. To that effect, I decided to compare the Heed to my Naim NAC 112/NAP 150.

The most immediate feature of the si, via the Sugababes' 'Blue', is it's slightly warming, certainly characterful, bass while the Naim's bass is powerful and meaty but it is also dry. The Heed, on the other hand, adds richness to the mix, providing more tonal characteristics and humanity to the response.

The si recognised the compression that swamped this track while harsh upper mid frequencies attacked my ears but, still, there was more focus to the Heed's higher frequencies than in the Naim pre/power.

Turning to jazz and Horace Silver's 'Cape Verdean

for the Heed when comparing itself to the Naim boxes.

Playing the Sugababes' track, the now dual-boxed Heed experienced a tremendous stretching of the soundstage that provided a wealth of new space for both vocals and instruments to work within, giving each time to expound more efficiently but, in addition, a sense of ease and effortlessness. The space also provided a new smoothness

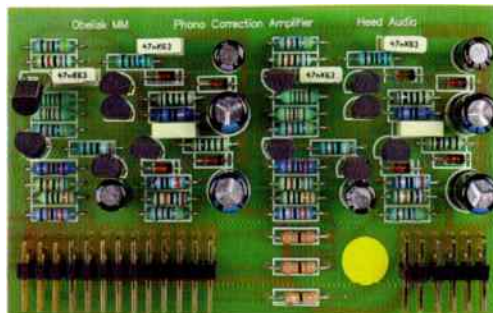

Heed Obelisk phono board uses discrete transistors, not silicon chips, an unusual feature nowadays.

FURUTECH

Ultimate Performance
Ultimate Refinement
Ultimate Luxury

Pure Transmission Principles at their finest!

The new XLR sockets feature α (Alpha) pure copper conductors for minimal impedance and a special nonresonant nylon/fiberglass housing incorporating Furutech' ultra-effective Piezo Ceramic Damping Material. Unique to FT-786F and FT-785M XLR sockets are nonmagnetic stainless steel plates incorporated into the piezo compound using a special patent-pending process.



FT-903 RCAs feature α (Alpha) pure-copper conductor for minimal impedance with a heat resistant LCP (Liquid Crystal Polymer Resin) housing. LCP is a superior compound damping material that is also incorporated into the chassis nut to ensure there are no disturbing resonances. The construction of the FT-903 is patent pending and its design.



FURUTECH Co., Ltd.
Tokyo Japan

e-mail: service@furutech.com
URL: www.furutech.com

sound foundations
www.soundfoundations.co.uk

+44 (0)1276 501 392
info@soundfoundations.co.uk
25 New Road, Blackwater Camberley
Surrey GU17 9AY Great Britain



Emis Audio

EMIS > SHEFFIELD > ENGLAND



HVA1 Valve Amplifier

Five HI-FI World globes awarded
January 2012

"a sound that not only left me deeply impressed,
I was actually quite taken aback."

Noel keywood HI-FI World

www.emisaudio.co.uk

T: 07425 568989 E: brian@emisaudio.co.uk

Tellurium Qtm

The first cables designed to successfully
combat phase distortion



Find out why more
and more people
are talking about
Tellurium Qtm.

Don't just believe
all the incredible
reviews, test our
cables for yourself
against any other
cable in the same
price range and
be surprised.

Talk to your nearest local Tellurium Qtm
dealer now and find out how your system
can really perform.

www.TelluriumQ.com

01458 251997



2010
2011
2012

hi-fi+

Products of the Year 2010



Jan 2011



Hi Fi World
Cable of the Year 2010

Filling The Gap

Releasing the latest incarnation in its iPod docking hardware, the Arcam drDock offers a host of new features. Paul Rigby plugs in for a listening session.

Well, I say iPod dock but the Arcam drDock is more than that because it can also handle the iPhone and, now, the iPad. The drDock spans just 100x65x72mm but its sturdy, 335g, weight manages to keep the iPad in place and stable. Plugging an iPod and iPhone into the dock activates recharging, but not with the iPad which always requires a direct connection to charge; it does not charge through its docking connector.

Well built with a quality feel the drDock sits snugly on a shelf. A power light indicator sits on the front of the moulded, solid cast alloy chassis. On the rear are an array of connection sockets, including a pair of analogue phono sockets to plug into the hi-fi, along with an HDMI output for transferring video direct to a TV, or via an AV receiver. In addition, a digital audio S/PDIF output enables connection to a DAC. If you have them to hand, the drDock can be controlled via Arcam's own Solo Neo, Solo Mini or AV Amps.

The drDock arrives with a small, lightweight, plastic remote control. With it, you can access the iDevice interface, moving up and down menu trees, selecting your music in varied ways such as by album or playlist, accessing the repeat of shuffle modes as well as the usual CD transport-like button controls.

Sonically, the Arcam drDock bypasses the iDevice's internal DAC and output amplifier, providing a direct digital connection to an external DAC, improving sound quality.

SOUND QUALITY

To get to the point, the drDock does some things very well and others satisfactorily so – but then there's the price point to consider.

Soundstage is a big plus. Starting with EAC-ripped WAV files, the vocals in the jazz piece, 'It Never Entered My Mind' from

Carol Kidd, had so much depth that listening to this track was only recommended with the attendance of a trained lifeguard. Instrumental separation was impressive, providing a busy, organised and mature musical presentation that showed a generous amount of air in and around each instrument and reflected Kidd at ease in the studio.

There are some issues with the drDock, however., notably a measure of bass bloom and further distortive bloom in the mids during crescendos via the analogue output. For the price, however, the Arcam provides a surprisingly audiophilic performance that fills a room with cultured and well constructed sounds.

On the highly compressed Sugababe's track, 'Blue', the drDock pumped out a meaty, beaty bass track with plenty of aggressive punch. This, basically, unlistenable track was nicely restrained by the Arcam, providing a sense of mature control over the excessive peak limiting. Yet the Arcam remained honest and transparent, at all times, retaining its edge and hence letting the ear know that there was a range of nasty high frequencies floating about in there.

Finally, an EAC-ripped 320kbps MP3 Mozart piece may have butted the Arcam's head against the inherent limitation of the format but what information was available was processed efficiently, with care and attention, to make the bitter MP3 pill as sweet as possible.

CONCLUSION

Via its analogue outputs the drDock is not a perfect solution, but it is a convenient



one, connecting simply to any stereo system. Better audio quality can be had by using one of its three digital connections, feeding an external DAC. With HDMI able to transfer video as well as audio Arcam provide tremendous value for money; few docks have an HDMI output.

Without doubt, the drDock has been carefully put together, providing the best output, pound for pound, that I have heard in a dedicated docking device, for a long time.



VERDICT

Providing sound quality that exceeds the competition at its price point, this well designed dock offers a civilised sonic performance.

ARCAM drDOCK £200

Arcam
+44 (0)1223 203 200
www.arcam.co.uk

FOR

- 3D soundstage
- instrumental separation
- design

AGAINST

- slight bass bloom
- peaking mid distortion

Q up

A floorstanding loudspeaker for around £500? Join the queue for a 2050i from Q Acoustics, says Noel Keywood.

If you want a big, floorstanding loudspeaker for peanuts, our usual advice is to buy a Q Acoustics 2050. Priced at around £400, according to finish and the latest discounts, the 2050 offered a generous sound underpinned by the sort of big, rolling bass you'd hope from such a beast, and no real weaknesses to upset the picture. For some tastes it was a little mild mannered up top and you might be surprised to learn that's because German designer Karl Heinz Fink tailored it toward the traditional BBC sound than anything more international, even though – ironically – British loudspeakers today sound more like German ones of yesterday (boom and ting) and German loudspeakers today are balanced more toward the sort of accuracy Brits demanded yesterday. It's a topsy turvy world!

Into this Merry-go-Round the 2050i changes little. It has been re-tuned a little so the tweeter better matches the bass/midrange unit, comparison of our measurements of the original 2050 (Aug 2010 issue) and today's 2050i show. There's a smooth midrange and just a tad more midrange detail and insight as a result, but otherwise Q Acoustics keep the loudspeaker's basic characteristics. Meaning this remains a well balanced budget floorstanding loudspeaker.

Our review samples came in a striking gloss white finish that ups the price slightly to around £525. The cabinet is clean lined, to the point of having rear panel connections concealed in the base. This does mean the loudspeaker must be laid on its side to connect up, but this will be an occasional process for most people. The rear panel does carry a large port though, and big foam bungs are provided to stuff into them should bass sound a little too heavy, more of which later. The terminals allow bi-wiring, enabled by using twin cables and removing connecting links, as usual.

The front panel carries two synthetic cone bass/midrange units, sitting above and below a 25mm dome tweeter in a D'Apollito arrangement. This gives symmetrical dispersion, so the floor and ceiling waves are the same, making the sound at the listening position less anomalous between different listening positions.

The cabinet stands one metre high, like most floorstanders, width measures 321mm and depth 270mm. The 2050i sits firmly on a steel base that carries spikes, helped by a weight of 21kgs, that makes them feel hefty.

Q Acoustics recommend they are angled in toward listeners, but in truth steadily rising treble from each tweeter means they are more accurate if positioned to face straight down the room,



and listened to off axis. This sort of positioning is best sorted out by experiment. I tend to prefer a large, spacious sound stage; angling inward compresses stage width but intensify images a little.

For the price you get a lot for your money as this is a sizeable beast and ours were very well finished.

SOUND QUALITY

In our large 24ft square listening room the 2050is had solid deep bass and the initial drum strike at the start of Angelique Kidjo's 'Agolo' sounded taut and powerful, whilst kettle drums thundered strongly in Holsts 'The Planets'. However, this was when driven by an Audiolab 8200A transistor amplifier, which has good electrical damping and kept the 2050i bass cones under control. Potentially, the 2050is suit valve amplifiers but even with our Icon Audlo MB845 MkII monoblocks they were a little boomy, even with feedback switched on. Also, because the 2050is produce strong deep bass they will excite smaller rooms and generate a boomy sound in this situation as well.

"the 2050is are full bodied in their demeanour"

The 2050is offer large bass that runs deep but they can easily tip into sounding over inflated – and that is why foam bungs are supplied. However, the bungs are a little drastic and tend to kill bass output, so a little experiment may be needed to get the sound balanced for a room, but then this applies to most loudspeakers.

With a clean, powerful amplifier like the Audiolab, the 2050is were happy enough and this is how they should be driven. The rear ports let out some boxy coloration and this can be heard in the sound, making for slightly boxy bass, obvious with the heavy bass line behind Amy Winehouse's 'Rehab'. Although the

loudspeakers are a little workmanlike in this respect they still do a very good job at the price, giving bass notes consistent strength across the bass scale. This makes for smooth, intelligible bass lines, rather than 'one note' boominess. The 2050is are

full bodied in their demeanour, a property I appreciated. They don't lack power, giving the barrel chested vocals of Jackie Leven a strength that suits the man. Strummed guitar in 'Fear of Women' had a sharp edge that swung attention to the tweeter, its prominence marking it out a little boldly. The treble lift we measured can be heard, but for the most part it isn't upsetting, being just the right side of acceptable. My acid test of tweeter behaviour lies with Nigel Kennedy playing Vivaldi's 'Spring' where his own enthusiastic performance is accompanied by the strings of the English Chamber Orchestra and here to 2050is managed well, making Nigel's violin sound full bodied enough to be a credible musical instrument, rather than a contrived



'hi-fi' representation, and nicely detailed too. Far more expensive loudspeakers commonly produce far worse results, as this is an area where designers possess little sensitivity, it seems to me.

With vocals I was aware of some clothiness somewhere in the midband and generally the 2050is were a little recessed and lacking projection. This made them mild mannered in contrast with metal cone loudspeakers or B&Ws, for example, which tend to be pushy with vocals. But the 2050is did a good job all the same, with a nice even nature that comes from their smooth measured frequency response.

CONCLUSION

The Q Acoustics 2050i is a fundamentally well engineered and honest loudspeaker free of flaws. It offers a balanced and even sound, with plenty of deep, tuneful bass. Add in an enormous sensitivity of 91dB, higher than almost all rivals, and you have a big floorstander that needs no more than 40 Watts to go very, very loud. This widens amplifier choice, but having said that the 2050i suits transistor amplifiers able to keep its bass cones under tight control, if bass quality is felt to be important. At the price this Q Acoustics loudspeaker remains a great buy.

VERDICT ●●●●●£

A large floorstander for little money, the 2050i works well, offering high sensitivity and big sound.

Q ACOUSTICS 2050i £525

Armour Home Electronics
☎ +44 (0)1279 501111
www.qacoustics.co.uk

FOR

- full bodied sound
- strong deep bass
- well finished

AGAINST

- obvious treble
- clothly mid quality
- some boxiness



MEASURED PERFORMANCE

Frequency response had obvious treble lift on-axis but it was smoother off axis, as shown in our response analysis. There is still some lift in treble output of +2dB but it is smooth and this illustrates the non-resonant nature of the tweeter. Strong output through the lower midband will give the 2050i a good sense of warmth and body to its sound and vocals may well sound a little less forward than in loudspeakers with a raised midband.

Bass from the two bass drivers runs down to 65Hz, below which the port takes over our red trace shows. It has a broad peak around 50Hz and exerts good damping on the bass cones the impedance curve shows, as expected from such a broad acoustic peak. The loudspeaker's lower limit is 30Hz so there is plenty of deep bass. Inserting the supplied foam bung turns the 2050i into a closed box design and bass below 200Hz falls by -2dB, giving a characteristic that suits near wall placement.

Impedance measured 6.6 Ohms but the loudspeaker drops to 4 Ohms and this helps toward an enormous sensitivity figure of 91dB from one nominal watt of input (2.8V). So the 2050i will go loud from very little power and needs 40 Watts at the most. The white trace is with foam bung in place

and shows 'sealed box' or 'infinite baffle' behaviour.

Our decay graph shows a broadly clean midband and treble but bass overhang around 80Hz.

The 2050i measures well in all areas, much like the earlier 2050. It goes very loud from little power so big amps are unnecessary. NK

FREQUENCY RESPONSE



Green - driver output
Red - port output

IMPEDANCE

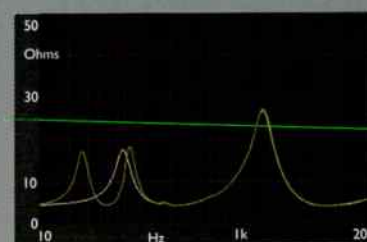



Bespoke Audio Visual Furniture

Create excellence in audio performance and appearance with our beautiful tailor-made hardwood Hi Fi and AV Furniture

Come and see our new products launching at ...

SOUND & VISION
THE BRISTOL SHOW

24 - 26
February 2012



'Award winning performance'



↑ FOR Tonally Balanced; Good Detailing; well made; very easy to put together
↓ AGAINST Nothing of Note – What Hi Fi October 2009.

'You get a lot here for your money a high Quality, Attractive, Hard wearing rack.' – What Hi Fi 11.11
'They may pass the style test but it's the sound that impresses more.' – Hi Fi World Jan 2012

www.hifiracks.co.uk

t: +44 (0) 1572 756447

info@hifiracks.co.uk, Unit 24F Pillings Road, Oakham, Rutland, UK. LE15 6QF



Scan this code into your iPhone/Android



Go With Grace

Taking headphone amplification into the high-end along with a bundled DAC, Paul Rigby reviews the Grace M903

Founder, Michael Grace, started Grace Design, with his brother Eben, in 1994 after working with the hi-fi outfit, the Jeff Roland Design Group. Primarily a manufacturer of studio gear, Grace possess products which cross over into the hi-fi community, like the M903 headphone amplifier with accompanying DAC. The reason? Because Grace take an audiophile ethic into designing its studio equipment. "From a design objective, there are parallels," said Michael Grace. "We look for absolute clarity and musicality. Accuracy is one thing but there are plenty of super analytical and accurate amplifiers and DACs out there and they are fatiguing to listen to over time. When you're working all day under headphones it

can be tiring for the brain".

The design of the M903 creates a busy appearance. Looking at the front fascia, there are two, full size, headphone sockets, wired in parallel. One amplifier runs both sockets, "Sound quality is not impaired because the amp can run multiple pairs of headphones with low impedance and a low damping factor" said Grace.

The volume read-out doubles as a display screen for a rather cryptic set-up menu. Behind that is an infra-red receiver for a remote control unit (which can be bought separately). Indicators relate to the output that the volume is referring to "So, if you push the volume knob" said Grace, "it selects between the phones or line outputs. The line outputs can also be individually

selected, if required".

The M903 volume rises in half dB steps, and they are matched within a tenth of a dB on the left and right channels for perfect channel balance, "The advantage of using a digital gain on this unit – which offers low noise and the contacts never wear out – is to enable us to keep control of channel matching and volume steps right down to very low levels. People using highly sensitive, in-ear type headphones often need to be 40-50dB down in overall voltage from what you might need for standard circumaural headphones". Standard attenuator knobs often jump up to 6dB per 'step' when low volumes are tackled.

An intriguing feature on the fascia is the X-Feed light. This circuit simulates listening to loudspeakers



The internal circuit board is packed with miniature surface mount components. There are ten power supplies, a digital section, balanced input amps and display drivers. This is no simple headphone amplifier.

in an acoustic space but through your headphones. "It's a simple passive circuit, tonally neutral, that simulates how sound refracts around your face from your right speaker into the left ear and vice versa. Your brain has a difficult time establishing sonic cues for sound staging without it. The circuit helps to minimise listening fatigue. It's a subtle effect that, when used over time, is more noticeable when you turn it off as the soundstage image then collapses into the right and left cans."

The DAC sample rate indicators are also present with a topmost LED, known as the S-LOCK, a dual stage, crystal-based phase lock loop indicating when you are using a digital source that is not USB-based.

Around the back are connections to the power supply (connected to a low noise, isolated, toroidal unit), S/PDIF, USB (which is galvanically isolated from the M903 chassis meaning that there is no ground connection when connected to a computer, to reduce noise), TOSLINK, AES3, unbalanced phono outs, balanced line outputs, unbalanced inputs and balanced inputs.

Inside, the M903 design is notable for purposely not using asynchronous circuits for its USB sampling connection. "They are cheap to make

and work pretty well but our belief is that not altering any of the bits and, instead, presenting the most pristine clock to your DAC that's synchronous to your sound source is the most high fidelity approach. In USB mode, the M903 acts as a clock master to the USB system so, when the data arrives from the computer, the internal crystal oscillators are utilised. The M903 becomes completely immune to any jitter effects".

There are ten different power supplies inside the M903 that minimises interactions between circuits and there are instrumentation amplifier line receivers for the balanced line inputs, which means that any noise picked up by the cable or in the ground is rejected.

"Also, the headphone output is based upon a current feedback amplifier, extremely fast and able to resolve complex harmonic overtones with more fidelity than voltage type amps."

Finally, Grace uses Burr Brown DACs because they have current outputs which allows Grace to make it's own current to voltage convertors, "... which is a critical part of a DAC. Where the current from the DAC is converted to a voltage, the conversion is critical because the pulse coming from a DAC is fast. You need a high performance amp to



properly convert them to a voltage. There are plenty of DACs where that process is built in. The sound quality from such DACs looks good on technical specification sheets but they don't sound very good. Which is why, when people ring us and ask us what chip are we using for our DAC, I can tell them the part number but that's only half the equation".

Notable for what this box does not have is electrolytic capacitors in the signal path, "They have lots of non-linearities," said Grace. "They have varying impedances, so they have distortion and a blurring in harmonics giving a metallic and tizzy top end. Also, they are filled with a liquid electrolyte, so they eventually dry out which changes their characteristics which then changes your audio quality. We use film capacitors, they're very stable and will last many years. Longevity and reliability are what we consider in every design decision".

SOUND QUALITY

To begin the sound tests, I attached my Sennheiser HD650 headphones to a Musical Fidelity X-Can 8VP headphone amplifier for a reference comparison. Yes, it is only worth around £350 but it offers great value and performs out of its skin, exceeding the capabilities of many other, more expensive, units so the Grace needs to be pretty amazing to warrant the extra money. Just 'better' isn't really good enough.

Listening to Skunk Anansie's 'Hedonism', via the phono connections, there are two principle elements that hit you immediately during the first few bars of this song. Firstly, there is an immense sense of integrity in how each instrument is described and presented to the listener, with the M903. How a guitar, for example, is portrayed is a very important part of the M903's make-up. There is real care and attention to detail here that provides an immense sense of truth for each instrument in the band. I have never experienced such 'realism' in a headphone amp before. The other principle element that hit me was more disappointing and involved the lifting of the upper midrange, providing a sound that leaned towards a more well lit upper midrange. Bass was tight, weighty and punchy while mids were backed by a reassuring quietness, emphasising a welcome clarity. Treble, meanwhile, had a light, unforced and very natural quality.

Switching on the X-Feed feature was intriguing. Adding the feature provided a fuller, more rounded, bass. Less one-dimensional and more

musically encompassing. The midrange seemed full of holes when the X-Feed was switched off. When 'on', the soundstage appeared busier, with more information on offer.

Running the same song though the balanced outputs eliminated the rising midrange problem but also brought a range of additional benefits. Initially, I thought that the unbalanced phonos supplied a more immediate, dynamic presentation until I plugged in the balanced cables which alerted me to the fact that I was merely listening to 'noise'. The balanced connection, after stripping away the distortion, provided an extra magnitude of focus. The previously diffuse and foggy tambourine was

essential husky softness that Christy was known for. Bass was less plummy in balanced mode, providing greater character and note-defined boundaries while midrange was also more finely etched which greatly aided piano. Drum brushes seemed to depict space within the brush stroke itself, as if the fibres of the brush were more distinct.

Replacing the standard power cable with the Tellurium Q Black (£798/metre), removed further distortion while improving dynamics by improving clarity. It was noticeable, for example, that a slight bloom around the vocals had been removed to enable a new focus to occur, while bass received a similar increase in

effects had real shine and gloss to their action. All in all, there was a tremendous complexity via the Grace that allowed it to perform in a very authentic manner.

On the Sugababes' 'Blue', the differences between the Arcam and the Grace were even more stark, because this track is highly compressed and inherently damaged by peak limiting. Firstly, via the Grace, the soundstage was much wider with clearer and more complex vocal harmonies while the lead singer sang in front of a clear blackness, pushing the vocal out from the mix. The bass had a physical punch while the synths, all of a sudden, were a *ménage* of multifaceted effects and extraneous



The Grace has a full range of S/PDIF digital inputs, and USB, as well as balanced and unbalanced analogue inputs.

now immediately recognisable for example, while clarity was much improved, enhancing the entire aural spectrum.

Returning to the phono outputs, replacing the mid-range Sennheiser HD650s with the top-of-the-range HD800s and bringing in my Avid Acutus turntable to spin the June Christy album, 'The Cool School' (Pure Pleasure), as with the CD transcription, vinyl playback appeared more real than from the Musical Fidelity. The M903 provided an informative playback with a more expressive vocal that was both rounded and mature, a voice that hinted at experience and a considered style along with a texture that, while present on the Musical Fidelity, was infused with greater nuance and subtlety on the Grace. Backing instruments now played a greater part in the performance with piano being almost playful but also affecting a greater presence, as did both bass and drums. The feathered percussive brushstrokes had less swish and more personality, while the upper-mid lift problem was curtailed.

Switching to balanced outputs and, again, the connection drew in all of the relatively diffuse, foggy, confused frequencies and corralled them into a far more focused presentation, giving the vocal more power and drive along with that

intensity, double bass relaxing into a rhythmic pace.

Testing the M903 as a DAC, attached to my quad-core PC plus Rega Mira amp and a pair of Mission 70 speakers and comparing it to a my reference, Arcam rDAC, the Grace, via Carol Kidd's 'It Never Entered My

elements that surprised and delighted with each musical bar.

CONCLUSION

It might not woo you with a sculptured chassis or fine, cultured lines but the M903 isn't about superficial aesthetics, it's about sound,

"The vocal was now not only clearer but also revealed a series of layers and modulations"

Mind' firstly removed the excessive bloom that surrounded the lower cost unit, providing again more focus to the vocals and the instrumental backing over all frequencies. The vocal was now not only clearer but also revealed a series of layers and modulations that previously only appeared as a solid blob of sound.

Bass had a more complex life too, solidifying into a range of more gradated tones that were expressed by degrees rather than by a single thump. Similarly, the piano and cymbal

that's its priority. As such, this dinky box does a fine job, offering a class-leading headphone amplifier that shines a light on even the finest detail. The DAC will turn your computer into a source that you can use with satisfaction.

REFERENCE SYSTEM

Icon Audio CD-X1 CD Player
Avid Acutus/SME IV/Benz Glider turntable
Icon PS3 phono amp
Aesthetix Calypso Preamp
Icon MB845 Monoblocks
Quad ESL-57 Speakers (One Thing Modified)
Tellurium Q Graphite speaker cables

VERDICT

Compact and offering great value, this two-in-one wonder puts sound quality first, providing a top quality DAC and a headphone amp that will please any audiophile.

GRACE M903 £1,980.80
(optional remote control: £130.80)
+44 (0)1869 600 817
www.sound-link.co.uk

FOR

- driving bass
- focus
- balanced output
- solid design

AGAINST

- runs hot
- unbalanced rising mids
- industrial aesthetics

icon Audio

Our New Stereo 40 MK III KT88m



Our best value amplifier just got a bit better



We have a passion for making well engineered Valve Amplifiers.

One of the advantages of being a private company is the ability to offer value and service without reference to accountants and shareholders. Whilst our flagship models rightly get superb praise from reviewers worldwide for their performance and value, we never lose focus on our more affordable products and regularly update them when the opportunity arises. Such is the case with our Stereo 40. Our original brief over 10 years ago to make the best possible EL34/KT88 valve amplifier for a reasonable price still holds true. Our latest Stereo 40 MK IIIm incorporates several improvements. Most importantly a meter which allows a very simple way to check that the output valves are operating at their optimum value and best performance, so easy anyone could do this. This will also tell you when a valve is due for replacement or when it is failing. Something other designs don't do. The Stereo 40 is almost unique in its ability to use a very wide range of valves including 6L6, 5881, EL34, 6CA7, KT66, KT77, 6550, KT88. Now made very easy to change if you like "tube rolling".

In our quest to make the best amplifier in its class we also include all the features we think a good amplifier should have including Triode or Ultralinear operation, remote control, a record loop, a warm up/standby facility, valve rectifier, Low Distortion Tertiary output transformers and many more.

There are also things we don't include like printed circuit boards and transistors both of which we feel degrade the performance of valve amplifiers.

Obviously the overriding priority is the sound quality which must come from good engineering which we believe to be far ahead of the Stereo 40's modest price.

We guarantee you will not be disappointed!

Our four cornerstones are Quality Performance and Value. And in the future, Service when you need it. In this age of "built in obsolescence" it may be unfashionable to talk about repairs and spares but our commitment to future service means you should be able to enjoy your amplifier for at least 20 years.

Our new series of "Low Distortion Tertiary" output transformers are the best we have ever made, enabling us to reduce global feedback by about 40%. All of our amplifiers are designed in Leicester they are commissioned and serviced by the people that designed them so you can be sure of long term performance.

All of our amplifiers are hand made using "point to point" soldering without using printed circuit boards. We are convinced this sounds better. It allows for very easy servicing, upgrades and modifications. Remote controlled volume is useful for fine tuning your listening level to match your taste. High quality components are used throughout including an "ALPS" volume control, silver plated PTFE audio cable SCR capacitors audiophile resistors. Power Amplifier operation is possible by selecting a lower "gain" on the rear of the amplifier (this is not done with attenuation which would lose quality). Loudspeakers of nominal impedance between 3 ohms and 10 ohms may be used with virtually no reduction in power or quality. A choke regulated power supply adds a richness to the sound quality that silicon devices alone are unable to do. Tape and other methods of recording and playback are catered for by the "Tape Monitor". Also useful for Home Cinema application. In short we have created an amplifier of excellent flexibility and quality which retains the qualities of traditional design and performance.

From £1,499.95 (Complete including VAT) Upgradeable See also our similar Stereo 40 2A3, Stereo 6AS7 and other award winning amplifiers on our website

www.iconaudio.com sales@iconaudio.com

icon Audio

Leicester UK

World Radio History

WORLD STANDARDS

Your guide to the best products we've heard that are currently on sale in the UK...

TURNTABLES

REGA RPI 2010 £225

Pleasing sound, fine build and ease of set-up and use make this a great first 'real' hi-fi turntable.

REGA P2 2008 £300

Excellent value for money engineering, easy set up and fine sound.

REGA P3-24 2008 £405

Seminal affordable audiophile deck with fine bundled tonearm. Tweakable, and really sings with optional £150 outboard power supply.

MICHELL TECNODEC 2003 £579

Superb introduction to Michell turntables - on a budget. Top quality build and elegant design mean it's still the class of the mid-price field.

FUNK FIRM VECTOR II 2009 £860

Innovative engineering gives a nimble, pacy and musical sound that's one of the best at the price.



MICHELL GYRODEC SE 2005 £1,138

Design icon with superlative build and finish. Sound is beautifully smooth, effortless and exceptionally expansive. No longer peerless at the price, but still a brilliant platform.

MARANTZ TT-1551 2005 £1,299

Cracking all in one deck/arm/cartridge combination, this must surely be the best sounding 'plug and play' package at this price point.

ROKSAN RADIUS S.2 2011 £1,450

Although getting expensive, the latest Radius is a highly grown up package with a flowing yet engaging nature; a fine package.



AVID DIVA II SP 2010 £2,000

New twin belt drive and power supply make this a more commanding performer, although there's a substantial price hike. Speed, dynamics and detail are hard to beat anywhere near the price.

INSPIRE ECLIPSE SEV2 12

2010 £2,349

Finely engineered, smooth and detailed sounding deck offering valuable twelve inch tonearm compatibility.

NOTTINGHAM ANALOGUE HYPERSPACE 2010 £2,390

Deliciously spacious, lyrical and beguiling sounding turntable, but lacks ultimate grip.

MICHELL ORBE 1995 £2,500

The top Michell disc spinner remains a superbly capable all rounder with powerful, spacious sound that's delicate and beguiling.

DR FEICKERT WOODPECKER 2010 £3,445

Elegant deck with great low frequency solidity, coherent soundstaging and a precise midband.



LINN LPI2SE 2010 £3,510

Surely hi-fi's most iconic turntable, the legendary Sondek goes from strength to strength. New Keel subchassis and Radical DC motor add precision and grip to one of the world's most musical disc spinners. Expensive, though.

ACOUSTIC SIGNATURE

STORM 2011 £3,612

An excellent high end design with a smooth, solid, open and lyrical sound and razor sharp styling and build.

FLETCHER AUDIO OMEGA .5 2010 £3,699

Charming high end turntable that's a fitting testament to the late Tom Fletcher.

PALMER 3 2010 £3,750

Eccentric hand built high end turntable with a pleasingly smooth, sweet and lucid sound.



E.A.T. FORTE 5 EVO 12 2010 £4,750

Excellent premium price turntable with power, precision and passion aplenty, but relaxed and easy going by nature too. Great value package with the Pro-ject Evo 12" arm option.

ACOUSTIC SOLID

ONE 2007 £4,050

Huge turntable, both in terms of sheer mass and sonic dynamics. Fit up to three arms and enjoy, just don't damage your back moving it...

SME MODEL 10A 1995 £4,556

Exquisitely engineered deck and SMEV tonearm combo that's an extremely accomplished performer with classical music.

AVID VOLVERE

SEQUEL 2007 £4,600

Stylish high end vinyl spinner with industrial strength build quality and a sound to match. Exceedingly neutral yet powerful sound is edge-of-the-seat stuff.

BRINKMANN

BARDO 2010 £5,845

Unique high end direct drive turntable with amazing grip and focus, albeit not the most romantic of natures.



McINTOSH MT10 2008 £8,995

Big, expensive, controversially styled and glows more than some might consider necessary, but an astonishingly good performer.

EAT FORTE 2009 £12,500

Lavishly finished two box, two motor turntable with gorgeous Ikeda 407 tonearm bundled. Exceptionally stable and unfussy performer with a relaxed but highly enjoyable gait.

TO NEARMS

REGA RB251 2009 £136

Capable way past its price point, the new 3-point mount version of the classic RB250 serves up a taut and detailed sound. A little lean for some tastes, but responds well to rewiring and counterweight modification.

MICHELL

TECNOARM A 2003 £442

The late John Michell's clever reworking of the Rega theme, using blasting, drilling and rewiring! Surely the best overall performer under £500.

ORIGIN LIVE SILVER 3C 2010 £599
Excellent mid-price tonearm with a clean and open yet lyrical sound.



HADCOCK GH-242 EXPORT 2010 £770
Consummately musical, lyrical sounding tonearm, but needs the right turntable. Excellent value.

SME 309 1989 £767
Mid-price SME comes complete with cost-cut aluminium armtube and detachable headshell. Tight, neutral sound with good tonality, but lacks the IV's pace and precision.

FUNK FIRM FXR II 2010 £1,175
Clever reworking of the ubiquitous Rega platform, the FXR II gives a wonderfully musical, almost unipivot like performance.



AUDIO ORIGAMI PU7 2007 £1,300
The classic Syrinx PU3 updated to spectacular effect. Hand made to order, with any mass, length and colour you care for. Fit, finish and sound truly impressive.

NAIM ARO 1987 £1,425
Charismatic unipivot is poor at frequency extremes but sublime in the midband; truly emotive and insightful.

HELIUS OMEGA 2008 £1,595
Stylish and solid lump of arm with fabulous build quality, that turns in a dynamic and weighty performance.

SME SERIES IV 1988 £1,620
Offers nine tenths of the SMEV's magic at just over half price. Exquisitely built and finished, and a design classic. Faces stiff competition these days, but lovely nevertheless.

SME 312S 2010 £1,750
Twelve inch magnesium alloy armtube plus SMEV bearings makes an impressive transcription tool with an insightful yet composed sound. Superlative build completes the package.



GRAHAM PHANTOM 2006 £3,160
Sonically stunning arm with magnificent bass dexterity and soundstaging. Build quality up to SME standards, which is really saying something!

TRI-PLANAR PRECISION 2006 £3,600
Immaculate build, exquisite design and one of the most naturally musical and lucid sounds around.

SME SERIES V 1987 £2,389
Vice-like bass with incredible weight, ultra clear midband and treble astound, although some don't like its matter of factness!

LINN EKOS SE 2010 £3,700
Subtle mods over the years, including revised bearings and the recent new wiring has kept it a serious contender in the superarm stakes. Has a commanding musicality all of its own.

OL ENTERPRISE 3C 2010 £4,500
Few if any pivoted arms come close to this arm's combination of liquid musicality and forensic grip.

CARTRIDGES

AUDIO TECHNICA AT-95E 1984 £25

Great starter cartridge that's detailed and musical beyond its price. Superglue the stylus in for better sound!

AUDIO TECHNICA AT-F3/III 2010 £189

Great value entry level moving coil with detail and grip you just can't get from similarly priced moving magnets.

ORTOFON 2M RED/BLUE 2007 £60/£120

Modern, high resolution budget moving magnets that are always an engaging listen.



GOLDRING G1042 1994 £239
One of the best MMs going, with sweet and extended treble and punchy, muscular bass.

ORTOFON VIVO BLUE 2011 £275
Super new budget moving coil cartridge from respected Danish manufacturer; a real step up from previous efforts.

DENON DL103R 2006 £295
Awkward to get working properly with a poor mounting arrangement, yet it rewards with a musical performance that makes similar priced cartridges sound cold.

DYNAVECTOR DVI0X52003 £295
Distant descendent of the classic Ultimo 10X, this has warmth and sweetness in spades, allied to a punchy bass. Beats G1042 comfortably.

ORTOFON 2M BLACK 2007 £350
Staggeringly good high-end MM that uses a stylus from the MC Jubilee and easily rivals similarly-priced MCs

DYNAVECTOR DV20X-H2003 £395
Deliciously sweet sound with fantastic get-up-and-go makes this a great value budget MC. High output version works a treat with valve phono stages too.



AUDIO TECHNICA AT-OC9MLIII 2010 £399
New stylus and cantilever breathe life into this feisty, punchy and detailed performer.

ORTOFON RONDO BRONZE 2005 £500
Excellent mid-price moving coil with real rhythmic alacrity and a decent deal of finesse.

LYRA DORIAN 2007 £649
Incisive and musical, this baby Lyra is one of the most powerful and revealing MCs at its price point. Beware the sharp treble, though!



BENZ MICRO GLIDER L2 2008 £650
Crisp, clean and detailed MC; particularly impressive at both ends of the frequency spectrum

ZYX R-100H 2005 £799
Exceptionally tight sounding and detailed cartridge with the musical skills to match, this is up with the best at the price, with a presentation all of its own.

TRANSFIGURATION

AXIA 2007 £890
Musically adept and highly resolute cartridge with impressive tracking abilities. Top end lift means careful matching required, however.

BENZ MICRO WOOD SL 2010 £945
Highly finessed Swiss moving coil that plays music with riflebolt precision.



ORTOFON CADENZA BLUE 2009 £1,000
Musical, out of the box sound, allied to real finesse, makes this a great do-it-all high end moving coil.

ORTOFON CADENZA BRONZE 2010 £1,350
Smooth and engaging high end MC with a slightly warmer and more relaxed presentation than its superb bigger brother.

ORTOFON CADENZA BLACK 2010 £1,650
Ultra incisive, transparent and dimensional moving coil with grip and punch aplenty.

ORTOFON MC WINDFELD 2008 £2,250
Ortofon's new flagship MC is a sophisticated and alluring performer that takes the vinyl experience to a new level.

KOETSU RED K SIGNATURE 2007 £2,399
The new K Signature adds a hefty dose of insight and finesse to the already impressive Red and the results are fabulous.



DIGITAL SOURCES

MUSICAL FIDELITY V-DAC 2010 £170
Clear, concise, low distortion sound belies giveaway price. Supelative value for money.

CAMBRIDGE AUDIO DACMAGIC 2010 £230
A flexible new DAC, this is an impressively rhythmic and detailed performer.

ARCAM rDAC 2010 £300
Cracking budget DAC sporting a fulsome and musical sound with gorgeous build and styling.

MUSICAL FIDELITY MI DAC 2010 £400
Surprisingly sophisticated upsampling DAC with oodles of detail and air, but bass isn't quite as powerful as it could be.

STELLO DA100 SIGNATURE £750
Superbly finessed sounding DAC at the price, with strong driving bass and plenty of air and space.



CAMBRIDGE AZUR 840C 2006 £800
Well built CD player with a silky, yet detailed sound and a whole host of useful facilities. Excellent value for money.

NAIM CD5i 2008 £895
Naim's new italic 'i' variant improves even further on the original mid-price classic, offering super tight, grippy and musical sound.

ROKSAN KANDY K2 CD 2010 £900
A charmingly musical performer at the price, this is a surprisingly sophisticated CD player for the money.

BENCHMARK DAC-1S 2009 £930
Power, precision and poise - allied to real seat-of-the-pants musicality, this DAC justifies its premium price.

MUSICAL FIDELITY M3 CD 2011 £995
Excellent mid-price machine with slick slot loading and an open and inviting sound.

ELECTROCOMPANIET PD-1 2011 £1,250
Quirky but highly capable digital convertor with an effective wireless radio option (£250) and balanced outputs.

SIMAUDIO MOON 300D 2010 £1,290
Lovely fluid sounding DAC with a deep, dark, velvety tonality.



CYRUS CD8 SE 2008 £1,350
Bespoke Servo Evolution mech makes this the most musically engaging machine at the price, with super smooth tonality to boot. Optional PSX-R adds bass and dimensionality.

DENON DCD2010AE 2010 £1,700
Powerful, open sound allied to a rich tonality and satisfying subtlety make this an excellent mid-price buy.

NAIM DAC 2010 £1,995
Superb high end digital convertor with a probing, punchy and forensically detailed sound.

MERIDIAN GO8.2 2011 £2,400
Everyman's modern high end CD player, the stylish, well made Meridian has an extremely enjoyable yet refined and accurate sound.

MARANTZ SA-KI PEARL CD 2010 £2,500
Finely honed affordable high end silver disc spinner, this has a musical lucidity that's unexpected at this price.



LEEMA ANTILLA IIS ECO 2011 £2,995
Stable and smooth yet superbly detailed and musically engaging, this is class of the £3,000 CD player field.

CHORD QBD64 2008 £3,000
Bespoke architecture gives a uniquely musical sound that's beguiling yet proffers dizzying incision and grip.

ELECTROCOMPANIET EMC-1UP 2009 £3,450
Quirky yet extremely capable high end upsampling CD spinner, with a musical fluency that beguiles more than it impresses.



ACCUSTIC ARTS CDPI MK2 2007 £3,985
Styling not to everyone's taste but build quality is impeccable and the performance is stunningly musical.

ESOTERIC X-05 2010 £4,495
Superlative 'affordable high end' CD/SACD spinner with excellent build, massive detail and great poise.

WEISS DAC202 2010 £4,600
Brilliantly open and insightful sounding DAC with a range of useful features.

ELECTROCOMPANIET EMP-1/S 2011 £4,650
Epic in scale, lavish in tone and exuberant in its musicality, this is a memorable SACD spinner. Quirky in operation and modest in finish, though.

NAIM CDX2-XPS2 2003 £4,950
A fine high end machine, but add an XPS2 and it becomes one of the most charismatically engaging 16bit machines we've ever heard. Plays music with such passion!

NAIM CDS3 2003 £7,050
The most polished Naim CD to date; tremendously capable and musical, but lacks the Rottweiler quality of the cheaper CDX2-XPS2.

dCS DEBUSSY 2011 £7,500
Compact, stylish DAC bringing the gloriously smooth, svelte, spacious sound of dCS to a wider audience.

ACCUSTIC ARTS DRIVE I MK2/TUBE DAC 2 2007 £7,980
Superbly built high end CD transport and DAC combo that shows just what the format can be capable of. Very tangible, musical sound with wonderful dynamics and glistening harmonics. Only curious styling and clunky build detract from its brilliance!

DCS PAGANINI DAC £9,599
Digital rarely sounds better; dCS's bespoke Ring DAC makes for power, punch and insight on an epic scale. Add clock and upsampler for an even more profound experience.



NAIM CD555/555PS 2006 £14,000
Very probably the best CD player yet made - certainly the most expensive; a digital *tour de force*.

**NETWORK**

NAIM HDX 2009 £4,405
Interesting one-box network enabled hard disk music system gives superb sonics together with impressive ease of use.

LINN KLIMAX DS 2007 £9,600
Landmark network music player, offering brilliant sonics at up to 24/96 resolution from hard disk/NAS. Expensive, but you can hear why...

PHONO STAGES

CAMBRIDGE AUDIO 640P 2009 £99
Excellent entry level design that raises the bar for budget phono stages. Crisp, smooth yet brightly lit sound on both MM and MC that's a vast improvement on most budget inboard designs.

GRAHAM SLEE ERA GOLD V 2004 £370
Warm, open and musical nature makes this a great budget phono stage.

ICON AUDIO PSI.2 2007 £599
Excellent valve phono stage with good range of facilities and fine imaging abilities.



CHORD CHORDETTE DUAL 2010
£799

Well presented mid price designed with detailed sound and USB input for archiving.

ASTIN TREW AT8000 2010 £880
Expansive, detailed, powerful sound makes this a leading sub-£1,000 contender.

A.N.T. AUDIO KORA 3T LTD 2010 £995
Exceptionally musical and natural sounding all discrete transistor phono stage, with highly lucid, valve-like presentation.

AVID PULSUS 2010 £1,100
Powerful, propulsive, expansive sound puts this right at the top of the £1,000 phono stage tree.

QUAD QC24P 2007 £1,200
Dynamic performer that can be used on its own as a complete phono-level preamp.

ICON AUDIO PS3 2008 £1,500
Super sounding valve phono preamplifier, with an expansive, engaging and organic nature that makes vinyl sheer joy!

SUTHERLAND 20/20 2010 £1,999
Well engineered, smooth sounding solid-state phono stage with a charm of its own.

EMILLE ALLURE 2010 £2,495
Just as the name suggests, this is a lovely way to play LP with an exceptionally open and lucid sound.



AVID PULSARE 2010 £3,800
This superbly built, well specified phono stage has a powerful and authoritative sound that bristles with detail and energy.

WHEST PS.30 RDT SE2011 £4,500
The least solid-state sounding Whest we've heard, this builds on the family strengths of precision and grip but adds a welcome poise and fluidity.

NAT AUDIO SIGNATURE 2011 £5,633
Sophisticated sounding, unusually engineered MM and MC phono stage, but faces stiff competition at this lofty price.

AMPLIFIERS

ICON AUDIO STEREO 40/III
2010 £1,200
Excellent starter tube integrated, with plenty of detail and an expansively musical sound.



AUDIOLAB 8000S 2006 £400
In another life, this sold for three times the price, making it a stand-out bargain now. Very clean, powerful and tidy sound but not the world's most beguiling.

NAIM NAIT 5i 2007 £725
The italic 'i' version remains one of the most musically competent and dynamically engaging integrateds at the price.

CAMBRIDGE 840A V2 2007 £750
Version 2 addresses version 1's weaknesses to turn in a mightily accomplished performance, offering power, finesse and detail.

SUGDEN MYSTRO 2010 £1,225
Sugden's first Class AB integrated in a long time surprises; rollickingly good fun, it loses surprisingly little in smoothness to its Class AB siblings.

NAIM NAIT XS 2009 £1,250
With much of the sound of the Supernait at half the price, this is powerful, articulate and smooth beyond class expectations.

CREEK DESTINY 2 2010 £1,445
Beautifully voiced integrated amplifier with a distinctly seductive, tube like sound. A solid-state superstar!

SUGDEN A21A S2 2008 £1,469
Crystalline clarity, dizzying speed and forensic detailing makes this seminal design the most musical at the price, but power limited so needs sensitive speakers.



CYRUS 8XPD 2010 £1,500
A quality integrated that suits all genres of music providing insight and clarity in a compact but flexible package.

ANATEK A50R 2007 £1,600
Simple integrated amplifier with super bass grip and effortless dynamics.

VINCENT SA-236MK 2010 £1,749
Big, powerful and expansive sounding hybrid transistor amplifier, with a lively, musical nature.

NAIM SUPERNAIT 2007 £2,475
Integrated *tour de force* from Naim that combines impressive functionality and connectivity with super sound.

AUDIO RESEARCH VS160 2009 £3,298
Load of tube power allied to a strong bass and smooth open midband makes this a grin-inducing listen.

LEEMA TUCANA II 2010 £3,495
Polished high end integrated amp that combines power, detail and genuine musicality with a good range of facilities.



SUGDEN IA4 2007 £3,650
Goodly amount of Class A power, icy clarity and a breathtakingly fast, musical sound make this one of the very best super-integrateds.

QUAD II CLASSIC 2010 £4,500
Beautiful retro styled integrated amplifier with a subtle, supple sound - although needs matching to speakers that are easy loads.

QUAD II CLASSIC INTEGRATED
2010 £4,500
Thoroughly modern music maker with classic style and great pedigree, this amp sings with gentle music but is no headbanger!

SIM AUDIO MOON 600I 2010 £5,750
Sturdy build, useful facilities and a wonderfully relaxed, seamless and even-handed sound will win this many friends.

MUSICAL FIDELITY AMS35I 2010 £6,000
One of the best high end integrateds we've come across, this combines hear-through transparency with musical get-up-and-go.

DARTZEEL CTH-8550 2010 £16,500
Charismatic and quirky high end solid-state integrated amplifier with superb sound and a charming visage.

HEADPHONE AMPLIFIERS

FIDELITY AUDIO HPA 100 2011 £350
Great little headphone amplifier with a lively yet refined and open sound.

MUSICAL FIDELITY X-CAN V8 2008 £350
Open and explicitly detailed sound plus serious bass wallop and the ability to drive anything to very high levels makes this a great partner for most mid-to-high end headphones.

PREAMPLIFIERS

CREEK OBH-22 2008 £350
Brilliant value budget passive, with remote control, mute and input switching, plus an easy, a neutral sound.

ICON AUDIO LA-4 2011 £800
Uses early 6SN7 triodes for liquid sound, has plenty of gain and remote control.

NUFORCE P-9 2007 £2,200
Impressive two box preamp with superb resolution and an engaging sound.



DPA CA-1 2010 £2,650
Excellent solid-state preamp with a meticulously detailed and propulsive sound, but a deep velvety tonality.

MELODY PURE BLACK 101D 2007 £3,295
The clarity and openness of valves plus firm grip and fine detail make this a preamplifier masterclass.

MF AUDIO CLASSIC CII SILVER 2010 £4,500
One of the best preamplifiers we've heard at any price, this transformer coupled marvel does very little wrong; its powerful, clean, open yet delicate sound is unmatched at or near the price.



MODWRIGHT 36.5 PRE/PSU
2010 £5,995

Exceptionally open and expansive, yet musically expressive sounding high end preamplifier.

MUSICAL FIDELITY PRIMO
2009 £7,900

Seriously expensive, but one listen explains why. Wonderfully exuberant sound that can only come from a top quality tube design.

POWER AMPLIFIERS
XTZ AP-100 2010 £520

Decently smooth yet usefully muscular, this power amp punches way beyond its price point in sonic and value terms.

QUAD 909 2001 £900

The latest current-dumper has a smooth and expansive character with enough wallop to drive most loads. Not the most musical, but superb value all the same. Lovely build, finish and Quad's legendary service are nice.

NUFORCE REFERENCE 9SE V2
2006 £1,750

Brilliant value for money monoblocks with massive power and super-clean, three dimensional sound.

**DPA SA-1** 2010 £2,850

Pacey, engaging and rhythmic almost to a fault, this solid-state power amplifier isn't the world's most powerful but is none the worse for it.

QUAD II-40 2005 £3,230

Modern tube monoblock power amplifiers with plenty of power, liquid and open mid-band and spacious, airy treble. Explicit, engaging sound, but not as euphonic as some.

ELECTROCOMPANIET NEMO
2009 £4,450 (EACH)

The Norwegian power station is as cool as a glacier tonally, yet impresses with its sheer physicality and fleetness of foot. 600W per channel makes for a massive bang per buck.

ICON AUDIO MB845 MkII 2010
£5,500

With 120W from big 845 valves right down to low frequencies, this power amplifier has massive dynamics and bass swing, yet is easy on the ear.

**QUAD II-80** 2005 £6,000

Quad's best ever power amplifier, this is a dramatic performer with a silky but dark tonality, blistering dynamics, serious power and a compellingly musical sound. They don't come much better.

MUSICAL FIDELITY AMS50
2010 £7,000

Mighty, assured high end full Class A integrated proffering icy clarity allied to real musicality. Lacks the lucidity of the best tube amps but redeems with power and punch.

LOUDSPEAKERS**Q ACOUSTICS 2020** 2010 £140

Great little standmounters with a friendly, fun yet surprisingly refined gait. Excellent value starter speakers.

ACOUSTIC ENERGY NEO I
2007 £199

Tidy and well balanced standmounters with pleasing clarity and detail.

MISSION MX2 2011 £200

Sophisticated sound alloyed with real musical insight makes these small standmounters super value for money.

ACOUSTIC ENERGY NEO I v2
2010 £225

Civilised sounding speaker with fast and tuneful bass.

B&W 686 2007 £279

B&W's new baby standmounters offer a sophisticated and mature performance that belies both their dimensions and price tag.

WHARFEDALE DIAMOND 10.3
2010 £290

Great small standmounters for audiophiles on a budget; dry punchy sound with impressive soundstaging at the price.

MORDAUNT SHORT AVIANO 2 2010 £300

Classy sounding standmounter at a still affordable price.

KEF IQ30 2009 £330

Beautifully built, classily styled standmounters with exceptional image projection and a very clean, detailed sound.

**USHER S-520** 2006 £350

Astonishingly capable budget standmounters that offer detail and dynamics well beyond their price and dimensions.

XTZ 99.25 2010 £640

Disarmingly open and refined at the price, these standmounters bring unexpected civility, refinement and insight to the price point. Exceptional value for money.

**ACOUSTIC ENERGY AEI CLASSIC**
2006 £845

Brilliantly successful remake of an iconic design; not flawless, but surely one of the most musical loudspeakers ever made.

SPENDOR S3/S5 2004 £950

A natural successor to the BBC LS3/5a, whose impressive neutrality, imaging and evenhandedness makes this a superior, if less charismatic, loudspeaker.

MY AUDIO DESIGN MY1920 2011 £1350

Exceptionally smooth, spacious and refined mini monitors that beguile and excite in equal measure.

ELAC BS243 2010 £1,000

More transparent and spacious than they've a right to be at this price, these refined mid-price standmounters represent top value.

RRR FS100 2007 £1,055

Mind-boggling amount of loudspeaker for the money. Big and sturdily built with serious bass and awesome soundstage scale. A real bargain.

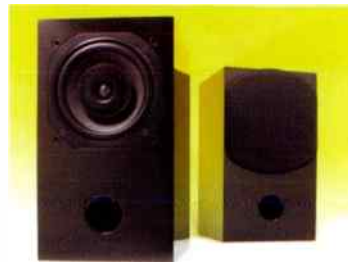
**ONE THING AUDIO ESL57**
2007 £1,450

One Thing Audio's modifications keep the good old ESL57 at the very top of the game.

GURU QM-10P 2007 £1,595

Quirky but adorable standmounters that are way off the pace in respect of detail and power, but well capable at playing a tune and pulling you in to the music.

USHER BE-718 2007 £1,600

Beryllium tweeters work superbly, allied to a fast and punchy bass driver. The result is subtle, smooth and emotive.

MARTIN LOGAN SOURCE
2008 £1,600

Brilliant entry level electrostatics, giving a taste of loudspeaker esoterica for the price of most moving coil boxes. Tremendous clarity, evenness and delicacy, although not the world's most powerful sound.

SPENDOR S8E 2008 £1,895

Generously large, silky smooth delivery, this dynamic sounding floorstander is an excellent all rounder.

**ISOPHON GALILEO** 2007 £2,100

Big standmounters that really grip the music and offer quite startling dynamics and grip.

MONITOR AUDIO PL100 2008 £2,300

The flagship 'Platinum' series standmounter has a lovely warm and delicate sound with superlative treble.

EMMINENT TECHNOLOGY LFT8B 2010 £2,300

Brilliant ribbon/moving coil hybrid with seamless, delicate and expansive yet tremendously musical nature.

PMC OB11 2008 £2,950

Cleverly updated floorstanders give scale and solidity in slim and well finished package.

MY AUDIO DESIGN MYCLAPTON SE 2010 £3,299
Powerful, dynamic, musical yet refined, this unconventional point-source design yields dramatic sonic benefits.

MAD MY CLAPTON GRAND MM 2010 £3,599
Distinctive coaxial standmounters with wonderful soundstaging, bright lucid midband and true musical insight.

YAMAHA SOAVO I.1 2009 £3,000
Musical, transparent large floorstanders with impressive dynamics and cohesion. Excellent build and finish.



MOWGAN AUDIO MABON 2007 £3,995
Massively capable loudspeakers that offer dynamics, scale and clarity in an elegantly simple package. Wide range of finishes, too.

B&O BEOLAB 9 2007 £5,000
Technically impressive and visually striking loudspeakers with sound quality that more than matches their looks.

TANNOY DEFINITION DC10T 2010 £5,000
Wonderfully wide and open, super fast and amazingly engaging to listen to.

ECLIPSE TD712z/2 2011 £5,100
Flawed genius, and wilfully so. These loudspeakers don't do everything well, but what they can do is profound and enthralling; rhythms, dynamics and soundstaging.

ARS AURES MI 2006 £5,995
Sublime build and finish allied to an insightful, assured and even-handed musical performance makes these an essential high end audition.



QUAD ESL-2905 2006 £5,995
The old 989 with all the bugs taken out, this gives a brilliantly neutral and open sound like only a top electrostatic can; still not a natural rock loudspeaker, though.

SPENDOR ST 2010 £5,995
This classy sounding, superbly presented big floorstander will appeal to those seeking high end sonics with subtle looks.

REVOLVER CYGNIS 2006 £5,999
Revolver pull out all the stops and show what they can do with this magnificent flagship loudspeaker. A superb monitor that is like a mini B&W 801D in many ways.

VIVID VI.5 2010 £6,000
Breathtaking transparency, superlative coherence and dizzying speed make these one of the best standmounters ever made - providing you like their 'studio sound'.



GERMAN PHYSIKS LIMITED II 2011 £7,800
Don't be fooled by the austere looks; this is a superbly enjoyable omnidirectional speaker with a wonderfully fast, expansive sound.

USHER BE-10 2009 £10,500
Clever high end moving coil design with immense speed and dizzying clarity allied to epic punch. Needs the best ancillaries to fly, though...

B&W 801D 2006 £10,500
In many respects, the ultimate studio monitor; dazzling clarity and speed with commanding scale and dynamics.



ISOPHON CASSIANO 2007 £12,900
Drive units featuring exotic materials allied to superlative build quality result in an immensely capable loudspeaker. Not an easy load to drive, however.

REVOLVER CYGNIS GOLD 2010 £15,000
Vast in scale with effortless dynamics and an easy, barrel chested bass, these big bangers are great for lowish power tube amps. Large room needed!

MARTIN LOGAN CLX LINEAR 2010 £15,990
Meticulously crafted electrostatic that's free from traditional limitations, this is one of the very best loudspeakers money can buy.

ACCESSORIES WADIA I701 2010 £349
The first iPod dock to extract the music digitally, letting you hook your little Apple direct to a DAC for superior sound.

ISOTEK AQUARIUS 2010 £795
Highly accomplished premium priced mains conditioner that delivers the sonic goods, unlike so many others.

TOWNSHEND MAXIMUM 2003 £800
Classy ribbon supertweeter with flexible level settings and cool styling - you'll be amazed at the difference it makes, especially with Quad electrostatics.

HEADPHONES JAYS V-JAYS 2010 £49
Wonderful little budget over-ear portable phones with a clean, smooth sound to beat the best of the rest at the price.



SENNHEISER MX-550 2005 £19
Our unqualified recommendation for those seeking a serious sounding pair of in-ear phones. Smooth, detailed and musical.

SENNHEISER PX-100 2002 £29
Cracking pair of lightweight open back cans ideal for personals, but good enough for real hi-fi use. Superb build allied to a smooth and engaging performance make them the spiritual successor to the HD400s.



GOLDRING DR150 2006 £70
Excellent build and fine sound makes these budget cans superlative value for money.

SENNHEISER HD-590 1998 £199
The company's best real-world cans to date. Open and smooth with plenty of detail. Brightly lit midband makes them an ideal partner for a valve headphone amp.

SENNHEISER HD-650 2004 £250
A super all round reference design with crisp, detailed and even sound allied to superlative build and comfort. Cable upgrade yields great results.

SENNHEISER HD800 2010 £1,000
The ultimate expression of the Sennheiser philosophy offers massive speed, clarity and insight, although lacks some of the charm of the softer, more beguiling rival Staxes.



STAX SR-007T OMEGA II/SRM-007T 2006 £2,890
Simply the best headphones we've ever heard at any price, these sweetly translucent electrostatic earspeakers are like no other headphone, or loudspeaker for that matter...

INTERCONNECTS

TELLURIUM Q

BLACK 2010 £276/3m
A deep, dark, velvety performer that's nevertheless highly musical, it represents excellent value as mid-price cables go.



TECHLINK WIRES

XS 2007 £20
Highly accomplished interconnects at an absurdly low price. Stunning value for money.

WIREWORLD

OASIS 5 2003 £99/M
Excellent mid-price design with a very neutral, silky and self-effacing sound. Superb value for money.

CHORD COMPANY

CHAMELEON 2 £90/M
One of our favourites, these are musical performers with a smooth yet open sound.



DNM RESON 2002 £40/M
Neutral and transparent - a steal!

VDH ULTIMATE

THE FIRST 2004 £260/0.6M
Carbon interconnects that help you forget the electronics and concentrate on the music. Miraculous transparency. Tight and tuneful bass mixed with air and space results in a cracking cable for the money.



TCI CONSTRICTOR

13A-6 BLOCK 2003 £120
Top quality 'affordable' mains outlet block, with fine build and good sonics. Well worth the extra over standard high street specials, which sound coarse and two-dimensional by comparison.

MISSING LINK CRYO REFERENCE

2008 £375
Currently our favourite 'affordable high end' interconnects, with a deliciously smooth, open and subtle sound without a hint of edge or grain. Superb value, inasuch as it's as good as some designs at three times the price.

TUNERS

DENON TU-1500AE 2006 £120
Excellent entry level analogue tuner; slick sonics and fine feature count make it a bargain.



CAMBRIDGE

AUDIO 640T 2005 £250
Sweet sounding digital/analogue hybrid with fine build and finish at the price.

ARCAM FMJ T32 2009 £550
Excellent hybrid FM/DAB+ tuner with a smooth, engaging sound. Factor in its fine build and it's a super value package.

CREEK CLASSIC

TUNER 2006 £550
No tuner offers better sound per pound; wonderfully three dimensional and smooth from bottom to top.

MICROMEGA FM-10 2010 £750
Don't let the modest proportions fool you, this is a state-of-the-art modern analogue tuner with bespoke internals giving a warm, expansive sound.

MYRYAD MXT-2000 2005 £800
Sumptuous sound and excellent build is all most will ever need in a tuner; superb.

MAGNUM DYNALAB MD-90T

2010 £1,295
Exceptionally able, but commensurately priced, audiophile tuner that cannot fail to charm.

MAGNUM DYNALAB

MD-100T 2006 £1,895
One of the best ways to hear FM that we know; superbly open and musical sound in a quirky but characterful package.



SYSTEMS

YAMAHA CRX-M170 2007 £200
One heck of a lot of quality performance on DAB, CD and FM for £200! Optional matching £120 NX-E300 loudspeakers aren't too shabby either.

TEAC DR-H300DAB 2008 £329
Nicely built and styled mini with fine performance on all sources that even plays DVDs!



NAD C-715DAB 2008 £429
Small, neat looks cover a truly capable system that shows just what a compact design can achieve.

ARCAM SOLO MINI 2008 £650
Half the size and two-thirds the price of a full-sized Solo, the Mini gives very little away in terms of performance to its bigger brother.

SHANLING MC-30 2007 £650
Quite possibly the cutest all-in-one around with fine performance from the CD player, tuner and MP3 player input. Very low power, though.



PEACHTREE AUDIO

IDECCO £1,000
Excellent sounding iPod dock, impressive DAC and fine amplifier section make this an excellent one box style system.

ARCAM SOLO 2005 £1,249
Excellent all-in-one system, with a warm, smooth and balanced sound to match the features and style.

LINN CLASSIK MUSIC 2008 £1,250
Neat update of the original and best one-box stereo system; superbly musical sound beats equivalently priced separates.

NAIM UNITIQUITE 2010 £1,350
Great little half width one-box system with truly impressive sound allied to a wealth of source options.



MERIDIAN F80 2007 £1,500
Fantastically built and versatile DVD/CD/DAB/FM/AM unit, designed in conjunction with Ferrari. Ignore nay-sayers who sneer that it isn't a 'proper' hi-fi product; most see sense when they listen to it...



AURA NOTE MUSIC CENTRE 2007 £1,500
Lovely shiny CD/tuner/amplifier with fine sound quality and dynamic abilities.

NAIM UNITI 2009 £1,995
Uniquely versatile one box music system with excellent ergonomics and sonics to match. A landmark product for Naim.

LINN CLASSIK MOVIE 2007 £2,250
Superbly built all-in-one that offers excellent sound across all formats and is surprisingly easy to use.



MERIDIAN SOOLOOS 2.1

2010 £6,990
Thanks to its crisp styling and bright, colourful touchscreen, plus excellent search facilities this is one hard disk music system with a difference. Best partnered to Meridian active loudspeakers.

MARANTZ 'LEGEND' 2007 £22,000
The combination of SA-7S1 disc player, SC-7S2 preamp and MA-9S2 monoblocks delivers jaw-dropping performance.





Spectral Shift

Adam Smith comes over all young and trendy with the help of the Paradigm Shift A2 loudspeakers.

As I was discussing with a professional loudspeaker manufacturer at the Munich High End Show recently, there is a definite disparity between the popularity of active loudspeakers from a technical point of view, and their uptake within the domestic market. At the top end, they are seen as acceptable because of those very links with the professional studio setup, and one or two manufacturers such as Bang & Olufsen and Meridian have doggedly stuck with the technology and made some true loudspeaker masterpieces as a result. Elsewhere, however, active speakers have tended to remain a somewhat left-field option.

Until now, that is, and it seems fitting that the resurgence in one

area of the market is yet another walk of life in which we are re-living the newly-trendy 1980s once more! Back then, the arrival of the portable CD player suddenly opened up a whole new world of music on the move that didn't actually have to sound rather unpleasant, unlike a good many of the cassette portables at the time.

Personal CD players prompted loudspeaker manufacturers of the time to pop amplifiers into their proven bookshelf models so that you could take them with you, plug them in and strike up Duran Duran and Modern Romance wherever you saw fit.

The leaders at that time were Goodmans with their Maxamp models and Wharfedale with their Active Diamonds, the latter even

coming in shades of red and white and in their own carrying bags.

Fast-forwarding to the present, the MP3 player has turned into the main musical source for many, and the resurgence of the budget active loudspeaker is in full swing. Sadly Goodmans are no more, in a loudspeaker sense at least, and Wharfedale don't seem in any hurry to 'activate' the current Diamond 10, but there is no shortage of other contenders.

Newest on the scene hail from Canada and are part of loudspeaker manufacturer Paradigm's new trendy sub-brand Paradigm Shift, introducing a range of personal audio, PC and gaming products to the UK. At present the range consists of three pairs of in-ear headphones and the A2 powered loudspeakers under

consideration here.

Reassuringly, the A2s feel like proper high quality loudspeakers rather than just a vain and half-hearted attempt to appeal to the trendy youth, and fit some fine technology into their neat cabinets. Said cabinets themselves cost £279 each in Black Ash or £329 each in Gloss Red, Grey, and White, or Satin Black.

The business end is taken care of by a 1" anodised aluminium dome tweeter and a 5.5 inch aluminium coned bass/midrange driver with inverted dust cap. Each unit is driven by a 50W amplifier with "DSP for an Intense Bass Experience" and at the rear you will find both 3.5mm stereo jack and phono socket inputs, plus corresponding outputs which allow the second loudspeaker to be daisy-chained from the first. As a result there is also a three position switch on the back of each unit to tell it to reproduce the left, right or both channels from the jack plug or phono sockets (yes, you can start off with a mono setup and buy the second speaker later if you like!)

The rear of the loudspeaker is completed by a mains input socket, on/off switch and a volume control, with the manual giving recommended settings for the latter depending on what the units are connected to. Grilles are supplied which not only look smart but take the edge off the eye-woundingly bright front panel power LED, and there is the option of smart desk stands and a Bluetooth receiver unit for £60 that allows direct music streaming from a suitably equipped source.

On their painfully trendy website, Paradigm Shift say that you can also make use of an Airport Express, however telephone calls to a couple of local taxi firms specialising in trips to Heathrow and Gatwick left me none the wiser, so I elected to listen to the A2s using good old fashioned connecting wires...

SOUND QUALITY

Heading the wise words of Paradigm Shift's PR man to "Give 'em large; they were made to party!" I duly slotted a DJ cartridge into my Vestax turntable's headshell and cued up some Underworld. He had a good point. I always like my review surprises to be of the pleasant variety and the A2s may be little on the outside but they have a mighty big heart on the inside. They really do love to punch out a rollicking tune and can come up with a bass line that belies their diminutive dimensions. Even more encouragingly that bass line wasn't of the overblown,

overstrained 'She's gonna blow, captain...' type, but had an impressive sense of control behind it. Equally the top end was crisp and spry but without being harsh or spitty. All in all, a great first impression, but now was time to don the serious hat for a more in-depth analysis...

With the cartridge changed for something a little more sophisticated and couth I was very pleased to note that the A2s were more than happy with the changes and proceeded to put on a highly impressive show. With a more sympathetic source and some more refined material passing under it, the A2s blossomed into a mature and eminently capable loudspeaker



with a good sense of soundstage scale and fine insight. Popping Neil Young's 'After the Gold Rush' onto the turntable I was most taken by the central image stability of his vocals and the way in which each inflection as he sang was very well captured by the A2s.

As I moved through a wide range of material, the Paradigm Shifts never failed to surprise me with their general enjoyability and sheer competency, proving that you should never judge a book by its cover (or in this case, its website). Possibly the most amusing event of the listening period was when I left the speakers playing Radio 2 for the evening to warm up and happened to wander into the room as that well-known beacon of youthfulness, 'The Organist Entertains' was on. Amusingly, the Wurlitzer being played from somewhere in Ohio sounded superb, with real pace and

impact!

Ultimately, though, I kept being drawn back to material with a beat and this was where the A2s really excelled, with a very impressive sense of punch and timing. Generally I would say the bass DSP works well, the only times it seemed to be caught out were in the likes of Paul Simon's 'Diamonds on the Soles of her Shoes', when the bass guitar had fine depth and weight, but each note was somewhat lacking in detail. It seems a little upper bass insight has been sacrificed for extra punch but, equally, not disastrously so.

CONCLUSION

The Paradigm Shift A2s are a very surprising loudspeaker. Although the website clearly is aiming them towards the funky, trendy young things with their iPods and Playstations, anyone who dismisses them as unruly blasters is doing them a grave disservice. Beneath that glossy exterior is a well developed and hugely enjoyable loudspeaker that would make the perfect partner for a second system and can even make a great case for itself as part of an affordable primary one. According to my encyclopaedia, a 'paradigm shift' is a change in the basic assumptions, or paradigms, within the ruling theories of science. I'm not quite sure the A2s are quite ready to re-write the active loudspeaker rulebook in this way but I can see them re-writing a good many listeners' assumptions when they hear them.

REFERENCE SYSTEM BOX
 Vestax PDX-D3Mk2 Turntable
 Ortofon Nightclub S and Goldring 2500 cartridges
 Sondex SP1/PS1 preamplifier
 Technics SL-XP140 portable CD player

VERDICT ●●●●●
 Well developed and hugely enjoyable loudspeakers, the Paradigm Shift A2s should be high on your compact active loudspeaker audition list.

PARADIGM SHIFT A2 £658
 (GLOSS FINISH)
 Anthem AV Solutions
 ☎ +44 (0)1825 750858
 www.anthemavs.co.uk

FOR
 - impressive bass weight
 - ebullient nature
 - sense of control
 - build and finish

AGAINST
 - bass DSP not quite perfect

MEASURED PERFORMANCE

Our frequency response analysis of the Paradigm Shift A2 shows a relatively smooth characteristic with steadily rising treble and no crossover suckout, a balance that will give a bright sound with strong detail. Measuring off axis by around 15 degrees saw treble fall just enough to give a net flat response, so the Shift A2 is a well balanced loudspeaker that certainly won't sound dull, but should not come across as unbearably bright or sharp either, when pointed down a room and not angled in toward listeners. The absence of peaks and dips suggests low coloration and our 200mS decay analysis bore this out: coloration was low for such a small cabinet.

Paradigm claim Digital Signal Processing has been used to enhance bass, a technique that when used heavily handedly gives excessive and

boomy bass. In the Shift A2, however, there appears to be a little upper bass boost around 100Hz but a sharp cut off below 60Hz to limit bass distortion from excessive cone displacement, maintain power handling and keep the Shift sounding 'fast' - a good sign.

The little Shift A2 is well engineered to sound fast and detailed, yet well balanced at the same time. It appears to have low coloration too. NK

FREQUENCY RESPONSE

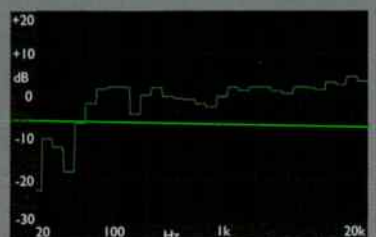



Easy as XTZ

XTZ's CD-100/11 CD player cuts price without cutting corners, finds Paul Rigby.

You can tell that Olle Eliasson, President of XTZ, has a skewed take on hi-fi life just by asking him what XTZ stands for: "Well, it's 'eXtreme Transfer and Sound'...with some wrong spelling".

That skewed take continues with his CD player, the CD-100/11, a quite remarkable box, a real wolf in sheep's clothing. Why? Because "we have put a lot of money into this CD player, especially when you compare it with others at the price point. I claim that very few other companies have been able to put so much valuable equipment into a CD player and sell it at such a low price. This is because we offer our CD players at a very low margin".

XTZ's wish is that it wants to make money by selling volume and reducing the middle man. "To begin with, we even sold direct, which cut a lot of margin," said Eliasson.

"When the big brands sell, they don't spend a lot on the CD player itself. The high price they ask takes into account the big cut taken by the distributor and the retailer. So, there are plenty of CD players out there that cost much more than ours but they don't actually put as much high

quality equipment into their design as we do."

So I asked Eliasson "what if the CD-100/11, priced by XTZ at £400, was sold by Big Brand X instead. How much would it cost us, the customer?"

"This £400 CD player would ordinarily cost you between £1,200-£1,600," said Eliasson. And you think that this situation occurs only with CD players? Think again.

So what about this 'wonder' CD player then? "We are too small to invent something from scratch. For us to do that is stupid. It is better to buy something in and then improve over and above that," said Eliasson. "We've done this by upgrading the initial XTZ CD-100 to the CD-100/11 model. It's better to have the basic construction and improve the weak things. The design is our own, we wanted a timeless design so went for the matt aluminium look with a brushed black finish which helped to give the design a solid feel. Then we tried to use good, chassis-mounted connectors with two analogue outputs, balanced outputs and a trigger to allow us to connect other XTZ components to the CD and to run the player from another box".

The improvements even extended to the remote control, adding new tooling to improve the basic Chinese model has extended the remote's range that initially required careful 'pointing' at 5m to work. "We improved upon that," added Eliasson.

Inside the chassis, XTZ has also built its own output stage and power supply with an improved transformer – even the resistors display better power handling, "The supplied components include a 1W limit but we have upped that to 2W to improve reliability", said Eliasson. "We also changed the capacitors from electrolytic to MKP, the basic PCB and the system clock to reduce the incidence of jitter, along with the internal software and the display".

On a more immediate note, the drive mechanism on the last CD-100 has now been improved. That was found to be less than robust. "It's often the case that a drive works perfectly for the first weeks and months but we found that, over a year's use, problems started to occur. That's been changed".

The DAC is an AD1955, the best DAC for the XTZ budget but a DAC that is often used within CD players

of a much higher price point than the CD-100. "The power supplies are divided and isolated into analogue and digital stages", added Eliasson. "Inside, it is divided into four sections so the drive has one shielded section, the digital board has another, then the power supply and output stage has one each".

Amongst the host of improvements and tweaks, however, is a definite sonic philosophy. For example, Eliasson is of the firm opinion that the drive mechanism itself has no major bearing on sound quality. "I don't believe that the drive itself influences the sound quality too much, so the example we use is mainly geared towards consistency and stability. It's a Hitachi DVD drive; we chose it because it was the best choice in this price range that we could find".

So, in sound terms, is the CD-100/11 a big fish in a budget strewn pond?

SOUND QUALITY

Compared to my reference CD player, the valve-powered Icon CD-X1 (£1,200), the most noticeable first impression and one that didn't surprise me too much was the tighter and punchier bass from the solid state XTZ. The latter, however, presented a surprisingly focused, lower frequency presence with that impressive bass performance.

What lifted, not one but two eyebrows, was the XTZ's overall midrange and treble performance during Skunk Anansie's 'Hedonism'. My reference Icon CD-X1 CD player is notable for its involving midband and the XTZ surprised me in supplying a similarly detailed suite of midrange highlights. What's more, the XTZ exhibited an impressive instrumental separation performance so the music had more room to grow and express itself. The Icon has always been the epitome of clarity so it was remarkable that the low cost XTZ could compete with this lucid performer. This effect was best heard on the subtle acoustic guitar in the background along with the cymbals and tambourine. The XTZ provided a wealth of information for all three, which conveyed a dominant presence while presenting a filigree enhancement that gave a degree of delicacy to the track.

The prog-based rock CD from Cripple Black Phoenix, '(Mankind) The Crafty Ape' showed the impressive XTZ soundstage. It's full 3D effect gives this complex piece more body. The Icon provided a mighty presentation and it was a big 'ask' to expect the XTZ to do the same



but the XTZ offered a similarly majestic response. Tonally, the XTZ is fascinating and 'real', with plenty of information available constructing the electric guitar, for example, as a realistic image, while the drum had an expressive quality. Vocals, meanwhile, exuded new levels of emotion

while the cymbals added a welcome contrast of daintiness.

Turning to the jazz-infused Stacey Kent album, 'Raconte-moi...' and 'Les Eaux de Mars', this track is a very busy, low key production that has a laid-back attitude. It's one of those Bossa tracks where every instrumentalist is busy concentrating on his own job, within a creative bubble. This hive of activity resulted in a wave of sonic detail. The XTZ handled these musical components with aplomb. The new level of focus made Kent's already personal vocal even more intimate. Her voice displayed focus and precision. The result was that the track flowed easily, sounding organic and musical.

Swapping the phono interconnects for balanced cables and continuing with Kent's album further improved sound quality. It became apparent, after the balanced cables had been connected, that the previously phono cables had been suffering from a measure of 'distortion'. In relative terms, this distortion affected all frequencies and the removal of those distortive qualities gave the music a smoother ride. Vocals were further focused. The Kent delivery now had a richer, more concentrated presentation. New space was created between instruments while the whole track relaxed and swung with

an almost erotic groove.

Don't confuse this open approach with a sweet presentation. The XTZ is nothing if not transparent and will tell you, in no uncertain terms, if your recording has been badly mastered or pressed, although, unlike just about every

"the best value piece of hi-fi that I have ever listened to"

other player in its price bracket, it won't punish your ears in such circumstances. The XTZ has far too much class to do that.

CONCLUSION

The XTZ has to be the best value piece of hi-fi that I have ever listened to. To think that you can purchase this box for just £400 is not only laughable, it is frankly ridiculous. I would even feel vaguely guilty handing over such a small amount of cash for such an obviously 'expensive' piece of kit.

VERDICT

For the price, a stunning CD player that will even give a £2,000 CD player competition. Well built, sounds great, bags of features.

XTZ CD-100/11 £400
 Audio Sanctum
 (+44 (0)1623 857707
 www.audiosanctum.co.uk

FOR

- overall sound quality
- build
- balanced output performance

AGAINST

- nothing

MEASURED PERFORMANCE

Frequency response measured flat to 21kHz our analysis shows, so this player will have an even tonal balance and is unlikely to have brightness in its sound.

Distortion levels were low for 16bit, right through the dynamic range, measuring a low 0.18% at -60dB against a typical figure of 0.22%, so the XTZ player is linear. Low noise and low distortion together combine to give a good EIAJ Dynamic Range figure of 100dB, again a little above the average 98dB, but below the best possible result of 102dB.

Output measured 2V from the phono sockets and - surprisingly - from the XLR sockets too; these usually deliver 4V.

The only blemish found was more jitter on the digital output than usual, a broad jitter peak around 1kHz measuring 200pS. This is far above anything normally encountered and will likely blemish sound quality via an external DAC, in the absence re-clocking.

The CD-100 measures well in most areas and should give good sound quality. NK

Frequency response (-1dB)
 CD 2Hz-21.3kHz

Distortion	0.003
0dB	0.0015
-6dB	0.18
-60dB	4.2
-80dB	112dB
Separation (1kHz)	-114dB
Noise (IEC A)	100dB
Dynamic range (EIAJ)	2V
Output	

FREQUENCY RESPONSE



DISTORTION



Analogue Experts

LA Lehmannaudio

ortofon
accuracy in sound

Pro-ject
AUDIO SYSTEMS

ROKSAN



The vinyl market is alive and well in 2012, and we at Henley Designs are proud to offer some of the world's finest and most meticulously designed record players and phono accessories to this flourishing UK scene. Like the Roksan Radius 5.2 (above); a turntable built on the knowledge gained from years of ground-breaking research and extensive listening tests. The award-winning 5.2 utilises a new high-tolerance main bearing, upgraded decoupling and motor suspension mounts, and a custom made silicon drive belt. On top of this, premium features such as the stainless steel feet with silicone coupling, beautiful high-quality finishes and improved Nima tonearm with upgraded cabling are also included to help make a turntable worthy of any serious audiophile's Hi-Fi system.

Everything we sell at Henley Designs comes from a rich heritage of analogue excellence, and we pride ourselves on offering you the best possible advice and after-sales support, online and over the phone.

Henley Designs Ltd, Unit 11, Moorbrook Park,
Didcot, Oxfordshire, OX11 7HP
sales@henleydesigns.co.uk
Tel: 01235 511 166 Fax: 01235 511 266

Turntables



Xperience Basic+

The most affordable turntable package for the hugely popular 2 Xperience Turntable.
Gloss Black Finish - Brand New Uni-Pivot Tonearm - Pro-Ject Pick-IT Cartridge Pre-Fitted - Spiked Feet



Pro-Ject RPM 10.1

Extensive testing and years of experience combined to create this monster of a turntable.
Superlative Anti-Vibration Technologies - Ground-IT Deluxe Supplied - 10CC Evolution Arm



Roksan Xerxes 20+

A true icon of high-end Hi-Fi. So impressive, it will never need to be replaced.
High-Quality Construction - Beautiful Finishes - Arm Board Options - Smooth Performance



Pro-Ject Debut S/E3

Special Edition version of the world-famous Debut turntable; the ultimate in affordable Hi-Fi.
Improved Motor Suspension - 12" Platter - Gloss Black Finish - Ortofon OM 10 Super Pre-Fitted



Pro-Ject Xpression III

Latest incarnation of the original Pro-Ject 1 turntable. An improvement on the Mk II model.
Stylish Anthracite Finish - Acrylic Platter - 8.6C Tonearm - Ortofon 2m Red Pre-Fitted



Ortofon TA-110 Tonearm

Stylish arm with innovative internal damping, for a more solid performance than its predecessor.
9" Arm - S-Shape Design - Easy to Set-Up - Supplied with Headshell and Arm Wire

Pick-Up Cartridges



Ortofon 2m

The new standard in moving-magnet cartridges. Along with a unique styling, the 2m Series boasts numerous technological advances and better stylus cuts than all that came before them.

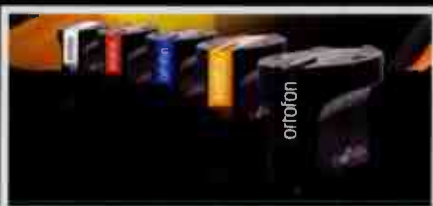

Ortofon Cadenza

An award-winning, high-end series of Moving-Coil cartridges that replaced the extremely popular MC Jubilee and Kontrapunkt models. All-new processes now combine to make a market-leading range.



Ortofon MC Windfeld

Possibly the world's most high-tech analogue cartridge. Lovingly designed by Ortofon's ex-Chief Engineer, Per Windfeld - a true Hi-Fi visionary.

Phono Stages and Accessories



Pro-Ject Phono Box S

Brand new phono pre-amp inspired by the world's most popular budget phono stage - the Phono Box. This S version combines great sound and features for MM & MC cartridges at an attractive price.



Lehmann Black Cube Decade

Lehmann Audio equipment is made for music enthusiasts, by music enthusiasts. The Black Cube Decade was designed as a celebration of the cult Black Cube phono stage's enduring success in 2005.



Accessories

We keep in stock an impressive catalogue of accessories and spare parts; from the Spin Clean Record Washer System to replacement Power Supplies. See our website for more information.

Visit us Online

Brand New Website!

We are delighted to announce the launch of our new website. With extensive information on all of our products and brands, a detailed 'Where to Buy' section offering informative listings of all our recommended resellers, a 'Help & Advice' section covering product-specific and general Hi-Fi topics, and an all-new Shop; 2012 will see henleydesigns.co.uk turn into the ultimate Hi-Fi portal.

Visit us now: www.henleydesigns.co.uk

WORLD CLASSICS

Here is our list of the great and good from audio's glorious past, products that have earned their place in hi-fi history. You'll also see some oddities which aren't classic as such, but are great used buys. The year of introduction is given, alongside the original UK launch price.

**We do not sell these products
It is for your information only.**

DIGITAL

CAMBRIDGE AUDIO CDI 1986 £1500
Inspired Stan Curtis redesign of Philips CD104, complete with switchable digital filter. Lean but tight and musical performer.

CAMBRIDGE AUDIO CD4SE 1998 £200
A touch soft in the treble and tonally light, but outstanding in every other respect.

LINN KARIK III 1995 £1775
The final Karik was a gem. Superb transport gives a brilliantly tight, grippy dynamic sound, albeit tonally dry.

MARANTZ CD73 1983 £700
A riot of gold brushed aluminium and LEDs, this distinctive machine squeezed every last ounce from its 14x4 DAC -super musical



MARANTZ SA-1 2000 £5,000
The greatest argument for SACD. This sublime Ken Ishiwata design is utterly musically convincing with both CD and SACD, beating most audiophile CD spinners hands down.



MERIDIAN 207 1988 £995
Beautifully-built two-box with pre-amp stage. Very musical although not as refined as modern Bitstream gear. No digital output.

MUSICAL FIDELITY TRIVISTA 2002 £4000
When playing SACDs, the sweetest, most lucid and lyrical digital disc spinner we've heard. Old school stereo, pure DSD design. CD sound is up in the £1000 class, too! Future classic.

MERIDIAN MCD 1984 £600
The first British 'audiophile' machine was a sweeter, more detailed Philips CD100. 14x4 never sounded so good, until the MCD Pro arrived a year later.



NAIM CDS 1990 £ N/A
Classic Philips 16x4 chipset with serious attention to power supplies equals grin-inducing sonics.



SONY CDP-101 1982 £800
The first Japanese CD spinner was powerful and involving. Brilliant transport more than compensated for 16x2 DAC, and you even got remote control!

SONY CDP-R1/DAS-R1 1987 £3,000
Sony's first two boxer was right first time. Tonally lean, but probably the most detailed and architectural sounding machine of the eighties.



SONY CDP-701ES 1984 £890
Sony's first ever bespoke high end audiophile machine used a 16x2 DAC to provide a clinically incisive sound; supreme build quality allied to the pure unadulterated luxury of a paperback-sized remote control.

TECHNICS SL-PI200 1987 £800
CD version of the Technics SL-1200 turntable. Massively built to withstand the rigours of 'pro' use and laden with facilities - a great eighties icon. Sonically, it's pure fun, with hefty bass that can still show weedy modern players a thing or two!

YAMAHA CD-X1 1983 £340
Nicely built 16x2 machine with a very sharp and detailed sound; sometimes too much so. Excellent ergonomics, unlike almost every other rival of the time.

COMPACT DISC TRANSPORTS
TEAC VRDS-T1 1994 £600
Warm and expansive sound made this a mid price hit. Well built, with a slick mech.



ESOTERIC P0 1997 £8,000
The best CD drive bar none; TEAC's Tokyo boys pushed the boat out in style. Brilliantly incisive, ridiculously over engineered.

KENWOOD 9010 1986 £600
The first discrete Jap transport was beautifully done and responds well to re-clocking even today.

DACs

CAMBRIDGE AUDIO DACMAGIC 1995 £99
Good value upgrade for budget CD players with extensive facilities and detailed sonics.



DCS ELGAR 1997 £8500
Extremely open and natural performer, albeit extremely pricey - superb.



DPA LITTLE BIT 3 1996 £299
Rich, clean, rhythmic and punchy sound transforms budget CD players.



PINK TRIANGLE DACAPO 1993 £ N/A
Exquisite; the warmest and most lyrical 16bit digital audio we have ever heard. Clever plug-in digital filter modules really worked!



QED DIGIT 1991 £90
Budget bitstream performer with tweaks aplenty. Positron PSU upgrade makes it smooth, but now past it.

TURNTABLES

ARISTON RD11S 1972 £94

Modern evolution of Thorens' original belt drive paradigm, Scotland's original super-deck was warm and musical, albeit soft. Still capable of fine results today.

ADC ACCUTRAC 4000 1976 £300

Bonkers 1970s direct drive that uses an infra red beam to allow track selection and programming. More of a visual and operational delight than a sonic stunner.

PIONEER PL12D 1973 £36

The beginning of the end for the British turntable industry. When vinyl was the leading source, this bought new standards of noise performance and stability to the class, plus a low friction S-shaped tonearm. Later PL112D was off the pace compared to rivals



PIONEER PLC-590 1976 £600

Sturdy and competent motor unit that performs well with a wide range of tonearms. Check very thoroughly before buying due to electronic complexity and use of some now-obsolete ICs.

DUAL CS505 1982 £75

Simple high quality engineering and a respectable low mass tonearm made for a brilliant budget buy. Polished, smooth and slightly bland sound.

GOLDRING LENCO GL75 1970 £15.65

Simple, well engineered motor unit with soft, sweet sound and reasonable tonearm. Good spares and servicing support even today from specialists. Eminently tweakable. Similar 88 and 99 motor units are budget 301/TD124 rivals.

LINN AXIS 1987 £253

Simplified cut-price version of the Sondek complete with LVX arm. Elegant and decently performing mid-price package. Later version with Akito tonearm better.

LINN SONDEK LP12 1973 £86

For many, the Brit superdeck; constant mods meant that early ones sound warmer and more lyrical than modern versions. Recent 'SE' mods have brought it into the 21st century, albeit at a price..



MARANTZ TT1000 1978 £ N/A

Beautiful seventies high end belt drive with sweet and clean sound. Rare in Europe, but big in Japan.



MICHELL GYRODEC 1981 £599

Thanks to its stunning visuals, this bold design wasn't accorded the respect it deserved until recently. Early examples sound cold and mechanical, but now right on the pace. Clean, solid and architectural sound.

TECHNICS SP10 1973 £400

Seminal Japanese engineering. Sonics depend on plinths, but a well mounted SP10/II will give any modern a hard time, especially in respect of bass power and midband accuracy.

REGA PLANAR 3 1978 £79

Brilliantly simple but clean and musical performer, complete with Acos-derived S-shaped tonearm. 1983 saw the arrival of the RB300, which added detail at the expense of warmth. Superb budget buy.

GARRARD 301/401 1953 £19

Heavy metal - tremendously strong and articulate with only a veiled treble to let it down. In many respects, better than the seventies 'superdecks' that succeeded it.



ROKSAN XERXES 1984 £550

Supposedly the first to 'better' the LP12, Super tight and clean sound, with excellent transients. Less musical than the Sondek, but more neutral. Sagging plinth top-plates make them a dubious used buy.

SONY PS-B80 1978 £800

First outing for Sony's impressive 'Biotracer' electronic tonearm. Built like a tank with a clean and tidy sound, albeit lacking involvement. Scarily complicated and with no spares support - buy with caution!

THORENS TD124 1959 £ N/A

The template for virtually every 1970s 'superdeck', this iconic design was the only real competition for Garrard's 301. It was sweeter and more lyrical, yet lighter and less impactful in the bass.



TOWNSHEND ROCK 1979 £ N/A

The product of academic research by the Cranfield Institute, this novel machine has an extremely clean and fluid sound. Substantially modified through the years, and capable of superb results even today.

TRIO LO-7D 1978 £600

The best 'all-in-one' turntable package ever made, Trio/Kenwood threw their 'engineering best practice' book at this one with startling results. Clean, powerful and three-dimensional sound, ultimately limited by the tonearm,

TO NEARMS

ACOS LUSTRE GST-1 1975 £46

The archetypal S-shaped seventies arm; good, propulsive and involving sound in its day, but ragged and undynamic now.

AUDIO TECHNICA AT 1120 1978 £75

Fine finish can't compensate for this ultra low mass arm's limited sonics - a good starter arm if you've only got a few quid to spend.

ALPHASON HR100S 1981 £150

First class arm, practically up to present-day standards. Buy carefully, though, as there is no service available now. Totally under priced when new, exceptional.



SME 3009 1959 £18

Once state of the art, but long since bettered. Musical enough, but weak at frequency extremes and veiled in the midband. Legendary serviceability and stunning build has made it a cult, used prices unjustifiably high.

GRACE G707 1974 £58

This early Japanese example of the tonearm art has a smooth, lyrical sound. Imported by Linn, fitted to early LP12s. Sonically way off the pace now, though.

REGA RB300 1983 £88

Inspired budget esoterica. Detailed, tight, neutral sound but tonally grey sounding in absolute terms. Responds well to tweaking, and its cheaper RB250 brother better still.



SME SERIES III 1979 £113

Clever variable mass design complete with Titanium Nitride tube tried to be all things to all men, and failed. Charming nonetheless, with a warm and inoffensive sound.

HADCOCK GH228 1976 £46

Evergreen unipivot with lovely sweet, fluid sound. Excellent service backup.



LINN ITTOK LVII 1978 £253

Arguably the first 'superarm'; Japanese design to Linn specs made for a muscular, rhythmic sound with real dynamics. Now off the pace, but the final LVIII version worth seeking out.

NAIM ARO 1986 £875

Truly endearing and charismatic performer - wonderfully engaging mid-band makes up for softened frequency extremes.



TECHNICS EPA-501 1979 £ N/A
Popular partner for late seventies Technics motor units. Nice build and Titanium Nitride tube can't compensate for middling sound.

INTEGRATED AMPLIFIERS/COMBOS

DELTEC 1987 £1900
Fast, dry and with excellent transients, this first DPA integrated is the real deal for eighties obsessives. Ridiculously punchy 80W per channel from a tiny, half-size box. Radical, cool and more than a little strange.

ROGERS A75 1978 £220
The prototypical Audiolab 8000a – lots of sensible facilities, a goodly power output and nice sound in one box. The later A75II and A100 versions offered improved sonics and were seriously sweet and open to listen to.

EXPOSURE VII/VIII 1985 £625
Seminal mid-eighties Exposure pre-power, offering most of what rival Naim amps did with just that little bit extra smoothness and sweetness. Still, it's by no means 'sweet' by today's standards, being lean, punchy, musical. It's also possessed of that quintessentially eighties look – frumpy black steel boxes with rough silk screened logos!



SUGDEN C51/P51 1976 £130
Soft sounding early Sugden combo with a plethora of facilities and filters, complete with seventies-tastic DIN socketry. A sweet and endearing performer as you'd expect, but lacking in power and poor load driving ability, so partner carefully.

VTL MINIMAL/50W MONOBLOCK 1985 £1,300
Vacuum Tube Logic was one of the Europe's biggest tube names in the eighties, and it shows. Rugged, professional build and finish allied to a lively and punchy sound (albeit with limited power) make them an excellent used buy.

A&R A60 1977 £115
Sweet and musical feature-packed integrated; the Audiolab 8000A used its blueprint to great effect.



CREEK CAS4040 1983 £150
More musical than any budget amp before it; CAS4140 loses tone controls, gains grip.

AUDIOLAB 8000A 1985 £495
Smooth integrated with clean MM/MC phono stage and huge feature count. Extremely reliable, too. Post '93 versions a top used buy.



MCINTOSH MA6800 1995 £3735
Effortlessly sweet, strong and powerful with seminal styling to match.

SUGDEN A21 1969 £ N/A
Class A transistor integrated with an eminently likeable smoothness and musicality. Limited inputs via DIN sockets.

MISSION CYRUS 2 1984 £290
Classic eighties minimalism combines arresting styling with clean, open, lively sound. Further upgradeable with PSX power supply.



MUSICAL FIDELITY A1 1985 £350
Beguiling Class A integrated with exquisite styling. Questionable reliability.



NAIM NAIT 1984 £350
Superb rhythms and dynamics make it truly musical, but tonally monochromatic. Fine phono stage, very low power.

NAD 3020 1979 £69
Brilliantly smooth, sweet and punchy at the price and even has a better phono stage than you'd expect. The archetypal budget super-amp.



MYST TMA3 1983 £300
Madcap eighties minimalism, but a strong and tight performer all the same.

ROGERS CADET III 1965 £34
Sweet sounding valve integrated, uses ECL86 output valves, even has a half useable phono stage, sweet, warm a good introduction to valves



ROTEL RA-820BX 1983 £139
Lively and clean budget integrated that arguably started the move to minimalism.

CHAPMAN 305 1960 £40
Smooth pre/power combo with a sweet and open sound. Not quite up to Leak/Quad standards but considerably cheaper second-hand.

PREAMPLIFIERS
AUDIOLAB 8000C 1991 £499
Tonally grey but fine phono input and great facilities make it an excellent general purpose tool.

CROFT MICRO 1986 £150
Budget valve pre-amp with exceptionally transparent performance.

AUDIO RESEARCH SP-8 1982 £1,400
Beautifully designed and built high end tube preamplifier with deliciously sweet and smooth sound. Not the last word in incision or grip, but that didn't matter to those who aspired to it.

CONRAD JOHNSON MOTIV MC-8 1986 £2,500
Minimalist FET-based preamplifier from the Yank valve specialists is brilliantly neutral and smooth with a sly, light balance in the mould of Sugden high end stuff. Something of a curio, but worthwhile nonetheless.

LEAK POINT ONE STEREO 1958 £ N/A
Good for their time, but way off the pace these days. Use of EF86 pentode valve for high gain rules out ultra performance. Not the highest-fi!

LINN LK-1 1986 £499
A brave attempt by the Glasgow boys to bring remote controlled user-friendliness to hair-shirt audiophile hi-fi. Didn't quite work, but not half bad for under £100.

LECSON AC-1 1973 £ N/A
Amazing styling courtesy of Allan Boothroyd can't disguise its rather cloudy sound, but a design classic nonetheless.



QUAD 22 1958 £25
The partner to the much vaunted Quad II monoblocks - cloudy and vague sound means it's for anacrophiles only.

QUAD 33 1968 £43
Better than the 22, but Quad's first tranny pre isn't outstanding. Responds well to tweaking/ rebuilding though...

NAIM NAC32.5 1978 £ N/A
The Salisbury company came of age with this, their classic high end pre. Brilliantly fast and incisive sound that's a joy with vinyl but a tad forward for digital.

POWER AMPLIFIERS
HH ELECTRONICS TPA-50D AMPLIFIERS 1973 £110
Simple design with easily available components, solid build quality and fine sound make for a surprisingly overlooked bargain. Not exactly stylish, however.

LEAK STEREO 20 1958 £31
Excellent workaday classic valve amplifier with decent power and drive. Surprisingly modern sounding if rebuilt sympathetically. Irrepressibly musical and fluid.



LEAK STEREO 60 1958 £N/A

Leak's biggest valve power amp offers 35 Watts per channel and more low end welly than the smaller Stereo 20. Despite concerns over reliability their rarity means high prices are the order of the day.

LECSON API 1973 £ N/A

Madcap cylindrical styling alluded to its 'tower of power' pretensions, but it wasn't. Poor build, but decently clean sounding when working.

MARANTZ MODEL 9 1997 £8000

Authentic reproduction monoblocks still more than cut the sonic mustard. Highly expensive and highly sought after.

MICHELL ALECTO 1997 £1989

Crisp, clean and beautifully controlled with gorgeous styling. Partnered with the £1650 Orca this sounds delicious!

LEAK POINT ONE, TL10, TL12.1, TL/12 PLUS 1949 £28

Early classics that are getting expensive. Overhauling is de rigueur before use, using original parts if possible. Surprisingly crisp and musical sound, that's far more modern than Quad IIs. Deeply impressive when in fine fettle.



MUSICAL FIDELITY XA200 1996 £1000PR

200W of sweet smooth transistor stomp in a grooved tube! Under-rated oddity.



QUAD II 1952 £22

The all-time classic valve amplifier, with a deliciously fluid and lyrical voice. In other respects though, it sounds hopelessly dated. Low power and hard to partner properly



QUAD 405 1978 £115

The first of the current dumpers is a capable design with smooth, effortless power and a decently musical sound. 606 and 707 continue the theme with greater detail and incision.

QUAD 303 1968 £55

Bullet proof build, but woolly sound. Off the pace, but endearing nonetheless. Some pipe smoking slipper wearers swear by them!

KRELL KMA100 II 1987 £5,750

Ludicrous monoblock version of the giant KSA-100 is one of the seminal eighties transistor power amplifiers. Massive wallop allied to a very clean and open Class A sound makes this one of the best amplifiers of its type, ever.

RADFORD STA25 RENAISSANCE 1986 £977

At the time, very possibly the least cool amplifier on the planet – and we're not talking heat dissipation here. This reworking of Radford's original late sixties design was possessed of a wonderfully rich, old school valve sound with enough power (25W) and lots of subtlety.



PIONEER M-73 1988 £1,200

Monster stomp from this seminal Japanese power amplifier, complete with switchable Class A and Class B operation. Clean, open and assured sounding, albeit a tad behind the pace on high speed dance music. Rosewood side cheeks and black brushed aluminium completes the eighties-tastic experience.



PHONO STAGES

CREEK OBH-8 SE 1996 £180

Punchy, rhythmic character with oodles of detail makes this a great budget audiophile classic. Partner with a Goldring G1042 for an unbeatable budget combination.



LINN LINNK 1984 £149

Naim-designed MC phono stage built to partner the original Naim NAIT - yes, really! Fine sound, although off the pace these days.

MICHELL ISO 1988 £ N/A

This Tom Evans-designed black box started the trend for high performance offboard phono stages. Charismatic, musical and punchy - if lacking in finesse.

TUNERS

MARANTZ ST-8 1978 £353

Marantz's finest radio moment. Warm, organic sound plus an oscilloscope for checking the signal strength and multipath.



CREEK CAS3140 1985 £199

Excellent detail, separation and dynamics - brilliantly musical at the price. T40 continued the theme...

NAD 4040 1979 £79

Tremendously smooth and natural sound allied to low prices and good availability make this budget analogue esoterica. Needs a good antenna to work properly, however.

NAIM NAT03 1993 £595

The warm, atmospheric sound is further proof of Naim's proficiency with tuners.

PIONEER TX-9500 1976 £295

Another of the serious classic solid-staters. Boasts the usual high end Jap package of fine sound, brilliant sensitivity and superb build.

LEAK TROUGHLINE 1956 £25

Series I an interesting ornament but limited to 88-100MHz only. II and III are arguably the best-sounding tuners ever. Adaptation for stereo easy via phono multiplex socket. Fed to a modern outboard decoder they're deliciously lucid with true dimensionality.



YAMAHA CT7000 1977 £444

Reputedly the best of the classic Jap analogues, this combines sleek ergonomics, high sensitivity and an explicit, detailed sound.

QUAD FM4 1983 £240

Supreme ergonomics and styling allied to a pleasingly lyrical sound with plenty of sweetness and detail made this one of the best tuners around upon its launch.



REVOX B760 1975 £520

More of a semi-pro machine than a domestic bit of kit, the Revox offers superlative measured performance although the sound isn't quite as staggering as the numbers. Fine nonetheless, and surely the most durable tuner here?

NAD 4140 1995 £199

Brilliant affordable digital tuner has a smooth, detailed musical sound plus sensible real-world facilities.

ROGERS T75 1977 £125

Superb mid-price British audiophile design, complete with understated black fascia. Fine sound in the true Rogers mould – smooth and sweet with fine dimensionality.

SANSUI TU-9900 1976 £300

A flagship Japanese tuner designed to steal sales from the likes of Accuphase and Revox, it boasts superlative RF performance and an extremely smooth and lucid sound, along with very fine build and finish.

SONY ST-5950 1977 £222

One of the first Dolby FM-equipped tuners, a format that came to nought. Still, it was Sony's most expensive tuner to date, and boasted a very good sound quality allied to brilliant ergonomics.

SEQUERRA MODEL I 1973 £1300

Possibly the ultimate FM tuner. Massive in terms of technology, size and features dedicated to extracting every ounce of performance from radio, including impressive multi-purpose oscilloscope display.



TECHNICS ST-8080 1976 £180

National Panasonic's specialist hi-fi brand was a big hitter back then, and this is no exception. Superb FM stage makes for a very clean and smooth listen with lots of detail and depth.



ANALOGUE RECORDERS

YAMAHA TC-800GL 1977 £179

Early classic with ski-slope styling courtesy of Mario Bellini. Middling sonics by modern standards, but cool nonetheless!



AIWA XD-009 1989 £600

Aiwa's Nak beater didn't, but it wasn't half bad nonetheless. Massive spec even included a 16x4 DAC!

NAKAMICHI CR-7E 1987 £800

The very best sounding Nakamichi ever - but lacks the visual drama of a Dragon.



PIONEER CTF-950 1978 £400

Not up to modern standards sonically, but a great symbol of the cassette deck art nonetheless.



REVOX A77 1968 £145

The first domestic open reel that the pros used at home. Superbly made, but sonically off the pace these days. B77 better, but couldn't match the Japanese.



SONY WM-D6C 1985 £290

Single capstan transport on a par with a Swiss watch, single rec/replay head better than most Naks. Result: sublime.



SONY TC-377 1972 £N/A

A competitor to the Akai 4000D open reel machine, the Sony offered better sound quality and is still no slouch by modern standards

DIGITAL RECORDERS

SONY MDS-JE555ES 2000 £900

The best sounding MD deck ever, thanks to awesome build and heroic ATRAC-DSP Type R coding.



PIONEER PDR-555RW 1999 £480

For a moment, this was the CD recorder to have. Clean and detailed.

MARANTZ DR-17 1999 £1100

Probably the best sounding CD recorder made; built like a brick outhouse with a true audiophile sound and HDCD compatibility.



KENWOOD DM-9090 1997 £500

Serious and sophisticated sound thanks to well implemented ATRAC 4.5; surprisingly musical MD recorder.

SONY TCD-8 DATMAN 1996 £599

Super clean sound makes this an amazing portable, but fragile.

LOUDSPEAKERS

ACOUSTIC RESEARCH AR18S 1978 £125

Yank designed, British built loudspeaker became a budget staple for many rock fans, thanks to the great speed from the paper drivers, although finesse was most definitely not their forte...

BBC LS3/5A 1972 £88

Extremely low colouration design is amazing in some respects - articulation, stage depth, clarity - and useless in others (both frequency extremes). Came in wide variety of guises from various manufacturers building it under licence. Partner with Rogers AB1 subwoofers for an extra two octaves of bass!

LOWTHER PM6A 1957 £18 EACH

This seminal full-range driver is still manufactured. High sensitivity, as fitted to many classic horn designs.

HH ELECTRONICS TPA-50D AMPLIFIERS 1973 £110

Simple design with easily available components, solid build quality and fine sound make for a surprisingly overlooked bargain. Not exactly stylish, however.

TANNOY WESTMINSTER 1985 £4500

Folded horn monsters which certainly sound good if you have the space. Not the last word in tautness but can drive large rooms and image like few others.

JR 149 1977 £120

Infamous cylindrical speaker that was ignored for decades but now back in fashion! Based on classic KEF T27 / B110 combo as seen in the BBC LS3/5a. Doesn't play loud, needs a powerful transistor amplifier, but rewards with fine clarity and imaging.



SPENDOR BCI 1976 £240

Celestion HFI300 tweeter meets bespoke Spendor Bextrene mid-bass unit - and the result is a beautifully warm yet well focussed sound. A little bass bloom necessitates careful low-stand mounting, but these prove that the seventies did have some fine designs after all!

QUAD ESL57 1956 £45 EACH

Wonderfully open and neutral sound puts box loudspeakers to shame. Properly serviced they give superb midband performance, although frequency extremes less impressive. Ideally, use in stacked pairs or with subwoofers and supertweeters.



KEF R105 1977 £785

Three way Bextrene-based floorstander (complete with castors!) gave a truly wide-band listen and massive (500W) power handling. A very neutral, spacious and polite sounding design, but rhythmically well off the pace. The quintessential nineteen seventies loudspeaker.

IMF TLS80 1976 £550

Warm and powerful nineteen seventies behemoth with transmission loading and a mixture of KEF and Celestion drive units. Impressively physical wideband sound but rhythms aren't its forte.

MAGNEPLANAR SMGA 198X £800

Technological loudspeaker with genuinely musical abilities; fast, smooth, open, dry.



MISSION 770 1980 £375

Back in its day, it was an innovative product and one of the first of the polypropylene designs. Warm, smooth, clean and powerful sound.



MISSION 752 1995 £495

Cracking Henry Azima-designed floorstanders combined HDA drive units and metal dome tweeters with surprisingly warm results. Benign load characteristics makes them great for valves.

HEYBROOK HBI 1982 £130

Peter Comeau-designed standmounters with an amazingly lyrical yet decently refined sound. Good enough to partner with very high end ancillaries, yet great with budget kit too. A classic.

CELESTION SL6 1984 £350

Smallest two way design complete with aluminium dome tweeter and plastic mid-bass unit set the blueprint for nineteen eighties loudspeakers. Very open and clean sounding, albeit course at high frequencies and limp in the bass. Speakers would never be the same again...

LEAK SANDWICH 1961 £39 EACH

Warm sounding infinite baffle that, with a reasonably powerful amplifier can sound quite satisfying.

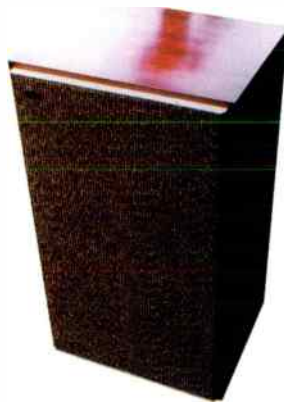

QUAD ESL63 1980 £1200

An update of the ESL57, with stiffer cabinets. Until the 989, the best of the Quad electrostatics

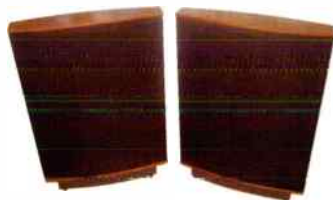

YAMAHA NS1000 1977 £532

High tech Beryllium midband and tweeter domes and brutish 12" woofers in massive sealed mirror image cabinets equals stunning transients, speed and wallop allied to superb transparency and ultra low distortion. Partner carefully!



MISSION X-SPACE 1999 £499

The first mass production sub and sat system using NXT panels is a sure-fire future classic - not flawless, but a tantalisingly unboxy sound nevertheless!



CLASSIC CONTACTS

When a classic goes 'poof' your troubles have just started, but there may be a good ending. Replacing failing parts can improve the sound, so here is a short listing of all these companies who specialise in getting a classic up and running again after its deposited a small ring of soot on your ceiling!

GT AUDIO

(Graham Tricker, Bucks)
Leak Troughline specialists. Also Quad and most classic tuners, radios and amplifiers restored, repaired.
Tel: 01895 833099
Mob: 07960 962579
www.gtaudio.com

TECHNICAL AND GENERAL

(East Sussex)
Turntable parts - wide range of spares and accessories, plus arms and cartridges.
Tel: 01892 654534

CARTRIDGE MAN

(Len Gregory, London)
Specialist cartridge re-tipping service and repairs. High quality special cartridges.
Tel: 020 8688 6565
Email: thecartridgeman@talktalk.net
www.thecartridgeman.com

QUAD ELECTROACOUSTICS

(Cambs) Quad's service department, able to repair almost all Quad products, from the very first. (Also Audiolab, Mission & Wharfedale).
Tel: 0845 458001 | www.quad-hifi.co.uk

Dr MARTIN BASTIN

(Shropshire) Garrard 301/401 restoration, renovation and service. Special plinths; rumble cures, etc.
Tel: 01584 823446

ARKLESS ELECTRONICS

(Northumberland)
Specialist in repairs, restoration and modifications to all amplifiers, valve or solid state, ancient and modern.
Tel.: 01670 530674
Email: info@arklesselectronics.com
www.arklesselectronics.com

CLASSIQUE SOUNDS

(Paul Greenfield, Leicester)
ESL-57s restored, rebuilt, fully renovated or improved. Leak, Quad valves amps etc.
Tel: 0845 123 5137/
Mob: 0116 2835821
Email: classique_sounds@yahoo.co.uk
www.flashbacksales.co.uk/classique

WEMBLEY LOUDSPEAKER

(Paul MacCallam, London)
Comprehensive loudspeaker servicing.
Tel: 020 8 743 4567
Email: paul@wembleyloudspeaker.co.uk
www.wembleyloudspeaker.com

CLASSIC NAKAMICHI

(Paul Wilkins, Worthing, West Sussex).
Restore, Repair & Service Nakamichi Cassette Decks.
Tel: 01903 695695
Email: paul@bowersandwilkins.co.uk
www.bowersandwilkins.co.uk

ONE THING

(Coventry) Specialist in electrostatic panel manufacture and repair. Can refurbish ESL 57s and 63s as well as Leak Troughlines and Quad IIs.
Email: one.thing@ntlworld.com
www.onethingaudio.com

LORICRAFT AUDIO

(Terry O'Sullivan, Bucks)
Garrard 301/401 and their own 501 repair, spares and service.:
Tel: 01488 72267
www.garrard501.com

EXPERT STYLUS COMPANY

(Wyndham Hodgson, Surrey) Stylus replacement service for all types of cartridge. Including precise profiling for 78s. Tel: 01372 276604
Email: w.hodgson@btclick.com

OCTAVE AUDIO WOODWORKING

(Bristol) Unit 2, 16 Midland Street, St Phillips. Bristol. Tel: 0117 925 6015
www.octave-aw.co.uk

REVOX

(Brian Reeves, Cheshire)
Revox tape recorder spares, service and repair. Accessories also available.
Tel: 0161 499 2349
Email: brian@revoxservice.co.uk
www.revov.freeuk.com

SOWTER TRANSFORMERS

(Brian Sowter, Ipswich)
Large range of audio transformers for valve amps, cartridges, line drive, interstage plus all associated services.
Tel: 01473 252794
www.sowter.co.uk

LOCKWOOD AUDIO

(London)
Tannoy loudspeaker parts, restoration and repair. Also Epos and TDL loudspeakers.
Tel: 020 8 864 8008
www.lockwoodaudio.co.uk

ATV AUDIO

(Henry Dulat, Surrey)
Repairs, restorations and upgrades to valve and transistor amps and all analogue audio including Revox.
Tel: 01372 456921 Mobile: 07730 134973

High End Show

The High End Show, Munich, Germany, has become one of the world's leading hi-fi shows – and it attracts plenty of Brits, both as visitors and exhibitors. Flying to Munich for this yearly event, something we have been doing for many years, seems like visiting a UK show, faces and brands are so familiar. This year the products and systems on display had a slicker feel to them. I heard more smooth, balanced and well developed systems than previously, and fewer crude “boom and ting” setups.

Product quality was extraordinarily high too, something our report pictures convey, but I left feeling slightly worried that the UK is barely keeping up with Europe in a field of engineering where we are still active participants, unlike AV or television. My worry came from seeing the many component manufacturers there, exhibiting high quality parts, something absent from UK shows because the UK has few such specialists – and high fidelity relies much upon component quality.



The talk of the show was the amazing Silbatone room. Forget standard hi-fi: this room housed huge Western Electric Cinema bass horns with all the visual appeal of a baby elephant. They dated back to 1928 we were told and were part of Silbatone's collection (www.silbatoneacoustics.com), shipped over from Korea no less.

Alongside them were modern replica Western Electric cinema horn arrays from GIP of Japan (www.gip-laboratory.com). This little speaker ensemble occupied a good 6 metres of wall space, presenting an impressive spectacle to awe struck visitors. Drive came from Silbatone's own valve amplifiers.

Prices were astronomic – figures of £30,000 were mentioned when I enquired – but the valve amplifiers are very limited edition, as are the loudspeakers.

Where did all this come from? Silbatone was funded by the chairman of LG I heard, above the turmoil of the display room which was jammed to the door by visitors. And where most other exhibitors ran plink-plonky demo tracks, Silbatone ran Led Zeppelin.



A room I am drawn to every year is run by Transrotor of Germany and their gorgeous array of extravagantly chrome plated turntables, including the floor standing Artus (at right) and a lovely piece of Euro-bling, the Rondino Gold (left). The Artus costs 118,000 Euros!

Munich 2012

Cessuro of Germany (www.cessaro-horn-acoustics.com) had their vast Beethoven loudspeaker on display. Inside the bass bin lurked two 16in bass drivers driven by a 1200 Watt transistor power amplifier. The upper horns were driven directly by Tron Discovery and Telstar valve power amplifiers (www.tron-electric.co.uk).



In the Swissonor room was a lovely display of classic Thorens turntables, including a TD224 auto-changer that fascinated Adam Smith and Faiza Chunara of Hi-Fi World.



Triangle held a press conference to talk about their new upgraded Quartet loudspeaker, from the Genese range. This Quartet is a fine loudspeaker at a great price, so the new one promises much.



I got to hear and enjoy the Swissonor BACH 12 loudspeaker (www.swissonor.ch). This uses a Tractrix horn behind a 12in bass/midrange unit, in front of which sits a tweeter working from a low 1.4kHz upward.



Sticking with more home-oriented loudspeakers, Gobel High End made the short trip across their native city to the show to demonstrate their new Epoque Fine and Epoque Reference loudspeakers. These use a square bending-mode driver for most of the frequency range, with bass drivers and passive radiators filling in the very bottom end. Having personally often found bending mode drivers to be rather underwhelming I was very pleasantly surprised by the clarity, crispness and sheer openness that these loudspeakers offered. Sadly, at 40,000 Euros per speaker for the smaller Fines and 60,000 for the References, they are destined to remain out of the financial reach of most.



The stark Danish style of the Bergmann Air Bearing arm and turntable was alluring, if you value domestic acceptability. I somehow suspect a lot of people would like one of these in their lounge, as parallel tracking air bearing arms have a certain magic about them. At a practical level they eliminate tracking error distortion, arm bearing friction and the need for bias compensation – that's a lot of woes eliminated. And the Bergmann looked good.



Tannoy were showing their new Precision 6.4 featuring a 6in dual concentric, a bass/midrange and twin bass units. Also on show was an updated DC10, now a DC10A, with mass loading chamber that greatly improves imaging and bass slam. An Alnico magnet has been fitted and other upgrades made such as hard wiring. The DC10 is a big hitter, so all this sounds very promising.



I was drawn to the output valves of the Thrax 'Spartacus' power amplifier, a pair of very large 520Bs from Emission Labs of Japan that I also spotted on Ayon amplifiers. This massive valve, replete with anode cooling fins, is an eye catcher and we will be seeing more of it I suspect. Muscle valve amps are an upcoming species; the 211 and 845 started the trend and there are more contenders to open a road ahead, like the Osram DA100.

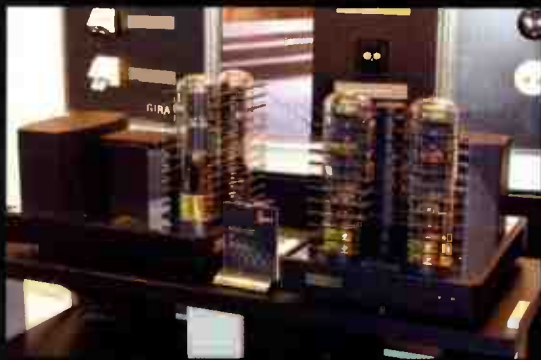

If you want to frighten your neighbours then you need a Kronzilla – perhaps the DX shown here (www.kraudio.com). It's Single-Ended but delivers 100 Watts, they claim. The massive output valves are their own T1610 design, working in parallel pairs. Each one weighs 37kgs. Awesome!



The EMT JPA66 all-tube phono preamplifier offers massive adjustment capability in one purposeful looking package. It has turnover frequency and high frequency (75µS) curve adjustment, a subsonic filter and Mono switch, plus of course those good old fashioned V.U. meters. As EMT are famous for their professional turntables and were showing some sexy MC cartridges, it should be good.



Reminding us as always what live instruments sound like were roaming musicians, a great feature of the High End show, year after year. And as always live instruments have more visceral impact and acoustic power, without the thin nature and stinging treble of so many hi-fi set ups.



There seems to be a way to go before hi-fi emulates reality but this year's show was running systems that made a good stab at getting there and one we enjoyed was in the SurrounTec room (www.surrountec.com) where we sat in front of their Monolog loudspeakers, in Orange Fever finish. Fed from a Chris Feickert turntable through Teac power amplifiers this system came across as detailed and dynamic, yet also relaxed and natural.



These really caught my attention: full range 'Leonardo' ribbon planar loudspeakers, from Italy. Big magnetic planars can sound wonderful but at present are rare beasts. Details were scarce as they were on demo in an 'alternative' hotel, a sign said (naughty). But I begged for review samples.



Audio Exklusiv of Germany (www.audio-exklusiv.de) were demonstrating their P3.1 full range electrostatic loudspeaker and it sounded pure and open. The demo music wasn't too revealing, having little low end energy, but the P3.1 still gave a sound that captivated many listeners, it seemed.



Labelling your product Poison is either a bold or a foolish strategy, but that's what Dome Phase (<http://domephase.us>) name their striking looking red loudspeaker (right). An offshoot of Microlab, Shenzhen, China, Dome Phase make their co-axial drive unit under license from Reckhorn of Germany.



Gato Audio of Denmark (<http://gato-audio.com>) were showing the novel looking CDD-1 DAC / CD player with S/PDIF and USB inputs, all up-sampled to 24/192 resolution and controlled asynchronously by an on-board clock. The meter shows track running time.



I was intrigued by a parallel tracking system on the ingenious Thoren's TD121 turntable. Its mechanical ingenuity reminded me of Garrard's Zero 100, arranged differently.



Hmmm... Seems left field but in truth Kurt Muller (loudspeaker) cones are likely in your loudspeaker (www.kurt-mueller.com/). "We make only cones, spiders and dust caps" they told me, but their cones are used by a large number of drive unit manufacturers. Kurt Muller are German specialists with a great reputation.

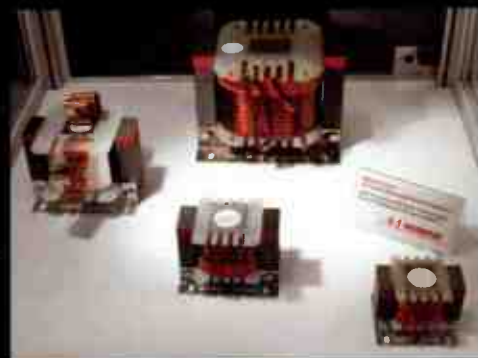

Can a transformer look sexy? Well, Mundorf (www.mundorf.com/) have tried! They make high quality specialist audio components and were showing a range of high quality capacitors and inductors, as well as transformers.

PUT A SPRING INTO YOUR

VISIT OUR WEBSITE: www.hi-fiworld.co.uk

**UK SUBSCRIPTION
SAVE UP TO**

16.5%

SAVE UP TO 16.5% off the cover price when you subscribe to Hi-Fi World. That's an amazing £3.42 per issue, including postage.



FOR BACK ISSUES ENQUIRIES PLEASE CALL

01442 820580

OVERSEAS SUBSCRIPTIONS IF YOU LIVE OUTSIDE THE UK,
PLEASE CALL FOR OUR LATEST PRICES

+44 (0) 1442 820580

SO WHAT ARE YOU WAITING FOR? CALL NOW!!!

SUBSCRIPTION HOTLINE 01442 820 580

Lines open Mon-Fri 9.00-5.00 or (weekend answering service available)

FOR OUR
ON-LINE MAGAZINE
GO TO WWW.HI-FIWORLD.CO.UK

email:
hifiworld@webscribe.co.uk

Fax No:
01442 827912



KEB' MO'
Keb' Mo'
Mobile Fidelity

A blues guitarist and songwriter who looks back to the country blues style of legends like Robert Johnson (he played the blues great in a 1990 docudrama, so he knows the Johnson tone) while also adding his own contemporary twist by flavouring his blues output with flakes of soul and jazz.

This 1994 debut featured two Robert Johnson covers: 'Come On In My Kitchen' and 'Kindhearted Woman Blues'. There's a simple sparcity in the production that, with a slice of reverb, smacks of the blues singer sat on his porch on a still, moonlit night, singing his joys, his woes and emotions into the night for the benefit of nocturnal animals and passing spirits.

Mo' has an undoubted skill with a blues guitar that, with his husky, rasping vocal, gives an educated rawness to the arrangement.

Mobile Fidelity's (www.mofi.com) mastering is exemplary. Using master tapes with an analogue delay (see my Column this month for an explanation) the source has been treated gently, providing a relatively quiet background with a deep soundstage. Upper mids and treble are both crisp and airy while bass, which is not a dominant feature on the album, does offer a real, founda-

tional presence when it appears on the scene.

Also look out for other Mo-Fi releases that have been released this month: folk singer and multi-instrumentalist, Priscilla Ahn's 'A Good Day' (2008) is a mature debut full of whimsy and contrasting earthy strength; Lynyrd Skynyrd's 'Street Survivors' (1977) features a strong line-up of tight songs that stands in the shadow of sadness because, just days after the record hit the stores, many of the band members were killed in a plane crash. Finally, Carol King's classic album, 'Music' provides top notch song-writing, even if her delivery sometimes doesn't match it.

LES RALLIZES DENUDES
Great White Wonder
Phoenix Records

Japanese underground psychedelic rockers, formed in 1967 (split in 1996), noise initiates, avant garde sound sculpturists, punk pioneers – Les Rallizes Denudes were all of those things along with a reputation for extreme left-wing politics and violence. The band's bassist, Moriaki Wakabayashi was part of the Red Army faction that took part in a 1970 hi-jacking of a Japanese Airlines flight, for example. A band of mystery, they released very few records while hardly ever touring and yet they pioneered psychedelic noise-based

rock. Highly collectable with even devoted fans finding it difficult to access their music, Phoenix Records has done fans a favour by issuing this SLP box set of live recordings, limited to 1000 units.

Covering gigs from 1974 to 1980 and using a digital source, the sound quality is, remarkably, supposed to be poor. The idea is to reduce detail and squeeze dynamics to give that rare bootleg feel. Within this sonic structure, the sensory assaulting guitar works at its most devastating. Providing a raw power, at the Meiji Gakuin University on 13 July 1974, the performance bullies its way into your ears combining an intense bass guitar with stripped psychedelia topped with a pained, flailing vocal.

The 1 October 1975 set slows the pace somewhat but only serves to concentrate the energy by filling the available space to a more intense degree, generating noise, feedback, a plodding bass with an unhinged, Can-like vocal.

The 22 July 1977 gig at Maison Franco-Japonaise, Tokyo is frankly mind blowing and will shred your brain of every living cell before the rock-based vocal takes control. The Kanagawa University set on 7 November 1980 is almost low key, in comparison. Still spaced out, this is music to listen to as you walk down a long dark tunnel of your own making.

4 CD SET

Les Rallizes Denudes

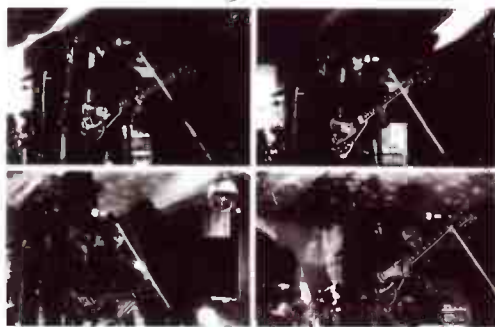

真ついにめざめた私を眠らせやすらぎの歌を聞かせてくれる...

Great White Wonder



A-AUSTR
A-Austr
Anazitisi

Produced via Holyground and run by Mike Levon, this album was a limited edition (ninety-nine copies) when it was originally released. Taking a psychedelic pathway, the project was a collaboration between friends that drew influences from each. Hence, the LP also embraces a low key rock ethic along with baroque pop and more eastern influences.

Anazitisi (www.anazitisirecords.com) has endeavoured to retain the look and feel of the original release. To that effect, it has even printed the sleeve and labels on vintage seventies paper; "We tried very hard to find it," said the label. In addition, you will find seventeen, A4-sized paper sheets with lyrics, credits and sketches, as per the original issue. In addition, you also get a four-page colour insert with photos and notes written and designed by Levon, a reproduction of a rare A-Austr A4 poster and three A-Austr business cards. Limited to 300 black and 200 coloured copies on 180gm vinyl, this production is a real work of love.

In terms of sound quality and musical style, the LP features a comparatively complex arrangement with tape-spliced effects and quick edits. The music, nevertheless, never takes itself too seriously. There's a

uniquely English whimsy at play here that reminds me of late sixties Kinks or even 'White Album'-era Beatles. A light touch that tippy toes around the English culture and its mores. A-Austr are also never afraid to experiment in either instrumentation, vocalisations of musical genres or even dropping established music sequences into a newly composed song to add a frisson of familiarity. As such, this album is a sensory and psychological playground.

Unique in its construction with a decent but understandably non-audiophile playback – the LP is derived from master tapes but processed with a digital delay. This is a surprisingly refreshing album that delights at every turn.

ANVIL
Strength Of Steel
SPV

Anvil takes the New Wave Of British Heavy Metal (NWOBHM) scene and ratches up the rock vibe a notch by adding more punch and energy. A sonic continuity throughout the album is the particularly tight and melodic drum backing that provides a firm, strong and driving force while the lead guitar adds a touch of thrash. Vocals retain the classic NWOBHM style, being forceful and powerful but, in this case, backed by a swathe of reverb to add body.

In production terms, the disc has



been mastered via analogue tape but with a digital delay and pressed on red vinyl which, for audiophiles, is both good and bad. Bad because coloured vinyl is inherently noisier than black and this can be heard clearly on the intro but is not an issue during play because the recording signal is touching the red. It's also a good thing, though, because the carbon black of vinyl retains iron which holds a weak magnetic force affecting the cartridge. Non-black records are always that touch more focused, therefore.

As for the musical content, Strength Of Steel, originally released on Metal Blade in 1987, is not the band's best work (you're looking at 'Metal On Metal' or even 'Forged In Fire' for that) but it, along with their next release – the disappointing 'Pound For Pound', also available here from SPV (www.spv.de) and also released in 1987 – retained the original line-up, so the soul of the band is still intact. It also provided enough structure and focus, along with sufficient breadth of ideas to keep the fans interested.

Also look out for an additional Anvil LP release from SPV: 'Worth The Weight', which introduced a new guitarist, Sebastian Marino, the replacement for departed axeman Dave Allison, an excellent release that hit the streets in 1991.

PR

The Heathkit Amplifier

Haden Boardman uncovers a surprisingly common but forgotten about home-made valve amplifier from the 1950s. Soldering iron at the ready...

At Hi-Fi World we have always valued the 'home constructor' and experimenter. Back in the 1950s, unless you were seriously rich, a home-made amplifier was simply expected. My Grandfather was one of these home constructors and, at the time, there were two options to building your own amplifier: fabricating the whole lot from blueprints, or purchasing a complete 'ready to go' bolt-together-kit. The latter was a more expensive option of course, but had step by step instructions and would give guaranteed results.

One of the most popular complete kit makers was Heathkit. An American Company sensible enough to set up UK operations in Gloucester, more than a little distance from Niles, Michigan in the U.S.A. The American Heath Company was founded in the 1930s by Edward Heath, manufacturing airplane kits. Mr Heath died performing a test flight back in 1931. The Heath Company was declared bankrupt by 1935, and was purchased by fellow American Howard Anthony. Post WWII Mr Antony launched the first 'Heathkit' product, an oscilloscope, the O1, built from War surplus stock.

By the mid 1950s the Americans had the high fidelity choice of a real classy Williamson style chassis (with the option of home-made 'Voice of the Theatre' loudspeakers), to a tiny tot of a 6V6 based amplifier. Back in England, by 1959, Daystrom Ltd



had been set up marketing Heathkit audio, radio and high fidelity products.

The MA12 shown here was the top of the British 1960s Heathkit line. Clearly based on the Philips/Mullard classic '5-10' (five valves for ten watts output), the matching USC-1 preamp was also clearly Philips/Mullard circuit based, although fitted with printed circuit boards.

The Heathkit MA12 looks rather a sweet little power amplifier. A compact twelve by six inch chassis holds a GZ34 rectifier valve, a pair of EL84 output pentodes, an EF86 pentode voltage amplifier, and an ECC83 double triode 'Schmitt' type direct-coupled phase splitter.

Where Philips/Mullard direct coupled the EF86 pentode to the phase splitter, Daystrom chose not to; maybe this avoided paying any royalties on the established circuit. Regardless, what is substantially better than most contemporary products is the chassis layout. Real thought and knowledge has gone in to this. The GZ34, about the only component on the entire chassis not susceptible to transformer hum field is positioned exactly at

the transformer axis. The output transformer is located as far away as possible and rotated to avoid any chance of hum pick up. The output transformer is grain orientated steel. Several manufacturers contributed this component over the lifetime of the MA12, including Hinchley and Radford. I have neither measured nor heard any difference between the different transformer makes; pointing to tight quality control at Daystrom. There's no need to get giddy at the mention of Radford.

A high value of smoothing block capacitors are fitted to the power supply, 60µF plus 250µF – high values by vintage standards. An input volume control is fitted directly to the EF86 input valve.

Audio input is via little RF sockets (I do actually prefer these to phono plugs!) and are easy to replace with a phono socket if need be. Circuit layout is neat and tidy, and very logical. The circuit also differs from the classic '510 in having 90k/100k anode load resistors on the phase splitter ECC83 valve.

A 'hum bucker' is fitted (adjust for minimum hum in your

460520

loudspeakers) on the 'low tension' heater supply, and the usual Octal socket can feed power supply to the matching preamplifiers. One word of caution here, the pre amp umbilical cable has two plugs rather than the usual plug and socket arrangement; this makes a loose cable lethal at the preamp end! Throw it in the bin now. It is an easy enough job to by-pass the mains on the back of the octal socket, but see our pictures; I used the existing mains cable hole, and fitted a proper power switch to the chassis.

Speaker connections are the usual 1960s screw terminals and it is easy enough to fit 4mm banana sockets. Output impedances are ideally 2-4 ohm, 8-11 ohm, and 14-16 ohm. On testing the output transformer, 4 ohms reflected 8,000 ohm load to the output valves. EL84s can deliver 10 watts across 5,000 – 8,000 ohms load, so this little amp is quite load tolerant. I would suggest most 'modern' speakers are connected to the 2-4 ohm tap. To use the 8-11 ohm tap requires a little work on the inside of the amplifier; The 'ground' wire inside the amplifier, on the loudspeaker terminal, needs to be moved from the "C" common terminal to the normal "3" ohm output terminal. The loudspeaker output negative connection then becomes the 3 ohm terminal, and positive connection to the 15 ohm terminal. Frankly, it is easier to stick with the 3 or 15 ohm set up!

Most of these amplifiers, if not all, were sold as kits. The instructions and documentation are stunning. The layout picture-grams, the text, the point by point, wire by wire instructions would enable anyone who can read, to put the amp together. The manual is entertaining and interesting, and of very high quality. No electronics knowledge needed, but with enough technical savvy to satisfy those who are that little bit more 'technical'. Instructions on how to solder, and lay things out, making your bench space; etc. All very practical stuff.

Quoted specifications are pretty modest. Ten Watts rms, with a maximum of twelve Watts output between '30 c/s and 10,000 c/s' For full output 120 mV is required on the coax socket (for 10 watts).

Distortion is quoted as 0.1% at 1,000c/s, 0.2 at 5,000c/s, and 0.31 at 40 c/s. Damping factor 30, hum and noise -85dB, and overall negative feedback 26dB. No better or worse than any other vintage amp from the era, but hardly setting the world alight.

The condition of this pair of MA12s was pretty good. Kit made, budget priced – a lot of variables do not guarantee stability! They were powered up on a 'variac' transformer, given 70v for 24 hours, then slowly cranked up to 100V (sounds began to emerge at half power). At 120v and once running all capacitors were checked for leakage. When OK, 170V was applied and the amps double checked before given the full 240V. Only the output valve cathode by-pass capacitors needed changing. To be sporting, I replaced the anode resistors on the EF86 and ECC83 valves for modern high tolerance types, as the original 1960s types are rubbish. On the workbench 15 watts output was available at the clipping point.

The fitted input controls made set up a doddle. A pair of Celestion Ditton 15 loudspeakers proved a stunning match, and various digital sources were connected to the input terminals direct. From the off, it was clear these little amplifiers had tremendous weight and solidity to the sound. I am not a fan of the Mullard 5-10 circuit, and even less so of the Leak TL12+ circuit. Too much gain in the phase splitter results in much sonic mush; although most people (including me at one point) blamed the EF86 pentode, it is the phase splitter that is in my humble opinion the weak link. The sonic differences the Heathkit circuit has over the 5-10 are nothing but marginal. It is the layout, and frankly, the jewel of an output transformer which marks the Heath out from competitors, and by a margin.

My favourite Jimmy Smith 'The Cat' album really swung. The marked bass lines, powerful orchestration, and stunning Hammond punched through with such gravity, and frankly clarity, it was quite a shock from a 1950s amp design pretty much 'as is'. In Prog Rock mode (very rare around these parts) some 1970s Genesis was again delivered with clean bass lines and open vocals; normally you think 400 watt per channel with this kind of material. The ECM disc 'Officium' from Jan Garbarek / The Hilliard Ensemble proved the amplifiers real clarity...

So impressed was I, I chanced the Heaths in the main system: driving 106dB/W horns would show up any

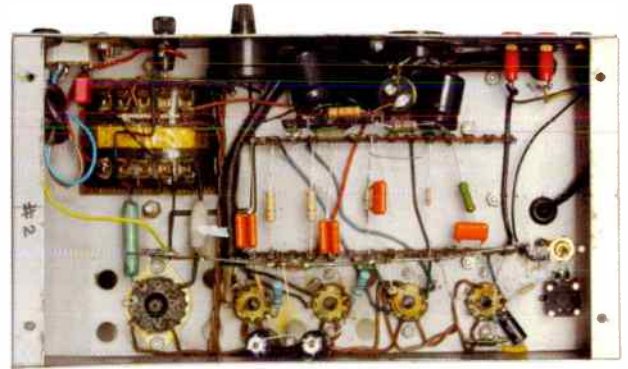

problems. As expected, there was a bit of hiss and noise, but it was no disgrace.

Another set of MA12s turned up and the original set have now been tweaked. ECC83 replaced with an ECC82, 100k on each anode, 22k common cathode resistor, and the 'second' grid connected to earth via a 0.1 capacitor and a 1M resistor; a mod I have been doing on the Leak STEREO 20 and TL12+ for the past twenty years (the STEREO 50/60 and TL25+/TL50+ are beyond serious audio salvage – only for the deluded). This simple mod restores treble and lower bass, reduces gain and noise, and makes these little amplifiers very serious. Sadly, I had run out of decent EF86 valves so these were ultimately replaced by half of an ECC83 on the tweaked and modified set.

In stock form these little amps are better than Leak's TL12+. Rebuilt and tweaked, both amplifiers can deliver similar sonic delights, but I still feel the output transformer fitted to the Heath, and the chassis layout are much superior. Leaks have a name and a justified strong reputation. But the price of TL12+ amplifiers has got to the point of poor value. The 'homemade' Heaths are selling for less than half what even a 'tatty' set of Leaks sell for. Don't be put off by the 'home made' nature, after 40+ years any of the teething problems will have gone, and frankly, rebuilt and modified, these amps are awesome.





Inspire Hi-Fi



Presenting high class, award winning UK built analogue equipment and bespoke turntable upgrades.

SEE AND HEAR ALL OUR TURNTABLES AND TURNTABLE UPGRADES IN OUR NEW DEMONSTRATION FACILITY



MONARCH DIRECT DRIVE TURNTABLE HI FI WORLD 5 GLOBE WINNER



Verdict: Startlingly musical performer with blistering speed and dynamics, yet smoothness, sophistication and purity of tone too. Superb

For:

- Superb transient speed
- Excellent dynamics
- Tonal purity
- Overall musicality

Against:

- nothing

AS WELL AS OUR AWARD WINNING UPGRADES FOR LINN LP12'S AND REGA TURNTABLES, WE NOW ALSO DO COMPREHENSIVE UPGRADE PACKAGES FOR MOST THORENS, PINK TRIANGLE AND MANY MORE TURNTABLES, PHONE OUR TURNTABLE HOTLINE ON **01246 472222** FOR MORE INFORMATION OR A QUOTE



Units 3 & 4 Prospect House Colliery Close Staveley Chesterfield S43 3QE
T: 01246 472222 M: 07932 367555 E: robert@inspirehifi.co.uk

www.inspirehifi.co.uk



Hear the Difference, Clearly.

www.ar-sound.com

AR Sound Lunar Hi-end RCA interconnects

- Select aerospace grade cable: 1.68 mm² of silvered copper alloy conductors and extruded PTFE dielectric insulation.
- Multi layered shielding structure: 3 braiding per channel with 99.5% coverage ensuring fully protection from RFI & EMI.
- Pseudo balanced configuration: A floating double screen for extremely low noise floor and superb dynamics.
- Anti vibration mechanism: An anti resonant polymer treatment for the air gap between the cable and the plug.
- Electrical connection method: A direct gold plating over WBT-110 Cu pure copper connectors and 4% silver solder.

ar sound
connects your music

Solus issue

A believer in mains power conditioning, Tony Bolton considers the issues tackled by IsoTek's Solus Evo 3 mains power conditioner.

The mains power that comes into our houses is something that we all take for granted, expecting it to confirm to certain parameters regarding voltage and the frequency of the alternating current. These aspects are controlled by the energy companies that supply your electricity, but there are issues over which they have no control that can adversely affect the sounds coming from your hi-fi. These can include RFI (Radio Frequency Interference) and extraneous noises from the power supplies from common household products such as fridges and computers.

For the last decade Hampshire based IsoTek have been developing equipment that goes a long way to ameliorating, if not entirely solving these problems, and their latest design is the Solus Evo 3, under discussion here.

As the name suggests this is the third generation of units to bear the Solus name. This one uses technologies, such as IsoTek's proprietary KERP and Polaris-X that have already appeared in some of the Company's more expensive products. The former, Kirchoff's Equal Resistance Path, equalises resistance across all six of the mains outlets at the back of the Solus whilst Polaris-X shunts AC mains borne noise to earth without compressing the dynamic range of the music. There is also a Unique Individual Differential Gate filter network to eliminate cross-contamination between the outlet sockets.

The Solus also provides protection against mains spikes and surges with up to 22,500

Amps of instantaneous protection on tap. The unit will deliver up to 2300 VA allowing quite substantial power amplifiers to benefit from its filtering. Internal wiring is silver plated oxygen-free copper. All of this is housed in a 444 x 105 x 305mm (w x h x d) steel casework with a brushed alloy fascia. The units are available in either black or natural aluminium.

Setting up is simple. The Solus is placed in a suitable position, preferably on a shelf so that the ventilation holes underneath are not blocked, the chosen equipment is plugged in to it and the mains supply is connected to the IEC socket at the back. A blue LED will then glow at the front to signify power is present. (It is worth noting that IsoTek refuse to supply cheap off the shelf mains cables with their products, so discuss the choice of suitable cables with your retailer.)

Mains borne noise is one of those things that we are not aware of until we listen to a system without it. The immediately obvious advantages are a lower noise floor, giving the impression of darker, blacker silences in between notes, and the shape of the notes themselves are tidier. The opening attack of a sound, and its decay are more accurately described, sometimes being faster in their opening, and tailing off more naturally, while sounds that start quietly - the opening drum roll in Greig's Piano

Concerto, for instance, seem to start earlier, last longer and the impact of the final strikes, melding with the opening piano chords, have far greater impact.

I found that the odd extraneous noises that can interfere with FM radio listening all but disappeared, and the sound, as with that from CD and LP, seemed to have far greater presence in the room. I also found that although the overall volume of, say an announcer's voice seemed slightly reduced, the difference between the quiet and loud bits of music seemed considerably greater (a quick check with my iPad mounted SPL meter revealed that the volume was exactly the same).

The Solus can be used either on its own or in conjunction with a Titan, leaving the power amps to the latter and the source components to be fueled through the Solus. This seemed to provide a little more air and definition around the more delicate noises such as triangles and small percussion instruments.

Overall an excellent product that provides a substantial upgrade to the sound of your entire system. Rather than upgrade individual components I would recommend listening to your system through a Solus. You may well be surprised at just how good it actually is, and how much our polluted mains detracts from its performance.



VERDICT ●●●●●
Provides effective cleansing of the mains supply at an affordable price - recommended.

ISOTEK SOLUS EVO 3 MAINS CONDITIONER £595.00
IsoTek Systems
www.isoteksystems.com

FOR

- noticeably lower noise floor
- improved attack and decay of notes.
- smoother and tidier presentation of music.
- prevents cross-contamination between components.

AGAINST

- nothing I can think of.

Music has been my life
and now I can fit it all
and more on my
brilliant Brennan



Jools Holland



"If you've got 100s or even 1000s of
CDs like me, you'll just love it!"

**The Brennan JB7 is a revolutionary CD player
with a hard disk that stores up to 5,000 CDs**

Key features

- ▶ Browse albums by spinning the volume knob - push to play
- ▶ Display track names as they play
- ▶ Delete tracks you don't like
- ▶ Seven rainbow colour coded playlists
- ▶ Segue function blends one track into the next
- ▶ One touch record from vinyl, cassette or radio
- ▶ One button plays the entire music collection at random
- ▶ Plays MP3 downloads - future proof
- ▶ Clock with alarm
- ▶ 60 Watt, 4.8 x 16 x 22 cm steel and aluminium construction
- ▶ Backup music to external USB hard disk for safe keeping
- ▶ You can use it with your existing hi-fi or on its own



Jools Holland has always loved music of every kind and during his illustrious musical career he's bought and collected 100s and 100s of CDs and albums many of

which he continues to play on his weekly radio show. Trouble was, the space they took up, keeping them in some sort of order, the need to find a certain album and then a particular track was always hugely time consuming.

Then Jools was introduced to the Brennan JB7. Now his whole collection is stored on something no bigger than a hardback book. Titles of his CDs, albums, even the tracks are automatically recognized and finding them again using the remote control takes just seconds.

"I can honestly say I've rediscovered lots of my music purely because the Brennan has made it so accessible. Just to be able to find what I want instantly rather than have to wade through CD after CD is a joy!"

Jools Holland pianist, bandleader, composer, singer and television host. He was a founder of Squeeze and the multi-million selling Rhythm and Blues Orchestra. He has collaborated with many artists including Sting, Eric Clapton, George Harrison, B.B.King, David Gilmour, Amy Winehouse and Bono. He tours regularly with his Rhythm & Blues Band and currently hosts 'Later...with Jools Holland' on BBC2.



The Brennan JB7 is available in Cobalt Blue or Titanium Metallic



Money back guarantee

If you're not suitably impressed with your Brennan JB7 we'll collect it free of charge and refund you in full.

ONLY AVAILABLE DIRECT. To order visit www.brennan.co.uk

brennan

"analogue delays are rare and expensive"



paul rigby

German-based audiophile vinyl reissue outfit, Speakers Corner (www.speakerscornerrecords.com), has just reissued a batch of vinyl. Each one has something in common, see if you can spot it.

There's the Duke Ellington And His Orchestra 'Newport 1958' a lesser known appearance compared to the 1956 outing yet also a quite brilliant concert, while Billy Holiday's 'Solitude' (1952), show-cased an older Holiday on top form. Henry Mancini's 'The Pink Panther', the music from the film score, features the classic cartoon illustration emblazoned upon the sleeve plus the Mancini soundtrack for the film, "Breakfast At Tiffany's", with the similarly classic sleeve-based photograph of Audrey Hepburn.

Got it yet? Well, I'm being rather unfair on this one because the one thing that connects all of the above records together can only be heard and not seen - an analogue delay. The evidence is in the grooves and the story goes back to two earlier issues, released by the now defunct German label Audiophile Record Service, of the same two Mancini releases. Both were produced using a digital delay, as opposed to an analogue delay. This is a crucial, little discussed, little known aspect of vinyl creation but any audiophile needs to understand what it does and doesn't do because it might affect your buying decision.

So what is this 'delay' and what is the difference between a digital delay and an analogue delay? On a normal turntable, the groove leads the tone arm into the middle of the LP. But what happens when there is no groove? When the cutting head has to dig that very first groove

into a lacquer for later pressing? You need a force to push the arm holding the cutter head. You could have a standard mechanical force to do the job but, if you did, all of the grooves would be unnecessarily large and the LP playing time would be reduced to fifteen minutes per side. An alternative solution is required.

Let's assume that you have a master tape, rolling on an open-reel, tape recorder. The solution is to use half of the signal from the master to drive the movement of the cutter head while the rest enters the groove. This is the clever bit. Just before the second half of the signal is dumped onto the new groove, the cutter does a quick preview (for the length of a single platter rotation), listening to the first half of the signal. The cutter, upon hearing the first half preview, then decides how to cut the groove. So, during that one-turn preview, if the cutter head hears a loud portion of music, it adjusts the process to cut a larger groove to cope with that second half signal while a quieter moment prompts the cutting of a smaller groove.

The second half signal, therefore, is 'delayed'. This 'delay' can be processed digitally or as analogue, as Speakers Corner MD, Kai Seemann, explained. "For the second signal, the tape travels much further, so distance creates that important delay. The problem is that, when you have a digital delay it's much easier because you can use a much simpler recorder. These digital delays, in most cases, only have a CD-quality resolution. So the signal is reduced in resolution. The previous Mancini releases both used a digital delay. We use an analogue. There are only a few companies which really care about using an analogue delay."

What Seemann is saying, therefore, is that, if a mastering facility utilises a digital delay during the cutting process, it really doesn't matter if you use a pristine, top quality, tape source. Once the signal has been through the digital delay process, the resolution is reduced to a mere digital, CD quality signal. Hence, if you buy an 'audiophile' LP derived from a master tape - but that master tape has been processed using a digital delay - then that audiophile LP can only produce CD sound quality resolution. Shocking, isn't it?

"We guarantee that we have no digital delay processing on any of our releases. They are 100% analogue except for one digital delay recording but that's it," said Seemann. "The reason that a lot of people use digital delays is that the specialist tape machines for analogue delays are rare and expensive."

Many companies use a hi-res digital source where it's possible to bypass the delay and load the information direct to the workdesk. Master tapes are a relatively rare resource and masters can go missing or degrade for various reasons.

Still, you have to be aware that, just because a company claims to use the original master tape during the production for a new LP, if that same company uses a digital delay during the cutting process, it will not be a true analogue vinyl LP.

This is why, from this time forward, Hi-Fi World will not only provide source information in every Vinyl Review Column but will ensure that analogue masters truly are analogue by securing cutting delay information. This is why my Hi-Fi World vinyl reviews are the only reviews you can really trust! ●

SPECIAL INTRODUCTORY OFFER!!!

HI-FI WORLD ELECTRONIC EDITION

VISIT OUR WEBSITE: www.hi-fiworld.co.uk

Queries to - esubs@hi-fiworld.co.uk

**Subscribe to our
eco-friendly e-edition of
Hi-Fi World and receive a
50% discount!!!**

- **Receive your issue a week before on-sale dates.**
- **Be the first to grab a bargain in our Free Reader Classified Ads.**
- **In-house lab. tests to AES and IEC standards**
- **Run by dedicated hi-fi engineers & enthusiasts.**
- **No missed issues, or postal delays.**
- **Access your issues from anywhere in the World.**
- **PC and Mac friendly.**
- **Eco-friendly.**

**Subscribe today and receive 12 issues for
£20 – that's an amazing £1.90 per issue!**

check out our free trial issue

**VISIT OUR WEBSITE:
www.hi-fiworld.co.uk and select
"ELECTRONIC EDITION"**

To purchase your e-edition click here

Pay in Sterling, US Dollars or Euros. Non-sterling prices vary according to exchange rate.
Cards accepted: Visa, Maestro (Switch), Mastercard, Solo and Delta.



"I found myself the proud owner of a pair of Voigts"



tony bolton

For me, one of the delights in shopping for second hand records and hi-fi ephemera is that you never know what you are going to find when you walk into a shop or an auction. I have a mental "wants list" that periodically has another item crossed off it, but often I come across something that interests me that I either didn't know existed or, at least, never knew that I wanted. Certainly with records, this approach has led to me discovering all sorts of musical genres and artists that I wouldn't ever have come across if I had sourced my records from only new-stock outlets.

Auctions can sometimes prove very interesting - and also frustrating - an early, grease bearing equipped Garrard 301 with an SME 3009 attached recently went through one of the local auction houses for £1700 after a bidding war erupted between a couple of people in the room and an internet bidder. I pulled out of the bidding long before the price reached those stratospheric heights. I look at something, decide what is my maximum price, and go one bid over that for luck. Knowing just how easy it can be to get carried away in the heat of the moment I stick very firmly to this rule.

However, I found this self discipline tested to the limits a few weeks ago when I came across a pair of Voigt Domestic Corner Horns in another auction house a few miles from my home. I had heard of these speakers, and seen pictures of them, but nothing prepared me for the sheer size of these beasts in real life. They stand 5 foot 3 inches tall, are 2 foot square and weigh 1 cwt each. They piqued my curiosity so I went home after the viewing and did some

research on the internet.

I soon found the Lowther Voigt Museum, (www.lowthervoigtmuseum.org.uk) an online resource run by John Howes, who also runs the audio-jumbles that are held twice a year. I discovered that these speakers were produced between 1934 and 1950 when Paul Voigt moved to Canada and subsequent production was carried out by Lowther under license. In total about 400 individual examples were produced, and John currently knows of 40 survivors. These date from the days of mono, so were sold as individual units, and I understand that finding a pair together is a very rare thing indeed.

John was most helpful, advising me how to check that the cones were still inside (impossible to see without some dismantling) to check them for woodworm, which they can be prone to, and wished me good luck.

The following day I turned up at the auction but because of the crowd there, was unable to carry out any of the checks mentioned above. So I crossed my fingers and waited for the sale to begin. My heart sank about five minutes before their Lot number came up, as one of the buyers from the Garrard bidding war walked in the door.

My worst fears were realised as he started the bidding, against two other buyers and myself in the room, and a couple of people on the telephone. The price started to rise alarmingly fast and one by one the other in-room bidders dropped out. By this stage the normal background hubbub of conversation that is the norm at these events had died away, and the price just kept climbing. Then one of the telephone bidders dropped out, leaving just three of us.

The price kept rising, getting

perilously close to my maximum. By this point the room was silent, and all heads were rotating between myself and the other bidder in the room, and the auctioneer handling the telephone bid. It kept on rising, and then the remaining 'phone bidder dropped out, leaving just myself and the man who pursued the Garrard so hard. We kept going until I was doing my one last bid for luck. I didn't turn round to look, convinced I would be outbid. There was silence. I glanced round to see "Garrard man" shaking his head. The gavel came down and I found myself the proud owner of a pair of Voigts.

The following day I returned to pay for them and to check my new toys over. There was no woodworm, and, after removing a couple of hatches to get inside the cabinets, I found the cones were there. They are a pair of Lowther PM6 drivers that are suffering from very advanced foam rot around the edges but otherwise seemed intact, so they were removed and boxed up for safety, and I proceeded to transport the Voigts one by one to a friend's house where they currently reside - Bolton Towers is currently bulging at the seams with hi-fi and records so I can't bring them home just yet.

When new they were offered in a variety of finishes. My pair are painted white with the internal walls, either side of the reflector, painted a pale green. If you want to get an idea of the scale of these speakers have a look at www.groundsound.com/gallery/BjarneR.php where a similarly coloured pair can be seen in the domestic environment.

Obviously my pair need some work to restore them and this will be carried out over the Summer, so watch this space for updates as they happen. ●

6 Essential Questions To Ask Before Upgrading

1 Surely upgrading my cartridge is better than changing my arm?

Staggeringly, tests show that a £120 cartridge can outperform a £2500 one, just by virtue of being in a better arm. Not only this but in the long run it saves a fortune to run a good arm with a lesser cartridge. Arm installation is usually easier than cartridges, with help from adaptors and guidance - Visit our web site for help or phone us.

2 Is it worth changing my arm?

Users say they could never have imagined the level of improvement achieved by simply upgrading their arm. The below comment is typical.

"I'm extremely impressed with the sound and happy I made the right choice with your tonearm. I feel there's no other tonearm that could come close to the dynamics it produces. The sound I'm getting now is pure perfection. I am in total analogue heaven and enjoying my vinyl investments for the first time. In the past I was not happy with the sound and not interested in playing any vinyl. Now I'm looking forward to an entirely new experience. I feel very fortunate in discovering your product." Craig Larson

3 Do I need to invest more than the value of my current arm to get an upgrade?

You can actually invest less and still get a massive upgrade. This surprises many, but at Origin Live we think well outside the box - to create both awesome performance and higher value designs than normal. For example one editor stated in a review of the Silver arm "Price tag is laughably low could probably charge 5 times the amount words can't express how good this is ... one of the designs of the decade."

4 What about new innovations and materials - what do I believe?

The need for trusted high performance arms has never been greater. At Origin Live we have devoted over 25 years of continuous development to achieve ultimate sonic performance.

Origin Live arms consistently win awards around the world, year on year, testament to their leading performance. For example the Onyx arm won "Tonearm of the year 2011 award" in Hi Fi World. In addition to this, review endorsements from respected magazines could not be higher with comments such as;

"So far ahead of the pack...looks about to lap them" STEREO TIMES,

"The best arm I've heard" HI FI WORLD.

5 Who has an arm to suite my budget and needs?

The range of Origin Live arms is probably the most extensive in the world. Designs range from £4500 down to £250 - including a 12" version for every model.

6 What if I am not happy that the arm lives up to the claims?

You may be apprehensive about an investment of this nature without first hearing it in your system. Every arm ordered through Origin Live comes with a one month, money back guarantee if you are not absolutely delighted (dealers can offer this at their own discretion).

Why not start enjoying an entirely new level of performance?

To find out more, please visit our web site. You can order the arm of your choice either directly or through one of our dealers.



WHAT HI-FI?
SOUND AND VISION



ORIGIN LIVE LTD
Tel: +44 02380 578877
originlive@originlive.com
www.originlive.com



Reproducing the original sound

"the sheer weight of detail and solidity of images is more than any other amplifier type"



noel keywood

We were contemplating a round up of Single-Ended (SE) amplifiers this month, but I had doubts. They're, big, heavy, run at worryingly high temperatures. Dealing with a group of them is like substituting elephants for sheep in a sheepdog trial: not a wise thing to do for obvious reasons.

Sometimes described as the simplest form of amplifier going, the sort that kicked off audio back in the good old days, meaning the 1920s no less, you'd be forgiven for dreaming that their simplicity and purity of concept may well add up to great sound quality. It does, sort of, when the designer can get it right.

Rose tinted spectacles that put a warm glow on "the old days" have to be taken off when dealing with amps like this. Few exist, handling them at 40kgs apiece is a task, and both performance and reliability can be less than perfect, shall we say.

But they are not all bad news. What I find fascinating about SEs is that their sound is subtly better than that of all other amplifier types. And that especially includes those that rely on complicated signal processing schemes, such as Class D 'switching' amplifiers. With a Single Ended you get a more solidly wrought quality to music; instruments and vocalists having a stronger sense of physical form. Quite how this could be is difficult to explain, but it is especially apparent in transistor Single Ended amplifiers that, at present, are as rare as hen's teeth.

The other property of transistor SEs – at least, in those I have heard – is a glassy hardness to treble that is challenging in one sense, but impressive in another. The quality of brightness, and the sheer amount of treble energy that seems to lance the ears is difficult to take and not

especially to my liking, yet at the same time the sheer weight of detail and solidity of images is more than any other amplifier type seems able to deliver and wins the argument in favour of the SE, as far as I am concerned.

Glassy hardness is usually generated by odd-order distortion in a signal but our measurements show there is no great distortion problem in Single-Ended transistor amplifiers that are well designed. Feedback around them can and does keep distortion under reasonable control, as it does in push-pull amplifiers. But this is where design difficulties start to arise. Ideally, the output stage is coupled to the loudspeaker directly but this isn't so easy with an SE. The way around the problem in the past was to use a coupling capacitor but this is a discredited idea as far as hi-fi goes and it limits the amount of feedback that can be applied too.

Valve amplifiers use an output transformer and this prevents d.c. reaching the loudspeakers, but transistor SE amplifiers have no such thing (they could use a transformer but never do because transistor amplifier designers hate and fear such things!). So in a transistor amplifier direct coupling has to be achieved by setting the red loudspeaker output terminal to nominal ground and making certain it stays there with a servo, or some other trick (assuming the black terminal is at ground of course). There are many ways to skin this cat.

The trouble all SEs have is that by their very nature they run a lot of current through the output stage and run very hot as a direct result. They are also very inefficient, converting little of the energy consumed into music. This makes them less 'green' than any other amplifier, especially Class D. We're not talking much more power than a few 100W light

bulbs at most, so SEs aren't quite an environmental disaster. But they aren't so domestically friendly either. For all the heat you get little power, around 20 Watts or so for either a valve or transistor SE to be liftable.

With an 8 Ohm loudspeaker connected to its 4 Ohm tap the Ming Da MC805-A I review this month gave 35 Watts or so – a respectable figure for any SE, especially one that can just about be lifted. But if you really want to enjoy the sound of an SE it isn't realistic to expect power as well.

That's no problem, however. Few of us use much more than 5-10 Watts, because this is plenty enough to drive a reasonably sensitive loudspeaker very loud. And anyone moving into such rarefied territory should not expect to run an expensive, specialist amplifier with loudspeakers that don't allow it to give its best. Which is why I don't make too much of an issue about the MC805-A's limited power output. There's no doubt that the output transformer should be better designed, as Ming Da's claim of 40Watts isn't met in practice. This is a 3dB shortfall in power, which isn't so great in loudness terms. I ran the MC805-A very loud in a large room and never got near to full output; the meters stayed well below their red zone.

In return I enjoyed once again the subtle but real delight of hearing a rare Single-Ended amplifier in action. Perhaps they're not for those who want to play Rock really loud, like one reader this month (see Letter) whose system is as loud as Concorde was when taking off! But then we don't all want to live at the end of a Heathrow runway. For those who like it a little less louder a Single-Ended amplifier is worth hearing. They aren't 'night-and-day' better, but by a whisker they do offer the best sound going. ●

**£700
TRADE-IN DISCOUNT**
Roksan CD Exchange Offer



**M2
SERIES**



ROKSAN

ROKSAN

HENLEY



ROKSAN

£700 TRADE-IN SCHEME

Roksan Audio and Henley Designs are delighted to announce a product exchange program on a scale like no other. In 2009 we showed our commitment to our customers by increasing the warranty term on all products to 5 years. Now we're back with a CD Player exchange scheme that allows existing customers to dramatically elevate their systems in a more affordable way.

Any owners of the Caspian, Attesa or DP-1 CD Player - whether the unit works or not - can return their old model to an authorised M2 reseller in exchange for £700 off the value of a brand new M2 CD Player!* In a market where trade-in values are falling sharply, we are continuing to support our loyal customers.

The Caspian M2 CD Player is a multi-award winning feat of engineering. The stylish and innovative design delights the eyes as well as the ears, and it represents the pinnacle of Roksan's technical prowess.

For more information on your nearest reseller, contact Henley Designs.

Web: www.henleydesigns.co.uk | Tel: 01235 511 166 | Email: sales@henleydesigns.co.uk

* Offer expires: 31st August, 2012

"transaction took place in a lay-by just off the M1"



adam smith

I have no doubt that some of you are wondering just how things are progressing in the new Smith Towers and I am more than happy to offer an update. Generally speaking, my wife and I love the house and the area and are making good headway with the cleaning, decorating and tidying of the garden. The latter took a bit of a stumble when I discovered that it took the best part of six hours to mow the lawn with our old 'Compact' Flymo a couple of weekends ago and, naturally, a visit to a garden machinery emporium is high on the list! Still, you lot aren't really interested in any of this are you...?

Fortunately, you will be pleased to hear that I have been able to devote a good number of hours to all matters listening room-related and am delighted to report that things are coming along very nicely indeed. As an initial step I took the opportunity to give everything a good cleaning as I set it back up; from glass shelves and pins of mains plugs to styli and cassette deck heads, if it didn't move it was cleaned, and if it moved it was held down until it stopped moving and cleaned anyway.

The result was a very smart looking rack full of equipment, solidly spiked to the floor and levelled to within a millimetre of its life. Things were starting well so, naturally, there was only one way they could go wasn't there?

The first hiccup came with the connection of my loudspeakers. I had positioned them perfectly and sat the equipment rack exactly where I wanted it, only to discover that my speaker leads were about a foot too short for the left speaker – damn! Well, a temporary solution was found in that said speaker's lead currently does not tuck neatly behind the record rack on its way round the room but instead sits in front of it. This allowed the connection to be

made but is upsetting my tedious sense of tidiness and must be resolved soon!

Still, connection was made, a CD was loaded and back I sat for a listening evaluation. First impressions were good – a nice emotive midrange and the larger room added a glorious sense of scale that tended to be rather lacking in my old room. At the low end, bass was impressively deep. Actually, very deep. Too deep. I soon realised that the room was playing along somewhat with the bass line and making everything rather too flabby. Obviously there was a certain impressiveness to the whole thing, as was confirmed by my wife who arrived home in the middle of me listening to my favourite bass torture track (Bela Fleck – 'Flight of the Cosmic Hippo') at a completely anti-social volume. She pulled up outside, I gave her a cheery wave from the listening room window, which she returned. Then she climbed out of her car, looked towards the front door with a rather shocked expression, then looked up and glared at me. It turned out the whole front door was rattling in its frame – something had to be done!

Having ascertained that, no, it would not be acceptable for me to fill the hall under the listening room with concrete, I switched to plan B. The loudspeakers came out from the walls by a good eight inches, then down went a nice thick rug that had been surplus to requirements and off came the thin, wispy, elegant curtains at the window behind the loudspeakers and up went our old lounge ones – much thicker and more absorbent. The result was much better; there is possibly still a little room for improvement, but I am reluctant to experiment further until the new comfy sofa for the room has been acquired, for fear of making things too 'dead'. I also need to work up the energy to lug my Leak 2075s upstairs

and see how they sound in there. Although they go deeper, they lack the gentle 30-60Hz rise in output that my Ferrographs exhibit and so will behave differently in situ – they certainly excited my old room less. That might have to wait for a bit, though, as my back still hasn't recovered from the aforementioned mowing marathon...

All in all, there's lots still to be done, including re-locating the remainder of the Smith turntable collection from my parents' house and, most importantly of all, successfully finding my beloved Alphason HR-100S tonearm which was packed carefully back into its original box for the move and has yet to re-appear – my concern over its whereabouts is rising daily!

Unfortunately, the last few weeks have been full of magnificent distractions, such as the Munich High End Show and then the annual National Vintage Communications Fair at the Warwick Exhibition Centre. The latter was a superb day out and the sun actually shone all day, which improved everyone's mood hugely. Unfortunately mine came crashing down later that day, on discovering a beautiful Thorens TD224 autochanger under a stall table. The bad news was that a dealer had already snapped it up and when I cajoled him into a re-sale price, the figure he quoted was not actually unreasonable but was sadly quite a bit deeper than my pockets, currently.

Still, all was not lost as I came home with wallet lightened to a lesser extent and two very lovely items in the car. Even better, as one was a pre-arranged sale that simply required a hand-over in the car park and the other transaction took place in a lay-by just off the M1 (it's not as dodgy as it sounds, I promise you!), I feel I can quite legitimately say with a clear conscience that I bought nothing at the NVCF. That's my story and I'm sticking to it. ●

vinyl section

contents

JULY 2012

www.hi-fiworld.co.uk

ORTOFON MC EXPRESSION CARTRIDGE 92

Adam Smith listens to a cartridge that is a headshell too!

AUDIO INNOVATION SOLE LP12 95

Tony Bolton checks out another Linn LP 12 turntable upgrade.

MASTERING LP 98

Paul Rigby on how LPs are mastered.

STYLUS GAUGE ROUND UP 103

Tony Bolton and Noel Keywood look at what is available.



BONOBO
BLACK SANDS

NINJA'S TUNES

Taking a remix project for his 'Black Sands' album, Bonobo's new release, *Via Ninja Tune* (www.ninjatune.net) features Falty D, Machine Drum, Duke Dumont, Banks and Mark Pritchard that flits between rapping and smoky vocalisations and dub funk to dubstep. There's two new tracks from Bonobo: 'Ghost Ship' and 'Brace Brace'.

Also look out for hip hop artist, Speech Debelle's 'Freedom Of Speech'. One of the most exciting British MCs on the scene whose agile raps flow like a river stressed with complex tides.

news

AT THE ROCK FACE

Rock fans take note, there's plenty on offer, this month. From Golden Axe (<http://www.myspace.com/goldenaxerecords>) are two picture discs via the uniquely British symphonic metal band, Pythia. The first, 'Beneath The Veiled Embrace' (2009) combines the classic metal vocal with a slightly thrashy guitar backing while 'The Serpent's Curse' (2012), while similar and more punchy, offers a more directly serious take on the genre.

Fans of Music On Vinyl (www.musiconvinyl.com) will love that label's rock output, this month. The UK blues outfit,



Alvin Lee's Ten Years After released 'Stonedhenge' (1969) with a more blues/jazz direction showed the band hitting its peak. Status Quo's 'Hello!' (1973) was a number one album with the top five single, 'Caroline'. Denim rock at its booggiest. Australian heavy metalists, Wolfmother's self-titled debut (2006) arrives on limited edition red and yellow vinyl while the two double albums detailing the greatest hits of Journey have been newly remastered for vinyl.

Germany's SPV (www.spv.de) has released four perky little albums, all limited edition on coloured vinyl. US-based heavy metal band, Riot's 'Immortal Soul' (2011) is a magnificent album that reflects that band at their very best with top flight songs, catchy melodies and some excellent instrumental work. UFO's new album, 'Seven Deadly', shows leader singer, Phil Mogg, tweaking the voice down a register or two but the songs suit and the guy still rocks with the kids. A more focused album than the last outing, 'The Visitor'. Melodic metal's Freedom Call's new LP, 'Land Of the Crimson Dawn', offers well positioned power metal although it can sound a little dated while Virgin Steele's 'Age Of Consent' includes a suite of shorter, snappier tunes from 1988 that hit the commercial button.

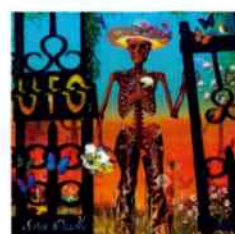



LADY BE GOOD

From the guys to the gals and, from Pure Pleasure (www.purepleasurerecords.com), Peggy Lee's 'The Man I Love' (1957) with the orchestra conducted by Frank Sinatra was her first 12" LP for Capitol, the then new format standard. A love-based concept album packed with terrific song titles.

From Diverse Records, Carrie Rodriguez's 'Love And Circumstance' is a wonderful covers album, mainly because not too many people will have heard of the originals. Offering a sweet delivery, it succeeds superbly because it's also fresh and vibrant, a tough thing to do when you tackle Hank Williams and Merle Haggard.

Also look out for Dusty Springfield's 'Dusty...Definitely!' (Music On Vinyl; www.musiconvinyl.com) from 1968, featuring soul tracks that are up there with her 'Dusty In Memphis' classic while Cassandra Wilson's 'Blue Light 'Til Dawn' (Pure Pleasure) has a blues and rocking sensibility.



MAN ALONE

Music On Vinyl (www.musiconvinyl.com) has a selection of albums featuring male solo singers. A welcome rarity is to see a reissued Donovan album. 'The Hurdy Gurdy Man' (1968) features excellent songs, totally ruined by producer Mickie Most yet, within the wreckage, there's still plenty of highlights. Tricky's 'Maxinquaye' (1995) is his debut and best work, a haunting trip-hop, electronica masterpiece. Sometime country artist and full time roots rocker, Steve Farle's debut, 'Guitar Town' (1986) is a brilliant evocation of rhythms and tragedies within day to day life while Bob Marley & The Wailer's 'Rastaman Vibration' (1976) is similarly militant, 'War' being a notable track. Next is Bill Withers's 'Just As I Am' (1971) the debut, featuring the hit single 'Ain't No Sunshine', that is full of intimacy, intensity and warmth.

Finally, look out for Marvin Gaye's 'Here, My Dear' (1978) a revealing disc that exposes Gaye's divorce on a single LP from Anna Gordy Gaye. Revealing and often vicious.

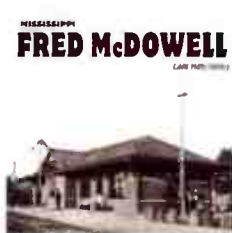
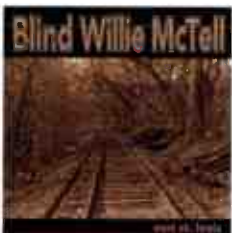

...AND FINALLY

Watch out for two blues classics from Doxy: Mississippi Fred McDowell's 'Lord Have Mercy', recorded in September, 1959, shows his superb bottleneck guitar style, a mixture of Charlie Patton and Son House while Blind Willie McTell's 'East St. Louis' (1949-50) showcases' McTell's superb 6-string acoustic, finger-picking style.

Next is Rumble Record's Bobby Darin and his self-titled debut from 1958, featuring the hit, 'Splish Splash'. Darin co-wrote seven of the twelve songs.

John Cipollina was a founding member and lead guitarist for Quick Silver Messenger Service, leaving in 1970 and releasing 'Raven' (Vinyl Lovers) in 1980 Raven being, in fact, a Cipollina-fronted five or seven-piece band playing Jefferson Starship-type rock.

July 15, 1972 is an unlikely LP title for the Taj-Mahal Travellers (Klimt), an improv band from Tokyo using eastern and western instruments that resulted in flowing jams with plenty of pulsing and droning. A sort of Japanese flavoured krautrock.

Finally, check out the Scorch Trio with Mars Williams' 'Made In Norway' (Rune Grammofon; www.runegrammofon.com), a jazz/rock fusion live double album heavily leaning towards a free jazz style.



Smug Xpression

Adam Smith plugs in Ortofon's new Xpression moving coil cartridge.

It is often quite amusing how, in the hi-fi industry, things that make one's life a bit easier are so often frowned upon. Nowhere is this seemingly more prevalent than in the world of vinyl replay, where automation is scorned and many people have upgraded from a turntable with a nice push-button speed change to one that requires fumbling with belts and platters to achieve the same effect! The thing that most often flummoxes the vinyl novice, though, is the whole cartridge fitment issue – why couldn't this be a bit easier?

The interesting thing is that it used to be. Back in the late days of shellac and early days of vinyl, the cartridge was more commonly known as a pickup and came in the form of a 'head' that plugged into the tonearm of your choice. Of course, headshells then came along giving a wider range of cartridge choice, then tonearms became largely more one-piece when rigidity was the buzzword and now, the idea of an easily swappable cartridge is still something of a left-field idea.

One of the most famous exponents of the combined headshell/cartridge configuration is Ortofon – a company that was around in those early days with the SPU, a model still selling well today. They also came up with the Concorde range in the 1970s, which made the OM style cartridge fit easily into an SME style headshell socket. However, their latest offering of this kind is very definitely back in SPU territory in price terms, as the Xpression under consideration here simply plugs in to the end of an arm but retails for a fairly hefty £3,500. Presumably it is no coincidence that Ortofon themselves make a fine range of arms with headshell

connections of this type, but it definitely seems that the good old S-shape isn't quite

the pariah that it once was. Certainly my own experience suggests there are a few gems out there.

In terms of design, though, the mounting method is all that the Xpression shares with the SPU as the technology contained within its sleek body is most definitely bang up to date, and Ortofon state that their intention with its design was to "bridge the gap between SPU-type headshell cartridges and high-end cartridges like the MC A90 and the MC Windfeld. To this end, the Xpression bears a generator based on that used in the MC Windfeld and limited edition MC A90 models, plus a body created by the same Selective Laser Melting methodology (SLM) as the A90. For those not familiar with the process, fine layers of stainless steel particles are welded together to create a stack-up of layers. The result is a very rigid body but one that is also self-damping, and the damping properties themselves can

be adjusted during the manufacturing process.

The stylus is Ortofon's most advanced Replicant 100 type and the coils to which it is attached are wound in fine 6NX oxygen-free Copper wire. Other technologies crammed into the sleek case include Wide Range Damping which reduces distortion, plus Ortofon's Field Stabilizing Element, which is a small cylinder of conductive material inside the magnet system, that "guarantees that the force field remains stable regardless of the movement of the armature" according to Ortofon, resulting in improved channel separation and reduced distortion.

The cartridge itself weighs in at a healthy 28 grams, necessitating the use of auxiliary counterweights on some arms, and it also tracks at a relatively high 2.6g, which may be a shock to those of a nervous disposition. Mind you, it's quite light compared to the likes of an SPU Classic GM...

I found the Xpression a doddle to fit into my Jelco SA-750D arm and alignment on my Garrard 301 was definitely a much faster process than usual. I was also able to have on hand my Ortofon Kontrapunkt b mounted in the Jelco's normal headshell and have to say that never has a cartridge comparison been so easy!

SOUND QUALITY

I have often been asked by users of good quality MCs like my own Kontrapunkt just how much of an



improvement that they can expect to obtain by changing to a cartridge costing three or four times as much, when their own already lightens the wallet to the tune of somewhere approaching four figures.

Having heard one or two of these high-priced rarities I have asked myself the same question and failed to come up with a convincing answer, but then something like the Xpression comes along and suddenly that price hike seems much less of an issue.

In some ways it is a little disheartening to hear that cartridge that you know and love suddenly sounding...well...a bit rough and ready, but that is exactly what the Xpression did to my Kontrapunkt.

One of my favourite female vocal tracks that often pops up in my vinyl review playlist is Tift Merrit's 'Still Pretending' from her 'Tambourine' album and it is a glorious piece of music. The trouble is, the pressing isn't completely faultless and with a less than perfect tracker playing it, she can sound ever so slightly hoarse. My Kontrapunkt had no issues in this respect, or so I thought until the Xpression came along and simply sliced through any uncertainty like a hot knife through butter. Its well-developed stylus is simply one of the finest trackers I have come across and, provided records are in good basic condition and decently clean, it offers a purity, delicacy and treble sweetness that I don't think I have heard from any cartridge before.

One surprising aspect unveiled by this sense of clarity at the top end was the sheer atmosphere that the Xpression gave to recordings. Hope Sandoval's tremulous vocals on Mazzy Star's 'Into Dust' suddenly came at me from a convincingly three-dimensional recording studio, with the after-effects of each line fading deliciously off into the background, rather than just ending. The Xpression really is most uncanny in the way in which it adds space and air to proceedings, but yet this never felt artificial.

I've heard cartridges that give a strange kind of 'echo' to performances that is impressive but somehow unreal, but the Ortofon never feels as if it is adding anything that shouldn't be there. Equally, poor recordings were not magically made magnificent, but that Replicant stylus just seemed better able to retrieve



what was there without any sense of strain.

Once again, Ortofon have not endowed the Xpression with any added artifice or peculiarly boosted frequency response and the result is a cartridge that simply tells it like it is across the frequency range, but somehow seems to just do it more effortlessly than ever before. Orchestral material was an absolute revelation in this respect and I found myself playing 'The Magic Flute' louder than usual, simply because the Xpression gave absolutely no hint of strain when the action went from whisper to full crescendo. Its dynamic range seems positively gargantuan and it made most of the cheaper cartridges I own sound blatantly compressed by the way in which set the music soaring from my loudspeakers.

Most readers know that I am something of a bass fan and the Xpression continued its masterclass in this area as well. Spinning some dub reggae set my trousers (and floor, and kittens...) flapping but the bass notes were not just bottomless pits of impact; they had real form and shape to them and they started and finished properly. Double basses were an absolute joy to behold in all their woody glory and Bakithi Kumalo's bass lines on Paul Simon's 'Graceland' LP almost had me whimpering with happiness!

CONCLUSION

Just when I thought it wasn't possible to get a great deal better than the likes of the MC Windfeld, Ortofon have come along and moved the goalposts once more with the

Xpression. As easy-to-fit cartridges go, they really don't come any better than this and if your arm has an SME style socket on the end, but you're not really sure that an SPU is quite for you, then you need look no further.

Ironically, I can't help but wonder if the mounting system will put off some buyers who like to be able to play with headshells and the like, or even still harbour some misguided belief that detachable headshell arms are in some way second class to their rigid one-piece items. Whilst I would concur that the Xpression is probably a little overkill for the old Rega R200 in your loft, it is worth remembering that not only are classic detachable-shell arms like those from SAEC, Koetsu, Fidelity Research, Ikeda, Micro Seiki and indeed Ortofon becoming more collectable than ever and are more than able to hold their own, sonically, against modern designs. There are a number of new designs too. To overlook such arm designs because of the way they accept a cartridge is misguided and, to hear them at their very best, I'd say that you will struggle to beat the Xpression.

REFERENCE SYSTEM BOX

Garrard 301 turntable
Jelco SA-750D arm
Anatek MC-1 Phonostage
Naim Supernait amplifier
Modified Ferrograph S1 loudspeakers

MEASURED PERFORMANCE

The Xpression has an almost ruler flat frequency response that stays within tight 1dB limits from 20-20kHz. This will provide a super smooth sound, with character free treble. For some listeners, those used to the more common high frequency lift, Ortofon's top end cartridges can sound a little reticent, lacking in sparkle. But in truth they are extraordinarily accurate and this is what accuracy sounds like.

Tracing loss on inner grooves reduced output by -5dB at 20kHz, our red trace shows. This is enough to produce softness or warmth on inner grooves.

Tracking was very good, and up with the best at 2.5gms VTF. Top level torture test tracks at 300Hz and 1kHz were just cleared.

Although Ortofon quote a Vertical Tracking Angle of 23 degrees our German DIN test disc measured around 27degrees.

Output was very low at 0.35mV at 50ms/sec rms (0.25mV at 5cms/sec peak). The Xpression will need a quiet preamp.

The Xpression measured well in

all areas. It will display a neutral tonal balance and sound confident in the groove. NK

Tracking force	2.5gms
Weight	28gms
Vertical tracking angle	27 degrees
Frequency response	20Hz - 18kHz
Channel separation	21dB
Tracking ability (300Hz)	
lateral	80µm
vertical	45µm
lateral (1kHz)	25cms/sec.
Distortion (45µm)	
lateral	1%
vertical	5%
Output (5cms/sec rms)	0.35mV

FREQUENCY RESPONSE

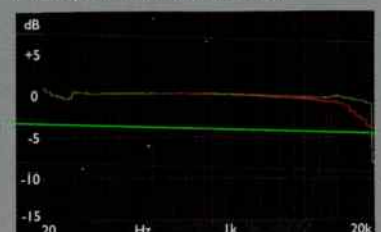

VERDICT

Another superlative cartridge from Ortofon, the Xpression brings the SPU ethos bang up to date.

ORTOFON XPRESSON £3,500

Henley Designs

(C) +44 (0)1235 511166

www.henleydesigns.co.uk

FOR

- treble purity
- glorious tonality
- effortless musicality
- mounting method advantages

AGAINST

- mounting method disadvantages



Vinyl is black!



The Evo! What an evocative name and rightly so too! The SL-1200 evolved from a Hi Fi turntable into a DJ deck and now we turn it back into a Hi Fi turntable again! Fitted with the legendary SME 309 tonearm and the Audio Technica AT33EV your emotions will run wild. The AT33EV is itself an evolutionary cartridge hence its EV suffix and matches the SME 309 so well. We have worked with direct drive turntables and moving coil cartridges for over 30 years now and the EVO has evolved into a mature product that is quite simply a world beater. We can supply completely new units with 5 year guarantees or we can convert your own, even if you bought it used.

The SME 309 tonearm is a delight to use, to look at and more importantly to listen with! Featuring the very same tapered magnesium armtube as the SME V you might wonder why this tonearm has such a low price tag. SME have a very long history and pedigree of making as they say "The best tonearms in the world" and we agree with them. This might be the last tonearm you buy, and in the long term has to be the very best value for anyone. We fit more 309s than all other arms added together, we simply love them to bits!

SME - Shelter - AT/OC9, Benz & Denon cartridges - Clearaudio - Jelco - Hadcock - SL-1200 mods
Oyaide - Cassette & reel to reel tape - Marantz - Focal - Whest Audio - A.N.T - Puresound - 78rpm - Iso pods - Audiolab - Onkyo
All demonstrated in a relaxing setting with river views! Very high part exchanges & World wide mail order.
Sound Hi Fi Dartmouth Devon 01803 833366 web www.SoundHiFi.com

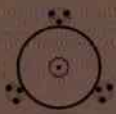

AVID HIFI

"The Truth, nothing more, nothing less..."

Precision engineering is the lifeblood of vinyl reproduction. From our entry-level turntables and accessories through to our mid and high-end ranges, each and every AVID product is cast, milled, turned and built to deliver nothing short of high fidelity perfection.

www.avidhifi.co.uk



www.facebook.com/avidhifi



"As far as I am concerned, the Diva II leads the field at its price point."



AVID HIFI LIMITED, Bicton Industrial Park, Kimbolton, Huntingdon, Cambs, PE28 0LW, England, Tel: +44(0)1480 869 900



Sole partner

A subchassis and arm board upgrade for the Linn Sondek LP12 is reviewed by Tony Bolton.

As regular readers know, my Linn Sondek has been a test bed for various replacement motors and currently runs with an Origin Live Ultra kit using the optional upgrade transformer, and is armed with a Hadcock 242 Cryo. In the November 2011 issue of this magazine I discussed the very beneficial effects of fitting the Khan top plate and cross brace from Tiger Paw. I was so impressed that this upgrade has remained in situ.

I have recently come across the Sole Subchassis from a company called Analogue Innovation who are based in Wales. This subchassis is currently in Mark VI configuration and consists of a layer of MDF sandwiched between two layers of structural grade aluminium which are anodised in black. The anodising process serves two purposes: it protects the surface from oxidation and also stiffens the aluminium. The Company also offer a replacement armboard made of the same combination of materials so I elected to try both.

When they arrived I was immediately impressed with the quality of the construction and finish of these products. They were very obviously made by someone who not only took a pride in their

manufacture but also had access to very high quality engineering facilities.

Having examined the Sole, the first thing I did was to dismantle the Sondek and remove all of the Tiger Paw fittings (the cross brace and top plate) and return the LP12 to standard form so that I could assess the effects of the Sole on its own. Having done a couple of hours listening I then took it apart again and installed the Sole and the armboard, which was supplied already attached to the Sole. Care had been taken to ensure that the Sole weighed the same as the steel subchassis so when correctly set up, the suspension springs were under the same loading as they were designed to take. Therefore rebalancing the deck and getting the bounce from the suspension just right proved to be quite straightforward.

For those who wish to try the Sole and are not used to dismantling Sondeks I am pleased to report that John Ruggles (owner and founder of Analogue Innovation) had included very comprehensive, step by step instructions on how to dismantle and install his product, along with notes on how to service the deck as you go. A practically minded novice should have little trouble in doing this, although if you are not confident

in this then the Company offer to do the job for a quite reasonable fee.

Having returned the newly fitted out deck to the listening room I started off by playing Rimsky-Korsakov's 'Sheherazade'. This record is one of the first of the RCA Living Stereo recordings and very ably demonstrates the spacial imaging capabilities of the then new format.

Compared to the standard Sondek I found the Sole produced a wider and deeper soundstage that extended both further forward of the speakers and further back behind them. I felt that I was more aware of the size of the venue in which the recording was done and the presentation had a certain degree of effortlessness that made it seem more alive and natural than when listening with the conventional steel subchassis in place.

The tonality also displayed a few differences, especially in the bass regions where the familiar richness of the Sondek bass was reduced and cleaned up somewhat to be a cooler, drier sound that seemed to allow the midrange to be rather more expansive and expressive. This in turn seemed to let the high frequency detail be a little more prominent, all of which helped portray the image of an orchestra actually playing in front of me, rather than me listening to a

well produced recording.

I moved onto an old favourite of mine - 'The Benny Goodman Trio Plays For The Fletcher Henderson Fund'. This 1952 disc, recorded off air from the New York based radio station WNEW's "Make Believe Ballroom" series showed the band in fine form. This copy is not in the first flush of youth, but I was impressed with the way that any surface noise was reduced and displayed merely as a brief passing aberration, rather than as an intrinsic part of the recording.

At the same time I felt that there was more detail within the background audience noise, which helped me get involved in the event taking place in front of me. The penultimate track 'I've Found A New Baby' features some sizzling pyrotechnics by drummer Gene Krupa, interspersed with Goodman's clarinet fills before ending with Krupa reversing the beat for the last few bars. With the steel chassis in place this can degenerate into a slightly muddled beat but the Sole subchassis/armboard combination seemed to ground it nicely, making sense of the rhythm and further enhancing the impression of a real live performance.

After such sizzling noises I put on something rather calmer, Otis Redding

singing various ballads. This is a modern reissue of a 1965 Stax recording and features the top ten hit 'Mr. Pitiful'. This song was apparently written in response to a comment by radio DJ Moohah Williams who described Redding as 'Mr. Pitiful' because of the heartfelt way that he sang ballads. Legend has it that having heard the comment on the radio while in the shower, the song was written on the drive to the studios that morning and recorded in just a couple of takes. Whether this is true or not, the song ends the LP with Redding's inimitable voice in excellent form, backed with a beat that owes more to funk than balladic soul. Again I felt that the sense of calm projection of the sounds into the room, the more refined tonal balance, and the greater spacial sensations around the music left me feeling more in contact with the

emotion of the performance.

Having successfully negotiated the requirements of conventional music I turned to a 2001 recording by Quantic. This is one of the several guises of musician, DJ and record producer Will Holland. His music draws on various Latin themes and the LP 'The Fifth Exotic'

features vocals from British soul singer Alice Russell alongside Holland's playing of guitars, bass, double bass, piano, organ, saxophone and percussion. There is also a flavour of trip-hop with homage paid to modern genres of electronica. Again I found myself more absorbed in the atmosphere created by the

sounds. Quite complex rhythmic forms were opened out for analysis and the whole presentation

was so absorbing that I ended up playing all four sides, not just the one that I intended to listen to.

I think the Sole subchassis should come with a warning: once fitted you will find that you lose hours of your life rediscovering your record collection and enjoying the less euphonic presentation of your music. The Sole seemed to have a similar effect to the Khan, in that it took away some of the bass vulgarity of the stock LP12, enhanced its rhythmic abilities and made it present music in a totally entrancing manner. It was as though the performers on whichever record that I played were on particularly sparkling form and seemed better rehearsed. There was a sense of greater polish to the presentation and more sophistication to the sonic image in front of me.

I also took the deck apart again just to try the Sole in conjunction with the Khan top plate and cross brace. Each seemed to build on the other's strengths, creating a very grounded and detailed sound. Anyone who enjoys the deck's plus points; its sense of timing and innate musicality, but finds the sound a bit too rich and fruity, will thoroughly appreciate what either of these modifications can do individually. Combined they made the deck sound considerably more modern and less coloured. Individually they each improve on aspects of the performance that needed tidying up. The Khan removes a lot of the bass bloom, the Sole also does this but provides a coolness to the sound that many would feel the deck needed.

If you still run your Sondek in standard form then I would definitely recommend auditioning the Sole. Analogue Innovations offer a 60 day money back guarantee should you not be satisfied with the results. I think it unlikely that this will happen, but since the deck can easily be returned to stock issue, it is an experiment that I would advise making. The standard of finish and the precision of the manufacturing are excellent and I felt the resulting sonic enhancement of the deck was well worth the money. Analogue Innovations also offer the Sole without an armboard but I personally would spend the extra few pounds and get their armboard as well.

Overall a well thought out and well made alternative to Linn's own Keel subchassis/ armboard combination (but at considerably lower cost) that, I feel, works extremely well, and as such, I recommend that you try it. I think it is great.

MUSIC USED:

Rimsky-Korsakov 'Sheherazade' Pierre Monteux conducting the London Symphony Orchestra RCA Records SB - 2003 1958

Benny Goodman Trio 'Benny Goodman Plays for the Fletcher Henderson Fund' Columbia Records 33SX1020 1952

Otis Redding 'The Great Otis Redding Sings Soul Ballads' 4 Men With Beards 4M105 2001

Quantic 'The Fifth Exotic' Tru Thoughts Records TRULP 016 2001

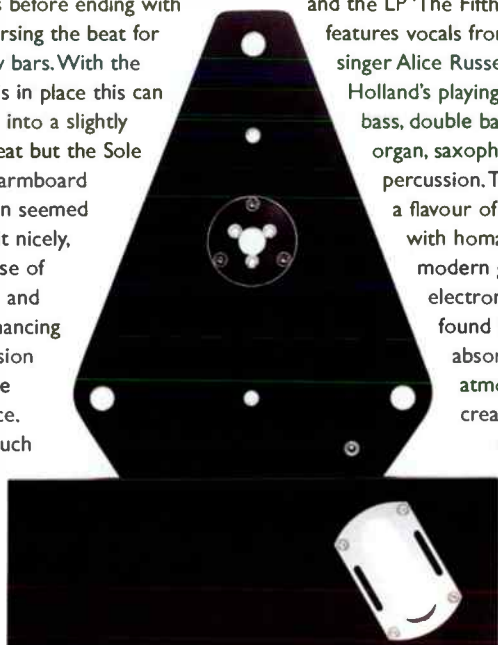

SYSTEM USED:

Linn LP12/ Origin Live DC motor/ Hadcock 242 Cryo arm/ Clearaudio Concept MC. Luxman E200 phonostage. Bent Audio TAP-X passive pre-amp. 2 x Quad 303 power amps. Kelly KT3 loudspeakers.

VERDICT ●●●●●

High quality replacement subchassis and armboard for the LP12 turntable.

SOLE SUBCHASSIS (WITH ANALOGUE INNOVATION ARMBOARD) £625.00

Analogue Innovation
 ☎ +44 (0)1554 890414
www.analogueinnovation.com

FOR

- same weight as standard
- LP12 subchassis
- lower noise floor
- better timing
- more expressive and expansive sound

AGAINST

- nothing I've found so far

Hear The Silence

The holy grail of vinyl-based music production, the half-speed master, is doing well and thriving in London, says Paul Rigby. Miles Showell, Mastering Engineer at Metropolis Mastering, London, has assumed the position of wax evangelist.

To many, the notion of half speed vinyl will be a strange one. It conjures up visions of albums rotating at, what, 16 and a bit revolutions per minute? But, when that vinyl is initially being created, that's basically, what happens. During recording of a vinyl record, the master tape is played back at precisely half its recorded speed while the cutting lathe is similarly turned at precisely half the desired playback speed. The end result? Wonderful sound.

Pioneered by the, still active, Stan Ricker, a veteran mastering engineer, who is renowned for his development of the half-speed mastering process, the technique was an effective spin-off from the technology brought in to cut JVC's, normal speed, CD-4 quadrasonic albums. CD-4 was dying a death by the mid-'70s due to unsuitable vinyl raw materials: only Japanese vinyl was hard enough to do the job, American sourced plastic being too soft.

Naive quadrasonic mixing methods didn't help sales either. For example, the mix would sometimes include scoring specific instruments to individual speakers. As for the sound quality, let's not even go there.

Ricker began his half-speed mastering experiments through preservation instincts. No more quadrasonic sound meant no more clients, no more expensive machinery and no more factory. Ricker realised that if he by-passed the CD-4 processors, the system lent itself to cutting stereo at very high quality

(see 'She's Breaking Up!').

The final half-speed mastered product was pressed to a specially produced, thick disc of virgin 180g vinyl that JVC trademarked as SuperVinyl. The result yielded a wonderful sonic presentation. It didn't take long for audiophiles to catch on and they sought the records out at every opportunity. In fact, they were very often the first records to be played when showing off a prized audio system to envious friends. Pink Floyd's 'Dark Side of the Moon' was a popular choice to rattle window and door frames with the famous opening heart beat sequence.

Aurally, the half-speed master was something to behold. Cymbals sounded bronzier, voices were more lifelike and emotive and easier to understand. Bass was faster, deeper and more defined, offering improved pitch definition and clarity. Micro and macro dynamics were effortless. The silence between tracks or, especially during the quieter passages within the music, was...well, quiet.

This sonic accumulation had the effect of an overall increase in clarity



and realism that couldn't be denied.

So why did half-speed mastered vinyl disappear? A good indication is offered by Stan Ricker himself, "I may have a good reputation with the audiophile people, but the audiophile people are few and far between...and they don't do many gigs".

Money – or lack of it – was behind the demise of half-speed mastering and many of the companies associated with it. It may appear surprising, therefore, that top London-based mastering house, Metropolis, an outfit that knows the importance of maintaining a profit, has been supporting its own mastering engineer, Miles Showell, in his dream to resurrect the technique. There is method in this particular



madness, however.

"Our investigations started a few years back with an experiment to see what we were missing. Our lathes have never remained in standard factory condition but have been improved and modified over the years to increase the level/duration envelope", Showell explained. "After modifying the RIAA encode equalisers (Recording Industry Association of America – a recognised standard of equalisation) we realised that there was plenty of scope for improvement, so the experiments with half speed cutting started".

To get things rolling, Showell and his team initially cut half speed trials without any RIAA equalisation, in order to provide a benchmark. Then they experimented with RIAA in the digital domain. However, it is not a process that readily lends itself to digital signal processing and also that limited Showell to solely digital sources.

"Therefore, in house, we developed and fabricated our own custom analogue equalisers. The test cuts that followed surpassed our wildest expectations. We then started experimenting with half speed playback systems, with custom valve electronics in our analogue tape machines and with modified filter characteristics for D to A conversion for the digital sources," recalled Showell.

The process itself is one that is approved by Showell as it makes it easier for the cutter head to transcribe the signal, as a consequence of reducing the accelerations and velocities. The current feed to the cutter is approximately a quarter to a third of a real time cut and the damping is reduced which minimises overshoot and cutting

inaccuracies. Also, the reduction in heating of the cutter coils improves the linearity. The high frequency phase response is dramatically improved too, which increases the accuracy of the stereo image.

"We prefer it because quite simply, it sounds fantastic" grinned Showell. "A popular misconception of our comparison 'test cuts' for clients, is that we have applied equalisation to the half speed version when, in fact, all that

has happened is that the full spectra and clarity of the original has been faithfully recorded".

It is, however, important to have a well maintained and calibrated machine for the source. For example,

an established process, problems do threaten to arise. Not so much 'new problems' as different versions of the original problems.

"Digital sources might seem like an easier solution," warned Showell, "but it is not just as simple as playing it at half the sampling rate. In fact, the most significant down side is sibilance. As we are not using any high frequency limiting we have to watch out for this".

Reactions to Showell's half speed work have been favourable. Of course vinyl is a niche yet "...we have many clients, especially artists and producers, who value the quality of the product they release, a great many of these clients still like vinyl" enthused Showell.

So will the process catch on? Half-speed mastering is a specialist technique and, as in the past, one would assume that costs will be prohibitive, for both clients and the man on the street. Showell takes issue. Whilst conceding that clients will pay more for the privilege of



THICK AND FRUITY

One of the basic assumptions for any half-speed mastered vinyl release is the thickness and, by association, weight of the final product. The standard that is often quoted is a final weight of 180gm. Thinner records have a shorter cycle time in the presses, this can lead to uneven temperatures in the stampers causing noisy and/or warped records. In the oil crisis of the early 1970s, RCA came up with the Dynaflex pressing, which they marketed as a "fantastic development". In reality the records were frighteningly thin (if you shook one between your fingers it sounded a bit like one of Rolf Harris' wobble boards) but they saved lots of money making records like this. The other companies saw RCA getting away with this and, in turn, slimmed down their own pressings. Fortunately the days of Dynaflex have gone. Showell agrees but admits that, "...most modern pressings are not as heavy as I would like though but, yes, I would recommend 180gm pressings".

it is imperative that the bass response of the analogue machine is as uncompromised as is technically possible. For Showell's process, the entire signal path has been optimised for low frequency amplitude and phase linearity and extension. As with any new process or, as in this case, furthering the boundaries of

utilising the half-speed technique, he was keen to position the process as one of a range of specialist services that Metropolis currently offer.

"Metropolis has a history of trying to push the audio boundaries and, as a result, tends to attract business from people that care about the quality of the end product. Half

Web classiquesounds.co.uk

Classique Sounds

Specialist Supplier of Vintage Audio

61 Aylestone Drive
Aylestone
Leicester, Le289e



Tel 0116 2835821
Local rate 0845 1285137
Mobil 07815 188040

Leak Stereo 20 full rebuild using Paper in oil caps £299.00
Conversion of Leak valve pre to passive including Silver wire/soldered/rhodium plugs £299.00

**wanted classic and modern hi-fi eqpt.
FOR SALE. PRE/POWER AMPLIFIERS**

Leak Stereo 20. Stunning condition Rare grey model £ 949	Arcam Delta 90 integrated amplifier. Black £ 99
PS Audio Model 2C power amplifier. Separate PSU £ 169	Linsley Hood transistor power amplifier. Awesome £ 199
Sony TA-1130 integrated amplifier A classic Silver £ 195	Arcam Alpha amplifier. Boved and good condition £ 99
Quad 34 (brown version). Good cond. MM phono £ 195	Rogers stereo valve pre amplifier. Very rare. £ 149
Leak TL12 + champagne. £ 349	Rotel RC-970BX pre amplifier. Good condition. £ 99
Concordant Exhilarant valve pre amp. Wood case £ 449	Rotel RC850 pre amplifier. Good condition. £ 69
Musical Fidelity A100 pure class A integrated 50W £ 299	Myryad MA240 power amplifier. £ 499
Inca Design Talen integrated amplifier. 80W channel class A/B. One of only 50 in the UK. Boved/reminstr. Rare £ 699	Leak Point one mono pre amplifier. Excellent cond. £ 99
Beam Echo (Avantis) DL7-35 monoblocks X 2 £POA	Croft OTL series 3 valve power amplifier. Ex cond. £ 999
Naim Nac-12. Boved. Naims First. £ 99	Arcam Alpha 10 int amp. Bxd. remote & mint. £799 £ 449
Kora Explorer 90S1 hybrid/valve 60W int amplifier. £ 375	Quad QC22 pre amplifier. Mono. £ 49
Audio Symphonies V2 valve pre amp. Mint/boxed. £ 299	Leak Varislope pre amplifier Ex condition. £ 199
Rogers Cadet 2 power amplifier. Good condition. £ 275	Leak Varislope valve tuner. Very unusual and rare £ 599
Chapman 305 stereo valve power amp. 205 valve pre amplifier and FM195 valve tuner. £ 599	Leak pre amplifier for Leak TL10.1 Ex condition. £ 99
Quad II's. Various condition. £POA	Croft series V1 valve power amplifier. Good cond. £ 699
Rotel RA-840 BX int amplifier with MM & MC £ 99	Pioneer A300X integrated amplifier. Nice condition. £ 129
Quad 33 pre amplifier. Boved. Ex condition. £ 129	Quad 33 pre amplifiers. From... £ 75
Akai AM-U33 int amplifier. Silver/Mint & boxed. £ 69	Sugden A48 & T48 tuner in wooden steeve. £ 299
Leak TL12+. Amplifier. Bronze. Mullard tubes. £ 349	Leak Point One stereo pre amplifier. Ex Cond £ 199
Scott stereomaster 260 American integrated amp. £ 169	Converted to Passive. Pure silver/silver solder/Silver plate phono/alps pot. £ 425

TURNTABLES/CD PLAYERS

Graham Slee ERA Gold V MM phono stage Boved £ 249	Graham Slee Elevator EXP MC head amplifier. Bxd £ 379
Nagaoka MPH Borm MM cartridge. £ 35	Denon 103 MM cartridge. Boved. Excellent cond. £ 60
SME 3009 S/2 detachable headshell. Beautiful. £ 249	Michel Focus One turntable and arm. £ 349
Garrard 401 chassis. Excellent condition. Serviced. £ 575	SME headshell. Boved. £ 45
SME 3109 S/2 improved tonearm. Nice condition. £ 249	Shure V-15 MK III. Boved. Good condition. £ 149
Thorens TD160B MK II turntable. Sme cut. Black/lid £ 99	Shure M95 cartridge. MM. Used. £ 29
Project RPM5 turntable. Boved & excellent cond. £ 299	Arcam Alpha CD player. Boved with remote. £ 99
Cambridge Audio CDS. Black finish. Boved/remote £ 59	Ortofon VMS20E MKII. New and boxed (NOS) £ 69
Ortofon MCA-10 battery MC phono pre amp £ 149	Denon DCD-620 CD player. Good condition. £ 29
Rotel RCD 965 BX CD player. Tweakers dream. £ 149	Goldring Lenco GL75 with arm. £ 149
Origin Live Encounter Mk3 tonearm. Boved. £ 595	Ortofon MCA-76 phono pre amplifier. Rare. £ 149
Ortofon MCA-76 pre amplifier. Boved/mint £ 179	Sony CDP911E CD player/remote/book. Cost £300 £ 119
STD 305S with SME mount. Black finish. £ 129	Thorens TD150. Teak finish. No lid. Nice condition £ 99
Nad 504 CD player. Ex condition. No display £ 49	Arcam DV78 DVD player. Manual/remote. Silver. £ 249

SPEAKERS

Usher X-719 speakers & usher stands. Cost £1550. £ 799	Radford bookshelf speakers. Teak £ 149
Wharfedale 505.2 speakers. Black ash £ 59	Tannoy 605's. Black ash finish. £ 59
Monitor Audio studio Mini Monitor speakers £ 299	Kef Q5 loudspeakers in cherry. Good condition. £ 249
Pair Wharfedale Super10. RS DD drive units. Mint £ 199	Bose Acoustimass -5 2.1 speaker & sub manual. £ 199
Quad ESL63 full rebuild from.... £ 1290	Ruark Talisman MK1 speakers. Excellent condition £ 159
Heco 330S speakers. A classic. New unused/boxed. £ 199	Quad ESL57's. Black. Good condition. £ 649
Miller & Kresell M&K VX-4 active subwoofer. Blk £ 229	Celestion DL12 floor standing speakers £ 129
Pair Quad ESL63 loudspeakers. Fully reconditioned with all new panels, socks etc. 12 months warranty. Awesome £ 1699	Pair Quad ESL57 speakers. Fully reconditioned, including 2 new Otec treble panels. Awesome sound & dynamics. £ 1799
Pair Quad ESL57 speakers. Fully reconditioned, including 2 new Otec treble panels. Awesome sound & dynamics. £ 1799	Quad ESL57 speakers. All fully serviced with full 3 months warranty. Hear what ESL57's should sound like From £ 1199
Quad ESL57 speakers. All fully serviced with full 3 months warranty. Hear what ESL57's should sound like From £ 1199	Celestion Little one speakers in white. Boved. £ 99
Celestion Little one speakers in white. Boved. £ 99	Quad ESL57's. Black. standard service. Beautiful. £ 1299

OTHER ITEMS

Quad FM2 valve tuner. One Thing Audio serviced complete with OTA stereo decoder. Better than a Troughline. £ 249	Kenwood KX-5010 cassette deck. Boved. £ 59	Mullard used tested 12AX7 ECC83 valves. Each £ 25
A&R canbridge tuner. Black £ 25	Arcam Alpha tuner. AM/FM. Black £ 29	Denon DR-M24HX 3 head cassette deck Superb. £ 59
Yamaha KX-580 SE 2 head cassette deck. Hb pro £ 39	Quad FM2 valve tuner. Sound amazing. £ 149	Quad FM2 valve tuner. £ 29
Creek OBH-15 MM/MC phono pre amp. Boved. £ 149	Rotel 850 stereo tuner. £ 29	Marshall ECC83 12AX7 valve. New. Boved. £ 95
Rotel RB-950BX tuner. Boved. £ 49	1000PI paper in oil capacitors. Used in Leak amps. £ 3.99	Quad FM1 multiplex decoder. £ 89
Nakamichi 600 cassette deck. Very rare. Nice cond. £ 299	Stunning Quad FM1 valve tuner. Boved. Rare cond. £ 125	Mission Cyrus AM/FM tuner. Grey finish. £ 79
Transparent powerlink/Schuko plug. 1.9M £ 149	Meridian remote for 206 series. Rare & good cond £ 99	HiQ balanced phono pre amplifier. Awesome £ 249
Hitachi FT-5500 FM tuner. A real classic. £ 99	Akai AT-K33L FM/AM stereo tuner. Mint & boxed £ 39	Yamaha YSP 800 5.1 speakers with digital amps. £ 299
Quad FM valve tuner to go with Quad 2/2. From... £ 40	Quad FM3 tuner in excellent condition. From... £ 99	Top quality PIO capacitors 0.1 and 0.22uf £ 5.99
Marshall ECC83 12AX7 specially selected valves. £ 99	Paper in oil capacitors. Metal bodies. I use these on all Quad II rebuilds and they sound amazing. 0.1 and 0.22uf £ 8.99	Rupert stands for Quad ESL57 £ 239
George stands for ESL63 speakers £ 239		

QUAD ESL57 & ELS63 PANELS/SERVICING ETC

New One Thing Audio "Widge". All round improvement for 57's & a kinder load for amp £79 pr
Full rebuild of 57's including latest Otec treble panels for only £1290.00
We sell serviced Quad ESL57 speakers from only £1200.00pr. Why spend £4000+?
ESL57 SPEAKERS STANDARD SERVICE £690. PR
Price includes 2 completely rebuilt treble panels etc. Ring for further info.
"Classique Sounds servicing restores the Quads to a position where they can hold their head high". Jan Marks. HIFI WORLD, April 1999. Full servicing facilities available.

Outstanding in our Field

Audio Home Cinema Multi-Room Installation



Brands offered include:
Arcam
Bryston
Chord Co.
Dynavector
HiFi Racks
Guru Pro Audio
Isoblu
Lehmann
Linn
Naim
Okki Nokki
PMC
Rega
REL
Sennheiser
Wilson Benesch
Wireworld

Located in the midst of rural Norfolk, Basically Sound offers a relaxing, out of town location for you to visit and experience the best performing audio systems available.

From turntables to the latest in network audio solutions, we ensure that you hear music as it should be heard - and the parking and coffee are free.

Calvey Court, Reymerton, Norfolk. NR9 4QD
01362 820800
enquiries@basicallysound.co.uk
www.basicallysound.co.uk



Tellurium Qtm

Audio designed to combat phase distortion



Find out why more and more people are talking about Tellurium Qtm products.

Don't just believe all the incredible reviews, test our products for yourself against any thing else in the same price range.

Find out how your music can really sound and talk to your nearest Tellurium Qtm dealer now.

Cables, amplifiers and the unexpected!

www.TelluriumQ.com

hi-fi+
Products of the Year 2010
Jan 2011

Hi Fi World
Cable of the Year 2010

01458 251997

PURE SOUND

The thickness of the vinyl is often, surprisingly, not the first problem the engineer has to consider. That difficulty, stems right back to the initial production stages with the creation and selection of the actual vinyl itself.

"Virgin vinyl is considered to be the best among the audiophile labels as it is free from contaminants (i.e. dust, dirt, release agent, finger marks, etc.) which can be introduced when re-ground vinyl is used," explains Showell. "That said, if the vinyl to be re-ground is properly cleaned and no paper from the labels contaminates the mix, there probably are benefits to using a small quantity of re-grind as a stabiliser to the rest of the vinyl. The only problem is keeping the mix free from contaminants".

RELEASES

Half speed vinyl is alive and well and available to buy. One of the principle backers of the format is the venerable re-issue label, the audiophile friendly outfit, Mobile Fidelity, that releases half speed LPs on a regular basis. Some of the more recent issues include Keb Mo's self-titled debut plus the well received Carole King album, 'Music', along with other titles such as the Grateful Dead's 'Wake Of The Flood'.

There are plenty of other releases out there, however. Alabama 3's newly reissued 1997 album, 'Exile On Coldharbour Lane' is due out, via UK-based indie label One Little Indian, using half speed, along with 200gm vinyl, no less.

More exclusive releases are also using this process. Ex-Japan lead singer, David Sylvian, has been releasing the odd LP on 180gm, half speed vinyl. 'Blemish', for example, was mastered at Metropolis. Sylvian found the experience of issuing his work on the format both a sign of respect to his own art and also a selling point, to set his work apart from the competition and to encourage more direct sales.



"SHE'S BREAKING UP!"

For recordings, audiophiles value those made from 'the original master tape'. Yet play a tape back at half speed and you solve many inherent 'tape playback' problems that this source contains, such as lag in signal input in the tape pre-amp and those in the playback head. At half speed, the signal is cleaner as it passes through the system, especially for brass instruments. Also, it is not apt to cause any kind of power supply or slew rate distortion.

Hence, the tape machine itself is a problem. It's easy to get the signal recorded – it's harder to recover it. So, if you recover a signal at only half speed, then transfer it onto another medium and you have a really good playback of that other medium, the record, then when you compare the analogue tape played at real time versus the lacquer played at real time, the signal off of the lacquer has managed to come out without all the problems inherent in real-time tape playback. Most of the improvement is due to scanning the tape at reduced velocity and not driving those tape head preamplifiers into gross distortion.

speed cutting is another in a long line of improved services we offer to our clients. These days vinyl album runs are typically 8,000 to 10,000, so when divided by the production run the increased cost per unit is not enormous".

Which is fine and dandy for the mega-buck record companies of this world but the penniless and somewhat beleaguered audiophile should, according to Showell, take heart.

"The cost to cut the master lacquers at half speed is approximately three times that of cutting 'real time' However, this is a one-off cost and when divided by the production run is largely insignificant. We strongly advise our clients to get their records pressed at a good plant on high grade, preferably classical grade, vinyl. This obviously will have an impact on the man in the street. I would estimate the total price increase to the consumer be under £1.00. However once the lacquers are out of my hands I have little or no say as to what happens." Showell and, indeed, Metropolis have declared that the resurrection of half-speed mastering is part of the 'grand plan'.

"We are constantly seeking ways to improve our signal path. Having a transparent signal path will, by its very nature, benefit not only our half speed cuts but also allow us to make better sounding CD and SACD Masters for our clients. The future releases are in the hands of our clients. It is our job to educate as many people as possible about the benefits of half speed cutting. It is the most accurate way of recording music to vinyl, bar none."

RETRO REPRODUCTION

QUALITY HIGH FIDELITY & VINTAGE

AMPLIFIERS

Audionet kit1 300b amp massively modified	£995
Audiolab 8000Q british built mint boxed	£395
Anatek monoblocks £2400 new	£995
Audionet integrated amp superb engineering and german construction	£1995
Biel Canto remote valve pre amp	£695
BKS T140 American power amp great for driving electrostatics	£345
Croft integrated valve amp 4x EL34 with valve phono stage	£495
Croft micro25 new style	£395
Dynaco stereo 80 valve power amp JBL Synthesis S650 5 channel power amp EAR 834L	£495
Golden Tube Audio superb American made tube pre amp	£475
Hoveland HP100 with MM phono stage valve pre amp	£2995
Hoveland Sapphire valve power amp	£3495
Krell KSA250 Class A power amp	£2295
Linn Akave amp module	£45
Marantz PM8200 integrated amp, £395 new boxed mint	£275
Meridian 100 series three box power amp	£295
Meridian 100 series pre amp	£95
Meridian 518 digital audio processor	£445
Meridian 568 series processor	£395
Mission 776/777 pre and power amplifier 100w cast case work a real classic	£795
Naim 552 top of the range pre amp	£POA
Naim 90 power amp boxed	£225
Naim Flatcap 2 boxed	£445
Naim 62 pre amp	£195
Naim 42.5	£225
Naim NAC 145	£145
Naim 140 valve case work	£345
Naim Nait 5i boxed mint	£595
Naim CD S with power supply	£1395
Naim NACDS power supply new style front panel	£695
Naim Teddy Pardo PSU	£575
Naim 52 pre amp	£795
Pase Linear 700 power amp	£495
Pioneer A9 heavy weight classic 80's integrated amp superb phono stage with variable cartridge loading	£295
Pioneer stereo master SM-R151 1959 a rarity	£POA
Pinnacle A20 integrated amp	£395
Pinnacle preprocessor remote balanced	£395
Quad 405 MkII & service history boxed	£245
Quad 2 mono blocks with original valves	£795
Quad valve tuners and pre amps various	from £45
Rotel RA 920AX	£195
Russ Andrews power pak III Naim switch mode power supply	£225
Shangling MC30 all in one valve system black & silver	£475
Sugden HeadMaster headphone/line level remote control pre amp	£475
Sugden Masterclass power amp	£1995
Sugden Masterclass pre amplifier remote balanced input/output	£795
Unico DM hybrid power amp	£995
Yamaha 2020 receiver top of the range	£245

SPEAKERS

Acoustic Energy AE1	£495
Aurum Cantus black orchid speakers piano black	£495
ATC Anniversary 50's new £1795	£6995
ATC SCM7 boxed mint	£395
AVI Neutron 4 cherry finish boxed	£395
Beaumont Virtuoso reference Lowther horn loaded splits with brand new DX4 drive units	£2995
B&W DM1	£95
B&W DM3	£105
Cabinet for 12" Tannoy with amplification built in model M508	£195
Castle Howard 2 oak finish	£495
Castle Chester dark oak finish	£345
Duvel Planet omni directional speakers	£495
Gradient SW63 bass modules for with active crossover for ESL boxed	£695
Final 500 Electrostatics	£795
Goodmans Axon 201 12" full range 15ohm speaker 1 pair	£295
Goodmans Magnum K's	£125
KEF Reference 51AC active studio speaker very rare	£POA
Linn MKII Kans	£195
Linn Sara active speakers	£145
Lockwood Mirror cabinet for Tannoy 10"	£195
Martin Logan Aenus Electrostatic speakers	£945
Martin Logan Aeon Electrostatic speakers	£1195
Mono Pulse 32A 8 months old ex dem	£495
Mono Pulse 32S ex dem	£645
Monitor Audio Silver 8i cherry finish	£495
Monitor Audio GS10 piano black finish	£495
Musical Stones Italian Solid Marble floorstanding speaker with Dynaudio drive units	£495
Musical Fidelity Reference 2 excellent condition Qued ESL63 need work	£495
Russ Equinox walnut finish	£745
Rogers LS5	£225
Seftonian early 60s corner speaker pair	£295
Sara Fuji SF-135 open baffle 3 way design	£495

Tannoy 15" HPD rebuilt by Tannoy mint never used	£995
Velodyne SPL 800MKII subwoofer	£395
Velodyne SPL 1200 remote control sub	£595

TURNTABLES/TONEARMS

Audio Synthesis moving coil phono stage with 2 box PSU	£245
Clearaudio Victory cartridge £1000 new	£345
Clearaudio Emobot turntable with unipivot tonearm boxed mint	£595
Clearaudio Master Reference with parallel tracking tonearm	£POA
Creek QBH 9 moving coil pre amp	£95
EAR 834P mm/mc with volume	£795
Garrard 301 with custom aluminium & polished granite plinth	£1195
Garrard 401 in birch ply custom plinth with lid	£POA
Garrard 401	£595
Graham Slee Fanfare Gram amp 3 moving coil phono stage boxed as new 10mths old	£195
Graham Slee PSU1 power supply upgrade as new	£130
Graham Slee Era Gold V with PSU1	£325
Infinity Black Widow tonearm SME mount great with high compliance cartridges	£195
Linn LP12 various	from £445
Linn Basik turntable no arm or lid	£65
Linn Ittok boxed mint	£595
Linn Ittok MKIII	£POA
Leak early 60's tonearm	£95
Luxman PT300 turntable	£375
Michell Hydraulic Transcriber	from £495
Michell Focus 1	£295
Michell IsoHera phono stage	£375
Pure Sound P10 valve phono stage 1 month old boxed	£575 00
Pure Sound T10 moving coil transformer high and low settings 1 month old boxed	£275
Roksan Xerxes with Rega arm and golding cartridge	£495
Rothwell Rossan phono stage mm	£295
Rotel phono stage RG970BX	£95
SME 10 with tonearm with V	£3295
SME 3009 tonearm series II	£225
SME series 3 tonearms various	from £175
Synrix LE1 tonearm recently wired with cardas cable fitted and checked by Audio Ongam	£275
System Deck P100 direct drive turntable with SME arm mount	£225
System Deck II biscuit tin model (SME mount)	£225
Thorens PD125	£225
Technics SP10 direct drive turntable	£495

CD PLAYERS, DACs

Arcam CD73 24bit cd player black finish	£225
Arcam CD92 DCs ringdac HDCD boxed mint	£395
Cambridge Audio DAC Magic 2	£165
Cyrus DAC Master	£195
Leema Stream 3 cd player 1mth old	£895
Marantz CD52 MKII special edition	£145
Marantz CD50 multibit dac	£95
Meridian 506 20 bit CD player	£495
Meridian G08 CD player	£1195
Micromega CD132	£295
Musical Fidelity A3CD 24bit CD player boxed	£375
Musical Fidelity A5 CD player boxed mint	£795
Moon Equinox RS new £2295	£995
Nakamichi CD player 2	£175
Nakamichi MB10 5 disc music bank cd player	£175
North Star DAC	£195
Pink Triangle litaural HDCD superb player	£95
£3000 new serviced	£595
Phillips CD610 16bit cd player	£95
Rotel RA965 BX classic old school cd player	£195
boxed mint condition	£125
Sony GDF X-B920E	£195
Sony XE680 SACD player	£195
TEAC UDH01 USB DAC	£275

TUNER

Creek T40 FM Tuner	£95
Cyrus AM/FM tuner (original version)	£95
Magnum Dyalab 205 FM signal sluth boxed mint	£275
Magnum Dyalab Etude	£475
Meridian Z04 Tuner	£245
Naim MAF02 recently serviced	£690
Nakamichi BX150E	£145
Rotel RT1082 DAB tuner	£225
Sony ST5100 FM/AM classic 70's tuner	£125
Sony 700ES tuner	£75
Sony ST8900 QS DAB Tuner	£145

MISCELLANEOUS

Aka GX77 open reel with various tapes mint condition	£495
Pioneer MXA3 valve multiplex FM decoder ultra rare superb sound	£295
Audio Technica OC9 original	£225
Cardas Anthem 3mtr balanced interconnect	£295
Cardas golden ref. 8.5mtr balanced interconnect	£995
JPS super conductor 2	£645
Marantz super scope 3 head portable cassette deck just serviced	£295
Nakamichi receiver 2	£195
Nakamichi LX3 cassette deck	£245
Nordost cable valkyria 1.5mtr interconnect new £1500	£495
Townshend ISOL DCL1 loudspeaker cable 5mtr pair	£495
Townshend super tweeters with ESL57 brackets & cables	£395

WE NOW HAVE ON DEMONSTRATION THE SUPERB LEEMA PULSE + STREAM WITH XERO SPEAKER + AGENA HI-END PHONO STAGE WITH USB

GENEROUS PART-EX. ON ALL EQUIPMENT, NEW OR USED. WILL BUY GOOD QUALITY EQUIPMENT AS ABOVE. NEXT DAY MAIL ORDER & UPLIFT FACILITIES

Opening times: 10.30 - 5.30 Tues. to Sat.
28a Haddington Place, Edinburgh EH7 4AF
Tel/Fax: 0131 558 989
Email: retro.reproduction@virgin.net
Website: www.retroreproduction.co.uk



"...so good I swear it is surrounded by magic"

- Noel Key wood - Hi Fi World

Our award winning Hi Fi products are handmade in the UK and let you hear your music the way it was recorded

Please contact us to arrange a demonstration of a complete music system in your own home

www.mfaudio.co.uk : info@mfaudio.co.uk : +44 (0) 1424 858260 music first audio

IAN HARRISON HI-FI TEL: 01283 702875

HIFI AT DISCOUNT PRICES. FREE NATIONWIDE DELIVERY

SALE! UP TO 40% OFF!

Email: ian.harrison@mercian.myzen.co.uk

TRADE IN YOUR OLD MOVING COIL CARTRIDGE & SAVE UP TO 60% OFF THE RRP.

AKG HEADPHONES	£POA	LEHMANN AUDIO	£POA
AKG K240DF	£POA	MICHELL ENGINEERING	£POA
AUDIO TECHNICA HEADPHONES	£POA	MOTH GROUP	£POA
AUDIO TECHNICA CARTRIDGES	£POA	NAD RECEIVERS & AMPS	£POA
BENZ MICRO	£POA	NAD TUNERS	£POA
BEYER DT431	£POA	NAD CD PLAYERS	£POA
BEYER HEADPHONES	£POA	NAD TURNTABLE	£POA
CLEAR AUDIO	£POA	OPERA SPEAKERS	£POA
CREEK/EPOS	£POA	ORTOFON CARTRIDGES	£POA
DENON AMPLIFIERS	£POA	PALMER AUDIO	£POA
DENON AV AMPLIFIERS	£POA	PROJECT	£POA
DENON BLU RAY/UD	£POA	PSB SPEAKERS	£POA
DENON CARTRIDGES	£POA	QUAD	£POA
DENON CD PLAYERS	£POA	ROKSAN CARTRIDGES	£POA
DENON HEADPHONES	£POA	ROKSAN TONEARMS	£POA
DENON TUNERS	£POA	SENNHEISER HEADPHONES	£POA
DIGITAL STYLUS GAUGE	£POA	SUMIKO CARTRIDGES	£POA
EAR/YOSHINO	£POA	THORENS	£POA
GOLDRING CARTRIDGES	£POA	TOM EVANS	£POA
GRADO CARTRIDGES	£POA	TRANSFIGURATION	£POA
HARBETH SPEAKERS	£POA	TRICHORD	£POA
ICON AUDIO	£POA	WHEST AUDIO	£POA

I ALSO SUPPLY:
ACCUSTIC ARTS, ACOUSTIC SOLID, ALPHASON AMATEK, APOLL, AUROUSAL, BLACK RHODIUM, C.A.T. CARTRIDGE MAN, CUSTOM DESIGN, DIAPASON, ERGO, GAMUT, GRAHAM SLEE, GRAHAM, HADCOCK, HALCR0, HEED, HI DIAMOND, IXOS, KOETSU, LONDON (DECCA), MILTY, PATHOS ACOUSTICS, PRO-JECT, PURE SOUND, QED, REGA, SME, SONY, SOUNDSTYLE SUGDEN, SUPRA, TIVOLI AUDIO, TRANSPARENT, UNISON RESEARCH, VAN DEN HUL, WIREWORLD, KEMP, ZYX,

PLEASE PHONE TO CONFIRM PRICE & AVAILABILITY PRIOR TO ORDERING. ALL GOODS ARE BRAND NEW & BOXED WITH FULL U.K. GUARANTEES. NO EX. DEM OR EX DISPLAY GOODS. NO GREY IMPORTS. GOODS ARE NOT SUPPLIED ON APPROVAL. SORRY, NO GENERAL CATALOGUES. PLEASE PHONE OR WRITE FOR SPECIFIC REVIEWS, BROCHURES OR PRICES. SUPPLIER OF HIFI PRODUCTS & ACCESSORIES SINCE 1986 MAIL ORDER ONLY FROM: IAN HARRISON, 7 MILL HILL, REPTON, DERBY, DE65 6GQ.
TEL: 01283 702875. 9am - 9pm INCLUDING SUNDAYS.

Force facts

Here's our simple, quick guide to setting cartridge tracking force. Tony Bolton rounds up modern gauges to help you.

Over the years there have been many gadgets for reading the tracking force being applied to a record by the stylus. The majority have been mechanical devices whose quality and calibration have varied from acceptably accurate to virtually useless. Some, such as Garrard's SPG 2 and SPG 3 gauges, are well made and accurate, but date from the days when 8 - 10g was an acceptable tracking force and are too crude in their operation to be of any practical use nowadays, except when adjusting vintage equipment.

Nowadays, with digital technology being fairly cheaply and easily available, the mechanical balances have all but disappeared off the market, apart from the evergreen Shure SFG-2, and the freebies given away with some cartridges. The latter will provide a 'ballpark' setting for the tracking force, and make a reasonable starting point for tuning in the stylus force by ear. However, given that most modern cartridges are sensitive enough that an alteration of 0.1g can make a noticeable difference to the sound coming from your record player, a gauge that reads to at least that level of accuracy is desirable.

Some arms come with calibrated tracking force weights, or adjustment is via a calibrated dial operating a spring mechanism. Most of these seem to be reasonably accurate, but some arms, such as my Hadcock 242 Cryo, have no markings whatsoever, so some sort of accurate scale is a must when setting up a cartridge.

Of the older equipment, mostly available through eBay, few are practical in the 21st Century due to the aforementioned calibration problems, and also, their construction tends to be from ferrous materials which can work OK with the lower magnetic field surrounding Moving Magnet cartridges but are useless when faced with the more powerful magnets in Moving Coil designs.

So here is a quick roundup of a few of the varied designs currently available.

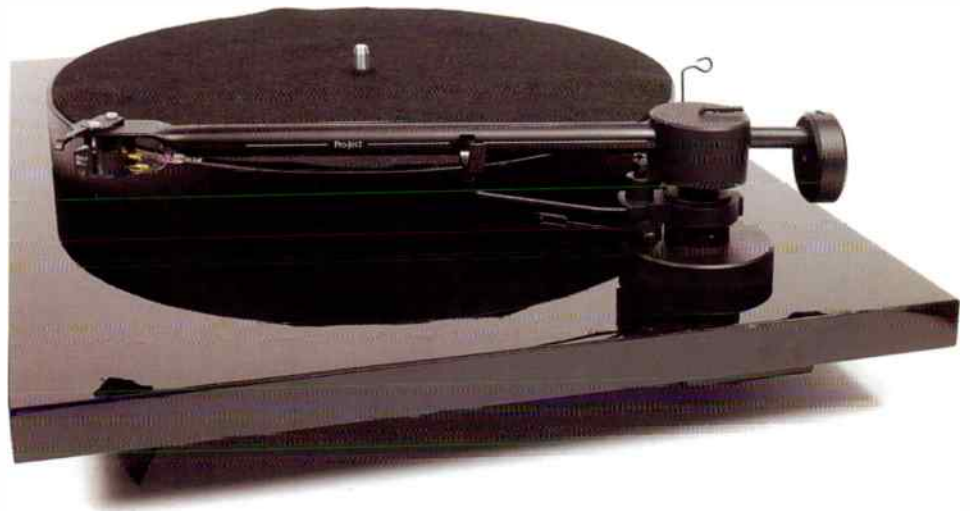

1) First, get the arm balanced. The stylus guard must be taken off, if it is a removable type, and no anti skate force (bias) applied. Then the rear counterweight must be moved to a position where the arm settles to a horizontal position, as shown. Be careful not to bend the stylus – use care!



2) If the counterweight has a rotating scale it must now be set to zero and the counterweight screwed forward to the required tracking force.

If there is a tracking force dial, Rega style, it must be set to zero before the arm is balanced then to the required tracking force after balance.

In our example, using a simple Project arm lacking any form of tracking force mechanism, the counterweight is moved forward by around 1mm at a time, until the tracking force quoted by the cartridge manufacturer is achieved, using a gauge for measurement.

ISOKINETIK



ISOkinetik Audio Enhancement

Take your Rega turntable to a higher level of perfection transform your standard Rega to a deck which will compete with others priced over £2,000.

Rega upgrades as reviewed in **HI-FI WORLD**
 "There is no doubt that each item make a positive contribution to the overall sound produced"

"Best bang for buck? The ISOweight at under £50 is the first thing to have on your shopping list - it's great value and a surprising improvement"
 Neville Roberts HI Fi World Feb 2010

ISOsub Rega sub platter and Ruby bearing Improved kit from £99.99
 ISOdrive Rega, Linn, Systemdek, Thorens PSU £329.99
 ISOtone Cardas Rega arm rewire kit £99.99
 ISOplatter 25mm Rega acrylic platter £119.99
 ISOweight Rega tonearm counterbalance £49.99 available in 106g 130g 144g versions



Dealer and distributor enquiries welcome. For a full range of upgrades and accessories, interconnects or speaker cables please email info@isokinetik.co.uk or call 0208 241 8890 www.isokinetik.co.uk

MIDLAND AUDIO XCHANGE

The Old Chapel t. 01562 731100
 Forge Lane f. 01562 730228
 Belbroughton
 Worcestershire e-mail. sales@midlandaudiox-change.co.uk
 DY9 9TD web . www.midlandaudiox-change.co.uk



Ex-demo and second hand items

	Was	Now
Digital		
Abingdon Music Research AMR77.1 S/H	7800	5295
Classe CDP300 Universal Player S/H	4950	1799
Electrocompaniet PC-1 x-demo	1390	899
Esoteric SA60 S/H	3500	1699
Heed Audio DACtilus DAC BNIB	370	269
Krell 505 Evolution SACD player x-demo	9189	6499
Krell SACD Standard III x-demo	6587	4950
Leema Antilii CD Player S/H	2999	1299
living Control Music Box 3 BNIB	2887	1499
living Control Room Box4 BNIB	1712	999
Rega Planet Black CD S/H	489	275
Sugden CD21 series II CD player S/H	1600	699
Wadia 170i Transport BNIB iPod dock	499	349
Analogue		
Bel canto Phono VB S/H	1299	895
Heed Audio Quasar MM/MC 2 box Phono stage x-demo	740	499
Mark Levinson No320s Phono Module x-demo	995	499
Preamplifiers		
Audoicci AP01 preamplifier S/H	2100	899
Bel canto Pre3 S/H	1899	795
DPA CA1 preamplifier BNIB	2650	1699
Krell KAV250p preamplifier S/H	2398	799
Spectral DMC 15SS x-demo full warranty	6850	3799
Amplifiers		
Audio Technica AT-MA50 Mixing Amplifier S/H	399	149
Bel Canto EV04 MKII amplifier S/H	3895	1499
Conrad Johnson MV60SE Valve S/H	2990	1499
DPA MA1 class A monos BNIB	4400	2999
DPA Power Plus BNIB	950	649
Electrocompaniet AW250R S/H	4999	1799
Electrocompaniet PI-1 x-demo	1425	999
Krell Evolution 302 black x-demo	12900	8999
Melody SP3 MKII valve S/H	1200	499
Loudspeakers		
Cura CA21 Cherry S/H	N/A	350
Konus Essence Bosnian Pine S/H	3500	1750
Magneplanar MG1.5 Black S/H	2500	£499
Martin Logan Fresco Centre x-demo	750	299
Martin Logan Summit X Cherry x-demo	12998	9799
PenAudio Charm Sub modules x-demo	2175	999
Sonus Faber Cremona Elipsa Maple x-demo	12980	7999
Sonus Faber Guaneri Momento Graphite x-demo	9098	7499
Cables and Accessories		
Apollo 80cm single column Stands S/H	149	99
CD 4 pillar 60cm stands HEAVY! S/H	279	149
Electrocompaniet ECS1 M6 feet x4 BNIB	189	49
Jadis KT90 Valves x4 BNIB	600	300
JPS Ultra Dual bi wire 2x8 Spades to banana S/H	549	279
MIT Terminator II Biwire 2x10ft S/H	599	249
Partington Dreadnought 60cm stands S/H	199	139
Spectral MI-330 UL2 1m BNIB	800	399
Spectral MI-330 UL2 1.5m BNIB	850	425
Spectral MI-330 UL2 10ft BNIB	965	479
Spectral MI-330 UL2 15ft BNIB	1125	579
Spectral MH-750 25ft speaker cables x-demo	2000	995
Stereovox 2x2.5m HDXV speaker cable S/H	350	169
Symposium Super Plus Platform 11x13 S/H	600	199
Tara labs 1.5m RSC Prime RCA-RCA S/H	350	175
Tara labs 1.0m RSC Prime RCA-RCA S/H	250	125
Transparent Music Link ultra balanced MM 1.5m	2270	995
Transparent Music Wave Plus 2x 10ft Spade	824	399
Transparent Music Link Super 2m RCA-RCA x-demo	795	379
Tuners & Tape decks, power supplies		
Magnum Dynalab FTR remote/Preset Tuner for Etude S/H	395	179
Naim Audio NAT03 FM Tuner S/H	N/A	299
Rotel RT850L AM/FM Tuner with Presets S/H	N/A	39

Midland Audio X-change are looking for All high end audio separates best prices paid for good examples.

FIDELITY AUDIO
 CLASS LEADING PRODUCTS
 "SMOOTH, BALANCED AND UNEXAGGERATED"

HI-FI WORLD WHAT HI-FI? SOUND AND VISION HI-FI WORLD

01302 563124
 sales@fidelityaudio.co.uk
 www.fidelityaudio.co.uk

Fidelity Audio . 33 Arksey Lane . Bentley
 Doncaster . South Yorkshire . DN5 0RX

3) With tracking force set, the cartridge must be adjusted in the head shell to minimise tracking error, using a gauge like that sitting on the turntable in our photograph. Tracking force will then need to be checked and possibly corrected, as a large cartridge movement fore or aft in the head shell will change tracking force. Once all this has been completed, bias can be set – and that's it.



The Cartridgeman Digital Stylus Force Gauge

£250.00

www.thecartridgeman.com

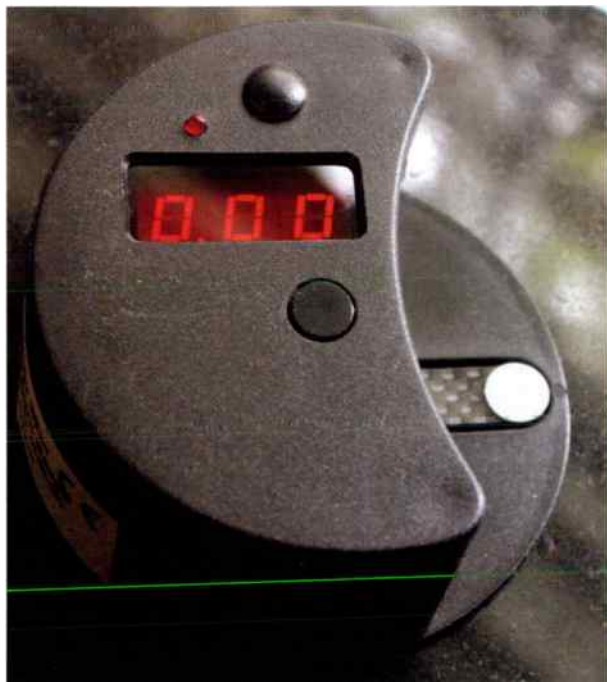

This circular unit has been in production for 15 years and uses built-in rechargeable batteries, fed from the 9V DC, 100mA charger provided. A full charge takes 30 minutes.

It weighs from 0.2 to 4.0g with an accuracy of 0.05g, the results of which are displayed in a three digit LED readout. The unit recalibrates itself every time it is switched on.

The weighing area is a tongue with a dimple in it enabling the stylus to rest in the same place every time it is used. This is surrounded by the casing, so making it very difficult to damage the platform through mishandling.

Enjoy the Music.com
Audiophile Equipment & Music Reviews
Your Resources For High-End Audio News & Information

Search

Audiophile Review Magazine
High-End Equipment
Audiophile Reviews!
Plus DVD Audio!

High-End Show Reports
RMAF 2011 Show
TAVES 2011
CA Audio Show
THE Show Newport
High-End Munich
APOXNA Atlanta
Sason Son & Image
CES Consumer
Electronics Show 2011
THE Show Audiophile Event
Show Reports Before 2011

Partners & Magazines
Hi-Fi Magazine
The Absolute Sound
Hi-Fi Critic
Hi-Fi World
Sound Practices
VALVE Magazine

Audio Industry News
Linn's Digital Music Collections
HiFiMAN HM-101 & HE-300
Righteous Brothers & Andrea Bocelli
1/2 Off Energy & Klipsch Heresy III
HiFi+ December Edition Now Online
Crystal Cable's Arabesque Mini
Benchmark Media Systems Trade-Up
Comtek Dinosaur DNS-0610 Stand
ASL AQ1001 MK II & AQ1003 MK II
Audioregine ASV Powered Monitor
Chane Brown Christmas @ 24/192
Rem Audio K2DAC 24-bit/192kHz
Bryton SP-3 Preamp/Processor
Save 50% Off Energy & Mirage
Lindemann USB-DAC 24/192
Firewood Mac & U2 in High Rez
XTZ MH800 DSP Speaker System
Spectral Audio SDR-4000SL CD/Pre-
Nov High-End Audio Reviews
Aurander \$10 By Videolab Server

Recent Audiophile Information
Music Definitions
Hi-Fi Definitions
High-End Audio Manufacturer Links

For The Front End
About Us
Press Releases
Official Site Graphics

Internet Browser
Audiophile Browser v11

Monthly Show Alerts
Android Audiophile App
Windows Phone 7 App

Share This

Add Us To Your Favorites
Make Us Your Homepage
Link Your Website To Us
Add Us To my MSN.com

Android

www.EnjoyTheMusic.com

10:08

Billy Vee

SOUND SYSTEMS

248 Lee High Rd, London SE13 5PL (Mon - Sat 10am to 6.30pm Closed Thurs & Sun)

The London naim Specialists

Call (020) 8318 5755 or 8852 1321. Now!

Web: - www.billyvee.co.uk email: sales@billyvee.co.uk. Full delivery and installation services.



Hello there. Fancy upgrading your Naim? With the fabulous new **SuperUniti** one box solution, the new **ND5 XS** Network player and **UnitiServe** Hard disk players there has never been a better time. A Supernait or SuperUniti can offer astonishing results when used with a Uniti Serve front end playing uncompressed music. Come and hear for yourself and audition your choices in a friendly relaxed environment, call and speak to one of our experienced sales advisors today. We also offer part exchange and a range of 0% A.P.R. flexible finance options to help spread the cost.

naim sales & service

- visit billyvee.co.uk for naim news
- Experienced Naim sales advisors
- Full setup and installation service
- Full warranty & technical support
- Flexible 0% A.P.R. finance options
- Range of Ex-Dem and pre-owned

FIDELIO SOUND

VIVID AUDIO LOUDSPEAKERS.

WE HAVE THE ONLY COMPLETE RANGE OF VIVID LOUDSPEAKERS ON DEMO IN BRITAIN, WITH THE NEW GIYA G3 ARRIVING SOON. BESPOKE HI-FI & 5.1 SURROUND SOUND. SIM2 1080P PROJECTORS.

"The G1's incredible resolution of low-level detail means that harmonics, reverb, imaging and fine details are brought to the fore."

Jason Komeedy, Hi Fi Choice

"Breathtaking transparency, superlative coherence, dizzying speed and an unyielding musicality."

David Price, Hi Fi WORLD

FACEBOOK: FIDELIO SOUND WEBSITE: WWW.FIDELIOSOUND.COM
EMAIL: INFO@FIDELIOSOUND.COM CALL FOR AN AUDITION ON:
01403 782221 CELL 07980 665356.
THE OLD BARN
ROSER BUSINESS PARK CONEYHURST RD BILLINGSHURST WEST SUSSEX
RH14 9DE

(VISIT BY APPOINTMENT ONLY)



vivid audio

Ortofon D S-1

£110.00

www.henleydesigns.co.uk

This digital scale measures in increments of 0.1g between 0.1 to 200g and, like the Pro-Ject device, can be set to operate in the four modes mentioned above as well as in grains (gn) and troy ounces (ozt).

The needle is placed on a weighing platform that sticks out like a tongue from the back of the scale. No calibration weight is provided since this is done at the factory. Power comes from two CR2032 lithium batteries which are user replaceable, and the unit switches off after 60 seconds if not used.



Clearaudio Weight Watcher

£172.00

www.audioreference.co.uk

This digital scale has an accuracy of 0.05g. Calibration is automatic every time the unit is switched on although a calibration weight is also provided and it is recommended that this is used every three months.

The measuring surface is a wide tongue of alloy that sticks out at the back of the unit and the scale works wherever the needle is placed on it.

Batteries are two AAA size so can easily be replaced from other household items such as remote control units, should they run out of power during use - as always seems to happen to me!



HEATHCOTE AUDIO

WE URGENTLY REQUIRE YOUR HI FI NOW!!

TEL: 07860 511111 WEB SITE www.heathcoteaudio.co.uk

VINYL

MICHELL FULL GYRODEC & OC GYRO PSU (RECENTLY SERVICED)
 MICHELL GYRO 6 & RB-300 ARM WITH CARTRIDGE
 VPI JMW MEMORIAL TONEARM
 SME V TONE ARM (YES ANOTHER ONE BE QUICK!)
 ORACLE DELPHI MK III 1 OWNER
 ORACLE DELPHI MK IV
 MICHELL ISO PHONO STAGE & HERA HUGE POWER SUPPLY
 ORIGIN LIVE ARM WITH INTERNAL/EXTERNAL/STRUCTURAL MODS
 AUDIO NEEMES PHONO STAGE (E1000 +)
 VOYD VALDI 2 MOTOR AND SPLIT PHASE PSU
 HEED QUASAR MM/MC 2 BOX PSU
 TOM EVANS MICRO GROOVE
 FIDELITY RESEARCH FR-1 MK3 CARTRIDGE LIGHT USE
 AUDIO INNOVATIONS 1000 STEP UP ONE OWNER FROM NEW
 DENON DP-1200 LTD./SHURE CARTRIDGE DIRECT DRIVE CLASSIC
 MISSION 774 TONE ARM UPGRADED LEAD
 EMINENT TECH MODEL 2 AIR BEARING LINEAR TONEARM
 LINN LP-12 CIRCUIT/TRAMPOLIN/VALHALLA (JUST SERVICED)
 NOTTS ANALOGUE MENTOR
 ANTIQUE SOUNDLABS MINI PHONO (2 BOX WITH NOS MULLARD VALVES)
 RUSS ANDREWS TORILYTE TURNTABLE SUPPORT

VALVE - AMPS

ANTIQUE SOUNDLABS AQ-1009 845 MONOBLOCKS (REVALUED SERVICED)
 LEAK STEREO 20 & VARISLOPE PRE ORIGINAL AND BOXED (RARE)
 ROGUE AUDIO 99 MAGNUM 2 BOX REMOTE PRE AMP (ONE OWNER)
 AUDION GOLDEN NIGHTS 3008 MONOBLOCKS (CURRENT SPEC)
 ONE OWNER VERY LIGHT USE
 AUDIBLE ELLISON MODULUS 3a 2 BOX PRE LITTLE USE 240v
 PAPWORTH M-100 MONOBLOCKS ONE OWNER FEW MONTHS USE
 AUDIO RESEARCH VS-110 POWER AMP 1 OWNER
 PAPWORTH AUDIO TVA-10 50 WATT REMOTE INTEGRATED (2K7)
 BALANCED AUDIO TECH. BAT VK-60 POWER AMP (68K7 ONE OWNER FROM NEW)
 PATHOS INPOWER CLASS A HYBRID MONOBLOCKS (SUPERB 68K7)
 ART AUDIO JOTA VOL POT. SINGLE ENDED 32B FABULOUS 1 OWNER
 MATSISE REFERENCE 2 BOX PRE-AMP 64 STEP ATT./MM/MC PHONO 1 OWNER
 CROFT MEGA MICRO 2 BOX PRE-AMP 1 OWNER
 CROFT OTL-3 POWER AMP 1 OWNER
 ART AUDIO INTEGRA 30W INTEGRATED (ONE OWNER FROM NEW)
 RTL PRE AMP (DAVID MANLEY DESIGN 1 OWNER)
 ROGUE AUDIO 66 MAGNUM REMOTE PREAMP (ONE OWNER FROM NEW)
 ANTIQUE SOUND LABS LXJ1 PRE AMP/HEADPHONE AMP
 ANTIQUE SOUNDLABS MINI PHONO (2 BOX WITH NOS MULLARD VALVES)

SOLID STATE

BELCANTO PRE-1 & 200.2 POWER AMPS
 LYNGDORF SDAI 2175 INTEGRATED AMPLIFIER
 DENSERI 6200 PRE AMP & B350 MONOBLOCKS
 ROTEL RSP-1098 FABULOUS PRE-AMP/PROCESSOR 1 OWNER
 OCM SOLID-200 POWER AMP 1 OWNER
 KRELL KAV 300R RARE TUNER AMP (E3950 ONE OWNER FROM NEW)
 MERIDIAN 501 PRE AMP
 JOHN SHEARNE PHASE 2 INTEGRATED & PHASE 2 POWER AMPS
 ONE OWNER FROM NEW
 JOHN SHEARNE 2.5 INTEGRATED AMP
 JOHN SHEARNE 3.5 POWER AMP
 COP-2 CD PLAYER/PRE AMP ALSO AVAILABLE
 KRELL EVOLUTION 402 STEREO POWER AMP ONE OWNER BOXED
 DENON PMA-QS101 30 KILD INTEGRATED & MATCHING TU-QS10 TUNER
 VERY RARE CHAMPAYNE GOLD FINISH CAN SPLIT
 JEFF ROWLAND MODELS MONOBLOCKS
 JEFF ROWLAND COHERENCE-1 2 BOX PRE C/W PHONO STAGE
 MCCORMACK DNA-125 POWER AMP (1 OWNER FEW MONTHS USE (E22007)
 PATHOS INPOWER CLASS A HYBRID MONOBLOCKS (SUPERB 68K7)
 H-CAT 12-B AMERICAN PRE AMP WITH WTC CONTROL (E2800)
 H-CAT F-12A AMERICAN PRE AMP (E25007)
 ROKSAN S1.5 POWER AMPS 2 OFF EXCLT CONDITION RARE
 ADVANTAGE 200 INTEGRATED AMP (2K7)
 DENON AVC-A11 SR AV AMP GOLD (E2K ONE OWNER)
 DPA ENLIGHTENMENT PRE AMP
 DPA THREE BOX PRE AMP EXCLT
 DPA 50S PRE AMP C/W PHONO STAGE
 DPA 50S POWER AMP & CABLES (ONE OWNER LITTLE USE)
 DPA 50S POWER AMP & CABLES
 ALDHEMIST FORSETTI 2 BOX PRE RCA/XLR (ONE OWNER)
 MUSICAL FIDELITY MA-50 MONOBLOCKS
 CLASSE SD-L TWO BOX PRE AMP ONE OWNER
 ROTEL RSP9018 PROCESSOR ONE OWNER (E15007)
 NAKAMICHI 620 WEDGE POWER AMP MINT/BOXED
 CAMBRIDGE AUDIO AZUR 740A INTEGRATED
 QUAD 44 PRE AMP
 CYRUS INTEGRATED AMPLIFIER

DIGITAL

LYNGDORF CD-1 CD PLAYER
 LYNGDORF CD-1 CD PLAYER
 THETA CARMEN CD/DVD TRANSPORT
 THETA DSP PROP GEN II RCA/AES/8 GLASS IN RCA/BALANCED OUT
 MERIDIAN 500 TRANSPORT
 MERIDIAN 563 DAC
 SONY XA-1200ES MULTI CHANNEL SACD PLAYER
 CHORD 1500E 192KHZ/DIGITAL PRE AMP 3 SEPARATE DACS AD/AKM/PULSE
 REMOTE VOLUME SUPERBLY FLEXIBLE (E6800 NEW ONE OWNER)
 STELLO CDA-320 24 BIT/44/96/192 CD PLAYER WITH DIGITAL INPUTS
 THETA DATA UNIVERSAL GOLD PLAYER (ONE OWNER) RARE
 VACCUUM STATE JLT SACD/CD PLAYER (LAST 1 E1300)
 VACCUUM STATE LOGIC JLT SACD/CD PLAYER
 DENON 3810 UNIVERSAL PLAYER (ONE OWNER)
 DENON 2910 UNIVERSAL PLAYER
 INERGE S-2000 180 GB MUSIC SERVER (2K PLUS?)
 MICROMEGA STAGE 2

MINT/BOXED E995
 MINT/BOXED E995
 BRAND NEW E995
 MINT/BOXED E1195
 MINT/BOXED DUE
 DUE DUE
 EXCLT/BOXED E305
 DEM/BOXED E575
 BOXED E995
 MINT/BOXED E375
 EXCLT E375
 BOXED E249
 EXCLT/BOXED E485
 VGC E595
 VGC E395
 VGC/BOXED E995
 BOXED E795
 VGC E995
 EX.DEM E349
 BOXED E75

EXCLT/BOXED E2795
 TIMEWARP! DUE
 MINT E1295

MINT/BOXED E2495
 MINT/BOXED E2385
 MINT/BOXED E2385
 MINT/BOXED E2750
 BRAND NEW E1395
 EXCLT/BOXED E2750
 EXCLT E4250
 EXCLT E3750
 EXCLT E3750
 EXCLT E795
 EXCLT E850
 SALE! E1295
 EXCLT/BOXED E395
 MINT/BOXED E995
 DEM/BOXED E375
 EX.DEM E350

EXCLT/BOXED E1895
 EX.DEM/BOXED E1295
 EXCLT/BOXED E3850
 EXCLT/BOXED E595
 DUE DUE
 EXCLT/BOXED E1495
 MINT/BOXED E450

EXCLT E875
 EXCLT E450
 EXCLT E450
 AS NEW/BOXED E850
 SALE! E7995

MINT E1395
 SALE! E1585
 SALE! E895
 SALE! E1195
 SALE! E3995
 SALE! E1495
 SALE! E995
 EACH E595
 SALE! E795
 SALE E995
 EXCLT/BOXED E495
 VGC E795
 VGC E485
 EXCLT/BOXED E995
 VGC/BOXED E595
 MINT/BOXED E995
 EXCLT/BOXED E495
 SALE! E485
 SALE! E449
 EXCLT/BOXED E295
 GC E249
 GWO E89

MERIDIAN 203 DAC
 CD 925 LASER DISC PLAYER (ONE OWNER FROM NEW)
 ONKYO NOS-1 MEDIA TRANSPORT
 CAMBRIDGE AUDIO 740C CD PLAYER

TUNERS/TAPE/DAT/MINIDISC/MISC.

BLACK RHODIUM SUPERMAINS 25 BRAIDED POWER CORD
 BLACK RHODIUM SUPERMAINS 25 BRAIDED POWER CORD/RHODIUM EASY PLUG
 BLACK RHODIUM 8 WAY MAINS BLOCK
 MICROMEGA MINIMUM TUNER
 GRAHAM SLEE SOLD MIC HEAD AMP & PSU-1 (E500)
 COMPLETE NAKAMICHI SYSTEM ONE
 SONY PROFESSIONAL WALKMAN & CASE
 KRELL KAV 300R RARE TUNER AMP (E3950 ONE OWNER FROM NEW)
 MERIDIAN 504 TUNER
 REVOK A77 MKIV PROFESSIONAL 2 TRACK 3.5/7.5 PERSPEX COVER/HANDBOOKS
 ONE OWNER FROM NEW LITTLE USED POSSIBLY BEST AVAILABLE
 DENON TU-QS10 REMOTE HEAVYWEIGHT GOLD TUNER VERY RARE
 DENON TU-1880 REMOTE DAB RADIO (SILVER)
 STAX PROFESSIONAL HEADPHONE AMP AND HEADPHONES
 TECHNICS GT-550 RDS TUNER (ONE OWNER)
 AVI REF.7 BAND TUNER (ONE OWNER)
 PIDNEER ELITE SERIES MINIDISC RECORDER (URUSHI CHEEKS 110V)
 THE ESSENCE REF-Power CORD (E1000?)
 AUDIOPIA KAV 300R RARE TUNER AMP (E3950 ONE OWNER)
 LAT POWER CORD (BLUE ONE)

LOUDSPEAKERS

B&W 802 MATRIX MONITORS IN WALNUT FABULOUS!
 B&W 801 MATRIX SERIES-2 MONITORS IN WALNUT FABULOUS!
 2 WAY PRECISION MONITORS PIANO BLACK (68K+)
 SPENDOR L358A MATCHED PAIR IN SUPERB CONDITION
 PROAC STUDIO 50 FLOORSTANDERS IN PREMIUM YEW FINISH
 THEIL CS 1.5 SUPERB COMPACT FLOORSTANDERS (ONE OWNER)
 INNERSOUND ISIS ELECTROSTATICS
 MARTIN LOGAN CLARITY'S EXCELLENT HYBRID ELECTROSTATICS
 REFERENCE 3a VEENA FLOORSTANDERS
 ONE OWNER FROM NEW LITTLE USED POSSIBLY BEST AVAILABLE
 KLIPSCH CORNER HORNS RARE/WALNUT/FANTASTIC/BARGAIN
 FAB AUDIO FAB 1 DEM/REVIEW USE ONLY 9608 ULTRA FAST!(FERRARI RED)
 MARTEN MILES CHERRY (8K+ NEW ONE OWNER FROM NEW)
 ENSEMBLE FIGURA (SOLID ALUMINIUM E5800?) ONE OWNER
 HARPER QUARTETO FABULOUS FLOORSTANDERS (E4000)
 AJURIM CANTUS MUSIC GODDESS (E2500) BRAND NEW BOXED
 AJURIM CANTUS LESURE 3 SE BRAND NEW BOXED (LAST PAIR E1350)
 AJURIM CANTUS BLACK ORCHID BRAND NEW BOXED (LAST PAIR E1300)
 BOLZANO VILLETTRI BV3003 & BV SUBWOOFER FANTASTIC!
 HALES TRANSCENDENCE 5 HUGE FLOORSTANDERS 2 OWNERS
 AJURIM CANTUS VOLLA (LAST PAIR)
 PODIUM 1a FEW WEEKS USE ONLY (E6000?) NEW!
 MIRAGE M181 BIPOLAR GIANTS (E6500) (ONE OWNER FROM NEW)
 AJURIM CANTUS V3M GLOSS BLACK (E1700)
 SNEEL TYPE-C MKIV AMERICAN WALNUT
 AJURIM CANTUS LESURE 3SE
 T&A TMR-100 SIZEABLE TRANSMISSION LINES
 TLC CLASSIC ONES LARGE FLOORSTANDERS
 ACOUSTIC ENERGY AEGIS EVO ONE (LIGHT MAPLE)
 ROGERS LSa2A LOUDSPEAKERS
 CASTLE HARLEIGH NICE FLOORSTANDERS IN BLACK ASH
 RUARK TALKISMAN II WITH EXTERNAL X-OVERS

INTERCONNECT CABLE

AUDIENCE Au24 REFERENCE INTERCONNECTS
 BLACK RHODIUM ORATORIO 1.5 RCA METRE PAIR
 XLO REFERENCE 1 METRE BALANCED PAIR
 ACOUSTIC ZEN MATRIX REFERENCE II 1 METRE RCA
 ACOUSTIC ZEN MATRIX REFERENCE II 1 METRE RCA
 DPA BLACK SLINK 2.3 METRE PAIR RCA
 DPA BLACK SLINK 0.8 METRE PAIR RCA
 HARMONIX HARMONIC-STRINGS HS-101 1METRE RCA
 HARMONIX HARMONIC-STRINGS HS-101 1METRE XLR
 CHORD CO.SIGNATURE 1 METRE BNC
 PURIST AUDIO DESIGN MUSAES 4FT PAIR
 PURIST AUDIO DESIGN 0.5 METRE DIGITAL COAX
 VAN DEN HUL MCD102 HYBRID 1 METRE XLR
 VAN DEN HUL MCD102 HYBRID 1 METRE XLR TO RCA
 DPA SLINK 1 METRE XLR
 AUDIOQUEST/AUDIOTRUTH EMERALD 1 METRE PAIR
 AUDIOQUEST RUBY 0.8 METRE PAIR
 AUDIOQUEST AES/EBU PRO DIGITAL CABLE 1 FT
 TRANSPARENT LINK-100 COAX DIGITAL CABLE
 CHORD CO.PRODAC DIGITAL CABLE RCA TO BNC

LOUDSPEAKER CABLE

TARA LABS RSC 5 METRE SHOTGUNNED BI-WIRE PAIR
 PS AUDIO X-STREAM 3 METRE PAIR SHOTGUNNED (VERY HEAVY)
 BLACK RHODIUM POLAR NINJA OCT 2.9 METRE PAIR
 XLO 5.2 SIGNATURE-1 4FT PAIR
 SONORAM PLATEAU 4 METRE VERY HEAVY HI END PAIR
 COGAN HALL INTERMEZZO 5FT PAIR
 KIMBER APR 2.5 METRE TERMINATED PAIR
 NIRVANA SL-3 2.3 METRE PAIR
 RAPPORT (USHER) 5 METRE PAIR FACTORY TERMINATED
 DPA 5 METRE PAIR TERMINATED FOR 50S AMP
 QED GENESIS SILVER SPIRAL 3 METRE PAIR
 XLO REF.2.5 METRE PAIR
 BLACK RHODIUM S-300 BI WIRE 7 METRE BI WIRE PAIR (E560)
 BLACK RHODIUM S-300 BI WIRE 5 METRE BI WIRE PAIR (E400)
 BLACK RHODIUM S-300 BI WIRE 4 METRE PAIR (E240)

MAJOR DEBIT/CREDIT CARDS ACCEPTED

The Electric Multiroom
 Design & Installation Specialist in Balanced Electrical Circuits

The Electric Multiroom are providers of bespoke electrical infrastructure, for home cinema, multiroom audio, multiroom video, lighting systems, integrated security, practice, rehearsal rooms, home automation and balanced electrical circuits.

Operating throughout the West Midlands and UK.

Contact us:
 Phone: 02476457081
 Mobile: 07989200961
 Email: Support@theelectricmultiroom.com

Pro-Ject Measure IT

£80.00

www.henleydesigns.co.uk

This is a digital balance with a read-out that goes to 3 decimal places and has various modes for weighing in grams, ounces, pennyweights (dwt) and carats (ct), selected by one of the four buttons on the touch-screen display. It is recommended that 30 seconds is allowed after switching on to enable the electronics to warm up.

A 5g calibration weight is provided and should be used to set the machine up before it is used for the first time. Care needs to be taken to ensure that the stylus rests on the black dot in the centre of the weighing platform.

Power is provided by two AAA 1.5V cells which are accessed through a cover on the underside. The unit automatically switches off after 60 seconds of inactivity.



Shure SFG-2

Suggested retail price £38.52 + VAT

www.shure.co.uk

This balance seems to have been around as long as anyone can remember and still works effectively with MM cartridges. However it is made of a ferrous material so cannot be used with MCs.

The scale is graduated in 0.05g intervals from 0.5 to 1.5g, and a piece of metal is slid along the scale until the slot in one side is centred on the desired reading. There are two lines where the stylus can be placed, one giving a $\times 1$ reading from the scale, the other providing a $\times 2$ reading (so for example a 2g tracking force is read by moving the pointer to the 1.00 spot and placing the stylus on the $\times 2$ line).

A mirror is fitted at the end of the arm so that you can see when the end of the beam is perfectly aligned with the fixed marker.



Jo Sound

Jo 45/1

*"their spirit makes
music joyful
rather than merely
pleasant – in
this respect they're
sublime..."*



David Price
September 2011

Nature's Beauty in Sight & Sound

Web: www.josound.net

E-Mail: info@josound.net



Naim arrives at Sevenoaks



Naim's Uniti range and Ovator S-400 loudspeakers are now available in selected Sevenoaks stores nationwide.

Consisting of the UnitiQute, NaimUniti 2 and SuperUniti all-in-one players, and the UnitiServe hard disk player/server, Naim's Uniti range represents a new way to enjoy your music. Controlled via the n-Stream or n-Serve app for iPad, iPhone or iPod Touch, these innovative all-in-one solutions liberate your listening experience and put a world of music at your fingertips.

The Ovator S-400 loudspeaker is the perfect partner for the SuperUniti or NaimUniti 2. Its precision engineered design and innovative use of BMR technology create an immersive, room-filling sound.

Visit your local Sevenoaks Naim dealer today for a demonstration.

STORES NATIONWIDE

- Aberdeen* 01224 252797
- Brighton (Hove)* 01273 733338
- Bristol* 0117 974 3727
- Bromley 020 8290 1988 ●
- Cambridge* 01223 304770
- Chelsea* 020 7352 9466
- Cheltenham* 01242 241171

- Chorleywood (Watford)* 0845 5046364
- Epsom* 01372 720720
- Exeter* 01392 218895
- Glasgow* 0141 332 9655
- Guildford 01483 536666
- Holborn* 020 7837 7540
- Kingston* 020 8547 0717
- Leeds (Wetherby) 01937 586886 ●
- Loughton* 020 8532 0770
- Maidstone* 01622 686366

- Norwich* 01603 767605
- Poole* 01202 671677
- Reading* 0118 959 7768
- Sevenoaks 01732 459555 ●
- Sheffield* 0114 255 5861
- Southampton* 023 8033 7770
- Tunbridge Wells 01892 531543 ●
- Weybridge 01932 840859 ●
- Witham (Essex) 01376 501733
- Yeovil* 01935 700078

VISIT OUR WEBSITE



For more information on the Naim Uniti range and the Ovator S-400 loudspeakers along with the latest news, offers and a convenient option to order many products on-line or reserve before you travel go to www.ssav.com

● NAIM PRODUCTS ARE CURRENTLY ONLY AVAILABLE AT THESE STORES - WITH MORE STORES BEING ADDED SOON!

PLEASE NOTE: SOME BRANDS/PRODUCTS ARE NOT AVAILABLE AT ALL STORES. SPECIAL/ADDED VALUE OFFERS ARE NOT IN CONJUNCTION WITH ANY OTHER OFFER (NICWAO). ADVERT VALID UNTIL 29/06/2012. E&OE *THESE STORES ARE EITHER LICENSED OR FRANCHISED AND OPERATE UNDER A LICENCE AGREEMENT TO SEVENOAKS SOUND & VISION.

www.SSAV.com

SEVENOAKS
SOUND & VISION

World Radio History

REAL STORES

Sevenoaks Sound & Vision have stores nationwide - each carries the very best in home cinema and hi-fi equipment on display, ready for you to watch, listen to and compare in our dedicated demonstration rooms.



REAL PEOPLE

Our staff are friendly, knowledgeable and passionate about music and film and the equipment needed to get the most out of your collection. They will be delighted to assist you in making the right selection to ensure you enjoy your system for years to come.



REAL PRODUCTS

A wide selection of products from the world's leading manufacturers is in stock and available for you to take home. We also offer a delivery and installation service as well as a convenient on-line click and reserve option for many of our products.



REAL VALUE

Fantastic value for money is our aim. Although we remain independent, you'll be pleasantly surprised just how competitive we can be - with the added benefit of seeing, hearing and touching the product before you buy, and someone to help if things go wrong.

FOR OUR LATEST PRICES AND OFFERS VISIT WWW.SSAV.COM



CYRUS CD6 SE2 • 6A CD PLAYER / AMPLIFIER
With its impressive 40 Watts per channel and six analogue inputs, the 6a amplifier is the perfect partner for the CD6 SE2 CD player.



AUDIOLAB 8200CD OLED • 8200A CD / AMPLIFIER
The award-winning 8200CD features a wealth of digital inputs that will keep it playing all your music regardless of how it may be stored.



LEEMA ELEMENTS CD PLAYER / AMPLIFIER
The Elements Series is the latest in the line of Leema high-performance audio equipment.



MARANTZ CD6004 • PM6004 CD / AMPLIFIER
This award-winning CD player and amplifier is the result of extensive research and development by Marantz's engineering team, under the direction of Brand Ambassador Ken Ishiwata.



ROKSAN CASPIAN M2 CD / AMPLIFIER
The M2 amp boasts 85wpc and five line inputs while the matching CD features a 24-bit DAC plus dedicated power supplies for the outputs.



ARCAM FMJ CD17 • FMJ A18 CD / AMPLIFIER
Arcam's FMJ products combine sleek design, flexible connectivity and sound quality far beyond that of budget separates. Available in a black finish to seamlessly blend with any style of décor.



DENON CEOL RCD-N7 CD NETWORK RECEIVER
This network CD / iPod receiver lets you set your iPod or iPhone in its dedicated dock and enjoy music with high-quality sound or listen to Internet radio.



MARANTZ M-CR603 CD NETWORK RECEIVER
Features CD playback, a DAB/DAB+/FM/AM tuner along with a USB connection and network capability via its ethernet port.



ARCAM SOLO MINI CD RECEIVER
The award-winning Solo Mini provides premium performance in a discrete and stylish unit.



PRO-JECT DEBUT CARBON TURNTABLE
With its Carbon armtube and supplied Ortofon 2m Red cartridge, the Debut Carbon sets new standards in its price range.



REGA RPI TURNTABLE
Excellent build quality, reliability and ease of use combine to make the RPI a product that will offer a lifetime of musical enjoyment.



PRO-JECT XPRESSION III TURNTABLE
Features an improved, carbon-fibre tonearm, superior isolation feet and comes supplied complete with a factory-fitted and aligned 'Ortofon 2M Red' cartridge.

SPENDOR A-LINE
A3 • A5 • A6 • A9

These high performance, floorstanding speakers combine smart styling with natural veneer finishes. Each model benefits from important advances in Spendor's drive unit technology, cabinet design and crossover engineering.



ESSAV.COM



ESSAV.COM

MONITOR AUDIO GOLD GX

Monitor Audio's new Gold GX speakers use technology that has filtered down from their flagship Platinum PL range. The range comprises two standmounts, two floorstanders, two centre speakers, a pair of surround speakers and a single subwoofer.



ESSAV.COM

KEF AUDIO R SERIES

Using trickle-down technology from the company's flagship Blade speakers, the R Series comprises standmount, floorstanding, centre, surround and subwoofer models.

NEW



ESSAV.COM

BOWERS & WILKINS PMI

This luxury, compact loudspeaker is the latest in a long line of Bowers & Wilkins audiophile mini monitors. It offers an extremely high-quality audio performance and features several technological innovations including a new tweeter and groundbreaking cabinet design.



ESSAV.COM

PMC TWENTY RANGE

The twenty series is the next generation of elegant, hand-crafted British loudspeakers that follow in the lineage of worldwide acclaimed PMC designs. The 4 models use PMC's innovative ATL™ technology, providing a supremely rich and detailed performance ideally suited to all styles and sizes of interior.



ESSAV.COM

£229 OR LESS



PIONEER N-50 NETWORK AUDIO PLAYER

Audiophile Network player supporting AirPlay® and DLNA wireless technologies, allowing you to stream music wirelessly from your iTunes libraries or iOS devices.

DENON DNP-720AE NETWORK AUDIO PLAYER

Enjoy a wide variety of internet radio and on-line digital content. The DNP-720AE also supports AirPlay™ so that you can stream music from any compatible device.



£499 OR LESS

ESSAV.COM



MARANTZ NA7004 NETWORK AUDIO PLAYER

This AirPlay® compatible player lets you connect to all your favourite music, whether it's from your PC, external hard disc or as an FM / DAB radio station, broadcast or even, on the other side of the world via Internet Radio.



£999 OR LESS

ARCAM SOLO NEO NETWORK MUSIC SYSTEM

Combines superb music performance, network audio capabilities along with an internal CD player and radio tuner.



£1199 OR LESS

NAIM SUPERUNITI MUSIC STREAMER

Combines all Naim's experience in integrated amplification and audio streaming into a single casing, the SuperUniti is the reference all-in-one player in the Uniti range.

CYRUS STREAMLINE MUSIC STREAMER

This compact all-in-one music system is the perfect choice for any room. Based upon the Stream XP but complete with a high performance stereo power amplifier built-in. Includes the stylish and intuitive n-remote control.



ESSAV.COM



SONOS - THE WIRELESS HI-FI SYSTEM

Play your digital music all over your house without a PC. In every room. The award-winning Sonos lets you play your favourite tunes all over the house and control them from the palm of your hand. You can even play different songs in different rooms.

NEW COMING SOON

KEF LS50 SPEAKERS

Using KEF's latest driver technology along with numerous patent pending technological breakthroughs in cabinet construction, baffle shape and port design, the new KEF LS50 brings studio sound quality into the home.



£800 OR LESS

NEW COMING SOON



Sansui returns to UK with new hi-fi range

The Sansui brand is relaunching in the UK with a wide range hi-fi components. The range includes a CD player; a 40W integrated amplifier with built-in DAC and a network audio player featuring a DAB/DAB+ tuner, internet radio and music streaming options supporting a wide variety of formats including FLAC (up to 24bit/48kHz) and WAV.

SAP201V	AMPLIFIER / DAC	£299
CDD201V	CD PLAYER	£199
WLD+201V	NETWORK PLAYER	£349



£599 OR LESS



AUDIOLAB M-DAC

Award-winning DAC featuring a USB input with asynchronous data processing along with two coaxial and optical digital inputs. High-res 24-bit/192kHz music files can be played via its coaxial input.

Please Note: Some brands/products are not available at all stores. Special/added value offers are not in conjunction with any other offer (NICWAOO).

ADVERT VALID UNTIL 29/06/2012. E&OE.

SEVENoaks
SOUND & VISION

World Radio History

BERKSHIRE**LORICRAFT AUDIO**

Loricraft Audio is now open for visitors but please call to arrange for a visit. You can buy all our products directly from us or through your local dealer. Our internet shop site can take direct orders for our turntables and accessories! Loricraft Audio, The Piggery, Mile End Farm, Wantage Road Lambourn, Berkshire, RG17 8UE Office
Phone/Fax : +44 (0)1488-72267
Email: terry@garrard501.com
website: <http://garrard501.com>

STUDIOAV LTD

44 High Street, Eton, Berkshire SL4 6BL
Tel: 01753 631000
Email: sales@studioav.co.uk
www.studioav.co.uk

We are Berkshire's premier Linn dealer (complete range) and LP12 specialists. Naim, Focal, Totem, The Chord Company, Lyra, Dynavector, Benz Micro, with more to follow.

BRISTOL & BATH**THE RIGHT NOTE**

Tel: 01225 874728
www.rightnote.co.uk

Happy with your system? Wonder why there's so much for sale secondhand? Avoid the frustration and expense of "upgrade-itis", never quite "there". With infinite patience we'll help you plan longer-term. Brands selection: Accoustic Arts, Audio Physic, Aesthetix, Bel Canto, CAT, Clearaudio, dCS, Focal, Gamut, Graham, Halcro, Kawero, Magnum Dynalab, VertexAQ, VTL, Wadia.

V'AUDIO HI FI CONSULTANTS

36 Druid Hill, Stoke Bishop, Bristol. BS9 1EJ.
Tel: 0117 968 6005.
Website: www.v-audio.co.uk
Email: icvhifi@yahoo.co.uk
ATC, AVI, Nola, ALR Jordan, Audio Analogue, Avid, Black Rhodium, Electrocompaniet, Edge amps/cd, Harman Kardon, Infinity, Jamo, Lyra, Origin Live, Opera,

Ortofon, PS Audio, Michelle, REL, SME, Sugden, Townshend. Specialist in Video Projects by SIM2, Infocus, Sanyo, Power Plan. Screens by Stewart, smx and da-lite. Demos by appointment only. Home trial facilities.

CHESHIRE**ACOUSTICA**

17 Hoole Rd, Chester CH2 3NH.
www.acoustica.co.uk
Tel: 01244 344227.
B&W 800 Diamond series dealer
Naim Audio specialist & 500 Series stockist. Other brands carried include Arcam, Audiovector, Audio Analogue, B&W, Classe, Piega, Rega & Spondor. Full demonstration facilities.
Open Tuesday to Saturday 10.00 to 5.30

ACTON GATE AUDIO

www.acton-gate-audio.co.uk
4 Ruabon Road, Wrexham, LL13 7PB,
Tel: (01978) 364500
Arcam, Atlas, Audiolab, Denon, Grado, Michell, Monitor Audio, Dali, Leema, Loewe, Musical Fidelity, Ortofon, Onkyo, Project, Sonos, QED, Quad, Rel, Roksan, van-den-Hul, Wharfedale, Yamaha.
Tuesday - Saturday 9.00 - 17.00
email: info@acton-gate.com

DOUG BRADY HI FI KINGSWAY

Studios, Kingsway North, Warrington, WA1 3NU
Tel: 01925 828009 Fax: 01925 825773.
Visa Mastercard, Specialist High-End Turntable, Loudspeaker, Streaming and Amplifier retailer. Extensive range online to buy and will ship worldwide Luxurious demonstration facilities. Dedicated work shop for service and repairs. Custom cables made Installations and home delivery available. Car park directly outside
Lowest price guaranteed.

CORNWALL**BIGEARS AUDIO**

To find a system that will allow you to hear the music instead of the equipment

phone Bigears Audio, here you will find an interesting array of new and good quality used equipment! my intention is to have satisfied customers whatever their audio preferences. Naim dealer for the South West.

Email: chrisburchley@btinternet.com
Tel: 01736-740421

ESSEX**ROCOCO SYSTEMS & DESIGN**

Essex/London Linn Specialist
Tel: 01371 856 407 – 0207 454 1234
www.rococosystems.com
We have over 30 years in entertainment solutions, We can give you expert advice on your Linn Hi-Fi, Multi-room AV and Home Cinema systems. P/EX, ex-demo and used Linn available, Demos by appointment. Home Demos welcome. Authorised dealers for Arcam, Artcoustic, Chord, Denon, Linn, Lutron, Kaleidescape, Marantz, Opus, Runko, Systemline, Sonos, Sim2. Linn Service & Repairs

RADLETT AUDIO

Saffron Walden, NW Essex
Tel: 01799 599080
E-mail: radlettaudio@hotmail.co.uk
Website: www.radlettaudio.co.uk
Selling sensible Hi-Fi systems since 1973
ATC, Chord Co, Croft, EAR, Harbeth, Icon Audio, Kudos, LFD, London/Decca, Lyra, Michell, Naim, Neat, Nottingham Analogue, Ortofon, Puresound, PMC, Rega, SME, Something Solid, Sugden, Sumiko, Tellurium Q.
Turntable specialist - repair and set up.

LANCASHIRE**HOUSE OF LINN MANCHESTER**

Telephone: 0161 766 4837
Email: Info@houseoflinn.com
www.houseoflinn.com
The Linn specialists. Independently owned by former Linn staff. Straightforward, professional expertise with demonstration, sales, installation and support for the Linn range of components and systems. The listening experience is so good that demonstrations can last for hours. Discover how we make music sound real in your home! Appointments only.

LONDON**THE CARTRIDGE MAN LTD**

88 Southbridge road, Croydon
 CRO 1AF Telephone: 020 8688 6565
 www.thecartridgeman.com
 Email: thecartridgeman@talktalk.net.
 UK Distributor: Hiaudio Distribution
 Makers of the prize-winning range of MusicMaker cartridges and other desirable audio accessories. We also have a cartridge refurbishing service and rebuild classic valve equipment to the highest standards. "It doesn't have to cost an arm and a leg - but there is no such thing a free lunch, either."

MY AUDIO DESIGN

35 Whitehall, London, SW1A 2BX
 Tel: 020 7839 8880 / 07782 137 868
 E-mail: sales@madengland.com
 Website: www.madengland.com
 E-Shop: www.shop.madengland.com
 We offer MAD, Benchmark Media, SONOS, WBT, Trichord Research, ATC, FatmanTube, Project, Lehmann, Ortofon, VandenHul, QED, NAD, Goldring, Grado, Focal, Musical Fidelity, Ex-demo & second hand gears. Custom Installation, Servicing, Custom Design. Appointment Only. Short walk from Embankment, Charing-X & Westminster Tube.

MANCHESTER**AUDIO COUNSEL**

26 High St Cheadle SK8 1AL
 www.audio-counsel.co.uk
 Tel: 0161-491-6090
 Email: dave@audiocounsel.co.uk
 Hi Fi from, B&W Densen, Dynavector Cartridges, Dynavector Amplifiers, Isobluе, Naim, Neat Acoustics, Piega, Quadraspire, Rega, Revolver,, Shahinian, Totem, Well Tempered Turntables, Zu Loudspeakers. Quality Hi Fi is not plug and play. We deliver and install all systems. Tuesday to Saturday 10.00am to 5.30pm Thursday till 8pm

MIDLANDS (WEST)**SOUND CINERGY**

37 high street, Aldridge, WS9 8NL
 Tel: 01922 457926
 www.soundcinergy.co.uk
 clive@soundcinergy.co.uk
 Quality hifi and home cinema from black rhodium, chord co, exposure, focal, linn, marantz, michell, monitor audio, mordaunt short, nad, okki nokki, ortofon, project, rel, roksan, themescene, trichord, vdh. Check our website for ex dem and secondhand bargains. free car parking. tues - sat 10 - 5.30

SOMERSET**ALTERNATIVE AUDIO,**

Taunton, Somerset,
 Tel: 01984 624242
 Email: peter@alternativeaudio.co.uk
 www.alternativeaudio.co.uk
 We specialise in valve amplification and vinyl replay with the accent on high quality musical enjoyment, demonstration by appointment. Ex-Dem and used equipment for sale. Analysis Audio, Benz, Brinkmann, Definitive Technology, EAR /Yoshino, Graham Engineering, Lector, LFD Audio, Lyra, NAT Audio, Nottingham Analogue Studio, Shun Mook, SME, Transfiguration, Vandersteen Audio.

SUSSEX**15 AUDIO**

Churchward Court, 15 Western Road
 Lewes, BN7 1RL
 Tel: 08448 22 11 15
 Email: sales@15audio.co.uk
 www.15audio.co.uk
 Formerly Sounds of Music, new ownership - demonstration facilities in centre of Lewes. Friendly staff. Free parking. Ayon, Bladelius, Boulder, Coda, Hansen, LSA, SoundLab, SME, WBT and more. Quad centre - 'Digital Clinic' - service centre. Home demo's, delivery and installation. Mon - Frid 10:00am - 6:00pm. Sat 10:00 - 2:00pm. Closed Wednesday.

YORKSHIRE**THE AUDIO ROOM**

2 George Street, Hedon, Hull, HU12 8JH
 01482 891375.
 www.theaudiroom.co.uk
 Authorised agents for Audio Research, Bowers & Wilkins inc 800 series, Bryston, Classe, Denon, Dynavector, Koetsu, Krell, Linn inc Klimax Range, Micromega, Naim, Prima Luna, PMC, ProAc, Quad, Rega, Rotel, Sonus Faber, Stax, Wilson Audio and others. Free & easy car parking, 4 demonstration suites, part exchange welcome, quality & friendly staff, mail order available. The North's most complete hifi dealer!

AUDIO REPUBLIC

78 Otley Road, Leeds
 Tel: 0113 2177294
 www.audio-republic.co.uk
 For the best in quality hifi in West Yorkshire, representing Naim Audio, Rega, Sugden, Audio Research, VPI, Krell, Copland, Sonus Faber, Arcam, Nottingham Analogue, Roksan, Hutter, Martin Logan, Proac, PMC, M&K, Finite Elements, SME, Cardas, Kudos Loudspeakers and others. Open Tuesday-Saturday 9.30am to 5.30pm

FANTHORPES HI-FI, TV & CUSTOM INSTALLATION SPECIALISTS

HEPWORTH ARCADE, SILVER STREET,
 HULL, HU1 1JU
 Established over 60 years
 Tel: 01482 223096
 Web: www.fanthorpes.co.uk
 Email: shop@fanthorpes.co.uk
 Part exchange welcome. High-end Second Hand Equipment. Multi-room installations. Demonstration by appointment. Home trials welcome. Interest free credit available. Experienced staff. We stock Arcam, Cyrus, Dali, Denon, Dynaudio, Exposure, Kef, Loewe, Onkyo, Primare, Roksan, Spondor, Sugden and much more.

UK**HIFI BOUGHT AND SOLD WE ARE ACTIVELY LOOKING TO BUY VINTAGE AND MODERN HIFI.**

07896 284 373
 emporiumhifineil@yahoo.co.uk
 Collection arranged
 We buy all good quality equipment, complete systems or single pieces. Established 20+ years, Helpful, knowledgeable staff, dealers for: AMR, Benz, Croft, Funkfirm, Grahamslee, Lector, Luxman, Michell, Musicfirst, Nightingale, Ortofon, Okkinokki, Puresound, SME, Stereoknight.

IRELAND**TONE-PEARLS RECORDS "REVOLUTIONARY OLD"**

Tel: 353-87-942-7618
 Email: info@tonepearls.com
 www.tonepearls.com
 New audiophile LP/vinyl records using the revolutionary new Tone-Pearls and pure analogue techniques. Live recording, unedited, unprocessed, pure analogue recording and cutting, 180g virgin vinyl pressing. New LP released: Piano Music in a Church of West Ireland, Classics of Chopin and Debussy and more...

ARDHOWEN HIFI

10 Menapien Way
 Enniskillen, Fermanagh, BT74 4GS
 Abbingdon Music Research, Acoustic Masterpiece, Airtight, Benz Micro, Croft, Acoustics, Custom Design, Deltec Precision Audio, Firestone Audio, Graham Slee, Hanns Acoustics, Harmonix, Luxman, My Audio Design, Opera Audio/Consonance, Drigin Live, Project, Reference 3A, Reiyomo, Sugden Audio, True Colours Industries, Trafomatic, Usher, Verity Audio, WLM
 www.Ardhowenhifi.com
 07800 575070 Tom

FREE READER CLASSIFIEDS

TERMS AND CONDITIONS: Only one advert per reader. No Trade adverts. This section is strictly for readers selling secondhand hi-fi equipment only. Maximum length per advert is 30 words, Adverts over 30 words will not be accepted. Telephone numbers and E-mail addresses are treated as one word. Model numbers are treated as one word i.e. Quad 303 = two words. Email your advert to; classifieds@hi-fiworld.co.uk or fill in the form on page 129 and post it to Hi-Fi World Free Readers Ads, Suite G4, Argo House, Kilburn Park Road, London NW6 5LF. Sorry, we cannot accept adverts over the telephone. The Publisher reserves the right to judge submissions.

WANTED FOR enthusiast: Quad 2 amps, pre-amps, Tuners and related spares. Any literature & valves would also be appreciated. I am also looking for a single Radford Auditorium speaker. 0117 9467188 slkw@btinternet.com

OPERA SP3 speakers. Excellent condition. superb sound, sold med mahogany, £750 (£1750). Townsend speaker platforms, pair, £95, (£500). Buyer collects. Tel: 01323 767 647 (Eastbourne)

RICHARD ALLEN Pavane loudspeakers. Offers. Mission M53 loudspeakers, beech finish, good condition, £100. Mission M5AS active sub-woofer, beech finish, good condition, £150. Tel: 0151 639 6001

FIDELITY AUDIO HP-100 headphone amp, black finish, silver faceplate. 2012 fully run-in 400 hours, £250. Tel: 07411 388 152

QUAD PRE-AMP late model with dedicated CD input, very good condition, £100. Tel: 01277 219 639 (Essex)

MUSICAL FIDELITY A3.2 CD player in excellent condition with remote, manual, and power lead. £425 ONO. 01903 200705 or email: keithlewis@bulldoghome.com

NAIM CD5XS two months old, immaculate, £1500. Tel: 0794 671 0965 (West Midlands)

ATC SIA2 150 integrated amp, perfect condition, very powerful, fantastic sound. cost £2500 new. £1250, boxed. Tel: Lee 01225 706 783 (Wilts)

SPENDOR PRELUDE quality monitors £230. Wanted: Wand arm for Audio Technica AT1100. Tel Toni 07971 953 628 (West Yorks)

AVI NEUTRON 2.1 system. 4 digital and 1 analogue inputs. 3 100watt amplifiers, preamp, DAC, remote control. 7 months old. Cost £1299. Accept £799. Original boxes. Email: ealesgordon@hotmail.com (Devon)

ARCAM CD36, boxed, immaculate, as new with unused remote. Audition welcome. £550. Collection please. Tel: 01329 668 149 (Hants)

BURMESTER 995-Rondo speakers in semi-gloss black and chrome, excellent condition, fantastic sound from these hi-end german speakers, can email pics on request. No boxes so they will be collection only from Northampton. Tel: 07806455032, £1,250.

NAIM SUPERNAIT, mint, late 2008 model, boxed, £1500. Musical Fidelity V-Dac Mk1, mint, £95. Pioneer TX9100, classic tuner, mint condition, £150. For more details Tel: 07879 712 822 or Email: alan@kim58.fsnet.co.uk (N.Notts)

QUAD QC Twenty Four pre-amp, new condition, offers around £450. Tel: 01530 272 801

EXPOSURE 25RC integrated amplifier, mint condition, boxed, £595. Pair Klipsch Heresy II horn loudspeakers, unused, in sealed boxes. £695. Buyer collects. Tel: 0121 706 0313

NAIM NAC 202 pre amp £870. Naim CDX2 CD player £1730. Naim XPS2 power supply £1530. Naim HiCap power supply £562. Naim NAPSE power supply £147. Naim NAP 250 power amp £1480. Tel: 0151 677 3521 (Wirral)

ROKSAN RADIUS 5 turntable for sale with Origin Live Rega RB600 arm, Goldring GX 1022 cartridge. Clear acrylic version. Superb condition and sound. £675 with arm. £500 without. Tel: 01484 427 426

WANTED: QUAD II 80s power amps. (Oxford area) Tel: 01491 614 325

I.P.L. ACOUSTICS SW5 sub-woofer. Ash veneer finish, as new, £200. I.P.L. Acoustics S3TL Kevlar, black ash finish, £150. Tel: 07811 627 203 or 01652 648 681

ADC SS2 24 band graphic equaliser £50. PWB headphones £20. Roksan Attessa CD, factory service, offers. Marantz PM7001 amplifier, boxed, unused, £180 ono. Ceramic cartridge styli (50) £25. Tel: 01708 457 691

NAIM CD 3.5 and FlatCap PSU, very good condition, boxed, new remote and CD securing puck. DIN to RCA interconnect included. £450. Tel: 07846 675 141 (Northants)

LINN LP12, Basik LVX. Nakamichi LX-5 cassette deck. Meridian CD player 200. Meridian digital converter 203. Naim NAC72. Naim NAPI40, Naim Hi-Cap. Rega Ela loudspeaker. £850 the lot! Tel: 01989 767 425

RUSS ANDREWS Kimber Scart leads. 0.75m, 0.5m. Both in perfect condition. £35 each. Buy both cables get extra 0.5m cable free. Tel: Graham 01388 606 920

QUAD FM4 tuner £80, Garrard 401 turntable £400, SME 3009 tone arm £190. Telephone 01189 413708.

RUSS ANDEWS
Superpurifier filter. RRP £390, £195 ono. Yellow 6 way extension, 3m lead, super clamp, £85 ono. Kimber KCAG, -14dB CD interconnect. RRP £515, £385 ono. Other items. Tel: 01902 884 694

SUGDEN MYSTRO integrated amplifier, lightly used. Boxed. Can be posted. £650. Tel: 01782 785 734 (Staffordshire)

ARCAM CD72, silver, 24 Bit, DAC, vgc, manual, remote, £85. Rogers LS55 floorstanders (late 90's), black, 34"H x9"W x9"D ("inches), vgc, manual, £75 pair. Collection only. Tel: 01273 709 330 (Brighton/Croydon)

SONY CDP 101, remote, £50. Micro-Seika MBI0 turntable, Ortofon cartridge, (small mark on cover), £50. Naim NAC A5 speaker cable, Naim plugs, 2 x 4m, £65. B&O SPI4 cartridge, £30. Tel: 01722 334 694

ANATEK RESEARCH A50R int. Great condition, sweet sound, highly rated. Remote. £490. Tel: 07716 139 026

QUAD 909 power amp. Excellent condition. 99 pre-amp plus Quadlink cable. Both immaculate. £850. CDP2 Quad player, serviced by Quad. £425. Buyer collects. Tel: 020 8866 3523 (London)

ORTOFON CADENZA Red, 10 hours use, excellent condition, brand new. £600 ono. Michell Iso Hera phono-stage, boxed. £250 ono. Linn Karik CD player, boxed, immaculate condition. £250. Tel: 07979 300 421 (Wigan)

REVOLVER RW45i loudspeakers. Friendly 90dB, 8ohm load. Ideal for valves. Naim Naits etc. Light cherry unmarked finish. Original packing. £350. Tel: 01639 641 043

KRELL KSA-50-S, boxed, mint, £750. EAR 834P, revalved, boxed, mint £500. Densen B410 CD player, boxed, Gizmo remote, £500 ono. Proac Future One, ebony, £1900. Tel: 07979 300 421 Wigan

ARCAM SOLO Neo Amp/CD/FM/DAB All-In-One unit, still with 16 months guarantee. £775. Original Arcam Solo £450. Quad L-Series sub-woofer £225. All mint with boxes. Tel: 023 8073 8935. Email: golf3385@hotmail.co.uk

KIMBER SELECT KS3038 speaker leads 1.00m, KS1136 XLR-XLR 1.00m and Siltech FTM4-SG3 1.00 and 0.50m, Kimber Silver mains leads and silver purifier box etc.. All boxed and perfect, working overseas forces sale. Contact 01925 656990 or nemail@aol.com for superb prices!

WANTED FOR enthusiast: Quad 2 amps, pre-amps, Tuners and related spares. Any literature & valves would also be appreciated. I am also looking for a single Radford Auditorium speaker. 0117 9467188 silkw@btinternet.com

COLLECTION OF 26 new and 14 second hand vinyl albums for sale. Prices from £2, will separate. For list, contact Roy - 01453 519700 or roy.wagstaff@yahoo.co.uk.

MARANTZ CD67se £75. NAD 340 amplifier £40. Systemdek 11xe turntable & ortofon cartridge £140. Wharfedale Diamond 9.1 speakers £50. Moving and need to sell. Tel David 02088892266 N. London

FOR SALE: Technics SL1210 Mk2 £249. Garrard 401 plus power supply £1200. Both in very good condition. Telephone: 0207 499 8729

AUDIO RESEARCH Ref 210 mono amplifiers. 200 Hours use from new, perfect, boxed and all accessories. Sale due to overseas work £9,995.00 Contact 01925 656990 or npage_jv@midmac.net

LEAK POINT One pre-amp and Leak TL10 mono amp. With leads, Sensible offers. Buyer collects, Worcester. Photos available. Tel: 01905422942

GARRARD 301 serial no 57767, hardly used in 30 yrs no suction pad marks. £850 Also, SME 3009 arm £200 Adrian 01372-454308 Surrey

ACCUPHASE DP800/801 CD/DAC. Absolutely perfect, boxed, stunning sound. Inspection welcome 9,995.00. For more details contact Neil on 01925 656990 or npage_jv@midmac.net

SONY WALKMAN Pro WM6DC a real classic VGC £200. Firestone Audio Fubar USB DAC plus Power Supply as new £100. HRT Streamer II USB DAC 24/96 brand new £100. reisvictor25@gmail.com.

ORIGIN LIVE Conqueror Mk3c tonearm. Absolutely immaculate, latest version, 13 months old, boxed, documents, £2000. P/Ex cheaper arm possible. Denon DL304 cartridge, brand new, sealed box, £295. Tel: 01323 728 118

EBAY MY **** Ortofon MC 30 £55 goldring aciore (eroica) £45 ring for more info both moving coils tel 07976 621529 leeds

FOR SALE, "Popular Hi-Fi" magazines, 1981 issues, in excellent condition. JBL LX33 floor-standing hi-fi loudspeakers, in excellent condition, in original packaging. Tel. 01922 644775.



Heatherdale
audio limited

Tel. 01903 261213 or (after hours) 07860 660001
e-mail: heatherdale@hifi-stereo.com Web: www.hifi-stereo.com

SPEAKERS

Q Acoustics 2050 speakers in white, as new £295
Tannoy Kensington SE speakers, our demo units. (£7999) only £5,995
NEW Furayama Audio Lab Supreme/S speakers from Japan with HEIL AMT tweeters (RRP 7995) £3495
Yamaha Soave 1's in MINT condition, boxed with instruction book, cost new £2000) only £795

PRE-AMPS

Boulder 1012 pre amp with built in DAC, absolutely superb, Cello Palette pre amp, boxed £7995
Trilogy 909 pre amp, ex demo, mint, full man' warranty, (£4495) only £3495
Audio Note Zero Remote controlled pre amp, MINT £350
Audio Note Zero pre amp, Ex cond'. £250

AMPLIFIERS

Mark Levinson ML-532H power amp, superb/boxed £3995
Audio Note SORO SE with phono input £1895
Audio Note OT0 PP with phono stage £149
Wavac MD-805, 55 watt monoblocks (£14,500) MINT £6995

Audio Note SORO integrated amp with phono £1495
Wavac MD 300B integrated amp, superb/boxed (RRP £7995) £3495
Almaro A50125A integrated amplifier, MINT with crate (RRP £5730) only £1995
Audio Note P2-SE power amp £1595
Audio Innovations 2nd Audios mono blocks, Ex. cond' £1195
Pure Sound 18 integrated valve amp, superb cond' boxed £1295
Almaro 205 Mk11, NEW, (£1250) special offer £995
Trilogy 968 power amp, ex demo, full man' warranty, (£4695) only £3750
Lindley Tyson (Quad 11's) KT88 valve monoblocks £2495

CD PLAYERS & TRANSPORTS

Audio Research CD5 CD player (£5500) only £2395
Accustic Arts reference DAC (£7000) only £3500
Accuphase DP55 CD player superb condition £1495
Meridian 506 CD player with remote (£1200) ex'cond' £395
Mark Levinson 390S CD player, superb condition boxed £3295
Accuphase DP-75V CD player, MINT/BOXED, cost new £10,000 offered for £4250
Lector Digidrive transport with DigiCode DAC, NEW £3795
TRI CD player, (NEW, (£1895) special offer £1499

Audio Note Zero CDT CD Transport £395
Audio Note Zero DAC, new £399

TURNTABLES, CARTRIDGES & TONEARMS

Noteworthy Audio PhonoNote MM phonostage £595
2 Tier Turntable wall mount turntable stand £195
Clearaudio Insider Reference "WOOD" MC cartridge, BRAND NEW 1/2 PRICE £2995
Koetsu Black MC cartridge, new/unused £1455
Selection of high end MC cartridges at discount prices. Please call

MISCELLANEOUS

Pepetual Technologies P-1A/P-3a DAC with up sampler and monolift PSU complete with revelation Audiobits dedicated I2S cables £995
1 Metre pair Madrigal CZ Gel (Mark Levinson) Bal' interconnect £295
MIT 1.5 mtr. Extended 11 Bal' interconnect £195
Townshend 3 tier S/Sink stand £395
Solo headphone amplifier £195
Wavac AC-2 mains conditioner RRP £17,500, this unit is brand new and offered for only £7500
Yamamura 1.5 mtr. balanced interconnect £395

ALL USED CARTRIDGES ARE CHECKED UNDER A MICROSCOPE BEFORE BEING OFFERED FOR SALE. WE TAKE PART EXCHANGE ON NEW & USED STOCK and BUY IN FOR CASH VIA SWITCH - MASTER CARD - AMEX - DINERS CLUB WELCOME

HI FI RACKS Cyrus 5 tier mahogany stand £65
Technics SL7 turntable in good working order with instruction manual offers over £200 buyer to collect from Leamington Spa
Tel 01926315728

SONY XA9000ES cd/sacd player i-link stereo/multi-channel excellent condition. £600 (£3000) Trichord Pulsar DAC + power supply upgraded by trichord, clock 4, NCPS, £400 (£2000)
Email: b.nicol@ntlworld.com

AUDIONOTE OTO SE Phono single-ended integrated valve amplifier (black) - 4x RCA inputs including phono stage,tape & preamp outputs,recently serviced, completely re-tubed with top quality valves,boxed, manual, excellent quality amp. £1,150. 01483-271669 (Surrey)

FOR SALE. Sony TA-E86B Esprit. Ultra High End Pre-amp. Near Mint and in daily Use.Very Rare. For Sale @ £450 Contact details: Mobile 0787 571 9136
Email: Lesliegriffiths@fastmail.fm

MERIDIAN BY Van den Hul Interconnects Interconnects 900mm length Neutrik phono connectors £37 + postage. Interconnects 600mm length Neutrik phono connectors £32 + postage 01582 573570
i.fraser587@btinternet.com

MUSICAL FIDELITY KW 25 DAC/Transport. Unmarked with moderate usage.Original boxes and Manuals.£1500 or reasonable offer.Tel. Nick,01484719804 or e-mail: nickandjean@o2.co.uk for further details.

ARCAM CD36, boxed, immaculate, as new with unused remote. Audition welcome. £550. Collection please. Tel: 01329 668 149 (Hants)

GARRARD 401 number 25557 in original box with manual. Superb condition. £400 ono. Excellent SME 3009 series II number 81827 boxed with manual and Shure M95ED. £200 ono. email aawl59@yahoo.co.uk.

DENON TUNER TU1800S, £50 Sony CD-W100, (records and plays), £50 Marantz PM6002 amp, £100 Above in silver, as new, boxed. Kef HTS300ISE speakers, black, new. £100 Please phone Clive 01474 872863

MARANTZ KI-PEARL SACD Player. Mint Condition Minimal Use For Sale @ £1750.00 Contact details: Mobile 0787 571 9136
Email: Lesliegriffiths@fastmail.fm

HOBBYIST REQUIRES for repair or spares non working Quad 44 preamps, Quad 303 amplifiers. Also required Denon DL103 pick up cartridge. Contact Mike on 01758 613790 with reasonable offers, please no time wasters.

KIMBER SELECT 3038 speaker cables 1.00m silver next gen spades, Siltech FTM4SG3 1.00m and 0.5m, Russ Andrews Silver mains and distribution etc, Krystal Cable silver mains with furutech mains plugs, silver wattgate etc.. All approximately 50% of retail, all perfect boxed and very little use. For more details contact Neil on 01925 656990 or npage_jv@midmac.net

KIMBER MONACLE-XI 8ft pair speaker cable £500. Kimber Select KS1030 1m interconnect £600 original packaging Tel no 01772 314151 jamesmckendrick@btinternet.com

QUAD QC Twenty Four pre-amp, new condition, offers around £450. Tel: 01530 272 801

SONY T-CK80II Tape deck Mint Condition. Minimal Use For Sale @ £ 250.00
Sony T-CK88b Tape deck- Good Condition. Minimal Use For Sale @ £ 250.00
Contact details: Mobile 0787 571 9136 Email: Lesliegriffiths@fastmail.fm

WANTED FOR enthusiast: Quad 2 amps, pre-amps, Tuners and related spares. Any literature & valves would also be appreciated. I am also looking for a single Radford Auditorium speaker. 0117 9467188
slkw@btinternet.com

OPERA SP3 speakers. Excellent condition. superb sound, sold med mahogany, £750 (£1750). Townsend speaker platforms, pair, £95, (£500). Buyer collects. Tel: 01323 767 647 (Eastbourne)

RICHARD ALLEN Pavane loudspeakers. Offers. Mission M53 loudspeakers, beech finish, good condition, £100. Mission M5AS active sub-woofer, beech finish, good condition, £150. Tel: 0151 639 6001

FIDELITY AUDIO HP-100 headphone amp, black finish, silver faceplate. 2012 fully run-in 400 hours, £250. Tel: 07411 388 152

QUAD PRE-AMP late model with dedicated CD input, very good condition, £100. Tel: 01277 219 639 (Essex)

MUSICAL FIDELITY A3.2 CD player in excellent condition with remote, manual, and power lead. £425 ONO. 01903 200705 or email: keithlewis@bulldoghome.com

QUAD 909 power amp. Excellent condition. 99 pre-amp plus Quadlink cable. Both immaculate. £850. CDP2 Quad player, serviced by Quad. £425. Buyer collects. Tel: 020 8866 3523 (London)

GUIDELINES FOR BUYING AND SELLING SECOND-HAND EQUIPMENT

FOR THE BUYER

1. Not everyone is honest - Buyer Beware!
2. Don't send cash!
3. Accept no verbal guarantees.
4. Have you heard the item or something similar? If not, why do you want it?
5. Don't pretend to have knowledge - it's your fingers that will get burnt!
6. Is it working? If not, why not? Can it be repaired and if so is it worth it?
7. Has it been modified and, if so, have notes been kept?
8. Was it any good in the first place?
9. Don't send cash!
10. If you are in the slightest doubt, arrange an audition (see point 5) If it's too far, wait for another time.
11. Either buy it or don't: vendors are excusably impatient with 'consultation' exercises.

FOR THE SELLER

1. Not everyone is honest - Seller Beware!
2. Make no verbal guarantees.
3. Even 'nearly new' is still second-hand. If the manufacturer's guarantee is no longer in force, your price should reflect this.
4. There is very little intrinsic value in second-hand hi-fi; it's only worth what someone will pay for it.
5. The best guide to pricing is last month's Classifieds: that a 'classic' was worth £xxx a year or two ago is no guide. Values fall as well as rise.
6. Amateur second-hand dealing is not a big money game: you win some, you lose some.
7. Be prompt with despatch. If in doubt about buyer's bona-fides, either wash out the deal or send C.O.D.
8. There will always be time-wasters; be tolerant within reason!

Gadgets

Gadgets are the oil that grease your hi-fi experience. Paul Rigby takes a look at eight new arrivals.

I love gadgets, they're fun to play with but, more often than I care to remember, they have saved me from a spot of bother. Also, they can be tremendous time savers, especially

if you are either in a rush or are approaching some rather finicky hi-fi tweaking.

Take one of the simplest 'gadgets' on offer this month (all supplied

by Analogue Studios), the humble Record Cleaning Cloth (£5.99), presented here as an antistatic, red rectangle. Although I use an expensive Loricraft Record Cleaning Machine, plus Knosti Disco Antistat 'pre-wash' machine, I prefer to reach for this simple cleaning cloth to remove a

spot of surface dust. It just wasn't worth re-cleaning for such an irrelevancy but I couldn't let the dust lie there. The cloth was invaluable.

Then there are two bubble levels: the Turntable Bubble Level With Spindle Holder (£24.98) plus the VTA And

Azimuth Bubble Level (£4.99). The first pops over your spindle holder to level your turntable. Very important to allow your arm to run smoothly, preventing distortion and excessive record wear. The 'VTA' bubble gadget sitting on top of your arm's headshell, to make sure that the cartridge and headshell are level. Simple but effective.

Next is the Carbon Fibre Stylus Brush (£7.99). The idea is that you brush your stylus, from back to front to preserve the cartridge cantilever, and this removes both dust and fluff. In conjunction with your favourite cleaning liquid, it removes grime.

The stubby bristles provide a useful scrubbing action.

Slightly more expensive is the



Stainless Steel Record Stabilizer Clamp (£39.98). It might not be the most innovative clamp that you've ever seen but uses its dense weight to couple the record to the platter very well, providing more focus to the overall soundstage.

Next, the Mirrored Cartridge Alignment Protractor (£12.98) helps you to align your newly fitted cartridge. It will result in your stylus tracking the record grooves without any undue pressures being forced

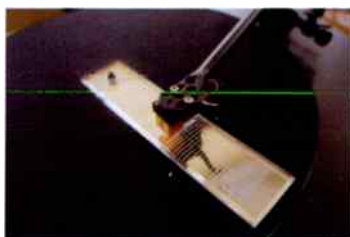

upon it laterally, reducing distortion and excessive wear. The rear of the Protractor features full operating instructions.

Next is the 45 RPM 7" Centre Hole



Spindle Adaptor. Essentially, this simple gadget provides a useful filler and grip for 'dinked' 7" singles. That is, those jukebox singles that are bereft of a central, spindle holder. This is not an archaic device, either, because there are still plenty of new, 7" single releases that arrive without the spindle holder attached. Yes, you can buy a push-in plastic sample for just a few pennies but this metal version will not snap, is more easily replaceable between 7" singles and is harder to lose during day-to-day hi-fi operations.

Finally, the Professional Cleaning Work Mat (£12.98) is a thick, sponge surface that you construct from five, interlocking pieces, forming a 12.5"



square, enabling you to clean records. It arrives with a vinyl and CD spindle to secure your disc. A simple but brilliant idea.

[Contact: +44 (0) 1733 350878
www.analogueseducation.net]

NEXT MONTH



It came packed in flight cases, complete with internet router and wi-fi receiver. And all we asked for was a Linn Akurate DSM player! But this is a big, modern and interesting system Linn will deliver to your door for demonstration.

So don't miss it in our August 2012 issue. Plus much, much more that is under review at this very minute, but is hush, hush!

PICK UP THE AUGUST 2012 ISSUE OF HI-FI WORLD ON SALE JUNE 29TH, OR SUBSCRIBE AND GET IT DELIVERED TO YOUR DOOR: p74

ADVERTISERS INDEX

2nd Hand Hi-Fi	96
Absolute Sounds	OBC
Air Audio	10
AR Sound	80
Avid Hi-Fi	94
Basically Sound	100
Billy Vee	106
Black Rhodium	28
Brennan	82
Classique Sounds	100
Emis Audio	42
Enjoy The Music.Com	106
Exposure	24
Fidelio Sound	106
Fidelity Audio	104
Furutech	42
Heathcote Audio	108
Heatherdale Audio	117
Henley Designs	62,63,88
Hi-Fi Racks	46
Hi-Fi Sound	96
IAG	26
Ian Harrison	102
Icon Audio	50
Inspire Hi-Fi	40, 80
IsoKinetik	104
JoSound	110
Midland Audio Exchange	104
Music First	102
Origin Live	86
Oriton	20
PMC	14
QAT	6
Retro Reproduction	102
Sevenoaks	111,112,113
SME	28
Sound Fowndations	IFC
Sound Hi-Fi	94
TelluriumQ	42,100
The Electric Multiroom	108
Turntable World	96
Usher	IBC

FREE READER CLASSIFIED ADS ORDER FORM

STOP PRESS

TERMS AND CONDITIONS: Only one advert per reader. Maximum length per advert is 30 words, Adverts over 30 words will not be accepted. No Trade Adverts. This section is strictly for readers selling secondhand hi-fi equipment only. Telephone numbers and E-mail addresses are treated as one word. Model numbers are treated as one word i.e. Quad 303 = two words. Sorry, we cannot accept adverts over the telephone. The Publisher reserves the right to judge submissions.

You can email your advert to us at: classifieds@hi-fiworld.co.uk
or write or type your advertisement copy in block capitals with one word per box and post it to us at:

Hi-Fi World Free Readers Ads,
Unit G4, Argo House, Kilburn Park Road,
London, NW6 5LF.

**We cannot accept
adverts over the
telephone**

WE WILL ACCEPT PHOTOCOPIES OF THIS FORM

1	2
3	4
5	6
7	8
9	10
11	12
13	14
15	16
17	18
19	20
21	22
23	24
25	26
27	28
29	30

Name: _____
Address: _____
Post Code: _____
Daytime Tel: _____

FREE READER CLASSIFIED ADVERTS COPY DEADLINES

AUGUST 2012 - 7TH JUNE

SEPTEMBER 2012 - 5TH JULY



IKE TURNER

IKE TURNER STUDIO PRODUCTIONS: NEW ORLEANS AND LOS ANGELES 1963-1965 ACE

"highly influential guitarist, talent scout, songwriter"

This is a new CD based upon UK independent label Ace's ongoing Producer Series so it only briefly features Turner himself but mainly highlights Turner's work, behind the scenes. This is an element of Classic Cuts that needs to be addressed and highlighted. The problem with most classic records is that, in some cases, far too much time and attention is given to the people singing the songs. Without the guys writing the lyrics and music, the classic...isn't. More than that, the 'voice' of a great producer can be heard throughout a classic album or song. Think about Phil Spector's Motown productions, for example. Without Spector, the songs would be a shadow of their final selves despite the presence of the talented singer(s) and the skills of the songwriters.

It's on that basis that I'm listing Ike Turner himself as the subject for Classic Cuts this month, displaying the CD as just a small portion of evidence to back it up.

Tony Rounce, A&R Representative for Ace, described what this CD attempts to do. "The Producer Series is there to celebrate the career of a producer and to take an overview of their work. The producer has to have an immediately identifiable sound or an ingredient that is common to that producer so that, when you listen to one of their tracks, you know who is behind it. They put a little bit of themselves into the music. That's why we have been very selective about who enters the series. If a producer's records don't have that spark of originality

that identifies them as being part of that producer then we won't include it. Take Sir George Martin. You wouldn't listen to one of his productions and recognise that it was produced by him." Many people, in fact, have bought records based purely on the strength that a certain producer is behind it.

Turner's reputation as a producer rests upon his R&B work he did during the fifties working with the likes of Elmore James and, later in that decade, with his band in East St Louis. "I can listen to them and say, yep, Ike Turner production". He features heavy riffing horns and extremely violent use of the whammy bar on the guitar. Ike's reputation on the guitar is partly because he's bloody good but also because he largely brought the whammy bar into everyday use for rhythm and blues musicians. The tracks on this CD all have a uniform sound. There's always a strong use of rhythm in his work."

The problem with Ike Turner is his public profile which, if anything, gets in the way of the amazing music he made and produced. Ex-wife, Tina Turner's literary biographical revelations, accusing Ike of physical abuse, was also repeated in a full blown film. "What Ike got up to in his personal life is distasteful but, in the studio, he separated the personal from the professional – as you can hear during the session chat on this CD – and when you weigh up someone's musical output you have to keep an open mind. I don't

condone what he may have done but the music community judges Ike on a music catalogue stretching over fifty years," said Rounce.

And you have to appreciate Ike Turner's work as an innovator. Turner's work on the track, 'Rocket 88' was immense. A track that, according to Turner, invented rock'n'roll. Although that might be stretching the truth, the track certainly formed a major ingredient in the genre's formation

This CD, derived from digital files which, themselves, have been mastered from 2-track and 3-track masters, include Jimmy Thomas, Stacy Johnson, Vernon Guy, Jessie Smith, Bobby John, Jackie Brenston, Venetta Fields, Tina Turner herself, Ernest Lane and Dee Dee (Delores) Johnson.

There are previously unreleased songs, unreleased versions and alternate takes of a few cuts only ever issued before on a long-deleted Ace LP, plus rare 45s not issued on CD before. If they have been, Ace provide longer versions from the master.

An highly influential guitarist, talent scout, songwriter and, as can be seen here, a top producer, Ike Turner was an immense music industry figure. "Ike Turner would have made it without Tina Turner or any number of women in his life", added Rounce, "but I don't think Tina would have become the star that she eventually became without having Ike's back-story to lean on." **PR**

USHER

**Not all diamonds are forever.
This one is.**

USHER Dancer Diamond Series. Featuring the world's first Amorphous DLC (diamond-like-carbon) diaphragm tweeter, which makes all current diamond tweeters on the market obsolete. To find out more, visit www.usheraudio.com, or USHER'S UK Distributor Hi-Fidelity to find your local stockist.



Behind the Scene

A world renowned authority in audio and acoustics, Dr. Joseph D'Appolito designs crossovers and does the final tuning for Usher's speaker systems. Consulting to a couple of famous audio companies, Dr. D'Appolito finds the tremendous value of Usher's products a pleasant surprise in today's high end audio world.



Hi-FIDELITY

visit our website at:

www.hi-fidelityuk.co.uk

or contact us on 08450 525259 for your local stockist

World Radio History

PRIMALUNA.

'NOTHING SHORT OF AMAZING'

HI-FI WORLD

'PERFORMANCE THAT LIFTS THEM ABOVE THE COMPETITION'

HI-FI NEWS

'INVITING AND BEGUILING, SMOOTH AND REFINED'

HI-FI+

'A SIGNIFICANT BREAKTHROUGH IN HIGH-PERFORMANCE AUDIO'

THE ABSOLUTE SOUND

'ILLUMINATES MUSIC LIKE VERY FEW OTHERS'

HI-FI WORLD

'NO EQUALS AT ITS RETAIL PRICE'

HI-FI NEWS

'BOY OH BOY, CAN I EVER RECOMMEND THIS AMP!'

STEREOPHILE



The living heart of your sound system.

When Herman van de Dungen founded PrimaLuna, his mission was to create affordable valve amplifiers and CD players that not only harnessed the sheer, sensual musicality of valve technology, but also defied the issues of reliability that sometimes accompany it.

PrimaLuna's Prologue and Dialogue ranges continue to expand, featuring ground-breaking advances such as the unique Adaptive AutoBias™ circuit that allows easy switching between valve types and the jitter-reducing SuperTubeClock™, exclusively incorporated into PrimaLuna's CD players. These innovations help create a benchmark-setting suite of products that builds on the marque's past triumphs, combining excellent sonic definition with a beautifully balanced tonality.

Aesthetically stunning to look at, with a hand-polished black or silver faceplate, PrimaLuna consistently fulfils Herman's original promise of creating the best you can get for the least you can pay.

 PrimaLuna®

pistol 

Pistol Music – a division of Absolute Sounds Ltd.

58 Durham Road, London SW20 0TW T: +44 (0)20 89 71 39 09 F: +44 (0)20 88 79 79 62 www.pistolmusic.co.uk info@absolutesounds.com

World Radio History